

ACHTECK

**NEW
PRODUCT!**

AHM20-LN06

High Feed Milling Cutter



www.achtecktool.com



Achteck is launching a new high feed mini milling cutter, which is mounted negative, double sided four cutting edges insert. It provides a very good high feed milling solution.

The new cutter with a 20 degree kappa angle is ideal choice for high feed milling. Two kinds of geometry MM3, MM4 combined with Achteck's PVD coating technology provide exceptional performance. It can achieve excellent performance, good tool life and better surface finish quality. And can cover steel, stainless steel, cast iron, superalloy materials machining.

Product Features

- The insert has 4 cutting edges, gives a good economical solution.
- With optimized micro geometry edge, produced by selective production method, the MM3 geometry in combination with AP301U, AP401U grade, are suitable for stable condition, light cutting application and especially for more exotic materials. Predictable tool life and expected surface finish quality.
- The MM4 geometry has a strong cutting edge design for high efficiency machining.
- Max depth of cut 1.0mm.
- Approach angle 20 degree, brings ability for higher feed rates and more efficient machining processing.
- Introduced in a wide range of cutter diameters, from diameter 16mm to 63mm.
- The cutter design has a variety of interface forms: the screw modular type, the cylindrical type and the shell mill(Arbor) .
- Carbide shanks can be easily used for machining processing applications, such as large cutting depth and long overhanging. Smooth chip removal and minimal vibration.

Chip breaker Features

Chip breaker name	Edge Preparation	Feature
MM4		<ul style="list-style-type: none"> • For general machining • Can be used for 1st choice
MM3		<ul style="list-style-type: none"> • For better working conditions and finishing • Low cutting force (for low power machine)

Grade application

Grade	Coating	Material					
		P	M	K	S	N	H
AP301U	PVD	●	◐		○		
AP351U	PVD	●	◐		○		
AP401U	PVD		●		◐		

● Marked : 1st Choice ◐ Marked : 2nd Choice ○ Marked : Supplementary application

Case stories

Work piece: Die mould

Material: Alloy steel

Hardness: HB280

Insert: LNMX 060410R-MM4 AP301U

Cutter description: AHM20-020-Z03-C20R-LN06-L130-C

Cutting parameters: $V_c=188\text{m/min}$, $f_z=0.56\text{mm/z}$

$a_p=0.8\text{mm}$, Dry cutting

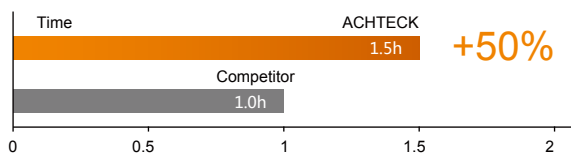

Work piece: Die mould

Material: Alloy steel

Hardness: HB280

Insert: LNMX 060410R-MM4 AP351U

Cutter description: AHM20-016-Z02-C16R-LN06-L100-C

Cutting parameters: $V_c=160\text{m/min}$, $f_z=0.60\text{mm/z}$

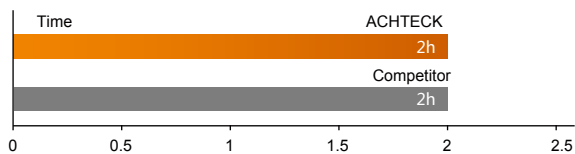

$a_p=0.8\text{mm}$, Dry cutting

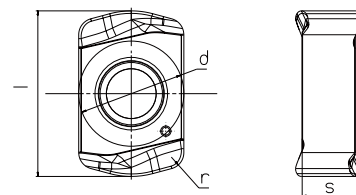

The same processing time, the cost per piece is reduced by 20%

● **Insert stock item**
LNMX 06









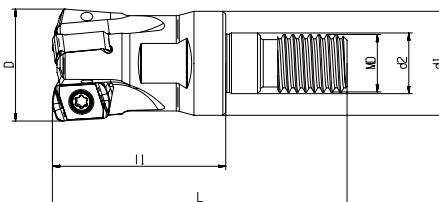



Insert	Designation	Dimensions (mm)				Grades						
						CVD coated		PVD coated			Un-coated	
		l	d	s	r	AC301P	AC301K	AP301U	AP351U	AP401U	AP351K	AW100K
	LNMX 060410R-MM3	10	6.35	3.6	1.0			●	●	●		
	LNMX 060410R-MM4	10	6.35	3.6	1.0			●	●			

Remark: ● represent for standard stock

● **Cutter stock item**
AHM20-LN06-C (Screw modular)



Designation	Dimension(mm)							Coolant	Z	Insert
	D	d1	d2	MD	L	l1	apmax			
AHM20-016-Z02-M08R-LN06-C	16	14.5	8.5	M08	42	25	1.0		2	LNMX 0604
AHM20-017-Z02-M08R-LN06-C	17	14.5	8.5	M08	42	25	1.0		2	
AHM20-020-Z03-M10R-LN06-C	20	18	10.5	M10	51	30	1.0		3	
AHM20-021-Z03-M10R-LN06-C	21	18	10.5	M10	51	30	1.0		3	
AHM20-025-Z04-M12R-LN06-C	25	23	12.5	M12	59	35	1.0		4	
AHM20-026-Z04-M12R-LN06-C	26	23	12.5	M12	59	35	1.0		4	
AHM20-032-Z05-M16R-LN06-C	32	29	17	M16	70	43	1.0		5	
AHM20-033-Z05-M16R-LN06-C	33	29	17	M16	70	43	1.0		5	
AHM20-035-Z05-M16R-LN06-C	35	29	17	M16	70	43	1.0		6	
AHM20-040-Z06-M16R-LN06-C	40	29	17	M16	70	43	1.0		6	

AHM20-LN06-C (Cylindrical type)

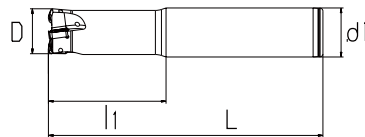

Designation	Dimension(mm)					Coolant	Z	Insert
	D	d1	L	l1	apmax			
AHM20-016-Z02-C16R-LN06-L100-C	16	16	100	30	1.0		2	LNMX 0604
AHM20-017-Z02-C16R-LN06-L150-C	17	16	150	25	1.0		2	
AHM20-020-Z03-C20R-LN06-L130-C	20	20	130	50	1.0		3	
AHM20-021-Z03-C20R-LN06-L160-C	21	20	160	30	1.0		3	
AHM20-025-Z03-C25R-LN06-L140-C	25	25	140	60	1.0		3	
AHM20-026-Z03-C25R-LN06-L180-C	26	25	180	35	1.0		3	
AHM20-032-Z04-C32R-LN06-L150-C	32	32	150	70	1.0		4	
AHM20-033-Z04-C32R-LN06-L200-C	33	32	200	35	1.0		4	
AHM20-035-Z05-C32R-LN06-L200-C	35	32	200	35	1.0		5	

AHM20-LN06-C (Shell mill)

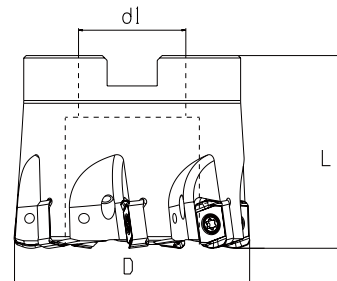

Designation	Dimension(mm)					Coolant	Z	Insert
	D	d1	L	l1	apmax			
AHM20-040-Z06-A16R-LN06-C	40	16	40	-	1.0		6	LNMX 0604
AHM20-050-Z07-A22R-LN06-C	50	22	40	-	1.0		7	
AHM20-052-Z07-A22R-LN06-C	52	22	40	-	1.0		7	
AHM20-063-Z08-A22R-LN06-C	63	22	40	-	1.0		8	

Dimension	Cutter spare parts		
	Screw	Wrench	Torque
φ16-φ63	AST25064-50P	ADT-T15	1.0Nm

Application		
Face milling	Cavity milling	Ramp milling

Remark: represent for coolant
 represent for no coolant

- Shank stock item(used for screw modular type cutter)

1-Taper head shank

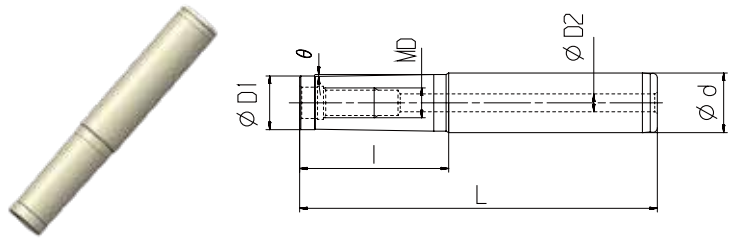

Designation	Dimension(mm)						Materials
	MD	φd	φD1	φD2	L	l	
AMS-M08-020-080-16T	M8	16	14.5	5	80	20	Steel
AMS-M08-040-100-16T	M8	16	14.5	5	100	40	Steel
AMC-M08-080-150-16T	M8	16	14.5	5	150	80	Carbide
AMC-M08-150-200-16T	M8	16	14.5	5	200	150	Carbide
AMS-M10-030-100-20T	M10	20	18	6	100	30	Steel
AMS-M10-050-120-20T	M10	20	18	6	120	50	Steel
AMC-M10-090-150-20T	M10	20	18	6	150	90	Carbide
AMC-M10-140-200-20T	M10	20	18	6	200	140	Carbide
AMS-M12-030-110-25T	M12	25	22.5	6	110	30	Steel
AMS-M12-050-130-25T	M12	25	22.5	6	130	50	Steel
AMC-M12-120-180-25T	M12	25	22.5	6	180	120	Carbide
AMC-M12-140-250-25T	M12	25	22.5	6	250	140	Carbide
AMS-M16-035-125-32T	M16	32	28.5	8	125	35	Carbide
AMS-M16-055-145-32T	M16	32	28.5	8	145	55	Steel
AMC-M16-120-200-32T	M16	32	28.5	8	200	120	Steel
AMC-M16-180-260-32T	M16	32	28.5	8	260	180	Carbide

2-Straight shank

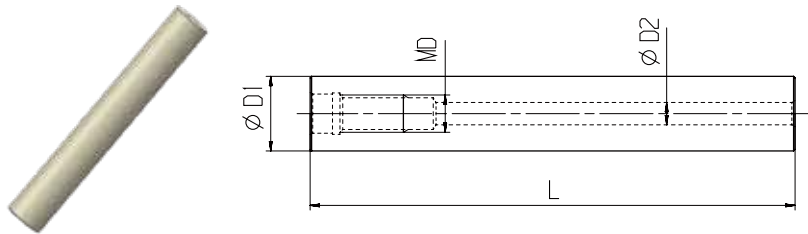

Designation	Dimension(mm)				Materials
	MD	φD1	φD2	L	
AMC-M08-105-16S	M8	16	5	105	Carbide
AMC-M08-160-16S	M8	16	5	160	Carbide
AMC-M10-130-20S	M10	20	6	130	Carbide
AMC-M10-250-20S	M10	20	6	250	Carbide
AMC-M12-145-25S	M12	25	6	145	Carbide
AMC-M12-285-25S	M12	25	6	285	Carbide
AMC-M16-157-32S	M16	32	8	157	Carbide
AMC-M16-287-32S	M16	32	8	287	Carbide

• Technical information

Straight Ramping

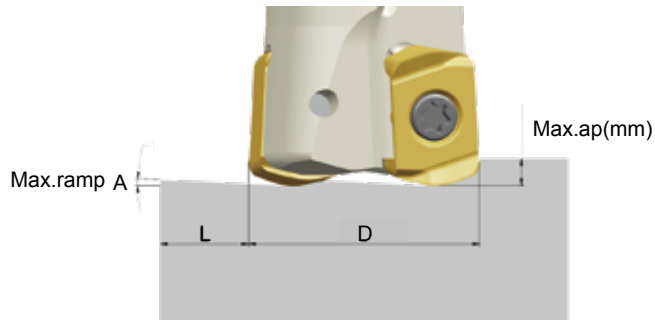

Helical Ramping

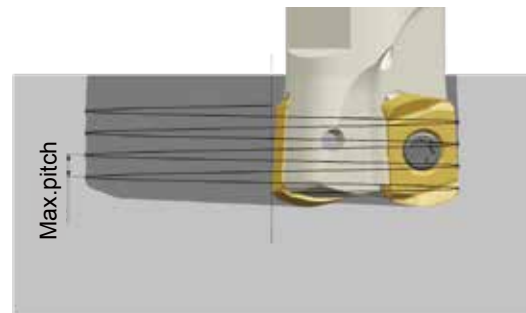

Cutter Dia(D)	Straight ramp down			Helical Ramping		
	Max.ramp-A	Max.ap(mm)	Min.length-L(mm)	Min.Dia.(mm)	Max.Dia(mm)	Max.pitch(mm)
φ16	2.9°	0.7	13.8	23	32	0.7
φ17	2.6°	0.7	15.4	25	34	0.7
φ20	1.9°	0.7	21.1	31	40	0.7
φ21	1.8°	0.7	22.3	33	42	0.7
φ25	1.3°	0.7	30.8	41	50	0.7
φ26	1.3°	0.7	30.8	43	52	0.7
φ32	0.9°	0.7	44.6	55	64	0.7
φ33	0.9°	0.7	44.6	57	66	0.7
φ40	0.7°	0.7	57.3	71	80	0.7
φ50	0.5°	0.7	80.2	91	100	0.7
φ63	0.4°	0.7	100.3	117	126	0.7

NC Program Radius

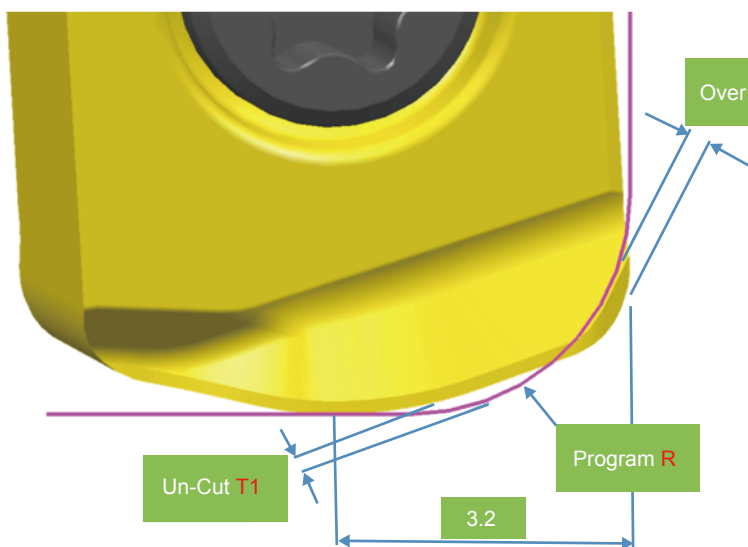

Technical information for NC program

Program R	Un-Cut T1	Over-Cut T2
R1.5	0.43	0
R2.0	0.29	0.06
R2.5	0.15	0.24

Note : select R1.5 as program R , without over-cut.

Recommended cutting speed by materials

Machined Materials		Achteck Milling Grades Application Ranges										Cutting depth and feed rate									
ISO	Material classification	Tensile strength (N/mm ²)	Hardness (HB)	AP301U			AP351U			AP401U			LNMX 0604								
				PVD			PVD			PVD			Chip breaker								
				P15-35			P30-45			P20-40			MM3			MM4					
				M15-35			M30-45			M20-40											
				-			-			-											
				-			-			-											
-			S30-45			S20-40			ap(mm)			Feed rate(mm/z)									
-			-			-															
Feed rate(mm/z)			Min			Med			Max			Min			Med			Max			
Cutting speed(m/min)			Min			Med			Max			Min			Med			Max			
P	Non-alloyed steel	<600	<180	450	340	290	230	205	170				0.1	-	-1.0	0.30	-	2.00	0.30	-	2.00
		<950	<280	320	240	200	200	180	160												
	Alloyed steel	700-950	200-280	290	210	185	200	155	110												
		950-1200	280-355	280	210	200	180	130	90												
M	Duplex stainless steel	778	230	165	150	130	270	215	155	150	115	85	0.1	-	-1.0	0.30	-	2.00	0.30	-	2.00
		675	200	270	185	90	260	180	90	185	140	105									
	Austenitic stainless steel	1013	300	300	225	165	170	150	110	125	95	70									
		778	230	165	150	130	270	215	155	150	115	85									
K	Grey cast iron	700	220										0.1	-	-1.0	0.30	-	2.00	0.30	-	2.00
	Nodular Cast iron	880	260																		
	Malleable cast iron	800	250																		
S	Fe based alloy	943	280										0.1	-	-1.0	0.30	-	2.00	0.30	-	2.00
	Co based alloy	1076	320																		
	Ni based alloy	1177	350																		
	Ti-alloy	1262	370																		
N	Aluminum	260	75										0.1	-	-1.0	0.30	-	2.00	0.30	-	2.00
	Aluminum alloy	447	130																		
H	Hardened steel	-	50-60HRC										0.1	-	-1.0	0.30	-	2.00	0.30	-	2.00
	Chilled cast iron	-	55HRC																		

* The recommended cutting conditions always refer to general conditions. These cutting conditions should be adjusted according to the practical machine rigidity, tools, work piece clamping and coatings.

* When slotting , $ap=1/2ap_{max}$

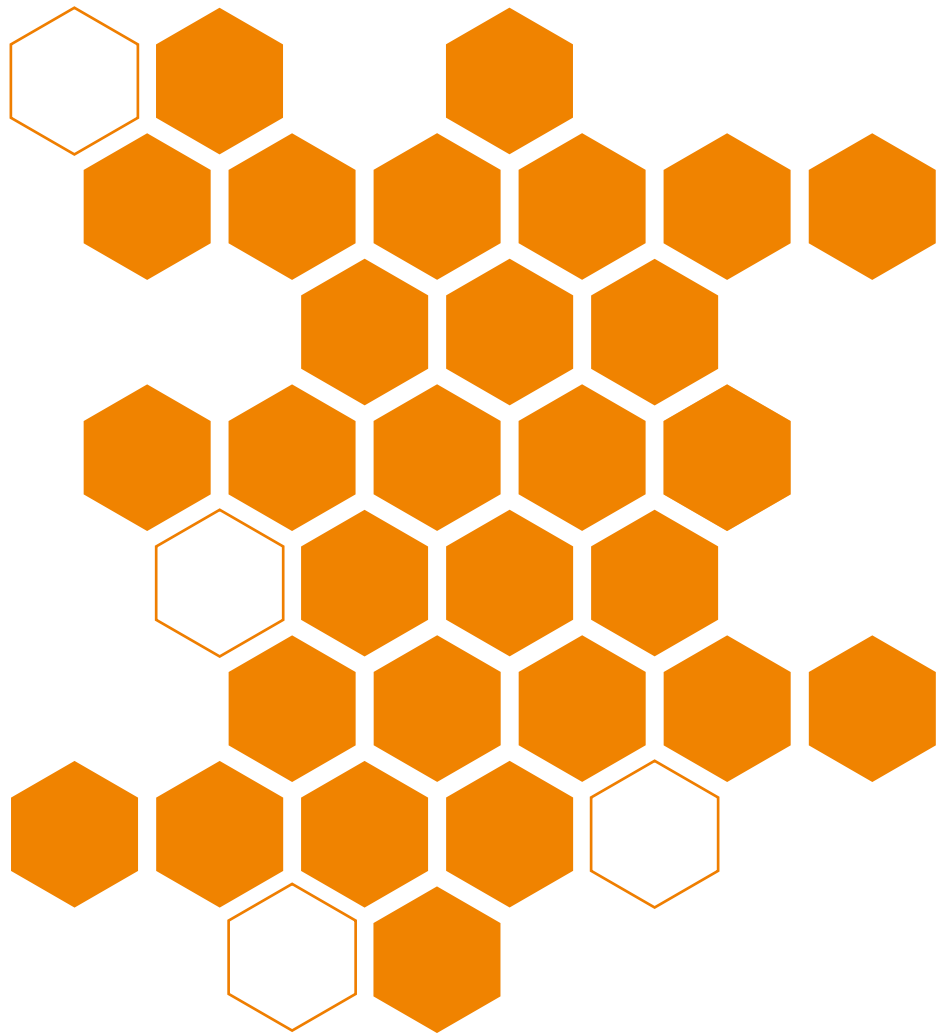

GANZHOU ACHECK TOOL TECHNOLOGY CO.,LTD.

Address:Ganzhou Economic Development Area,jiangxi,China
Tele:0086-797-8086879 Fax:0086-797-8166166 E-mail:export@achtecktool.com