



eW Profile Powercore

Ultra-low-profile LED under-cabinet fixture for task and accent lighting



eW Profile Powercore

Ultra-low-profile LED under-cabinet fixture for task and accent lighting

eW Profile Powercore is a direct line voltage, under-cabinet LED fixture for common task lighting and display case applications. Available in 2700 K, 3000 K, or 4000 K color temperatures, eW Profile Powercore is suitable for new installations and retrofits requiring superior illumination quality and dramatic energy savings. With an ultra-low-profile housing, three fixture lengths, versatile jumper options, and housing colors to match any environment, eW Profile Powercore offers an unprecedented level of design flexibility and ease of use.

- Integrates patented Powercore technology — Powercore rapidly, efficiently, and accurately controls power output to fixtures directly from line voltage, eliminating the need for external power supplies. Contractor-friendly installation dramatically simplifies installation and lowers total system cost.
- Industry leading quality — eW Profile Powercore offers long useful source life. Optibin, our proprietary binning optimization process, guarantees uniformity and consistency of hue and color temperature across LED sources, fixtures, and manufacturing runs.
- Exceptional illumination performance — Meets IESNA illumination intensity specifications for optimal usability and safety in task lighting applications. For commercial display purposes, the 105° x 100° with 20° offset beam angle provides designers with uniform beam quality to develop visual interest and enhanced product attractiveness.
- Dimming capability — Patented DIMand technology offers smooth dimming capability with select reverse-phase ELV-type dimmers.
- Energy cost savings — Consumes as little as 5.5 W of energy per fixture, and can support continuous runs of up to 50 ft (15.3 m). eW Profile Powercore fixtures use 40% less energy than comparable fluorescent sources, and 80% less energy than incandescent sources. No off-state power consumption increases energy savings.
- Versatile installation options — An ultra-low-profile housing allows discreet under-cabinet placement. Available in 9.25 in, 19.25 in, and 39.25 in fixture lengths with multiple jumper cable and connector options to accommodate nearly any layout. UL rated for dry and damp environments.



Superior Light Output

eW Profile Powercore produces highly uniform white light output at 2700 K, 3000 K, and 4000 K color temperatures.

White Is the New White

White-light LED technology for general and task illumination is rapidly coming into its own, driven by the imperatives of energy-efficiency and cost-effectiveness.

White-Light LED Fixtures for General Illumination

Philips Color Kinetics white light LED fixtures that bright, affordable, and flexible in general lighting applications. By bringing high-quality white LED lighting to everyday work, retail, and living spaces, Philips Color Kinetics continues to deliver on its commitment to providing lighting solutions that improve people's lives, protect the environment, and surpass the limitations of traditional lighting sources.



Innovative and Energy Efficient Lighting for Task Areas

The advantages of innovative, energy-efficient white-light LED solutions are on display in a high-end kitchen in a private residence in Cambridge, Massachusetts, USA.

The homeowners wanted to create a hip and modern lighted environment without sacrificing energy efficiency. The lighting designer selected a combination of LED fixtures, including iColor Cove QLX for color-changing accent lighting and eW Profile Powercore for task lighting above the kitchen's generous counter space. eW Profile Powercore offers high color rendering for superior visualization in the task areas while helping to reduce the kitchen's overall energy consumption by a significant percentage over the previously installed conventional light sources.

Photometrics

Photometric data is based on test results from an independent NIST traceable testing lab. IES data is available at www.philipscolorkinetics.com/support/ies.

eW Profile Powercore 9.25 in, 2700 K

Lumens	229
Efficacy	37.1 lm / W

Polar Candela Distribution

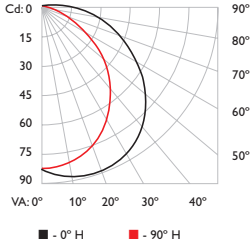

	0.0	25.0	45.0	70.0	90.0
0	82	82	82	82	82
5	86	85	85	83	82
15	89	88	86	82	78
25	88	86	83	77	71
35	83	81	77	68	61
45	75	72	67	56	48
55	63	60	54	42	34
65	50	46	40	29	21
75	36	32	26	16	10
85	22	20	15	7	2
90	17	15	10	3	0

Illuminance at Distance

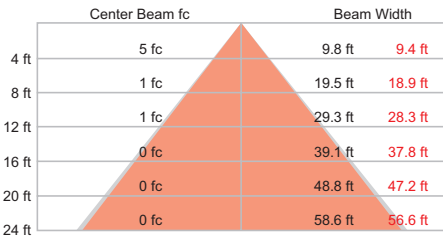

9.1 ft (2.7 m) Vert. Spread: 101.3°
1 fc maximum distance Horiz. Spread: 99.4°

Coefficients Of Utilization - Zonal Cavity Method

RC	80	70	50	30	10	0
RW	70 50 30 10	70 50 30 10	50 30 10	50 30 10	50 30 10	0
0	118118118118	115115115115	110110110	104104104	100100100	97
1	107102 98 94	104100 96 92	95 92 89	91 88 86	87 85 83	80
2	98 89 82 76	95 87 81 75	83 78 73	80 75 71	76 72 69 67	78
3	89 78 70 64	86 77 69 63	73 67 61	70 65 60	67 63 59 56	66
4	82 70 61 54	79 68 60 54	65 58 53	63 57 52	60 55 51 48	42
5	75 62 53 47	73 61 53 46	59 51 46	56 50 45	54 49 44 42	37
6	70 56 47 41	67 55 47 41	53 46 40	51 45 39	49 43 39 37	37
7	65 51 42 36	63 50 42 36	48 41 36	47 40 35	45 39 35 33	33
8	60 47 38 32	58 46 38 32	44 37 32	43 36 31	41 36 31 29	29
9	56 43 35 29	55 42 34 29	41 34 29	40 33 28	38 32 28 26	26
10	53 40 32 26	51 39 31 26	38 31 26	37 30 26	36 30 26 24	24

Zonal Lumen

ZONE	LUMENS	%FIXT
0- 30	62.8	27.5
0- 40	101.3	44.3
0- 60	173.2	75.7
0- 90	222.9	97.5
60- 90	49.7	21.7
70-100	28.1	12.3
90-120	5.6	2.5
90-180	5.8	2.5
0-180	228.7	100.0

eW Profile Powercore 9.25 in, 3000 K

Lumens	220
Efficacy	36.8 lm / W

Polar Candela Distribution

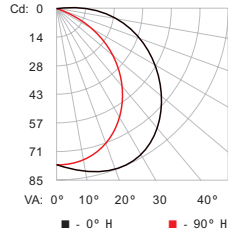

	0.0	45.0	90.0	135.0	180.0
0	77.2	77.2	77.2	77.2	77.2
5	79.7	79.3	77.0	74.6	73.4
15	83.8	81.2	73.8	66.1	62.7
25	84.3	79.5	67.1	54.8	50.1
35	80.8	74.0	57.3	42.2	37.1
45	73.5	65.1	45.0	29.7	25.0
55	63.1	53.3	31.9	18.7	15.0
65	51.0	40.0	19.6	10.2	8.0
75	38.3	27.5	9.2	4.2	3.4
85	24.5	16.3	1.7	0.6	0.5
90	18.5	11.7	0.0	0.0	0.0

Illuminance at Distance

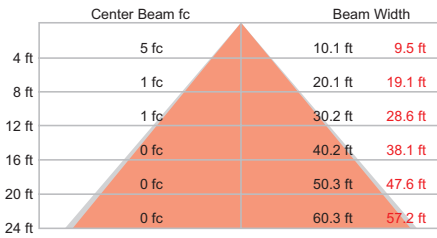

8.8 ft (2.7 m) Vert. Spread: 103.0°
1 fc maximum distance Horiz. Spread: 99.9°

Coefficients Of Utilization - Zonal Cavity Method

RC	80	70	50	30	10	0
RW	70 50 30 10	70 50 30 10	50 30 10	50 30 10	50 30 10	0
0	118118118118	115115115115	109109109	104104104	99 99 99 97	97
1	107102 97 93	104 99 95 92	95 91 88	90 87 85	86 84 82 79	79
2	97 89 82 76	94 87 80 75	83 77 72	79 74 70	75 72 68 66	66
3	89 78 70 63	86 76 68 62	73 66 61	70 64 59	67 62 58 56	56
4	81 69 60 53	79 68 59 53	65 58 52	62 56 51	59 54 50 47	47
5	75 62 53 46	72 61 52 46	58 51 45	56 49 44	54 48 43 41	41
6	69 56 47 40	67 55 46 40	53 45 39	51 44 39	49 43 38 36	36
7	64 51 42 36	62 50 41 35	48 40 35	46 39 34	44 39 34 32	32
8	60 46 38 32	58 45 37 32	44 36 31	42 36 31	41 35 31 29	29
9	56 42 34 29	54 42 34 29	40 33 28	39 33 28	38 32 28 26	26
10	52 39 31 26	51 39 31 26	37 30 26	36 30 25	35 29 25 23	23

Zonal Lumen

ZONE	LUMENS	%FIXT
0- 30	59	26.8
0- 40	95	43.3
0- 60	164	74.3
0- 90	214	96.9
90-120	7	3.0
90-130	7	3.0
90-150	7	3.1
90-180	7	3.1
0-180	220	100.0

eW Profile Powercore 9.25 in, 4000 K

Lumens	276
Efficacy	47.3 lm / W

Polar Candela Distribution

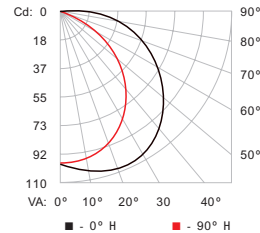

	0.0	45.0	90.0	135.0	180.0
0	96	96	96	96	96
5	101	99	96	93	91
15	106	102	92	83	78
25	106	100	84	69	63
35	102	93	72	53	47
45	93	82	56	37	31
55	80	67	40	23	19
65	64	51	25	13	10
75	48	35	12	5	4
85	31	21	2	1	1
90	24	15	0	0	0

Illuminance at Distance

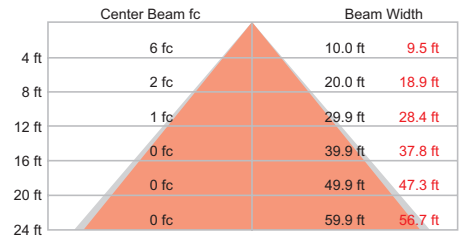

9.8 ft (3 m) Vert. Spread: 102.5°
1 fc maximum distance Horiz. Spread: 99.5°

Coefficients Of Utilization - Zonal Cavity Method

RC	80	70	50	30	10	0
RW	70 50 30 10	70 50 30 10	50 30 10	50 30 10	50 30 10	0
0	118118118118	115115115115	109109109	104104104	99 99 99 97	97
1	107102 97 93	104 99 95 92	95 91 88	90 87 85	86 84 82 79	79
2	97 89 82 76	94 87 80 75	83 77 72	79 74 70	75 72 68 66	66
3	89 78 70 63	86 76 68 62	73 66 61	70 64 59	67 62 58 55	55
4	81 69 60 53	79 68 59 53	65 58 52	62 56 51	59 54 50 47	47
5	75 62 53 46	72 61 52 46	58 51 45	56 49 44	54 48 43 41	41
6	69 56 47 40	67 55 46 40	52 45 39	50 44 39	49 43 38 36	36
7	64 51 42 36	62 50 41 35	48 40 35	46 39 34	44 39 34 32	32
8	60 46 38 32	58 45 37 32	44 36 31	42 36 31	41 35 30 29	29
9	56 42 34 29	54 42 34 28	40 33 28	39 33 28	38 32 28 26	26
10	52 39 31 26	51 39 31 26	37 30 26	36 30 25	35 29 25 23	23

Zonal Lumen

ZONE	LUMENS	%FIXT
0- 30	74	26.7
0- 40	119	43.2
0- 60	205	74.3
0- 90	267	96.9
90-120	8	3.0
90-130	8	3.1
90-150	8	3.1
90-180	8	3.1
0-180	276	100.0

eW Profile Powercore 19.25 in, 2700 K

Lumens	441
Efficacy	43.9 lm / W

Polar Candela Distribution

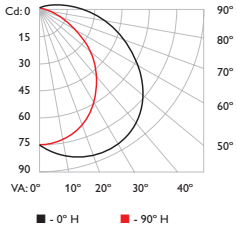

	0.0	25.0	45.0	70.0	90.0
0	150	150	150	150	150
5	158	157	155	153	149
15	170	166	160	152	142
25	174	168	158	143	128
35	170	163	149	129	108
45	158	149	134	108	85
55	138	128	111	83	61
65	112	102	85	57	37
75	86	76	59	34	18
85	62	53	38	16	3
90	50	42	29	10	1

Illuminance at Distance

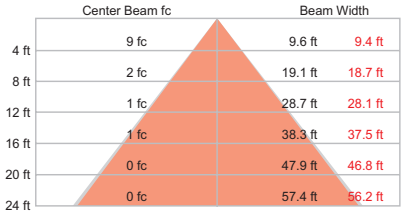

12.3 ft (3.7 m) ■ Vert. Spread: 100.2°
 1 fc maximum distance ■ Horiz. Spread: 99.0°

Coefficients of Utilization - Zonal Cavity Method

Effective Floor Cavity Reflectance: 20%

RC	80	70	50	30	10	0
0	118118118118	114114114114	108108108	102102102	96	96
1	106101	96	92	103	98	94
2	96	88	80	74	93	85
3	88	77	68	62	85	75
4	80	68	59	52	77	66
5	74	61	52	45	71	59
6	68	55	46	39	66	53
7	63	50	41	35	61	48
8	59	45	37	31	57	44
9	55	42	33	28	53	41
10	52	38	30	25	50	38

Zonal Lumen

ZONE	LUMENS	%FIXT
0-30	114.1	25.1
0-40	184.7	40.6
0-60	320.2	70.3
0-90	427.1	93.8
60-90	106.9	23.5
70-100	68.5	15.0
90-120	21.9	4.8
90-180	28.1	6.2
0-180	455.2	100.0

eW Profile Powercore 19.25 in, 3000 K

Lumens	450
Efficacy	44.1 lm / W

Polar Candela Distribution

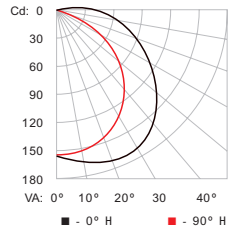

	0.0	45.0	90.0	135.0	180.0
0	155	155	155	155	155
5	161	161	153	150	149
15	169	165	147	133	127
25	171	163	135	111	101
35	166	154	117	85	74
45	152	137	93	59	48
55	132	114	67	36	27
65	106	86	41	18	13
75	80	58	19	7	5
85	51	34	4	1	1
90	37	24	0	0	0

Illuminance at Distance

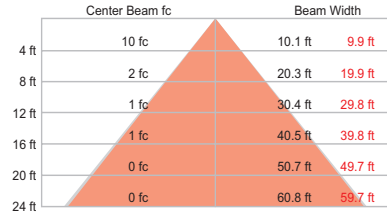

12.4 ft (3.8 m) ■ Vert. Spread: 103.4°
 1 fc maximum distance ■ Horiz. Spread: 102.4°

Coefficients of Utilization - Zonal Cavity Method

Effective Floor Cavity Reflectance: 20%

RC	80	70	50	30	10	0
0	118118118118	115115115115	110110110	104104104	99	99
1	107102	97	93	104	99	95
2	97	88	82	76	94	87
3	89	78	70	63	86	76
4	81	69	60	53	79	67
5	75	62	53	46	72	60
6	69	56	47	40	67	54
7	64	50	42	35	62	49
8	60	46	38	32	58	45
9	56	42	34	28	54	42
10	52	39	31	26	51	38

Zonal Lumen

ZONE	LUMENS	%FIXT
0-30	119	26.5
0-40	193	43.0
0-60	335	74.4
0-90	437	97.1
90-120	13	2.8
90-130	13	2.9
90-150	13	2.9
90-180	13	2.9
0-180	450	100.0

eW Profile Powercore 19.25 in, 4000 K

Lumens	479
Efficacy	46.5 lm / W

Polar Candela Distribution

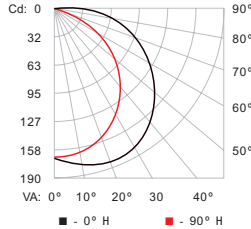

	0.0	45.0	90.0	135.0	180.0
0	167	167	167	167	167
5	173	173	165	162	160
15	181	177	159	145	138
25	181	173	145	121	111
35	173	160	124	93	83
45	157	140	98	66	56
55	135	115	70	42	34
65	109	86	44	23	19
75	81	59	21	10	8
85	53	36	4	1	1
90	41	26	0	0	0

Illuminance at Distance

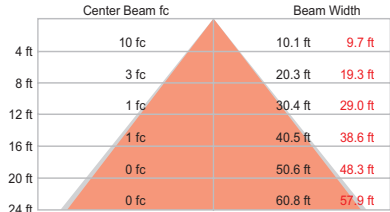

12.9 ft (3.9 m) ■ Vert. Spread: 103.4°
 1 fc maximum distance ■ Horiz. Spread: 100.7°

Coefficients of Utilization - Zonal Cavity Method

Effective Floor Cavity Reflectance: 20%

RC	80	70	50	30	10	0
0	118118118118	115115115115	109109109	104104104	99	99
1	107102	97	93	104	99	95
2	97	89	82	76	94	87
3	89	78	70	63	86	76
4	81	69	60	53	79	67
5	75	62	53	46	72	60
6	69	56	47	40	67	54
7	64	51	42	35	62	49
8	60	46	38	32	58	45
9	56	42	34	29	54	42
10	52	39	31	26	51	38

Zonal Lumen

ZONE	LUMENS	%FIXT
0-30	128	26.7
0-40	207	43.1
0-60	356	74.2
0-90	465	96.9
90-120	14	3.0
90-130	15	3.0
90-150	15	3.1
90-180	15	3.1
0-180	479	100.0

For lux multiply fc by 10.7

eW Profile Powercore
39.25 in, 2700 K

Lumens	886
Efficacy	43.1 lm / W

Polar Candela Distribution

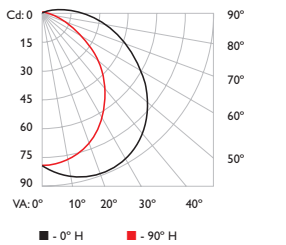

	0.0	25.0	45.0	70.0	90.0
0	307	307	307	307	307
5	322	320	316	311	304
15	340	333	323	309	291
25	343	334	316	290	262
35	329	316	295	258	223
45	300	285	259	214	175
55	258	241	212	163	124
65	209	192	161	112	77
75	158	141	111	66	37
85	106	93	69	31	7
90	82	71	51	18	2

Illuminance at Distance

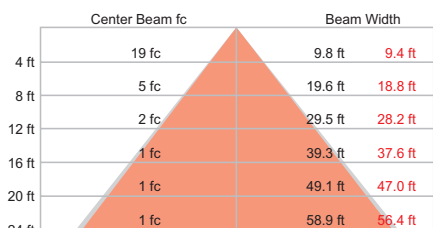

17.5 ft (5.3 m)
1 fc maximum distance

■ Vert. Spread: 101.7°
■ Horiz. Spread: 99.2°

Coefficients Of Utilization - Zonal Cavity Method

Effective Floor Cavity Reflectance: 20%

RC	80	70	50	30	10	0
RW	70 50 30 10	70 50 30 10	50 30 10	50 30 10	50 30 10	0

0	118118118118	114114114114	108108108	102102102	97 97 97	95
1	106101 97 92	103 98 94 90	93 90 87	88 86 83	84 82 80	77
2	97 88 81 75	93 86 79 74	81 76 71	77 73 69	73 70 66	64
3	88 77 69 62	85 75 67 61	71 65 59	68 62 58	65 60 56	54
4	81 68 60 53	78 67 58 52	64 56 51	61 54 49	58 53 48	46
5	74 61 52 45	72 60 51 45	57 50 44	54 48 43	52 46 42	40
6	69 55 46 40	66 54 45 39	52 44 38	49 43 38	47 41 37	35
7	64 50 41 35	62 49 41 35	47 40 34	45 38 34	43 37 33	31
8	59 46 37 31	57 45 37 31	43 36 31	41 35 30	40 34 30	28
9	55 42 34 28	54 41 33 28	40 32 28	38 32 27	37 31 27	25
10	52 39 31 26	50 38 30 25	37 30 25	35 29 25	34 28 24	23

Zonal Lumen

60- 90	206.2
70-100	127.2
90-120	37.6
90-180	49.5
0-180	905.5

eW Profile Powercore
39.25 in, 3000 K

Lumens	862
Efficacy	42.3 lm / W

Polar Candela Distribution

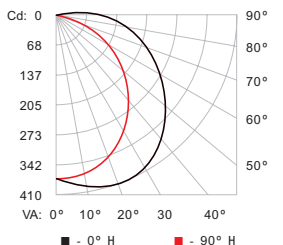

	0.0	45.0	90.0	135.0	180.0
0	299	299	299	299	299
5	310	306	298	288	285
15	325	312	286	257	246
25	325	305	261	215	200
35	312	285	224	168	149
45	284	251	177	119	101
55	244	206	125	76	62
65	197	155	77	42	34
75	147	106	36	18	15
85	96	64	7	3	3
90	73	46	0	0	0

Illuminance at Distance

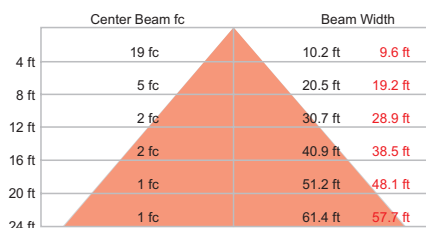

17.3 ft (5.3 m)
1 fc maximum distance

■ Vert. Spread: 104.0°
■ Horiz. Spread: 100.5°

Coefficients Of Utilization - Zonal Cavity Method

Effective Floor Cavity Reflectance: 20%

RC	80	70	50	30	10	0
RW	70 50 30 10	70 50 30 10	50 30 10	50 30 10	50 30 10	0

0	118118118118	115115115115	109109109	104104104	99 99 99	97
1	107102 97 93	104 99 95 91	95 91 88	90 87 85	86 84 82	79
2	97 89 82 76	94 87 80 75	82 77 72	79 74 70	75 71 68	66
3	89 78 70 63	86 76 68 62	73 66 61	69 64 59	66 62 58	55
4	81 69 60 53	79 68 59 53	65 57 52	62 56 51	59 54 50	47
5	75 62 53 46	72 60 52 46	58 50 45	56 49 44	53 48 43	41
6	69 56 47 40	67 55 46 40	52 45 39	50 44 39	49 43 38	36
7	64 50 42 36	62 50 41 35	48 40 35	46 39 34	44 38 34	32
8	60 46 38 32	58 45 37 32	44 36 31	42 36 31	41 35 30	28
9	56 42 34 29	54 42 34 28	40 33 28	39 32 28	38 32 27	26
10	52 39 31 26	51 38 31 26	37 30 26	36 30 25	35 29 25	23

Zonal Lumen

ZONE	LUMENS	%FIXT
0- 30	229	26.6
0- 40	371	43.1
0- 60	640	74.2
0- 90	835	96.9
90-120	26	3.0
90-130	27	3.1
90-150	27	3.1
90-180	27	3.1
0-180	862	100.0

eW Profile Powercore
39.25 in, 4000 K

Lumens	1079
Efficacy	52.6 lm / W

Polar Candela Distribution

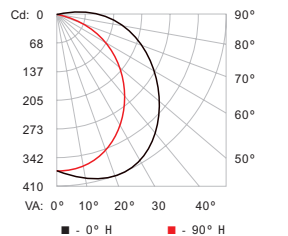

	0.0	45.0	90.0	135.0	180.0
0	375	375	375	375	375
5	390	383	374	361	358
15	407	392	358	322	309
25	407	382	327	270	250
35	388	355	280	209	187
45	353	312	221	150	128
55	302	257	157	97	79
65	243	194	98	54	44
75	182	133	47	23	19
85	117	80	9	4	4
90	90	58	0	0	0

Illuminance at Distance

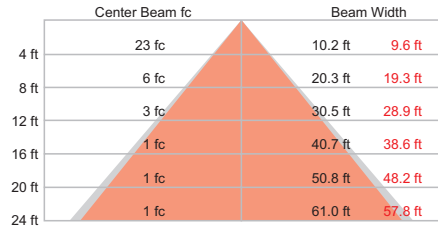

19.4 ft (5.9 m)
1 fc maximum distance

■ Vert. Spread: 103.6°
■ Horiz. Spread: 100.6°

Coefficients Of Utilization - Zonal Cavity Method

Effective Floor Cavity Reflectance: 20%

RC	80	70	50	30	10	0
RW	70 50 30 10	70 50 30 10	50 30 10	50 30 10	50 30 10	0

0	118118118118	115115115115	109109109	104104104	99 99 99	97
1	107102 97 93	104 99 95 91	95 91 88	90 87 85	86 84 82	79
2	97 89 82 76	94 87 80 75	82 77 72	79 74 70	75 71 68	66
3	89 78 70 63	86 76 68 62	73 66 61	69 64 59	66 62 58	55
4	81 69 60 53	79 68 59 53	65 57 52	62 56 51	59 54 50	47
5	75 62 53 46	72 60 52 46	58 50 45	56 49 44	53 48 43	41
6	69 56 47 40	67 55 46 40	52 45 39	50 44 39	49 43 38	36
7	64 50 42 36	62 50 41 35	48 40 35	46 39 34	44 38 34	32
8	60 46 38 32	58 45 37 32	44 36 31	42 36 31	41 35 30	28
9	56 42 34 29	54 42 34 28	40 33 28	39 32 28	38 32 27	26
10	52 39 31 26	51 38 31 26	37 30 26	36 30 25	35 29 25	23

Zonal Lumen

ZONE	LUMENS	%FIXT
0- 30	287	26.6
0- 40	464	43.0
0- 60	800	74.1
0- 90	1046	96.9
90-120	32	3.0
90-130	33	3.1
90-150	33	3.1
90-180	33	3.1
0-180	1079	100.0

For lux multiply fc by 10.7

Specifications

Due to continuous improvements and innovations, specifications may change without notice.

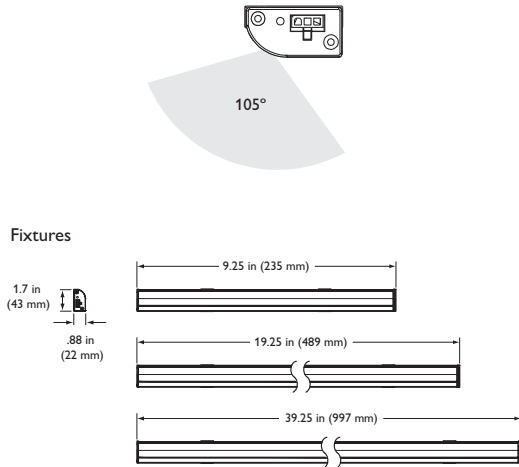

Fixtures

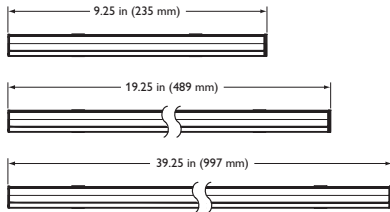
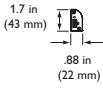

Length	Effective Length
9.25 in	11 in (279 mm)
19.25 in	21 in (533 mm)
39.25 in	41 in (1041 mm)

Effective length includes cable connectors and Terminators

Jumper / Leader Cable

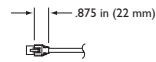

Terminator

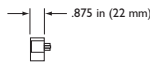

Jumper / Leader Cable



Switched Leader Cable

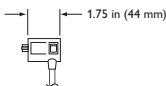

End-to-End Connector

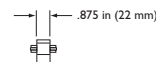

Wiring Compartment

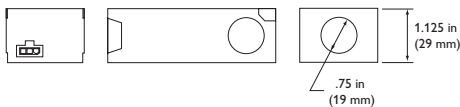
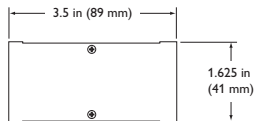

Switched Wiring Compartment

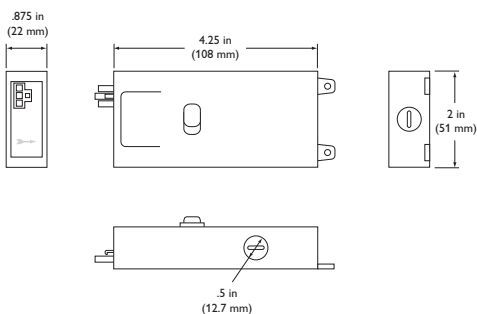

Item	Specification	9.25 in	19.25 in	39.25 in	
Output	Beam Angle	105° x 100°			
	Lumens†	2700 K*	229	441	886
		3000 K*	220	450	862
		4000 K*	276	479	1079
	Efficacy (lm / W)	2700 K*	37.1	43.9	43.1
		3000 K*	36.8	44.1	42.3
		4000 K*	47.3	46.5	52.6
	Mixing Distance	2 in (51 mm) to uniform light			
	CRI	2700 K*	82	82	82
		3000 K*	85	85	85
4000 K*		81	87	81	
Lumen Maintenance‡	48,000 hours L70 @ 25° C		37,000 hours L70 @ 50° C		
	50,000 hours L50 @ 25° C		50,000 hours L50 @ 50° C		
Input Voltage	100 / 120 / 220 – 240 VAC, 50 / 60 Hz				
Electrical	Power Consumption	5.5 W max. at full output, steady state	10 W max. at full output, steady state	20 W max. at full output, steady state	
		6 W peak in-rush	13 W peak in-rush	25 W peak in-rush	
	Power Factor	.99 @ 120 VAC (19.25 in fixture)			
Control	Dimmer	Compatible with selected commercially available reverse-phase ELV-type dimmers			
	Dimensions (Height x Length x Depth)	.88 x 9.25 x 1.7 in (22 x 235 x 43 mm)	.88 x 19.25 x 1.7 in (22 x 489 x 43 mm)	.88 x 39.25 x 1.7 in (22 x 997 x 43 mm)	
	Weight	7 oz (198 g)	13 oz (369 g)	1.6 lbs (728 g)	
Physical	Housing	Extruded aluminium, polycarbonate White, Black, or Gray powder-coated finish			
	Lens	Polycarbonate			
	Fixture Connections	Integral male / female connectors			
	Temperature Ranges	-4° – 122° F (-20° – 50° C) Operating -4° – 122° F (-20° – 50° C) Startup -40° – 176° F (-40° – 80° C) Storage			
	Humidity	0 – 95%, non-condensing			
	Fixture Run Length	Up to 50 ft (15.3 m) of fixtures in a single run, ≤ 324 W			
Certification and Safety	Certification	UL / cUL, FCC Class B, CE, C-Tick			
	Environment	Dry / Damp Location, IP50			

* Color temperatures conform to nominal CCTs as defined in ANSI Chromaticity Standard C78.377A.



† Lumen measurement complies with IES LM-79-08 testing procedures.

‡ L70 = 70% lumen maintenance (when light output drops below 70% of initial output). L50 = 50% lumen maintenance (when light output drops below 50% of initial output). Ambient luminaire temperatures specified. Lumen maintenance calculations are based on lifetime prediction graphs supplied by LED source manufacturers. Calculations for white-light LED fixtures are based on measurements that comply with IES LM-80-08 testing procedures. Refer to www.philipscolorkinetics.com/support/appnotes/lm-80-08.pdf for more information.

§ See www.colorkinetics.com/support/appnotes/ for specific details.

DIMAND™ | **OPTIBIN**™ | **POWERCORE**™
CKTECHNOLOGY | CKTECHNOLOGY | CKTECHNOLOGY

Product Selection

To order eW Profile Powercore, choose a line voltage connection option, fixture length, and fixture connection options.

1 Line voltage connection options

North America Installations

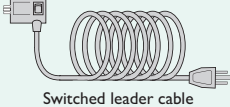

Switched leader cable

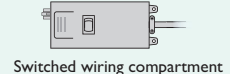

Switched wiring compartment

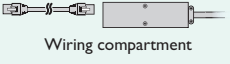

Wiring compartment

Outside North America Installations

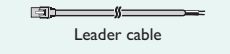

Leader cable

2 Fixture options

Length



9.25 in (235 mm) / 19.25 in (489 mm) / 39.25 in (997 mm)

Housing Color

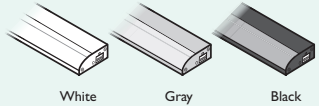

White Gray Black

Color Temperature



2700 K 3000 K 4000 K

Voltage 100 VAC / 120 VAC / 220 – 240 VAC

3 Fixture connection options



End-to-End connector

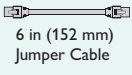

6 in (152 mm) Jumper Cable

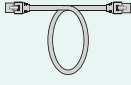

12 in (305 mm) Jumper Cable

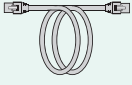

18 in (457 mm) Jumper Cable

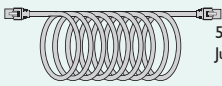

5 ft (1.5 m) Jumper Cable

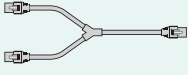

“Y” Jumper Cable



Mounting Track

eW Profile Powercore offers flexible installation options

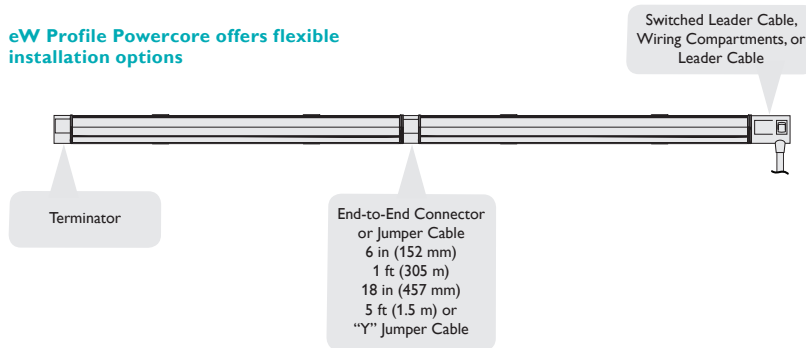

eW Profile Powercore are wired like traditional under-cabinet lighting fixtures

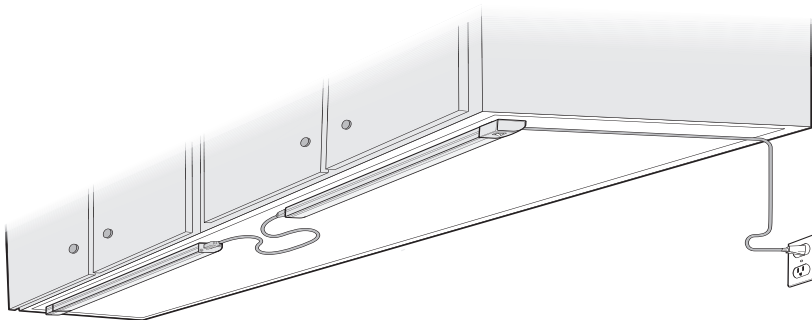

Fixtures 100 VAC / 120 VAC

Item	Color Temperature	Housing Color	Length	Item Number	Philips 12NC
eW Profile Powercore 100 VAC <i>including Mounting Clips and End-to-End Connector</i>	3000 K	White	9.25 in (235 mm)	523-000026-42	910503702214
			19.25 in (489 mm)	523-000026-43	910503702215
			39.25 in (997 mm)	523-000026-44	910503702216
		Black	9.25 in (235 mm)	523-000026-36	910503700761
			19.25 in (489 mm)	523-000026-37	910503700762
			39.25 in (997 mm)	523-000026-38	910503700763
		Gray	9.25 in (235 mm)	523-000026-30	910503700755
			19.25 in (489 mm)	523-000026-31	910503700756
			39.25 in (997 mm)	523-000026-32	910503700757
	4000 K	White	9.25 in (235 mm)	523-000026-45	910503702217
			19.25 in (489 mm)	523-000026-46	910503702218
			39.25 in (997 mm)	523-000026-47	910503702219
		Black	9.25 in (235 mm)	523-000026-39	910503700764
			19.25 in (489 mm)	523-000026-40	910503700765
			39.25 in (997 mm)	523-000026-41	910503700766
		Gray	9.25 in (235 mm)	523-000026-33	910503700758
			19.25 in (489 mm)	523-000026-34	910503700759
			39.25 in (997 mm)	523-000026-35	910503700760
eW Profile Powercore 120 VAC <i>including Mounting Clips and End-to-End Connector</i>	2700 K	White	9.25 in (235 mm)	523-000027-84	910503705061
			19.25 in (489 mm)	523-000027-85	910503705062
			39.25 in (997 mm)	523-000027-86	910503705063
		Black	9.25 in (235 mm)	523-000027-81	910503705058
			19.25 in (489 mm)	523-000027-82	910503705059
			39.25 in (997 mm)	523-000027-83	910503705060
		Gray	9.25 in (235 mm)	523-000027-78	910503705055
			19.25 in (489 mm)	523-000027-79	910503705056
			39.25 in (997 mm)	523-000027-80	910503705057
	3000 K	White	9.25 in (235 mm)	523-000027-72	910503704137
			19.25 in (489 mm)	523-000027-73	910503704138
			39.25 in (997 mm)	523-000027-74	910503704139
		Black	9.25 in (235 mm)	523-000027-66	910503704131
			19.25 in (489 mm)	523-000027-67	910503704132
			39.25 in (997 mm)	523-000027-68	910503704133
		Gray	9.25 in (235 mm)	523-000027-60	910503704125
			19.25 in (489 mm)	523-000027-61	910503704126
			39.25 in (997 mm)	523-000027-62	910503704127
	4000 K	White	9.25 in (235 mm)	523-000027-75	910503704140
			19.25 in (489 mm)	523-000027-76	910503704141
			39.25 in (997 mm)	523-000027-77	910503704142
Black		9.25 in (235 mm)	523-000027-69	910503704134	
		19.25 in (489 mm)	523-000027-70	910503704135	
		39.25 in (997 mm)	523-000027-71	910503704136	
Gray		9.25 in (235 mm)	523-000027-63	910503704128	
		19.25 in (489 mm)	523-000027-64	910503704129	
		39.25 in (997 mm)	523-000027-65	910503704130	





Use Item Number when ordering in North America.

Fixtures 220 – 240 VAC

Item	Color Temperature	Housing Color	Length	Item Number	Philips 12NC		
eW Profile Powercore 220 – 240 VAC including Mounting Clips and End-to-End Connector	3000 K	White	9.25 in (235 mm)	523-000028-60	910503700640		
			19.25 in (489 mm)	523-000028-61	910503700641		
			39.25 in (997 mm)	523-000028-62	910503700642		
		Black	9.25 in (235 mm)	523-000028-54	910503700546		
			19.25 in (489 mm)	523-000028-55	910503700547		
			39.25 in (997 mm)	523-000028-56	910503700548		
		Gray	9.25 in (235 mm)	523-000028-48	910503700540		
			19.25 in (489 mm)	523-000028-49	910503700541		
			39.25 in (997 mm)	523-000028-50	910503700542		
		4000 K	White	9.25 in (235 mm)	523-000028-63	910503700643	
				19.25 in (489 mm)	523-000028-64	910503700644	
				39.25 in (997 mm)	523-000028-65	910503700645	
	Black		9.25 in (235 mm)	523-000028-57	910503700549		
			19.25 in (489 mm)	523-000028-58	910503700550		
			39.25 in (997 mm)	523-000028-59	910503700551		
	Gray		9.25 in (235 mm)	523-000028-51	910503700543		
			19.25 in (489 mm)	523-000028-52	910503700544		
			39.25 in (997 mm)	523-000028-53	910503700545		
	eW Profile Powercore 220 – 240 VAC including Mounting Clips, Leader Cable, and Terminator		3000 K	White	9.25 in (235 mm)	523-000028-78	910503700658
					19.25 in (489 mm)	523-000028-79	910503700659
					39.25 in (997 mm)	523-000028-80	910503700660
		Black		9.25 in (235 mm)	523-000028-72	910503700652	
				19.25 in (489 mm)	523-000028-73	910503700653	
				39.25 in (997 mm)	523-000028-74	910503700654	
Gray		9.25 in (235 mm)		523-000028-66	910503700646		
		19.25 in (489 mm)		523-000028-67	910503700647		
		39.25 in (997 mm)		523-000028-68	910503700648		
4000 K		White	9.25 in (235 mm)	523-000028-81	910503700661		
			19.25 in (489 mm)	523-000028-82	910503700662		
			39.25 in (997 mm)	523-000028-83	910503700663		
		Black	9.25 in (235 mm)	523-000028-75	910503700655		
			19.25 in (489 mm)	523-000028-76	910503700656		
			39.25 in (997 mm)	523-000028-77	910503700657		
		Gray	9.25 in (235 mm)	523-000028-69	910503700649		
			19.25 in (489 mm)	523-000028-70	910503700650		
			39.25 in (997 mm)	523-000028-71	910503700651		

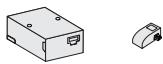
Use Item Number when ordering in North America.

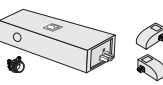
Accessories

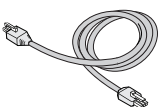
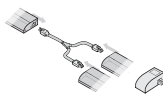
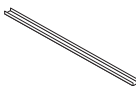
	Item	Size	Housing Color	Item Number	Philips 12NC				
For permanent installations outside of North America.		Leader Cable and Terminator, 100 / 220 – 240 VAC	10 ft (3 m)	White	108-000034-01	910503700259			
			Black	108-000034-07	910503700461				
For permanent installations in North America.		Permanent Wiring Compartment and Terminator, 120 VAC†	1.125 x 1.75 x 3.5 in (29 x 45 x 89 mm) (Height x Width x Depth)	White	120-000065-00	910503700270			
			Black	120-000065-03	910503700505				
			Gray / Black*	120-000065-02	910503700499				
For portable installations in North America.		Switched Portable Leader Cable and Terminator, 120 VAC	10 ft (3 m)	White	108-000034-00	910503700258			
			Black	108-000034-06	910503700460				
			Gray / Black*	108-000034-03	910503700457				
For permanent installations in North America.		Switched Permanent Wiring Compartment and Terminators, 120 VAC	.875 x 2 x 4.25 in (22 x 51 x 108 mm) (Height x Width x Depth)	White	120-000065-04	910503701022			
			Black	120-000065-05	910503701023				
			Gray / Black*	120-000065-06	910503701024				
End-to-End Connectors connect fixtures in a solid linear run.		End-to-End Connector, Quantity 5	.875 in (22 mm)	White	108-000035-10	910503700368			
			Black	108-000035-42	910503700494				
Jumper Cables add extra space between fixtures in a series.		Jumper Cable, 100 / 220–240 VAC	6 in (152 mm)	White	108-000035-05	910503700265			
			Black	108-000035-37	910503700489				
			12 in (305 mm)	White	108-000035-06	910503700266			
			Black	108-000035-38	910503700490				
			18 in (457 mm)	White	108-000035-07	910503700267			
			Black	108-000035-39	910503700491				
			5 ft (1.5 m)	White	108-000035-08	910503700268			
			Black	108-000035-40	910503700492				
			Jumper Cable, 120 VAC	6 in (152 mm)	White	108-000035-00	910503700260		
				Black	108-000035-32	910503700484			
				12 in (305 mm)	White	108-000035-01	910503700261		
				Black	108-000035-33	910503700485			
18 in (457 mm)	White	108-000035-02		910503700262					
Black	108-000035-34	910503700486							
"Y" Jumper Cables split a single run of fixtures into two separate runs.		"Y" Jumper Cable and Terminator, 100 / 220 – 240 VAC	16.5 in (419 mm)	White	108-000035-09	910503700269			
			Black	108-000035-41	910503700493				
			"Y" Jumper Cable and Terminator, 120 VAC	16.5 in (419 mm)	White	108-000035-04	910503700264		
				Black	108-000035-36	910503700488			
			Optional Mounting Track ensures straight runs of fixtures.		Mounting Track	25 @ 9 in (229 mm)	White	120-000064-02	910503700273
						Black	120-000064-09	910503700502	
Gray	120-000064-06	910503700449							
25 @ 19 in (483 mm)	White	120-000064-00				910503700271			
Black	120-000064-10	910503700503							
Gray	120-000064-07	910503700450							
24 @ 39 in (991 mm)	White	120-000064-01				910503700272			
Black	120-000064-11	910503700504							
Gray	120-000064-08	910503700498							

* Housings are Gray, Cables are Black

† Requires Jumper Cable for fixture connection

Use Item Number when ordering in North America.

Installation

Owner / User Responsibilities

It is the responsibility of the contractor, installer, purchaser, owner, and user to install, maintain, and operate eW Profile Powercore fixtures in such a manner as to comply with all applicable codes, state and local laws, ordinances, and regulations. Consult with the appropriate electrical inspector to ensure compliance.

Installing in Damp Locations

When installing in damp locations, it is good practice to seal all fixtures and junction boxes with electronics-grade RTV silicone sealant to ensure that moisture cannot enter or accumulate in wiring compartments, cables, or other electrical parts. You must use suitable outdoor-rated junction boxes when installing in damp locations. Additionally, you must use gaskets, clamps, and other parts required for installation to comply with all applicable local and national codes

***** See the eW Profile Powercore Installation Instructions for specific warning and caution statements.

Planning Your Installation

Regardless of the size and complexity of your installation, the time you spend planning up front can help minimize installation and configuration issues later. Well-designed lighting brightens an area, highlights architectural features or products, and enhances the ways you perform tasks. Keep these suggestions in mind as you plan your installation:

1. Using information from kitchen plans, architectural drawings, CAD files, or other available materials, create a layout map that specifies and locates all fixtures, dimmers, and power sources. Identify any obstacles or physical features requiring extra spacing between fixtures.
2. eW Profile Powercore fixtures are installed in series. A single series can include fixtures totalling up to 50 ft (15.2 m) or 324 W, not including Leader Cables and Jumper Cables. Select a mix of fixture lengths to optimize the lighting of the areas you wish to illuminate, and use any combination of End-to-End Connectors and Jumper Cables to position fixtures exactly where you want them.

***** To reduce the risk of fire, electric shock, or injury, use only insulated staples or plastic ties to secure cables. Route and secure cables so that they will not be pinched or damaged during or after installation.

End-to-End Connectors allow you to create solid linear runs. Jumper Cables in various lengths and configurations let you turn corners, continue runs across gaps or around appliances or other obstacles, and add more spacing between fixtures when necessary. If a power source is located in the middle of a run, you can use a “Y” Jumper Cable to run fixtures in opposite directions, originating from a location near the power source.

3. Outside of North America, you can install a run of eW Profile Powercore fixtures using the 10 ft (3 m) Leader Cable with flying leads.

In North America, use the Switched Permanent Wiring Compartment when you want to run branch conduit all the way to the first fixture in a series, or where local codes require it. You can also create a portable installation by using the Switched Portable Leader Cable with plug.

4. Although the nominal fixture lengths are 9.25 in, 19.25 in, and 39.25 in, the effective fixture lengths vary once end-to-end connectors or Jumper Cables are attached. Use the nominal lengths when calculating the total number of fixtures in a run, and use the effective lengths when measuring for spacing and fit.

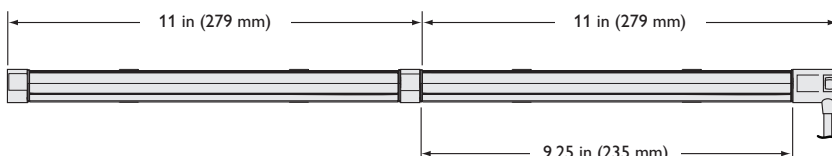

Distance between fixtures

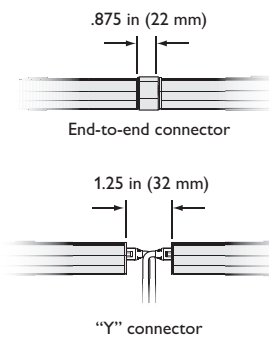

Fixture lengths

Length	Effective Length
9.25 in	11 in (279 mm)
19.25 in	21 in (533 mm)
39.25 in	41 in (1041 mm)

Effective length includes Cable Connectors and Terminators

- eW Profile Powercore fixtures are not intended for recessed installation in ceilings or soffits, or for surface installations inside built-in residential furnishings. The U.S. National Electrical Code (NEC) does not permit cables to be concealed where damage to insulation may go unnoticed. Do not run cables behind walls, cabinets, ceilings, or soffits where it may be inaccessible for examination. Cables should be visually examined periodically and immediately replaced when damage is noted.
- For best results, position fixtures as close as possible to the outer edge of the cabinet or enclosure. Make sure the light is pointing toward the backsplash and away from the viewer. eW Profile Powercore fixtures are designed to throw light at the optimal angle for under-cabinet applications, so no shimming or tilting of fixtures is necessary.

eW Profile Powercore
105° x 100° beam angle

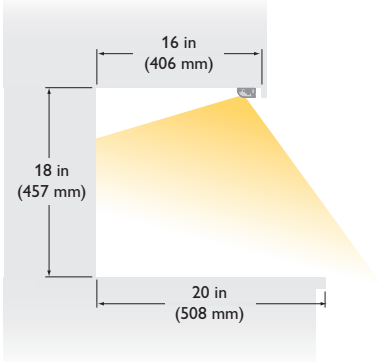

The illustration to the left shows a typical under-cabinet installation. Specific dimensions will vary from application to application. Note that, for fire safety, fixtures should be installed no closer than .25 in (7 mm) from a cabinet wall, or in a compartment smaller than 12 in (305 mm) wide by 12 in (305 mm) high. Also, make sure to leave a minimum of 2.5 in (64 mm) clearance between the sides of the compartment and the fixtures on either end of a run.

Install the Fixtures

eW Profile Powercore fixtures mount directly under cabinets or other secure surfaces using the supplied clips or optional mounting track kits. Philips mounting hardware to install clips and tracks is preferred, but depending on the substrate, nuts and bolts and double-sided adhesive mounting foam may be used.

For best results, mount fixtures near the front edge of a cabinet or display unit, away from back walls and vertical task surfaces. If using end-to-end connectors for a linear application, draw a straight line on the mounting surface for accurate placement of mounting hardware. Straight alignment ensures uniform light distribution.

Mount the First Fixture

Make sure the power is OFF before mounting eW Profile Powercore fixtures.

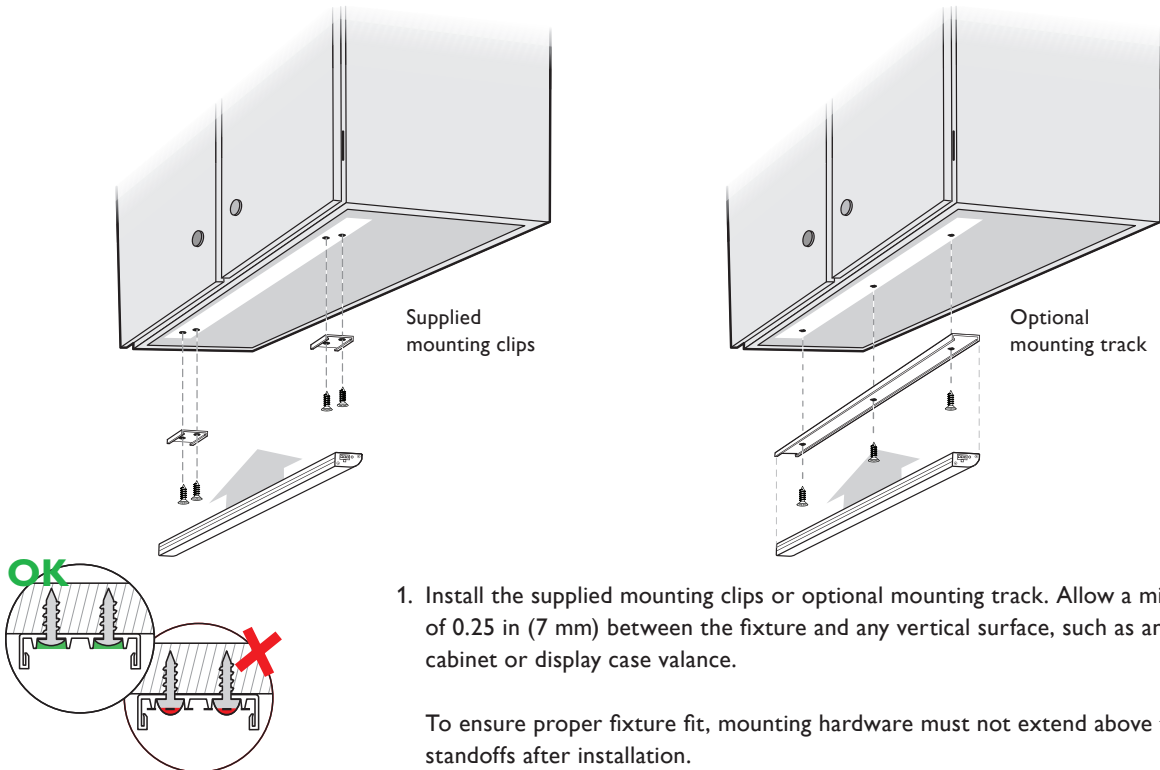

1. Install the supplied mounting clips or optional mounting track. Allow a minimum of 0.25 in (7 mm) between the fixture and any vertical surface, such as an under cabinet or display case valance.

To ensure proper fixture fit, mounting hardware must not extend above the track standoffs after installation.

- Position the fixture with the rounded edge facing toward the back wall or vertical task surface and snap securely into place.

If using mounting clips, you can make minor adjustments to the fixture position by sliding it back and forth within the clips.

If using mounting track, once snapped into place, the fixture does not move within the track.

Connect Additional Fixtures

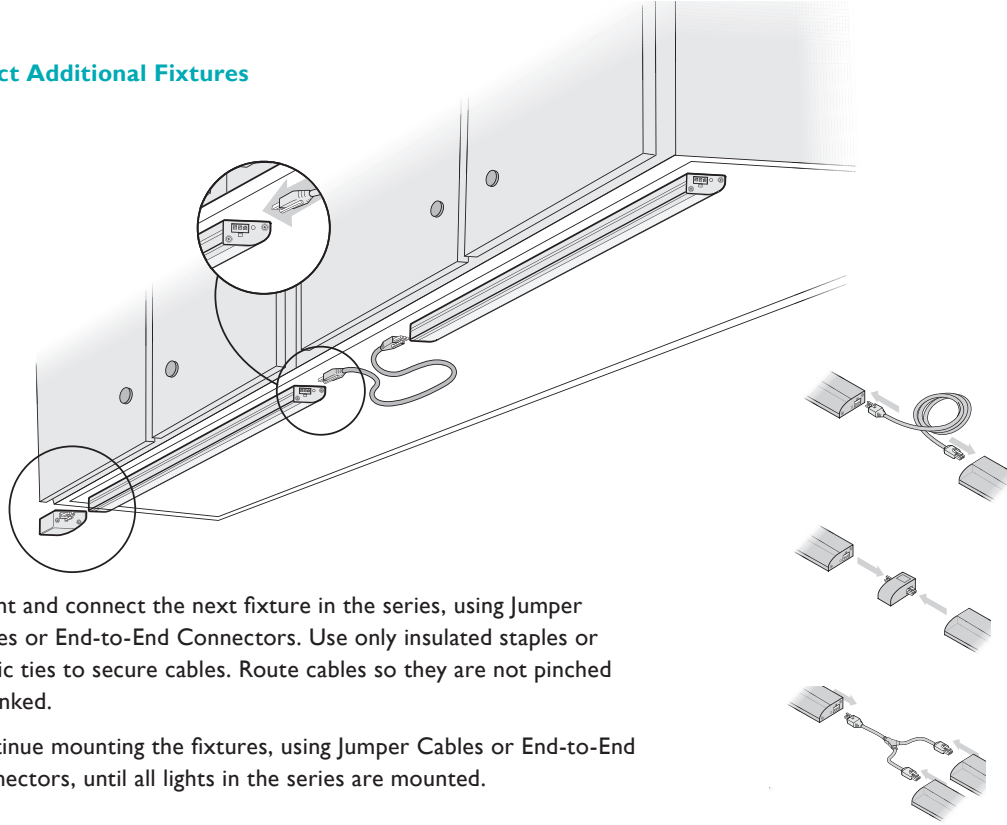

- Mount and connect the next fixture in the series, using Jumper Cables or End-to-End Connectors. Use only insulated staples or plastic ties to secure cables. Route cables so they are not pinched or kinked.
- Continue mounting the fixtures, using Jumper Cables or End-to-End Connectors, until all lights in the series are mounted.

Connect the Leader Cable and Terminate the Run

There are four installation configurations, two for installations in North America that must meet national and local electrical and building codes, one for installations outside of North America, and one for installations that must comply with CE requirements for terminal blocks.

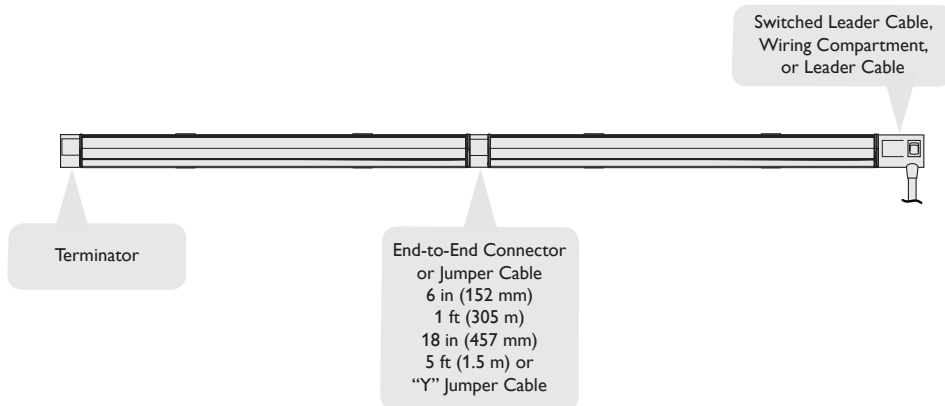

* Note that the switched leader cable connects to the right side of the fixture only.

Portable Installations in North America

1. Connect the UL-compliant Switched Portable Leader Cable to the first fixture in the run, and plug the Leader Cable into a 120 VAC outlet.
2. Insert the provided terminator into the last fixture in the run.

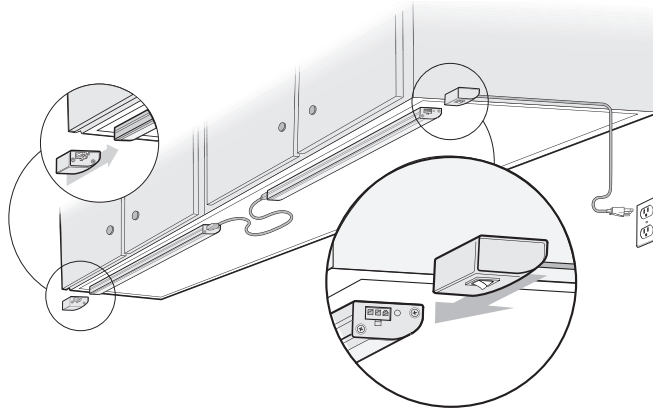

Permanent Installations in North America

1. Mount the Switched Permanent Wiring Compartment close to the first fixture in the run.
2. Run 2 + ground cable from a power source to the Wiring Compartment. Using wire nuts, connect line, neutral, and ground inside the Wiring Compartment Housing.
3. Using a Jumper Cable, connect the Wiring Compartment to the first fixture in the run.
4. Insert the provided terminator into the last fixture.

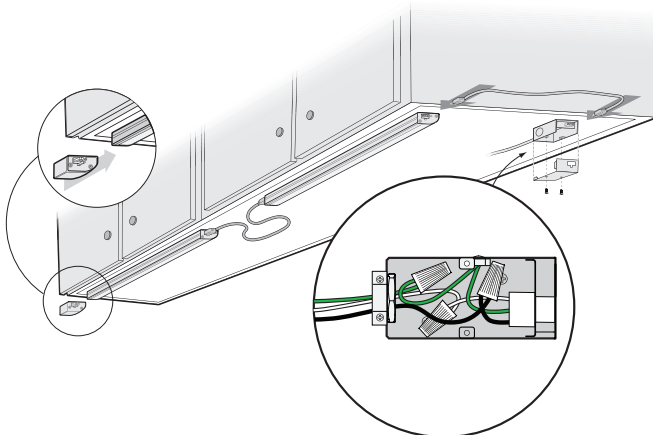

Installations Outside of North America

1. Connect a Leader Cable to a line circuit by a method that meets all national, regional, and local regulations.

If necessary for CE compliance, use a terminal block. The terminal block must conform to EN 60998-2-1 or EN 60998-2-2 and meet the specified ratings for the voltage and amperage listed in this Product Guide.

3. Connect the Leader Cable to the first fixture in the run.
4. Insert the provided terminator into the last fixture.

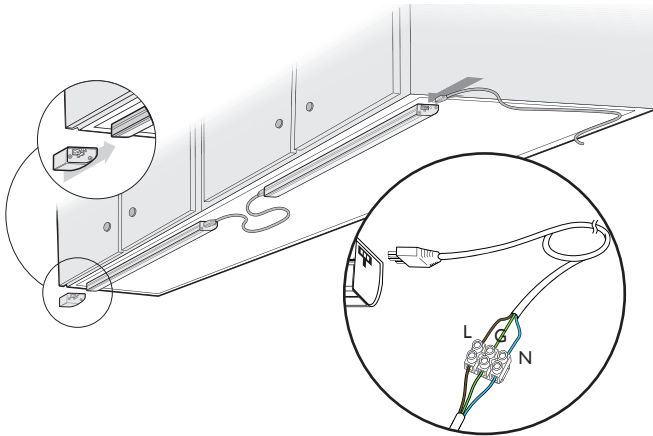

Copyright © 2016 Philips Solid-State Lighting Solutions, Inc. All rights reserved. Chromacore, Chromasic, CK, the CK logo, Color Kinetics, the Color Kinetics logo, ColorBlast, ColorBlaze, ColorBurst, ColorGraze, ColorPlay, ColorReach, iW Reach, eW Reach, DIMand, EssentialWhite, EvenBalance, eW, iColor, iColor Cove, IntelliWhite, iW, iPlayer, Optibin, Powercore, and PureGlow are either registered trademarks or trademarks of Philips Solid-State Lighting Solutions, Inc. in the United States and/or other countries. All other brand or product names are trademarks or registered trademarks of their respective owners. Due to continuous improvements and innovations, specifications may change without notice.



Philips Color Kinetics
3 Burlington Woods Drive
Burlington, Massachusetts 01803 USA
Tel 888.385.5742
Tel 617.423.9999
Fax 617.423.9998
www.philips.com/colorkinetics