

Celebrating Our 50<sup>th</sup> Year In Business



## *Product Catalog*

Complete Line of Agricultural & Landscape Implements, and Construction Attachments

### *Farm*



### *Vineyard*



### *Orchard*



### *Ranch*



### *Landscape*



### *Construction*



**2014  
PRODUCT  
CATALOG**

15  
"NEW"  
Products

This catalog presents a wide selection of equipment. Farm, ranch, landscape, municipal, and construction equipment users will find 224 different implements in 712 different widths or capacities to fit their exact requirements.

Gearmore provides quality implements, through servicing tractor dealers. It is Gearmore's continuing goal to develop and provide the finest and most reliable equipment at affordable prices.

Please use this catalog when considering your equipment requirements, then visit your local tractor dealer for more detailed product information and pricing.



Please visit our website ([www.gearmore.com](http://www.gearmore.com)) to download the latest version of our catalog. We also have expanded literature pages to download. Plus, you can download a copy of parts/operation manuals for current as well as prior models of our implements.

**CELEBRATING OUR 50<sup>TH</sup> YEAR OF PROVIDING  
QUALITY IMPLEMENTS AT AFFORDABLE PRICES!!!**

*Specifications Subject To Change Without Notice*

Aerators, Slicing.....	1
Aerators, Coring.....	2
Backhoes, Thumbs.....	3
Blades.....	4, 5
Chippers.....	6
Cultivators, Arena.....	7
Cultivators, Spin Weeders.....	8
Cultivators, In-Row.....	9
Diggers, PTO & Quick Hitches.....	10
Diggers, Hydraulic.....	11
Discs.....	12 - 17
Dusters.....	18, 19
Dusters, Row Crop.....	20
Forks, Bale Spear.....	21 - 23
Harrows, Chain.....	24, 25
Harrows, Rotary.....	26
Hedger/Toppers.....	27
Implements, Compact Tractor.....	28
Implements, Construction.....	29
• Flail Mowers, 4-in-1 Bucket, Sifting Bucket, 3-Point Trencher.....	29
Implements, Various.....	30, 31
• Plows, Spring Shank Cultivators, Ripper Bars, Mixer.....	30
• Arena-Vator Jr., Spreader, Compact Wheel Disc, Roller Compactors.....	31
Loaders, Implements & Hyd. Kits.....	32
Log Splitters.....	33
Mowers/Shredders, Flail.....	34 - 38
Shredders, Row Crop.....	39, 40
Mowers, Rotary.....	41 - 44
Mulchers, Row.....	45
Planters.....	46, 47
Quick Hitches.....	10
Rakes, Basket.....	48
Rakes, Landscape.....	49
Ridgers.....	50
Rippers.....	51 - 54
Scrapers, 3-Point.....	55 - 58
Scrapers, Corral.....	59
Scrapers, Drag.....	59, 60
Scrapers, Grading.....	61
Scrapers, Laser.....	62, 63
Skid Steer Attachments.....	64, 65
Sprayers, Boom.....	66 - 69
Sprayers, Air Blast.....	70, 71
Sprayers, Venturi, 3-Point.....	72 - 74
Sprayers, Venturi, Trailer.....	75 - 78
Sprayers, Wrap-A-Round.....	79
Sprayer, Air Boom.....	80
Spreaders, Spinner.....	81 - 83
Spreaders, Pendulum.....	84
Spreaders, Manure.....	85
Sweepers.....	86
Tillers.....	87 - 90
Top Dressers.....	91
Top & Tilt Kits.....	55
Trailers, Dump.....	92
Vineyard Implements.....	93 - 95
• Vine Trimmers, Leaf Removers, ..... Prepruners.....	93 - 95

# AERATORS

30 Years of Earth Shattering Innovation

Advanced Aeration Systems

"NEW"

**AerWay®**

## VINEYARD



The AerWay family of AWW3 Models has been designed to eliminate soil compaction, without destroying the soil structure in berries, orchards and vineyards. Improved soil conditions will result in reduced run off with improved moisture retention and balanced stimulated root growth with more efficient use of fertilizer and increased yields. AWW3 Series features beveled front corners to deflect vines, maintenance free 2" block bearings, additional space for ballast, non-continuous tillage path up and down slopes, single roller or Close Coupled Tandem (CCT) configurations, compact dimensions for vine clearance and tractor compatibility.

## TURF



Regular treatment with AerWay can turn your soil around with compaction relief, increased pore space, reduced bulk density, increased gas exchange, efficient nutrient movement, optimum water content, increased air content, and deeper root penetration. Soil conditions improve with increased water infiltration, improved drainage, reduced erosion, greater root mass, increased microbial activity, less nutrient leaching, and reduced risk of injury. Plant response is enhanced with even turf growth, well developed plants, healthier roots, increased root mass, better drought tolerance, improved disease resistance, decreased weed pressure.

## HAY & PASTURE



Revitalize your pastures with AerWay technology. AerWay Shattertines lift and fracture tough soil to increase air and water movement. As the AerWay moves over the surface, the unique angles of the AerWay Shattertines crack and shatter compacted soil 8" and deeper to open new channels for air and water. Plants respond with stronger roots and better yields. Plus, you'll see improved fertilizer utilization, reduced runoff, and greater soil moisture retention. See for yourself why thousands of cattlemen and hay producers agree - there's nothing else like AerWay.

## TILLAGE



The AerWay family of patented "Vertical Tillage" tines are designed to relieve compaction, manage crop residue and to warm the loosened soil for seedbed preparation. The patented tine technology is available in both Shatter Tine® and Leaf Tine® profiles. AerWay "vertical tillage" is accomplished by the unique lean and twist of the tines designed to move soil laterally plus lift and fracture soils to 8" and deeper. New pathways are created for air and water movement, while maintaining the valuable protective surface residue.

Marketed by Gearmore, Inc.

# AERATORS

3-Point Hitch or Tow Type

*Coring & Slicing*

Our **Aerators** are available for tractor mount or pull type, which can be towed by many different types of vehicles. The aerators have a special protection shield for increased safety. The spoon tine wheel assemblies turn independently on the axle, which reduce lateral torque when making gentle turns, minimizing turf damage. These units reduce compaction and thatch, thereby improving water and air movement into the soil. The aerators stimulate root growth and improve turf grass health. Excellent for sports turf and areas with heavy traffic. The aerators are available with coring spoon tines or optional slicing blades.

## FEATURES:

- Cat. 1, 3-point hitch
- 1" Diameter main shaft
- All-steel construction aerating wheels, temper hardened spoons
- Oil impregnated spool wheel bearings for longer life
- ¾" Closed spoons, 6 spoons per wheel
- Up to 4" coring depth, depending on soil conditions
- Heavy steel mesh protector shield - std. on all models
- Coring pattern - 5" x 9 ½"

## OPTIONS:

- ~ Slicer blades in lieu of spoons
- ~ Tow behind kit with wheels and drawbar



*Wheels adjust hydraulically from travel model to coring mode*



### SLICER BLADES

For loosening and aerating turf without pulling cores, Millcreek's optional **Slicer Blades** offer the ideal solution.



*Spoon tine*

## SPECIFICATIONS:

Model #	420	630	840
Width:	42"	63"	84"
Coring Width:	39"	60"	81"
Weight:	300#	410#	480#
No. Spoon Wheels:	8 Std.	12 Std.	16 Std.
No. of Spoons:	48 Std.	72 Std.	96 Std.
Coring Pattern:	5"x9 ½" Std.	5"x9 ½" Std.	5"x9 ½" Std.
Max. Weights:	350 lbs.	450 lbs.	550 lbs.

**Tow-Behind Aerators** can be used with any vehicle equipped with hydraulic outlets, or a hand-operated hydraulic unit is available. Tow-Behind Aerators include pneumatic wheels for travel maneuverability, and feature a hydraulic lift system that allows the operator to easily adjust from travel mode to coring mode.



*Grounds managers rely on core aeration to increase soil permeability and enhance turf growth.*

**Marketed by Gearmore, Inc.**

# BACKHOES

3-Pt. Hitch or 4-Pt. Sub Frame Mount

Manufactured by Bradco



PALADIN LIGHT CONSTRUCTION

Marketed by Gearmore, Inc.

Model 365 Shown



PTO pump kits available for 365 and 485 backhoes

Our complete line of tractor mounted **Backhoes** were designed with the strength and features of construction backhoes. Available in 3-point hitch or sub-frame mount; makes it easy to install when trenching projects are required. The large operator area allows for easy entry and comfortable operation.

### FEATURES:

- 180° Dual-cylinder swing with internal hydraulic cushioning provides smooth operation and maximum power where it is needed
- Built from high-strength T1 steel to minimize weight and increase strength for durability
- Standard swing speed control allows the operator to adjust swing speed
- Inline filter and check valve insures longer valve life and less maintenance
- High capacity buckets provide more volume per cycle - widths from 8" to 36" depending on size of backhoe

Model #	365	485	3509	3511
Max. digging depth:	6' 4"	8' 5"	9' 8"	11' 1"
Dig. depth (2') flat bottom:	6' 4"	8' 4"	9' 7"	11' 0"
Dig. depth (8") flat bottom:	4' 4"	4' 4"	8' 3"	9' 11"
Loading height:	4' 7"	5' 3"	6' 10"	8' 0"
Loading reach:	3' 10"	4' 10"	4' 2"	5' 0"
Reach from swing pivot:	9' 0"	10' 7"	12' 9"	14' 5"
Stabilizer spread op. pos:	9' 3"	7' 6"	7' 11"	7' 11"
Stabilizer below grade:	10"	10"	16"	16"
System relief valve setting:	2250 PSI	2750 PSI	2100 PSI	2100 PSI
Digging force bucket cyl:	2599 lbs.	2895 lbs.	4768 lbs.	4768 lbs.
Digging force dipper cyl:	1358 lbs.	2358 lbs.	2162 lbs.	2567 lbs.
Bucket & swing arc rotation:	180°	180°	180°	180°

## ADJUSTABLE THUMB

Lets Your Backhoe Curl Cylinder Perform The "Clam" Action

The **Adjustable Thumb** is designed to increase the productivity and versatility of your backhoe or mini-excavator. Ideal for landscapers and contractors. Dig and load with the same machine. These rugged built thumbs fit most compact tractor backhoes, 3-point agricultural backhoes, skid steer backhoes, small excavators, and commercial backhoes. Designed to do a wide range of material handling jobs such as: land clearing, demolition work, brush removal, and pipe placement. The thumb is also handy for the loading and unloading of rocks, railroad ties, etc. A qualified welder must complete the installation.

Model No:	GAT-50	GAT-100	GAT-200	GAT-300
For buckets measuring from pivot pin to end of teeth:	Up to 17"	48" to 22"	24" to 29"	35" to 44"
Base mounting plate:	3 ½"x19"	4"x18"	5"x21"	7"x38"
Thumb width:	4 ¾"	5 ½"	7½"	12"
Weight:	45#	60#	110#	280#

- "Claws" are made of high strength T-1 steel
- 2 Pin adjustable working position allows for handling a wide variety of material
- Folds flat against the dipper boom for storage
- Mounting requires welding unit to backhoe or mini-excavator dipperstick



**CAUTION:** When lifting heavy objects, never exceed the lift capacity of the backhoe or mini-excavator

# REAR BLADES

3-Point Hitch - 5 Foot to 10 Foot Widths

"GB" Series

These **Gearmore Rear Blades** are the answer for compact tractor earth-moving requirements. They are the most versatile rear blades on the market today, as all of the standard features normally found only on large expensive rear blades, are standard on the Gearmore Rear Blade. Tilt, angle, offset, and reverse are easy to adjust so that any grading or ditching operation may be accomplished. Parking stand is now standard equipment.

## SPECIFICATIONS FOR GB5, GB6, & GB7:

Tractor HP:	Up to 30 HP	Blade Tilt:	14° to 25° Up or Down
Main Beam:	4" x 4" Steel tubing	Blade Offset:	6" Right or Left
Moldboard:	¼" x 13" High	Cutting Edge:	½" x 6" Reversible
3-Pt. Hitch:	Category 1	Weights:	Model GB5, 5' - 260#
King Pin:	2" Solid Round		Model GB6, 6' - 285#
Blade Angle:	Up to 45° Right or Left		Model GB7, 7' - 300#

CAT I  
A.S.A.E.  
QUICK  
HITCH  
COMPATIBLE



GB5, GB6, GB7

## GB60, GB70

These **Gearmore Rear Blades** are the answer to your mid-size tractor earth-moving requirements. These blades feature "Beam Swing" offset, which allows the heavy 4" x 4" beam to swing right or left to obtain maximum offset. Tilt, angle, offset, and reverse positions are easy to adjust so that any grading or ditching operation can be done. Parking stand is now standard equipment.

CAT I  
A.S.A.E.  
QUICK  
HITCH  
COMPATIBLE

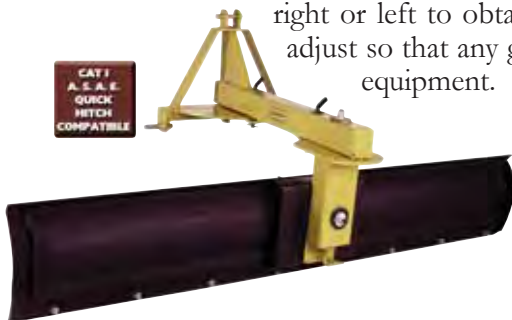

GB75, GB85, GB95

## SPECIFICATIONS FOR GB60 & GB70:

Tractor HP:	Up to 50 HP	Blade Tilt:	14° to 25° Up or Down
Main Beam:	4" x 4" Steel tubing	Blade Offset:	Up to 35" Right or Left
Moldboard:	¼" x 16" High	Cutting Edge:	½" x 6" Reversible
3-Pt. Hitch:	Category 1	Weights:	Model GB60, 6' - 360#
King Pin:	2" Solid Round		Model GB70, 7' - 380#
Blade Angle:	Up to 45° Right or Left		



CAT II  
A.S.A.E.  
QUICK  
HITCH  
COMPATIBLE

The **Gearmore All Manual or Hydraulic Adjustment Rear Blades** are the answer to low cost, medium horsepower, earth moving requirements. These blades are easily set for beam swing offset, tilt, and angle. Change ditching or grading angles by just pulling a pin. The heavy duty design is rugged and reliable, assuring years of trouble-free use.

## SPECIFICATIONS FOR GB75, GB85, & GB95:

Tractor HP:	Up to 95 HP	Angle (man. or hyd.):	Up to 50° Right or Left
3-Pt. Hitch:	Cat. 2 Clevis	Tilt (man or hyd.):	20° Up or Down
Kingpin & Ped. Tube:	3" Solid Round	Offset (manual):	Up to 40" Right or Left
Main Beam:	5"x5" Steel Tube	Cutting Edge:	½" x 6" Reversible
Moldboard:	¼" x 19" Box	Weights:	Model GB75, 7' - 770#
Offset-Swing Pivot Plt:	¾" Thick		Model GB85, 8' - 800#
Parking Stand:	Fold-A-Way		Model GB95, 9' - 830#

The **Gearmore Hydraulic Rear Blades** are the answer to your high horsepower earth-moving requirements. These blades are available in full manual or any combination of manual/hydraulic functions. Tilt, angle, offset, and reverse positions are easy to adjust so that any grading or ditching operation can be done. The heavy duty frame is rugged and reliable, assuring years of trouble-free use.

## SPECIFICATIONS FOR GB800, GB900, & GB1000:

Tractor HP:	Up to 125 HP	Blade Offset:	Up to 30" Right or Left
Main Beam:	6"x8" Steel Tube	Kingpin Size:	4" Solid Round
Moldboard:	¼" x 20" Box	Cutting Edge:	½" x 6" Reversible
3-Pt. Hitch:	Cat. 2, Clevis	Weights:	GB800, 8' - 1105#
Parking Stand:	Fold-A-Way		GB900, 9' - 1155#
Blade Angle:	Up to 30° R or L		GB1000, 10' - 1215#
Blade Tilt:	14° Up or Down		

CAT II  
A.S.A.E.  
QUICK  
HITCH  
COMPATIBLE

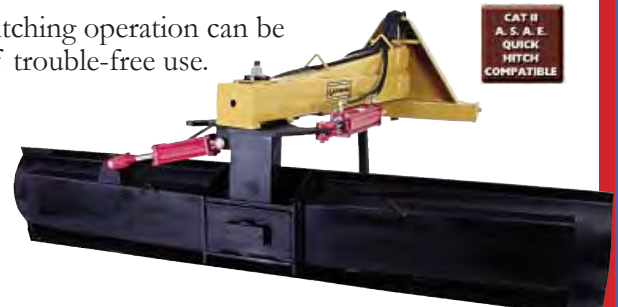

GB800, GB900, GB1000

# REAR BLADES

For Up To 40 and 70 Horsepower Tractors

## 22 & 40 Series

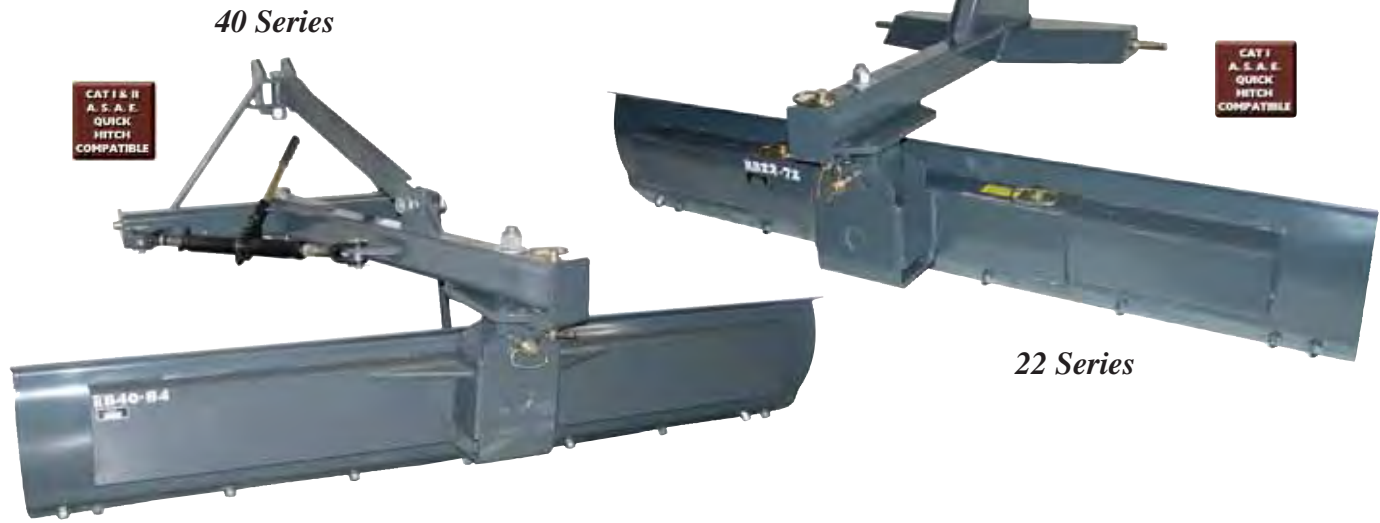

Our **Rear Blades** are the ideal implement for landscaping, road and driveway maintenance, The rounded moldboards with cutting edges rolls the soil, which allows the moving of more material. The hitches are built to A.S.A.E. standards for easy hook-up to quick attach tractor systems. The unique ratchet turnbuckle allows for easy adjustment of blade offset of up to 24 inches right or left. The tilt, angle, offset, and reverse positions are all easy to adjust, so that any grading or ditching operations can be done. The heated powder coated paint keeps a quality finish for years.

### FEATURES:

- Cat. 1 & 2, A.S.A.E. quick hitch compatible
- Ratchet turnbuckle adjustment for up to 24" of blade offset to right or left (40 series)
- Forward and reverse angle settings
- Clevis type hitch brackets for added strength
- Rolled moldboard 22 Series - 3/16" x 15", 40 Series - 1/4" x 16"
- Heavy channel moldboard back support
- Reversible cutting edge, 1/2" x 6"
- Parking stand 40 Series - Standard, 22 Series - Optional
- Powder coated charcoal grey

### SPECIFICATIONS:

Model No:	22 Series			40 Series		
	RB22-60	RB22-72	RB22-84	RB40-72	RB40-84	RB40-96
Width:	60"	72"	84"	72"	84"	96"
Max. HP:	40	40	40	70	70	70
Angle Adj:	Up to 45°	Up to 45°	Up to 45°	Up to 45°	Up to 45°	Up to 45°
Tilt Adj:	20°	20°	20°	Up to 25°	Up to 25°	Up to 25°
Offset Adj:	6" or 12", RH or LH	6" or 12", RH or LH	6" or 12", RH or LH	24" RH or LH	24" RH or LH	24" RH or LH
Cut. Edge:	Reversible	Reversible	Reversible	Reversible	Reversible	Reversible
Cut. Edge Size:	1/2" x 6"	1/2" x 6"	1/2" x 6"	1/2" x 6"	1/2" x 6"	1/2" x 6"
Weight:	280#	300#	330#	505#	540#	580#

# CHIPPERS

Effectively Chips Branches Up to 4 ½" or 5 ½" Dia.

*Power & Gravity Feed*

These gravity or power feed **Chippers** quickly turn branches into usable mulch. The 420 chipper was developed for a maximum capacity of 4 ½" branches and the 520 has a maximum capacity of 5 ½" wood, as anything larger is usually considered firewood. The 4 knife flywheel was developed for smooth operation and finer cut chips. Our chippers offer a number of added value features not available from most competitive machines. These chippers are the all-in-one solution for agricultural, landscape, and property maintenance.

## FEATURES - Model 420:

- Cat. 1 A.S.A.E. 3-point quick hitch
- 4 Special "chipper steel" reversible knives
- Adj. 4 way positioning heat treated cutter bar
- Balanced flywheel plate machined steel plate
- The top half of the chipper housing swings open and the belt guard is easily removed for maintenance
- 360° rotating 6" diameter discharge chute
- Large support stand f/operating stability
- HD 540 RPM driveshaft w/overrunning clutch

## FEATURES - Model 520:

- Cat. 1, A.S.A.E. quick hitch
- Speed adjustable hydraulic power feed system
- For 540 RPM tractors from 25 to 80 HP
- Safety bar to instantly stop, reverse, and forward the feeding of branches
- 6 ½" Diameter power feed roll
- Steel oil reservoir tank w/replaceable oil filter canister
- 4 Reversible tool steel knives to insure smooth operation and finer cut chips
- Adjustable 4 edge tool steel bed knife
- 1 ¼" x 20" Dia. heavy 140# machined steel flywheel
- Large fixed input hopper - 27" wide by 24" deep
- Hinged blower housing cover for easy blade access
- Blower feed opening is 5 ¾" wide x 7" high
- 5" x 5" Square 360° tubing discharge chute
- Safety overrunning clutch on PTO driveshaft to prevent damage to the chipper and tractor

Model 420



Model 520



Model No:	Min. HP	No. of Knives	Depth	Width	Height	Weight
420	20	4	50"	45"	76"	660#
520	25	4	74"	45"	76"	770#



# CULTIVATORS

One Pass System For Re-conditioning Arenas

## Arena Vator II

AV2-6 with Spiral Rod Roller



AV2-6M with Optional Mesh Roller

Model No:	Description	Wt.
AV2-4	4' with 11 S-Tines	370#
AV2-5	5' with 13 S-Tines	500#
AV2-6	6' with 15 S-Tines	575#
AV2-7	7' with 17 S-Tines	640#
AV2-8	8' with 19 S-Tines	775#

Add "M" to model number for mesh roller units



### FEATURES:

- Cat. 1, 3-point hitch
- Heavy 3 bar frame
- Two large adjustable 8" wide gauge wheels with 18.5 x 8.5 floatation tires
- Two rows of 1 1/4" x 3/8" x 22" S-tine vibrating spring shanks
- Heat treated reversible shank points
- Special 3/4" thick rear finishing comb

The **ARENA-VATOR II** was designed to renovate and condition horse arenas and tracks in a single pass. The units consist of two rows of heavy duty "S" tine shanks that vibrate in a circular motion when contacting the ground. This action loosens and cultivates a large area around the shank points. The adjustable blade then breaks down any clods and levels the soil. The new special steel mesh roller with mud scraper produces a firm, yet giving surface for even, secure footing. The fine small indentions in the soil leaves no "shadows" which could affect horses in their workouts. Units are also available with a spiral rod roller.

### FEATURES:

- Steel wire mesh 12" diameter rear roller with adjustable feature
- Units are also available with spiral rod roller plus additional widths of 10 and 12 feet
- S-tine 1 1/4" x 3/8" x 22" long with reversible and replaceable points
- Adjustable leveling blade 1/2" x 6" heat treated, beveled, and reversible
- Modern top mast
- Cat. 1 hitch on 4', 5', 6', & 7' models
- Cat. 1 & 2 hitch on 8' unit

# CULTIVATORS

For Depth Control To Protect Arena Base Material

## Arena-Comb

The **ARENA-COMB** was developed for the highest quality arenas that usually have decomposed granite or ground rubber base under approximately 4 inches of quality sand. If the base material is disturbed the arena will be damaged. Thus, two large 8 inch wide adjustable floatation gauge wheels for depth control are mounted in the front. The two rows of heavy-duty vibrating S-tine shanks loosen and aerate the soil. The special 3/4" thick steel comb levels, gauges the depth on the rear of the machine, and finish combs the sand.

Model No:	Description	Wt.
AC-6	6' Arena-Comb with 15 S-tines	430#
AC-7	7' Arena-Comb with 17 S-tines	530#
AC-8	8' Arena-Comb with 19 S-tines	630#

# CULTIVATORS

*Three Separate Finish Tilling Functions*

*Soil Conditioners & Spin Weeders*

This unique tool from Gearmore combines heavy-duty "S" tines to break the soil. A spring loaded spike tooth bar follows the "S" tines to level the soil and break clods. Then the aggressive spring loaded rolling crumbler completes the work by creating a fine, level surface. This is a very versatile finish tilling implement. The soil conditioner is being used in many different applications such as - Vineyards, Orchards, and Field Crops.

A.S.A.E.  
QUICK  
HITCH  
COMPATIBLE

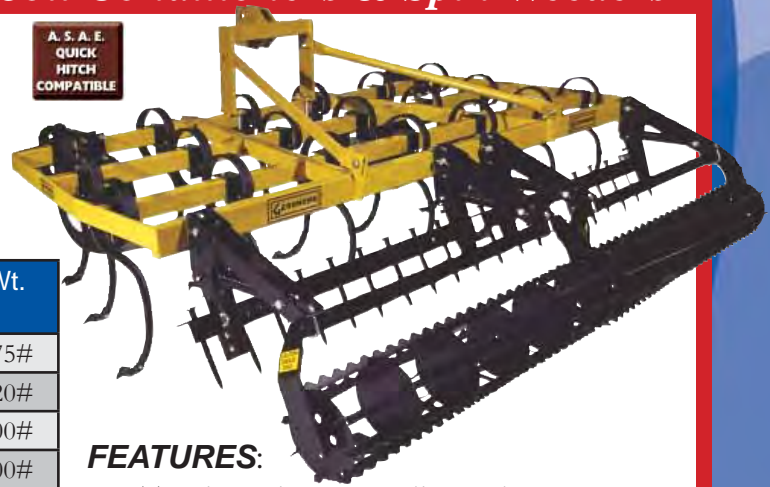

Model #:	Width	"S" Tine Bars	"S" Tines	No. of Teeth	Rolling Crumblers	Wt.
GSC4	4'	2	7	8	1 - 4'	475#
GSC5	5'	3	9	10	1 - 5'	620#
GSC6	6'	3	11	12	1 - 6'	800#
GSC7	7'	3	13	14	1 - 7'	900#
GSC8	8'	3	15	16	1 - 8'	1000#
GSC10	10'	3	19	20	2 - 5'	1300#
GSC12	12'	3	23	24	2 - 6'	1620#
GSC13	13'	3	25	26	1 - 6' & 1 - 7'	1700#
GSC14	14'	3	27	28	2 - 7'	1840#
GSC15	15'	3	29	30	3 - 5'	1900#

*Cultivators 4 to 7 feet are Cat. 1 - Cultivators 8 to 15 feet are Cat. 2*

*10 to 15 Foot Cultivators come standard with gauge wheels*

## FEATURES:

- Travel speeds up to 8 miles per hour
- 20" High clearance "S" tines - penetrate & till up to 7" deep
- Leaves ground perfectly level, ridges are knocked down and holes filled-in
- Completely mixes soil, does not fold it over or move it to the side like a disc
- Spring loaded, 12" dia. rolling crumbler serrated bars angled to finish mulching the soil
- Optional 7" sweeps

The **Spin Weeder** is a "patent pending" berm tilling and in-row weeding system. The Spin Weeder digs into the row line, tills the soil and uproots the weeds. Also, the 18" half sweep aids the wheel to enter the ground and weeds up to an additional 9 inches. The units can be mounted on fixed or hydraulic adjustable frames. Spin Weeders operate most effectively at 5 to 7 MPH.

## SPECIFICATIONS:

- 18" Diameter weeder heads with 1 3/4" deep flange
- Weeder head flanges are lined with 1/4" thick, long wearing, replaceable UHMW plastic
- Weeder wheels can be angled for raised berms or flat ground
- Hydraulic frames come complete with hoses and male couplers

## OPTIONS:

- ~ 18" Diameter adjustable coultter assembly
- ~ Dual gauge wheels with 18 x 8.5 tires



*KW2502-SW w/Optional Dual Gauge Wheels*

## FEATURES:

- Tills and weeds up to 3" deep
- Operates effectively at tractor speeds from 5 to 7 MPH

Model No:	Row Width	Frame Adjust	3-Point Hitch	No. of Spin Weeders	Weight
KW-2204	6' and 7'	Fixed	Cat. 1 Rear Mount	1 or 2	220#
KW-2306	8'	Fixed	Cat. 1 Rear Mount	1 or 2	260#
KW-2308	10'	Fixed	Cat. 1 Rear Mount	1 or 2	300#
KW-2460-SW	6' to 8'	Manual	Cat. 1 Rear Mount	2	870#
KW-2402-SW	8' to 10'	Hydraulic	Cat. 1 & 2 Rear Mount	2	1120#
KW-2502-SW	10' to 12'	Hydraulic	Cat. 1 & 2 Rear Mount	2	1200#

# CULTIVATORS, IN-ROW

*Eliminates The Use Of Herbicides*

## *In-Row Blade & Spedovator*

*In-Row Blade  
For Row Widths of  
6 to 12 Feet*



This economy **In-Row Blade** undercuts weeds, while at the same time loosening and turning back the soil. The small moldboard mounted on the blade throws weeds on the surface. The unit was developed for one side weeding only, so as to operate at higher speeds with safe, accurate control. The in-row blade comes with three spring settings to allow quick tension setting of the blade trip system. Also, standard is cable control from tractor seat to allow for blade retraction when required.

### FEATURES:

- Cat. 1 & 2, 3-point hitch
- Clevis lower link brackets
- Double tubing main frame
- Manual sliding tube - adjusts for different row widths
- Hydraulic blade trip retraction system
- Simple 2 hose coupler connection to tractor
- Sensor rod to trip blade
- Sensor rod tension comes with 3 springs for either light, medium, or heavy rod trip
- Cable control from tractor seat to allow for blade retraction when required
- 24" Long blade with moldboard to throw weeds on the surface
- Coulter with depth band
- Dual gauge wheels with mud scrapers
- Dual parking stands

*NOTE: Tractor requirements minimum 6 G.P.M. with one set of remotes with open center hydraulics and run detent hydraulic system of at least 2000 P.S.I.*

Model No.	Description	Row Widths	Weight
ECO-10	RH In-Row Blade Assy.	6' to 12'	510#

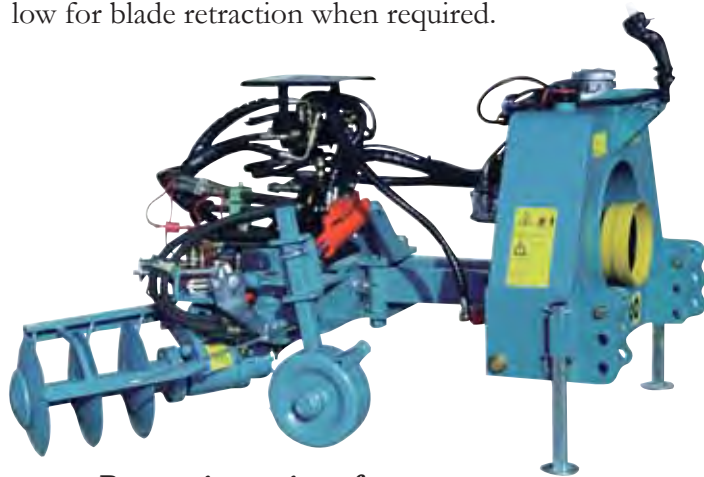

### **Base unit consists of:**

Cat. 1 & 2, 3-point hitch, gauge wheels, 4 spool valve, PTO pump, reservoir, hydraulic side shift, remote tool lifting system and hydraulic sensing system that automatically retracts the 6 different tools.

The one implement available on the market for in-row maintenance all year long. The **Spedovator** with Power Disc will knock down berms and removes tall weeds; the Back Fill Blade will rebuild the berms; the Power Harrow and Rotary Tiller will remove weeds and till the soil; the In-Row Blade will control light weeds; the Flail Shredder mows in-row grass when planted to prevent erosion. All tools hydraulically retract with a highly sensitive feel arm to prevent damage to the plants.

*"Perfect for Organic Growers"*

MODEL NUMBER	OFFSET - 3 BLADE UNIT INCHES	INCHES	INCHES	MIN. H.P.
ALL MODELS	* 30" Min.	60" Min.	20" Min.	30

*\* Designed to work 5 to 8 foot rows with tractor centered on the row.*



**In-Row Blade**



**Back Fill Disc**



**Flail Shredder** ●



**Rotary Hoe** ●

- Tools that require double pump units with oil coolers for operating tools effectively. Available with electro or hydraulic controls.

# DIGGERS

*3 Digger Models To Match Your Tractor HP*

*3-Point Post Hole*



*Standard Duty Augers*



*Pengo Boring Head Augers*

## FEATURES:

- Tubular steel construction
- 2" Output shaft
- Replaceable fishtail auger point
- Rugged 540 RPM gearbox
- Fully shielded driveshaft, gearbox & auger collar
- Shear pin drive
- Semi double fighting augers
- Std. duty augers w/bolt-on teeth
- Pengo® Aggressor® augers w/bolt on 40/50 teeth & TriFlow® pilot bit

Model No:	H.P.	Cat.	Boom Length	Max. Auger Diameter	Auger Length	Weight
D20	20 H.P.	1	45"	12"	34"	120#
D40	40 H.P.	1	62"	12"	40" & 42"	170#
D60*	60 H.P.	1 & 2	70"	24"	45" & 48"	200#

\* D60 Digger now available with hydraulic down force kit



*Model D40 Shown*

# QUICK HITCHES

*The Quick, Safe Way To Attach Implements For Tractors*

Our Cat. I & II *Quick Hitches* were designed to make changing implements easier, safer and faster. Thus eliminating the lifting and moving heavy implements into position for mounting to the tractor. You can safely change implements in seconds.

## FEATURES:

- Operator can engage and secure implements from the tractor seat
- Reduces chance of personal injury as no need to put yourself between the tractor and the implement, except for attaching driveshafts
- Automatic lock with quick release handles
- Heavy all steel construction
- Optional hydraulic top link cylinders are available for easier hook-up
- Additional bushing kits for each implement are available

CAT I & II  
A.S.A.F.  
QUICK  
HITCH  
COMPATIBLE



*Cat. I*

*Cat. II*

Model No:	Description	Wt.
GQH-1	Cat. I - Complete with 7/8" shouldered bushings and swivel yoke	75#
GQH-2	Cat. II - Complete with 1 1/8" mounting pins & adapter bushings - 100 HP Max.	135#

*Strongly recommend ordering optional hydraulic top link cylinder, as it greatly aids aligning to implement 3-point hitch when not "parked" perpendicular to the ground.*

# DIGGERS

7 Sizes To Match Your Tractor GPM

## Hydraulic



"X" Series

The "X" Series is the most trouble free hydraulic digger on the market today. These diggers feature an "in-line" sealed planetary gear reduction drive design. This clean, effective system ensures long, trouble free usage. All "X" Series models feature reverse rotation for quick backout when obstructions are encountered. The systems hydraulic relief valve protects the digger from damage when an auger hits large immovable objects.

### FEATURES:

- 7 Models to match tractor GPM's from 5 to 60
- All units feature planetary gear reduction, except D450
- High torque motors ensure digging through the toughest of conditions
- Adapter plate mounting on most popular skid steers, backhoes, loaders, etc.
- 2 Models of augers designed to match your soil conditions

Model No:	D450	X975	X1475	X1975	X2475	X4075	X5075
Min. Hyd. Flow GPM:	5	6	10	15	20	24	28
Max. Hyd. Flow GPM:	10	15	25	30	35	32	40
Max. Auger Diameter:	12"	24"	30"	36"	36"	48"	48"
Output Shaft Options:	2" Rd.	2 1/16" 2" Hex	2 1/16" 2" Hex	2 1/16" 2" Hex	2 1/16" 2" Hex	2" Hex	2" Hex

Auger extensions available in 2" and 2 1/16" round and 2" hex in lengths of 24", 48", and 72".

# AUGERS

Medium Duty, Heavy Duty and Rock Augers

High Quality Construction

### HEAVY DUTY - "HDC" STYLE AUGERS

For difficult ground conditions

"HDC" Auger	Dia.	Tooth Qty.
	6"	2
	8"	4
	9"	4
	10"	4
	12"	4
	15"	6
	16"	6
	18"	6
	20"	6
	24"	8
30"	10	
36"	12	

### ROCK AUGERS - "HDR" STYLE AUGERS

For solid, frozen ground and compacted soils

"HDR" Auger	Dia.	Tooth Qty.
	6"	6
	9"	8
	12"	12
	18"	18
STD. FEATURES		
<ul style="list-style-type: none"> <li>• Bullet style teeth &amp; fabricated boring head</li> <li>• HD Single flight - 3/4" thick bottom flight</li> <li>• 2" Hex collar ONLY</li> <li>• Available in 4' length</li> </ul>		

### MEDIUM DUTY - "HDF" STYLE AUGERS

For light to moderate ground conditions

"HDF" Auger	Dia.	Tooth Qty.	STANDARD FEATURES
	6"	2	
	8"	2	
	9"	3	• Hardened bolt-on teeth
	10"	3	
	12"	4	• Hardened fishtail point
	15"	5	
	16"	5	• HD dbl fighting
	18"	6	
	20"	6	• Collars-2" rnd., 2" hex, & 2 1/16" rnd.
	24"	8	
	30"	9	• 3', 4', 5' & 6' lengths available
36"	11	• 4' Length stocked	

### STANDARD FEATURES FOR "HDC" STYLE AUGERS:

- HD Cast steel boring head
- Hardened drive-in teeth
- Hardened fishtail point
- HD double fighting
- Collars - 2" round, 2 9/16" round and 2" hex
- Available in 3', 4', 5', & 6' lengths
- Stocked in 4' length

Manufactured By:



**McMILLEN**

**PALADIN LIGHT CONSTRUCTION**

# DISCS, OFFSET

## 3-Point Hitch Light Duty Discs

### "C/D" Series

#### FEATURES:

- Cat. I, 3-point hitch
- 7" Blade spacing
- Triple sealed ball bearings
- Adjustable front and rear gangs
- 1 1/8" Square high carbon axles
- 18" Notched front and plain rear blades
- Heavy quick hitch mast

Model No:	Cutting Width	Approximate H.P. Required	No. of Blades	Weight
C1218	42"	14 H.P.	12	375#
C1418	48"	16 H.P.	14	420#
C1618	54"	18 H.P.	16	480#
D1818	60"	22 H.P.	18	620#
D2018	66"	24 H.P.	20	670#



# DISCS, OFFSET

## 3-Point Hitch Heavy Duty Discs

### "GO" Series



#### FEATURES:

- Cat. II, 3-point hitch
- Frame has 2" x 4" and 4" x 4" tubing
- 24" Notched front and plain rear blades
- 9" Blade spacing
- 1 1/2" Square gang axles
- Flange mounted, triple sealed bearings
- Adjustable rear gang and 3-point hitch
- Steel spacer spools



Model No:	Cutting Width	No. of Blades	Weight
GO24-60	6' - 0"	16	1120#
GO24-69	6' - 9"	18	1170#
GO24-76	7' - 6"	20	1405#
GO24-83	8' - 3"	22	1560#
GO24-90	9' - 0"	24	1600#

Manufactured By:

**BWI**implement

# DISCS, TANDEM

3-Point Hitch

*Light Duty*



## FEATURES:

- Cat. I, 3-point hitch
- 7" Blade spacing
- Triple sealed ball bearings
- Adjustable front and rear gangs
- 1 1/8" Square high carbon axles
- 18" Notched front and plain rear blades
- Heavy quick hitch mast

Model No:	Cutting Width	Approximate H.P. Required	No. of Blades	Weight
T1618	60"	18 H.P.	16	525#
T2018	72"	22 H.P.	20	630#
T2418	84"	26 H.P.	24	695#

# DISCS, TANDEM

3-Point Hitch

*Medium Duty*



# DISCS, TANDEM

3-Point Hitch

*Heavy Duty*



Model No:	Cutting Width	Blade Diameter	No. of Blades	Weight
18-16-CBF	60"	18"	16	760#
20-20-CBF	72"	20"	20	820#
20-24-CBF	84"	20"	24	880#

## FEATURES:

- Cat. I, 3-pt. hitch, with 3" square tubing frame
- Notched front and plain rear, high carbon blades
- Heavy cast blade spools
- Sealed bearings provide superior performance
- Easy, quick angle adjustments of 16°, 30°, 44°, and 57°

Model No:	Cutting Width	Blade Diameter	No. of Blades	Weight
T1622	5' - 6"	22"	16	1100#
T2022	6' - 6"	22"	20	1230#
T2422	7' - 6"	22"	24	1515#
T2822	8' - 6"	22"	28	1660#
T3222	9' - 6"	22"	32	1760#

## FEATURES:

- Cat. I & II, 3-pt. hitch, A.S.A.E. quick hitch
- 3/16" x 22" Notched front and plain rear blades
- Easy gang adjustment w/special pull handles
- Front and rear gangs adjustable to 7°, 14°, or 21°
- 1 1/8" High carbon square axles
- 7 1/2" Long cast spool spacers

# DISCS, TANDEM

*Heavy Built For Years of Troublefree Usage*

*Narrow Row "GV" Series*

Narrow row crops like grapes, berries, pole tomatoes, etc., also require heavy duty tillage tools. Our **Narrow Row Tandem Disc** fits those requirements. This disc is excellent for knocking down weeds, leveling and mixing in residue. The 22" diameter notched front blades aid in cutting through hard soils, while the rear smooth blades give a smooth finish. Flange mounted, double sealed, shielded bearings. A number of options are available, such as: dirt shield fenders, extension blades, bearing guards, special low position 3-point hitch.



## SPECIFICATIONS:

Model No:	Row Width	No. of Blades	Frame Width	Cutting Width	Weight
GV-5R	5' (60")	8	48"	32" to 44"	1200#
GV-6R	6' (72")	12	57"	56" to 62"	1420#
GV-8R	8' (96")	16	75"	68" to 80"	1745#

# DISCS, TANDEM

*Reversible Tandem Disc*

*"GRT" Series*

Our heavier duty series of **Reversible Vineyard Discs** were designed for maximum strength and durability. The frame was built with heavy wall tubing for additional weight in tough soil conditions. The disc has 24" diameter plain blades front and rear. The 3-point hitch is Cat. II quick hitch. The reversible hitch can easily be remounted on the opposite end of the disc when required.



## SPECIFICATIONS:

Model No:	Cutting Width	No. of Blades	Weight
GRT24P-HD-16	5' 8" to 7'	16	2160#
GRT24P-HD-18	7' 2" to 8' 6"	18	2260#
GRT24P-HD-20	7' 2" to 8' 6"	20	2490#

Manufactured By:

**BWI**implement



# DISCS, WHEEL

Medium Duty Pull Type Tandem Discs

**Narrow "VWT" Series**



Model No:	Cutting Width	No. of Blades	Weight
VWT24-16	5' 8" - 7' 0"	16	2480#
VWT24-18	7' 2" - 8' 6"	18	2600#
VWT24-20	7' 2" - 8' 6"	20	2680#
VWT24-22	8' 8" - 9' 8"	22	2720#
VWT24-24	8' 8" - 9' 8"	24	2800#

**FEATURES:**

- Frame:** 4" x 4" x 1/4" Structural tubing
- Hitch:** Self leveling, spring cushioned with hand crank
- Gangs & Bearings:** 1 1/2" Square gang axles with greaseable trunnion mounted, triple sealed bearings with wear guards
- Gangs:** Adjustable - front 12° to 22° - rear 9° to 21°
- Blades:** 24" x 6mm notched front & plain rear - 9" spacing
- Scrapers:** Standard, adjustable individually or by gang
- Wheels & Tires:** 2 - 6 Bolt hub and spindle assy. 2 - 9.5L x 15" 8-ply tires
- Hydraulics:** 3 1/2" x 8" Cylinder with depth control and hoses
- Rear Hitch:** Standard equipment

Manufactured By:

**BWI**Implement

**FEATURES:**

- Frame:** 4" x 4" x 1/4" Structural tubing
- Gang Frame:** Fully adjustable front to rear
- Hitch:** Self leveling, spring cushioned with hand crank
- Bearings & Axles:** 1 1/2" Square axles with trunnion mount triple lip sealed greaseable bearings with wear shield
- Blades:** 24" x 4.5 mm smooth blades
- Spools:** 9" Steel spacer spools and cast iron half spools
- Hydraulics:** 3 1/2" x 8" Cylinder with depth control
- Shank:** 1" x 3" Center shank with adjustable footpiece
- Wheel & Tire:** 6 Bolt hub and spindle assemblies with 9.5L x 15" 8 ply tire

# DISCS, WHEEL

Medium Duty Pull Type Tandem Discs

**Wide "GT" Series**



Model No:	Cutting Width	No. of Blades	No. of Wheels	Weight
GT-24T	9' 2"	24	2	3300#
GT-28T	10' 8"	28	2	3700#
GT-32T	12' 2"	32	4	4140#
GT-36T	13' 8"	36	4	4360#
GT-40T	15' 2"	40	4	4800#
GT-44T	16' 8"	44	4	5130#
GT-48T	18' 2"	48	4	5610#

## DISCS, WHEEL

*Excellent General Purpose Wheel Discs*

*Offset Pull Type "300" Series*

The **Gearmore 300 Series Offset Discs** are ideal for light and medium tillage conditions. We offer sizes from 4'-6" to 9'-9"; for vineyards, berries, narrow row orchards, general field cultivation, etc. The offset design enables maximum penetration and even tillage of soil. Heavy construction with 4" x 3" x 1/4" frame, 1 1/4" axles, 22 inch diameter blades in notched or smooth, self leveling hand crank, and triple sealed bearings. Built in the West for tough, western conditions.



### SPECIFICATIONS:

Model No:	G301	G302	G303	G304	G305	G306	G307	G308
Width:	4' 6"	5' 3"	6' 0"	6' 9"	7' 6"	8' 3"	9' 0"	9' 9"
No. of Blades:	12	14	16	18	20	22	24	26
H. P. Req'd:	35 - 45 HP	35 - 45 HP	40 - 55 HP	40 - 55 HP	45 - 60 HP	50 - 65 HP	55 - 70 HP	60 - 75 HP
Weight:	1300#	1400#	1500#	1600#	1700#	1800#	1900#	2000#

## DISCS, WHEEL

*Excellent General Purpose Wheel Discs*

*Offset Pull Type "500" Series*

The **Gearmore Low Profile Offset Discs** are of rugged design for deep tilling in all soil conditions. We offer the most popular widths of 8'-3" to 10'-6", for orchard and general tillage operations. The offset design enables maximum penetration and even tillage of soil. Heavy construction with 1 1/2" square gang axles, 24 inch diameter blades in notched or smooth, self leveling hand crank and trunnion mounted, sealed bearings. Built in the West for tough, western conditions.



### SPECIFICATIONS:

Model No:	Cutting Width	No. of Blades	Frame	No. of Wheels	Tractor HP Req'd	Wt. Per Foot	Weight
G503	8' 3"	22	4" x 4" x 1/4"	2	60 to 80 HP	335 lbs.	2800#
G504	9' 0"	24	4" x 4" x 1/4"	2	65 to 85 HP	345 lbs.	3100#
G505	9' 9"	26	4" x 4" x 1/4"	2	70 to 90 HP	370 lbs.	3600#
G506	10' 6"	28	4" x 6" x 1/4"	4	75 to 100 HP	390 lbs.	4100#
G507	12' 0"	32	4" x 6" x 1/4"	4	80 to 120 HP	400 lbs.	4800#

Manufactured By:

**BWI**implement

# DISCS, WHEEL

*Excellent For Heavy Duty Tillage Operations*

## *Offset "700" Series*



The *Gearmore Heavy Duty Offset Finishing Discs* are of rugged design for finish tilling in all soil conditions. We offer the most popular widths of 15'-6" to 22'-3", for general tillage operations. The offset design enables maximum penetration and even tillage of soil. Heavy construction with 1 ½" square gang axles, 26 or 28 inch diameter blades in notched and smooth, self leveling hand crank, and trunnion mounted sealed bearings. Built in the West for tough, western conditions.

### **SPECIFICATIONS:**

Model No:	Cutting Width	No. of Blades	Frame	No. of Wheels	Tractor HP Req'd	Wt. Per Foot	Weight
G704-9	15' 6"	42	6" x 8"	4	80 to 150 HP	610 lbs.	9,140#
G705-9	16' 0"	44	6" x 8"	4	90 to 160 HP	580 lbs.	9,220#
G711-9-F	18' 0"	48	6" x 8"	4	130 to 170 HP	600 lbs.	10,800#
G712-9-F	20' 9"	56	6" x 8"	4	150 to 185 HP	605 lbs.	12,465#
G714-9-F	22' 3"	60	6" x 8"	4	190 to 220 HP	580 lbs.	12,700#
G716-9-F	23' 9"	64	6" x 8"	4	200 to 225 HP	550 lbs.	13,000#

"F" stands for folding models - other widths available upon request

### **FEATURES:**

- Frame & Tongue:** 4" x 8" Structural tubing with hand crank
- Hitch:** Hydraulic adjusted for easy tractor hook-up
- Gangs & Bearings:** 2 ¼" Square gang axles with greaseable trunnion mounted triple sealed bearings with additional external seals
- Gang Beams:** 8" x 8" Structural tubing
- Blades:** 32" Diameter x 9.5 mm notched front and rear with 13" spacing
- Scrapers:** Heavy duty high tensile steel
- Wheels:** Dual with 8 bolt hubs and spindles
- Tires:** 4 - 12L x 15 8 Ply

Manufactured By:

**BWI** implement

# DISCS, WHEEL

*Excellent For Heavy Duty Tillage Operations*

## *HD Offset "900" Series*



### **SPECIFICATIONS:**

Model No:	Cutting Width	No. of Blades	H.P. Req'd	Weight
G903	14' 2"	26	145 to 235 HP	12,150#
G904	15' 3"	28	160 to 250 HP	12,530#
G905	16' 4"	30	170 to 265 HP	13,200#
G906	17' 5"	32	180 to 280 HP	13,600#
G907	18' 6"	34	190 to 285 HP	14,850#

# DUSTERS

*Perfect For Organic Growers*

**3-Point**

## **Model G2V**

The **Gearmore Mini Duster** is a simple all gear drive unit. The dust is accurately applied with easy to set application rates. A mechanical agitator insures even flow of material. The wind velocity of 150 MPH achieves maximum coverage. This economy duster is just right for use in narrow vineyard, berries, and other pole crops such as snow peas.

### **FEATURES:**

- Requires only 15 PTO horsepower to operate
- All gear drive for low maintenance
- Mechanical agitation for even flow
- High wind velocity for maximum coverage
- Adjustable distribution nozzles



## **Model S420 & S530**

**Gearmore Dusters** combine simple design with quality craftsmanship. The all-gear drive provides maximum performance with low maintenance. Sulfur is accurately applied with easy to set application rates. The model S530, with a large 400 lb. capacity poly hopper and extended fishtail distributors, is preferred by growers with wide row spacings. The model S420 with 300 lb. capacity poly hopper is the perfect machine for vineyards with narrow row spacings.

### **FEATURES:**

- Polyethylene hopper and cover
- Wrap-A-Round tubular steel frame isolates and supports hopper
- All gear drive for low maintenance
- Mechanical agitation for even flow
- Wind velocities up to 180 MPH for maximum coverage
- Manual rate control allows for setting the pounds per acre
- Adjustable fishtail nozzles



### **SPECIFICATIONS:**

Model No:	Hopper Capacity	Fan Dia.	Wind Velocity	Row Width	Width	Height	Depth	Fishtail Ext.	Width w/ Fishtails	Wt.
G2V	150 lbs.	12"	150 MPH	4' - 6'	17"	42"	24"	D.N.A.	40"	100#
S420	300 lbs.	15 ¾"	150 MPH	6' - 8'	37"	48"	48"	Optional	37"	230#
S530	400 lbs.	19 ¾"	180 MPH	9' - 12'	37"	58"	48"	Yes	72"	310#
S530N*	400 lbs.	19 ¾"	180 MPH	6' - 8'	37"	58"	48"	No	37"	300#

\* Same narrow fishtails as S420

# DUSTERS

*High Capacity - Less Fill-ups*

## *Trailer*



Our **Trailer Duster** now features new attachments as standard equipment. An electro hydraulic cylinder with control box for adjusting flow rate from the tractor. Also, a hydraulic motor to control the speed of the full length spiral conveyor and agitation system. This insures uniform, accurate distribution of the dust. The high 1000 pound capacity hopper insures maximum coverage between fill-ups. The duster is compact and easy to maneuver even in narrow rows.



### **FEATURES:**

- Heavy gauge steel hopper with up to 1000# capacity
- Large hopper opening and hinged lid for easy re-fill
- High performance, precision balanced, all-steel centrifugal turbine fan
- Built-in overrunning clutch protects the drive train
- Swivel distribution nozzles adjust for vines and trees
- Full hopper length, large diameter agitator feeds spiral conveyor in bottom of hopper
- Tongue length and tire width are adjustable
- Heavy duty clevis hitch
- Screw adjustment tongue jack
- Wide angle constant velocity driveshaft
- Adjustable rear bumper shields the distribution heads from impact and possible damage
- All steel parts are undercoated with anti-corrosive paint and finish coated
- Application rates from 5 to 100 lbs. per acre
- Special domed trash screen
- For 540 RPM tractors

### **SPECIFICATIONS:**

Model No:	Hopper Capacity	Min. H.P.	Volume of Air	Air Speed	Height	Width	Length	Tires	Wt.
MAXI600-SPC	1000 lbs.	40 HP	3180 CFM	420 MPH	50"	50" to 68"	110"	9.5Lx15-8Ply	940#

# DUSTERS, ROW CROP

*High Speed Turbine Fan Insures Total Coverage  
With Hydraulic Folding Boom*

**Gearmore Row Crop Sulfur Dusters** combine simple design with quality craftsmanship. The all-gear drive provides maximum performance with low maintenance. Dust is accurately applied with easy to set application rates. The large 400 lb. capacity polyethylene hopper allows dusting of many acres between "re-fills".

The booms are available for 5 to 12 rows with adjustable nozzles to insure accurate dust placement on the plant foliage. Our Row Crop Sulfur Dusters have successfully controlled mildew on strawberries, tomatoes, watermelons, pumpkins, cantaloupes, peppers, cucumbers, and many other crops.

If you are an organic grower, dusting with sulfur will not affect your organic status.

### DUSTER FEATURES:

- Cat. 1 & 2, 3-point hitch
- All gear drive for low maintenance
- Wind velocities up to 180 M.P.H. at manifold
- Manual rate control allows for setting the pounds per acre
- Mechanical agitation for even flow
- Lever control, reachable from tractor seat, allows operator to turn the dust on and off
- Optional parking stands for high clearance tractors (ground to hitch pins - 23")

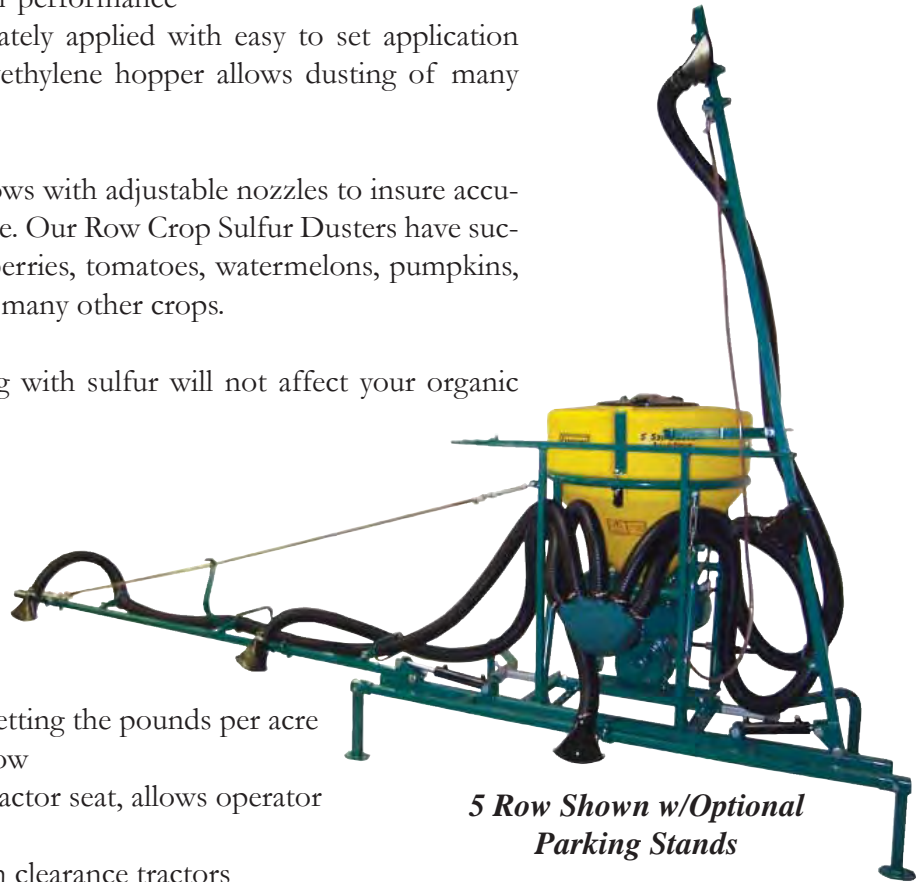

*5 Row Shown w/Optional Parking Stands*

### DUSTER BOOM FEATURES:

- Available in 5, 10, & 12 row, hydraulic foldaway booms
- Steel frame that easily bolts to duster frame
- Adjustable nozzles allows for angling to the foliage
- Wide spread fishtail shaped nozzles for better coverage
- 2 3/4" I.D. flexible black hose



*Sulfur has been proven to be the most effective way to control powdery mildew.*

### SPECIFICATIONS:

Model No:	Description	Boom Length	Maximum Nozzle Centers	Weight
S530B-5HF	5 Row Duster	31' 2"	68"	400#
S530B-10HF	10 Row Duster	31' 2"	40"	460#
S530B-10HF-3MT	10 Row Duster	41' 2"	48"	470#
S530B-12HF-3MT	12 Row Duster	41' 2"	40"	500#

# FORKS

*Tools To Make Your Loader More Productive*

## *Bucket & Trash Forks*

### *Bucket Forks*



**Bucket Forks** are a quick, easy way to make your loader bucket into a forklift. Mounts in seconds to most loader buckets without tools.

Forks are equipped with handles for ease in mounting and spacing adjustments. Both forks now have baked-on powder coated paint for rust-free durability and long lasting glossy finish.

Model No:	Capacity (lbs.)	Fork Dimension	Weight
1000	1000 lbs.	2" x 3" x 32"	90#
2000	2000 lbs.	2" x 3" x 36"	110#
3000	3000 lbs.	2" x 4" x 42"	150#
4000	4000 lbs.	2" x 4" x 42"	170#
6000	6000 lbs.	3" x 5" x 48"	275#

If loader buckets are equipped with bolt-on cutting edges, both the forks on this page are available with wide opening, just add **W** to model number.

### *Trash Forks*



Models:	GTF48	GTF54	GTF60	GTF66	GTF72
Bucket Size:	48"	54"	60"	66"	72"
Width:	46"	52"	58"	64"	70"
Tines:	5	5	6	6	7
Approx. Space Between Tines:	8 ½"	10"	8 ½"	10"	9"
Weight:	160#	170#	180#	195#	210#

A loader bucket is great for moving soil, but handling trash is a problem. Our **Trash Forks** are an economical and easy mount solution to this problem. This handy tool will make moving tree branches and other debris an easy task.

- 2 Heavy screw-lock clamp brackets w/zinc plated handle/screw assemblies
- 2" Square, ¼" wall tubing by 20" long tines
- Clamps fit deep into the bucket for added strength
- Clamping brackets placed near bucket side plates for added strength

### *Bale Spears*



All Forks and Bale Spears come with sliding handle, screw and swivel locking plate. They are zinc coated for easy operation and to prevent rust.

These **Clamp-on Bucket Bale Spears** are a quick and handy tool to convert your loader bucket into bale spears. The units have a capacity of 3000 pounds and can handle square or round bales.

- Spear length - 41"
- Spear diameter - 1 ⅝"
- Overall length - 56"
- 1 ¼" Opening for bucket cutting edge



Model No:	Description	Capacity	Weight
CBS-3000	Pair of Bale Spears	3000 lbs.	135#

# BALE SPEARS

*Easily Converts Bucket To Bale Spears*

## *Clamp-On*

# FORKS

*For Lifting Without The Expense of a Forklift*

## 3-Point Mounted

ADJ. TINE FORKS

Model 1500AT



ADJ. TINE FORKS  
Model 3548

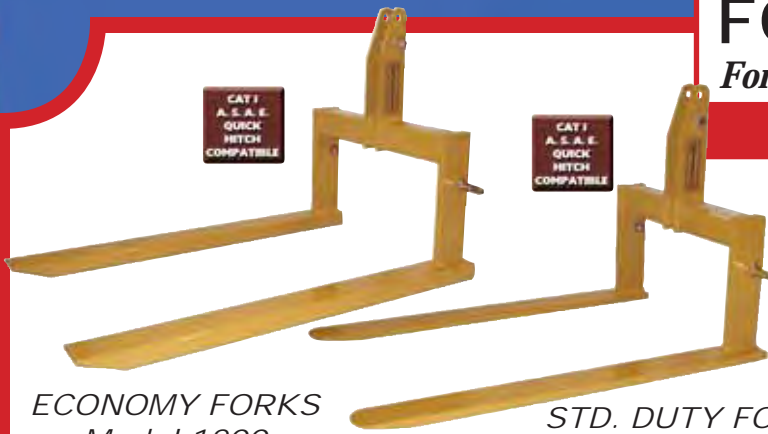

ECONOMY FORKS  
Model 1200



STD. DUTY FORKS  
Model 1500 & 2000-3PT

Model No:	Cap.	Fork Width (center to center)	Fork Thickness	Fork Length	Wt.
1200	1200 lbs.	26"	2"x4"x $\frac{3}{16}$ " tube	41"	90#
1500 QH	1500 lbs.	26"	1" x 4" solid	41"	160#
2000-3PT QH	2000 lbs.	26"	1 $\frac{1}{4}$ " x 4" solid	41"	180#
1500AT	1500 lbs.	5" to 26"	1 $\frac{1}{4}$ " x 4" solid	41"	290#
3548 Cat. 2	3500 lbs.	10" to 36"	1 $\frac{1}{4}$ " x 4" solid	48"	315#

# FORKS

*Turns Your Loader Bucket Into A Forklift*

## Bucket Forks

The **Gearmore Bucket Forks** allows you to turn your tractor into a forklift in seconds. Our simple safety lock brackets are welded to your bucket. You then curl down the bucket and drive into the forks. Next level the bucket and the forks lock into place.

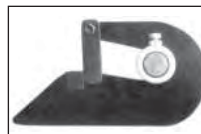

Safety Lock System

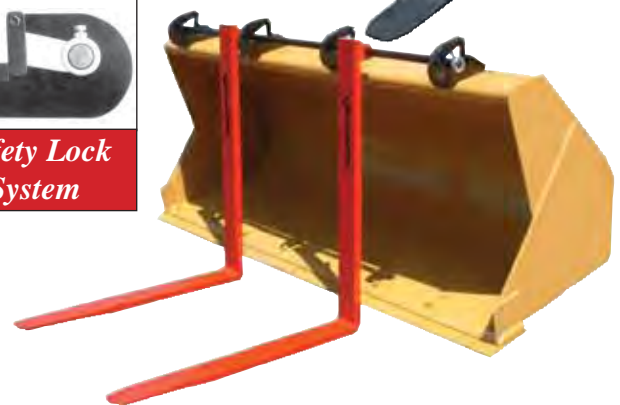

- Mounts to loader bucket in seconds
- Patented forming process increases the bend and heel thickness by 20%
- Tines made of special boron steel and fully heat treated after bending
- Heavy plate mounting brackets
- Rods made of 4140 ground and polished, high carbon steel
- Extra long tine taper for easier load entry
- Adjustable tine spacing
- Forks have a safety rating of 3 times the stated capacity (except 1200# forks)

Model No:	12 UNIV	25 UNIV	40 UNIV	60 LB	60 UNIV	80 UNIV	110 UNIV*
Max. Load Cap. Tine Ct:	1200 lbs.	2500 lbs.	4000 lbs.	6000 lbs.	6000 lbs.	8000 lbs.	11000 lbs.
Bucket Opening up to:	23"	32"	40"	40"	49"	54"	67"
Tine Height**:	31"	38"	46"	46"	55"	61"	73"
Tine Length:	36"	36"	42"	46"	46"	48"	60"
Adj. Width:	60"	60"	72"	72"	72"	72"	84"
Weight:	185#	240#	330#	400#	435#	690#	960#
Rod Size:	1 $\frac{1}{4}$ " x 5'	1 $\frac{1}{4}$ " x 5'	1 $\frac{1}{4}$ " x 6'	1 $\frac{1}{2}$ " x 6'	1 $\frac{1}{2}$ " x 6'	1 $\frac{3}{4}$ " x 6'	2" x 7'
Tine Size:	1" x 4"	1 $\frac{3}{8}$ " x 4"	1 $\frac{3}{8}$ " x 4"	1 $\frac{3}{4}$ " x 4"	1 $\frac{3}{4}$ " x 4"	2" x 5"	2" x 6"
No. of Brkts:	3	3	4	4	4	4	4

\* By adding a 3<sup>rd</sup> tine, capacity is 16,500 lbs. and by adding a 4<sup>th</sup> tine, capacity is 22,000 lbs.

\*\* Deduct 2" to calculate center of rod bushing height.



# FORKS

Available in Pin-On, J.D. & Skid Steer Quick Attach  
**Pallet**

**"NEW"**

Brackets For Loader Pin-On,  
JD Quick Attach, & Skid Steer



These handy **Fork Attachments** can make your tractor/loader into a low cost forklift. Models include John Deere and Skid Steer quick attach pallet forks. The forks feature lockable tines and slotted rails. The solid tines are made of Boron Steel and then are heat treated. Two mounting styles are available; direct pin-on and JD quick attach.

- Load capacities of 2250 & 3750 lb.
- Fits compact and utility loaders
- Forks are constructed of Boron steel and heat treated
- Adjustable and lockable rail style forks
- Equipped with high visibility load guard
- New Skid Steer forks have bolt-on Gearmore logo plate - when removed become walk through design



**WARNING:** The loader mounted fork attachments are specifically designed to engage and load palletized materials. Do not use forks to handle large loads, such as bales, posts, etc., and avoid carrying loose or shiftable loads, as they can fall or roll back onto operator causing serious injury or death.

Models:	ULF-2242	ULF-3548	JLF-2242	NPF-3742F/48F
Lift Cap:	2250 lbs.	3750 lbs.	2250 lbs.	3750 lbs.
Fork Length:	42"	48"	42"	42" & 48"
Tine Size:	1 ¼" x 3" Solid	1 ¼" x 4 ½" Solid	1 ¼" x 3" Solid	1 ¼" x 4" Solid
Loader Mounts:	Fits many compact loaders that measure between 28 ¼" ID & 47 ¼" OD with ¾" or 1" pins	Fits many loader frames between 32" ID & 48" OD with 1" or 1 ½" pins	Fits JD compact loaders with quick change attachment carrier	Fits skid steer quick attach 3750# capacity at 21" load center
Weight:	280#	385#	280#	355# & 360#

Available For Universal, John Deere & Global / Euro Quick Attach



- Available in 2300, 3750 & 5500 lb. capacities
- Fork tines available in 42" & 48" length
- Exclusive load retention hook for securing and positioning pallet loads
- Solid tine positioning w/spring loaded toggle operation
- Easy loading with tapered tines

The new heavy duty frames are designed to handle both the 3750 and 5500 lb. capacity forks. The 10 gauge brickguard offers outstanding strength and smooth surface for protection and less load damage. Also, the convenient non-skid step offers easy operator access, except 2300 lb. capacity. The tine end visibility is excellent.

Code No:	Description	Capacity	Tine Length	Wt.
108308	QA Fork Assy.	2300 lbs.	42"	250#
108309	QA Fork Assy.	2300 lbs.	48"	265#
17380 / 102028	QA Fork Assy.	3750 lbs.	42"	335#
17380 / 102030	QA Fork Assy.	3750 lbs.	48"	355#
101177/102028	JD Fork Assy.	3750 lbs.	42"	410#
101177/102030	JD Fork Assy.	3750 lbs.	48"	440#
17380/102032	QA Fork Assy.	5500 lbs.	42"	375#
17380/102034	QA Fork Assy.	5500 lbs.	48"	395#

# CHAIN HARROWS 1/2"

*Aggressive, Light, or Minimum Action Positions*

*Drag or Lifiable*

- Tines 1/2" dia. by 4 1/4" long
- No parts to lubricate/adjust
- Offset tines eliminate ridges
- Evenly works ground regardless of terrain
- Cold formed tines eliminate breakage
- Can be operated at speeds up to 8 MPH

**NOTE: 4' Lift harrow Not Cat. 1 quick hitch compatible**

**DRAG**  
Available in all sizes

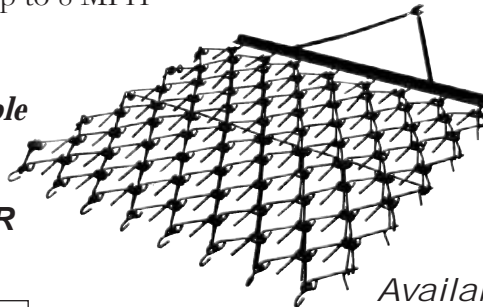

CAT 1  
A.S.A.E.  
QUICK  
HITCH  
COMPATIBLE

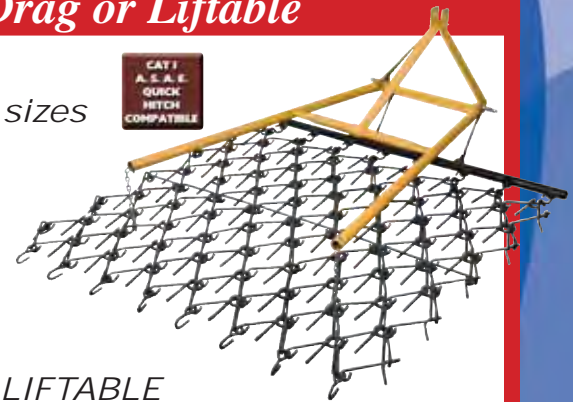

**LIFTABLE**  
Available in 4x4, 6x6 & 8x6

## VARIABLE ACTION FOR EVERY APPLICATION



**AGGRESSIVE ACTION**  
Tines stand up at 75° angle



**LIGHT ACTION**  
Reversed tines angled farther back



**MINIMUM ACTION**  
Tines in smoothing position

### PASTURE RENOVATION & MAINTENANCE

Spreads and incorporates manure, thatches dead growth, aerates soil, increases moisture penetration and renovates pastures by preparing soil for seeding while stimulating existing growth.

### DIRT & GRAVEL MAINTENANCE

For ball diamonds, race tracks, dirt and gravel roads, rodeo arenas, etc. Smooths rough spots, fills holes and incorporates moisture.

### GRASS & TURF MAINTENANCE

For parks, golf courses and playing fields. Incorporates seed, dethatch turf and aerates soil. Pulls out dead material without disturbing new growth.

### ALL TILLAGE APPLICATIONS

Prepares firm, level seedbed in combination with drills, cultivators and discs. Can be used to break up crusts and clods. Incorporates herbicides evenly because flexible design assures uniform depth.



### Flexible Two-Way Design For Optimum Debris Clearance

Pull backwards for light penetration

Pull forward for deep penetration

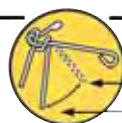

light penetration  
deep penetration

### Chain Sections

Model #	Width	Depth	Wt.
H4X4	4'	4'	70#
H5X4	5'	4'	86#
H6X4	6'	4'	105#
H6X6	6'	6'	157#
H6X8	6'	8'	209#
H8X6	8'	6'	209#
H10X4	10'	4'	174#

### Drawbars Only

Model #	Width	Wt.
D4	4'	16#
D5	5'	18#
D6	6'	22#
D8	8'	27#
D10	10'	60#
D12	12'	70#
D1D	Adaptor Kit	

# CHAIN HARROWS

5/8" Diameter - Double Sided

Heavy Duty Series



## 5/8" DOUBLE SIDED SERIES

- Made from 5/8" diameter high carbon steel teeth both sides
- 3" Teeth are angled 45° for better trash harrowing action on one side
- This harrow, because of its unique tooth arrangement, is self-cleaning under most conditions

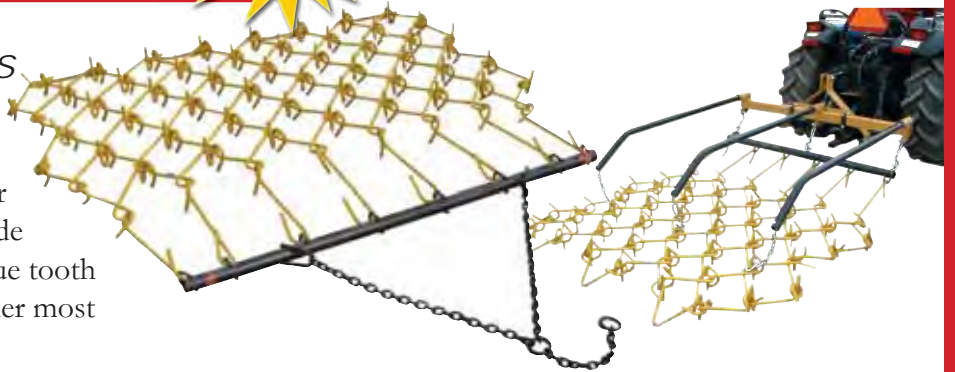

BLANKET HARROWS				DRAWBARS			
Model	Description	Width	Weight	Model	Drawbar Size	Length	Weight
AW-CH05-3-X	5' W x 6' D	4' - 4"	100#	AW-CH05-BAR	5'	29"	55#
AW-CH07-3-X	7' W x 6' D	6' - 6"	175#	AW-CH07-BAR	7'	55"	60#
AW-CH09-3-X	9' W x 6' D	8' - 8"	225#	AW-CH09-BAR	9'	81"	75#
AW-CH11-3-X	11' W x 6' D	10' - 10"	275#	AW-CH11-BAR	11'	107"	85#
AW-CH13-3-X	13' W x 6' D	13' - 0"	325#	AW-CH13-BAR	13'	133"	105#
AW-CH15-3-X	15' W x 6' D	15' - 2"	375#	AW-CH15-BAR	15'	159"	125#
AW-CH17-3-X	17' W x 6' D	17' - 4"	425#	AW-CH17-BAR	17'	185"	135#
AW-CH19-3-X	19' W x 6' D	19' - 6"	475#	AW-CH19-BAR	19'	211"	155#
AW-CH22-3-X	22' W x 6' D	21' - 8"	525#	AW-CH22-BAR	22'	2 - 120"	175#
AW-CH24-3-X	24' W x 6' D	23' - 10"	575#	AW-CH24-BAR	24'	2 - 133"	225#

## 3-POINT HARROW CARRIERS

Model	Fits Harrow Sections	Hitch	No. of Lift Bars	Weight
HC-206	7'	Cat. 1	3	160#
HC-208	9'	Cat. 1	3	182#
HC-210	11'	Cat. 2	4	235#
HC-212	13'	Cat. 2	4	260#

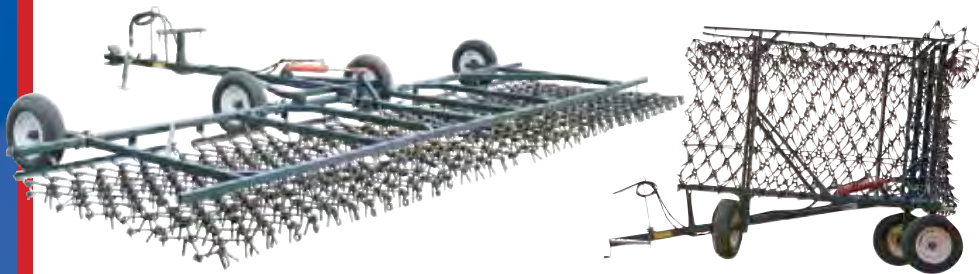

## PULL TYPE

- Heavy duty cast pintle hitch
- Manual forward fold wings
- Floating drawbar design
- Single hydraulic lift cylinder
- Adjustable floating pull bars
- Harrow sections - 1/2" dia. teeth

## HARROW CARTS

Model	Working Width	Center Section	Wing Sections	Weight	Sections Included	
					6 x 8	4 x 8
10-112016	16'	8'	4'	1800#	0	4
10-112020	20'	8'	6'	1900#	2	2
10-112024	24'	8'	8'	2000#	0	6
10-112028	28'	8'	10'	2100#	2	4
10-112032	32'	8'	12'	2500#	4	2
10-112036	36'	12'	12'	3000#	6	0
10-112042	42'	14'	14'	4900#	3	6

# HARROWS

*Compact & Standard Duty Rotary Harrows*  
***Arena Rotary Harrows & Drag Mats***



**Now With  
Replaceable Teeth**



*GRH6B With Optional  
Drag Mat Shown*



- Cat. 1, 3-point hitch
- 2" x 2" Square tubing wheel with 5 spokes
- 5 1/2" High carbon teeth
- Sealed bearing hub
- Heavy 3" x 4" tubing frame

The **GRH Series** of Rotary Harrows were designed to aerate soil and pull weeds. The unique turning action allows the harrow to level soil by redistributing it inward. Excellent tool for moving high spots away from fences and walls. Levels, floats and breaks up clods. The ideal product to use in arenas.

The heavy duty **Drag Mats** finish the soil to a fine smooth surface. The mat also catches and drags out clods and small rocks. The units are galvanized to prevent rust and are long wearing. The carrier frame is easy to install on current and existing Rotary Harrows.

*GRH5E Shown*



- Available for GRHB rotary harrows only
- Adjustable bolt-on carrier frame
- Rust resistant galvanized steel mats
- 1" x 1" Mesh openings and full length rods
- 3 Times the strength of standard mats

Model No.	Description	Weight
AH-DMC	Carrier, fits all mats widths	35#
DM-6	Drag Mat, 6' x 30" deep	65#
DM-8	Drag Mat, 8' x 30" deep	95#

Model No.	Description	Weight
GRH4E	Rotary Harrow, 4 Foot	155#
GRH5E	Rotary Harrow, 5 Foot	170#
GRH5B	Rotary Harrow, 5 Foot	240#
GRH6B	Rotary Harrow, 6 Foot	290#
GRH7B	Rotary Harrow, 7 Foot	335#
GRH8B	Rotary Harrow, 8 Foot	385#

These compact **Arena Rotary Harrows** were especially designed for compact tractors from 15 to 24 horsepower. By extending the tractor right side lower link arm, the unique turning action allows the harrow to level the ground by moving the soil inward. The heavy main frame and the strong pipe circle with replaceable teeth insures long life and easy maintenance.

- Cat. 1, 3-point hitch
- 6" Long replaceable teeth
- 1 1/2" Pipe circle
- 4 - 1 1/2" Pipe spokes
- Sealed bearing hub
- Frame 3" x 3" square tubing

# HEDGER/TOPPER

*Designed to Hedge & Top Trees & Bush Crops*

*Front or Rear Tractor Mounted*



The **COLLARD Hedger/Topper** was designed to hedge, top trees and bush crops. Easy to operate with electric controls. The cutting bar length is 6 feet and additional blades can be added for longer cuts. Cutting bar can be rotated from side to side for different cutting passes. This unit is great for orchard hedging, topping and fence line maintenance.

### FEATURES:

- Standard cutter bar length 6.8 feet
- Vertical reach of 20 feet
- Flat topping height of 13 feet
- Tractor requirement of only 11 G.P.M. at 2140 PSI
- Electro hydraulic controls
- Hedger comes with all hoses, fittings and JIC couplers
- 18" Dia. flail knives are standard, saw blades are optional

### SPECIFICATIONS:

Model No.	Description	Reach	Topping	Wt.
TA400	Hedger/Topper 6 Blade	20 Ft.	13 Ft.	860#

### FEATURES:

- 7 Cylinder hydraulic system which allows for many different applications
- Electro hydraulic controls
- 18" Diameter saw blades are standard with optional flail knives for green material
- 6 Blades per side - optional 7, 8, and 9 blades per side
- Requires minimum of 12 GPM @ 3000 PSI
- Designed so that blades throw much of the brush into the rows, instead of dropping into the tree canopy
- Effective trimming for both nut and fruit orchards

The **COLLARD Hedger** is a total adjustable pruning system for hedging, topping and skirting orchards. Allows growers to maximize production and reduce pruning costs. By reducing heavy crop set limb damage, opens middles for better sunlight, cleans out lower branches to reduce herbicide damage and allows passage of tractors without limb breakage.

### SPECIFICATIONS:

Order No.	Description	Hedging	Topping	Weight
P2000A-6	Hedger/Topper/Skirter 12 Blades	Minimum - 48" Maximum - 170"	Minimum - 84" Maximum - 133"	1560#

**Marketed by Gearmore, Inc.**

# HEDGER/TOPPER/SKIRTER

*Orchard Management of Tree Canopies*

*Allows Total Control of Orchard Profile*



# IMPLEMENTS

*For Tractors 24 PTO Horsepower Maximum*

*For Sub Compact Tractors*

These 6 implements allow compact tractors to perform many different tasks. The tractor 3-point hitch makes it easy to change these tools. Whether you want to grade, disc, mow, rake, or subsoil, these economy implements will do those jobs with minimal effort.

**RAKE 60"**  
**TYR-60-XB**



- Heavy duty heat treated spring steel shanks
- 5 Forward and 5 reverse settings
- Reinforced square tubing frame
- Adjustable stabilizer bar

**BOX SCRAPER 48"**  
**BB-48-XB**



- Front and rear reversible heat treated cutting edges
- Adjustable heat treated shanks
- 12" High self cleaning moldboard
- 2" x 4" Main beam

**REAR BLADE 60"**  
**TRB-60-XB**



- 10" High ¼" thick moldboard
- 5 Forward and 5 reverse settings
- Reinforced square tubing frame
- Reversible high carbon cutting edge

**FINISH MOWER 48"**  
**FM-48-XB**



- Dual wheels front and rear
- Free floating flex hitch system
- 3 Cast iron spindles and ¼" thick blades
- Front anti-scalp roller

**MIDDLE BUSTER SUBSOILER MB-S-XB**



- Steel tubing shank
- Heavy steel frame
- Heat treated, furrower and subsoiler point
- Forged lift pins

**TANDEM DISC 60"**  
**14-16-N-XB**



- Heavy angle iron frame
- Cast iron bearing spools w/grease fittings
- Adjustable angle settings
- 1" Square axles & 14" high carbon blades

# IMPLEMENTS

Construction Attachments Mfg. by Bradco

*Construction*

Manufactured By:



PALADIN LIGHT CONSTRUCTION

"NEW"

## FLAIL MOWERS



- Designed for mini excavators
- Cutting widths of 28.5" and 38.5"
- Rotation speeds of 1800 to 2200 RPM
- 4" Cutting capacity
- 5 Second blade stopping feature
- Models for excavators capacities on 3 to 10 metric ton
- Model FME30 - 830#, FME40 - 1175#

## 4-IN-1 BUCKETS



*Construction Series shown w/ opt. side cutter & spill guard*

- 3 Series in widths of 60", 66", 72", 78", & 84"
- For machine weights - 4,000, 8,000 & 12,000#
- Long floor design improves cutting edge visibility
- "Hose Saver" spring kit standard, except on compact units
- Unique side cutters on construction series only
- Effective loader bucket for clam, dozer, scraper and bottom dump operations

## SIFTING / ROCK BUCKETS

**66" With Loader Arms**



*Optional Grapple*

- Widths of 55", 66", 75" and 84"
- Brackets to fit loader arms, Skid Steer and quick attach
- Unique tine design is contoured to cradle the debris and rocks
- Rods are 1 1/4" diameter high alloy steel
- Standard buckets come with 3 1/8" spacing between tines, with the option of 2" spacing
- 55" Bucket has 3/4" diameter rods

## TRENCHERS



*Model 612 For Tractors 22 - 35 H.P.*

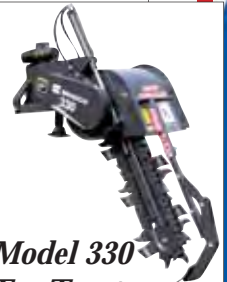

*Model 330 For Tractors 15 - 30 H.P.*

- 3 Pt. hitch, PTO driven for 15 to 35 HP hydrostatic transmission tractors
- Digging depths from 30" to 60" deep
- Digging widths from 3" to 12" wide
- Large discharge auger places soil away from trench
- Built with the best of heavy duty components

# IMPLEMENTS

## Time And Labor Saving Implements

### Miscellaneous

#### PLOWS



These **Moldboard Plows** are ideal for small acreage farms when deep tillage is required.

- Cat. 1, 3-point hitch
- Available in 1 or 2 - 14" bottoms
- 1" x 4" Plow beams
- Replaceable plow share, shins and landsides

#### CULTIVATORS



Our **"S" Tine Cultivators** are available in widths of 4 to 10 feet. The tine springs vibrate to aid in breaking up the soil.

- Heavy duty "S" tines penetrate and till up to 7" deep
- "S" tines are heavy duty  $\frac{3}{8}$ " x  $1\frac{1}{4}$ " x 22" spring steel
- Available w/1  $\frac{3}{8}$ " reversible points or 7" sweeps

#### RIPPER BARS



These **Ripper Bars** are excellent for aerating pastures and other ripping applications.

- Cat. 1, 3-point hitch
- 5, 6 and 7 Shank sizes
- Rips up to 8" deep
- Shear bolt protection

#### ALL-PURPOSE MIXERS



Our economy **Mixer** effectively blends materials including concrete, feed, and fertilizers.

- Cat. 1, 540 RPM P.T.O.
- Capacity - 11 cu. ft.
- Mixes 1  $\frac{1}{2}$  sacks of cement
- Single acting cylinder with hose



# IMPLEMENTS

## Time And Labor Saving Implements

### Miscellaneous

#### SPINNER SPREADER



This spreader features a 12 volt motor with variable speed control and on/off switch. The molded poly hopper has the capacity of 145 pounds. Includes brackets to mount on all types of vehicles.

- Model ATV-DMS-12V can spread fertilizer, seeds, and powders
- Adjustable spread widths of 5 to 45 feet
- Stainless steel six blade spinner
- Optional 1 ¼" or 2" hitch receiver

#### ARENA-VATOR JR.



Unique tool for cultivating and to finish smooth out your arena. The tilling depth is controlled by an electro cylinder operated from the vehicle seat.

- 5' Cultivating width
- 13 - ½" x 1" x 15" "S" Tines w/points
- Adjustable smoothing box
- Model # AV-JR

#### ROLLERS, 3-PT. & PULL TYPE



These rollers are available in 3-point or pull type in many different widths. For more compaction, adding water will greatly increase the rolling force.

- Available in widths of 60", 72", 84" & 96"
- Roller diameter of 16" and 20"
- ¼" Thick roller tubing
- 1 ½" Full length shaft

#### WHEEL DISC



The wheel design is engineered for smooth transition from off-road transport to cutting position with just the turn of a crank. The turnbuckle mounted tongue to frame gives down pressure to increase cutting action.

- 33" Cutting width
- 10 - 14" Diameter notched blades
- Dual floatation tires
- Model # 14-10-CD

# IMPLEMENTS

## Implements For Quick Attach or Loader Pin-on Loader & Electro Hydraulic Kits

The **Quick Attach Bracket** for compact tractors allows you to change loader attachments in minutes. Just unlatch the quick attach, back out of one implement and drive into another, flip the locking handles and you are ready to go back to work.

- The Quick Attach mounts directly to your loader arm and cylinders in minutes
- No special pins or modification to the loader are necessary
- Available for most popular compact tractor loaders
- Weld-on plates are available to convert standard brackets to Quick Attach



**For other quick attach or pin-on loader implements, see the index.**



Root rakes available in widths of 60", 66" & 72"  
Available in quick attach only

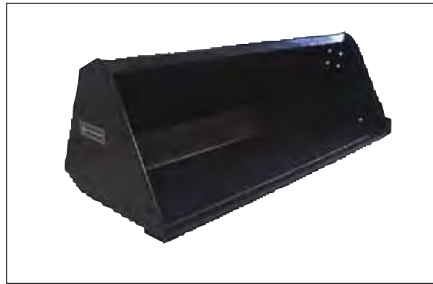

Standard, light material and heavy duty buckets in widths of 60", 66" and 72"



Multi-purpose 4-in-1 buckets in widths of 60" & 66" - Also HD buckets in 66", 72" & 78"



*Turns your standard bucket into a versatile grapple bucket*

**Bolt-on bucket grapples are available in single 48" to 72" and double 60" to 84" buckets**

Gearmore **Electro Hydraulic Components** were developed to obtain a simple, compact way to operate loader mounted hydraulic implements. The mounted electro hydraulic valve is easily operated by a push button switch knob mounted on the tractor loader valve lever. This allows operation of the loader functions and hydraulic implements without moving your hand.

- Electro hyd. valve, operates hydraulic functions up to 13.2 G.P.M.
- Easily installed replacement loader knob with pushbutton electric switch
- Valve mounting bracket and hardware

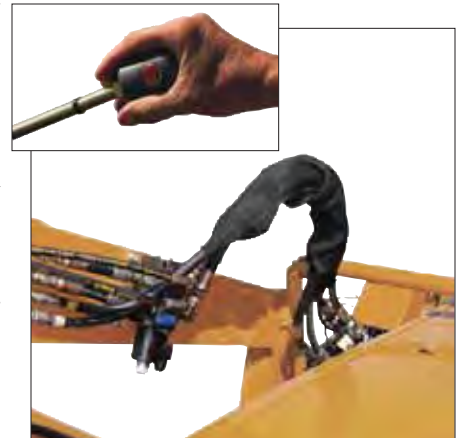

**Model # EH-100 Electro Hydraulic Valve components for installation on tractor loaders**

# LOG SPLITTERS

Can Be Operated in Vertical or Horizontal Position

## Trailer & 3-Point



3-Pt. Hitch Model  
15 Ton Capacity

Trailer Model  
34 Ton Capacity



Splitting Wedge &  
Stripper Bracket



Built-in Log  
Cradle



10.5 HP Briggs &  
Stratton Engine

The Gearmore 3-point hitch mounted, hydraulic driven **Log Splitter** is a powerful, low cost unit. The hydraulic 4" cylinder with 24" stroke is powered by the tractor's hydraulic system. This Log Splitter will split any diameter log up to 26" long. The heavy 6" x 6" main beam ensures years of trouble free use.

Our **Log Splitters** are available in 3-point hitch and trailer mounted. Splitting capacities of 15 and 34 ton, depending on your requirements. Both models feature automatic cylinder return for convenience. The built-in log cradle makes splitting wood easier and safer. These top of the line splitters will give you years of trouble free usage. The log splitters can be used in the vertical or horizontal position. The 2" ball hitch allows the log splitter to be towed by ATVs, utility vehicles, small tractors, etc.

Model No.	LS20E	T34B
Capacity:	15 Ton	34 Ton
Mount:	Cat. 1 - 3-Point	Trailer
Cylinder Size:	4" x 24"	5" x 24"
Power:	Hydraulic	10.5 H.P. Briggs & Stratton
Pump:	Tractor	2 Stage 16 G.P.M.
Beam Size:	4 ½" x 7"	8" x 10"
Splitting Wedge:	7"	8"
Maximum Log Length:	26"	26"
Weight:	375 lbs.	675 lbs.
Trailer mount log splitter comes with 4:80 x 8" Tires, 2" ball hitches, safety chains, and jackstands.		

### FEATURES:

- Operates in the vertical or horizontal position
- Log stripper for stuck log removal
- Auto return on control valve
- 7" High splitting wedge with spreader wings
- Adjustable stroke for different length logs
- Vertical position allows operator to be at side of tractor for safety

# FLAIL MOWERS

Featuring "No Tools" Blade Changing System

"SLE" & "GML" Series

This Gearmore **SLE Series** mower was developed for mowing grass and light weeds with side slicing Y blades. All models are also available with finish mowing cupped "ducksfoot" blades for mowing grass. Standard features include ASAE quick attach 3-point hitch, low profile design, center mount or offset, adjustable rear roller and many more. These flail mowers were designed to achieve fine shredding on cover crops, parks, golf courses, pastures, and light weed abatement.

- Cat. 1, ASAE quick hitch compatible for easy attaching to tractor
- Low profile design for clearing obstructions
- Available with side slicing Y blades for light brush or grass finishing ducksfoot blades
- Center mount or offset 9 inches to right
- 45 Horsepower, 540 rpm gearbox
- Internal "saw tooth" cutter bar to reduce size of shredded material
- 5" Diameter rear roller
- Safety chain shield in front and rubber rear deflector



"SLE" Series



Quick Change Y Blade



Quick Change Ducksfoot Blade

Model No:	Mow Width	Overall Width	No. of Knives	Min. H.P. Req'd	Wt.
SLE-120	48"	54"	22	20 H.P.	415#
SLE-160	63"	69"	30	28 H.P.	525#
SLE-190	75"	81"	36	35 H.P.	620#

The **Gearmore Flails** are the ultimate in flail mowers. The mowers are heavy built with 40 H.P. gearbox, to give years of trouble free service. Two types of blades are available - hammer and Y blades, both do clean cutting on light brush and grass. High speed 2300 R.P.M. rotor makes for smooth finished cut. The adjustable rear roller ensures even mowing. These flail mowers are just right for use in mowing cover crops, parks, schools, golf courses, pastures, roadsides, etc.

- Fits Cat. 1, 3-pt. hitches, 540 R.P.M. tractors
- Mows grass and weeds up to 1/2" with Y blades
- Shreds brush up to 1 1/2" dia. w/swinging hammer blades
- Computer balanced vibration free rotor turns @ 2300 RPM
- 3 Belt drive protects gearbox, driveshaft and rotorshaft
- Front metal flaps provide safety from flying material
- Rear rubber safety flaps



"GML" Series



Hammer Knife Up to 1 1/2" Brush



Y Blade Up to 1/2" Brush

Model No:	Mow Width	Overall Width	No. of Hangers	Min. H.P. Req'd	Wt.
GML-41	41"	46"	18	16 H.P.	580#
GML-49	49"	53"	24	20 H.P.	640#
GML-61	61"	66"	27	24 H.P.	720#
GML-69	69"	73"	33	28 H.P.	770#
GML-79	79"	84"	39	35 H.P.	840#

# FLAIL SHREDDERS

Center Mount, Offset Mechanical or Hydraulic

"SFG" Series

SFG155 Shown



Double Y Blade



Hammer Knife



Our **SFG Series** of flail mower/shredders feature fixed center mount, manual or hydraulic side shift. The narrow shredders are fixed center mount. The two largest shredders are manual offset, return to center with optional hydraulic offset. Two style of blades can be purchased, hammer knives or double Y blades. These blades are also interchangeable on the same shredders. The low profile design of the machine aids when working in tight areas. These are popular mowers in vineyards, berries, roadsides, weed abatement, rental yards, etc.

## OPTIONS:

- Rake Teeth
- Hydraulic offset SFG185 & 200

- Cat. 1, ASAE quick hitch, 540 RPM tractors
- Fixed center mount hitch, except SFG 185/200
- 70 HP gearbox with built-in overrunning clutch
- Low profile belt housing, 23" high for clearance
- Hammer knives shreds brush and prunings up to 2" diameter
- Double Y blades mow weeds and light brush up to 1" diameter
- Cutting height adjusts from 1" to 4" above ground
- Rotor speed - 2200 RPM
- Two rows of heat treated re-cutter blades
- Rear hatch adjusts for various types of mowing
- Rear hatch slotted for rake teeth
- Balanced 5 ½" rotor tubing
- 5 ½" Diameter rear roller adjusts vertically and horizontally
- Models SFG95 & 125 are **not** quick hitch
- 4 Belt final drive to provide maximum power to the rotor
- Series 6 PTO driveshaft
- Front mounted safety chains

Model No:	Working Width	Overall Width	Max. Offset*	No. of Hammers	No. of Y Blades	H.P. Req'd	Rake Slots	Wt.
SFG95	38"	43"	-	8	32	20 H.P.	6	660#
SFG125	49"	55"	-	8	32	25 H.P.	8	770#
SFG140	55"	61"	-	10	40	30 H.P.	9	810#
SFG155	61"	67"	-	10	40	35 H.P.	10	880#
SFG185*	73"	78"	44"	12	48	40 H.P.	12	1005#
SFG200*	79"	84"	48"	14	56	45 H.P.	13	1100#

\*These shredders come with manual offset, hydraulic offset is optional. Offset shown is the maximum offset from centerline of tractor to the right.

# FLAIL SHREDDERS

Both Shredders Can Be Front Or Rear Mounted

## "GCF" & "GRF" Series

Our **GCF Series Mower/Shredders** are now designed for front or rear tractor mount.

To front mount, just re-bolt the A-frame to the back of the shredder. Equipped with a rear deflector which in open position discharges grass and allows tractor speeds up to 6 MPH, and in closed position contains and further shreds brush to a finer mulch. Just right for use in vineyards, berries, and other narrow row crops. Also used by roadsides, parks, rental yards, and general weed abatement.

- Fits Cat. 1 & 2, 3-point, 540 R.P.M. tractors
- HD 72 H.P. gearbox with built-in overrunning clutch
- Hammer knives shred brush and prunings up to 2", and will also mow grass
- Y blades mow heavy grasses & light brush up to 1 ½" and require less horsepower
- Computer balanced vibration free rotor turns at 2000 RPM
- Adjustable A-frame allows offsetting mower 6" to the right
- Front safety chains provide safety from flying material



"GCF" Series



Hammer Knife  
Up to 2" Brush



Y Blade  
Up to 1 ½" Brush

Model No:	Mow. Width	Overall Width	No. of Knives	Min. H.P. Req'd	Wt.
GCF41	41"	46"	9	20 H.P.	680#
GCF45	45"	50"	12	25 H.P.	700#
GCF53	53"	58"	12	30 H.P.	790#
GCF61	61"	66"	15	35 H.P.	920#
GCF69	69"	74"	18	40 H.P.	970#
GCF79	79"	84"	21	45 H.P.	1030#

The **Gearmore Mower/Shredders** are the ultimate in flail mowing. The 3 lb. drop forged hammer knives will shred up to 3" diameter branches and yet will mow grass. Just right for use in vineyards, orchards, roadsides, parks, pastures and weed abatement. You will find that these heavy duty machines will give many years of low maintenance usage.

- Available in Cat. 1 or 2, 540 or 1000 R.P.M.
- Reversible front or rear center mount
- Shreds brush or prunings up to 3", constant use 2 ½"
- Cutting height adjusts from 1" to 4"
- Equipped with an adjustable rear deflector
- Double row drop forged cutter bars increase shredding of material
- Computer balanced vibration free rotor turns at 2000 RPM
- Heavy duty 85 H.P. gearbox with built-in overrunning clutch



"GRF" Series



Hammer Knife

*NOTE: All models are available with dual swivel gauge wheels with 15" diameter laminated tires. Add GW to model no.*

Model No:	Mow Width	Overall Width	No. of Knives	Min. H.P. Req'd	Wt.
GRF69	69"	78"	18	36 HP	1190#
GRF79	79"	88"	21	45 HP	1280#
GRF89	89"	98"	24	50 HP	1380#
GRF98	98"	108"	24	58 HP	1520#

# FLAIL SHREDDERS

For Heavy Duty Grass & Brush Shredding

"GOL" & "GOF" Series



"GOL" Series

- Cat.2, 3-point hitch
- Hydraulically offsets 22" to the right
- Low profile belt housing and gearbox
- 90 HP gearbox w/built-in overrunning clutch
- Shreds brush up to 4" diameter with hammer knives and up to 1 1/2" diameter w/Y blades
- 5 Belt final drive

This **GOL Series Shredder** features a unique side shift system that moves horizontally on front and rear mounted heavy steel tubes. The feature allows for close coupling to the tractor for added strength and stability. Available with hammer knives and Y blades, depending on your requirements. The "low profile" belt housing and gearbox is a great advantage when operating in orchards and vineyards.



Hammer Knife



Y Blade

- Three rows of drop forged cutter bars to increase the shredding of material
- Adjustable rear hatch - closed for maximum shredding, open for maximum forward travel
- Double wall hood of 1/4" thick plate
- Heavy steel belt cover with hinged door
- Front mounted safety chains & rear rubber guards

Model No:	Mow Width	Overall Width	Max. Offset - Rt of Center Line	No. of Knives	Min. H.P. Req'd	Wt.
GOL79	79"	89"	60"	21	55 H.P.	1745#
GOL89	89"	99"	70"	24	65 H.P.	1950#



"GOF" Series



Hammer Knife

- Fits Cat. 1 or 2, 3-pt. hitch, 540 R.P.M. tractors
- Shreds brush/prunings up to 3", constant use 2 1/2"
- Adjustable swing hitch allows quick setting for an additional 28" of offset
- Double row of drop forged cutter bars to increase the shredding of material

The **Gearmore Mower/Shredders** are the ultimate in flail mowing. The 3 lb. drop forged hammer knives will shred up to 3" diameter branches and yet will mow grass. Equipped with a patented rear deflector which in open position discharges grass and allows tractor speeds up to 6 MPH, and in closed position contains and further shreds brush to a finer mulch. In offset position, the units are ideal for mulching prunings and heavy grass in orchards. Municipalities find these shredders excellent for roadside maintenance.

- Computer balanced vibration free rotor turns at 2000 RPM
- HD 85 H.P. gearbox w/built-in overrunning clutch
- 5 Belt drive protects gearbox, driveshaft & rotorshaft, 4 belt on model GOF69-79
- Front mounted safety chains provide protection from flying material
- All models have slotted rear hatches for brush teeth

Model No:	Mow Width	Overall Width	Max. Offset f/Tractor Center Line	No. of Knives	Min. H.P. Req'd	Wt.
GOF69	69"	78"	64"	18	40 H.P.	1190#
GOF79	79"	88"	74"	21	45 H.P.	1300#
GOF89	89"	98"	84"	24	50 H.P.	1430#
GOF98	98"	108"	93"	24	57 H.P.	1560#

# FLAIL SHREDDERS

**Both Series Are Front or Rear Mount**

**"GHF" & "GMS" Series**

These **GHF Shredders** were specially designed for severe conditions. Tall grass and weeds, cover crops, orchard prunings and even citrus brush are no match for this heavy duty machine. The 3 lb. drop forged hammer knives shred branches up to 4" in diameter. The 2000 R.P.M. large diameter rotor, makes a fine mulch. Easy to switch hitch allows the shredder to be mounted on the rear or front of tractors.

- Cat. 2, 3-pt. hitch, center mount
- Front or rear tractor mount
- Shreds brush or prunings up to 3", intermittent 4"
- Gearbox HP at 540 RPM-90 HP, 1000 RPM - 110 HP with built-in overrunning clutch
- Equipped w/rear deflector which in open position discharges grass & allows tractor speeds up to 6 MPH, closed position contains and further shreds brush to a finer mulch
- Double row of drop forged cutter bars to increase the shredding of material
- 10" Diameter, computer balanced, vibration free rotor turns at 2000 RPM
- 8" Diameter, full width gauge roller
- Double row of front safety chains



**Hammer Knife**

*"GHF" Series*



Model No:	GHF90	GHF100	GHF140
Mowing Width:	90"	100"	140"
Overall Width:	100"	112"	152"
No. of Knives:	24	26	36
Min. H.P. Req'd:	50 HP	58 HP	78 HP
Weight:	2620#	2730#	3260#

The **GMS Shredders** were developed for shredding standing trees and tall shrubs or for down material. The brush frame, as shown, is used when driving into standing material. When driving over loose, down material, a rear roller is used in place of the brush frame and skids. The GMS Shredder has a 1000 R.P.M., 110 HP gearbox. It can be front or rear mounted. The reversible, drop forged, hammer knives will shred trees up to 8" in diameter.

*"GMS" Series*



**Reversible Hammer Knives**

Model No:	GMS70	GMS80	GMS90
Mowing Width:	70"	80"	90"
Overall Width:	81"	91"	101"
No. of Knives:	29	33	38
Approx. H.P. Req'd:	60 HP	70 HP	80 HP
Weight:	2420#	2590#	2850#

- Cat. 2, 3-point hitch, center mount
- Front or rear tractor mount
- Shreds brush and trees up to 8"
- Gearbox HP at 1000 R.P.M., 110 HP with built-in overrunning clutch
- Hydraulically operated deflector hood
- 16" Diameter, computer balanced, vibration free rotor turns at 2000 R.P.M.
- 5 Belt drive protects gearbox, driveshaft & rotorshaft
- Double row of safety chain
- Brush frame & adjustable skids for standing brush or a rear roller for operating in low or down material



# FLAIL SHREDDERS

3-Pt. Hitch or Pull Type - 12'-10", 15' & 19'-10"

## "VEGETABLE" Series



15' Shown

### FEATURES:

- Cat. 2 or 3 ASAE quick hitch or pull type
- 280 HP 1000 RPM gearbox w/built-in overrunning clutch
- Rotors are 10 3/4" dia. and 1/2" thick wall with 2 3/16" diameter alloy shafts
- Computer balanced rotor with speed of 1400 RPM
- Cupped blades 5/16" x 2" x 8" - or contoured blades
- Non-swivel adjustable gauge wheels with turnbuckle adjustment



20' Shown

### FEATURES:

- Cat. 3 and 3N, 3-point or pull type
- 280 HP 1000 RPM gearbox w/built-in overrunning clutch
- Outer and center rotor bearings are Timken® double tapered roller bearings for long life
- 8 5/8" Diameter split rotors x 3/8" thick wall with 2 3/16" alloy shafts
- Computer balanced rotor w/speeds of 1690 or 2000 RPM
- Y blade design 5/16"x2", heat treated and reversible

Our *Flail Shredders* were designed exclusively for shredding vegetable residue. After harvest, fine shredding of the remaining vegetation greatly aids decomposition after tilled in for the next crop. The rotors come standard with 8" long cupped blades or optional contoured blades that can be used in combinations of 5", 6 1/2", 8" and 9 1/2" lengths to conform to any furrow size.

### SPECIFICATIONS:

Model No:	V1220	V1520	V2030
Cutting Width:	12' 10" (154")	15' (180")	20' (240")
Overall Width:	14'	16'	22'
No. of Belts:	6	6	8
No. of Blades:	84	102	132
Gauge Wheels:	2	2	4
Minimum HP:	80 H.P.	90 H.P.	120 H.P.
Weight:	4295#	4950#	7100#

# FLAIL SHREDDERS

Designed For Extreme Duty Shredding

## "UNIVERSAL" Series

These *Flail Shredders* are built in the West for tough western conditions. The shredders were designed to provide maximum mulching of crops such as: cotton, rice, corn, tomatoes, wheat and other field crops. The units have a number of special features - hoods have open and closed positions depending on grower requirement and also for easy maintenance, hoods are domex steel which is highly resistant to wear.

### SPECIFICATIONS:

Model No:	U1530	U1830	U2030
Cutting Width:	15' (180")	18' (216")	20' (240")
Overall Width:	17' 3"	20' 3"	22' 3"
No. of Belts:	12	12	12
No. of Blades:	88 Sets	104 Sets	112 Sets
Gauge Wheels:	2	4	4
Minimum HP:	100 H.P.	120 H.P.	130 H.P.
Weight:	5985#	6750#	7200#

Built by Newhouse Mfg. Co. Inc., Redmond, OR

# FLAIL SHREDDERS

*Builds Clean Windrows At High Tractor Speeds*

**"WINDROWING" Series**

Our **Windrow Shredders** chop and build neat, uniform windrows in one pass. The hydraulic driven, 24" wide, high capacity, chain cross conveyor processes the maximum amount of material at high speeds. The special large screened top allows dirt and dust to escape resulting in cleaner windrows. Operating the shredder at 6 miles per hour will produce a windrow approximately 2 feet high by 4 feet wide. We use a heavy duty 280 H.P. gearbox with built-in over-running clutch to insure the highest reliability. With the current high cost of grain, reclaiming corn stover will greatly reduce your cattle feeding costs.



15' Shown



Wide Chain Conveyor

### SPECIFICATIONS:

Model No:	C1535	C2035
Cutting Width:	15' (180")	20' (240")
Overall Width:	17'	22'
No. of Belts:	6	8
No. of Blades:	102	144
Gauge Wheels:	2	4
Minimum Horsepower:	135+ H.P.	150+ H.P.
Weight:	7190#	9255#

### FEATURES:

- Heavy duty pull type hitch
- 280 HP, 1000 RPM gearbox w/built-in overrunning clutch
- High volume cross belt conveyor for windrowing
- Hydraulic motor powers the conveyor and is protected by cushion relief and priority valve
- Special screened top allows dirt and dust to escape the shredders resulting in cleaner windrows
- Front mounted toolbar for adding tools like gauge wheels for additional depth control
- Rotors are 10 3/4" dia. and 1/2" thick wall with 2 3/16" dia. alloy shafts

- Computer balanced rotor with speed of 1400 RPM
- Cupped blades 3/16" thick x 2" wide x 8" long
- Triple sealed ball outer bearings in ductile iron housings
- Timken® dual spherical center bearing on 20' shredders is standard equipment
- Hoods are made of 3/16" thick DOMEX® steel, which has the strength of T-1 and higher wear resistance than AR200
- 9.5L x 15 - 16 Ply tires
- Large 8 1/2" diameter spring loaded idler belt tensioner assures belt tension at all times

### OPTIONS:

- ~ Timken dual spherical rotor outer roller bearings
- ~ Extra set of gauge wheels for 15' shredder

**Built by Newhouse Mfg. Co. Inc., Redmond, OR**

# ROTARY MOWERS

*Pull Type Mowers Can Be Operated By ATV's*

## *Engine Driven*



Our **Rotary Mowers** are designed with a special safety remote, electrical stop feature. The system has dual action engine stopping controls: a manual stop switch if you run into obstructions in the mowing area, and an automatic stop system by placing the controls between your hip and the vehicle seat. This feature automatically stops the engine for the unlikely event that you fall from the vehicle.

*NOTE: Mowers sold less battery*

- Cuts grass & light weeds only
- Mowers not designed for commercial use
- Briggs & Stratton industrial/commercial OHV engines
- 12 Volt electric start
- 48" & 60" Cutting widths
- Dual action remote control electrical engine/blade stop safety system
- Both models have separate poly fuel tanks
- Center mount and easy to offset - right or left

- Two ¼" x 2 ½" swing brush blades
- Single point height adjustment 1" to 5"
- Large 16 x 6.50 x 8 pneumatic tires
- ⅛" Steel plate deck
- Rubber front & rear safety guards
- Chrome plated, diamond plate steel rear safety deck
- Centrifugal clutch for slip protection

Model No:	Cutting Width	Engine H.P.	Overall Width	Hitch Offset	Wt.
ERM-416	48"	17.5 HP	55 ½"-68"	Up to 24"	500#
ERM-617	60"	17.5 HP	67 ½"-80"	Up to 30"	600#

# ROTARY MOWERS

*Rear Discharge Mowers*

## *Finishing Mowers*



We now have available rear discharge mowers featuring totally open rear deck with belt guards that allow the grass to be safely and smoothly discharged giving your turf that rich, manicured look. Some of the other outstanding features are: Free floating flex hitch, dual tires front and rear, self-tightening belt, 40 H.P. gearbox, and heavy duty fully baffled steel deck.

- Free floating, flex hitch system
- Heavy duty steel deck, with rear discharge
- Heavy duty cast iron gearbox
- Easy height adjustment
- Turf friendly, 9 x 3.50 - 4 ply solid rubber tires
- Anti-scalp front roller
- Fully baffled deck

Model No:	Cutting Width	Blade Size	Blade Tip Speed - FPM	Wt.
RFM-48	48"	¼" x 2" x 16"	14,400 FPM	620#
RFM-60	60"	¼" x 2" x 20"	17,985 FPM	660#
RFM-72	72"	¼" x 2" x 24"	18,463 FPM	710#
RSFM-72*	72"	¼" x 2" x 24"	18,463 FPM	720#

*\*Special belt with double V design helps to prevent slippage in rough mowing conditions*

# ROTARY MOWERS

*Dual Gauge Wheels For Stability*

*48" & 60" Width Mowers*

Our **Rotary Mowers** were developed to obtain maximum strength and stability. The strength was obtained by using the same gearbox, spindle assembly, blades and driveshaft that are used on our heavy I beam mowers. The stability was obtained by mounting the mower closer to the tractor with the addition of twin rubber tailwheels. The combination of strength and stability allows the operator to mow in rough terrain with maximum control of the tractor and mower.

- Cat. 1, 3-point hitch
- Adjustable cutting heights from 1 to 6 inches
- Bolt-on replaceable side plates
- External front to rear deck ribbing for added strength
- Heavy round dished spindle pan
- Floating hitch design follows the contour of the terrain
- Heat treated ½" thick x 3" wide blades
- Adjustable dual rubber tailwheels
- Front rubber safety shielding, standard
- Standard color yellow - available in tractor colors



Model L-48-40-XB

Model No:	Cutting Width	Overall Width	Overall Depth	Wt.
L-48-40-XB	48"	51"	62"	400#
L-60-40-XB	60"	63"	74"	450#

# ROTARY MOWERS

*Round Back Design for Easy Maneuverability*

*"200" Series Standard Duty*

Our **200 Series Mowers** feature round back design for easy maneuvering in tight corners, around trees, fences, and other obstructions. The rounded rear opening also allows for more even distribution of exiting material. All models now feature higher horsepower gearboxes, which allow for operating safely with higher horsepower tractors. The flexible floating hitch follows the contour of the terrain without putting stress on the mower and tractor. Also, hitch is designed to A.S.A.E. quick hitch standards for easy hook-up to tractor with a quick hitch system.



60" Mower w/Optional Chain Shielding Shown

### FEATURES: Now Fully Welded Deck

- Cuts up to 1" diameter material
- Flexible floating hitch follows contour of terrain
- Two 2" x 2" full length angles for main deck support
- Shielded series 4 PTO shaft
- Powder coated paint
- Optional - rubber or chain safety shielding

### SPECIFICATIONS:

- Hitch: Cat. 1, ASAE Quick Hitch
- Gearbox: 540 RPM
- Deck Thickness: 11 Gauge
- Deck Depth: 7 ½"
- Tailwheel: 3 ¾" x 15" Laminated
- Cutting Height: 1" to 9"
- Blade Size: ½" x 3"
- Blade Pin: 1 ½" Diameter
- Driveshaft: Shear Pin Protection or Slip Clutch



**WARNING:** *If operating mower near roads and/or where people are present, you must equip mower with deck shielding*

Model No:	Cutting Width	Gearbox H.P.	Overall Width	Overall Length	Blade Tip Speed - FPM	Wt.
RC200-48	48"	50 H.P.	52"	85"	13,090 FPM	510#
RC200-60	60"	65 H.P.	63"	98"	14,335 FPM	585#
RC200-72	72"	65 H.P.	76"	110"	14,955 FPM	710#

# ROTARY MOWERS

*With I Beam Sides For Added Strength*

## "Flex-Hitch" Mowers

5' Mower with  
Optional Safety  
Chains



- 3-Pt. Hitch: ASAE Cat. 1, quick hitch compatible
- Flex-Hitch: Allows hitch to flex front to rear and side to side
- Side Plates: 6" I Beams full length
- Gearbox: 40 H.P. - 540 RPM
- Tailwheel: Laminated rubber
- Cutting Height: 1" to 8"
- Blade Size: ½" x 3" w/ 1 ½" Dia. Blade Pin
- Driveshaft: Shear Pin or Optional Slip Clutch

L72-60HD Shown with  
Optional Chain Shielding



These **Gearmore Rotary Mowers** are the economical answer for medium duty use in weed and brush mowing. Special built-in features include floating hitch that follows the contour of the terrain, heavy round spindle pan to protect the gearbox, strong 8" I beam side channels for added strength, laminated tailwheel, and slip clutch driveshaft; all engineered to assure years of trouble-free service.



**WARNING:** *If operating mower near roads and/or where people are present, you must equip mower with deck shielding*

The **Rotary Mowers** feature a Patent Pending "Flex-Hitch" that allows the mower to roll 15° front to rear and side to side. This allows the mower to follow the contour of the ground and is not available from other manufacturers. Another special feature is the sloped domed deck that sheds water and debris preventing material from collecting on the deck. Also, 6" full length I beams insure strength where the mower needs it the most. All these mower features were designed to insure years of trouble free service.

Model No:	Cutting Width	Overall Width	Overall Depth	Blade Tip Speed	Wt.
L-48-40-P-FH	48"	51"	82"	11,500	430#
L-60-40-P-FH	60"	63"	95"	12,500	535#
L-72-40-P-FH	72"	75"	107"	15,000	710#

- Sloped, domed deck sheds water & debris
- No stitch welds, all fully welded seams
- Heavy round dished spindle pan for gearbox protection
- Two full length rails for deck support
- Heat treated heavy blades and blade bolts
- Color yellow

# ROTARY MOWERS

*Floating Hitch To Follow Contour of Terrain*

## "Medium Duty" Series

- Floating hitch design follows contour of terrain
- Heavy 8" I beam sides w/ribbed crossmembers
- Slip clutch driveshaft to prevent damage
- Forged heat treated blades and blade pins
- Optional safety shielding, front and rear
- Dual tailwheels for increased stability

- Side Rails: 8" I Beams
- Top Deck: ¾" Plate
- Hitch: Cat. 2
- Gearbox RPM: 540
- Tailwheels: Laminated
- Blade Holder: Spindle Pan
- Blade Size: ½" x 4"
- Driveshaft: Slip Clutch

Model No:	Cutting Width	Overall Width	Overall Length	Tail Wheels	Gearbox H.P.	Wt.
L60-60-HD	60"	62"	86"	1	60 H.P.	800#
L72-60-HD	72"	74"	92"	2	60 H.P.	1100#
L84-80-HD	84"	86"	104"	2	80 H.P.	1480#

# ROTARY MOWERS

3-Pt. or Pull Type - 540 or 1000 RPM Tractors

Available in 10' & 15'

These 10 foot wide **Rotary Mowers** are available in 3-point lift type or trailer pull type. For stability, both models are fitted with dual wheels supported with large 21" diameter laminated tires. The dual spindles are powered by 90 horsepower gearboxes. For added protection, a constant velocity driveline is provided. Designed for those tough mowing jobs and insures years of trouble free usage.

- 2 - 90 HP, 540 RPM outboard gearboxes
- 125 HP, 540 RPM splitter gearbox
- 2" x 3" Tubular deck reinforcement
- Slip clutch gearbox protection
- 16,233 FPM blade tip speed
- ½" x 4" Swinging blades
- Cutting height - 1 ½" to 12"
- Chain shielding - front & rear
- Up to 2" brush diameter
- Minimum PTO H.P. - 50
- ¼" x 10" Side plates
- 7 Gauge deck (¾")
- Round stump jumper
- Replaceable skid shoes
- Hitch type - Cat. 2 & 3 ASAE quick hitch or pull type

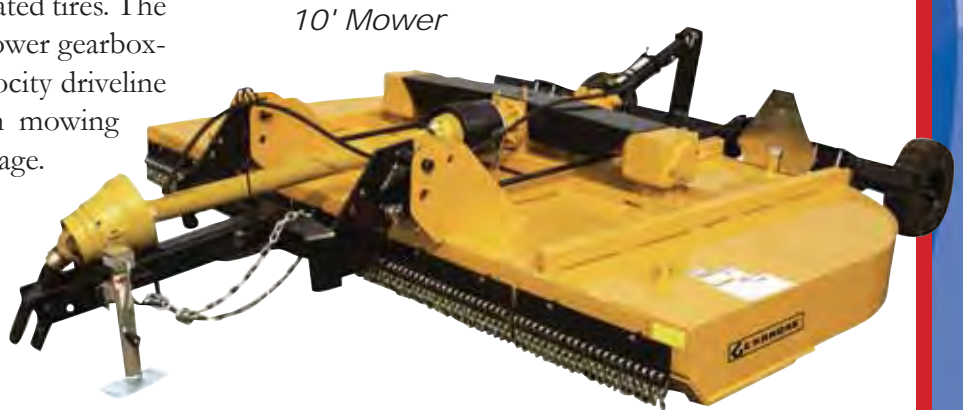

10' Mower

### SPECIFICATIONS:

Model No:	Type	Cutting Width	Overall Width	Overall Length	Min. PTO H.P.	Wt.
270-120-L-SL-CG	3-Point	120"	10' - 4"	9' - 6"	50 H.P.	2250#
270-120-P-SL-CG	Pull Type	120"	10' - 4"	19' - 6"	50 H.P.	2725#

These large 15 foot **Rotary Mowers** feature 2 bat wings that hydraulically fold to 9 feet for transporting. These 1500 series mowers have heavy 7 gauge (¾") steel decks, ¼" side skirts, stump jumpers, reversible clevis hitch, and spring wheel shock absorbers. The dependable four gearbox design features slip clutch driveline and constant velocity input driveshaft. These mowers have been time tested in commercial, governmental and agricultural applications.

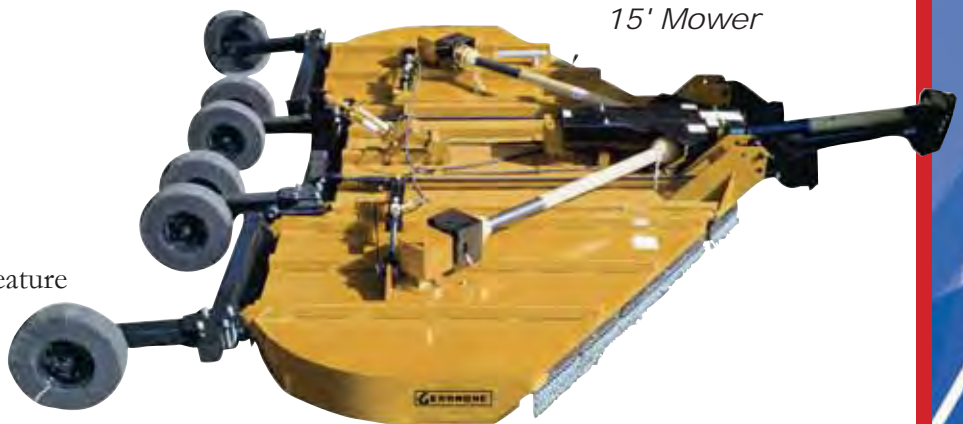

15' Mower

### FEATURES:

- 125 HP, 540 RPM splitter gearbox or 180 HP, 1000 RPM splitter gearbox
- 3 - 90 HP gearboxes, 540 RPM or 3 - 140 HP gearboxes, 1000 RPM
- Spring cushioned wheel axles
- Blade tip speed - 15,000 FPM
- 7 Gauge deck thickness
- Round stump jumper
- Cat. 4 wing drivelines
- Cutting height 1" to 15"
- Cuts brush up to 2" dia.
- Self-leveling tongue
- Wing fold hydraulics
- Minimum PTO H.P. - 65
- ¼" x 10" Side plate
- Skid shoes, wing
- Center section skid shoes
- Tongue jack
- Dual center wheels
- CV input driveline
- Wing cylinders - 3" x 12"
- Transport cylinder - 3" x 8"
- All cylinders and hoses included
- Safety chain front and rear

### SPECIFICATIONS:

Model No:	PTO R.P.M.	Cutting Width	Transport Width	Length	Wt.
1550-DL-CG-CY	540 R.P.M.	15'	9'	15'	4875#
1510-DL-CG-CY	1000 R.P.M.	15'	9'	15'	4875#

# ROW MULCHERS

*Effective Application of Bulk Materials in Rows*

*Marketed by Gearmore*

More and more vineyards and orchards are incorporating organic mulch and compost as a means to help reduce chemical usage.

The **Row Mulcher** makes large scale use of mulch feasible for any size vineyard, orchard, or row crops.

The machine applies neat, uniform rows of mulch right where you want. These mulchers are constructed with 11 gauge (1/8") thick galvanized steel bodies on heavy channel chassis. The special poly floors guaranteed to last at least 10 years.

The mulchers are easy to adjust the spread pattern to suit your personal requirements. The removable cross conveyor allows for spread down row centers.



- Spreads right side, both sides and center drop
- Applies virtually any type of organic mulch
- Optional cleated belt is ideal for bark/mulch, and wet compost
- Many other options to choose from

Applies:

- ~ Bark Mulch
- ~ Compost
- ~ Wood Chips
- ~ Mushroom Soil
- ~ Topsoil/Peat Mixtures
- ~ Sawdust

Model No:	Heaped Capacity	Maximum Payload	Overall Width	Overall Length	Loading Height	Tires	Weight
304	4.4 yd. <sup>3</sup>	3,000 lbs.	55"	15'	6'	9.5Lx15x8 Ply	2100#
406	5.4 yd. <sup>3</sup>	4,000 lbs.	62"	16'-10"	6'	11Lx15x12 Ply	2500#
506	6.7 yd. <sup>3</sup>	3,800 lbs.	62"	18'-10"	6'	11Lx15x12 Ply	2700#
606	8 yd. <sup>3</sup>	7,800 lbs.	67"	20'-10"	6'-6"	14Lx16.1x12 Ply	3300#
706	9.3 yd. <sup>3</sup>	7,500 lbs.	67"	22'-10"	6'-6"	14Lx16.1x12 Ply	3500#
588	7.8 yd. <sup>3</sup>	6,000 lbs.	85"	16'-10"	6'-6"	14Lx16.1x12 Ply	3200#
1028	13.5 yd. <sup>3</sup>	10,500 lbs.	85"	22'-10"	6'-10"	14Lx16.1x12 Ply	4200#

# VACUUM PLANTERS

*The Precision Vegetable Seeder*

*Custom Built Planting Systems*

*We custom build planting systems to growers individual requirements, see our website for details.*



*Standard 8 Row Vegetable Planter Shown*

The **Gearmore Precision Vacuum Planters** are designed for extremely accurate vegetable seed placement. The P.T.O. driven turbine fan or optional hydraulic drive creates a vacuum that draws seeds against the seed plates. Inner and outer singulators remove doubles to insure that individual seeds are secured to the vacuum hole. At the seed release point, vacuum is cut off and the seed is deposited in the furrow. The air compressor then injects a short blast of air to insure the hole is clean for the next seed. Easy to operate and maintain, this durable precision planter efficiently handles the smallest of seeds either raw or coated.

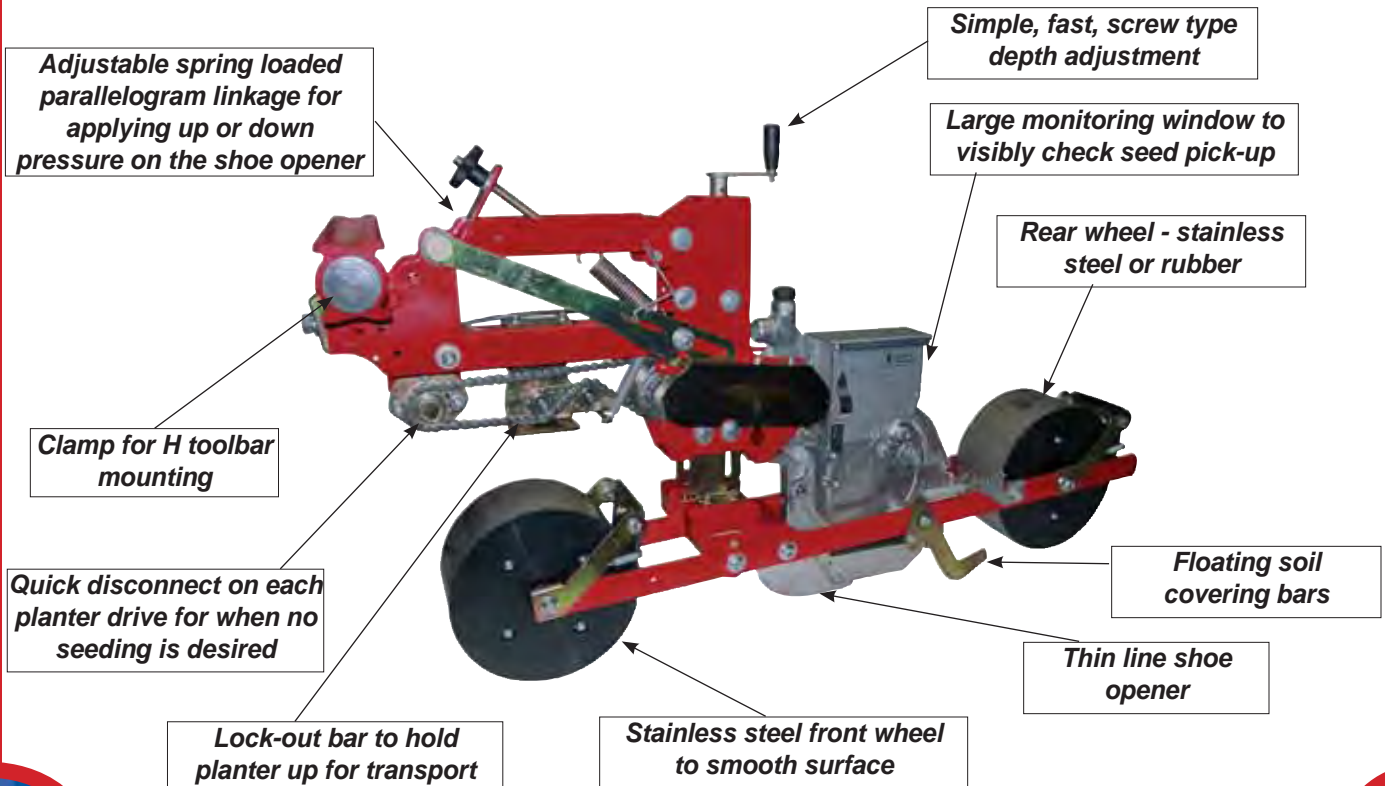



# SEED PLANTER

For Planting Leafy Green Produce

*High Density*



This *High Density Salad Seed Mechanical Planter* allows for planting rows as close as 1/4" apart. The polilatex sponge horizontal feed rollers are easy to remove for unloading seeds and cleaning before changing seeds. Tandem tool-bars with 32 soil openers are adjustable and removable if wider row widths are required. Four crank adjustment with planting depth gauges for precise raising and lowering of soil openers. Front and rear stainless steel rollers insure a smooth level bed top for mechanical harvesting. One of the many unique features is the positive ground drive. Thus the planter obtains equal seed distribution no matter what the speed of the tractor.



Seeding Distributors



Easy Disassembly of Rollers



Easy Distributor Disassembly

Model No:	Description	Width	Depth	Wt.
AI-620-SNT-32	Salad Seed Planter - 32 Lines, 2" Spacing	6' - 2"	6'	1200#



# SEED PLANTER

Plant 96 Lines on 3-80" or 3-84" Rows

*Folding Planter*

Our massive hydraulic folding frame was designed to mount 3 separate high density planter modules. The planter features 12 seed distributors with polilatex horizontal sponge rollers with 8 outlets each, so a total of 96 rows can be planted at the same time. A hydraulic motor powers the 6 stainless steel front and rear rollers to insure smooth level beds.

The 96 stainless steel soil openers are adjustable for spacings as close as 1 1/4" apart. Simple crank adjustment give exact depth control. The quantity of seeds planted is controlled by changing chain and sprocket ratios. The most unique and important feature of the planter is the positive hydraulic ground drive which obtains equal seed distribution, no matter what the tractor speed.



Model No:	Description	Overall Width	Folded Width	Depth	Wt.
AI-620-SNT-F	Folding Hydraulic Frame with 3 High Density Planter Modules	23'	15'	8'	6600#

# BASKET RAKES

*Designed For Heavy Duty Usage*

*High Production Basket Rakes*



*Model 2030-G2 Shown with Optional Gauge Wheels*



*Fluffy, Uniform Windrows*



*27' & 30' Raking Widths*

**Generation 2 Twinstar Basket Rakes** are designed for growers committed to producing superior quality hay. Twinstar Rakes produce consistent uniform windrows with less dirt, rocks, and debris than traditional wheel and rotary rakes. Twinstar models 2027 and 2030 are equipped with 7 tine bars which makes fluffier windrows, allows for increased raking time and higher ground speed. They are designed with double slide tubes for added strength. The baskets are now powered by heavy duty motors as standard equipment. The main hydraulic hoses fold and unfold in the unique Twinstar "Hose Trac" system. This clean, trouble free system gives total hose protection when extending and closing the double extension beams. Gauge wheels front and rear are optional equipment.

Model No:	2024-G2	2027-G2	2030-G2
Maximum Raking Width:	Up to 24'	Up to 27'	Up to 30'
Transport Width:	11' - 3"	10' - 9"	10' - 9"
Transport Depth:	18'	20' - 2"	20' - 2"
Basket Sizes:	24" Dia. x 10 ½' Long	30" Dia. x 10 ½' Long	30" Dia. x 12' Long
Basket Reel Speed:	Maximum 90 RPM	Maximum 90 RPM	Maximum 90 RPM
Tine Bars:	5 Bars	7 Bars	7 Bars
Rubber Mounted Tines:	Std: 100 per basket-Option: 150	Std: 154 per basket-Option: 224	Std: 175 per basket-Option: 259
Operating Speed:	Up to 8 MPH	Up to 10 MPH	Up to 10 MPH
Hydraulic Requirements:	12 GPM @ 2000 PSI	12 GPM @ 2000 PSI	12 GPM @ 2000 PSI
Tire Size:	(4) ST205/75R15	(4) LT235/75R15	(4) LT235/75R15
Clevis Hitch:	Standard	Standard	Standard
Gauge Wheels:	Front & Rear - Optional	Front & Rear - Optional	Front & Rear - Optional
Ball Hitch 2 ½":	Optional	Optional	Optional
Weight:	3500#	5100#	5600#

**Marketed by Gearmore, Inc.**

# RAKES

For 20 to 60 Horsepower Tractors

## Landscape

Model LRU-7  
Rake Shown



Optional Dual Caster  
Gauge Wheels

These **Landscape Rakes** are ideal for general grooming, soil preparation, removing rocks, roots and debris, and spreading crushed rock or top soil. Five forward and reverse angle position for windrowing material. The reverse positions are great for pushing material into low spots.

We have two different series of rakes available, one for tractors up to 40 H.P. and one for tractors up to 60 H.P.

CAT I  
A.S.A.E.  
QUICK  
HITCH  
COMPATIBLE



Model LR20-72 Rake  
with Optional Gauge  
Wheels Shown

### Features for LRU Series:

- Cat. 1, A.S.A.E. quick hitch compatible
- For tractors up to 60 H.P.
- 5/16" x 1" x 15" High carbon steel teeth
- 1" Spacing between teeth
- Five forward and reverse angle settings
- Frame is made of 3/16" x 4" x 4" steel tubing

### Optional equipment:

- ~ Dual caster gauge wheels
- ~ Teeth stiffeners

### Features for LR Series:

- Cat. I, A.S.A.E. quick hitch compatible
- 5 Forward and reverse angle positions
- Maximum angle setting of 45°
- Heat treated replaceable tines
- Formed tine with lockable tine spacing
- 5/16" x 1" Heat treated spring steel tines
- 1" Spacing between tines
- Grade 5 plated hardware
- Powder coated charcoal

### Option:

- ~ Dual caster gauge wheels

Model No.	Width	Horsepower	No. of Teeth	Weight
LR20-60	60"	20 to 40 H.P.	30	195#
LR20-72	72"	20 to 40 H.P.	36	212#
LRU-6	72"	30 to 60 H.P.	36	240#
LRU-7	84"	30 to 60 H.P.	42	270#
LRU-8	96"	30 to 60 H.P.	48	300#

# RIDGERS

*Built For Heavy Duty Use*

*Adjustable Gangs*

## FEATURES:

- Cat. 2, 3-point A.S.A.E. quick hitch
- 4" x 6" x ¼" Wall x 8' long toolbar
- Gangs adjust for tilt and pitch
- Self aligning trunnion 1 ½" bearings
- Available in 3 or 4 blade
- Blades on 9" centers with cast iron spacers
- Parking stand
- Optional mud scrapers



## SPECIFICATIONS:

Model No.	Description	Required Horsepower	Weight
BE222-3	3 Blade Ridger with 22", 24", & 26" Blades	60 Minimum H.P.	1000#
BE422-4	4 Blade Ridger with 22", 24", 26", & 28" Blades	60 Minimum H.P.	1080#
<i>NOTE: 3 and 4 gang ridgers are also available for mounting on 2 ¼" diamond toolbar</i>			

# RIDGER BLOCKERS

*Built For Heavy Duty Use*

*Complete With Ridger*

## FEATURES:

- Ridger specifications same as above
- Blocker frame - 4" x 6" x ¼" wall
- Toolbars are 8 feet long
- Blocker width 24" with ¾" x 4" replaceable plow steel edge
- 3 ½" x 8" Hydraulic cylinder with hoses



## SPECIFICATIONS:

Model No.	Description	Required Horsepower	Weight
BE222-3B	Complete 3 Blade Ridger with Blockers	60 Minimum H.P.	1200#
BE422-4B	Complete 4 Blade Ridger with Blockers	60 Minimum H.P.	1280#

# RIPPERS

3 Sizes Available For 25, 50 & 75 HP Tractors

## Single Shank



The **GR100** is for tractors up to 25 horsepower. These rippers are great for cutting narrow trenches for irrigation pipe. The optional 12" furrower shovel digs a smooth trench for water flow.

The **GR200** is for tractors up to 50 horsepower. This unit is recommended for breaking up compacted soil to increase root growth and yields.

The **GR300** is for tractors up to 75 horsepower and was designed for heavier duty use. Thus, the ripper can be used for high horsepower tractors. This ripper is recommended when deep ripping is required.

Model No:	H.P. Rating	Frame Tube Size	Shank Length	Shank Size	Hitch	Shear Bolt Protection	Optional 12" Furrower	Parking Stands	Weight
GR100	Up to 25	3" x 3"	19"	1" x 4"	Cat. 1	Yes	Yes	No	85#
GR200	Up to 50	4" x 4"	23"	1" x 6"	Cat. 1	Yes	No	Standard	130#
GR300	Up to 75	4" x 8"	27"	1" x 10"	Cat. 2	Yes	No	Standard	240#



# RIPPERS

*Breaks Up "Hard Pan" Created By Tractor Tires*  
**Tractor Tire Track Rippers**

Tractors have to make many passes through vineyards and orchards. This creates hard pan under the tractor tires. From time to time, it is recommended to rip that area to aerate the soil for better water penetration to increase root growth. The spread width of the ripping shanks can be set to the tractor tire centers and this then shatters the soil over the compacted area up to 18" deep. These rippers have two 4" x 6" beams for added strength. Models available for all popular vineyard row spacings.

- Cat. 1 & 2, 3-point, ASAE quick hitch
- 2 - Adj. shanks for ripping soil up to 18" deep
- Adj. bolt-on shank brackets can be set for different tractor tire tread widths
- Shear bolt design, shanks swing up if hitting obstructions
- Shanks are made of 1" x 6 1/2" x 22" steel

- Main beam 4" x 6" x 1/4" wall tubing
- Replaceable high carbon, heat treated points
- Clevis type hitch bracket
- Parking stand

Option:

~ Hard faced shanks & points

Model No.	Description	For Row Widths	Beam Width	Adjustable Shank Centers	Weight
R2-55	3-Pt. Ripper	6' (72")	55"	38" to 48"	320#
R2-67	3-Pt. Ripper	7' (84")	67"	40" to 60"	350#
R2-72	3-Pt. Ripper	8' (96")	72"	48" to 66"	360#
R2-96	3-Pt. Ripper	10' (120")	96"	60" to 90"	390#

# V-RIPPERS

*Narrow & Wider Widths For Vineyards or Farm Use*

*Cat. 1 - 30 to 50 Horsepower*

These *V-Rippers* come in narrow widths for vineyards and berries and wider widths for general farm use. The "V" design main beam and curved shanks reduce horsepower requirements. The deep ripping obtains excellent soil aeration, which allows greater water penetration and absorption. Also increases root growth and penetration. All this adds up to better crops and higher profits.

## FEATURES:

- For ripping up to 18" deep
- Heavy 4" x 6" beam construction to insure long life
- 1" x 6" x 22" Shanks
- Shanks adjustable with shear bolt protection
- Replaceable high carbon, heat-treated points



## SPECIFICATIONS:

Model No:	No. of Shanks	Beam Width	Weight
R3-50	3	50"	420#
R3-60	3	60"	435#
R3-70	3	70"	450#
R5-60	5	60"	550#
R5-70	5	70"	570#

# V-RIPPERS

*Deep Ripping Aids in Excellent Soil Aeration*

*Cat. 2 & 3 - 80 to 195 Horsepower*



## SPECIFICATIONS:

Model No:	No. of Shanks	Hitch Category	Shank Size	Maximum Horsepower	Shank Spacing	Beam Size	Weight
VR3F	3	2	1" x 27"	80 H.P.	Fixed 30"	4" x 6" x 70"	675#
VR3	3	2	1" x 27"	80 H.P.	Adjustable	4" x 6" x 84"	715#
VR5F	5	2 & 3	1 1/4" x 34"	140 H.P.	Fixed 20"	6" x 8" x 90"	1300#
VR7F	7	2 & 3	1 1/4" x 34"	195 H.P.	Fixed 20"	6" x 8" x 130"	1525#

## FEATURES:

- "V" design & curved shanks reduce horsepower requirements
- Fixed and adjustable shanks available
- Shear bolt protection
- Replaceable high carbon, heat-treated points
- Parking stands that store in frame
- Optional gauge wheels for VR7F only

# RIPPERS

*For Extreme Duty Sub Soiling*

**"GE" Series**

Model GE36-24 Shown



- Cat. 3 & 4N 3-point A.S.A.E. quick hitch
- Frame - 6" x 8" x 3/8" structural tubing
- "L" style shanks are 1 1/2" thick by 36" long
- 1" Thick "plow steel" lower hitch brackets
- Double dual steel wheels, 8" wide x 30" diameter (Optional on 5 shank rippers)
- Chrome shin guards on shanks - replaceable
- Heavy duty chrome chisel points - replaceable
- 1 1/4" Grade 5 swing shank bolts
- 1 1/4" Grade 2 shear shank bolts

**Options:**

- ~ SW30 - Set of steel wheels for 5 shank ripper
- ~ WW16 - Set of dual 11L x 16 rubber tires for 5 shank ripper
- ~ WW16-7 - Set of dual 11L x 16 rubber tires in lieu of steel wheels for 7 shank ripper

Model No.	No. of Shanks	Shank Spacing	Frame Width	Weight
GE536-24	5	24"	8 Feet	3750#
GE536-30	5	30"	10 Feet	3910#
GE736-24	7	24"	12 Feet	4920#
GE736-30	7	30"	15 Feet	5050#

# RIPPERS

*Pull Type - Heavy Duty Tongue*

**"BE" Series**



**CAUTION - You must lower the rear parking stands and lock in place before uncoupling from the tractor.**

- Heavy duty tongue assembly
- Frame made of 6" x 8" x 3/8" thick structural tubing
- "L" style shanks are 1 1/2" thick x 36" long
- Replaceable chrome shin guards on shanks
- 15.5L x 22.5 Tires
- 5" x 18" Hydraulic cylinders with depth stops
- Parking stands, front and rear
- Requires 45 horsepower per shank

**Options:**

- ~ 42" Long shanks
- ~ Rear hitch

Model No.	No. of Shanks	Shank Spacing
BE5PRS36-30	5	30"
BE7PRS36-24	7	24"
BE7PRS36-30	7	30"
BE7PRS36-36	7	36"

Manufactured By:

**BWI**implement

# RIPPING IMPLEMENTS

## Deep and Shallow Ripping Tools

### Heavy Duty "RS" Series V-Rippers

The "V" design of the shanks are available in standard curved or parabolic style. Both types of deep ripping shanks obtain excellent soil aeration, which allows greater water penetration and absorption. Also increases root growth and penetration. The rippers are very effective for first pass soil preparation for easier discing and other finish tilling implements.

- V frame is constructed with 6" x 8" x 3/8" tubing
- Standard curved design shanks - 1 1/4" x 31" long
- Shanks also available 1 1/4" x 34" in standard and parabolic design
- Chrome shin guards and points
- Shank pockets are available as fixed or adjustable
- Horsepower required is 25 HP per shank
- Gauge wheels available as single or dual - 9.5L x 15
- Cat. 2 or 3, 3-point hitch (please specify)

7 Shank with optional single gauge wheels and parabolic shanks shown



Model No.	Description	Width	Weight
RS-30HD	3 Shank V-Ripper	5' - 3"	1200#
RS-50HD	5 Shank V-Ripper	8' - 2"	2200#
RS-70HD	7 Shank V-Ripper	13' - 8"	2800#
RS-90HD	9 Shank V-Ripper	15' - 6"	3500#

# RIPPING CHISELS

## Loosens Soil Up To 15" Deep

### "GRC" Series

- Cat. 3 & 4 narrow, 3-pt. quick hitch compatible
- Frame 5" x 5" x 3/8" wall steel tube
- 3 Shank beams on 36" center
- Beam cross braces 5" x 5" x 3/8" wall
- 4 Tubing braces to support top mast
- 1 1/4" x 30" Rigid plow steel shanks w/shear bolt
- Welded plow steel shank pockets
- Shanks are on 12" centers
- Single gauge wheels - 9.5L x 15

#### Options:

- ~ 3/4" x 15" Reversible spike points
- ~ Rear clevis hitch
- ~ Dual gauge wheels (in lieu of single)

Our 3 bar finishing **Ripper Chisel** is an effective implement for loosening soil up to 15 inches deep. The rigid shank design insures consistent depth. The narrow 12" shank spacing is excellent for breaking up and incorporating of residue. These ripping chisels are the perfect tool for opening up heavy soils for aeration. The shear bolt shanks allow for higher speeds than most tillage implements.



21' Model shown with single gauge wheels and optional rear hitch and points

Model No.	No. of Shanks	Width	Weight
GRC-15	15	15 ft.	4450#
GRC-17	17	17 ft.	4750#
GRC-19	19	19 ft.	5050#
GRC-21	21	21 ft.	5350#
Other Widths Available Upon Request			

Manufactured By:

**BWI**implement



# SCRAPERS, BOX

For Tractors up to 30 & 40 Horsepower

**"BSL" & "Econo" Series**

"BSL" Series



"Econo" Series

To make box scrapers more versatile, nothing works better than being able to control the tilt and pitch of the implement. Grading jobs are more accurate because you have complete control to develop the slopes you require when landscaping, building roads, etc.



*Valve & Bracket Assembly*

- Special built-in oil flow restrictors which insure smooth operation
- Specially designed to fit your tractor
- Cylinders are available in 2", 2 1/2" and 3" bore, depending on the tractor size
- Cylinders can be purchased in any combination, top only, tilt only or both

- For compact tractors up to 30 H.P.
- Clevis type hitch brackets
- Side plates are 1/4" x 16" x 22"
- Main beam 1/4" x 4" x 4" tubing
- Heat treated scarifier shanks w/replaceable points

Model No.	Cut. Width	No. of Shanks	Weight
BSL-42	42"	3	275#
BSL-48	48"	4	290#

- For tractors up to 40 PTO H.P.
- Main beam - 3" x 5" tubing
- Heat treated shanks with replaceable points
- 3 Depth settings on scarifier shanks
- Side plates are 1/4" x 16" x 24"

Model No.	Cut. Width	No. of Shanks	Weight
EC4	48"	4	285#
EC5	60"	5	330#
EC6	72"	6	375#

## TOP & TILT KITS

*Makes Box Scrapers More Versatile*

***Valve & Bracket Assy, & Cylinders***

- Valves are available in 2 & 3 spool
- Valves handle flows from 15 to 17 GPM (10-13 GPM through the ports) @ 3000 PSI
- Brackets available for most popular models on Case, New Holland, John Deere and Kubota compact tractors
- Bracket assemblies consist of: rollbar clamp, adjustable arm with valve mounting and safety valve cover



*Top & Tilt Cylinders*

# SCRAPERS, BOX

Manual, Mechanical & Hyd. Shank Retracting

**"GBS" Series**

"GBS/H" Series



"GBS" Series



"GBS/R" Series



## FEATURES:

- For Cat. 1 tractors of up to 40 HP 4 WD & 50 HP 2 WD, A.S.A.E. Quick Hitch
- 3 types of shank adjustments to choose from: MANUAL, MECHANICAL and HYDRAULIC
- Designed so that shanks retract straight up, thus improves view of cutting edge and reduces machine weight (GBS/R & GBS/H)
- Positive locking system in both engaged and retracted positions
- Adjustable heat-treated scarifier shanks with replaceable points
- ½" x 6" Reversible cutting edges front & rear
- Side plates are ¼" thick x 18 ½" high x 26 ½" long - 72" and up are ⅜" thick
- Clevis type hitch points
- 4" x 4" Steel tubing main beam
- Sizes to fit your width requirement

## SPECIFICATIONS:

Cutting Width	Overall Width	No. of Shanks	Weights		
			GBS	GBS/R	GBS/H
42"	42 ½"	3	330#	360#	360#
48"	48 ½"	4	355#	405#	405#
54"	54 ½"	4	395#	435#	435#
60"	60 ½"	5	440#	480#	480#
66"	66 ½"	5	490#	505#	505#
72"	72 ¾"	6	540#	575#	575#
76"	76 ¾"	6	560#	600#	600#
80"	80 ¾"	7	600#	630#	630#
84"	84 ¾"	7	620#	665#	670#

# SCRAPERS, BOX

For Tractors 15 to 60 Horsepower

## Industrial "2G" Series



"2G1" Series



"2G2" Series

The **2G1 Series Scrapers** are designed especially for small compact tractors. Available in widths of 42", 48", 54" & 60" for tractors from 15 to 40 HP, 2 or 4 wheel drive.

The **2G2 Series Scrapers** are ideal for general landscape work such as: terracing, back-filling, scarifying and leveling the soil. Available in widths of 60", 66", 72", 76", & 84" for tractors from 30 to 60 HP, 2 or 4 wheel drive. Available in manual or hydraulic shanks. Now with bushings on 3-point hitch.



Cylinder raises scarifier beam



1 1/2" Dia. scarifier locking pin

### FEATURES:

- Unique hydraulic scarifier system raises scarifier to high clearance position and lowers beam to working position plus automatically self-locks with heavy hardened pin
- Available in fixed or floating tailboard
- Two position, forged, heat-treated shanks with replaceable points
- 2 1/2" x 6" Reversible heat-treated cutting edges, front and rear
- Non-rotating pins or replaceable bushings at all pivot points
- Heavy plate top mast for added strength
- Cat. 1 clevis lower hitch brackets

*Unique hydraulic scarifier system raises scarifier to high clearance position and lowers beam to working position plus automatically self-locks with heavy hardened pin*

### SPECIFICATIONS:

Models	2G1 Series				2G2 Series				
	2G1-42	2G1-48	2G1-54	2G1-60	2G2-60	2G2-66	2G2-72	2G2-76	2G2-84
Working Width:	42"	48"	54"	60"	60"	66"	72"	76"	84"
Overall Width:	42 1/2"	48 1/2"	54 1/2"	60 1/2"	60 3/4"	66 3/4"	72 3/4"	76 3/4"	84 3/4"
No. of Shanks:	4	4	5	5	5	6	7	7	7
Approx. Weight:	410#	445#	480#	520#	770#	830#	860#	890#	920#
Moldboard Ht:	18"				21"				
Main Beam:	1/4" x 4" x 4"				3/8" x 4" x 4"				
Side Plates:	1/4" x 18" x 28"				3/8" x 21" x 33"				

**Available With Fixed or Floating Tailboard**

# SCRAPERS, BOX

For Tractors 50 to 100 Horsepower

## Industrial "4G" Series

The **4G2 Series Scrapers** are designed to handle the demanding work of commercial landscaping and finish grading with its floating tailboard. Available in widths of 72", 76", 80" & 84" for tractors 50 to 70 HP, 2 or 4 wheel drive. Can be built to be A.S.A.E. quick hitch.

"4G2" Series



"4G4" Series



"4G5" Series



The **4G4 Series Scrapers** are extremely rugged and ideal for construction site clean-up, trench back-filling and demanding material handling. Available in widths of 80", 84" & 88" for tractors 60 to 100 HP, 2 or 4 wheel drive.

The **4G5 Series Scrapers** were developed for grading contractors with high horsepower tractors that demand floating tailboard scrapers. The scraper was designed with 4G4 strength, but the versatility of the floating tailboard. In float position, the cutting of hard material is much greater over fixed tailboard units. Available in widths of 80" & 84" for tractors 65 to 85 HP, 2 or 4 wheel drive.

### FEATURES:

- 2 ½" Cylinders in lieu of 3"
- Floating and fixed tailboard models
- 2 Position, forged, heat-treated shanks w/replaceable points
- Main beam ¾" x 5" x 5" tubing
- Moldboard height of 24"
- Non-rotating pins or replaceable bushings at all pivot points



Cylinder & heavy linkage brackets



Solid steel hook and lock assembly



Top mast wraps around 3 sides

### SPECIFICATIONS:

Models	4G2 Series				4G4 Series			4G5 Series	
	4G2-72	4G2-76	4G2-80	4G2-84	4G4-80	4G4-84	4G4-88	4G5-80	4G5-84
Working Width:	72"	76"	80"	84"	80"	84"	88"	80"	84"
Overall Width:	73"	77"	81"	85"	81"	85"	89"	81"	85"
Approx. Weight:	1150#	1190#	1220#	1260#	1340#	1400#	1470#	1350#	1410#
Side Plates:	½" x 24" x 32"				½" x 24" x 35"			½" x 24" x 35"	
HP Rating:	50 to 70 H.P.				60 to 100 H.P.			65 to 85 H.P.	

# SCRAPERS

## 3-Point Hitch and Pull Type Scrapers

### Corral Scrapers

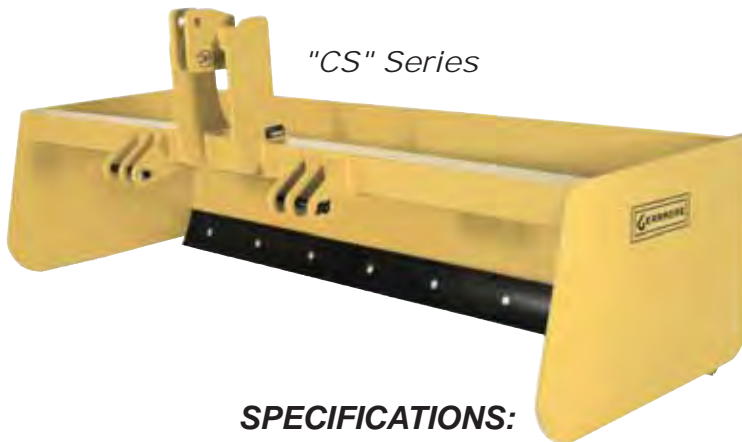

"CS" Series

### FEATURES:

- Designed to move a lot of material fast
- Combination Cat. 1 and 2 clevis hitch
- Square tube main beam 4" x 4" x ¼"
- Rear moldboard ¼" thick
- Heavy duty, large capacity, all welded construction
- Features 24" high x 36" deep x ⅜" thick side plates
- Combination Cat. 1 and 2 clevis hitch
- Stepped, non-turning, combination Cat. 1 & 2 lower link pins

### SPECIFICATIONS:

Model No.	Width of Cut	Capacity	Weight
CS72	72"	36 cu. ft.	660#
CS84	84"	42 cu. ft.	700#
CS96	96"	48 cu. ft.	740#
CS120	120"	60 cu. ft.	800#

½" x 6" Single reversible high-carbon cutting edge



"CD" Series

# SCRAPERS, DRAG

## Makes Turns Loaded and Unloaded

### Compact

### FEATURES:

- Extremely versatile-countless jobs can be done all year round. Level ditches, clean sheds and pens, repair roads, spread gravel, general earth-moving
- Hydraulically operated and controlled from your tractor seat
- Now with removable tongue
- Highly maneuverable - makes turns loaded and unloaded
- Cutting edges are ½" x 6" high carbon and reversible
- Scrapers come standard with tires, cylinder, and hoses
- Clevis type hitch

Specifications:	
Working Width:	5, 6, and 7 Foot
Moldboard:	¼" x 18"
Side Plates:	⅜" x 18" x 24"
Tongue:	Removable ¾" x 3" x 3"
Tires:	Equipped with (2) 5.70-8 Tires
Hydraulics:	2" x 6" Double acting cylinder & hoses
Clearance:	Raised: 12" - Cuts: 3" Below grade
Approx. HP:	25 to 50 Horsepower
Capacity:	(5') - ⅞ cu. yd., (6') - ½ cu. yd., (7') ⅔ cu. yd.
Weight:	(5') - 500#, (6') - 550#, (7') - 600#

### Option:

- ~ Tilt axle assembly

# SCRAPERS, DRAG

## The Easy Way To Carry, Grade & Spread Material

### All Purpose Drag Scraper

Our **Drag Scrapers** are an excellent implement for carrying and spreading all types of material. Landscapers find the scrapers great for general grading and spreading exact depths of top soil. Contractors set the cutting edge to spread different depths of gravel for rebuilding roads and storage yards. Dairy men find the scrapers best for moving you know what. The Drag Scrapers feature a removable 4" x 4" beam tongue that extends to the rear moldboard and is held in place by a 5" x 5" heavy gusseted tube. This feature gives added strength at the point of the most stress.

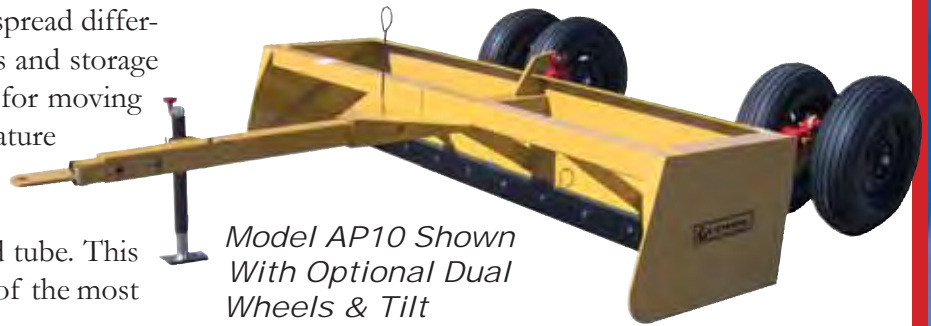

Model AP10 Shown With Optional Dual Wheels & Tilt

#### Options:

- ~ Tilt Axle w/cylinder & hoses,
- ~ Dual Wheels
- ~ Bolt-on Weight Boxes

Model No.	Width	Capacity	Weight
AP8	8'	1 ¾ cu. yd.	1430#
AP10	10'	2 ¼ cu. yd.	1525#
AP12	12'	3 cu. yd.	1895#

- For tractors 70 to 120 horsepower
- Working widths of 8, 10, & 12 foot
- ¾" x 24" x 36" Deep side plate
- Clearance of 23" raised and 5" below grade
- Hydraulically operated from the tractor seat
- Moldboard ¼" plate, 24" high
- Main cross beam 4" x 4" tubing
- 3" x 8" Double acting cylinder and hoses
- Ribbed implement tires - 9.5L - 15SL
- Bolt-on hitch with swivel ball

# SCRAPERS, DRAG

## Drag and Deposit Large Amounts of Material

### High Capacity Drag Scraper

- For tractors 70 to 120 horsepower
- Working widths of 8, 10, & 12 foot
- ½" x 30" x 40" Deep side plates
- Clearance of 23" raised and 5" below grade
- Hydraulically operated from the tractor seat
- Moldboard ¼" plate, 30" high
- Internal braces to side plates and moldboard
- Main cross beam 4" x 4" tubing
- 3" x 8" Double acting cylinder and hoses
- Ribbed implement tires - 9.5L x 15
- Bolt-on swivel slotted hitch



Model HC10 Shown

The **"HC" High Capacity Series of Drag Scrapers** feature heavy, large side plates - ½" thick. These side plates are 30" high by 40" deep, thus allowing for dragging and depositing large amounts of material. Like the "AP" series, the beam tongue extends to the rear moldboard and is held in place by a 5" x 5" heavy gusseted tube. The new axle assembly is built with 4" x 2" tubing. The larger dairies and feedlots find these scrapers best for their operations.

#### Options:

- ~ Tilt Axle w/cylinder & hoses,
- ~ Dual Wheels
- ~ Bolt-on Weight Boxes

Model No.	Width	Capacity	Weight
HC8	8'	2 ½ cu. yd.	1450#
HC10	10'	3 ¼ cu. yd.	1630#
HC12	12'	3 ¾ cu. yd.	2100#

# SCRAPERS, GRADING

Best Implements For Repairing & Maintaining Roads

## Compact & Industrial Series



Compact 5' Shown

Now Available  
Less Shanks



Industrial 8'  
Shown



The **Gearmore Grading Scrapers** were designed to perform many different tasks, such as: landscaping, road repair, arena maintenance, etc. Many unique features enable the operator to do a number of different tasks, no matter what the soil conditions.

**General Landscaping** - The deep ripping scarifier shanks will break-up the hardest of soils. Dual cutting blade will allow for the movement of large amounts of material when required. To finish grade, set the shanks in the storage position and lightly grade, to finish your landscaping project.

**Repairing Roads** - The dual blade flow through action cuts out high spots, fills holes and moves material from the edge of the road toward the center, thus achieving a smooth finished road.

- Quick hitch compatible
- For tractors from 20 to 80 horsepower
- Heavy steel tubing main front beam
- Heavy steel tubing rear support beam
- Heat treated scarifier shanks with replaceable points
- Shanks adjust to ripping & storage positions
- Two ½" x 6" heat treated reversible beveled cutting edges
- Easy to adjust cutting edges with settings of 1 to 1 ½" below side panels (preset at ¼")
- Formed side panels capture and retain material
- ¼" x 2" Replaceable skid plates on side panels

### SPECIFICATIONS:

Model No.	Hitch Type	Cutting Width	Overall Width	Min. H.P.	Main Beam	Weight
GS4	Cat. 1	48"	52"	20 H.P.	3" x 3"	415#
GS5	Cat. 1	60"	64"	25 H.P.	3" x 3"	450#
GS6	Cat. 1	72"	76"	30 H.P.	3" x 3"	505#
GSI7-SS	Skid Steer	84"	89"	45 H.P.	5" x 5"	820#
GSI7	Cat. 1 & 2	84"	89"	45 H.P.	5" x 5"	830#
GSI8	Cat. 2	96"	101"	50 H.P.	5" x 5"	860#
GSI10	Cat. 2	120"	125"	70 H.P.	5" x 5"	1020#
GSI12	Cat. 2	144"	149"	80 H.P.	5" x 5"	1140#

By:

# Level Best

## SCRAPERS, GRADING

Skid Steer, Track Loader & 3-Pt. Tractor Mount

Optional Laser System Available

Para-Level 7' Scraper With Optional Laser System Shown



Model SC60 Compact Scraper Shown With Optional Drawbar Hitch

The compact series of **Grading Scrapers** are available in 3-point hitch for tractor mount or towable for utility or all terrain vehicles. Horsepower requirements are approximately 20 H.P. The scraper is available with hydraulic or electronic liner actuator compatible with most laser systems. Optional drawbar hitch available. The scraper is available with linear electronic or hydraulic and without laser grading system.

### Features for SC & PL Series Scrapers

- Rugged casters w/wheel hubs and tapered roller bearings
- Wide, flat free tires eliminates tire repair and leaves less tire track
- High carbon steel replaceable cutting edges on moldboard and side plates
- Tough, long-lasting, powder coated paint reduces rust/corrosion

Model	Box Size	PTO H.P.	Capacity	Wt.
SC48	48"	20 H.P.	4.1	345#
SC54	54"	20 H.P.	4.6	365#
SC60	60"	20 H.P.	5.1	395#
SC66	66"	20-25 H.P.	5.6	410#
SC72	72"	20-25 H.P.	6.1	425#

These Scrapers are usually sold with the optional laser grading system, as it allows the scrapers to finish grade elevations to within 1/4 inch. The top of the line **Para Level Scraper** is the smoothest operating system, as the grading box adjusts independently from the skid steer and the floatation wheels. The double box on the Para-Level also allows grading in forward and reverse. These high strength scrapers are designed to give years of trouble free use. Hydraulic packages are designed to fit most popular laser systems.

- Composite epoxy - fiberglass bushings in all pivot points eliminates the need for greasing
- Durable steel construction of 3/8" & 1/4" steel plate & heavy wall steel tubing to take daily abuse on a job site

Model	Box Size	PTO H.P.*	Box Capacity		Wt.
Skid Steer Para-Level Grading Box, Dbl			Front	Rear	
PL72	6'	60 +	11.5 cu. ft.	7 cu. ft.	1530#
PL84	7'	70 +	13.4 cu. ft.	8 cu. ft.	1590#
PL96	8'	80 +	15.3 cu. ft.	9 cu. ft.	1650#

\* Recommended horsepower under optimal conditions.  
Custom sizes available.

Optional Laser Scraper Models - Para-Level Slope includes Slope-Tach for cross-slope operation.



# SCRAPERS, GRADING

*With Controls & Beacons For Laser Systems*

*Standard or Super Capacity*

By:

# Level Best

Model LBS7  
Shown

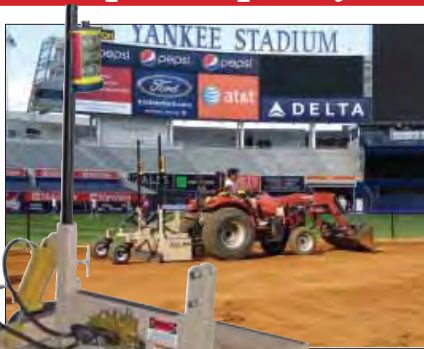

These two series of 3-point hitch **Grading Scrapers** are available in standard or super capacity. The standard capacity scrapers are available in Cat. 1 & 2 and can be operated with tractors as low as 30 PTO horsepower. The super capacity scrapers are Cat. 2 only and can be operated with tractors as low as 60 PTO horsepower. Both series of scrapers are available with or without laser grading system.



Same features as Para-Level plus:

- 4 Flootation tires on super capacity scraper
- Optional drawbar hitch, scarifier bar, and rear hinged cutting edge - standard capacity only

Model No.	Box Size	PTO H.P.	Box Capacity	Wt.
<b>Standard Capacity Tractor Grading Box</b>				
LBS6	6'	30 to 42 H.P.	17.0 cu. ft.	1060#
LBS7	7'	35 to 49 H.P.	19.9 cu. ft.	1120#
LBS8	8'	40 to 56 H.P.	22.8 cu. ft.	1180#
<b>Super Capacity Tractor Grading Box</b>				
LBSE8	8'	70 to 90 H.P.	37.5 cu. ft.	1750#
LBSE9	9'	80 to 100 H.P.	42.3 cu. ft.	1835#
<i>Optional Laser Scraper Models - Double Box Scraper includes cross-slope operation</i>				

## Laser Systems



Hydraulic Pkg.



Apache

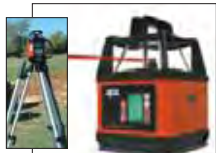

Grado Plane 15



Grado Plane 25

**Laser Mounted Grading Systems** were designed to replace the traditional three person grading crew with a single operator. The units will finish grade elevations to within 1/4 inch. The laser controls are easy to learn and use. As the operator grades, the system's receiver detects laser light from the rotating beacon and transmits a signal to the scraper hydraulic controls. The hydraulic valve uses the signal from the receiver and automatically lowers or raises the grading box to the required grade. Precise finish grade is attained when the "on grade" light remains illuminated.

To make grading scrapers into laser grading scraper 3 components are required:

1. Hydraulic System
  2. Laser System
  3. Tripod Mounted Rotating Laser Beacon
1. **HYDRAULIC PACKAGE**  
Consists of digitally proportional valve, hoses, fittings, & hardware for the following laser systems:
    - Apache - Trimble
  2. **LASER CONTROLS**  
The controls consist of control panel, 360O sensor, cables, and manual override.
    - Apache
  3. **ROTATING LASER BEACONS**  
The tripod mounted rotating laser beacons are either single slope or dual slope.
 

**ROTATING LASER BEACONS**

    - Tripod mounted rotating laser beacons provide either single or dual/cross slope features
    - Automatic or manual programming with remote
    - Self leveling and H.I. Alert
    - 1,000 to 3600 Foot diameter range
    - Tripod, Grade Rod, and Detectors suitably matched to application

# ATTACHMENTS

Makes Skid Steer & Track Loader More Productive

*Skid Steer*

Manufactured By:



PALADIN LIGHT CONSTRUCTION

## Brush Cutters



- Available in 60", 72" & 78" widths
- High speed dual blades for brush up to 4" diameter
- Heavy 1/4" thick steel deck with formed side plates
- Available in standard or high flow
- New heavy duty motor and drive train

## Root Rake



- Dual use - rip out roots and grapple material
- Widths of 72", 78" & 84"
- 49" Grapple opening
- Dual hydraulic cylinders
- Built for extreme duty use

## Trencher



- Available in digging depths of 36", 42" & 48"
- Trench digging widths of 6", 8" & 10"
- Equipped w/2 position side shift
- High torque hydraulic motor for maximum digging power
- Replaceable headshaft driven auger for spoil removal

## Brush Shredder



- 72" Cutting width
- Front of deck swings up for cutting down trees
- Knocks down and shreds trees up to 7" in diameter
- 4 Reversible 3/4" thick blades
- Optional carbide teeth stump grinder

## Cold Planer



- High flow and standard flow models are available
- Planing widths of 12", 16", 18", 24", 30" & 40"
- Fully adjustable with electro-hydraulic controls
- Joystick controls for depth, tilt, and side shift
- Drum diameters of 19" & 22" with carbide picks

## Backhoe



- Available in digging depths of 8 1/2' thru 12'
- Bucket sizes of 12", 16", 18", 20", 24" & 36"
- Dual cylinder swing provides max. power where needed
- Cushioned swing brings backhoe to gentle stop
- Operates with hydraulic systems of 9 to 12 G.P.M.

# ATTACHMENTS

Makes Skid Steer & Track Loader More Productive

*Skid Steer*

Manufactured By:



PALADIN LIGHT CONSTRUCTION

## Dozer Blade



- Available in widths of 84" and 96"
- Rated for tractors up to 110 H.P.
- Electro hydraulic controlled angle and tilt
- Heavy moldboard - .31" thick and 28" high
- Replaceable cutting edge and skid shoes

## Mulcher



- 60" Cutting width
- Shreds up to 8" diameter trees
- Hydraulic deflector door
- 45 Hammers with carbide teeth
- Hydraulic flow of 30 to 60 G.P.M.

## QA Grapple Buckets



"Closed Bottom"

- 2 Series of buckets in widths - 60", 66", 72", 76", 82", & 88"
- For machine weights of 8,000 and 11,000 lbs.
- Patented cushioned and sleeved cylinder
- Steel guards to protect cylinders
- Load check valve system

## Quick Attach Grapple Brush Buckets



"Skeleton Bottom"

- 2 Series of buckets in widths of 66", 72", 78", 84", & 90"
- For machine weights of 8,000# & 20,000#
- Patented cushioned & sleeved cylinder
- 100,000 PSI yield strength tine material
- Load check valve system

## Quick Attach Low Profile Material Buckets



- Widths - 60", 66", 72", 78" & 84"
- Std. 30" length for more severe conditions when break out force is required
- Long length floor - 36" for better visibility, productivity, & cutting grade
- Strong box sections & full wear strips for better bottom protection
- Designed w/20° rollback angle

## JAWZ™ Grabbing Tool



"NEW"

- Sizes to fit skid steers, compact tool carrier & compact tractors w/quick attach
- Dual cylinders power steel jaws
- Mini - Jawz max. lifting wt. 2340#, jaw opening 26"
- Standard - Jawz max. lifting wt. 3000#, jaw opening 33"
- Allows for grabbing & lifting all types of material

# SPRAYERS

Spot • ATV • Utility • Skid • Trailer • 3-Pt.

Spot Sprayers - 15 to 110 Gallon Cap.

## Spot Series 15, 25 & 40 Gallon

- Corrosion resistant polyethylene tank
- Full length drain sump
- 5" Fill lid with tether
- Larger hose wrap horns for hose storage
- Both gallon & liter fluid volume indicator on tank
- 12 Volt (demand) diaphragm pump
- Maximum horizontal throw - 30 ft.
- Maximum vertical throw - 18 ft.
- Ready for Roundup



Model	Gallons	G.P.M.	PSI	Handgun	Hose	Nozzles	Coverage	Wt.
LG-13-P	15 Gal.	2.1 GPM	60 PSI	Lever	15'	-	-	20#
LG-29-P	25 Gal.	2.1 GPM	60 PSI	Lever	15'	-	-	24#
LG-40-SS	40 Gal.	3.8 GPM	45 PSI	Pistol Grip	25'	-	-	50#
UTL-40-5	40 Gal.	2.1 GPM	60 PSI	Pistol Grip	25'	5	100"	117#
UTL-40-12V-BL	40 Gal.	3.8 GPM	45 PSI	Piston Grip	25'	3	30' Fan	108#



## Trailer & Boom Series 25 & 40 Gal.

- Corrosion resistant polyethylene tank
- 12 Volt (demand) diaphragm pump
- Adjustable pressure and gauge
- Larger hose wrap horns for hose storage
- Both gallon & liter fluid volume indicator on tank
- Full length drain sump
- 5" Fill lid with tether
- Ready for Roundup

Model	Gallons	G.P.M.	PSI	Handgun	Hose	Nozzles	Coverage	Wt.
LG-2500-303	25 Gal.	2.1 GPM	60 PSI	Lever	15'	2	80"	55#
TR-40-EX	40 Gal.	2.1 GPM	60 PSI	Pistol Grip	25'	5	100"	155#

## LG 3-Pt. Series 55 & 110 Gal. Cap.

- High quality polyethylene tanks
- Cat. 1, 3-point hitch
- Pressure gauge and relief valve
- 3-Way boom control valve on 110 gallon
- Standard or XL Silvercast pumps
- Optional 21' & 28' booms for 110 gal.
- Quick coupler adapter to PTO connection
- Optional handgun and hose kit

Model	Gallons	G.P.M.	PSI	Pump	Wt.
LG-55-3PT	55 Gal.	9.76 GPM	300 PSI	Cast Iron or Silvercast	130#
LG-110-3PT	110 Gal.	9.76 GPM	300 PSI	Cast Iron or Silvercast	190#

Spray Booms	Spray Width	Boom Type	Nozzle Type	No. of Nozzles	Nozzle Spacing	Wt.
BK-70A	140"	Folding	Fan	7	20"	20#
257-6	21'	Folding	Fan	13	20"	82#
257-8	28'	Folding	Fan	17	20"	96#



# SPRAYERS

## 3-Point and Trailer Models

### 40 Gallon 3-Point



LG-40-3PT-12V

Our 40 gallon **3-Point Sprayer** applies pesticides, herbicides, insecticides or fungicides. The sprayer attaches in minutes to a Category 1, 3-point hitch. The sprayer is equipped with a 4 nozzle spray boom allowing 120" of spray coverage. The 3 section boom features break-away hinges for transport or striking objects such as trees, while spraying.

#### FEATURES:

- 12 Volt High-Flo pump; 2.1 GPM, 60 P.S.I.
- Break-away hinges on boom
- Fold behind 3 section boom
- Deluxe pistol grip handgun
- 15 Feet of hose

These high quality **Trailer Mounted Sprayers** feature a special diaphragm pump which produces 5.3 G.P.M., with pressures up to 275 P.S.I. The sprayers are available with 2.2 horsepower Honda or 3 horsepower Briggs & Stratton engine. Other features of the sprayer are jet agitation, adjustable valve control, line strainer, pressure gauge and zinc plated frame.

#### FEATURES:

- 50 Gallon polyethylene tanks with sump, hatch cover and strainer screen
- Diaphragm piston pump
- Honda or Briggs & Stratton pump
- Steel frame with zinc plating to prevent rust
- Optional 5 and 10 foot booms and handgun with 25 feet of hose

# SPRAYERS

## 3-Point and Trailer Models

### 50 Gallon Trailer



"ET" Series

# SPRAYERS

## Two Sprayer Series

### Economy and Deluxe

You will achieve total versatility and economical performance from our two series of **3-Point Hitch Sprayers**. The rear rails on both series allows for easy mounting of a number of bolt-on attachments such as a vertical boom, horizontal booms, hose reels, and handguns. The sprayers feature reinforced polyethylene tanks suspended from a tubular steel frame to isolate the tanks. Also featured are piston diaphragm pumps and a hand wash tank for convenience and safety.

#### FEATURES:

- Category 1, 3-point hitch
- Polyethylene tanks with liquid level gauge
- Tank capacities of 100 & 150 gallon
- Three piston diaphragm pumps produce up to 11 G.P.M. at 580 PSI
- Pressure regulator valve and gauge
- Large suction filter
- High pressure jet agitation
- Separate clean water tank for safety
- Rear mounted rails for mounting booms



"GC" Series

150 Gallon Shown  
With Folding Boom

#### SPECIFICATIONS:

Model No.	Tank Capacity	Pump GPM / PSI	Width	Height	Depth	Wt.
GC400	100 Gal.	11 / 580	44"	44"	36"	190#
GC600	150 Gal.	11 / 580	44"	48"	36"	225#

#### FEATURES:

- Category 1, 3-point hitch on 50 gallon, Category 1 & 2 hitch on 100, 150, and 200 gallon
- Tanks are made of reinforced polyethylene with smooth lines that are gentle to plants
- High pressure 3 piston diaphragm pump
- Pressure regulator valve with manual controls
- Clean water 12 gallon tank for flushing chemical residue, 6 gallon on 50 gallon sprayer
- High pressure jet agitation
- Clean water 4 gallon tank for hand washing



"GDL" Series

#### SPECIFICATIONS:

Model No.	Tank Capacity	Pump GPM / PSI	Width	Height	Depth	Wt.
GDL200	50 Gallon	11 / 580	38"	38"	20"	230#
GDL400	100 Gallon	11 / 580	48"	45"	30"	250#
GDL600	150 Gallon	11 / 580	48"	52"	30"	290#
GDL800	200 Gallon	11 / 580	61"	55"	39"	350#

# SPRAYERS

High Pressure Pump For Handgun & Boom Spraying

## Boom / Handgun



**Model GN200D-23  
With 28' Hydraulic  
Boom**

The **200 Gallon Sprayer** has a high volume and high pressure pump, best for multiple handgun use and with new 20 and 28 foot hydraulic booms. The simple design makes the sprayer easy to use. Recessed pump location allows close coupling to tractor and reduces angle of driveshaft. Tank is suspended from a heavy tubular frame to isolate it from vibration and stress. All these features, plus many more, add up to high value sprayers.

- Fiberglass tank with hatch and strainer basket
- Mechanical agitation with stainless steel propeller and shaft
- Diaphragm pump produces 23 GPM @ 780 PSI
- Cat. 1 or 2, 3-pt. hitch 540 R.P.M., PTO driven
- Sight gauges in tank and tubing
- Controls are reachable from tractor seat allowing operator to switch liquid from off to right or left spraying

Model No.	Tank Capacity	Pump Type	Pump GPM	Pump Pressure	Wt.
GN200D-23	200 Gal.	Diaphragm	23	780 PSI	450#



# SPRAYERS

With Low Profile Polyethylene Tank

## All Purpose Trailer / Skid

Our sprayers offer the latest design in an **All Purpose Sprayer**. The low profile polyethylene tank has a full length stainless steel agitation system and a large hatch with shower head to easily put wettable powder into suspension. An additional water filling hatch is included to keep chemicals from being splashed while filling. The sprayer can be used as a horizontal boom, row line boom, and/or hose/reel/handgun sprayer. The applications for these sprayers are endless - municipalities, golf courses, nurseries, farms, ranches, etc.

Model No.	Type	Width	Length	Height	Wt.
GPE800	Trailer	54"	102"	48"	490#
GSE800	Skid	35"	80"	36"	360#

- Available in trailer or skid mount
- 8 H.P. Honda engine
- Reinforced polyethylene tank with 2 hatches
- Screw type, pin away tongue jack
- 3 Piston diaphragm pump, produces 14 GPM at maximum pressure
- Pressure regulator w/manual controls reachable from seat
- Trailer tire size is 20 x 10.00- 6 ply

- Unique rear rail system for mounting many spraying attachments
- Available options:
  - ~ Horizontal Booms
  - ~ Row Line Booms
  - ~ Hose/Reel/Handgun

# SPRAYERS, AIR BLAST

*Value & Standard Series*

*For Effective Chemical Spraying*



Our **Value Series Air Blast Sprayers** have outstanding features such as: reinforced smooth lines polyethylene tanks; hot galvanized frame and fan housing to prevent rust; top of the line smooth running 3 piston diaphragm pumps; high speed fans with adjustable blades; gearbox with neutral for handgun and boom operations; built-in fan deflectors to direct the spray where required. The sprayers even have a separate safety fresh water tank for handwashing.

- Cat. 1, 3-point hitch
- Tanks made of reinforced polyethylene with smooth lines - gentle to plants
- 3 Piston diaphragm pump 14 GPM, maximum pressure 580 PSI
- One speed gearbox with neutral for handgun and boom operations
- Stainless steel nozzle manifold
- High pressure jet agitation
- Adjustable top and bottom wings to direct air and spray only to the foliage
- Clean water 4 gallon tank for hand washing



					LBS.	
Model - Gal.	Inch	R.P.M.	C.F.M.	No.	HP	Wt.
APL-G200-50	24"	2100	19,200	8	20 HP	300#
APL-G400-100	24"	2100	19,200	8	25 HP	375#

Our **Standard Series Air Blast Sprayers** are ideal for small to medium size vineyards, orchards, berries, etc. The sprayers feature reinforced polyethylene tanks with smooth lines that are gentle to the plants. The tanks are suspended from heavy duty tubular steel frames to isolate it from vibration and stress. The gearboxes have a neutral position which shuts off the fan during handgun or boom work. The sprayers are easy to operate and have all the features required for easy maintenance and long life.

- Cat. 1 & 2, 3-point hitch
- 3 Diaphragm piston pump, 14 GPM @ 580 P.S.I.
- One speed gearbox with neutral
- High pressure jet agitation
- Stainless steel manifolds with anti-drip nozzles
- Clean water 12 gallon tank for flushing chemical residue,
- Clean water 4 gallon tank for hand washing

**Add "V" to model for volute sprayer**



					LBS.	
Model - Gal.	Inch	R.P.M.	C.F.M.	No.	HP	Wt.,
APL200 - 50 Gal.	24"	2100	19,200	8	20 - 25	300#
APL400 - 100 Gal.	28"	2100	25,000	10	30 - 40	375#
APL600 - 150 Gal.	28"	2100	25,000	10	40 - 50	440#



# SPRAYERS

500 Gallon - Stainless Steel

## Air Blast Trailer



This **Air Blast Sprayer** features stainless steel tank, with mechanical agitation, also stain- less steel shaft and propellers. The model has a modern front shield to protect the pump and tank from damage when spraying in confined areas.

Added to the tank features are high pressure piston diaphragm pumps, two speed transmissions with neutral, heavy steel frames, adjustable pitch fans, shower heads in the strainer basket to dissolve wettable powders; which add up to state of the art sprayers to fit your spraying requirements.

### FEATURES:

- 500 Gallon stainless steel tanks
- Mechanical agitation system with stainless steel shaft and propellers
- Fans have adjustable pitch blades and rubber clutch
- Modern dome front shield
- Wheels are adjustable up or down; front or rear
- Fold-up steps on both sides of sprayers
- Steel rear bumper
- Large pressure gauge
- Two speed gearbox with neutral
- Piston diaphragm pumps
- Frames are powder coated black
- Shower head in strainer basket to put wettable powders into solution
- Stainless steel manifolds with anti-drip nozzles
- Adjustable clevis drawbar
- Constant velocity P.T.O. shaft
- Electro valve controls

### OPTIONS:

- ~ Sharp angle turning hitch in lieu of clevis drawbar
- ~ Flip over nozzles in lieu of single nozzles
- ~ 12.5 x 15 tires in lieu of 11L x 15

### SPECIFICATIONS:

Model No.	ATSS2000
Tank Capacity:	500 Gallon
Fan Diameter:	32"
Fan C.F.M.:	40,000
Horsepower Required:	75 H.P.
Pump Specs:	30.7 GPM @ 725 PSI
Tires:	11L x 15 8-Ply
Minimum Width:	63"
Height:	60"
Length:	11' - 6"
Weight:	2155#

# SPRAYERS

Popular Models Operate on Tractors As Low As 18 PTO H.P.

## Venturi Air - 3-Point Hitch Models

These **Venturi Air Sprayers** feature the 8 nozzle distribution head for vineyard rows up to 10 foot width.



**Model No. P42N1-300-G  
Narrow Row Berry  
Sprayer With 12 Nozzle  
Distribution Head**



These unique **Venturi Air Sprayers** feature the latest technology in concentrate spraying. Thus, growers achieve the following benefits: spray atomization of droplets are smaller and more uniform, less fill-ups, even distribution of concentrated spray, complete foliage coverage, better product utilization, less chemical waste and soil/water contamination. All Venturi Air Sprayers shown on the following pages have these same advantages.

### FEATURES:

- Cat. 1, 3-point hitch, P.T.O. 540 RPM
- High performance, precision balanced all steel centrifugal fan
- Translucent heavy walled polyethylene tank with lid, sump and strainer basket
- Compact, rounded tank design permits traveling through vegetation without damaging it
- Simple, efficient "Dial-A-Rate", 15 position metering disc
- Agitation by liquid sparging tube and air from the fan
- Low pressure spraying system - 15 to 40 PSI spraying pressure means less maintenance for pumps and nozzles
- Power band fan speed-up is automatically adjusted by spring loaded idler
- Broad range of Venturi distribution heads that produce 50 micron droplets and are specially designed to match a variety of foliage profiles
- Capable of application rates of 20 to 200 gallons per acre, depending on row width
- Built-in 6 gallon fresh water safety tank

### SPECIFICATIONS:

Model No.	Gallons	Volume of Air	Width	H.P. Required	Wt.
P42N1-300-G	75 Gallons	2350	38"	18 H.P.	400#
P42N1-400-G	100 Gallons	2350	44"	18 H.P.	440#
P45N1-400-G	150 Gallons	3180	44"	32 H.P.	455#

# SPRAYERS

*Sprays 2 Complete Rows In One Pass*

*Spraying Time Is Cut In Half*



## FEATURES:

- Cat. I & II, 3-point hitch, P.T.O. 540 RPM
- High performance, precision balanced all steel centrifugal fan
- Special molded polyethylene fan housing
- Translucent heavy walled polyethylene tank with lid, sump and strainer basket
- Compact, rounded tank design permits traveling through vegetation without damaging it
- Simple, efficient "Dial-A-Rate", 15 position metering disc
- Agitation by liquid sparging tube and air from the fan
- Low pressure spraying system - 15 to 40 PSI spraying pressure means less maintenance for pumps and nozzles
- Reachable controls from tractor seat, allows operator to switch liquid from off to right, left or both sides spraying
- Built-in 6 gallon fresh water safety tank

The **Venturi 2 Row Sprayer** covers two complete rows at one time so your spraying time is cut in half; reducing your labor, fuel, wear and tear on your tractor/sprayer, and since you are travelling every other row, you will have less soil compaction. Plant coverage is greatly increased because the spray enters the foliage from opposite directions at the same time. Thus, chemical drift is greatly reduced as the spray is held in the foliage longer. These sprayers are available with many different types of distribution heads, however the most productive is the unit shown above. The over the row nozzles are adjustable for 6 to 10 foot rows. The extensions have hydraulic cylinders for folding away when required

## SPECIFICATIONS:

Model No.	Gallons	Volume of Air	Width	H.P. Required	Wt.
P50N1-400-G	100 Gallons	4444	44"	45 H.P.	510#
P50N1-600-G	150 Gallons	4444	57"	45 H.P.	540#
P50S1-600-G	150 Gallons	4875	57"	52 H.P.	540#

# SPRAYERS

*One Sprayer - 3 Different Applications*

## *Venturi Air Sprayers*



This model features fishtail type distribution heads for orchards with trees up to 35 feet in height. The fishtails are fitted with special manifolds with a total of 64 orifice outlets. This feature produces a fine mist spray to obtain total plant coverage. Also, growers have found that the sprayer is the most economical way to apply foliar feed.

The development of this sprayer was for horizontal spraying up to 90 feet. The system features 4 upper cannons, one central cannon and 4 lower nozzles. This cannon sprayer is popular in areas of limited tractor roads and is used in nurseries and crops like melons.

### **FEATURES:**

- Cat. 2, 3-point hitch, P.T.O. 540 RPM
- Translucent heavy walled polyethylene tank with lid, sump and strainer basket
- Built-in overrunning clutch to protect the tractor and sprayer drive train
- Simple, efficient "Dial-A-Rate", 15 position metering disc
- Agitation by liquid sparging tube and air from the fan
- Low pressure spraying system - 15 to 40 PSI
- Electro valve controls to switch liquid from off to right, left or both sides spraying
- Built-in 6 gallon fresh water safety tank



This sprayer has special tall tree cannons that will give complete coverage on trees up to 50 feet in height. The unit was designed for spraying walnuts, avocados, and other tall tree orchards. The sprayer is also excellent for applying foliar feed.

### **SPECIFICATIONS:**

Model No.	Gallons	Volume of Air	Width	H.P. Required	Wt.
P55S1-600-G	150 Gallons	8240	57"	60 H.P.	550#

# SPRAYERS

*Designed So Driveshaft Is Always Straight In Line*

*Venturi Air - Short Turning Hitch*



**300 Gallon With Optional Distribution Head**

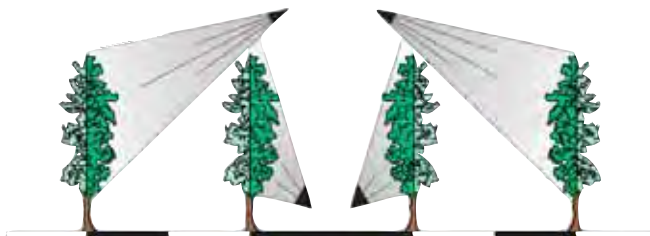

**Developed especially for vineyards with short head lands.**

- Cat. I, 3-point hitch, P.T.O. 540 RPM
- Turns as sharp as your tractor
- Parking stands for 3-point and trailer assemblies
- High performance, precision balanced all steel, front mounted centrifugal fan
- Special molded polyethylene fan housing
- Translucent heavy walled polyethylene tank with hinged lid, sump, strainer basket and shower head

The sprayer shown is equipped with 2 - 4 nozzle lower heads and 2 upper cannons for spraying 4 half rows. For increased coverage late in the season, the upper cannons can be adjusted down for spraying vines in the tractor row. The unique feature of the sprayer is that the fan and distribution head is 3-point hitch mounted. The trailer/tank assembly is attached to the 3-point hitch with a heavy duty swivel hitch. This allows the sprayer to "turn on a dime" with no stress or damage as the drive system is also straight.

This 3-point/trailer sprayer is perfect for narrow rows and short head lands.

- Dual tank lids for safety, one for water and one for adding chemicals
- Simple efficient "Dial-A-Rate", 15 position metering disc
- Centrifugal pump - 37 G.P.M.
- Dual agitation systems, liquid and air
- Low pressure spraying system - 15 to 40 PSI spraying pressure means less maintenance for pumps and nozzles
- Power band fan speed-up is automatically adjusted by spring loaded idler
- Reachable controls from tractor seat, allows operator to switch liquid to right, left or both sides spraying
- 8 Gallon fresh water safety tank

Model No.	Gallons	Volume of Air	Width	Length	Tire Size	H.P. Required	Wt.
L50N1-800	200 Gallons	4444 C.F.M.	43"	9'	9.5Lx15-8 Ply	48 H.P.	855#
L50S2-1200	300 Gallons	5000 C.F.M.	54"	9'	11Lx15-8 Ply	52 H.P.	960#

# SPRAYERS

*Built For Low HP Tractors Spraying Narrow Rows*

*Venturi Air - 200 Gallon Trailer*

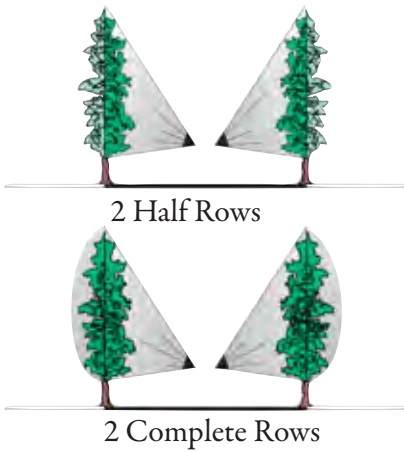

## FEATURES:

- Trailer mounted, P.T.O. 540 R.P.M.
- Translucent heavy walled polyethylene tank with hinged lid, sump, strainer basket and shower head
- Unique polyethylene belly mounted air tubing to the distributor heads
- Dual tank lids for safety, one for water and one for adding chemicals
- Compact, rounded tank design permits traveling through vegetation without damaging it
- Adjustable tread width, facilitates matching sprayer tread with tractor tread
- Tongue with clevis hitch has length adjustment
- Simple, efficient "Dial-A-Rate", 15 position metering disc
- Dual agitation systems, liquid and air
- Low pressure spraying system - 15 to 40 PSI spraying pressure means less maintenance for pumps and nozzles
- Built-in overrunning clutch to protect the tractor and sprayer drive train
- Power band fan speed-up is automatically adjusted by spring loaded idler
- Electro-valve controls to allow operator to switch liquid from off to right, left, or both sides spraying
- Built-in 8 gallon fresh water safety tank



Our **200 Gallon Trailer Mounted Sprayer** was developed for low horsepower tractors doing narrow row spraying. Tractors with P.T.O. horsepower of as low as 36 will handle this sprayer. The 48 inch overall sprayer width allows for operating in the narrowest of rows. Growers achieve the following additional benefits - spray atomization of droplets are smaller and more uniform, less fill-ups, even distribution of concentrated spray, complete foliage coverage, better product utilization, less chemical waste and soil/water contamination.

## SPECIFICATIONS:

Model No.	Gallons	Volume of Air	Width	Length	Tire Size	H.P. Required	Wt.
T45N1-800	200 Gallon	3180 C.F.M.	48"	10' - 5"	9.5Lx15-8 Ply	36 H.P.	910#

# SPRAYERS

*For High Production, Accurate Spraying*

## *Venturi Air - 300 Gallon*



The ***Gearmore 300 Gallon 2 Row Venturi Air Sprayer*** covers two complete rows at one time so your spraying time is cut in half; reducing your labor, fuel, wear and tear on your tractor/sprayer, and since you are travelling every other row you will have less soil compaction.

Plant coverage is greatly increased because the spray enters the foliage from opposite directions at the same time. Thus, chemical drift is greatly reduced as the spray is held in the foliage longer.

### **FEATURES:**

- Molded polyethylene 300 gallon tank
- Sprayer operates with a low pressure centrifugal pump which produces 37 GPM at the normal operating pressure of 40 PSI
- Total agitation is obtained by another separate 37 gallon centrifugal pump that feeds a full length sparging tube in the bottom of the tank
- Wheels are adjustable up or down, front or rear, in or out to obtain the best balance
- Electro-valve system controls spray off or on, both sides spray, right or left only
- Rotating calibration discs are easy to adjust and provide accurate regulation of the chemical application
- Shower head is built into the main strainer basket to easily put wettable powders into suspension
- Separate safety clean water 8 gallon tank for handwashing
- 4 Distribution heads w/4 Venturi nozzles on each head w/individual shut off valves
- Frame width adjusts for row from 6' to 10'

### **SPECIFICATIONS:**

Model No.	Gallons	Volume of Air	Width	Length	Tire Size	H.P. Required	Wt.
T50S2-1200	300 Gallons	5000 C.F.M.	55"	11' - 8"	11Lx15-8 Ply	52 H.P.	970#

# SPRAYERS

Total Plant Coverage At Lowest Cost Per Acre

*Venturi Air - Trailer Models*



500 Gallon

**"10 Year Warranty  
On Polyethylene  
Trailer Tanks"**



**Optional Flotation Tracks smooths out the ride, floats over wet ground and greatly reduces compaction.**

These unique *Venturi Air Sprayers* feature our most powerful high speed turbine fans and are the latest technology in low volume spraying. Thus, growers achieve the following benefits: spray atomization of droplets are smaller and more uniform, less fill-ups, even distribution of concentrated spray, complete foliage coverage, better product utilization, less chemical waste and soil/water contamination.



The sprayer is operating with 2 lower and 2 upper orchard distribution heads to insure coverage on the upper half of trees.

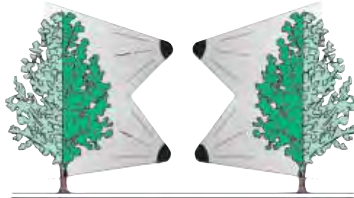

- High performance, precision balanced all steel, front mounted, centrifugal fan
- Translucent heavy walled polyethylene tank with hinged lid, sump, strainer basket and shower head
- Dual centrifugal pumps - 37 GPM for spraying and 37 GPM for agitation
- Dual agitation systems, liquid and air
- Low pressure spraying system - 15 to 40 PSI spraying pressure means less maintenance for pumps and nozzles
- Broad range of Venturi distribution heads that produce 50 micron droplets and are specially designed to match a variety of foliage profiles
- Electro-valve controls to allow operator to switch liquid from off to right, left, or both sides spraying
- Built-in 8 gallon fresh water safety tank

Model No.	Gallons	Volume of Air	Width	Length	Tire Size	H.P. Required	Wt.
T55S2-1200	300 Gallon	8240 C.F.M.	55"	12'	11Lx15-8 Ply	60 H.P.	1020#
T55S2-2000	500 Gallon	8240 C.F.M.	71"	14'	12.5Lx15-10 Ply	60 H.P.	1555#
T55E2-2000	500 Gallon	9123 C.F.M.	71"	14'	12.5Lx15-10 Ply	74 H.P.	1555#



# SPRAYERS

*For High Production, Accurate Spraying  
With Wrap-A-Round Booms*

**500 Gallon Sprayer Shown  
With Boom Model TS56MC55D12**



*We custom build booms and  
electro / hydraulic controls  
to grower's requirements*

Now available is a complete series of high strength **Wrap-A-Round Spray Booms**.

The booms feature extra strong framing with heavier support tubings to the sprayer frame.

The five hydraulic cylinders give total control on height adjustment, swing up for in row obstructions, and fold away for transport. The width adjustment is manual, optional electro cylinders operated from the tractor seat are available. These booms are available to spray two complete rows or two complete rows and two half rows. Boom controls require 5 rear remotes or Gearmore's optional electro over hydraulic kits. The booms are designed to fit the popular 300 and 500 gallon Venturi Air Sprayer.



- Sprayer features same as page 78
- Booms swing hydraulically from operational to closed position
- Booms fold forward for transport and lock
- Height adjustment is hydraulic
- Boom bottoms can be fitted with single or double 4 + 4 nozzles or fishtails
- Boom tops can be fitted with 4 + 4 nozzles, cannons, fishtails, or neither head

Boom Model No.	Sprayer Model No.	Gals.	No. of Rows	No. of Nozzle Assy's	Row Space	Max. Crop Height	Boom Clearance	Nozzle Positions	Type of Bottom Nozzles	Type of Top Nozzles
TS56MB55M12 "A" Boom	T55S2-1200	300	2-Full 2-Half	6	7.5'-10'	7 ft.	8 ½ ft.	Bottom Only	4 Outlet Head	None
TS56MC55D12 "A" Boom	T55S2-2000	500	2-Full 2-Half	6	9.5'-13'	8 ft.	9 ½ ft.	Bottom Only	4 Outlet Head	None
TS54M4CC55D12 "B" Boom	T55E2-2000	500	2-Full	8	9.5'-13'	8 ft.	9 ½ ft.	Top & Bottom	4 Outlet Head	Cannons
TS512MC55D12 "D" Boom	T55E2-2000	500	2-Full 2-Half	12	9.5'-13'	8 ft.	9 ½ ft.	Top & Bottom	4 Outlet Head Bottom & Top	
TS52V4V6V55D12 "Olive" Boom	T55E2-2000	500	2-Full	12	9.5'-13'	8 ft.	9 ½ ft.	Top, Center & Bottom	Fishtail Head Bottom, Center & Top	

# SPRAYERS

*Achieves Total Plant Coverage on Field Crops*

*Venturi Air Boom Sprayers*



27' Boom Sprayer Shown



## FEATURES:

- Air velocity of 200 MPH at nozzle breaks down spray to fog size (50 microns) droplets which penetrate in and around all areas of each plant
- Air movement allows chemical to completely cover vegetation, especially the underside of leaves
- Volume as low as 5 gallons per acre results in fewer refilling stops and more acres covered per day
- Spray drift is reduced by 50% to 75%.
- Boom has breakaway and hydraulic fold away features to prevent damage and for transport
- Boom raises and lowers hydraulically for different crop heights, independent of the sprayer
- Boom nozzles are completely adjustable in width and angle for maximum coverage
- Chemicals only come in contact with plastic, rubber, and stainless steel parts

- Tank:** Translucent polyethylene 150 gallon with hatch and strainer basket
- Agitation:** Adjustable liquid bypass, and air from fan when required
- Drive:** 540 RPM P.T.O. driven with belt drive to fan and pump with overrunning clutch
- Nozzles:** "No drip" system on each nozzle and individual liquid shut-off by hand, replaceable stainless steel discs and screens
- Controls:** Reachable from tractor seat allowing operator to switch liquid from off to right or left
- Filtration System:** 3 Stages - at filler, at pump, and at nozzles
- Fan:** Centrifugal type with PVC housing
- Pump:** Centrifugal with maximum 37 GPM
- Sight Gauges:** In tank and tubing
- Pressure Gauge:** 0 to 80 P.S.I. in liquid case to reduce vibration and extend life

Models:	Boom Width	Rows	No. of Nozzles	Boom Design	Tank Cap.	Dia. of Fan	Fan (RPM)	Volume of Air	Air Speed at Foliage	Controls	Min. Tr. HP	Wt.
P50S-600-27	27'	8	2+2=32	Steel Tubing	150 Gal.	19.75"	4320	4875	10-50 MPH	Liquid	52 H.P.	1230#
P55S1-600-40S	40'	7	2+3+2=49	Framed Poly Air Tubing	150 Gal.	21.75"	3720	8240	10-50 MPH	Electro-Valve	60 H.P.	1800#
P55S1-600-40	40'	12	2+2=48	Framed Poly Air Tubing	150 Gal.	21.75"	3720	8240	10-50 MPH	Electro-Valve	60 H.P.	1800#

# SPREADERS

3-Pt. PTO & Ground Driven w/PVC Hoppers

3-Pt./Trailer Mounted Spinner Spreaders

## 3-Point Seeder / Spreaders



Model No.	Capacity		Overall Height	Wt.
	Lbs.	Cu. Ft.		
PL180	480 lbs.	5.8 cu. ft.	36"	120#
PL500	1000 lbs.	12.3 cu. ft.	45"	140#

## Trailer Mounted Seeder / Spreaders



Model No.	Capacity		Height	Width	Depth	Wt.
	Lbs.	Cu. Ft.				
PTP180-P	480 lbs.	5.8 cu. ft.	51"	41"	59"	175#
PTP300-P	765 lbs.	9.2 cu. ft.	51"	41"	59"	185#

Our **3-Point Hitch Spreaders** feature a strong, corrosion proof PVC hopper. These spinner units have double levers and stainless steel slides which allow for spreading at 180° or 90° to the right or left. They are ideal for even spreading fertilizer, seed, salt, and other flowable materials.

- Cat. 1, 3-point hitch, 540 PTO
- Corrosion proof PVC hopper
- Stainless steel spreading disc with 4 stainless steel fins
- Steel oil tight gearbox with grease zerck
- Extended handle for engaging and disengaging
- Choice of 3 spread patterns: full rear, left or right side
- Effective spreading width from 20' to 46'
- Built in rear hitch
- Adjustable uniform rates from 20 to 900 lbs./acre

### OPTIONS:

- ~ Larger extended hopper agitator
- ~ One and two row band spreader attachments

Our **Seeder/Spreader** is a self contained, towable implement that can be operated by almost any vehicle. This unit has a ground driven, cast iron, oil bath gearbox that can be disengaged when transporting. It is ideal for spreading seed, fertilizer, sand, and salt. The large 16" diameter x 6.5" wide tires make this a "Turf Friendly" implement. This spreader is a handy tool for farmers, landscapers, and homeowners.

- Ground wheel driven
- Corrosion proof PVC hopper
- Cast iron, oil bath gearbox
- Gearbox disengages for transport
- Stainless steel spreading disc with 4 stainless steel fins
- Extended handle for engaging and disengaging material flow
- 16 x 6.5-8 Ply turf tires
- 1 7/8" Ball hitch
- Spreading widths from 20' to 46'
- 3 Spread patterns:
  - ~ full rear
  - ~ left side
  - ~ right side

# SPREADERS

*High Capacity 3-Pt. PTO Driven Spreaders*

## *Spinner Spreaders*

Our high capacity **3-Point Spreader** features a stainless steel, single spinner disc with 6 stainless steel vanes. Spreaders have a heavy duty stamped and ribbed frame. All metal hoppers and frames have special phosphated undercoat, then epoxy powder painted and baked at 300 degrees to insure long life. The spreader can be set at 180°, 90° right, or 90° left spreading pattern.

### **FEATURES:**

- Cat. 2, 3-point hitch
- Low loading height
- Sturdy stamped and ribbed steel frame
- Levers control on and off
- 6 Fins spreading disc for even spreading width
- Spreading width from 32' to 59'

### **Single Spinner**



### **SPECIFICATIONS:**

Model No.	Capacity		Height	Width	Depth	Wt.
	Lbs.	Cu. Ft.				
RT-800	1700 lbs.	28 cu. ft.	40"	59"	53"	345#

Our 2200 pound capacity **3-Point Spreader** features dual stainless steel spinner discs, which are extremely accurate with only 6.7% variance across the spread pattern. The spreaders are supplied with manual lever controls with optional hydraulic controls when the tractor has a cab. The usual special painting system insures long life.

### **FEATURES:**

- Cat. 2, 3-point hitch
- Hydraulic cylinder controls, off and on
- Stainless steel construction
- Two stainless steel disc with 3 vanes each
- Easy on and off band spread attachment
- Spreading width from 39' to 59'

### **Double Spinner**



**Shown With Optional 2 Row Band Spreader Attachment**

### **SPECIFICATIONS:**

Model No.	Capacity		Height	Width	Depth	Wt.
	Lbs.	Cu. Ft.				
RE-1000	2300 lbs.	35 cu. ft.	45"	59"	53"	450#

# SPREADERS

*Composting Crops Effectively Increases Yields*

## *Compost & Pull Type*

**Compost Spreader Shown With  
Optional Band Spread Attachment**



This unique **Compost Spreader** is able to spread a wide range of materials such as: compost, peat, concentrated manure, lime, gypsum, dried grape pomace and other types of fertilizer. The spreader was designed for two different spreading operations. You can broadcast spread and add the side conveyor for band spreading. Features are built into the spreader to achieve the application of this large group of products. Patented two gear-box system, one to power the spinner and a second gearbox geared to a low R.P.M. for the agitator.

**FEATURES:**

- Cat. 1 & 2, 3-point hitch, 540 RPM P.T.O.
- Spinner turns at 718 RPM and the agitator turns at 77 RPM
- Hydraulic cylinder for on and off
- For tractors 50 to 150 HP, capacity - 35.3 cu. ft.
- Spread width 20 to 45 ft., up to 12 ft. with band spread attachment

**SPECIFICATIONS:**

Model No.	Capacity	Width	Depth	Height	Wt.
SCU1000	2000 lbs.	48"	64"	55"	780#

**OPTION:**

- ~ Stainless steel side conveyor

**Pull Type Seeder / Spreader**



Our **Seeder/Spreader** is a self contained, towable implement that can be operated by almost any vehicle. This unit has a ground driven, cast iron, oil bath gearbox that can be disengaged when transporting. It is ideal for spreading seed, fertilizer, sand, and salt. The large 20" diameter x 10 wide tires make this a "Turf Friendly" implement. The spreader features a cable control that allows the operator to adjust spread rate and turn the spreader on and off from the vehicle seat. This is a popular, low cost spreader for golf courses, parks, sport fields, and turf farms.

**FEATURES:**

- Remote cable control from vehicle
- Agitators to prevent bridging
- 20 x 10:00 - 8 tires
- Full width or spreading to one side
- Height adjustment on 2" ball hitch

**OPTIONS:**

- ~ Clevis type hitch
- ~ Secondary chain agitator
- ~ Canvas hopper cover
- ~ Cable control mounting bracket
- ~ Remote hopper vibrator

**SPECIFICATIONS:**

Model No.	Capacity		Spreading Width	Machine			Wt.
	Lbs.	Cu. Ft.		Height	Width	Depth	
PTB560	1070 lbs.	14.2 cu. ft.	Max. 52'	51"	65"	96"	350#

# SPREADERS

*Achieves Accurate Placement of Fertilizers & Seeds*

## *Pendulum Spreaders*

Our line of **Pendulum Spreaders** feature an advanced mechanism with regulating key which allows for quickly setting the spread pattern. Other features are exact rate/spread control, quick change spouts, low filling heights, and easy maintenance. The model PDC400 has a molded plastic hopper, all other models have formed fiberglass hoppers. The spreading width with the standard spout is 20 to 46 feet. A large variety of spouts are available for standard broadcast, narrow row and wide row vineyards and orchards. Spreaders can also be set for band and one sided banding. Hopper capacities from 925 to 2000 pounds.

**Model PDC400**

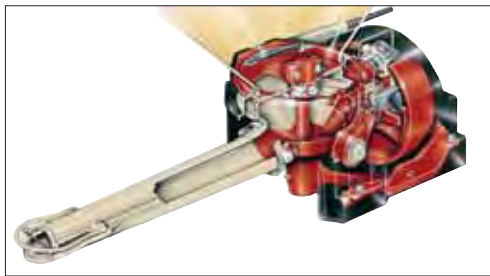

**Model PDV500**



*304.101 Spout  
Full field spreading  
13 to 26 feet*



*304.102 Spout  
Narrow spreading  
3 to 14 feet*



*304.103 Spout  
Vineyard spreading  
6 to 13 feet*



*304.105 Spout  
Vineyard / Orchard  
6 to 33 feet*

**The above spouts fit all models**

### **SPECIFICATIONS:**

Model No.	Hitch Category	Capacity		Overall Width	Overall Height	Wt.
		Lbs.	Cu. Ft.			
PDC400	Cat. 1	925 lbs.	13.6 cu. ft.	46"	47"	225#
PDV500	Cat. 1 & 2	1155 lbs.	17 cu. ft.	54"	36"	290#
PDV600	Cat. 1 & 2	1450 lbs.	20.5 cu. ft.	54"	40"	315#
PDHV800	Cat. 2	2000 lbs.	32 cu. ft.	74"	40"	375#

# MANURE SPREADERS

Models From 1 to 25 Plus Horses

*We Stand Behind Our Product-Way Behind*



**Marketed by Gearmore, Inc.**

Whether you have one horse or twenty, Millcreek makes a spreader that's just right for you. Every detail is engineered to save time and protect against breakdowns. From the heavy duty, all-steel construction to the top quality powder coating, durable linkage and beater systems, you can be sure that your Millcreek Spreader was built to last. Convenient, time saving options - including the adjustable dolly wheel/jack and the manual endgate - further enhance your investment. We're sure that your Millcreek spreader will quickly become the most-valued piece of equipment in your stable!



### Operating Levers

Our soft handle grips and easy action design make our levers truly easy to engage.

### Thick-Skin Urethane Lining

Prevents corrosion and adds years of life to the spreader box, lining comes with a 10 year prorated warranty against rust through. (Optional for most models)

### Poly Floor

Made from recycled, high-density plastic so it will never rust or rot and comes with a 20-year warranty. (Not included with all models)

### Adjustable Hitch

Conveniently adjusts to the height of the towing vehicle, making the process safe and easy, even when fully loaded. (Not included with all models)

### Adjustable Dolly Wheel / Jack

Provides easy, hand maneuvering in and around the barn. Allows the spreader to rest in level position when not hooked up for towing. (Not included with all models)

### Beaters

Expertly designed to handle the messiest of loads, even pen packed manure.

### Safety Bar

An important safety feature that minimizes the potential for injury or damage.

### End Gate

A great help containing loads during transport, and for shielding the operator when spreading. (Not included with all models)



## SPECIFICATIONS:

Model No.	22	27	37	57	77	97	127
No. of Horses:	1 - 2	1 - 4	4 - 6	5 - 10	11 - 20	20 +	25 +
Capacity, cu. ft. Heaped:	16.2 cu. ft.	28 ft. <sup>3</sup>	37.3 ft. <sup>3</sup>	56 ft. <sup>3</sup>	72 ft. <sup>3</sup>	109 ft. <sup>3</sup>	140 ft. <sup>3</sup>
Overall Length:	98"	9' 3"	11' 3"	11' 6"	13' 6"	13' 6"	13' 6"
Overall Width:	42"	46.5"	46.5"	58"	58"	79"	79"
Overall Height:	26.5"	26.5"	26.5"	34"	34"	39"	47.5"
Construction:	All Steel Galvanized	All Steel, Poly Floor	All Steel, Poly Floor	All Steel, Poly Floor	All Steel, Poly Floor	All Steel, Poly Floor	All Steel, Poly Floor
Weight:	250#	405#	470#	660#	740#	1260#	1440#
Tractor Size:	10 H.P.	15 H.P. + Lawn & Garden Tractor or 350cc ATV	18 H.P. + Lawn & Garden Tractor or 450cc ATV	18 H.P. + Compact Tractor or 500cc ATV	22 HP + Compact Tractor	25 HP + Standard Tractor	28 HP + Standard Tractor

# SWEEPERS

*Many More Models Available*

*Contact Us For Complete Catalog*

Manufactured By:



**PALADIN** LIGHT CONSTRUCTION

*Rear Mount*



Rear Mount Sweepers mount to rear 3-point of compact and industrial tractors. Mechanical or hydraulic brush drive. Manual and hydraulic angle change 30° left/right available. Sweeps forward and windrows debris outside of rear tires on paved and turf areas. Pulling action cleans thatch without damaging grass. Brush rotation can be reversed for operation backing up. Brush widths from 4 ft. to 8 ft.

*Pick-Up Sweeper*



The Standard Pick-up Brooms clean up in construction, municipal and industrial applications. The 26" diameter brushes come in poly, wire or half of each. Options available are: sprinkler system and gutter brush. The Cold Planer Special has special compacted dense wafer brushes the width of the cold planer cut. These wafers do not flex as much as the balance of the brush, thus it cleans out the milled grooves.

*Angle Sweeper*



Angle Sweepers mount to skid steer loaders and is available for mounting on utility tractor loaders. Hydraulic brush drive, with manual or hydraulic angle change 30° left/right available. Single or dual motor configurations are available. Brush is equipped with a quick change core for easy brush change. Heavy duty design with quick attach mounting. Brush widths from 5 ft. to 8 ft.

*Compact Front Mount*



Compact Front Mount Sweepers mount to commercial turf mowers, compact utility tractors and industrial loaders. Available in a hydraulic or mechanical brush drive, with manual or hydraulic angle change 30° left/right. Keep your tractor and sweeper busy all year sweeping snow, dirt, thatch, and leaves. Brush widths from 4 ft. to 8 ft.

**Marketed by Gearmore, Inc.**



# ROTARY TILLERS

For Compact Tractors 15 to 35 Horsepower

## "B" Series



Model No.	Tilling Width	Overall Width	No. of Tines	Approx. H.P.	Wt.
B100	40"	44"	30	20 HP	300#
B120	48"	52"	36	25 HP	335#
B140	55"	59"	42	30 HP	370#
B150	60"	64"	42	35 HP	420#

These compact "B" Series of tillers are quality constructed units that are built to last. The adjustable skid shoes control the cutting depth while the rear tailboard controls the soil mix. The tiller is equipped with a slip clutch to protect the tiller and tractor. Ideal for preparing seedbeds, renovating pastures, and other tillage uses. The tiller provides uniform mix throughout the cultivated depth.

- Cat. 1, 3-point hitch
- 7" Approximate tilling depth
- One speed gearbox, 540 RPM
- 80# Heavy duty roller chain
- Slip clutch driveshaft to protect tractor and tiller drive system
- Curved saber style, heat treated, long wearing tines
- 6 Tines mounted on each rotor plate for maximum tilling action
- Tines staggered in scroll design for easy soil penetration
- Side mounted skids for depth control

Our "C" Series is the modern replacement to our "L" Series tiller. A number of special features are standard at no added cost, such as; slip clutch, all gear final drive, 6 tines per rotor plate, and heavy A.S.A.E. quick hitch A-frame. Excellent tiller for vegetable growers, landscapers, nurseries, vineyards, and general maintenance operations.

- Cat. 1, 3-point hitch
- 8" Approximate tilling depth
- One speed gearbox, 540 RPM
- Strong, smooth running, all gear final drive
- Slip clutch driveshaft to protect tractor and tiller drive system
- Curved saber style, heat treated, long wearing tines
- 6 Tines mounted on each rotor plate for maximum tilling action
- Tines staggered in scroll design for easy soil penetration
- Powder coated, baked-on paint to reduce corrosion

Model No.	Tilling Width	Overall Width	No. of Tines	Approx. H.P.	Wt.
C85	34"	38"	30	20 HP	460#
C105	42"	46"	30	25 HP	485#
C125	50"	54"	36	30 HP	510#
C145	56"	60"	36	35 HP	545#
C165	65"	69"	42	40 HP	590#
C185	72"	76"	48	45 HP	640#

# ROTARY TILLERS

For Compact Tractors 20 - 45 Horsepower

## "C" Series



# ROTARY TILLERS

For Tractors 20 to 50 Horsepower

**"E" Series - Forward & Reverse Models**

**Reverse Rotation E Series** in 60" and 72" tilling widths. The counter rotation greatly aids in operating in hard ground. The reverse rotation achieves more depth and pulverizes the soil, plus buries clods, stones and debris. Ideal for preparation of seedbeds, renovation of pastures, orchards, vineyards and mulching-in cover crops and stubble. Provides uniform mixture through-out cultivated depth. Produces loose textured soil that holds moisture, reduces erosion.

- Connects to 3-point., Cat. 1, 540 R.P.M. tractors - 7' Cat 1 & 2
- All gear, final drive
- Rugged construction for long life
- Heat treated, long wearing tines
- 6 - L shaped tines per flange
- Adjustable skids for depth control
- Torque tube frame to absorb shock loads
- Driveshaft with slip clutch
- Up to 70 H.P. - E84 only



Reverse Rotation



Model No.	Tilling Width	Overall Width	No. of Tines	Approx. H.P.	Wt.
E48	48"	53"	36	20-35 HP	600#
E60	60"	65"	42	25-40 HP	690#
E72	72"	77"	54	35-45 HP	780#
E84	84"	89"	66	50-70 HP	805#
E60R*	60"	65"	42	40-45 HP	710#
E72R*	72"	77"	54	45-50 HP	800#

\*R - Reverse Rotation

# ROTARY TILLERS

For Tractors 40 - 70 Horsepower

**"N" Series**

These medium duty **"N" Series** tillers feature a smooth running, all gear drive system. Powered through a heavy 70 horsepower gearbox to an all gear final drive. The tilling action provides a uniform mixture throughout the cultivated depth. Producing loose textured soil that holds moisture and reduces erosion. These are the ideal tillers for farm, vineyard, orchards, landscapers, nurseries, etc.

- Cat. 1 & 2, 3-point hitch
- 9" Approximate tilling depth
- One speed gearbox, 540 RPM
- Strong, smooth running, all gear final drive
- Slip clutch driveshaft to protect tractor and tiller drive system
- Curved saber style, heat treated, long wearing tines
- Tines staggered in scroll design for easy soil penetration
- Powder coated, baked-on paint to reduce corrosion
- Side mounted skids for depth control



Model No.	Tilling Width	Overall Width	No. of Tines	Approx. H.P.	Wt.
N130	53"	58"	30	40 HP	780#
N155	63"	68"	36	50 HP	895#
N180	72"	77"	42	60 HP	970#
N205	82"	87"	48	70 HP	1045#

# ROTARY TILLERS

For Tractors 50 to 160 Horsepower

## "S" Series



Model No.	Tilling Width	Overall Width	No. of Tines	Approx. H.P.	Wt.
S160-CT	63"	68"	36	50 HP	1190#
S180-CT	73"	78"	42	60 HP	1255#
S205-CT	83"	88"	48	70 HP	1350#
S230-CT	92"	97"	54	80 HP	1430#
S255-CT	102"	107"	60	90 HP	1490#

**CT in model number stands for Tungsten Coated Tines**

These **"S" Series Tillers** were designed for high usage in agricultural and industrial applications. At a depth of 8 inches, the saber tines produce a uniform mixture of loose, textured soil that holds moisture and reduces erosion. These tillers are extremely well built, with 4 speed gearbox, all gear final drive and slip clutch driveshaft for heavy duty use. There is no better tool for preparation of seedbeds.

- Cat. 2 fixed center mount
- 90 HP, 4 speed gearbox
- 4-speeds at 540 RPM
- All gear final drive
- Slip clutch driveshaft
- 6 Tines on each rotor plate - staggered
- Torque tubing frame to absorb shock loads
- Adjustable skids for depth control

**OPTION:**

- ~ 2 Speed 1000 RPM gears

These **"T" Series Tillers** were designed for high horsepower tractors to produce a finished seedbed in a single pass. For crops such as vegetables, timing is everything. The basic plow, disc, cultivator tilling operation requires too many passes, wasted fuel, and causes excessive compaction. At a depth of 10 inches, the saber tines produce a uniform mixture of loose, textured soil that holds moisture and reduces erosion. There is no better tool for preparation of seedbeds and incorporating crop residue.

**FEATURES:**

- Cat. 2, 3-point hitch
- 10" Approximate tilling depth
- 4 Speed gearbox - 2 speeds @ 540 RPM & 2 speeds @ 1000 RPM
- Strong, smooth running, all gear final drive
- Slip clutch driveshaft to protect tractor and tiller drive system
- Curved, saber style heat treated, long wearing tines
- Side mounted skids for depth control
- 6 Tines mounted on each rotor plate for maximum tilling action
- Large, oil bath, long wearing rotor bearings

# ROTARY TILLERS

For Tractors 90 to 160 Horsepower

## "T" Series

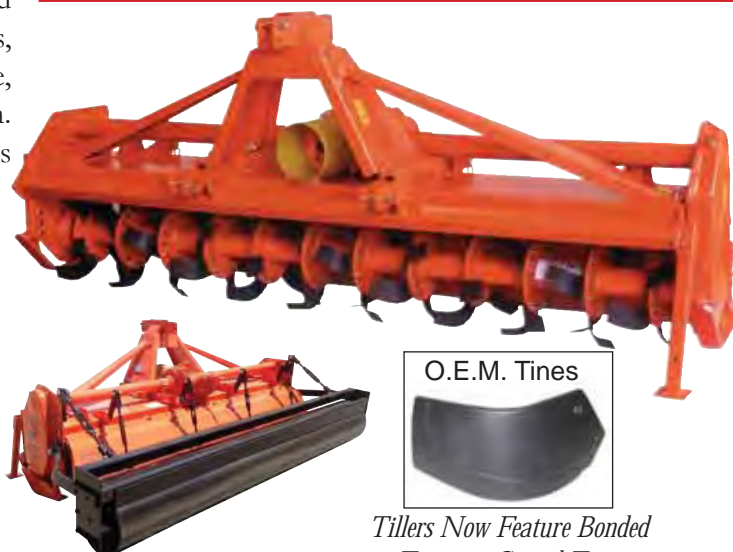

*Tillers Now Feature Bonded Tungsten Coated Tines*

Model No.	Tilling Width	Overall Width	No. of Tines	Approx. H.P.	Wt.
T230-CT	90"	97"	54	90-100	2140#
T280-CT	110"	117"	66	100-120	2205#
T305-CT	120"	127"	72	110-160	2275#
T355-CT	140"	147"	84	120-160	2415#



# ROTARY TILLERS

*For Year Round Orchard Floor Maintenance*

*Orchard Mulch Incorporators*

An important application for these tillers with rear rollers is to bury wood chips by tilling 2 to 3 inches deep. The roller then slightly compacts and smooths out the orchard floor. The wood chips will decompose at a faster rate and the rolled out area is then in better condition for the harvesters. The University of California Cooperative Extension recommended keeping wood chips and shreadings in the orchards. They also stated that if well managed, prunings can become a source of organic matter and nutrients in the soil. Growers have found many more uses for the Incorporators. Such as - tilling out tire tracks, mulching in weeds and general floor maintenance.

**Model S255RR-CT**



**Model T305RR-CT**



O.E.M. Tines

*Tillers Now Feature Bonded Tungsten Coated Tines*



**S Tiller with Adjustable Rear Roller**



**Cleaned, Tilled, and Rolled Orchard Floor**



**T Tiller with Adjustable Rear Roller**



Features:	S255RR-CT	T305RR-CT	T355RR-CT
Tilling Width:	102" (8' 6")	120" (10')	140" (11' 8")
Minimum Tractor Horsepower Req'd:	70 HP	90 HP	90 HP
Gearbox Maximum Capacity:	90 HP	160 HP	160 HP
Speeds:	4 Speed @ 540 RPM	2 Speeds @ 540 RPM 2 Speeds @ 1000 RPM	2 Speeds @ 540 RPM 2 Speeds @ 1000 RPM
Final Drive:	All Gear	All Gear	All Gear
Category:	Cat. 2 Fixed Center Mount	Cat. 2 Fixed Center Mount	Cat. 2 Fixed Center Mount
Rear Roller Diameter:	16"	18"	18"
Tiller w/Roller Weight:	2200#	3165#	3485#

**Other widths of tillers with rollers are available upon request**

# TOPDRESSERS

Accurate Spreading of Wet & Dry Materials

## Turf Tiger



Marketed by Gearmore, Inc.

twin spinners are best for light applications, with spreading widths up to 35 feet. The brush attachment provides precision drop spreading 42" wide. Here are just some of the wet or dry materials you can spread with the Turf Tiger:

- ~ Sand/Peat Topdressing
- ~ Soil Amendments
- ~ Wet sand
- ~ Infield Conditioners
- ~ Compost
- ~ Soil & Infield Mixtures
- ~ Sewage Sludge



### Generous Load Capacity

3.2 cubic yards heaped capacity; optional extension sides available

### Large 7500 lb. Payload

Allows fewer trips, fewer loads

### Rubber Coated Drive Rollers

Prevent belt slippage

### Dual Hydraulic Controls

Provide infinite speed adjustments for belt and attachment(s)

### Powerful Hydraulic Drive System

Standard tractor hydraulics or PTO driven hydraulics

### Flotation Turf Tires

Provide low ground pressure and wide track stability



### Self-aligning V-Track System

Keeps the material delivery belt aligned

### Saber Tooth™ Beater

Spreads any material, wet or dry; 8 to 12 ft. wide spread pattern. Alternate spreading attachments include dual spinners, a rear cross conveyor and a 42" wide brush.



Topdress twice as fast without compromising precision. Exclusive Millcreek Saber Tooth technology gives you speed, accuracy and versatility unlike any other topdresser on the market today. There's nothing else as affordable for limited budgets at schools, park and recreation departments, and golf courses. Turf Tiger Cub comes in two sizes, 1.8 and 2.3 cubic yard capacity. Turf Tiger Cub is user friendly and more versatile than any other equipment of its kind thanks to the exclusive Saber Tooth beater. Turf Tiger Cub spreads all kinds of bulk material such as sand/peat topdressing, infield mixes, compost, grass clippings, synthetic material, lime, and wood chips with precision, power and speed.



### Loading Flares

Simplify loading

### Choose Your Capacity

Two models available - 1.8 or 2.3 cu. yd. heaped capacity

### Drive System

Simple, heavy-duty drive components are more reliable

### Standard PTO Hookup



### Metering Gate

Easily adjusts for high/low volume material flow

### Apron Conveyor

Exclusive design for guaranteed tracking and no slipping

### Saber Tooth Beater

Spreads various textured materials - even wet, damp, or clumpy. Up to 8' wide spread pattern; from a dusting up to 1" per pass

Model No.	Width*	Height	Length	Wt.
4300	93"	73"	12' 8"	1750#

\*With turf tires, implement tires optional

Model No.	Heaped Capacity	Pound Capacity	Overall Width	Overall Height	Overall Length	Wt.
3100	1.8 cu. yd.	3000 lbs.	70"	54"	11'	1140#
3200	2.3 cu. yd.	3750 lbs.	70"	54"	13'	1300#

# TRAILERS

Capacities 1 1/2 to 8 Ton - Rear & 3-Way

## Dump Trailers

Our Gearmore **Dump Trailers** offer 5 sizes and capacities to choose from, in rear and 3-way dump. We offer models in single and tandem axle with rear hinged tailgates on all models for ease in dumping. All our models offer foldaway tongue jacks and swivel clevis type hitches. Any user who needs to "haul and dump" will find these trailers save time and money. Some of the popular uses are golf courses, parks, cemeteries, landscapers, growers and ranchers.

### OPTION:

- ~ Central door with adjustable gate for 5 & 8 ton trailers



### SPECIFICATIONS:

Model:	1.5T50X72	2.5T60X96	4T63X99	5T63X99	8T60X120
Capacity Weight:	1.5 Ton	2.5 Ton	4 Ton	5 Ton	8 Ton
Capacity:	35 cu. ft.	77 cu. ft.	2.5 cu.yd.	2.5 cu.yd.	3.5 cu.yd.
Tire Size:	18x9.5 - 8	23x10.5-12	11L x 15	11L x 15	11L x 15
No. of Tires:	4	4	2	4	4
Weight:	600#	1500#	1800#	1875#	2000#
Bed Width:	50"	60"	63"	63"	60"
Bed Length:	70"	94"	99"	99"	120"
Bed Height:	21"	30"	33"	33"	31"
Bed Floor:	12 Gauge Steel	3/16" Plate	3/16" Plate	3/16" Plate	3/16" Plate
Overall Width:	54"	64"	68"	66"	88"
Overall Length:	8' 6"	11' 8"	11' 6"	11' 6"	13' 8"
Overall Height:	34"	52"	61"	61"	61"
Dump Angle:	45°	45°	45°	45°	45°
Side Panels:	13" High	14" High	14" High	14" High	16" High
Rear Panel:	14" High	19" High	18" High	18" High	24" High
Front Panel:	13" High	19" High	18" High	18" High	24" High

1 1/2 Ton Rear Dump



2 1/2 Ton Rear Dump



4 Ton 3-Way Dump



5 Ton 3-Way Dump



8 Ton Rear Dump



# VINE TRIMMERS

**Profilmatic® High Speed Rotary Blade Trimming**  
*For Vineyards*



COLLARD designed the first vine trimmers, and continues to be the World leader in trimmers. The heart of **COLLARD Trimmers** is the unique lightweight aluminum alloy extrusion that provide a rugged, rust proof framework for the cutting blades. This framework is so strong that it has a lifetime guarantee.

The most popular model is the P2200S which trims two half rows. A unique added feature with this trimmer is the adjustable bottom skirting blades, which ensures under row vegetation is cut perfectly. Other models are available for trimming half rows, one complete row and two complete rows. Our

trimmers eliminate excess vine growth, open canopies for better air circulation and greatly improve spray and dust penetration.

## FEATURES:

- Heavy duty forklift style frame
- Trims two half rows
- Frame cutting blades adjustable from 4' to 9'
- Equipped with electro-hydraulic joystick controls for precise trimmer adjustment
- Strong, but lightweight and easy to operate
- Vertical breakaway system to protect trimmer and tractor
- High speed stainless steel blades, self cleaning and never need sharpening
- Adjustable angle motor driven skirts
- Blades turn at 2200 RPM ensures clean cane ends which dry and seals neatly to reduce the risk of disease
- Requires hydraulic tractor capacity of 5.2 GPM at 2200 PSI
- Most operators are confidently operating our trimmers at 6 miles per hour
- Machines have a wide range of adjustments for setting trimmers to operator's exact requirements
- Trimmers have both mechanical and hydraulic protection on side and topping blade assemblies
- Hydraulic cylinders are fitted with load/hold check valves for safety in case a hose fails
- Trimmers come with all hoses, fittings and JIC couplers
- Other models are available for half row, one complete row, and two complete rows - split frame trimmer is available for terraced vineyard
- Front mountings are available for most popular tractors

1 half row

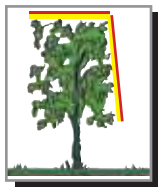

1 complete row



2 half rows



2 half rows w/skirts



2 complete rows



Model No.	Description	Width Adjustment	Cutting Height	Cutting Tops	Weight
P2200S	Trimmer with Skirts	49" to 108"	63"	30.7"	790#

**Marketed by Gearmore, Inc.**

# RAPTOR LEAF REMOVERS

*Pulsed Air Shatters The Leaves*

*Single or Double Heads*



The patented **COLLARD System** achieves leaf removal by a flow of low pressure air produced by a 3-point hitch, P.T.O. driven air compressor. The air is blown through the leaves at fruit level by adjustable rotating defoliating heads. This rapid pulsing air literally shatters the leaves from the foliage and rattles the caps free from the berries.

Our leaf removal system is so effective that it can be used through the whole season from before flowering to harvest.

The COLLARD exposes the clusters to air and sunlight and improves spray penetration. We are able to give all the results like handwork at a fraction of the cost per acre.



## FEATURES:

- Front mount leaf removers available in single or double defoliating heads
- Heads are 24" in diameter with twin rotors for maximum coverage
- Rapid pulses of low pressure (15 PSI) air shakes the leaves to pieces
- The stainless steel defoliating heads are effective up to 6" away from the grape clusters
- Both inner and outer leaves and trash are removed around fruit zone
- Electric oil flow regulator to adjust the nozzle rotation speed
- Hydraulic adjustment for in and out, up and down, of the defoliating head
- Tractor requirement is 60 HP minimum with hydraulic capacity of 8 GPM at 2400 PSI
- Air compressor is 3-point hitch mounted with 540 RPM P.T.O.
- Compressor has exhaust silencer and air intake filter
- Electro hydraulic controls are standard
- Leaf trimmers come with all hoses, fittings and JIC couplers
- Comes with storage/parking stand

## SPECIFICATIONS:

Order No.	No. of Heads	Position of Heads	Working Position	Heads Reverse
E2200 3P	2	Rear	In-Row	No
E1100 FR	1	Front	In-Row	Yes
E2200 F	2	Front	In-Row	No
E2200 FR	2	Front	In-Row & Over the Row	Yes

**Marketed by Gearmore, Inc.**



# PREPRUNERS

*To Reduce The Costs Of Hand Pruning  
For Vineyards*



The **COLLARD Prepruners** will greatly reduce your pruning costs. Growers state that the finish hand pruning takes only 25% of the time versus total hand pruning costs. The Prepruner cuts the long canes small enough that they fall through the wire which is an aid in clean-up.

The Prepruner features two systems for opening and closing of the cutting heads, unique optical cells "electric eyes" and manual hand lever.

These front mounted Prepruners for vertical trellis vine grapes are low maintenance, and high production giving the Collard units high marks with several leading California growers.

## FEATURES:

- Heavy front mount frame for mounting to tractor
- Cane cutting length of 27.8" or 32.5"
- Dual hydraulic motors to power the cutting blades
- Three hydraulic cylinders - one for up and down, one stroke cylinder for in and out and one stroke cylinder for cross slope
- Cylinders are fitted with anti-fall safety valves
- Simple spring system to adjust the blade pressure
- Prepruners come with a special storage stand
- Tractor requirements of at least 6.6 GPM at 2030 PSI
- Custom built brackets are required for tractors and harvesters



Cutting blades and notched discs for clean cuts and trellis post protection



Optical cells that are for automatic opening and closing cutting heads

## SPECIFICATIONS:

Order Number	Cutting Height	Space Between Blades	No. of Blades	Weight
0176 4201 0705	27.8"	3.2"	9	1310#
0176 4201 1825	32.5"	4.3"	8	1285#

*Many other models are available - contact us for your special requirements.*

**Marketed by Gearmore, Inc.**

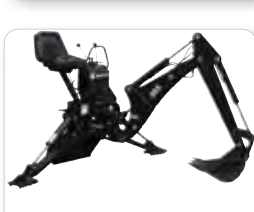
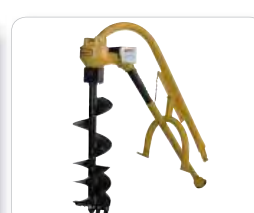
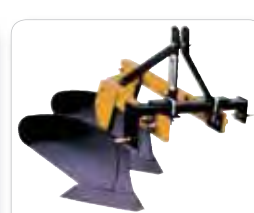

*For Gearmore products, parts, & service,  
see your local tractor dealer listed below*

