



# HP ScanJet Enterprise 7500/Flow 7500

User Guide

**Copyright and License**

© Copyright 2020 HP Development Company, L.P.

Reproduction, adaptation, or translation without prior written permission is prohibited, except as allowed under the copyright laws.

The information contained herein is subject to change without notice.

The only warranties for HP products and services are set forth in the express warranty statements accompanying such products and services. Nothing herein should be construed as constituting an additional warranty. HP shall not be liable for technical or editorial errors or omissions contained herein.

Edition 4, 7/2020

**Trademark Credits**

ENERGY STAR® and the ENERGY STAR® mark are registered U.S. marks.

---

# Table of contents

<b>1 Scanner overview</b> .....	<b>1</b>
Scanner components .....	2
Scanner front panel .....	2
USB and power connections .....	3
Scanner software .....	4
HP Scan software .....	4
HP Scanner Tools Utility .....	5
Power use .....	5
<b>2 Use the scanner</b> .....	<b>7</b>
Load originals .....	8
Use the automatic document feeder (ADF) .....	8
Document loading tips .....	8
How to load documents .....	9
Use the scanner glass .....	11
Scan documents .....	13
Tips on scanning .....	13
Scan from the scanner buttons .....	13
Scan from HP Scan software .....	13
Scan from ISIS- or TWAIN-compliant scanning software .....	14
<b>3 Useful scanner features</b> .....	<b>15</b>
Work with scan shortcuts .....	16
View scan shortcuts .....	16
Create scan shortcuts .....	16
Modify shortcuts .....	16
Scan to a picture .....	17
Scan to a PDF .....	17
Scan text for editing (OCR) .....	17
Scan to email .....	17
Send to cloud .....	17

Scan to FTP .....	18
Scan to SharePoint .....	18
Everyday Scan .....	18
Scan long documents .....	18
Filter out color from a document (color dropout) .....	19
Automatically crop scanned image .....	19
Automatically detect color .....	19
Misfeed (multipick) detection .....	20
Automatically detect page size .....	20
Automatically delete blank pages .....	20
Automatically adjust page orientation .....	21
Scan using text-enhanced black and white mode .....	21
Automatically straighten scanned images .....	21
Add or remove device .....	22
<b>4 Care and maintenance .....</b>	<b>23</b>
HP Scanner Tools Utility Maintenance tab .....	23
Order maintenance and scanning supplies .....	23
Clean the scanner glass, scanning strip, and automatic document feeder (ADF) duplex background .....	24
Clean the rollers .....	26
Replace the rollers .....	27
Replace the separation pad .....	31
Replace the front panel .....	34
<b>5 Troubleshooting .....</b>	<b>37</b>
Scanner errors .....	38
Basic troubleshooting tips .....	39
Scanner installation troubleshooting .....	40
Check the cables .....	40
Uninstall and then reinstall the HP Scanjet utilities .....	40
Scanner initialization or hardware problems .....	41
Check the USB connection .....	41
Check that the scanner has power .....	42
Reset the scanner .....	42
The scanner has stopped working correctly .....	42
Scanner operation problems .....	44
Scanner will not turn on .....	44
Scanner keeps turning off .....	44
The LCD is having display issues or scanner buttons are not working as expected .....	45
Scanner does not scan right away .....	45
Scanner scans only one side of a two-sided page .....	45

Scanned pages are missing at the scan destination .....	45
Scanned image is fuzzy .....	45
Scanned pages are out of order at the scan destination .....	45
Optimize scanning and task speeds .....	46
The scan is completely black or completely white .....	46
Scanned images are not straight .....	46
Vertical white stripes appear on the printed page .....	46
Vertical colored stripes appear on the printed page .....	46
Scan files are too large .....	46
Scanner buttons are not working correctly .....	48
Scanner paper path problems .....	49
Paper jamming, skewing, misfeeds, or multiple-page feeds .....	49
Scanning fragile originals .....	49
Paper does not feed from the scanner .....	49
Originals are curling up in the scanner output tray. ....	50
The bottom of the scanned image is cut off .....	50
The scanned images have streaks or scratches .....	50
An item loaded in the scanner jams repeatedly .....	50
Clear jams from the scanner paper path .....	50

## 6 Product accessibility and support ..... 53

LCD Reader .....	53
Control of the scanner buttons .....	53

## 7 Specifications and warranty ..... 55

Scanner specifications .....	56
Document feeder specifications .....	56
Environmental specifications .....	57
Regulatory information .....	58
Energy information .....	58
Disposal of waste equipment by users (EU and India) .....	59
HP limited warranty statement .....	60
UK, Ireland, and Malta .....	61
Austria, Belgium, Germany, and Luxemburg .....	61
Belgium, France, and Luxemburg .....	62
Italy .....	63
Spain .....	63
Denmark .....	64
Norway .....	64
Sweden .....	64
Portugal .....	64

Greece and Cyprus .....	65
Hungary .....	65
Czech Republic .....	65
Slovakia .....	66
Poland .....	66
Bulgaria .....	66
Romania .....	67
Belgium and the Netherlands .....	67
Finland .....	67
Slovenia .....	68
Croatia .....	68
Latvia .....	68
Lithuania .....	68
Estonia .....	69
Russia .....	69

Index .....	71
-------------	----

---

# 1 Scanner overview

This User Guide covers what you need to know about using your scanner.

- [Scanner components](#)
- [Scanner software](#)
- [Power use](#)

## Scanner components

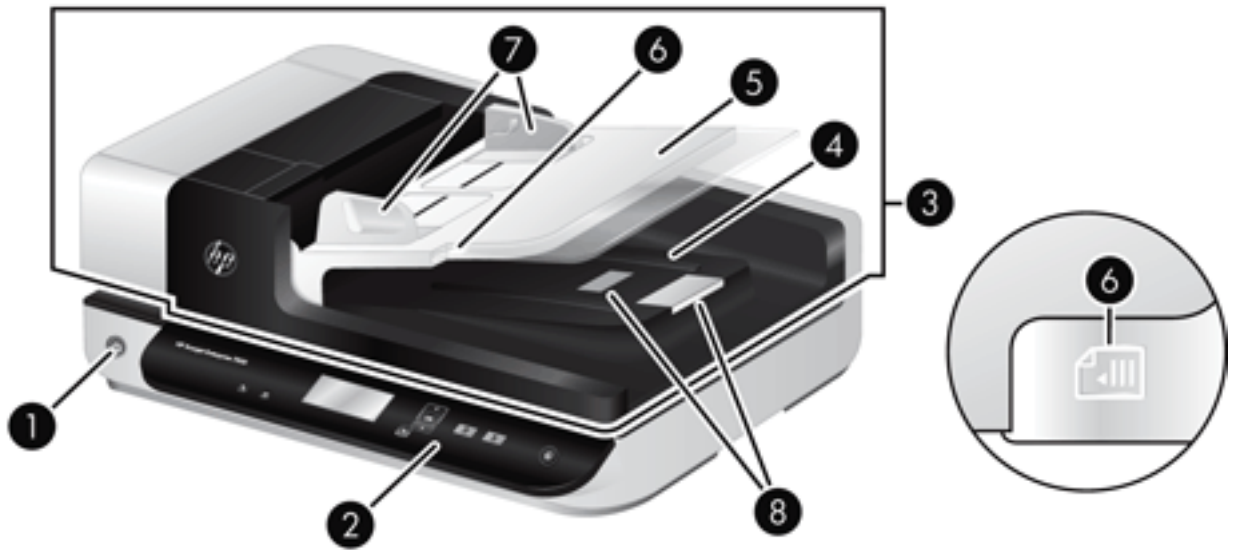







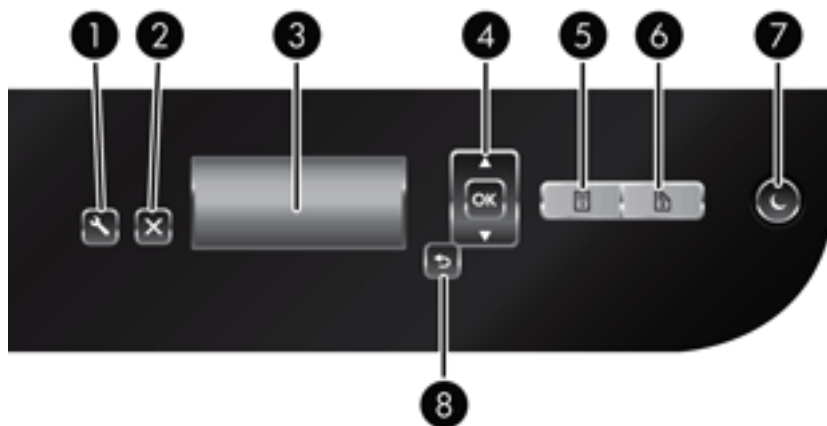

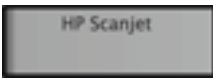

1	Power button
2	Front panel
3	Automatic document feeder (ADF)
4	ADF output tray
5	ADF input tray
6	Document load/detect LED
7	Paper guides
8	Paper stops

## Scanner front panel

Use the buttons on the scanner front panel to start a scan and to configure some scanner settings.





Icon	Button name	Description
1 	Tools	Opens the HP Scanner Tools Utility where you can perform the following tasks: <ul style="list-style-type: none"> <li>• Configure the list of profiles on the scanner front panel</li> <li>• Create scan profiles that use third-party scanning software</li> <li>• Change the scanner power management settings</li> <li>• View information about scanner settings, status, and maintenance</li> </ul>
2 	Cancel	Cancels a scan in progress.
3 	LCD	Displays available scan profiles and status and error messages.
4 	OK/Select	Allows you to scroll the list of scan profiles and view their details. <ul style="list-style-type: none"> <li>• Press  and  to scroll through profiles.</li> <li>• Press <b>OK</b> to view scan profile details or return to the list of profiles when viewing scan profile details.</li> </ul>
5 	Scan Simplex	Starts a one-sided scan.
6 	Scan Duplex	Starts a two-sided scan.
7 	Sleep	Initiates Sleep Mode. When in Sleep Mode, pressing this button wakes up the scanner.
8 	Back	Returns you to the list of profiles when you are viewing profile details.

## USB and power connections

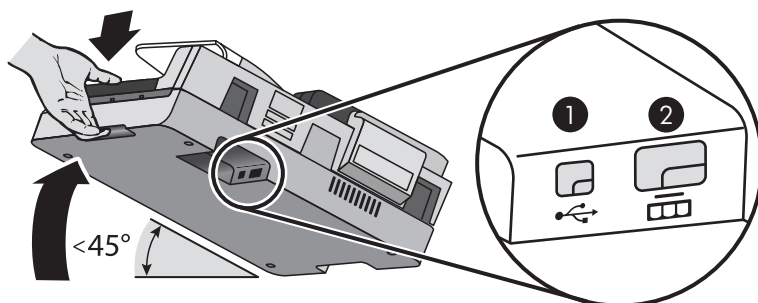

Callout	Description
1	USB input
2	Power supply input

**⚠ CAUTION:** Use care when tilting the unit and do not allow the automatic document feeder (ADF) cover to open accidentally.

## Scanner software

The scanner comes with an assortment of scanning and document-management programs, including:

- [HP Scan software](#)
- [HP Scanner Tools Utility](#)

### HP Scan software

You can use HP Scan software to do the following:

- Scan to PDF
- Scan to JPEG
- Email as a PDF
- Email as a JPEG
- Scan text for editing (OCR)
- Scan to the cloud
- Everyday Scan

## HP Scanner Tools Utility

Use the HP Scanner Tools Utility to complete the following tasks:

- Set maintenance and status update notification options.
- Change the scanner's power management settings.
- View scanner information, such as version, serial number, total number of pages scanned.
- Modify scan profiles.

To open the utility, do one of the following:

- Windows 8.1 and 10: On the Start screen, click **HP Scanner Tools Utility** tile.
- Launch HP Scan Assistant from your desktop, and then select **Tools**.

## Power use

By default, the scanner will enter Sleep Mode after 15 minutes of inactivity, and will turn off automatically after two hours of inactivity to conserve power. To change the default settings or disable these modes, complete these steps.

1. Press the **Tools** (🔧) button to start the HP Scanner Tools Utility.
2. Click the **Settings** tab, and then select the appropriate Sleep Mode and Auto-Off settings.
  - To specify the period of inactivity after which the scanner goes into Sleep Mode, select **15 minutes** or **Never** from the **Sleep: Put the scanner to sleep after:** drop-down list.
  - To specify the period of inactivity after which the scanner automatically turns off, select the appropriate value from the **Auto-Off: Turn off the scanner after:** drop-down list.



---

## 2 Use the scanner

The following topics describe the HP Scanjet 7500/Flow 7500 scanner as well as how to scan originals.

- [Load originals](#)
- [Scan documents](#)

## Load originals

You can load originals into your scanner using one of the following methods:

- [Use the automatic document feeder \(ADF\)](#)
- [Use the scanner glass](#)

## Use the automatic document feeder (ADF)

For helpful information on loading your documents properly, refer to the following topics.









- [Document loading tips](#)
- [How to load documents](#)

### Document loading tips

- The maximum capacity of the document feeder and output tray varies by paper size and weight. For 75 g/m<sup>2</sup> (20 lb) paper (the standard weight for most printer and photocopier paper), the maximum capacity is 100 sheets. For heavier paper, the maximum capacity is less.
- The automatic document feeder (ADF) supports the following paper types.

	Width	Length	Weight (or thickness)
Standard stock (single page)	68-216 mm (2.7-8.5 in)	148-864 mm (5.8-34 in)	49-120 g/m <sup>2</sup> (13-32 lbs)
Standard stock (multiple pages)	68-216 mm (2.7-8.5 in)	148-356 mm (5.8-14 in)	49-120 g/m <sup>2</sup> (13-32 lbs)

- In the scanning software, always specify the following items:
  - Set the page size to match the width and length of the paper that you are scanning.
  - Select a profile whose page loading selection matches the edge you are feeding first.
- Scanning the following types of documents with the ADF might result in paper jams or damage to the documents. To scan these documents, use the scanner glass instead of the ADF.

	Wrinkled or creased documents		Curled documents
	Torn documents		Documents with paper clips or staples
	Carbon paper		Coated paper
	Extremely thin, translucent paper		Paper with adhesive notes or flags attached



Photos



Overhead transparencies



Papers that are stuck together



Paper with wet substances such as glue or correction fluid

- Smooth out any folds or curls in your documents before placing them into the feeder. If the leading edge of a document is curled or folded, it may cause a paper jam.
- When loading paper that is smaller than 148 mm (5.8 in) in width, place the long edge of the page parallel to the paper guides.
- To scan fragile documents (such as photos or documents on wrinkled or very lightweight paper), place the document face down on the scanner glass.
- Make sure that the hatch on the document feeder is securely latched. To properly close the hatch, press until you hear a click.
- Adjust the paper guides to the width of the documents. Make sure that the paper guides touch the edges of the original. If there is any clearance between the paper guides and the edges of the documents, the scanned image might be skewed.
- When placing a stack of documents into the feeder, gently set the stack in the document feeder. Do not drop the stack into the feeder.



**TIP:** The document load/detect LED on the clear portion of the document feeder input tray is on when documents are positioned correctly.

- To prevent skewing, always load stacks of documents of the same dimensions. However, if you must load stacks of mixed document sizes, center all documents in the stack by width before inserting them in the document feeder.
- Clean the scanning rollers if the rollers are visibly dirty or after scanning a document that has pencil writing on it.

## How to load documents

1. Adjust the paper guides to the width of the documents. Take care not to overtighten the guides, which can restrict paper feeding.



When scanning small originals such as checks, it is especially important that the paper guides fit snugly against the edges of the original.

2. Fan the stack of document pages to ensure that the pages do not stick together. Fan the edge that will be pointing into the feeder in one direction, and then fan that same edge in the opposite direction.



3. Align the edges of the documents by tapping the bottom of the stack against the table top. Rotate the stack 90 degrees and repeat.

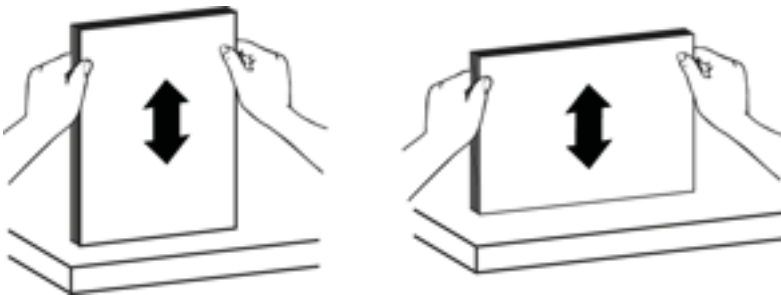



4. Gently set the stack in the document feeder. Load the pages face up with the top of the pages pointing into the feeder.

*For best results, do not drop the stack into the feeder and do not tap the top edge of the stack after you have placed it in the document feeder.*



---

**TIP:** Avoid feeding a document with a leading edge that has been folded or frayed. When you begin scanning, select a profile whose page loading selection matches the edge you are feeding first to ensure that the scan reflects the orientation of the original document.

---

5. Verify that the paper guides are aligned with the edges of the stack.

## Use the scanner glass

Place items that do not meet the specifications for the automatic document feeder (ADF) directly onto the scanner glass.

---

Minimum size:	No minimum size
Maximum size:	216 x 356 mm (8.5 x 14 in)

---

---

**NOTE:** Not all the length of the scanner glass is in the active imaging area, so make sure to position your originals as indicated by the reference mark on the edge of the scanner glass.

---

Place the original face down on the scanner glass, as indicated by the reference mark. For landscape pages, place the page face down with the top of the page pointing toward the back of the scanner.



---

 **TIP:** To scan multiple pictures at the same time, arrange the pictures that you want to scan on the scanner glass with at least 6 mm (0.25 in) of space between items.

---

# Scan documents

The following topics describe how to scan originals using the scanner and the scanner software.

- [Tips on scanning](#)
- [Scan from the scanner buttons](#)
- [Scan from HP Scan software](#)
- [Scan from ISIS- or TWAIN-compliant scanning software](#)

## Tips on scanning

- If the scanner LCD does not display any scan profiles, open the HP Scanner Tools Utility to load the profiles onto the scanner.
- To reduce paper jams, use scan settings that specify the actual dimensions of the pages that you are scanning.
- To cancel a scan, press the **Cancel** (X) button.
- If you press **Scan Duplex** (📄) and the selected profile is configured to use the automatic document feeder (ADF), the scanner processes both sides of the original regardless of the scan profile setting. If you press **Scan Simplex** (📄), the scanner processes the face up side of the original when scanning from the ADF or the face down side when scanning from the scanner glass.

---

 **NOTE:** If the selected scan profile is configured to use the scanner glass (rather than the ADF), the scanner processes only one side of the original regardless of the scan button (📄 or 📄) you press.

---

- You can create scan profiles that use third-party scanning software. For more information, see the HP Scanner Tools Utility Help.

## Scan from the scanner buttons

To scan using the scanner buttons, follow these steps:

1. Load the originals.
2. Use ▲ and ▼ to select the scan profile you want.

---

 **TIP:** Pressing **OK** displays the scan profile's file type, color mode, and resolution. To return to the profiles list, press the **Back** (↶) button.

---

3. Press either **Scan Simplex** (📄) for one-sided scans or **Scan Duplex** (📄) for two-sided scans.

## Scan from HP Scan software

You can scan from the HP Scan software.

1. Open the HP Scan software.
2. Select a shortcut, and then click **Scan**.

---

 **TIP:** Choose any other scan shortcut, select **File Type** and the file destination, and then click **Scan**

---

## Scan from ISIS- or TWAIN-compliant scanning software

You can scan an image or document directly into a software program if the program is ISIS- or TWAIN-compliant. Generally, the program is compliant if it has a menu option such as **Acquire**, **Scan**, **Import New Object**, or **Insert**. If you are unsure whether the program is compliant or what the option is, see the documentation for that program.

1. Start the scanning software, and then select the ISIS or TWAIN data source.
2. Select the settings that are appropriate for the documents that you are scanning.
3. Carry out the appropriate actions to complete the scan.

For more information, see the online help for the scanning software.

---

## 3 Useful scanner features

Experienced document management professionals might be interested in the following scan features. These features are available from any document TWAIN or ISIS application that allows you to modify the scan settings in its user interface.

- [Work with scan shortcuts](#)
- [Scan to a picture](#)
- [Scan to a PDF](#)
- [Scan text for editing \(OCR\)](#)
- [Scan to email](#)
- [Send to cloud](#)
- [Scan to FTP](#)
- [Scan to SharePoint](#)
- [Everyday Scan](#)
- [Scan long documents](#)
- [Filter out color from a document \(color dropout\)](#)
- [Automatically crop scanned image](#)
- [Automatically detect color](#)
- [Misfeed \(multipick\) detection](#)
- [Automatically detect page size](#)
- [Automatically delete blank pages](#)
- [Automatically adjust page orientation](#)
- [Scan using text-enhanced black and white mode](#)
- [Automatically straighten scanned images](#)
- [Add or remove device](#)

## Work with scan shortcuts

Scan shortcuts provide a fast, efficient way to select the settings for frequently performed scanning tasks. Use HP Scan software to create and modify scan shortcuts.

- [View scan shortcuts](#)
- [Create scan shortcuts](#)
- [Modify shortcuts](#)

### View scan shortcuts

To view existing scan shortcuts, open **HP Scan**. Existing scan shortcuts will display in a list to the left.

### Create scan shortcuts

To create a scan shortcut, follow these steps:

1. Open the HP Scan software.
2. Click **Create New Scan Shortcut**.
3. Enter a name for the new shortcut.
4. Choose to create the new shortcut from current settings, or a previous existing shortcut.
5. Click **Create**.
6. Modify the settings for the new scan shortcut. Click **More** for more settings.
7. Click the **Save** icon next to the name of the new shortcut in the shortcut list to save the modifications to the shortcut.

-or-

Click the **Undo** icon to undo modifications.

### Modify shortcuts

To modify a scan shortcut, follow these steps:

1. Open the HP Scan software.
2. Select the shortcut to be modified from the list to the left.
3. Change the settings on the right side of the screen. Click **More** for more settings.
4. Click the **Save** icon to the right of the shortcut name to save the changes.

## Scan to a picture

1. Load the document into the input tray.
2. Open the HP Scan software.
3. Select **Save as JPEG** or **Email as JPEG**, and then click **Scan**.

-or-

Choose any other scan shortcut, change the **Item Type** to **Photo**, select a picture file from the **File Type** drop down list, and then click **Scan**.

## Scan to a PDF

1. Load the document into the input tray.
2. Open the HP Scan software.
3. Select **Save as PDF** or **Email as PDF**, and then click **Scan**.

-or-

Choose any other scan shortcut and select PDF from the **File Type** drop down list, and then click **Scan**.

## Scan text for editing (OCR)

The HP scanner software uses optical character recognition (OCR) to convert text on a page to text that can be edited on a computer. The OCR software comes with the ReadIris Pro software. For information about using the OCR software, see **scan text for editing** in the online Help.

## Scan to email

---

 **NOTE:** To scan to email, make sure there is an Internet connection.

---

1. Load the document into the input tray.
2. Open the HP Scan software.
3. Select **Email as PDF** or **Email as JPEG**, and then click **Scan**.

-or-

Choose any other scan shortcut and select **Email** from the **Send To** drop down list, and then click **Scan**.

## Send to cloud

---

 **NOTE:** To scan to the cloud, make sure there is an Internet connection.

---

1. Load the document into the input tray.
2. Open the HP Scan software.

3. Select **Send to Cloud**, and then select the file destination, such as Google Drive or DropBox.
4. Select **Scan**.

## Scan to FTP

You can upload a scanned image to a FTP folder by using the HP Scan software.

1. Load the document into the input tray.
2. Open the HP Scan software.
3. Select a scan shortcut. From the **Destination** area, select **Send to**.
4. Select a FTP folder as the destination.



---

**NOTE:** If using this feature for the first time, click **Add** to set up FTP as the destination.

---

5. Click **OK**, and then click **Scan**.

## Scan to SharePoint

You can upload a scanned image to a SharePoint site by using the HP Scan software.

1. Load the document into the input tray.
2. Open the HP Scan software.
3. Select a scan shortcut. From the **Destination** area, select **Send to**.
4. Select a SharePoint site as the destination.



---

**NOTE:** If using this feature for the first time, click **Add** to set up a SharePoint site as the destination..

---

5. Click **OK**, and then click **Scan**.

## Everyday Scan

The **Everyday Scan** shortcut allows users to define and save a scan shortcut for their everyday needs. The following **Scan Shortcut Settings** are customizable when the **Everyday Scan** shortcut is selected:

- **Item Type**
- **Page Sides**
- **Page Size**
- **Color Mode**
- **Destination/File Type**

## Scan long documents

By default, the HP Scan software accepts a stack of originals up to 216 mm x 356 mm (8.5 in x 14 in). You can choose to scan single pages up to 216 mm x 864 mm (8.5 in x 34 in).



---

 **NOTE:** If the scanner is set to scan long pages and a page jams, up to 864 mm (34 in) of document pages can be wrinkled as a result of the jam. Therefore, select scan profiles that specify long pages only when you are scanning pages longer than 356 mm (14 in).

---

## Filter out color from a document (color dropout)

You can filter out a color channel (red, green, or blue) or up to three individual colors. For specific colors, the sensitivity setting controls how closely a scanned color must approximate the specified color.

Removing colors from the scan might reduce the scan file size and improve optical character recognition (OCR) results.

To select colors to eliminate from a scan in an HP Scan software profile, follow these steps:

1. Open the HP Scan software.
2. Scan a sample page that has the colors to be dropped into the viewer.
3. Click the **More** button, and then click the **Image** tab and select the **Color Dropout** feature.
4. Enable a color to drop, and then select the color from the preview using the eyedropper tool. Be sure to save the colors.

Only the color dropout options available for your scanner are selectable.

For information about the color dropout settings, see the online help for the scanning software that you are using.

## Automatically crop scanned image

To automatically crop a scan, follow these steps:

1. Open the HP Scan software.
2. Select a scan shortcut, and then click **More** for more settings.
3. Select your crop options from the **Input Page Size** drop-down list.
  - To automatically crop to the content of the document, select the **Detect Content on Page**.
  - To automatically crop to the dimensions of the document, select the **Detect Size**.
4. Make sure the **Same as Input** option is selected for **Output Page Size**, and then click **Scan**.

---

 **NOTE:** Use the ISIS or TWAIN user interface to set crop options when scanning from third-party scanning software.

 **NOTE:** For information about the auto-crop settings, see the online help for the scanning software that you are using.

---

## Automatically detect color

You can use this feature to reduce the size of the scanned file by only saving pages that contain color as color scans, and saving all other pages as black and white.

To automatically detect color in a scanned image, follow these steps:

1. Open the HP Scan software.
2. Select a scan shortcut.
3. To adjust the **Auto Detect Color** sensitivity and output mode settings, click **More**, select **Image**.
4. Click the **Color Mode** drop-down box, and then select **Auto Detect Color**.
5. Select the **Auto Detect Color** drop-down box, change settings, and then click **OK**.
6. Click **Scan**.

---

 **NOTE:** For information about the automatic color detection settings, see the online help for the scanning software that you are using.

 **NOTE:** Use the ISIS or TWAIN user interface to automatically detect color when scanning from third-party scanning software.

---

## Misfeed (multipick) detection

The Misfeed multipick detection feature stops the scan process if it senses that multiple pages are fed into the scanner at one time. This feature is enabled by default.

You might want to disable this feature if:

- You are scanning multipart forms (a use that HP does not recommend).
- Documents have labels or sticky notes attached to them.

---

 **NOTE:** Use the ISIS or TWAIN user interface to enable misfeed detection when scanning from third-party software.

---

## Automatically detect page size

The HP Scan software is capable of automatically detecting page size using the **Detect Size** option. When the **Detect Size** option is selected from the **Page Size** drop-down list, the scanned image is cropped to the size of the detected page and any skewed content is straightened.

## Automatically delete blank pages

When the **Delete blank pages** feature is enabled, scanned pages are evaluated for content. The blank pages detected show up in the viewer with a delete notation on them. These detected blank pages are deleted automatically when the scanned document is saved to the destination.

1. Open the HP Scan software.
2. Select a scan shortcut.
3. Click **More**.
4. Select the **Document** tab, select **Delete blank pages** from the **Adjust documents** drop-down box, and then click **OK**.

---

 **TIP:** The Sensitivity slider allows you to adjust the sensitivity value on how blank pages are detected and deleted. At the lower end of the slider, more pages are detected as blank and deleted. At the upper end of the slider, pages must be almost completely blank to be detected and deleted. The sensitivity value can be also set by entering a value or clicking the arrow buttons.

---

## Automatically adjust page orientation

Use this feature to automatically adjust page orientation by language.

1. Open the HP Scan software.
2. Select a scan shortcut.
3. Click **More**.
4. Under the **Scan** tab, select the **Page Orientation** drop-down box, and then select the **Auto Orient** check box.
5. Select a document language, click **OK**, and then start **Scan**.

## Scan using text-enhanced black and white mode

Use this feature to enhance the scanned image when scanning black and white text. To use this feature, complete the following steps:

1. Open the HP Scan software.
2. Select a scan shortcut.
3. Click **More**.
4. Select the **Image** tab, and then select **Black/White (1 bit)** from the **Color Mode** drop-down box.
5. Select **Threshold for Black/White**, select **Enhance Content**, and then click **OK**.

## Automatically straighten scanned images

Windows: Use the **Auto-Straighten** feature to straighten content that is skewed relative to the page dimensions in the source document. Use the **Detect Size** feature to deskew page images that might have become skewed during the scanning process.

1. Open the HP Scan software.
2. Select a scan shortcut.
3. Click **More**, select the **Document** tab, and then select **Straighten Content**.

## Add or remove device

You can use the HP Scan software to add or remove a device on the computer.

1. Open the HP Scan software.
2. Click the **Settings** icon  to open the **Device Settings** window.
3. Do one of the following:
  - To add a device, click the plus **+** icon, click **Connect a new device**, and then follow the on screen instructions.
  - To remove a device, select the scanner name from the existing scanner list, and then click the **Delete** button.

---

 **TIP:** You can select multiple scanners to delete them at once.

---

 **TIP:** You can also use HP Scan Assistant to add a new device. Launch HP Scan Assistant from the computer desktop, click **Tools**, click **Device Setup & Software**, and then select **Connect a new device**.

---

---

## 4 Care and maintenance

This section presents information about how to care for and maintain the scanner. For the latest maintenance information, see [www.hp.com/support](http://www.hp.com/support).

- [HP Scanner Tools Utility Maintenance tab](#)
- [Order maintenance and scanning supplies](#)
- [Clean the scanner glass, scanning strip, and automatic document feeder \(ADF\) duplex background](#)
- [Clean the rollers](#)
- [Replace the rollers](#)
- [Replace the separation pad](#)
- [Replace the front panel](#)

Occasional cleaning of the scanner helps ensure high-quality scans. The amount of care necessary depends upon several factors, including the amount of use and the environment. You should perform routine cleaning as necessary.

The scanner software includes animations that guide you through the following maintenance tasks. These animations are also available at [www.hp.com/support](http://www.hp.com/support).

- Removing and replacing rollers
- Removing and replacing the separation pad
- Removing and replacing the front panel

### HP Scanner Tools Utility Maintenance tab

The **Maintenance** tab of the HP Scanner Tools Utility displays the scanner usage, maintenance history, and settings. You can record scanner maintenance and change the setting for maintenance alerts.

For detailed information, see the HP Scanner Tools Utility Help. To open the Help, press the **Tools**  button on the scanner front panel, and then click **Help** in the dialog box.

### Order maintenance and scanning supplies

You can purchase maintenance parts for your scanner.

1. Visit the HP scanner parts Web site at [www.hp.com/buy/parts](http://www.hp.com/buy/parts).
2. Select your language, and then click the arrow.

## Clean the scanner glass, scanning strip, and automatic document feeder (ADF) duplex background

The scanner glass, scanning strip, and ADF duplex background should be cleaned periodically or any time a scanned image has streaks.

To clean these components, follow these steps:

1. Press the **Power** (⏻) button to turn off the scanner, and then disconnect the USB cable and power supply from the scanner.
2. Open the scanner lid.
3. Clean the scanner glass and scanning strip with a soft, lint-free cloth that has been sprayed with a mild glass cleaner.



---

**CAUTION:** Use only glass cleaner to clean the scanner glass and scanning strip. Avoid cleaners that contain abrasives, acetone, benzene, and carbon tetrachloride, all of which can damage the scanner glass. Avoid isopropyl alcohol because it can leave streaks on the glass.

Do not spray the glass cleaner directly on the scanner glass or scanning strip. If too much glass cleaner is applied, the cleaner could leak under the scanner glass or scanning strip and damage the scanner.

---

4. Dry the glass with a dry, soft, lint-free cloth.

5. Close the scanner lid, and then raise the scanner input tray until it is perpendicular to the scanner.



6. Press in on the ADF duplex background tabs to release the ADF duplex background, and then pull forward to remove the ADF duplex background from its housing.

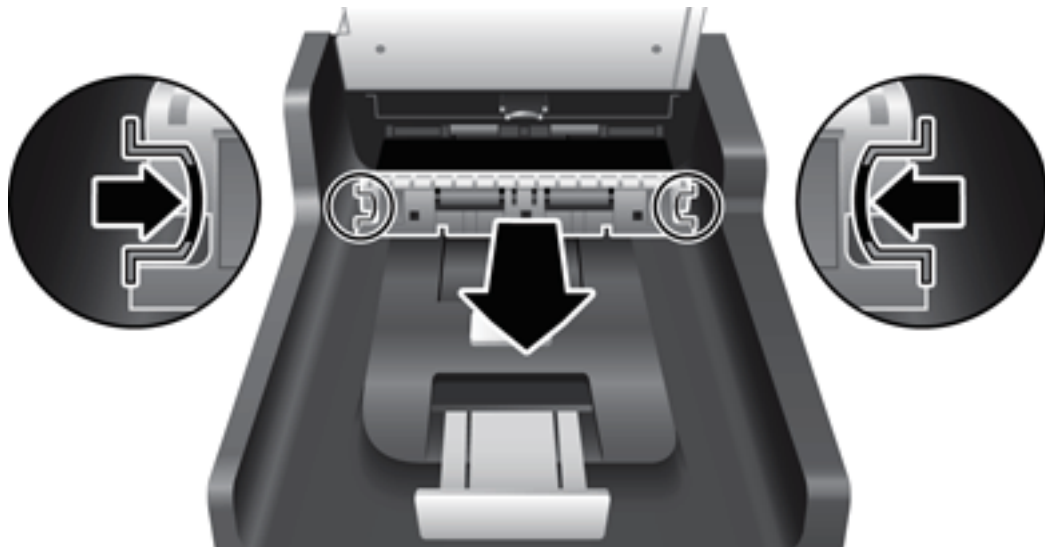

7. Wipe the ADF duplex background with a soft, lint-free cloth that has been moistened with warm water.
8. Dry the ADF duplex background with a dry, soft, lint-free cloth, and then slide the component into its housing until it clicks into place.
9. Lower the scanner input tray into place, and then reconnect the USB cable and power supply to the scanner.

## Clean the rollers

Clean the rollers under the following conditions:

- The HP Scanner Tools Utility indicates that cleaning is needed.
- You experience repeated document jams.
- The scanner does not pull pages into the paper path.
- The scanned images are elongated.
- You frequently scan any of the following types of documents: coated paper, chemically treated documents such as carbonless paper, documents with a large amount of calcium carbonate, documents written with pencils, documents on which the toner has not fused.

To clean the rollers, follow these steps:

1. Press the **Power** (⏻) button to turn off the scanner, and then disconnect the USB cable and power supply from the scanner.
2. Open the automatic document feeder (ADF) hatch.





3. Remove any visible lint or dust from each of the feed rollers and the separation pad using compressed air or a clean lint-free cloth moistened with warm water.

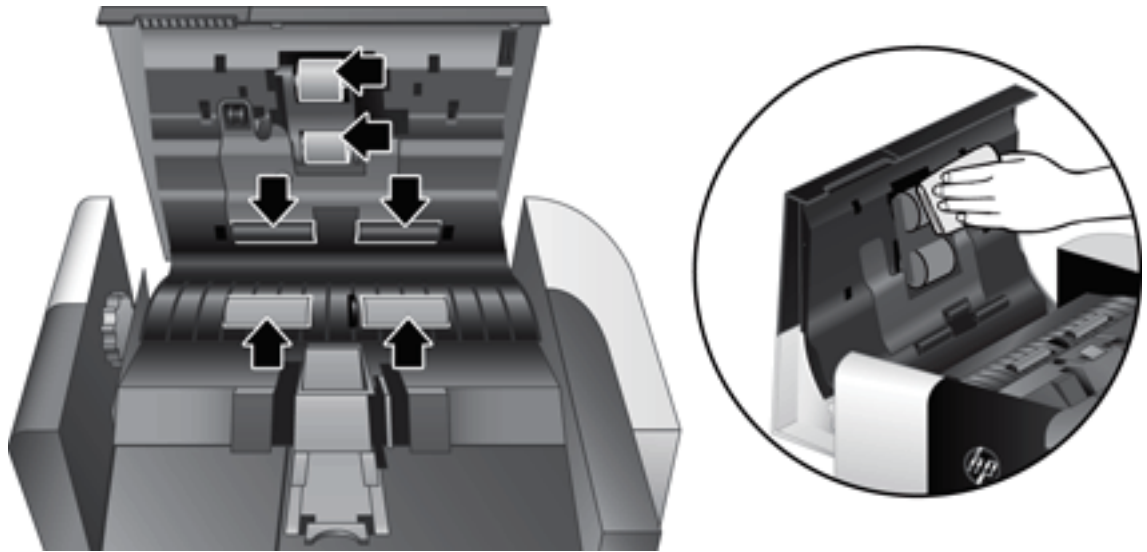

4. Close the ADF hatch, and then reconnect the USB cable and power supply to the scanner.
5. Press the **Power** (⏻) button to turn on the scanner, and then update the scanner maintenance history:
  - a. Press the **Tools** (🔧) button on the scanner front panel to open on the HP Scanner Tools Utility.
  - b. In the **Record Cleaning** section of the **Maintenance** tab, click **Record Cleaning**.

For more information, see the HP Scanner Tools Utility Help.

## Replace the rollers

Replace the rollers under the following conditions:

- When the **Maintenance Recommended** dialog box indicates they are due for maintenance.
- If you experience repeated document jams and cleaning the rollers did not help.

---

**TIP:** The scanner software includes an animation which guides you through removing and replacing the rollers. This animation is also available at [www.hp.com/support](http://www.hp.com/support).

---

The roller replacement kit includes a replacement separation pad. To order the replacement kit, see [www.hp.com/buy/parts](http://www.hp.com/buy/parts).

---

**NOTE:** The roller replacement kit is a consumable and is not covered under warranty or standard service agreements.

---

To replace the rollers, follow these steps:

1. Press the **Power** (⏻) button to turn off the scanner, and then disconnect the USB cable and power supply from the scanner.

2. Open the automatic document feeder (ADF) hatch.



3. Slide your fingertip behind the tab on the roller assembly door, and then pull gently forward and down to open the door.

 **TIP:** Lift the ADF input tray slightly to make it easier to reach the tab.

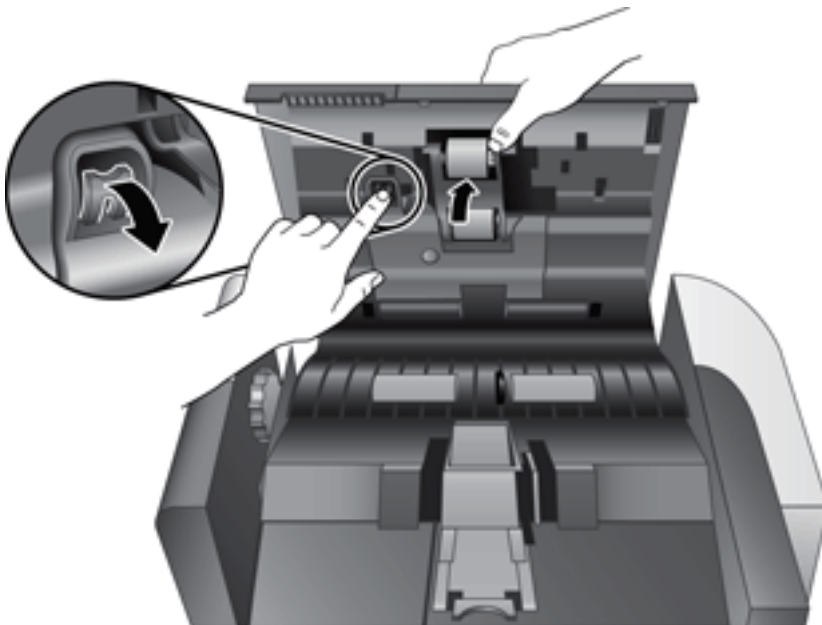

4. Holding the roller assembly door down and out of the way, grasp the roller assembly and slide it to the left to release it from the enclosure.

**⚠ CAUTION:** Do not touch the rollers with bare fingers, as oils from your fingers could impact performance.

**📝 NOTE:** You might feel a slight resistance when sliding the roller assembly.

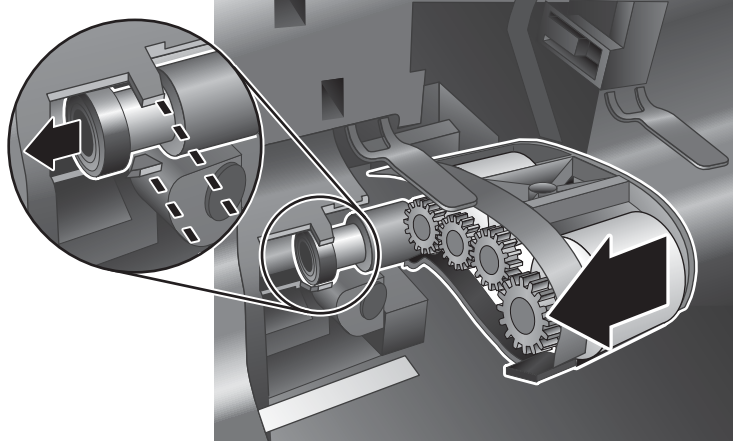

**⚠ CAUTION:** Take care not to press down on the alignment tabs or against the tab to the right of the roller assembly.

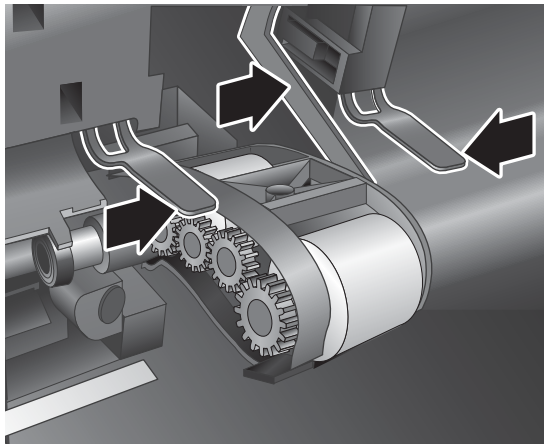

5. Lift the roller assembly out and set it aside.

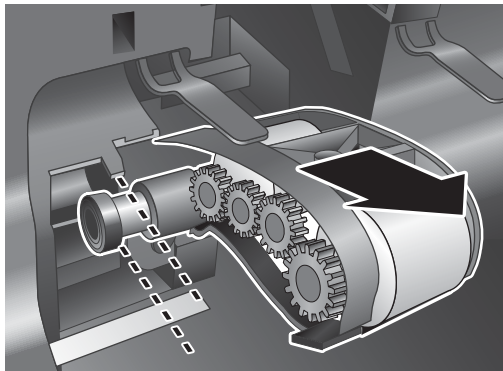

6. Holding the roller assembly door down and out of the way, insert the new roller assembly into the enclosure and slide it to the right until it is seated firmly.

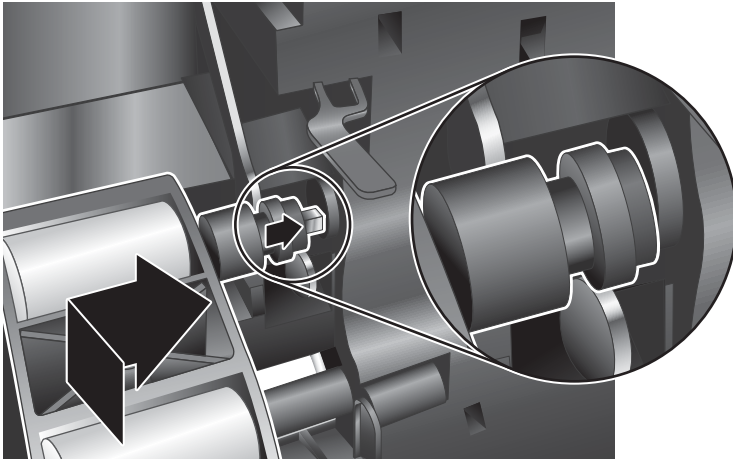

7. Close the roller assembly door, ensuring that the latch seats firmly.

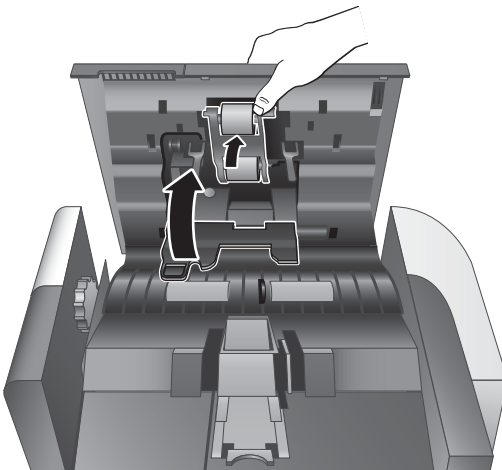

8. Close the ADF hatch, reconnect the USB cable and power supply to the scanner, and then turn on the scanner.
9. Update the scanner maintenance history:
  - a. Press the **Tools** (🔧) button on the scanner front panel to open the HP Scanner Tools Utility.
  - b. In the **Record Replacement** section of the **Maintenance** tab, click **Record Replacement**.  
For more information, see the HP Scanner Tools Utility Help.

---

 **NOTE:** HP recommends that you replace the rollers every 100,000 scans.

The HP Scanner Tools Utility can remind you when service is needed, which depends on many conditions and might be sooner than this replacement interval.

---

## Replace the separation pad

The roller replacement kit includes a replacement separation pad. Always replace the separation pad when you replace the rollers. To order the roller replacement kit, see [www.hp.com/buy/parts](http://www.hp.com/buy/parts).

**TIP:** The scanner software includes an animation that guides you through removing and replacing the separation pad. This animation is also available at [www.hp.com/support](http://www.hp.com/support).

To replace the separation pad, follow these steps:

1. Press the **Power** (⏻) button to turn off the scanner, and then disconnect the USB cable and power supply from the scanner.
2. Open the automatic document feeder (ADF) hatch.



3. Press forward (toward the rear of the ADF) on the separation pad latch to release the separation pad.

**TIP:** This is easier to do if you raise the ADF input tray slightly.

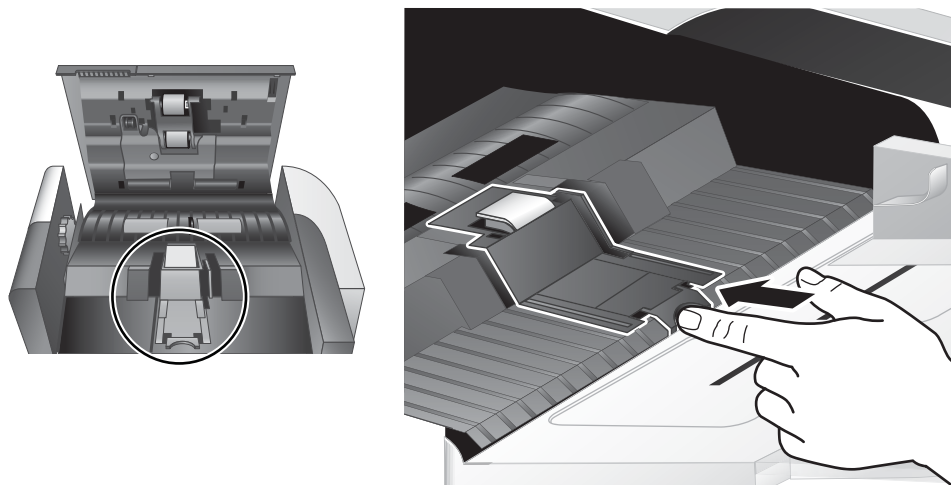

4. Lift up on the separation pad component, release it from its housing, and set it aside.

**⚠ CAUTION:** Do not touch the pad itself with bare fingers, as oils from your fingers could impact performance.

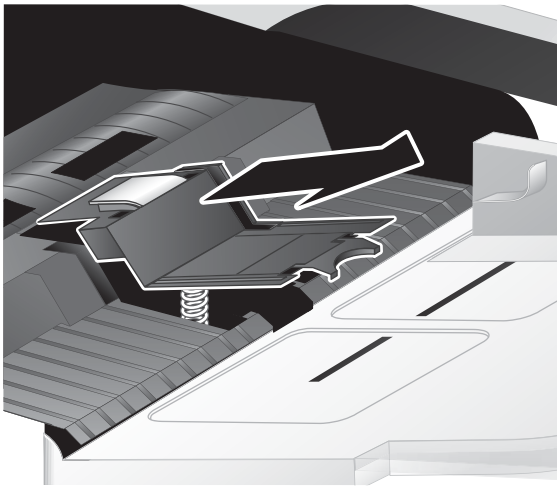

5. Slide the rear edge of the new separation pad component into its housing, ensuring that the spring below the pad is not bent down.

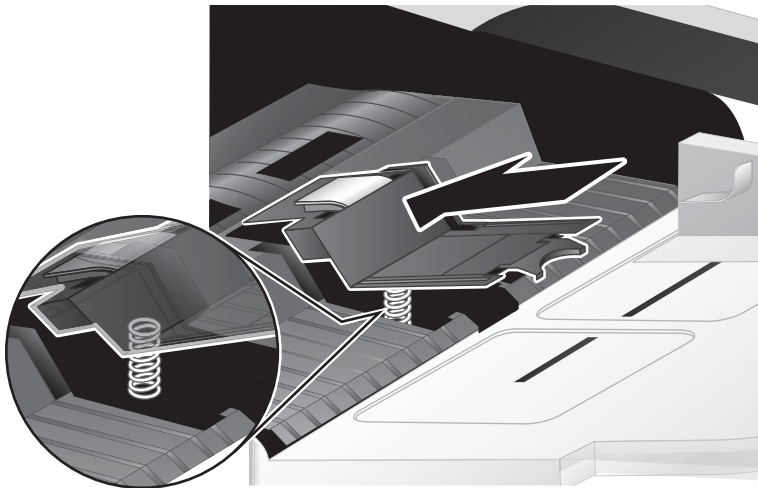

6. Press down on the front portion of the separation pad component until you hear an audible click, indicating that the pad is seated firmly.

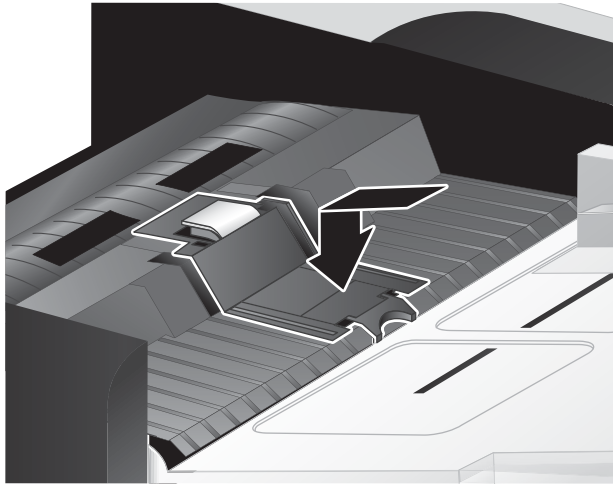

**TIP:** Taking care not to touch the pad with bare fingers, press down on the pad and then release, ensuring that the pad springs back up. This indicates that the spring below the pad is positioned correctly.

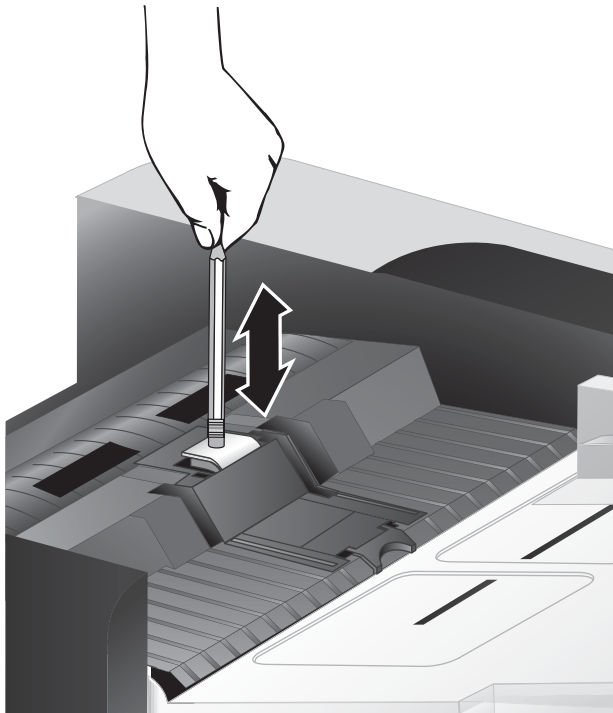

7. Close the ADF hatch, reconnect the USB cable and power supply to the scanner, and then turn on the scanner.

## Replace the front panel

**TIP:** The scanner software includes an animation which guides you through removing and replacing the front panel. This animation is also available at [www.hp.com/support](http://www.hp.com/support).

To replace the front panel, follow these steps:

1. Press the **Power** (⏻) button to turn off the scanner, and then disconnect the USB cable and power supply from the scanner.
2. Raise the scanner lid.
3. Loosen the front panel cover.
  - a. Locate the access hole on the underside of the front panel, and press the bottom end of a pen upward into the hole.
  - b. While pressing the pen upward, use your fingers to gently pry at the tab location shown, lifting the front panel gently as you release the tab.

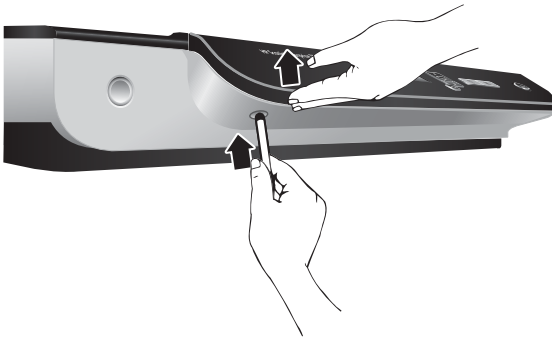

4. Continue to pry at the remaining tab locations, lifting the front panel gently as you release each tab.

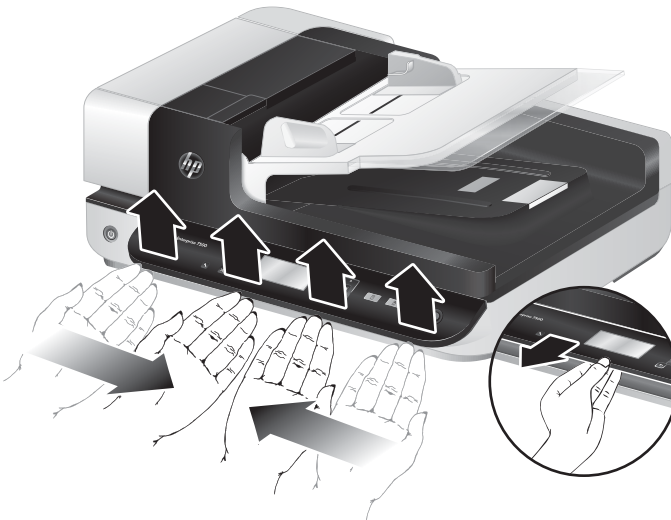



5. Invert the front panel, hold it firmly with one hand, disconnect the 6-pin connector, and set the front panel aside.

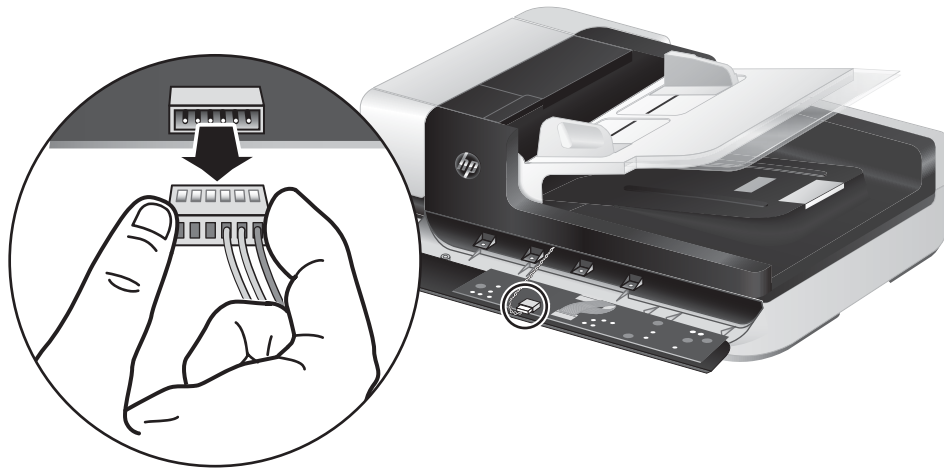

6. Connect the new front panel, taking care to align the notches on the 6-pin connector with the 6-pin receptacle on the front panel.

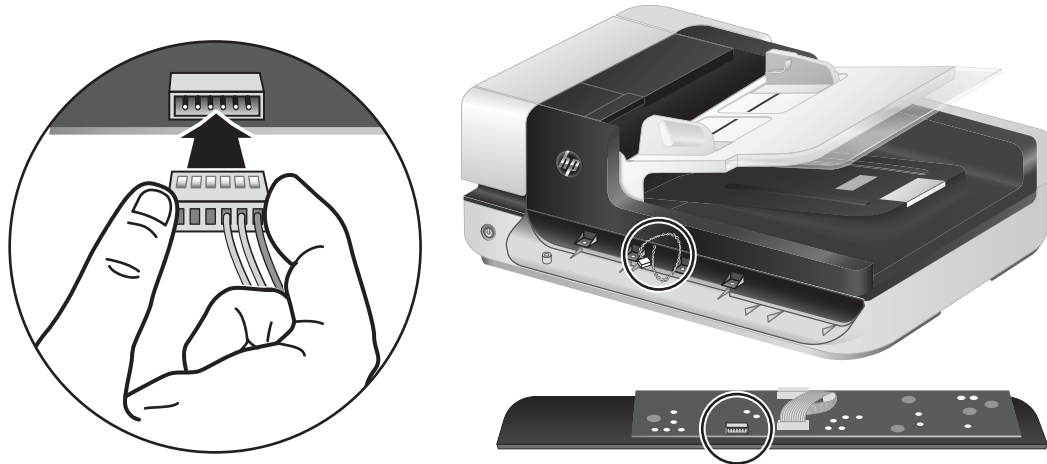

7. Invert the front panel so that it is LCD side up, and position the front panel horizontally to the front panel bezel so the four tabs on the front panel align with the tab slots on the scanner.

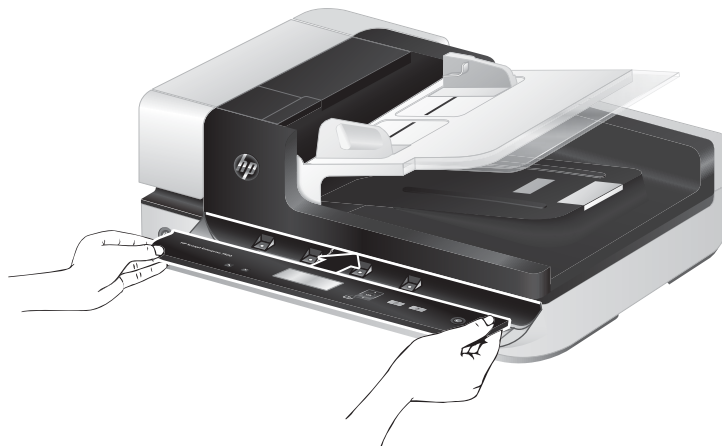

8. Gently push the front panel against the bezel (ensuring that the entire front panel is aligned properly), rotate down, and then press down on the front panel to seat it in place.

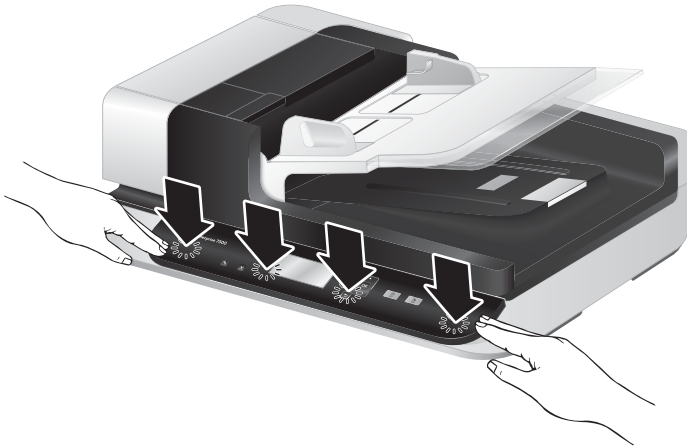

9. Close the scanner lid, reconnect the USB and power cable, and then turn on the scanner.

---

# 5 Troubleshooting



This section contains solutions for common problems with the scanner.

- [Scanner errors](#)
- [Basic troubleshooting tips](#)
- [Scanner installation troubleshooting](#)
- [Scanner initialization or hardware problems](#)
- [Scanner operation problems](#)
- [Scanner buttons are not working correctly](#)
- [Scanner paper path problems](#)

For additional troubleshooting, see the Help for the HP scanning program that you are using.

# Scanner errors

For help responding to an error, see the appropriate topics below.

Error	Description
USB Error	<ol style="list-style-type: none"><li>1. Check the USB connection between the scanner and the computer.</li><li>2. Use the <b>Windows Device Manager</b> tool to verify that the computer recognizes the scanner.<ul style="list-style-type: none"><li>– <b>Windows XP/XP, 64 bit:</b> The <b>Windows Device Manager</b> tool is available on the <b>Hardware</b> tab of the <b>Systems</b> tool in the <b>Control Panel</b>.</li><li>– <b>Vista/Vista, 64 bit, Windows 7:</b> If you have the categorized Control Panel view, select <b>Control Panel</b>, select <b>Hardware and Sound</b>, and then select <b>Device Manager</b>. If you have the Classic view, select <b>Control Panel</b>, then select <b>Device Manager</b>.</li></ul></li><li>3. If the computer does not recognize the scanner, uninstall and then reinstall the scanner software.</li><li>4. If the problem persists, see <a href="http://www.hp.com/support">www.hp.com/support</a>.</li></ol>
Paper Jam	A document feeder paper jam has been detected. Open the hatch and clear the jam.
Hatch Open	The hatch on the document feeder is open or not securely latched. Please close the hatch by pressing until you hear a click, and then rescan.
Motor Failure	Press the <b>Power</b>  button to turn off the scanner, wait 30 seconds, and then turn on the scanner. If the message is still displayed, see <a href="http://www.hp.com/support">www.hp.com/support</a> .
Paper Error	The document feeder cannot pick up the paper or the paper is jammed. Follow these steps to resolve the error: <ol style="list-style-type: none"><li>1. Remove the paper from the document feeder.</li><li>2. Sort through the stack to make sure the sheets are not stuck together.</li><li>3. Make sure the paper meets the size and weight specifications, as specified in the scanner User Guide.</li><li>4. Verify that the roller assembly and separation pad are installed correctly.</li><li>5. Replace the stack of originals and try again.</li></ol>
Hardware Error	A hardware failure occurred. Press the <b>Power</b>  button to turn off the scanner, wait 30 seconds, and then turn on the scanner. If the message is still displayed, see <a href="http://www.hp.com/support">www.hp.com/support</a> .

## Basic troubleshooting tips

Simple issues such as smudges on the scanner glass or loose cables can cause your scanner to produce fuzzy scans, operate in an unexpected manner, or fail to operate. Always check the following items when you encounter scanning problems.

- If scans are fuzzy, check to see if the scanning strip to the left of the scanner glass is dirty or smudged. If so, clean the scanning strip.  
  
If you are scanning a document that will be analyzed using Optical Character Recognition (OCR), make sure that the original document is clear enough to be analyzed.
- Make sure that the USB and power cables are firmly seated in their respective connectors on the back of the scanner, and that the power cord is plugged into a working electrical outlet.
- Ensure that the scanner is receiving power.
  - Check that the green LED on the power supply case is on.
  - If the green LED is not on, ensure that power is available to the power outlet or surge protector that the power supply is plugged into.
  - If power is available to the power outlet or surge protector but the green LED is still not on, the power supply might be defective. Contact [www.hp.com/support](http://www.hp.com/support) for assistance.
- If you have connected the scanner to the computer through a USB hub or through a USB port on the front of the computer, disconnect the scanner and then reconnect it to a USB port on the back of the computer.
- Make sure that the scanner buttons are enabled.
- Turn off the scanner, wait 30 seconds, and then turn on the scanner.
- Make sure the automatic document feeder (ADF) hatch is closed.
- Restart the computer.

If you continue to have problems, it is possible that your HP scanning software, firmware, or associated drivers are out of date or have become corrupted. See [www.hp.com/support](http://www.hp.com/support) to locate software, firmware, and driver updates for your scanner.

# Scanner installation troubleshooting



- [Check the cables](#)
- [Uninstall and then reinstall the HP Scanjet utilities](#)

## Check the cables

Cable type	Action
Power cable	<p>The power cable is connected between the scanner and a power outlet.</p> <ul style="list-style-type: none"><li>• Ensure that the power cable is securely connected between the scanner and a live electrical outlet or surge protector.</li><li>• If the power cable is connected to a surge protector, ensure that the surge protector is plugged into an outlet and turned on.</li><li>• Press the <b>Power</b>  button to turn off the scanner, and then turn off the computer. After 30 seconds, turn on the scanner and then turn on the computer, in that order.</li></ul>
USB cable	<p>The USB cable is connected between the scanner and the computer.</p> <ul style="list-style-type: none"><li>• Use the cable that was included with the scanner. Another USB cable might not be compatible with the scanner.</li><li>• Ensure that the USB cable is securely connected between the scanner and the computer.</li><li>• If the USB cable is connected to a USB port on the front of the computer, move it to a USB port on the back of the computer.</li></ul> <p>For additional USB troubleshooting information, see <a href="http://www.hp.com/support">www.hp.com/support</a>, select your country/region, and then use the search tool to find USB troubleshooting topics.</p>

## Uninstall and then reinstall the HP Scanjet utilities

If checking the scanner cable connections did not solve the problem, the problem might have occurred because of an incomplete installation. Try uninstalling and then reinstalling the HP Scanjet utilities.

1. Press the **Power**  button to turn off the scanner, and then disconnect the USB cable and power cable from the scanner.
2. Use the **Add/Remove** tool (in Windows Vista and Windows 7, the **Programs and Features** tool) from the **Control Panel** to uninstall the following items:
  - ISIS driver
  - TWAIN driver
  - **HP Scanjet 7500 Utilities**
3. Restart the computer.
4. Use HP Scanning Software downloaded from [www.hp.com/support](http://www.hp.com/support) to reinstall the HP Scanjet Drivers and Tools.
5. Reconnect the USB cable and power cable to the scanner, and then press the **Power**  button to turn on the scanner.

## Scanner initialization or hardware problems

- [Check the USB connection](#)
- [Check that the scanner has power](#)
- [Reset the scanner](#)
- [The scanner has stopped working correctly](#)

### Check the USB connection

Check the physical connection to the scanner.

- Use the cable that was included with the scanner. Another USB cable might not be compatible with the scanner.
- Ensure that the USB cable is securely connected between the scanner and the computer. The trident icon on the USB cable faces up when the cable is properly connected to the scanner.

If the problem persists after verifying the above items, try the following:

1. Do one of the following tasks depending on how the scanner is connected to the computer:
  - If the USB cable is connected to a USB hub or a docking station for a laptop, disconnect the USB cable from the USB hub or the docking station, and then connect the USB cable to a USB port on the back of the computer.
  - If the USB cable is directly connected to the computer, plug it into a different USB port on the back of the computer.
  - Remove all other USB devices from the computer except for the keyboard and the mouse.
2. Press the **Power**  button to turn off the scanner, wait 30 seconds, and then turn on the scanner.
3. Restart the computer.
4. After the computer has restarted, try using the scanner.
  - If the scanner works, reconnect any additional USB devices one at a time; try the scanner after connecting each additional device. Disconnect any USB devices that prevent the scanner from working.
  - If the scanner does not work, uninstall and then reinstall the HP Scanjet drivers and utilities.

## Check that the scanner has power

The power cable is connected between the scanner and a power outlet.

- Ensure that the power cable is securely connected between the scanner and a live electrical outlet.
- If the power cable is connected to a surge protector, ensure that the surge protector is plugged into an outlet and turned on.
- Ensure that the scanner is receiving power.
  - Check that the green LED on the power supply case is on.
  - If the green LED is not on, ensure that power is available to the power outlet or surge protector that the power supply is plugged into.
  - If power is available to the power outlet or surge protector but the green LED is still not on, the power supply might be defective. Contact [www.hp.com/support](http://www.hp.com/support) for assistance.

If the problem persists after verifying the above items, follow these steps:

1. Press the **Power**  button to turn off the scanner, and then disconnect the power supply from the scanner.
2. Wait 30 seconds.
3. Reconnect the power supply, and then turn on the scanner.

## Reset the scanner

If you receive an error message similar to **Scanner initialization failed** or **Scanner not found** when trying to use the scanner, you should reset the scanner.

To reset the scanner, follow these steps:

1. Close the HP Scan software and HP Scanner Tools Utility, if they are open.
2. Press the **Power**  button to turn off the scanner, and then disconnect the power supply from the scanner.
3. Wait 30 seconds.
4. Reconnect the power supply, and then turn on the scanner.

## The scanner has stopped working correctly

If the scanner stops scanning, follow these steps. After each step, start a scan to see if the scanner is working. If the problem persists, proceed with the next step.

1. A cable might be loose. Ensure that both the USB cable and power supply are properly connected.

Use the cable that was included with the scanner. Another USB cable might not be compatible with the scanner.
2. Ensure that the scanner is receiving power.



- a. Check that the green LED on the power supply case is on.
  - b. If the green LED is not on, ensure that power is available to the power outlet or surge protector that the power supply is plugged into.
  - c. If power is available to the power outlet or surge protector but the green LED is still not on, the power supply might be defective. Contact [www.hp.com/support](http://www.hp.com/support) for assistance.
3. Unplug the power cable from the power source, wait 30 seconds, and then plug it back in.
4. Restart your computer.
5. Use the **Add/Remove** tool (in Windows Vista, the **Programs and Features** tool) from the **Control Panel** to uninstall the following applications:
  - ISIS/TWAIN software
  - **HP ScanJet Enterprise 7500 Utilities**
6. Reinstall using HP Scanning Software downloaded from [www.hp.com/support](http://www.hp.com/support).
7. Reconnect the USB cable and power cable to the scanner, and then press the **Power**  button to turn on the scanner.

## Scanner operation problems

- [Scanner will not turn on](#)
- [Scanner keeps turning off](#)
- [The LCD is having display issues or scanner buttons are not working as expected](#)
- [Scanner does not scan right away](#)
- [Scanner scans only one side of a two-sided page](#)
- [Scanned pages are missing at the scan destination](#)
- [Scanned image is fuzzy](#)
- [Scanned pages are out of order at the scan destination](#)
- [Optimize scanning and task speeds](#)
- [The scan is completely black or completely white](#)
- [Scanned images are not straight](#)
- [Vertical white stripes appear on the printed page](#)
- [Vertical colored stripes appear on the printed page](#)
- [Scan files are too large](#)

### Scanner will not turn on

If the scanner will not turn on when you press the front panel scanner buttons, check the following:

- The scanner may be turned off. Press the **Power**  button to turn on the scanner.
- The scanner may have been unplugged. Check to see that the power supply has not become disconnected from the scanner or unplugged from the power source.
- The power supply might not be working.
  - Check that the green LED on the power supply case is on.
  - If the green LED is not on, ensure that power is available to the power outlet or surge protector that the power supply is plugged into.
  - If power is available to the power outlet or surge protector but the green LED is still not on, the power supply might be defective. Contact [www.hp.com/support](http://www.hp.com/support) for assistance.

### Scanner keeps turning off

By default, the scanner will enter Sleep Mode after 15 minutes of inactivity, and will turn off automatically after two hours of inactivity to conserve power.

To change the defaults, complete these steps:

1. Press the **Tools**  button to start the HP Scanner Tools Utility.
2. Click the **Settings** tab, and then select the appropriate Sleep Mode and Auto-Off settings.

- To specify the period of inactivity after which the scanner goes into Sleep Mode, select **15 minutes** or **Never** from the **Sleep: Put the scanner to sleep after:** drop-down list.
- To specify the period of inactivity after which the scanner automatically turns off, select the appropriate value from the **Auto-Off: Turn off the scanner after:** drop-down list.

## The LCD is having display issues or scanner buttons are not working as expected

The following symptoms indicate a problem with the scanner front panel.

- LCD issues: The display is blank, or part of the display content is missing.
- Button issues: Buttons are unresponsive, or the wrong action occurs when you press a button (for example, you get a single-sided scan when you press the **Scan Duplex**  button).
- LED issues: LEDs are not working, or are staying in the wrong state.

If the scanner exhibits any of these problems, contact HP support at [www.hp.com/support](http://www.hp.com/support).

## Scanner does not scan right away

Make sure the automatic document feeder (ADF) hatch is closed, and that the scanner is turned on.

## Scanner scans only one side of a two-sided page

- When scanning using the scanner buttons, press the **Scan Duplex**  button.
- When using a scan profile for a third-party application, verify that the application supports duplex scanning.

## Scanned pages are missing at the scan destination

When scanning, pages that stick together are scanned as one item. The hidden pages are not scanned.

## Scanned image is fuzzy

Verify that the document original is not fuzzy.

Use the Kofax Virtual ReScan Software which shipped with your scanner to process the scanned data. Such software cleans up the image and compresses the data.

Check for any obstructions in the scanner paper path and make sure the paper width guides are positioned appropriately. Try another scan.

Clean the scanning strip to the left of the scanner glass.

Check the JPEG compression setting. If scanner compression is high, scanned data might be lost by the compression.

## Scanned pages are out of order at the scan destination

Verify that the page order of the original document is correct before placing it face-up into the document feeder.

Make sure that there are no staples, paper clips, or any other attached material (such as adhesive notes) that may cause the pages to feed incorrectly.

Verify that pages are not stuck together.

## Optimize scanning and task speeds

Several settings influence the total time for a scanning job. When you want to optimize scanning performance, consider the following information.

- To optimize performance, make sure your computer meets the recommended system requirements. To view minimum and recommended system requirements, see [www.hp.com](http://www.hp.com), select your country/region, search on your scanner model, and then search on **datasheet**.
- In the scanning software, choose the layout setting that matches the orientation of the originals in the document feeder.
- To optimize data transfer from the scanner to the scanning software on the computer, enable scanner hardware (JPEG) compression. Typically, the use of scanner compression reduces the time to complete all color scans and grayscale scans with resolution above 300 dpi. Scanner compression affects the rate of data transfer only and can be used with all output formats.



---

**NOTE:** You cannot use scanner compression with black and white originals.

---

- Saving a scanned image to a searchable format (for example, searchable PDF) takes more time than saving to an image format because the scanned image is analyzed using Optical Character Recognition (OCR). Turn on OCR only when you need a searchable document.



---

**NOTE:** For the best OCR results, scanner compression should be set to the minimum compression level or disabled.

---

- Scanning at a higher resolution than necessary increases scanning time and creates a larger file with no additional benefit. If you are scanning at a high resolution, set the resolution to a lower level to increase scanning speed.

## The scan is completely black or completely white

The item might not be placed correctly in the document feeder. Make sure that the item you are trying to scan is placed face up.

## Scanned images are not straight

Verify that the document feeder guides are centered on the scanner and set to an appropriate width for the original being scanned. Make sure the paper guides touch the edges of the original.

## Vertical white stripes appear on the printed page

The destination printer might be out of toner or ink. Scan a different original to the same printer to see if the issue lies with the printer.

If the second scan has the same problem, try scanning to a different printer.

## Vertical colored stripes appear on the printed page

Dust can build up on the scanning strip and cause artifacts in scanned images. Clean the scanning strip (which is to the left of the scanner glass) with a soft, lint-free cloth that has been sprayed with a mild glass cleaner.

## Scan files are too large

If the saved scan files are very large, try the following:

- Verify the scan resolution setting:
  - 200 dpi is sufficient for storing documents as images.
  - For most fonts, 300 dpi is sufficient for using optical character recognition (OCR) to create editable text.
  - For Asian fonts and small fonts, 400 dpi is the recommended resolution.

Scanning at a higher resolution than necessary creates a larger file with no additional benefit.

- Color scans create larger files than do black and white scans.
- If you are scanning a large number of pages at one time, consider scanning fewer pages at a time to create more, smaller files.
- Use the Kofax Virtual ReScan Software which shipped with your scanner to process the scanned data. Such software cleans up the image and compresses the data, which can result in a smaller file.

## Scanner buttons are not working correctly

After each step, press a button to see if it is working correctly. If the problem persists, proceed with the next step.

1. A cable might be loose. Ensure that the USB cable and the power supply are securely connected.
2. Turn off the scanner, wait 30 seconds, and then turn the scanner back on.
3. Restart your computer.
4. If the problem still persists, there may be a problem with the front panel. Contact HP Support at [www.hp.com/support](http://www.hp.com/support).

# Scanner paper path problems

- [Paper jamming, skewing, misfeeds, or multiple-page feeds](#)
- [Scanning fragile originals](#)
- [Paper does not feed from the scanner](#)
- [Originals are curling up in the scanner output tray.](#)
- [The bottom of the scanned image is cut off](#)
- [The scanned images have streaks or scratches](#)
- [An item loaded in the scanner jams repeatedly](#)
- [Clear jams from the scanner paper path](#)

## Paper jamming, skewing, misfeeds, or multiple-page feeds

- Check that all rollers are in place and that the roller doors and automatic document feeder (ADF) hatch are closed.
- If the pages look skewed as they feed into the scanner paper path, check the resulting scanned images in the software to ensure that they are not skewed.
- The pages might not be placed correctly. Straighten the pages and adjust the paper guides to center the stack.
- The paper guides must be touching the sides of the paper stack to work properly. Please ensure that the paper stack is straight and the guides are against the paper stack.
- The document feeder or output tray might contain more than the maximum number of pages. Load fewer pages in the document feeder, and remove pages from the output tray.
- Clean the scanner paper path to help reduce misfeeds. If misfeeds still occur, clean the rollers. If misfeeds still occur, replace the rollers.

## Scanning fragile originals

To safely scan fragile originals (photographs or documents on wrinkled or very lightweight paper) place originals on the scanner glass. Do not use the automatic document feeder (ADF).

## Paper does not feed from the scanner

Reload the pages into the document feeder, ensuring that they make contact with the rollers.

The automatic document feeder (ADF) hatch might not be securely latched. Open the ADF hatch and then close it by pressing firmly.

A problem with the scanner hardware might exist. Follow this procedure to test the scanner:

1. Ensure that the power supply is securely connected between the scanner and a live electrical outlet or surge protector. Check that the green LED on the power supply case is on to verify that the power supply is functional.
2. If the power supply is connected to a surge protector, ensure that the surge protector is plugged into an outlet and turned on.

3. Disconnect the power supply from the scanner and turn off the computer. After 30 seconds, reconnect the power supply to the scanner and then turn on the computer, in that order.
4. Try to rescan.

## Originals are curling up in the scanner output tray.

Under dry conditions, lightweight originals such as those printed on carbonless copy paper may curl in the output tray. To minimize curl, flatten curled edges on the originals before placing them in the document feeder. If you cannot flatten curled edges, make sure the curled edges are facing down when you place the originals in the document feeder.

## The bottom of the scanned image is cut off

By default, the scanning software can scan media that is up to 356 mm (14 in) long. For longer pages, the end of the document is not included in the scanned image.

Verify that you have specified an appropriate page size in the scanning software.

## The scanned images have streaks or scratches

After each step, try another scan to see if the streaks or scratches are still apparent. If so, then try the next step. For information on cleaning the scanner, see the **Care and maintenance** section.

- Check that the originals are clean and unwrinkled.
- Clean the scanning strip, which is to the left of the scanner glass.
- Clean the rollers manually.

## An item loaded in the scanner jams repeatedly

- The item might not meet the guidelines for acceptable originals.
- The item might have something on it, such as staples or self-adhesive notes on the original that must be removed.
- Make sure the paper guides touch the edges of the original.

## Clear jams from the scanner paper path

To clear a paper jam:

1. Open the automatic document feeder (ADF) hatch.





2. Remove the originals or any obstructions from the paper path.

 **TIP:** Use the green thumb wheel on the left side of the open hatch to manually advance originals through the paper path.

3. Remove the ADF duplex background, remove any debris, and then slide the component back into its housing until it clicks into place.

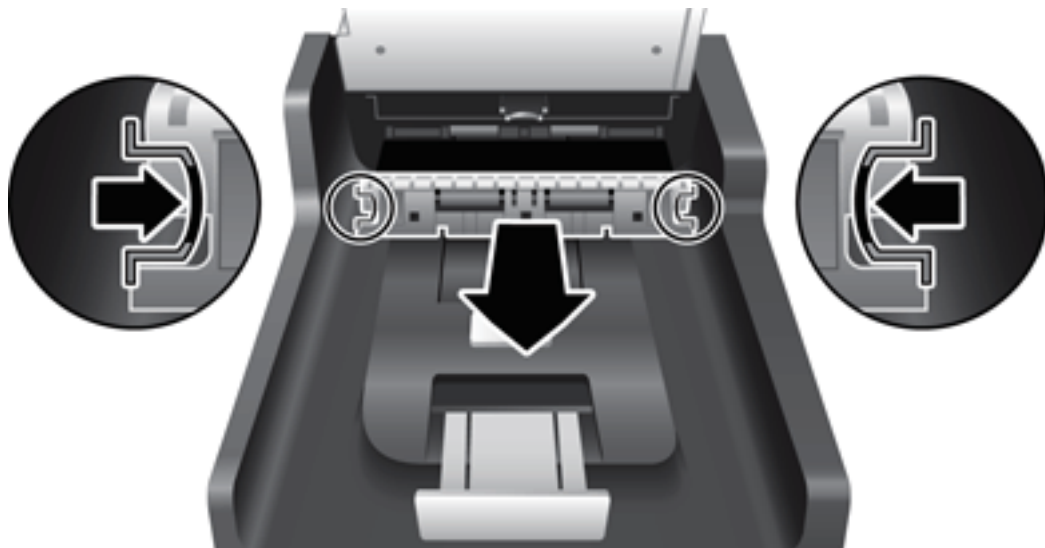

4. Close the ADF hatch until it snaps into place.
5. Reload the unscanned originals in the document feeder.
6. Resume scanning.



---

## 6 Product accessibility and support

Accessibility options on this scanner include an LCD Reader and the ability to enable and disable scanner buttons.

- [LCD Reader](#)
- [Control of the scanner buttons](#)

### LCD Reader

The LCD Reader is software that outputs the status of the LCD on the scanner front panel to the computer monitor as the LCD changes. The LCD Reader enables accessibility software tools to express what is being shown on the scanner front panel.

To use the LCD Reader, follow these steps:

1. On your hard drive, navigate to C:\Program Files\Common Files\Hewlett-Packard\Scanjet\, and then to the **7500** directory.
2. To open the program, double-click **hplcd.exe**.

---

 **NOTE:** The LCD Reader is not able to display the LCD text when there is a USB connection error or the scanner is off.

---

### Control of the scanner buttons

To prevent buttons from being pushed accidentally, you can disable the buttons on the scanner front panel.

When the buttons are disabled, you always start scans and copies from the computer using scanning software. You can still press the **Cancel**  button on the scanner front panel to stop a scan.

To turn off the scanner buttons, follow these steps:

1. Open the HP Scanner Tools Utility.
2. On the **Profiles** tab, select the **Disable front panel buttons** check box.

To turn on the scanner buttons, clear the **Disable front panel buttons** check box.

---

 **NOTE:** You must have administrative privileges on the computer to change the setting of this check box.

---



---

# 7 Specifications and warranty

- [Scanner specifications](#)
- [Document feeder specifications](#)
- [Environmental specifications](#)
- [Regulatory information](#)
- [Energy information](#)
- [Disposal of waste equipment by users \(EU and India\)](#)
- [HP limited warranty statement](#)

## Scanner specifications

Name	Description
Scanner type	Flatbed with automatic document feeder (ADF)
Size	Width: 570 mm (20.35 in), Depth: 434.6 mm (17.1 in), Height: 206.6 mm ( 8.14 in)
Weight	10.6 kg (23.37 lbs)
Scanning element	Charge-coupled device (CCD)
Interface	USB 2.0 high speed (compatible with USB 1.1)
Optical resolution	600 x 600 dpi hardware
AC power	<ul style="list-style-type: none"><li>AC input for power supply: 100V–240V~, 50/60Hz, 1300mA</li><li>DC output for power supply: 32 Vdc, 1560mA, 50W</li></ul>
Power consumption	For power consumption information, see the regulatory_supplement.pdf file on the HP Scanning Software.
System requirements	To view minimum and recommended system requirements, go to <a href="http://www.hp.com">www.hp.com</a> , select your country/region, search on your scanner model, and then search on <b>datasheet</b> .

## Document feeder specifications

Name	Description
Paper tray capacity	100 sheets of 75g/m <sup>2</sup> (20 lb)
Minimum paper size	68 x 148 mm (2.7 x 5.8 in)
Maximum paper size	216 x 864 mm (8.5 x 34 in)
Minimum paper weight	49 g/m <sup>2</sup> (13 lb)
Maximum paper weight	120 g/m <sup>2</sup> (32 lb)

## Environmental specifications

Name	Description
Temperature	Operating the scanner: 10° to 35° C (50° to 95° F)
	Storage: -40° to 65° C (-40° to 149° F)
Relative humidity	Operating the scanner: 10% to 80% noncondensing 10° to 35° C (50° to 95° F)
	Storage: up to 90% at 0° to 65° C (32° to 149° F)

 **NOTE:** In the presence of high electromagnetic fields, it is possible the output from the HP scanner may be slightly distorted.

 **NOTE:** HP is committed to providing our customers with information about the chemical substances in our products as needed to comply with legal requirements such as REACH (Regulation EC No 1907/2006 of the European Parliament and the Council). A chemical information report for this product can be found at [www.hp.com/go/reach](http://www.hp.com/go/reach).

## Regulatory information

**Regulatory Model Identification Number:** For regulatory identification purposes your product is assigned a Regulatory Model Number. The Regulatory Model Number for your product is FCLSD-1004. This regulatory number should not be confused with the marketing name HP ScanJet Enterprise 7500/Flow 7500 or product number L2725A/L2725B. Additional regulatory information about your scanner can be found on the regulatory\_supplement.pdf file on the HP Scanning Software.

## Energy information

HP printing and imaging equipment marked with the ENERGY STAR® logo is qualified to the U.S. Environmental Protection Agency's ENERGY STAR specifications for imaging equipment. The following mark will appear on ENERGY STAR qualified imaging products:



Additional ENERGY STAR qualified imaging product model information is listed at:

[www.hp.com/go/energystar](http://www.hp.com/go/energystar)



## Disposal of waste equipment by users (EU and India)

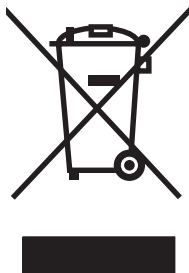

This symbol means do not dispose of your product with your other household waste. Instead, you should protect human health and the environment by handing over your waste equipment to a designated collection point for the recycling of waste electrical and electronic equipment. For more information, please contact your household waste disposal service, or go to: [www.hp.com/recycle](http://www.hp.com/recycle).

## HP limited warranty statement

HP PRODUCT	DURATION OF LIMITED WARRANTY
HP ScanJet Enterprise 7500/Flow 7500	One-year limited warranty

HP warrants to you, the end-user customer, that HP hardware and accessories will be free from defects in materials and workmanship after the date of purchase, for the period specified above. If HP receives notice of such defects during the warranty period, HP will, at its option, either repair or replace products which prove to be defective. Replacement products may be either new or equivalent in performance to new.

HP warrants to you that HP software will not fail to execute its programming instructions after the date of purchase, for the period specified above, due to defects in material and workmanship when properly installed and used. If HP receives notice of such defects during the warranty period, HP will replace software which does not execute its programming instructions due to such defects.

HP does not warrant that the operation of HP products will be uninterrupted or error free. If HP is unable, within a reasonable time, to repair or replace any product to a condition as warranted, you will be entitled to a refund of the purchase price upon prompt return of the product.

HP products may contain remanufactured parts equivalent to new in performance or may have been subject to incidental use.

Warranty does not apply to defects resulting from (a) improper or inadequate maintenance or calibration, (b) software, interfacing, parts or supplies not supplied by HP, (c) unauthorized modification or misuse, (d) operation outside of the published environmental specifications for the product, or (e) improper site preparation or maintenance.

TO THE EXTENT ALLOWED BY LOCAL LAW, THE ABOVE WARRANTIES ARE EXCLUSIVE AND NO OTHER WARRANTY OR CONDITION, WHETHER WRITTEN OR ORAL, IS EXPRESSED OR IMPLIED AND HP SPECIFICALLY DISCLAIMS ANY IMPLIED WARRANTIES OR CONDITIONS OF MERCHANTABILITY, SATISFACTORY QUALITY, AND FITNESS FOR A PARTICULAR PURPOSE. Some countries/regions, states or provinces do not allow limitations on the duration of an implied warranty, so the above limitation or exclusion might not apply to you. This warranty gives you specific legal rights and you might also have other rights that vary from country/region to country/region, state to state, or province to province.

HP's limited warranty is valid in any country/region or locality where HP has a support presence for this product and where HP has marketed this product. The level of warranty service you receive may vary according to local standards. HP will not alter form, fit or function of the product to make it operate in a country/region for which it was never intended to function for legal or regulatory reasons.

TO THE EXTENT ALLOWED BY LOCAL LAW, THE REMEDIES IN THIS WARRANTY STATEMENT ARE YOUR SOLE AND EXCLUSIVE REMEDIES. EXCEPT AS INDICATED ABOVE, IN NO EVENT WILL HP OR ITS SUPPLIERS BE LIABLE FOR LOSS OF DATA OR FOR DIRECT, SPECIAL, INCIDENTAL, CONSEQUENTIAL (INCLUDING LOST PROFIT OR DATA), OR OTHER DAMAGE, WHETHER BASED IN CONTRACT, TORT, OR OTHERWISE. Some countries/regions, states or provinces do not allow the exclusion or limitation of incidental or consequential damages, so the above limitation or exclusion may not apply to you.

THE WARRANTY TERMS CONTAINED IN THIS STATEMENT, EXCEPT TO THE EXTENT LAWFULLY PERMITTED, DO NOT EXCLUDE, RESTRICT OR MODIFY AND ARE IN ADDITION TO THE MANDATORY STATUTORY RIGHTS APPLICABLE TO THE SALE OF THIS PRODUCT TO YOU.

## UK, Ireland, and Malta

The HP Limited Warranty is a commercial guarantee voluntarily provided by HP. The name and address of the HP entity responsible for the performance of the HP Limited Warranty in your country/region is as follows:

**UK:** HP Inc UK Limited, Cain Road, Amen Corner, Bracknell, Berkshire, RG12 1HN

**Ireland:** Hewlett-Packard Ireland Limited, Liffey Park Technology Campus, Barnhall Road, Leixlip, Co.Kildare

**Malta:** Hewlett-Packard Europe B.V., Amsterdam, Meyrin Branch, Route du Nant-d'Avril 150, 1217 Meyrin, Switzerland

**United Kingdom:** The HP Limited Warranty benefits apply in addition to any legal rights to a guarantee from seller of nonconformity of goods with the contract of sale. These rights expire six years from delivery of goods for products purchased in England or Wales and five years from delivery of goods for products purchased in Scotland. However various factors may impact your eligibility to receive these rights. For further information, please consult the following link: Consumer Legal Guarantee ([www.hp.com/go/eu-legal](http://www.hp.com/go/eu-legal)) or you may visit the European Consumer Centers website ([http://ec.europa.eu/consumers/solving\\_consumer\\_disputes/non-judicial\\_redress/ecc-net/index\\_en.htm](http://ec.europa.eu/consumers/solving_consumer_disputes/non-judicial_redress/ecc-net/index_en.htm)). Consumers have the right to choose whether to claim service under the HP Limited Warranty or against the seller under the legal guarantee.

**Ireland:** The HP Limited Warranty benefits apply in addition to any statutory rights from seller in relation to nonconformity of goods with the contract of sale. However various factors may impact your eligibility to receive these rights. Consumer statutory rights are not limited or affected in any manner by HP Care Pack. For further information, please consult the following link: Consumer Legal Guarantee ([www.hp.com/go/eu-legal](http://www.hp.com/go/eu-legal)) or you may visit the European Consumer Centers website ([http://ec.europa.eu/consumers/solving\\_consumer\\_disputes/non-judicial\\_redress/ecc-net/index\\_en.htm](http://ec.europa.eu/consumers/solving_consumer_disputes/non-judicial_redress/ecc-net/index_en.htm)). Consumers have the right to choose whether to claim service under the HP Limited Warranty or against the seller under the legal guarantee.

**Malta:** The HP Limited Warranty benefits apply in addition to any legal rights to a two-year guarantee from seller of nonconformity of goods with the contract of sale; however various factors may impact your eligibility to receive these rights. Consumer statutory rights are not limited or affected in any manner by the HP Limited Warranty. For further information, please consult the following link: Consumer Legal Guarantee ([www.hp.com/go/eu-legal](http://www.hp.com/go/eu-legal)) or you may visit the European Consumer Centers website ([http://ec.europa.eu/consumers/solving\\_consumer\\_disputes/non-judicial\\_redress/ecc-net/index\\_en.htm](http://ec.europa.eu/consumers/solving_consumer_disputes/non-judicial_redress/ecc-net/index_en.htm)). Consumers have the right to choose whether to claim service under the HP Limited Warranty or against the seller under two-year legal guarantee.

## Austria, Belgium, Germany, and Luxemburg

Die beschränkte HP Herstellergarantie ist eine von HP auf freiwilliger Basis angebotene kommerzielle Garantie. Der Name und die Adresse der HP Gesellschaft, die in Ihrem Land für die Gewährung der beschränkten HP Herstellergarantie verantwortlich ist, sind wie folgt:

**Deutschland:** HP Deutschland GmbH, Schickardstr. 32, D-71034 Böblingen

**Österreich:** HP Austria GmbH., Technologiestrasse 5, A-1120 Wien

**Luxemburg:** Hewlett-Packard Luxembourg S.C.A., 75, Parc d'Activités Capellen, Rue Pafebruc, L-8308 Capellen

**Belgien:** HP Belgium BVBA, Hermeslaan 1A, B-1831 Diegem

Die Rechte aus der beschränkten HP Herstellergarantie gelten zusätzlich zu den gesetzlichen Ansprüchen wegen Sachmängeln auf eine zweijährige Gewährleistung ab dem Lieferdatum. Ob Sie Anspruch auf diese Rechte haben, hängt von zahlreichen Faktoren ab. Die Rechte des Kunden sind in keiner Weise durch die beschränkte HP Herstellergarantie eingeschränkt bzw. betroffen. Weitere Hinweise finden Sie auf der folgenden Website: Gewährleistungsansprüche für Verbraucher ([www.hp.com/go/eu-legal](http://www.hp.com/go/eu-legal)) oder Sie können die Website des

Europäischen Verbraucherzentrums ([http://ec.europa.eu/consumers/solving\\_consumer\\_disputes/non-judicial\\_redress/ecc-net/index\\_en.htm](http://ec.europa.eu/consumers/solving_consumer_disputes/non-judicial_redress/ecc-net/index_en.htm)) besuchen. Verbraucher haben das Recht zu wählen, ob sie eine Leistung von HP gemäß der beschränkten HP Herstellergarantie in Anspruch nehmen oder ob sie sich gemäß der gesetzlichen zweijährigen Haftung für Sachmängel (Gewährleistung) sich an den jeweiligen Verkäufer wenden.

## Belgium, France, and Luxembourg

La garantie limitée HP est une garantie commerciale fournie volontairement par HP. Voici les coordonnées de l'entité HP responsable de l'exécution de la garantie limitée HP dans votre pays:

**France:** HP France SAS, société par actions simplifiée identifiée sous le numéro 448 694 133 RCS Evry, 1 Avenue du Canada, 91947, Les Ulis

**G.D. Luxembourg:** Hewlett-Packard Luxembourg S.C.A., 75, Parc d'Activités Capellen, Rue Pafebruc, L-8308 Capellen

**Belgique:** HP Belgium BVBA, Hermeslaan 1A, B-1831 Diegem

**France:** Les avantages de la garantie limitée HP s'appliquent en complément des droits dont vous disposez au titre des garanties légales applicables dont le bénéfice est soumis à des conditions spécifiques. Vos droits en tant que consommateur au titre de la garantie légale de conformité mentionnée aux articles L. 211-4 à L. 211-13 du Code de la Consommation et de celle relatives aux défauts de la chose vendue, dans les conditions prévues aux articles 1641 à 1648 et 2232 du Code de Commerce ne sont en aucune façon limités ou affectés par la garantie limitée HP. Pour de plus amples informations, veuillez consulter le lien suivant : Garanties légales accordées au consommateur ([www.hp.com/go/eu-legal](http://www.hp.com/go/eu-legal)). Vous pouvez également consulter le site Web des Centres européens des consommateurs ([http://ec.europa.eu/consumers/solving\\_consumer\\_disputes/non-judicial\\_redress/ecc-net/index\\_en.htm](http://ec.europa.eu/consumers/solving_consumer_disputes/non-judicial_redress/ecc-net/index_en.htm)). Les consommateurs ont le droit de choisir d'exercer leurs droits au titre de la garantie limitée HP, ou auprès du vendeur au titre des garanties légales applicables mentionnées ci-dessus.

### POUR RAPPEL:

Garantie Légale de Conformité:

*« Le vendeur est tenu de livrer un bien conforme au contrat et répond des défauts de conformité existant lors de la délivrance.*

*Il répond également des défauts de conformité résultant de l'emballage, des instructions de montage ou de l'installation lorsque celle-ci a été mise à sa charge par le contrat ou a été réalisée sous sa responsabilité ».*

Article L211-5 du Code de la Consommation:

*« Pour être conforme au contrat, le bien doit:*

*1° Etre propre à l'usage habituellement attendu d'un bien semblable et, le cas échéant:*

*- correspondre à la description donnée par le vendeur et posséder les qualités que celui-ci a présentées à l'acheteur sous forme d'échantillon ou de modèle;*

*- présenter les qualités qu'un acheteur peut légitimement attendre eu égard aux déclarations publiques faites par le vendeur, par le producteur ou par son représentant, notamment dans la publicité ou l'étiquetage;*

*2° Ou présenter les caractéristiques définies d'un commun accord par les parties ou être propre à tout usage spécial recherché par l'acheteur, porté à la connaissance du vendeur et que ce dernier a accepté ».*

Article L211-12 du Code de la Consommation:

*« L'action résultant du défaut de conformité se prescrit par deux ans à compter de la délivrance du bien ».*

## Garantie des vices cachés

Article 1641 du Code Civil : « *Le vendeur est tenu de la garantie à raison des défauts cachés de la chose vendue qui la rendent impropre à l'usage auquel on la destine, ou qui diminuent tellement cet usage que l'acheteur ne l'aurait pas acquise, ou n'en aurait donné qu'un moindre prix, s'il les avait connus.* »

Article 1648 alinéa 1 du Code Civil:

« *L'action résultant des vices rédhibitoires doit être intentée par l'acquéreur dans un délai de deux ans à compter de la découverte du vice.* »

**G.D. Luxembourg et Belgique:** Les avantages de la garantie limitée HP s'appliquent en complément des droits dont vous disposez au titre de la garantie de non-conformité des biens avec le contrat de vente. Cependant, de nombreux facteurs peuvent avoir un impact sur le bénéfice de ces droits. Vos droits en tant que consommateur au titre de ces garanties ne sont en aucune façon limités ou affectés par la garantie limitée HP. Pour de plus amples informations, veuillez consulter le lien suivant : Garanties légales accordées au consommateur ([www.hp.com/go/eu-legal](http://www.hp.com/go/eu-legal)) ou vous pouvez également consulter le site Web des Centres européens des consommateurs ([http://ec.europa.eu/consumers/solving\\_consumer\\_disputes/non-judicial\\_redress/ecc-net/index\\_en.htm](http://ec.europa.eu/consumers/solving_consumer_disputes/non-judicial_redress/ecc-net/index_en.htm)). Les consommateurs ont le droit de choisir de réclamer un service sous la garantie limitée HP ou auprès du vendeur au cours d'une garantie légale de deux ans.

## Italy

La Garanzia limitata HP è una garanzia commerciale fornita volontariamente da HP. Di seguito sono indicati nome e indirizzo della società HP responsabile della fornitura dei servizi coperti dalla Garanzia limitata HP nel vostro Paese:

**Italia:** HP Italy S.r.l., Via G. Di Vittorio 9, 20063 Cernusco S/Naviglio

I vantaggi della Garanzia limitata HP vengono concessi ai consumatori in aggiunta ai diritti derivanti dalla garanzia di due anni fornita dal venditore in caso di non conformità dei beni rispetto al contratto di vendita. Tuttavia, diversi fattori possono avere un impatto sulla possibilità di beneficiare di tali diritti. I diritti spettanti ai consumatori in forza della garanzia legale non sono in alcun modo limitati, né modificati dalla Garanzia limitata HP. Per ulteriori informazioni, si prega di consultare il seguente link: Garanzia legale per i clienti ([www.hp.com/go/eu-legal](http://www.hp.com/go/eu-legal)), oppure visitare il sito Web dei Centri europei per i consumatori ([http://ec.europa.eu/consumers/solving\\_consumer\\_disputes/non-judicial\\_redress/ecc-net/index\\_en.htm](http://ec.europa.eu/consumers/solving_consumer_disputes/non-judicial_redress/ecc-net/index_en.htm)). I consumatori hanno il diritto di scegliere se richiedere un servizio usufruendo della Garanzia limitata HP oppure rivolgendosi al venditore per far valere la garanzia legale di due anni.

## Spain

Su Garantía limitada de HP es una garantía comercial voluntariamente proporcionada por HP. El nombre y dirección de las entidades HP que proporcionan la Garantía limitada de HP (garantía comercial adicional del fabricante) en su país es:

**España:** Hewlett-Packard Española S.L. Calle Vicente Aleixandre, 1 Parque Empresarial Madrid - Las Rozas, E-28232 Madrid

Los beneficios de la Garantía limitada de HP son adicionales a la garantía legal de 2 años a la que los consumidores tienen derecho a recibir del vendedor en virtud del contrato de compraventa; sin embargo, varios factores pueden afectar su derecho a recibir los beneficios bajo dicha garantía legal. A este respecto, la Garantía limitada de HP no limita o afecta en modo alguno los derechos legales del consumidor ([www.hp.com/go/eu-legal](http://www.hp.com/go/eu-legal)). Para más información, consulte el siguiente enlace: Garantía legal del consumidor o puede visitar el sitio web de los Centros europeos de los consumidores ([http://ec.europa.eu/consumers/solving\\_consumer\\_disputes/non-judicial\\_redress/ecc-net/index\\_en.htm](http://ec.europa.eu/consumers/solving_consumer_disputes/non-judicial_redress/ecc-net/index_en.htm)). Los clientes tienen derecho a elegir si reclaman un servicio acogiéndose a la Garantía limitada de HP o al vendedor de conformidad con la garantía legal de dos años.

## Denmark

Den begrænsede HP-garanti er en garanti, der ydes frivilligt af HP. Navn og adresse på det HP-selskab, der er ansvarligt for HP's begrænsede garanti i dit land, er som følger:

**Danmark:** HP Inc Danmark ApS, Engholm Parkvej 8, 3450, Allerød

Den begrænsede HP-garanti gælder i tillæg til eventuelle juridiske rettigheder, for en toårig garanti fra sælgeren af varer, der ikke er i overensstemmelse med salgsaftalen, men forskellige faktorer kan dog påvirke din ret til at opnå disse rettigheder. Forbrugers lovbestemte rettigheder begrænses eller påvirkes ikke på nogen måde af den begrænsede HP-garanti. Se nedenstående link for at få yderligere oplysninger: Forbrugers juridiske garanti ([www.hp.com/go/eu-legal](http://www.hp.com/go/eu-legal)) eller du kan besøge De Europæiske Forbrugercentres websted ([http://ec.europa.eu/consumers/solving\\_consumer\\_disputes/non-judicial\\_redress/ecc-net/index\\_en.htm](http://ec.europa.eu/consumers/solving_consumer_disputes/non-judicial_redress/ecc-net/index_en.htm)). Forbrugere har ret til at vælge, om de vil gøre krav på service i henhold til HP's begrænsede garanti eller hos sælger i henhold til en toårig juridisk garanti.

## Norway

HPs garanti er en begrenset og kommersiell garanti som HP selv har valgt å tilby. Følgende lokale selskap innestår for garantien:

**Norge:** HP Norge AS, Rolfbuktveien 4b, 1364 Fornebu

HPs garanti kommer i tillegg til det mangelsansvar HP har i henhold til norsk forbrukerkjøpslovgivning, hvor reklamasjonsperioden kan være to eller fem år, avhengig av hvor lenge salgsgjenstanden var ment å vare. Ulike faktorer kan imidlertid ha betydning for om du kvalifiserer til å kreve avhjelp iht slikt mangelsansvar. Forbrukers lovmessige rettigheter begrenses ikke av HPs garanti. Hvis du vil ha mer informasjon, kan du klikke på følgende kobling: Juridisk garanti for forbruker ([www.hp.com/go/eu-legal](http://www.hp.com/go/eu-legal)) eller du kan besøke nettstedet til de europeiske forbrukersentrene ([http://ec.europa.eu/consumers/solving\\_consumer\\_disputes/non-judicial\\_redress/ecc-net/index\\_en.htm](http://ec.europa.eu/consumers/solving_consumer_disputes/non-judicial_redress/ecc-net/index_en.htm)). Forbrukere har retten til å velge å kreve service under HPs garanti eller iht selgerens lovpålagte mangelsansvar.

## Sweden

HP:s begränsade garanti är en kommersiell garanti som tillhandahålls frivilligt av HP. Namn och adress till det HP-företag som ansvarar för HP:s begränsade garanti i ditt land är som följer:

**Sverige:** HP PPS Sverige AB, SE-169 73 Stockholm

Fördelarna som ingår i HP:s begränsade garanti gäller utöver de lagstadgade rättigheterna till tre års garanti från säljaren angående varans bristande överensstämmelse gentemot köpeavtalet, men olika faktorer kan påverka din rätt att utnyttja dessa rättigheter. Konsumentens lagstadgade rättigheter varken begränsas eller påverkas på något sätt av HP:s begränsade garanti. Mer information får du om du följer denna länk: Lagstadgad garanti för konsumenter ([www.hp.com/go/eu-legal](http://www.hp.com/go/eu-legal)) eller så kan du gå till European Consumer Centers webbplats ([http://ec.europa.eu/consumers/solving\\_consumer\\_disputes/non-judicial\\_redress/ecc-net/index\\_en.htm](http://ec.europa.eu/consumers/solving_consumer_disputes/non-judicial_redress/ecc-net/index_en.htm)). Konsumenter har rätt att välja om de vill ställa krav enligt HP:s begränsade garanti eller på säljaren enligt den lagstadgade treåriga garantin.

## Portugal

A Garantia Limitada HP é uma garantia comercial fornecida voluntariamente pela HP. O nome e a morada da entidade HP responsável pela prestação da Garantia Limitada HP no seu país são os seguintes:

**Portugal:** HPCP – Computing and Printing Portugal, Unipessoal, Lda., Edifício D. Sancho I, Quinta da Fonte, Porto Salvo, Lisboa, Oeiras, 2740 244

As vantagens da Garantia Limitada HP aplicam-se cumulativamente com quaisquer direitos decorrentes da legislação aplicável à garantia de dois anos do vendedor, relativa a defeitos do produto e constante do contrato de venda. Existem, contudo, vários fatores que poderão afetar a sua elegibilidade para beneficiar de tais direitos. Os direitos legalmente atribuídos aos consumidores não são limitados ou afetados de forma alguma pela Garantia Limitada HP. Para mais informações, consulte a ligação seguinte: Garantia legal do consumidor ([www.hp.com/go/eu-legal](http://www.hp.com/go/eu-legal)) ou visite o Web site da Rede dos Centros Europeus do Consumidor ([http://ec.europa.eu/consumers/solving\\_consumer\\_disputes/non-judicial\\_redress/ecc-net/index\\_en.htm](http://ec.europa.eu/consumers/solving_consumer_disputes/non-judicial_redress/ecc-net/index_en.htm)). Os consumidores têm o direito de escolher se pretendem reclamar assistência ao abrigo da Garantia Limitada HP ou contra o vendedor ao abrigo de uma garantia jurídica de dois anos.

## Greece and Cyprus

Η Περιορισμένη εγγύηση HP είναι μια εμπορική εγγύηση η οποία παρέχεται εθελοντικά από την HP. Η επωνυμία και η διεύθυνση του νομικού προσώπου HP που παρέχει την Περιορισμένη εγγύηση HP στη χώρα σας είναι η εξής:

**Ελλάδα /Κύπρος:** HP Printing and Personal Systems Hellas EPE, Tzavella 1-3, 15232 Chalandri, Attiki

**Ελλάδα /Κύπρος:** HP Συστήματα Εκτύπωσης και Προσωπικών Υπολογιστών Ελλάς Εταιρεία Περιορισμένης Ευθύνης, Tzavella 1-3, 15232 Chalandri, Attiki

Τα προνόμια της Περιορισμένης εγγύησης HP ισχύουν επιπλέον των νόμιμων δικαιωμάτων για διετή εγγύηση έναντι του Πωλητή για τη μη συμμόρφωση των προϊόντων με τις συνομολογημένες συμβατικά ιδιότητες, ωστόσο η άσκηση των δικαιωμάτων σας αυτών μπορεί να εξαρτάται από διάφορους παράγοντες. Τα νόμιμα δικαιώματα των καταναλωτών δεν περιορίζονται ούτε επηρεάζονται καθ' οιονδήποτε τρόπο από την Περιορισμένη εγγύηση HP. Για περισσότερες πληροφορίες, συμβουλευτείτε την ακόλουθη τοποθεσία web: Νόμιμη εγγύηση καταναλωτή ([www.hp.com/go/eu-legal](http://www.hp.com/go/eu-legal)) ή μπορείτε να επισκεφτείτε την τοποθεσία web των Ευρωπαϊκών Κέντρων Καταναλωτή ([http://ec.europa.eu/consumers/solving\\_consumer\\_disputes/non-judicial\\_redress/ecc-net/index\\_en.htm](http://ec.europa.eu/consumers/solving_consumer_disputes/non-judicial_redress/ecc-net/index_en.htm)). Οι καταναλωτές έχουν το δικαίωμα να επιλέξουν αν θα αξιώσουν την υπηρεσία στα πλαίσια της Περιορισμένης εγγύησης HP ή από τον πωλητή στα πλαίσια της νόμιμης εγγύησης δύο ετών.

## Hungary

A HP korlátozott jótállás egy olyan kereskedelmi jótállás, amelyet a HP a saját elhatározásából biztosít. Az egyes országokban a HP mint gyártó által vállalt korlátozott jótállást biztosító HP vállalatok neve és címe:

**Magyarország:** HP Inc Magyarország Kft., H-1117 Budapest, Alíz utca 1.

A HP korlátozott jótállásban biztosított jogok azokon a jogokon felül illetik meg Önt, amelyek a termékeknek az adásvételi szerződés szerinti minőségére vonatkozó kétéves, jogszabályban foglalt eladói szavatosságból, továbbá ha az Ön által vásárolt termékre alkalmazandó, a jogszabályban foglalt kötelező eladói jótállásból erednek, azonban számos körülmény hatással lehet arra, hogy ezek a jogok Önt megilletik-e. További információért kérjük, keresse fel a következő webhelyet: Jogi Tájékoztató Fogyasztóknak ([www.hp.com/go/eu-legal](http://www.hp.com/go/eu-legal)) vagy látogassa meg az Európai Fogyasztói Központok webhelyét ([http://ec.europa.eu/consumers/solving\\_consumer\\_disputes/non-judicial\\_redress/ecc-net/index\\_en.htm](http://ec.europa.eu/consumers/solving_consumer_disputes/non-judicial_redress/ecc-net/index_en.htm)). A fogyasztóknak jogában áll, hogy megválasszák, hogy a jótállással kapcsolatos igényüket a HP korlátozott jótállás alapján vagy a kétéves, jogszabályban foglalt eladói szavatosság, illetve, ha alkalmazandó, a jogszabályban foglalt kötelező eladói jótállás alapján érvényesítik.

## Czech Republic

Omezená záruka HP je obchodní zárukou dobrovolně poskytovanou společností HP. Názvy a adresy společností skupiny HP, které odpovídají za plnění omezené záruky HP ve vaší zemi, jsou následující:

**Česká republika:** HP Inc Czech Republic s. r. o., Za Brumlovkou 5/1559, 140 00 Praha 4

Výhody, poskytované omezenou zárukou HP, se uplatňují jako doplněk k jakýmkoli právním nárokům na dvouletou záruku poskytnutou prodejcem v případě nesouladu zboží s kupní smlouvou. Váš nárok na uznání těchto práv však může záviset na mnohých faktorech. Omezená záruka HP žádným způsobem neomezuje ani neovlivňuje zákonná práva zákazníka. Další informace získáte kliknutím na následující odkaz: Zákonná záruka spotřebitele ([www.hp.com/go/eu-legal](http://www.hp.com/go/eu-legal)) případně můžete navštívit webové stránky Evropského spotřebitelského centra ([http://ec.europa.eu/consumers/solving\\_consumer\\_disputes/non-judicial\\_redress/ecc-net/index\\_en.htm](http://ec.europa.eu/consumers/solving_consumer_disputes/non-judicial_redress/ecc-net/index_en.htm)). Spotřebitelé mají právo se rozhodnout, zda chtějí službu reklamovat v rámci omezené záruky HP nebo v rámci zákonem stanovené dvouleté záruky u prodejce.

## Slovakia

Obmedzená záruka HP je obchodná záruka, ktorú spoločnosť HP poskytuje dobrovoľne. Meno a adresa subjektu HP, ktorý zabezpečuje plnenie vyplývajúce z Obmedzenej záruky HP vo vašej krajine:

**Slovenská republika:** HP Inc Slovakia, s.r.o., Galvaniho 7, 821 04 Bratislava

Výhody Obmedzenej záruky HP sa uplatnia vedľa prípadných zákazníkových zákonných nárokov voči predávajúcemu z váš, ktoré spočívajú v nesúlade vlastností tovaru s jeho popisom podľa predmetnej zmluvy. Možnosť uplatnenia takých prípadných nárokov však môže závisieť od rôznych faktorov. Služby Obmedzenej záruky HP žiadnym spôsobom neobmedzujú ani neovplyvňujú zákonné práva zákazníka, ktorý je spotrebiteľom. Ďalšie informácie nájdete na nasledujúcom prepojení: Zákonná záruka spotrebiteľa ([www.hp.com/go/eu-legal](http://www.hp.com/go/eu-legal)), prípadne môžete navštíviť webovú lokalitu európskych zákazníckych stredísk ([http://ec.europa.eu/consumers/solving\\_consumer\\_disputes/non-judicial\\_redress/ecc-net/index\\_en.htm](http://ec.europa.eu/consumers/solving_consumer_disputes/non-judicial_redress/ecc-net/index_en.htm)). Spotrebiteľia majú právo zvoliť si, či chcú uplatniť servis v rámci Obmedzenej záruky HP alebo počas zákonnej dvojročnej záručnej lehoty u predajcu.

## Poland

Ograniczona gwarancja HP to komercyjna gwarancja udzielona dobrowolnie przez HP. Nazwa i adres podmiotu HP odpowiedzialnego za realizację Ograniczonej gwarancji HP w Polsce:

**Polska:** HP Inc Polska sp. z o.o., Szturmowa 2a, 02-678 Warszawa, wpisana do rejestru przedsiębiorców prowadzonego przez Sąd Rejonowy dla m.st. Warszawy w Warszawie, XIII Wydział Gospodarczy Krajowego Rejestru Sądowego, pod numerem KRS 0000546115, NIP 5213690563, REGON 360916326, GIOS E0020757WZBW, kapitał zakładowy 480.000 PLN.

Świadczenia wynikające z Ograniczonej gwarancji HP stanowią dodatek do praw przysługujących nabywcy w związku z dwuletnią odpowiedzialnością sprzedawcy z tytułu niezgodności towaru z umową (rękojmia). Niemniej, na możliwość korzystania z tych praw mają wpływ różne czynniki. Ograniczona gwarancja HP w żaden sposób nie ogranicza praw konsumenta ani na nie nie wpływa. Więcej informacji można znaleźć pod następującym łączem: Gwarancja prawna konsumenta ([www.hp.com/go/eu-legal](http://www.hp.com/go/eu-legal)), można także odwiedzić stronę internetową Europejskiego Centrum Konsumentckiego ([http://ec.europa.eu/consumers/solving\\_consumer\\_disputes/non-judicial\\_redress/ecc-net/index\\_en.htm](http://ec.europa.eu/consumers/solving_consumer_disputes/non-judicial_redress/ecc-net/index_en.htm)). Konsumenti mają prawo wyboru co do możliwości skorzystania albo z usług gwarancyjnych przysługujących w ramach Ograniczonej gwarancji HP albo z uprawnień wynikających z dwuletniej rękojmi w stosunku do sprzedawcy.

## Bulgaria

Ограничената гаранция на HP представлява търговска гаранция, доброволно предоставяна от HP. Името и адресът на дружеството на HP за вашата страна, отговорно за предоставянето на гаранционната поддръжка в рамките на Ограничената гаранция на HP, са както следва:

HP Inc Bulgaria EOOD (Ейч Пи Инк България ЕООД), гр. София 1766, район р-н Младост, бул. Околовръстен Път No 258, Бизнес Център Камбаните

Предимствата на Ограничената гаранция на HP се прилагат в допълнение към всички законови права за двугодишна гаранция от продавача при несъответствие на стоката с договора за продажба. Въпреки това,



различни фактори могат да окажат влияние върху условията за получаване на тези права. Законите права на потребителите не са ограничени или засегнати по никакъв начин от Ограничената гаранция на HP. За допълнителна информация, моля вижте Правната гаранция на потребителя ([www.hp.com/go/eu-legal](http://www.hp.com/go/eu-legal)) или посетете уебсайта на Европейския потребителски център ([http://ec.europa.eu/consumers/solving\\_consumer\\_disputes/non-judicial\\_redress/ecc-net/index\\_en.htm](http://ec.europa.eu/consumers/solving_consumer_disputes/non-judicial_redress/ecc-net/index_en.htm)). Потребителите имат правото да избират дали да претендират за извършване на услуга в рамките на Ограничената гаранция на HP или да потърсят такава от търговеца в рамките на двугодишната правна гаранция.

## Romania

Garanția limitată HP este o garanție comercială furnizată în mod voluntar de către HP. Numele și adresa entității HP răspunzătoare de punerea în aplicare a Garanției limitate HP în țara dumneavoastră sunt următoarele:

**România:** HP Inc Romania SRL, 5 Fabrica de Glucoza Str., Building F, Ground Floor and Floor 8, 2nd District, București

Beneficiile Garanției limitate HP se aplică suplimentar față de orice drepturi privind garanția de doi ani oferită de vânzător pentru neconformitatea bunurilor cu contractul de vânzare; cu toate acestea, diverși factori pot avea impact asupra eligibilității dvs. de a beneficia de aceste drepturi. Drepturile legale ale consumatorului nu sunt limitate sau afectate în vreun fel de Garanția limitată HP. Pentru informații suplimentare consultați următorul link: garanția acordată consumatorului prin lege ([www.hp.com/go/eu-legal](http://www.hp.com/go/eu-legal)) sau puteți accesa site-ul Centrul European al Consumatorilor ([http://ec.europa.eu/consumers/solving\\_consumer\\_disputes/non-judicial\\_redress/ecc-net/index\\_en.htm](http://ec.europa.eu/consumers/solving_consumer_disputes/non-judicial_redress/ecc-net/index_en.htm)). Consumatorii au dreptul să aleagă dacă să pretindă despăgubiri în cadrul Garanției limitate HP sau de la vânzător, în cadrul garanției legale de doi ani.

## Belgium and the Netherlands

De Beperkte Garantie van HP is een commerciële garantie vrijwillig verstrekt door HP. De naam en het adres van de HP-entiteit die verantwoordelijk is voor het uitvoeren van de Beperkte Garantie van HP in uw land is als volgt:

**Nederland:** HP Nederland B.V., Startbaan 16, 1187 XR Amstelveen

**België:** HP Belgium BVBA, Hermeslaan 1A, B-1831 Diegem

De voordelen van de Beperkte Garantie van HP vormen een aanvulling op de wettelijke garantie voor consumenten gedurende twee jaren na de levering te verlenen door de verkoper bij een gebrek aan conformiteit van de goederen met de relevante verkoopovereenkomst. Niettemin kunnen diverse factoren een impact hebben op uw eventuele aanspraak op deze wettelijke rechten. De wettelijke rechten van de consument worden op geen enkele wijze beperkt of beïnvloed door de Beperkte Garantie van HP. Raadpleeg voor meer informatie de volgende webpagina: Wettelijke garantie van de consument ([www.hp.com/go/eu-legal](http://www.hp.com/go/eu-legal)) of u kan de website van het Europees Consumenten Centrum bezoeken ([http://ec.europa.eu/consumers/solving\\_consumer\\_disputes/non-judicial\\_redress/ecc-net/index\\_en.htm](http://ec.europa.eu/consumers/solving_consumer_disputes/non-judicial_redress/ecc-net/index_en.htm)). Consumenten hebben het recht om te kiezen tussen enerzijds de Beperkte Garantie van HP of anderzijds het aanspreken van de verkoper in toepassing van de wettelijke garantie.

## Finland

HP:n rajoitettu takuu on HP:n vapaaehtoisesti antama kaupallinen takuu. HP:n myöntämästä takuusta maassanne vastaavan HP:n edustajan yhteystiedot ovat:

**Suomi:** HP Finland Oy, Piispankalliontie, FIN - 02200 Espoo

HP:n takuun edut ovat voimassa mahdollisten kuluttajansuojalakiin perustuvien oikeuksien lisäksi sen varalta, että tuote ei vastaa myyntisopimusta. Saat lisätietoja seuraavasta linkistä: Kuluttajansuoja ([www.hp.com/go/eu-legal](http://www.hp.com/go/eu-legal)) tai voit käydä Euroopan kuluttajakeskuksen sivustolla (<http://ec.europa.eu/consumers/>)

[solving\\_consumer\\_disputes/non-judicial\\_redress/ecc-net/index\\_en.htm](http://www.hp.com/go/eu-legal)). Kuluttajilla on oikeus vaatia virheen korjausta HP:n takuun ja kuluttajansuojan perusteella HP:lta tai myyjältä.

## Slovenia

Omejena garancija HP je prostovoljna trgovska garancija, ki jo zagotavlja podjetje HP. Ime in naslov poslovne enote HP, ki je odgovorna za omejeno garancijo HP v vaši državi, sta naslednja:

**Slovenija:** Hewlett-Packard Europe B.V., Amsterdam, Meyrin Branch, Route du Nant-d'Avril 150, 1217 Meyrin, Switzerland

Ugodnosti omejene garancije HP veljajo poleg zakonskih pravic, ki ob sklenitvi kupoprodajne pogodbe izhajajo iz dveletne garancije prodajalca v primeru neskladnosti blaga, vendar lahko na izpolnjevanje pogojev za uveljavitev pravic vplivajo različni dejavniki. Omejena garancija HP nikakor ne omejuje strankinih z zakonom predpisanih pravic in ne vpliva nanje. Za dodatne informacije glejte naslednjo povezavo: Strankino pravno jamstvo ([www.hp.com/go/eu-legal](http://www.hp.com/go/eu-legal)); ali pa obiščite spletno mesto evropskih središč za potrošnike ([http://ec.europa.eu/consumers/solving\\_consumer\\_disputes/non-judicial\\_redress/ecc-net/index\\_en.htm](http://ec.europa.eu/consumers/solving_consumer_disputes/non-judicial_redress/ecc-net/index_en.htm)). Potrošniki imajo pravico izbrati, ali bodo uveljavljali pravice do storitev v skladu z omejeno garancijo HP ali proti prodajalcu v skladu z dvoletno zakonsko garancijo.

## Croatia

HP ograničeno jamstvo komercialno je dobrovoljno jamstvo koje pruža HP. Ime i adresa HP subjekta odgovornog za HP ograničeno jamstvo u vašoj državi:

**Hrvatska:** HP Computing and Printing d.o.o. za računalne i srodne aktivnosti, Radnička cesta 41, 10000 Zagreb

Pogodnosti HP ograničenog jamstva vrijede zajedno uz sva zakonska prava na dvogodišnje jamstvo kod bilo kojeg prodavača s obzirom na nepodudaranje robe s ugovorom o kupnji. Međutim, razni faktori mogu utjecati na vašu mogućnost ostvarivanja tih prava. HP ograničeno jamstvo ni na koji način ne utječe niti ne ograničava zakonska prava potrošača. Dodatne informacije potražite na ovoj adresi: Zakonsko jamstvo za potrošače ([www.hp.com/go/eu-legal](http://www.hp.com/go/eu-legal)) ili možete posjetiti web-mjesto Evropskih potrošačkih centara ([http://ec.europa.eu/consumers/solving\\_consumer\\_disputes/non-judicial\\_redress/ecc-net/index\\_en.htm](http://ec.europa.eu/consumers/solving_consumer_disputes/non-judicial_redress/ecc-net/index_en.htm)). Potrošači imaju pravo odabrati žele li ostvariti svoja potraživanja u sklopu HP ograničenog jamstva ili pravnog jamstva prodavača u trajanju ispod dvije godine.

## Latvia

HP ierobežotā garantija ir komercgarantija, kuru brīvpātīgi nodrošina HP. HP uzņēmums, kas sniedz HP ierobežotās garantijas servisa nodrošinājumu jūsu valstī:

**Latvija:** HP Finland Oy, PO Box 515, 02201 Espoo, Finland

HP ierobežotās garantijas priekšrocības tiek piedāvātas papildus jebkurām likumīgajām tiesībām uz pārdevēja un/vai ražotāju nodrošinātu divu gadu garantiju gadījumā, ja preces neatbilst pirkuma līgumam, tomēr šo tiesību saņemšanu var ietekmēt vairāki faktori. HP ierobežotā garantija nekādā veidā neierobežo un neietekmē patērētāju likumīgās tiesības. Lai iegūtu plašāku informāciju, izmantojiet šo saiti: Patērētāju likumīgā garantija ([www.hp.com/go/eu-legal](http://www.hp.com/go/eu-legal)) vai arī Eiropas Patērētāju tiesību aizsardzības centra tīmekļa vietni ([http://ec.europa.eu/consumers/solving\\_consumer\\_disputes/non-judicial\\_redress/ecc-net/index\\_en.htm](http://ec.europa.eu/consumers/solving_consumer_disputes/non-judicial_redress/ecc-net/index_en.htm)). Patērētājiem ir tiesības izvēlēties, vai pieprasīt servisa nodrošinājumu saskaņā ar HP ierobežoto garantiju, vai arī pārdevēja sniegto divu gadu garantiju.

## Lithuania

HP ribotoji garantija yra HP savanoriškai teikiama komercinė garantija. Toliau pateikiami HP bendrovių, teikiančių HP garantiją (gamintojo garantiją) jūsų šalyje, pavadinimai ir adresai:

**Lietuva:** HP Finland Oy, PO Box 515, 02201 Espoo, Finland

HP ribotoji garantija papildomai taikoma kartu su bet kokiomis kitomis įstatymais nustatytais teisėmis į pardavėjo suteikiamą dviejų metų laikotarpio garantiją dėl prekių atitikties pardavimo sutarčiai, tačiau tai, ar jums ši teisė bus suteikiama, gali priklausyti nuo įvairių aplinkybių. HP ribotoji garantija niekaip neapriboja ir neįtakoja įstatymais nustatytų vartotojo teisių. Daugiau informacijos rasite paspaudę šią nuorodą: Teisinė vartotojo garantija ([www.hp.com/go/eu-legal](http://www.hp.com/go/eu-legal)) arba apsilankę Europos vartotojų centro internetinėje svetainėje ([http://ec.europa.eu/consumers/solving\\_consumer\\_disputes/non-judicial\\_redress/ecc-net/index\\_en.htm](http://ec.europa.eu/consumers/solving_consumer_disputes/non-judicial_redress/ecc-net/index_en.htm)). Vartotojai turi teisę prašyti atlikti techninį aptarnavimą pagal HP ribotąją garantiją arba pardavėjo teikiamą dviejų metų įstatymais nustatytą garantiją.

## Estonia

HP piiratud garantii on HP poolt vabatahtlikult pakutav kaubanduslik garantii. HP piiratud garantii eest vastutab HP üksus aadressil:

**Eesti:** HP Finland Oy, PO Box 515, 02201 Espoo, Finland

HP piiratud garantii rakendub lisaks seaduses ettenähtud müüjapoolsele kaheaastasele garantiile, juhul kui toode ei vasta müügilepingu tingimustele. Siiski võib esineda asjaolusid, mille puhul teie jaoks need õigused ei pruugi kehtida. HP piiratud garantii ei piira ega mõjuta mingil moel tarbija seadusjärgseid õigusi. Lisateavet leiate järgmiselt lingilt: tarbija õiguslik garantii ([www.hp.com/go/eu-legal](http://www.hp.com/go/eu-legal)) või võite külastada Euroopa tarbijakeskuste veebisaiti ([http://ec.europa.eu/consumers/solving\\_consumer\\_disputes/non-judicial\\_redress/ecc-net/index\\_en.htm](http://ec.europa.eu/consumers/solving_consumer_disputes/non-judicial_redress/ecc-net/index_en.htm)). Tarbijal on õigus valida, kas ta soovib kasutada HP piiratud garantiid või seadusega ette nähtud müüjapoolset kaheaastast garantiid.

## Russia

### **Срок службы принтера для России**

Срок службы данного принтера HP составляет пять лет в нормальных условиях эксплуатации. Срок службы отсчитывается с момента ввода принтера в эксплуатацию. В конце срока службы HP рекомендует посетить веб-сайт нашей службы поддержки по адресу <http://www.hp.com/support> и/или связаться с авторизованным поставщиком услуг HP для получения рекомендаций в отношении дальнейшего безопасного использования принтера.



# Index

## A

- accessibility 53
- add or remove device 22
- ADF
  - clean duplex background 24
  - load paper 8
- adjust page orientation, by language 21
- applications
  - scan from 14
- Auto color detect 19
- automatically adjust page orientation 21
- automatically crop scanned image 19
- automatically delete blank pages 20
- automatically detect page size 20

## B

- Back button 3
- black scans
  - troubleshoot 46
- blurry images 45
- buttons
  - power 2
  - scanner front panel 2

## C

- cables
  - troubleshoot 40
- Cancel button 3
- clean
  - ADF 24
  - rollers 26
  - scanner glass 24
  - scanning strip 24
- cloud, scan to 17
- Color dropout 19

- colored stripes
  - troubleshoot 46
- crooked images 46
- crop scanned image 19
- cut-off images
  - troubleshoot 50

## D

- detect page size 20
- disable scanner buttons 53
- display problems 45
- document feeder
  - load paper 9
  - tips on loading 8

## E

- environmental specifications 57

## F

- features
  - auto color detect 19
  - automatically crop scanned image 19
  - color dropout 19
  - long-page support 18
  - Misfeed (multipick) detection 20
  - scan profiles 16
- feed rollers
  - replace 27
- feeding problems 49
- fragile items, scanning 49
- front panel
  - replace 34
- FTP, scan to 18
- fuzzy images 45

## G

- glass, clean 24

## H

- HP Scan Software
  - about 4
  - scan from 13
- HP Scanner Tools Utility
  - Maintenance tab 23
  - uses for 5
- humidity specifications 57

## I

- install software
  - troubleshoot 40

## J

- jams
  - troubleshoot 50

## L

- LCD problems 45
- LCD Reader 53
- lines
  - troubleshoot 46
- long-page support 18

## M

- maintenance
  - clean rollers 26
  - HP Scanner Tools Utility
    - Maintenance tab 23
- manage power settings 5, 44
- media
  - jams 50
  - misfeeds 49
  - not feeding 49
  - troubleshoot 49
- misfeeds
  - troubleshoot 49
- multipick detection 20
- multiple-page feeds 49

- O**
- OK/select button 3
- operating environment
  - specifications 57
- order
  - roller replacement kit 27
  - supplies 23
- P**
- pages missing, troubleshoot 45
- pages out of order 45
- paper
  - jams 50
  - misfeeds 49
  - not feeding 49
  - troubleshoot 49
- paper-path
  - feeding problems 49
- parts
  - order 27
- power management 5, 44
- power supply
  - troubleshoot cable 40
- problems with LCD 45
- product support 53
- programs
  - scan from 14
- R**
- replace
  - front panel 34
  - rollers 27
  - separation pad 31
- reset scanner 42
- rollers
  - clean 26
  - replace 27
- S**
- scan
  - feeding problems 49
  - files too large 46
  - fragile items 49
  - from HP Scan Software 13
  - from other programs 14
  - paper originals 9
  - scan profiles 16
  - scan to cloud 17
  - scan to FTP 18
  - scan to SharePoint 18
- scanner
  - front panel 2
  - power use 5
  - reset 42
  - specifications 56
- scanner glass
  - load original 11
- scanning black and white text 21
- scanning strip, clean 24
- screen reader 53
- separation pad
  - replace 31
- SharePoint, scan to 18
- skewed images 46
- software
  - troubleshoot installation 40
  - uninstall and reinstall 40, 42
- specifications
  - document feeder 56
  - environmental 57
  - scanner 56
- speed
  - troubleshoot 45
- speed, troubleshoot 46
- storage specifications 57
- streaks
  - troubleshoot 50
- stripes
  - troubleshoot 46
- supplies
  - order 23
  - support 53
- T**
- temperature specifications 57
- troubleshoot
  - basic tips 39
  - black scans 46
  - cables 40
  - check power 42
  - colored lines 46
  - crooked images 46
  - cut-off images 50
  - feeding problems 49
  - fragile items 49
  - fuzzy images 45
  - installation 40
  - jams 50
  - large scan files 46
  - misfeeds 49
  - page order 45
  - pages missing 45
  - paper not feeding 49
  - power 44
  - reset scanner 42
  - scanning fragile items 49
  - speed 45, 46
  - stops working 42
  - streaks 50
  - two-sided scans 45
  - uninstall and reinstall software 40, 42
  - white lines 46
  - white scans 46
- troubleshooting
  - buttons 45
  - display 45
  - LCD 45
- turn on scanner
  - troubleshoot 44
- TWAIN-compliant programs
  - scan from 14
- two-sided scans
  - troubleshoot 45
- U**
- uninstall and reinstall software 40, 42
- USB cable
  - troubleshoot 40
- V**
- vertical colored stripes
  - troubleshoot 46
- vertical white stripes
  - troubleshoot 46
- W**
- warranty
  - product 60
- waste disposal 59
- Web sites
  - order supplies 23
  - replacement parts 27
- white scans
  - troubleshoot 46
- white stripes
  - troubleshoot 46
- Z**
- zonal multipick detection 20