



CONTENTS

2m / 440 MHz HTs



DJ-596TMKII

\$Call – HRO Discount Price

VHF + UHF operations from a high output, easily operated HT. Features an enhanced TXCO allowing for ± 2.3ppm frequency stability. NiMH battery, 100 memories, CTCSS + DCS encode / decode. Optional digital voice communications. Alphanumeric channel labels, keyboard frequency input, theft alarm, backlit keys and display, scan modes, narrow FM mode. CAP compliant (application pending).

Credit Card Size

DJ-C7T

\$Call
HRO Price



This compact 2m / 440 MHz dual band has standard or non-standard splits, AM air band receive, CTCSS encode / decode, 200 memories, volume / squelch control, key lock, auto-power OFF, mike / earphone / DC jack.

Single Band HTs

DV-V17T

2 m – \$Call

DV-V27T

220 MHz – \$Call

DJ-V47T

440 MHz – \$Call

HRO Prices

These HT's are compact full-powered FM HT's that are submersible 3ft for 30 minutes. They are perfect for outdoor activities. Direct frequency input from keypad. 200 memories plus one call channel. 39 CTCSS encode-dscode settings. Digital coded squelch.



440 MHz Handheld

DJ-496T

440 MHz – \$Call

HRO Price

This HT has alphanumeric display, back-lit keypads, 5 W out with standard EBP-48N battery, CTCSS encode / decode, DCS and 4 different tone bursts, theft alarm. It has 41 memories.



Power Supplies

DM-340MVT

\$Call

HRO Discount Price



The DM-340MVT delivers high quality, steady DC at a maximum of 35 A (30A continuous) with a reliable protection circuit. Features V/A twin meters, forced air cooling fan, 16mm main terminals, 2 pairs of auxiliary snap-in and cigar socket output terminals and a fuse socket on the front panel.



DM-330MVT

Communications Grade Switching Power Supply

Compact, lightweight power supply for portable operations. Provides 32 amps peak, 30A continuous. Variable output 5-15 VDC. Preset voltage function. Patent pending noise offset circuit moves pulse noise. Short circuit protection. Front panel connections. Internal switch to convert voltage to 220V. Cigarette plug socket. HRO Price **\$Call**

Tuner



EDX-2 Automatic Tuner

Mates with DX-70 / 77 radios. Tunes wire antenna 8-80 feet. Use for base, mobile, or marine installations. HRO Price **\$Call**

Digital Voice

Digital Voice Modulator

Communicate via digital voice modulation using the publicly-open ITU-TV.32 protocol. Experiment with digital voice modes. Easily switch between analog and digital modes. HT and mobile boards are on-air compatible with each other. Available boards: EJ-40U Digital Voice Board for DR-135 / 235 / 435 mobile and EJ-43U Digital Voice Board for DJ-596 HT.

- Amateur Radios 3-26
- Mics & Keyers Accessories 27-37
- SWL & Antennas 38-41
- GPS & Scanners 42-45
- Books & CDs Software 46-50
- Power Supplies Batteries & Amps 71-77
- Accessories of All Kinds 78-82
- Cable, Connectors Rotators Tuners 83-90
- Antennas 91-107
- Towers 108-113
- Store Locations 116-117
- Complete Index 118

© 2008 Ham Radio Outlet and Asterisk Design.
This catalog may not be reproduced in whole or in part without permission.

MOBILES

RECEIVERS

Dual-Band Mobile



DR-635T
\$Call – HRO Discount Price

The DR-635T is a mobile / base VHF+UHF transceiver plus an expanded range receiver.

- Output on VHF is 50 / 25 / 5 W and 35 / 20 / 5 W on UHF.
- 200 memories.
- Cross-band repeater functions.
- Large, 6 character alphanumeric display with selectable color illumination.
- Removable control head for remote mounting.

- Internal duplexer.
- CTCSS and DCS encode/decode plus four different tone bursts.
- CTCSS tone and SCS scan.
- Optional 1200 and 9600 bps packet operation (EJ-50U).
- Programmable VFO and memory scan modes.
- Aircraft band reception.
- Receive frequencies: 87.5-107.995, 108-173.995, 335-479.995 MHz.

Single Band Mobiles

DR-135TMKIII
2 m – \$Call – HRO Price

2 meter FM and receive Airband (AM). Ignition key power control, theft alarm, 7 place alphanumeric display, front panel data input, optional internal packet module can be used with APRS (TM), real panel serial port connection. 100 memories, 10 autodial memories.



DR-235T
220 MHz – \$Call

DR-435TMKIII
440 MHz – \$Call
HRO Prices

Features a unique multifunction backlit microphone with direct frequency input. These 220 MHz and 440 MHz models can accept optional EJ-41U internal TNC or EJ-47U digital voice module. The MKII TXCO supports a specification of ± 2.5 ppm frequency stability.

Alinco Mobile Accessories

Model	Item	DR-130T, 430T M06T, M03	DR-135T 235T, 435T	DR-140T 150T	DR-620T 635	HRO Price
EDS-9	Remote Kit				*	\$Call
EJ-19U	Memory Expansion	*				\$Call
EJ-20U	Tone Squelch	*		*		\$Call
EJ-40U	Digital voice board		*			\$Call
EJ-47U	Digital voice board				*	\$Call
EJ-41U	TNC unit		*			\$Call
EJ-50U	TNC unit				*	\$Call
PC-15B	Power Cord	*	*	*		\$Call
MB-130	Mounting Bracket	*		*		\$Call

Alinco Mobile Specifications

Model	Primary Use	Frequency Range	Power	Current Drain Xmit	Current Drain Rec	Power Out	Memory Channels	Ant Z ohms	Mike Z ohms	Sensitivity at 12 dB	Height in	Width in	Depth in	Weight lbs
DR-135TMKIII#	Mobile	2 m	13.8 VDC	11 A	400 mA	5/10/50 W	100	50	600	<.16 µV	1.57	5.58	6.83	2.2
DR-235T	Mobile	222-225 MHz	13.8 VDC	8 A	400 mA	5/10/25 W	100	50	600	<.16 µV	1.57	5.58	6.83	2.2
DR-435TMKIII#	Mobile	430-450 MHz	13.8 VDC	10 A	400 mA	5/10/35 W	100	50	600	<.16 µV	1.57	5.58	6.83	2.2
DR-150TQ	Mobile	2 m Trans	13.8 VDC	10 A	600 mA	50 W	100	50	600	<.16 µV	1.6	5.6	6.2	2
DR-03T	Mobile	28-29.695 MHz	13.8 VDC	11 A	600 mA	10 W	100	50	600	<.25 µV	1.57	5.58	6.83	2.2
DR-06T	Mobile	54-53.995 MHz	13.8 VDC	11 A	600 mA	50 W	100	50	600	<.25 µV	1.57	5.58	6.83	2.2
DR-635T	Mobile	2m/440 MHz	13.8 VDC	11 A	1.2 A	50 W/35 W	50	50	600	<.16 µV	1.6	5.6	7	2.43

* Expand to 100 with optional EJ-19U †Expand to 240 with optional EJ-23U #TXCO with ± 2.5ppm frequency stability.

HF / 6 Meter



DX-70TH
HF / 6m – \$Call
HRO Discount Price

All-mode, general coverage receiver, 100 watt output from 1.8-30 MHz & 6 m, 100 memories with 10 memory group scans, detachable control head, dual VFO, CTCSS for 6/10 m, full QSK and auto CW break-in, built-in narrow band filter, RF preamplifier, speech processor, noise blanker, Size 2.25"(H) x 7"(W) x 9"(D).

6 or 10 Meters

DR-06T
6 Meters
– \$CALL



DR-03T
10 Meters – \$CALL

Catch the exciting world of the 6m and 10m bands with these rigs. The DR-06T covers 54-53.995 MHz and the DR-03T covers 28-29.695 MHz. Output on 6 m is 50 W and 10 m is 10 W. Both radios have convenient scan features, variety of selective calling tones, theft alarm, ignition key on/off, direct frequency input and controls from the EMS57 key pad microphone.

Receivers

Small Size Handheld

DJ-X7
\$Call

HRO Discount Price



Features include: Credit card size, WFM, NFM, AM, covers 100 KHz - 1299.995 M H z (cellular blocked), help navigation,

1000 channels, downloadable software (optional cable required), 39-tone tone squelch, 3 different antenna modes (earphone, internal bar, external SMA), pager function.

DJ-X30T
\$Call

HRO Discount Price



Features include: Selectable keyboard system; compact size; remote control with optional EDS-12; triple conversion AM/NFM;

double conversion WFM; 1000 memories; five scan modes; priority receive; 3 antenna modes; cable-clone;

receives 100 kHz to 1.29999 GHz (cellular blocked).



HF RIGS

Take your DXing to the Next Level
+30 dBm Third-order Intercept Point



IC-756PROIII

The 756PRO Third Generation's New Features

- Improved third order intercept points of +30 dBm.
- Large inductors instead of small coils in the bandpass filter stage handle both strong and weak signals without distortion.
- Diodes with wide bandwidth characteristics provide low-distortion BPF switching.
- Fundamental-type 64 MHz roofing filter using a monolithic crystal filter is less susceptible to intermodulation distortion.
- Real time spectrum scope with a mini scope function allows you to monitor the scope screen while you use other function menus.
- Two newly designed preamplifiers use the same basic circuit as the IC-7800 to minimize distortion and maximize dynamic range. Preamp-1 is a noiseless feedback design. Preamp-2 uses bipolar transistors for high gain.
- Eight channel RTTY TX memory where you can edit and send up to a 62 character message for each memory.
- Adjustable SSB transmit bandwidth with three types of high low combinations stored in memory. The built-in audio equalizer has separate bass and treble adjustments to tailor your transmit audio quality.

Inherited Properties from the 756PROII

- 32-bit floating point DSP & 24-bit AD/DA converters.
- 30 kHz to 60 MHz general coverage receiver.
- AGC loop management.
- Dual watch to receive 2 signals on the same band simultaneously.
- Digital twin passband tuning.
- Manual notch function featuring 70 dB attenuation..
- Automatic notch function.
- Digital voice recorder with a total of 90 seconds available for the 4 memory channels. Soft partitioned channels allow custom recording sizes.
- CW Memory Keyer.
- Adjustable noise reduction using 32-bit DSP processing.
- Adjustable noise blanker.
- Digital RF speech compressor.
- Highly stable transmitter using two 2SC5125 transistors in the PA unit.
- Highly stable crystal unit providing ± 0.5 ppm (-10 C to +50 C).
- Triple band stacking register.
- SSB data communication.
- 5-inch TFT color display.
- Built-in high speed auto antenna tuner.
- 2 TX / RX antenna connectors and RX antenna connector.
- Analog and digital meter.

All-Band HF

IC-718

- Receives 0.03 ~ 29.995 MHz.
- Transmits: HF amateur bands except 60m.
- Output power: SSB/CW/RTTY: 5 ~ 100 W variable, AM: 2 ~ 40 W variable.
- Modes: USB, LSB, CW, RTTY, AM.
- 101 memory channels.
- IF shift interference rejection.
- DSP built-in.
- Built-in electronic keyer.
- VOX operation, mike compressor, RF gain control.
- 10-key pad for direct operating frequency entering and memory channel selection.



IC-7700

The Contester's Rig



The IC-7700 Contesting Rig features two 32-bit floating point units – one for the transmitter / receiver and the other the for the spectrum scope. There is a +40 dBm 3rd order intercept point and ultra wide dynamic range. With only two IF stages and Icom's image rejection technology, very weak signals as well as the very strong signals are heard without distortion.

- Automatic tracking pre-selector.
- 200W output at full duty with high speed automatic antenna tuner.
- Professional 6m receiver..
- Ultra high frequency stability.
- Multi-function spectrum scope.
- RTTY/PSK31 operation without PC connection.
- Digital Voice Recorder.
- IF notch filter with adjustable characteristics.
- USB ports in front panel.
- RS-232C port for PC connection.
- General coverage receiver for 0.3 to 60 MHz.



IC-7800



The IC-7800 has 110 dB dynamic range and +40 dBm 3rd order intercept point in the HF bands. It features a general coverage receiver for 300kHz to 60 MHz, transmits on amateur HF bands (except 60m) plus 6m with 5-200 watts out (5-50 W AM). There is a high speed antenna tuner, two types of receive preamps and 7-step attenuator, two completely independent receiver circuits, digital IF filter and manual notch filter.

- 50 CTCSS tone encoder / decoder.
- VOX capability.
- DSP controlled CW keying waveform shaping. Memory keyer.
- Mechanical relay band pass filter.
- Three roofing filters.
- Automatic tracking.
- Double conversion super-hetrodyne system.
- AGC loop management using the DSP unit.
- AGC volume knob fine tuning.
- Real time spectrum scope.
- Four 32-bit floating point DSP units and 24-bit AD/DA converters.
- Ultra high stability OCO.
- 50 MHz band preamplifier & mixer.
- Digital twin passband tuning.
- Variable level noise reduction.
- 7" wide color TFT LCD.
- RTTY / PSK31 operation without PC connection.
- Microphone equalizer and adjustable transmit bandwidth.
- CF memory card for recording personal settings.
- Digital voice recorder.
- RF speech compressor.
- SSB data mode.
- 4 antenna connectors.
- Triple band stacking register.
- Variable noise blanker.

HF PLUS

HF + 6m + 2m



IC-746PRO
HF Plus 6m + 2m



The IC-746PRO uses 32-bit DSP features to create the most flexible signal enhancing and interference reduction ever offered in this type of radio. With the 32-bit DSP processor and 24-bit AD/DA converter, the ham radio operator has the best listening environment for current band and operating conditions.

All mode digital modulation and demodulation

For signal purity and clarity, an all mode digital PSN (Phase Shift Network) system has been incorporated into the DSP system. For transmit, this greatly reduces intermodulation distortion, producing the highest quality audio. The PSN separates the signal from noise by phasing out noise and other unwanted signals. With more than 51 different filter widths included, just dial in the width you want. Then select whether you want a sharp or soft filter shape for SSB and CW modes. Digital filters are separate from the SSB filters.

- Continuous coverage receiver from 30 kHz to 60 MHz and 108-174 MHz. Transmits on HF, 50MHz and 144 MHz bands.
- RTTY demodulator and decoder, ample CW functions, memory keyer, full break-in keying.
- Microphone equalizer, digital RF speech compression and a continuous duty 100W transmitter for all bands and all modes (AM is 40W).
- Large, multi-function LCD for ease of use in most any light-in condition. Multi-functions include band scope, memory names, key assignments, twin PBT settings, split frequency and memory keyer contents.
- Digital Twin PBT with manual notch filter, digital noise reduction and AGC loop management.
- Built-in automatic antenna tuner covers HF and 6 meter bands.

QRP HF + 6m

IC-703 Plus

HF Plus 6m



The IC-703 Plus is a full featured QRP, portable transceiver covering the HF and 6m bands. It features a built-in automatic antenna tuner, DSP capabilities, 10 watts of output power, a highly sensitive receiver, current consumption control and high frequency stability (± 0.5 ppm). Features a built-in antenna tuner, noise reduction function, automatic notch, Detachable controller from main unit, spectrum scope and SWR graphic functions, multiple filter options, CI-V capability, 9600 bps data terminal, bandstacking registers and built-in preamplifier.

HF Plus VHF / UHF

IC-7000
HF Plus VHF / UHF



With the IC-7000, IF-DSP technology comes to a multi-band transceiver. With 2X DSP, it outperforms some base stations. Notable features include improved AGC loop performance, digital IF filters, 2 X manual notch filters, a digital voice recorder, flexible installation with a detachable panel, remote control microphone, a 2-mode band scope with simplified one-touch operation. The 2-mode band scope will, in Center mode, center on the receiving frequency. In Fixed mode, the band scope sweeps a fix range.

- Internal memory keyer.
- Control circuit for optional antenna tuners.
- Built-in voice synthesizer.
- CI-V control capability.
- 503 memory channels.
- 100-step digital noise blanker.
- Multi-function S /PWR/SWR meter.
- Receiver preamp and attenuator.
- 16-step digital noise reduction, RIT.
- CTCSS and DTCS tone squelch.
- ± 0.5 ppm high frequency stability.
- Continuously adjustable RF output.
- Digital RF speech compressor.
- Bass and treble audio equalizer.
- Adjustable SSB transmit bandwidth.

HF + 6m + 2m + 70cm All-Mode

IC-706MKIIG

The compact, feather-weight IC-706MKIIG all-mode transceiver updates the IC-706. Improvements include: VHF band RF stage, standard tone squelch, 2 optional filters, and a built-in DSP plug in IC-UT106.



The IC-706MKIIG covers the HF bands from 160 - 10* meters as well as the six, two meter and 70 cm bands. It includes all modes over its entire frequency range, including FSK for RTTY operation, and narrow FM on the HF bands. Receives 30 kHz to 70 cm with wide AM and wide FM broadcast reception.

It has a 100 watt output transmitter (40 watts AM) from 160 through 6 meters, with 50 watts output on 2 meters (4 watts AM) and 20W on 70cm. VOX is included, as well as a speech processor, I-Loop PLL circuit, and optional slot for narrow SSB filter (FL-223). Multiple CW functions include a built-in keyer, optional narrow receiver filter slot, full break-in (QSK), adjustable CW pitch and CW reverse functions, tone squelch, backlit switches, AF DSP, and auto repeater function.

101 memories store up to 9 alphanumeric characters each. A dot matrix

display shows the popular menu features, frequency and multifunction meter data. A spectrum scope displays band activity at a glance.

The front panel detaches to aid mobile installation. The PS-85 optional switching power supply is great for making the IC-706 a base station. The AT-180 optional automatic antenna tuner for coax systems and the AH4 for long wire, whip or backstay operation.

* Not 60 m

Remote Head Kit
RMK-706



Remote head kit for 706 product. (Includes MB-62, MB-63, and OPC-581.)
HRO Price \$70.95

HF ACCESSORIES

VHF / UHF BASE

HF Antenna Tuners



AH-4 Automatic HF Antenna Tuner

Tune up from HF through 50 MHz band. The AH-4 auto-tuner covers all amateur bands from 80 to 6 meters when used with a minimum 23' long wire antenna. With the optional AH-2b antenna element, tune 40 through 6 meters for mobile operation.

It has automatic band changes and tunes usually in less than 2.5 seconds. The 45 memories store SWR minimum and tuning combinations. With those Icom radios with the TUNER feature, the AH-4 is remotely controlled from the radio front panel. Requires only 300 mW to tune and handles up to 120 watts. **HRO Price \$259.95**

Icom HF Tuners

Features	AT-180	AH-4
Input Power (Watts)		
Max	120	120
Min	8	10
Auto Tune Time (seconds)		
New Band	2 - 4	2 - 3
Same Band	≤3	1
Tuning Accuracy	VSWR<1.5	VSWR<2:1
Auto Band Switching	yes	yes
Preset	CPU	CPU
Matching	Controlled	Controlled
Power Supply	13.8 VDC	13.8 VDC
Frequency Coverage	1.8-28 MHz	3.5-54 MHz
Antenna System	Coax fed Antennas	Long wire, whip, boat backstay
Radios	IC-706	Most
HRO Price	\$364.95	\$259.95

Note: AT180 will work with most Icom HF rigs, but some need additional cabling to operate.

Icom HF Filters

Filter	Center Frequency	Bandwidth	Mode	781	775	765	756	746	738	737 A	736	735	729	728	725	726	718	707	706	706 MKII	703	R 71A	R 72	R 75	R 8500	R 9000	HRO Price
FL52A	455 kHz	500 Hz	CW	std		std	*	*	*	*	*						*	*		*			*	*	*		\$179.95
FL53A	455 kHz	250 Hz	CW	std	*	*		*	*	*	*						*	*		*			*				\$179.95
FL63A	9.0106 MHz	250 Hz	CW									*															\$99.95
FL96	455 kHz	2.8 kHz	SSB					*									*							*			\$179.95
FL100	9.0106 MHz	500 Hz	CW				*	*	*	*	*		*	*	*	*			*	*		*	*	*			\$119.95
FL101	9.0106 MHz	250 Hz	CW	std	*	*	*	*	*	*	*		*	*	*	*			*	*		*	*	*			\$99.95
FL102	9.0100 MHz	6.0 kHz	AM	std	*	*													*	*							\$75.95
FL103	9.0115 MHz	2.8 kHz	SSB	*				*											*	*		std		*			\$109.95
FL-222	455 kHz	1.9kHz	SSB		*		*	*									*			*				*			\$199.95
FL-223	9.0115 MHz	1.9 kHz	SSB		*		*	*											*	*				*			\$99.95
FL-232	9.0115 MHz	350 Hz	CW		*		*	*											*	*				*			\$89.95
FL-257	9.0115 MHz	303 kHz	SSB														*			*			*				\$199.95

VHF / UHF Base Station

2m 440 MHz (+1.2 GHz) IC-910H



Two meters and 70 cm are standard on the IC-910H. With the optional UX-910, it also operates on 1200 MHz. It is an all mode transceiver with up to 100 W output. It's a great rig for satellite operation. It features a large LCD display and 10-key pad for ease of operation.

- 100 W on 2 meters, 75 W on 440 MHz and 10 W with the optional UX-910 on 1200 MHz.
- Simultaneously works two bands. Cross band and full duplex operation.
- Satellite mode operation support.
- 10-key pad for direct entering of frequency or memory channels.
- 3.5 inch large LCD.
- 9600 bps PACKET communication.
- IF shift interference rejection.
- Optional DSP capability with the AF DSP UT-106.
- Full CW support with speed adjustment, full and semi-break in.
- 50 CTCSS tone encoder, VOX, speech compressor, 99 memory channels.
- PC interface with optional CT-17.

HF + 6m Amplifier



IC-PW1

The IC-PW1 linear amplifier provides a wide frequency coverage with up to 1kW output requiring only a maximum of 100 watts input. The duty cycle is 100 percent with full break-in operation. It covers amateur bands from 160 meters to 15 meters plus 6 meters (10 m conversion information for licensed hams) and includes an automatic antenna tuner for all bands. Internal circuitry allows the ALC to be adjusted over a wide range allowing the PW1 to be used with almost any rig – not just Icom. Operates on 110 or 220 VAC 50 or 60 cycle. Single box shipping and the remote head is included.

Cloning Software

Icom cloning software for Windows allows you to preprogram memory channels with operating frequencies, set tones, set power levels, set squelch levels, set up auto-dial DTMF frequencies, and exchange operating frequencies. Call for price quotes.

- **RS-746** is remote software for IC-746.
- **CSWHHRX** software/cable (R2, R10).
- **CS-R3** without cable (R3).
- **CS-R5** without cable* (R5).
- **CS-2720H** without cable* (2720H).
- **CS-V8000** without cable (V8000).
- **CS-V8A** without cable (V8A).
- **CS-2800** without cable (2800).
- **CS-T90A** without cable (T90A).
- * OPC-478U USB cable for IC-2720H and IC-R5.
- **RS-91** for IC-91A series.
- **CS-2820** for IC-2820H.
- **CS-D800** for IC-ID800



VHF / UHF MOBILES

Digital Transceivers

ID-800H



The dualband ID-800H transceiver is a vital part of a D-Star digital voice system.

- TX: 144-148 MHz and 420-450 MHz.
- RX: 118-173.995 MHz, 230-549.995 MHz, 810-999.99 MHz (cell blocked).
- Power out on VHF is 55 W, 5 W selectable; UHF 50 W with 15 W, 5 W selectable.

- FM (analog), AM (analog RX only), GMSK (digital) modes.
- 512 memory channels with 500 regular, 2 call, and 10 scan edges.
- Detachable front panel included.
- GPS position exchange with external GPS.
- 20 character short text messaging with on-screen display.

IC-ID-1

While the ID-1 transceiver is a vital part of a D-Star system, you won't have to wait for a new repeater to be set up in your area.

This rugged little rig operates with current analog 1.2 GHz repeaters, plus simplex digital operation with another ID-1. Its operating frequency range is 1240-1300



MHz with FM and GMSK (Digital) modulation formats. The ID-1 includes alphanumeric memory channels, CTCSS encode/decode and scanning, PLUS full PC control via the USB port (a black box 1.2 GHz radio!). Now for the fun part

... the ID-1 supports a 10 BASE-T ethernet cable for the 128K Data operation! Explore the benefits of wireless high-speed integrated digital connections!



Display Unit

Icom VHF Specifications

Model	Freq Range	Mode	Power Supply	Current Drain Xmit	Current Drain Rec	Power Out Watts	Ant Z ohms	Mike Z ohms	Sens	Audio Power	Built-in AC Supply
IC-208H	2m / 440 MHz%	FM	13.8 VDC	12 A	1.0 A	55 / 50	50	600	<.18 μV	3 W	no
IC-910H	2m / 440 MHz*	All	13.8 VDC	23 A	2.5 A	100/75/10*	50	600	<.18 μV	2 W	no
IC-2200H	2m	FM	13.8 VDC	16 A	1.0 A	65	50	600	<.18 μV	2.4 W	no
IC-V8000	2m	FM	13.8 VDC	15 A	1.0 A	75	50	600	<.15 μV	>2.0 W	no
IC-2720H	2m / 440 MHz%	FM	13.8 VDC	12A	1.8 A	50 / 35	50	600	<.18 μV	>2.4 W	no
IC-2820H	2m / 440 MHz%	FM	13.8 VDC	13A	1.8A	50 / 50	50	600	<.18 μV	>2.4 W	no
ID-800H	2m / 440 MHz%	FM	13.8 VDC	12.5A	1.1A	50 / 50	50	600	<.18 μV	>2.0 W	no

† Extended receiver coverage 118-174 MHz (airband included), 440-450 MHz %extended receiver range. See text with radio.

2m Mobiles

IC-V8000

75 watts of power for your ultimate 2m mobile experience.



The IC-V8000 combines a one piece, die-cast aluminum chassis with 75W of transmit power to give you the most powerful 2m mobile transceiver in its class.

- Remotely control rig with HM-133 mike.
- Easy operation with a quick reference of user-defined memory channel information.
- 6 character alphanumeric display.
- CTCSS & DTCS are standard.
- DTMF encoder is standard with 10 channels with up to 24 digit DTMF codes.
- Front firing speaker.
- Optional UT-108 DTMF decode.
- Dynamic Memory Scan has 200 alphanumeric memories. DMS system allows full customized scanning in 10 banks.
- FM narrow mode switchable.
- Clone from a PC or between radios.
- Weather Alert Scan (US version only).

IC-2200H

The IC-2200H provides enhanced digital features plus a stable 65W output through a MOS-FET amplifier. A one-piece aluminum chassis keeps the transceiver cool even at high duty cycles.



- Retains simple operation with a large tuning dial. Secondary functions are recalled by holding the appropriate button.
- A total of 207 alphanumeric memory channels.
- Dynamic memory scan allows scanning of selected memory banks.
- 50 CTCSS and 104x2 DTCS encode/decode.
- 24 DTMF autodial memories.
- Selectable green or amber display.
- "Pocket Beep" signals an incoming call.
- Optional Digital Unit (UT-115). When connected to an external GPS, position information can be exchanged.
- DTMF code squelch/pager with optional UT-108.
- Weather channel.
- Selectable squelch delay.
- Built-in 10dB squelch attenuator.

HANDHELD ACCESSORIES

Dual Band Mobiles

IC-2820H

Ready for the Road
with D-Star and GPS



This fully D-STAR-compatible mobile transceiver, packed with useful features, provides 50 W on both VHF and UHF. Die-cast aluminum chassis keeps the powerful MOS-FET power amplifiers running cool. The optional UT-123 provides an on-board GPS module for D-PRS operation and realtime location data on the 2820's display. V/V U/U simultaneous receive, diversity receive capability with 2 antennas, 522 memory channels, built-in wide band receiver. Controller can be separated from main unit.

- Wideband receive covers 118-549.995 and 810-999.990 MHz (cellular blocked).
- Easy to read graphical interface display. Tuning buttons and display buttons are arranged side-by-side for easy operation.
- Band scope functions let you watch conditions near the receiving frequency and easily locate other stations.
- 104x2 DTCS/50 CTCSS tone squelch operation.
- DTMF pager and code squelch.
- Automatic attenuator.
- Max 45 channels / sec high speed scan in programmed scanning mode.
- 9600 bps packet terminal, mini DIN (6 pin) connector.
- FM narrow capability.
- 16 DTMF memory channels.
- DTMF pager and code squelch function.
- GPS features (with optional UT-123) include, location information exchange, GPS alarm, GPS location tracking.
- Low speed data communication when connected to a PC with optional OPC-1529R.



IC-208H

The IC-208H features 55 watts out on 2 m and 50 watts on 70 cm. The output is switchable in three steps from 5 watts to 15 watts to the maximum power for each band.

- Wide-band receiver – 118 to 999.990 MHz (cellular blocked).
- 500 memory channels separable into 10 banks.
- Controller separation capability with included cable.
- 6-character alphanumeric LCD display. Name memory channels for easy recognition.
- Weather alert function.
- Select LCD backlighting color: amber or green.
- Big clearly labeled function keys.
- Dynamic memory scan.
- Multiple scanning modes.
- Switchable wide/narrow channel spacing.
- Standard accessories include HM-133 hand microphone, OP-600 separation cable, DC power cable and mounting bracket.

Handheld Batteries / Chargers

Model	Volts	Rating mAh	Wall Charger	Desk Charger	HRO Battery Prices
BP-8	8.4	800	BC-16u	BC-35	\$99.95
BP-83	7.2	600	BC-110A	BC-72	\$90.95
BP-84	7.2	1000	BC-110A	BC-72	\$99.95
BP-131	7.2	900		BC-119*	\$119.95
BP-157	7.2	900	BC-77A	BC-119*	\$59.95
BP-160	7.2	700	BC-77A	BC-119*	\$66.95
BP-171	4.8	700	BC-74A	BC-119*	\$83.95
BP-172	4.8	650	BC-74A	BC-119*	\$69.95
BP-173	9.6	600	BC-74A	BC-119*	\$99.95
BP-180	7.2	600		BC-119*	\$83.95
BP-194	**				\$18.95
BP-195	9.6	700	BC-110A	BC-119*	\$42.95
BP-196	9.6	1050	BC-110A	BC-119*	\$53.95
BP-197	**				\$24.95
BP-198	4.8	700	BC-110A	BC-119*	\$59.95
BP-199	6	700	BC-110A	BC-119*	\$70.95
BP-200L	9.6	760	BC-110	BC-119N	\$89.95
BP-202				BC-119N	\$17.95
BP-204	**				\$35.95
BP-206	3.6	1650	BC-136A	BC-135	\$63.95
BP-208N	**				\$18.95
BP-209N	7.2	1100	BC-137	BC-119N	\$53.95
BP-210N	7.2	1650	BC-137	BC-119N	\$79.95
BP-211N	7.4	1600	BC-137	BC-119N	\$89.95
BP-217	7.4	1300		BC-139	\$99.95
BP-222	7.2	600	BC-137	BC-119N	\$35.95
BP-227	7.2	1700	BC-145	BC-119N	\$84.95

* Note: The new BC-119N-01 has to have either the AD-75 or AD-88 as well as adapters (see left).

** "AA" Alkaline Pack.

BC-119 Adapters

Adapter	For Batteries	HRO Price
AD-25	BP-131A, BP-132A, BP-157A	\$63.95
AD-27	BP-100, BP-130	\$18.95
AD-28	BP-131/132/167, BP-160/174 (+AD-75)	\$18.95
AD-50	CM-166 (+AD-75)	\$17.95
AD-51	BP-171/172/173, BP-180 (+AD-75)	\$14.95
AD-56	BP-171/172/173, BP-180 (+AD-75)	\$18.95
AD-67	CM-140/141/142	\$10.95
AD-68	CM-138/139/185	\$14.95
AD-69	BP-185/186	\$19.95
AD-81	BP-195, BP-196	\$17.95
AD-87	BP-198, BP-199, BP-200(+ AD 88)	\$8.95
AD-94	BP-209/210/222	\$17.95
AD-100	BP-227	CALL
AD-101	BP-209/210/211, BP-222	\$25.95

Ham Radio Outlet will ship your products quickly
from the store nearest you.

Most orders greater than \$100 receive free UPS Brown shipping in continental US.



HANDHELDS

2 m / 70 cm Handhelds

Single Band

IC-V85 2 Meter

The water resistant IC-V85 with up to 7 W of output power features a hi-capacity, 1700 mAh, Li-Ion battery pack. The DC powerjack allows use of an external DC source. (CP-19R required for operation from a DC source higher than 11 VDC.) The radio features 136-174 MHz wideband VHF receive, 144-148 MHz transmit with ± 2.5 ppm high frequency stability. Power output is adjustable to 7.0/4.0/0.5 W. A weather alert is also provided.



IC-V82 2 Meter



IC-U82 UHF D-STAR Digital with optional UT-118

The IC-V82 has 7 watts out and the IC-U82 has 5 watts.

- FM (analog) GMSK (digital).
- V82: TX 133-148 MHz; RX 136-174 MHz.
- PC programmable.
- Optional DTMF decoder
- Optional voice scrambler unit, UT-109 or UT-110.
- 10 memory banks and band link scan.
- 200 alphanumeric memory channels, 1 call channel, 6 scan edges.
- 20 character short text messaging.
- Built-in CTCSS /DTCS encoder/decoder.
- 16 DTMF autodial memories.
- 5 character alphanumeric display.
- Optional Digital Unit UT-114.

IC-V8 Sport 2 Meter

Features include:

- 5 character alphanumeric display.
- CTCSS / DTCS standard.
- 100 memories.
- 5.5 W output.
- Reverse shift function.
- 16 button keypad for easy-to-access functions.
- PC cloning capability.
- Std DTMF encoder.
- Optional DTMF decoder (UT-108).
- Battery case (AA battery).



D-STAR Digital IC-92AD

The IC-92AD D-Star handheld is submersible to a depth of one meter for 30 minutes.

- Wideband receiver has dualwatch capability.
- 5 watts output.
- Simple bandscope.
- Built-in voice recorder.
- Large dot-matrix display; one touch reply button; keypad navigation.
- Optional PC remote control capability.
- Exchanging position information is easy.
- 1304 memory channels.
- Optional GPS speaker-microphone (HM-175GPS).
- Built-in CTCSS / DTCS tone encoder.
- 26 memory banks with selected bank and band link scanning.
- 10 channel DTMF memory (16 digit).
- Weather channel with weather alert (US and Canada versions only).



D-STAR Digital IC-91AD / IC-91A

One Radio. Two Bands. Three times the fun!

The IC-91AD/A features advanced digital technology in the D-Star DV mode.

Digital mode includes:

- DV mode operation with an AMBEC codec. 950 bps data can be sent simultaneously with the digital voice transmission. Optional UT-121 required for the IC-91A.
- One touch reply button.
- Built-in voice recorder and auto reply button.
- Optional PC remote control capability with optional RS-91 software.
- Position information exchange when connected to an external GPS receiver (receive only when no external GPS is attached).
- DX communication over D-STAR.



Other features include:

- Wide band receiver with dualwatch capability. VFO A Range: 0.495-999.990 MHz (cellular blocked); VFO B: 118-174, 350-470 MHz.
- Large dot matrix display.
- Spectrum bandscope.
- 5 watts (typical) output.
- Keypad navigation to give quick access to the many functions.
- External DC power jack. With the optional OPC-254L you can operate and charge at the same time.
- Built-in CTCSS / DTCS encoder / decoder.

- Squelch release function to monitor weak signals.
- Water resistant construction.
- Auto power save, power off / on.
- 26 memory banks with selected bank and band link scanning.
- 10-channel 16-digit DTMF memory.
- 10 dB built-in attenuator.
- Total of 1304 memory channels.
- Automatic repeater function on USA models.
- Weather channel with weather alert on USA models.

IC-P7A

- VHF / UHF with 1.5 W / 1.0 W output.
- 1000 alpha numeric memory channels.
- Ultra compact.
- 20 hours of operating time or 15 hours of continuous TV / FM receive.



- CTCSS / DTCS tone.
- Wideband receiver for FM, TV (audio) and other services.

IC-T7H-Sport



This HT fits easily in your palm or pocket.

- 70 memories, 9 DTMF autodial memories.
- High speed scan/ scan timer.
- Encode / decode included.
- 6W out 13.8 VDC.



- PC programmable.
- One touch operation.
- Easy scanning display.
- Autoband selection, memory allocation.
- Wide band receive.
- Microphone remote control.
- Compatible with T22A, W31A and Z1A accessories.
- Battery case (AA batteries)

Tri-Band

IC-T90A 6 m / 2 m / 770 cm

- Features include:
- Wideband AM, FM, WFM receive.
 - 5 watts out on 6 m, 2 m and 70 cm.



- Receiver 495 kHz to 999.990 MHz (cellular blocked).
- 555 alphanumeric memory channels with DMS.
- DTCS and CTCSS tone squelch.
- DTMF encoder with 10 memories.



RECEIVERS



IC-R75



This receiver covers the HF bands plus 6 meters (0.03 to 60 MHz). It features twin PBT, built-in DSP capability, and a front mounted speaker. Modes include USB/LSB, CW, RTTY, AM/S-AM and FM. A complete line of filters are available. Operates at 13.8 VDC ± 15% at 2.0 A. Features 101 memories (99 regular and 2 scan edges). Program scan, memory scan and priority scan. Direct frequency input with numeric keypad. Two-level pre-amp, noise blanker and selectable AGC.

IC-R5-Sport \$174.95

The IC-R5-Sport receives 100 kHz to 1209.996 MHz (822-851 & 867-896 MHz blocked). It has 500 alphanumeric memory channels, DTCS and CTCSS built-in, high speed scanning, pulse control squelch function and weather alert. Icom's exclusive DMS scanning system allows the user to customize memory channels into separate scanning lists from 2-100 channels per bank. Receives AM / FM / WFM. The Icom Hot 100 SWL frequencies and TV channels are pre-programmed. The IC-R5 is computer programmable with optional software and programming cables (RS-232 or USB cables are available). Battery/Charger optional



IC-R5-Sport Accessories

Model	Description	HRO Price
Cloning		
CS-R5	Cloning software requires OPC478 or OPC478U	\$40.95
OPC478	PS232C Cloning cable	\$45.95
OPC478U	USB Cloning Cable	\$60.95
OPC474	Cloning Cable-Handheld to handheld	\$18.95
Headphone Accessories		
HP-4	Lightweight headphone	\$29.95
HM-133	Earphone	\$90.95
Other Accessories		
AS-92SMA	BNC antenna adapter	\$16.95
BC-149A/D	Wall Charger	\$40.95
CP-18A	Cigarette Lighter Cable	\$30.95
LC-146A	Carrying Case	\$24.95

IC-R3 (Limited Availability)

A first for a hand-held receiver: a built-in TFT color LCD shows tuning step, receiving frequency, memory channel number, and more. A clear TV picture can be displayed. NTSC M, PAL N, PAL B/G or PAL I is supported depending on version (only NTSC in US). Has super wide frequency coverage from 0.495-2450 MHz (821.995-851.995 and 867-896 MHz blocked) with AM, FM, wide-FM, and TV picture receive capability standard. Receives ATV on 430, 900, 1200 and 2400 MHz.



IC-R20

The IC-R20 retains many of the features of the R10 including voice scan control, attenuator, RF gain control, noise blanker, automatic noise limiter, multiple scan functions, CI-V PC control, backlit keypad. New features include wide range receive 0.15 to 3304.9999 MHz (822-851 and 867-896 MHz blocked), SSB/CW/AM/FM/WFM, dual watch between bands, IC audio recorder, auto squelch, 1250 memory channels, CTCSS / DTCS / DTMF decode, internal bar antenna for MF reception.



IC-R9500

Professional Communications Receiver

- +40 dBm IP3 / 110 dB wide dynamic range.
- Measuring class accuracy. Dual IF filter.
- Superior BPF unit.
- Dual DSP. 10 VFOs.
- 7" wide color TFT LCD.
- High resolution spectrum scope. 1000 memories.
- 2 channel noise blanker.
- 5 roofing filters. 2 point manual notch filter.
- 0.005-3335 MHz. Cellular blocked.
- All bands: SSB, CW, FSK, AM, FM, WFM on some.
- Digital voice recorder.
- 4 antenna connectors

PC-Controlled

IC-R2500 Dualwatch Digital Mode Diversity Receiver



The IC-2500 is a great receiver for the mobile operator.

- Dual watch (2 antennas required) receive covering 0.01-3299.999 MHz.
- Receives AM, FM, WFM, SSB, CW, DV (optional UT-118), and P25 (optional UT-122) on main receiver. Covers 50-130MHz in AM, FM and WFM on sub-receiver.
- Diversity receive capability selects the antenna with best signal (2 antennas required).
- 1000 alphanumeric memories.

IC-R1500 Mobile

Wideband mobile receiver with remote control head (cable supplied) covers 0.01 - 3299.999 MHz (cellular blocked).

- 60 channel /second scan.
- Optional DSP with UT-106.
- 1000 alphanumeric memories in 21 banks.
- CTCSS / DTCS tone and pocket beep.
- VSC (voice squelch control).
- IF filter, IF shift (CW, SSB).
- Noise blanker (SSB, CW, AM).
- RF attenuator.
- Weather alert (US only).
- All functions are available when connected to a PC. Cloning to read/write memory channels from the PC.

IC-PCR2500 All Mode

A PC controlled dual band, dual watch digital mode receiver. It covers 0.01-3299.99 MHz in AM, FM, WFM, SSB CW, DV and P25 modes on the main receiver. The sub-receiver can simultaneously cover 50-1300 MHz in AM, FM and WFM modes. (Two antennas are required for dual mode operation.) Cellular blocked.

- Recording function allows digital mode reception with optional UT-118 and UT-122 (P25).
- Diversity receive ability.
- 3 receiver screens.
- Multi channel monitor.
- DSP capability.
- Bandscope and time-line scope.
- Recording function.
- Up to 2600 memories.

IC-PCR1500 All Mode

All functions are controllable from your PC. Receives from 0.01 to 3299.999 MHz (cellular blocked).

- Multi-channel monitor.
- 3 interface screens.
- Timeline and bandscope.
- Recording function.
- DSP capability opt. UT-106.
- High speed scanning.
- CTCSS/DTCS tones and duplex mode operation.
- S-meter squelch.
- Up to 2600 memory channels per file.

Notice: The R3, R5, PCR1500 and R1500 are available unblocked to authorized Federal Agencies.

KENWOOD

HF RIGS

HF Mobile



TS-480HX & TS-480SAT

Compact, Portable HF Transceiver

With its separate control panel, the TS-480 is perfect for base station use, while ample receive audio makes it outstanding for mobile applications. Using 13.8V for power, the TS-480HX delivers 200W; the TS-480SAT delivers 100W. The TS-480SAT also has an automatic antenna tuner.

- 500 kHz–60 MHz general coverage receiver.
- Separate LCD control panel with speaker. It can be positioned up to 4 meters from the main unit.
- PC-based control.
- TX / RX AF DSP. 16-bit AF digital signal processing offers noise reduction, TX / RX equalizer and AF filters.
- Optional IF filters available.
- TX covers all amateur bands 1.8 MHz to 60 MHz. Includes 5 MHz band for the US market.
- Quad-mixer provides RX dynamic range in the TS-950 class.
- PSK-31 compatibility.
- Packet cluster tune with optional TM-D700E/A.

HRO will ship products quickly from the store nearest you.
Most orders greater than \$100 receive free UPS Brown shipping in continental US.

Kenwood HF Specifications

Model	Receiver Frequency Range	Power Supply		Current Drain		Power											
		50/60 Hz AC	DC	Xmit	Rec	AM	FM	SSB	CW	FSK	FSK Shift	Mike Z ohms	Receive Circuitry	Sensitivity	RIT / XIT	Notch Filter	Audio
TS-2000*	0.5-30 MHz, 50-54 MHz, 144-138 MHz, 430-450 MHz, 1240-1300		13.8 V	20.5 A	2.0 A	100	100	100	100	100	100	600	Quadruple Conversion	<.11µV SSB,CW,FSK (varies with band and mode)	±20 kHz	> 30 dB	1.5 W
TS-480SAT†	500 kHz - 60 MHz		13.8 V	20.5 A	1.5 A	25	100	100	100	100	600	#	<.2 µV	±9.99 kHz	-	2 W	
TS-480HX	500 kHz - 60 MHz		13.8 V	41.0 A	1.5 A	50	200	200	200	200	600	#	<.2 µV	±9.99 kHz	-	2 W	

Double Conversion SSB, CW, AM; Triple FM (1)170,200,425,850 Hz *Output 440MHz 50 W and 1000 MHz 10 W †Output 6M 480HX - 100W/50W AM 480AT 50W/25 W AM

All-Mode / All-Band



TS-2000

\$CALL – HRO Price

The TS-2000 is a marvel of electronic engineering. Kenwood's stylish all-mode multibander is packed with top-end features yet compact enough to use at home, in your car, or on a DX'pedition. With a 3D front panel featuring backlit keys and a large amber display, its appearance is as distinctive as its performance. The TS-B2000 is a "Black Box" version for computer control or vehicle use with the optional RC-2000 mobile controller. ARCP-2000 radio control software is supplied with the TS-B2000.

- All mode multibander: HF*/50/144/440/1200 MHz (optional UT-20 required for 1200 MHz operation on the TS-2000).
- 500 kHz to 1300 MHz wide band receiver with dual-channel receive. Has satellite mode plus a sub 144/440 MHz FM/AM receiver so two frequencies can be received simultaneously.
- The high-duty transmitter provides 100 watts on HF/50/144 MHz bands (AM 25 watts). There is 50 (AM 12.5) watts on 440 MHz. For 1200 MHz operation, the unit delivers 10 (2.5 AM) watts.
- Digital signal processing combines IF-DSP with AF-DSP (sub band) to provide precision filtering and interference reduction.
- The IF digital signal processing provides for DSP detection, digital filtering, IF auto notch and IFAGC. The AF digital signal processing features an automatic beat cancel,

cel, a manual beat cancel, CW auto tune, two types of Noise reduction and TX audio shaping.

- High speed processing using two 16-bit DSP chips, double precision computing and a 100 MHz CPU and 24-bit A/D and D/A converters to provide quick response.
- Satellite communications uses main-band circuits which benefit from the IF-DSP.
- The Kenwood Sky command System II Plus is built-in allowing the transceiver to be operated remotely with one handheld transceiver.
- High frequency stability is obtained with a built-in TCXO with professional performance ±0.5 ppm (-10 to 50 degrees C).
- Optional mobile controller and optional control software allows for remote and computer controlled operations. Has a built-in auto antenna tuner, DX cluster tune and an antenna terminal dedicated to HF low-band operation.
- The TNC is compliant with the AX.25 protocol for Sky Command and DX cluster tune.
- The TS-2000 has other expanded power and performance features.

* Not 60m

TS-B2000

\$CALL – HRO Price



KENWOOD

ACCESSORIES

Power Supplies



PS-53

Designed for the TS-570 D/S(G), TS-480 series and TS-2000 operating all modes for the rated periods of time. Provides 13.8 VDC at 20.5 A. Has a cooling fan and protection circuits. **HRO Price \$269.95**

KPS-15

HRO Discount Price \$159.95

The KPS-15 is a compact, switching power supply for high current applications. It is rated at 23 amps. The supply is for 110-230 VAC. Weighs only 4.5 pounds. **HRO Price \$229.95**

Kenwood Power Cables

Part Number	Radio	HRO Price
PG-2Z	TS-140, 690, 790, 450, 850, 130, 440, 570	\$37.95
PG-2N	TM-2530/ 50/ 70, 721, 621A, 221/ 321/ 421, 241, 231/ 431/ 531, 251/ 451/ 551, 255/ 455, 261/ 461, 441, 201B, 401B, 541, 631, 642A, 731, 741, 941, 732A, 733A, 642A, 742A, 942A, TR-751A	\$17.95
PG-2W	TH-26, 46, 28, 48, 79, 235A	\$17.95
PG-2Y	TS-50S / 60S	\$39.95
PG-3J	TH-22AT, 26, 27, 46, 47, 79A, 235A, F6A	\$37.95

Single Band Mobile

TM-271A

2 Meters

\$CALL HRO Discount Price



On or off road, the TM-271A delivers powerful mobile performance with 60 W maximum output. The TM-271A is a tough, rugged unit meeting MIL-STD 810 C/D/E/F specifications. It features weather alert (US only), 200 memories plus call channel, multiple scan functions, CTCSS (42 subtones) and DCS (104 codes) encoder/decoder built-in, illuminated keys and large LCD with adjustable green backlighting, automatic repeater offset, memory channel lockout, memory control program.

Kenwood VHF / UHF Specifications

Model	DC Power Supply	Current Drain		Output Power	Sensitivity	HRO Price
		Transmit	Receive			
TM-271A	13.8 V	13 A	1.2 A	60 W	<.16 μ V	CALL
TM-G707A	13.8 V	11.5 A	1.2 A	50W/35W	<.16 μ V	CALL
TM-V71A	13.8 V	13 A	1.2 A	50W/50W	<.16 μ V	CALL
TM-D710A	13.8 V	11.5 A	1.0 A	50W/50W	<.16 μ V	CALL
TM-V708A	13.8 V	11.5 A	1.0 A	50W/35W	<.16 μ V	CALL

HF Accessories

Option	Model	950 SDX	940S	930S	850S	870S	570D 570S	450S 690S	440S	430S	140S 680S	480	50S	60S	HRO Discount Price
Microphone Hand Hand Desk Desk Desk	MC-43S	std	std	std	std		*	std	std	std		*	*	*	\$59.95
	MC-47						*					*	std	std	\$59.95
	MC-60A	*	*	*	*		*	*	*	*		*	*	*	\$139.95
	MC-80	*	*	*	*		*	*	*	*		*	*	*	\$109.95
	MC-90	*					*								\$249.95
Filters 500Hz CW 500Hz CW 270Hz CW 1.8kHz SSB 500Hz CW	YG-455C-1	std	*	*	*			*				*			\$149.95
	YK-88C-1	std	*	*	*		*	*							\$129.95
	YK-88CN-1	*			*		*	*							\$129.95
	YK-88SN-1	*			*		*	*					*	*	\$129.95
	YK-107C												*	*	\$129.95
Hi Stability Oscillator	SO-2	std			*		*	*					*	*	\$169.95
	SO-3											*			\$109.95
Headphones	HS-5	*	*	*	*	*	*	*	*	*		*			\$79.95
	HS-6	*	*	*	*	*	*	*	*	*		*			\$59.95
External Speaker	SP-31				*										\$99.95
	SP-50B						*	*	*	*		*	*	*	\$55.95
	SP-23						*	*				*			\$76.95
	SP-950	*													\$139.95
	VS-2	*			*			*							\$69.95
Voice Synthesizer	VS-3						*								\$39.95
	AT-50												*		\$309.95
Antenna Tuner	MB-13												*	*	\$55.95
	MB-430						*	*	*	*					\$49.95
Power Supply	KSP-15	*	*	*	*	*	*	*	*	*	*	*	*	*	\$199.95
	PS-53						*	*				*	*	*	\$269.95
Voice Memory	DRU-2	*			*								*	*	\$134.95
	DRU-3A						*								\$129.95
	VG-1											*			\$69.95

DUAL BAND MOBILES



HRO Discount Price \$CALL

TM-V71A
2 m / 70 cm

NEW!

Kenwood's TM-V71A FM dual bander is locked and loaded for action. It is equipped to shine in any mobile communications role. It features 50 W output, 1000 memory channels, multiple scan options and PC connectivity.

- High power output - 50W on VHF/UHF.
- Dual receive on same band (VxU, UxU).
- Compatible with ARRL TravelPlus.
- "Five-in-One" programmable memory storing five different operating profiles.
- 1000 split memory channels plus an additional 10 for programmable scan.
- PC programmable w/PG-5G (optional).
- Built-in CTCSS encoder/Invertible front panel.
- 104-code digital code squelch.
- Choice of two back-light colors (amber/green).
- Voice guidance and storage option with optional VGS-1.
- Weather alert/RX (US only)
- EchoLink® Sysop mode for node terminal operation.
- EchoLink® memory autodialer.
- Wide band receive (118-524MHz and 800-1330 MHz cellular blocked)
- MC-59 16-key hand mic with backlighting.
- Selectable repeater offset.
- Auto repeater offset (VHF only)



RC-D710
TNC with APRS

NEW!

The RC-D710 is a stand alone 1200 / 9600 bps TNC with APRS firmware. With the supplied accessories, the RC-D710 is a full upgrade to the TM-V71A.

Supplied accessories include: Open ended GPS cable, cable with modular plug for panel connection, two bases for control head (mobile and base), line filter, and instruction manual on CD-ROM.

By exchanging the TM-V71A panel with the RC-D710, you will have the full functionality of the TM-D710A.



PG-5J
Interface Kit

Functioning as an external modem, the PG-5J connection kit makes the RC-D710 a complete stand alone APRS /TNC for any of these Kenwood models: TM-D710A, TM-V71A, TM-D700A, TM-G707A, TM-V7A, TM-732A, TM-733A, TM-255A, TM-455A. Includes data and DC cables.



HRO Discount Price \$CALL

TM-D710A
2 m / 70 cm

NEW!

Kenwood continues to provide advanced APRS™ ham radio equipment in the TM-D710A mobile transceiver. For current owners of the TH-D7A handheld with built-in TNC and APRS™ software, the TM-D710A offers even more features and versatility. The control head is detached and comes with remote cable for easy installation. The radio incorporates a 9-pin PC connection for easy hook-up to program frequencies and other APRS™ mapping programs. Your TM-D710A is a full dual-band operation radio so VHF+VHF / VHF+UHF / UHF+UHF operation is possible. Full digipeater functions allow anyone to set up a digipeater location wherever needed to help fill in APRS™ nationwide network. Internet gateway operation is also possible for world-wide text communication over VHF.

- Output 50 W VHF/ UHF.
- Receives 118-1300 MHz (cellular blocked).
- Full dual-band operation.
- Built-in TNC.
- 2 back light colors: amber / green.
- Alphanumeric dot-matrix LCD amber display.
- Easy-to-use menus.
- Internal clock for APRS® time & date stamping.
- APRS Filter function.
- APRS Sort function.
- APRS speed and altitude beaconing.
- APRS QSX function, delay algorithm, voice alert and weather beaconing.
- Three different APRS grids.
- EchoLink® Ready with 10 dedicated memories.
- Dual receive and NOAA weather alert.
- 1000 memories.
- SkyCommand II.
- Sound card interface.
- VGS-1 Voice Guide and Storage optional.
- NMEA 0183 GPS i/O port.
- Free MCP programming software.

Kenwood VHF Accessories

Option	Model	211A 411A	221A 421A	231A3 31A43 1A531 A	241A4 41A54 1A	251A4 51A55 1A	255A4 55A	261A4 61A	711A 811A	751A 851A	2530A2 550A25 70A	4100A	621A 721A	631A 731A	732A	733A	642A 742A	641A 741A	941A	V7A	HRO Price	
Microphone Hand	MC-43S	*	*	*					*	*	*	*	*	*								\$59.95
	MC-57DM			*	*																	\$79.95
	MC-58DM					*	*	std								*	std			std		\$79.95
Desk	MC-60A	*	*	*	*	*	*	*	*	*	*	*	*	*	*	*	*	*	*	*	*	\$139.95
Modular Plug Adapt	MJ-88							*														\$32.95
External Speaker	SP-50B	*	*	*	*			*		*	*	*	*	*	*	*			*	*	*	\$55.95
	VS-2										*	*	*	*	*	*					*	\$69.95
Voice Synthesizer	VS-3																				*	\$39.95
Noise Filter	PG-3B	*	*	*	*			*		*	*	*	*	*	*	*	*	*	*	*	*	\$29.95
Tone	TU-7									*	*	*										\$54.95
	KQT-8			*	*								*	*								\$49.95
	TSU-7														*		*	*	*	*	*	\$59.95
	TSU-8						*	*								*	*	*	*	*	*	\$59.95
Mobile Mount	MB-201		*	*	*			*							*					*	\$25.95	
Power Cable	PG-2N	*	*	*	*	*	*	*	*	*	*	*	*	*	*	*	*	*	*	*	*	\$17.95
Data Cable	PG-5A																				*	\$15.95
Extension Cables	DFK-3C																*				*	\$44.95
	13' DFK-4C																*			*	\$64.95	
	22' DFK-7C																*			*	\$99.95	

KENWOOD

HANDHELDS

Single Band



TH-K2AT
2m
Also
TH-K2ATK2
Drycell Version



This 2-meter handheld is PC programmable.

- Priority scan.
- Large LCD panel & backlit keys.
- 5W RF output.
- Weather alert/RX.
- Automatic Simplex Checker.
- Auto repeater offset.
- Internal vox.
- Multiple scan functions.
- Built-in CTCSS, DCS and 1750 HZ tone burst.
- Meets MIL-STD-810 standards for resistance to rain, vibration, shock and humidity.
- High-gain antenna.
- More receive audio than most other handhelds on the market.

Dual Band

TH-D7A(G)
With APRS Operation



Kenwood's deluxe dual band handheld has Automatic Packet Reporting System™ allowing you to track mobile stations on a map on a computer screen. The TH-D7A (G) includes a 1200 / 9600 built-in TNC and a program that deals with date formats supported by APRS. Its display shows information each time correct APRS data is received; you do not need a computer. Without a GPS receiver, you can manually enter your position. The HT has jacks to connect to your computer and to a GPS receiver.



- 2m / 440 MHz dual-band.
- Backlit keypad.
- Aircraft receive and dual receive on same VHF band for voice and data.
- Call channel and CTCSS.
- 3 scan modes and 200 memories.
- DX packet cluster monitor.
- Wireless remote control.
- 16 digit, 10 DTMF autodial memories.
- VC-H1 messaging control.
- Large (12 digits X 3 lines) dot-matrix LCD.

Handheld Battery Packs / Chargers

Battery	Voltage	Rating MAH	Desk Charger	Radio Series	HRO Price
PB-32	6	600	KSC-14	TH-22AT/ 42AT/79A	\$66.95
PB-33	6	1200	KSC-14	TH-22AT/ 42AT/79A	\$79.95
PB-34	9.6	600	KSC-14	TH-22AT/ 42AT/79A	\$89.95
PB-42L	7.4	1550	-	TH-F6A	\$79.95
PB-43N	7.2	1100	KSC-24	TH-K2AT	\$49.95

Kenwood Handheld Options

Option	Model	K2AT	22AT 42AT	26AT 46AT	27AT 47AT	28A 48A 78A	25AT 45AT 75AT	77A	79A (D)	215AT 315AT 415AT	225A T	235	2600A 3600A	HRO Price
Headset	HMC-3	*	*	*	*		*	*	*	*	*	*		\$59.95
	EMC-3	*										*		\$29.95
	KHS-21	*												\$40.95
Speaker Mike	SMC-32	*	*	*	*	*	*	*	*	*	*	*	*	\$52.95
	SMC-33	*	*	*	*	*	*	*	*	*	*	*	*	\$65.95
	SMC-34	*	*	*	*	*	*	*	*	*	*	*	*	\$39.95
Prog. Tone Decoder	KQT-8						*							\$49.95
	TSU-7			*		std								\$59.95
	TSU-8		*											\$59.95
DC/DC Converter	PG-2W	*	*		*	*						*		\$17.95
Filtered Lighter Cord	PG-3J	*			*			*				*		\$37.95
Base Quick Charge	KSC-14		*						*			*		\$87.95
	KSC-24	*												\$59.95
Programming Cable	PG-4Y	*												\$34.95
Battery Case	BT-9		*						*					\$29.95
Wall Charger	BC-17		*											\$29.95
	BC-21	*												\$22.95

*Cellular frequencies blocked

Tri Band

TH-F6A
2 m / 220 Mhz / 70 cm



\$CALL
HRO Price



The TH-F6A has a dual personality: it's a 3-band transceiver and also a wide-band (0.1-1300 MHz*) receiver. In addition to FM / FMW / FMN / AM and SSB / CW, the receiver has a special weather channel mode.

It can receive 2 frequencies simultaneously, even on the same band.

The rig features 435 memories including 3 call channels and another 20 for programmable scan. The HT comes equipped with a 7.4 volt 1550 mAh lithium-ion battery providing 5 watts output. Ease of operation is achieved with a multi-scroll key that can be rocked up and down (frequency), left and right (band) with the thumb. Has a 16-key pad for direct entry, menu-driven interface, key illumination and backlit LCD display. Includes memory shift, key lock, time-out timer, wireless remote control.

Kenwood Handheld Specifications

Model	Freq Range	Power Supply	Power Out	Current Transmit	Current Receive	Sensitivity	Height in (cm)	Width in (cm)	Depth in (cm)	Weight oz (g)	HRO Discount Price
TH-K2AT	144-148 MHz	6-16 VDC	5 W	1.8 A	30 mA	<.13 µV	4.4 (11.2)	2.3 (5.8)	1.5 (3.5)	11.3 (320)	CALL
TH-F6A	144/220/440MHz	5-7.5VDC	5 W	2.0 A	35 mA	<.13 µV	3.4(8.7)	2.3(5.8)	1.2(3.0)	8.8 (250)	CALL
TH-D7A (G)	2m & 440 MHz	6 VDC	5 W	1.8 A	45 mA	<.18 µV	4.75(11.9)	2.25(5.4)	1.5(3.5)	12.0(340)	CALL

† Higher power output with optional batteries.



HF TRANSCEIVERS

Compact HF + 6m Transceiver with DSP



FT-450 **FT-450AT**
\$CALL **\$CALL**
 HRO Discount Prices

The super compact FT-450 HF transceiver with DSP is just 9" W X 3.3" H X 8.5" D and weighs 7.9 pounds. It transmits on HF bands plus 6 meters. It has an easy-to-read 9-segment LCD display, DSP modulation / demodulation, microphone equalizer with speech processor, VOX operation. Other features include: 2 voice memory channels, TCXO, 500 memory channels, IF shift, clarifier, electronic built-in keyer, FSK-RTTY operation, long wire antenna usage with optional FC-40. The FT-450AT includes a built-in AT450 antenna tuner.

5 Watt Backpack HF Plus

Now with FNB-85 battery
 1400 mah NiMH
 + NC-72B Charger



FT-817ND
\$CALL
 HRO Discount Price



- Product concept: fully self-contained battery-powered low-power amateur transceiver for portable, camping, or mountain use. Includes 60m.
- Transmits on: 160-10 m,* 50 / 144 / 430-450 MHz, plus Alaska Emergency Channel (5167.5 kHz).
- Receives: 100 kHz-56 MHz; 76-154 MHz; 420-470 MHz. (Exact frequency range may be slightly different.)
- Operating modes: USB, LSB, CW, AM, FM, WFM, digital (AFSK), packet (1200 / 9600 FM).
- Power output: 5 watts SSB / CW / FM with 13.8V external DC; 1.5 W AM carrier; 2.5 W SSB / CW / FM with 9.6V Ni-Cd Pack or 8 "AA" batteries (AM: 0.7 W); up to 5 W SSB / CW / FM power (maximum) programmable via menu on Ni-Cd / AA cells.

The Smallest HF + 6m + 2m + 70cm

Optional Remote Head

FT-857D
\$CALL

HRO Discount Price

Now with DSP-2 built-in



The world's smallest HF/ VHF / UHF mobile transceiver provides base station performance from an ultra-compact package. The convenience of remote-head operation (optional YSK-857 separation kit) makes the FT-857 ideal for mobile or portable work.

The power amplifier uses bipolar transistor devices for low noise, low distortion and high reliability. Has an extensive cooling system with a thermostatically-controlled fan and aluminium die cast chassis.

The receiver front-end has a very low noise floor and wide dynamic range. Features a double conversion superheterodyne system (single on WFM) with the second IF at 455 kHz; bandpass filtering, device selection and gain distribution for strong signals. On VHF and UHF, the very low noise MOSFET preamplifier and active DBM mixer aid in working weak signals and rejecting intermodulation.

- Receive coverage 100 kHz to 56 MHz, 76-108 MHz, 420-470 MHz. Includes 60m.
- Transmits 160-6 m, 144-148 MHz, 430-450 MHz and 5167.5 kHz (Alaska emergency frequency on USA version).
- SSB, CW, AM, FM, packet (1200 / 9600 bps) operation.
- Power out: 100 W (160-6 m), 50 W (2 m), 20 W (70 cm).
- DSP bandpass filter, DSP auto-notch filter, DSP noise reduction, mike equalizer.
- VHF / UHF features: versatile tone control selections, automatic repeater shift, Smart Search™, Spectrum Scope and ATS™.
- Easy-to-use "Scrolling Front Panel" keys allow adjustment of several transceiver functions during use.

- DXer features: IF shift, IF noise blanker, intercept point optimization, adjustable AGC, RIT. RF gain control, and VOX.
- CW features: built-in electronic keyer, CW message memory with beacon mode, CW pitch / sidetone control, and CW trainer.
- Easy data mode for operation on 1200 / 9600 bps FM packet, RTTY, SSTV or PSK31. Rear panel 6-pin mini-DIM connector for each connection of these modes.
- Memory system: 200 main memories, 8 character alphanumeric labels. 10 groups with 20 memories each. "Quick Memory" and "Home Channel" for each band.
- Large multi-color display.
- Battery voltage meter, TX meter selection, two antenna connectors, TX / RX status LEDs, versatile scanning features. auto power off, time out timer and CAT system.

Options include:

- **ATAS-120:** Active Tuning Antenna System for mobile, portable or apartment / balcony use. Designed for use on the 7 / 14 / 21 / 18 MHz amateur bands. Can be used fully retracted on the 50 / 144 / 430 MHz bands. **HRO Price \$349.95**
- Collins® Mechanical Filters:
YF-122S 2.3 kHz SSB
YF-122C 500Hz CW
YF-122CN 300Hz CW
HRO Price each \$169.95
- **YSK-857** Separation Kit
HRO Price \$169.95
- **TCXO-9** High Stability Reference Oscillator. **HRO Price \$95.95**

10m / 6m / 2m / 70cm FM

FT-8900R

\$CALL
 HRO Price



The FT-8900 combines "traditional" 2m / 70cm local communications with the exciting capability of Sporadic-E or F2 DX on the 10m and 6m bands, allowing nationwide FM communication.

- Covers 28-29.7 / 50-54 / 108-180 / 320-480 MHz and 700-985 MHz (cellular blocked and non-restorable).
- Independent 2-channel, dual-receive, full duplex.
- High power output with 50 watts on 10m / 6m / 2m and 35 on 70cm.
- Large, easy-to-read LCD display.
- Built-in duplexer.
- More than 800 memory channels. 799 "regular," 6 "home," 5 sets of band edge, and 6 "Hyper."
- Cross-band repeater capability.
- Versatile scanning.
- CTCSS / DCS built-in.
- User-programmable mike keys.
- Remote head mounting with optional YSK-800.



HF TRANSCEIVERS

Base Station All-Mode



All Mode FT-950
\$CALL – HRO Discount Price

NEW! HF + 6m

The FT-950 has been designed especially for the DX enthusiasts and features superb receive performance. There is the optional Yaesu exclusive fully automatic tuning preselector system with the same capability available on the FT-DX9000 / FT-2000. It is connected externally with no internal modifications required. When engaged, the VRF system is bypassed but the fixed bandpass filters are still in the received signal path. The optional External Data Management Unit (DMU-2000) provides many of the display capabilities available on the FT-DX9000 and FT-2000.

- Triple conversion receiver.
- Receive frequency 30 kHz to 56 MHz.
- 5-100 watts out (2-25 watts AM).
- 8 narrow, bandpass filters.
- 1st IF 3 kHz roofing filter.
- High-speed direct digital synthesizer and high-spec digital PLL.
- IF shift / IF width / CONTOUR / notch and DNR.
- CTCSS / DCS encoders / decoders built-DSP enhancement with parametric microphone equalizer and speech processor.
- High stability TXCO.
- Built-in automatic antenna tuner with 100 memories.
- 5 voice message memories with the optional DVS-6 unit.
- Large multi-color vacuum fluorescent display.

Portable All-Mode

HF + 6m + 2m + 70cm
Now with TXCO built-in

All Mode FT-897D
\$CALL – HRO Discount Price



The innovative FT-897 rugged multiband portable transceiver covers the 160-10 meter bands (now includes 60m) plus 6m, 2m and 70cm. All mode operation includes SSB, CW, AM, FM and digital. With the internal batteries (optional) it will produce 20 watts out. With an external 13.8 volt DC supply it will produce 100 watts out.

- 200 memory channels with alphanumeric tags.
 - ATAS-120 / 100 compatible.
 - Digital signal processing built-in.
 - Bolt-on FC-30 automatic antenna tuner optional.
 - IF shift control.
 - IF noise blanker.
 - AGC selector (auto / fast / slow / off).
 - VOX operation.
 - CTCSS / DCS encoders / decoders built-in.
 - Collins® 2.3 kHz SSB mechanical filter and 500 Hz CW filter (optional).
 - Built-in 3 message memory keyer with adjustable pitch control.
 - Automatic repeater shift.
 - Smart Search™.
 - Spectrum scope.
 - Automatic beacon mode.
- Accessories:**
- **FNB-78** internal 4.5 Ah ni-MH battery **\$119.95**
 - **FC-30** antenna tuner **\$249.95**
 - **FP-30** internal power supply **\$219.95**
 - **CD-24** 4-hour charge adapter for FNB-78 **\$119.95**
 - **PA26B** charger for CD-24 **\$85.95**
 - **ATAS-120** active tuning antenna **\$349.95**
 - **MMB-80** mounting bracket **\$35.95**

Rebirth of the renowned FT DX series



FT-DX9000 Contest Shown

Choose from three models
FT-DX9000 – \$CALL

The FT DX 9000 has the electronic DNA from the FT-1000D, but it has advanced far more than just one generation. The only HF/50 MHz transceiver capable of cross-band full duplex operation (for one-box SO2R contest operating), the identical dual receivers feature unmatched real-world, close-in dynamic range, selectable (15/6/3 kHz) roofing filters, and superb filtering thanks to the 32-bit IF DSP. On transmit, the industry's only 3-band parametric microphone equalizer yields superb SSB audio, and the FT DX 9000D's TFT display provides a two-band spectrum scope, world clock with sunrise/sunset illumination, rotator control page for Yaesu G-800 / 1000 / 2800 DXA rotators, an audio scope / oscilloscope page with waterfall display, and much more. Three FT DX 9000 configurations are available:

FT-DX 9000MP – 400 Watts output; external switching power supply with twin speakers and audio filters; LCD display plus four analog meters; flash memory card to store configuration and log data; full dual receive (identical receivers) for SO2R; and main and sub receiver VRF preselectors.

FT-DX 9000D – 200 Watts output; 6.5" TFT display plus two analog meters; flash memory card for configuration and logging data; very-high-Q "µ-Tune" narrow-band preselector modules for 160-20 m (main receiver) plus VRF for both receivers; full dual receive for SO2R; internal switching supply.

FT-DX 9000 Contest – 200 Watts output; LCD display plus four analog meters; single receiver with VRF; internal switching supply; extra key and headphone jacks. Second RX, VRF/µ-Tune modules, and data management unit (to enable external monitor) are optional and may be added.

- HF + 50 MHz.
- Four TX / RX antenna jacks; two RX in / out BNC jacks; one SO239 RX antenna jack.
- PS/2 & USB keyboard connectors.
- Data port for PC connection.
- Direct frequency entry.
- One-touch band change.
- Direct input / output sound card connections.
- One-touch "Narrow" DSP filter selection.
- Class-A with continuous A1AB bias control.
- Rotator interface jack for direction indication and control (TFT-equipped models).
- Order rig from HRO; add options for direct shipment from Yaesu / Vertex Standard headquarters after performance verification at factory.

Secure Ordering from HRO on the Web: <http://www.hamradio.com>

RECEIVERS

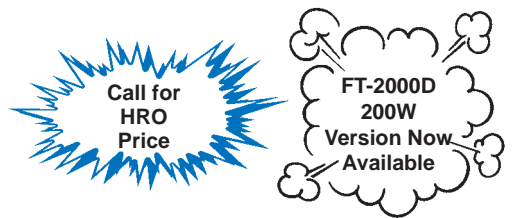

FT-2000
HF / 50 MHz Transceiver

The FT-2000 is the 2nd Generation in the proud lineage of the FTdx9000 Series! Featuring extensive DSP filtering, 100 watts of power output, and a host of outstanding ergonomic and performance features, the FT-2000 is destined to be the centerpiece of your HF / 50 MHz station.

- Provides a full 100 watts of power output (AM: 25 W) on the 160-6 m amateur bands. U.S. version includes a special memory bank containing the five 60-meter channels, continuous receiver coverage from 30 kHz to 60 MHz.
- Receiver front end includes VRF (variable RF tuning) preselector and optional u-tuning for low bands available.
- Variable SSB bandwidth capability. Default bandwidth is 2.4 kHz (300-2400 Hz @ -6 dB). Other selections are 50-3000 Hz, 100-2900 Hz, 200 - 2800 Hz, and 400-2600 Hz.
- First IF roofing filters included.
- Strong receiver design provides wide dynamic range and high intercept point.
- Dual receive in same band.
- Wide array of IF-DSP interference rejection filters.
- External display port for viewing of RF scope, audio scope, and X-Y oscilloscope displays. (Requires data management unit and external display.)
- Five-group, 99 channel memory with 5 channel quick memory bank.
- A host of CW features.
- Unique receiver configuration display.

Yaesu HF Specifications

Model	Frequency Range	Power Supply		Current Drain		Power Output				Mike Z ohms	Receive Circuitry	Sensitivity †	RIT/XIT Range	Audio Output	HRO Price
		AC	DC	Xmit	Rec	AM	FM	SSB	CW						
FTDX9000MP	30KHz-60MHz	117		9 A		100 W	400 W	400 W	400 W	200-10K	Triple	< .2µV	±9.99kHz	2.5W	CALL
FTDX9000D				6.5 A		75 W	400 W	200 W	200 W	200-10K	Triple	< .2µV	±9.99kHz	2.5W	CALL
FTDX9000Contest				6.5 A		75 W	400 W	200 W	200 W	200-10K	Triple	< .2µV	±9.99kHz	2.5W	CALL
FT-897D	100 kHz - 30 MHz 50-54 MHz 144-148 MHz 430-450 MHz	117/234	13.8 VDC	23 A	1 A	20 W (batt)* 100 W+	20 W (batt)* 100 W +50 W@ +50 W@	20 W (batt)* 100 W +50 W@ 20 W%	20 W (batt)* 100 W+	200-10K	Double	< .2µV	±9.99kHz	2.5W	CALL
FT-817ND	100 kHz - 56 MHz 76 - 154 MHz 420 - 470 MHz		13.8 VDC	2A	450mA	1.5 W	5 W	5 W	5 W	200-10K	Double	< .25µV	±9.99kHz	1.0W	CALL
FT-857D	See page 19		13.8 VDC	22 A	1 A	25 W 12.5 W 2m 5w 70cm	100W 50 W 2m 20 W 70cm	100 W 50 W 2m 20 W 70 cm	100W 50 W 2m 20 W 70cm	200-10K	Double	< .2µV	±9.99kHz	2.5W	CALL
FT-450	HF + 6m		13.8 VDC					100 W	100 W	200-10K			±9.99kHz		CALL

† Sensitivity measurements for 1.8-30 MHz SSB,CW *Optional module required @2m %70cm *HF-6M battery +HF-6M AC/13.8VDC

SWL Receivers

VR-5000

\$599.95
HRO Discount Price



This multimode desktop scanning receiver has continuous frequency coverage from 100 kHz to 2.6 GHz (cellular frequencies are blocked and non-restorable). Features direct keypad entry and a wide variety of scanning capabilities. The 2000 memory channels may be separated into as many as 100 memory banks. Banks and channels may have alphanumeric labels. Sort channels by frequency, alphanumeric name or operating mode. Special pre-loaded bank of most popular shortwave broadcast stations. List may be user edited.

Built-in world clock. Dual receive, band scope graphical activity monitor, field strength meter, audio waveform meter, "Smart Search™" memory loading feature. Optional DSP-1 digital signal processor, DVS-4 digital voice recording unit and FVS-1 voice synthesizer.

VR-500

\$CALL
HRO Discount Price



This high performance miniature communications receiver provides general coverage reception from 100 kHz to 1300

MHz on CW, SSB (LSB and USB), AM and FM (wide and narrow).

- Receives 0.1 to 1300 MHz (cellular blocked).
- Dual watch.
- Band scope.
- 8 character alpha numeric display.
- 1000 memory channels, skip memory 100 channels, 10 channel search band, 10 channel dual receive, one priority channel.

Communications Receiver

VR-120D
with 12v input
\$CALL



For professional-grade monitoring in the field, the VR-120 provides wide band coverage from 0.1 to 1299.996 MHz in AM / FW / Wide-FM modes (cellular and other restricted frequencies blocked). The receiver is constructed with a durable, high-impact polycarbonate case and is water resistant to survive the rigors of outdoor use. The VR-120 has low current consumption and can provide up to 20 hours of use on a pair of "AA" batteries.

- Hear worldwide shortwave broadcasts.
- Simple one-touch memories.
- Front-end attenuator.
- Special bank of 12 preset mode memories.
- Wide selection of scanning modes.
- Cloning capability to other VR-120's.
- BNC type antenna connector.

HF Amp & Power Supply



Quadra System

HRO Discount Price \$3999.95

Here's all the linear amplifier you should need for operation on both HF (160 - 15 meters) and 6 meters. It is designed for automatic band switching with the FT-1000D, FT-1000MP, FT-920, FT-990 and the FT-900 HF radios. The amp features 8 MRF150 power MOSFet transistors designed into 4 units of 2 transistors in a push-pull circuit at 48 VDC.

The separate power supply, the VP-1000, allows for easy installation. There are two input voltages, 117 VAC or 220 VAC. Output power is a function of the power supply voltages. At 220 VAC there is 1000 watts out on HF and 500 watts on 6 meters. At 117 VAC the output is 500 watts on HF. The amplifier comes with a built-in high speed antenna tuner with four antenna outputs and two inputs. The multifunction omni-glow LCD display shows the status of the amplifier. There is automatic system monitoring with VSWR protection.

50 MHz Transverter

FTV-1000 for FT-1000MP Mark V



The FTV-1000 uses high performance MOSFET transistors to provide 200 watts at 50 MHz. The unit runs cool with extensive heat sinking and cross-flow cooling fan. It features exclusive Class-A bias capability. When selected, output power is reduced to 50 watts. Class-A operation provides the best signal on 6 meters.

The receive section follows the same design as the FT-1000MP Mark V. It has a low noise pre-amp with two gain selections. For local work, these preamps may be bypassed. **HRO Discount Price: \$CALL SPECIAL**

Power Supplies



FP-1030A \$239.95

FP-1023A (not shown) \$149.95 HRO Prices

Yaesu's two low profile switching powers supplies operate on 110 or 220 VAC. The FP-1023A has 23 amps continuous and 25 intermittent. The FP-1030A is 25 amps and has meters.

Microphones



MD-200 A8X \$379.00 HRO Price

The MD-200A8X is a stylish, high-quality desk microphone designed for base station use with Yaesu's newest generation of transceivers. (It is fully compatible with the FT-1000MPMKV, FT-1000MP, FT-920, FT-900C/ATC, FT-847, and FT-817. CT-69 adapter required for use with the FT-100/100D.)

Features a studio-quality polyethylene terephthalate film dynamic element optimized for SSB operation. The variable side pressure control allows the operator to adjust the frequency response of the mike from totally flat to high-articulation. Provision for incorporating user supplied mike element with a switch to select between the standard and user element.



MD-100 A8X \$125.95 HRO Price

This desk microphone features selectable low-cut filtering and high-emphasis active filtering that allow you to tailor the microphone response for optimum voice clarity or DX punch. It has a large push-to-talk switch and latching button, along with a large rotary up/down, slow/fast control for scanning.

The MD-100a8x is especially designed for the FT-1000MP and the FT-900, but can be used with the following Yaesu HF transceivers: FT-747GX, FT-757GXII, FT-890, FT-840, and FT-1000.

Programming Kits

To Program Handhelds:

- ADMS-1E (\$38.95)** FT-10/ 40/ 11/ 41/ 50/ 51 / VX-1R / VX-5R
- ADMS-1F (\$38.95)** VX-110 / VX-150
- ADMS-1G (\$38.95)** VX-7R
- ADMS-1H (\$38.95)** VX-2R
- ADMS-1J (\$38.95)** FT-60R

To Program Mobiles:

- ADMS-2D (\$39.95)** FT-3000 / 8000 / 8100 / 8500
- ADMS-2E (\$39.95)** FT-90R / 2600M
- ADMS-2F (\$38.95)** FT-1500M
- ADMS-2H (\$48.95)** FT-8900
- ADMS-2I (\$48.95)** FT-8800
- ADMS-2J (\$48.95)** FT-280\$0
- ADMS-2K (\$48.95)** FT-7800

To Program a Receiver:

- ADMS-3 (\$38.95)** VR-500

Internet Linking

HRI-100 Wires-II Interface Box



Give your repeater worldwide coverage with the Wires-II Internet repeater enhancement system

Wires™-II uses DTMF signaling to establish a bridge via the Internet from your repeater or home station to another Wires™-II equipped station anywhere in the world. No proprietary tones are used, so any manufacturer's radio (equipped with a DTMF encoding keypad) may be used to bring up the Internet link.

At the repeater site, a PC is connected to the HRI-100 Wires™-II interface box which serves as a command and audio-patching controller. Use either a dial-up or high-speed line for Internet connection.

Wires™-II may be configured to allow on-the-fly selection for linked or non-linked communications. Wires™-II uses voice recording technology as a buffer and will never interrupt a conversation in progress on a distant repeater.

Wires™-II provides two operating network concepts. Up to 10 repeaters and / or home stations may join to form a "Sister Radio Group" for closed network operation. The Wires™-II server also maintains a worldwide listing of repeaters operating in the "Friends' Radio Group" mode that may be contacted using a 6 digit DTMF string to establish a link.

The Wires™-II kit includes:

- AP01 CD-ROM, power cable, data cable (RS-232 DB-9 plug), data cable (8-pin mini-DIN plug), two audio cables (3.5 mm plug) and the Wires™-II user / server agreement. **HRO Price \$149.95**

Linking system requirements are:

- Wires™-II kit.
- Transceiver or repeater (with standard PKT jack recommended).
- Intel® MMX 200 MHz or faster processor.
- Internet connection (56 kbps modem if dial-up connection is used).
- Microsoft® Windows® 98 SE or later operating system.
- 30 MB of available hard disk space, 64 MB or more of RAM, CD-ROM drive for installation, 640 x 480 color display with 256-bit color support.
- Sound card with 44.1 kHz sampling rate (some sound cards may not work).

MOBILES

2m Mobiles



FT-2800M
2 meters
\$CALL

The FT-2800M, the most ruggedly built 2m amateur transceiver ever, provides 65 watts of power along with Yaesu's bullet-proof receiver front end. Direct keypad frequency entry,

alphanumeric memory system, high power output and unsurpassed ergonomics make the transceiver an operator's dream come true.

- 65 watts output with 4 selectable power output levels (65/25/10/5 watts). Power levels may be stored in memory.
- Extensive memory system provides a total of 221 memory channels including 200 regular memories, 10 pairs of band-limit memories, and an instant recall "Home" channel. Memories store repeater shift, CTCSS / DCS data, power level, scanning status, and alphanumeric labels.
- CTCSS and DCS encode / decode built in.
- Versatile scanning capability includes a choice of scanning / resume options. Scans memories, VFO or a limited VFO sub-band.
- Wide / narrow deviation selection.
- Weather channels with "severe weather" alert.
- Smart Search™ may be used to automatically load a special bank of 31 memories based on activity.
- Wires™-II internet linking access feature. (Optional Wires™-II Kit required.)
- Multi-function LCD display shows memory channels, alphanumeric label.
- HM-48A6J DTMF direct access microphone allows direct keypad frequency entry and other controls.
- RF-level squelch and dual watch.
- Interactive programming menu.
- Supply voltage display.
- Also: time out timer, auto power off, auto repeater shift, 4-level display dimmer.

FT-1802M
2 m + extended receive
\$CALL – HRO Price



The FT-1802M brings you Yaesu's legendary mechanical toughness along with outstanding receiver performance and crisp, clean audio. It has a rugged die-cast chassis that will withstand the roughest conditions. It covers the 2 meter band with extended receiver range of 136-174 MHz. Power output is 50 Watts with four selectable ranges (50 / 25 / 10 / 5 watts).

- Keyboard frequency entry from the microphone.
- Four user-programmable "soft" keys on the microphone.
- Wires™ VoIP internet linking capability.
- Illuminated front panel keys for night time use.
- 221 memory channels with alpha-numeric labeling.
- Eight memory banks for organizing memory channels.
- WX channels with "Severe Weather" alert (USA only).
- Adjustable microphone gain and wide / narrow deviation & RX bandwidth.
- Built-in CTCSS / DCS encoder / decoder.
- Enhanced paging and code squelch system.
- CW trainer to practice Morse code.
- Security password helps prevent unauthorized use..
- Automatic repeater shift.
- Dual watch.
- Advanced track tuning for intermod rejection.
- Multiple scanning modes.

Call Toll-Free for Up-to-Date Quotes

2m / 440 MHz Dual Band



FT-7800R
\$CALL – HRO Price

The FT-7800R is designed for simplicity of operation along with high performance in the receiver section. It is the ideal rig for the active Ham who has a need for simplex, repeater, or FM satellite operation on both bands, but without the complication of cross-band repeat capability.

- NOAA Weather Alert (U.S. Version only).
- More than 1000 memory channels, each capable of storing a 6-character alpha-numeric label.
- WiRES™ internet linking capability.
- YSK-7800 remote mounting kit (option).
- One-touch "Hyper Memory" operation.
- High power output - 50 Watts of power output on 144 MHz and 40 Watts on 430 MHz.

FT-8800R
\$CALL – HRO Price



The FT-8800R provides easy operation, outstanding receiver performance and crossband repeat capability.

- Wide receiver frequency coverage of public safety, commercial, aircraft and government communications.
- Independent two channel operation operates as two radios in one.
- Large LCD display.
- High power output with 50 Watts on 2m; 35 on UHF.
- Over 1000 memory channels with 512 regular memories on each band.
- One-touch band-pattern.
- CTCSS and DCS tone systems.
- User-programmable microphone keys.
- Convenient remote-head mounting capability with the optional YSK-8900 separation kit.

DC Noise Filter

LF-1

\$26.95 – HRO Price

Especially designed for mobile use, consists of a heavy choke coil to suppress alternator DC line noise.

YAESU MOBILES

Dual Band Mobile



FTM-10SR
\$CALL

FTM-10R
\$CALL

The FTM-10R is a New Concept mobile rig. Mount it most anywhere using the separate front panel. Front panel magnets allow installation without screws in many cases.

The FTM-10SR features a thin sleek, aerodynamic enclosure; 13.8 VDC from an external source; RF power output of 10 W on 2m and 7 W on 70cm. Unit is waterproof and can be mounted on motorcycle handlebars. PTT switch on the front panel allows transmission without connecting any microphone. Mobile bracket allows for easy releasing of the radio.

- 50 W on 2 m and 40 W on 70 cm.
- Wide receiving capability and independent AM / FM broadcast receiver.
- Loud audio external speaker (optional MEK-200-M10) and Bluetooth unit for hands-free operation.
- High brightness and ocean blue color LCD display.
- Large aluminum die cast chassis.
- Waterproof front panel.
- Great for the motor sports scene. PA function, intercom function, VOX.
- Line input can be connected to listen to external audio devices.
- Message transfer function..
- Wireless clone feature and WiRES.
- Lap counter, interval timer / alert, clock and date display.

Accessories for FTM-10R and FTM-10SR

Model	Description	HRO Price
MMB-M10	Multi-angle Stand Bracket	\$30.95
MMB-M11	Multi-angle Handle Bar Bracket	\$30.95
CT-M10	Separation cable – 12 ft	\$31.99
MLS-200-M10	External Speaker – waterproof	\$39.99
MEK-M10	Microphone Jack	\$14.95
MH-68A6J	Microphone – 16 key	\$59.95
MH-68B6J	Microphone – 3 key	\$49.95
CT-M11	External after-market headset cable	\$30.95
Bluetooth Kit	Kit with BH-1, BU-1, CAB-1	\$159.95
BH-1	Bluetooth Headset	\$99.95
BU-1	Bluetooth Unit – mounts in radio	\$79.95
CAB-1	Charger Sleeve for BH-1	\$10.95
FEP-4	Earphone for either ear to BH-1	\$19.95
YHA-M10	Mobile Antenna	\$40.95
AMK-1	Antenna Base	\$23.95
COX-2MM	Antenna Cable	\$32.95

Single Band Handhelds

VX-127
8 Keys

\$159.95
HRO Discount Price

VX-177
16 Keys

\$169.95
HRO Discount Price



These compact, high performance FM handhelds provide up to 5 watts RF power and a wealth of convenient features for the 440 MHz amateur band. These units provide high battery capacity (1400 mAh) and outstanding audio output (700 mW).

The display is the same as on the VX-120 / 170 with high visibility and clear information. The 8-key VX-127 provides the ultimate in simple operation, while the 16-key VX-177 provides a full 4-column DTMF pad along with direct frequency entry.

The rigs have enhanced paging and code squelch to page a particular station and only receive calls from that station. You have one-touch access to the Yaesu Wires™-II VOIP internet linking system.

Receiver frequency coverage is 420-470 MHz and it has 1000 memory channels, CTCSS / DCS encode / decode. Units are rugged, submersible to IPX7 specifications.

VX-170
16 Keys

VX-120
8 Keys

\$CALL
HRO Discount Price



- TX: 144-148 MHz; RX: 137-174 MHz.
- 5 watts with power levels hi/ med/ low.
- Cloning.
- Dual watch.
- ARTS.
- IPX7 submersible 30 min. @ 3 ft.
- 200 memory channels.
- CTCSS / DCS included.
- Direct keypad entry (VX-170).
- Smart Search™ memories.



VX-150
16 Keys

VX-110
8 Keys



- CTCSS/DCS.
- TX: 144-148 MHz; RX: 140-174 MHz.
- 5 watts with power levels hi/ med/ low.
- Direct keypad entry.
- 209 memory channels.
- 7 character alphanumeric display.
- Optional ADMS-1F.
- Smart Search™ auto memory loading.
- ARTS system.

Charger Adapters

NC-50 Charger Adapters

Yaesu's NC-50 quick charger supports most Yaesu hand-held batteries. An appropriate adapter is required. Adapters and batteries supported are shown in the table.

Model	Batteries Supported	HRO Price
CA-7	FNB-12 / 14 / 17	\$22.95
CA-8	FNB-25 / 26 / 27	\$27.95
CA-10	FNB-31 / 33 / 38	\$14.95
CA-14	FNB-40 / 41 / 42	\$25.95
CD-26	FNB-83	CALL
VAC-370	FNB-83	CALL

HANDHELDS

Dual Band



VX-3R 2 m / 70 cm
\$CALL – HRO Discount Price

The world's smallest dual-band HT has up to 1.5 W of output power. (up to 3 watts w/external DC power supply - optional) It's your gateway to VHF, UHF, shortwave broadcast, marine and aircraft bands or WIRES-II™ Internet linking.

- Covers 500 kHz to 999 MHz (cellular blocked).
- 1286 memories.
- AF dual monitor function.
- 3 watts out on 2m (2 on rugged aluminum die-cast chassis).
- Exchange text messages with another VX-3R or FTM-10R.
- Mechanical dial lock.
- Auto Range Transponder System (ARTS).
- Frequency Counter operation.
- Emergency Automatic ID function..
- Optional "AA" battery case..
- CW learning and training feature.

FT-60R
2 m / 70 cm

Extensive Receive Frequency Coverage

Emergency Automatic ID for Search & Rescue

Receives 108-520 MHz and 700-999 MHz (cellular blocked) for monitoring amateur, public safety, business, marine, aircraft, government communications.

- Tough die-cast, water resistant construction.
- 1000 memories w/alphanumeric labels.
- 10 memory banks.
- 5 Watt output.
- CTCSS and DCS (encode/decode) with split tone; DCS encode only capable.
- One-touch to NOAA.
- Nine DTMF auto-dial memories.
- WIRES™ Internet linking.
- Huge LCD display.

- ARTS™.
- Tough die-cast, water resistant construction.
- Two front panel programmable keys.
- Automatic repeater shift.



Call Toll-Free for Up-to-Date Prices

Tri-Band

VX-6R
2m / 220 Mhz / 70 cm
\$CALL

HRO Discount Price

The VX-6R is an easy-to-use little brother to the VX-7R, and is both submersible (JIS7: 30 minutes of submersion at depth of 3 feet) and rugged.

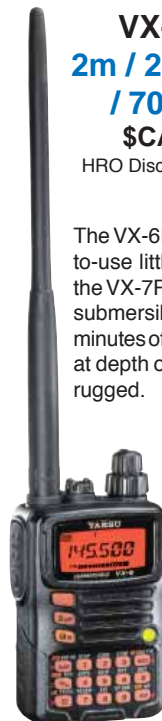

- Covers 504 kHz to 998.99 MHz (with cellular blocked).
- 5 Watts of power 144 and 440 MHz bands (1.5 W on 222 MHz).

- FNB-80LI 1400 mAh lithium-ion battery pack standard.
- Emergency automatic ID (EAI) system.
- Enhanced paging and code squelch (EPCS).
- Wake-up battery saver .
- Security password.
- 900 memory channels with alpha-numeric labels.
- One-touch memory access.
- CW trainer.
- Compact package measuring just 2.3" x 3.5" x 1.1" WHD.
- Oversized volume and squelch knobs.

Quad-Band

VX-7R
2 m / 220 MHz / 70 cm / 6m

VX-7RB

(Black color same specs)

\$CALL

HRO Discount Price

The world's first submersible handheld has true dual receive. Output is 5 Watts on 6m / 144 / 440 MHz; 300 mW on 220 MHz.



- Covers 500 kHz to 999 MHz, cellular blocked.
- Over 900 memories.
- Dual receive V-V, U-U, V-U.
- WIRES compatible.
- CTCSS/DCS encoders/decoders built-in.
- 256 color status indicator strobe LCD.
- Submersible (3 feet for 30 minutes).
- ARTS capable.
- "Split-tone" capability including DCS encode-only.
- 7.4 volt 1300 mAh lithium ion battery.
- "Quick-draw" swivel-mount belt clip.
- 24 hour clock.
- Spectrum scope display.

Yaesu Handhelds

Model	Frequency	Mode	Pwr Supply	Power Out	Current Transmit	Drain Receive	Sensitivity	Height in (cm)	Width in (cm)	Depth in (cm)	Weight oz (g)	HRO Price
FT-60R	2m/70 cm	FM	7.2 VDC	5 W	1.5 A	125 mA	.16 µV / 12dB	4.3 (10.9)	2.3 (5.8)	1.2 (3.0)	13.5(370)	CALL
VX-3R	.5-999MHz@	FM	3.7 VDC	1.5W††	1.3 A	120 mA	.16 µV / 12dB	3.2 (8.1)	1.9 (4.7)	0.9 (2.3)	4.6(130)	CALL
VX-6R	504- 999 MHz@	FM		5 W ***				3.4 (8.7)	2.3 (5.8)	1.1 (2.8)		CALL
VX-7R	50/144/440MHz	FM/AM	7.4 VDC	5 W †	1.6/1.7/1.4 A	150mA	.16 µV / 12dB	3.4 (8.7)	2.3 (5.8)	1.1 (2.8)	8.9(255)	CALL
VX-110	144-148 MHz#	FM	7.2 VDC	5 W	1.3 A	130mA	.16 µV / 12dB	4.2 (10.8)	2.3 (5.8)	1.1 (2.65)	11.5 (325)	CALL
VX-120/170	144-148 MHz#	FM	7.2 VDC	5 W	1.5 A	125mA	.16 µV / 12dB	4.7 (12.0)	2.4 (6.0)	1.3 (3.2)	13.5 (390)	CALL
VX-127/177	70cm#	FM	7.2 VDC	5 W				4.2 (10.8)	2.3 (5.8)	1.1 (2.65)	11.5 (325)	CALL
VX-150	144-148 MHz#	FM	7.2 VDC	5 W	1.3 A	130mA	.16 µV / 12dB	4.2 (10.8)	2.3 (5.8)	1.1 (2.65)	11.5 (325)	CALL

*Power output can be increased depending on the battery pack selected. #Extended Rx range @Cell phone blocked. **2 and 6m 4.5 W UHF. †300 mW on 22- MHz. ††1.5 W 2m/1 W UHF. *** 1.5 W on 220 MHz

Prices in this print catalog are subject to change



YAESU

HT ACCESSORIES

Accessory	Model	10R 40R 50 R	60R	11 41	51R	23R 33R 73R	411 811 911	470	530	VX-1R	VX-2R	VX-3R	VX-5R	VX-7R	VXF-1 VXF-10 VX-150	VX- 120/170 VX- 127/177	HRO Discount Price
Headset/Boom Mike	YH-2					*	*	*	*								\$30.95
Micphone Aadapter	CT-44		*														\$14.95
VOX Headset	VC-25		*							*			*		*		\$84.00
Speaker/Mike	MH-32			*		*	*	*	*								\$30.95
Speaker/Mike	MH-34B4B	*	*														\$38.50
Speaker/Mike	MH-30C2B			*		*	*					*					\$45.95
Speaker/mike w/ear jack	MH-35A2B			*													\$35.95
Speaker/Mike	MH-57A4B													*		*	\$30.95
Speaker/Mike waterproof	CMP-460A													*		*	\$69.95
Ear Piece Mike	MH-37A4B		*										*				\$40.00
Ear Piece Mike	MH37B2B	*		*	*	*	*	*	*	*					*		\$30.95
Ear Piece Mike	VC-27													*		*	\$30.95
Ear Phone	FEP-10	*								*							\$9.95
Microphone adapter	CT-91													*		*	\$10.95
DC/DC adapter	PA-6					*	*	*									\$30.95
DC/DC cigar adapter	EDC-5B	*	*						*				*	*		*	\$26.95
DC/DC adapter	EDC-6	*	*										*	*		*	\$7.95
DC Adpt w/Trickle Charger	EDC-12			*													\$38.95
DC/DC adapter	EDC-15									*					*		\$38.95
Wall Charger 117 VAC	NC-28B					*	std	std	std								\$14.95
Wall Charger 110 VAC	NC-34B																\$14.95
Wall Charger 117 VAC	NC-60B	*															\$16.95
Wall Charger 117 VAC	NC-66B									*					*		\$18.95
Wall Charger 117 VAC	NC-72B												*				\$18.95
Wall Charger 117 VAC	NC-88B		*														\$24.00
Wall Charger 220 VAC	NC-18C					*	*	*	*								\$15.95
Wall Charger 220 VAC	NC-28C					*	*	*	*								\$26.95
Wall Charger 220 VAC	NC-34C					*	*	*	*								\$29.95
Rapid Charger	CD-15												*				\$29.95
Rapid Charger	CD-15A													*			\$29.95
Desk Top Rapid Charger	VAC-370		*													*	\$79.95
Desk Top Rapid Charger	VAC-400B														VX150/110		\$69.95
Battery 600 mAh 12V	FNB-12S					*	*	*									\$71.95
Battery 600 mAh 7.2 V	FNB-17					std	std	std									\$52.95
Battery 600 mAh 12 V	FNB-27							*									\$62.95
Battery 600 mAh 9.6 V	FNB-38			*	*												\$75.95
Battery 600 mAh 9.6 V	FNB-41	*															\$58.95
Battery 1100 mAh 9.6 V	FNB-42	*															\$62.95
Battery 600 mAh 6.0 V	FNB-49	*															\$19.95
Battery 1100 mAh 7.2 V	FNB-V47	*															\$55.95
Battery	FNB-58LI												*				\$69.95
Battery 1400 mAh	FNB-80LI													*			\$83.95
Battery 1000 mAh	FNB-82LI									*							\$38.95
Battery 1300 mAh 7.4 V	FNB-83		*														\$65.95
Battery	FNB-53														*		\$19.95
Battery case AA batteries	FBA-17					*	*	*									\$25.95
Battery case AA batteries	FBA-20									*							\$22.95
Battery case AA batteries	FBA-23												*	*			\$25.95
Battery case AA batteries	FBA-25		*													*	\$20.95
Battery case AA batteries	FBA-37											*					\$20.95
Cloning Cable	CT-27	*	*														\$14.00
Cloning Cable	CT-35			*													\$9.95
Mike Adapter	CT-44									*							\$12.95
Ant Adapt BNC - Rev SMA	CN-2	*											*				\$8.95
Ant Adapt SMA - BNC	CN-3	*	*							*						*	\$11.00
Belt Clip	Clip 10	*											*				\$7.95
Radio case	CSC-V10	*															\$35.95
Radio Case FNB-26/27	CSC-52																\$19.95
Radio case FNB-41/FBA-15	CSC-68	*															\$16.95
Radio case FNB-40	CSC-69	*															\$16.95
Radio Case	CSC-73	*											*				\$19.95
Radio Case (soft)	CSC-88													*			\$15.95
Radio Case (soft)	CSC-92											*					\$15.95
Leather Case	LCC-150/TT														VX150/110		\$23.95
Leather Case w Swivel	LCC-150S/TT														VX150/110		\$31.95
BNC-SMA Adapter	CN-3													*		*	\$8.95
Barometric pressure sensor	SU-1												*	*			\$39.95

EQUIPMENT MOUNTS



UltiMount

The UltiMount installs in seconds and can be swiveled, rotated and adjusted to virtually any position. Secured with a flexible pad that has 3M automotive adhesive on the back, the UltiMount can be removed without leaving any residue.

Included with the UltiMount: a belt clip, a Nokia style button, two adhesive backed buttons, and a specially formulated surface prep kit used to remove dirt and silicon emulsions from your dash to ensure maximum adhesion. **HRO Price \$24.95**

WindowMate Mount

The WindowMate is a premium suction mount for windshield or glass applications and features an integrated swivel with an AMPS hole pattern. It can be adjusted 30-degrees in any direction and requires no locking or tightening mechanisms.



A six-inch flexible arm attaches the swivel to a strong suction cup base that holds tight by simply pushing down the locking lever. Includes mounting hardware. **HRO Price \$14.95.**

WindowMate Express Mount

The WindowMate Express is a version of the original WindowMate and features an Express Mount attached to the integrated swivel. This mount is perfect for any electronic device using a button, leather case or OEM clip.



Turn the mounting platform upside down to reveal a slot big enough to accommodate a belt clip. Includes a belt clip, two buttons and mounting hardware. **HRO Price \$19.95.**



Portable Solution

Secure a button to the back of your electronic device with reliable 3M adhesive. Attach the Portable Solution to your vehicle's dash and the system is complete. The Portable Solution even works on phones in leather cases or with built-in clips.

Included with the Portable Solution is a belt clip, a Nokia style button and two adhesive backed buttons. Also included is a specially formulated surface prep kit used to remove dirt and silicon emulsions from your dash to ensure maximum adhesion. **HRO Price \$12.95**



LoBoy Mount

A universal, low profile mount for securing hands free cradles, XM and Sirius satellite radios, TFT displays and more. The LoBoy features an integrated swivel which allows easy adjustment in any direction, holding securely without locking or tightening levers. The flexible mounting pad with its 3M adhesive back makes installations fast, simple and strong.

Just added to the LoBoy Mount at no additional cost is an L-Bracket. This bracket can be used to mount a device on a horizontal surface like the top of a dash panel or to hold devices in a vertical manner, for example, on the side of a dash console. **HRO Price \$19.95.**

The BUG Mount

shown with optional radio



The BUG is a mount for securing small, narrow profile radio control heads for Satellite radios, (both XM and Sirius); VHF radios, HAM radios and more.

The BUG features a pivoting action for the two arms which rotate on a solid shaft. This allows for simple alignment of the arms



to match varying hole patterns for mounting different control heads. Double face adhesive pads are included to secure items without mounting holes. **HRO Price \$19.95**

GPS / Radio / Phone Mounts

Portagrip

Portagrip's collection of holders for cellular phones, GPS units and radios that will make your mobile operations easier and safer. Standard foot size: 2.5 x 2.5 inches. For tight quarters, use the small foot: 2 x 1.625 inches.



Portagrip Holders: Holds most phones from 1.6" to 2.6" wide. Includes models **701**, 706 Portagrip / Slim-line with set screw adjustment, 707 Porta-grip / Slimline with knob adjustment.

Portagrip 2000: Holders adjustable both in width and length. Includes models **702** for narrow phones, 703 for phones up to 2.25" and 704 for flip-style phones.



Standard Mounts: Split ball base with 90 degree tilt movement. Includes models 320 std mount w/6" rise, **322** deluxe mount w/6" rise, 328 mount base only accommodates 5/8" diameter post tilts 0 to 90 degrees, 329 base only accommodates 5/8" diameter post and tilts to 45 degrees over center.



Stay-put Flex Mount: Includes model **782**.

Uniflex Mount: Includes model **797** with knob adjustment under mounting plate.



Mini Mount: Perfect for tight installations, height only 4". Includes models **726-04** set screw adjustment at head and 727-04 knob adjustment at head.



PR-781



This is a truly remarkable dynamic microphone! From the Amateur Radio division of Heil Sound, Ltd., comes the PR 781, a professional-quality dynamic cardioid microphone that is specifically designed for use with most elite-class transceivers

from Kenwood, Yaesu, Ten Tec and Icom. Heil engineers were requested by Icom to develop a very special microphone package for their new IC-7800 radio. They didn't want just a microphone; they wanted a SUPER microphone for a super radio, and the Heil PR 780 was born. The PR 781 is an improvement on the popular PR 780; it's a beautiful performer into just about any microphone input, such as TS 870, 950, Pro 1, 2, 3, 7800, Yaesu Mk 5, MP, 2000, and 9000. Using one of the dynamic elements from the Heil broadcast division, the PR 781 offers a wide frequency response, while keeping that traditional Heil Sound articulation of the speech pattern. Its clarity and fullness are without peer in the Amateur Radio world. The PR 781 comes with the SM-3 mount. **HRO Price \$ 179.95**

GM / GMV Series

The "Gold Standard" GM Series has become the most-widely-used dynamic microphone for Amateur Radio. Available in the GM 5 configuration (with the full-range HC-5 element), the GM 4 version (with the HC-4 "DX Dream Machine" element), or the high-impedance GM "Vintage"(GM-V) version, the GM Series also includes the Heil Sound's "broadcast" wide-frequency element, for superb fidelity.

- GM-4 with HC-4 \$129.95**
- GM-5 with HC-5 \$129.95**



HM-10 Series

Without a doubt the HM-10 Dual is a dual element communications microphone specifically designed for clean, articulate audio from your amateur radio rig. The HM-10 Dual contains both the HC-5 and the HC-4 "DX Dream Machine" elements.

Model	Description	HRO Price
HM-10 Dual	Microphone with HC-4 & HC-5 elements	\$119.95



The Classic

Today's Studio Sound in the Classic Look of the 1930's

The Classic is an exact copy of a 1930-vintage broadcast microphone, but designed to be used with Amateur Radio transceivers. It includes two microphone elements: the "professional" line wide-frequency-range broadcast element, along with the HC-5 full range communications element, the HC-4 "DX Dream Machine" element, or the "iC" full-range element designed for Icom transceivers. The Classic comes with the CB-1 base, and it also includes a Low/High Impedance switch.

- HRO Prices: Classic 5 (HC-5) \$239.95**
- Classic 4 (HC4) \$239.95**
- Classic- IC (pre-Pro Icom) \$239.95**



Commemorative Classic

The Commemorative Classic is a limited-edition version of the Classic microphone, bearing a serial number and signed by live sound pioneer Bob Heil, which commemorates the opening of the Heil Sound technology display in the Rock and Roll Hall of Fame (located in Cleveland, Ohio). Proceeds from the sale of this product are being returned to the museum for furthering the preservation of historical musical items. **HRO Price \$319.95**

For Icom Radios

iCM Salvation for Icom Users!

The iCM microphone answers the need for a high-quality microphone for the early Icom transceivers, featuring a high-quality, high-gain condenser element that provides full-bodied audio with plenty of drive to match up with the low-gain audio systems of the earlier Icom rigs. It also works great with the higher-gain "Pro" radios and IC-7800 from the current Icom line. **HRO Price \$95.95**



Handheld



Handi-Mics

The Handi Mic is an ultra-compact hand microphone utilizing a special open sorbothane shock mount, yielding superior audio compared to the standard microphones offered by the radio manufacturers. The Handi Mic is available with the HC-5 full-range element, the HC-4 "DX Dream Machine" element, or the "iC" element designed for Icom rigs; a special "Pro" version is also available, with a wide-frequency "broadcast" element that sounds great on



Dash hanger

FM mobile rigs. **HRO Price \$84.95 each**

Model	Element	PTT
HM-4	HC4DX Dream Machine	Yes
HM-5	HC5 full range	Yes
HM-iC	Electret for most Icom	Yes
HM-PRO	Wide range broadcast	Yes
HM-PRO+	Used on live sound stage & as an interview microphone	No*

* 3 pin connector

Switches

HS-2

PTT Hand Switch



Heil's high quality hand switch made for P.T.T. operation is shaped to fit your hand naturally and comfortably. Comes with a 6 foot cable that plugs into the AD-1 or CC-1 adapter. **HRO Price \$29.95**

FS-2 Dual Footswitch



The FS-2 is a unique dual-action footswitch ideal for the modern Ham station. The FS-2 provides two sequenced micro-switches, one each for connection to your transmitter and your linear amplifier; when you press down on the footswitch, the amplifier's switch is engaged first, followed immediately by the switch for the radio, and when you let up the reverse sequencing takes place. This provides safe T/R switching for both radio and amplifier without need for a control cable between the two units. **HRO Price \$38.95**

MICROPHONES



Classic PRO

shown with optional boom PL-2T

The Classic PRO is an exact reproduction of the 1930 RCA 74B broadcast microphone - complete with your call letters. Using the high quality Heil Pro series dynamic element, the Classic PRO is used in many top commercial FM radio stations. 600 ohms, balanced output, 8' cable terminated into a 3 pin XLR. Comes mounted on the CB-1 base which can be removed and mounted on our PL2T as shown. **HRO Price \$245.95**



Heritage™

The Heritage is a high-performance dynamic microphone, yielding a remarkably natural, clear sound. Its special "Show-chrome" chrome finish is plated over a copper-clad molded steel body, and the Heritage is specially designed to produce a high directional cardioid pattern. The Heritage is fitted with a standard 3-pin XLR connector, and adapter cables for most all amateur base rigs are available as options. **HRO Price \$135.95**

The Fin™

The Fin utilizes the PR-20 element so popular in the professional audio realm. It is housed in a gorgeous high-gloss chrome-finish enclosure reminiscent of the Heritage microphone. If phantom power (not compatible with Icom transceivers) is provided to The Fin, the blue wind screen becomes illuminated by 4 imbedded LEDs. **HRO Price \$196.95**



Heil PR40

The PR 40 was designed for commercial broadcast, live sound and recording. It features the Heil Dynamic element with a perfectly flat response from 28 Hz all the way up to 18kHz and has gorgeous articulation. The PR 40 is shipped with the SM-3 5/8" -27 mount and a lined metal carrying case. All the PR Series microphones require additional cables to interface with your transceiver. **HRO Price \$325.95**

Heil PR30

The PR 30 was designed for commercial broadcast, live sound and recording. It has comparable sound to the finest condenser microphones because of its wide frequency response, excellent transient response and low IMD. The PR 30 comes standard with the SM-3 5/8" -27 mount. All the PR Series microphones require additional cables to interface with your transceiver. **HRO Price \$249.95**



Heil PR20

The PR 20 was designed for commercial broadcast, live sound and recording. It has a smooth, flat response over a wide frequency range and it uses the Heil Pro Series microphone element for excellent transient response, low IMD and reduced proximity effect. The PR 20 comes standard with 3 mesh screens (black, gold and silver). All the PR Series microphones require additional cables to interface with your transceiver. **HRO Price \$149.95**

Spotlight Series

The Spotlight Series professional quality, dynamic, cardioid microphones are ideal for broadcast recording and live sound. They employ a smooth, flat response over a wide frequency range and have excellent transient response. They are finished with gorgeous pearlized enamel in red, white or pink. Like the microphones in the PR Series, the Spotlight Series requires additional cables to interface with your transceiver.

HRO Prices: Pink Pearl 20 \$179.95
Red Pearl 20 \$179.95
White Pearl 20 \$179.95

Pro Connector Cables

This 8 ft long cable is used to connect the Classic Pro, Pro, and Heritage microphones to your 8-pin Kenwood, Yaesu, or Icom transceiver. Made with Heilwire to help reduce RFI and noise. Pig tail easily connects to HS-1 or FS-2.

CC-1 XLR Y (Yaesu cable) \$35.95
CC-1 XLR I (Icom cable) \$35.95
CC-1XLR K (Kenwood cable) \$35.95

Mounts



PL-2T Studio Boom

The PL-2T "Topless" boom is a unique cantilevered mount that gives your station a professional-looking solution for mounting your base station microphone. It features a unique channel with a removable cover that lets you tuck the microphone cable away for a clean, clutter-free installation. The PL-2T accepts all Heil Sound industry-standard 5/8-27 microphone mounting clips. **HRO Price \$99.95**

WM-1

Vertical Surface Mount

The WM-1 is a unique mount for the Heil booms that allows them to be mounted on a vertical surface. The brass insert of the WM-1 insures smooth, perfect fit. **HRO Price \$25.95**

SB-2 Small Boom



Extends from 10 to 24 inches with angle adjustments for positioning. Standard 5/8 X 27 thread. Includes Teflon stem adapter to mount into all of the Heil PL2T mounts. Comes with the C clamp. **HRO Price \$42.95**
SB-2B black deluxe mount \$89
SB-2C chrome deluxe mount \$89

RS-1 Riser

12" Riser allows you to mount the PL2T behind the transceiver or console and lift the base 12" from the table. Works with SB-2 or PL-2T. **HRO Price \$25.95**

FL-2

Flange Mount

With brass insert. Fits the PL-2T & SB-2. **HRO Price \$25.00**



SM-1

Shock Mount

The ultimate mount for Pro, HM-10 or iCM can be used on all booms or stands. 8 point flexible suspension supports and isolates the Heil microphone from mechanical vibrations. 5/8" X 27 standard threads will mount onto microphone stand and boom arms. (Shown with the GM-5 microphone, not included.) **HRO Price \$72.95**

CB-1 / CB-1 PTT Classic Base

Beautiful reproduction of a 1930 RCA microphone base. Heavy three pound cast steel with stainless trim. 3" chrome mount accepts 5/8" X 27 hardware. **HRO Price \$58.95**
CB-1 PTT w/ PTT switch \$69.95



DT-1

Desktop Flush Mount

Allows PL-2T and SB-2 to slip into 1-1/2" hole drilled into desktop. **HRO Price \$31.95**



Proset

The award-winning Pro Set is the choice of top DX and contest operators worldwide. Offering a comfortable dual-earmuff design with 40 dB of outside noise rejection, The Pro Set is available with the HC-5 full-range element, the HC-4 "DX Dream Machine" element, or the "iC" element designed for Icom rigs. The Pro Set iC includes an AD-1-iC (8 pin foster) cable. **HRO Price \$129.95**



**Proset Plus
Dual Element
Headset**

The Pro Set Plus is the ultimate boomset for DX and contest operators. Featuring oversized earmuffs with acoustically-tuned chambers for the speakers, and dual microphone elements, the Pro Set Plus is fully adjustable for maximum operator comfort. The Pro Set Plus is equipped with the HC-5 full-range element and the HC-4 "DX Dream Machine" element, while the Pro set Plus iC includes the HC-4 plus the full-range "iC" element designed for Icom rigs. The Pro Set Plus iC includes an AD-1-iC (8 pin foster) cable. **HRO Price \$189.95**



BAG -1 Leatherette travel bag for Pro Set and Pro-Plus. **HRO Price \$25**
BAG -2 Leatherette travel bag for Quiet Phone, Traveler, & BM Series. **HRO Price \$20**

**BM-10
Headset / Microphone**

Heil has taken a fresh look at the headset The BM-10 is an ultra-lightweight, double-sided boomset that's ideal for portable use, or for maximum comfort during long hours of public-service operation. The BM-10 is available with the HC-5 full-range element, the HC-4 "DX Dream Machine" element, or the "iC" element designed for Icom rigs. The BM 10-iC includes an AD-1-iC (8 pin foster) cable.
BM-10-5 Full range articulation (needs AD-1). **HRO Price \$110.95**
BM-10-ic For Icom only. **HRO Price \$129.95**
BM-10-4 w / HC-4 element. **HRO Price \$110.95**



HEADSETS

Noise Canceling

**Active Noise Canceling
Headset
HRO Price \$99**

The Heil Sound Quiet Phones are the result of many years of research and development, utilizing Heil Sound's Active Noise Cancellation System that provides significant reduction on low-frequency background noise, especially while flying. Now you can actually hear the audio accompanying that movie you're trying to watch on your flight!



**Quiet
Phone**

Traveler

Lightweight headsets for ALL occasions

**HTSS
Single sided Traveler
HRO Price \$75.95**

The Traveler Single Side headset is a unique headset/boom microphone system, featuring Heil Sound's carefully-designed electret condenser microphone. A unique interface cable system utilizes various patch cables to allow interfacing to over 100 different radio models, including hand-helds, along with personal computers, cell phones, etc. All adapter cables are sold separately.



**HTDS
Dual sided Traveler
HRO Price \$95.95**

The Traveler Dual Side headset is a unique headset/boom microphone system, featuring Heil Sound's carefully-designed electret condenser microphone. A unique interface cable system utilizes various patch cables to allow interfacing to over 100 different radio models, including hand-helds, along with personal computers, cell phones, etc. All adapter cables are sold separately.



Adapters and Cables

Interface Adapters:

Yaesu YM	HTAYM
Icom 706	HTA706
Icom 8 pin	HTA18
Kenwood 8 pin	HTAK8
Kenwood Modular	HTAKM
PC Soundcard	HTAPC

HRO Price \$23.95

Cables for handi talkies*:

Yaesu VX except VX7	HTA-VX
Kenwood handhelds	HTA-KHT
Icom handhelds	HTA-iHT

HRO Price \$23.95

*PTT works with handhelds, but UP and DOWN do not.

MICROPHONES & HEADSETS

PRYME[®] Radio Products

Premier Communications has a Pryme product to meet any portable communication need. They offer small speaker microphones (the SPM-100 series) and full sized microphones (the SPM-900s). Users on the go will appreciate ultra comfortable lapel microphones (SPM-200 and 200E) and the patented over-the-ear boom microphones (SPM-400). For high-noise environments, use a noise resistant throat mic (SPM-500). Users that need "low profile" communications should check out the flesh-colored "palm mic" (SPM-700) which can easily be concealed.

**PMC-200
Desk
Microphone**



This advanced microphone uses a highly sensitive ceramic condenser element and an amp with three compression levels. A graphic equalizer helps you customize your audio. Adjustments are easy with the built-in analog meter. It has an on-air indicator, frequency up/down controls, and locking and momentary PTT.

24 Hour FAX Order Numbers

Anaheim	714-533-9485
Atlanta	770-263-9548
Denver	303-745-7394
New Castle	302-322-8808
Oakland	510-534-0729
Phoenix	602-395-1244
Portland	503-684-0469
Salem	603-898-1041
San Diego	858-560-1705
Sunnyvale	408-736-9499
Burbank	818-842-5283
Woodbridge	703-494-3679



SPM-200EB



SPM-400A



SPM-100



SPM-800



EH-100



EH-1000

Model	Description	HRO Price
SPM-100	Speaker / microphone for ADI, Icom, Standard, Yaesu	\$22.95
SPM-101	Speaker / microphone for Kenwood	\$29.95
SPM-102	Speaker microphone for FT-50R / VX-1	\$27.95
SPM-103	Speaker microphone for Motorola Radius Line	\$33.95
SPM-300EB	Lapel mic with ear hook for ADI, Icom, Yaesu, Alinco	\$29.95
SPM-301EB	Lapel microphone and ear hook for Kenwood	\$29.95
SPM-302EB	Lapel microphone with ear hook for FT-50R / VX-1	\$29.95
SPM-303EB	Lapel microphone with ear hook for Motorola Radius Line	\$29.95
SPM-400A	Earpiece/mini boom mic for ADI, Icom, Standard, Yaesu	\$34.95
SPM-401A	Earpiece with mini boom microphone for Kenwood	\$30.95
SPM-402A	Earpiece with mini boom mic w/ PPT cord FT-50R / VX-1	\$29.95
SPM-403A	Earpiece with mini boom mic w/ PPT cord Motorola Radius	\$29.95
SPM-800B	In-helmet speaker mini boom for ADI, Icom, Stanadard, Yaesu	\$68.00
SPM-801B	In-helmet speaker mini boom for Kenwood	\$59.95
SPM-802B	In-helmet speaker mini boom for FT-50R/VX-1	\$59.95
SPM-803B	In-helmet speaker / mini boom for Motorola Radius Line	\$68.00
SPM-800F	In-helmet speaker / mic for ADI, Icom, Stanadard, Yaesu	\$68.95
SPM-801F	In-helmet speaker / mic for Kenwood	\$68.95
SPM-802F	In-helmet speaker / mic for FT-50R/VX-1	\$59.95
SPM-803F	In-helmet speaker / mic for Motorola Radius Line	\$68.95
EH-169S	Earphone for speaker/mic 10" cord, 2.5mm	\$20.95
EH-189S	Earphone for speaker/mic 10" cord, 3.5mm	\$20.95
EH-169X	Earphone for Handheld radios, 22" cord, 2.5mm	\$20.95
EH-189X	Earphone for Handheld radios, 22" cord, 3.5mm	\$20.95
EH-1069S	Earphone for speaker/mic 15" cord, 2.5mm	\$32.95
EH-1089S	Earphone for speaker/mic 15" cord, 3.5mm	\$32.95
EH-1069X	Earphone for Handheld radios, 30" cord, 2.5mm	\$32.95
EH-1089X	Earphone for Most Handheld radios, 30" cord, 3.5mm	\$32.95

VIBROPLEX®

Quality and Pride Throughout

"Vibrokeyer"

The Vibrokeyer is designed for those who prefer a non-iambic paddle. The single lever paddle imitates the automatic dots and dashes of the electronic keyer with the same motion used to operate the "Bug".

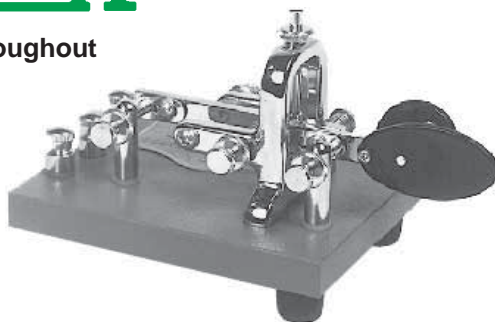

Vibrokeyer Gold: The entire base is 24K gold plated with bright decorative chrome top parts. Smooth, jeweled movements for precision control. Stainless steel hardware where appropriate. **HRO Price \$299.95**

Vibrokeyer Deluxe: Highly polished decorative chrome base with bright chrome top parts. Silky smooth movements are jeweled as in fine Swiss watches. **HRO Price \$189.95**

Vibrokeyer Standard: A neat, crisp black textured finish base with bright decorative chrome parts. Non-jeweled movement. **HRO Price \$149.95**

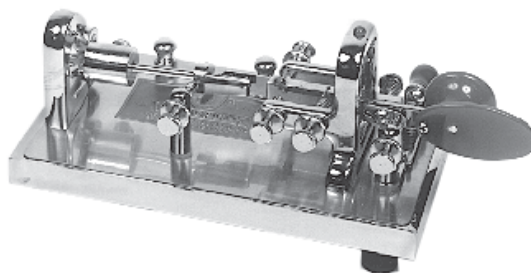

"Original"

The Original Vibroplex is a genuine piece of history. First patented in 1894, the Original is still manufactured today using tools and dies very similar to those used by its inventor, Horace G. Martin. Modern-day operators can put their fist

to the same equipment as the Western Union and railroad operators of old.

Original Gold: The entire base is 24K gold plated, with bright decorative chrome top parts. Smooth, jeweled movements for precise control. Stainless steel hardware where appropriate. **HRO Price \$299.95**

Original Presentation: 24K gold plated brass plate on a highly polished decorative chrome base with bright chrome top parts. **HRO Price \$299.95**

Original Deluxe: Same as the Presentation but without the 24K gold plated brass plate. **HRO Price \$219.95**

Original Standard: A neat, crisp black textured finish base with bright decorative chrome top parts. **HRO Price \$169.95**

"Iambic"

This is the modern descendent of the Original. It incorporates the traditional Vibroplex look for use with modern electronic keyers.

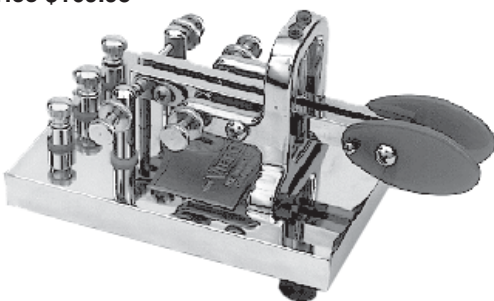

Iambic Gold: The entire base is 24K gold plated with decorative chrome top parts. Smooth, jeweled movements for premium control. Stainless steel hardware where appropriate. **HRO Price \$289.95**

Iambic Presentation: 24K gold plated brass plate on a highly polished decorative chrome base with bright chrome top parts. Its silky smooth jeweled movements are like those found in fine Swiss watches. **HRO Price \$279.95**

Iambic Deluxe: Same as Presentation but without the 24K gold plated brass plate. **HRO Price \$189.95**

Iambic Standard: A neat, crisp black textured finish base with bright decorative chrome top parts. **HRO Price \$149.95**

"Brass Racer"

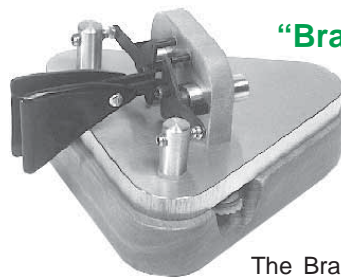

The Brass Racer keys are unique in that there are NO springs in the design. They are crafted from solid brass and mounted on a base of polished hardwood. Tension on the paddle is infinitely adjustable by the use of magnets.

Brass Racer Iambic: This iambic paddle is designed for use with an external keyer or the keyer in your radio. The Triangle Brass base is mounted on polished hardwood. **HRO Price \$139.95**

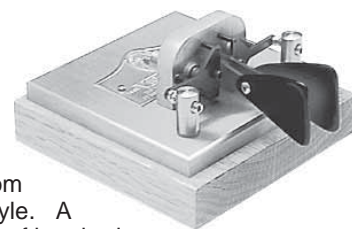

Square Brass Racer: This key is a departure from our traditional style. A distinctive design of brushed lacquered SQUARE brass mounted on polished hardwood. **HRO Price \$144.95**

Combination

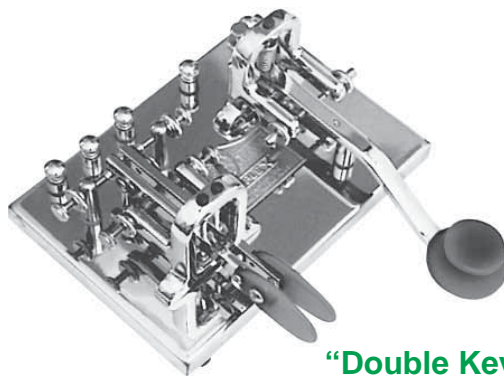

"Double Key"

By popular request, Vibroplex has combined its Straight Key with the classic Vibrokeyer or Iambic paddle on one massive steel base. The Double Key allows the operator to instantly switch from an electronic keyer to the personal touch of a straight key.

Gold Double Key: The entire base is 24K gold plated with bright decorative chrome top parts. Stainless steel hardware where required. **HRO Price \$419.95**

Double Key Deluxe: Highly polished chrome base with decorative chrome top parts. **HRO Price \$369.95**

Double Key Standard: A neat, crisp, black-textured finish base with bright chrome top parts. **HRO Price \$329.95**

KEYERS & KEYS



BY Series Iambic Paddles

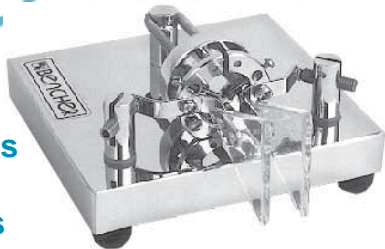

You will enjoy the smooth, precise action of a Bencher paddle with any iambic keyer. These paddles feature a heavy steel base, gold plated silver contact points, non-skid feet, stainless steel adjustable spring, self-adjusting needle bearings, and large acrylic finger paddles.

HRO Prices:	BY-1	Black	\$99.95
	BY-2	Chrome	\$119.95
	BY-3	Gold	\$319.95
	BY-4	Gold/Bik	\$199.95



Hex Key

Gold plated silver contacts. Molded acrylic finger pads. Polished chromium parts. Magnetic tension adjustment and adjustable contact spacing. Black power coated steel base **HRO Price \$179.95**



RJ Series Hand Keys

The "RJ" hand keys have an advanced American-style design derived from the telegraph keys that won the west, yet with modern features like Oilite bearings, a solid navy knob, gold-plated solid silver contacts, full locking adjustments of all tension and spacing parameters, and Bencher quality materials throughout. These keys are ideal for the new amateur just mastering code as well as the old time brass pounder anxious to "clear the hook." This key offers the Morse code operator an investment that will bring years of pride and satisfaction. Try the Bencher "RJ" hand key at your nearby HRO. You will be convinced there is no better key available.

HRO Prices:	RJ-1	Black	\$99.95
	RJ-2	Chrome	\$119.95

ST Series Single Lever Paddles

Superb Bencher features and construction for the ham who prefers single lever operation.

HRO Prices:	ST-1	Black	\$109.95
	ST-2	Chrome	\$129.95

Kent

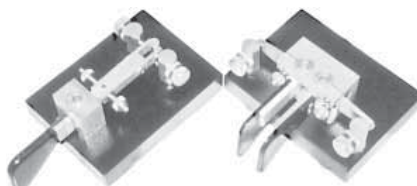

Kent Paddles

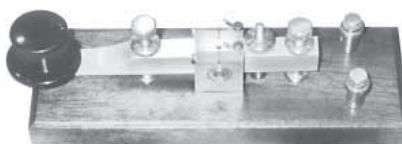

Kent Straight Key

These paddles offer a smooth feel with sealed ball bearings. Precise gap adjustments with knurled heads on fine pitched screws and locking nuts. Made from solid brass within a permanent brass housing.

Twin Paddle	(TP-1)	\$149.95
Single Paddle	(SP-1)	\$139.95
Straight Key	(SK-1)	\$129.95

Straight Keys

VIBROPLEX®

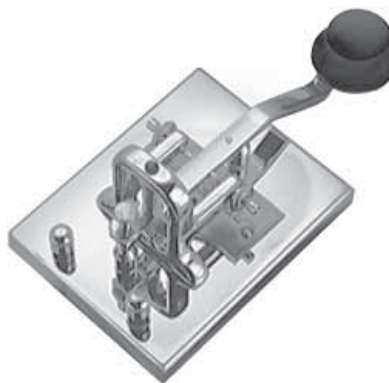

Vibroplex® offers a STRAIGHT key with a unique mechanical action, unlike any other straight key that has ever been manufactured.

Straight Key Gold: The entire base is 24K gold plated with bright decorative chrome top parts. Stainless steel hardware where appropriate. **HRO Price \$299.95**

Straight Key Deluxe: Highly polished chrome base with decorative chrome top parts. **HRO Price \$189.95**

Straight Key Standard: A neat, crisp black textured finish base with bright chrome top parts. **HRO Price \$149.95**

LOGIKEY



K-5 Iambic Memory Keyer

Fully iambic keyer can emulate most other keyers including Curtis "A" timing and Accukeyer. It works with single-lever, non-iambic paddles.

Has 6 active messages plus 12 "banked" messages, 1530 characters total. Messages may "call." Others contain programmed functions, loop for continuous replay, can allow break-in for paddle-inserted text with automatic resumption. Existing messages can be edited. Ultra Speed mode allows messages at speeds to 990 WPM! Contest serial number: 001 to 9999, with push-button decrement if needed.

Linear speed control: 5 to 60 WPM. Adjustable weighting: 25% to 75%. Adjustable frequency sidetone monitor, 500-900 Hz.

Internal monitor level control. Tune function for transmitter adjustment, hand key mode from paddle. Operator selectable automatic character spacing. Full beacon capability.

Messages and keyer configuration saved if power is lost. Variable compensation for QSK transmitter character shortening. Keyer offers precise speed read-out. Keys all solid state and most tube rigs. No paddle "buffering" or "debouncing" required with any paddle.

Comes complete with printed manual (English). Runs on 12 volts DC, less than .1 amp, or on 3 AAA batteries when installed in internal battery pack. 90 day limited warranty. **HRO Price \$149.95**

PHONE PATCHES

Telephone Interconnects



Connect Systems manufactures a wide range of telephone interconnects and commercial equipment. Please contact HRO or visit the CSI Worldwide Web page at <http://www.connectsystems.com>



CS-800

Full Duplex Interconnect & Repeater Maker

This low cost automatic, full duplex patch converts your dual band base and dual band handheld or mobile into a cellular like duplex phone system. A built-in repeater maker can be enabled which makes the CS-800 suitable for private or club repeater/ auto patch use. The CS-800 comes with standard features unavailable in competing brands such as 90 memory speed dialer, redial, hookflash, CW ID, advanced toll restricts, secret toll override access code, built-in programming keypad and digital readout, tone / pulse dial out, and more. The only connections required are to the mike and speaker jacks of your rig. Fully FCC and DOC approved. **HRO Price \$349.95**

CS-900

Simplex Interconnect

This low cost automatic simplex patch converts your single band base and handheld or mobile into a powerful phone system. A 1/2 second digital voice delay prevents word clipping caused by transceiver and vox switching speed. It can be used base to mobile or through repeaters to extend range (phone-base-repeater-mobile and back mobile-repeater-base-phone). The CS-900 comes with many standard features unavailable in competing brands such as 90 memory speed dialer, redial, hookflash, CW ID, advanced toll restricts, 10 programmable toll override sequences, secret toll override access code, tone/pulse dialout and more. It can be user programmed using the built-in keypad with digital readout, over the air using DTMF, or from any telephone. The only connections required are to the mike and speaker jacks. Fully FCC and DOC approved. **HRO Price \$399.95**

CD-2

Communications Decoder

The CD-2 decodes and displays 51 CTCSS tones and 112 DCS codes originating on the channel you are monitoring. DTMF tones are decoded and displayed as they occur and are replayed a second time slowly so that you can read high speed auto-dialers etc. The gimbal makes the CD-2 easy to mount in a vehicle so you can easily see which CTCSS tone is needed. The RS-232 port can transport all decoded data to a computer. **HRO Price \$199.95**



CD-2P Software

The CD-2p DOS-based application stores the time and date of each decoded CTCSS, DCS or DTMF from your CD-2. Accumulated data can be displayed or printed. Graphical displays show channel loading and more. **HRO Price \$109.95**

ACCESSORIES

Aids for Icom and Yaesu Transceivers

Better RF

706 Tune Control

For Icom IC-706 or 706 MkII

Tune control consists of a small OPC board that plugs into the Molex connector on the back of your radio and makes the "Tuner/Call" button operational. Push once and the transceiver emits 10 watts, steady carrier and sidetone through the speaker (internal or external). Use the signal to tune your antenna, an antenna tuner, or to check your SWR. Press twice more and the transceiver reverts to the previous mode and power. Works 160 through 10 meters. **Suggested List \$32.95**

7000 Tune Control

For Icom IC-7000

- Makes the TUNE / CALL button functional.
- Displays SWR as you tune an antenna or external tuner.
- Constant 30 watts or pulsed output at normal power.
- Senses voltage on a screwdriver antenna motor.

Suggested List \$54.95

7000 Screwdriver Control

For Icom IC-7000



Control any screwdriver antenna from your Icom 7000 radio. A 7000 Tune Control unit is required. The Screwdriver Control finds antenna resonance with the push of the TUNE button on the radio. SWR visible on the IC-7000 during the tuning process. No modifications required to the radio or antenna. **Suggested List \$84.95**

Yaesu Tune Control

For Yaesu FT-100, FT-857 or FT-897

Make the TUNE button function on your radio provide a low power output for tuning, adjusting antennas, checking SWR, no matter what mode you are using. Interface cable included. Provides an interface between your Yaesu transceiver and Icom type accessories. **Suggested List \$44.95**



I-Mate

For Icom IC-746-Pro or IC-756-Pro II

The I-Mate allows the external selection of pre-recorded voice and keyed messages for the IC-756PROII and keyed messages for the IC-746PRO. It eliminates the necessity to shift the display from an operating mode to a memory select mode simply to transmit the pre-recorded messages.

Pressing one of four buttons on the I-Mate transmits the message associated with that button. It provides a pulsed sine-wave oscillator for tuning of high powered amplifiers and antenna tuners.

The I-Mate plugs directly into a transceiver's microphone jack and receives its power from the transceiver. **Suggested List \$74.95**



D-Star Audio

INET Labs



DV Dongle

NEW!

The DV Dongle connects to your PC or Apple Mac via a USB port and provides encoding and decoding of compressed audio using the DVSI AMBE2000 full duplex vocoder DSP chip. AMBE technology is used in all D-Star radios to provide efficient voice transmissions. It is also used in some HF digital protocols by vendors like AOR. The DVTool application used with the DV Dongle may be installed and run on Microsoft XP/Vista, Mac OS Leopard or many flavors of Linux. The unit includes a USB A to mini-N cable. PC and Mac users must download an FTDI USB device driver. **HRO Price \$199.95**

PACKET & HF MODEMS

Kantronics



Talon Commercial UDC

The Talon's exceptional design allows for reliable point-to-point, or point-to-multipoint, communications under less than perfect conditions and excellent performance under adverse signal paths. This is a commercial product designed for asset and vehicle tracking, gas/oil production monitoring, traffic control, water management, utility monitoring, public safety, test messaging and emergency management. The Talon features include:

- MAP™ technology.
- LMR frequencies.
- Embedded GPS module (option).
- Data throughput of 9600 bps.
- Field configurable as master or remote.
- Real time SCADA and telemetry.
- Transparent operation.
- Peer to peer communications.

**HRO Price \$1399.95 (w/ GPS)
\$1199.95 (w/o GPS)**

KML-5000 Passive Tracker



The KML-5000 passive Tracker provides recording of vehicle or equipment location for later retrieval. The unit includes a GPS receiver and data-logger. Once installed in a vehicle, it can record up to 36 eight-hour days of GPS data (location, velocity, time) in a nonvolatile internal memory. At your convenience, the captured history can be transferred from the internal memory to a removable memory card for transport to a personal computer for viewing and analysis. **HRO Price \$349.95**

MT1200 / MT1200G Mobile Tracker



Built on the proud heritage of the KPC-3+, the very compact MT1200 and MT1200G Mobile Trackers allow users to transmit real-time vehicle tracking information for use in APRS networks or NMEA interface mapping software.

The MT1200 and MT1200G may be utilized within an existing packet network, using the Mobile Tracker unit as a mobile and Kantronics legacy TNC at the base. The MT1200 may be used with an external NMEA GPS receiver and the MT1200G includes an embedded GPS with active magnetic mount antenna. 512K flash memory is included for extended GPS or telemetry logging or storage.

HRO Prices: MT1200 \$159.95 MT1200G \$269.95



KAM XL™ Multi-Mode DSP Controller

Kantronics' third generation multi-mode TNC is a state of the art design for operations on HF, VHF and UHF while supporting DSP modems and popular new modes of operation. The unit provides modes of Packet 300, 1200 or 9600 baud, G-TOR, Pactor 1, AMTOR ARQ, PSK31, RTTY, NAVTEX/AMTEX, ASCII, WEFAX and CW. It has a dual port mailbox and remote SYSOP access. It is GPS NMEA-0183 compatible and provides Kantronics Host Mode and KISS. **HRO Price \$419.95**



KPC-3 Plus VHF / UHF TNC

This compact, low current TNC has become the work horse of packet radio today. It features multiple packet connects, digipeating for APRS operations, WEFAX reception, a GPS mode for tracking, personal packet mailbox and more. **HRO Price \$199.95**



KPC-9612 Plus / 128 Dual-Speed Dual-Port TNC

TNC is the rapid delivery model, supporting 9600 baud. It features both 1200 and 9600 packet ports, advanced APRS digipeating (APRS is a trademark of Bob Bruninga), (K-Net) networking, amateur beeper (paging) and more. **HRO Price \$399.95**

Keeping Up to Date . . .

The KAM '98 8.3 and KPC-3 Plus 9.1 will provide a second serial port for GPS and APRS capabilities, plus additional GPS improvements.

The KPC-9612 Plus, now sold at version 9.1, has advanced digipeating for GPS, plus the ability to download EMWIN weather broadcasts.

All Kantronics TNCs work great with Pacterm 3.0.

Terminal Software



For Kantronics or Timewave /AEA

HRO Price \$99.95

Creative Services Software presents 32 bit terminal software for the Kantronics (PacTerm 3.0) and Time-wave/AEA TNCs (PkTerm 3.0) and Soundcard Inter-faces. This software is for the Windows operating system.

The software takes advantage of true multi tasking in Windows and uses the standard Windows interface for ease of use. From PSK-31, MFSK, MT63 and SSTY to CW, RTTY, Amtor, Pactor and VHF and HF packet, from single to dual port TNCs or your sound card and its interface, it is now more fun to use the digital modes of amateur radio. You can log each contact with the built-in logbook. Requires AEA /Time-wave Host Mode or Kantronics TNC Hostmode for TNC interface.

You don't even need a TNC with the soundcard only interface. Use with any of the popular soundcard interfaces, even the ones you build yourself. For sound card only mode, requires soundcard interface like Hamhub or MFJ-127X interfaces.

Call a Helpful Ham at HRO for Special Offers

FILTERS

Timewave Technology Inc.

Antenna Noise Canceller

ANC-4

The ANC-4 rf device eliminates or reduces power line noise, computer noise, TV generated interference, and other types of electrical noise. Attach the unit directly to the antenna connector of the receiver or transceiver to cancel locally generated noise before it affects the receiver AGC circuits. Reception of signals well below the noise level of the local interference is possible.

To cancel locally generated interference, the ANC-4 detects the interfering signal and adjusts its phase and magnitude so that it matches the offending interference at the receiver input, but is 180 degrees out of phase, effectively cancelling the interference. Front panel controls allow adjustment of both phase and magnitude, providing extremely deep cancellation.

Connect the ANC-4 between the main station antenna and the receiver antenna connector. A second antenna connects to the ANC-4 to pickup noise. A short wire antenna or a short collapsible whip is generally satisfactory for eliminating noises generated around the operating position or in the house, but an external antenna usually works better to eliminate noises generated outside the home. Any noise antenna that works, including combinations of horizontal and vertically polarized antennas, is satisfactory.

The ANC-4 operates as an active antenna by using the noise antenna and the NOISE GAIN control to amplify the antenna output. The unit can also be used as a diversity combiner to peak weak signals or null interfering signals.

HRO Price 189.95

Digital Processor

All Mode Noise Filter & RTTY Modem



DSP-599zx

This powerful noise and QRM filter surpasses the newest "DSP" radios with its flexible features. Continuous filter tuning up to 5 kHz opens up wider bandwidth modes like shortwave, AM broadcast, and VHF/UHF FM. Heterodynes disappear, weak signals pop up from the noise, and the sharp filters slice away QRM. The DSP RTTY modem (w/optional DSP-RTTY software) pulls out solid copy when you can barely hear a signal. An AM line noise filter dramatically reduces noise. Filter settings are easy-to-read on the backlit alphanumeric LCD display. Pushbuttons select noise reduction, memories, voice, CW, and data modes. Optical encoders tune the filters.

- Hyperspeed DSP - 27 ns, 36.8 MIPS.
- 2 selectable channels with multiple memories.
- Front panel programmable input sensitivity and line output level.
- AC line noise AM filter.
- Calibrated audio voltmeter & generator.
- 13 preset data filters plus two user presets.

HRO Price \$399.95
AC-5 P.S. \$24.95

Telephone Filters



K-COM

Stop telephone RFI from transmitters in the 0.5 to 30 MHz range. These filters are assembled and come with instructions. Special order either model to cover 500 kHz to 3.0 MHz. Call for prices and information.

Model RF-1 Single Line Filter for phones, answering machine, modems, faxes, & cordless phones. RJ-11 modular connectors. Special ordered for two-line phones. **HRO Price \$16.95**

Model RF-2 For inserting RFI filtering into telephone wiring: inside phone jacks, behind wall-mounted phones, etc. Solder-less connectors.

Noise Reduction



SG-7014 Speaker
HRO Price \$159.95

The affordable ADSP2 speaker delivers top of the line noise reduction for any receiving device. Two levels of noise reduction (13 dB, 26 dB) and 3 band pass filters (100 Hz, 500 Hz, 1800 Hz) with simple push-button operation. Includes an external headphone jack. 110 – 500 mA consumption.

Call for Quotes
Toll Free

Low Pass Filter



YA-1



Bencher's low-pass filter has exceptional specifications. Working range: 1.8-29 MHz. Impedance: 50 ohms. Power rating: 1.5 KW continuous, 5 KW peak. Attenuation: at least 80 dB at 54 MHz. **HRO Price \$88.95**

Bandpass Filters



DIGITAL COMMUNICATIONS INC.

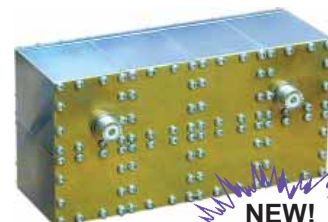

DCI-146 / 440-DB

NEW!
Dual Band Filter

Eliminate intermod with these band-pass filters for 144, 220, or 440 MHz or with the 2m / 440 MHz dual band filter. Connect a filter between your VHF / UHF, base or mobile rig and antenna. Enjoy your favorite station without listening to the squawks and squeals of intermod. These filters reduce the strength of interfering signals while allowing the signals you want to hear to pass through at virtually full strength.

The filters are made to first-class specifications with silver-teflon connectors and extruded aluminum, copper and brass. In addition to the standard 4-pole filters, 7-pole and larger ultra-sharp filters are available. The DCI-146-4H intermod filter for 2 meters is 12" X 3" X 5" and has UHF connectors.

Model	Band	HRO Price
DCI-146-4H	2m	\$169.95
DCI-223.5-3H	220 MHz	169.95
DCI-445-10C	440 MHz	189.95
DCI-146/440-DB	2m/440 MHz	239.95

LIGHTNING / SURGE PROTECTION

Coax Switches

ALPHA DELTA

Delta-4B

4 Position Switch

This lightning protected 4 position RF coax switch uses the Alpha Delta Arc-Plug cartridge to protect your equipment from electrical surges. The exclusive center "off" (ground) position internally disconnects and grounds all antenna circuits. It has cast housing with constant impedance micro-strip cavity construction. Features a positive detent roller bearing switch drive. Handles full legal power. Delta-4/N for type "N" connectors. The Delta-4 handles frequencies through 500 MHz and the Delta-4/N through 1.3 GHz. **HRO Price \$89.95; Type N \$89.95**



Delta-2B

2 Position Switch

This 2 position coax switch is precision lightning surge protected. Has the same constant impedance cavity construction with "center-off" ground as the Delta-4 and a built-in replaceable Arc-plug® cartridge. Order UHF or type "N" connectors for low-loss performance through 1.3 GHz. **HRO Price \$59.95; Type N \$75.95.**



Daiwa has two heavy-duty coaxial switches. Both are useable to 500 MHz and the unused positions are grounded. Switches are available at slightly higher prices with type "N" connectors.



CS-201
2 Position Switch

HRO Price \$32.95

Surge Protectors

ALPHA DELTA

Transi-Traps

The Defense Logistic Agency (DLA) has assigned National Stock Number (NSN)5920 01 5470278 to the Model TT3G50 Coax Surge Protector and NSN 5325 01 5466841 to the 3G50 ARC-PLUG (tm) Cartridge for use in all US Military and NATO applications, Worldwide. The **ATT3G50** coaxial surge protector was designed for the cellular, microwave point-to-point, and the broadband wireless industry. These products feature very low loss performance through 3 GHz. Typical loss is 0.1 dB at 1 GHz through 0.5 dB at 3 GHz. This series represents the lowest loss broadband design in the industry. Choose type "N" or "UHF" connector.



Model	Description	HRO Price
ATT3G 50	200 W – 3.0 GHz, Type N	\$59.95
ATT3G 50HP	2 kW – 3.0 GHz, Type N	\$59.95
ATT3G 50U	200 W – 500 MHz, UHF	\$49.95
ATT3G 50UHP	2 kW – 500 MHz, UHF	\$49.95

Lightning Protection

PolyPhaser®

CORPORATION

Coaxial Impulse Suppressors

Hermetically-sealed voltage sensitive gas tubes and other components assure that surge voltages and currents will not reach your equipment.

Flange Mounts

HRO Price \$61.95

Model	Freq. Range MHz	Maximum Power Watts
IS-50 UX-CO	1.5-400	HF – 2 kW
		VHF – 35 W
IS-50 UX-C1	50-700	UHF – 125 W
		VHF – 375 W
IS-50 NX-C2	125-1000	UHF – 125 W
		VHF – 375 W
		UHF low – 125 W
		800 MHz-1 GHz – 50 W

Bulkhead Mounts

HRO Price \$64.95

Model	Freq. Range MHz	Maximum Power Watts
IS-B50 LU-CO	1.5-400	HF – 2 kW
		VHF – 375 W
IS-B50 LU-C1	50-700	UHF – 125W
		VHF – 375 W
IS-B50 LN-C2	125-1000	UHF – 125 W
		VHF – 375 W
		UHF low – 125 W
		800 MHz-1 GHz – 50 W

Rotator Control Protector

Model IS-RCT

Provides protection for rotator controllers, motors, control box and other nearby equipment.

HRO Price CALL

Power Line Extension Protector

Two-outlet extension cords with master on/off switch and circuit breaker offer added power line protection.

Model	Length	HRO Price
IS-PLDO-120-15A	15' 120V@15A	CALL
IS-PLDO-120-20A	6' 120V@20A	CALL

Grounding Panel

Model CU-SPGP

A .062" thick copper plate mounted on a painted 1/2" plywood backing. Mounting protectors and a single ground point established for station equipment. Comes with concrete anchors, all mounting screws, 10' of 1.5" copper grounding strap, 2 brass sandwich plates, and joint compound. 18" x 12". **HRO Price \$CALL**

Ham Radio Outlet Accepts





Discover AOR, the serious choice in Advanced Technology Receivers

SHORTWAVE LISTENING

AR-8600BMKII

Blocked — \$Call

AR-8600UMKII

Unblocked — \$Call
HRO Discount Prices



Use this versatile receiver as a mobile, base, or transportable. Power it by an external 12VDC power supply, optional DC lead from a 12V vehicle, or from an optional internally fitted NiCd battery pack. All mode: (narrow FM, wide FM, narrow AM, plus the standard modes) with SSB capability. Steps down to 50Hz, has a TCXO for high stability, and an RS232 port for computer control with free software from the AOR web site. Frequency coverage is 530 kHz to 2040 MHz with no gaps (cellular blocked). Noise limiter and attenuator, band scope with save trace facility, twin frequency readout with bar signal meter, separate controls for volume and squelch, programmable scan and search, custom back-lit LCD display, a total of 1000 memories in 20 memory bands.

Digital Modem



ARD9800 Digital SSB

\$549.95 — HRO Discount Price

The ARD9800 modem connects to the microphone input of any transceiver. The user simply wires a connector for his particular transceiver, connects the speaker output of his transceiver to the modem and then connects the modem to a 12VDC power source. The normal analog operation of the transceiver remains intact. Digital voice HF is possible by selecting the Digital Mode. Incoming digital voice signals are automatically decoded, no selection is necessary. No modifications are needed to the transceiver.

AR-8200MKIIIB

All-Mode

\$Call — HRO Discount Price



This handheld wide range receiver has all mode reception including super narrow FM, wide and narrow AM, USB, LSB, CW and standard AM and FM modes. Covers 500 kHz to 3000 MHz (cell band blocked) with 1,000 memory channels (20 banks of 50 ch.). True carrier reinsertion in SSB modes. Includes 3 kHz SSB filter! Detachable MW antenna with negative feedback. Computer control and programming (requires optional connection cable). Download free control software from AOR web site! Optional internal cards expand capabilities.



VR-5000

\$CALL — HRO Price

This multimode desktop scanning receiver has continuous frequency coverage from 100 kHz to 2.6 GHz (cellular frequencies are blocked and non-restorable). Features direct keypad entry, a wide variety of scanning capabilities, and 2000 memory channels which may be separated into as many as 100 memory banks. Memory banks and memory channels may have alphanumeric labels. Sort channels by frequency, alphanumeric name or by operating mode.



FRG-100B

\$CALL — HRO Price

This receiver provides general coverage of CW, SSB, AM and FM modes from 50 kHz to 30 MHz, broadcast bands included. Select standard or user-programmable tuning steps. Features include: LCD display w/10 Hz read-out, 50 tunable memories, Multi-function scanning, Adjustable BFO; selectable CW sideband, and Optional FM unit, CW filters.



Dualwatch, Digital Mode,
Diversity Receive

IC-PCR-2500

- 3 receiver screens.
- PC controlled
- 0.10-3299.999 MHz AM, FM, WFM, DV (UT-118), P25 (UT-122) main rcvr. Cellular blocked.
- Bandscope / time-line scope.
- DSP capability

IC-R2500

- Wide LCD display
- Digital mode reception.
- 1000 alphanumeric memory channels.
- 0.10-3299.999 MHz AM, FM, WFM, DV (UT-118), P25 (UT-122) main rcvr. Cellular blocked.



IC-R75

The IC-R75 covers 0.03-60 MHz — marine, amateur radio and short wave broadcasts. Features a high stability receiver circuit, superior dynamic range, twin PBT, DSP capabilities, provisions for 2 optional filters, FM mode standard, alphanumeric read out and selectable RF gain/squelch control.

IC-R1500



The IC-R1500 is a wideband mobile receiver with a remote control head (cable supplied). It covers 0.01 - 3299.999 MHz (cellular blocked). Features include: 60 channel per second scan; optional DSP with UT-106; 1000 alphanumeric memory channels arranged in 21 banks; CTCSS/DTCS tone and pocket beep; VSC (Voice Squelch Control); IF filter and IF shift (CW,SSB); Noise blanker (SSB, CW,AM); RF attenuator; All functions are available when connected to a PC. Cloning function allows you to read/write memory channels from the PC.

SWL RECEIVERS

SANGEAN



WFR-20
\$279.95

HRO Discount Price



The WFR-20 Wi-Fi Internet radio offers direct access to over 6000 Internet radio stations and 21242 on-demand streams. Using the radio or your web browser and computer, you can search for specific stations. Upload the stations to "My Stations" folder for quick access. Don't have a computer? The WFR-20 provides access as a stand-alone unit. All you need is a broadband internet connection. Has large 3-line display, extra large clock display, 12 / 24 hour clock format, 4 alarm timers, aux input for MP3 player.

ATS-505P
\$119.95

HRO Discount Price



The world's first affordable professional digital multi-band receiver offers the performance and features of more expensive table model receivers. It has continuous coverage, auto-memory scan, SSB reception, auto present system, human wake system, illuminated display, dual time, 12/24 hour display, AM/FM stereo/SW receiver, auto/manual search, tone control, keypad entry, 9/10 kHz switch.

ATS-909
\$239.95

HRO Discount Price



- Three timers.
- Auto SW search.
- Wide / narrow filter.
- 5 tuning methods.
- ATS auto tuning system.
- Mono / stereo selector switch.
- 306 memories: 261 SW, 18 MW, 18 FM, 9 LW.
- Direct recall of a favorite station.
- SSB (LSB and USB) with 40 Hz tuning steps.
- Manual editing to insert 8 alpha-numeric characters on the display.
- PLL dual conversion receiver with tone control.
- Separate audio recorder output and standby control jacks.

ATS-404
\$79.95

HRO Discount Price



This digital, AM/FM stereo shortwave receiver provides continuous coverage of all shortwave bands and any frequency in between; has an auto preset system; auto memory scan; human wake system; illuminated display with seconds display; keypad entry; 45 preset memories; auto/manual search and 12/24 hour display.



MMR77
\$49.95

HRO Discount Price

The MMR77 is a top quality AM/FM Radio with multi-purpose emergency capabilities. It features a dynamo powered one-minute wind for 30 minutes play time. It can be powered by 2 standard AA batteries or an optional AC adapter.

SONY

ICF-SW7600GR

\$159.95
HRO Price



Travelers love this versatile World Band Radio® receiver with stereo FM reception and instant access to all channels and bands. Built-in clock timer has sleep / stand-by functions.

- AM (LW, MW, SW) / FM stereo reception.
- Dual-conversion superheterodyne circuitry.
- 10-key direct access™ tuning.
- Liquid crystal display (LCD).
- PLL quartz synthesis tuning gives accurate, drift-free frequency selection.
- A 3" speaker and high / low tone provides a wide range of sound for music or news.
- Manual & automatic scan tuning.
- A jack for easy antenna connection.
- Antennas: built-in ferrite bar for MW /LW & a telescoping whip.
- SSB circuitry for reception of voice and Morse code (CW) on amateur bands.
- Requires 4 AA batteries (not included) or the optional worldwide AC adapter.

Books



World Radio TV Handbook

Complete source-book for 1000+ English broadcasts. Stations listed by country and frequency. Pages of advice, tips, Internet addresses. 2008 edition.

HRO Price: \$29.95

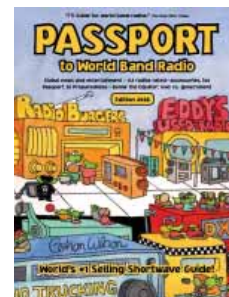

Passport to World Band Radio

News and shows from 160 countries. Reviews and advice on how to get started listening to international radio. 2008 edition.

HRO Price: \$22.95

Call
HRO
for
More
SWL
Books

Prices in this print catalog are subject to change

GRUNDIG / *eton*®

SWL



Satellit 750

\$300.00
HRO Price



When you want full shortwave capabilities and a classic design, choose the Satellit 750. Advanced DSP technology and a 360-degree rotating AM antenna enhance the radio's tuning sensitivity to help you pull in weak

signals. Listen to AM, FM, shortwave with SSB, and aircraft band frequencies. Program up to 100 of your favorite choices. You can also connect your MP3 player for even more listening choices.

- AM, FM, aircraft band (117-137 MHz) and shortwave (1711-30000 KHz).
- Set 9/10 KHz AM tuning; set FM tuning range.
- Single side band (SSB).
- Using DSP technology to enhance the highest sensitivity and selectivity with excellent S/N ratio and anti-interference results in good reception sound quality.

- 360 degree rotating AM antenna.
- Auto / manual / direct frequency key-in and station memory tuning.
- Auto tuning storage function (ATS) for FM / AM / shortwave.
- Mute function.
- 100 station memories (each band 100 memories, 500 customizable).
- Dual alarm clock function.
- 12K AM output socket.
- Line in socket (can be used as a speaker for MP3 players).
- Line out socket (radio broadcasting can be transferred to other devices).
- External antenna jacks for both AM and FM.
- USB (5 V) outlet for MP3 or mobile phone charging function.
- AC/DC 6V power supply included.



HRO
Discount Price
\$30.95

FR-150

**Solar-Powered / Self-Powered
AM / FM / Weather
Portable Radio**

The FR-150 Microlink is a full featured radio in a compact design. The ultra portable unit is ideal to have on hand when you are roughing it. It also makes a great addition to any emergency preparedness kit. No plugs or wires are required. Instead, turn the hand crank to power the FR-150 or capture the sun's energy to run it on solar power. It operates on the AM, FM and Weather Bands. You can also tune in to FCC and EAS public alert systems. Add the flashlight, the cell phone charger and you've got one versatile little device.

- AM (520-1710 KHz); FM (87-108 MHz).
- NOAA weather – all 7 channels..
- Built-in hand crank power generator recharges the internal NiMH rechargeable batteries and cell phone batteries.
- Built-in 3 white LED light source.
- Can be powered from solar power; the built-in rechargeable NiMH batteries, or from an AC adapter (not included).
- Built-in cell phone charger with output jack.
- Earphone jack – 3.5 mm socket.
- All antennas are built-in: telescopic antenna for FM; internal ferrite bar antenna for AM.
- Weighs just 7.5 ounces (200 g).
- Includes a preparedness guide, protective pouch, and card for cell phone tip.

**Be Ready for the Next
Power Blackout**



HRO
Discount Price
\$49.95

**FR-300
Emergency
Radio**

The FR-300 Emergency Radio lets you stay informed in case of an emergency. It is self powered with a dynamo crank or 3 AA batteries (not included) or from an AC adapter (not included). It receives the standard AM and FM broadcast bands, TV VHF channels 2-13 and all 7 NOAA weather channels plus "Alert." It features a built-in 2 white LED light source and one flashing red LED; emergency siren, built-in cell phone charger, ear phone jack, and antennas for FM and AM. The siren and flashing LED can be used to alert rescuers as to your location. The hand crank lets you power the radio even without any batteries or electrical source.



G4000A

\$149.95 – HRO Price

The Yacht 400 just gets better! The G4000A has the same technical specifications and basic appearance as the Yacht Boy 400 but with addition of a leather case. This now brings the receiver into the "Porsche" design family of radios.

Yacht Boy

550

\$99.95
HRO Price



Travel the world from the comfort of your home or tune in the sounds of home when you're on the road. The YB550 is a lightweight, compact unit with direct key in, manual/auto tuning or manual/auto scan of 100 memories. Shortwave tuning from 1715 - 29995 kHz; AM (MW) 520-1710 kHz and FM 87-108 MHz. Features a dual clock, clock and sleep timer, auto power off and AM/FM stereo.



Yacht Boy 300PE

\$79.95 – HRO Price

The Yacht Boy 300PE covers broadcast AM and FM (in stereo by earphones), and 13 SW bands from 2.3-26.1 MHz. Expanded shortwave coverage now has 2.3-7.8 MHz in SW1 and 9.1-26.1 in SW2. The improved AM / shortwave tuner eliminates audio muting when the ± tuning buttons are pressed. Features digital tuning and display with 24 memories and direct frequency entry. Includes an alarm clock with wake-up to a radio station and 90-minute sleep timer. Has a dynamic micro-speaker and a jack for earphones. Use the telescoping antenna or attach an external antenna to the jack. Preserve the titanium-look finish with the protective travel pouch included.

SWL / WIDEBAND ANTENNAS



G4 World Recorder \$CALL - HRO Price

Keep the comforts of home with you, even when you are far, far away. This AM / FM radio offers 10 shortwave bands so you can access news, weather and entertainment for wherever you may be. Set the alarm to your favorite station and wake up with a song in your heart.

- LW, AM, FM and shortwave (300-29999 KHz)
- Digital display world-band radio.
- Digital tuning methods including auto-scan, manual scan, direct key-in and manual tuning.
- 1000 programmable memory presets.
- FM station tuning storage (ATS) provides automatic acquisition of the strongest stations in your area.
- 3 built-in timers to control on / off switch of the radio, radio recorder, and MP3 player.
- Recorder for direct radio or external recording through a microphone.
- 3D SR5 sound effects.
- Supports MP3 / WMA decoder / MPEG 1/2/2.5.
- Supports SD / MMC card / mini USB port.
- Built-in 1 GB / 2 GB flash, USB 2.0.
- MP3 player has 3 playback cycle modes with 7 equalizer configurations.
- Battery level indicator.
- Charging function to the rechargeable batteries (not included).
- Full-featured world time zone clock and sleep timer.
- Input for included AC adapter.
- Input for included earbuds.
- Input for external antenna (not included).
- Power source: 3 AA batteries (not included) or AC adapter (included).
- Protective pouch included.

G6 Aviator \$CALL

for Special HRO Price



The G6 Aviator provides reception on FM / AM / Aircraft and shortwave bands with SSB. Tuning is easy with direct keypad entry. You can use the STOP tuning feature to browse stations and stop on the next available frequency. You can also use D5 tuning to get a taste of what's playing - stop on the next available frequency for 5 seconds at a time. With the international clock and wake-up alarms you can stay on schedule worldwide.

- AM, FM, aircraft (117-137 MHz) and shortwave (1711-30000 KHz).
- Set 9/10 KHz AM tuning and set FM tuning range.
- Single sideband (SSB) operation.
- Dual conversion.
- Digital tuning with LCD digital frequency readout.
- 700 memories with 4 character page naming.
- Tuning knob tuning system with FAST / SLOW setting.
- Full featured world time zone: clock and sleep timer.
- Signal strength indicator.
- Button lock feature.
- Input for AC adaptor (included).
- Input for earbuds (included).
- Input for external antenna (not included).
- Power source: 2AA batteries (not included); 2AA rechargeable NiMH batteries (not included); AC power adapter (included).
- Includes a protective pouch.

SWL Antennas

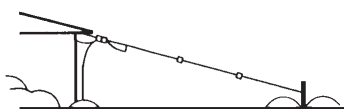

DX-SWL

The DX-SWL is tuned for the most popular SWL bands (13, 16, 18, 19, 21, 25, 31, 41, 49, 90 and 120 meters). It can be used as a multi-band transmit antenna with the appropriate antenna tuner. Length is 60 feet. Requires a single support. Standard coax connects antenna to your radio. Feed point is 50 ohms. SO-239 connection. **HRO Price \$90.95**

DX-ULTRA

The multi-element DX-ULTRA has extremely low-noise performance. Tapered wing design allows broadband operation. Configure as dipole, inverted vee, or sloper. Covers MW, tropical, SW, government, military, embassy, maritime, aircraft, and commercial frequencies. 80 feet long. Made with ISO-RES inductors and parallel wire elements. Uses the Delta-C center insulator, Delta-CIN end insulators, and 12 gauge solid copper wire with grey PVC insulation. Elements are separated by grey PVC rod. **HRO Price \$119.95**



SWL Sloper

The Sloper covers SWL bands from 11-120 meters. Automatic band switching. SO-239 connector for attaching coaxial cable. **HRO Price \$99.95**

Eavesdropper™

This high performance trapped dipole for the 11-60 meter SWL bands is 42 feet long. Twin lead or coax models are available. **HRO Price \$99.95**



Active Antenna AN-1

For the SW listener with space problems, the AN-1 has a frequency range of 150 kHz to 30 MHz. Has a low noise FET in the built-in pre-amp. Built-in attenuator. Requires 6 AA batteries or AC-12 adapter. Antenna can be used inside or outside. Comes with 39 feet of cable. **HRO Price \$89.95**

Log Periodic

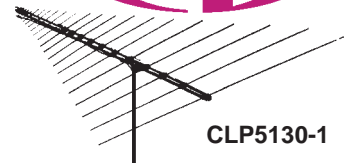

CLP5130-1

The CLP5130 antennas are high gain, wide band VHF/UHF log periodic beams for horizontally polarized base station use. Covers amateur bands from 50-1300 MHz, FM broadcasting, scanning, VHF / UHF TV, air band communications, government and business bands.

Forward gain is 10 to 12 dB - 10 to 16 times the gain of a nondirectional discone type antenna. The VSWR is less than 2.0:1 across the band. The high-quality aluminum antennas have a boom design that allows movement of the phasing line. Distortions in the vertical and horizontal planes are minimized and element adjustment is not necessary. The boom-to-mast bracket is made of a lightweight and rugged magnesium alloy.

	CLP 5130-1	CLP 5130-2
Frequency	50-1300 MHz	108-1300 MHz
No. Elements	23	19
Power PEP	500W	500W
Forward Gain	10-12 dBi	10-12 dBi
Front/Back	15 db	15 db
Longest element	9' 10"	4' 6"
Boom length	5' 9"	4' 6"
HRO Price	\$449.95	\$319.95



D-130J D-130NJ Super Wideband Discone



Monitor 25-1300 MHz. Transmit on 50, 144, 430, 1200 MHz. All stainless steel. Input power 200 watts. Impedance: 50 ohms. VSWR: 1.5:1. Length: 1.7 meters. Mounts on 1" to 2" masts. DJ-130 UHF and DJ-130NJ Type-N connector. **HRO Price D-130J \$99.95; D-130NJ \$99.95**

AVIATION



Com

VXA-150 Pro V \$CALL

Vertex Standard VXA-150 Pro V is a communications-only airband transceiver.

- 5 watts pe p transmit power output.
- Direct frequency entry from 16 button keypad.
- Backlit keypad and display.
- Ten NOAA weather channel receive.

- 150 memory channels with 8 character alpha-numeric display.
- One touch monitor for easy squelch access.
- Comes with rechargeable battery, battery charger, headset adapter, antenna and belt clip.
- Three year manufacturer parts and labor warranty.



Nav / Com

IC-A4 \$CALL

for HRO Price

The IC-A4 is a low cost, light weight and compact portable for providing reliable communications for pilots. The channel name function allows you to assign 5-character names to each channel. Transmits and receives on all 760 aviation channels. Has 2 scanning modes.



Nav / Com

VXA-710 Spirit

\$399.95
HRO Price

Airband transmit and receive (5 watts P.E.P). Navigation with VOR / CDI display. Business band radio receive. FM broadcast receive. NOAA weather channel receive. Powered by a long life lithium ion battery. Submersible design. Comes supplied with

rechargeable battery and charger, headset adapter antenna and belt clip. 3 year parts and labor warranty.



VXA-300 Pilot

\$CALL
for HRO Price

Airband transmit and receive (5 watts P.E.P). Navigation with VOR / CDI display. Extra loud audio amplifier and large LCD display. Powered by a

long life nickel metal hydride battery. Submersible design. Comes supplied with rechargeable battery and charger, headset adapter, antenna, and belt clip. 3-year parts and labor warranty.



Call HRO for Up-to-Date Quotes

GPS



Global Positioning Systems

Geko™ Series Personal Navigators

Gekos are the smallest, lightest (3 oz.), waterproof GPS units on the market; inexpensive, with sleek designs and simple operating systems.

Features	Geko 201	Geko 101
WAAS	Yes	No
Upload/Download	Yes	No
External Power Input	Yes	No
Waypoints	500	250
Altitude stored w/WPT	Yes	Yes
Routes	20	0
Legs per route	125	0
Saved Tracks	10	0
Tracklog Points	10,000	3,000
Datums	>25, 1 user	18
Number of Grids	17, 1 user	11
Distance and Sun	Yes	No
World Time Zones	Yes	Yes
Games	Yes	No
HRO Price	\$139.99	\$99.99



Geko 201



Geko 101

eTrex™ High Sensitivity 12 Parallel Channel GPS



The six-ounce eTrexHT™, only four by two inches, operates 180 hours on two AA batteries. It will maintain satellite lock even while in forest-like conditions. It stores up to 500 user waypoints with icons and has Garmin's exclusive Trac-Back™ to help you return home. Animated graphics help you identify waypoints. **HRO Price \$99.99**

eTrex Camo In camouflage casing. Operates on six "AA" batteries (not supplied) or use the included AC adapter on 110-120 VAC. **HRO Price \$129.95**

eTrex™ Legend C & Vista C

The eTrex Legend C and eTrex Vista C bring exciting new features into the popular eTrex series including a 256 color, TFT display. These models, among the smallest handhelds, are housed in water proof cases.

Each has a 12 channel GPS receiver, an ARM processor, high resolution liquid crystal display, and a rocker switch for quick, accurate map panning. All offer full navigation capabilities, satellite status, position format options and interface in English, French, German, Italian or Spanish. Load the optional Map Source to display addresses and businesses.

eTrex Legend - Color Basemap for North, South and Central America. 8 megabytes of internal memory. Accepts download data from Garmin's entire line of MapSource CD-ROMS. **HRO Price \$299.99**

eTrex Vista - Color Same as the Legend plus a detailed basemap, built-in barometric altimeter, electronic compass, and 24 MB internal memory. **HRO Price \$349.99**

GARMIN PRODUCTS

GPS

Part Number	Description	2610	Street Pilot	GPS 12 CX	GPS II Plus	GPS III	Nav Talk	GPS III Plus	GPS V	e TREX	e MAP	HRO Price
Antennas, etc												
010-10052-00	GA 28 Low profile remote marine antenna with 30' cable / BNC		*			*						\$129.95
010-10052-02	GA 26 Low profile antenna, mag. & suction mounts, 8' cable, BNC		*		*	*						\$99.95
010-10052-04	GA 26C remote Antenna								*			CALL
010-10052-05	GA 27C external antenna	*									*	\$99.99
010-10061-00	GA 26 Trunk mount		*		*	*						\$17.95
010-10062-00	GA 26 Flange mount		*		*	*						\$17.95
010-10067-00	GA 28 Flange mount kit		*									\$20.95
010-10139-00	GA 26 Suction cup mount		*		*	*						\$17.95
010-10152-00	GA26 8 ft extension cable		*		*	*						\$29.95
010-10157-00	8 ft extension for GA 27C										*	\$38.95
011-00237-00	Handheld / portable antenna		*		*	*						\$93.95
013-00002-00	30 ft low-loss antenna extension cable with connectors for GA 28		*									\$107.95
Bracket Mounts												
010-10048-00	Swivel mount bracket			*								\$31.95
010-10111-00	Dash mount bracket				*	*			*			\$31.95
010-10115-00	Bicycle mount kit			*								\$17.95
010-10122-00	Bicycle mount kit			*	*	*			*			\$25.95
010-10156-00	Swivel mount bracket								*			\$12.95
010-10199-02	Dashboard mount base only		*									\$17.95
010-10202-00	Dash mount										*	\$39.98
010-10204-00	Handlebar mount										*	\$17.99
010-10262-00	Suction cup mount										*	\$39.98
010-10267-00	Bicycle mount									*		\$17.99
Cables, Etc												
010-10082-00	Power/data cable		*		*	*			*			\$27.95
010-10084-00	Cigarette lighter adapter			*								\$39.95
010-10085-00	Cigarette lighter adapter		*		*	*			*			\$23.95
010-10086-00	Data cable				*							\$22.95
010-10141-00	PC interface cable		*	*	*	*						\$38.95
010-10142-00	Data transfer cable (unit/unit)		*	*	*	*						\$46.95
010-10164-00	PC interface cable w/8v cigarette lighter adapter			*								\$50.95
010-10165-00	PC interface cable w/cigarette lighter adapter		*		*	*						\$45.95
010-10310-00	USB to Serial Conv. Cable								*			CALL
010-10477-00	PC/USB cable									C model		\$14.95
010-10563-00	12v adapter cable									C model		\$39.95
Cases												
010-10117-01	Carry Case								*			\$12.95
010-10220-00	Leather case w/view window						*					\$24.99
010-10231-01	Deluxe carrying case	*										\$32.00
010-10221-00	Soft holster						*					\$19.99
010-10232-00	Carrying case w/storage for cartridges (color map only)		*									\$24.95
010-10234-00	Yellow protective case										*	\$15.95
010-10235-00	Leather carry case										*	\$24.99
010-10266-00	Neoprene carrying case								*	*		\$14.99
Other												
010-10054-00	PC software and cable kit		*	*	*	*						\$92.95
010-10203-00	12v cigarette power cord									*	*	\$39.98
010-10205-00	Power cable (bare wire)									*	*	\$22.85
010-10206-00	PC interface cable									*	†	\$39.95
010-10227-00	Blank 8MB mem cartridge		*									\$99.99
010-10226-00	Blank 16MB mem cartridge		*									\$179.95
010-10277-00	A/C PC Adapter								*			\$44.95
010-10477-04	128MB CompactFlash	*										\$60.67
010-10477-05	256MB CompactFlash	*										\$100.00
Map Source CD-ROMs												
010-10215-00	US Roads & Recreational						*	*		*	*	\$99.99
010-10215-01	MapSource World Map						*	*		*	*	\$89.95
010-10215-02	Map Source US Topo						*	*		*	*	\$116.95
010-10215-03	MapSource US Metro	*								*	*	\$149.99
010-10215-13	MapSource US Metro w/ 8MB mem cart						*	*		*	*	\$139.95
010-10332-00	Unlock Coupon entire USA/Canada								*			\$95.95
010-10564-00	Auto navigation kit									C model		CALL

† Included with EMAP DELUXE and works with MAPSOURCE CD's to download waypoints and routes. All Mapsource CD's will work with both eMap and eTrex, however, on eTrex, map detail will not be downloaded.

AvMap

SATELLITE NAVIGATION



AvMap G5

A new Touch in APRS Operations

HRO Price \$649.95

The AvMap G5 personal navigator is a smart driving assistant for your business or pleasure trips throughout North America. The unit comes preloaded with highly detailed TeleAtlas street maps of North America on a 2GB SD card and gives you color 2D and 3D views with turn-by-turn voice prompts in 14 different languages.

The practical AvMap G5 is easy to use with a built in highly sensitive 20 channel Sirf 3 GPS engine for fast and highly accurate fixes. The ultra bright non-glaring 5 inch TFT touchscreen is easy to view. Night mode and auto brightness features make viewing easy and hassle-free in any lighting condition.

Working in conjunction with Kenwood-USA, the G5 is your out-of-the-box solution for APRS operations. Watch APRS activity right on the screen and you can distinguish between fixed and mobile APRS stations. You can even set your G5 to navigate to your favorite APRS station and get rerouting instructions when the new position is reported.

Included with the G5 is a Kenwood-ready cable and exclusive APRS interface built into the G5. This bi-directional RS-232 APRS interface is balanced for ALL current APRS ready Kenwood radios. Other features include: detachable 12v power cable, bi-directional NMEA 183 serial port, external antenna port, NTSC / PAL video and audio input, PC connection for software updates via USB port, off road, fastest route and least turns calculations with turn details. Routing instructions include current road name and house number with road name and the next turn command. "Drive Me Home" rapid command. Improved intuitive touch screen address lookup with millions of points of interest.

GPS TRACKER / RECEIVERS



**Satellite
Personal
Tracker**



\$149.99 – HRO Price

(All Satellite Service Plans are sold separately direct to the user.)

Unlike a traditional GPS device which only receives satellite signals indicating your location, SPOT uses a second satellite technology that allows it to communicate your coordinates to emergency authorities or to people you know and trust.

SPOT uses 100% satellite technology, so you don't have to worry about coverage. SPOT covers virtually all of North America, Europe, and Australia; most of South America, northern Africa, and northeastern Asia; and hundreds or thousands of miles off shore of these areas.

You can communicate in four simple ways

- Alert 9-1-1: Dispatch emergency responders to your location.
- Check in: Let contacts know where you are and that you are okay.
- Help: Request help from friends and family at your exact location.
- Track: Send and save your location and allow contacts to track your progress using Google Maps.™

How it works

- GPS satellites provide coordinates.
- SPOT Messenger's onboard GPS chip determines your exact location and sends it and a message to SPOT's commercial satellite system..
- SPOT satellites relay your message to specific satellite antennas around the world.
- Satellite antenna and supporting equipment route your message and location to the appropriate network.
- Your message is delivered according to instruction via text message, email or emergency notification to the appropriate service.



GRE America, Inc.

Take Control With GRE!

PSR-100

\$99.99 – HRO Price

- Five pre-programmed bands: Marine, Fire / Police, Air, Ham, Weather.
- Quick program.
- Built-in priority channel.
- 200 channel memories.
- 200 channels automatic scanning for VHF to UHF.



PSR-200

\$99.99
HRO Price

- Weather alert / Skywarn.
- Quick program.
- Five pre-programmed bands: Marine, Fire / Police, Air, Ham, Weather.
- 200 channel memories.
- 200 channels automatic scanning for VHF to UHF.

- Weather alert / Skywarn.
- Quick program.

Triple Trunking



PSR-300

\$199.99
HRO Price

- Selected bands from 25-1300 MHz (cellular excluded).
- 700 MHz coverage.
- Upgradeable CPU firmware for future rebanding.
- Multi trunking of Motorola (type I, II and hybrid analog system) EDACS and LTR.
- Pre-programmed conventional bands.
- Scan both trunking and conventional channels at the same time.
- 1500 ID memories in 10 banks.

PSR-400

\$199.99 – HRO Price

- Desktop / mobile scanner.
- Selected bands from 25-1300 MHz (cellular excluded).
- 700 MHz coverage.
- Upgradeable CPU firmware for future rebanding.
- 10 bank and 100 channel memories for trunk bank and channel combined with conventional mode memory.
- Multi trunking of Motorola (type I, II and hybrid analog system) EDACS and LTR.



Digital

Handheld Desktop & Mobile



PSR-600

\$499.99 – HRO Price

- Selected bands from 25-1300 MHz (cellular excluded).
- Intuitive "Object Oriented" user interface design for ease of use.
- Powerful and flexible scan list functionality.
- Flexible Free-Form Memory Organization.
- Menu-driven programming with context-sensitive help.
- Upgradeable CPU and DSP Firmware lets you keep you radio current with software enhancements.
- V-Scanner Technology lets you save complete radio configurations for quick recall.
- Multi System Trunking.



PSR-500

\$499.99
HRO Price

HF Receiver



NRD-545

\$1799.95
HRO Price



The NRD-545 HF receiver provides clear, distortion free sound through the application of 40-bit digital signal processing (DSP). 13 types of circuits are handled by the DSP unit including all mode detection, IF filter, pass band shift, noise reduction, beat canceller, noise blanker, notch filter, AGC, BFO, RF Gain, squelch, tone control and s-meter. Features a variable tuning system, high sensitivity, wide dynamic range RTTY demodulation, large LCD display, remote control by a personal computer. The NRD-545 covers .01 to 30 MHz and 30 MHz to 2000 MHz with the optional board. Covers all modes with outstanding sensitivity.

uniden®

SCANNERS



BCD-396T
TrunkTracker
IV Handheld
\$CALL – HRO Price

- 6000 dynamically allocated channels.
- TrunkTracker IV (Motorola APCO 25 Digital, Motorola, EDACS, LTR).
- Close Call™ RF capture.
- Fire tone-out. Alpha tagging. Search with scan.
- 100 quick key random access.
- Continuous coverage - 25 MHz to 1.3 GHz (cellular blocked).
- DCS/CTCSS rapid decode.

BC-RH96
Remote Head
for Scanners

Lets you fully control your BCD996T or BCD396T TrunkTracker IV Digital scanners or the BCT15 and BR330T Trunk Tracker III scanners, including volume and squelch! Turn your handheld scanner into a mobile, or install your mobile scanner when space is limited. The perfect companion to your Uniden Bearcat Public Safety Scanner.

- Backlit keypad and display.
- Compact size.
- Includes 10 foot data cord and power cable.
- Controls all functions including volume and squelch.
- Full remote control for the BCD996T, BCT15, BCD396T and the BR330T.



BC-246T
Handheld
\$CALL – HRO Price

- 1600 channels typical / 2500 maximum.
- Frequency coverage 25-54, 108-174, 216-225, 400-512, 806-956, 1240-1300 MHz (excluding cellular).
- Dynamically allocated memory.
- TrunkTracker III design.
- Alpha tagging.
- S.A.M.E. weather alert.
- 10 custom search ranges.
- 10 preprogrammed service searches.
- Automatic repeater reverse.
- Close Call™ RF capture.
- DCS/CTCSS rapid decode.
- Pager skip / channel alert.
- Backlit display.
- PC control includes a PC cable to transfer information from the computer.

Trunking /
Mobile Series

BC-350C
\$129.95 – HRO Price

The BC-350C has 100 channels, 14 band coverage, 800 MHz, preprogrammed service search, local police, fire/EMS scan, marine, air, CB, one touch weather, backlit display, AC or DC operation.

BC-T8
\$199.95 – HRO Price

This rig has 250 channels, 14-band coverage, Trunk Tracker technology, pre-programmed trunked state highway patrol, highway patrol alert, local police, CB, weather, fire, EMS, 800 MHz, air, DOT and news, backlit keys and display, AC or DC operation.

Mobile Trunking Scanner with
GPS Support and APCO-25



BC-996D
\$CALL
HRO Price

- 6000 dynamically allocated channels.
- Location-based scanning.
- TrunkTracker IV (motorola APCO 25 digital, EDACS, LTR).
- 100 system quick keys.
- Dual color display.
- Temporary lockout.
- Dangerous crossing, dangerous road and POI alert.
- DIN-E mounting.
- Multi-site trunking support.
- Close-Call™ RF capture technology.
- Public safety scanner.
- PC control/programming (free download).

BearTracker Mobile Trunking
Scanner with GPS Support



BC-BCT-15 \$CALL – HRO Price

- Frequency coverage 25-54, 2500 dynamically allocated channels.
- Up to 400 systems.
- TrunkTracker III.
- Location-based scanning.
- 100 system quick keys.
- BearTracker™ warning system.
- Close Call™ RF capture technology.
- Dangerous crossing, dangerous road and POI alert.
- Public safety scanner.

Base / Mobile Rig



BC-898T
\$CALL
HRO Price

- Multiple channels - 500 in 10 banks.
- Frequency coverage 25-54, 108-174, 216-512, 806-956 MHz (excluding cellular).
- 1000 talk group ID's. 10 lists of 10 per bank.
- TrunkTracker III technology for motorola, EDACS and LTR systems.
- DCS / CTCSS rapid decode.
- S.A.M.E. weather alert
- Priority operation.
- Conventional and trunked search operations.
- AC adapter, SC power cable and automotive power outlet plug.
- Programmable delay. Programmable search. 100 search skip memories.
- AM / FM / NFM modes.
- Frequency steps 5, 6.25, 12.5 and 25 kHz.
- 200 talk group skip memories.

Scanner
Software

BuTel

Proper programming is critical to the success and enjoyment of scanner listening. BuTel software is the world's most user-friendly and feature-rich scanner software. The software allows you not only to program your scanner but also control it and conduct signals logging with the PRO versions. Requires Windows 98 or later.

For Bearcat
Scanners

HRO Prices
Basic version \$39.95
Pro version \$69.95

- ARC8** (BearTracker 8)
- ARC230** (Sportcat 230)
- ARC246** (BC-246)
- ARC250** (BC-250, 785, 296, 796)
- ARC330** (BC-330)
- ARC396** (BC-396)
- ARC780** (BC-780)
- ARC898** (BC-898)
- ARC996** (BC-996)

For ICOM Scanners

HRO Price \$39.95

- ARC2** (ICOM R2)
- ARC3** (ICOM R3)

For AOR Scanners

- ARC5000** (AOR 5000) \$99.95
- ARC8200** (AOR 8200) \$69.95
- ARC8600** (AOR 8600) \$69.95

Software is sold on a non-returnable basis. Any software problems will be resolved under the terms of the manufacturer's warranty.

RADIO CASES

STUDY AIDS

Radio Protectors

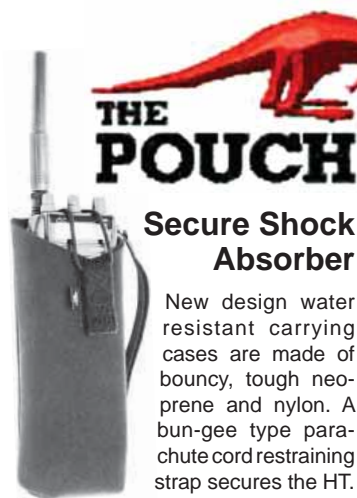

THE POUCH

Secure Shock Absorber

New design water resistant carrying cases are made of bouncy, tough neoprene and nylon. A bun-gee type parachute cord restraining strap secures the HT. Has a durable quick-release clasp on a web belt loop.



Analyzer POUCH

Neoprene & nylon plus water-resistant padding protect your analyzer. Clear window over read-outs. Back-pocket for accessories. Includes adjustable shoulder strap. Specify any model. **HRO Price \$24.95**



Chest POUCH

"Hands-free" security. Double-ply cordura "bib" with adjustable harness. Pouches for radio & spare battery. Pen holders and big pocket on back for accessories. Specify ANY radio or pouch. **HRO Price \$25.95**



Packer POUCH 817

The Packer Pouch 817 was especially designed for the Yaesu 817. **HRO Price \$24.95**

Make	Radio Model	Pouch Model	HRO Price
ADI	AT-201	T2A	\$17.95
Alinco	DJ-G5T	32-5T	\$14.95
	DJ-V5DC/V5TH	A5T	\$14.95
	DJ-280TH/480T	A3T	\$14.95
	DJ-196/496/596	P-5	\$14.95
Icom	IC-Q7	S508-Q7	\$12.95
	IC-T2H	T2A	\$14.95
	IC-T7A/T22A	P-5	\$14.95
	IC-T8A/81A	S510-T8	\$14.95
	IC-T90A	90Z	\$14.95
	IC-V8	A3T	\$14.95
	IC-W32A	32-5T	\$14.95
	IC-91	RP-IC91	\$12.95
Kenwood	TH-D7A	DTX	\$17.95
	TH-F6A	K6	\$15.95
	G71A	G71	\$17.95
	TH-79A 5.0 w	S2	\$17.95
	TH-79A 2.7 w	S1	\$17.95
	VC-H1	S2	\$17.95
Yaesu	FT-50RD	10R	\$14.95
	VX-1R	1R	\$12.95
	VX-3	3R	\$19.95
	VX-5R/VR-120	5R	\$14.95
	VX7R	7RX	\$19.95
	VX-150	110/150	\$15.95
	FT-60R	P60	\$19.95
	VX-170	Y170	\$19.95
Uniden	BCD-396T	UN-TT4	\$22.95



Gordon West

Study with the Best!

Part Number	Description	HRO Price
Study Manuals		
GWTM	Technician Class Book	\$18.95
GWTW	Technician Audio Theory Course on 6 CDs	27.95
NCS	Tech Book plus Software Package	39.95
GWGM	General Class Book	20.95
GWGW	General Audio Theory Course on 4 CDs	29.95
GWEM	Extra Class Book	24.95
GWEW	Extra Audio Theory Course on 7 CDs	39.95
ECS	Extra Book plus Software Package	49.95
TPG	Tech plus General Value Package	69.95
HOS	W5YI Ham Operator Software – no books	39.95
HOSB	W5YI Ham Operator Software plus 3 books	94.95
GUS	General Book plus software	44.95

Morse Code Study Materials

GW05	Morse Code 0-5 wpm 8 CDs	39.95
GW13	Morse Code 6-16 wpm 6 tapes	29.95
GW20	Morse Code 10-28 wpm 6 tapes	29.95
GWCT	CW Refresher Course 0-5 wpm, 2 audio CDs	14.95

Other Books

GSTD	Getting Started in Electronics	19.95
MINI-1	Mini Notebook, Vol. 1: timer, op amps, optoelectronic circuits and projects	12.95
MINI-2	Mini Notebook, Vol. 2: science and communication circuits and projects	12.95
MINI-3	Mini Notebook, Vol. 3: electronic sensor circuits and projects	12.95
MINI-4	Mini Notebook, Vol. 4: electronic formulas, symbols and circuits	12.95
BELC	Basic Electronics	19.95
BDIG	Basic Digital Electronics	19.95
BCOM	Basic Communications (analog) Electronics	19.95
GROL	Get Your Commercial Radio License – Book	39.95
GRSP	Get Your Commercial Radio License – Book plus W5YI Study Software Package	69.95

Flash Cards

Flash-N-Pass

Study for your license exams with these easy-to-use Flash and Pass study flash cards.

Technician Class

Flash Cards
Flash-TECH \$24.95

General Class

Flash Cards
Flash-GEN \$39.95

Extra Class

Flash Cards
Flash-EXTRA \$39.95
HRO Prices

Reference Book

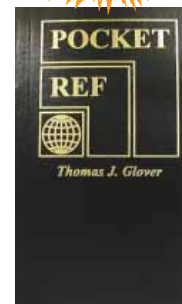

Pocket Reference Third Edition

This concise all-purpose reference has hundreds of tables, maps, formulas, constants & conversions. More than 200 new pages and thousands of updates!

Call HRO for More Books

AMATEUR BOOKS

Scanner Books

HRO stocks many books with frequencies for localities around the country. Contact your nearest HRO for details.

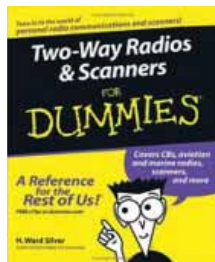

2 Way Radios & Scanners for Dummies
HRO Price 21.99

Scannerstuff

Southern California Frequency Directory

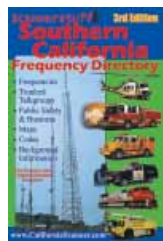

3rd Edition
Covering 10 Southern California counties in detail, the SCFD is the most up-to-date scanner information resource for the area. Organized by county for easy use, this 448 page directory

includes frequencies, channel numbers, PL tones, trunked frequencies and maps. **HRO Price: \$24.95**

Southwest Frequency Directory (10th Edition)

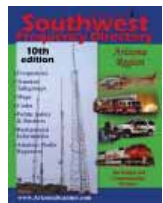

The most up-to-date directory for Arizona has 256 pages of scanner frequencies, codes, aircraft, businesses, and talk-groups for public safety. Organized by county, it includes detailed coverage of the new Phoenix/Mesa digital trunked radio system. **HRO Price: \$34.95**

Northwest Frequency Directory (10th Edition)

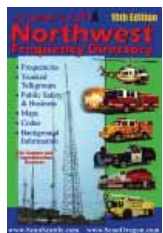

The most complete scanner information for western Washington and Oregon. Covers 38 counties on 324 pages of frequencies and codes for aircraft, fire, rescue, amateur, businesses, and more. Written and edited by local experts. Includes digital trunked radio systems. **HRO Price: \$24.99**

artsci BOOKS

U.S. Repeater Map Book 14th edition USRG

The PERFECT traveling companion for the radio enthusiast. Road maps show major highways and cities in every state. Amateur radio repeater frequencies are included. This is a must for truckers and travelers. Enhanced maps provide great highway detail. **HRO Price \$9.95**

Guides to Technical Radio Modifications & Alignment Controls RTM

Easy to follow instructions (with detailed drawings) to enhance almost all brands of amateur HT's and mobiles. Includes extended frequency plans. **HRO Price \$19.95 each**

Volume A (Icom, Kenwood, Scanners)

Volume B (Alinco, Standard, Yaesu, others)

Ham Overview

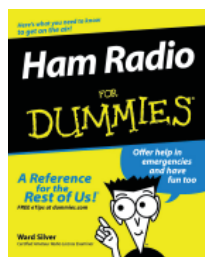

Ham Radio For Dummies

Hams do cool things like talking to folks around the world and helping with communications during emergencies. If hamming it up sounds like fun, here's the scoop, including licensing requirements and how to set up a station. And if you're already licensed, this book will help you start sounding (and feeling) like a pro!

The Dummies Way

- "Get in, get out" information.
- Explanations in plain English.
- Icons and other navigational aids.
- Tear-out cheat sheet.
- A dash of humor and fun.
- Top ten lists.

Discover how to:

- Set up a radio shack.
- Be a ham on the go.
- Understand ham jargon.
- Communicate on the air.
- Prepare for license exam.
- Help in an emergency or natural disaster.

HRO Price \$21.99

Software is sold on a non-returnable basis. Any software problems will be resolved under the terms of the manufacturer's warranty.

Radio Manuals

Nifty Mini-Manuals



Mini-Manuals are fully laminated, spiral bound booklets, 4.25 x 8 inches, providing simplified step-by-step instructions for all your radio's features. These short-form manuals are smaller, more durable, and easier to use than manuals normally supplied with a radio.

Model	Mini-Manual Description	HRO Price
NIFTY-MM-BandPlan	Amateur Radio Band Plan	\$10.95
NIFTY-FT-2000/D	For FT-2000 Series	\$20.95
NIFTY-FT-450	For FT-450 Series	\$20.95
NIFTY-FT7800R	For FT-7800R	\$16.95
NIFTY-FT817/ND	For FT-817 Series	\$16.95
NIFTY-FT857/D	For FT-857 Series	\$16.95
NIFTY-FT8800R	For FT-8800R	\$16.95
NIFTY-FT-8900R	For FT-8900R	\$16.95
NIFTY-FT897/D	For FT-897 Series	\$16.95
NIFTY-FT950	For FT-950	\$20.95
NIFTY-IC7000	For IC-7000	\$20.95
NIFTY-IC-706MKIIG	For IC-706MKIIG	\$16.95
NIFTY-IC-718	For IC-718	\$16.95
NIFTY-IC-746PRO	For IC-746PRO	\$20.95
NIFTY-IC-756PROIII	For IC-756PROIII	\$20.95
NIFTY-IC-910H	For IC-910H	\$20.95
NIFTY-IC-91A/AD	For IC-91A Series	\$20.95
NIFTY-IC-2820H	For IC-2820H	\$20.95
NIFTY-MFJ259B	For MFJ259 Series	\$12.95
NIFTY-MFJ269	For MFJ269 Series	\$12.95
NIFTY-TH-F6A	For TH-F6A	\$18.95
NIFTY-TM-D700A	For TM-D700A	\$16.95
NIFTY-TM-V71A	For TM-V71A	\$18.95
NIFTY-TS2000	For TS-2000 Series	\$18.95
NIFTY-TS-480S/HX	For TS-480 Series	\$18.95
NIFTY-TS-570D?S	For TS-570 Series	\$16.95
NIFTY-VX7R	For VX-87R	\$18.95
NIFTY-VX6R	For VX-6R	\$18.95
NIFTY-RADIOMG	Radio Monitoring Guide	\$15.95

CQ Publications

ARC2008	Amateur Radio Calendar 2008
BAUBAU	Building & Using Baluns & Ununs
LMOA	Lew McCoy on Antennas
Quadantennas	Quad Antennas
TPROM	Packet Radio Ops Manual

Ham Magazines

CQ	CQ Monthly
CQVHF	CQ VHF Quarterly
Popular	Popular Communications
QST	QST Monthly
MT	Monitoring Times Monthly
Scanning USA	Scanning USA
WRN	World Radio News



ARRL BOOKS

The ARRL Handbook for Radio Amateurs

The most complete update in a decade! Entire sections are updated: analog and digital signals and components; surface-mount components; high-speed multimedia (HSMM); previously unpublished antennas and advice on baluns; satellites and EME, now with new phase 3E details; oscillators, DSP and software radio design; a new chapter with Internet tips for hams, wireless fidelity (Wi-Fi) and other wireless and PC technology.

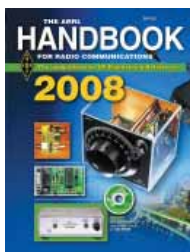

Thorough coverage of theory, references and practical projects. Here is an unmatched source for building receivers, transceivers, power supplies, RF amplifiers, station accessories and antennas. Now with more antenna projects and a 10-W, 60-meter SSB transceiver! Something for all skill levels.

Includes ARRL Handbook CD (version 9.0) – the fully searchable and complete book on CD-ROM (including many color images).
Softcover w/ CD \$39.95
Hardcover w/ CD \$54.95

Ham Radio FAQ

You've got questions... We've got answers! The ARRL Lab's Technical Information Service and "The doctor" have been answering ham's questions for nearly 8 decades. This book is a compilation of actual questions and their answers. Also includes a reference chapter. **HRO Price: \$14.95**

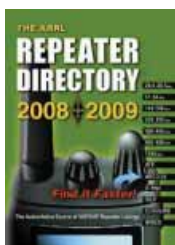
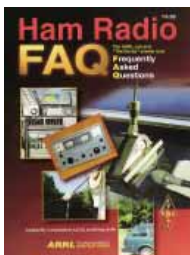

ARRL 2008-09 Repeater Directory

Now in two sizes:
Desktop and Pocket Size

- Thousands of FM voice and ATV repeater frequencies.
 - Latest directory of Frequency Coordinators.
 - Coverage of North, Central, South America, & some listings in Europe and the Middle East.
 - Now including IRLP (Internet linked) nodes.
- Pocket Size \$10.95 Desktop size \$15.95**

Software on CD

TravelPlus™ for Repeaters

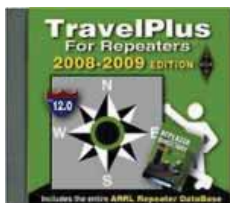

2008-2009 Edition
 With this traveling companion, you'll never be alone on the road. Locate ham radio repeaters on any US or Canadian travel route using this map-based software. Point and click. It's that easy. Includes the entire

ARRL Repeater Database. **HRO Price: \$39.95**

ARRL Antenna Compendium

Volume 7

43 all new articles! Nine articles deal with low-band antennas and operating, 4 on antennas for 10 meters and many more. Learn how to motorize a tower, how to safely put up a through-the-roof antenna system. CD-ROM included with propagation prediction software! **HRO Price \$24.95**

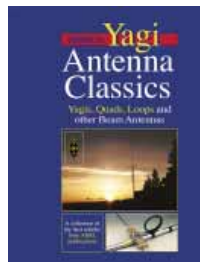
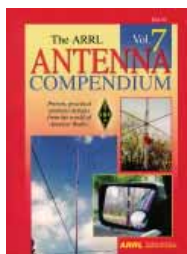

Yagi Antenna Classics

This collection of articles covering all types of beam antennas was taken from QST, QEX, NJ and other ARRL publications. Written by some of the best known authors on the subject, the articles provide the reader with a historical perspective, novel ideas and computer optimized designs. **HRO Price: \$17.95**

This collection of articles covering all types of beam antennas was taken from QST, QEX, NJ and other ARRL publications. Written by some of the best known authors on the subject,

The ARRL Antenna Book

21st Edition

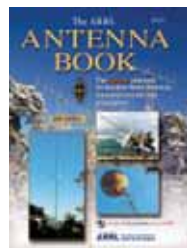

Hams and professionals will find projects and practical information on designing, building, and installing almost any imaginable type of antenna. Select and use the proper feed line and antenna tuner. Expanded coverage of low frequency

antennas. Greatly expanded coverage of elevation angles needed for world-wide HF propagation. New chapters cover the fundamentals, including the effects of irregular local terrain, plus more information on mobile and maritime antennas. Software included (MAC and PC). **Retail \$44.95**

APRS Moving Hams on Radio and the Internet

Your one stop for quick-and-easy instructions for installing and using the exciting new APRS software. Anyone with a packet station and computer can join the fun. APRS provides a real-time map display of participating stations. When used with a GPS receiver, it is ideal for tracking moving stations. Separate sections cover DOS, Windows and MAC platforms. Chapters include custom installation, map-making, hardware requirements, and even specialized uses such as direction finding, telemetry and DX plotting. **\$17.95**

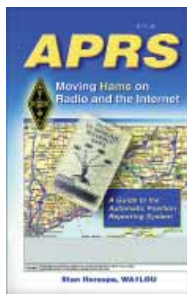

Satellites & Space

The Radio Amateurs Satellite Handbook

By **Martin Davi-doff, K2UBC** (author of the highly acclaimed predecessor, *The Satellite Experimenter's Handbook*).

The most comprehensive book ever written about amateur satellites! Long-time satellite operators and beginners will enjoy its in-depth coverage: setting up a station, choosing the right antenna for the right satellite, and tracking the "birds." Includes operating details for every active amateur satellite, the upcoming Phase 3D satellite, and all Amateur Radio operations from the US Space Shuttles (SAREX) and Russian Mir space station. Thorough appendices covering profiles of computer programs, Internet sites, FCC Rules, and a complete history of amateur satellite and space operations. **HRO Price \$24.95**

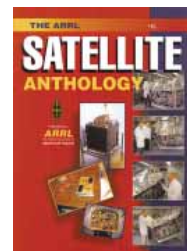

Satellite Anthology 5th Edition

Here are the best articles on current (and future!) amateur spacecraft from QST, The AMSAT Journal, the World Wide Web and other sources. We've included recent satellite columns from RadCom (Great Britain), Radio ZS (South Africa) and Amateur Radio (Australia). Includes specific operating details for the newest amateur satellites! **HRO Price \$15**

Weather Satellite Handbook

An easy-to-use reference for anyone interested in viewing our world from space. The expanded 5th edition has an interface project that allows you to capture images from various weather satellites and HF WEFAX broadcasts (a kit is available). You'll learn how weather satellites function, how to build or modify your own receiving equipment and how to buy or build the right antennas. **\$20. Companion software** (revised for the 5th edition) available for IBM PCs and compatibles. **\$10**



BOOKS / MAPS / SOFTWARE / CD-ROMs

ARRL TECHNICAL BOOKS

- HK Hints and Kinks (16th ed.)
- ITRFD Intro to Radio Freq. Design
- LBD Low Band DXing
- MEM Microwave Experimenter Manual
- OM Operating Manual
- PDOYA Yagi Design
- RASH The Radio Amateur's Satellite Handbook
- Reflections SWR Theory
- RFE RF Exposure and You
- RFI Radio Frequency Interference
- RSGB-Awards Awards Book
- RSGB-Opman Amateur Radio Operating Manual
- RSGB-RCH Radio Communication Handbook
- RSGB-VHF VHF / UHF Handbook
- SA Satellite Anthology
- SEH Satellite Experimenters Handbook
- SSS Spread Spectrum Source Book
- TFRB FCC Rule Book (13th ed.)
- TLT Transmission Line Transformers
- TAH ARRL 2008 Handbook
- WSH Weather Satellite Handbook

ARRL LISTINGS

- DXCC LIST Official ARRL DXCC List
- LB Log Book
- ND Net Directory
- RD Repeater Directory



ARRL READING

- CQGS CQ Ghost Ship
- DVQTH Death Valley QTH
- DXBD DX Brings Danger
- DXCC Companion DX Guidebook
- HFNH Help for New Hams
- MBQ Murder by QRM
- NCJ Bi-Monthly National Contest Magazine
- NS Night Signals
- NN Novice Notes
- QRP NOTE QRP Notebook
- QST Monthly Magazine of ARRL
- SOSAM SOS at Midnight
- YVC Your VHF Companion
- ET Easy Target Novel

ARRL MAPS

- WM World Map (Azimuthal)
- WM-R World Map (Robinson)
- GRID ATLAS Grid Locator Atlas
- GRID MAP Grid Locator Map
- MONA Amateur Radio Map of North America



ARRL ANTENNA BOOKS

- AB 21st Antenna Book
- ACVOL5 Antenna Compendium Vol. 5
- ACVOL6 Antenna Compendium Vol. 6
- ACVOL7 Antenna Compendium Vol. 7
- RSGB-ANT H.F. Antenna Book
- RSGB-WIRE Wire Antennas
- YAD Yagi Antenna Design

Low Power Operation

Low Power Communication

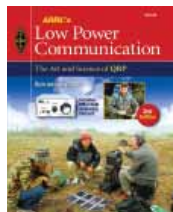

The Art and Science of QRP

by Richard Arland, K7SZ

Here's the low-down on low power operating, from selecting gear, to advanced operating techniques, antennas, emergency communications, solar power, and more! 208 pages. **HRO Price: \$14.95**

QRP Power

Whether you've just been bitten by the urge to operate flea power, or you've already discovered just how much fun it is to operate with 5 watts or less, this is the book you've been looking for. It's crammed with projects you can build and resource information you can use. In addition to the best recent QRP-related articles from QST, QEX and The ARRL Handbook, there's a new, in-depth article on NN1G's popular 40-40 transceiver. **\$19.95**



Study With ARRL

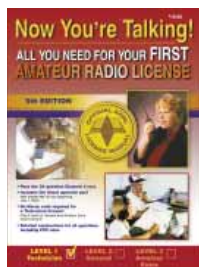

Ham Radio License Manual

Includes the latest question pool with answer key, for use to pass the 35-question license test. Designed for self-

study or classroom use. Discover the unique mix of technology, public service, convenience, and fun that makes up ham radio. **Retail \$19.95**

ARRL's Tech Q&A

Take the quick and easy path to your first ham license. Pass the 35-question Technician class examination by studying this question pool with brief, clear explanations. 3rd edition, for exams beginning July 1, 2003. **Retail \$12.95**



GENVIDEO / Soft
Gen Class Video / IBM Exam

TECHVIDEO / Soft
Tech Class Video / IBM Exam (New)

HRLM Ham Radio License Manual
TAGCLM General Class Manual
TAECLM Extra Class Manual
TFRB FCC Rule Book

ARRL CD-Roms

QST View



Back issues of QST on CD-ROMs. All the ads, articles, columns and covers have been scanned in black-and-white to read on screen or print. Easy-to-use software included allows you to: search for articles by title and author, select

specific year and issue, and browse individual articles. Available sets: 1990-94; 1985-89; 1980-84; 1975-79; 1970-74; 1965-69; 1960-64; 1950-59; 1940-49; 1930-39. Each set is an indexed. Requires Windows 3.1 or higher. **Each set \$39.95**

ARRL Periodicals CD-ROM Sets

Each space-saving CD-ROM is a compilation of an entire year's periodicals! You'll find the full text of every QST (ARRL's membership journal), QEX (The ARRL Experimenter's Exchange) and NCJ (The National Contest Journal). Includes every article, column, product review; drawing, table, illustration and photograph (many in color); and more than 1000 advertisement images, indexed alphabetically by vendor and product. Search engine finds information quickly by article titles, call signs, names or just about any word. Bookmark your favorites. Windows printing and clipboard support.

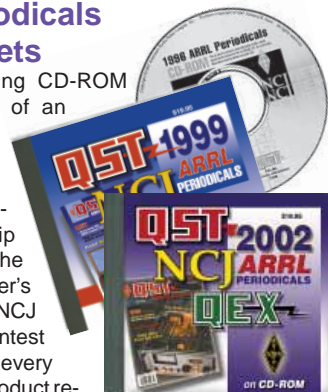

Part Number	Description	HRO Price
CDROM 15-29	QST Magazine 1915-1929 Editions	\$39.95
CDROM 30-39	QST Magazine 1930-1939 Editions	\$39.95
CDROM 40-49	QST Magazine 1940-1949 Editions	\$39.95
CDROM 50-59	QST Magazine 1950-1959 Editions	\$39.95
CDROM 60-64	QST Magazine 1960-1964 Editions	\$39.95
CDROM 65-69	QST Magazine 1965-1969 Editions	\$39.95
CDROM 70-74	QST Magazine 1970-1974 Editions	\$39.95
CDROM 75-79	QST Magazine 1975-1979 Editions	\$39.95
CDROM 80-84	QST Magazine 1980-1984 Editions	\$39.95
CDROM 85-89	QST Magazine 1985-1989 Editions	\$39.95
CDROM 90-94	QST Magazine 1990-1994 Editions	\$39.95
CDROM 95-99	QST Magazine 1995-1999 Editions	\$39.95
CDROM 95	QST, QEX, NCJ, HR on CD 1995	\$19.95
CDROM 96	QST, QEX, NCJ on CD 1996	\$19.95
CDROM 97	QST, QEX, NCJ on CD 1997	\$19.95
CDROM 98	QST, QEX, NCJ on CD 1998	\$19.95
CDROM 99	QST, QEX, NCJ on CD 1999	\$19.95
CDROM 2000	QST, QEX, NCJ on CD 2000	\$19.95
CDROM 2001	QST, QEX, NCJ on CD 2001	\$19.95
CDROM 2002	QST, QEX, NCJ on CD 2002	\$19.95
CDROM 2003	QST, QEX, NCJ on CD 2003	\$19.95
CDROM 2004	QST, QEX, NCJ on CD 2004	\$19.95
CDROM 2005	QST, QEX, NCJ on CD 2005	\$19.95
CDROM 2006	QST, QEX, NCJ on CD 2006	\$19.95

CD-ROMs

Radio Amateur Callbook CD-ROM 2008

HRO Price \$49.95

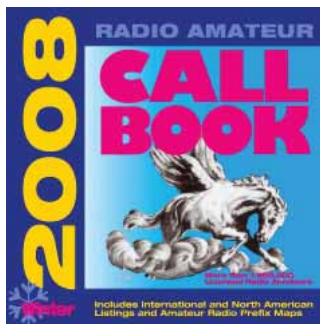

This is the most extensive radio amateur directory on the market. Incorporating both the North American and International editions of the world's most respected callbooks, it provides more than 1.6 million listings in more than 250 countries, islands, and dependencies. By including several countries not found in other directories, the Callbook offers unmatched world coverage.

- Windows / DOS platform.
- Data display by call-sign, last name, city, license class, issue, and expiration dates.
- Search U.S. stations by callsign, last name, and city.
- Search international by callsign, last name, city. Text search by name, street, city, province, or region after selecting country.
- Unique sound output of Morse code alphabet can be used by the blind or anyone who wants to learn Morse code.
- Windows clipboard tool for single label or applications. Import data into logging spreadsheet, word processor, or label printing program. Logging program interface available.
- Listings of clubs, "Then and Now" call letter changes, military, and silent keys.
- Text files listing prefixes by countries (40 zones), DXCC countries list, census of amateur prefixes, QSL bureaus, reciprocal operating agreements, 10-meter beacons, 6-meter beacons, international "Q" signals, and much more.



Ham Radio CD-ROM Version 30 – HRO Price \$24.95

Use the QRZ callsign data base with several ham radio logbook utilities. QRZWIN call sign search-and-retrieval software allows easy access to more than 600,000 names and addresses of US and Canadian hams. The full name, address and FCC license information is included with each record. QRZWIN provides editing and printing functions which make custom mailing lists easy. Import the information to your favorite word processor for advanced formatting and list processing. QRZ features an open database with documentation so users can create their own custom applications. Also on the CD: the complete text to FCC approved license examinations, questions and answers, current rules and regulations, and 100's of shareware utilities. For use with Windows 3.1, Windows 95, or DOS software.

BUCKMASTER

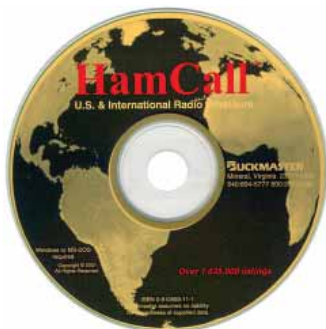

HamCall™ CD-ROM HRO Price \$50.00

HamCall™ contains more than 1,623,000 Us and International call-signs on one CD-ROM updated every month. When you buy a HamCall CD-ROM, it will contain the latest listings at that time. Your purchase entitles you to a FREE password to access the HamCall Internet search service for a full 6 months. This lets you search by callsign, name, address, class and more.

- Run HamCall from your hard drive.
- Ability to skip already printed labels.
- Double click any address to send email or a web address to visit it.
- Add your own notes to any call-sign.
- Print entire field search results (US records only).
- Calculates short and long path distance and bearing.
- Choose display font and color.
- Shows country flag and map.
- Shows CQ, ITU zone, continent.
- History list shows each call sign entered..
- View and search internet profiles for more than 35,000 hams.
- Search for club, military, RACES, vanity and silent keys.
- Over 122,000 email addresses.
- Latitude/longitude for more than 90% of US and DX addresses. US lat/long is calculated from the street address for precision down to a few hundred feet.
- Easy to use main menu.
- Data displayed includes: call sign, name, address, license issue date, license expiration date, birth date, previous calls, previous class, grid square, county, time zone, area code, email address, QSL manager and WWW home page.
- Edit information, change addresses, add new records, delete edited records, add email addresses, phone numbers, fax numbers and add your own notes.

CLOCKS

GEOCHRON

Computer Clock

World Watch™ & Screen Saver HRO Price \$49.95



Keep time with the world. With Geochron World Watch Time Piece for Windows®, just glance at your computer screen to see whether the rest of the world is open for business. The current time for any city in the world is displayed in an attractive graphic. You can even set it up as a World Watch Screen Saver. Customize the display using various maps, user-defined cities, and map settings. The graphic shows you instantly which parts of the world are in sunlight and which are dark. Individual clocks across the bottom of your screen display local time for any locations you select. International Daylight Savings Time adjusts automatically. With orders of 20 or more units, the Geochron World Screen Saver can be customized to show your company name and logo. A pull-down menu allows further customizing. Available for Microsoft Windows® 3.1 and above. Windows '95/98/NT/2000 compatible.

Wall Clock

Standard GEOCHRON Global Time Indicator A "must item" for a First Class Ham Shack.

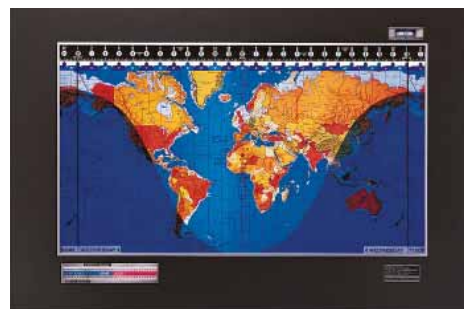

Size: 34" x 22" x 5"

Geochron is a true global time indicator. At any moment, Geochron displays the correct time everywhere in the world – the week, date, the sun's declination and distribution of daylight and darkness on the earth's surface.

Geochron is available in four (4) models and a multitude of housing finishes and trim colors. Packaged for "drop shipment" anywhere in the world via UPS or DHL. Geochron can be surface mounted on the wall like a picture or recessed using optional mounting brackets.

Call HRO for special pricing opportunities.

TOOLS / ANALYZERS / SWR / WATT METERS

Soldering Equipment

Weller®

WTCPT Soldering Station

HRO Price
\$129.95



A soldering station is a must for every ham shack.

- Quick disconnect plug for iron and lighted on / off switch.
- Special "closed loop" method of controlling maximum tip temperature.
- Transformer powered with macro style, low voltage, temperature controlled soldering iron.
- Power unit housing features impact resistant plastic.
- Separate conductor grounds iron tip and terminates at third pin of power cord.
- Uses PT series tips and operates at 600°F, 700°F and 800°F.

WLC-100 Solder Station

HRO Price \$49.95



40 watt solder station, 110 volts.

Adjustable 5-40 watts with safety guard solder iron. Includes holders, sponge and tip.

8200

Solder Gun

HRO Price \$39.95

100/140W, 110 V. Ready to solder in 6 seconds. Finger tip selection of high / low power. Great for soldering coax connectors.

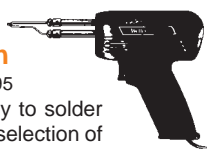

D650

Solder Gun

HRO Price \$59.95

Solder gun, 200/300 watts. Great for soldering coax connectors outside.

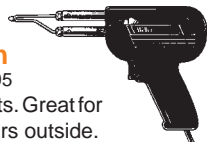

ECG®

SOLDERING PRODUCTS



J-060VT

Soldering Iron

25-60 W

HRO Price \$19.95



JT-009

Three Replacement Tips for the J-060VT

HRO Price \$7.95

DAIWA

CN-101

- Cross needle design reads forward, reverse and VSWR simultaneously, no calibration required.
- Easy to read meter.
- PEP monitor function
- Illuminated meter, 12vdc plug provided.



CN-101	
Frequency	1.8 - 150 MHz
Power Range	15 /150 / 1.5 KW
Power Rating	1.5 KW (1.8-60 MHz) 1 KW (144 MHz)
SWR Detection	4 W minimum
HRO Price	\$99.95

CN-801

Professional Series



- Easy to read, illuminated, extra large meter face with mirrored graph in .5 watt increments.
- Cross needle design reads forward, reverse and VSWR simultaneously, no calibration required.
- PEP monitor function
- Illuminated meter, 12vdc plug provided.

	CN-801H	CN-801V	CN-801S
Frequency	1.8-200 MHz	140-525 MHz	900-2500 MHz
Power Range FWD	20/200/2kW	20/200 W	2/20W
Impedance	50Ω	50Ω	50Ω
Connectors	SO-239	SO-239	N-Type
SWR	5 W	5 W	0.5 W
Detection	minimum	minimum	minimum
HRO Prices	\$129.95	\$149.95	\$229.95



SX-40C

Diamond RF SWR / Watt meters cover the full range of amateur applications. The SX-20C and SX-40C are the newest models. The SX-40C can be used on 220 MHz with a correction factor.

DIAMOND

SX-1000



All models:

- Illuminated meters.
- Require 12 volts DC.
- Low insertion loss generally less than 0.2 dB in HF range and 0.3 dB at higher frequencies.
- Power measurement accuracy is generally ±10% on the higher power ranges and ±5% on the lower.
- Low loss SO-239 connectors are used except for the high frequencies as noted in the table.
- Measurements are forward power, reflected power, SWR &, on selected frequencies, PEP monitor.

Impedance Analyzer

Timewave Technology



TZ-900 AntennaSmith™ Analyzer

Analyze an antenna system in real time with customized graphs for individual installations. Uses a full color TFT LCD graphic display. Show SWR plot or Smith chart. With the push of a button the data can be stored for later on-screen comparison, download, analysis, and print-out. Upload your saved files to compare new and old antennas on the display in real time. (Uses the included Timewave AS-1 software on the PC. Requires Windows 98 or XP.)

Quickly tune the cursor to check your antenna system at the desired frequency while looking at the big picture on the graph. The direct digital synthesizer makes a great RF signal generator. Easily calibrate to WWV with 1 Hz frequency resolution.
HRO Price \$999.95

Diamond Meters

Model	Freq MHz	Power Ranges	Con- nector	HRO Price
SX-20C	3.5-30	30/ 300 W	SO-239	\$89.95
	50-54			
	130-150			
SX-40C	144-470	30/ 300 W	SO-239	\$79.95
SX-100	1.6-60	30/ 300/ 3KW	SO-239	\$129.95
SX-200	1.8-200	5/ 20/ 200 W	SO-239	\$89.95
SX-400	140-525	5/ 20/ 200 W	SO-239	\$109.95
SX-600	1.8-160	5/ 20/ 200 W	SO-239	\$169.95
	140-525			
SX-1000	1.8-160	5/ 20/ 200 W	SO-239 Type N Type N	\$199.95
	430-450			
	800-930 1230-1300			

POWER SUPPLIES



DM-330MVT
Switching Power Supply

Super compact, lightweight power supply is great for portable operations. Provides 32 amps peak, 30A continuous. Variable output 5-15 VDC. Preset voltage function. Patent pending noise offset circuit moves pulse noise. Short circuit protection. Convenient front panel connections. Cigarette plug socket. **HRO Price \$Call**



DM-340MVT

The DM-340MVT delivers high quality, steady DC at a maximum of 35 A (30A continuous) with a reliable protection circuit. Features V/A twin meters, forced air cooling fan, 16mm main terminals, 2 pairs of auxiliary snap-in and cigar socket output terminals and a fuse socket on the front panel. **HRO Price \$Call**



Switching Mode DC Power Supply
GZV4000

The GZV4000 switching mode DC power supply has a 40 amp continuous rating at 100% duty cycle. The supply has variable voltage from 5-15 VDC using a voltage control knob with a center detent at 13.5 VDC. There is overload and short circuit protection with current feedback at approximately 42 amps and temperature protection with a variable speed fan. An AC line filter provides EMI protection. The meter selector allows monitoring of voltage and current. Power and overload indicators are included. Connect your rig easily with front panel DC terminals and a cigarette lighter jack. The unit has an internal 8 ohm speaker. Operates on 120 VAC ± 20%, 50-60 cps. Ripple and noise is less than 8mV rms. **HRO Price: \$199.95**



MODEL RS-35M

All of Astron's solid-state electronically regulated Power Supplies have fold-back current limiting to protect from excessive current and a heavy duty heat sink. Output voltage: 13.8 VDC ±.05 volts. 220 V supplies available on special order at slightly higher price.

RS-A Series Standard power supply with on / off switch. Voltage may be adjusted internally.

SL Series Slim Line design for low-profile looks.

RS-M Series Power supply with front meters. One is for voltage and the other current.

SS Series High efficiency switching supplies specially filtered for use with communications equipment for all frequencies including HF. Heavy duty design, low profile, light weight and EMI filter.

VS-M Series Variable power supplies with separate volt and amp meters. Adjustable output: 2-15 volts.

RM Series 19" x 5 1/4" rack-mount power supplies available with or without meters and may be variable. The new RM-60 comes with or without meters.

Power Supplies

Brand	Model	Cont. Duty 13.8 VDC	Intermit Duty	Height in	Width in	Depth in	Weight lbs	HRO Price
Alinco	DM-330MVT	30 A	32A	2.75	7	7	5	\$Call
Astron	RS-4A	3 A	4 A	3.75	6.5	9	5	\$39.95
	RS-7A	5 A	7 A	3.75	6.5	9	9	\$59.95
	RS-10A	7.5 A	10 A	4	7.5	10.75	11	\$69.95
	RS-12A	9 A	12 A	4.5	8	9	13	\$79.95
	RS-20A	16 A	20 A	5	9	10.5	18	\$96.95
	RS-35A	25 A	35 A	5	11	11	27	\$149.95
	RS-50A	37 A	50 A	6	13.75	11	46	\$219.95
	RS-70A	57 A	70 A	6	13.75	13.75	48	\$299.95
	RS-12M	9 A	12 A	4.5	8	9	13	\$89.95
	RS-20M	16 A	20 A	5	9	10.5	18	\$116.95
	RS-35M	25 A	35 A	5	11	11	27	\$169.95
	RS-50M	37 A	50 A	6	13.75	11	46	\$239.95
	RS-70M	57 A	70 A	6	13.75	12.12	48	\$329.95
	RM-50A	37 A	50 A	5.25	19	12.5	50	\$299.95
	RM-60A	50 A	55 A	7	19	12.5	63	\$349.95
	RM-35M	25 A	35 A	5.25	19	12.5	38	\$259.95
	RM-50M	37 A	50 A	5.25	19	12.5	50	\$329.95
	RM-60M	50 A	55 A	7	19	12.5	63	\$389.95
	VS-20M	16 A	20 A	5	9	10.5	20	\$139.95
	VS-35M	25 A	35 A	5	11	11	29	\$199.95
VS-50M	37 A	50 A	6	13.75	11	46	\$259.95	
SL-11A	7 A	11 A	2.75	7.62	9.95	11	\$79.95	
SL-15R	12 A	15 A	2.75	7.62	9.95	14	\$109.95	
SS-10	7 A	10 A	1.125	6	9	3.2	\$80.95	
SS-12	10 A	12 A	1.375	6	9	3.4	\$89.95	
SS-18	15 A	18 A	1.375	6	9	3.6	\$99.95	
SS-25	20 A	25 A	2.875	7	9.375	4.2	\$119.95	
SS-30	25 A	30 A	3.75	7	9.625	5	\$129.95	
Diamond	GZV4000	40 A	42 A	4.5	8.25	13	8	\$179.99
Diawa	SS-330W	30 A	33 A	4	5	11	4.8	\$169.95
	SS-505	50 A	55 A	4.3	8.5	11	8.25	\$399.95
Icom	PS-85	15 A	20 A					\$269.95
	PS-125	25 A	25 A	3.7	4.4	11.3	6.6	\$349.95
Kenwood	KPS-15	20 A	23 A	2.38	7.1	8.88	4.5	\$199.95
	PS-52	22.5 A	22.5 A	4.25	7	12.25	16	\$279.95
	PS-53	22.5 A	22.5 A	6.81	3.78	11.66	15.2	\$269.95
Samlex	SEC1212	10 A	12A	2.2	7	8.25	3	\$79.95
	SEC1223	23 A	24 A	2.2	7	8.25	4	\$99.95
	SEC1235	30 A	35 A	2.1	10.4	7.1	5	\$129.95
	SEC1235M	30 A	35 A	2.1	10.4	7.1	5	\$139.95
Yaesu	FP-1023	23 A		2.25	6	8.25	4.2	\$149.95
	FP-1030A	25 A	30 A					\$239.95

* Internal Supply
(220 volt versions of some models available at additional cost by special order. Contact HRO for details.)

POWER SUPPLIES



Switching Supplies

THE "Power supply choice of radio manufacturers worldwide"

NEW!



SEC-1235M

This unit has volt and amp meters built in. 100-130 VAC, 13.8 VDC.

- Best power supply value available today.
- 30 amps continuous, 35 amps intermittent.
- **3 year warranty** - "no questions asked."
- UL + cUL Safety approved. FCC compliant.
- Thermal activated fan. **No hash..**
- Fully protected - voltage / current / short-circuit.
- Perfect for all 100-200 watt applications.
- Dim 7"w x 2.1"h x 7.1"d; 4.5 lbs.

HRO Price \$139.95



SEC-1235

Same as the 1235M above, but without volt and amp meters.

HRO Price \$129.95

For Base Stations

Switching Mode Power Supplies

SEC-1223 23A Switching Power Supply

The perfect light-weight companion for 100 Watt Class transceivers. Input 100-130VAC; Output: 13.8VDC @ 23 Amps; UL approved. Also works on 200-240VAC input with a simple jumper change. Safety features: Current limiting; Short circuit protection; Overvoltage protection; Quiet temperature controlled cooling fan.

- 3 year warranty - "no questions asked."
- Dim 7"w x 2.1"h x 7.1"d; 4.5 lbs.

HRO Price \$99.95



SEC-1212 12A Switching Power Supply

Same size as the 1223, this model is highly filtered to provide clean power to HF, VHF and UHF radios. Input: 100-130VAC; Output: 13.8 VDC @ 12 Amps: UL approved. Also works on 200-240VAC input with a simple jumper change. Safety features: Current Limiting; Short circuit protection; Overvoltage protection; Quiet temperature controlled cooling fan.

- 3 year warranty - "no questions asked".
- Dim 7"w x 2.1"h x 7.1"d; 4.5 lbs.

HRO Price \$79.95



Switching Supplies



Daiwa switching power supplies are one-third the weight and one-half the size of conventional power supplies. Daiwa models can be used for DC motors that require peak starting currents and will accept input voltage from 90-130V. Switching supplies can create pulse noise, but Daiwa engineers have isolated any noise and moved it out of the amateur bands creating a super quiet power supply.

SS-330W: 30 amp

- 30 amps continuous voltage (33 peak).
- Voltage adjustable: 5-15V.
- Dual meters, amp and voltage.
- Automatic cooling fan built in.
- Weight: ONLY 4 lbs 14 ozs.
- Dimensions: 5" x 4" x 11" (approx).
- Ripple voltage: less than 10 mV.
- Short circuit protected.
- Carry handle for portability.

HRO Price \$169.95

SS-505: 50 amp

- 50 amps continuous voltage (55 peak).
- 50 amps available at all output voltages.
- Voltage adjustable: 5-15V.
- Binding posts on back, cigarette-lighter socket, spring loaded connectors on front.
- Voltage fluctuation: less than 1.5%.
- Dual purpose meter - amp and voltage.
- Automatic cooling fan built in.
- Weight: ONLY 8 lbs 4 ozs.
- Dimensions: 8.5" x 4.3" x 11" (approx).
- Ripple voltage: less than 5 mV.
- Short circuit protected.
- Carry handle for portability.
- Perfect for industrial, laboratory, or ham use.

HRO Price \$399.95

Kilowatt Monitor

Kill-A-Watt

Connect equipment into the Kill-A-Watt™ to assess its efficiency. A large LCD display counts consumption by the kilowatt hour just like utility companies. You can figure out your electrical expenses by the hour, day, week month, even an entire year. Monitor the quality of your power by displaying voltage, line frequency, and power factor.

Specifications: Operating Voltage: 115VAC. Maximum Voltage: 125 VAC. Maximum Current: 15A. Maximum Power: 1875 VA.

HRO Price \$39.95



Rig-Matching Power Supplies



HP-450



The HP-450 is a matching power supply for the HL-450B and HL-350V DX amplifiers. It features a light weight design with 60A maximum (8 hours continuous). It operates on 100-140 VAC.

HRO Price \$Call

KENWOOD



KPS-15

The KPS-15 is a compact, switching power supply for high current applications. It is rated at 23 amps and is similar in size to the TS-50. The supply is for 110-230 VAC. Weighs only 4.5 pounds. **Suggested List Price \$229.95**



PS-125



This is the matching supply for the IC-756PRO. It will work with all Icom HF radios. 25A continuous switching supply. **HRO Price \$299.95**



FP-1030A

Yaesu has power supplies primarily designed for use with their HF rigs. These include the FP-712, FP-1023 and the FP-1030A and are low profile switching supplies.



BATTERY PACKS / CHARGERS

MH-C9000
WizardOne
Charger-Analyzer
\$59.95



Features 4 independent slots, large backlit LCD display and endless programming possibilities.

There are 5 modes of operation: Charge; Refresh & Analyze; Break-in; Discharge and Cycle. Use the charger for battery matching. Battery matching refers to grouping batteries with similar "actual" capacity for best performance when used together. Use the Battery Forming to force a full charge into a new or fully discharged battery by charging at a very slow rate. It comes with a light worldwide power supply and is 12VDC compatible.

MH-C808M
8 Cell
Multi Charger
\$89.05



This is a dependable, high speed charger that can charge AA, AAA, C and D cells. There are 8 independent charging circuits to charge 1 to 8 batteries. Mix rechargeable AA / AAA / C / D Ni-CD and Ni-MH batteries. Backlit display shows charging and conditioning status. Selectable soft and rapid charge modes. Built-in deep battery conditioning system.

MH-C801D
8-Cell One Hour Charger
\$69.95



- Eight independent charging circuits. Charge 1 to 8 batteries. Mix rechargeable AA / AAA batteries.
- LCD display shows charging and conditioning status in English.
- Precision microprocessor controlled 0.001 V voltage detection. No under-charge. No over-charge.
- Selectable soft and rapid charge modes soft charge option for highest battery life. Rapid charge option for shortest charge time.
- Built-in deep battery conditioning system.

Model	Description	HRO Price
MH-C9000	WizardOne Charger-Analyzer	\$59.95
MH-C800S	8 Cell Smart Charger	\$56.95
MH-C801D	8 Cell 1-hour Charger	\$69.95
MH-204W	1-Hour Worldwide Travel Conditioning	\$29.95
MH-C808M	Ultimate Professional Charger for Eight AA/AAA/C/D NiMH/NiCD	\$89.95

NiMH Ham Radio Battery Packs

Model	Volts (Vdc)	Capacity (Mah)	Compatible Handheld	HRO Price
MH-CNB-152	12	1000	ADI AT-201, 401	\$59.95
MH-FNB-12	12	1000	Yaesu FT-470, 411, 811, 23R, 33R	\$59.95
MH-FNB-17	7.2	1000		\$49.95
MH-FNB-27	12	1000	Yaesu FT-530, 76, 415, 815, 729	\$59.95
MH-FNB-31	4.8	650	Yaesu FT-51R, 41, 11	\$49.95
MH-FNB-38	9.6	650		\$59.95
MH-FNB-40H	7.2	1000	Yaesu FT-50R, 40, 10	\$59.95
MH-FNB-41	9.6	1800		\$55.95
MH-FNB-V47	7.2	1800	Vertex VX-400, VX-210	\$69.95
MH-FNB-V57	7.2	1500		\$49.95
MH-FNB-58LI	7.4	1200	Yaesu VX-5R, VX-7R	\$59.95
MH-FNB-72	9.6	1700	Yaesu FT-817	\$59.95
MH-FNB-80LI*	7.4	1400	Yaesu VX6R, VX7R (lithium)	\$59.95
MH-FNB-83	7.2	1650	Yaesu VX150, VX170, FT60R	\$59.95
MH-BP-7	13.2	1000	Icom 2GA, 2AT, 4GAT, 12GAT	\$69.95
MH-BP-8	8.4	1200	Icom 2GA, 2AT, 4GAT, 12GAT	\$59.95
MH-BP-8H	8.4	1800		\$69.95
MH-BP-83	7.2	1300	Icom W2A, 4SA, 2-3-24SAT	\$49.95
MH-BP-132G	12	1300	Icom W21, 2GXAT, V21AT Gray	\$59.95
MH-BP-132B	12	1300	Icom W21, 2GXAT, V21AT Black	\$59.95
MH-BP-173	9.6	650	Icom W31, W32, T7A, T22, T44, Z1A	\$69.95
MH-BP-180	7.2	1000		\$49.95
MH-BP-196M	9.6	1350	Icom T2A, T2H	\$49.95
MH-BP-199	6	700	Icom T8A, T81	\$55.95
MH-BP-200	9.6	680		\$59.95
MH-BP-209N	7.2	1100	Icom -V82, IC-U82	Call
MH-BP-210N	7.2	1650		Call
MH-BP-211N*	7.4	1800		Call
MH-BP-212N	7.2	600	Kenwood TH77, 450T, 55AT, 26, 75	Call
MH-PB-8	12	1300		\$62.95
MH-PB-17	12	1300	Kenwood TH-27, 247, 28, 48	\$69.95
MH-PB-18	7.2	1300		\$49.95
MH-PB-32	6	1000	Kenwood TH-22, 42, 79AD	\$47.95
MH-PB-34	9.6	1000		\$57.95
MH-PB-39	9.6	1050	Kenwood TH-G71A, D7	\$59.95
MH-PB-39H	6	1800		\$59.95
MH-PB-42LI	7.4	1800	Kenwood THF6A	\$69.95

* Lithium

NiMH Rechargeable Battery Cells

Model	Volts (Vdc)	Capacity (Mah)	Description	HRO Price
MH-4AA270	1.24	2700	4 pack "AA" size NiMH Cells	\$12.95
MH-AAA1000	1.24	1000	2 pack "AAA" size NiMH Cells	\$5.99
MH-2C500	1.24	3800	2 pack "C" size NiMH Cells, 5000 mAh	\$19.95
MH-2D110	1.24	7500	2 pack "D" size NiMH Cells, 11000 mAh	\$29.95
MH-RAAI4	1.24	2100	4 pack "AA" size NiMH Cells	\$10.95
MH-RAAAI4	1.24	800	4 pack "AAA" size NiMH Cells	\$9.95

Prices in this print catalog are subject to change

SOLAR POWER SYSTEMS



Steca Controllers

The SunWize-Steca Solsum controller is an economical pulse-width modulated shunt controller. A tricolor LED indicates three ranges of battery voltage and a green LED indicates current array. The Solsum controller features overcharge and over discharge protection, temperature compensated charging, MOSFET transistors and fuse protection. These controllers ensure maintenance-free operation and long product life. Available with or without a low-voltage disconnect.

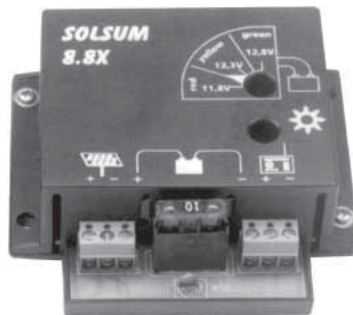

The SunWize-Steca Gamma, Sigma and Omega controllers use an advanced control algorithm that sets new standards for solar charge technology. The self-learning controller automatically adjusts for the capacity and age of the battery. Patented hybrid regulator design combines both series and shunt technology for nominal power consumption. These controllers provide standard protection features as well as a tricolor information LED and tricolor state-of-charge LED. Available with or without an LCD.

Model	Voltage	Rated PV Current	Rated Load	Size (inches)	Weight (lbs)	HRO Price
Solsum 5.0X	12/24 VDC	5A	5A	3.4 x 3.85 x 1.37	0.22	CALL
Gamma	12/24 VDC	12 A	12 A	7.4 x 4 x 1.93	1	CALL
Sigma	12/24 VDC	20 A	20 A	7.4 x 4 x 1.93	1	CALL
Omega	12/24 VDC	30 A	30 A	7.4 x 4 x 1.93	1	CALL



OEM Solar Module Kits

The Solar Module Kits include a solar module, the SunWize SW-1L6 prewired voltage regulator with output cable and a fixed tilt, 45" side-of-pole mount. The waterproof controller has a multi-function LED indicator and fuse protection. 20 year warranty. OEM 5 and 10 kits include 5' cable and OEM 20 and 40 10' cable.

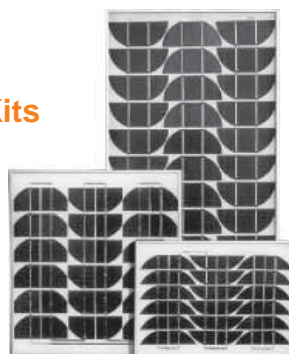

Kit Model	Rated Voltage	Rated Power	Open Circuit Voltage	Rated Current	Size (inches)	Weight (lbs)	HRO Price
OEM5	16.4	5 W	20.5	.31 A	11.82 x 9.84	7	CALL
OEM10	16.4	10 W	21	.61 A	15.15 x 14.76	8.5	CALL
OEM20	16.5	20 W	21	1.22 A	20.86 x 16.93	12.5	CALL
OEM40	16.7	40 W	21	2.40 A	38.38 x 17.13	18.5	CALL



Batteries



The valve-regulated, gelled-electrolyte Deka Solar batteries offer reliable, maintenance free power for renewable energy applications. All models 12VDC. Sealed construction eliminates periodic watering, corrosive acid fumes and spills. The electrolyte will not stratify so no equalization is required. These batteries are rated non-spillable by ICAO, IATA and DOT. Safe to ship by truck or air.

Model	Capacity @ 100 Hr. Rate	Capacity @ 20 Hr. Rate	Size (inches)	Weight (pounds)	HRO Price
8GUI	36 Ah	31 Ah	7.75 x 5.13 x 7.25	24	CALL
8G22NF	56.5 Ah	48 Ah	9.4 x 5.5 x 9.25	39	CALL
3G27	98 Ah	86 Ah	12.75 x 6.75 x 9.87	64	CALL

SPEAKERS

West Mountain Radio



Computer Speakers for your Ham Station



COMspkr

Amplified speaker system is optimized for operation in close range of any radio transmitter. High rejection of RF interference, 1 to 1000 MHz. Use with computer, radio, MP3 player. Stereo high-fidelity. Audio cables and wall mount power supply included. Wooden cabinet. HRO Price \$69.95

The following products contain a ClearSpeech® adaptive noise reduction digital signal processor. Reduces or eliminates atmospheric noise, hum, hiss, hetrodynes and static for voice and CW. They greatly improve the signal-to-noise ratio for all QSOs.



Noise Reducing Speaker



CLRspkr

This small, amplified loudspeaker is ideal for mobile operation. Plugs into radio's speaker or headphone output. Small size 5.25 x 7 x 2.5 inches. Constructed of a heavy duty molded case with adjustable mounting bracket. Includes a 6 foot audio cable and a 6 foot power cable with PowerPole connectors for an optional VDC 13.6 power source. HRO Price \$199.95



Noise Reducing Processor CLRdsp

Outboard processor is ideal for hamshack operation. Processor contains a 2 watt audio power amplifier. Metal case just 5.5 x 4.5 x 1.25 inches. Connects between your radio's speaker or headphone output and your station loudspeaker. Uses 1/8 inch audio plugs. Includes two 6 foot audio cables and a 6 foot power cable with PowerPole connectors for an optional 13.6 VDC power source. HRO Price \$199.95

Wall Mount Power Supply for CLRdsp, 117Vac to 12 VDC at 1 amp. HRO Price \$14.95

AMPLIFIERS



**IC-PW1
w/ Solid State
Remote
Control Head**



Icom's linear amp provides wide frequency coverage with up to 1kW output requiring only a 100-watt maximum input. The duty cycle is 100 percent with full break-in operation. It covers amateur bands 160 to 15 meters plus 6 meters. Includes an automatic antenna tuner for all bands. Internal circuitry allows the ALC to be adjusted over a wide range so the PW1 to be used with almost any rig, not just Icom. Operates on 110 or 220 VAC 50 or 60 cycle.



**Quadra System
\$3899.95 – HRO Price**



Here's all the linear amplifier you should need for operation on both HF (160 to 15 meters) and 6 meters. It has automatic band switching with the FT-1000D, FT-1000MP, FT-920, FT-990, and the FT-900 HF radios.

The amp has 8 MRF150 power MOSFet transistors designed into 4 units of 2 transistors in a push-pull circuit at 48 VDC. The

HRO will provide 10 meter modification information to amplifier customers upon receipt of a copy of your valid, current amateur radio license.

separate power supply, the VP-1000 allows for easy installation. There are two input voltages, 117 VAC or 220 VAC. Output power is a function of the power supply voltages. At 220 VAC there is 1000 watts out on HF and 500 watts on 6 meters. At 117 VAC the output is reduced to 500 watts on HF.

The Quadra is equipped with a built-in high speed tuner to match the amp to your antennas. It has four antenna outputs and two inputs. The multifunction omni-glow LCD display shows the status of the amplifier. There is automatic system monitoring with VSWR protection.

Maker	Model	Frequency Range	Modes	Power In	Power Out	Voltage	Current	Pre-amp	Connector	Wgt	HRO Discount Price
Ameritron	AL-1500	160-15 M*	SSB, CW	65 W	1500+ W	220 VAC	15 A	--	SO-239	50 lbs#	\$2,999.95
	AL-1200	160-15 M*	SSB, CW	100 W	1500 W	220 VAC	15 A	--	SO-239	50 lbs#	\$2,999.95
	ALS-500M	160-15 M*	SSB, CW	100 W	500 W	13.8 VDC	80 A	--	SO-239	7 lbs	\$799.95
	AL-572	160-15 M*	SSB, CW	100 W	1300 W	110/220 VAC	12 A 110V	--	SO-239		\$1,399.95
	ALS-600	160-15 M*	SSB, CW	100 W	600 W	110/220 VAC	16 A 110V	--	SO-239	13 lbs#	\$1,129.95
	AL-80B	160-15 M*	SSB, CW	100 W	1000 W	110/220 VAC	15/10 A	--	SO-239	54 lbs	\$1,249.95
	AL-800	160-15 M*	SSB, CW	100 W	750 W	110 VAC	12 A	--	SO-239	67 lbs	\$1,799.95
	AL-800H	160-15 M*	SSB, CW	55 W	1500 W	240 VAC	9 A	--	SO-239	69 lbs	\$2,899.95
	AL-811	160-15 M*	SSB, CW	75 W	600 W	110/220 VAC	8/4 A	--	SO-239	40 lbs	\$699.95
	AL-811H	160-15 M*	SSB, CW	75 W	800W	110/220 VAC	8/4 A	--	SO-239	41 lbs	\$849.95
	AL-82	160-15 M*	SSB, CW	100 W	1500 W	220 VAC	15 A	--	SO-239	52 lbs#	\$2,299.95
Icom	IC-PW1	160-15 M*	SSB, CW	100 W	1000 W	110/220 VAC		--	SO-240	55 lbs	\$4,699.95
Mirage	A-1015G	50-54 MHz	All	10 W	150 W	13.8 VDC	23 A	yes	SO-239	5 lbs	\$359.95
	B-34	144-148 MHz	FM	2 W	35 W	12-15 VDC	4 A	--	SO-239	2 lbs	\$99.95
	B-34G	144-148 MHz	FM	2W	35 W	12-15 VDC	4 A	yes	SO-239	2 lbs	\$109.95
	BD-35	143-149/430-450	FM	7 W	45 W	12-15 VDC	7 A	--	SO-239	3 lbs	\$179.95
	B-310G	144-148 MHz	All	4 W	100 W	13.8 VDC	15 A	yes	SO-239		\$229.95
	B-1018G	144-148 MHz	All	10 W	160 W	13.8 VDC	25 A	10 dB	SO-239	5 lbs	\$399.95
	B-1030G	144-148 MHz	All	10 W	300 W	13.8 VDC	48 A	yes	SO-239		\$729.95
	B-2518G	144-148 MHz	All	25 W	160 W	13.8 VDC	25 A	10 dB	SO-239	5 lbs	\$299.95
	B-2530G	144-148 MHz	All	25 W	300 W	13.8 VDC	48 A	yes	SO-239	15 lbs	\$729.95
	B-5018G	144-148 MHz	All	50 W	160 W	13.8 VDC	24 A	yes	SO-239		\$299.95
	B-5030G	144-148 MHz	All	50 W	300 W	13.8 VDC	48 A	yes	SO-239		\$699.95
	C-22G	222-225 MHz	All	2 W	20 W	13.8 VDC	5 A	yes	SO-239	2 lbs	\$159.95
	C-211G	222-225 MHz	All	2 W	110 W	13.8 VDC	20 A	yes	SO-239	5 lbs	\$349.95
	C-1012G	222-225 MHz	All	10 W	120 W	13.8 VDC	5 A	yes	SO-239	5 lbs	\$349.95
	C-2512G	222-225 MHz	All	25 W	120 W	13.8 VDC	20 A	yes	SO-239	5 lbs	\$329.95
	C-2522G	222-225 MHz	All	30 W	200 W	13.8 VDC	42 A	yes	SO-239		\$699.95
	D-15N	425 - 450 MHz	All	2 W	15 W	13.8 VDC	3 A	--	N type		\$189.95
	D-26N	430-450 MHz	All	2 W	60 W	13.8 VDC	12 A	--	N type	2 lbs	\$289.95
	D-1010N	430-450 MHz	All	10 W	100 W	13.8 VDC	20 A	--	N type	5 lbs	\$399.95
D-3010N	430-450 MHz	All	30 W	100 W	13.8 VDC	20 A	--	N type		\$379.95	
D-100-ATVN	429 MHz ATV	All	1 W	52 W	13.8 VDC	20 A	--	N type		\$429.95	
D-1010-ATVN	430 MHz ATV	All	10 W	100 W	13.8 VDC	20 A	--	N type		\$429.95	
SGC	SG-500	160-15M*	All	1-150W	500 W	13.8 VDC	80-90A**	--	SO-239	21 lbs	\$1,299.95
Tokyo HyPower	HL-2.5KFX	160-10 M	SSB, CW	100 W	1500 W	200-240 VAC		--	SO-239	57.3 lbs	CALL
	HL-1.5KFX	160-10 M + 6 M	SSB, CW	85 W	1000 W	100/240 VAC		--	SO-239	45.5 lbs	CALL
	HL-1.2KFX	160-10 M	SSB, CW	90 W	750 W	100/240 VAC		--	SO-239	33 lbs	CALL
	HL-1.1KFX	160-10 M	SSB, CW	75-90	600	100/250 VAC		--	SO-239	22 lbs	CALL
	HL-450B	160-10 M	SSB, CW, FM	50	400	13.8 VDC	60 A max	--	SO-239	11 lbs	CALL
	HL-45B	160-10 M + 6 M	SSB, CW, FM	5	45	13.8 VDC	8.5 A	--	SO-239	12.5 lbs	CALL
	HL-350VDX	144-148 MHz	SSB, FM	10/25/50	330	13.8 VDC	45 A	--	SO-239	12 lbs	CALL
HL-500V	144-148 MHz	SSB, CW, FM	20/50	500	100/240 VAC		--	N type	33 lbs	CALL	
Yaesu	Quadra System	160-15 M* + 6 M	SSB, CW	100 W	1000 W	110/220 VAC	†	--	SO-239	21 lbs	\$3,899.95

*Owner modifiable for 10 m #Add 35 pounds. Transformer shipped in separate package. **SGC PS-50 recommended †VP-1000 power supply inc.

HF Amplifiers



HL-2.5KFX
\$CALL – HRO Price

The HL-2.5KFX is a compact, light weight desk-top HF linear power amplifier with the maximum input power of 3 kW. It boasts of being smallest and lightest in the industry using our solid state broad band power amp technology.

Typical output power is 1.8 kW PEP / SSB (1.5 kW CW min.) on entire HF bands (slightly less on 10m) with the drive power of 80-95 W. The built-in band decoder will let you forget about the band setting when the amplifier is hooked to your modern radio through such band data cables as Icom CI-V, DC voltage (Icom, Yaesu), and RS-232C (Kenwood). There is a band data output socket to command the external auto antenna tuner, HC-1.5KAT.

Two pieces of extremely rugged high voltage RF power FET's of the latest design are used in push-pull form. 1,500 W of power dissipation and 500 V of breakdown voltage. Several protection circuits are built in such as over drive, high antenna SWR, thermal shutdown. Two large analog meters monitor Pf and Vd / Id / Pr. On the LCD panel meter are shown freq. band, heat sink temperature, mode of auto band setting, etc.



HL-1.5KFX
\$CALL – HRO Price

1.8 MHz - 29 MHz amateur bands including WARC bands plus 50 MHz, FCC certified, built-in power supply 110 or 220 VAC (240 V preferred). 10.7 x 5.6 x 14.4 inches, approx. 45 pounds. Fully solid state, auto-band switching with most Icom, Kenwood, Yaesu radios (cables included). Manual band switching as well. Two antenna ports selectable from front panel. Built-in RF power meter. HF 1 kW PEP SSB (typical). 6m 650 W PEP output. RF drive 85 W typical (100 W max). Great for DX-peditions or home station. External fan option for high duty cycle RTTY. Modes: SSB / CW / RTTY.



HL-1.1KFX
\$CALL – HRO Price

Typical output power for this compact, lightweight unit is 600 W PEP max, 600 W CW and 500 W RTTY (5 minutes) with a drive power of 75-90 W. The unit includes a built-in switching mode power supply. Operates on 1.8-28 MHz – all amateur bands including WARC bands.

Features include: full breakin CW; analog multimeter to monitor forward and reflected power, and drain voltage/current of power FET; operates in AC line or 100 to 250 V; multiple high speed protection circuits.



HL-1.2KFX
\$CALL
– HRO Price

This solid-state broadband amplifier is the lightest, most compact semi 1 kW HF amplifier in the industry. Compact, rugged HF linear amp operates on all amateur bands from 1.8 to 28 MHz, including WARC bands. Class AB parallel push-pull for 750 W output on SSB, 650 W on CW, or 400 W RTTY. Input 75-90 W. QSK compatible for fast CW break-in. Forced air cooling. Runs on 100-120 or 200-240 VAC. The broadband characteristics require no further tuning once the operating band is selected.

HF 400W Linear Power Amplifier



HL-450B
\$CALL – HRO Price

The HL-450B has a built-in auto band-select function using a newly developed microprocessor based technology that works a smooth automatic operation when driven by the radio. Manual band settings are also possible. Operation is possible from remote locations with the optional HRC-60. Smooth send/receive switching is possible through the hard-key terminal. ALC output is also provided. A number of circuits protect the amplifier. The amplifier operates on SSB, CW and FM with 400 W maximum output. Typical is 350 W. 50 W drive is required. Frequency coverage is 3.5 - 28 MHz including the WARC bands.

HF 45W Linear Power Amplifier



HL-45B
\$CALL – HRO Price

This amplifier covers 1.8 - 28 MHz including the WARC bands. Modes include SSB, CW and FM. Output power is 45 W maximum with a drive of 5 W. The HL-45B has a built-in auto band-select function that interfaces with the Yaesu FT-817 QRP radio.

VHF Amplifiers

VHF 330 W Amplifier



HL-350VDF
\$CALL – HRO Price

The HL-350VDF is a 144 MHz 330 W amp for RF drive of 10W, 25W and 50W. Multimeter for power out, auto SWR, DC line voltage. GaAs low noise RX pre-amp included.. It covers 144-148MHz on both FM and SSB. It requires 13.8 VDC at 48 A maximum (negative ground). The connectors are SO-239. There is protection for DC reverse polarity and High SWR. It features a terminal for the optional HRC-60 remote controller. The amp is 9.6 x 3.9 x 14 inches (WxHxD) and weighs 12.5 pounds.

VHF 500 W Amplifier



HL-500V \$CALL – HRO Price

The HL-500V is a solid state VHF linear power amplifier for 144-148 MHz that provides maximum output of 500 W with a drive of 20 W or 50 W. Includes a built-in switching AC to DC power supply, selectable between 110 V and 240 VAC. Modes are SSB, CW and FM. Type N connectors for input / output. No tuning with a broadband output design. RF key circuitry is built-in, keying the amp when RF driving power is sensed. Large analog meter monitors the forward and reflected power.

MFJ

TUNERS / AMPS

Automatic Antenna Tuners

MFJ-929. 200 Watt Automatic HF Antenna Tuner. Compact size 6-1/2 W x 2-7/8 H x 8-3/8 D inches.



Ultra-fast, 20,000 VirtualAntenna™ Memories, antenna switch, efficient L-network, matches 6-1600 Ohms, 1.8-30 MHz. Digital SWR / Wattmeter, radio interface.

MFJ-993B. 300 Watt Automatic HF Antenna Tuner.



Like MFJ-929, but you can select 300 Watts (6-1600 Ohms matching range) or 150 Watts (6-3200 Ohms matching range). Also has 4:1 current balun, remote control port.

MFJ-994B. 600 Watt Intelli-Tuner™. Like MFJ-993B, but has 10,000 VirtualAntenna™ memories and handles 600 Watts CW / SSB, matches 12-800 Ohms. Does not have LCD display, antenna switch or 4:1 balun.



MFJ-998. 1500 Watts SSB / CW Intelli-Tuner™.

Digital and analog SWR / Wattmeter, ultra-fast, automatic tuning, wide tuning range (12-1600 Ohms from 1.8 to 30 MHz), radio interfaces, built-in antenna switch for two coax / long wire, automatic bypass to protect your amplifier, field upgradeable software.

HF Roller Inductor Tuners



MFJ-989D. The world's most popular legal limit antenna tuner! Easily handles a full 1500 Watts SSB / CW,

1.8 to 30 MHz including MARS / WARC bands. 500 pF air variable capacitors, AirCore™ roller inductor with fast-tune crank knob, TrueActive™ peak-reading cross-needle SWR / Wattmeter, high voltage current balun, more! 12-7/8 W x 6 H x 11-5/8 inches.

MFJ-986. Similar to MFJ-989D, but has 2-knob tuning (differential capacitor and AirCore™ roller inductor) to make tuning fool-proof and easier than ever.



MFJ-962D. Handles 1.5 kW PEP SSB amplifier input power (800 W output).

Ideal for Ameritron's AL-811H! Peak-reading cross-needle SWR / Wattmeter, AirCore™ roller inductor.



MFJ-969. Covers 6 thru 160 meters! 300 Watts PEP SSB. TrueActive™ peak-reading SWR / Wattmeter, antenna switch, built-in dummy load, 4:1 balun, lexan front panel. 3-1/2 H x 10-1/2 W x 9-1/2 D inches.

Ameritron HF Amplifiers

AMERITRON



AL-811H. 800 Watt PEP output. This low-cost desktop linear HF amplifier gives plenty of power to burst through QRM. This will plug right into a 120 VAC outlet. Four tough 811A transmitting tubes, heavy-duty power supply, all HF band coverage, operate / stand-by switch, transmit LED, plus more! UPS shippable. AL-811. Similar but has three 811A tubes, 600 Watts PEP output.

AL-80B. 1 kW PEP output from a compact, desktop linear that plugs into 120 VAC outlet. Classic 3-500G tube, inrush current protection, two year limited warranty.



ALS-600. No tuning, no fuss, no worries – just turn on and operate. 600 Watts PEP / 500 W CW, 1.5-22 MHz, instant bandswitching, SWR protected. 120 / 220 VAC. 9-1/2 W x 6 H x 12 D inches. Includes matching transformer power supply.



ALS-600S. ALS-600 with 10 lb. switching power supply.

HF Switched Inductor Tuners



MFJ-949E. More hams use MFJ-949s than any other antenna tuner in the world! 300 Watts, 1.8 to 30 MHz, custom inductor switch, 1000 volt tuning caps, full size peak / average lighted cross-needle SWR / Wattmeter, 8 position antenna switch, dummy load, scratch proof lexan front panel. Size 3-1/2 H x 10-5/8 W x 7 D inches.

MFJ-948. Economy version of MFJ-949E, less dummy load, lexan front.

MFJ-941E. Super value tuner handles 300 Watts PEP, covers 1.8-30 MHz, lighted cross-needle SWR / Wattmeter, 8 position antenna switch, 4:1 balun, 1000 volt capacitors. 10-1/2 W x 2-1/2 H x 7 D inches.

MFJ-945E. HF and 6 meter mobile tuner. Extends mobile antenna bandwidth. Tiny 8 x 2 x 6" fits easily in car.



MFJ-971. Portable / QRP Tuner tunes coax, balanced lines, random wire 1.8-30 MHz. 30 / 300 or 6 Watt ranges. Matches MFJ QRP rigs. 6 x 6-1/2 x 2-1/2 inches.



MFJ-901B. Wide range 200 Watt PEP versa tuner. Covers 1.8 to 30 MHz.



MFJ-902. Tiny Travel Tuner, 4-1/2 x 2-1/4 x 3", full 150 W, 80-10 M, tuner bypass switch.

MFJ-904H. Similar but adds SWR / Watt-meter, 4:1 balun. 7-1/4 x 2-1/4 x 2-3/4 inches.

MFJ SWR Analyzers

MFJ-259B. SWR Analyzer™ with impedance meter reads antenna SWR, complex RF impedance, resistance (R) and reactance (X) or magnitude (Z) and phase (degrees), coax cable loss in dB, coax cable length and distance to fault, return loss, reflection coefficient, inductance and capacitance. Tells battery voltage, has huge LCD digital readout with built-in frequency counter, side-by-side SWR and RF impedance meters, Ni-Cd / Ni-MH internal battery charger, battery saver feature, low battery warning, and easy-access batteries. Has smooth, reduction drive tuning. Truly portable. Uses 10 alkaline, Ni-Cd or Ni-MH batteries (not included) or 110 VAC with optional MFJ-1312D.



MFJ-269. Covers 1.8 to 170 MHz and 415 to 470 MHz. Has all of the features of the MFJ-259B plus a 12-bit A/D converter (gives much better accuracy and resolution), CoaxCalculator™ (calculates coax line length in feet given coax length in electrical degrees and vice versa) and coaxial characteristic impedance input (zero to six hundred Ohms).



HF Antenna Switches

MFJ-1702C. 2 position antenna coax switch. New center ground, lightning arrester. 2.5 kW PEP, 1 kW CW. Loss below .2 dB. 50 dB isolation @ 450 MHz. 50 ohms. 3 x 2 x 3 inches.



MFJ-1704. Like MFJ-1702C. 4 positions. 6.25 x 4.25 x 1.25 inches. 50 load. SWR 1.1: 1 to 30 MHz; 1.5:1, 30-650 MHz. SO-239. 2.25 x 2.25 x 7 inches.

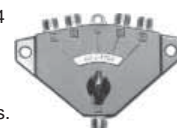

MFJ-1701. 6 position antenna switch, 50-75 ohms. Handles 2 kW PEP or 1 kW CW. 1.8-30 MHz. SO-239 connectors. Unused positions automatically grounded.

MFJ-1700C. 6 position antenna and transceiver switch switches between 1-6 antennas and 1-6 rigs. Handles 2 kW PEP or 1 kW CW, 1.8 to 30 MHz.

Dummy Loads

MFJ-250. 1 kW Dummy Load, 50-Ohm. Oil filled, low SWR to 400 MHz. Rated 1 kW CW or 2 kW PEP for 10 minutes. One half rating for 20 minutes. 200 Watts CW or 400 Watts PEP continuous. Includes industrial transformer grade oil (no PCB).



MFJ-264. HF/VHF Dry Dummy Load covers up to 650 MHz, usable to 750 MHz. Rated 1.5 kW for ten seconds, 100 Watts continuous. Perforated metal cabinet. SO-239.



MFJ-260C. HF/VHF Dry Load is similar to MFJ-264, but handles 300 Watts for 30 seconds. Has derating curve. SO-239.

ANTENNAS

Mobile Antennas

MFJ-1724B. Mobile magnetic mount dual band antenna gives you a quarter wave stainless steel whip for 2 meters and 440 MHz, coax and connector. Low SWR, 200 Watts.

MFJ-1728B. Mobile magnetic mount 5/8 wave 2 / 6 meter antenna. Low SWR, 300 Watts.

MFJ-1729. Mobile Magnetic Mount super gain dual band antenna. Get a whopping 2.6 dB gain on 2 meters and 6.3 dB gain on 440 MHz.

MFJ-1734. Dual band glass mount 144 / 440 MHz antenna gives 2.6 dB gain on 2 meters and 6.3 dB gain on 440 MHz. Low SWR on both bands. FREE BNC adapter is included for handhelds.

MFJ-1738. 2 meter glass-mount antenna handles 50 Watts with 2.6 dB gain, low SWR over entire 2 meter band.

MFJ-1432. Dual band, 62.5" RuffRider™ hyper gain mobile antenna. 7.6 dB gain on 440 MHz, 5 dB gain on 2 m. Requires tri-magnet mount, not included.



HF Antennas

MFJ-1798. Ten band half-wave vertical antenna. Covers 10 bands: 75 / 80, 40, 30, 20, 17, 15, 12, 10, 6 and 2 meters. No ground radials or ground needed because of the effective counterpoise that is 12 feet across. Mount from ground level to roof top. The feedline is isolated from the antenna using MFJ's AirCore™ balun. Achieves full-sized performance with full-size radiators for 2-20 meters and high efficiency end-loading for 30, 40 and 75 / 80 meters. UPS Shippable.

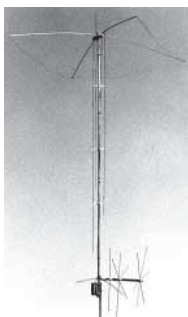

MFJ-1796. 6 Band Vertical. Covers 40 through 6 meters. 12 feet tall with tiny 24-inch footprint. Mounts anywhere, handles 1500 Watts PEP.

MFJ-1775. 1/2 Wave, 6-band rotatable mini-dipole. Just 14 feet wide, can be turned by a small tv-type rotator. Covers 40 through 2 meters, handles 1500 Watts.



MFJ-1778. All-band G5RV antenna. 102 feet long, 32.5 foot ladder line ending in SO-239 connector for your coax feedline. 1500 Watts. 80-10 m, 160 meters with tuner/ ground.

MFJ-1778M. G5RV Junior. Half-size, 52 feet. Covers 40-10 meters.

Speaker

MFJ-281. MFJ ClearTone™ restores the broadcast quality sound of shortwave listening. Makes copying easier, enhances speech, improves intelligibility, reduces noise, static, hum. 3-inch speaker handles 8 Watts. 8 ohm impedance. 6 foot cord.



Power Supplies

MFJ-4125. MightyLite™ Switching Power Supply. 25 amps surge, 22 amps continuous. No RF hash! Low ripple, highly regulated. Great review by QST magazine. Over-voltage and over-current protection circuits. Switchable AC input voltage, works for 85 to 135 VAC or 170 to 260 VAC. Replaceable fuse. Tiny 5.5 W x 2.5 H x 5.75 D inches. Weighs just 3.5 lbs.



MFJ-4225MV. Similar to MFJ-4125, but adds large 3-inch amp, volt meters and cigarette lighter plug. 5.25 W x 4.5 H x 6 D inches. Weighs 3.7 pounds.



MFJ-4245MV. Similar to MFJ-4225MV but handles 45 amps surge and 40 amps continuous. 7.5 W x 4.75 H x 9 D inches. Weighs just 5.5 pounds.



hy-gain

Hy-Gain® Rotators

Ham IV is the most popular rotator in the world. Designed for medium communications arrays of up to 15 square feet. New low temperature grease permits normal operation down to -30 degrees Fahrenheit. New alloy ring gear gives extra strength up to 100,000 PSI. New indicator potentiometer, new ferrite beads to reduce RF susceptibility, new cinch plug connector plus 8-pin plug at the control box. Dual 98 ball bearing race for load and bearing strength and electric locking steel wedge break prevents wind introduced antenna movement. North or south center of rotation scale on meter. Low voltage control. Order HAM-IVX for 220 volts.



T2X. For large and medium antenna arrays up to 20 sq. ft. wind load. Available with DCU-1 Pathfinder digital control or standard analog control box.



Hy-Gain® Antennas

AV-640. Uses quarter wave stubs on 6, 10, 12, and 17 Meters and efficient end loading coil and capacity hats on 15, 20, 30, and 40 Meters. No radials. No traps. No ground. No tuning. Handles 1500 Watts. Sleek and low profile, small area required for mounting. Automatic bandswitching, single coax cable feed, each band is individually tunable, wide VSWR bandwidth.



AV-620. Covers all bands 6 through 20 Meters.

Hygain also sells a large assortment of multi-band beams, yagis, wire antennas and other verticals. Ask about baluns, aluminum tubing and parts.

METERS / KEYERS

DC Power Strips

MFJ-1118. High current multiple DC outlet. Use for two HF and / or VHF transceivers and six or more accessories from your transceiver's main 12 VDC power supply.



MFJ-1116. Deluxe multiple DC power outlet. 8 outlets for powering accessories.



MFJ-1112, like the MFJ-1116 without on / off switch, voltmeter and fuse. 6 pair outlets.

MFJ-1117. For powering four HF / VHF radios (two at 35 amps each and two at 35 amps combined) simultaneously.

MFJ-1129. Get the best of both connectors. Has Anderson® powerpoles and high-current binding posts. Outlets 1, 2, 4-8 are Powerpoles®, outlet 3 is a 35A high current binding post. Includes 7 pairs of Power-Pole® 35A contacts, ten fuses.

MFJ-1128. 12 outlets, factory installed fuses, handles 20 amps total.

MFJ-1126. 8 outlets. (12) 35A contacts.

MFJ-1124. 6 outlets. (8) 35A contacts.

SWR / Wattmeters

MFJ-267. Dry Dummy Load / SWR / Wattmeter combination. Large 3" cross-needle SWR meter, 1500 Watt dry load. 1.8 to 30 MHz. Perforated metal.



MFJ-868. Giant SWR / Wattmeter measures 6.5 inches diagonally across face. Covers 1.8 to 30 MHz.

MFJ-867. Giant VHF/UHF SWR / Wattmeter. Same size as MFJ-868.

MFJ-862. Covers 144 / 220 / 440 MHz. 30 / 300 Watts forward, 6 / 60 Watts reflected ranges. 5.64 W x 2.5 H x 2.25 D inches. Has one sensor for all three bands.

Morse Reader / Tutor

MFJ-461. Morse Reader, 3-60 WPM. Use 9V, not included.

MFJ-418. Morse Tutor 3-60 WPM. Use 9V, not included.



MFJ-557. Practice code oscillator, telegraph key.

MFJ-464. Keyer / Reader. They won't even know you never passed the code test! Sends / reads 5-99 WPM. Auto speed tracking. 2-line LCD. Use paddle or keyboard. Easy menu operation. Front panel speed, volume controls.



West Mountain Radio

ACCESSORIES

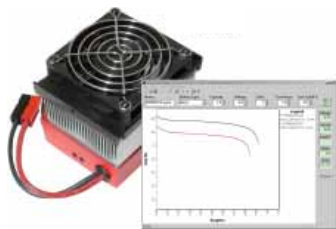

Computerized Battery Analyzer

HRO Price \$109.95

CBA II: Test any battery type, size, chemistry, up to 48 volts. Micro-processor controlled tester plugs into PC's USB port. Plots constant current discharge voltage vs. ampere-hours to show battery capacity. Extremely accurate. Tests a few mA to 40 amperes, limited to 120 watts, safely. User friendly software, easy to install, set up, run. Save and print graphs. Print date and performance labels for your batteries. Ideal for anyone relying on rechargeable battery power. 6 ft USB cable, CD, PowerPole connectors.

Temperature Probe: Measures battery temperature during high current CBA test. Magnetic. Turns off test if over temperature. **HRO Price \$13.95**



RIGtalk



USB Rig Control Interface

CI-V Icom, Ten Tec, and Yaesu TTL CAT mini or standard DIN jack. Windows Plug and Play serial to TTL level converter. CD ROM with Plug and Play preinstall, third party rig control software collection and operator's manual. Order packaged with pre-wired radio cable below.

HRO Price

RT1/CIV RIGtalk \$56.95

with cable for Icom & Ten-Tec

RT1/CAT RIBtalk \$61.95

with cable for Yaesu FT-100, 100D, 817, 857, 897

RT1/CAT6 RIGtalk \$61.95

with cable for Yaesu FT-736, 747, 767, 980, 990, 1000, 1000D



PWRcrimp

The PWRcrimp tool is a high performance tool for crimping 15, 30 and 45A Anderson Powerpole contacts. Ratcheted with contact positioner. Better than soldering. Easy to use. **HRO Price \$49.95**



PWRgates

PWRgates provide backup power for the ham shack, repeater, or emergency communications center. Equipment is instantly switched between 13.8V DC supply and battery during a power failure. Keeps battery charged. Handles up to 40A.

PG-40S – SuperPWRgate has a built-in four stage battery charger. Selectable 1, 4, 6 and 10A rate. **HRO Price \$129.95.**

PG-40 – Powergate has a simple float charger. **HRO Price \$69.95**



RIGrunners

RIGrunners power panels are the most convenient and safe way to connect all your 12 volt equipment. Uses Anderson Powerpoles, the ARES, RACES, RSGB standard, polarized and color keyed. All models rated at 40amps. Each outlet is fused with assorted ATC/ATO automotive fuses. Blown fuse LED indicators. For home and mobile use. Includes a 6' cable, 5 spare fuses.

RR / 4010S / C: 10 outlets. One "always on" and nine auto or manually switched outlets. FET on/off system controls switched outlet so you can turn on the entire station with the power button on your rig. Quick status precision LED, high, normal and low voltage monitor and warning buzzer. 12 pair Powerpole sets. **HRO Price \$129.95**

RR / 4012 / C: 12 outlets. Quick status precision LED, high, normal and low voltage monitor and warning buzzer. 12 pair Powerpole sets. **HRO Price \$129.95**

RR / 4008 / C: 8 outlets. Quick status precision LED, high, normal and low voltage monitor and warning buzzer. 12 pair Powerpole sets. **HRO Price \$109.95**

RR / 4005 / C: 5 outlets. Perfect for small or mobile installs, or as expansion unit. 6 pair Powerpole sets. **HRO Price \$79.95**

RIGblasters



A RIGblaster is the easiest way to connect your radio to your computer to operate PSK31, SSTV, RTTY, Echolink, AMTOR, Packet, APRS, CW, DVK, WSJT, logging and more. RIGblasters connect to a radio's microphone input, computer's sound card output, and USB. Ground isolated, rf filtered. Supplied with all cables, AC-power cubes (not Nomic), CD ROM (over 100 programs), instructions. All work with 8-pin and RJ-45 microphones. 4-pin and RJ-11 style microphone conversion kits are available.

RB/PR/CUSB – RIGblaster Pro / USB: Does everything you can do with a computer and a radio: all sound card modes, microphone equalization, records QSO's. rig control, direct CW and FSK. Automatic microphone switching. A must for the serious contester / logger. **HRO Price \$279.95**

RB / PL / CUSB – RIGblaster Plus / USB: All sound card modes, direct CW, FSK, USB or serial control, automatic microphone switching. Easy to hook up. **HRO Price \$149.95**

RB / NO / CUSB – RIGblaster Nomic / USB: All sound card modes. No microphone switching. No power needed. Great for Ecolink, portable or temporary setups. **HRO Price \$59.95**

Yaesu MOD6 CBL: 6-pin microphone conversion cable. **HRO Price \$16.95**

4T8 / Kit: 4-pin microphone conversion cable kit. **HRO Price \$23.95**



RIGblaster P&P Plug and Play USB, Data Jack sound card interface

Other RIGblasters work with more than 2000 different radios through the microphone jack. If your radio has a data jack that allows operation on all bands and modes while supporting proper microphone operation, the RIGblaster P&P may be your best choice.

Simple USB "Plug and Play" installation: one plug to the radio, USB and sound for the computer. Built-in USB to serial converter for PTT, CW and CAT or CI-V rig control. Unlike other USB sound card interfaces, this RIGblaster is compatible with more than 100 amateur radio sound card programs and more than 25 modes.

FEATURES: USB powered, no external power supply. Compact, great for portable or QRP operation. Built in TTL CAT or CI-V rig control. CW keying. Isolated audio and keying unlike other USB interfaces. LED indicators for USB, PTT keying and CW keying status.

SUPPLIED WITH: Radio specific 8' data jack cable. 12" computer audio and USB cables. CD-ROM with USB Plug and Play installation, owner's manual, ham radio sound card software collection.

Plug and Play RIGblasters

Model Number	Description	HRO Price
RB/PP/I8D	Icom 8 pin DIN ACC1	\$109.95
RB/PP/I13D	Icom 13 pin DIN	\$109.95
RB/PP/IYK6MD	Yaesu, Icom, Kenwood mini 6 pin DIN	\$99.95
RB/PP/K13D	Kenwood ACC2 13 pin DIN	\$109.95

Accessory Cables

Model Number	Description	HRO Price
PP/CW/CBL	CW cable 1/8" mini phone with 1/8-1/4" adaptor	\$8.95
CIV/CBL	Icom CI-V cable 1/8" mini stereo to 1/8" mono	\$8.95
CATMINI/CBL	Yaesu CAT 8 pin mini DIN cable	\$12.95
CAT/6D/CBL	Yaesu CAT 6 pin DIN cable	\$12.95

CONNECTIONS

Rig Control Cables

Timewave Technology

HamLinkUSB™ USB Rig Controller Plus

Connect and control transceiver via USB with Plus option for T-R switch, key, footswitch input or user I/O



The HamLinkUSB™ Rig Controller Plus is a USB to logic level conversion device for CAT / CI-V enabled transceivers that provides PTT output, keying output, or foot switch input options.

The CAT / CI-V feature provides a logic level serial interface which connects directly with non-RS-232 CAT / CI-V inputs on Kenwood, Icom, Yaesu, Ten-Tec, Elecraft and Alinco models.

The controller is compatible with most soundcard and software control programs such as PK-Term 3.0. **HRO Price \$59.95**

HamLinkUSB Optional Cable Assemblies

Model		HRO Price
HLUSB-CIV	CI-V - Icom, Ten-Tec, Elecraft	\$8.95
HLUSB-CAT	MiniDIN-8 cable assembly for Yaesu FT-857/817/100/100D	\$13.95
HLUSB-4CON	4 conductor with 3.5 mm plug to open end cable	\$13.95

Control Software

RT Systems

Windows based software that addresses memory channel details and global settings of a specific radio through easy to use spread sheet entry, check boxes and listed selections. Kit includes RT Systems software on mini-CD. Serial cable and – where needed – adapter specific to the radio. For Windows 2000 and XP. Free serial port, USB compatible with proper serial adapter and local CD required.

Model	Radio Models	Includes	HRO Price
WSC-T90	IC-T90	Software/Serial Cables	\$49.95
WSC-2720	IC-2720	Software/Serial Cables	\$49.95
WSC-208	IC-208	Software/Serial Cables	\$49.95
WSC-V8000	IC-V8000	Software/Serial Cables	\$49.95
WSC-Q7A	IC-Q7	Software/Serial Cables	\$49.95
WSC-T91	IC-T91	Software/Serial Cables*	\$49.95
WSC-2200	IC-2200	Software/Serial Cables	\$49.95
WSC-P7	IC-P7	Software/Serial Cables	\$49.95

* Programming software rather than software for control of the digital functions

All RT Systems Programmer Cables (RTS-03). USB to Serial adapter. (True RS-232. Works with all programmers.) **HRO Price \$14.95**

ENCODERS

SARATOGA AMATEUR RADIO PRODUCTS

Power Panels

Power Panels provide convenient, safe, and reliable power distribution for all the radios and accessories in your shack or mobile installation. Easily move rigs between operating positions without worrying about the power cords.

- Anderson PowerPole connectors.
- ARES / RACES standard connection.
- Mini ATC automotive fuses.
- Surge suppression & reverse polarity protection.
- One-year warranty.
- Made in the U.S.A.



PowerPanel 4
HRO Price \$24.95

PowerPanel 4

- 4 port DC power distribution panel.
- 1 input & 3 outputs.
- 25 Amp rating.



PowerPanel 6
HRO Price \$34.95



PowerPanel 8
HRO Price \$59.95

PowerPanel 8

- 8 port DC power distribution panel.
- 30 Amp rating.



PowerPanel 14
HRO Price \$79.95

PowerPanel 14

- 14 Port DC power distribution panel.
- 30 Amp rating.

Encoders / Decoders



CTCSS Encoder
TE-32: HRO Price \$49.95

Tone encoders and decoders are just what you need to control your repeater or listen only to signals that are meant just

	Encode	Decode	Comments	HRO Price
TS-64DS	*	*	Universal design. CTCSS encoder / decoder capability for all FM transceivers	\$57.95
SS-64	*		DIP switch programmable CTCSS encoder for all FM transceivers	\$28.95
TE-32	*		Multi-purpose CTCSS / Burst Tone encoder	\$59.95

for you. TE-32 multi-tone CTCSS encoder is powered by a 6 to 28 vdc unregulated source, has a three position range switch, a frequency accuracy ± 0.1 Hz maximum over the temperature operating range. The TE-32 is low impedance (1K), low distortion, with adjustable sine wave output, 5 V peak to peak.



ACCESSORIES

Designed by Hams for Hams. Made in the USA.



AT Auto 1500 Antenna Tuner

On Palstar's 1500 watt auto tuner, a 2-line large print display shows the status of antenna feed, frequency, and up to 32 channels of memory. The AT-Auto has a custom-built capacitor for differential tuning. What sets the AT-Auto apart from other tuners is its software-based tuning. Includes PM 2000A active peak/peak hold watt meter to measure and display forward power, reflected power, and SWR simultaneously. The backlit meter displays either peak or average power readings with 300 and 3000 watt range settings.

- 1500 Watts single tone, high efficiency, low tuner losses and wide Z range.
- 160m to 20m.
- Tuning time 1-30 seconds with high-speed processor controlled stepper motors.
- Serial port for field upgradeable software.
- Custom large plate variable capacitors at 5 kV.
- Ceramic body roller inductor (28 uH) wound with 12 ga plated solid copper wire.
- Size: 12 1/2" x 5 1/2" x 16".
- Weight: 25 lbs.

ZM30 Antenna Analyzer

The ZM30 is an automated micro-controlled SWR antenna analyzer with an 8 bit micro-controller with a precision low power DDS signal generator. It includes a self-calibrating reflectometer. The digital display shows SWR at selectable frequencies from 1 to 30 Mhz. It measures: SWR, impedance, reactance, inductors and capacitors, transmission lines, stubs, Q, and resonant frequency. There is a serial port for field upgradeable software. Battery operated.



B4000 Balun

Palstar's B4000 is a 1:4 voltage balun for use with Hi-Z antenna applications and center-fed wire antennas with open wire and twin lead transmission lines. It features a die-cast aluminum case for all weather indoor/outdoor usage. Inside the aluminum case are statite insulators with a large 3.25" Ferrite core with Teflon sleeved 12 ga. wire and rated up to 4kW plus.



SP30 Shortwave Speaker

The compact SP30 shortwave speaker is tonally matched to the R30 and designed to put out clear, low-distortion reproduction of the frequency range of broadcast human speech.

- 20 W peak power.
- 70 Hz to 15 kHz.
- 1/4" mono plug included.
- Size: 6" x 6" x 6" deep.
- Weight: 4 lbs.



DL2K Dummy Load

The fan-cooled DL2K is capable of handling 2000 watts for 1.5 minutes—long enough to tune your amp.

- Frequency range DC to 30 Mhz.
- Internal watt meter and analog metering.
- PL259 coax connector.
- Size: 6" x 5" x 12.5" deep.
- Weight 5 lbs.



WM150 Watt Meter

The WM150 measures and displays forward power, reflected power, and SWR simultaneously on its dual meter. The backlit meter can display either peak or average power readings, and has 300 and 3000 watt range settings. Accuracy of the readings is assured because the WM150 features a true shielded directional coupler.

- Range: 1.8 MHz to 60 MHz.
- PL259 coax connector.
- 115 VAC to 12 VDC adapter included.
- Size: 4.5" x 3.25" x 3.25" deep.
- Weight 1.2 lbs. / 0.55 Kg.



AT4K Antenna Tuner

The AT4K has a power rating of 2500 watts single tone continuous.

- Unbalanced/balanced output (switch activated on front panel) with high power balun at the input of tuner circuit.
- T match circuit: impedance matching range 8 ohms to 2000 ohms.
- Custom large value (460pf) variable capacitors at 6 kV.
- 10 amp edge-wound silver plated ceramic body roller inductors crank handle driven.
- Switchable antenna inputs.
- Ferrite 1:1 input balun.
- Peak / peak hold dual cross-needle metering (1-2 sec hold) with backlighting.
- Size: 15" x 7" x 16" deep.
- Weight: 20 lbs.

Palstar Antenna Products

Model	Description	Price
Antenna Tuners		
AT-AUTO	1500 W Antenna Tuner	1195.95
AT5K	3500 W Antenna Tuner	1195.95
AT4K	2500 W Antenna Tuner	895.95
BT1500A	1500 W Balanced Antenna Tuner	695.95
AT1500CV	1500 W Antenna Tuner <i>Extended 3 Year Warranty</i>	459.95 74.99
AT1500DT	2000 W Differential Antenna Tuner <i>Extended 3 Year Warranty</i>	479.95 74.99
AT1KM	1200 W Differential Antenna Tuner <i>Extended 3 Year Warranty</i>	379.95 74.99
Wattmeters		
PM2000A	2000 W Wattmeter 1.8Mhz to 60Mhz	149.95
WM150	1500 W Wattmeter 1.8Mhz to 60Mhz	119.95
WM150M	1500 W Wattmeter 1.8Mhz to 60Mhz	119.95
Antenna Analyzer		
ZM30	Antenna Analyzer SWR 1Mhz - 30 Mhz	369.95
ZM60	Antenna Analyzer SWR 1Mhz - 60 Mhz	389.95
Shortwave Accessories		
R30C	Shortwave Receiver AM/SSB Collins Filter-SSB Only	595.95
R30CC	Shortwave Receiver AM/SSB Collins Filters	675.95
SP30	Speaker 12 Watts (for R30C/CC)	49.95
MW550P	Medium Wave Active Preselector	275.95
AA30	Shortwave Active Antenna Matcher .3 - 30Mhz	99.95
Dummy Loads		
DL1500	Dummy Load 1500 W - 450 Mhz	79.95
DL2K	Dummy Load 2000 W - 30 Mhz meter/fan	199.95
DL5K	Dummy Load 5000 W - 30 Mhz meter/dual fan	399.95
Baluns		
B4000	Balun 4/1 4000W-Voltage-Hi-Z	89.95
B4000C	Balun 1/1 4000W-Current-Low-Z	89.95

Prices in this print catalog are subject to change

POWER CABLE ACCESSORIES



Adapter Cables

Cig-2-PP-5-15A
Cigarette Lighter Plug Fused (AGC) to Powerpole (Length: 5 ft., Amps: 15 amps). **HRO Price \$14.95**

Cig-2-OEM-5-15A
Cigarette Lighter Plug Fused (AGC) to OEM-T Male Connector (Length: 5 ft., Amps: 15 amps). **HRO Price \$14.95**

PP-2-OEM-5
Powerpole to OEM "T" Male Connector (Length: 5 ft.) **HRO Price \$14.95**

SOC-PP-1-15A
Cigarette Lighter Socket with Internal ATC Fuse and Powerpole End (Length 1 ft., Amps: 15 amps). **HRO Price \$14.95**

PP-45-2-Ring-10G
6 ft. 10 gauge Power Supply Cable with 45 amp Powerpoles and 1/4 inch gold plated ring terminals on the other. **HRO Price \$13.95**

PP-75-2-Ring-8G
10 foot of 8 gauge Power Supply Cable with 75 amp Powerpole connectors on one end and 1/4 inch gold plated ring terminals on the other. **HRO Price \$18.95**

Red / Black Wire

Model	Description	HRO Price per Foot
RB-08	Red/Black 8 gauge wire	\$1.56
RB-10	Red/Black 10 gauge wire	\$1.25
RB-12	Red/Black 12 gauge wire	\$0.99

Model	Description	HRO Price per Roll
RB-14-25	25 ft Roll 14 Gauge	\$14.95
RB-18-25	25 ft Roll 18 Gauge	\$6.95
RB-22-25	25 ft Roll 22 Gauge	\$6.95

Fused Adapter Cables

PP-HOLD-ATC-12-15A
ATC Style 12 gauge fuse holder with 30 amp Powerpoles mounted on each end. Includes (2) 15 amp ATC fuses. **HRO Price \$12.95**

PP-HOLD-ATC-10-40A
ATC Style 10 gauge fuses holder with 45 amp Powerpoles mounted on each end. Includes (2) 40 amp ATC fuses. **HRO Price \$14.95**

PP-HOLD-MAXI-8-80A
ATC Style 8 gauge MAXI fuse holder with 75 amp Powerpoles mounted on each end. Includes (2) 80 amp MAXI fuses. **HRO Price \$24.95**

Ring-HOLD-ATC-12-15A
ATC Style 12 gauge fuses holder with 30 amp Powerpoles mounted on one end and gold plated 1/4" ring terminals on the other. Includes (2) 15 amp ATC fuses. **HRO Price \$12.95**

Ring-HOLD-ATC-10-40A
ATC Style 10 gauge fuses holder with 45 amp Powerpoles mounted on one end and gold plated 1/4" ring terminals on the other. Includes (2) 40 amp ATC fuses. **HRO Price \$14.95**

Ring-HOLD-MAXI-8-80A
ATC Style 8 gauge MAXI fuses holder with 75 amp Powerpoles mounted on one end. Includes (2) 80 amp MAXI fuses. and gold plated 1/4" ring terminals on the other. Includes (2) 80 amp ATC fuses. **HRO Price \$24.95**

Meter

Watt-BLK-PP
Watt's Up meter with Powerpole ends by RC Electronics. **HRO Price \$58.95**

Powerpole Splitters

Red-Dee-2 Connect PS-4
Red-Dee-2™ Connect Powerpole Splitter **HRO Price \$14.95**

PS-4 Plus
Red-Dee-2™ Connect Powerpole Splitter. **HRO Price \$14.95**

PS-8
Red-Dee-2™ Connect Powerpole Splitter. **HRO Price \$24.95**

PS-75 / 45-4
Red-Dee-2™ Connect Powerpole Splitter. **HRO Price \$34.95**

PS-6AA
Red-Dee-2™ Powerpole Splitter with Powerpole connectors on both ends **HRO Price \$31.95**

Powerpole Bags

PP-RB-15

Model	Description	HRO Price Per Bag
PP-RB-15-10	Powerpole 15A 10 pack	\$9.95
PP-RB-15-25	Powerpole 15A 25 pack	\$19.95
PP-RB-30-10	Powerpole 30A 10 pack	\$9.95
PP-RB-30-25	Powerpole 30A 25 pack	\$19.95
PP-RB-45-10	Powerpole 45A 10 pack	\$14.95
PP-RB-45-25	Powerpole 45A 25 pack	\$29.95

CABLES / COAX / CONNECTORS

Cable Assemblies

CABLE X-PERTS Ready-Made Coax Cable Assemblies

Model	Connector Both Ends	Burial	UV Resistant	Shields	Attenuation @ 100 Feet	Best Frequencies
CXP1318FC	PL259	Yes	Yes	2 (100% bonded foil + 95% TC Braid V/P 84%)	50 MHz 1.1 150MHz 1.9 450MHz 3.3	50-450 MHz
CXP008C	PL259	No	Yes	1 (95% BC Braid) V/P 78%	10 MHz 0.51 30MHz 0.9 50MHz 1.2	1-50 MHz
CX1318FN	"N"	Yes	Yes	2 (100% bonded foil + 95% TC Braid V/P 84%)	150MHz 1.9 450MHz 3.3	150 MHz and Higher
CXP08XC	PL259	No	Yes	1 (95% BC Braid) V/P 78%	10 MHz 0.98 30MHz 2.0	1 - 30 MHz
CPX213C	PL259	Yes	Yes	1 (97% BC Braid) V/P 66%	10 MHz 0.62 30MHz 1.2	1 - 30 MHz (High Power)

Coax & Connectors



Andrew coax and all the matching connectors you will need are available as a special order drop shipment. Contact your nearest HRO store for complete details.

Model #	Cable Type	Diameter Inches	\$/100 feet*
LDF2-50	Foam Dielectric	3/8 inch	189.00
LDF4-50A	Foam Dielectric	1/2 inch	255.00
LDF5-50A	Foam Dielectric	7/8 inch	585.00
FSJ4-50B	Superflex	1/2 inch	373.00

*Plus Shipping

Patch Cables

Soldered with teflon PL-259 silver connectors.

Item	Description	HRO Price
HRO213/100U	100' 213 coax with PL259	\$99.95
HRO213/125U	125' 213 coax with PL259	\$119.95
HRO213/3U	3' 213 coax with PL259	\$16.95
HRO213/50U	50' 213 coax with PL259	\$54.95
HRO213/6U	6' 213 coax with PL259	\$17.95
HRO8X/100U	100' 8X coax with PL259	\$59.95
HRO8X/18U	18' 8X coax with PL259	\$19.95
HRO8X/25U	25' 8X coax with PL259	\$26.95
HRO8X/3U	3' 8X coax with PL259	\$11.95
HRO8X/50U	50' 8X coax with PL259	\$39.95
HRO8X/6U	6' 8X coax with PL259	\$14.95
HRO8X/75U	75' 8X coax with PL259	\$46.95

Coax-Seal

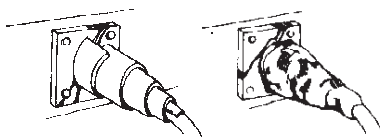

Coax-Seal will seal all types of coax fittings, baluns, antenna parts and connectors of any shape. Adheres to most surfaces. Wrap Coax-Seal around the object you want to protect and then mold it into shape. Keeps moisture out of the coax fitting on antenna feed lines. Need to make a change? Just remove it and start over. HRO Price: \$2.99 / roll

Because of the current world-wide volatility of copper prices, HRO wire and coax prices are subject to change. Please call toll free to check current prices.

RG213/U w/PL259		
Part Number	Length (feet)	HRO Price
CXP213C100	100	\$112.95
CXP213C50	50	\$69.95
CXP213C6	6	\$24.95
CXP213C3	3	\$22.95
RG8/U Foam w/PL259		
CXP008C100	100	\$99.95
CXP008C50	50	\$55.95
CXP008C25	25	\$39.95
CXP008C12	12	\$32.95
CXP008C6	6	\$29.95
CXP008C3	3	\$26.95
RG8X-Mini w/PL259		
CXP08XC100	100	\$54.95
CXP08XC75	75	\$44.95
CXP08XC50	50	\$34.95
CXP08XC25	25	\$24.95
CXP08XC18	18	\$22.95
CXP08XC6	6	\$17.95
CXP08XC3	3	\$15.95
9913-type Flexible w/N-Connector		
CXP1318FN150	150	\$190.95
CXP1318FN100	100	\$132.95
CXP1318FN50	50	\$78.95
CXP1318FN25	25	\$51.95
CXP1318FN6	6	\$30.95
CXP1318FN3	3	\$27.95
9913-type Flexible w/UHF Connectors		
CXP1318FC100	100	\$126.95
CXP1318FC50	50	\$63.95
CXP1318FC6	6	\$22.95
CXP1318FC3	3	\$20.95
Tinned Copper Ground Braid		
235	1" wide	\$1.99/ft
2332	1/2" wide	\$0.67/ft
235RT-5	1" 5 ft long*	\$13.95
235RT-10	1" 10ft long*	\$17.95
2332RT-5	1/2" 5ft long	\$7.95
2332RT-10	1/2" 10ft long*	\$9.95

* w/Ring Terminals

Cable Ties



Light Duty Cable Management



Reusable 300 Times

These are the perfect products for managing all those cables in the shack or computer room.

Model	Size	HRO Price
Y-05-010-BLK	1/2" X 5"	10 Pack \$7.95
Y-05-010-Rainbow	1/2" X 5"	10 Pack \$7.95
Y-08-010-BLK	1/2" X 8"	10 Pack \$9.95
Y-08-010-Rainbow	1/2" X 8"	10 Pack \$9.95
G-05-030-GRN	1/2" X 30 ft Roll	\$4.95

BALUNS

Connectors

Model	Description	HRO Price
BNC-44	BNC to UHF Adapter (BNC-255)	\$5.99
N-31	N to UHF Adapter (4400)	\$9.99
PL-259ST	PL-259	\$2.59
N-T6S	Type N Male	\$6.99
UHF-8	4 hole SO-239 Chassis Connector	\$4.99
UHF-10	Double Male UHF (83-877)	\$8.99
UHF-11	UHF Barrel (83-1J)	\$4.99
UG-363-4	Long UHF-UHF Barrel (83-1F)	\$6.99
UHF-15	RT. Angle Teflon, Gold Pin (83-1AP)	\$8.99
UHF-13	UHF "T" (83-1T)	\$6.99
UHF-19	BNC to UHF Adapter (31-28)	\$6.99
UHF-18	UHF to N Adpter (14000)	\$8.99

Communications Cable

Times

Call HRO for Low Discount Prices on Times Cable

LMR-200 – RG58 type

This is a standard RG58 'type' outdoor cable that is ideal for jumper assemblies, short antenna feeder runs, or any application requiring an easily routed, low loss RF cable. It has a solid BC inner conductor, foam polyethylene dielectric, aluminum tape outer conductor, a tinned copper overall braid and black polyethylene jacket. The velocity factor is 83%. It will withstand 1000VDC, a peak power of 2.5 kW, and shielding effectiveness is >90 dB.

LMR-240 – RG8X type

This RG8X 'type' outdoor cable has a solid BC inner conductor, foam polyethylene dielectric, aluminum tape outer conductor, a tinned copper overall braid and black polyethylene jacket. The velocity factor is 84%. It will withstand 1500 VDC, a peak power of 5.6 kW, and shielding effectiveness is >90 dB.

LMR-400 – RG8 / RG213 type

This is a standard RG8 / RG213 'type' outdoor cable that has a solid BCCA inner conductor, foam polyethylene dielectric, aluminum tape outer conductor, a tinned copper overall braid and black polyethylene jacket. The velocity factor is 85%. It will withstand 2500 VDC, a peak power of 16 kW, and shielding effectiveness is >90 dB.

LMR-400 - UltraFlex

Similar specification as LMR-400 with TPE jacket.



Coax

Coax can be purchased in any length up to 1000 feet. 1000' continuous lengths of 9913 or 8214 must be sent by truck.

8214 - RG8 / U

8214 is a standard RG8/U, #13 stranded copper center conductor, cellular polyethylene insulation, 97% bare copper shield, PVC jacket, 50 ohm impedance, 78% velocity factor and 1.8 dB loss per 100' at 100 MHz. The most popular cable for HF/VHF/UHF. Use when long cable runs are not required.

RG213 / U

RG-213 / U coax, #13 stranded copper center conductor, solid polyethylene insulation, 97% bare copper shield, non-contaminating PVC jacket, 50 ohm impedance, 66% velocity factor and 2.2 dB loss per 100' at 100 MHz. This RG-8 type cable is best for HF. It may be buried.

9913F-7

9913F-7 is RG8-type coax, #9.5 stranded copper conductor, foam polyethylene insulation, 100% foil plus 88% braid shield, PVC jacket, 50 ohm impedance, 84% velocity factor and 1.4 dB loss per 100' at 100 MHz. The best cable for VHF and UHF applications.

9258 - RG8X

RG8X is small diameter coax, #16 stranded copper center conductor, cellular polyethylene insulation, 95% bare copper shield, PVC jacket, 50 ohm impedance, 78% velocity factor and 3.7 dB loss per 100' at 100 MHz. Good for short VHF runs and most HF uses.

9356 - RG8 / U

100' roll of 8214 RG8 / U coax with PL-259 connectors (crimp type) installed on each end for your convenience.

Rotator Cable

HRO carries two **Belden rotator cables**. Use standard duty cable for runs up to 100 feet. For longer runs, please use heavy duty cable. Belden quality is **tops** in the industry.

8 wire, standard duty - Model 8448 - 8 wire cable using six #22 and two #18 tinned copper conductors. PVC insulation; chrome PVC jacket.

8 wire, heavy duty - Model 9405 - 8 wire cable using 6 - #18 m and 2 - #16 tinned copper conductors. PVC insulation; chrome PVC jacket.

When Ordering Cable

Please order cable in multiples of 50 feet. Continuous length spools up to 1000 feet are available. Call for quotes.



Baluns



Low-profile baluns mount directly to your yagi boom for easy installation. All are 50 ohms and broad band. From left to right, EB-3: 7-30 MHz, 10 kW CCS, AWG 10 wire, DIN-7-16 connector; EB-1: 1.8-30 MHz; EB-2: "shorty" for tri-banders and LP's, 10-60 MHz. EB-1 and EB-2 are 3 kW, AWG 14 wires, connector mates with PL-259. Wire leads are easy to connect and are color coded for antenna phasing. CAL-AV baluns are vacuum impregnated and sealed for durability and protection from the weather. **HRO Price EB-1 \$46.95; EB-2 \$42.95; EB-3 \$259.95**

Mark-V Antenna Spring



At last – a commercial grade antenna spring of polished, all-stainless construction. The MARK-V provides improved immunity to side winds, gusts, bumps, etc. over smaller, wimpy springs. It reduces fading due to match/resonance changes while in motion. The MARK-V is 2" in diameter by just under 5" long, with ham-standard 3/8-24 threaded hole in each end. **HRO Price \$89.95**

Mast Mount



CQ-1

The CQ-1 is a spring loaded boom to Mast plate that allows for quick connect of antenna to mast. Great for dxpeditions /VHF



rovers / emergency ops. Attach one plate to the antenna boom and the other plate to the mast. Mate the two plates by placing them together so that spring loaded pins go thru the opposite plate and lock into place when the plate is brought to level. U bolts and U-bolt hardware NOT included. Good up to 2" diameter mast / boom. Not for permanent installations. **HRO Price \$34.99**

CQ-V

For Vertical Antennas. **HRO Price \$34.99**

Prices in this print catalog are subject to change



ROTATORS

Yaesu's high quality rotators for amateurs include models for medium to large arrays and for satellite work. There are also provisions for computer control. Contact your nearest HRO for more specifications and discount prices on Yaesu products.



G2800DXA

The G-2800DXA is a high-technology rotator designed to turn the largest tower-mounted antenna arrays.

G-800SA / G-800DXA

The G-800 rotator series is designed for medium to heavy loads and antennas up to 20 square feet. The G-800DXA is the same as the G-800SA with the addition of presets.

Rotator Computer Controllers

Rotator	GS-23	GS-232	GS-232B
G-800S/SDX	✓	1	1
G-1000S/SDX	✓	1	1
G-2000S/SDX	✓	1	1
G-2300S/SDX	✓	1	1
G-2700S/SDX	✓	1	1
G-2800S/SDX	✓	1	1
G-800DXA			✓
G-1000DXA			✓
G-2800DXA			✓
G-5400B		✓	✓
G-5600B		✓	✓
G-5500		✓	✓
G-400		2	3
G-500	2	2	3
G-500A	2	2	3
G-500B	2	2	3
G-5500	2	2	3

✓ Fully Compatible

1. Requires C-1000 Interface Cable
2. Requires GX-500 Interface for GS232
3. Requires GX-500 Interface for GS-232B

Rotator Specifications

	Model	Input Voltage	Motor Voltage	Rotation Time	Stationary Torque	Rotation Torque	Maximum Windload	Max. Vert Load	Max. Mast Size	Cable Type	Weight lbs (kg)	HRO Price
M2	OR-2800DC	110/220 VAC	28 VDC	55 sec	17,000 in lbs	3200 in lbs	35 sq ft	1800 lbs	3-1/8 in	8-wire	42 (19)	CALL
Yaesu	G-450A	110 V	24 VDC	51 sec	217 ft lbs	39.8 ft lbs	10 sq ft	242 lbs	2 in	5-wire	7 (3.2)	\$249.95
	G-800SA	110 VAC	24 VDC	55 sec	3456 in lbs	43-79 ft lbs	17 sq ft	440 lbs	2.5 in	6-wire	10 (4.5)	\$349.95
	G-800DXA	110 VAC	24 VDC	55 sec	3456 in lbs	43-79 ft lbs	17 sq ft	440 lbs	2.5 in	6-wire	10 (4.5)	\$399.95
	G-1000DXA	110 VAC	24 VDC	55 sec	5200 in lbs	79 ft lbs	22 sq ft	440 lbs	2.5 in	6-wire	15 (6.8)	\$499.95
	G-2800DXA	110 VAC	24 VDC	55 sec	20,832 in lbs	219 ft lbs	34 sq ft	880 lbs	2.5 in	6-wire	26 (11.8)	\$1,129.95
	G-5500	110 VAC	24 VDC	58 sec	289 ft-lbs	*	10.7 sq ft	440 lbs	2.5 in	6-wire	20(9)	\$629.95
	G-550	110 VAC	24 VDC	67 sec	289 ft-lbs	101 ft-lbs	10.7 sz ft	440 lbs	1-5/8 in	6-wire	7.9 (3.6)	\$249.95

* Elevation 101 ft-lbs, Azimuth 44 ft-lbs

G-1000DXA

The G-1000DXA is designed to handle bigger arrays up to 22 square feet. A great value.

G-450A

The G-450A is ideal for smaller HF and VHF/UHF antennas. Features 360 degree radial compass display with overlap.



G-5500

This is the most popular azimuth and elevation rotator for satellite, moon-bounce or other space communications work. It provides horizontal and vertical antenna rotation in a single unit. The control box has two large meters, one showing elevation and the other azimuth. Meter aiming accuracy is within ±4%. The G-5500 provides 180° elevation rotation with a rotation time of 67 seconds. A 360° azimuth rotation takes just 50 seconds. This rotator accepts up to a 2.5" mast, a maximum 1-5/8" horizontal cross-boom and 440 pounds of vertical load. Computer controllable with optional GS-232 computer interface. **HRO Price \$649.95**

G-550

This is an elevation rotator for satellite work. The control box shows elevation in degrees. **HRO Price \$249.95**

Rotator Separation Kit

For some applications it is desirable to separate the azimuth from the elevation rotator on the tower. This separation kit provides all the hardware for the rotator to implement this separation. **HRO Price \$23.95**



Orion OR-2800DC Rotator

The Orion OR-2800DC is engineered for long life, reliability and performance while turning large antennas or systems. It has a strong ductile iron mast clamp to support up to 3-1/8" masts (optional long bolts required), extended and hardened drive shaft, and prop-pitch style torque plate. The rotator housing fits inside most popular towers and mates to standard tower / rotator plates.

The RC2800P Control Box has digital readout, variable speed control, slow start, and reverse delay, programmability, preset, 2 rotator capacity, coast-down, true AZ readout-continuous and infinite limit position control. The USA-made OR-2800DC has a one year warranty. **HRO Price \$CALL**

Wind Area Capacity	35 sq. ft.
Starting Torque	4200 in. lbs.
Rotating Torque	3200 in. lbs.
Breaking Torque	17000 in. lbs
Vert. Load Capacity	1800 lbs.
Mast Size (O.D.)	1.75-3-1/8"
Rotation Speed (360)	55-270 sec.
Readout Accuracy	1 degree
Input Voltage	110/220 AC 50/60 Hz
Motor Voltage	28-42 VDC
Cable Type	8 conductor
Weight (Rotator unit)	42 lbs.

ANTENNA TUNERS

hy-gain

Hy-gain rotators are the first choice of hams around the world! One is perfect for your antenna configuration.

Ham - IV

The popular Ham-IV is designed for medium antenna arrays up to 15 square feet. It features a dual 98 ball bearing race for load bearing strengths and an electric locking steel wedge brake. Maximum mast size 2 1/16". **HRO Price \$529.95**



Tailtwister Series II

This unit handles medium communications arrays up to 20 square feet wind load area. Available with the DCU-1 Pathfinder digital control box or standard analog control box. Has 138 ball bearings for large load bearing strength. Maximum mast size 2 1/16". **HRO Prices: T2X \$599.95, T2XD \$1029.95**



Ham - V

For medium antenna arrays up to 15 square feet wind load. Includes the DCU-1 Pathfinder digital control unit. No more terminal strips. Features inch connector plus 8-pin plug at the control box. Maximum mast size 2 1/16". **HRO Price \$949.95**

HDR-300A

Choose this rotator for king-sized antenna arrays up to 25 square feet of wind load. Heavy-duty self-centering steel mast clamp and hardware. Digital display accurate to 1 degree. **HRO Price \$1379.95**

AR-40

Especially for large FM-TV and compact communication antenna arrays up to 3.0 square feet wind load area. Dual 12 ball bearing race. Automatic position sensor never needs resetting. Maximum mast size 2 1/16". Includes MSLD light duty tower mast support. **HRO Price \$289.95**

CD-45II

The CD-45II handles up to 8.5 square feet of antenna wind load when mounted inside the tower or 5 square feet with the included MSLD light duty lower mast adapter. Has 58 ball bearing race. Maximum mast size 2 1/16". **HRO Price \$389.95**

DCU-1

Pathfinder

A digital control unit for the T2S, Ham-IV and Ham-V rotators. **HRO Price \$649.95**



Antenna Rope

Synthetic Textiles

Black Dacron® Polyester

This antenna rope is constructed of strong, double braid Dacron® polyester. It is black for UV protection and has excellent resistance to mildew and abrasion. The rope ties and cuts easily, sealing effectively with a hot knife. No expensive hardware is required. Sizes and prices shown in the chart.

Size	Model	Strength	HRO Price*
3/32"	ST-3/32-100	260+ lbs	\$9.95
3/16"	ST-3/16-100	770+ lbs	\$14.95
5/16"	ST-5/16-100	1790+ lbs	\$24.95

** Price per 100 feet

Line Thrower



EZ HANG

EZ HANG 2 can be used to "throw" a line up to 100 feet over a tree or other object. Cable pullers can use EZ HANG to "throw" a line through a dropped-ceiling/plenum and avoid using long pull-ropes. It cuts installation time and your cost dramatically.

EZ HANG's basic construction is steel attached to a reel that is corrosive resistant plastic and stainless steel. The reel comes with 300 feet of 10-pound-test monofilament line installed, a quick-disconnect clip to release the weight and an easy-to-see "bright yellow" one-ounce lead weight.

EZ HANG 2 Package

includes spare bands, 2 weights and clips and the EZ HANG
HRO Price \$89.95



Note: This is a "slingshot" device. Before ordering, please check local laws regarding possession and / or use of a slingshot.

ICOM

Icom's antenna tuners are automatic and, using the front panel controls, can be used with most HF exciters. Random wire and balanced line antennas cannot be used with the resonant antenna tuners. See the table on Page 13 for more tuner / radio compatibilities.

AT-180

Resonant Tuner

Fully automatic 100 W tuner styled for the IC-706. HF/6 meters. **HRO Price: \$364.95**



IC-706 transceiver shown for illustration purposes

AH4

Random Wire Tuner



This automatic tuner covers 3.5 - 50 MHz with a 7 meter or longer antenna or the optional AH-2b antenna element (7 MHz to 50 MHz). Use with all Icom transceivers. Forty-five memories store channel information for quick tuning. Installation is simple: no adjustments are necessary. Just connect the control and antenna cables. Its small size allows installation in a variety of locations. **HRO Price \$259.95**

Emergency Lights

Emergen-See

Windup Flashlight

FS-01BK

HRO Price \$9.95



LiteFlare

Emergency Flasher LF-01



LiteFlare is an economical alternative to the road flare. Unlike single-use disposable incendiary flares, each

reusable Lite Flare provides more than 400 hours of operating efficiency. One LiteFlare replaces more than 750 (30 minute) incendiary flares. Just insert two fresh "AA" batteries.

The Lite Flare operating mechanism is enclosed inside a rugged military-grade, high impact plastic case that resists water, snow, dust, rough pavement – even the weight of an automobile. LiteFlare is safe to use and won't ignite fuel or clothing. LiteFlares produce no toxic residue or fumes to harm the environment or the user.

Lite Flare's flashing red light is visible for more than two miles during darkness! It is designed for night time use but can also be used during foggy or heavy overcast daytime conditions or stormy weather. To operate, just flip the switch and the LiteFlare begins flashing. **HRO Price \$14.99**



HF Auto Antenna Tuners



HC-200AT
\$CALL – HRO Price

The HC-200AT works with a variety of antennas, tuning with lightning speed. The large analog meter automatically displays SWR status as well as forward power.

- Frequency Range: 1.8 - 54 MHz.
- Impedance Range: 5 - 500 Ω (3.5-54 MHz) / 15 - 500 Ω (1.8 MHz).
- Handling Power: 200 W maximum PEP / CW.
- Input Impedance: 50 Ω (SO-239).
- Output Connectors: Two SO-239's and one wire antenna terminal.
- Tuning Time: 1.5 sec (typ), 4 sec max, 0.2 sec for memory tuning mode.
- DC Power: 12-14 VDC, 0.8A max, 0.1A after tuning is finished.
- Dimensions: 7.7 x 2.4 x 9.5 inches (WxHxD).
- Weight: approx. 2.3 pounds.
- Optional Parts: Radio Interface Cable (Icom) HTC-100AT / Icom5 (17ft).



HC-1.5KAT
HRO Price \$CALL

HC-1.5KAT is a high power HF auto antenna tuner designed to work with Tokyo Hy-Power HL-1.5KFX and HL-2.5KFX linear amplifiers. When combined with these THP amplifiers, the band change is made automatically through the band data signal from the radio and the amplifier. (Version 1.2 firmware or higher required on HL-1.5KFX).

It handles maximum power of 1.5 kW pep / cw when the intrinsic antenna SWR is no more than 2 to 1. Maximum impedance matching range is SWR 4 to 1 on HF and 3 to 1 on 6 m. Input impedance is 50 Ω.

Two high grade 3.5 kV rating 200 pF air variable capacitors form a "T" match circuit being driven by high speed stepping motors. Our own tuning algorithm together with an advanced 16 bit micro-processor enables an extremely fast tuning speed of one second typical and four seconds maximum. It features three SO-239 output connectors.

The display is an LCD module with 16 characters in 2 rows. The unit is 8 x 5.6 x 12 inches (WxHxD) and weighs 11 pounds.



ACCESSORIES

Antenna Switches

Your Cable Problems – Solved!



RCA-14

RCA-14 is a breakout box for the accessory jacks on most popular transceivers. It comes with cables with the right DIN plugs, and all the outputs are blessedly simple RCA jacks. You simply plug the RCA-14 into your radio's accessory jacks, and all your ports are right there at your fingertips; just plug and play, one function or all of them, makes no difference. And, you can change things around as often as you like; it's as simple as swapping out an RCA plug.

The RCA-14 comes with a DIN 13 cable, a mini DIN 6 and a mini Din 8. The DIN 13 cable breaks out the functions to RCA jacks 1 - 13, while the mini DIN 6 goes to RCA 1 - 6, and the mini DIN 8 goes to RCA 7 - 14. You can use the DIN 13 or the mini DIN 6 and/or 8, depending on your radio. The RCA-14 is compatible with: Icom 703, 706, 718, 746, 756, 7000 and 7800; Yaesu 187, 857, 897 and 840; Kenwood 480, 570, 2000; Ten Tec Orion. **HRO Price \$59**

The DTS Series Antenna Switches

Tired of that tangled mess of coax and pigtails in your shack? Always worrying about whether you set the ground switch on your antenna before you left your shack? LDG's new DTS Series antenna switches are for you. Instantly switch your rig between 4 or 6 antennas with the press of a button. Auto-grounding when you shut your rig down. Purchase the additional remote control and put the DTS Series switch anywhere indoors and operate it from your desk. They handle up to 1500 watts of RF power on HF (250 W on 6 M), and can be used with any coax-fed antenna.



HRO Prices:
DTS-4 \$79.95, Remote \$39.95



HRO Prices:
DTS-6 \$99.95, Remote \$49.95



No Questions Asked!
Every LDG Product comes with our industry leading 2-year warranty on the performance of your product. Just contact us to let us know your problem and we will repair or replace your product
No Questions Asked!

Baluns and Cables



- | | | |
|---------|--------------------------|----------------|
| RBA-4:1 | Remote 4:1 Balun | HRO Price \$30 |
| RBA-1:1 | Remote 1:1 Balun | HRO Price \$30 |
| Y-ACC | FT-897, FT-857 Interface | HRO Price \$12 |

HRO Ships from the Store Nearest You

TUNERS



Portable Tuners



Z-11Pro The Return of a Legend

The original portable Z-11 was one of LDG's most popular tuners, accompanying adventurous hams to their backyards, or to the ends of the earth. Now meet the Z-11Pro, everything you always wanted in a small, portable tuner designed from the ground up for battery operation.

Only 5" x 7.7" x 1.5" and weighing only 1.5 pounds, it handles 0.1 to 125 watts, making it ideal for both QRP and standard 100 watt transceivers from 160 - 6 meters.

With 8,000 memories in LDG's exclusive "3-D Memory" array, the Z-11Pro uses LDG's state-of-the-art processor-controlled switched-L tuning network. It will match dipoles, verticals, inverted-Vs or virtually any coax-fed antenna. With an optional LDG balun, it will also match longwires or antennas fed with ladder-line. **HRO Price \$179.95**



Z-100 Definitive low cost automatic tuner!

Designed from the ground up to provide the 100 watt power handling you asked for, in a small, lightweight package, perfect for portable as well as sitting on your desk in your shack!

The Z-100 will tune with 0.1 to 125 watts (50 watts on 6 meters), making it an excellent choice for almost any radio or operating style. Backpackers and QRP operators will appreciate the latching relays. Power can be removed from the tuner once you have tuned. Additionally, when the tuner is not tuning, it draws nearly zero amps. Additionally, the Z-100 features 200 fast memories which will decrease tuning time up to 95%! **HRO Price \$149.95**

Automatic Antenna Tuners

AT-7000 for the Icom IC-7000 The Hottest Radio in the Industry! Now with It's Own Autotuner



(radio not included)

The AT-7000 is the ideal tuner for IC-7000 and other Icom radios. Covers all frequencies from 1.8-54 MHz, and will automatically match your antenna in a flash. Requires just 0.1 W for operation, but will handle up to 125 W (100 W on 6 m), making it suitable for everything from QRP (IC-703 Plus) to a typical 100 W Icom transceiver.

Tune with the AT-7000 or use your radio. Includes over 2,000 memories, uses latching relays, tuning range is 4-800, powered by your radio. Includes Icom interface cable. **HRO Price \$169.95**



AT-897 for the Yaesu FT-897

(radio not included)

If you own a Yaesu FT-897 and want a broad range automatic antenna tuner, look no further! The AT-897 Autotuner mounts on the side of your FT-897 just like the original equipment. We even added the ability to mount the "feet" on the side of the tuner so when you are transporting your rig by the handle, you can safely set it down and not worry about scratching the case. The AT-897 takes power directly from the CAT port of the FT-897 and provides a second CAT port on the back of the tuner so, if you are using another CAT device, hooking it up couldn't be easier. **HRO Price \$199.95**



AT-1000 Pro Autotuner Convenience

The AT-1000 Pro is a refined and expanded version of the popular AT-1000. It features an auto mode that automatically starts a tuning cycle any time the SWR exceeds a limit you set. There are provisions for two antennas and you can switch between them. There are 2000 memories that store tuning parameters for each antenna. The unit will operate at any power level between 5 and 1000 watts peak RF input.

There is a large, easy to read cross needle meter with 2 selectable ranges. It will tune from 1.8 to 54 MHz matching a wide range of antennas. **HRO Price \$549.95**



AT-200 Pro

The first auto tuner specifically designed for today's high-powered transceivers

The AT-200 features LDG's new "3-D memory system" allowing up to eight antenna settings to be stored for each frequency. Handles up to 250 watts SSB or CW on 1.8-30 MHz, and 100 watts on 54 MHz (including 6 Meters).

Rugged and easy-to-read LED bar graphs show power and SWR, and a function key on the front panel allows you to access data such as mode and status. **HRO Price \$249.95**

Watt Meters

FT Meter-Blue

for the Yaesu FT-897/857

(radio not included)



The FT-Meter presents a lush, highly readable 2.5" meter face with calibrated scales for signal strength and discriminator reading on receive, and power output, SWR, modulation, ALC action and supply voltage on transmit. Each function is selectable from the radio's menu. Easily visible from anywhere on your desk or dash, the FT-Meter is illuminated by any external 12 vdc source. The FT-Meter comes fully assembled and ready to go; just plug it into the radio and you're in the picture like never before. **HRO Price \$49.95**



AT-100 PRO

Automatic Antenna Tuner

This desktop tuner covers all frequencies from 1.8 - 54 MHz, and will automatically match your antenna in no time. It features a two-position antenna switch, allowing you to switch instantly between two antennas. The AT-100Pro requires just 1 watt for operation, but will handle up to 125 watts, making it suitable for everything from QRP to a typical 100 watt transceiver. The AT-100Pro includes more than 2,000 memories for each antenna, automatically storing tuning configurations for each frequency and band as you use them. **HRO Price \$209.95**

Prices in this print catalog are subject to change



ANTENNA TUNERS PLUS

Smartuners™ deliver greater impedance matching, more tuning steps and more antenna choices than any other antenna coupler on the market. For frequency agility and precision tuning, choose a Smartuner. They are independently intelligent, matching ANY HF transceiver and ANY antenna. Smartuners are microprocessor controlled; analyzing the conditions of your antenna and automatically adjusting for the best match. They also remember each match, cutting retuning time to under 10 milliseconds when changing frequencies. Smartuners are available for power levels from 1.5 to 500 Watts and frequency ranges from 1.0 to 60 MHz. They provide all-purpose tuning ideal for base, mobile, portable, marine or aviation. Any budget, any installation... Your choice for antenna tuning should be an SGC Smartuner.

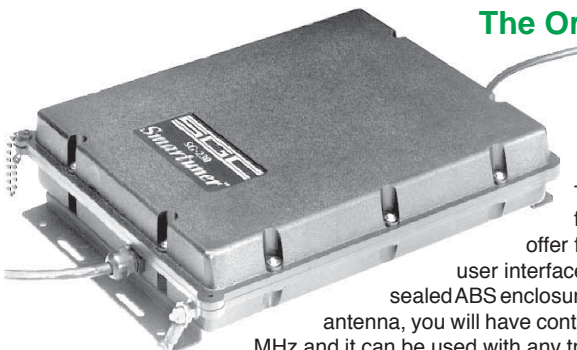

The Original Smartuner™

SG-230 – \$499.95
HRO Price

The SG-230 Smartuner was the first product in the HF market to offer fast, flexible tuning without any user interface. It is built in a rugged, factory sealed ABS enclosure. With this tuner and any single antenna, you will have continuous coverage from 1.8 to 30 MHz and it can be used with any transceiver you'll ever own. The

SG-230 can be used in base station, mobile, marine and aviation applications, and has been the "Gold Standard" of automatic antenna tuning for more than a decade.

The Budget Smartuner™

SG-239 – \$195.95

Get quality performance from a low cost package. The SG-239 will operate from 1.8 to 30 MHz with 1.5 to 200 W. Like all Smartuners, it gives you the most flexibility because it will work with any antenna and any transceiver. It also has push buttons for a manual tune option. It weighs only 2 pounds, so you can use it for base or portable.



The General Purpose Smartuner™

SG-237 – \$359.95

The SG-237 is the most popular Smartuner. Its rugged construction and small size allow for maximum flexibility. It has a 100 W power rating and expanded coverage to 60 MHz, matching it perfectly with the most popular HF transceivers. It will work with any balanced or unbalanced antenna including whips, backstays, dipoles, loops and long wires.



SGC Smartuners

Specifications	SG-230	SG-235	SG237	SG-239	MAC-200
PEP Input (W)	3-200	3-500	3-100	1.5-200	1.5-200
CW Max Input (W)	80	200	40	80	80
Frequency (MHz)	1.8-30	1.8-30	1.8-60	1.8-30	1.8-60
Input Current (A)	0.9	1.4	0.3	0.23	0.23
DC Input (VDC)	13.6	13.6	13.6	13.6	13.6
Tuning Combinations	0.5 million	0.5 million	0.5 million	1/8 million	1/8 million
Antenna Length (<3.3MHz)	8 ft	50 ft	8 ft	40 ft	40 ft
Antenna Length (>3.3MHz)	23 ft	300 ft	28 ft	100 ft	100 ft
Dimensions (in)	16x12x3	16x12x3	7x6x1.5	7.5x6x2	8.5x6.5x3
Weight (lbs)	8	8	2	2	5
Waterproof	yes	yes	yes	no	no
HRO Price	\$499.95	\$1,295.95	\$359.95	\$195.95	\$265.95

* Operates from 4 AA batteries - factory installed

HF Amplifier

SG-500

Smart PowerCube™
\$1399.95 – HRO Price



For 500 Watt operation in your base station or mobile, the SG-500 SmartPowerCube™ provides maximum reliability and unattended operation. The SG-500 is microprocessor

controlled. It automatically monitors your power needs and selects the correct broadband filter. It also has the most advanced self-protection on the market.

Master Antenna Controller



MAC-200 – \$265.95

Select the right antenna, for the right band, at the right time with the MAC-200. You can select among up to five antennas and tune automatically to minimum SWR. Monitor your power and SWR with meters on the front panel. The MAC-200 automatically selects the correct antenna for your operating frequency, quickly and accurately. It stores the correct settings in memory and will recall them in less than ten milliseconds.

Whip Antennas

500 W SG-303 – \$CALL
100 W SG-307 – \$CALL

Helically wound whip antennas can be used with SGC and other couplers. SG-307 (55-28 & 55-69), up to 100 W, 1.8-60 MHz, 7 feet. SG-303 (55-27 & 55-67), up to 500 W, 1.8-30 MHz, 9 feet (2 sections). Both antennas can be supplied with or without a stainless steel swivel ratchet mount (55-75).



Multi-band HF Verticals

HF9V

More efficient than conventional trapped designs or "halfwave" verticals, the exclusive Butternut Differential Reactance Tuning system allows more of the antenna to be active on each band, for greater bandwidth, lower radiation angle, and superior performance!

- 9 bands, 80 thru 6 meters.
- No-radial operation with CPK counterpoise.
- Highly efficient 26 foot vertical radiator.

HRO Price \$399.95

HF2V →

Are you ready for the sunspot shortage when the action will be on 80 and 40? Be prepared with the HF2V. The entire antenna radiates on both bands for low radiation angle and maximum performance.

- Dual-band optimized for 80 and 40 meters.
- 32 feet tall; no guying required.
- 160 or 30 meters with optional adapters.

HRO Price \$269.95

← HF6V

Work the 6 most popular bands— 80, 40, 30, 20, 15 & 10 meters—with a single, highly efficient vertical radiator only 26 feet tall!

- No radial operation with CPK counterpoise.
- Add 160, 17 & 12, or 6 meters with optional adapters.

HRO Price \$349.95

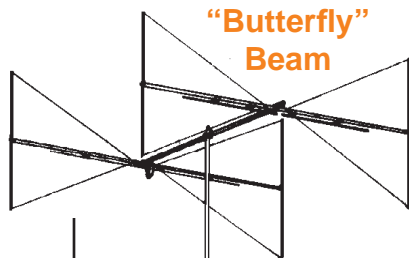

HF5B

Five popular bands in a single light-weight 2 element beam antenna. Ideal where space is limited, the HF5B provides up to 3 dBd on 20, up to 5 dBd on 15, 12, and 10. Light enough to turn with a TV rotator, the HF5B has a 6 foot boom and a wingspan of only 12.5 feet. Weighs only 20 pounds; surface area is 3 square feet.

HRO Price \$399.95

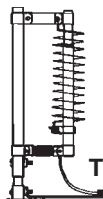

Vertical Antenna Accessories

TBR-160S

TBR-160S 160 Meter kit for HF9V-X, HF2V or HF6V-X. Not recommended for CPK.

HRO Price \$149.95

CPK Counterpoise kit for HF9V-X, HF6V-X. Allows operation with no radial system.

HRO Price \$139.95

STR-II Resonant radial kit for above ground mounting of Butternut verticals.

HRO Price \$129.95

A-17-12 Adapter for 17 and 12 meters for 6 band Butternut verticals.

HRO Price \$65.95

RMK-II-Roof mounting kit. Includes STR-II. **HRO Price \$179.95**

GPK Ground Radial Kit. **HRO Price \$75.95**

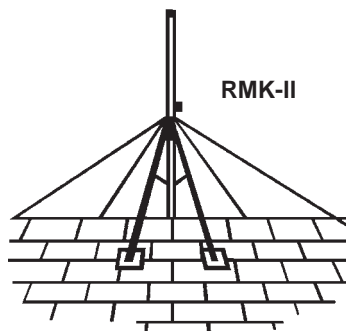

HF BASE ANTENNAS



Skyhawk 3X10

The Next Generation HF Yagi

HRO Price \$1099.95

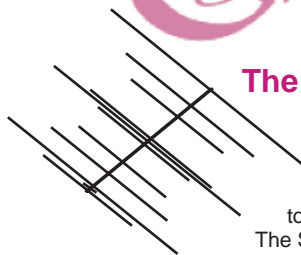

The Bencher Skyhawk antenna is a major step forward for serious HF operators. It is not just another trapped tribander.

The Skyhawk features 10 elements on a 23 foot boom, with three full-sized yagis sharing a common feedline and a common boom. There are three elements on 20 meters, three on 15 meters and four on 10 m. All elements are full-sized with no lossy traps and driven directly.



Special features of the Skyhawk include wide bandwidth, excellent F/B ratios, superb gain, and low weight. With boom and element wind compensators, there is zero rotational mast torque and 90 mph wind survival. All materials are corrosion and UV resistant. Stainless steel blind rivets are used for element assembly.

Custom aluminum extrusions make assembly a snap and assure longevity. A new design of boom to mast bracket makes installation the easiest ever. Heavy wall boom construction means that no boom truss cable is required, making it easier to stack antennas for other bands. A Bencher P5 balun is included.

Band Specifications

Band	Effective Boom Length	VSWR	F/B	Gain
20	23	<1.4:1	>20 dB	>7 dBi
15	15'6"	<1.3:1	>16 dB	>7 dBi
10	16'9"	<1.6:1	>14 dB	>7.7 dBi

The wind load is 8.5 sq. ft, turning radius 22 feet, wind survival is 90 mph with no ice, 2" boom, 50 ohm impedance and a maximum power rating of 5KW.



Cobra Antenna

UltraLite Senior

160-10 Meters, 140 feet

HRO Price \$89.95

UltraLite Junior

80-10 Meters, 73 feet

HRO Price \$85.95

On its primary and harmonic operating frequencies, the Cobra antenna works identically to a ladder-line fed doublet, but its unique close-spaced multi-wire element also introduces two added resonant responses below the antenna's fundamental operating frequency. These responses extend frequency coverage far beyond that of a conventional doublet or G5RV. For example, the 140-foot (80-meter) Cobra also resonates near 2.8 MHz and on 160 meters. Similarly, the 73-foot (40-meter) Cobra also covers 60 and 75 Meters.

UltraLite Cobras are designed and engineered to survive harsh winter climates. Weighing only four pounds including the feedline, they install quickly and pull up higher with far less stress on tree branches and support lines. The black marine-grade ABS insulators won't deteriorate in sun or fracture in cold. All hardware is stainless. All wire is UV stable and pull-tested for strength. UltraLites come pre-assembled and ready to install with 100-feet of rugged copper-weld ladder line attached.

All Cobras require a tuner. In most installations, the auto-tuner built into your transceiver should provide sufficient tuning range. Because the Cobra presents a balanced load, we recommend installing a 4:1 current-style balun at the station end of the feedline (many external tuners provide a built-in balun).



Challenger

The Challenger antenna is the first production multiband utilizing GAP technology. It is capable of operating on eight separate bands from 3.5 MHz to 144 MHz. Use it on 80, 40, 20, 15, 12, 10, 6 and 2 meter bands with over 130 kHz bandwidth on 80 m. The antenna is designed to be mounted directly in the ground or elevated. A ground mount is provided with each antenna. The Challenger may be roof mounted. The antenna requires a counter poise of three 25 foot insulated wires.



Eagle DX

Gap's smallest antenna, the Eagle DX, weighs just 11 pounds and can be installed most anywhere. It is essentially a set of vertical dipoles. No traps, coils or transformers are used. It covers 40, 20, 17, 15 and 20 meters with the entire band at a VSWR of 2:1 or less. For 10 m this is 500 kHz. No antenna tuner is required.



Voyager DX

The Voyager DX is the first antenna manufactured specifically to provide efficient low band operation from the typical backyard without a huge investment in time, money, and space. It is not another "add a kit" antenna for 160m. GAP technology opens up the low bands. Emphasis was given to 160 m and 80 m when designing the Voyager. The antenna employs a capacity hat with circular ring to reduce the physical height to 45 feet while maintaining an electrical height of 66 feet. Parallel tuner rods are used in its design. No tuning or matching are required to put the Voyager on the air.



GAP Antennas

Model	Bands	Bandwidth (under 2:1)	Height (ft)	Weight (lbs)	Mount	Counter poise	Ground Area Required	HRO Price*
Challenger	80, 40, 20, 15, 12, 10, 6, 2m	Entire band except 130kHz 80m	31.5	18	Ground or elevated. Ground Mt supplied	3 at 25'	10' x 12'	CALL
Voyager DX	160, 80, 40 20m	Entire band except 900kHz 160m	45	30	Ground. Aluminum pivot and guy brackets supplied	3 at 57'	4 guy points 25 ft from base	CALL
Eagle DX	40, 20, 17, 15, 12, 10m	Entire band except 500 kHz 10m	21	11	Most anywhere. Pole mount supplied for 1.25 ant Mast	3 rigid at 80" long		CALL

* All GAP antennas shipped PLUS freight

Log Periodic



ELK 2m / 440 Dual Band

The Elk 2m / 440 is a dual band log periodic antenna for 144-148 MHz and 430-450 MHz. The antenna features 6.6 dBd gain on 2 meters and 7 dBd on 440 MHz. The SWR is 1:1 in these frequency ranges. The antenna handles 200 watts on 2 meters and 100 watts on 440 MHz. The boom length is 24 inches and the antenna weighs only 1.4 pounds. The ELK 2m / 440 assembles quickly with color coded threaded elements that screw into the color coded boom. Access two bands with just one coax fitting. No duplexer is required. All of the band may be used without retuning. Easily change the polarity of the antenna by twisting the mounting assembly. **HRO Price \$CALL**

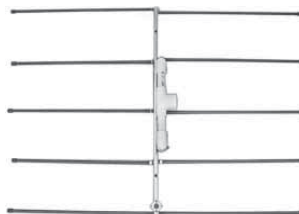

Wireless Antennas

Wi-Fi / 802.11b Wireless LAN Antennas

NGC offers a wide selection of directional and omnidirectional antennas for Amateur Television, the ISM band, LAN/WAN, data links and wireless internet.



GP-24

ATV/ISM Band
2400-2500 MHz
Omnidirectional
Gain: 15.4 dBi
Height: 5' 10"

Connector:
N-Type

HRO Price:
\$199.95



GP-24-3

Same as GP-24 but omnidirectional with 3 degree electrical downtilt.
HRO Price: \$CALL

Baluns

RadiWavz

Product	Model	HRO Price
---------	-------	-----------

G5RV Line

G5RV Jr.	g5jr	\$28.99
G5RV Lite	g5lt	48.95
G5RV	g5rv	39.99
G5RV CL	g4rvcl	45.00
G5RV MAX	g5rvmax	75.99

Dipoles with 1:1 Balun

160 m	160dp11	79.95
80 m	80dp11	59.95
40 m	40dp11	47.95
20 m	20dp11	39.95
10 m	10dp11	37.95

Dipoles without Balun

160 m	160dp	70.99
80 m	80dp	50.99
40 m	40dp	40.99
20 m	20dp	32.99
10 m	10dp	32.99

Double Bazooka

160 m	160dbx	129.95
80m	80dbz	95.00
75 m	75dbz	79.95
60 m	60 dbz	70.00
40 m	40 dbz	59.95
30 m	30dbz	59.95
20 m	20 dbz	39.95
17 m	17 dbz	37.95
15 m	15 dbz	37.95
12 m	12dbz	37.95
11 m	11 dbz	37.95
10 m	10dbz	37.95
6 m	6 dbz	37.95
2 m	2dbz	37.95
220b	220dbz	37.95
440b	440dbz	37.95

DX Loop

160 m	160lp	250.95
80 m	80lp	139.95
40 m	40lp	79.95
20 m	20lp	59.95
11 m	11lp	49.95
6 m	6lp	49.95
2 m	2lp	45.00

DX (OCF) Windom

DX 40	dx40	55.00
DX 80	dx80	75.00
DX 169	dx16040m	125.00

HF BASE ANTENNAS

VAN GORDEN

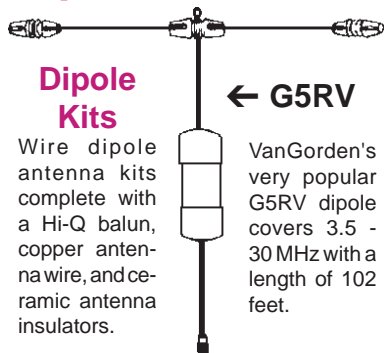

Dipole Kits

Wire dipole antenna kits complete with a Hi-Q balun, copper antenna wire, and ceramic antenna insulators.

← G5RV

VanGorden's very popular G5RV dipole covers 3.5 - 30 MHz with a length of 102 feet.

Standard Length

Models D-10 for 10 meters, D-15 for 15 m, D-20 for 20 m, D-40 for 40 m, and D-80 for 75 / 80 m.

Shortened

Models SD-40 for 40 m and SD-80 for 75 / 80 m.

Parallel

These models are made of multiple dipoles connected at the center balun and fed at this one point. Model PD-8010 is for 10-80 meters, PD-8040 is for 40 and 80 m, PD-4010 is for 10-40 m, and PD-4020 is for 20-40 m.

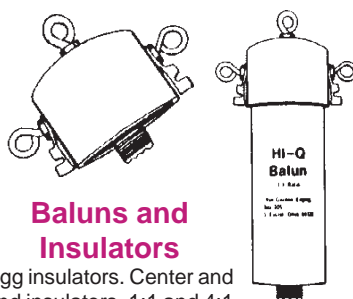

Baluns and Insulators

Egg insulators. Center and end insulators. 1:1 and 4:1 Baluns.

Van Gorden Antennas

Model	Type	Band	Length ft (m)	Power PEP	Wire Size	HRO Price
D-10	Standard Dipole	10	16(4.9)	2KW	#14	\$34.95
D-15	Standard Dipole	15	22(6.7)	2KW	#14	\$35.95
D-20	Standard Dipole	20	33 (9.9)	2KW	#14	\$36.95
D-40	Standard Dipole	15/40	66 (19.8)	2KW	#14	\$38.95
D-80	Standard Dipole	75/80	130 (39)	2KW	#14	\$41.95
All-Bander	Standard Dipole	160-10 *	134 (40.8)	2KW	#14	\$35.95
Shorty	Dipole	160-10 *	70(21)	2KW	#14	\$55.95
SD-40	Shortened Dipole	40	45 (13.5)	2KW	#14	\$44.95
SD-80	Shortened Dipole	75/80	90 (27)	2KW	#14	\$46.95
PD-8010	Parallel Dipole	10 to 80	130 (39)	2KW	#14	\$55.95
PD-8040	Parallel Dipole	15/40/80	130 (39)	2KW	#14	\$51.95
PD-4010	Parallel Dipole	10/20/15/40	66 (19.8)	2KW	#14	\$49.95
PD-4020	Parallel Dipole	20, 15/40	66 (19.8)	2KW	#14	\$43.95
G5RV	Dipole	3.5-30 MHz	102(31)	2KW	#14	\$69.95

* Antenna tuner required

Force 12

Classic Tribanders C Series

Force 12 has a lineup of antennas covering the 20-15-10 bands with a single feedline. All are trapless and are acclaimed as outperforming trapped antennas.

- C-3** 20-10 m, 18' boom.
- C-3S** 20-10 m, 12' boom.
- C-3SL** 20-15-10 m (3-element 20, 3-element 15, 4-element 10, w/ separate feedlines for maximum versatility).
- C-4** 40-10 m, 18' boom.
- C-4S** 40-10 m, 12' boom.
- C-4XL** 40-10 m, 30' boom (w/ 2 elements on 40).
- C-4SXL** 40-10 m, 23' boom (w/ 2 elements on 40).

Call HRO for Quotes



HF Dipole Antenna

YA-30 - \$249.95 - HRO Price

This 83-foot broadband dipole antenna provides optimum performance over 1.8-30 MHz. Usual requirements for an antenna tuner between the rig and antenna are eliminated by the unique broadband design. Handles 150 watts at an SWR of less than 1.9:1 on the amateur bands. Preamsembled and pretuned. Can be installed as a horizontal flat-top, inverted-V, or sloper. 100 feet of RG-8X with PL-259 included.

HF Antennas for Limited Space



ALPHA DELTA

All the limited space antennas use stainless steel hardware where required, are fully assembled, and are manufactured to withstand severe weather. SO-239 connectors.

Model DX-B is a single wire, high performance quarter-wave sloper antenna for 160, 80, 40 & 30 meters. For limited space, the antenna requires only 60 feet for installation. Use with a wide range antenna tuner. Pre-assembled and pre-tuned. Has stainless steel hardware, 12 gauge insulated solid copper wire and the Alpha Delta "ISO-RES" RF choke coils, 50 ohm coax feed. Full legal power. **HRO Price \$110.95**

Model DX-A: A quarter wave twin sloper for 160-80-40 meters. One leg is 67' and the other 55'. Installs as an inverted-V. **HRO Price \$99.95**

Model DX-CC: A no trap 80-40-20-15-10 meter dipole. 82' long. **HRO Price \$159.95**

Model DX-DD: A no trap 80-40 meter dipole. 82' long. **HRO Price \$130.95**

Model DX-EE: A no trap 40-20-15-10 meter dipole. Only 40' long. **HRO Price \$140.95**

Model DX-OCF: Off-center fed 6-band antenna (75 / 80, 40, 20, 17, 12 & 10M. No tuner required. Feed with 50 ohm coax to a 6:1 balun with SO-239 connector. Install in standard 135' configuration or in 67' (40, 10, 10 M). Constructed of 65 strand 12 gauge PVC coated wire. 300W CW / SSB **HRO Price \$175.95**

Beams for 6m / 2m / UHF



New Ham Starter Antennas 6m, 2m, 220 MHz, or 440MHz

These low cost antennas have a single heavy duty mounting cradle and stainless steel hardware - the quality construction you have come to expect from M². Built with size and portability in mind, these antennas are great for field days, mountain topping, fox hunts, DXpeditions and ATV use. The antennas break down to no more than 40" long, making them a natural for travel.

Model	Description	HRO Price
6M3-SS	3 element 6m beam	\$149.95
2M3-SS	3 element 2m beam	\$79.95
222-5SS	5 element 220 MHz beam	\$92.95
440-6SS	6 element 440 MHz beam	\$78.95

Visit Our Secure Website for Up-to-the-Minute Prices and Special Offers @ www.hamradio.com

AMATEUR BASE & PORTABLE ANTENNAS

Ventenna™
Company



Can you spot the antenna?

Neither can your neighbors.

At last a solution to antenna restrictions! The Ventenna™ quickly slips over an existing vent pipe and your signal really gets out! This nearly invisible antenna is one of the most rugged made.

The VT-27 dual-band is for 2 m/440 MHz. Single band models are for 2 m, 220 MHz and 440 MHz.

Model	Bands	HRO Price
VT-14	2 meters	\$69.95
VT-22	220 MHz	\$63.95
VT-44	440 MHz	\$63.95
VT-27	2 meter & 440 MHz	\$89.95

Portable HF Vertical Antenna
HFp — \$189.95
HRO Price

The HFp portable HF vertical antenna covers 6.5 MHz to 30 MHz. (An 80 m option is available.) It handles 200 watts and is 10.5 feet when fully assembled. The package weighs 2.2 pounds. Typical band width without adjustment is 200 kHz on 40 m, 400 kHz on 20 m, greater than 1 MHz on 10 m, and the full band on 30m, 17m, 15m and 12 m. The antenna includes elements for all bands, mounting base, ground radials on easy-to-use spools, and guy cable on an easy-to-use spool.

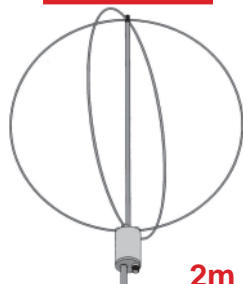

2m
Eggbeater

EB-144 / RK2M
HRO Price \$CALL

Use the Egg-beater for fixed and mobile operations. It produces smooth omnidirectional horizontal polarity at the horizon. Above the horizon, the pattern transforms to right hand circular off the top making it a natural for OSCAR use. No rotation or steering is required.

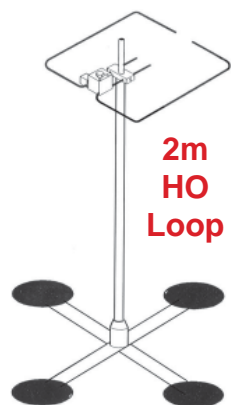

2m
HO Loop

Shown with optional mag mount

HRO Price \$CALL
Colored versions higher

Nothing satisfies more than our 2m "HO" Loop for horizontal performance. This easily adjustable antenna has plenty of bandwidth. It will handle a KW plus. Stack antennas for more gain. The Loop has durable construction for "tree bashers." Have no weather worries with the bright aluminum standard finish or an anodized finish in gold, black, turquoise or green.



High Sierra

This Platinum Package Deal has the best of High Sierra Antennas.

Suggested List Price \$630.
HRO Price \$545.95

- The famous HS-1800 / Pro in powder coated black. Continuous tuning from 3.5 to 30 MHz. Rated at 1000 watts. Weighs 6 pounds. Approximately 3 feet tall when fully retracted. Used at home or mobile.
- Stainless steel mounting bracket powder coated black has the coax connector and ground connection.
- Stainless steel 6 foot whip powder coated black.
- Cinch quick disconnect powder coated black.
- Installation kit including 20 feet of High Sierra coax with the motor wires, coax connectors, ground strap and connector seal.
- EZ-Tune controllers available for Icom, Kenwood & Yaesu transceivers.
- Standard remote control box.

Sidekick
HRO Price \$395.95

The Sidekick Antenna covers almost all of the HF spectrum. Its small size and high-Q coil provide an efficient, remotely tuned HF antenna.

- Just 15 inches tall, it has continuous tuning from 3.7 to 60 MHz with an SWR of less than 1.5:1. It weighs about 2 pounds and is rated at 200 watts. Standard 3/8-24 threaded base to use with many types of mounts. Easy to install and use at home, mobile or camping.
- Standard remote control box included.
- Stainless steel 3 foot whip powder coated black included.
- EZ-Tune controllers for semi-automatic tuning with Icom, Kenwood & Yaesu transceivers available.

Tripod Deluxe
HRO Price \$130.95

Perfect for camping, portable, emergency, or backyard use. Approx. 6 ft tall. Has a 3/8-24 stainless mount with coax connector for use with most mobile antennas. Comes complete with a counterpoise that has eight 10-foot wires. Sets up in just seconds.



SUPERANTENNAS

by Vern W6MMA

Multi-band HF screwdriver-portable antennas fit into your briefcase along with a K2, FT-817 or other small rig. The universal mount allows them to be set up on almost any object at any angle to operate QRP to 150 watts.

Portable HF Antenna

7 MHz - 450 MHz
3.5-4 MHz with optional coil
MP-1: \$99.95
HRO Price

Accessories:

80 Meter Coil	\$25.00
Tripod	\$19.95
Mobile Kit	\$15.00
FT-817 Bracket	\$19.95
Mobile Kit	\$15.00

(Shown with universal Mounting Bracket Assembly)



QRP Field Yagi

6 / 10 / 12 / 17 / 20 m Yagi
YP-2: \$359.95
HRO Price

The 2-element, driver-reflector QRP Field Yagi covers 10 and 6 meters with full length, widely-spaced elements for very wide band coverage. On 12 and 15 meters, the elements are loaded at specific points with 3.5 pH coils with an estimated Q of 200. On 17 and 20 meters, the elements are loaded at specific points with 7.0 pH coils, again with an estimated Q of 200. The antenna will fit into the side-to-side space of a 10-meter Yagi. It is light weight and fits into a 36" long carrying case for easy transport. It requires no matching network.

The Owl

Want to keep those birds off your antenna system?

The OWL is just the trick. Mount this fella on top of your tower and the birds will stay away.

HRO Price \$19.95





Hustler delivers reliability and performance **Beyond Your Expectations!**

VHF / UHF Base Antennas

2m Verticals

These easy-to-assemble verticals are made of aluminum and high-strength fiberglass. When disassembled the longest part is about 4'. Choose 3, 6, or 7 dB gain and the overall length that best suits your application.



- G7-144**
HRO Price \$199.95
- Frequency range: 144-148 Mhz.
 - Bandwidth: 4 MHz.
 - Gain: 7 dB.

- G6-144B**
HRO Price \$139.95
- Frequency range: 143-149 Mhz.
 - Bandwidth: 6 MHz.
 - Gain: 6 dB.

- G3-144**
HRO Price \$69.95
- Freq. Range: 144-148 MHz
 - Bandwidth: 4 MHz.
 - Gain: 3dB.



220 & 440 Verticals

The G7-220 is of similar design and construction as the G7-144.

- Freq. Range: 220-225 MHz.
- Bandwidth: 5 MHz.
- Construction: High strength fiberglass and aluminum.
- Gain: 7 dB.

- G6-440**
HRO Price \$169.95
- The G6-440 is of similar design and construction as the G6-270R.
- Frequency range: 440-450 MHz.
 - Bandwidth: 10 MHz.
 - Construction: One piece radome.
 - Gain: 6 dB.

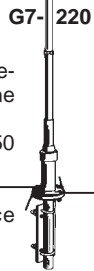

Repeater Antennas

The Spirit Series

Hustler's omnidirectional, collinear design base station antennas are enclosed in a rugged fiberglass radome that will help minimize pattern variations due to high winds or extreme conditions. Models are available for 144, 220, 440, 900 MHz, and 1.2 GHz. The gain will be unity, 3, 6, 9, or 12 dB depending on the frequency.

Call HRO for quotes on custom frequencies.

2m / 440 MHz Dual Band

G6-270R Dual band 2 m / 70 cm

HRO Price \$199.95

The G6-270R is a combination G6-144B and G6-440. It is factory tuned for quick and easy installation.

- Frequency range: 144-148 MHz / 435-445 MHz.
- Gain: 6 dB.
- Bandwidth: 4 MHz – 2 m / 10 MHz – 70cm.
- One piece radome.
- VSWR: < 1.5:1 @ resonance.



HF Base Antennas

HF Multi-band

- 6-BTV**
10, 15, 20, 30, 40, 75/80 m
HRO Price \$219.95

- 5-BTV**
10, 15, 20, 40, 75/80 m
HRO Price \$199.95

- 4-BTV**
10, 15, 20, 40 m
HRO Price \$169.95

- Broadbanded, low VSWR at band edges.
- Power capability – full legal limit on SSB or CW.
- Solid one-inch fiberglass trap forms for optimum electrical and mechanical stability.
- Heavy wall, high strength aluminum tubing, heavy duty aluminum mounting bracket and low loss, high strength insulators.
- Stainless steel clamps and hardware.
- Easy assembly and tuning.
- Single line feed with any length of 50 ohm coax used as ground mount with or without radials, or elevated mount with radials.
- All the BTV's can be mounted in a piece of PVC and disguised as a flagpole in deed restricted neighborhoods.

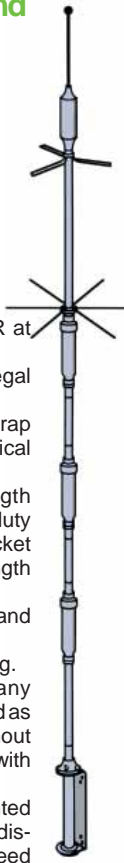

Model 30-MTK
30 meter add on kit for the 4 and 5-BTV

BASE ANTENNAS

HF Resonators

Customize your HF mobile system with Hustler products. Resonators may be used separately on one of the masts or up to three at a time with the VP-1. Add the QD-2, springs and mounts as needed for your installation.

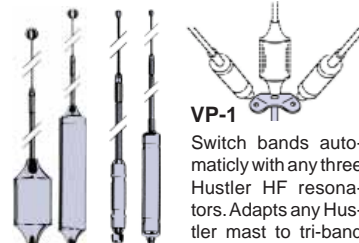

VP-1
Switch bands automatically with any three Hustler HF resonators. Adapts any Hustler mast to tri-band operation. \$6.95

Hustler HF Resonators

Model	Type	Band	Power SSB	Bandwidth 2:1 SWR	Weight lbs	HRO Price
RM-10	Standard	10 m	400 W	150-250 KHz	0.41	\$18.95
RM-11	Standard	11 m	400 W	150-250 KHz	0.41	\$18.95
RM-12	Standard	12 m	400 W	90-120 KHz	0.41	\$18.95
RM-15	Standard	15 m	400 W	100-150 KHz	0.42	\$18.95
RM-17	Standard	17 m	400 W	120-150 KHz	0.44	\$25.95
RM-20	Standard	20 m	400 W	80-100 KHz	0.46	\$25.95
RM-30	Standard	30 m	400 W	50-60 KHz	0.84	\$28.95
RM-40	Standard	40 m	400 W	40-50 KHz	0.84	\$30.95
RM-60	Standard	60 m	400 W			\$30.95
RM-75	Standard	75 m	400 W	25-30 KHz	1.05	\$30.95
RM-80	Standard	80 m	400 W	25-30 KHz	1.05	\$30.95
RM-10-S	Super	10 m	1 kW	250-400 KHz	1	\$27.95
RM-15-S	Super	15 m	1 kW	150-200 KHz	1.2	\$28.95
RM-20-S	Super	20 m	1 kW	100-150 KHz	1.25	\$32.95
RM-40-S	Super	40 m	1 kW	50-80 KHz	1.8	\$41.95
RM-75-S	Super	75 m	1 kW	50-60 KHz	2.1	\$57.95
RM-80-S	Super	80 m	1 kW	50-60 KHz	2.1	\$57.95

Hustler Base Antennas

Model	Band	Gain	Connector	Height ft(m)	HRO
G7-144	2m	7 dB	N Female	16.3 (4.6)	\$199.95
G6-144B	2m	6 dB	SO-239	9.8 (2.9)	\$139.95
G3-144	2m	3 dB	SO-239	7.5 (2.3)	\$ 69.95
G7-220	220 MHz	7 dB	N Female	10.2 (3.0)	\$185.95
G6-440	440 MHz	6 dB	N Female	7.3 (2.2)	\$189.95
G6-270R	2m / 70 cm	6 dB	N Female	7.6 (2.3)	\$199.95
6-BTV	10-30-80 m			24.0 (7.2)	\$219.95
5-BTV	10 to 80 m			25.0 (7.5)	\$199.95
4-BTV	10-40 m			21.4 (8.4)	\$169.95

Hustler VHF / UHF Mobile Antennas

Model	Band	Gain	Power	Mount	HRO
LMC-270	2m/70 cm	2.4/4	100	NMO	\$34.95
MX-270	2m/70 cm	2.4/4	100	Mag	59.95
LMG-144	2m	3.4	200	NMO	27.95
LMG-440-5	440	5	200	NMO	27.95
LMC-144	2m	3.4	200	NMO	23.95
LMC-440-5	440	5	200	NMO	24.95
LMB-144	2m	3.4	200	NMO	22.95
LMB-440-5	440	5	200	NMO	24.95
BBG-144	2m	3.4	200	NMO	49.95
BBG-440-5	440	5	200	NMO	50.95
BBGT-144	2m	3.4	200	Trunk	52.95
BBGT-440-5	440	5	200	Trunk	55.95
MX-2	2m	3.4	200	Mag	37.95
MX-220	220	3.4	200	Mag	37.95
MX-440	440	5	200	Mag	63.95
MX-2B	2m	3.4	200	Mag	39.95
MX-440B	440	3.4	200	Mag	39.95
SF-2	2m	3.4	100	3/8X24	17.95
SF-220	220	3.4	100	3/8X24	16.95
RX-2	2m	3.4	100	Mag	28.95
RX-220	220	3.4	100	Mag	28.95
RX-440	440	5	100	Mag	28.95
CG-144	2m	5.2	200	3/8X24	36.95
CG-220	220	5.2	200	3/8X24	36.95
CGT-144	2m	5.2	200	Trunk	59.95
CGT-220	220	5.2	200	Trunk	59.95
THF	140-500	Unity	200	Trunk	25.95
UHT-1	140-500	Unity	200	3/4 hole	17.95
UGM	140-500	Unity	25	Mag	23.95

MOBILE ANTENNAS / MOUNTS

VHF / UHF Mobile Antennas

Dual Band

Dual band models for 2m / 440 MHz give you 2.4 dB / 4 dB gain. The antennas are rated at 100 Watts.

LMC-270

- NMO style coil
- Chrome top
- Coil and whip only



MX-270

- Chrome top.
- NMO style magnetic mount.
- 17 ft RG58/U coax.
- PL-259 connector.

Magnetic Mounts

Models for 2m, 220 and 440 MHz are power rated for 200 Watts. Each has an NMO-style coil and a magnetic mount.

- MX-2** 144 MHz 3.4 dB gain
- MX-220** 220 MHz 5.0 dB gain
- MX-440** 440 MHz 5.0 dB gain
- Chrome top.
- 10 oz magnet.
- 17 ft RG58/U coax.
- PL-259 connector.



- MX-2B** 144 MHz 3.4 dB
- MX-440B** 440 MHz 5.0 dB
- Same as above but all black coil.

Collinear

Collinear models for 2m and 220 MHz provide 5.2 dB gain. They are power rated for 200 Watts. All have a swivel ball for vertical positioning.

- CG-144** 6 MHz bandwidth
- CG-220** 4 MHz bandwidth
- 3/8"x24 thread
- 5/8 over wave.

- CGT-144** 6 MHz bandwidth
- CGT-220** 4 MHz bandwidth
- Trunk mount base.
- 17 ft RG58/U coax.
- PL-259 connector.



Unity Gain

An antenna to custom trim as needed for VHF or UHF frequencies. Covers 140-500 MHz.

THF
Trunk Lip Mount

UHT-1
Roof/Deck Mount

UGM
Magnet Mount



Coil and Whip

Models for 2m or 440 MHz are power rated for 200 Watts. NMO-style coil on each requires an NMO mount.

- LMG-144** 3.4 dB gain
- LMG-440-5** 5.0 dB gain
- Chrome top and bottom.
- Contact- silver plated push pin.

- LMC-144** 3.4 dB gain
- LMC-440-5** 5.0 dB gain
- Black coil with chrome top.

- LMB-144** 3.4 dB gain
- LMB-440-5** 5.0 dB gain
- Black coil.

- BBG-144** 3.4 dB gain
- BBG-440-5** 5.0 dB gain
- Chrome top, swivel ball and spring

- BBGT-144** 3.4 dB gain
- BBGT-440-5** 5.0 dB gain
- Includes trunk mount.
- 17 ft RG58/U coax.
- PL-259 connector.

5/8 Wave

Base-loaded 5/8 wave models for 2m, 220 and 440 MHz are power rated for 100 Watts.

- SF-2** 144 MHz 3.4 dB gai
- SF-220** 220 MHz 3.4 dB gai
- 3/8" x 24 thread.
- Mount to any Hustler moun

- RX-2** 144 MHz 3.4 dB gai
- RX-220** 220 MHz 3.4 dB gai
- RX-440** 440 MHz 5.0 dB gai
- 3 oz magnetic mount.
- 15 ft RG-58/U coax.
- PL-259 connector.



Accessories

MKR-2 Radial Kit

Used to convert RX Series, SF Series, & C6 Series to fix station operation. Contains three radials. Mount can accept any 3/8 x 24 threaded mount.



QD-2 Quick Disconnect

Remove antennas easily with a push and twist release. Compression design of 100% stainless steel. 3/8 x 24 threads. \$19.95

Mobile Mounts

• **BM-1** Bumper mount with stainless steel strap and 1" diameter ball with 3/8 x 24 threads. \$25.95

• **MBM** Powerful 5" diameter magnet with 3/8 x 24 threads. 16' of RG58U coax with PL-259 connector. \$22.95

• **SSM-1** Heavy duty ball mount with 4" stainless steel spring with copper braided center conductor to prevent detuning. 180 degree adjustable 2" diameter stainless steel ball. Accepts 3/8 x 24 antennas. \$52.95

• **SSM-2** Heavy duty 2" diameter stainless steel ball mount. 180 degree adjustable. Accepts 3/8 x 24 antennas. \$32.95

• **SSM-3** Heavy duty stainless steel 4" spring with 3/8 x 24 coupling stud. Copper braided center conductor to prevent detuning. \$29.95

• **C-32** Chrome plated 1" ball mount. Accepts 3/8 x 24 antennas. \$12.95

• **C-29** Stainless steel 4" spring. Copper braided center conductor to prevent detuning. Accepts 3/8 x 24 antennas. \$21.95

• **C-30** Chrome plated 4" spring. Copper braided center conductor to prevent detuning. \$14.95

• **RSS-2** Stainless steel 3" spring. Used for mobile antenna between resonator and mast. Copper braided center conductor to prevent detuning. Accepts 3/8 x 24 antennas. \$13.95

• **HLM** Trunk lip mount designed for hatch and slanted back vehicles. 180 degree 1" diameter ball, which accepts 3/8 x 24 antennas. RG58U coax with PL-259 connector. \$25.95

• **HOT** Trunk lip mount with easy off/on with thumb knob. 180 degree 1" diameter ball, which accepts 3/8 x 24 antennas. RG58U coax with PL-259 connector. \$26.95

• **TLM** Trunk lip mount which accepts 3/8 x 24 antennas. RG58U coax with PL-259 connector. \$24.95

• **RVM** Recreational vehicle mount with heavy duty bracket. Easy antenna removal or lay down with thumb knob. 1" ball accepts 3/8 x 24 antennas. RG58U coax with PL-259 connector. \$23.95



All mounts below are supplied with 17" RG-58U cable.

Model	Description	HRO Price
CHMA	3/8" Hole mount without connector	\$10.95
CHMA-B	3/8" Hole mount w/crimp-on BNC	11.95
CHMA-P	3/8" Hole mount w/crimp-on PL-259	11.95
CHMA-T	3/8" Hole mount w/crimp-on TNC	11.95
CHMA-U	3/8" Hole mount w/crimp-on Mini UHF	11.95
CHMB	3/4" Hole mount without connector	10.95
CHMB-B	3/4" Hole mount w/crimp-on BNC	11.95
CHMB-P	3/4" Hole mount w/crimp-on PL-259	11.95
CHMB-T	3/4" Hole mount w/crimp-on TNC	11.95
CHMB-U	3/4" Hole mount w/crimp-on Mini UHF	11.95
CMMA	NMO 10 oz mag w/solder-on PL-259	17.95
CTMA	Trunk mount without connector	13.95
CTMA-B	Trunk mount w/crimp-on BNC	14.95
CTMA-P	Trunk mount w/crimp-On PL-259	14.95
CTMA-T	Trunk mount w/crimp-On TNC	14.95
CTMA-U	Trunk mount w/crimp-On Mini UHF	14.95

Mobile Masts

Fold-Over Masts

MO-1
Mobile mast 54" high for bumper, fender or hitch mounting. Folds over at 15" above base. 3/8 x 24 threaded \$33.95

MO-2
Mobile mast 54" high for bumper, fender or hitch mounting. Folds over at 27" above base. 3/8 x 24 threaded \$33.95

Solid Masts

MO-3
Mobile mast 54" high for bumper, fender or hitch mounting. Solid aluminum with white vinyl coating. 3/8 x 24 threaded \$25.95

MO-4
Mobile mast 22" high for trunk or deck mounting. Three retuning tip rods included. 3/8 x 24 threaded \$21.95

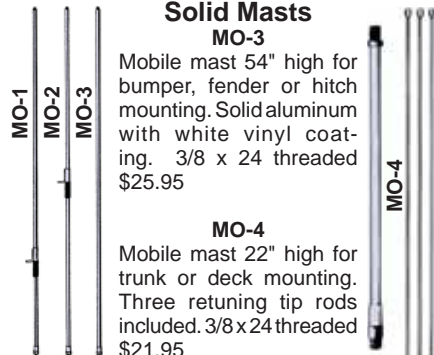



Comet Dual-Band Antennas

Dual- & Tri-band VHF / UHF

Comet developed the Super Linear Converter (SLC) to increase actual gain of dual and tri-band antennas.

- A complete pre-formed phasing coil and phosphorus copper element eliminates additional components and gain loss.
- The SLC is electrically very efficient, providing a low angle of radiation, directly to the horizon.
- Comet sectional antennas use ABS (Transparent to RF) connecting joints for the finest pattern and easiest assembly.

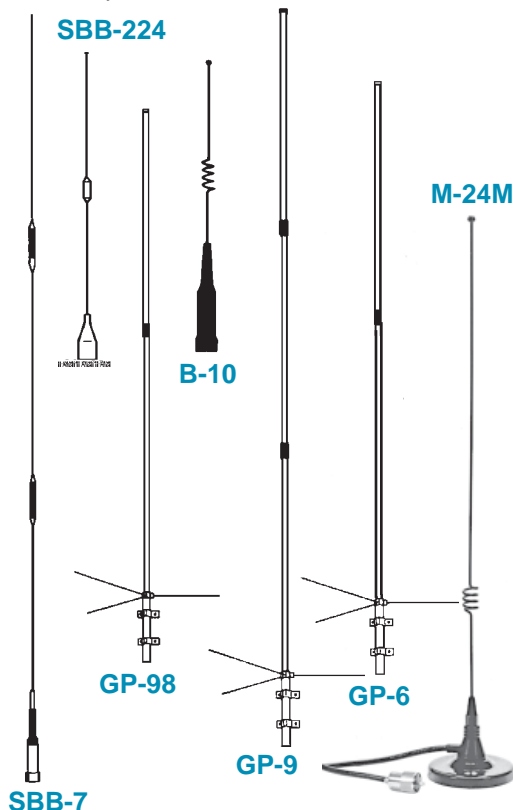

MODEL	BANDS	GAIN	MAX PWR Watts	CONN	WGT Lbs' oz"	LEN FT' In"	MAX Wind Speed MPH	HRO Price
Dual Band Base Station Repeater Antennas								
GP-9/GP-9N	2m/70cm	8.5/11.9	200	SO/N	5'11"	16'6"	90	\$199.95
GP-6	2m/70cm	6.5/9.0	200	SO-239	3'8"	10'5"	90	\$149.95
GP-3	2m/70cm	4.5/7.2	200	SO-239	2'12"	5'11"	112	\$99.95
Dual Band Mobile Antennas - All Black Anodized								
SBB-7/SBB-7NMO	2m/70cm	4.5/7.0	70	PL/NMO	-	4'7"	-	\$79.95
SBB-5/SBB-5NMO	2m/70cm	3.0/5.5	120	PL/NMO	-	3'2"	-	\$58.95
SBB-2/SBB-2NMO	2m/70cm	2.15/3.8	60	PL/NMO	-	20"	-	\$42.95
B-10/B10NMO	2m/70cm	-2/1.5	50	PL/NMO	-	12"	-	\$42.95
Dualband Fold-over Mobile Antennas								
C767/C767NMO	2m/70cm	3.5/6.0	80	PL-259/NMO	-	3'2"	-	\$64.95
C757/C757NMO	2m/70cm	2.15/5.5	80	PL-259/NMO	-	3'4"	-	\$59.95
Dualband Mobile Antennas								
AX-50	2m/70cm	0/5.0	60	PL-259	-	21"	-	\$49.95
AX-75	2m/70cm	3.2/5.7	60	PL-259	-	2'6"	-	\$59.95
AX-95	2m/70cm	3.3/5.8	60	PL-259	-	3'2"	-	\$66.95

Comet Tri-Band Antennas

MODEL	BANDS	GAIN	Max Pwr Watts	CONN	WGT Lbs' oz"	LEN FT' In"	Max Wind Speed MPH	HRO Price
TriBand Base Station Repeater Antennas								
GP-15	6m/2m/70cm	3/6.2/8.6	200	SO-239	2'15"	7'11"	90	\$169.95
GP-98	2m/70cm/23cm	6.5/9.0/13.5	100	N-Female	3'6"	9'4"	90+	\$199.95
CX-333	2m/220/70cm	6.5/7.8/9.0	120	SO-239	3'10"	10'2"	112	\$179.95
TriBand Mobile Antennas								
SB-15	6m/2m/70cm	2.15/4.5/7.2	120	PL-259	-	4'10"	-	\$89.95
SB-97	2m/70cm/23cm	3.0/6.8/9.6	100	N-Male	-	3'3"	-	\$84.95
SBB-224	2m/220/70cm	2.15/3.2/5.5	150	PL-259	-	3'1"	-	\$78.95
SBB-224NMO	2m/220/70cm	2.15/3.2/5.5	150	NMO	-	3'1"	-	\$78.95
HF Antennas								
UHV-6	40/(20")/(17")/15/10/6/2m/70cm	HF 0 dBi 2m 2.15 dBi 70cm 5.5 dBi	120 SSB HF 100W FM 6-70cm	PL-259	MAX 1'4"	MAX 6'4"	-	\$159.95
*L-14	Opt 20M coil for UHV-6						-	\$31.95
*L-18	Opt 17M coil for UHV-6						-	\$29.95
*L-3.5	Opt 75/80MM coil for UHV-6						-	\$34.95
HMC-6S	*40/20/15/10/6/2M/70cm	HF 0 2M/2.15dBi 70cm 5.3dBi	120W SSB HF 150W FM 6/2/70cm					\$159.95
HMC-7C	Opt 40MM coil for HMC-6S							\$34.95
CHA-250B	Ground Plane 3.5 57 MHz		150W SSB HF 125W CW	SO-239	7'11"	23'8"	67.5	CALL

Comet Single Band and HT Antennas

MODEL	BANDS	GAIN	Max Pwr Watts	CONN	LEN FT'In"	HRO Price
Single Band Antennas						
SBB-25/SBB-25NMO	2m	4.1	100	PL-259/NMO	4'8"	\$48.95
HT Antennas						
CH-32 MINI Ant	2m/70cm	-	10	BNC	1.75"	\$33.95
MH-510	6m/2m/70cm	0/0/3.2	10	SMA	20.75"	\$37.95
MH-511	6m/2m/70cm	-	10	SMA	4.25"	\$33.95
HT-224	2m/220/70cm	1.3/1.4/1.8	10	SMA	11"	\$47.95
MH-610	2m/220/70cm	0/1.8/3.2	10	SMA	14"	\$49.95
SMA-501 MINI Ant	2m/70cm	-	10	SMA	1.5"	\$29.95
SMA-3	2m/70/23cm	1.2/1.7/3.4		SMA	9.75"	\$41.95
SMA-24	2m/70cm	2.15/5.3	20	SMA	17.5	\$22.95
BNC-24	2m/70cm	-	20	BNC	17.5	\$22.95
SMA-503	2m/70cm	-	10	SMA	8.5"	\$29.95
CH-75	2m/70cm	-3.2	50	BNC	14.75	\$25.95
SH-95	2m/70/23cm	1.5/2/5.5	10	BNC	15"	\$34.95

6 Meter Antennas

MODEL	Description	FREQ	GAIN	F/B	Max Pwr Watts	CONN	SWR	LEN FT'In"	HRO Price
CA-52HB4	4 element beam	50-54 MHz	-	19 dB	400 W PEP	SO-239	<1.5:1	10'6 Boom	\$119.95
GH-50	Vertical (no radials)	50-54 MHz	2.15	-	60 FM	SO-239	<2.0:1	7'11 HI	\$99.95

Dual-Band Mag Mount Antenna

Economical black anodized 2m / 440 MHz antenna is 19.5" tall and comes with 13 feet of RG-58/U coax and either a gold-plated PL-259 (Model M-24M) or BNC connector (Model M-24B) soldered on.

- Gain: 146 MHz 1.7 dBi 3/8 wave
- 446 MHz 4.1 dBi 1/4 + 5/8 wave
- Max Power: 80 Watts
- VSWR: 1.5:1 or less
- Impedance: 50 Ohm
- HRO Price **\$39.95**

Flexible Dual-Band

Convenient, very flexible 2m / 70 cm 17" antenna. Comes with either a gold-plated PL-259 (Model SBB-1) or NMO connector (Model SBB-1NMO).

- Gain: 146 MHz 1.5 dBi 1/4 wave
- 446 MHz 2.15 dBi 1/2 wave
- Max Power: 60 Watts
- VSWR: 1.5:1 or less
- HRO Price **\$42.95**



ANTENNAS & ACCESSORIES

Mobile Antennas

UHV-6 40 m - 70 cm HRO Price \$159.95

The UHV-6 is Comet's 3rd generation HF-UHF mobile antenna. Without the HF coils attached, it is a tribander for 6m / 2m / 70 cm. The top of the element has a threaded socket for attaching either the 40 m, 15 m or 10 m coil that is included, making the UHV-6 a quad-band antenna.

- An inexpensive antenna system for the popular HF and VHF/UHF bands.
- Covers 40 / 15 / 10 / 6 / 2m / 70 cm with optional coils for 20 m and 17 m.
- Easy to mount and easily configured to your individual needs.
- Fold-over hinge included.
- GAIN on 2m (2.15 dBi); 70cm (5.5 dBi).

UHV-4 10 / 6 / 2 m / 70 cm HRO Price \$119.95

Developed for the Yaesu FT-8900. The 10m and 6m bands tune independently and will tune for SSM and FM.

Duplexers / Triplexers

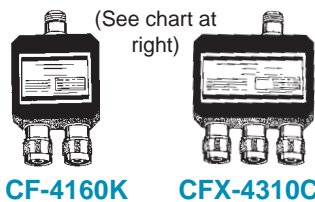

(See chart at right)

CF-4160K

CFX-4310C

Mounts



CP-5M
CP-5NMO
CP-5 3/8-24(shown)

These universal mounts use the heavy-duty RS-730 lip bracket. Each includes 5 meters (16'6") of deluxe 2-step coax and an antenna mount connector: gold-plated PL-259 on coax end with detachable barrel for easy installation. 18 inch lead of mini RG-174 coax for easy entry through the weather seal without causing wind noise, water leaks and/or coax damage. Choose the model that has the connector for the antenna you are using.

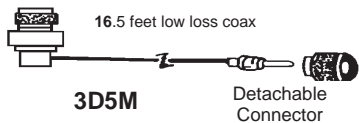

3D5M

Detachable Connector

RG-188 provides easy entry into the vehicle from an exterior mount.

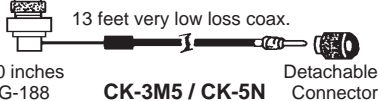

10 inches
RG-188

CK-3M5 / CK-5N

Detachable Connector

Comet High-Power Duplexers and Triplexers

Zinc-alloy, die-cast, twin cavity, low input loss, high-isolation, and high-power. Modernize your station with Comet high-performance antenna products.

MODEL	PORT	Freq MHz	CW Watts	PEP Watts	Loss dB	Isol dB	Mix Conn	Port Conn	HRO Price
CF-416A (2m/70cm)	LPF	1.3-150MHz	450	800	0.15	60	SO-239	PL-259 w/leads	\$49.95
	HPF	400-540MHz	300	500	0.25	60		PL-259 w/leads	
CF-416C (2m/70cm)	LPF	1.3-150MHz	450	800	0.15	60	N-Female	PL-259 w/leads	\$54.95
	HPF	400-540MHz	300	500	0.25	60		N-Male w/leads	
CF-4160I (2m/70cm)	LPF	1.3-150MHz	450	800	0.1	60	SO-239	PL-259 w/o leads	\$48.95
	HPF	400-540MHz	300	500	0.2	60		N-Male w/o leads	
CF-4160K (2m/70cm)	LPF	1.3-150MHz	450	800	0.1	60	SO-239	PL-259 w/o leads	\$48.95
	HPF	400-540MHz	300	500	0.2	60		PL-259 w/o leads	
CF-416B (2m/70cm)	LPF	1.3-150MHz	450	800	0.15	60	SO-239	PL-259 w/leads	\$49.95
	HPF	400-540MHz	300	500	0.25	60		N-Male w/leads	
CF-706A (2m/70cm)	LPF	1.3-90MHz	175	350	0.5	40	SO-239	PL-259 w/leads	\$74.95
	HPF	75-470MHz	175	350	0.5	40		PL-259 w/leads	
CF-530 (6m/125-470)	LPF	1.3-90MHz	350	600	0.2	45	SO-239	PL-259 w/leads	\$74.95
	HPF	125-470MHz	350	600	0.2	45		PL-259 w/leads	
CF-530C (6m/125-470)*	LPF	1.3-90MHz	350	600	0.2	45	SO-239	PL-259 w/leads	\$74.95
	HPF	125-470MHz	350	600	0.2	45		PL-259 w/leads	
CF-360A (10m/6m)	LPF	1.3-30MHz	350	600	0.2	45	SO-239	PL-259 w/leads	\$69.95
	HPF	50-470MHz	350	600	0.2	45		PL-259 w/leads	
CF-706 (2m/6m)	LPF	1.3-56 MHz	350	600	0.4	40	SO-239	PL-259 w/cable	\$69.95
	HPF	75-320 MHz	350	600	0.4	40		PL-259 w/cable	
CFX-4310C (2m/70cm/1.2)	LPF	1.6-60MHz	600	1KW	0.15	50	N-Female	PL-259 w/leads	\$79.95
	BPF	100-150MHz	450	800	0.25	50		N-Male w/leads	
	BPF	350-500MHz	300	500	0.25	50		N-Male w/leads	
	HPF	840-1.4GHz	100	200	0.3	50		N-Male w/leads	
CFX-514 (6m/2m/70cm)	LPF	1.3-90MHz	450	800	0.2	55	SO-239	PL-259 w/leads	\$79.95
	BPF	130-200MHz	450	800	0.25	55		PL-259 w/leads	
	HPF	380-500MHz	300	500	0.3	55		PL-259 w/leads	
CFX-514J (6m/2m/70cm)	LPF	1.3-90MHz	450	800	0.15	55	SO-239	SO-239 w/o leads	\$79.95
	BPF	130-200MHz	450	800	0.2	55		SO-239 w/o leads	
	HPF	380-500MHz	300	500	0.25	55		SO-239 w/o leads	
CFX-324A (2m/220/70cm)	LPF	1.3-150MHz	350	600	0.2	40	SO-239	PL-259 w/leads	\$88.95
	BPF	200-320MHz	350	600	0.25	40		PL-259 w/leads	
	HPF	390-500MHz	350	600	0.3	40		PL-259 w/leads	
CFX-324B (2m/220/70cm)	LPF	1.3-150MHz	350	600	0.2	40	SO-239	PL-259 w/o leads	\$85.95
	BPF	200-320MHz	350	600	0.25	40		PL-259 w/o leads	
	HPF	390-500MHz	350	600	0.3	40		PL-259 w/o leads	

* To run multiple antennas with the Yaesu FT-8900

Comet Mobile Mounting Systems

Comet has a wide variety of mobile mounts. Choose the mount and coax cable assembly that best fits your personal needs. All Comet cables have detachable connectors.

MODEL	DESCRIPTION	HRO Price
Mounts with Coax Cable Installed		
CP-5M	Universal multi-angle lip mount w/deluxe cable SO-239/PL259 Conn.	\$69.95
CP-5NMO	Same as CP-5M but with NMO/PL-259 Conn.	\$69.95
CP-5 3/8-24	Same as CP-5M but with 3/8-24/PL-259 Conn.	\$69.95
GR-5M	Deluxe trunk-lip mount w/CK-3M5 Cable, UHF connectors	\$67.95
GR-5N	Deluxe trunk-lip mount w/CK-5N Cable, N-Type connectors	\$69.95
CM-5M	Standard Hvy-Duty Mag Mt w/RG-58A/U, Coax, UHF Conn, Max Antenna Height 4 ft	\$24.95
Mounting Brackets Only, No Coax		
RS-730	Heavy Duty universal lip mount, accepts S)-239 connector	\$32.95
PRM-T	Heavy Duty trunk lip mount, accepts SO-239 connector	\$33.95
RS-720	Medium Duty universal lip mount, accepts SO-239 connector	\$29.95
RS-720NMO	Medium Duty universal lip mount, accepts NMO connector	\$29.95
RS-520	Light Duty universal lip mount, accepts SO-239 connector	\$29.95
EM-B80	Light Duty universal lip mount, accepts SO-239 connector	\$25.95
Coax Cable Assemblies		
CK-3M5	17 ft high quality cable inc 12" RG-188 to avoid water leak/cable damage. UHF Conn.	\$42.95
CK-3M	Same as CK-3M5 but 9' 9" of deluxe cable assy, UHF Conn.	\$35.95
CK-5N	13' 6" of deluxe 2-step cable assy, N- Conn.	\$49.95
5D4N	13' 6" low loss (2400MHz) coax cable, N-conn.	\$34.95
3D4N	13' 6" low loss (1200MHz) cable assy, N-conn.	\$28.95
Antenna Connector Adapters		
AD-25M	Turns an SO-239 mount into an NMO mount	\$14.95
AD-15M	Turns an NMO mount into an SO-239 mount	\$17.95
AD-10M	Turns an NMO mount into an N-female mount	\$17.95



Choosing Your Larsen Mobile Antenna

Choose your antenna configuration based on the frequency, base type (e.g., magnetic mount) and thread type (e.g., NMO). Keep in mind that it is necessary to select a base with the same mounting style as the antenna. Typical bases and styles are shown below.

Thread Types

These are examples of each of the thread types. Select one and then select the base.

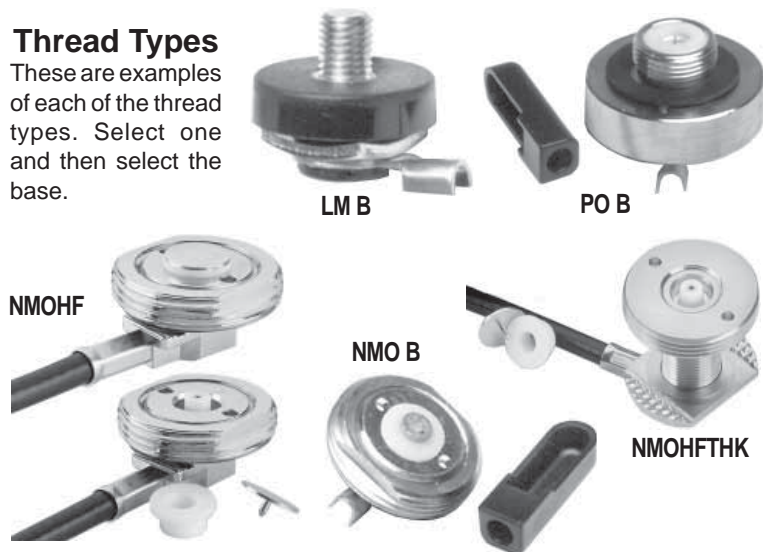

Mount Configurations

In addition to the popular Motorola 3/4" (NMO) mounts shown here, mobile antennas for the Larsen mount (LM) and PO mount (PO) are excellent choices for amateur use. Each of these mounts comes in one of the thread types.

Mounts:

- NMO K premium quality rooftop.
- NMO MMR mag mount, 90# pull strength.
- NMO TLP heavy duty trunk lid.
- NMO TMB electropolished trunk gutter bracket
- NMOHF for low or high frequencies (pull center pin in insulator for high frequencies)
- NMOHFTHK NMO thick mount (surfaces to 1/2" thick) high or low frequencies



Magnetic Mount BNC MM BNC

Connectors: BNC on the mag and coax. Coax: RG 58 A/U, 12'



Call Toll-Free for Quotes on Larsen Antenna

NMO Series Antennas

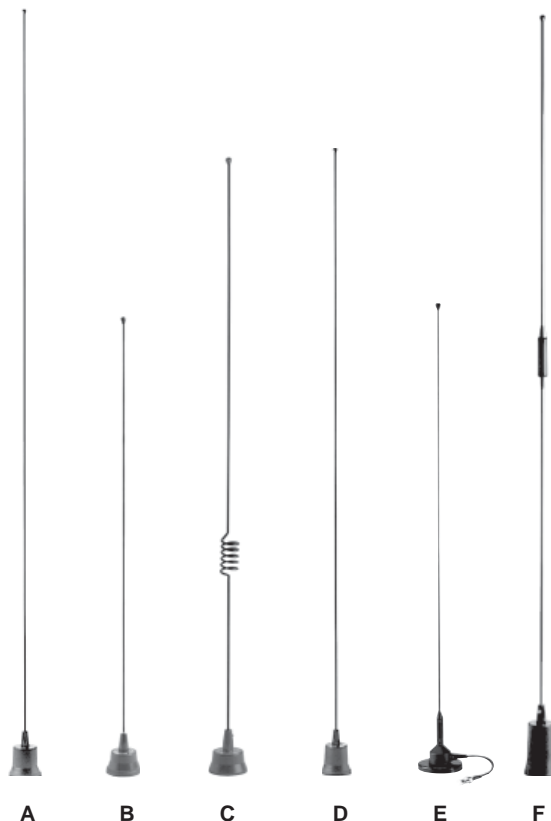

Once the base and thread type are selected, the final step is to choose the antenna. Gain antennas are made of a coil and a whip. Quarter wave antennas are just a whip. All Larsen mobile antennas meet the industry's most demanding specs for electrical efficiency and mechanical durability.

- VSWR at 1.5 to 1 or less.
 - Colors: Black coil base; chrome or all black whip.
 - 3-year No-Nonsense Warranty.™
 - Made in USA
- A** NMO 150 B (2m)
 Frequency:..... 144-174 MHz
 Gain:..... 3 dB
 Electrical:..... 5/8 Wave
 Height:..... 49"
- B** NMOQ C
 Frequency:..... 144-448 MHz
 Gain:..... Unity
 Electrical:..... 1/4 Wave
 Height:..... 22" max.
- C** NMO 440 B (70cm)
 Frequency:..... 440-460 MHz
 Gain:..... 3 dB
 Electrical:..... 5/8 over 1/4
 Height:..... 30"
- D** NMO 220 B (1.25m)
 Frequency:..... 220-225 MHz
 Gain:..... 3 dB
 Electrical:..... 5/8 Wave
 Height:..... 32"
- E** MS 144 FME
 Frequency:..... 144-148 MHz
 Gain:..... Unity
 Power:..... 35 watts
 Electrical:..... 1/4 Wave
 Base:..... 2" Mini Mag
 Height:..... 22"
 Coax:..... 12' RG 174
 Connector:..... FME Universal (Adapters available in BNC, PL, MPL, SPIN SMA, TNC)
 Also available in MS220 FME, MS440 FME.
- F** NMO 2 / 70
 Frequency:..... 144-148MHz
 442-448 MHz
 Gain: 3.8 dB VHF; 2.4 dB UHF
 Electrical:..... 5/8 wave VHF
 Collinear UHF
 Height: 2m / 70cm Dual band

MOBILE ANTENNAS

Dual-Band Antennas

Larsen dual band antennas provide excellent performance on 2m and 70 cm. Each antenna is factory preset to guarantee optimal performance with no tuning required.

- Range of dual band configurations are available.
- Kulrod copper-plated 17-7 stainless steel rods for greater transmit range.
- Soldered contacts.
- Premium materials and construction provide superior electrical performance and mechanical durability.
- VSWR 1.5:1 or less.
- 3-year No Nonsense Warranty.

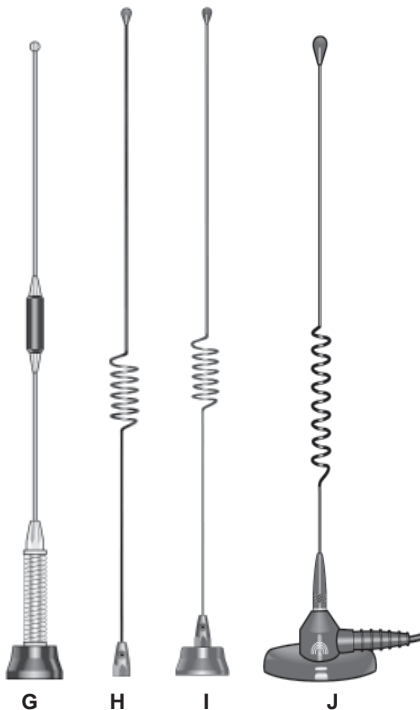

G NMO 2 / 70 SH
 Frequency: 144-148/440-450 MHz
 Gain: Unity
 Power: 100 Watts
 Type: VHF: Center load 1/4 wave
 UHF: Center load 3/4 wave
 Base: NMO UHF base B w/spring
 Height: 17"
 Whip: W NMO 2/70 SH

H LMC 2 / 70 B
 Frequency: 144-148/440-450 MHz
 Gain: Unity
 Power: 100 Watts
 Type: VHF: Center load 1/4 wave
 UHF: Center load 3/4 wave
 Base: Q CONE LMC B
 Height: 18"

I NMOQ 2 / 70 B
 Frequency: 144-148/440-450 MHz
 Gain: Unity
 Power: 100 Watts
 Type: VHF: Center load 1/4 wave
 UHF: Center load 3/4 wave
 Base: NMO UHF base B
 Height: 18"
 Whip: W NMOQ 2/70 B

J MM 2 / 70 PL
 Frequency: 144-148/440-450 MHz
 Gain: Unity
 Power: 100 watts
 Coax: RG58 A/U Dual Shield, 12'
 Pull strength: 54 lbs.
 Type: VHF: Center load 1/4 wave
 UHF: Center load 3/4 wave
 Base: 3" round magnet mount
 Connector: PL 259 installed
 Weight: 1 lb.
 Height: 17"

Scanner Antenna



Tri-Band Antenna
NMO-150 / 450 / 800

Frequency: 150-165 /
 450-470 / 806-940 MHz
 Gain: 2.14 dBi ± 1 dB
 Mount: NMO
 Height: 16.5"

This is a great antenna for scanner operation. It is NOT tunable for amateur operation.

Rubber Ducks On Page 105

On-Glass Antennas

Larsen's advanced design techniques in glass-mount antennas result in superior transmit range plus tremendous mechanical durability. Glass mount performance is nearly identical to rooftop mounts, with no holes to drill. Properly installed on-glass antennas grip for years under demanding conditions, yet are easy to remove and remount..

- Patented low-impedance design is electrically efficient.
- Single-band antennas are pre-cut, 1/2 wave design.
- Transformer outside vehicle.
- Copper plated whips.
- Rated 50 watts output.
- VSWR at 1.5 to 1 or less.
- Less than .5 dB loss through glass vs. rooftop.
- New circuit board technology locks in solid state performance.
- 3M's best on-glass adhesive grip.
- Made in USA with 3 year No-Nonsense Warranty™

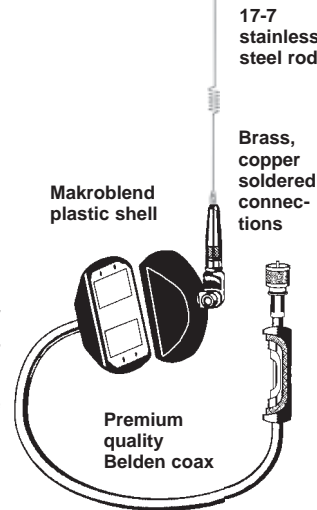

Dual-Band

The KG 2 / 70 is a VHF half-wave and a UHF collinear. It comes with 14 feet of RG-58/U coax.

The antenna installs easily on any flat surface. Remove the whip without tools for car washes or low garages. **HRO Price \$84.95**

K KG 2/70-CX-PL (Dual)
 Frequency: 144-148/442-448 MHz
 Gain: 2.4 dB VHF; 4.5 UHF
 Power: 50 Watts
 Type: 1/2 wave / Collinear
 Connector: PL 259 (loose)
 Height: 32-3/4"

Single Band

L KG 144 PL (2m)
 Frequency: 144-160 MHz
 Gain: 2.4 dB
 Type: 1/2 Wave
 Connector: PL 259 (loose)
 Height: 45"

M KG 440 PL (70cm)
 Band: 440-460 MHz
 Gain: 2.4 dB
 Type: 1/2 Wave
 Connector: PL 259 (loose)
 Height: 11-3/4"

Call a Helpful Ham at HRO

Prices in this print catalog are subject to change

**DIAMOND
ANTENNA**

The Standard by Which All Others are Judged

Diamond Base Antennas

All base antennas grounded for lightning protection. Factory adjusted for American amateur bands; no tuning required.

Model	Bands	Gain, dB	Watts	Con. Type	WT (lbs)	Lth (ft)	MPH (no ice)	Fig	HRO Price
A502HB	6m Yagi 2 elem.	6.3 dBi	400pep		3.75	2.6			\$89.95
A144S5	2 m Yagi 5 elem.	6.0 dBi	100pep		1.4	3.1			\$59.95
A430S10	430 Yagi 10 elem.	13 dBi	100pep		1.4	3.6			\$69.95
A430S15	430 Yagi 15 elem.	14.8 dBi	100pep		2.15	7.4			\$89.95
BC200	430-490 tunable	6.5	200	UHF	3	5.6	130		CALL
BC200-450	450-460	6.5	200	UHF	3	5.6	130		CALL
BC200-460	460-470	6.5	200	UHF	3	5.6	130		CALL
CP-22E	2 m	6.5	200	UHF	3	9	90	B	\$54.95
DP-GH62 ¹	6 m	6	200	UHF	7	21	80	B	\$149.95
F-22A	2 m	6.7	200	UHF	5	10.5	112	B	\$99.95
F-23H	144-174 tunable	7.8	350	UHF	5	15	90	A	\$149.95
F-718	70 cm	11.5	250	N	5	15	90	A	\$209.95
G-200	2.4 GHz	11		N		6	135	C	\$214.95
V2000A ¹	6m / 2m / 70cm	2.1 / 6.2 / 8.4	150	UHF	4	8.3	110	B	\$159.95
X-30A	2 m / 70 cm	3.0 / 5.5	150	UHF	2	4.5	135		\$69.95
X-50A	2 m / 70 cm	4.5 / 7.2	200	UHF	3	5.6	135	C	\$107.95
X-50NA	2 m / 70 cm	4.5 / 7.2	200	N	3	5.6	135	C	\$114.95
X-200A	2 m / 70 cm	6.0 / 8.0	200	UHF	4	8.3	112	B	\$129.95
X-300A	2 m / 70 cm	6.5 / 9.0	200	UHF	4	10	112		\$139.95
X-300NA	2 m / 70 cm	6.5 / 9.0	200	N	4	10	112	B	\$159.95
X510HDM	2 m / 70 cm	8.3 / 11.7	330/250	UHF	5	17.2	90	A	CALL
X-510NA	2 m / 70 cm	8.3 / 11.7	200	N	5	17.2	90	A	\$189.95
X-510NJ	144/430	8.3 / 11.7	200	N	5	17.2	90	A	\$219.95
X-500HNA	2 m / 70 cm	8.3 / 11.7	200	N	7	17.8	90+	A	\$299.95
X-700HNA	2 m / 70 cm	9.3 / 13.0	200	N	12	24	90	-	\$389.95
X-3200A ²	2m/1-1/4m/70cm	6.0 / 7.8 / 8.0	100@	UHF	4	10	112	B	\$179.95
X-6000A	2m / 70 / 23cm	6.5 / 9.0 / 10.0	100	N	5	10	112	B	\$199.95
BB7V	2-30 MHz		250	UHF	6	5/22	80		\$399.95
CP-725H	40 / 15 / 10 / 6 m		250	UHF	6.6	11.7	100		\$399.95

- 52-54 MHz only. DPGH62 is adjustable from 50-54 MHz.
- 15-148 MHz, 100 watts on 2m, 200 watts on 1-1/4m & 70 cm.

- Wide-band performance
- Highest gain
- Fiberglass radome
- Factory adjusted
- DC grounded
- UPS shippable
- High wind rating
- Stainless hardware

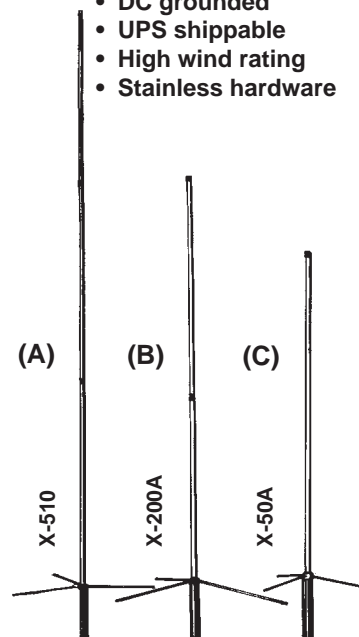

Diamond Mobile Antennas

Factory adjusted for American amateur bands, no tuning required unless specified. Mobile antennas have fold-over feature with spring loaded hinge (except NR72BNMO, NR73BNMO, M285, M685, MG200, MR77 and MR77SMA). Magnetic mount not recommended for antennas over 50".

Model	Bands	Gain/dB	Watts	Mount	Lth/in	HRO Price
CR-270A	2 m/70 cm	2.15 dBi	50	UHF	17.3	\$42.95
CR-320A ^{4,4,6}	2 m/1 -1/4 m/70cm	2.1/3.8/5.5	100@	UHF	36	\$82.95
CR320BNMO ^{4,4,6}	2 m/1 -1/4 m/70cm	2.1/3.8/5.5	100@	NMO	36	\$89.95
CR-627B ^{4,4,5}	6m/2m/70cm	2.1/4.5/7.2	150	UHF	60	\$99.95
CR-627BNMO ^{4,4,5}	6m/2m/70cm	2.1/4.5/7.2	150	NMO	60	\$99.95
CR8900A ^{4,7(FM Only)}	10m/6m/2m/70cm	2.15(2m) 5.5(70cm)	60	UHF	50	\$109.95
D220 discone	100-1600 MHz	2	50	PL-259	35.5	\$109.95
MG200 ⁷	2.4 GHz	7	-	N	23.6	\$99.95
HF6FX ^{4,7}	6 m	2.15	250	UHF	44	\$69.95
HF50CX ^{4,7}	6 m	3.5	200	UHF	71	\$99.95
M285 ^{4,8}	2 m	3.4	200	UHF	52.4	\$31.95
M285SNMO ^{4,8}	2 m	3.4	200	NMO	52.4	\$31.95
MR77 ^{4,7}	2 m/70 cm	2.15/3.4	70	†	20	\$39.95
MR77SMA ^{4,7}	2m/70cm	2.15/3.4	70	&	20	\$44.95
M685S ^{4,7}	6 m	2.15	200	UHF	52.4	\$31.95
M685SNMO ^{4,7}	6 m	2.15 dBi	200	NMO	52.4	\$31.95
NR124NMO	23 cm	8.4	100	NMO	25	\$64.95
NR140BNMO	220 MHz	4	159	NMO		\$53.95
NR22L ⁴	2 m	6.5	100	UHF	96.8	\$69.95
NR2000NA	2 m/70 cm/23 cm	3.15/6.3/9.7	100	N	39	\$89.95
NR-72BNMO ^{4,4,7}	2 m/70 cm	2.1/2.1	100	NMO	14	\$44.95
NR-73BNMO ⁴	2 m/70 cm	2.1/5.3	100	NMO	33	\$57.95
NR-770HA	2 m/70 cm	3.0/5.5	200	UHF	40	\$56.95
NR-770HNMO	2 m/70 cm	3.0/5.5	200	NMO	41	\$56.95
NR-770HB ⁴	2 m/70 cm	3.0/5.5	200	UHF	40	\$59.95
NR-770HNMO ⁴	2 m/70 cm	3.0/5.5	200	NMO	41	\$59.95
NR-770HRKS ⁴	2 m/70 cm	3.0/5.5	200	UHF	40.2	\$109.95
NR-7900 ⁴	2 m/70 cm	3.7/6.4	300/250	UHF	57	\$84.95
SG7000A ^{4,7}	2 m/70 cm	2.1/3.8	100	UHF	18	\$69.95
SG7500A	2 m/70 cm	3.5/6.0	150	UHF	41	\$77.95
SG7500NMO	2 m/70 cm	3.5/6.0	150	NMO	42	\$79.95
SG7900A ⁴	2 m/70 cm	5.0/7.6	150	UHF	60	\$119.95
SG7900ANMO ⁴	2 m/70 cm	5.0/7.6	150	NMO	62	\$124.95

Black anodized finish †Mag Mt with 13' RG58 Cable w/UHF &Mag Mt w/13' RG58 cable w/SMA
 4. Magnetic mounts not recommended. Vehicle ground required. 5. 52-54 MHz only.
 6. 100 watts on 1-1/4m; 200 watts on 2m and 70cm. 7. Gain Rated in dBi 8. Tunable from 144-174 MHz. 9. Blackwith adhesive-backed mount

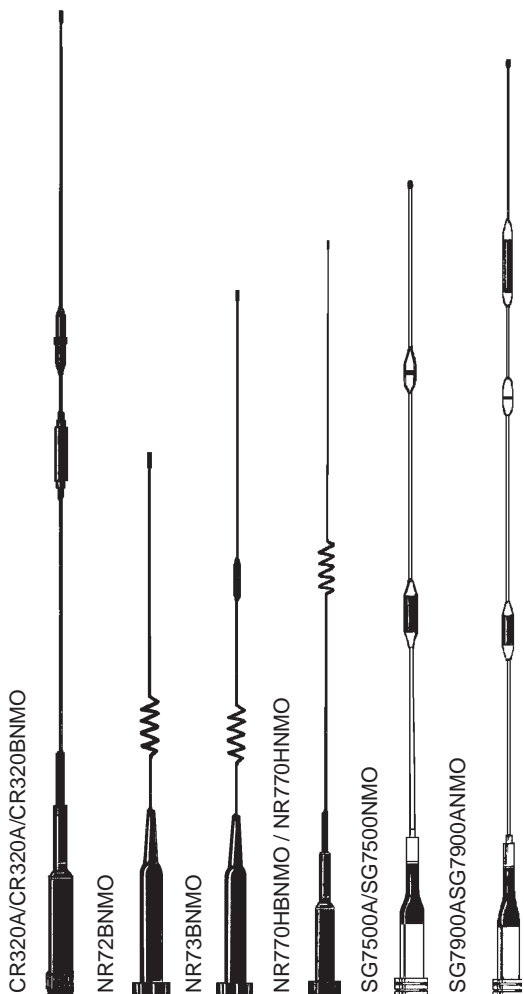

ANTENNAS & ACCESSORIES

Diamond Duplexers and Triplexers

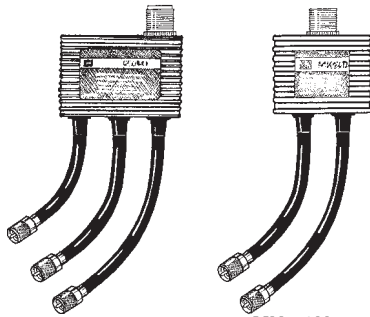

MX324
MX-2000
MX-3000
MX-3000N

MX-72H
MX-72N
MX-62M
MX-610

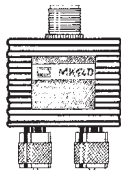

MX-72D

Model	Port	Freq MHz	CW Watts	PEP Watts	Loss dB	Isol. dB	MIX Conn.	Port Conn.	HRO Price
MX-37	LPF HPF	1.6 - 470 900 - 1300		100 50	.25 .45	45	Type N	PL-259/12" 5D cable N Male/12" 5D cable	\$59.95
MX62M	LPF HPF	1.6 - 56 76 - 470		200 200	.2 .2	50 50	SO-239	PL-259/12" cable PL- 259/12" cable	\$74.95
MX-72D	Similar to MX-72H, but Direct Connection								\$48.95
MX-72H	LPF HPF	1.6-30 140-150 400-460	400 150 100	400 150 100	.1 .1 .2	60 60 60	SO-239	PL-259/12" cable PL- 259/12" cable	\$54.95
MX-72N	Similar to MX-72H, but type-N on UHF port								\$49.95
MX-72A	Similar to MX-72N, but type-N , PL-259/12" 5D cable								\$54.95
MX-324	LPF BPF HPF	1.6-60 220-225 400-550		800 600 500	.3 .4 .4	40 40 40	SO-239	PL-259/12" cable PL- 259/12" cable PL- 259/12" cable	\$89.95
MX-610	LPF HPF	1.3 - 30 49 - 470		600 500	.2 .25	45 45	SO-239	PL-259/12" cable PL- 259/12" cable	\$89.95
MX-2000	LPF BPF HPF	1.6-60 110-170 300-950		800 800 500	.15 .20 .25	60 60 60	SO-239	PL-259/12" cable PL- 259/12" cable PL- 259/12" cable	\$84.95
MX-3000	LPF BPF HPF	1.6-160 350-500 800-1300		800 400 200	.15 .25 .30	55 55 55	N-Jack(F)	PL-259/12" cable PL- 259/12" cable N- male/12" cable	\$79.95
MX-3000N	Similar to MX3000, but with Type-N male on BPF connection								\$85.95

Mobile Mounts

Model	Description	HRO Price
C101	UHF base 6.5' RG316 Teflon coax w/PL259	\$37.95
C101NMO	NMO base 6.5' RG316 Teflon coax w/PL259	\$37.95
C101-3/8C	Replacement cable only for K400-3/8C	\$34.95
C101-3/8C Kit	Replacement cable and hardware for K400-3/8C	\$44.95
C104SMA	4' RG58/U Extension cable for PL-259. 90 degree SMA Male & SO-239	\$16.95
C105SMA	5' RG58/U Extension cable for C101/C101NMO. 90 degree SMA Male	\$16.95
C110BNC	10' RG316 extension cable for C101/C101NMO. Use front radio installations. BNC male	\$29.95
C110SMA	10' RG316 extension cable for C101/C101NMO. Use front radio installations. SMA male	\$29.95
C110	10' mini-8/RG8X extension cable for C101/C101NMO. Use front radio installations.	\$19.95
C211	Combination of C101 and C110. 16.5 feet cable assembly	\$49.95
C213	UHF base, 13.5' RG316 Teflon Coax with PL-259	\$44.95
C213NMO	NMO base, 13.5' RG316 Teflon Coax with PL-259	\$44.95
CRM	Stainless steel right angle mount with U-bolt	\$16.95
DPK-4NM-N	Type N Magnet. 13' 5mm coax w/Type-N plug. Good to 1300 MHz.	\$54.95
HRKS	Adhesive backed UHF mount, 13.5' RG316 teflon coax with SMA and PL-259 adapter	\$69.95
K400-3/8C °	Special mount for 3/8X24 thread Antenna. 6.5 feet RG316 w/PL-259	\$73.95
K400C °	Deluxe mount with UHF type base. 6.5 feet RG-316 Teflon coax w/PL-259	\$73.95
K400CNMO °	Deluxe mount with NMO type base. 6.5 feet RG316 Teflon coax w/PL-259	\$73.95
K400S	Deluxe mount with UHF type base. 13.5 feet RG316 w/SMA (PL259 adapter included)	\$79.95
K400SNMO	Deluxe mount with NMO type base. 13.5 feet RG316 w/SMA (PL259 adapter included)	\$79.95
K412C	Trunk/hatchback mount. UHF base, 6.5'Teflon coax w/PL-259. 45" max ant	\$64.95
K412CNMO	Trunk/hatchback mount. NMO base, 6.5'Teflon coax w/PL-259. 45" max ant	\$64.95
K412S	Trunk / hatchback mt. UHF base, 13.5' RG316 coax w/SMA. (PL259 adapter included)	\$69.95
K412SNMO	Trunk / hatchback mt. NMO base, 13.5' RG316 coax w/SMA. (PL259 adapter included)	\$69.95
K515S	Deluxe luggage carrier mt. UHF base.13.5 feet RG316 w/SMA(PL259 adapter included)	\$69.95
K515SNMO	Deluxe luggage carrier mt. NMO base.13.5 feet RG316 w/SMA (PL259 adapter included)	\$69.95
K540KM	Deluxe Mirror/Luggage rack mount. Black, adjustable. 13' RG58C/U w PL259	\$59.95
K550KM	Deluxe mini van luggage rack mount. Black, adjustable. 13' RG58C/U w PL259	\$69.95
K600M	Tilt angle (0-9 degrees) trunk mount. Black. RG-188 and low loss 7 mm cable.	\$57.95
K600S	Tilt angle (0-9 degrees) trunk mt UHF base. 13.5 feet RG316 w/SMA (PL259 adapter inc)	\$62.95
K702M	Deluxe low-profile magnet/suction mount. 6.5" diameter, 13' RG58 & PL-259	\$49.95
K9000LRM	Motorized mount for luggage rack. Use C-series cable assemblies	\$104.95
K9000LRMO	Same with oversize K515 hardware	\$109.95
K9000TM	Motorized mount for trunk lid. Use C-series cable assemblies	\$104.95
NMO/UHF-B	NMO to UHF adapter. Black Chrome. Low VSWR to 500 MHz	\$13.95
SPM35	UHF type base on heavy 1.5 lb/4" magnetic, 13' 5mm coax / PL-259.	\$39.95
SPMNMO	NMO type base on heavy 1.5 lb/4" magnet, 13' 5mm coax with PL-259	\$49.95



K702M

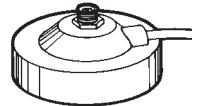

SPM35
SPMNMO
DPK4NM-N

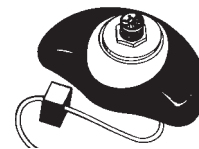

K600M
K600S

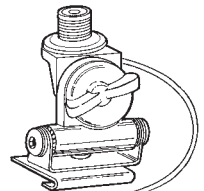

K412CNMO
K412SNMO
K412C
K412S

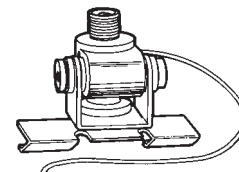

K400C
K400CNMO
K400-3/8C
K400S / K400SNMO

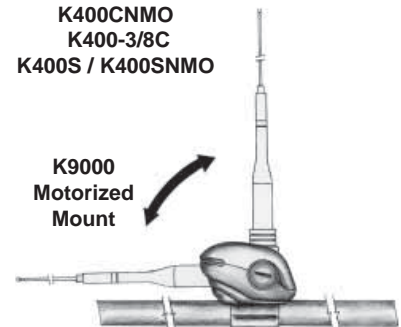

K9000
Motorized
Mount

9. Use C110 for front radio installations

DIAMOND ANTENNA

HV7A Mobile Antenna System For New HF / VHF Tranceivers (such as: IC706 series, FT100 series and the FT8900R)

The HV7A has 5 band capability: 70cm, 2m, 6m and 2 HF bands through use of loading coils. Fold-over feature allows for easy access into low overhead buildings.

Bands Supplied: 10m / 6m / 2m / 70cm
Opt. Loading Coils 40m / 20m / 17m / 15m
Power, P.E.P.: HF 120w / VHF 200w
Mount Connection UHF
Length: 54" (HV7A)
SWR: 1.5:1 nominal

HV7A Price: \$109.95

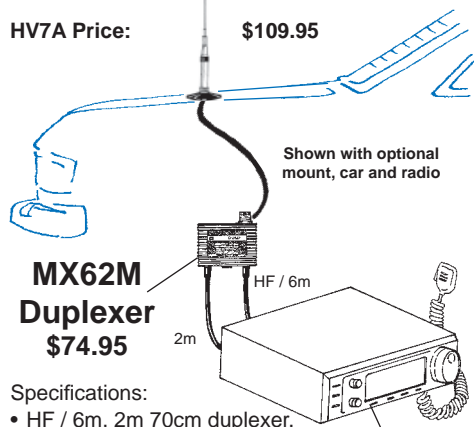

MX62M Duplexer \$74.95

Specifications:
• HF / 6m, 2m 70cm duplexer.
• 1.6-56 MHz LPF
• 76-470 MHz HPF
• (76-120 receive only)
• Watts: 600 P.E.P.
• Loss: .2 dB LPF
.3 dB HPF
• Isolation: 50 dB

Use with HF/ VHF mobile transceivers such as the IC-706 series, FT-100 or combine 2m and HF rigs.

Optional Loading Coils

HVC7	40m	\$44.95
HVC14	20m	\$37.95
HVC18	17m	\$37.95
HVC21	15m	\$37.95

Antennas for Handhelds

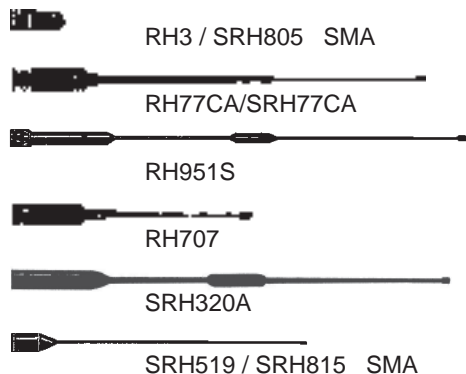

ANTENNAS & MOUNTS

K400-3/8C Special Trunk Mount

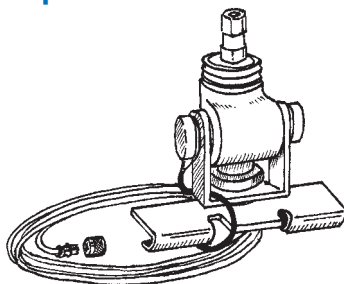

for 3/8 x 24 thread
Antennas

Here's the ideal mounting system for Outbacker Perth, OB Jr., and other medium weight antennas. A spring is recommended for stiff or heavy antennas.

Power: 350 watts RMS
Cable: 6 1/2' RG316
teflon coax
Connector: PL-259
Adjustment: 2 axis

K400-3/8C \$69.95
Note: Use C110, 10 ft extension for front radio installation. \$14.95

Specialty Antennas

**NR7900A
2m / 70cm Mobile**

High power dual-band 2m / 70cm mobile antenna. 300 watts (2m) and 250 watts (70cm). Excellent for high power applications. Use K400 and K600 series mounts. **HRO Price \$84.95**

**CR8900A
Quad Band FM**

10m / 6m / 2m / 70cm quad FM band antenna for FT8900A radio or multi radio applications. Use K400 and K600 series mounts. **HRO Price \$99.95**

**MR77 / MR77SMA
2m / 70cm Mobile**

Ideal antenna for increased performance of HT radio or where a compact antenna is required. Dual-band with magnetic mount base. 1/4 wave (2m) and 1/2 wave (70cm), black finish. Available in UHF or SMA cable configuration. **HRO Price \$34.95**

**NR-770HRKS
2m / 70cm Mobile
HRO Price \$109.95**

**CR270A
2m / 70cm Mobile
HRO Price \$42.95**

Diamond Accessories

Model	Description	HRO Price
CA23RS	Lightning surge protector, DC-2500 MHz, 200 w, type-N female conector	\$39.95
CA23RW	Lightning surge protector, DC-2500 MHz, 200 w, type-N female, waterproof	\$44.95
CA35RS	Lightning surge protector, DC-1000 MHz, 400 w, SO-239	\$29.95
CA35RPW	Lightning surge protector, DC-1000 MHz, 400 w, SO-239, waterproof	\$41.95
CX-210A	Heavy duty wideband coax switch, DC-1000 MHz. 1.5 kW, UHF(F) to UHF(M) Waterproof	\$44.95
CX-210N	Heavy duty wideband coax switch, DC-1500 MHz. 1.5 kW, N connector.	\$74.95
CX-310A	Heavy duty 3 position coax switch, wideband. DC-800MHz. SO-239 connectors.	\$83.95
DL-30A	Dummy load. DC-500 MHz, 15W RMS (max)/100w peak. PL-259 connector.	\$39.95
DL-30N	Dummy load. DC-500 MHz, 15W RMS (max)/100w peak. Type N connector.	\$39.95
NMO/UHF-B	NMO to UHF adapter converting antennas with PL259 to NMO-Black	\$13.95

Diamond Handheld and Receiving Antennas

Model	Description	HRO Price
D-130J	Wideband discone 25-1300 MHz. 200 W transmit 50-1300 MHz. No cable.	\$99.95
D-130NJ	Wideband discone 25-1300 MHz. 200 W transmit 50-1300 MHz. 50 W 6M, No cable, Type-N	\$99.95
MAY-1000	VHF/UHF Multiband handheld adjustable DF beam 120-500 MHz	\$99.95
RH-3	2m / 70cm dual-band HT antenna. 1.75" BNC. 120-900 MHz receive.	\$24.95
RH-77CA	High gain 2m / 70cm dual-band HT antenna. Receive range to 900 MHz. BNC	\$24.95
RHF-40	Super flexible version of Model RH-77CA	\$29.95
SRHF-40	Super flexible 15" tail SMA 2m / 440 HT antenna	\$29.95
RH-205	2m HT antenna, telescopic, 5/8 fully extended, 47.5"; 1/4 retracted, 9".	\$24.95
RH-519	2m / 70cm slim dual-band HT antenna. Flexible. 8" BNC, 10 watts.	\$24.95
RH-707	2m / 70cm dual-band, tiltable whip HT antenna. 8-1/4" BNC.	\$33.95
RH-951S	High gain 2m / 70 cm / 23 cm slim tri-band HT antenna. Flexible. BNC (Wide band receive)	\$44.95
SRH-519	2m / 70cm slim dual-band HT antenna. Flexible. 8" SMA, 10 watts.	\$27.95
SRH-77CA	High gain 2m/70cm dual-band flexible HT antenna, SMA	\$24.95
SRH-320A	2m/1-1/4m/70cm tri-band HT antenna. Flexible. SMA. 10 watts	\$49.95
SRH-789	Telescoping handheld antenna 95-1100 MHz, 6 sections, folds at base	\$34.95
RH-789	Same as SRH-789 but BNC connector	\$34.95
SRH-805	2m / 70cm / 23cm tri-band HT antenna. 1.75" SMA, 10 watts.	\$27.95
SRH-815	2m / 70cm / 23cm tri-band HT antenna. Flexible. 6" SMA, 6 watts.	\$31.95
SRH940		\$34.95
SRH-999	6m / 2m / 70cm / 23cm quad-band HT antenna. Flexible. 21 1/4" SMA, 10 watt	\$59.95

HANDHELD ANTENNAS / MOBILE ANTENNAS

Duckies & Telescoping Antennas

PRYME[®]
Radio Products

VHF / UHF Dualband Antennas

RD-2 SMA

2 M / 440 MHz, 2" tall small duck, SMA connector. **HRO Price \$19.95**

RD-8

2 M / 440 MHz, flexible 6.5" tall HT antenna, gold plated BNC connector. **HRO Price \$17.95**

RD-9

2 M / 440 MHz, thin 7" antenna, BNC connector. **HRO Price \$18.95**

RD-9 SMA

2 M / 440 MHz, thin 7" antenna, SMA connector. **HRO Price \$21.95**

RD-78

2 M / 440 MHz, flexible 15" tall HT antenna, 2.15 dB / 3.2 dB gain, gold plated BNC connector. **HRO Price \$22.95**

RD-98

2 M / 440 MHz, 17" tall, 1/16" diameter HT antenna, BNC connector. **HRO Price \$24.95**

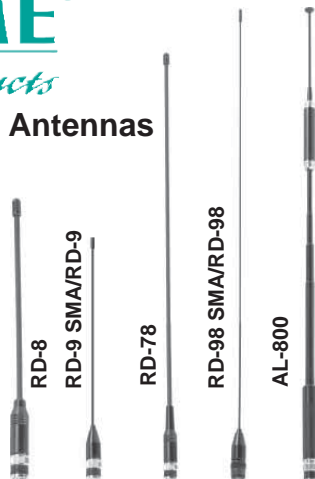

connector. **HRO Price \$24.95**

RD-98 SMA

2 M / 440 MHz, 17" tall, 1/16" diameter HT antenna, SMA connector. **HRO Price \$27.95**

AL-800

2 M / 440 MHz, telescoping antenna, extends to 34", collapses to 10". Whip replaceable with 9" rat tail (included), 3.2/5.5 dB gain, gold plated BNC connector. **HRO Price \$34.95**

LARSEN[®]
ANTENNAS

KulDuckies have outstanding transmit range with 1.5:1 VSWR. Made of copper and brass radiators, they are scope tuned to precise frequencies. Constructed with soldered connections, plasticol dip process, injection-molded housings and silver plated contact.

KulDuckies are available in Helical (VHF, UHF), HQ Helical (VHF), Dual Band, and Half Wave.

KulDuckies



HELICAL (VHF, UHF) DUAL BAND HQ (VHF) HW (VHF)

KD4 2/70

Amateur dual band KD antenna, BNC connector. **HRO Price \$48.00**

KD4 FREQ HQ

Helical 1/4 wave 136-222 MHz (specify frequency), 9 1/2" tall, BNC connector. **HRO Price \$30.00**

KD4 VHF

VHF helical 136-222 MHz (specify frequency), 8" tall, BNC connector. **HRO Price \$24.00**

KD4 UHF

UHF helical 406-512 MHz (specify frequency), 3" tall, BNC connector. **HRO Price \$24.00**

KD142 MHW

Collapsible 1/2-wave 144-155 MHz, 11" to 44 1/2" tall, BNC connector. **HRO Price \$46.00**

2m / 70 cm Dual-Band Antennas

There are more dual-band antennas on these pages:



See Page 98



See Page 101



See Page 102

Brand	Model	Type	Frequency MHz	Gain	Weight oz.	HRO Price
Larsen	NMO 2/70	2m	144-148	2.6 dB	3.9	\$54.00
		70 cm 5/8 collinear	440-450	5.5 dB		
Austin	500C	2 m	144 -148	Unity	6	\$32.95
		70 cm	440 - 450			
	Metropolitan	2 m	144 -148		6	\$39.95
		220 MHz	220 - 225	Unity		
Valor	GM270	2m	144 -148	2.6 dB	-	\$39.95
		70 cm	440 - 450	4.0 dB		
	MM270B	2m	144 -148	-	-	\$39.95
		70 cm	440 - 450	-		
	PM144-440	2m	144 -148	-	-	\$19.95
		70 cm	440 - 450	-		
	MO144-440	2m	144 -148	Unity	-	\$16.95
		70 cm	435 - 450	2. dB		

Duplexers

When using a single antenna with mobile radios that have separate 2 meter and 440 MHz outputs, you must use a duplexer.

Comet Antenna has a wide variety of duplexers & triplexers with gold-plated connectors, high isolation and the highest power handling abilities. See page 103.

Yaesu's AD-3 handles up to 50 watts. Its short cables attach to VHF radios with an SO-239 and to UHF with a type N connector. VHF to UHF isolation is 50 dB. **HRO Price \$49.95**

Diamond has a wide collection of duplexers and triplexers for coupling antennas and transceivers. See page 107.

On-Glass Antennas



Single Band 1/2-Wave

Larsen's full selection of on-glass antennas for single-band and dual band use are described on page 101. All single band antennas are pre-cut. A single 1/2 wave design provides 2.4 dB gain.

KG-144-PL 2 M HRO Price \$64.95
KG-440-PL 440 MHz HRO Price \$54.95



← **AP-143**

This unique on-glass styling with a coil looks like a cellular antenna. Broad banded. No tuning necessary. The length of the whip is only 26 inches. Black coating on the antenna is very attractive. No ground plane required. **HRO Price \$55.95**

Secure Ordering from HRO on the Web:

<http://www.hamradio.com>

MOBILE ANTENNAS



Dual Band Mobiles

Models for 2m / 70cm have a black finish.

Model	Max Pwr	Gain	Lgt	Conn
EX-107RB	80 watts	2.6/4.9	29"	PL-259
EX-107RBNMO	80 watts	2.6/4.9	29"	NMO
SHG-1500B	200 watts	4.5/7.5	59"	PL-259
SHG-1500BNMO	200 watts	4.5/7.5	59"	NMO

2 Meter Mobiles

Ground independent models are center loaded 5/8 wave.

Model	Max Pwr	Gain	Lgth	Conn
SHG-140	200 watts	4.1	56"	PL-259
SHG-140NMO	200 watts	4.1	56"	NMO

Ultra-Compact Vertical 8-Band HF / 2 m / 70 cm Base Antenna

HRO Price \$299.95

At only half the height and weight of traditional HF vertical antennas, model HVU-8 includes 2m and 70cm. It is easily configured and installed in confined or restricted spaces such as apartment balconies, or for temporary use. Each HF band and 6m has an independently tuned radiator and radial system while the main antenna mast is tuned for constant operation on 2m / 70 cm.

- HF and 6m: 1/4 wave.
- 2m: 1/2 wave 2.15dBi gain.
- 70cm: two 5/8 waves in phase, 5.5 dBi gain.
- Impedance: 50 Ohm.
- Max power HF: 200 W SSB;
- 6m-70 cm: 150 W FM.
- Height: 8 ft 6 inches; Weight: 5 lbs 7 ozs.

2m / 220 / 440



Super-M V/U NMO
VHF / UHF Mobile
HRO Price: \$72.95

Niljon Antennas

The typical 1/4 wave antenna used on commercial (taxi, trucking companies, etc.) and government vehicles (ambulances, other city vehicles, school buses, state patrol, etc.) can easily be replaced by the Super-M with tremendous, even life-saving, results. One antenna covers 140-170 MHz, 200-225 MHz and 400-480 MHz. It handles 200 watts with a direct feed and is only 18" high.

SUPER-M V/U screws directly onto a 5/16" - 24 thread stud mount [also called the "LM" Larsen Mount].

SUPER-M V/U-NMO comes packaged with an adapter to screw onto a Motorola NMO style mount.

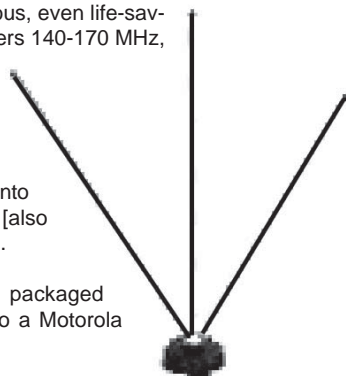

2 meter On-Glass

Glassmaster™ GM144 – 144-146 MHz

Pro-Am's on-glass antenna has a rugged copper plated whip with black finish and an interior coupler box with adjustable slot to fine tune the SWR. Power rated at 50 watts, they come with 14' of RG58 coax, a PL-259 connector, and mounting package for easy, no hole installation. **HRO Price \$19.95**

Mag Mount Whips

Micro-Mag™ 2 m, 220 or 450 MHz

2 m kit with 17-7 ph stainless steel whip and 12' of cable to a PL-259. Can be cut for 220 or 450 MHz.

VAA-002 PL-259 chrome
HRO Price \$23.95

VAA-002B PL-259 black
HRO Price \$23.95

VAA-002BNC with BNC
HRO Price \$27.95



AST-MMK

Model	Description	HRO Price
AST-TMK *	Universal trunk mount	\$39.99
AST-MMK *	Heavy duty mag mount	\$49.95
AST-HC	3/8 x 24 hex collar	\$6.95
AST-NMO	NMO mounting	\$6.95
AST-SO239	SO-239 mounting	\$6.95

* Includes 3/8 x 24 adapter

HF Mobiles

PHF Series Mono-Band Antennas

These mono-band mobile antennas have a black fiberglass lower section with integral coil and an adjustable (and removable) stainless steel whip (except for the PHF160). These antennas are designed for maximum efficiency, low SWR and broadbandwidth. They are power rated at 250 watts PEP and built to withstand considerable use. Standard 3/8x24 threads. Total assembled length on all models 96" (except PHF6 at 58").



Model	Band M	Band Width (kHz)	HRO Price
PHF160	160	12	\$79.95
PHF80	80	35	\$21.95
PHF75	75	36	\$21.95
PHF40	40	60	\$19.95
PHF30	30	100	\$17.95
PHF20	20	150	\$19.95
PHF17	17	175	\$19.95
PHF15	15	200	\$19.95
PHF12	12	300	\$19.95
PHF10	10	500	\$19.95
PHF6	6	1000	\$17.95

Mounts

To expedite delivery,
HRO ships from your nearest store.

HF MOBILE ANTENNAS



The Ultimate All-Band
HF Mobile Antennas

Perth & Perth Plus Antennas

HRO Prices:
Perth \$329.95
Perth Plus \$329.95

The Perth covers 10-80 meters and the Perth Plus adds the 6 m and 2 m bands. Both are sleek 3-1/2 foot stingers with a 4 foot main shaft where the taps are located. They have a tough, yet flexible fiberglass core, helically wound with copper wire hand tuned to the various "tap" frequency points. Both offer high performance with low wind drag. Mount them easily on a trunk lip, hatch, or bumper with a standard 3/8 X 24 stud. The stinger retracts into the main shaft for easy stowage. With a proper ground plane, Perth antennas are also suitable for apartment and condo installations.

Outreach Antenna

HRO Price \$419.95

- A portable antenna system for limited-space or temporary installations.
- All bands, 160–10 meters, including WARC and only 12 ft. tall!
- 10, 12, and 15 meters are $\frac{5}{8}$ wave; all bands are center loaded for peak performance.
- Handles 150 watts P.E.P.
- Split 8 foot shaft and 4 foot stinger—antenna breaks down to 4 feet for easy portability.
- Ends in standard $\frac{3}{8}$ x 24 base.
- Uses Outbacker's® band tap system.

Outbacker "Joey"

HRO Price \$299.95

- Covers HF/VHF bands 2m through 80m including WARC bands.
- Rated at 20 W, all modes.
- Uses Outbacker tap system.
- Smaller antenna packs away in its included cloth transport.
- Comes with a 12 foot copper braid counterpoise.
- Can be installed directly on the FT817 rear SO-239 connector.
- Has a 30" shaft and a 20" stinger when fully extended. Weighs just over a pound.

MicroMount

HRO Price \$49.95

For use with the "Joey," Micro-Mount has a fixed height of 8" with a 12" diameter footprint on 3 legs. It folds to an 8" length. Has a fully articulated pan head mount. Includes a 12" velcro strap for mounting to most anything. Includes a 3 counterpoise system and weighs less than 10 ounces.

Outbacker Antenna

HRO Price \$319.95

With the Outbacker® there is no need to change coils when changing HF bands. The antenna comes in a six foot version that handles up to 300 watts PEP and a four foot Junior model for up to 150 watts PEP. The antennas are made of fiberglass coated with smooth epoxy resin and polyurethane. The pre-tuned copper helical winding has connection sockets constructed of rust-free brass, clearly marked for each band. The antenna covers all bands from 10 to 80 meters. Mount the antenna with a standard 3/8 X 24 thread. Use Hustler's BM-1 or SSM ball mounts. Optional heavy duty spring and 2" base can be mounted at the bottom of the antenna and attached to a PL-259.

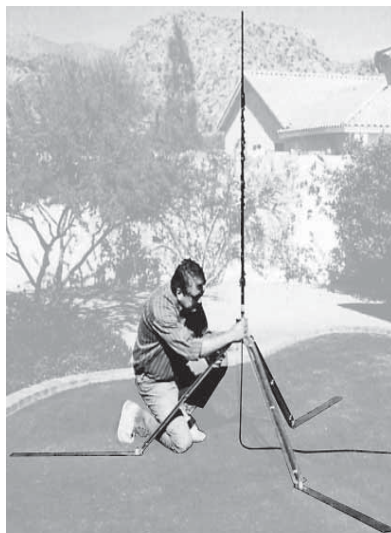

Alpha Delta Outpost™ Tripod / Ground Coupler Ground Mount System

HRO Price \$195.95

- Matches the base impedance of all Outbacker® antennas.
- Fold-over $\frac{3}{8}$ x 24 SO-239 top mount.
- Constructed of aircraft 6061-T6 aluminum, stainless steel hardware and wing nuts.
- No digging—no holes in ground—no concrete.
- Fold-out legs act as a large capacitor providing proper coupling to the ground and proper base impedance to the antenna. Fold-up design for 10-minute installation.



HF / VHF / UHF Mobile Antenna

ATAS-120

\$299.95 – HRO Price

The ATAS-120 provides HF / VHF / UHF coverage with automatic motorized tuning. Controlled from the transceiver, it adjusts the radiator length for best SWR. Compatible with Yaesu's FT-100, FT-847, FT-857, and FT-897.

HF / VHF / UHF Portable Field Antenna

ATAS-25

\$219.95 – HRO Price

The ATAS-25 has radiating elements covering amateur bands 10-40 m, 6 m, 2 m, and 70 cm. Mounts to a standard camera tripod (not included). Uses a manual tuning system. Dual frequency operation possible with a duplexer (not included). Antenna collapses to less than two feet to carry; expands to 7.2 foot maximum height. This is an ideal system to use with the FT-817, FT-897, and FT-857 transceivers. Weight is 2.05 pounds.

HF Mobile

Ham Sticks®

Ham Sticks® are two-piece mono-band antennas consisting of a hollow fiberglass base section, a loading coil wound directly onto the fiberglass, with a covering of PVC shrink tubing. The black oxide brass base fitting has 3/8" X 24 male threads that fit most amateur mobile mounts.

The top section is a tapered 17-7 PH tempered stainless steel whip that telescopes into the base section for frequency adjustment. The assembled antenna is about 7' long.

Ham Sticks Model	Band	HRO Price
9175	75 m	\$29.95
9160	60 m	\$28.95
9140	40 m	\$26.95
9130	30 m	\$26.95
9120	20 m	\$26.95
9117	17 m	\$26.95
9115	15 m	\$26.95
9112	12 m	\$26.95
9110	10 m	\$26.95
9106	6 m	\$26.95



CRANK-UP TUBULAR

MA-SERIES CRANK-UP MASTS

The premier MA-Series crank-up Tubular Towers are designed to be both safe and neighbor friendly. The slender design gives a Clean, flagpole-like appearance, while allowing for antennas up to 10 sq. feet in 50 mph winds. Per EIA Specifications, adequate safety margins are included. Uniform Building Code calculations are available for most models.

The MA-40 and 550 models come standard with flat base. two 1/2" x 10" anchor bolts, wall bracket and rotor plate mounted on top of top section. No guying is required when tower is properly bracketed to the eve of your roof.

MA-Series towers are completely self-supporting only when used with accessory MARB or MAB Series bases. The MARB Series rotor base allows the entire tower and antenna to be rotated from the base (rotor not included). This provides for easy rotor maintenance plus emergency hand rotation of the entire tower and antenna.

The MA-550MDP, 770MDP and 850MDP models include a heavy duty motor drive with positive pull down. The MDP models provide motorized raising and lowering of the tower. A remote control unit (RMC-1000) accessory is available that allows raising and lowering from your ham shack or other remote location.

All models without motor drives come standard with manual hand winches which have load actuated brakes for maximum safety. This feature prevents the winch from free-wheeling and causing injury to you or your installation in the event that you lose your grip during raising or lowering.

All steel used at US Tower conforms to ASTM specifications. All welding is done by certified factory personnel. All of our towers are factory tested by trained personnel before leaving the plant.

Model Number	Height Maximum	Height Minimum	Sections	Weight Pounds	Sec O.D. Top	Sec O.D. Bottom	HRO Price
MA-40	40'	21'6"	2	242	3" sq.	4.5"	CALL
MA-550	55'	22'1"	3	435	3" sq.	6.625"	CALL
MA-550MDP*	55'	22'1"	3	620	3" sq.	6.625"	CALL
MA-770	75'	22'10"	4	645	3" sq.	8.0"	CALL
MA-770MDP*	75'	22'10"	4	830	3" sq.	8.0"	CALL
MA-850MDP*	90'	23'6"	5	1128	3" sq.	10.0"	CALL

All Towers will handle 10 sq. ft antenna at 50 MPH winds.

* These towers also requires purchase of MCL-100 or RMC-1000

MA-SERIES BASE INFORMATION

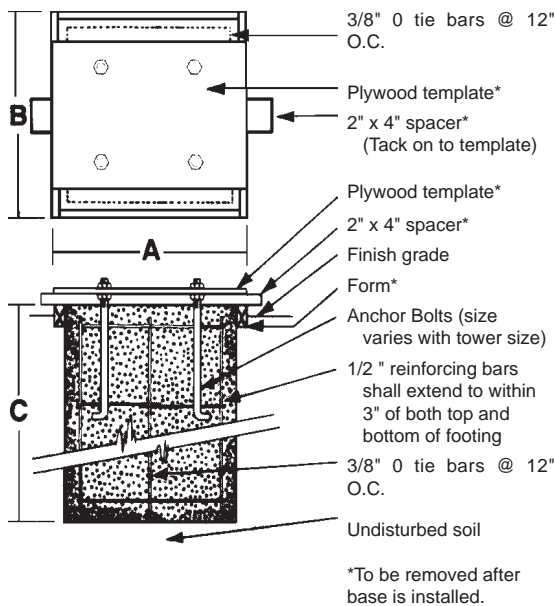

Model	A	B	C	HRO Price
MA-40 standard flat base	16"	16"	16"	CALL
MA-550 standard flat base	20"	20"	20"	CALL
MARB-40 Rotator Base	3'	3'	4'	CALL
MARB-550 Rotator Base	3'	3'	5'6"	CALL
MARB-770 Rotator Base	3'	3'	6'6"	CALL
MARB-850 Rotator Base	4'	4'	6'6"	CALL

Base dimensions may vary with different soil compositions. Allow ample time for concrete to cure. MAB and MARB dimensions are the same.

Tower base hole size and rebar are for illustration only, current UBC engineering calculations should be used to determine your specific installation.

Rebar is not provided by US Tower. MA-40 & 550 use their standard base as a template. These standard bases use only 2 bolts and require no rebar. Wooden template included with MAB & MARB bases.

Because of wide variations throughout the country in zoning requirements and loading conditions (snow, wind, ice, etc.), it is the responsibility of the customer to make Certain that his Tower conforms to all applicable codes. We recommend you obtain all necessary permits prior to purchase .

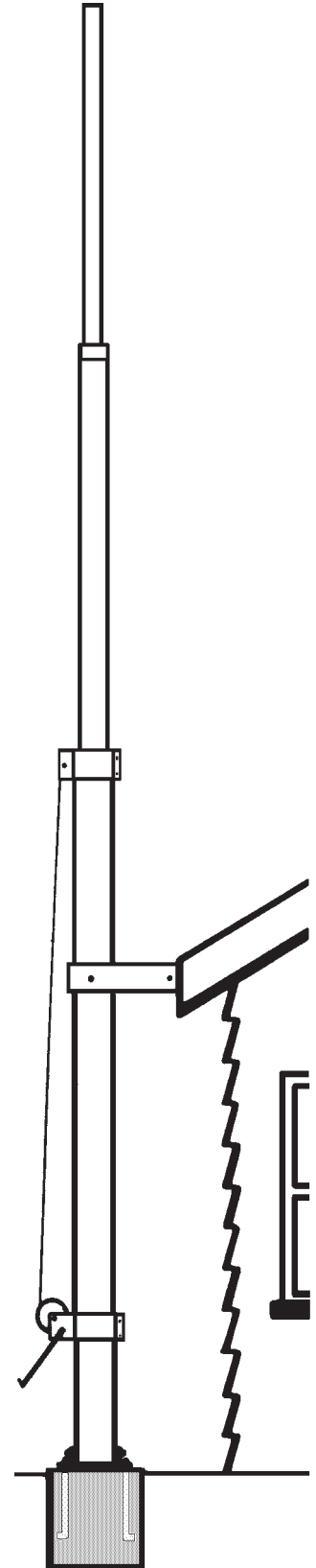

The factory reserves the right to make changes or modifications without notice.

MA-SERIES ACCESSORIES

The Customer is Responsible for obtaining all local city or county building and tower permits **AND** for taking the tower off the freight truck when it is delivered. Please arrange for adequate help.

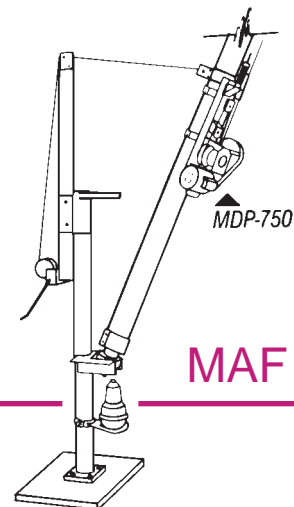

MAF

Model	Description	Weight
-------	-------------	--------

MAF Raising Fixture

MAF-Series Raising Fixture accessory for easy raising and antenna servicing. For use with MARB and MAB bases.

MAF-40	Raising fixture for MA-40	35#
MAF-550	Raising fixture for MA-550	70#
MAF-770	Raising fixture for MA-770	75#
MAF-850	Raising fixture for MA-850	80#

MARB Freestanding Rotator Base

MARB-40	Freestanding rotator base for MA-40 with four 3/4" x 27" anchor bolts and thrust bearing	75#
MARB-550	Freestanding rotator base for MA-550 with four 1" x 36" anchor bolts and thrust bearing	140#
MARB-770	Freestanding rotator base for MA-770 with four 1" x 36" anchor bolts and thrust bearing	195#
MARB-850	Freestanding rotator base for MA-850 with four 1-1/8" x 36" anchor bolts and thrust bearing	280#

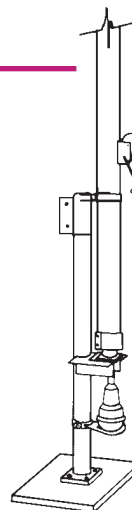

MARB

MAB Freestanding Type Base

MAB-40	Freestanding hinged base for MA-40 with four 3/4" x 27" anchor bolts	55#
MAB-550	Freestanding hinged base for MA-550 with four 1" x 36" anchor bolts	119#
MAB-770	Freestanding hinged base for MA-770 with four 1" x 36" anchor bolts	175#
MAB-850	Freestanding hinged base for MA-850 with four 1-1/8" x 36" anchor bolts	180#

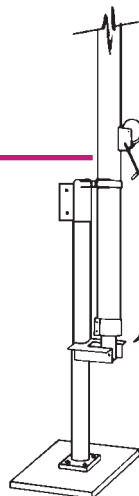

Hinging allows for easy installation on both MAB and MARB bases.

MAB

Coax Standoff Arms

CX-2M	Coax standoff arms for MA-40	4#
CX-3M	Coax standoff arms for MA-550	6#
CX-4M	Coax standoff arms for MA-770	8#
CX-5M	Coax standoff arms for MA-850	10#
IV-16	The IV-16 slips over the top of the mast and rests at the top of the tower to hold inverted vee antennas. The IV-16 cannot be used with the MARB rotator base.	5#

Model	Description	Weight
-------	-------------	--------

Motor Drives

MD-75	Heavy-duty motor drive with one HP motor and gear box.	155#
--------------	--	------

Remote Control Accessories

RMC-1000	Relay operated remote control for raising and lowering your tower from your ham shack or other remote location.	18#
MCL-100	Limit switch control package includes limit switches, limit switch brackets, and control box at the base of the tower.	7#

Call Toll-Free for Discounts on U.S. Towers and Accessories



TMM SERIES

US Tower's latest design includes the compact TMM Series towers giving Hams in restricted areas an alternative. The TMM Series has a minimum retracted height of 11'4" (may vary, depending on rotator used) and a maximum height of 47' including mast. At the towers' retracted height, visual impact is reduced to a minimum and antenna servicing is made easier. Typically the tower and antenna are below the roof line of your home when the tower is fully retracted.

The TMM Series towers are lightweight, freestanding crank-up towers that allow up to 18 square feet of antenna in 50 mph winds per EIA specifications. The TMM-433HD handles 24 square feet. These lightweight towers should provide many years of trouble free service. All of our towers have a hot dipped galvanized finish inside and out.

TX SERIES

US Tower's freestanding TX Series crank-up towers are as strong or stronger than most competitors' heavy-duty models. The TX Series towers have 21 foot sections with 4 foot overlap to provide extra height and strength. In addition, the overlap helps prevent binding while lowering your tower in high wind and conditions.

The TX Series towers have a large enough top section (12 1/2") to permit installation of most rotators inside the section for maximum strength while allowing the section to fully retract. Cross bracing at critical points on the tower ensures safety and additional strength. All US Towers crank-up towers have a heavy-duty, hot dipped galvanized finish both inside and out, which should provide many years of trouble free service.

The TX Series towers come complete with rotator plate and base hardware which includes, large steel anchor bolts and heavy-duty steel T-base that allows the tower to hinge on for easy installation. All T-bases will accept the TRX Series raising fixtures for easy one man installation. All TX Series

HDX SERIES

This superior strength allows for large stacked arrays, while using our commercial type bases and anchor bolts that can be easily installed and vertically adjusted. All HDX Series T-bases are designed to use our TRX Series raising fixtures to make installations and antenna servicing a one man job.

Modified top sections for the HDR-300 rotators are available at a small additional cost. US Tower carries as accessories many different sizes and strengths of masts which can be used with the HDX Series towers. The HDX-572MDPL and 589MDPL motorized towers provide dual level wind, positive pull down and heavy duty gear box features. The HDX-572MDPL comes only with limit switch brackets. The HDX-589MDPL comes complete with the MCL-100, limit switch package. All towers using MDP-750

The TMM-433SS and 541SS must have the rotator top mounted. The TM-433HD will accept the Alliance HD-73 and Telex Ham IV inside the tower. Oversized rotators will prevent full retraction of your tower; however, they may be used if full retraction is not required. This restriction is dependent on location of rotator plate. All TMM Series towers include anchor bolts, rotator plate, hinged T-base, load actuated winch, and eight feet of 2" OD x 120" antenna mast.

The TMM-433SS will accept the MD-75 motor drive accessory. The TMM-433HD and 541SS will accept the MD-75 and MDP-750 accessory motor drives. The MDP-750 motor drive accessory is compatible with both of our MCL-100 and RMC-1000 limit switch packages (see accessories).

towers include Fulton hand winches (except MDP and MDLP models) which feature automatic load actuated brakes for maximum safety. Masts and motor drives are available as accessories (see accessory page).

The TX-472MDP comes complete with MDP-750 motor drive and limit switch brackets. The TX-489MDPL includes the MDPL-1000 motor drive and limit switch brackets. Limit switch assemblies and remote raising devices are available (MCL-100) (RMC-1000) for all MDP-750 and MDPL-1000 motor drive units (see accessory page for description).

US Tower's TX Series requires no guying. The wind loading is calculated at 18 square feet of antenna in 50 mph winds per EIA specifications. To assist you in applying for necessary construction permits, Uniform Building Code calculations are available for most models.

US Tower's HDX Series heavy-duty crank-up towers have up to 2 1/2 times more windloading capacity than others commonly advertised.

and MDPL-1000 motor drives may use the RMC-1000 accessory limit switch package which allows the raising and lowering of your tower from the comfort of your ham shack or any remote location. MCL-100 is also available (see accessory page).

All HDX Series towers come complete with rotator plate, anchor bolts and heavy-duty T-base (doubles as template). US Tower's special T-base design allows the tower to hinge for easy installation. US Tower's crank towers do not require guy wires. The HDX Series towers are rated at 30 square feet of antenna at 50 mph winds per EIA specifications. To assist you in getting a construction permit, Uniform Building Code calculations are available for most towers.

CRANK-UP TOWER BASE INFORMATION

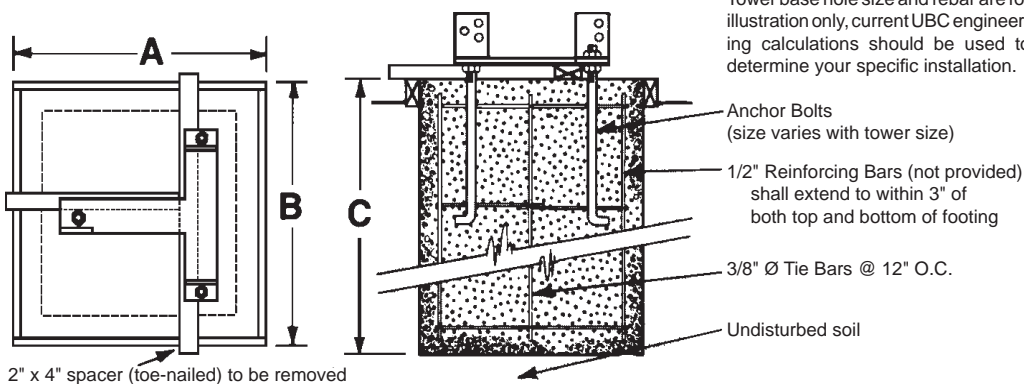

Tower base hole size and rebar are for illustration only, current UBC engineering calculations should be used to determine your specific installation.

Model	A	B	C
TMM-433SS	4'	4'	4'6"
TMM-541SS	4'	4'	5'
TMM-433HD	3'	3'	5'
TX-438	5'	5'	5'
TX-455	5'	5'	6'
TX-472	5'	5'	6'6"
TX-489	5'	5'	8'
HDX-538	5'	5'	6'
HDX-555	5'	5'	6'6"
HDX-572	5'	5'	7'
HDX-589	5'	5'	8'
HDX-5106	5'	5'	9'
MA40	3'	3'	4'6"
MA550	3'6"	3'6"	5'
MA770	5'	5'	5'6"
MA850	5'	5'	6'

Prices in this print catalog are subject to change

SELF-SUPPORTING CRANK-UP TOWERS

Tower Specifications

COMPACT TMM-SERIES CRANK-UP TOWERS

Model Number	Height Maximum	Height Minimum	Sec-tions	Weight Pounds	Sec O.D. Top	Sec O.D. Bottom	HRO Price
TMM-433SS	33' w/o Mast	11'4"	4	315	10"	18"	CALL
TMM-433HD	33' w/o Mast	11'4"	4	400	12.5"	20 7/8"	CALL
TMM-541SS	41' w/o Mast	12'	5	430	10"	20 7/8"	CALL

Towers handle 18 sq. ft. antenna at 50 MPH winds. TMM-433HD handles 24 sq. ft.

TX-SERIES FREE-STANDING CRANK-UP TOWERS

Model Number	Height Maximum	Height Minimum	Sec-tions	Weight Pounds	Sec O.D. Top	Sec O.D. Bottom	HRO Price
TX-438	38'	21'6"	2	355	12.5"	15"	CALL
TX-455	55'	21'	3	670	12.5"	18"	CALL
TX-472	72'	22'8"	4	1040	12.5"	21 5/8"	CALL
TX-472MDP*	72'	22'8"	4	1210	12.5"	21 5/8"	CALL
TX-489MDPL	89'	23'4"	5	1800	12.5"	25 5/8"	CALL

All Towers will handle 18 sq. ft. antenna at 50 MPH winds.

* This tower requires purchase of MCL-100 or RMC-1000

HDX-SERIES HEAVY-DUTY CRANK-UP TOWERS

Model Number	Height Maximum	Height Minimum	Sec-tions	Weight Pounds	Sec O.D. Top	Sec O.D. Bottom	HRO Price
HDX-538	38'	21'6"	2	600	15"	18"	CALL
HDX-555	55'	22'	3	870	15"	21 5/8"	CALL
HDX-572MDPL	72'	22'8"	4	1600	15"	25 5/8"	CALL
HDX-589MDPL	89'	23'8"	5	2440	15"	30 5/8"	CALL
HDX-689MDPL	89'	23'8"	5	3450	18"	37 1/8"	CALL
HDX-5106MDPL	106'	24'8"	6	3700	15"	37 1/8"	CALL

All Towers will handle 30 sq. ft. antenna at 50 MPH winds.

HDX-689MDPL rated at 60 sq. ft of antenna at 50 mph winds.

HDX-5106MDPL rated at 35 sq. ft. of antenna at 50 mph winds.

Call Toll-Free for Discounts on U.S. Towers and Accessories

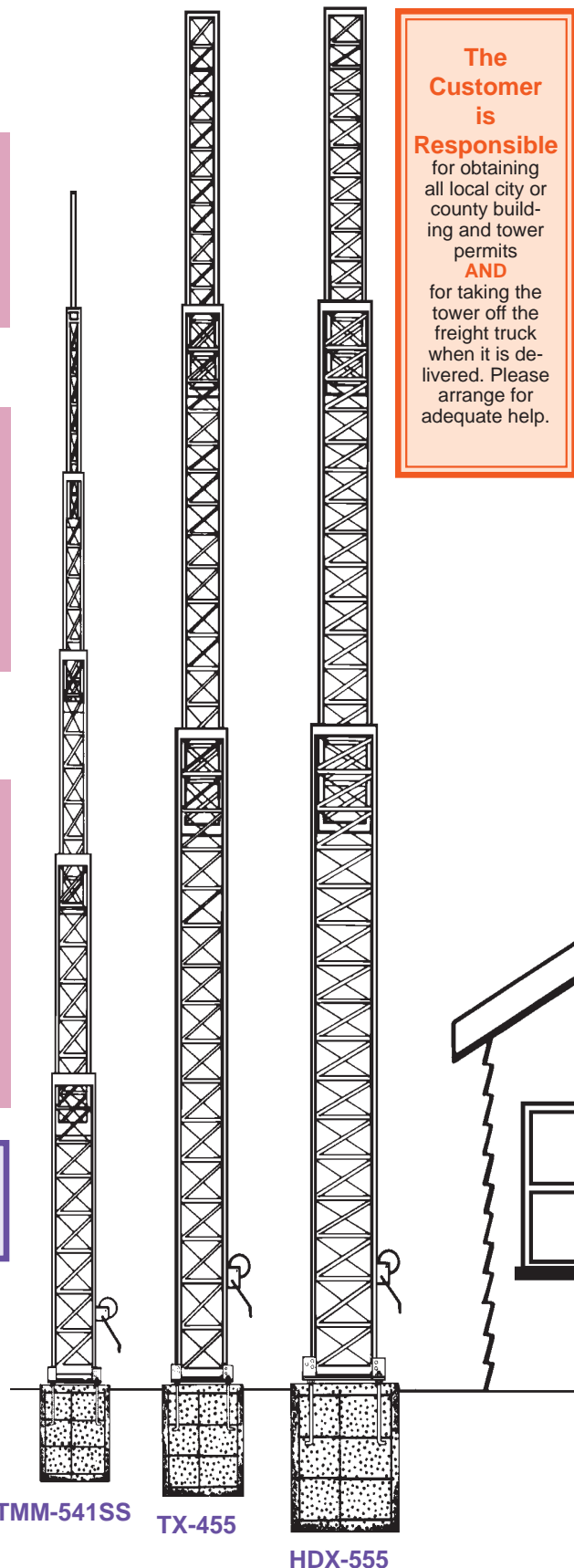
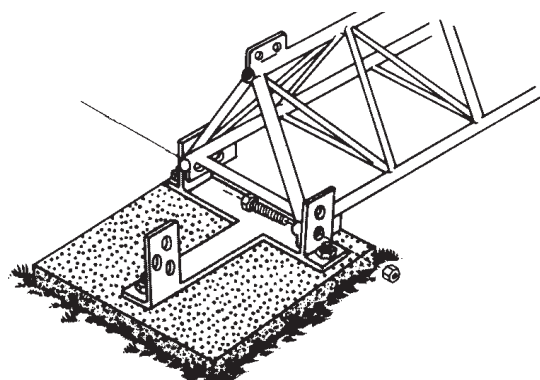

The Customer is Responsible for obtaining all local city or county building and tower permits AND for taking the tower off the freight truck when it is delivered. Please arrange for adequate help.

The factory reserves the right to make changes or modifications without notice.

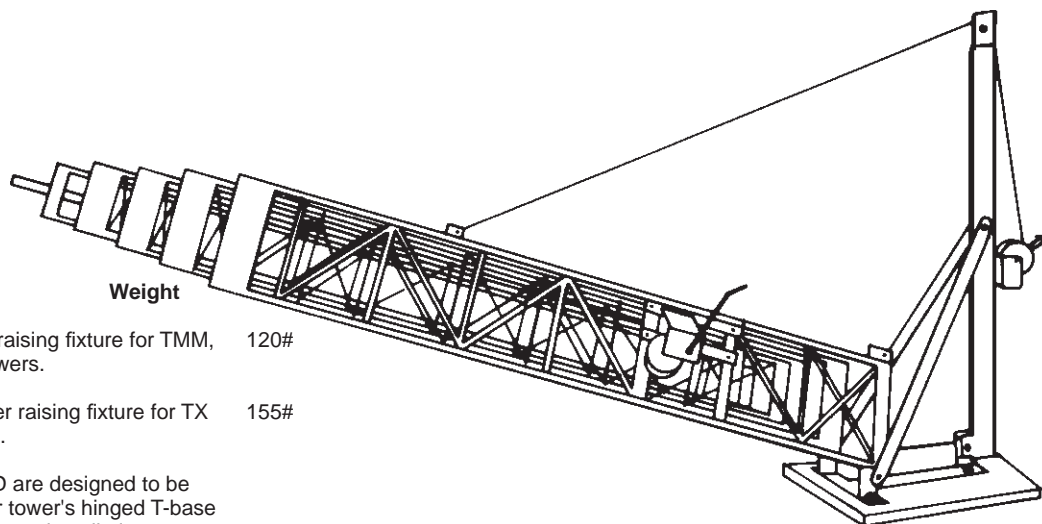

Raising Fixture

Model	Description	Weight
TRX-80	Standard model tower raising fixture for TMM, TX, and HDX series towers.	120#
TRX-80HD	Heavy-duty model tower raising fixture for TX and HDX series towers.	155#

Both TRX-80 and 80HD are designed to be easily mounted on your tower's hinged T-base for quick and safe one-man installation or antenna servicing.

Remote Control

Model	Description	Weight
RMC-1000	Relay operated remote control for raising and lowering your tower from your ham shack or other remote location. The RMC-1000 includes limit switches, limit switch brackets, and two relay boxes. The RMC-1000 can only be used with the MDP-750 and MDPL-1000 motor drives.	18#
MCL-100	Limit switch control package. The MCL-100 includes limit switches, limit switch brackets and control box at the base of the tower. The MCL-100 allows you to raise and lower your tower with automatic shut down when maximum or minimum height is reached. The MCL-100 can only be used with the MDP-750 and MDLP-1000 motor drives.	7#

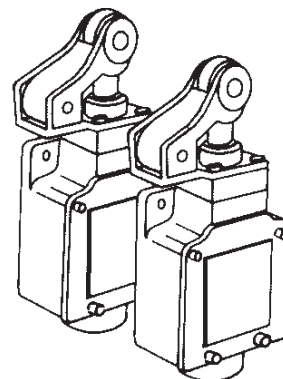
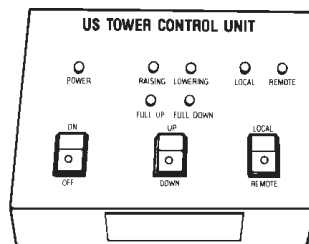

Motor Drives

Model	Description	Weight
MD-75	Heavy-duty motor drive with 1 HP motor and gear box.	155#

Call factory for replacement 1 HP motors, handwinches, limit switches, 3/16" x 7" x 19" and 1/4" x 7" x 19" aircraft cable, anchor bolts, belts, pulleys, sprockets, and modified bases. Tower dolly rentals are available. The factory reserves the right to make changes or modifications without notice.



MD-75

The Customer is Responsible
for obtaining all local city or county building and tower permits **AND** for taking the tower off the freight truck when it is delivered. Please arrange for adequate help.

CRANK-UP ACCESSORIES

Model **Description** **Weight**

Service Platform

HDP Large service platform with safety railings to provide a safe and comfortable surface while installing or maintaining your antenna and rotator. 125#

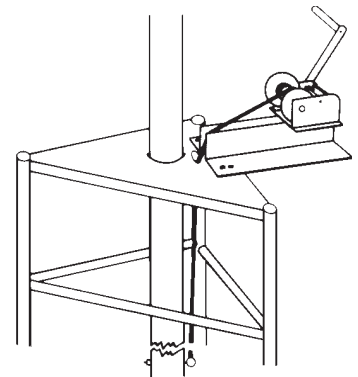
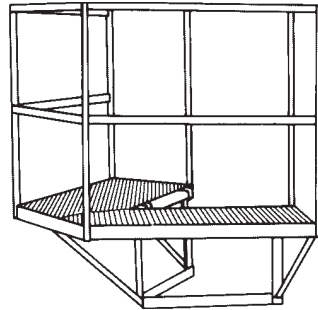

Mast Raising Fixture

MRF Mast raising fixture with winch and cable that attaches to the top of your tower to assist in raising and lowering your antenna mast. 20#

Coaxial Arm Sets

IV-16 The IV-16 slips over the top of the mast and rests at the top of the tower to hold inverted vee antennas. The IV-16 cannot be used with MARB rotator base. 5#



CX-2 Set of 2 coax standoff arms 6#
CX-3 Set of 3 coax standoff arms 8#
CX-4 Set of 4 coax standoff arms 10#
CX-5 Set of 5 coax standoff arms 13#

Thrust Bearing

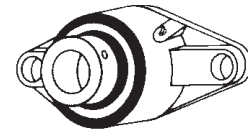

TB-2US Thrust Bearing for 2" mast, 2 flange holes 10#

Masts

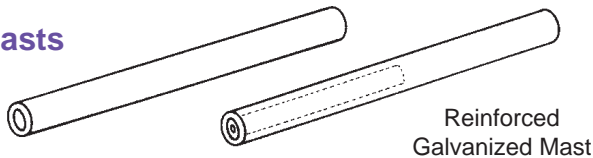

US Tower offers two different types of masts. The M-5, 10, 15 and 20 masts have .120" wall thickness. The M-15R and 20R have steel pipe inserts in the lower half of the mast which provides extra strength where most needed without adding unnecessary weight in the top portion. The M-15R and 20R have a wall thickness of .250".

Model **Description** **Weight**

M-5 2" O.D. x 5 foot galvanized mast 14#
M-10 2" O.D. x 10 foot galvanized mast 25#
M-15 2" O.D. x 15 foot galvanized mast 40#
M-15R 2" O.D. x 15 foot reinforced galvanized mast 50#
M-20 2" O.D. x 20 foot galvanized mast 55#
M-20R 2" O.D. x 20 foot reinforced galvanized mast 70#
CM-20 2" O.D. x 20 foot chromolly mast 140#

3/4" x 27" Anchor bolt with 2 nuts 5#
1" x 27" Anchor bolt with 2 nuts 10#
1-1/8" x 27" Anchor bolt with 2 nuts 12#
RP-3 Rotator plate for 10" section 5#
RP-4 Rotator plate for 12.5" section 7#
RP-5 Rotator plate for 15" section 9#

Tower Accessories

	TX438	TX-455	TX-472	TX-472MDP	TX-489	TX489MDPL	HDX-538	HDX-555	HDX-572	HDX-572MDPL	HDX-589MDPL	TMM-433SS	TMM-433HD	TMM-541SS	HRO Price
Masts															
M-5	0	0	0	0	0	0	0	0	0	0	0	0	0	0	\$60.95
M-8												S	S	S	-
M-10	0	0	0	0	0	0	0	0	0	0	0	0	0	0	\$99.95
M-15	0	0	0	0	0	0	0	0	0	0	0	0	0	0	\$159.95
M-20	0	0	0	0	0	0	0	0	0	0	0				\$199.95
M-15R	0	0	0	0	0	0	0	0	0	0	0				\$229.95
M-20R	0	0	0	0	0	0	0	0	0	0	0				\$299.95
CM-20	0	0	0	0	0	0	0	0	0	0	0				CALL
Raising Fixture															
TRX-80	0	0					0	0				0	0	0	\$599.95
TRX-80HD			0	0	0	0		0	0	0					\$799.95
Service Platform															
HDP			0	0	0	0		0	0	0					\$1,699.95
Coax Standoff Arms															
CX-2	0						0								\$80.95
CX-3		0						0							\$99.95
CX-4			0	0					0	0		0	0		\$169.95
CX-5					0	0					0			0	\$199.95
Motor Drives															
MD-75	0	0					0	0				0	0	0	\$1,499.95
MDP-750		0	0	S				0					0	0	\$1,929.95
MDPL-1000			0	0	S				0	S					\$2,999.92
Remote Control															
RMC-1000		0	0	0	0	0		0	0	0	0		0	0	\$1,449.95
MCL-100		0	0	R	0	S		0	0	S	S		0	0	\$649.95
Miscellaneous															
3/4" X 27 bolts	S														\$42.95
1" X 27" bolts		S			S	S	S	S	S	S					\$51.95
1-1/8" X 27" bolts			S	S				S			S				\$68.95
RP-3												S	S		\$52.95
RP-4	S	S	S	S	S	S							S		\$63.95
RP-5							S	S	S	S	S				\$70.95
MRF	0	0	0	0	0	0	0	0	0	0	0		0		\$399.95
TB-2US	0	0	0	0	0	0	0	0	0	0	0		0		\$149.95
IV-16	0	0	0	0	0	0	0	0	0	0	0		0	0	\$60.95

WEATHER STATIONS

Weather Stations



Ultimeter 2100
HRO Price \$399.95

*Tracking more than
100 weather values*

The Ultimeter 2100 features a stunning platinum-tone housing with brilliant blue display backlighting. To enhance the user interface still further, an illuminated keypad provides exceptional visibility in darkness or low-light conditions. The unit utilizes Peet Bros. patented and proven weather sensor technology, including a unique all-digital wind sensor. Its microprocessor is 8 times faster and has 4 times the memory of their earlier weather stations. Major features include:

- Barometric pressure and numeric pressure change over a 3 hour period plus preset barometric StormAlert, Wind Speed, Wind Direction, Outdoor Temperature, Indoor Temperature, Wind Chill, Time, Date and (with optional sensors) Indoor Humidity, Dew Point and Rainfall.
- Two versatile 4-mode serial ports can accept remote commands, making it easy to communicate with external devices to transmit data or collect it remotely by phone, modem, or radio link. The 5 minute packet mode is perfect for economical radio "beacon" transmission. The 2100 comes "APRS-Ready," requiring only direct cable connection to a TNC (cable not provided).
- The second serial data port is in the 2100's sensor junction box, delivering greater flexibility in the location and connection of the Weather Picture, PC Weather Data Logger or other peripheral weather accessory.
- An exclusive Triple-Bank Memory System stores highest and lowest readings – today's, yesterday's and long term – and the date and time that every high and low occurred.
- Each long term high and low can be reset individually or you can use a Master Reset to clear all long term memories simultaneously.
- The system includes built-in static electricity discharge protection for all outdoor sensors. Also includes a 3 prong grounded AC adapter.
- Features a unique Rain Rate Alarm serving as a flash flood alert. It is compatible with all of our optional rain gauge models.
- The 2100 has a full array of adjustable alarms and an optional electrical external alarm output. A predictive battery test circuit warns when the battery is getting weak.
- Optional sensors include humidity sensors and rain gauges.

WeatherText™ Special

WeatherText™ is an RS-232 serial data output mode in which the instrument puts out one human-readable text Weather Report each minute. Viewable on a PC monitor using terminal software such as HyperTerminal or may be transmitted as a data packet. For a limited time every 800/2100 Ultimeter Weather Station purchased will include the WeatherText™ Tools Data Logger key, including software and PC interface cable. \$69 retail value



Ultimeter 800
HRO Price \$279.95

The Ultimeter 800 has nearly all the features of the Ultimeter 2000 except the barometer. It has wind speed, wind direction, outdoor temperature, indoor temperature, wind chill temperature, time, date, automatic leap year adjustment and automatic scan mode as standard functions. With optional sensors, rain, outdoor humidity, indoor humidity and dew point reading are available. It automatically stores today's and yesterday's highs, lows and total rain fall. It also stores long term highs and lows. Alarms are provided for high wind, high and low outdoor temperature, high and low indoor temperature. The serial port has three output modes.

Ultimeter 100
HRO Price \$199.95

The Ultimeter 100 automatically stores today's and yesterday's highs, lows and total rainfall so you can compare the readings. Also stores long term high, low and rain information since it was last reset. Has a 3-mode serial port for interfacing telephone, modem or radio reporting.

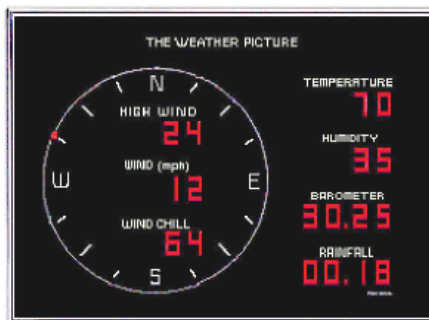

Weather Picture
HRO Price \$389.95
(aluminum version)

The Weather Picture receives data from an Ultimeter and continuously displays your pre-selected data. The 8 inch compass rose and big 0.8 inch illuminated red numerals are clearly visible day or night. View even from across the room.

Catalog Prices

HRO discount prices shown are current as of April 1, 2008, when this catalog was assembled.

Prices change both up and down. Please be sure to call one of our toll-free numbers or check our Web page for the latest prices.

We at HRO strive to offer the most competitive prices in the industry on a full line of quality ham radio products.

Many manufacturers offer "coupons" or similar promotions. Call or check our Secure Web Page at <http://www.hamradio.com> for the latest manufacturer promotions.

General Information for Our Valued Customers

Easy Ordering

Six toll-free 800 numbers are available for orders. They are located throughout the United States. This provides personnel at one location or another to answer your questions for extended hours Monday through Saturday. You will find the same low prices at all locations and, thanks to computers, we have the stock levels of all locations available to each salesperson for estimates of availability and delivery.

24 Hour "On-Line" Ordering is now available on the INTERNET! URL is <http://www.hamradio.com>

Shipments are made from any of our 12 locations that has the particular items you need in stock. In most cases, the shipment will be made from the location nearest you (if stock is available). HRO is trying to provide the quickest shipments in the industry using these methods.

California customers can now order using a toll-free number. The number is 1-800-854-6046. It is no longer necessary for California customers to pay for the phone call.

Sales Tax

State and local laws require us to collect and remit State sales / use tax on orders shipped from any of our 12 locations INTO Arizona, California, Colorado, Georgia, or Virginia.

You will find that this small extra charge will be more than overcome by the convenience of the largest ham radio inventories in the United States. You will also find courteous and knowledgeable salespeople to assist you. We think you will find HRO to be the company you want backing you when it comes to dealing with any problems you might have with manufacturers or shipping companies.

Phone Orders

To place a phone order using a credit card, please have the following information available if you are a first-time caller or have not made a recent purchase from HRO. We will ask for your call sign (if any), credit card number, expiration date, your home telephone number, and possibly the name, address, and telephone number of the bank listed on your charge card statement.

Payment

We accept Visa, MasterCard, American Express, and Discover Card. Personal checks are also accepted; however, processing time will delay shipment by some 10 days. When using a credit card, please have the card in front of you since we will need all the information, including the name of the issuing bank. If the card holder's BILLING address differs from the shipping address, please be sure to specify both addresses and telephone numbers. For your protection, we thoroughly investigate the validity of all credit card purchases.

COD Orders

COD payments must be made in cashiers check or money order at the time of delivery. There is a small fee for COD shipments.

Commercial Sales Purchase Orders

Written purchase orders will be accepted from city, state, and federal agencies, and, with prior approval of credit, from commercial organizations. HRO quotes, in most cases, prices that require payment on receipt of merchandise. You may find a surcharge for credit terms applied to your pricing. Please indicate that you require terms when calling for price quotes.

Delivery

Free UPS Ground Transportation in the continental US on most items over \$100.

All Alaska and Hawaii shipments via UPS must be shipped by Blue Label (2nd Day Air) or Red Label (Overnight). Please ask for charges.

In a Hurry? If necessary to expedite shipments, UPS has Red Label (overnight), Blue Label (2nd-day) and Orange Label (3 day) services available at an extra cost. Please request charges for these services.

Foreign Deliveries We ship world-wide. Contact our stores, preferably by fax, with your needs. We can give you quotes and details for placing your foreign order. Payment methods include wire transfer direct to our bank as well as payment by VISA/ MC charge cards or check drawn in U.S. Funds from a U.S. Bank. Shipments are made (depending on size) by UPS, FED EX, Emery, DHL, or international air mail. Some orders to some foreign countries cannot be insured to the full value.

Truck Delivery On day of delivery, if by truck, please be sure to have enough help, and / or proper equipment on hand for unloading merchandise. Truck drivers are NOT required to provide assistance. If you are not experienced at handling large, awkward items such as towers, antennas or amplifiers, please ask properly trained people to assist you.

Canadian Orders can now be shipped via UPS. These costs will be added to your invoice.

Damaged Items

UPS If the item is obviously damaged, note this with the driver and refuse shipment. This item will be returned to HRO and another will be sent at no additional charge. If hidden damage is noted, contact UPS as soon as possible. They will arrange pickup. Once the item is received by HRO, a replacement will be sent.

TRUCK If there is damage or the shipment is short, it is the customer's responsibility to file the claim with the trucking company. At the time of receipt of item, it is recommended that you have the driver write "damaged" or indicate shortage on the bill of lading he gives to you. Be sure to have the same notation as well as drivers signature on his copy also.

MAIL It is the customer's responsibility to file all loss or damage claims with the postal department.

Prices

Many prices shown are suggested list price. In most cases we offer large discounts. Equipment manufacturers constantly change prices, offer specials or react to the Dollar / Yen exchange rates. Simply call one of our 800 numbers and our staff will be happy to quote you the current selling price of the item you are interested in. Prices are subject to change without notice or obligation to the customer. Sorry, we cannot honor typos in this catalog.

Software

Software is sold on a non-returnable basis. Any software problems will be resolved under the terms of the manufacturer's warranty.

Lost Items

When your order is delivered, please carefully count items and if anything is missing, notify HRO at once.

Occasionally, cartons shipped at the same time will arrive at their destination two or three days apart.

If you notify HRO within 10 days, we will replace lost or damaged items after completion of proper documentation and acceptance by the shipping agency.

New Equipment Returns

Products are not sold for evaluation. Under some circumstances (at the discretion of HRO) and with prior approval of the store of purchase, HRO will accept an item for return. Under most circumstances a 15% restocking fee and all freight charges will be assessed.

Your means of refund for returns will be the same as that used for your original payment except for cash, which will be refunded by check. HRO will pay from its corporate offices. It can take up to two weeks.

Defective merchandise may be returned within 10 days of the original purchase for exchange. Original receipt must accompany the return. Items returned for warranty replacement consideration must also include a completed, signed, "Warranty Replacement Certification Form." Customers who return equipment for replacement consideration without this form completed and signed cannot be considered for any possible warranty replacement, only warranty repair. No exceptions. Contact your salesman for details.

Manufacturer's New Equipment Warranties

Ham Radio Outlet supports all manufacturers' warranties. Actual warranty terms are included within the shipping container of most items. If needed, you may request from any of our locations a free copy of the manufacturer's written terms for any warranted product. Please request by model number and indicate the page in this catalog that represents the product.

Ham Radio Outlet will in many cases provide in-store repairs; please contact the store of purchase for information. It will be necessary to provide us with the invoice number and purchase date, as most manufacturers need this information to process under their FREE warranty repair terms.

New Equipment Warranty Returns

When returning equipment for repair, please pack the item in original packing material or something similar to provide adequate protection during the shipping process. Note on box: "ATTENTION SERVICE." Include a copy of your purchase invoice, and a complete and detailed description of the problems. Without the invoice or a complete description, delays will be experienced in providing the proper service and returning the item to you. Be sure to insure the package for its replacement cost.

HRO will repair or replace the defective item at our option. If the item is found to be defective under the terms of the manufacturer's warranty, no charge will be made for service or return shipping within continental USA. It is the customer's responsibility to ship all defective items to the service center for warranty repair.

Problems

HRO prides itself in its ability to service the customer. If there is a problem please contact the manager of the store from which you purchased the merchandise. If for some reason, your problem cannot be corrected by that store manager, please feel free to call Ham Radio Outlet Corporate Headquarters at (925) 831-1771 and explain the situation. At this point our national sales staff will see that your problem is corrected.

Thank You for choosing



The World's Largest Ham Outlet

Prices in this print catalog are subject to change

Serving You From Coast to Coast and Around the World

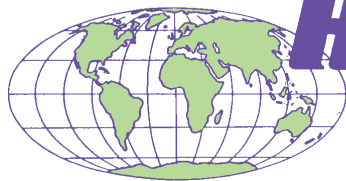

HAM RADIO OUTLET

Western
Canada & US

1-800-854-6046

Eastern
Canada & US

1-800-444-0047

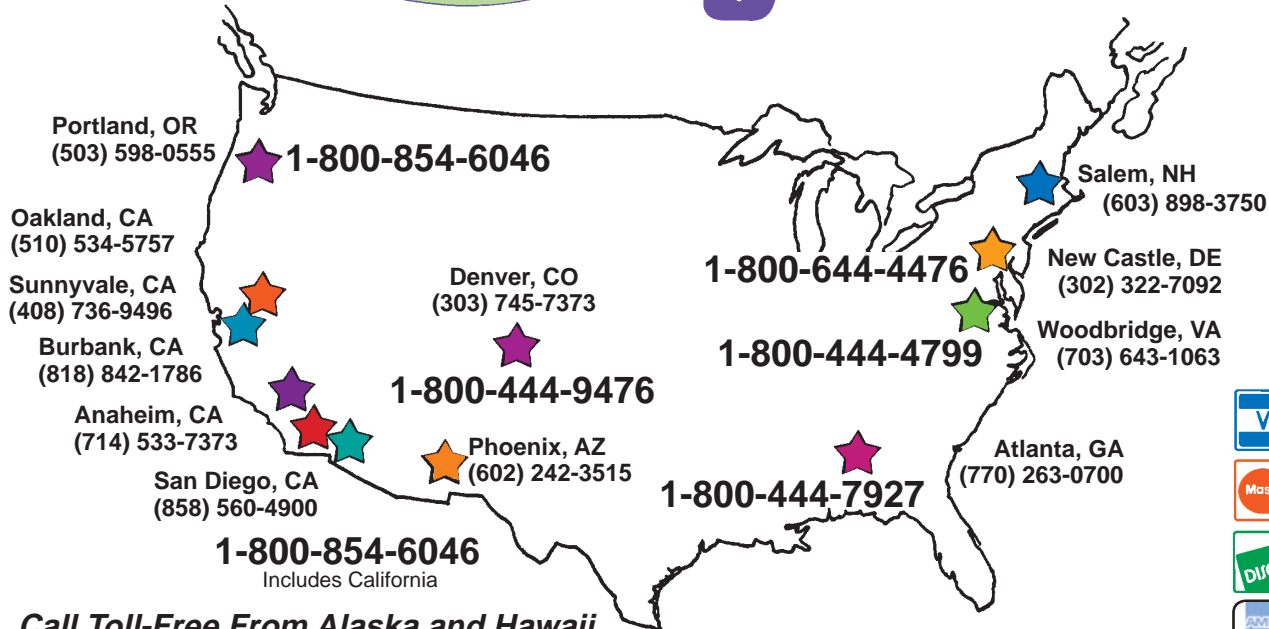

Order Toll-Free From a Location Near You

If your closest 800 number is busy, please call one of our other numbers.

Phone Hours: 9:30 AM to 5:30 PM Monday - Saturday

Secure 24-Hour Ordering: <http://www.hamradio.com>

24-Hour FAX Order Lines: At All 12 Locations

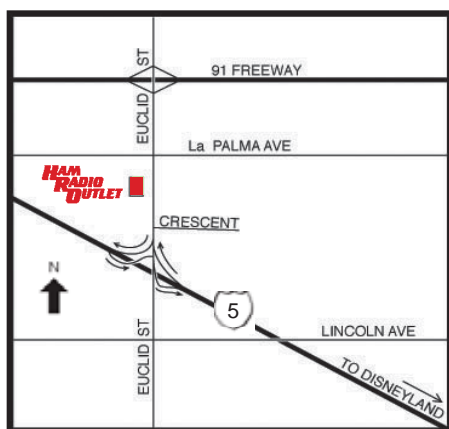

ANAHEIM, CA 92801
 933 N. Euclid St.
 Near Disneyland
 (714) 533-7373
 (800) 854-6046
 24 Hour FAX (714) 533-9485
 Email: anaheim@hamradio.com

Janet KL7MF Mgr
 Bill W1HJ
 Ted KB6CUS
 Steve K6CZA
 Phil AD6NH
 Art K6MIV Denis K9ADB
 Heiko AD6OI



ATLANTA, GA 30340
 6071 Buford Hwy.
 Doraville, 1 mi. north of I-285
 (770) 263-0700
 (800) 444-7927
 24 Hour FAX (770) 263-9548
 Email: atlanta@hamradio.com

Mark KJ4VO Mgr
 David KE4VDH
 Dale W4GCL
 Bill K8WF, Denise
 Josh W4JDH, Jim N1ABM
 John K14LMA, Bill W5ROR
 Michael K8YOY
 Zach K14CJF

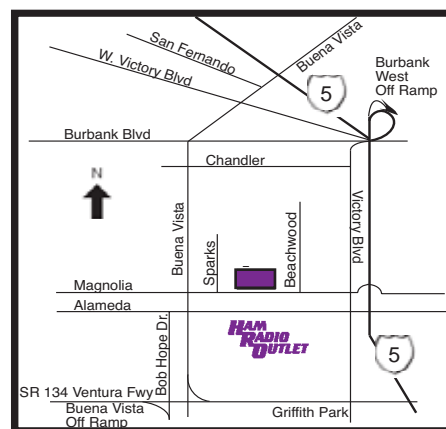

BURBANK, CA 91506
 1525 W. Magnolia
 (818) 842-1786
 (800) 854-6046
 24 Hour FAX (818) 842-5283
 Email: burbank@hamradio.com

Eric K6EJC Mgr
 Christie KØIU
 Rick K6VE
 Mark KC6HMO
 Sud AC6VP
 Tom K6WAC

Prices in this print catalog are subject to change

All Stores Open 10am - 5:30pm Monday - Saturday

STORE LOCATIONS



DENVER, CO 80231
 8400 E. ILIFF Ave. #9
 (303) 745-7373
 (800) 444-9476
 24 Hour FAX (303) 745-7394
 Email: denver@hamradio.com

John N5EHP Mgr
 Russ KA0ULN
 Kent K0TKM
 Mike KC0SM

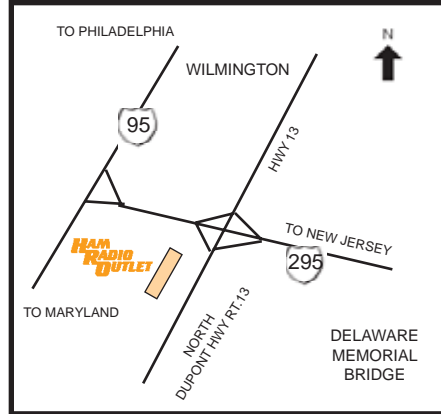

NEW CASTLE, DE 19720
 1509 North Dupont Hwy, US13
 Parkway Plaza #7
 (302) 322-7092
 (800) 644-4476
 24 Hour Fax (302) 322-8808
 Email: newcastle@hamradio.com

Rick K3TL Mgr
 Jim KJ3N
 Bob N9GG
 Andrew N3NZS
 Joe K13B
 Joe K3JV
 Dale KB3FEI



OAKLAND, CA 94606
 2210 Livingston St.
 I-880 at 23rd Ave. Ramp
 (510) 534-5757
 (800) 854-6046
 24 Hour FAX (510) 534-0729
 Email: oakland@hamradio.com

Mark W17YN Mgr
 Don W6ER
 Bob K6KF
 Vern K6VXY
 David AD6ME
 Dave N6SWE
 Rick N6DQU
 Rob K6GSKA

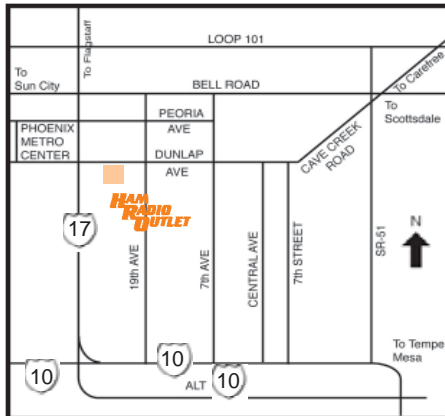

PHOENIX, AZ 85021
 1939 W Dunlap #102
 (602) 242-3515
 (800) 444-9476
 24 Hour FAX (602) 395-1244
 Email: phoenix@hamradio.com

Gary N7GJ Mgr
 Kathy N7AQM
 Mike K7DD
 Rick N7VAB
 Steve W7QY
 Paul KD6TAQ
 Morgan WW7B
 Jim KE7EEU Ralph W7JU

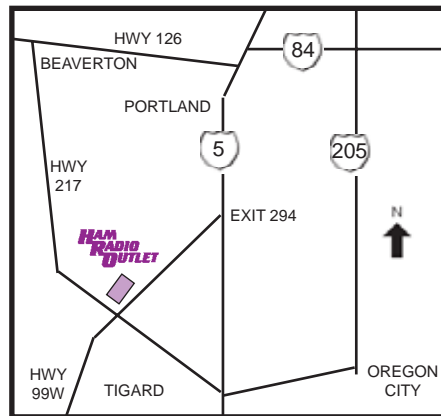

PORTLAND, OR 97223
 11705 S.W. Pacific Hwy (99W)
 Suite Z
 (503) 598-0555
 (800) 854-6046
 24 Hour FAX (503) 684-0469
 Email: portland@hamradio.com

Leon W7AD Mgr
 Dan N7UDE
 Ron W7ATX
 Pat K7PWN
 Phil W7AR
 Roy W6II
 Martin W7MSO

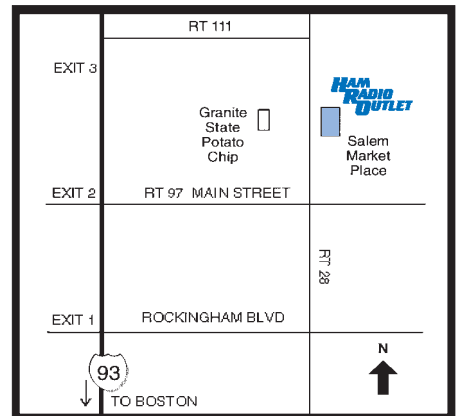

SALEM, NH 03079
 224 N. Broadway D-12
 28 mi. N of Boston, Exit 2, I-93
 (603) 898-3750
 (800) 444-0047
 24 Hour FAX (603) 898-1041
 Email: salem@hamradio.com

Chuck N1UC Mgr
 Nick K1JYA, Bob N1EUN
 Barry N1DNU
 Peter K11M, Larry W1MWW
 Cal WA1WOK, Dave N1EDU
 Steve W1FSK
 Greg K1GTS, Dave N1IX
 Jim W1KQ, Valdo

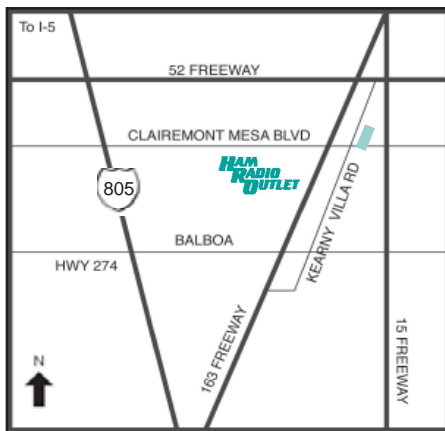

SAN DIEGO, CA 92123
 5375 Kearny Villa Rd. #113
 Hwy. 163 & Clairemont Mesa Blvd.
 (858) 560-4900
 (800) 854-6046
 24 Hour FAX (858) 560-1705
 Email: sandiego@hamradio.com

Tom KM6K Mgr
 Jose XE2SJB
 Jerry N5MCJ
 Art KG6NIZ

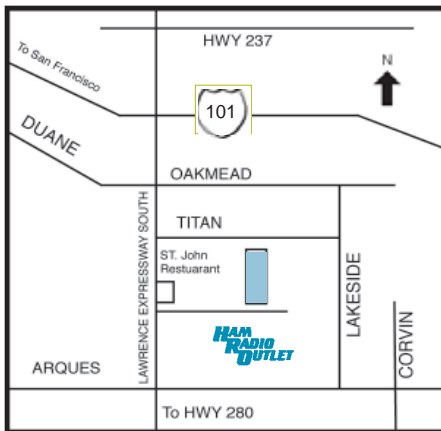

SUNNYVALE, CA 94085
 510 Lawrence Expwy, #102
 (408) 736-9496
 (800) 854-6046
 24 Hour FAX (408) 736-9499
 Email: sunnyvale@hamradio.com

Dan K6DN Mgr
 Rob W6KR
 George K6SV
 Paul W6EQB
 Wil AC6DC, Don N6MCE
 Howard W6HOC
 Ken KG6PO
 Jon K6WV

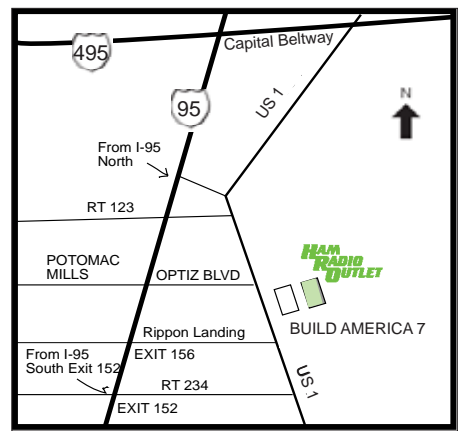

WOODBIDGE, VA 22191
 14803 Build America Drive Bldg B
 Exit 161, I-95 South to US 1
 (703) 643-1063
 (800) 444-4799
 24 Hour FAX (703) 494-3679
 Email: woodbridge@hamradio.com

Steve W4SHG Mgr
 Rocky N4SR
 Scott KT4ER
 Joe N4JCS
 Bill K9ZD
 Mary K14KPN
 Mike N4MDK
 Camden N2CLB

INDEX

MANUFACTURERS

Alinco.....	3-5, 72
Alpha Delta.....	37, 41, 93
Ameritron.....	76, 78
Andrew.....	84
Antenna Specialists.....	105
Antenna Supermarket.....	41
AOR.....	38
ARRL Products.....	48-49
Artsci.....	47
Astron.....	72
Austin Antennas.....	105
AvMap.....	43
Benchner.....	33, 36, 91
Belden.....	85
Better RF.....	34
Buckmaster.....	50
Butel.....	45
Butternut.....	91
Cal-Av Labs.....	85
Cable Xperts.....	84
Callbook.....	50
Coax-Seal.....	84
Cobra Antennas.....	91
Comet.....	98-99
Communication Specialists.....	81
Create.....	41
CSI (Connect Systems).....	34
CSS (Creative Services Software).....	35
Cushcraft.....	95
Daiwa.....	37, 71-73
Deka.....	75
Diamond.....	41, 71-72, 102-104
Digital Communications.....	36
ECG.....	71
Elk Antennas.....	92
Emergen-see.....	87
E Z Hang.....	87
Force 12.....	93
Gap Antenna.....	92
Garmin.....	42-43
Geochron.....	50
Gordon West School / W5YI.....	46
GRE.....	44
Grundig / Eton.....	40-41
Ham Sticks.....	107
Heil Sound.....	28-30
High Sierra.....	94
Hustler.....	96-97
HyGain.....	79, 87
Icom.....	6-14, 38, 42, 72-73, 76, 87
INET Labs.....	34
Ironworks.....	85
JRC.....	44
Kantronics.....	35
Kent.....	33
K-Com.....	36
Kenwood.....	15-18, 72-73
Kill-a-Watt.....	73
Larsen.....	100-101, 105
LDG Electronics.....	88-89
Lido.....	27
LiteFlare.....	87
Logikey.....	33
M ²	86, 93-94
Maha.....	74
Malddol.....	106
MFJ.....	78-79
Mirage.....	76
NCG.....	92
Nifty Mini-Manuals.....	47
Niijon Antennas.....	106
Outbacker.....	107
Palstar.....	82
Peet Brothers.....	114
PolyPhaser.....	37
PortaGrip.....	27
Pouch, The.....	46

PowerWerx.com.....	83
Pryme Radio Products.....	31, 105
QRZ!.....	50
Radiowavz Antennas.....	92
Rip-Tie.....	84
R T Systems.....	81
Samlex America.....	72-73
Sangean.....	39
Saratoga.....	81
Scannerstuff.....	47
SGC.....	36, 76, 90
Sony.....	39, 41
Spot.....	44
SunWize.....	75
SuperAntennas.....	94
Synthetic Textiles.....	87
Times Cable.....	85
Timewave Technology.....	36, 71, 81
Tokyo Hy-Power.....	73, 76-77, 88
Uniden.....	45
US Tower.....	108-113
Valor.....	105-106
Van Gorden.....	93
Ventenna.....	94
Vibroplex.....	32-33
Weller.....	71
West Mountain Radio.....	75, 80
Yaesu.....	19-26, 38, 42, 72-73, 76, 86, 93, 105, 107

PRODUCTS

Amplifiers.....	8-9, 22, 76-78, 90
Antenna Tuners.....	3, 8-9, 16, 78, 82, 87-90
Antennas	
GPS.....	43
Handheld.....	98, 104-105
HF.....	8, 79, 91-96, 102, 106-107
HF Mobile.....	90, 96, 99, 104, 106-107
On Glass.....	101, 105-106
SWL/ Scanner.....	41, 101, 104
VHF / UHF.....	92-96, 98, 102
VHF / UHF Mobile.....	24, 79, 96-98, 101-106
Baluns / Insulators.....	82, 85, 92-93
Batteries.....	4, 11, 13, 18, 26, 74-75
Books, CDs, Magazines.....	39, 46-50
Cables	
Cloning.....	14, 18, 26, 43
Coax.....	24, 80, 84-85, 99
Packet / Data.....	17, 43
Power.....	4-5, 13-14, 16-18, 43
Rotator.....	85
Cases, Radio.....	4, 13-14, 26, 46
Chargers.....	4, 11, 14, 18, 26, 74-75
Clocks.....	50
Computer Interface.....	8, 22
Computer Software	
Cloning.....	9, 14, 22
Databases.....	43, 48-50
Packet.....	35
Radio Control.....	8, 43, 45, 80-81
Study aids.....	46, 49
World time.....	50
Connectors / Adapters.....	4, 11, 14, 17, 24, 26, 30, 80, 83-85, 97, 99, 104
Digital voice modulator.....	3-5, 38
Dummy Loads.....	78, 82, 104
Duplexers.....	99, 103, 105
Email.....	sales@hamradio.com
Encoders / Decoders.....	4-5, 8, 17-18, 81
Filters	
Band / High / Low Pass.....	8-9, 16, 36
Noise.....	8, 17, 23, 36
Telephone.....	36
Global Positioning Systems.....	42-44
Headsets / Earphones.....	4, 13-14, 16, 18, 24, 26, 30-31
Internet.....	http://www.hamradio.com
Keys / Keyers.....	32-33, 79
Lightning / Surge Protectors.....	37, 78, 104



Serving You From Coast to Coast
& Around the World

Order Toll-Free
From a Location Near You

Western U.S. / Canada
800-854-6046

Mountain / Central
800-444-9476

Southeast / Central
800-444-7927

Mid-Atlantic / Central
800-444-4799

Northeast 800-644-4476

New England / Eastern Canada
800-444-0047

If Your Closest 800 Number Is Busy,
Please Call One of our Other Numbers.

24-Hour FAX Order Lines:
See pages 31 or 120 and 121

Maps.....	49
Masts / Tripod Mounts.....	85, 91, 94, 97, 107
Meters / Analyzers.....	71, 78-80, 82-83, 89
Microphones (see also Headsets)	
Desk.....	4, 8, 13, 16-17, 22, 26, 28-29, 31
Hand / lapel.....	4, 8, 16-18, 24, 26, 28, 31
Mounts / Brackets	
Equipment.....	27, 29, 43
Mobile Antennas.....	97, 99-100, 103-104, 106
Mobile Radios.....	4-5, 8, 13, 16-17, 24
Morse Code Practice.....	46, 79
Outlet Strips / Power Panels.....	29, 79-81, 83
Owl.....	94
Packet Controllers / TNC Units.....	5, 17, 35, 80
Phone Patches.....	34
Power Supplies.....	3, 8, 16, 22, 72-73, 79
Preamps.....	8
Radios, Amateur	
Base.....	6-7, 9, 15, 19-21, 44
Handheld.....	3, 12, 18, 24-25
Mobile.....	5, 7, 10-11, 15-17, 19-20, 23-24
Radios, Aviation Nav / Com.....	42
Radios, Family / GMRS.....	13
Rope.....	87
Rotators.....	79, 86-87
Scanners	
Antennas.....	41, 101, 104
Books / Software.....	45, 47
Radios.....	44-45
Short Wave Listening	
Antennas.....	41, 82, 104
Books.....	39
Receivers.....	5, 14, 21, 38-41, 82
Solar Power Systems.....	75
Soldering Equipment.....	71
Speakers.....	4, 8, 13, 16-18, 24, 26, 75, 79, 82
Store Locations.....	116-117
Study Aids.....	46, 49
Switches, Antenna.....	37, 78, 88, 90, 104
Towers.....	108-113
Voice synthesizer.....	8, 16-17, 34
Weather Stations.....	114
Wire.....	83
Worldwide Web	http://www.hamradio.com