

CATCM1001



2010-2011



 **FEDERAL  
MOGUL**



 [www.fmecat.eu](http://www.fmecat.eu)

# Leading the field in Small Engine Spark Plug Technology

## SOLID CONNECTION AGAINST VIBRATION

## PATENTED RESISTOR

Protects television and radio reception.

## HEAT DISSIPATING ELECTRODES

for maximum durability.  
Superior erosion resistance  
for longer life.

## NEAR DIAMOND HARD INSULATOR

Patented zirconia toughened alumina insulator for increased strength.

## TRIPLE COATED SHELL

Zinc plating plus two anti-seize coatings provide maximum corrosion resistance and easy plug removal.

## PRECISION ROLLED THREADS

Conform to all I.S.O. and S.A.E. standards.



## Champion fitted as Original Equipment by Briggs & Stratton, Tecumseh, Kohler, Poulan and Onan.

When you are choosing a spark plug, only one thing really matters. Will it perform like the original? Each plug in Champion's small engine spark plug range is designed to give identical or equivalent performance to the spark plug fitted by the engine manufacturers.

Whatever the application, from lawnmower to chainsaw, Champion small engine spark plugs are designed for easy starting, maximum durability and unbeatable performance. It's no wonder that many small engine manufacturers choose Champion spark plugs.



# On small engines, no-one's bigger

From gardens to forests,  
Champion performs



Champion is a major OE force in spark plugs for small engines, creating specialist ignition technology capable of performing non-stop for long periods without fault.



# Terms of Business

## GB - IMPORTANT

Reproduction of this catalogue or parts thereof is only allowed with our explicit permission in writing. Pictorial representations and design are copyrighted. Claims for damages, of any form whatsoever, resulting from details made in this catalogue or from incorrect use, application, storage or handling, are explicitly excluded. Contractual rights and any resulting or related claims based thereon, irrespective of form, initially come into being on the basis of a separate written agreement, in particular on the basis of our general terms of sale and delivery.

All former statements lose their validity with the publication of this catalogue.

The catalogue is not an operating manual for the use and installation of the spark plugs. It does not contain any advice in a legal sense. The catalogue neither replaces the constantly applicable technical regulations - particularly for tolerances - nor the installation and maintenance stipulations of the individual original equipment manufacturer.

Also, it is not possible to forego the expertise of those carrying out the installation and application. The individual references made in this catalogue for the installation and the application of the spark plugs are instructions solely for the technically qualified specialist and are to be checked and verified by them for their suitability in each case. Federal-Mogul accepts no responsibility for application decisions.

The contents of the catalogue are not intended to create or substitute any contractual agreement which has to be reserved exclusively to a separate agreement between 2 identified parties, whereby seller can be only one of our Federal-Mogul entities as mentioned on the back cover page.

The right is retained to correct errors and alterations, particularly with regard to amendments in the original equipment manufacturer's details and stipulations.

## F - IMPORTANT

La reproduction de ce catalogue, même partielle, n'est autorisée qu'avec notre accord préalable et par écrit. Les illustrations graphiques et la présentation font l'objet d'un copyright. Nous excluons toutes réclamations ayant pour objet ce catalogue ou pouvant résulter de son incompréhension, portant sur de mauvaises utilisations, manipulations, manutentions ou mauvais stockage. Des droits contractuels et des droits dérivés, de quelque nature qu'ils soient, ne peuvent résulter que d'un accord écrit, sur la base de nos conditions générales de ventes et de livraisons.

Ce catalogue annule et remplace toute édition antérieure.

Le catalogue n'est pas une notice d'utilisation et de montage des bougies d'allumage. Il ne contient pas de directives en tant que telles. Le catalogue ne remplace ni les prescriptions techniques, toujours prioritaires, particulièrement pour les tolérances, ni les prescriptions de montage et d'entretien des fabricants d'origine.

Il ne peut en aucun cas remplacer les connaissances professionnelles nécessaires pour le montage et l'utilisation des produits. Les remarques données pour le montage et l'utilisation des bougies d'allumage sont exclusivement destinées au professionnel averti et de formation technique, à qui il appartiendra de vérifier la conformité des indications pour chaque cas. La responsabilité quant aux décisions d'utilisation ne peut être prise en charge par Federal-Mogul.

Le contenu de ce catalogue ne peut constituer ou remplacer un contrat qui doit faire l'objet d'un document séparé établi entre 2 parties, dont l'une doit être une entité légale de Federal-Mogul (dont la liste figure sur la couverture arrière).

Nous nous réservons le droit d'apporter toutes corrections d'erreurs et modifications, suite notamment à de nouvelles données fournies par les fabricants.

## D - WICHTIGE HINWEISE

Nachdruck, auch auszugsweise, ist nur mit unserer ausdrücklichen schriftlichen Zustimmung gestattet. Die bildlichen Darstellungen und Ausstattungen sind geschützt. Ersatzansprüche, gleich welcher Art, aufgrund der Angaben in diesem Katalog oder auf Grund unsachgemäßem Umgang, unsachgemäßer Verwendung, Lagerung oder Handhabung der angebotenen Produkte, sind ausdrücklich ausgeschlossen. Vertragliche Ansprüche und daraus abgeleitete oder darauf beruhende Ansprüche, gleich welcher Art, kommen erst auf Grund einer besonderen schriftlichen Vereinbarung, insbesondere auf der Grundlage unserer allgemeinen Verkaufs- und Lieferbedingungen, zustande.

Der Katalog ist keine Einbauanleitung für Zündkerzen. Er enthält keine Beratung im Rechtssinne. Der Katalog ersetzt weder die immer vorrangigen technischen Vorschriften, insbesondere für Toleranzen, sowie die Einbau- und Wartungsvorschriften des jeweiligen Motorenherstellers, noch kann auf das notwendige Fachwissen des die Montage und die Verwendung Durchführenden verzichtet werden.

Die in diesem Katalog jeweils gegebenen Hinweise für Einbau und Verwendung der Zündkerzen sind Hinweise ausschließlich für den technisch ausgebildeten und versierten Fachmann, die von ihm im jeweiligen Anwendungsfall auf ihre Eignung geprüft und entschieden werden müssen. Eine Haftung wird von Federal-Mogul für Anwendungsentscheidungen nicht übernommen. Die Inhalte dieses Katalogs sind nicht dazu bestimmt eine vertragliche Verpflichtung zu begründen oder zu ersetzen, was ausschliesslich einer gesonderten Vereinbarung zwischen zwei konkret bezeichneten Parteien vorbehalten bleibt, wobei der Verkäufer eine unserer Federal-Mogul Gesellschaften sein wird, wie auf der Rückseite des Kataloges angegeben.

Die Korrektur von Irrtümern und Änderungen, insbesondere auf Grund von geänderten Angaben und Vorschriften der Motorenhersteller, bleibt vorbehalten.

## E - IMPORTANTE

Queda totalmente prohibida la reproducción, total o parcial, del contenido de este catálogo, salvo con nuestra previa autorización por escrito. Están, asimismo, reservados todos los derechos sobre el diseño y representación pictórica del catálogo. No se aceptará ningún tipo de reclamación fundamentada en la interpretación de los datos contenidos en este catálogo, así como en el incorrecto uso, manipulación o almacenaje de nuestras piezas. Únicamente se aceptarán reclamaciones que estén basadas en derechos contractuales o en los motivos arriba indicados siempre que exista un acuerdo especial y por escrito, con base en nuestras condiciones generales de venta y suministro.

Con la edición de este catálogo queda anulada toda la información contenida en publicaciones anteriores. El catálogo no es un manual para el uso e instalación de las escobillas limpiaparabrisas, y no representa una asesoría técnica en el sentido legal. Los datos del catálogo no sustituyen, en ningún caso, a las especificaciones técnicas, tanto en lo que se refiere a tolerancias como a las instrucciones de instalación y mantenimiento indicadas por los fabricantes de vehículos, especificaciones que serán siempre prioritarias.

Las indicaciones sobre uso y montaje de las escobillas limpiaparabrisas contenidas en este catálogo están exclusivamente dirigidas a profesionales con la debida cualificación y formación técnica, que deben decidir en cada caso sobre la exactitud de las mismas. La responsabilidad de estas decisiones no puede ser, en ningún caso, atribuida a Federal-Mogul.

La información facilitada en el catálogo no representa o sustituye ningún tipo de acuerdo, quedando a tal efecto el acuerdo por separado entre dos partes identificadas, donde la parte vendedora sólo puede ser una de las entidades de Federal-Mogul mencionadas en la contraportada del catálogo.

Los datos e instrucciones contenidos en este catálogo podrán ser corregidos o modificados sin previo aviso.

## IT - IMPORTANTE

La riproduzione di questo catalogo, anche parziale, è permessa soltanto in seguito ad una autorizzazione scritta. I grafici ed i disegni sono depositati. Reclami per difetti, di qualsiasi natura essi siano, relativi al contenuto di questo catalogo, o all'uso improprio di esso, verranno respinti. Le pretese avanzate od i reclami dovranno essere in conformità con le nostre condizioni generali di vendita. Il presente catalogo annulla e sostituisce tutte le edizioni precedenti.

Il catalogo non è un manuale per l'utilizzo ed il montaggio delle spazzole, non contiene indicazioni in questo senso e non sostituisce le descrizioni tecniche, che comunque sono sempre prioritarie, in particolare per le tolleranze, né le istruzioni relative al montaggio ed alla manutenzione date dai costruttori.

Non può in nessun caso essere paragonato alla conoscenza professionale necessaria per il montaggio e l'utilizzo. Le considerazioni sul montaggio delle spazzole, presenti su questo catalogo, sono destinate esclusivamente a professionisti con formazione tecnica i quali dovranno in ogni caso verificare l'esattezza della informazioni. Le responsabilità derivanti dall'utilizzo improprio dello stesso non potranno essere imputate a Federal-Mogul.

I contenuti del catalogo non sostituiscono in alcun modo gli accordi contrattuali che sono riservati esclusivamente a due contraenti definiti; come venditore si intende una delle società Federal-Mogul menzionate sul retro del catalogo.

Ci riserviamo di apportare correzioni e modifiche, relative, in particolare, a dati o istruzioni ricevute dal costruttore.



## RU - ВАЖНО

Воспроизводство этого каталога или ее частей возможно только с разрешением компании Federal-Mogul в письменной форме. Иллюстрированные представления и дизайн защищены авторским правом.

Требования о возмещении ущерба, любой формы, исходя из деталей в этом каталоге или от неправильного использования, хранения или обращения, явно исключены. Договорные права и любые связанные требования базировались вслед за тем, независимо от формы, отдельного первоначально письменного соглашения, в особенности на основе наших общих условий продаж и поставок.

Все прежние утверждения теряют свою юридическую силу с публикацией данного каталога.

Каталог не операционное руководство для использования и установки свечей зажигания. Оно не содержит совета в юридическом смысле. Каталог не заменяет постоянно применимые технические инструкции, соглашения установки и обслуживания отдельного производителя. Кроме того, не возможно предсказать профессионализм тех, кто выполняют установку и ремонт на тот или иной автомобиль.

Отдельные ссылки, сделанные в этом каталоге для установки и замены свечей зажигания, являются инструкциями исключительно для технически компетентного специалиста и должны быть проверены ими для их пригодности в каждом случае. Federal-Mogul не несет ответственность за ремонтные работы.

Содержание каталога не предназначено, чтобы создавать или заменять любые договорные соглашения, которое должны быть сохранены исключительно от отдельному соглашению между 2мя сторонами, посредством чего продавец может быть только одним из юридических лиц и компании Federal-Mogul как упомянуто на задней обложки с другой стороны.

Сохраняется право, исправлять ошибки и изменения, относительно к поправкам производителя и их условиям.

## PL - WAŻNE

Powielanie tego katalogu lub jakiegokolwiek jego części jest dopuszczalne wyłącznie po uzyskaniu naszej jednoznacznej pisemnej zgody. Prezentacje graficzne i projekt są chronione prawami autorskimi. Jednocześnie wykluczone są roszczenia odnośnie wszelkiego rodzaju szkód wynikających z informacji zawartych w tym katalogu, a także z nieprawidłowego użycia, zastosowania, magazynowania lub przechowywania. Wszelkie uprawnienia kontraktowe, a także wszelkie inne oparte na nich roszczenia, niezależnie od ich formy, wymagają do swej ważności osobnego pisemnego porozumienia sporządzonego w oparciu o nasze ogólne warunki sprzedaży i dostawy.

Wszelkie wcześniejsze oświadczenia tracą ważność wraz z publikacją niniejszego katalogu.

Niniejszy katalog nie jest podręcznikiem obsługi, opisującym sposób użytkowania i montażu świec iskrowych. Nie zawiera on żadnych porad o charakterze prawnym. Niniejszy katalog nie zastępuje także aktualnie obowiązujących norm technologicznych – w szczególności dotyczących tolerancji – ani wskazówek poszczególnych producentów pojazdów odnośnie montażu i konserwacji.

Nie może także zastępować specjalistycznego doświadczenia w zakresie montażu i zastosowań. Wszelkie podane w tym katalogu informacje odnośnie montażu i zastosowania świec iskrowych są przeznaczone wyłącznie dla specjalistów o odpowiednich kwalifikacjach technicznych i muszą być zawsze sprawdzane oraz weryfikowane pod kątem ich odpowiedniości do konkretnego przypadku. Firma Federal-Mogul nie ponosi odpowiedzialności za decyzje odnośnie konkretnych zastosowań.

Treść niniejszego katalogu nie może stanowić ani zastępować porozumienia, które musi przyjmować formę osobnej umowy pomiędzy dwoma ściśle określonymi stronami, w której jako Sprzedawca może występować wyłącznie jeden z podmiotów Federal-Mogul (zob. wykaz na tylnej okładce).

Zastrzegamy sobie prawo do wprowadzania poprawek i zmian, a w szczególności do modyfikacji danych wprowadzanych przez producentów pojazdów.

## CZ - DŮLEŽITÉ

Jakákoliv reprodukce tohoto katalogu nebo jeho části je přípustná jen s naším výslovným písemným povolením. Ilustrace a design jsou chráněny autorským právem. Výslovně se vylučují jakékoliv nároky na odškodnění jakéhokoliv druhu v souvislosti s detaily uvedenými v tomto katalogu nebo s nesprávným použitím, aplikací, skladováním nebo manipulací. Smluvní práva a jakékoliv vyplývající nebo související nároky, bez ohledu na jejich formu, primárně vycházejí ze samostatné písemné dohody, zejména z našich všeobecných prodejních a dodacích podmínek.

S publikací tohoto katalogu ztrácí platnost veškerá předchozí prohlášení.

Katalog není provozním návodem k použití a instalaci zapalovacích svíček. Neobsahuje žádné rady v zákonném slova smyslu. Katalog ani nenahrazuje trvale platné technické předpisy – zejména tolerance – ani podmínky instalace či údržby stanovené jednotlivými výrobci vozidel.

Dále je nutno zajistit kvalifikovanost osob provádějících instalaci a použití výrobku. Jednotlivé odkazy obsažené v tomto katalogu ve vztahu k instalaci a použití zapalovacích svíček jsou pokyny určené výhradně pro technicky kvalifikované specialisty, kteří jsou v každém případě povinni zkontrolovat a ověřit jejich vhodnost. Společnost Federal-Mogul nepřijímá žádnou odpovědnost za rozhodnutí o aplikaci (použití).

Obsah katalogu není určen k vytvoření nebo nahrazení jakékoliv smluvní dohody, které je nutno realizovat výlučně na základě samostatné smlouvy mezi 2 identifikovanými stranami, přičemž prodávající může být pouze jeden z našich subjektů Federal-Mogul uvedených na vnitřní straně obálky katalogu.

Ponecháváme si právo na opravu chyb a provádění změn, zvláště ve vztahu ke změnám detailů a podmínek výroby vozidel.

## HU - FONTOS

Ennek a katalógusnak vagy részének a sokszorosítása csak kifejezett írásos engedéllyel megengedett. A képi illusztrációkat és a formai kialakítást szerzői jog védi. Az ebben a katalógusban foglaltakkal kapcsolatos, illetve nem megfelelő használatból, alkalmazásból, tárolásból vagy kezeléssel eredően nem támasztható kárigeny. A szerződéses jogok, illetve az ezen alapuló vagy ebből eredő követelések jellegüktől függetlenül egy külön írásos szerződés keretén belül lépnek hatályra, különös tekintettel az általános értékesítési és szolgáltatási feltételeink szerint. Minden korábbi megállapodás elveszíti az érvényességét a katalógus kiadását követően.

Ez a katalógus nem egy, a dugattyúk, betétek és alkatrészek használatára és beszerelésére vonatkozó kézikönyv. Jogi értelemben nem tartalmaz semmilyen tanácsot. A katalógus nem helyettesíti a mindenkor érvényben lévő műszaki előírásokat (különösen a tűréseket nem), illetve az egyes motorgyártók beszerelési és karbantartási utasításait.

Ezen felül nem helyettesíti a beszerelést és alkalmazást végzők tapasztalatát. Az ebben a katalógusban lévő, a dugattyúk, betétek és alkatrészek beszerelésére és alkalmazására vonatkozó egyes hivatkozások kizárólag műszakilag képzett szakembereknek szólnak, és megfelelőségüket az egyes esetekben nekik kell ellenőrizniük. A Federal-Mogul nem vállal felelősséget az alkalmazással kapcsolatos döntésekért.

Ennek a katalógusnak a tartalma nem hoz létre vagy helyettesít egy olyan szerződéses megállapodást, amelyet kizárólag két külön fél között kívántak létrehozni, ahol az eladó valamelyik, a belső hátsó borítón említett Federal-Mogul jogi személy.

Fenntartjuk a jogot a hibák kijavítására és a módosításokra, különös tekintettel a motorgyártó részleteinek és a kikötéseinek részleteivel kapcsolatban.

# Agricultural Filters



L139



L140

## These brands rely on Champion's filters too

### L139

Auwaerter, Bautz, Benati, Bks, Buehrer, Bukh, Bungartz, Carraro, Claas, Demag, Dodich, Eicher, Fendt, Gottwald, Hanomag, Henschel, International Harvester, Iveco, John Deere, Kaelble, Kassbohrer, K.H.D., Kodel & Bohm, Kramer, Lanz, Liebherr, M.A.N., Massey-Ferguson, Mercedes, NISSAN Motor Iberica, Orenstein & Koppell, Perkins, PORSCHÉ, RENAULT, Schanzlin, Schluter, Seddon-Atkinson, Sonnebogen, Sperry New Holland, Steinbock, Steyr-Daimler-Puch, Ursus, Valmet, Van Hool, volvo, Weller, Zetor, Zettelmeyer.

### L140

Abg, Akermann, Ansaldo, Astra, Atlas Copco, Auwaerter, Bauer, Bauscher, Bks, Bolinder, Buessing, Bukh, Claas, Clark Scheid, Coles, Demag, Eicher, Faun, Gmeinder, Gottwald, Hanomag-Henschel, Hitachi, Hurlimann, Hydromac, International Harvester, Irion, Irmer & Helze, Iveco, Kaelble, Kassbohrer, K.H.D., Kodel & Bohm, Krupp, Liebherr, M.A.N., Massey-Ferguson, M.W.M., Orenstein & Koppel, Poclair, RENAULT, Saurer-Werke, Scania, Schluter, Schopf, Steyr-Daimler-Puch, Valmet, Van Hool, Winget, Zetor, Zettelmeyer.



## Supplier to

Bombardier | Johnson Evinrude | Mercruiser  
Mercury | Rolls Royce | Volvo Penta



When you are choosing a spark plug, only one thing really matters. It should perform like the original. With our outstanding technical design and performance, many marine engine manufacturers choose Champion spark plugs. Each Champion marine engine spark plug is developed to offer Original Equipment performance for your engine, whatever the application.





















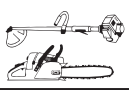
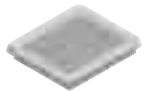

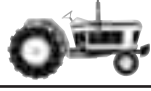



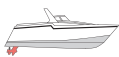
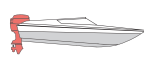





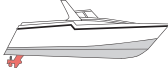

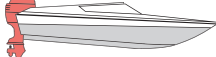









**Rely on Original Equipment quality. Rely on Champion.**









  	i
OE#   /   OE#	xvii
   	1
<b>AG01</b> 	215
 	217
 	227
       	277
 	278
 	299
 	327
 	333
   	337
  	339
   	359
   	364





GB	F	D	E	IT
Aerators	Aérateur	Belüfter	Aireadores	Aeratore
Aerial Lifts	Nacelle élévatrice	Hebebühnen	Teleférico	Piattaforme aeree
Aerifiers	Aérateur-humidificateur	Luftkonditionierer	Aerificadores	Aerificatore
Air Broom	Balai pneumatique, brosse pneumatique	Luftdruck-Kehrer	Escoba de aire	Spazzolone pneumatico
Air Compressors	Compresseur d'air	Luftkompressoren, -verdichter	Compresores de aire	Compressore pneumatico
Aircraft Tow Truck	Tracteur d'avions	Flugzeugschlepper	Camión-grúa de aviones	Rimorchiatori di aerei
All models	Tous modèles	Alle Modelle	Todos los modelos	Tutti i modelli
All models	Tous modèles	Alle Modelle	Todos los modelos	Tutti i modelli
Alternators	Alternateur	Wechselstromlichtmaschinen	Alternadores	Alternatore
Aluminium head	Culasse en aluminium	Aluminium Zylinderkopf	Culata de aluminio	Testate in alluminio
Asphalt Maintenance Equipment	Matériel d'entretien routier	Anlagen zur Instandhaltung von Asphaltflächen	Equipo de mantenimiento de asfalto	Dispositivi e attrezzature per manutenzione stradale
Augers	Tarière	Erd-bohrer	Taladros	Trivella
Auxillary Gap	Encartement auxiliaire	Vorfunkstrecke	Abertura auxiliar	Scaria ausiliaria
Backfillers	Remblayeuse	Verfüllmaschinen	Rellenadoras de zanjas	Macchine usate per ricoprire uno scavo con materiale di riempimento
Backhoe Loader	Chargeuse pelleteuse	Tieföffelbagger	Cargadora retroexcavadora	Pala scavatrice
Backhoes	Chargeuse pelleteuse	Grabenbagger	Retroexcavadora	Scavatori
Balers	Ramasseuse-presse	Ballenpresse	Empacadoras	Imballatori
Beet Harvester	Arracheuse-chargeuse de betteraves	Rübenerntemaschine	Cosechadora de remolacha	Miettrice per barbabietola da zucchero
Blowers	souffleuse	Lüfter	Soplantes	Ventilatore; compressore
Borers	Foreuse	Bohrer	Taladradoras	Perforatrici
Brush Chippers	Concasseur, désintégrateur	Spansammelbürsten	Astilladoras de matorrales	Spazzola sminuzzatrice
Brush Pick-up	Débroussaillieuse	Brush Pick-up	Recogedor de cepillos	Raccolta delle frasche
Brushcutters	Débroussaillieuse	Freischneidegeräte	Desbrozadoras	Spazzola tagliatrice
Cable Layers	Poseuse de câbles	Kabelleger	Cable por capas	Posacavi
Car Loader	Chargeuse sur pneus	Fahrzeugverlader	Cargador de vagones	Sollevatore macchine
Carrier	Porteur	Fahrgestell	Transportista	Trasportatore
Caterpillar Tractor	Tracteur à chenilles	Gleiskettenschlepper	Tractor de oruga	Trattore caterpillar
CD ignition	Allumage à décharge capacitive	CD Zündung	Encendido CD	CD Prodotti accensione
CD ignition	Allumage à décharge capacitive	CD-Zündung	Encendido D.C.	Accensione C.D.
Cement Cutters	Scie à ciment	Zementfräsen	Cortadoras de hormigón	Frese per cemento
Cement Finishers	Finisseur à ciment	Zementfertiger	Terminadores de hormigón	Stazioni di finitura del cemento
Cement Mixer	Malaxeur à ciment, cimentière	Zementmischvorrichtungen	Hormigonera	Betoniera
Cement Mixers	Malaxeur à ciment, cimentière	Zementmischvorrichtungen	Hormigoneras	Betoniere per cemento
Centrifugal Pumps	Pompe centrifuge	Zentrifugalpumpen, Kreiselpumpen	Bombas centrífugas	Pompa centrifuga
Chainsaws	Tronçonneuse à chaîne	Kettensägen	Motosierra	Motosega
Chippers	Machine à copeaux	Zerspanvorrichtungen	Astilladoras	Sminuzzatrice
cid = Cubic inches	Pouce Cubique	Kubic Inches	Pulgadas Cubicas	Pollici Cubici
Coil ignition	Allumage par bobine	Zündspule	Bobina de encendido	Bobina d'accensione
Cold Fouling	Encrasement à froid	Kaltstart Verrußung	Depósitos de carbonilla	Imbrattamento a freddo
Combines	Moissonneuse-batteuse	Mähdrescher	Segadoras-trilladoras	Miettrebbie
Commercial & Stationary mots	Moteur industriel et stationnaire	Handelsübliche & ortsfeste Motoren	Motores comerciales y estacionarios	Motore stazionario industriale
Commercial Equipments	Equipement industriel	Handelsübliche Vorrichtungen	Equipos industriales	Attrezzatura industriale
Commercial Mulcher	Broyeur industriel	Handelsüblicher Düngereinleger	Mullidora comercial	Concimatrice industriale
Compact Loader	Chargeur, chargeuse	Kompakte Ladevorrichtungen	Cargadora compacta	Pala compattatrice
Compactors	Compacteur	Kompaktierer, Verdichter	Compactadoras	Compattatore
Composters	Composteur	Kompostieranlagen	Mezcladoras de composte	Compostatore
Compressors	Compresseur	Kompressoren, Verdichter	Compresores	Compressore
Concrete Buggies	Chariot à béton	Zementwagen	Carretilas de hormigón	Carrelli per trasporto calcestruzzo



**RU**

**PL**

**CZ**

**HU**

Аэраторы	Aeratory	Levegőztetők	Kypriče
Пневматические подъемники	Kolejki linowe	Emelők	Zvedací plošiny
Аэрационные аппараты	Napowietrzacze	Levegőztetők	Provzdušňovače
Вакуумно-подметальная машина	Miotła pneumatyczna	Rendrefűvők	Pneumatický zametací stroj
Компрессоры	Sprężarki powietrzne	Kompresszorok	Kompresory
Аэродромный тягач	Ciągniki do wypychania samolotów	Repülőgépvontató teherautó	Letištní odtahové vozidlo
Все модели	Wszystkie modele	Minden típus	Všetchny modely
Все модели	Wszystkie modele	Minden típus	Všetchny modely
Генераторы	Alternatory	Generátorok	Alternátory
Алюминиевая головка	Głowica aluminiowa	Alumíniumfej	Hliníková hlava
Оборудование для ремонта асфальта	Urządzenia do utrzymania asfaltu	Aszfaltkarbantartó berendezés	Zařízení pro údržbu silnic
Буры	Świdry ziemne	Csigafúrók	Nebozezy
Вспомогательный зазор	Szczelina pomocnicza	Kiegészítő hézag	Technologická mezera
Машины для засыпки траншей	Maszyny do zasypywania wykopów	Ároktemetők	Zakladač
Экскаватор-погрузчик	Koparka podsiębierna	Kanalas rakodók	Lopatový nakladač
Экскаваторы	Koparki podsiębiernie	Markológépek	Rypadla
Упаковочные прессы	Urządzenia do belowania	Bálázók	Balíkovací lisy
Свеклоуборочная машина	Kombajny buraczane	Cukorrépa-kombájnok	Sklicečka řepy
Вентиляторы	Dmuchawy	Fúvatók	Foukače/dmyhadla
Бурильные установки	Wiertarki	Fúrógépek	Vrtací stroje
Машины для вырубания подлеска	Rozdrabniarki do gałęzi	Szárzúzók	Drtiče křovin
Подметальные машины	Zamiatarka	Kefés felszedő	Sadařský sběrač
Кусторезы	Rębaki do gałęzi	Bozótvégők	Křovinořezy
Кабелепрокладчики	Ukladarki kabli	Kábelfektetők	Pokládač kabelů
Погрузчик	Ładowarka samobieźna	Kocsirakodók	Nakladač vozidel
Транспортер	Pojazd do ładunków specjalnych	Hordozó	Nosič
Гусеничный трактор	Ciągnik gąsienicowy	Láncfalpas traktor	Traktor Caterpillar
Конденсаторная система зажигания	Zapłon CD	CD gyújtás	CD zapalování
Конденсаторная система зажигания	Zapłon CD	CD gyújtás	CD zapalování
Цементорезы	Pilarki do betonu	Betonvágók	Řezačky betonu
Машины для обработки поверхности цемента	Szlifyerki do betonu	Betoncsiszolók	Domíchávače cementu
Мешалка цемента	Betoniarka	Betonkeverő	Míchačky cementu
Цементомешалки	Betoniarki	Betonkeverők	Míchačky cementu
Центробежные насосы	Pompy odśrodkowe	Centrifugálszivattyúk	Odstředivá čerpadla
Бензопилы	Piły łańcuchowe	Láncfűrészek	Řetězové pily
Измельчители	Rębaki	Darálók	Sbjíjecí kladiva
cid = кубические дюймы	cid = cale sześciennie	cid = Köbhüvelyk	cid = krychlové palce
Зажигание с катушкой индуктивности	Zapłon z cewki zapłonowej	Tekercses gyújtás	Cívkové zapalování
Холодный нагар	Zakleszczenie na zimno	Hidegindítási hiba	Zanášení karbonem za studena
Комбайны	Kombajny	Kombájnok	Kombajny
Коммерческие и стационарные электродвигатели	Silniki przemysłowe i stacjonarne	Ipari- és állómotorok	Užitkové a stacionární motory
Коммерческое оборудование	Urządzenia przemysłowe	Ipari készülékek	Užitkové zařízení
Коммерческая машина для поверхностного рыхления почвы	Kosiarko-rozdrabniarka profesjonalna	Ipari mulcsozó	Užitkový mulčovač
Компактный погрузчик	Koparkoładowarka	Kompakt rakodó	Kompaktní nakladač
Уплотнители	Ubijarki	Tömörítők	Zhutnovače
Машины для приготовления компоста	Kompostery	Komposztálók	Kompostovače
Компрессоры	Sprężarki	Kompresszorok	Kompresory
Вагонетки для бетона	Wózki do masy betonowej	Betonkocsik	Vozíky na beton

GB	F	D	E	IT
Concrete Cutters	Scie à béton	Betonfräsen	Cortadoras de hormigón	Frese per calcestruzzo
Concrete Finishers	Finisseur à béton	Betonfertiger	Terminadores de hormigón	Stazioni di finitura del calcestruzzo
Concrete Mixers	Malaxeur à béton, bétonnière	Betonmischer	Hormigoneras	Betoniere per calcestruzzo
Concrete Pumps	Pompes à béton	Betonpumpen	Bombas de hormigón	Pompe calcestruzzo
Concrete Saws	Scie à béton	Betonsägen	Sierras para hormigón	Sega per calcestruzzo
Concrete Screeds	Planeuse à béton	(Beton-)Abgleichbohlen	Reglones para hormigón	Rasiera per calcestruzzo
Construction Machinery	Engin de chantier	Baumaschinen	Maquinaria de construcción	Macchinario di costruzione
Contractors Pumps	Pompe de chantier	Grubenpumpen, Baupumpen	Bombas para contratistas	Pompa edile
Conveyers	Transporteur, transporteur à rouleaux	Transportanlagen	Cintas transportadoras	Convogliatore, trasportatore
Corn Picker	Récolteuse de maïs	Maispflücker	Arrancadora-deshojadora de mazorcas	Raccogliatrice di grano
Cotton Pickers	Récolteuse de coton	Baumwollpflücker	Cosechadoras de algodón	Raccogliatrici cotone
Crane Carriers	Porte-grues	Kranfahrgestelle	Camiones-grúa	Autogru
Cranes	Grue	Kräne	Grúas	Gru
Crawler Tractors	Tracteur à chenilles	Raupenschlepper	Tractores de oruga	Trattori a cingoli
Crawlers	Chargeuse sur chenilles	Raupenfahrzeuge	Orugas	Cingolati
Crop Dryer	Séchoir agricole	Kornrockner	Secadero de cosecha	Essiccatoio
Crushers	Concasseur	Brecher	Aplastadoras	Frantoi
Cultivators	Cultivateur	Kultivatoren	Cultivadoras	Coltivatore
Curbers	Profileuse	Bordsteinmaschinen	Máquinas de colocación de bordillos	Cordolatrici
Cut Off Saw	Tronçonneuse	Trennsägen	Sierra de trocear	Sega da taglio
Cut-Off Saws	Tronçonneuse	Ablängsägen	Sierras retestadoras	Troncatrici
D.C. Arc Welders	Soudeuse à arc à courant continu	Bogenschweißer	Soldadores de arco	Saldatrici ad arco C.C.
Dethatchers	Eteuleuse	Moosentferner	Desempajadoras	Raccogli-stoppie
Diameter	Diamètre	Durchmesser	Diametro	Diametro
Diggers	Excavatrice	Bagger	Excavadoras	Scavatrici
Ditchers	Trancheuse	Löffeltiefbagger	Cuneteadoras	Scavafossi
Downdraft	Alimentation verticale	Fallstromvergaßer	Corriente descendente	Pescaggio sul fondo
Drill	Foreuse	Bohrer	Taladradora	Trapano
Drills	Foreuse	Bohrmaschinen	Sembradoras	Trapani
Dusters	Poudreuse	Stäubegerät	Espolvoreadoras	Polverizzatore
Eager Beaver	Rogneuse	Werkzeugmaschine	Cortadora	Macchina utensile
Earth Augers	Tarière à sonder	Erdbohrer, Tellerbohrer	Ahoyadores para postes	Trivella per terreno
Earth Borers	Perceuse	Erdbohrer, Tellerbohrer	Perforadoras de tierra	Sonda per terreno
Earth Drills	Foreuse	Erdbohrer	Barrenas de tierra	Trapano per terreno
Earth Movers	Engin de terrassement	Erdbewegungsmaschinen	Máquinas para mover tierra	Ruspe
Earth Rammer	Dameur	Stampfer	Compactadora	Costipatore
Edge Trimmers	Scie à déligner, ciseaux à bord	Kantentrimmer	Recortadoras de bordes	Rifilatrice
Edgers	Machine à dresser les bordures	Kantentrimmer	Canteadoras	Rifinitrice di bordi
Electric start	Démarrateur électrique	Elektrischer Anlaßer	Arranque eléctrico	Avviamento elettrico
Electric start	Démarrateur électrique	Elektrischer anlaßer	Arranque eléctrico	Avviamento elettrico
End Loader	Chargeuse frontale	Schaufellader	Pala cargadora	Pala caricatrice
Except	Sauf	Außer	Excepto	Eccetto
Farm Equipments	Matériel agricole	Bauernhofausstattung	Maquinaria agrícola	Attrezzatura agricola
Farm Machinery	Machine agricole	Landwirtschaftliche Maschinen	Maquinaria agrícola	Macchinario agricolo
Field Harvester	Récolteuse-hacheuse	Felderntemaschine	Cosechadora de forraje	Mietitrice
Field Sprayers	Pulvérisateur agricole	Feldspritzen	Pulverizadores	Irroratrici campi
Finishers	Finisseur	Fertiger	Acabadores	Finitrici
Fire Fighter	Véhicule de lutte contre l'incendie	Feuerlöschgerät	Bombero	Pompieri
Fire Fighting Pumps	Pompe d'incendie	Feuerlöschpumpen	Bombas para extinción de incendios	Pompa antincendio
Fire Pump	Pompe d'incendie	Feuerlöschpumpe	Bomba contra incendios	Pompa antincendio

**RU****PL****CZ****HU**

Машины для резки бетона	Pilarki do betonu	Betonvágók	Řezačky betonu
Машины для обработки поверхности бетона	Szliifierki do betonu	Betoncsiszológ	Domíhávače betonu
Бетономешалки	Betoniarki	Betonkeverők	Míchačky betonu
Насосы для подачи цемента	Pompy do betonu	Betonszivattyúk	Čerpadla betonové směsi
Пилы для бетона	Pilarki do betonu	Betonfűrészek	Pily na beton
Разравнивающие брусы для укладки бетона	Równiarki do betonu	Betonsímitők	Finišéry betonových vozovok
Строительная техника	Urządzenia budowlane	Építőipari gépek	Stavební stroje
Насосы типа Летесью	Pompy budowlane	Ipari szivattyúk	Kalová čerpadla
Конвейеры	Przenośniki	Szállítószalagok	Dopravníky
Кукурузные комбайны	Żniwiarka	Kukoricaszedő gépek	Zařízení pro sklizeň kukuřice
Хлопковые комбайны	Kombajn do zbioru bawełny	Gyapotszedő gépek	Zařízení pro sklizeň bavlny
Передвижные краны	Dźwigi samojezdne	Daruhordozók	Nosiče jeřábu
Краны	Dźwigi	Daruk	Jeřáby
Гусеничные тягачи	Ciągniki gąsienicowe	Láncfalpas traktorok	Pásově traktory
Гусеничные машины	Pojazdy gąsienicowe	Láncfalpasok	Pásová vozidla
Сушилка для сельскохозяйственной продукции	Suszarka do ziarna	Terményszárítók	Vysoušeč zemědělských plodin
Измельчители	Kruszarki	Törőgépek	Drtiče
Культиваторы	Kultywatory	Kultivátorok	Kultivátory
Укладчики дорожного покрытия	Układarki do krawężników	Szegélyezőgépek	Seřezávače krajnic
Концерезная пила	Pilarka	Levágófűrészek	Motorová pila
Бензопилы	Pily mechaniczne	Levágófűrészek	Odrezávací pila
Сварочные аппараты для дуговой сварки постоянным током	Spawarki łukowe prądu stałego	Egyenáramú ívhegesztők	Obloukové svářečky
Газонокосилки	Skaryfikatory	Gyepszellőtetők	Vyhrabovače staré trávy
Диаметр	Średnica	Átmérő	Průměr
Землеройные машины	Koparki	Ásógépek	Bagry
Экскаваторы с обратной лопатой	Rowkarki	Árokásók	Drenážní stroje (přikopové frézy)
Нисходящий поток воздуха	Dolnoścący	Leállítás	Spodní tah
Дрель	Wiertnica	Fúró	Vrtačka
Сверлильные машины	Wiertnice	Fúrógépek	Vrtací soupravy
Щетки для обметания	Odkurzacze	Permetező repülőgépek	Rozprašovač
Шпоночно-протяжный станок	Eager Beaver	Utánfutó	Obojížlivný nákladní vůz
Буровые инструменты	Świdry ziemne	Talajfúrók	Zemní nebozezy
Бурильные машины	Wiertnice ziemne	Talajfúrók	Vrtné soupravy
Земляные буры	Wiertnice ziemne	Talajfúrók	Zemní vrtáky
Машины для перемещения земляных масс	Glebogryzarki	Talajmozgató gépek	Buldozery
Машины для трамбовки грунта	Ubijarki do gruntu	Talajtömörítők	Zemní pěchovačka
Кромкофуговальные станки	Podkaszarki	Szegélyvágók	Ořezávače okrajů
Кромкофрезерные станки	Obrzynarki	Szegélyvágók	Obrubovačky
Электрический запуск	Rozruch elektryczny	Elektromos indítás	Elektrické startování
Электрический запуск	Rozruch elektryczny	Elektromos indítás	Elektrické startování
Погрузчик с задней разгрузкой	Ładowarka kubekowa	Homloktalás rakodógépek	Čelní nakladač
Кроме	Z wyjątkiem	Kivéve	Kromě
Сельскохозяйственное оборудование	Urządzenia rolnicze	Mezőgazdasági berendezések	Zemědělské zařízení
Сельскохозяйственная техника	Maszyny rolnicze	Mezőgazdasági gépek	Zemědělské stroje
Силооборочный комбайн	Żniwiarka polowa	Szántóföldi kombajn	Skřízeční stroj
Полевые опрыскиватели	Opryskiwacze polowe	Szántóföldi permetezőgép	Postřikovače
Станки для чистовой обработки	Szliifierki	Finisherek	Finišéry
Пожарная машина	Pojazd pożarniczy	Tűzoltógépek	Požární stroj
Насосы для пожаротушения	Motopompy pożarnicze	Tűzoltószivattyúk	Požární agregáty
Пожарный насос	Motopompa pożarnicza	Tűzoltószivattyú	Požární stříkačka

GB	F	D	E	IT
Fire Pumps	Pompe d'incendie	Feuer[lösch]pumpen	Bombas contra incendios	Pompa antincendio
Fire Truck	Camion d'incendie	Feuerwehrfahrzeug	Camión cisterna	Camion pompieri
Flail Mowers	Moissonneuse à fléaux	Anhängemäher	Segadoras desgranadoras	Falciatrice a flagello
Floating Pump	Pompe flottante	Tauchpumpe	Bomba flotante	Pompa flottante
Floor Cleaners	Nettoyeuse de sol	Bodenreinigungsmaschinen	Máquinas de limpieza de suelos	Lavapavimenti
Floor Saws	Scie à sol	Fugenschneider	Sierras para suelos	Tagliapavimenti
Foggers	Brumiseur	Zerstäuber	Nebulizadores	Nebulizzatore
Foldway Lift	Hayon élévateur rabattable	Unterflurhebebühne	Elevador plegable	Carrello elevatore retrattile
Forage Clipper	Récolteuse-hacheuse	Maisschneider	Recortador de forraje	Falciatrice per foraggio
Forage Harvester	Ensileuse	Maishäcksler	Segadora-picadora	Mietforaggi
Force Feed Loader	Chargeuse à alimentation forcée	Zwangsförderer	Pala cargadora de alimentador de carraca	Caricatore a lubrificazione forzata
Fork Lift	Chariot élévateur	Gabelstapler	Toro elevador	Elevatore a forche
Forklifts	Chariot élévateur	Gabelstapler	Carretillas elevadoras	Elevatore a forza
Formgraders	Niveleuse	Formgraders	Calibradoras	Livellatrici
Fouling	Encrassement	Verrußung	Ensuciamiento	Imbrattamento
Front End Loader	Chargeuse frontale	Frontlader	Pala cargadora delantera	Pala a caricamento frontale
Garden Plows	Charrue pour jardins	Gartenpflüge	Arador para jardinería	Aratro per giardino
Garden Tractors	Tracteur de jardin	Gartenbau-Schlepper	Tractores para jardinería	Trattore per giardino
Gas Pump	Pompe à carburant	Gaspumpen	Bomba de gas	Pompa benzina
Gasket Seat	Siège de joint	Dichtungssitz	Asiento de junta	Sede piana
Gasket Seat	Siège de joint	Dichtungssitz	Asiento de junta	Sede piana
Gasoline	Essence	Benzin	Gasolina	Benzina
Generators	Générateur	Generatoren	Generadores	Generatore
Golf cars	Voiturette de golf	Golfwagen	Vehículos de golf	Vettura da golf
Golf Cart	Caddie de golf	Golfkarren	Carrito de golf	Carrello da golf
Graders	Niveleuse	Sortierer, Sortiermaschinen	Niveladoras	Livellatrice
Grain Dryer	Séchoir à grains	Korn Trockner	Secadero de cereales	Essiccatore grano
Grinder	Broyeur/Concasseur	Häcksler, Zerfaserer	Trituradora	Smerigliatrice
Groovers	Rainureuse	Rillenschleifmaschinen	Ranuradoras	Attrezzi per effettuare scanalature
Hammers	Marteau-pilon	Hämmer	Martillos	Martello
Handler	Pelle de manutention	Bearbeiter	Descargador	Dispositivo di movimentazione
Harvesters	Moissonneuse	Erntemaschinen	Cosechadoras	Mietitori
Hay Baler	Ramasseuse-presse	Heuballenpresse	Recogedora-empacadora	Pressatrice per fieno
Hay Dryer	Séchoir à foin	Heutrockner	Secadero de heno	Essiccatore cereali
Haybine	Faucheuse conditionneuse	Mäher-Konditionierer	Henficadora	Falciatrice
Hayswather	Faucheuse	Heuschwader	Hileradora de heno	Tagliafieno
Heat Range	Gamme thermique	Wärmewert-Vergleichzahl	Grado térmico	Grado termico
Heat Units	Unité thermique	Heizer	Unidades térmicas	Unità termiche
Heater Igniters	Dispositif d'allumage de chaudière	Zündvorrichtungen für Heizöfen	Dispositivos de encendido de calefactores	Accenditore del riscaldatore
Heaters	Dispositif de chauffage	Heizgeräte, -apparate, -körper	Calefactores	Riscaldatore
Heaters (Oil Fired)	Dispositif de chauffage (au mazout)	ölbefeuerte Heizungen	Calefactores de gasoil	Riscaldatore (a combustibile liquido)
Heavy Service	Service intensif	Starke Beanspr.	Servicio pesado	Servizio gravoso
Heavy service	Usage intensif	Starke Beanspr.	Servicio pesado	Impiego gravoso
Hedge Trimmers	Taille-haies	Heckenscheren	Recortadoras de setos	Tagliasiepi
Hedgers	Coupe-haies	Heckenscheren	Recortadoras de setos	Tagliasiepi
High Compression	Compression élevée	Hochdruck, Überdruck	Alta compresión	Alta compressione
High Lifts	Chariot élévateur à grande levée	Stapler	de gran elevación	Sollevatori
High performance mot.	Moteur haute performance	Hochleistungsmotor	Motores de alto rendimiento	Mot. ad alte prestazioni
High performance mots.	Moteur haute performance	Hochleistungsmotor	Motores de alto rendimiento	Mot. ad alte prestazioni
High Pressure Washers	Dispositif de lavage à haute pression	Hochdruckscheibe	Lavadoras de alta presión	Guarnizione per alte pressioni

**RU****PL****CZ****HU**

Пожарные насосы	Motopompy pożarnicza	Tűzoltószivattyúk	Požární stříkačky
Пожарный грузовик	Samochód pożarniczy	Tűzoltókocsi	Požární vůz
Косилки с цеповым аппаратом	Kosiarki rotacyjne	Szárzúzók	Šnekové sekačky
Погружной насос	Pompa pływająca	Úszószivattyúk	Plovoucí čerpadlo
Машины для очистки полов	Urządzenia do czyszczenia posadzek	Padló tisztító gépek	Mycí stroje
Машины для нарезки швов	Pilarki do posadzek	Padlóvágók	Podlahové pily
Увлажнители	Zadymiacze	Párásítók	Zvlhčovače
Гидравлический подъемник	Podnośnik składany	Összecsukló emelőgépek	Výklopný zvedák
Силосоуборочный комбайн	Maszyna do zbioru paszy	Takarmányvágók	Ořezávač travin
Кормоуборочный комбайн	Kosiarka do roślin paszowych	Takarmányaratók	Skřížečka píce
Машина для подачи под давлением	Ładowarka z zasilaniem wymuszonym	Adagoló rakodók	Nakladače s nuceným podáváním
Вилочный подъемник	Podnośnik widłowy	Emelővillás targonca	Vysokozdvíhací vozík
Вилочные погрузчики	Wózki widłowe	Emelővillás targoncák	Vysokozdvíhací vozíky
Грейдеры	Równiarki	Prízmázók	Srovnávače
Нагар	Zakleszczanie	Hiba	Zanášení
Фронтальный погрузчик	Ładowarka	Homlokfalas rakodó	Čelní nakladač
Садовые плуги	Pług ogrodowe	Kertiekék	Zahradní pluhy
Садовые трактора	Ciągniki ogrodowe	Kerti traktorok	Zahradní traktory
Бензиновый насос	Pompa paliwa	Gázszivattyú	Benzínové čerpadlo
Гнездо под прокладку	Gniazdo uszczelki	Tömítés üléke	Sedlo ucpávky
Гнездо под прокладку	Gniazdo uszczelki	Tömítés	Sedlo ucpávky
Бензин	Benzyna	Benzin	Automobilový benzín
Генераторы	Generatory	Generátorok	Generátory
Гольф-мобили	Wózek golfowy	Golfautók	Golfové vozy
Тележка для гольфа	Wózek golfowy	Golfautó	Golfový vozík
Грейдеры	Równiarki	Talajgyaluk	Grejdry
Зерносушилка	Suszarnia do ziarna	Gabonaszárító	Sušička na obilí
Шлифовальная машина	Szlifierka	Köszörűk	Bruska
Машины для нарезки и прочистки швов	Rowkarka	Hornyolók	Drážkovací fréza
Молоты	Młoty	Kalapácsok	Kladiva
Устройство манипулирования	Podnośnik-ładowarka	Kezelőgépek	Podavač
Машины для заготовки	Žniwiarki	Aratógépek	Skřížecí stroje
Сеновязалка	Maszyna do belowania siana	Bálázó	Balíkovač sena
Сушилка для сена	Suszarnia do siana	Szalmaszárító	Sušička sena
Сенокосилка	Kosiarka rolnicza do trawy	Szalmavágó	Závěsná sekačka
Приспособление для уборки сена	Žniwiarka pokosowa do trawy	Szalmaforgató	Řádkovací žací stroj
Диапазон нагрева	Zakres cieplny	Fűtési tartomány	Tepelná hodnota
Обогреватели	Urządzenia ciepne	Fűtőegységek	Tepelné jednotky
Коммутаторы для обогревателей	Zapłonnik podgrzewacza	Hőgyújtók	Zapalovač topení
Подогреватели	Podgrzewacze	Fűtőkészülékek	Ohřívače
Подогреватели (на жидком топливе)	Podgrzewacze (olejowe)	Fűtés (olajtüzelésű)	Ohřívače (naftové)
Тяжелые условия работы	Praca ciężka	Nehéz üzem	Těžký provoz
Тяжелые условия работы	Ciężka praca	Nehéz üzem	Těžký provoz
Машинки для подрезания живой изгороди	Nożyce do żywopłotu	Sóvényvágók	Stříhače živých plotů
Машины для подрезки живой изгороди	Urządzenia do przycinania żywopłotu	Sóvényvágók	Stříhače živých plotů
Высокая степень сжатия	Wysoki stopień sprężania	Nagy sűrítés	Vysoká komprese
Краны	Podnośniki wysokiego podnoszenia	Magas emelőgépek	Vysokozdvíhací zvedák
Высокопроизводительные двигатели	Silniki o dużej wydajności	Nagyteljesítményű motor	Vysoce výkonné motory
Высокопроизводительные электродвигатели	Silniki o dużej wydajności	Nagyteljesítményű motorok	Vysoce výkonné motory
Омыватели с высоким давлением	Myjki wysokociśnieniowe	Nagynyomású mosó	Vysokotlaké myčky

GB	F	D	E	IT
Hoists	Engin de levage	Hebezeuge	Elevadores	Argani
Hole Diggers	Tarière	Lochstecher	Barrenadoras	Trivelle
Hoover mowers	Tondeuse autotractée	Saugmäher	Segadoras Hoover	Falciatrice aspiratrice
Hydra Hammers	Marteau hydraulique	Hydrahammer	Martillos hidráulicos	Martelli idraulici
Hydraulic Power Packs	Groupe hydraulique	Hydrauikaggregate	Generadores de energía hidráulica	Gruppi di alimentazione idraulica
Hydrocranes	Hydro-grue	Hydrokräne	Grúas hidráulicas	Gru idrauliche
Ice Drill	Machine à forer à travers la glace	Eisbohrer	Perforadora para hielo	Trapano per ghiaccio
Ice Pumps	Pompe à glace	Eispumpe, Frostpumpe	Bombas para hielo	Pompa per ghiaccio
Ignition	Allumage	Zündung	Encendido	Accensione
Inboard motor	Moteur fixe à bord	Innenbordmotor	Motor interior	Motore entro bordo
Industrial mots	Moteur industriel	Industriemotoren	Motores industriales	Motore industriale
Industrial Scrubber	Nettoyeur industriel à brosses	Industrie-Scrubber	Limpiauelos industriales	Pulitrice industriale
Industrial Scrubbers	Nettoyeur industriel à brosses	Industrieschrubber	Lavadoras de cepillos industriales	Scrubber industriali
Injection	Injection	Einspritzung	Inyección	Iniezione
Intake	Admission	Einlass	Admisión	Bobina integrale
Integral Coil	Bobine intégrée	Integralspule	Bobina integral	Kerosene/Paraffina
Kerosene/Paraffin	Kérosène/Pétrole	Kerosin/Paraffin	Petróleo	Gas liquido di petrolio (GLP)
Lawn Cleaners	Nettoyeur pour gazon	Rasenreiniger	Limpiadoras de césped	Pettinatrice per prati
Lawn Combers	Balayeuse à gazon	Rasenkämmaschinen	Peinadoras de césped	Aratro per prati
Lawn Plows	Charrue pour jardins	Rasenpflüge	Arados para césped	Rastrello per prati
Lawn Rakes	Râteau	Rasenrechen	Rastrillos para césped	Rullo per prati
Lawn Rollers	Rouleau presseur pour gazon	Rasenwalzen	Rodillos para césped	Scarificatore per prati
Lawn Scarifiers	Scarificateur	Rasenlockerer, Rasenvertikutierer	Escarificadoras de césped	Spazzatrice per prati
Lawn Sweepers	Balayeuse à gazon	Rasenkehrmaschine	Barredoras para césped	Trattore per prati
Lawn Tractors	Tracteur de jardin	Rasenbau-Schleppgeräte	Tractores para césped	Aspiratore per prati
Lawn Vacuums	Aspirateur à gazon	Rasenstaubsauger	Aspiradoras para césped	Impiego leggero
Lift Trucks	Chariot élévateur	Stapler	Carretillas elevadoras	Carrelli elevatori
Light Service	Utilisation modérée	Geringe Beanspr.	Servicio ligero	Servizio leggero
Light Service	Condition d'utilisation légère	Leichter Einsatz, geringe Beanspruchung	Servicio ligero	Raffreddamento a liquido
Liquid Cooled	Refroidissement à eau	Wässer Kühlung	Refrigerado por líquido	Pala caricatrice; caricatrice
Loader Tractor	Tracteur chargeur	Ladetraktor	Tractor cargador	Trattore con pala
Loaders	Chargeur, chargeuse	Beladevorrichtungen	Cargadoras	Gru semovente
Locomotive Cranes	Grue automotrice	Lokomotivkräne	Grúas locomóviles	Apritronchi
Log Splitters	Machine à fendre les bûches	Holzstammzerfaserer	Hendedoras de troncos	Bassa compressione
Low Compression	Faible compression	Niederdruck, Unterdruck	Baja compresión	Accensione a magnete
LP-Gas	GPL (Gaz de pétrole liquéfié)	Autogas	Gas licuado de petróleo	Pulitrice per prati
Machinery	Machine	Maschine	Maquinaria	Macchinario
Magneto ignition	Allumage par magneto	Magneto Zündung	Encendido por magneto	Accensione a magnete
Magneto ignition	Allumage par magneto	Magneto zündung	Encendido por magneto	Sega per calcestruzzo e muratura
Marine Mobile Hoists	Appareil de levage mobile pour bateaux	Selbstkletternde Hebebühnen für Schiffe	Elevadores móviles marítimos	Sollevatori mobili per imbarcazioni
Marine Trailer Hoists	Appareil de levage de remorque de bateau	Anhängerhebebühnen für Schiffe	Elevadores de remolque marítimos	Rimorchi con braccio elevatore imbarcazioni
Mason Tenders	Porte-auge	Maurergehilfen	Contratistas	Manovali edili
Masonry & Concrete Saws	Scie à béton	Mauer- und Betonsägen	Sierras para mampostería y hormigón	Impastatrice di malta; betoniera
Material Spreaders	Epandeuse	Materialstreuer	Distribuidoras de material	Diffusori di materiale
Mixers	Malaxeur	Mischer	Mezcladoras	Miscelatori
Mortar Mixers	Mélangeur à mortier	Mörtelmischvorrichtungen	Mezcladoras de hormigón	Motocoltivatore
Moto-Loader	Moto-basculer	Moto-Lader	Excavadora	Sollevatore moto
Motor Cultivators	Cultivateur à moteur	Motorkultivatoren	Cultivadoras motorizadas	Motoescavatore; escavatore
Motor Hoe	Bineuse à moteur	Motorhacke	Azada motorizada	Motoasportatore; rastrello meccanico



**RU****PL****CZ****HU**

Лебедки	Podnośniki	Daruk	Zvedací zařízení
Бурильные установки	Wiertnice	Oszlopfúrók	Půdní vrtáky
Газонокосилки с функцией сбора травы	Kosiarki z zasobnikiem trawy	Légpárnás fűnyírók	Sekačky
Гидравлические молоты	Młoty hydrauliczne	Hidraulikus kalapácsok	Hydraulická kladiva
Гидравлические силовые агрегаты	Agregaty hydrauliczne	Hidraulikus tápegységek	Hydraulické agregáty
Гидравлические краны	Dźwigi hydrauliczne	Hidraulikus daruk	Hydraulické jeřáby
Ледобур	Wiertnica do lodu	Jégfúró	Vrták do ledu
Насосы для льда	Pompy lodowe	Jégszivattyú	Čerpadla pro nízké teploty
Зажигание	Zapłon	Gyújtás	Zapalování
Бортовой мотор	Silnik zabudowany	Fedélzeti motor	Vestavěný motor
Промышленные электродвигатели	Silniki przemysłowe	Ipari motorok	Průmyslové motory
Промышленный нейтрализатор	Oczyszczacz przemysłowy	Ipari súrológép	Průmyslová pračka
Промышленные нейтрализаторы	Oczyszczacze przemysłowe	Ipari súrológépek	Průmyslové pračky
Впрыск	Wtrysk	Befecskendezés	Vstřikování
Впуск	Wlot	Szívás	Sání
Встроенная катушка	Cewka wewnętrzna	Belső tekercs	Integrovaná cívka
Керосин/парафин	Nafta/Parafina	Kerozin / paraffin	Kerosín/Paraffín
Машины для уборки газона	Czyszczarki do trawników	Gyep tisztítók	Čističe trávníku
Газонные щетки	Wertykulatory	Gyepfésűk	Česací stroje
Газонные плуги	Pług trawnikowe	Gyapekék	Zemní pluhy
Газонные грабли	Grabarki do trawników	Gyepgereblyék	Hrabací stroje
Газонные катки	Wały do trawników	Gyep hengerek	Zahradní válcovací stroje
Газонные культиваторы	Skaryfikatory do trawników	Gyepszellőztetők	Rozrývače
Газонные механические щетки	Zamiatarki do trawników	Gyepseprők	Čističe trávníku
Газонные тракторы	Ciągniki ogrodowe	Gyep traktorok	Zahradní traktory
Газонные пылесосы	Odkurzacze do trawników	Gyep porszívók	Zahradní vysavače
Автопогрузчики	Wózki widłowe	Darus teherautók	Vozík se zdvižnou plošinou
Легкие условия эксплуатации	Praca lekka	Könnyű üzem	Lehký provoz
Легкие условия эксплуатации	Praca lekka	Könnyű üzem	Lehký provoz
С жидкостным охлаждением	Chłodzony cieczą	Folyadék hűtésű	Kapalinové chlazení
Погрузочная машина	Ciągnik ładowarka	Rakodós traktor	Traktor nakladač
Погрузчики	Ładowarki	Rakodók	Nakladače
Рельсовые краны	Dźwigi kolejowe samobieżne	Vasúti daruk	Železniční jeřáby
Раскалывающие ножи	Rębaki do drewna	Rönkhasítók	Štípače polen
Низкая компрессия	Niski stopień sprężania	Kis kompresszió	Nízká komprese
Сжиженный нефтяной газ	Gaz płynny	LP-gáz	LPG
Техника	Urządzenia	Gépek	Strojní zařízení
Зажигание от магнето	Zapłon iskrownikowy	Mágneses gyújtás	Magnetové zapalování
Зажигание от магнето	Zapłon iskrownikowy	Mágneses gyújtás	Magnetové zapalování
Морские передвижные подъемники	Morske podnośniki mobilne	Tengeri mozgódaruk	Mobilní zvedací zařízení pro lodě
Морские подъемники-трейлеры	Morskie podnośniki doczepne	Vontatott tengeri daruk	Zvedací zařízení pro lodní aplikace
Транспотеры раствора и кирпичей	Narzędzia murarskie	Kőműves segédeszközök	Zednické zásobníky
Пилы для каменной кладки и бетона	Pilarki do tynku i betonu	Tégla- és betonfűrészek	Pily na zdivo a beton
Приспособления для раскладки	Układarki materiału	Anyagterítők	Posypové mechanismy
Миксеры	Mieszarki	Keverőgépek	Míchací zařízení
Растворосмесители	Mieszalniki do zaprawy murarskiej	Habarcseverők	Míchačky na maltu
Моторизованный погрузчик	Motoładowarka	Motoros rakodók	Motorový nakladač
Моторизованные культиваторы	Kultywatory z silnikiem	Motoros kultivátorok	Motorové kultivátory
Мотокультиватор	Glebogryzarka z silnikiem	Rotációs kapa	Motorový rýč

GB	F	D	E	IT
Motor Rake	Râteau à moteur	Motorrechen	Rastrillo motorizado	Motopompa
Motorpumps	Groupe moto-pompe	Motorpumpen	Motobombas	Falciatrice; tosaerba
Mowers	Tondeuse	Grasmäher	Segadoras	Concimatrice
Mulchers	Broyeur	Düngereinleger	Mullidoras	Trattore-rimorchiatore multiuso
Multi-Purpose Hauler	Tracteur multi-usages	Mehrzweckanhänger	Haladora universal	Macchina multiuso
Multi-Purpose Machine	Machine multi-usages	Mehrzweckmaschine	Máquina universal	Sega multiuso
Multi-Purpose Saws	Scie multi-usages	Mehrzwecksägen, Universalsägen	Sierras universales	Aspirato
Natural Aspirated	Aspiration naturelle	Saugmotor	Normalmente Aspirados	Gas naturale
Natural Gas	Gaz naturel	Erdgas	Gas natural	non prominente
Non-Projected	non projeté	Nicht Vorgezogen	sin Aisalador proyectado	senza resistore
Non-Resistor	sans résistance	ohne Widerstand	sin resistencia	Impiego normale
Normal Service	Condition d'utilisation normale	Normalbetrieb, normale Beanspruchung	Servicio normal	Valvola in testa
Off-Road Utility Vehicle	Véhicule utilitaire tout-terrain	Geländenufzahrzeuge	Vehículo off-road	Fuoristrada
OHV	Soupape en tête	Obengesteuertes Ventil	Válvula de culata	Modelli precedenti
Oil Drillers	Foreuse pétrolière	Ölbohrmaschinen	Perforadores de aceite	Trivelle per pozzi di petrolio
Older Models	Modèles anciens	ältere Modelle	Modelos antiguos	Altri modelli
Other Models	Autres modèles	Andere Modelle	Otros modelos	Accensione generatore di impulsi
Ovens	Etuve	Öfen	Hornos	Forni
Paint Sprayer	Pulvérisateur de peinture	Spritzpistole	Pulverizador de pintura	Aerografi
Pavement Equipment	Machine de revêtement routier	Pflastermaschinen	Equipo de pavimento	Attrezzatura per pavimentazione
Pavement Saws	Scie à sol	Pflastersägen	Cortadoras de suelo	Seghe per pavimentazioni
Pavers	Bétonnière motorisée	Straßenbetoniermaschinen	Pavimentadoras	Compattatori per pavimentazione
Paving Compactors	Dameuse à pavés	Straßenwalzen, Betonverdichter	Compactadoras de pavimento	Macchine per pavimentazione
Paving Machines	Machine à poser les pavés	Straßenbaumaschinen	Máquinas de pavimentar	Pavimentatrice
Payloaders	Chargeuse	Schauellader	Tractores con pala cargadora	Escavatori
Peanut Combine	Moissonneuse-batteuse pour arachides	Erdnussdrescher	Segadora de cacahuetes	Mietitrebba per arachidi
Pedestrian Lawnmowers	Tondeuse à gazon	Rasenwegmäher	Segadoras de césped a pie	Tosaerba
Petrol	Essence	Benzin	Gasolina	Benzina
Pickup Backhoes	Chargeuse pelleteuse	Kleinlaster-Grabenbagger	Retroexcavadoras recogedoras	Escavatori
Pipe Benders	Cintreuse de tubes	Rohrbiegemaschinen	Curvadoras de tuberías	Piegatubi
Pipelayers	Pose-tubes	Rohrleger	Máquinas de colocación de tuberías	Posatubi
Planeloader	Planeloader	Gabelstapler	Carretilla elevadora	Caricatore piani
Plate Compactors	Plaque vibrante	Plattenverdichter	Planchas vibratorias	Costipatrici
Platform Truck	Camion à plateau	Pritschenwagen	Carretilla transportadora	Autocarro piattaforma
Plows	Charrue	Pflüge	Azada	Aratro
Portable Pumps	Pompe portative	Ortsveränderliche Pumpen	Bombas portátiles	Pompa portatile
Post Hole Diggers	Excavatrice	Pfahllochbohrer	Excavadoras de hoyos para postes	Scavatore per pali
Post Hole Drills	Tarière	Pfahllochbohrer	Barrenas para hoyos de postes	Mototrivella
Power Augers	Tarière à moteur	Erd-bohrer	Ahoyadores motorizados	Trivella
Power Blowers	Compresseur à moteur	Leistungsgebläse	Soplantes motorizados	Ventilatore
Power Box Pavers	Finisseur Power Box	Power Box Pavers	Pavimentadoras asfálticas eléctricas	Pavimentatori
Power Broom	Balayeuse	Kehrgerät	Terminadora de superficie eléctrica	Motospazzatrice
Power Brush	Brosse mécanique	Maschinenbetriebe Bürsten	Cepillo motorizado	Motospazzola
Power Buggys	Brouette à moteur	Elektrowagen	Carretillas eléctricas	Carrelli per materiali pesanti
Power Cart	Chariot à moteur	Motorkarren, Kraftkarren	Carretilla motorizada	Carrello motorizzato
Power Carts	Chariot à moteur	Elektrokarren	Carretas eléctricas	Carrelli elettrico

**RU****PL****CZ****HU**

Мотограбли	Grabiarka z silnikiem	Motoros gereblye	Motorový kyprič
Насосы с электродвигателем	Motopompy	Motoros szivattyú	Motorová čerpadla
Газонокосилки	Kosiarki	Fűnyírók	Sekačky
Машины для поверхностного рыхления почвы	Rozdrabiacze	Mulcsozók	Mulčovače
Многофункциональный тягач	Ciągnik wielozadaniowy	Többcélú pótkocsi	Víceúčelový tahač
Многофункциональная машина	Maszyna wieloczynnościowa	Többcélú gép	Víceúčelový stroj
Многофункциональные пилы	Pilarki wieloczynnościowe	Többcélú fűrész	Víceúčelové pily
Естественное всасывание	Wolnossáçe	Természetes szellőzésú	S přirozeným nasáváním
Природный газ	Gaz ziemny	Földgáz	Zemní plyn
Не предусмотрено	Niewystający	Nem kivetített	Neindukční
Без резистора	Bez rezystora	Ellenállás nélkül	Bez rezistoru
Стандартная эксплуатация	Praca normalna	Normál üzem	Normální provoz
Внедорожный автофургон	Pojazdy terenowe	Terepjáró haszonjárművek	Terénni užítkové vozidlo
Внедорожный автомобиль	Górnozaworowy OHV	Felülselepeelt	OHV
Машины для сверления с масляным охлаждением	Wiertnice do ropy naftowej	Olajfúrók	Vrtné věže
Более старые модели	Starsze modele	Régebbi típusok	Starší modely
Другие модели	Inne modele	Egyéb típusok	Jiné modely
Печи	Piece	Sütők	Pece
Краскораспылитель	Rozpylacz do farby	Festékszórók	Stříkací zařízení
Оборудование для укладки тротуаров	Urządzenia do chodników	Aszfalterítő gépek	Asfaltovací zařízení
Нарезчики швов в бетонном дорожном покрытии	Piły do chodników	Aszfaltvágók	Silniční frézy
Машины для устройства дорожного покрытия	Brukarka	Aszfalterítők	Asfaltovací stroje
Дорожные катки	Ubijarka do chodników	Aszfalttömörítők	Zhutňovače asfaltu
Машины для мощения тротуаров	Maszyny do nawierzchni drogowych	Aszfaltozógépek	Asfaltovací stroje
Самоходные погрузчики	Ładowarki	Rakodógépek	Lopatové nakladače
Комбайн для уборки арахиса	Kombajn do orzeszków ziemnych	Mogyorókombajn	Speciální kombajn
Газонокосилки под управлением человека	Kosiarki do trawników nieasmobieźne	Kézi fűnyírók	Ruční sekačky
Бензин	Benzyna	Benzin	Benzín
Экскаваторы	Koparki podsiębiejne samojezdne	Felszedő rakodók	Sběrací rypadla
Трубогибы	Giętareki do rur	Csőhajlítók	Ohýbače trubek
Трубоукладчики	Układarki do rur	Csőfektetőк	Pokladače potrubí
Аэродромный автопогрузчик	Planeloader	Síktöltők	Letištní nakladač
Виброукладчики плит	Ubijarka	Lemeztömörítők	Deskové zhutňovače
Автопогрузчик с безбортовой платформой	Pojazd ciężarowy z platformą ładunkową	Platóс teherautó	Valníkový nákladní vůz
Плуги	Pługi	Ekék	Pluhy
Портативные насосы	Pompy przenośne	Mobil szivattyúk	Přenosná čerpadla
Буры-столбоставы	Wiertnice do otworów	Oszlopfúrók	Půdní rypadla
Буры для изготовления ям для столбов	Wiertnice do otworów	Oszlopfúrók	Půdní vrtáky
Механические буровые станки	Świdry z napędem	Motoros csigafúrók	Motorové spirálové vrtáky
Вентиляторы	Dmuchawy z napędem	Motoros fűvógépek	Motorová dmychadla
Укладчики с разгрузочным транспортером	Rozścielacze samobieźne	Aszfalterítők	Asfaltovací stroje
Механическая щетка	Zamiatarka samobieźna	Seprógép	Zametací stroje
Щетки с электроприводом	Szczotka z napędem	Motoros kefe	Kartáčovací zařízení
Мототележки	Miniwytrotki	Őnjáró talicska	Nákladní čtyřkolky
Самоходная тележка	Wózek samobieźny	Őnjáró kocsi	Motorový vozík
Самоходные тележки	Wózki samobieźne	Őnjáró kocsi	Motorové vozíky

GB	F	D	E	IT
Power Equipment mots	Moteur pour machines	Motoren für Vorrichtungen	Motores de maquinaria	Motore per attrezzature varie
Power Screed	Planeuse à moteur	Motorbetriebene Abgleichbohlen	Reglón motorizado	Motofinitrice
Power Screeds	Règle vibrante	Angetriebene Bohlen	Niveladoras eléctricas	Rasiere elettriche
Power Sprayers	Pulvérisateur à moteur	Motorbetriebene Zerstäuber	Rociadoras motorizadas	Motospruzzatore
Power Sweepers	Balayeuse à moteur	Motorbetriebene Kehrmaschinen	Barredoras motorizadas	Motospazzatrice
Power Trowels	Truelle mécanique	Motorbetriebene Putzkellen	Llanas motorizadas	Motolevigatrice
Powercutters	Tronçonneuse	Motorbetriebene Trennvorrichtungen	Cortadoras motorizadas	Motofresa o mototrancia
Preignition	Préallumage	Frühzündung	Autoencendido	Preaccensione
Pressure Cleaners	Nettoyeur à haute pression	Druckreiniger	Limpiadoras a presión	Pulitrice a pressione
Pressure Washers	Nettoyeur à haute pression	Druckscheiben	Lavadoras a presión	Lavatrice a pressione
Projected	bec projeté	Vorgezogene Isolatorspitze	Aisalador proyectado	Spergente
Pruners	Cisaille, sécateur	Okulirmesser, Gartenmesser	Tijeras de podar	Potatrice
Pruning System	Système d'émondage, système d'ébranchage	Motorbetriebene Gartensägen	Sistema podador	Sistema di potatura
Pulse Generator Ignition :	Allumage à générateur d'impulsions	Impulsengeneratorgesteuerte Zündung:	Encendido de generadores de impulsos	Pavimentatrice stradale
Pulverizer	Broyeur	Prallmühlen	Pulverizador	Erpice frangizolle
Push & Self-Propelled	A pousser ou autotractée	Schub- und Eigenantrieb	Autopropulsado	A spinta e da propulsione autonoma
Rack Runner	Chariot de préparation	Regalbestücker	Apiladora	Guida a cremagliera
Rakes	Râteau	Rechen, Harken	Rastrillos	Rastrello
Rammer	Dame	Rammen, Erdrammen	Pisón	Piantatrice
Rammers	Dames	Stampfer	Martillos neumáticos	Costipatori
Reach	Longueur de filetage	Gewindelänge	Longitud de rosca	Raggio
Refrigeration Units	Appareil réfrigérant	Kälteeinrichtungen	Grupos frigoríficos	Gruppo di refrigerazione
Refrigerator Compressor	Compresseur pour frigo	Kälteverdichter	Compresor de frigorífico	Compressore per refrigeratore
Regular heads	Culasse standard	Gußeisen (Normaler) Zylinderkopf	Culata estándar	Testate normali
Replacement Engine	Moteur en échange standard	Ersatzmaschine	Motor de recambio	Motore di scorta
Resistor	Résistance	Entstörte Kerze	Resistencia	Resistore
Riding Equipment	Equipement Tondeuse autoportée	Häufelvorrichtung	Equipo con asiento	Macchina con postazione di guida
Riding Mowers	Tondeuse Autoportée	Dammäher	Segadora con asiento	Tosaerba con postazione di guida
Road Equipment	Engin de génie civil	Straßenbauvorrichtungen	Maquinaria para carreteras	Attrezzatura stradale
Roller Screeds	Règle à rouleaux	Walzenbohlen	Niveladoras de rodillos	Livellatrici a rullo
Rollers	Rouleau compresseur	Walzen	Apisonadoras	Rullo
Root Remover	Machine a déraciner	Kultivator	Desbrozadora	Estirparadici
Rotary Tillers	Emotteuse	Sternkrümelwalze	Cultivadoras giratorias	Barra rotante
Rotobrooms	Balai rotatif	Rotierende Besen	Terminadoras de superficie rotatorias	Rotospazzatrici
Saws	Scie	Sägen	Sierras	Sega
Scarifiers	Scarificateur	Vertikutierer	Escarificadoras	Scarificatori
Scooter Loader	Scooter Loader	Scooter-Lader	Cargador de remolque	Sollevatore scooter
Screeds	Règle	Estriche	Niveladoras	Rasiere
Seeder	Semeuse	Sämaschinen	Sembradora	Seminatrice
Severe Service	Service intensif	Starke Beanspruchung	Servicio duro	Impiego gravoso
Sewer Cleaners	Camion hydrocureur	Kanalreinigungsggeräte	Máquinas de limpieza de canalizaciones	Autospurghi
Shearers	Tondeuse (Moutons)	Schrämmaschinen	Cizalladoras	Tosatrice
Shielded	Blindé	Abgeschirmt	Blindada	Schermata
Shielded	Blindé	Abgeschirmt	Blindado	Schermato
Shovels	Pelleteuse	Schaufeln	Palas	Pale
Shredders	Broyeur, déchiqueteur	Shredder, Fräsen	Trituradoras	Spezzettatrice; trinciatrice
Shuttle Wagon	Shuttle Wagon	Pendelwagen	Tractor de arrastre	Carro navetta



**RU**

**PL**

**CZ**

**HU**

Оборудование с электроприводом	Silniki napędowe do urządzeń	Szerszámgépmotorok	Motorok pro energetické zařízení
Разравнивающий брус с электроприводом	Równiarka z napędem	Simítógép	Motorový finišér
Механические виброрейки	Równiarka z napędem	Simítógép	Motorové finišéry
Разбрызгиватели с электроприводом	Opryskiwacz z napędem	Szórógép	Sřřikací zařízení
Уборочные машины с электроприводом	Zamiatarka z napędem	Kefélógép	Motorové zametací stroje
Затирочные лопаты с электроприводом	Układarki z napędem	Vakológép	Strojní hladičky
Режущие станки с электроприводом	Obcinarki z napędem	Vágógép	Motorové pily
Предварительное зажигание	Zapłon wstępny	Előgyújtás	Předzápal
Машины для очистки под давлением	Czyszczarki ciśnieniowe	Nagynyomású tisztítók	Tlakové čistěčky
Омыватели с высоким давлением	Myjki ciśnieniowe	Nagynyomású mosók	Tlaková mycí zařízení.
Предусмотрено	Wystający	Kivetített	Indukční
Секаторы	Nożyce	Metszőgépek	Prořezávače
Система подрезки деревьев	Układ obcinający	Metszőrendszer	Prořezávací systém
Зажигание от генератора импульсов:	Zapłon z generatora impulsowego	Impulzusgenerátoros gyújtás:	Pulsní zapalování:
Пульверизатор	Pulweryzator	Porlasztó	Práškováče
Толкаемые и самодвижущиеся	Niesamobieżne i samobieżne	Kézi és önjáró	Tažné a samohybný
Штатив	Podnośnik regałowiy	Sínfutó	Rack Runner
Грабли	Grabiarki	Gereblyék	Hrábě
Молот	Ubijak	Tömörítő	Pěchovadlo
Трамбовки	Ubijaki	Tömörítők	Pěchovadla
Охват	Zasięg	Elérés	Dosah
Холодильные установки	Zamrażarki	Hűtőegységek	Chladicí jednotky
Рефрижераторный компрессор	Sprężarka zamrażarki	Hűtő-kompresszor	Kompresor chlazení
Стандартные головки	Głowice normalne	Szokásos fejek	Běžné hlavy
Двигатель на замену	Silnik zamienny	Cseremotor	Náhradní motor
Резистор	Rezystor	Ellenállás	Rezistor
Машины, на которых едет оператор	Urządzenia samobieżne	Önjáró berendezés	Jezdecké zařízení
Газонокосилки с едущим оператором	Kosiarki samobieżne	Önjáró fűnyíró	Pojezdové sekačky
Дорожное оборудование	Urządzenia drogowe	Közúti berendezés	Silniční zařízení
Приспособления для разравнивания валиком	Równiarki walcowe	Görgős simítók	Válcovací finišér
Бегунки	Walce	Görgők	Válce
Машина для удаления корней	Usuwacz korzeni	Gyökéreltávolító	Odstraňovač kořenů
Почвообрабатывающие фрезерные машины	Glebogryzarki rotacyjne	Forgókapa	Rotační kypřiče
Роторные щетки	Zamiatarki ze szczotkami obrotowymi	Forgókefék	Rotační zametače
Пилы	Pilarki	Fűrészek	Pily
Скарификаторы	Spulchniarki	Kapálógépek	Rozrývače
Скутеры-погрузчики	Podnośnik platformowy	Kerekesszék emelő	Elektrický nakladač
Разравнивающие брусы	Równiarki	Simítók	Finišéry
Сеялка	Siewnik	Vetőgép	Secí stroje
Тяжелые условия эксплуатации	Praca ciężka	Nehéz üzem	Náročný provoz
Приспособления для очистки коллекторов и труб	Czyszczarki do kanałów	Csatormatisztítók	Čistěčky kanalizace
Стригальные машины	Wrębiarki	Nyírógépek	Strojní nůžky
Экранированный	Oslonięty	Védőlemez	Stíněný
Экранированный	Oslonięty	Védőlemez	Stíněný
экскаватор	Koparki jednoczerpakowe	Ásógépek	Lopatová rypadla
Уничтожители	Rozdrabniacze	Aprítógép	Drtiče
Челночная грузовая тележка	Przetaczarka do wagonów	Sínautók	Drezína

GB	F	D	E	IT
Sidedraft	Alimentation latérale	Seitlicher Vergaser	Corriente lateral	Pescaggio laterale
Skid-Loaders	Chargeuse à direction à glissement	Kompaktlader	Palas cargadoras	Miniescavatori
Skid-Steers	Chargeuse à direction à glissement	Lenkbare Kompaktlader	Miniexcavadoras	Skid-steers
Slab Surface Grinders	Rectifieuse plane à dalles	Steinplatten-Schleifmaschinen	Rectificadoras planas de bloques	Rettificatrici superfici lastre
Snow Removers	Déneigeuse	Schneepflüge	Quitanieves	Spazzaneve
Snowmobiles	Auto-neige, moto-neige	Schneemobile	Vehiculos para nieve	Motoslitta
Snowthrowers	Chasse-neige avec éjection de la neige	Schneekanonen, Schneepflüge	Lanzanieves	Sparabeve
Sod-Cutters	Coupe-gazon, tranche-gazon	Grasnarbenschneider, Rasendeckenschneider	Cortacéspedes	Taglia-zolle
Space Heaters	Radiateur soufflant	Raumheizungen	Calefactores	Riscaldatore d'ambiente
Speedcranes	Grue automotrice rapide	Kräne mit Selbstfahrantrieb	Grúas móviles	Gru
Speedrowers	Andaineuse automotrice	Schwadleger mit Selbstfahrantrieb	Segadoras	Andanatrici
Spray Rigs	Equipement de pulvérisation	Sprührigg	Máquinas pulverizadoras	Impianti di nebulizzazione
Sprayer	Pulvérisateur	Zerstäuber, Sprühzerstäuber	Rociador	Spruzzatore
Sprayers	Pulvérisateur	Zerstäuber	Pulverizadores	Irroratrici
Spreader	Epandeuse	Streuer	Distribuidora	Concimatrice
Stackers	Gerbeur	Stapler, Stapleinrichtungen	Apiladoras	Accatastatore; impilatore
Standard ignition	Allumage standard	Standard Zündung	Encendido estándar	Accensione standard
Starting Engines	Démarrur	Starthilfe Motoren	Motores de arranque	Motori di avviamento
Starting mots. for diesels	Démarrur pour Diesel	Anwerfmotoren für Dieselmotoren	Motores de arranque para motores Diesel	Motorino di avviamento per diesel
Stationary mots	Moteur stationnaire	Standmotoren, ortsfeste Motoren	Motores fijos	Motore stazionario
Steam Cleaners	Nettoyeur à vapeur	Dampfreiniger	Máquinas de limpieza por chorro de vapor	Dispositivi di lavaggio a getto di vapore
Stern drive	Transmission en Z	Z-Antrieb	Propulsor de popa	Entrofuorbordo
Stern drive	Transmission en Z	Z-Antrieb	Propulsor de popa	Gruppo poppiero
Stompers	Pilonneuse	Stampfer	Apisonadoras	Costipatori
Straddle Carriers	Chariot cavalier	Portalstapler	Carretillas pórtico	Straddle Carrier
Straddle Cranes	Grue portique	Torkräne	Grúas con estructura elevadora	Gru a carroponete
String Trimmers	Presse à faire des balles	Ballengarnspanner	Cortahebras	Rifilatrice
Stroke	Course du piston	Takt	Tiempos / Ciclos	Tempi
Stroke	2 temps, 4 temps	Takt	Tiempos / ciclos	Tempi (cicli)
Structural Panel Movers	Dépilleur de panneaux structuraux	Bauplatten-Transportmaschinen	Máquinas para mover paneles estructurales	Carrelli portapannelli strutturali
Stump Cutters	Machine à couper les souches	Stubbenschneider	Cortatocones	Taglia-ceppi
Stump Removers	Machine à déraciner, déracineuse	Baumstumpfpräumer, -zieher	Quitatocones	Estirpator di ceppi
Super Rake	Super râteau	Super-Rechen, -Harke	Superrastrillo	Super rastrello
Surface Grinders & Planers	Rectifieuse plane et raboteuse	Flächenschleifmaschinen und Abrichtobelmaschinen	Rectificadoras planas y aplanadoras	Rettificatrici & piallatrici per piani
Sustained full throttle	Utilisation permanente en pleine charge	Beidauerndem Vollasbetrieb	Funcionamiento continuado a plena carga	Per prolungata alta velocità
Sustained full throttle operation	Utilisation permanente en pleine charge	Bei dauerndem Vollastbetrieb	Funcionamiento continuado a plena carga	Per funzionamento prolungato a pieno carico
Swather	Faucheuse	Schwader	Hileradora	Falciatrice
Sweepers	Balayeuse	Kehrmaschine	Barredoras	Spazzatrice; motospazzatrice
Tampers	Bourreuse	Stampfer, Bodenverfestiger, Erdrammen	Máquinas de apisonar	Costipatore
Tamping Rammer	Machine à bourrer et à damer	Schafußramme	Pisón compactador	Martello costipatore
Tamping Rammers	Pilonneuse	Schafußrammen	Apisonadoras compactadoras	Costipatori
Tapered seat	Siège conique	Konussitz	Asiento cónico	Sede conica
Tapered seat	Siège conique	Konussitz	Asiento cónico	Sede conica
Thatchers	Machine à chaumer	Vertikutierer	Empajadoras	Coperture
Thread Size	Diam. du filet	Gewindedurchmesser	Diametro de rosa	Filettatura

**RU****PL****CZ****HU**

Горизонтальный поток воздуха	Wtrysk	Oldalirányú szivás	Boční tah
Бульдозеры с захватом для леса	Miniładowarki	Kompakt markológép	Smykem řízené nakladače
Погрузчики с боковым поворотом	Miniładowarki	Kompakt rakodógép	Kompaktní nakladače
Ленточно-шлифовальные станки	Szlifierki do płaszczyzn	Betonfödém-csiszológépek	Soupravy pro broušení betonu
Снегоборочные машины	Odśnieżarki	Hókotrók	Sněhové frézy
Снегоходы	Skutery śnieżne	Hószánok	Sněžné skútry
Снегоборочные машины	Odśnieżarki	Hómarók	Sněhové frézy
Дерноснайматели	Maszyny do cięcia darni	Gyepvágók	Řezačky dmu
Обогреватели помещений	Ogrzewacze pomieszczeń	Beltéri fűtések	Teplomety
Мобильные краны	Dźwigi hydrauliczne	Gyorsdaruk	Rychlojeřáby
Косилки	Żniwiarki pokosowe	Gyorsevezők	Speedrowers
Установки для опрыскивания	Opryskiwacze	Permetezőkocsik	Postřikové rámy
Пульверизатор	Opryskiwacz	Permetező	Postřikovač
Распылители	Spryskiwacze	Permetezők	Střikací zařízení
Приспособление для раскладки	Układarka	Terítők	Rozhrnovač
Сенокосилители	Zwałowarki	Rakodók	Stohovače
Стандартное зажигание	Zapłon standardowy	Standard gyújtás	Standardní zapalování
Пусковые двигатели	Silniki rozruchowe	Indítomotorok	Startovací motory
Пусковые электродвигатели для дизельных двигателей	Silniki rozruchowe do diesli	Dízel indítomotorok	Startéry pro naftové motory
Стационарные электродвигатели	Silniki stacjonarne	Állomotorok	Stacionární motory
Пароочистители	Oczyszczacze parowe	Góztisztítók	Parní čističe
Поворотно-откидная колонка	Napęd łopatkowy	Csavarhajtás	Pohon kormidla
Поворотно-откидная колонка	Napęd łopatkowy	Csavarhajtás	Pohon kormidla
Уплотнители	Stompery	Tömörítők	Pěchovací stroje
Погрузчики для длинномерных материалов	Wozy bramowe	Portálrakodó	Portálové nosiče
Самоходные козловые краны-погрузчики	Dźwigi bramowe	Portáldaru	Portálové jeřáby
Триммеры	Podkaszarki	Huzalos szegélynyírók	Strunové sekačky
Ход	Suw	Lökét	Zdvih
Ход	Suw	Lökét	Délka zdvihu
Устройства для перемещения строительных панелей	Wóz do transportu płyt warstwowych	Szerekezeti lemez mozgató	Zařízení pro manipulaci s panely
Измельчители пней	Maszyny do wycinania korzeni	Tönkvágók	Frézy na pařezy
Машины для корчевания пней	Maszyny do karczowania	Tönkeltávolítók	Odstraňovač pařezů
Грабли	Grabiarka	Gyepgereblye	Motorové hrábě
Плоскошлифовальные станки и строгальные станки	Szlifierki do płaszczyzn i strugarki	Felületcsiszoló- és gyalugépek	Soupravy pro broušení a rovnání podkladů
Поддерживаемый полный дроссель	Długotrwała praca przy pełnym otwarciu przepustnicy	Folyamatos teljes gáz	Stálý plný plyn
Поддерживаемый полный дроссель	Długotrwała praca przy pełnym otwarciu przepustnicy	Folyamatos teljes gáz	Trvalý provoz na plný plyn
Валкоукладчик	Żniwiarka	Rendrevágó	Řádkovací žací stroj
Уборочные машины	Zamiatarki	Sepřógépek	Zametací stroje
Трамбовки	Podbijarki	Tömörítők	Zhutňovače
Трамбовочный молот	Ubijarka udarowa	Tömörítő	Zhutňovací pěchovadlo
Трамбовочные машины	Podbijarki	Döngölőbékák	Zhutňovací pěchovadla
Коническое седло	Gniazdo stożkowe	Ferde ülék	Kúželové sedlo
Коническое гнездо	Gniazdo stożkowe	Ferde ülés	Kúželové sedlo
Газонокосилки	Skaryfikatory	Nádvágók	Vyhrabávače
Размер резьбы	Rozmiar gwintu	Menetméret	Velikost závitu

GB	F	D	E	IT
Thunderbolt ignition	Allumage 'Thunderbolt'	Thunderbolt Zündung	Encendido 'Thunderbolt'	Inietture 'Thunderbolt'
Tillers	Fraiseuse de labour, motobèche	Krümelwalzen, Ackerfräse, Motorspaten	Cultivadoras	Barra di sterzo
Tower Crane	Grue à tour	Turmkräne	Grúa de torre	Gru a torre
Tracked Carriers	Transporteur chenillé	Kettenfahrgestelle	Mecanismos de transporte de oruga	Autocarri cingolati
Tractor Mowers	Tracteur tondeuse	Schleppermähgeräte	Segadoras de tractor	Trattore tosaerba
Tractor Shovel	Chargeuse pelleteuse	Anbauschaufel	Pala de tractor	Trattore Pala
Tractor Shovels	Chargeuse pelleteuse	Anbauschaufeln	Tractocargadoras	Pale trattore
Tractors	Tracteur	Zuggeräte, Schlepper	Tractores	Trattore
Trenchers	Creuseur de tranchées	Grabenzieher	Zanjadoras hidráulicas	Scavatrincee; scavafossi
Trimmers	Taille-haies	Besäum-, Beschneidemesser	Recortadoras	Rifilatrice
Troweling Machines	Talocheuse	Spachtelgeräte	Máquinas de llanura	Fratazzatrice
Truck	Camion	Lastwagen	Camión	Autocarro
Truck Mixers	Camion malaxeur, camion toupie	Transportbetonmischer	Camiones hormigonera	Autobetoniere
Turf Equipment	Matériel de jardinage	Rasendeckenanlagen	Equipo para césped	Attrezzatura per torba
Turf Tractors	Tracteur à gazon	Rasentraktoren	Tractores sembradores de césped	Trattore agricolo
Turf Vacuums	Aspirateur à gazon	Rasendeckenstaubsauger	Aspiradoras de césped	Aspiratore di torba
Uni-loader	Mini-chargeuse	Lader	Pala cargadora	Minipale
Unshielded	Non blindé	Nicht abgeschirmt	Sin blindar	Non schermato
Utility Engines	Moteur utilitaire	Nutzmotoren	Motores de las utilidades	Motori di servizio
Utility Vehicles	Véhicule utilitaire	Nutzfahrzeuge	Vehículos utilitarios	Veicolo ausiliario
Vac. Blowers	Pompe centrifuge à vide	Unterdruckgebläse, Vakuumsauger	Soplantes por vacío	Compressore a vuoto
Vacuum Cleaners	Aspirateur	Staubsauger	Aspiradoras	Pulitrice a vuoto
Vacuum Collectors	Aspirateur collecteur	Staubsammler, -abscheider	Recogedoras por vacío	Accumulatori di vuoto
Vacuums	Aspirateur	Unterdruck, Luftleere	Aparatos de aspiración	Vuoto; depressione
Vibrators	Vibreur, secoueur	Schwingungserzeuger, Rüttler	Vibradoras	Vibratore
Vibratory Plate Compactors	Plaque vibrante	Rüttelplatten	Placas vibrantes	Costipatori a pala vibrante
Washer	Laveuse	Waschgeräte	Limpiador	Dispositivo di lavaggio
Waste Grinder	Broyeur de déchets	Abfallzerkleinerer	Trituradora de residuos	Polverizzatrice di rifiuti
Water Pumps	Pompe à eau	Wasser[umwälz]pumpen	Bombas de agua	Pompa dell'acqua
Weed Cutters	Sécateur	Unkrautschneider	Desherbadoras	Tagliaerbacce; sarchiatrice
Welders	Appareil à souder	Schweißvorrichtungen, -geräte	Soldadoras	Saldatrice
Well Drills	Foreuse de puits	Brunnenbohrgeräte	Mecanismos de perforación	Trivellatrici per pozzi
Wheel Barrow	Brouette	Schubkarren	Terrillo metálico de una rueda	Carriola
Wheel Tractors	Tracteur sur pneus	Raupenschlepper	Tractores de ruedas	Trattori a ruote
Windrowers	Andaineuse	Schwadleger	Hileradoras	Andinatori
Wood Splitters	Fendeur de bois	Holzspalter	Hendedoras de madera	Spaccalegna



RU

PL

CZ

HU

Электронное зажигание	Thunderbolt ignition	Szikracsavaros gyújtás	Zapalování Thunderbolt
Почвенные фрезы	Glebo Gryzarki	Forgókapák	Kypříče
Башенный кран	Żuraw wieżowy	Toronydaru	Věžový jeřáb
Гусеничные погрузчики	Transporter gąsienicowy	Láncfalpas hordozók	Pásové nosiče
Тракторные косилки	Kosiarki traktorowe	Fűnyírótraktorok	Motorové sekačky
Ковшовый погрузчик	Ładowarka łyżkowa	Traktoros ásógép	Lopatový nakladač
Ковшовые погрузчики	Ładowarka łyżkowa	Traktoros ásógép	Lopatové nakladače
Тракторы	Ciągniki	Traktorok	Traktory
Траншейные экскаваторы	Koparki do rowów	Árokásók	Příkopová rypadla
Машины для обрезки	Przycinarki	Szegélyvágók	Ostříhovače
Затирочные машины	Ukladarki kielniowe	Vakológépek	Stroje na hlazení omítek
Грузовик	Pojazd ciężarowy	Teherautó	Nákladní vozidlo
Автобетономешалка	Mieszarki na podwoziu samochodowym	Betonkeverős teherautó	Domichávače
Оборудование для работы с дерном	Urządzenia do darni	Gyepgépek	Zařízení pro údržbu trávniků
Газонные тракторы	Miniciągniki ogrodowe	Gyeptraktorok	Zahradní traktory
Пылесосы для дерна	Odkurzacze do darni	Gyeporszívók	Zahradní vysavače
Универсальный погрузчик	Ładowarka uniwersalna	Unirakodó	Univ. nakladač
Неэкранированный	Nieosłonięty	Védőlemez nélküli	Nestíněný
Промышленные двигатели	Silnik uniwersalny	Ipari motorok	Užitkové motory
Грузопассажирские автомобили	Pojazdy wielozadaniowe	Haszonjárművek	Užitková vozidla
Вакуумные Вентиляторы	Odkurzacze-dmuchawy	Vákuumos Fúvatók	Podtl. foukače
Пылесосы	Odkurzacze podciśnieniowe	Porszívók	Vysavače
Вакуумные сборники	Zbieracze podciśnieniowe	Vákuumos felszívók	Vakuové kolektory
Пылесосы	Odkurzacze	Vakuum	Vysavače
Вибраторы	Wibratory	Vibrátorok	Vibrátory
Виброплиты	Ubijarki wibracyjne	Síktömörítő vibrátorok	Vibrační deskové zhutňovače
Очиститель	Pralnica	Mosógépek	Mycí stroj
Мусородробилка	Rozdrabniacz do odpadów	Hulladékdarálók	Stroje na mletí odpadu
Водяные насосы	Pompy do wody	Vízszivattyúk	Vodní čerpadla
Устройства для уничтожения сорняков	Wycinarki do chwastów	Gyomvágók	Křovinořezy
Сварочные аппараты	Spawarki	Hegesztőgépek	Svářečky
Буровые установки	Wiertnice	Kútfúrók	Vrtací soupravy
Тележка на колесах	Taczka	Kerekes talicska	Kolečka
Колесные тракторы	Ciągniki kołowe	Gumikerekes traktorok	Kolové traktory
Рядовые жатки	Żniwiarki pokosowe	Rendsodrók	Řádkovače
Дровоколы	Rębaki do drewna	Rönkhasítók	Štípačka dříví

**OE#****OE#**

<b>OE005</b>	RC9YC
<b>OE006</b>	RN9YC
<b>OE011</b>	RS9YC
<b>OE013</b>	RC12YC
<b>OE018</b>	RN7YC
<b>OE039</b>	RC9YC4
<b>OE041</b>	RC12LYC
<b>OE042</b>	RN12YC
<b>OE049</b>	RN11YC4
<b>OE051</b>	RN11YC
<b>OE059</b>	L92YC
<b>OE064</b>	RL82YC
<b>OE073</b>	RA4HC
<b>OE081</b>	RC8YCC4
<b>OE083</b>	RA6HC
<b>OE086</b>	RL82C
<b>OE091</b>	RN2C
<b>OE098</b>	RN4C
<b>OE108</b>	RN3C
<b>OE116</b>	RN6YC
<b>OE134</b>	RC12PYP
<b>OE135</b>	REC14PYC
<b>OE148</b>	REC10YC4
<b>OE156</b>	RN13LYC

<b>L92YC</b>	OE059
<b>RA4HC</b>	OE073
<b>RA6HC</b>	OE083
<b>RC12LYC</b>	OE041
<b>RC12PYP</b>	OE134
<b>RC12YC</b>	OE013
<b>RC8YCC4</b>	OE081
<b>RC9YC</b>	OE005
<b>RC9YC4</b>	OE039
<b>REC10YC4</b>	OE148
<b>REC14PYC</b>	OE135
<b>RL82C</b>	OE086
<b>RL82YC</b>	OE064
<b>RN11YC</b>	OE051
<b>RN11YC4</b>	OE049
<b>RN12YC</b>	OE042
<b>RN13LYC</b>	OE156
<b>RN2C</b>	OE091
<b>RN3C</b>	OE108
<b>RN4C</b>	OE098
<b>RN6YC</b>	OE116
<b>RN7YC</b>	OE018
<b>RN9YC</b>	OE006
<b>RS9YC</b>	OE011



 **FEDERAL  
MOGUL**





CC BHP

21



OPT.



mm

**AALADIN****Pressure Washers**

Kohler OHV			OE013	RC12YC	0.8
Briggs & Stratton Vanguard V-Twin				RC14YC	0.8
Wisconsin	11			RD16	0.6
Kohler	10,12,23			RH10C	0.8
Briggs & Stratton	5,8,11,18			RJ19LM	QJ19LM 0.8
Tecumseh				RJ8C	0.8
Honda OHV			OE051	RN11YC	0.8
Kohler Twin				RV17YC	0.8

**AA-TACH****Sweepers**

EH65V (V-Twin), EH65X			OE006	RN9YC	0.6
EY21	Wisconsin			RJ8C	0.6
	Robin OHV	20,20.5	OE006	RN9YC	0.6

**ACE****Lawn Mowers**

Briggs & Stratton	3.5,4,5			RJ19LM	QJ19LM 0.8
-------------------	---------	--	--	--------	------------

**Pumps**

Briggs & Stratton	3			RJ19LM	QJ19LM 0.8
-------------------	---	--	--	--------	------------

**Riding Equipment**

Briggs & Stratton	3,5,8,10,5,12,18			RJ19LM	QJ19LM 0.8
-------------------	------------------	--	--	--------	------------

**ACME****Garden Tractors**

Clinton				RJ8C	0.8
---------	--	--	--	------	-----

**Generators**

(18mm)				RD16	0.8
--------	--	--	--	------	-----

**Lawn Mowers**

All Models				RJ19LM	0.8
------------	--	--	--	--------	-----

**Power Equipment**

ACT280	OHC	9	OE013	RC12YC	0.8
ACT340	OHC	11	OE013	RC12YC	0.8

**Pumps**

(Kerosene)	(18mm)			D21	0.8
	(14mm)			L90C	0.8
	(18mm)			RD16	0.8
	(14mm)			RL86C	0.8

**ACME MOTORI****Engines**

(Kerosene)	(18mm)			D21	0.8
	(14mm)			L90C	0.8
ACT280	OHC	9	OE013	RC12YC	0.8
ACT340	OHC	11	OE013	RC12YC	0.8
	(18mm)			RD16	0.8
	(14mm)			RL86C	0.8

**ACR EASE****Mowers**

Wing	Kohler OHV	12.5,14,15,20	OE013	RC12YC	1.0
	Briggs & Stratton	8,12		RJ19LM	QJ19LM 0.8
		17	OE098	RN4C	0.8
Wing 223000>	Tecumseh OHV	12.5,13	OE098	RN4C	0.8

**AERA-VATOR****Aerators**

Briggs & Stratton	8			RJ19LM	QJ19LM 0.8
Honda OHV	8,11		OE051	RN11YC	0.8

**AGGRESSOR****Trimmers**

Echo				RCJ8	0.8
------	--	--	--	------	-----



CC

BHP

21



OPT.

mm

**AGRIA**

**Brushcutters**

300	Rotax			D14		0.5
3400	MAG 4-Cycle			RL86C		0.6
	Rotax 2-Cycle			RL86C		0.6
5100	Kawasaki			RCJ8		0.5
5200	B & S			RJ19LM	QJ19LM	0.5
5300	B & S			RJ19LM	QJ19LM	0.5
5400	Rotax			D14		0.5
5500	Rotax 4-Cycle			D14		0.5
	Rotax 2-Cycle			RL86C		0.5
IT 25	Kawasaki			CJ6		0.5
IT 35, 45, 48				CJ6		0.5

**Cultivators**

400	B & S	3.5		RJ19LM	QJ19LM	0.6
5200	B & S			RJ19LM	QJ19LM	0.5
5300	B & S			RJ19LM	QJ19LM	0.5

**Motor Cultivators**

200	B & S 4-Cycle			RJ19LM	QJ19LM	0.5
	F & S 2-Cycle			RL86C		0.5
500	Kawasaki			RJ17LM		0.5
2100		4.5		D14		0.5
3000		4.5		D14		0.5
3001	Minsel			RL86C		0.7
3100	B & S 4-Cycle			RJ19LM	QJ19LM	0.5
6000		6.5		D14		0.5
100 - 3	B & S			RJ19LM	QJ19LM	0.5
100 - 4	B & S			RJ19LM	QJ19LM	0.5
100 - 5	B & S			RJ19LM	QJ19LM	0.5
1000 - 4	B & S			RJ19LM	QJ19LM	0.5
3100 (L101)	JLO 2-Cycle	4.5		RJ17LM		0.5

**Mowers**

5200R	Hirth	3.5		D9		0.5
	Aspera	3.5		RJ17LM		0.5
	F & S	3.5		RL86C		0.5
All Models	B & S			RJ19LM	QJ19LM	0.7
SW 519, 521, 621	Iseki / Kawasaki			OE051	RN11YC	0.6

**Snowthrowers**

7200 - 11	B & S	12.5		RJ19LM	QJ19LM	0.5
7200 - 2	Tecumseh	2		RJ12YC		0.5
7200 - 8	B & S	8		RJ19LM	QJ19LM	0.5

**Tractors**

2400	JLO 2-Cycle			RL86C		0.5
	MAG 4-Cycle			RL86C		0.5
3200	Kawasaki	6		RJ8C		0.5
3400	Rotax			RL86C		0.5
5500	MAG 4-Cycle			RL86C		0.5
	Rotax 2-Cycle			RL86C		0.5
6300	Renault	27		RL87YC		0.6
9300	Renault	25		RL87YC		0.6
6900 - 1	Renault	26		RL87YC		0.6
6900 - 2	Renault	35		RL87YC		0.6

**AGRICAT**

**Garden Tractors**

All Models				RD16		0.6
------------	--	--	--	------	--	-----

**AGRI-FAB**

**Mowers**

Trailmowers	Briggs & Stratton	14.5		OE013	RC12YC	QC12YC / XC92YC	0.8
	Briggs & Stratton	8,10,11,12			RJ19LM	QJ19LM	0.8

**Tillers**

	Briggs & Stratton	5			RJ19LM	QJ19LM	0.8
--	-------------------	---	--	--	--------	--------	-----

**Vacuums**

	Briggs & Stratton	5,8			RJ19LM	QJ19LM	0.8
	Tecumseh	8			RJ19LM		0.8



CC BHP

21



OPT.



## AGRIMETAL

### Power Equipment

Briggs & Stratton	13		RJ19LM	QJ19LM	0.8
Briggs & Stratton Twin	18		RJ19LM	QJ19LM	0.8
Honda OHV	11	OE051	RN11YC		0.8
Kohler Twin	18		RV17YC		0.6

## AGROMATIC

### Mulchers

Briggs & Stratton			RJ19LM	QJ19LM	0.8
Honda OHV		OE051	RN11YC		0.8

## AGROS

### Power Equipment

			RL86C		0.7
--	--	--	-------	--	-----

## AG-TRAC

### Riding Mowers

Briggs & Stratton			RJ19LM	QJ19LM	0.8
-------------------	--	--	--------	--------	-----

## AGTRONIC

### Generators

Briggs & Stratton			RCJ8		0.6
-------------------	--	--	------	--	-----

## AGWAY

### Chain Saws

754			RJ6C		0.8
PL-4, PL-5, PL-6			CJ6		0.8

## AIR RAKE

### Vacuums

Briggs & Stratton	5		RJ19LM	QJ19LM	0.8
-------------------	---	--	--------	--------	-----

## AIR-BROOMS

### Blowers

			RCJ8		0.8
--	--	--	------	--	-----

## AIRCAP

### Lawn Mowers

Briggs & Stratton			RJ19LM	QJ19LM	0.8
Tecumseh			RJ19LM		0.8

## ALAMO

### Flail Mowers

Briggs & Stratton	8,10		RJ19LM	QJ19LM	0.8
Honda	8,11	OE051	RN11YC		0.8

## ALBIN MOTORS

### Pumps

82009	Chrysler		OE086	RL82C	0.6
-------	----------	--	-------	-------	-----

## ALDENS

### Mowers

All Models			RJ19LM		0.8
------------	--	--	--------	--	-----

### Tillers, Tractors

All Models			RJ19LM		0.8
------------	--	--	--------	--	-----

## AL-KO

### Lawn Mowers

Briggs & Stratton			RJ19LM	QJ19LM	0.8
-------------------	--	--	--------	--------	-----

### Shredders

Briggs & Stratton			RJ19LM	QJ19LM	0.8
Tecumseh			RJ8C		0.8



CC BHP

21



OPT.



mm

## ALKOTA

### Pressure Washers

Kohler OHV	12,5,15	OE013	RC12YC		0.8
Kohler V-Twin	18	OE013	RC12YC		0.8
Briggs & Stratton Vanguard V-Twin	16,18,20		RC14YC		0.8
Briggs & Stratton	11		RJ19LM	QJ19LM	0.8
Tecumseh	8		RJ8C		0.8
Honda OHV	5.5,11,13	OE051	RN11YC		0.8
Tecumseh OHV	5.5	OE098	RN4C		0.8

## ALL AMERICAN

### Turf Equipment

Kohler V-Twin	20,25	OE013	RC12YC		0.8
Briggs & Stratton	5,8,11		RJ19LM	QJ19LM	0.8
Kohler	8		RJ19LM		0.6
Kohler Twin	16,18,20		RV17YC		0.6

## ALLEN

### Lawn Mowers

Suzuki	120		RCJ8Y		0.8
Briggs & Stratton	4		RJ19LM	QJ19LM	0.8
Tecumseh			RJ19LM		0.8

## ALLIS-CHALMERS

### Chain Saws

195, 295, 65, 75, 95

RCJ8 0.8

### Lawn Mowers

Briggs & Stratton			RJ19LM	QJ19LM	0.8
-------------------	--	--	--------	--------	-----

### Snow Removers

Tecumseh 2-Cycle			RJ18YC		0.9
Briggs & Stratton			RJ19LM	QJ19LM	0.8
Tecumseh 4-Cycle			RJ8C		0.8

### Turf Equipment

Kohler			RH10C		0.8
Onan			RH8C		0.8
Briggs & Stratton			RJ19LM	QJ19LM	0.8
Briggs & Stratton Twin			RJ19LM	QJ19LM	0.8
Tecumseh			RJ8C		0.8
Kohler Twin			RV17YC		0.6

## ALLSTATE

### Pumps, Compressors & Refrigeration Units

All Models

RJ19LM 0.8

## ALPINA

### Chain Saws

540i, 600i, A330, A40, A438, A70, AP70, AP90, P120, P34S, P400, P41, P45, P450, P540i, P55, P600i, P65, P700, P800, P90

RCJ7Y 0.8

### Lawn Mowers

Tecumseh	3.5,5		RJ19LM		0.8
Honda	4,5.5	OE051	RN11YC		0.8

### Power Equipment

25, 30, 34, 34D, 42, 42D, 42F, 52, 52F, 56T, 66T, VIP21, VIP34F, VIP52D

550.K, 550.M

Elite 402

RCJ7Y 0.8

RCJ7Y 0.8

RJ8C 0.8

## AMERICAN

### Lawn Mowers

Briggs & Stratton			RJ19LM	QJ19LM	0.8
-------------------	--	--	--------	--------	-----

## AMERICAN BRICK SAW

### Concrete Saws

Honda OHV	5.5,6.5,8,9,13	OE051	RN11YC		0.8
-----------	----------------	-------	--------	--	-----



CC

BHP

21



OPT.



mm

## AMERICAN CLEANING EQUIPMENT

### Pressure Washers

Briggs & Stratton Vanguard OHV	9	OE013	RC12YC	QC12YC / XC92YC	0.8
Briggs & Stratton Vanguard V-Twin	16		RC14YC		0.8
Briggs & Stratton	11		RJ19LM	QJ19LM	0.8
Briggs & Stratton	5,8		RJ19LM	QJ19LM	0.8
Honda OHV		OE051	RN11YC		0.8
Wisconsin Twin	30		RN5C		0.9
Kohler Twin	18,20		RV17YC		0.6

## AMERICAN IMC

### Air Compressors

Briggs & Stratton Vanguard OHV	9	OE013	RC12YC	QC12YC / XC92YC	0.8
Honda OHV	5.5	OE051	RN11YC		0.8

## AMERIND-MACKISSIC

### Chain Saws

9-P			RJ8C		0.8
-----	--	--	------	--	-----

### Log Splitters

			RJ8C		0.8
--	--	--	------	--	-----

### Power Equipment

All Models			RCJ8		0.8
------------	--	--	------	--	-----

## AMERQUIP

### Mulchers

Briggs & Stratton Vanguard V-Twin	16		RC14YC		0.8
-----------------------------------	----	--	--------	--	-----

## AMF

### Lawn Mowers

Briggs & Stratton			RJ19LM	QJ19LM	0.8
Tecumseh			RJ8C		0.6

### Power Equipment

Briggs & Stratton			RJ19LM	QJ19LM	0.8
Tecumseh			RJ8C		0.8

### Snow Removers

Briggs & Stratton			RJ19LM	QJ19LM	0.8
Tecumseh			RJ8C		0.8

## AQUA MULCHER

### Power Equipment

Kohler V-Twin	18,20,25	OE013	RC12YC		0.8
Briggs & Stratton Vanguard V-Twin	16		RC14YC		0.8
Briggs & Stratton Vanguard V-Twin	18,20		RC14YC		0.8
Briggs & Stratton Twin	18		RJ19LM	QJ19LM	0.8
Honda OHV	13	OE051	RN11YC		0.8
Honda V-Twin	20	OE051	RN11YC		0.8
Kohler Twin	18		RV17YC		0.6

## AQUA STRIPPER

### Pressure Washers

Briggs & Stratton Intek	5.5	OE013	RC12YC	QC12YC / XC92YC	0.8
Briggs & Stratton Vanguard	13	OE013	RC12YC	QC12YC / XC92YC	0.8
Briggs & Stratton Vanguard OHV	9	OE013	RC12YC	QC12YC / XC92YC	0.8
Briggs & Stratton	11		RJ19LM	QJ19LM	0.8
Briggs & Stratton	5,8		RJ19LM	QJ19LM	0.8
Tecumseh	5,5,8		RJ19LM		0.8
Tecumseh	5		RJ8C		0.8
Tecumseh	6,8,10		RJ8C		0.8
Honda	5,5,11,13	OE051	RN11YC		0.8
Honda OHV	5,5,11,13	OE051	RN11YC		0.8
Tecumseh OHV	5.5	OE098	RN4C		0.8





CC BHP



OPT.



## ARCTIC CAT

### Generators

AC1400G	4-Stroke	119	3.8	OE006	RN9YC	0.6
AC1800GD				OE006	RN9YC	0.6
AC2200G				OE006	RN9YC	0.6
AC2500G	4-Stroke	162	5.3	OE006	RN9YC	0.6
AC2500GD	4-Stroke	162	5.3	OE006	RN9YC	0.6
AC3000GD2	4-Stroke	252	6.8		RL95YC	0.6
AC4000G2	4-Stroke	272	9	OE051	RN11YC	0.6
AC4000GD2E	4-Stroke	272	9	OE051	RN11YC	0.6
AC7500GD2E	4-Stroke	419	14	OE006	RN9YC	0.5
AC750GT	2-Stroke	70	1.8		RL95YC	0.6

## ARCTIC ENTERPRISES

### Lawn Mowers

Briggs & Stratton				RJ19LM	QJ19LM	0.8
Sachs				RL86C		0.8

## ARGO

### Lawn Mowers

Briggs & Stratton				RJ19LM	QJ19LM	0.8
-------------------	--	--	--	--------	--------	-----

## ARIENS

### Lawn Mowers

Sachs SB140				RCJ7Y		0.6
Briggs & Stratton				RJ19LM	QJ19LM	0.8
Tecumseh				RJ19LM		0.8
Robin	6			RL95YC		0.6
Honda	5.5			OE051	RN11YC	0.8
Kawasaki OHV	5			OE051	RN11YC	0.8

### Power Equipment

BC350, BC460, LT210, LT210e				RCJ7Y		0.6
ST622	Tecumseh	6		RJ19LM		0.8
TB220, TB220e, TB260				RCJ7Y		0.6
Briggs & Stratton Intek	6.75			OE013	RC12YC	QC12YC / XC92YC
Briggs & Stratton Intek Single Cyl.	10,13			OE013	RC12YC	QC12YC / XC92YC
Briggs & Stratton Intek Single Cyl.	15			OE013	RC12YC	QC12YC / XC92YC
Briggs & Stratton Intek Single Cyl.	17			OE013	RC12YC	QC12YC / XC92YC
Briggs & Stratton Intek V-Twin	18			OE013	RC12YC	QC12YC / XC92YC
Briggs & Stratton Intek V-Twin	20			OE013	RC12YC	QC12YC / XC92YC
Briggs & Stratton Intek V-Twin	22			OE013	RC12YC	QC12YC / XC92YC
Briggs & Stratton Twin OHV	20			OE013	RC12YC	QC12YC / XC92YC
Briggs & Stratton Twin OHV	22			OE013	RC12YC	QC12YC / XC92YC
Briggs & Stratton Vanguard	15			OE013	RC12YC	QC12YC / XC92YC
Kohler OHV	14,15			OE013	RC12YC	1.0
Kohler V-Twin	20,22			OE013	RC12YC	1.0
Briggs & Stratton Vanguard V-Twin	14			RC14YC		0.8
Briggs & Stratton Vanguard V-Twin	16			RC14YC		0.8
Briggs & Stratton Vanguard V-Twin	18			RC14YC		0.8
Briggs & Stratton Vanguard V-Twin	25			RC14YC		0.8
Mitsubishi				RCJ7Y		0.6
Wisconsin				RD16		0.8
Clinton				RH10C		0.6
Briggs & Stratton	6,6.5			RJ19LM	QJ19LM	0.8
Kohler	8			RJ19LM		0.8
Lauson				RJ8C		0.5
Tecumseh Side Valve				RJ8C		0.8
Robin OHV	6			RL86C		0.6
Honda OHC Twin	5.5			OE051	RN11YC	0.8
Kawasaki OHV	5			OE051	RN11YC	0.8
Tecumseh OHV	13,16,16.5			OE098	RN4C	0.8
Kohler Twin	16,17,18,20			RV17YC		0.6

### Snow Removers

7-23	Tecumseh	7		RJ8C		0.8
10-30E	Tecumseh	10		RJ8C		0.8
9-26E	Tecumseh	9		RJ8C		0.8
M21, SS322	Tecumseh	3		RCJ8Y		0.8
SS522	Tecumseh	5		RCJ8Y		0.8



CC BHP

21



OPT.



mm

## ...ARIENS

### ...Snow Removers

ST1024	Tecumseh	10		RJ8C		0.8
	Tecumseh OHV	10,11		OE098 RN4C		0.8
ST1028DL, ST1032DL	Tecumseh	10		RJ8C		0.8
ST1128LE	Tecumseh OHV	10,11		OE098 RN4C		0.8
ST1236DL	Tecumseh	12		RL86C		0.8
ST1332, ST1336LE	Tecumseh OHV	13		OE098 RN4C		0.8
ST5+2, ST520	Tecumseh	5		RCJ8Y		0.8
ST521, ST5224				RJ8C		0.8
ST524	Tecumseh	5		RCJ8Y		0.8
ST624	Tecumseh OHV	6		OE098 RN4C		0.8
ST724	Tecumseh	7		RJ8C		0.8
ST824DL, ST824LC	Tecumseh	8		RJ8C		0.8
ST924	Tecumseh	9		RJ8C		0.8
	Clinton			RH10C		0.6
	Briggs & Stratton			RJ19LM	QJ19LM	0.8
	Lauson			RJ8C		0.5
	Tecumseh			RJ8C		0.8
	Kawasaki OHV	9		OE051 RN11YC		0.6
	Tecumseh OHV			OE098 RN4C		0.8

## ARIES

### Lawn Mowers

	Briggs & Stratton			RJ19LM	QJ19LM	0.8
	Tecumseh			RJ19LM		0.8

## ARMADILLO

### Power Equipment

SW9XT	Toyota	112		RN14YC		0.8
-------	--------	-----	--	--------	--	-----

## ARTICULATOR

### Articulating Mowers

	Kohler EFI	28		OE013 RC12YC		0.8
	Kohler V-Twin	22,25		OE013 RC12YC		0.8

## ARTISAN

### Lawn Mowers

All Models				RJ19LM		0.8
------------	--	--	--	--------	--	-----

## AS MOTOR

### Power Equipment

				RL86C		0.6
--	--	--	--	-------	--	-----

## ASPLUNDH

### Power Equipment

JEX	Ford	172		RH10C		0.8
JFX	Ford	330		RF10C		0.8
JFZ	Ford	300		RF10C		0.8

## ASTRO-KUT

### Lawn Mowers

All Models				RJ19LM		0.8
------------	--	--	--	--------	--	-----

## ASTRON

### Blowers

KB-22				CJ14		0.8
KB-55, KB-602, KB-80				RJ8C		0.8

### Brushcutters

150, 200, 250, HT767, HT838, KFS4-12AD, KFS4-24DX, PK2500F, PK2860G, PK3330G, Pro 750E				RCJ8		0.8
PS35302				RCJ7Y		0.8
Super 100, Super 160				RCJ8		0.8

### Hedge Trimmers

E-202, HT-766, HT-830				RCJ8		0.8
-----------------------	--	--	--	------	--	-----

### Vacuums

AS-110				RL86C		0.8
--------	--	--	--	-------	--	-----



CC BHP

21



OPT.



mm

**ATCO****Lawn Mowers**Briggs & Stratton  
Suffolk, TecumsehRJ19LM QJ19LM  
RJ8C0.8  
0.8**ATLAS****Generators**

Briggs &amp; Stratton

3,5,8

RJ19LM QJ19LM

0.8

**Lawn Mowers**Briggs & Stratton  
TecumsehRJ19LM QJ19LM  
RJ8C0.8  
0.8**Power Equipment**Briggs & Stratton  
Lauson, TecumsehRJ19LM QJ19LM  
RJ8C0.8  
0.8**Snow Removers**Briggs & Stratton  
Tecumseh  
LausonRJ19LM QJ19LM  
RJ19LM  
RJ8C0.8  
0.8  
0.8**ATOM****Edgers**

Ryobi

RCJ7Y

0.8

**ATWATER-STRONG****Power Equipment**Briggs & Stratton Vanguard  
Wisconsin S8  
Kohler  
Briggs & Stratton  
Briggs & Stratton  
Tecumseh

9

8,14

16

5,8

OE013 RC12YC QC12YC / XC92YC  
RD16  
RH10C  
RJ19LM QJ19LM  
RJ19LM QJ19LM  
RJ8C0.8  
0.8  
0.8  
0.8  
0.8  
0.8**AUTO-AUGER****Earth Drills**

Tecumseh

3

RJ19LM

0.8

**AUTO-HOE****Tillers**Briggs & Stratton  
Kohler  
Lauson  
Wisconsin

4

RJ19LM QJ19LM  
RJ19LM  
RJ8C  
W140.8  
0.8  
0.8  
0.6**AUTOMATIC****Generators**

All Models

W14

0.6

**BACHTOLD****Lawn Mowers**Briggs & Stratton  
Kohler K181 8RJ19LM QJ19LM  
RJ19LM0.8  
0.8**Log Splitters**Briggs & Stratton  
Honda OHV

5.5,8,9

OE051 RJ19LM QJ19LM  
RN11YC0.8  
0.8**Power Equipment**Briggs & Stratton Intek OHV  
Wisconsin  
Briggs & Stratton  
Kohler OHV  
Honda OHV

6

7,8

8

5,5.5,8

OE013 RC12YC QC12YC / XC92YC  
RD16  
RJ19LM QJ19LM  
RJ19LM  
OE051 RN11YC0.5  
0.6  
0.8  
0.8  
0.8



CC BHP

21



OPT.



mm

**BAD BOY****Mowers**

Briggs & Stratton Intek V-Twin	25	OE013	RC12YC	QC12YC / XC92YC	0.5
Kohler Command V-Twin	27	OE013	RC12YC		0.8
Briggs & Stratton Vanguard	31		RC14YC		0.5
Kawasaki Liquid-Cooled OHV	29	OE042	RN12YC		0.8
Kawasaki Liquid-Cooled V-Twin	26	OE042	RN12YC		0.8
Kawasaki Liquid-Cooled V-Twin	27	OE042	RN12YC		0.8
Kawasaki Liquid-Cooled OHV	27		RN14YC		0.8

**BADGER****Earth Augers**

80, 81				RCJ6Y	0.8
--------	--	--	--	-------	-----

**BAKER****Mulchers**

Kohler	23		RH10C		0.8
Briggs & Stratton	5		RJ19LM	QJ19LM	0.8
Tecumseh	8,10		RJ19LM		0.8
Tecumseh	5.5	OE098	RN4C		0.8
Kohler Twin	20		RV17YC		0.6

**BANDIT****Chippers**

CSG-649	Ford	300		RF10C	0.8
G-1600, G-2300	Hercules			RJ6C	0.6
LSG-423	Ford	140		RS12YC	0.9
VG4D	Wisconsin	37		RD16	0.8
VH4DI	Wisconsin	30		RD16	0.8
	Kohler V-Twin	25	OE013	RC12YC	0.8
	Kohler	23		RH10C	0.8
	Honda V-Twin	20	OE051	RN11YC	0.8
	Onan Twin	20,24		RS17YX	0.6
	Kohler Twin	20		RV17YC	0.6

**BANJO****Pressure Washers**

Kohler V-Twin	18	OE013	RC12YC		0.6
Briggs & Stratton Vanguard V-Twin	16		RC14YC		0.8

**Pumps**

GX160	Honda OHV	5.5	OE051	RN11YC	0.8
	Honda OHV with electric start	5.5	OE051	RN11YC	0.8
GX200	Honda OHV	6.5	OE051	RN11YC	0.8
GX240	Honda OHV with electric start	8	OE051	RN11YC	0.8
GX340	Honda with electric start	11	OE051	RN11YC	0.8
GX390	Honda with electric start	13	OE051	RN11YC	0.8
	Briggs & Stratton Intek OHV	5.5	OE013	RC12YC	QC12YC / XC92YC
	Briggs & Stratton Vanguard Series	6	OE013	RC12YC	QC12YC / XC92YC

**BARK BUSTER****Log Splitters**

Briggs & Stratton			RJ19LM	QJ19LM	0.8
-------------------	--	--	--------	--------	-----

**BARKER INDUSTRIES****Power Equipment**

50006, 50010	Chrysler			RCJ8	0.8
--------------	----------	--	--	------	-----



CC BHP

21



OPT.



mm

## BARNES

### Pumps

(LPG)	Teledyne			D9		0.5
	Wisconsin			D9		0.5
	Ford	172		L90C		0.8
10M, 15M, 20M, 30M, 3N, 40M, 40MV, 7M, 7MK				RJ8C		0.6
90M				RJ12C		0.6
E27W, EY18, EY25W	Robin			L90C		0.6
	Teledyne			RD16		0.6
	Wisconsin			RD16		0.6
	Ford	240		RF10C		0.8
	Ford	300		RF10C		0.8
	Ford	361		RF10C		0.8
	Ford	477		RF10C		0.8
	Ford	534		RF10C		0.8
	Ford	172		RH10C		0.9
	Kohler	12		RH10C		0.8
	Kohler	18		RH10C		0.8
	Briggs & Stratton			RJ19LM	QJ19LM	0.8
	Kohler	14		RJ19LM		0.8
	Kohler	24		RJ19LM		0.8
	Kohler	4,7,8		RJ19LM		0.8

## BARRETO

### Tillers, Trenchers

Briggs & Stratton Vanguard	9,16	OE013	RC12YC	QC12YC / XC92YC	0.8
Honda	13	OE051	RN11YC		0.8

## BARTON

### Pumps

AKN, AKS	Wisconsin			RD16		0.6
T-118	Chrysler			RJ6C		0.6
VF	Wisconsin			RD16		0.6

## BAUER

### Compressors

Utiul 10-G	Honda OHV	5.5	OE051	RN11YC		0.8
------------	-----------	-----	-------	--------	--	-----

## BCS

### Engines

All Models		5		RL86C		0.8
------------	--	---	--	-------	--	-----

### Power Equipment

710				RJ19LM		0.8
715	Kohler			RH10C		0.8
725				RL86C		0.8
730	Kohler			RH10C		0.8
735				RL86C		0.8
737	Briggs & Stratton Vanguard			RC14YC		0.8
830	Briggs & Stratton Vanguard V-Twin	12.5		RC14YC		0.8
	Kohler	8		RH10C		0.8
850	Briggs & Stratton Vanguard V-Twin	12.5		RC14YC		0.8
	Kohler	8		RH10C		0.8
945	Kohler	14		RH10C		0.8
201, 203, 205, 602, 604, 605				RL86C		0.8
716, 720				RJ19LM		0.8
737, 745	Kohler			RH10C		0.8
B10 80, Bio 100, Crusader 705, Gardner 710, Gardner Plus 716, Harvester				RJ19LM		0.8
Harvester Plus, Hercules 945				RH10C		0.8
	Briggs & Stratton Vanguard V-Twin	12.5		RC14YC		0.8
	Kohler	8,14		RH10C		0.8
	Briggs & Stratton	3.5,5,7,8		RJ19LM	QJ19LM	0.8
		10		RL86C		0.8



CC BHP

21



OPT.



mm

## BEAIRD-POULAN

### Blowers

940			RCJ8		0.8
1500			RJ6C		0.8

### Power Equipment

960			RCJ8		0.8
2610, 2620	350		CJ14		0.6
800, 900			RCJ8		0.6

### Trimmers

Line 2600	350		CJ14		0.6
Line 770			RCJ8		0.6

## BEAMAN

### Garden Tractors

(1/2"-14)			25		0.8
(18mm)			RD16		0.6
(7/8"-18)			W14		0.6

## BEAR CAT

### Lawn Mowers

Briggs & Stratton			RJ19LM	QJ19LM	0.8
Honda OHV 5			OE006	RN9YC	0.8

### Power Equipment

(1/2"-14)			25		0.8	
Briggs & Stratton Intek OHV	6,8,10,5,12,5,18		OE013	RC12YC	QC12YC / XC92YC	0.8
Kohler OHV	14		OE013	RC12YC		1.0
Kohler V-Twin	20,25		OE013	RC12YC		0.8
(18mm)			RD16			0.6
Wisconsin	35		RD16			0.6
Briggs & Stratton Single Cyl.			RJ19LM	QJ19LM		0.8
Tecumseh	8		RJ8C			0.8
Honda OHV	5,5,8,11,13		OE051	RN11YC		0.8
Honda V-Twin	20,24		OE051	RN11YC		0.8
Honda OHV	5		OE006	RN9YC		0.8
Ford 1.1, 1.3L			OE011	RS9YC		0.9
(7/8"-18)			W14			0.6

### Snow Removers

Honda OHV	8		OE051	RN11YC		0.8
Tecumseh OHV			OE098	RN4C		0.8

### Trimmers

Briggs & Stratton	3,75,4,5,6		RJ19LM	QJ19LM		0.8
Honda OHC Twin	5,5		OE006	RN9YC		0.8
Honda OHV	5		OE006	RN9YC		0.8

## BEAZLEY

### Mowers

(18mm)			RD16		0.6
(14mm)			RJ8C		0.6

## BED EDGER

### Edgers

Briggs & Stratton	10,5		RJ19LM	QJ19LM		0.8
Honda	8,9,13		OE051	RN11YC		0.8

## BED SHAPER

### Edgers

Kawasaki OHV	9,14		OE051	RN11YC		0.8
--------------	------	--	-------	--------	--	-----

## BEELINE

### Power Equipment

Kohler	20,25		OE013	RC12YC		0.8
Honda	20,24		OE051	RN11YC		0.8

## BEFCO

### Mowers

Kohler	8		RH10C			0.8
Briggs & Stratton	10,5		RJ19LM	QJ19LM		0.8



CC BHP

21



OPT.



mm

**BELL & GOSSETT****Pumps, Compressors & Refrigeration Units**

IHC				<b>RJ6C</b>		0.5
Confidental				<b>RM77N</b>		0.4

**BERKELY****Pumps**

Wisconsin				<b>RD16</b>		0.6
Ford 4-Cyl.				<b>RH10C</b>		0.6
Ford 6-Cyl.				<b>RH8C</b>		0.6
Briggs & Stratton				<b>RJ19LM</b>	QJ19LM	0.8

**BERNARD MOTORS****Chainsaws**

BM 230.0,230.1,236.3,441.3,651.3				<b>RCJ8</b>		0.6
----------------------------------	--	--	--	-------------	--	-----

**BETTER****Mowers**

Quick 36	Briggs & Stratton Intek	13		<b>RJ19LM</b>	QJ19LM	0.8
----------	-------------------------	----	--	---------------	--------	-----

**BFB****Riding Mowers**

Briggs & Stratton OHV		12.5,15.5	<b>OE013</b>	<b>RC12YC</b>	QC12YC / XC92YC	0.8
Briggs & Stratton Vanguard V-Twin		16,18,20		<b>RC14YC</b>		0.8

**BIG 'C' (→ Magna)****BIG SNAPPER****Mowers**

All Models				<b>RD16</b>		0.8
------------	--	--	--	-------------	--	-----

**BIG WHEEL****Lawn Mowers**

Briggs & Stratton				<b>RJ19LM</b>	QJ19LM	0.8
-------------------	--	--	--	---------------	--------	-----

**Power Equipment**

Briggs & Stratton				<b>RJ19LM</b>	QJ19LM	0.8
-------------------	--	--	--	---------------	--------	-----

**BIG-GIANT****Log Splitters**

K181	Kohler	8		<b>RJ19LM</b>		0.8
	Kohler	10,14,16		<b>RH10C</b>		0.8
	Briggs & Stratton	5,8,10,11		<b>RJ19LM</b>	QJ19LM	0.8

**BIG-PRO****Riding Mowers**

Kohler Twin		18,20		<b>RV17YC</b>		0.6
-------------	--	-------	--	---------------	--	-----

**BILLY GOAT****Power Equipment**

KS410	Kawasaki	7.5	<b>OE059</b>	<b>CJ6</b>		0.6	
	Briggs & Stratton Vanguard V-Twin	16		<b>L92YC</b>		0.8	
	Kohler	16		<b>RC14YC</b>		0.8	
	Briggs & Stratton	3.5,5.5,5.8,8.5,10.5,11			<b>RH10C</b>		0.8
					<b>RJ19LM</b>	QJ19LM	0.8
	Kohler				<b>RJ19LM</b>	0.8	
	Tecumseh	5.5			<b>RJ19LM</b>	0.8	
	Honda OHV	4	<b>OE051</b>		<b>RN11YC</b>	0.8	
	Honda OHV	5.5,8,11	<b>OE051</b>		<b>RN11YC</b>	0.8	
	Honda OHV	5	<b>OE006</b>		<b>RN9YC</b>	0.8	



CC BHP

21



OPT.



mm

**BINKS****Pumps**

1220, 1221, 1256, 1259

RD16

0.8

**Pumps, Compressors & Refrigeration Units**

1141, 1143, 1144, 1151, 1154, 1157, 1174

RJ8C

0.6

33-1129, 33-1150

RJ8C

0.6

33-1173, 33-1258

RD16

0.8

33-1280

OE042

RN12YC

0.8

**BLACK & DECKER****Trimmers**

RDJ7Y

0.7

**BLACK ROCK****Blowers, Mowers**

Briggs &amp; Stratton Vanguard

12.5

OE013

RC12YC

QC12YC / XC92YC

0.8

Kohler V-Twin

22

OE013

RC12YC

0.8

Kawasaki

2.4

RCJ8

0.8

Briggs &amp; Stratton

8,11

RJ19LM

QJ19LM

0.8

Kawasaki OHV

14

OE051

RN11YC

0.8

Kawasaki V-Twin

17,21,25

OE051

RN11YC

0.8

**Trimmers**

Grass, Hedge

RCJ8

0.8

**BLAIR****Lawn Mowers**

All Models

RJ19LM

0.8

**BLEC****Seeders**

Honda OHV

5.5

OE051

RN11YC

0.8

**BLITZ****Chainsaws**

B34, B35, N38, B42, B45, B50, B52, B54, B55, B60

RCJ7Y

0.5

B64, B80, B100F, B300, B304, B400, B404, B500

RCJ7Y

0.5

XB502, B504, B600, B701, B702, B800, B802, B804

RCJ7Y

0.5

**Trimmers**

27S, 33S, 40S

RCJ7Y

0.6

**BLOWMITE****Blowers**

Blower/Sprayer/Duster

RJ6C

0.8

**BLUE BIRD****Power Equipment**

Briggs &amp; Stratton Intek

5.5

OE013

RC12YC

QC12YC / XC92YC

0.5

Kohler OHV

6

OE013

RC12YC

0.8

Tecumseh

3.5

RJ17LM

0.8

Briggs &amp; Stratton

3,3.5,5

RJ19LM

QJ19LM

0.8

Briggs &amp; Stratton

7,8

RJ19LM

QJ19LM

0.8

Honda OHV

4,5,5,8

OE051

RN11YC

0.8

**BLUE BIRD (ITALY)****Augers**

NEA52E

RCJ7Y

0.8

**Hedge Trimmers**

H23E, H27E

CJ6

0.6

**Mowers**

Honda OHV

5

OE006

RN9YC

0.8

**Power Equipment**

K25, K29

RCJ8

0.8

M27

CJ6

0.6

M34

RCJ8

0.8

M41, M54

RCJ7Y

0.8

ZM34

CJ6

0.6

ZM47

RCJ7Y

0.8





CC BHP

21



OPT.

mm

**...BLUE BIRD (ITALY)**

**Pumps**

SA27E				CJ6		0.6
SA38E				RL86C		0.6
SE52E				RCJ7Y		0.6

**Riding Mowers**

Briggs & Stratton Vanguard V-Twin	16			RC14YC		0.8
Briggs & Stratton	12.5			RJ19LM	QJ19LM	0.8

**BLUE DIAMOND**

**Snow Removers**

All Models				RJ19LM		0.8
------------	--	--	--	--------	--	-----

**B-M**

**Lawn Mowers**

All Models				RJ19LM		0.8
------------	--	--	--	--------	--	-----

**BMB**

**Lawn Mowers**

All Models				RJ19LM		0.8
------------	--	--	--	--------	--	-----

**BOB-A-LAWN**

**Lawn Mowers**

All Models				RJ19LM		0.8
------------	--	--	--	--------	--	-----

**BOBCAT**

**Edgers, Trimmers**

				RCJ8		0.8
--	--	--	--	------	--	-----

**Mowers**

DM950G	Briggs & Stratton	31		OE013	RC12YC	QC12YC / XC92YC	0.5
--------	-------------------	----	--	-------	--------	-----------------	-----

**Power Equipment**

Briggs & Stratton Intek		12.5,13.5		OE013	RC12YC	QC12YC / XC92YC	0.5
Briggs & Stratton Intek		18		OE013	RC12YC	QC12YC / XC92YC	0.5
Briggs & Stratton Intek		6.5		OE013	RC12YC	QC12YC / XC92YC	0.5
Kohler OHV		12.5		OE013	RC12YC		1.0
Kohler OHV		15		OE013	RC12YC		1.0
Kohler V-Twin		18		OE013	RC12YC		0.8
Kohler V-Twin		20,22,23,25		OE013	RC12YC		0.8
Kohler V-Twin		27		OE013	RC12YC		0.8
Kohler V-Twin EFI		26		OE013	RC12YC		0.8
Kohler V-Twin EFI		28		OE013	RC12YC		0.8
Briggs & Stratton Vanguard V-Twin		16			RC14YC		0.8
Kawasaki		12.5,13.5			RCJ8		0.8
Kawasaki V-Twin		15,17			RCJ8Y		0.8
Kohler		14			RH10C		0.8
Kohler		16			RH10C		0.8
Briggs & Stratton		5			RJ19LM	QJ19LM	0.8
Briggs & Stratton		8.5,12			RJ19LM	QJ19LM	0.8
Briggs & Stratton Twin		18			RJ19LM	QJ19LM	0.8
Kawasaki OHV		14,15		OE051	RN11YC		0.8
Kawasaki V-Twin		19,21,23,25		OE051	RN11YC		0.8
Ford T.1L				OE049	RN11YC4		0.9
Tecumseh OHV		11		OE098	RN4C		0.8
Onan Twin		24			RS17YX		0.6
Kohler Twin		18			RV17YC		0.6
Kohler Twin		20			RV17YC		0.6

**Snow Removers**

Briggs & Stratton					RJ19LM	QJ19LM	0.8
-------------------	--	--	--	--	--------	--------	-----





CC

BHP

21



OPT.



**BOLENS**

**Chain Saws**

Swiftly 3014, Thrifty 3010

RJ6C

0.8

**Garden Tractors**

All Other

Tecumseh

RJ8C

0.8

Wisconsin

RD16

0.8

Kohler

18,19,20,23

RH10C

0.8

Onan BF

RH18Y

0.6

Briggs & Stratton

RJ19LM

QJ19LM

0.8

Tecumseh

14,16

OE086

RL82C

0.8

Kohler Twin

17

RV17YC

0.6

**Lawn Mowers**

Briggs & Stratton

RJ19LM

QJ19LM

0.8

Tecumseh

RJ8C

0.8

**Mulchers, Tillers**

Briggs & Stratton

RJ19LM

QJ19LM

0.8

Lauson, Tecumseh

RJ8C

0.8

**Snow Removers**

Briggs & Stratton

RJ19LM

QJ19LM

0.8

Lauson, Tecumseh

RJ8C

0.8

**BOMBARDIER-ROTAX**

**Engines**

95	2-Cycle	94	4.6
150	2-Cycle	148	5.8
182	2-Cycle	184	6.2
232	2-Cycle	232	8.8
299	2-Cycle	303	12
500	2-Cycle, 2-Cyl.	494	16.2
635	2-Cycle, 2-Cyl.	635	38.5

RL86C

0.5

D14

0.5

RL86C

0.5

RL86C

0.5

D14

0.5

D14

0.5

D6

0.5

**BORDERLINE**

**Power Equipment**

Honda	2,2,2,5
Briggs & Stratton	3.5
Honda	3
Honda OHV	4

CJ14

0.8

RJ19LM

QJ19LM

0.8

OE051

RN11YC

0.8

OE051

RN11YC

0.8

**BOTAG**

**Lawn Mowers**

Briggs & Stratton 5.5

RJ19LM

QJ19LM

0.8

**BRADLEY**

**Power Equipment**

Briggs & Stratton

RJ19LM

QJ19LM

0.8

**BRADSON**

**Pressure Washers**

5, 5.5	Tecumseh OHV		OE098	RN4C		0.8
	Briggs & Stratton Vanguard OHV	9	OE013	RC12YC	QC12YC / XC92YC	0.8
	Tecumseh	4.5		RCJ8Y		0.8
	Tecumseh	3.8		RJ19LM		0.8
	Tecumseh	8		RJ8C		0.8
	Honda OHV	5.5,6.5,9	OE051	RN11YC		0.8
	Tecumseh OHV	6.5	OE098	RN4C		0.8
	Honda OHV	5	OE006	RN9YC		0.8

**BRAID**

**Log Splitters**

Briggs & Stratton

RJ19LM

QJ19LM

0.8



CC BHP

21



OPT.

mm

**BRAVE**

<b>Lawn Mowers</b>						
	Briggs & Stratton			RJ19LM	QJ19LM	0.8
<b>Power Equipment</b>						
	Briggs & Stratton Vanguard	9		OE013	RC12YC	QC12YC / XC92YC
	Kohler OHV	11		OE013	RC12YC	1.0
	Briggs & Stratton	3.75,5,8			RJ19LM	QJ19LM
	Tecumseh	3.5,3,8			RJ19LM	0.8
	Tecumseh	8			RJ8C	0.8
	Honda OHV	5.5,8,11		OE051	RN11YC	0.8
	Tecumseh OHV	5.5		OE098	RN4C	0.8

**BREADY**

<b>Power Equipment</b>						
	(18mm)				RD16	0.8
	(14mm)				RJ8C	0.8

**BREW T**

<b>Air Compressors</b>						
	Honda OHV	4,8		OE051	RN11YC	0.8

**BRIGGS & STRATTON**

<b>Engines</b>							
12E000	1-Cyl. "L" Head	4			RJ19LM	QJ19LM	0.8
60100	1-Cyl. "L" Head	2			RJ19LM	QJ19LM	0.8
62000	1-Cyl. 2-Cycle	3			RJ19LM	QJ19LM	0.8
80000	1-Cyl. "L" Head	3			RJ19LM	QJ19LM	0.8
90100	1-Cyl. "L" Head	3			RJ19LM	QJ19LM	0.8
90200	1-Cyl. "L" Head	3			RJ19LM	QJ19LM	0.8
90700	1-Cyl. "L" Head	3.5			RJ19LM	QJ19LM	0.8
91200	1-Cyl. "L" Head	3.5			RJ19LM	QJ19LM	0.8
91700	1-Cyl. "L" Head	3.5			RJ19LM	QJ19LM	0.8
92200	1-Cyl. "L" Head	3.5			RJ19LM	QJ19LM	0.8
92500	1-Cyl. "L" Head	3			RJ19LM	QJ19LM	0.8
92900	1-Cyl. "L" Head				RJ19LM	QJ19LM	0.8
	1-Cyl. "L" Head	3.5			RJ19LM	QJ19LM	0.8
93200	1-Cyl. "L" Head	3.5			RJ19LM	QJ19LM	0.8
93900	1-Cyl. "L" Head	3.5			RJ19LM	QJ19LM	0.8
94500	1-Cyl. "L" Head	3			RJ19LM	QJ19LM	0.8
95700	1-Cyl. 2-Cycle	5			RJ19LM	QJ19LM	0.8
95900	1-Cyl. "L" Head	3.5			RJ19LM	QJ19LM	0.8
96500	1-Cyl. "L" Head	3.5			RJ19LM	QJ19LM	0.8
96700	1-Cyl. 2-Cycle	5			RJ19LM	QJ19LM	0.8
96900	1-Cyl. "L" Head	3.75			RJ19LM	QJ19LM	0.8
97700	1-Cyl. OHV	6		OE013	RC12YC	QC12YC / XC92YC	0.5
98900	1-Cyl. "L" Head	3.75			RJ19LM	QJ19LM	0.8
99700	1-Cyl. OHV	6		OE013	RC12YC	QC12YC / XC92YC	0.5
100200	1-Cyl. "L" Head	4			RJ19LM	QJ19LM	0.8
100700	1-Cyl. "L" Head	3.5			RJ19LM	QJ19LM	0.8
100900	1-Cyl. "L" Head	4			RJ19LM	QJ19LM	0.8
110000	1-Cyl. "L" Head	4			RJ19LM	QJ19LM	0.8
111000	1-Cyl. "L" Head	4			RJ19LM	QJ19LM	0.8
112000	1-Cyl. "L" Head	4			RJ19LM	QJ19LM	0.8
113000	1-Cyl. "L" Head	4			RJ19LM	QJ19LM	0.8
114000	1-Cyl. "L" Head	4			RJ19LM	QJ19LM	0.8
121000	1-Cyl. "L" Head	3.5			RJ19LM	QJ19LM	0.8
122000	1-Cyl. "L" Head	4			RJ19LM	QJ19LM	0.8
123000	1-Cyl. "L" Head	4			RJ19LM	QJ19LM	0.8
124000	1-Cyl. "L" Head	5			RJ19LM	QJ19LM	0.8
125000	1-Cyl. "L" Head	5			RJ19LM	QJ19LM	0.8
126000	1-Cyl. "L" Head	5			RJ19LM	QJ19LM	0.8
128000	1-Cyl. "L" Head	3.5			RJ19LM	QJ19LM	0.8
129000	1-Cyl. "L" Head	5.5			RJ19LM	QJ19LM	0.8
130000	1-Cyl. "L" Head	5			RJ19LM	QJ19LM	0.8
131000	1-Cyl. "L" Head	5			RJ19LM	QJ19LM	0.8
132000	1-Cyl. "L" Head	5			RJ19LM	QJ19LM	0.8
133200	1-Cyl. "L" Head	5			RJ19LM	QJ19LM	0.8
133400	1-Cyl. "L" Head	5			RJ19LM	QJ19LM	0.8
133700	1-Cyl. "L" Head	6			RJ19LM	QJ19LM	0.8





CC

BHP



OPT.



**...BRIGGS & STRATTON**

**...Engines**

Model	Cyl.	Head	CC	BHP	Code	Code	Code	mm
134400	1-Cyl.	"L" Head		5.5		RJ19LM	QJ19LM	0.8
135200	1-Cyl.	"L" Head		5		RJ19LM	QJ19LM	0.8
135700	1-Cyl.	"L" Head		6		RJ19LM	QJ19LM	0.8
136200	1-Cyl.	"L" Head		5		RJ19LM	QJ19LM	0.8
137000	1-Cyl.	"L" Head		5.5		RJ19LM	QJ19LM	0.8
170400	1-Cyl.	"L" Head		7		RJ19LM	QJ19LM	0.8
170700	1-Cyl.	"L" Head		6.5		RJ19LM	QJ19LM	0.8
171400	1-Cyl.	"L" Head		7		RJ19LM	QJ19LM	0.8
176400	1-Cyl.	"L" Head		7		RJ19LM	QJ19LM	0.8
190400	1-Cyl.	"L" Head		8		RJ19LM	QJ19LM	0.8
190700	1-Cyl.	"L" Head		8		RJ19LM	QJ19LM	0.8
191700	1-Cyl.	"L" Head		8		RJ19LM	QJ19LM	0.8
192400	1-Cyl.	"L" Head		8		RJ19LM	QJ19LM	0.8
193700	1-Cyl.	"L" Head		8		RJ19LM	QJ19LM	0.8
194000	1-Cyl.	"L" Head		8		RJ19LM	QJ19LM	0.8
195000	1-Cyl.	"L" Head		8		RJ19LM	QJ19LM	0.8
196400	1-Cyl.	"L" Head		8		RJ19LM	QJ19LM	0.8
196700	1-Cyl.	"L" Head		8.5		RJ19LM	QJ19LM	0.8
197400	1-Cyl.	"L" Head		8		RJ19LM	QJ19LM	0.8
197700	1-Cyl.	OHV		8.5	OE013	RC12YC	QC12YC / XC92YC	0.8
200400	1-Cyl.	"L" Head		8		RJ19LM	QJ19LM	0.8
221400	1-Cyl.	"L" Head		10		RJ19LM	QJ19LM	0.8
222400	1-Cyl.	"L" Head		10		RJ19LM	QJ19LM	0.8
226400	1-Cyl.	"L" Head		10		RJ19LM	QJ19LM	0.8
231400	1-Cyl.	"L" Head		9		RJ19LM	QJ19LM	0.8
233400	1-Cyl.	"L" Head		9		RJ19LM	QJ19LM	0.8
243400	1-Cyl.	"L" Head		10		RJ19LM	QJ19LM	0.8
250400	1-Cyl.	"L" Head		11		RJ19LM	QJ19LM	0.8
251400	1-Cyl.	"L" Head		11		RJ19LM	QJ19LM	0.8
251700	1-Cyl.	"L" Head		11		RJ19LM	QJ19LM	0.8
252000	1-Cyl.	"L" Head		11		RJ19LM	QJ19LM	0.8
253000	1-Cyl.	"L" Head		11		RJ19LM	QJ19LM	0.8
254400	1-Cyl.	"L" Head		11		RJ19LM	QJ19LM	0.8
254700	1-Cyl.	"L" Head		10		RJ19LM	QJ19LM	0.8
255400	1-Cyl.	"L" Head		11		RJ19LM	QJ19LM	0.8
255700	1-Cyl.	"L" Head		10		RJ19LM	QJ19LM	0.8
256400	1-Cyl.	"L" Head		11		RJ19LM	QJ19LM	0.8
256700	1-Cyl.	"L" Head		10		RJ19LM	QJ19LM	0.8
257700	1-Cyl.	"L" Head		10.5		RJ19LM	QJ19LM	0.8
258700	1-Cyl.	"L" Head		11		RJ19LM	QJ19LM	0.8
259700	1-Cyl.	"L" Head		11		RJ19LM	QJ19LM	0.8
	1-Cyl.	"L" Head		11		RJ19LM	QJ19LM	0.8
280700	1-Cyl.	"L" Head		12		RJ19LM	QJ19LM	0.8
281700	1-Cyl.	"L" Head		12		RJ19LM	QJ19LM	0.8
282700	1-Cyl.	"L" Head		12		RJ19LM	QJ19LM	0.8
283700	1-Cyl.	"L" Head		12		RJ19LM	QJ19LM	0.8
284700	1-Cyl.	"L" Head		12		RJ19LM	QJ19LM	0.8
285700	1-Cyl.	"L" Head		12.5		RJ19LM	QJ19LM	0.8
286700	1-Cyl.	"L" Head		12.5		RJ19LM	QJ19LM	0.8
287700	1-Cyl.	OHV		14.5	OE013	RC12YC	QC12YC / XC92YC	0.8
288700	1-Cyl.	"L" Head		12.5		RJ19LM	QJ19LM	0.8
289700	1-Cyl.	"L" Head		12.5		RJ19LM	QJ19LM	0.8
300400	1-Cyl.	"L" Head		12		RJ19LM	QJ19LM	0.8
301400	1-Cyl.	"L" Head		12		RJ19LM	QJ19LM	0.8
302400	1-Cyl.	"L" Head		13		RJ19LM	QJ19LM	0.8
320400	1-Cyl.	"L" Head		14		RJ19LM	QJ19LM	0.8
325400	1-Cyl.	"L" Head		15		RJ19LM	QJ19LM	0.8
326400	1-Cyl.	"L" Head		16		RJ19LM	QJ19LM	0.8
28E70	1-Cyl.	OHV		14	OE013	RC12YC	QC12YC / XC92YC	0.8
10A900	1-Cyl.	"L" Head		4		RJ19LM	QJ19LM	0.8
10B900	1-Cyl.	"L" Head		4		RJ19LM	QJ19LM	0.8
12A000	1-Cyl.	"L" Head		4.75		RJ19LM	QJ19LM	0.8
12B000	1-Cyl.	"L" Head		5.25		RJ19LM	QJ19LM	0.8
12C000	1-Cyl.	"L" Head		5.25		RJ19LM	QJ19LM	0.8
12D000	1-Cyl.	"L" Head		4.75		RJ19LM	QJ19LM	0.8
12F000	1-Cyl.	"L" Head		5		RJ19LM	QJ19LM	0.8
12G000	1-Cyl.	"L" Head		5		RJ19LM	QJ19LM	0.8
12H000	1-Cyl.	"L" Head		6		RJ19LM	QJ19LM	0.8





CC BHP



OPT.



**...BRIGGS & STRATTON**

**...Engines**

12J000	1-Cyl. "L" Head	6		RJ19LM	QJ19LM	0.8
12L000	1-Cyl. "L" Head	4.5		RJ19LM	QJ19LM	0.8
12M000	1-Cyl. "L" Head	5.5		RJ19LM	QJ19LM	0.8
12T000	1-Cyl. "L" Head	4		RJ19LM	QJ19LM	0.8
12U000	1-Cyl. "L" Head	5		RJ19LM	QJ19LM	0.8
12V000	1-Cyl. "L" Head	6		RJ19LM	QJ19LM	0.8
12W000	1-Cyl. "L" Head	6		RJ19LM	QJ19LM	0.8
19A400	1-Cyl. "L" Head	9		RC14YC		0.8
19B400	1-Cyl. "L" Head	9		RC14YC		0.8
19C400	1-Cyl. "L" Head	9		RC14YC		0.8
19E400	1-Cyl. "L" Head	10		RC14YC		0.8
19F400	1-Cyl. "L" Head	10		RC14YC		0.8
19G400	1-Cyl. "L" Head	10		RC14YC		0.8
28A700	1-Cyl. "L" Head	10		RJ19LM	QJ19LM	0.8
28B700	1-Cyl. "L" Head	10.5		RJ19LM	QJ19LM	0.8
28C700	1-Cyl. "L" Head	11		RJ19LM	QJ19LM	0.8
28D700	1-Cyl. "L" Head	11.5		RJ19LM	QJ19LM	0.8
28F700	1-Cyl. "L" Head	13		RJ19LM	QJ19LM	0.8
28M700	1-Cyl. "L" Head	13		RJ19LM	QJ19LM	0.8
28N700	1-Cyl. OHV	15.5	OE013	RC12YC	QC12YC / XC92YC	0.8
28R700	1-Cyl. "L" Head	13.5		RJ19LM	QJ19LM	0.8
28U700	1-Cyl. OHV	16	OE013	RC12YC	QC12YC / XC92YC	0.8
28W700	1-Cyl. OHV	16.5	OE013	RC12YC	QC12YC / XC92YC	0.8
93400 (No Tank)	1-Cyl. "L" Head	3.5		RJ19LM	QJ19LM	0.8
93400 (Top Tank)	1-Cyl. "L" Head	3.5		RC14YC		0.8
9C900	1-Cyl. "L" Head	3.8		RJ19LM	QJ19LM	0.8
9D900	1-Cyl. "L" Head	3.8		RJ19LM	QJ19LM	0.8
ELS 125300	Extended Life Series	6	OE013	RC12YC	QC12YC / XC92YC	0.7
ELS 125400	Extended Life Series	6	OE013	RC12YC	QC12YC / XC92YC	0.7
ELS 28AH00	Extended Life Series	15	OE013	RC12YC	QC12YC / XC92YC	0.7
ELS 28BH00	Extended Life Series	16	OE013	RC12YC	QC12YC / XC92YC	0.7
ELS 28CH00	Extended Life Series	16	OE013	RC12YC	QC12YC / XC92YC	0.7
ELS 31J700	Extended Life Series	16	OE013	RC12YC	QC12YC / XC92YC	0.7
ELS 31K700	Extended Life Series	17	OE013	RC12YC	QC12YC / XC92YC	0.7
ELS 31L700	Extended Life Series	18	OE013	RC12YC	QC12YC / XC92YC	0.7
ELS 31M700	Extended Life Series	18	OE013	RC12YC	QC12YC / XC92YC	0.7
ELS 40F700	Extended Life Series	18	OE013	RC12YC	QC12YC / XC92YC	0.7
ELS 40G700	Extended Life Series	20	OE013	RC12YC	QC12YC / XC92YC	0.7
ELS 40H700	Extended Life Series	22	OE013	RC12YC	QC12YC / XC92YC	0.7
ELS 446700	Extended Life Series	26	OE013	RC12YC	QC12YC / XC92YC	0.7
Fource	4-Cycle	0.75		RDJ7Y		0.8
Intek	1-Cyl. OHV	6	OE013	RC12YC	QC12YC / XC92YC	0.5
	1-Cyl. OHV	17.5	OE013	RC12YC	QC12YC / XC92YC	0.8
	1-Cyl. OHV	15.5	OE013	RC12YC	QC12YC / XC92YC	0.8
	1-Cyl. OHV	13.5	OE013	RC12YC	QC12YC / XC92YC	0.8
	1-Cyl. OHV	8	OE013	RC12YC	QC12YC / XC92YC	0.8
	1-Cyl. OHV	7	OE013	RC12YC	QC12YC / XC92YC	0.5
	1-Cyl. OHV	6.75	OE013	RC12YC	QC12YC / XC92YC	0.5
	V-Twin OHV	19	OE013	RC12YC	QC12YC / XC92YC	0.8
Intek 110400	1-Cyl. OHV	5.5	OE013	RC12YC	QC12YC / XC92YC	0.5
Intek 110600	1-Cyl. OHV	6.5	OE013	RC12YC	QC12YC / XC92YC	0.5
Intek 111400	1-Cyl. OHV	5.5	OE013	RC12YC	QC12YC / XC92YC	0.5
Intek 111600	1-Cyl. OHV	6.5	OE013	RC12YC	QC12YC / XC92YC	0.5
Intek 113400	1-Cyl. OHV	5.5	OE013	RC12YC	QC12YC / XC92YC	0.5
Intek 120400	1-Cyl. OHV	6.5	OE013	RC12YC	QC12YC / XC92YC	0.5
Intek 120600	1-Cyl. OHV	6.5	OE013	RC12YC	QC12YC / XC92YC	0.5
Intek 121400	1-Cyl. OHV	6.5	OE013	RC12YC	QC12YC / XC92YC	0.5
Intek 121600	1-Cyl. OHV	6.5	OE013	RC12YC	QC12YC / XC92YC	0.5
Intek 122600	1-Cyl. OHV	6.5	OE013	RC12YC	QC12YC / XC92YC	0.5
Intek 123400	1-Cyl. OHV	6.5	OE013	RC12YC	QC12YC / XC92YC	0.5
Intek 204400	1-Cyl. OHV	10	OE013	RC12YC	QC12YC / XC92YC	0.8
Intek 205400	1-Cyl. OHV	10	OE013	RC12YC	QC12YC / XC92YC	0.8
Intek 310700	1-Cyl. OHV	16.5	OE013	RC12YC	QC12YC / XC92YC	0.8
Intek 311700	1-Cyl. OHV	17	OE013	RC12YC	QC12YC / XC92YC	0.8
Intek 312700	1-Cyl. OHV	17	OE013	RC12YC	QC12YC / XC92YC	0.8
Intek 405700	V-Twin OHV	18	OE013	RC12YC	QC12YC / XC92YC	0.8
Intek 406700	V-Twin OHV	20	OE013	RC12YC	QC12YC / XC92YC	0.8
Intek 407700	V-Twin OHV	22	OE013	RC12YC	QC12YC / XC92YC	0.8





CC

BHP

21



OPT.



**...BRIGGS & STRATTON**

**...Engines**

Intek 445700	V-Twin OHV	25	OE013	RC12YC	QC12YC / XC92YC	0.8
Older Models	(18mm)			RD16		0.8
	(14mm)			RJ19LM	QJ19LM	0.8
				RJ19LM	QJ19LM	0.8
Opposed 400400	2-Cyl. "L" Head	14		RJ19LM	QJ19LM	0.8
Opposed 400700	2-Cyl. "L" Head	14		RJ19LM	QJ19LM	0.8
Opposed 401400	2-Cyl. "L" Head	16		RJ19LM	QJ19LM	0.8
Opposed 401700	2-Cyl. "L" Head	16		RJ19LM	QJ19LM	0.8
Opposed 402400	2-Cyl. "L" Head	16		RJ19LM	QJ19LM	0.8
Opposed 402700	2-Cyl. "L" Head	16		RJ19LM	QJ19LM	0.8
Opposed 404400	2-Cyl. "L" Head	12.5		RJ19LM	QJ19LM	0.8
Opposed 404700	2-Cyl. "L" Head	12.5		RJ19LM	QJ19LM	0.8
Opposed 40A700	2-Cyl. "L" Head	16.5		RJ19LM	QJ19LM	0.8
Opposed 421400	2-Cyl. "L" Head	18		RJ19LM	QJ19LM	0.8
Opposed 421700	2-Cyl. "L" Head	18		RJ19LM	QJ19LM	0.8
Opposed 422400	2-Cyl. "L" Head	18		RJ19LM	QJ19LM	0.8
Opposed 422700	2-Cyl. "L" Head	18		RJ19LM	QJ19LM	0.8
Opposed 42B700	2-Cyl. "L" Head	16		RJ19LM	QJ19LM	0.8
Opposed 42C700	2-Cyl. "L" Head	17		RJ19LM	QJ19LM	0.8
Opposed 42D700	2-Cyl. "L" Head	18.5		RJ19LM	QJ19LM	0.8
Opposed 42E700	2-Cyl. "L" Head	19.5		RJ19LM	QJ19LM	0.8
Opposed 460700	2-Cyl. "L" Head	20		RJ19LM	QJ19LM	0.8
Opposed 461700	2-Cyl. "L" Head	20.5		RJ19LM	QJ19LM	0.8
Outboard	1-Cyl. OHV	5	OE013	RC12YC	QC12YC / XC92YC	0.5
Vanguard	1-Cyl. OHV	2.4	OE013	RC12YC	QC12YC / XC92YC	0.5
	V-Twin OHV	31	OE013	RC12YC	QC12YC / XC92YC	0.8
Vanguard 104700	1-Cyl. OHV	5.5	OE013	RC12YC	QC12YC / XC92YC	0.5
Vanguard 115400	1-Cyl. OHV	5.5	OE013	RC12YC	QC12YC / XC92YC	0.5
Vanguard 117400	1-Cyl. OHV	6	OE013	RC12YC	QC12YC / XC92YC	0.5
Vanguard 138400	1-Cyl. OHV	7.5	OE013	RC12YC	QC12YC / XC92YC	0.5
Vanguard 161400	1-Cyl. OHV	9	OE013	RC12YC	QC12YC / XC92YC	0.8
Vanguard 185400	1-Cyl. OHV	9	OE013	RC12YC	QC12YC / XC92YC	0.8
Vanguard 235400	1-Cyl. OHV	11	OE013	RC12YC	QC12YC / XC92YC	0.8
Vanguard 245400	1-Cyl. OHV	13	OE013	RC12YC	QC12YC / XC92YC	0.8
Vanguard 260700	1-Cyl. OHV	12.5	OE013	RC12YC	QC12YC / XC92YC	0.8
Vanguard 261700	1-Cyl. OHV	14	OE013	RC12YC	QC12YC / XC92YC	0.8
Vanguard 28P700	1-Cyl. OHV	14	OE013	RC12YC	QC12YC / XC92YC	0.8
Vanguard 28Q700	1-Cyl. OHV	16	OE013	RC12YC	QC12YC / XC92YC	0.8
Vanguard 28S700	1-Cyl. OHV	15.5	OE013	RC12YC	QC12YC / XC92YC	0.8
Vanguard 290400	V-Twin OHV	12.5		RC14YC		0.8
Vanguard 290700	V-Twin OHV	12.5		RC14YC		0.8
Vanguard 294400	V-Twin OHV	14		RC14YC		0.8
Vanguard 294700	V-Twin OHV	14		RC14YC		0.8
Vanguard 303400	V-Twin OHV	16		RC14YC		0.8
Vanguard 303700	V-Twin OHV	16		RC14YC		0.8
Vanguard 350400	V-Twin OHV	18		RC14YC		0.8
Vanguard 350700	V-Twin OHV	18		RC14YC		0.8
Vanguard 351400	V-Twin OHV	20		RC14YC		0.8
Vanguard 351700	V-Twin OHV	20		RC14YC		0.8
Vanguard 380400	V-Twin OHV	23		RC14YC		0.8
Vanguard 380700	V-Twin OHV	23		RC14YC		0.8
Vanguard 381400	V-Twin OHV	21		RC14YC		0.8
Vanguard 381700	V-Twin OHV	21		RC14YC		0.8
Vanguard 85400	1-Cyl. OHV	4	OE013	RC12YC	QC12YC / XC92YC	0.5
Vanguard DM700G	3-Cyl. Liquid Cooled	23.5	OE013	RC12YC	QC12YC / XC92YC	0.8
Vanguard DM700P (LPG)	3-Cyl. Liquid Cooled	18	OE013	RC12YC	QC12YC / XC92YC	0.8
Vanguard DM950D	3-Cyl. Liquid Cooled	26.5	OE013	RC12YC	QC12YC / XC92YC	0.8
Vanguard DM950G	3-Cyl. Liquid Cooled	31	OE013	RC12YC	QC12YC / XC92YC	0.8
Vanguard DM950P	3-Cyl. Liquid Cooled	25.5	OE013	RC12YC	QC12YC / XC92YC	0.8
Vanguard DM950P (CNG)	3-Cyl. Liquid Cooled	25	OE013	RC12YC	QC12YC / XC92YC	0.8
Vanguard DM950P (LPG)	3-Cyl. Liquid Cooled	27	OE013	RC12YC	QC12YC / XC92YC	0.5
Vanguard DMG954G	3-Cyl. Liquid Cooled	34	OE013	RC12YC	QC12YC / XC92YC	0.5
	1-Cyl. OHV	15	OE013	RC12YC	QC12YC / XC92YC	0.8
	1-Cyl. OHV	10.5	OE013	RC12YC	QC12YC / XC92YC	0.8



CC BHP

21



OPT.



mm

**BRILL****Mowers**

Auto-Max 4 TB, Roto-Master 35	B & S			RJ19LM	QJ19LM	0.7
Brillmobil	B & S			RJ19LM	QJ19LM	0.7
Lord 4TS46, Monarch 56, Prinz 40M	Tecumseh			RJ17LM		0.7
Roto-Baron, Grande, King H4TB	B & S			RJ19LM	QJ19LM	0.7
Roto-Fox 46, Grande 46, King 46N, 46R	Aspera			RJ17LM		0.7
Roto-Fox, King H2TA	Aspera			RJ17LM		0.7
Roto-Lord 4TS, Prinz H4TB	B & S			RJ19LM	QJ19LM	0.7
Roto-Rapid 4TB	B & S			RJ19LM	QJ19LM	0.7
	ILO			RJ19LM		0.7

**BRINLY-HARDY****Tillers**

				RJ8C		0.8
--	--	--	--	------	--	-----

**BRISTER'S THUNDERWASH****Pressure Cleaners**

	Briggs & Stratton	5		RJ19LM	QJ19LM	0.8
	Honda OHV	5,8,11	OE051	RN11YC		0.8

**BROS****Snow Removers**

All Models				RJ19LM		0.8
------------	--	--	--	--------	--	-----

**BROUWER****Turf Equipment**

	Kohler OHV	15	OE013	RC12YC		0.8
	Kawasaki	1.2		RCJ8		0.8
	Mitsubishi			RCJ8		0.8
	Honda OHV	5.5	OE051	RN11YC		0.8
	Honda OHV	5	OE006	RN9YC		0.8

**BROYHILL****Sprayers**

				RCJ8		0.8
--	--	--	--	------	--	-----

**BRUNER****Pumps, Compressors & Refrigeration Units**

All Models				RJ19LM		0.8
------------	--	--	--	--------	--	-----

**BRUSHKING****Power Equipment**

BK100				RJ17LM		0.8
BK32, BK32LT				RCJ8Y		0.8
BK49				RCJ6Y		0.8
BK85				RJ17LM		0.8

**BRUTE (→ Canadiana)****BRUTUS POWER ROLLERS****Rollers**

	Briggs & Stratton Intek OHV	5.5	OE013	RC12YC	QC12YC / XC92YC	0.5
	Kohler Command Pro	6,13	OE013	RC12YC		1.0
	Briggs & Stratton	3.5,5		RJ19LM	QJ19LM	0.8
	Honda OHV	5.5	OE051	RN11YC		0.8

**BUCH****Lawn Mowers**

All Models				RJ19LM		0.8
------------	--	--	--	--------	--	-----

**BUFFALO SONIC****Sprayers**

				RL86C		0.8
--	--	--	--	-------	--	-----



CC BHP

21



OPT.



mm

**BUFFALO TURBINE**

**Blowers**

Kohler V-Twin	20,23	OE013	RC12YC		0.8
Wisconsin	36		RD16		0.6

**BUNDY**

**Power Equipment**

Aer-Eze			RCJ8		0.8
---------	--	--	------	--	-----

**BUNTON**

**Edgers, Trimmers**

			RCJ8		0.8
--	--	--	------	--	-----

**Garden Tractors, Rakes**

Briggs & Stratton Intek	18	OE013	RC12YC	QC12YC / XC92YC	0.5
Briggs & Stratton Intek	6.5	OE013	RC12YC	QC12YC / XC92YC	0.5
Briggs & Stratton Liquid-Cooled 3-Cyl.	31	OE013	RC12YC	QC12YC / XC92YC	0.5
Kohler OHV	12.5,14,15	OE013	RC12YC		1.0
Kohler OHV EFI	26	OE013	RC12YC		1.0
Kohler V-Twin	17,18,20,22,25	OE013	RC12YC		0.8
Briggs & Stratton Vanguard V-Twin	14,16		RC14YC		0.8
Briggs & Stratton Vanguard V-Twin	18,20		RC14YC		0.8
Kawasaki Liquid-Cooled V-Twin	14.5		RCJ8		0.8
Kawasaki Liquid-Cooled V-Twin	18		RCJ8		0.8
Kawasaki Liquid-Cooled V-Twin	20		RCJ8		0.8
Kawasaki V-Twin	15,17		RCJ8Y		0.8
Clinton			RJ12C		0.8
Briggs & Stratton	5		RJ19LM	QJ19LM	0.8
Briggs & Stratton	8		RJ19LM	QJ19LM	0.8
Tecumseh			RJ19LM		0.8
JLO			RL86C		0.8
Robin			RL86C		0.6
Honda OHV	11,13	OE051	RN11YC		0.8
Kawasaki OHV	12.5,14	OE051	RN11YC		0.8
Kawasaki V-Twin	19	OE051	RN11YC		0.8
Kawasaki V-Twin	21,25	OE051	RN11YC		0.8
Onan Twin	18,20		RS17YX		0.8

**Lawn Mowers**

Briggs & Stratton	5		RJ19LM	QJ19LM	0.8
-------------------	---	--	--------	--------	-----

**Mowers**

EstatePro	Briggs & Stratton	17.5	OE013	RC12YC	QC12YC / XC92YC	0.8
	Briggs & Stratton Intek V-Twin	18,25	OE013	RC12YC	QC12YC / XC92YC	0.8

**Trimmers**

LBF-18K, LBF-18KT, LBS-24K, LBS-24KT, LBS-33K, LBS-33KT			RCJ8		0.8
---	--	--	------	--	-----

**BURKEEN**

**Trenchers**

Honda OHV	13	OE051	RN11YC		0.8
Onan Twin	16		RS17YX		0.8

**BURNS (→ Gilson)**

**BUSH HOG**

**Power Equipment**

Briggs & Stratton	16	OE013	RC12YC	QC12YC / XC92YC	0.8
Kohler Command Pro	26,27	OE013	RC12YC		0.8
Kohler V-Twin	18,22,23,25	OE013	RC12YC		0.8
Briggs & Stratton Vanguard V-Twin	18		RC14YC		0.8
Kawasaki	12.5		RCJ8		0.6
Kawasaki Liquid-Cooled V-Twin	20		RCJ8		0.6
Honda 2-Cycle	11		RCJ8Y		0.8
Wisconsin			RD16		0.8
Briggs & Stratton			RJ19LM	QJ19LM	0.8
Tecumseh			RJ8C		0.8
Honda OHV	11,13,20,24	OE051	RN11YC		0.8
Kawasaki OHV	14	OE051	RN11YC		0.8
Kawasaki Liquid-Cooled V-Twin	25	OE042	RN12YC		0.8





CC BHP

21



OPT.

**BUSY BUZZER****Power Equipment**

Honda OHV	5.5	OE051	RN11YC		0.8
-----------	-----	-------	--------	--	-----

**BYERS****Power Equipment**

Kohler OHV	14	OE013	RC12YC		1.0
Kohler V-Twin	18,20,25	OE013	RC12YC		1.0
Briggs & Stratton Vanguard V-Twin	14,18		RC14YC		0.8
Tecumseh OHV	14	OE086	RL82C		0.8
Kawasaki OHV	14	OE051	RN11YC		0.8

**BYHO****Edgers**

Honda	2.5		CJ14		0.8
Briggs & Stratton	3.5		RJ19LM	QJ19LM	0.8

**C & S TURF CARE****Sprayers**

Briggs & Stratton Vanguard	9	OE013	RC12YC	QC12YC / XC92YC	0.8
Kohler Command V-Twin	20	OE013	RC12YC		0.8
Briggs & Stratton	3,5,5,5,8		RJ19LM	QJ19LM	0.8
Honda	4,5,5,8,9,11,13	OE051	RN11YC		0.8

**CAGLE****Sprayers**

Kohler	8		RH10C		0.6
Briggs & Stratton			RJ19LM	QJ19LM	0.8

**CAIRNS MFG.****Pressure Cleaners**

Kawasaki OHV	5,11	OE051	RN11YC		0.8
--------------	------	-------	--------	--	-----

**CAJUN****Mowers**

Cutter Mower	Briggs & Stratton Intek	6.75	OE013	RC12YC	QC12YC / XC92YC	0.5
	Briggs & Stratton Intek	6,5,8	OE013	RC12YC	QC12YC / XC92YC	0.5

**CAMPBELL-HAUSFELD****Air Compressors, Pressure Washers**

Briggs & Stratton OHV	6	OE013	RC12YC	QC12YC / XC92YC	0.8
Briggs & Stratton Vanguard OHV	13	OE013	RC12YC	QC12YC / XC92YC	0.8
Kohler OHV	12.5	OE013	RC12YC		0.8
Kohler	10		RH10C		0.8
Briggs & Stratton	3.75,4,5,5.5		RJ19LM	QJ19LM	0.8
Briggs & Stratton	8		RJ19LM	QJ19LM	0.8
Kohler	8		RJ19LM		0.6
Tecumseh	10		RJ19LM		0.8
Honda	5.5,6.5,11	OE051	RN11YC		0.8
Tecumseh OHV	5.5	OE098	RN4C		0.8

**Chain Saws**

2000, 3000, 3001, 3002, 3003			RDJ8J		0.8
------------------------------	--	--	-------	--	-----

**Generators**

Briggs & Stratton Intek	6	OE013	RC12YC	QC12YC / XC92YC	0.8
Briggs & Stratton Vanguard V-Twin	16,18,20		RC14YC		0.8
Briggs & Stratton	5,5.5		RJ19LM	QJ19LM	0.8
Briggs & Stratton	8,10,11		RJ19LM	QJ19LM	0.8
Honda OHV	13	OE051	RN11YC		0.8

**Sprayers**

Briggs & Stratton Intek	6.5	OE013	RC12YC	QC12YC / XC92YC	0.5
Briggs & Stratton			RJ19LM	QJ19LM	0.8

**CANADIANA (Brute)****Garden Tractors, Tillers**

Tecumseh			RJ8C		0.8
----------	--	--	------	--	-----

**Lawn Mowers**

All Models			RJ19LM		0.8
------------	--	--	--------	--	-----



CC BHP

21



OPT.



mm

**...CANADIANA (Brute)****Snow Removers**

Briggs & Stratton			RJ19LM	QJ19LM	0.8
Tecumseh			RJ8C		0.8

**CANYCOM****Mowers**

Briggs & Stratton Vanguard V-Twin	21		RC14YC		0.8
Kawasaki	23	OE042	RN12YC		0.8

**CARETAKER****Lawn Mowers****All Models**

			RJ19LM		0.8
--	--	--	--------	--	-----

**CARGILE****Lawn Mowers**

Tecumseh	5.5		RJ19LM		0.8
----------	-----	--	--------	--	-----

**CARLSON****Earth Drills, Trenchers**

Briggs & Stratton	5		RJ19LM	QJ19LM	0.8
Robin	4.5		RL95YC		0.6
Honda	5.5	OE051	RN11YC		0.8

**CARMEC****Hedge Trimmers****H27E**

			CJ6		0.6
--	--	--	-----	--	-----

**Power Equipment**

M27			CJ6		0.6
M34			RCJ8		0.8
M41			RCJ7Y		0.8
M45, M47, ZM41			RCJ8		0.8
Briggs & Stratton Vanguard	5.5	OE013	RC12YC	QC12YC / XC92YC	0.5
Briggs & Stratton Vanguard V-Twin	18		RC14YC		0.8
Briggs & Stratton	3.5,5		RJ19LM	QJ19LM	0.8
Briggs & Stratton	8		RJ19LM	QJ19LM	0.8
		OE051	RN11YC		0.8

**CAROLINA****Tillers, Plows**

Briggs & Stratton			RJ19LM	QJ19LM	0.8
Clinton			RJ8C		0.8

**CARTER****Power Equipment****Row Buster**

			RCJ8		0.8
--	--	--	------	--	-----

**CARVER****Pumps, Compressors & Refrigeration Units**

56	Chrysler		RN5C		0.6
7-263	Chrysler		RJ6C		0.6
A-2100	Clinton		RH10C		0.6
D-140	LeRoi (18mm)		RD16		0.6
	LeRoi (14mm)		RJ8C		0.6
D-201	LeRoi		RJ8C		0.6
D-700-900	Clinton		RJ8C		0.6
KN10L			RD16		0.6
KN11/2			RJ8C		0.6
KN2H, KN2LL, KN3H, KN3L, KN3YL, KN4H, KN4L, KN4M			RD16		0.6
KN6M			RJ8C		0.6
KN8L			RD16		0.6
UD-264, UD-6	IHC		D89D		0.6
	Continental, Wisconsin		RD16		0.6
	Ford	223	RF10C		0.6
	Ford	134	RH10C		0.6
	Ford	215	RH8C		0.6
	Ford	254	RH8C		0.6
	Briggs & Stratton		RJ19LM	QJ19LM	0.8



CC BHP

21



OPT.



mm

**CASAL****Mowers**

M 112, M 113			QL77JC4	0.5
M 131, M 132		OE086	RL82C	0.5
M 136			RL86C	0.5
M 137		OE086	RL82C	0.5
M 140			RL86C	0.5
M 147, M148, M149, 196, 197			RL86C	0.5
M 151		OE086	RL82C	0.5
M 153		OE086	RL82C	0.5
M 233		OE091	RN2C	0.5
M 234		OE091	RN2C	0.5

**CASE****Lawn Mowers**

All Models			RJ19LM	0.8
------------	--	--	--------	-----

**Turf Equipment**

Kohler	10,12,14		RH10C	0.8	
Onan B43M, B48M, BF			RH18Y	0.6	
Onan CCKA			RH8C	0.8	
Briggs & Stratton			RJ19LM	QJ19LM	0.8
Kohler	7		RJ19LM	0.8	
Tecumseh	7,10,12		RJ8C	0.8	
Onan NHC			RN5C	0.8	

**CASEY MOW****Lawn Mowers**

All Models			RJ19LM	0.8
------------	--	--	--------	-----

**CASTEL GARDEN****Lawn Mowers**

Briggs & Stratton	3.5,3.75,5,5.5		RJ19LM	QJ19LM	0.8
Tecumseh	3.5,4,5		RJ8C	0.8	
Honda	5	OE006	RN9YC	0.8	

**Riding Mowers**

Briggs & Stratton Vanguard V-Twin	16,18		RC14YC	0.8	
Briggs & Stratton	12.5,15,16		RJ19LM	QJ19LM	0.8

**CASTOR****Chain Saws**

330, 380, CP-41, CP-45			RCJ7Y	0.8
------------------------	--	--	-------	-----

**CAT PUMPS****Pressure Washers**

Honda OHV	5.5,9,11,13	OE051	RN11YC	0.8
-----------	-------------	-------	--------	-----

**CATERPILLAR****Generators**

D-13000 (CNG)			RJ6C	0.6
Other	(14mm)		RJ12C	0.6
	(7/8"-18)		W14	0.6

**C-B TOOL CO.****Power Equipment**

Chrysler			RCJ8	0.6
----------	--	--	------	-----

**CENTAUR****Garden Tractors**

(18mm)			RD16	0.6
(7/8"-18)			W14	0.6

**CENTRAL HYDRAULICS****Log Splitters**

Briggs & Stratton	5		RJ19LM	QJ19LM	0.8
Honda	5.5	OE051	RN11YC	0.8	





CC

BHP

21



OPT.

**CENTRAL MACHINERY****Pumps**

Briggs &amp; Stratton

RJ19LM

QJ19LM

0.8

**CENTRAL PARK****Lawn Mowers**

Briggs &amp; Stratton

RJ19LM

QJ19LM

0.8

**Riding Mowers**

Briggs &amp; Stratton Vanguard V-Twin

RC14YC

0.8

Briggs &amp; Stratton

RJ19LM

QJ19LM

0.8

**CERTIFIED****Lawn Mowers**

Clinton

RH10C

0.8

Briggs &amp; Stratton

RJ19LM

QJ19LM

0.8

**CHAIN-TRED****Garden Tractors**

(18mm)

RD16

0.6

(14mm)

RJ8C

0.6

**CHALLENGE****Power Equipment**

(1/2"-14)

25

0.6

**CHAMPION****Mowers**

Briggs &amp; Stratton

RJ19LM

QJ19LM

0.8

**Pumps, Compressors & Refrigeration Units**

(18mm)

D14

0.6

(14mm)

RJ8C

0.6

**CHARLES**

(→ Ditch Witch)

**CHARTERHOUSE****Power Equipment**

Honda OHV

5.5

OE051

RN11YC

0.8

**CHICAGO ELECTRIC****Generators**

Briggs &amp; Stratton Vanguard V-Twin

16

RC14YC

0.8

Briggs &amp; Stratton

5,8,16

RJ19LM

QJ19LM

0.8

**CHICAGO PNEUMATIC (C-P)****Compressors**

60, 85

RJ8C

0.6

85RG-1

RD16

0.6

**Pumps, Compressors & Refrigeration Units**

315

W14

0.6

105, 125RG-1, 125RG-2, 160

RJ8C

0.6

160RG-1, 175

RD16

0.6

185GZ-1

RJ8C

0.6

210RG-2, 219

W14

0.6

250RG-2

RJ8C

0.6

**CHIEF****Chain Saws**

D15

RCJ8

0.8

D35

RJ8C

0.8

E75, E95

RCJ8

0.8

**Lawn Mowers**

All Models

RJ12C

0.8



CC BHP

21



OPT.



mm

## CHIEFTAIN

### Lawn Mowers

Briggs & Stratton

RJ19LM QJ19LM

0.8

## CHIPPIT

### Power Equipment

800G, Chippit II

Kohler

12

RJ19LM

0.8

Kohler Twin

18

RH10C  
RV17YC

0.8  
0.8

## CHOREMASTER

### Garden Tractors

RJ8C

0.8

### Lawn Mowers

All Models

RJ19LM

0.8

### Tillers

RJ19LM

0.8

## CHRYSLER POWER BEE

### Engines

50000	4.25		RCJ8	0.8
50002	4.25		RCJ8	0.8
50004	4.25		RCJ8	0.8
50006	4.25		RCJ8	0.8
50012	4.25		RCJ8	0.8
50014	4.25		RCJ8	0.8
50052	3.3		RCJ8	0.8
50054	3.3		RCJ8	0.8
50056	2		RCJ8	0.8
51001	3		RJ8C	0.8
51005	3		UJ11G	1.0
51007	3		UJ11G	1.0
51009	3		UJ11G	1.0
51011	3		UJ11G	1.0
58011	4		RH8C	0.8
58021	4		RJ8C	0.8
58023	4		UJ11G	1.0
58029	4		UJ11G	1.0
58031	4		UJ11G	1.0
58033	4		UJ11G	1.0
58035	4		UJ11G	1.0
58037	4		RJ8C	0.8
58039	4		UJ11G	1.0
58041	4		UJ11G	1.0
58043	4		UJ11G	1.0
58045	4		UJ11G	1.0
58047	4		UJ11G	1.0
58049	4		UJ11G	1.0
58051	4		UJ11G	1.0
58053	4		UJ11G	1.0
61001	7.5	OE086	RL82C	0.8
61002	7.5	OE086	RL82C	0.8
61005	5.5		RL86C	0.8
61006	5.5		RL86C	0.8
61010	4.7	OE086	RL82C	0.8
61012	8	OE086	RL82C	0.8
70019	5		UJ11G	1.0
70033	5		UJ11G	1.0
70037	5		UJ11G	1.0
70039	5		UJ11G	1.0
70041	5		UJ11G	1.0
82001	10	OE086	RL82C	0.8
82002	10	OE086	RL82C	0.8
82003	7	OE086	RL82C	0.8
82005	6.2		RL86C	0.8
82006	6.2	OE086	RL82C	0.8
82007	6.7		RL86C	0.8
82008	6.5		RL86C	0.8
82009	6.2		RL86C	0.8
82010	6.5		RL86C	0.8





CC BHP

21



OPT.



mm

## ...CHRYSLER POWER BEE

### ...Engines

82011	6.7			RL86C	0.8
82017	6.2			RL86C	0.8
82019	6.2			RL86C	0.8
82021	6.2			RL86C	0.8
82023	6.2			RL86C	0.8
82026	7			RL86C	0.8
82027	7			RL86C	0.8
82029	6.7			RL86C	0.8
82030	7			L90C	0.8
82031	6.7			RL86C	0.8
82032	7			RL86C	0.8
82033	7			RL86C	0.8
82034	7			RL86C	0.8
82036	7			RL86C	0.8
82038	10	OE086		RL82C	0.8
82039	10	OE086		RL82C	0.8

## CIFARELLI

### Brushcutters

Nuvola L - 80, C 3

RCJ7Y 0.5

## CLARK

### Lawn Mowers

All Models

RJ19LM 0.8

### Power Equipment

830, 850 Tillers

RCJ8 0.8

## CLARKE

### Centrifugal Pumps

Briggs & Stratton	3,3,5,5			RJ19LM	QJ19LM	0.8
Honda OHV	8	OE051		RN11YC		0.8
Honda OHV	5	OE006		RN9YC		0.8

### Generators

Briggs & Stratton	5,8,11			RJ19LM	QJ19LM	0.8
Robin	8			RL86C		0.8
Honda OHV	8	OE051		RN11YC		0.8

### Log Splitters

Briggs & Stratton	3,75,4			RJ19LM	QJ19LM	0.8
-------------------	--------	--	--	--------	--------	-----

## CLARKE DELCO

### Power Equipment

Tecumseh	6			RJ8C		0.8
----------	---	--	--	------	--	-----

### Pumps, Compressors & Refrigeration Units

Briggs & Stratton Vanguard OHV	9	OE013		RC12YC	QC12YC / XC92YC	0.8
Briggs & Stratton Vanguard V-Twin	14,16			RC14YC		0.8
Briggs & Stratton	10			RJ19LM	QJ19LM	0.8
Briggs & Stratton	2,5,7,8,5,9			RJ19LM	QJ19LM	0.8

### Sweepers

Tecumseh	4,6			RJ8C		0.8
----------	-----	--	--	------	--	-----

## CLASSEN

### Aerators

TA-15	Briggs & Stratton	3.5		RJ19LM	QJ19LM	0.8
TA-15, TA-17, TA-19, TA-25, TA-26	Honda OHV	4	OE051	RN11YC		0.8

### Power Equipment

Honda OHV	8	OE051		RN11YC		0.8
-----------	---	-------	--	--------	--	-----

### Rakes

TR20, TRC20	Briggs & Stratton Intek	5.5	OE013	RC12YC	QC12YC / XC92YC	0.5
-------------	-------------------------	-----	-------	--------	-----------------	-----

### Seeder

RS-36	Honda OHV	5.5	OE051	RN11YC		0.8
	Honda OHV	5.5,8	OE051	RN11YC		0.8

### Seeders

TS-20	Briggs & Stratton Intek	5.5	OE013	RC12YC	QC12YC / XC92YC	0.5
	Briggs & Stratton	5		RJ19LM	QJ19LM	0.8
	Honda OHV	5.5	OE051	RN11YC		0.8



CC BHP

21



OPT.



mm

**...CLASSEN**

**Sod Cutter**

SC-12	Honda OHV	5.5	OE051	RN11YC	0.8
	Honda OHV	5.5,8	OE051	RN11YC	0.8
	Honda OHV	5.5,8	OE051	RN11YC	0.8
SC-18	Honda OHV	5.5,8	OE051	RN11YC	0.8
SC-20	Honda OHV	5.5,8	OE051	RN11YC	0.8

**CLEAN-CUT**

**Lawn Mowers**

All Models				RJ19LM	0.8
------------	--	--	--	--------	-----

**CLEMSON**

**Lawn Mowers**

All Models				RJ19LM	0.8
------------	--	--	--	--------	-----

**CLINTON**

**Chain Saws**

D15, D25				RCJ8	0.8
D35, D55, D65				RJ8C	0.8
E10				CJ6	0.6
E75, E95				RCJ8	0.8

**Edgers, Sprayers, Tillers**

				RJ12C	0.8
--	--	--	--	-------	-----

**Engines**

100				RH10C	0.6
190				RH10C	0.6
200				RH10C	0.6
400				RH10C	0.6
401				RH10C	0.6
402				RH10C	0.6
403				RH10C	0.6
404				RH10C	0.6
405				RH10C	0.6
406				RH10C	0.6
407				RH10C	0.6
408				RH10C	0.6
409				RH10C	0.6
410				RH10C	0.6
411				RH10C	0.6
412	(7/16" reach)			RH10C	0.6
	(3/8" reach)			RJ8C	0.6
413	(3/8" reach)			RJ8C	0.6
414	(7/16" reach)			RH10C	0.6
415	(7/16" reach)			RH10C	0.6
416	(7/16" reach)			RH10C	0.6
	(Shielded Plug)			XMJ17	0.6
418	(7/16" reach)			RH10C	0.6
419				RH10C	0.6
420				RH10C	0.6
422				RH10C	0.6
424				RH10C	0.6
426				RH10C	0.6
429				RH10C	0.6
431				RH10C	0.6
435				RH10C	0.6
437				RH10C	0.6
492	(3/8" reach)			RJ8C	0.6
494	(3/8" reach)			RJ8C	0.6
498	(3/8" reach)			RJ8C	0.6
499	(3/8" reach)			RJ8C	0.6
500				RJ12C	0.6
501				RJ12C	0.6
502				RCJ8	0.6
503				RCJ8	0.6
1200				RJ8C	0.6
1600				RH10C	0.6
1690				RH10C	0.6
2100				RH10C	0.6





CC

BHP

21



OPT.



**...CLINTON**

**...Engines**

2190			RH10C	0.6
2500			RH10C	0.6
2590			RH10C	0.6
2790			RH10C	0.6
3100			RH10C	0.6
3190			RH10C	0.6
4100			RH10C	0.6
4190			RH10C	0.6
A-1200			RJ8C	0.6
A-1600			RH10C	0.6
A-200			RH10C	0.6
A-2100			RH10C	0.6
A-2500			RH10C	0.6
A-300			RJ8C	0.6
A-400			RJ12C	0.6
AV-3100			RH10C	0.6
AVS-200			RH10C	0.6
AVS-3100			RH10C	0.6
AVS-400			RH10C	0.6
AVS-4100			RH10C	0.6
B-1290			RJ8C	0.6
B-2500			RH10C	0.6
BVS-400			RH10C	0.6
C-700			RJ8C	0.6
CVS-400			RH10C	0.6
D-700			RJ8C	0.6
E-65			RC18	0.6
V-100			RH10C	0.6
V-1000			RJ8C	0.6
V-1100			RJ8C	0.6
V-1200			RJ8C	0.6
V-3100			RH10C	0.6
VS-100			RH10C	0.6
VS-1000			RJ8C	0.6
VS-1100			RJ8C	0.6
VS-1200			RJ8C	0.6
VS-200			RJ12C	0.6
VS-2100			RH10C	0.6
VS-300			RJ8C	0.6
VS-3100			RH10C	0.6
VS-400			RJ12C	0.6
VS-4100			RH10C	0.6
VS-900			RJ8C	0.6

**Generators**

350W, 750W, Chief Miniature			RJ12C	0.6
-----------------------------	--	--	-------	-----

**Lawn Mowers**

Chief			RJ12C	0.8
Chieftain			RJ12YC	0.8

**Pumps, Compressors & Refrigeration Units**

404T			RH10C	0.6
492T			RJ8C	0.6
500P			RH10C	0.6

**CLIPPER CHIPPER**

**Power Equipment**

Beaver	Wisconsin		RD16	0.8	
Chipmunk	Briggs & Stratton		RJ19LM	QJ19LM	0.8

**CLUB CAR**

**Utility Vehicles**

Carryall	Kawasaki OHV	9,11.1	OE051	RN11YC	0.8
----------	--------------	--------	-------	--------	-----

**CM**

**Power Equipment**

CA148L, CA180L, CA295, CA340			RL86C	0.5
CA450, CA550			D14	0.5
CM46, CM80, CM90, CM115, CM24/1A			RL86C	0.5





CC BHP

21



OPT.



mm

**COATES****Power Equipment**

Little Giant

RJ8C

0.8

**COLDWELL****Power Equipment**

(1/2"-14)

Briggs &amp; Stratton

Clinton

(7/8"-18)

25

RJ19LM

QJ19LM

0.6

0.8

0.6

0.6

**COLEMAN****Compressors**

Honda OHV

11

OE051

RN11YC

0.8

**Garden Plows**

Briggs &amp; Stratton

3

RJ19LM

QJ19LM

0.8

**Generators**

PM0454024, PM0454025, PM0455024, PM0456025

PM0522000, PM0524000, PM0525000

PM0544202, PM0544222, PM0545202

PM0545305

PM0554222

Kawasaki

Briggs &amp; Stratton

Tecumseh

Honda OHV

3.1

5.5

OE051

RJ19LM

RJ8C

RJ19LM

RC14YC

RJ19LM

RCJ8

RJ19LM

RJ8C

RN11YC

QJ19LM

0.8

0.8

0.8

0.8

0.8

0.8

0.8

0.8

0.8

**Pressure Washers**

Tecumseh

6

RJ8C

0.8

**COLT****Power Equipment**

Kohler

Kohler

Tecumseh

10,12

7

RH10C

RJ19LM

RJ8C

0.6

0.6

0.8

**COLUMBIA****Lawn Mowers**

All Models

RJ19LM

0.8

**Power Equipment**

Tecumseh

Briggs &amp; Stratton

RJ17LM

RJ19LM

QJ19LM

0.8

0.8

**Snow Removers**

Tecumseh

Tecumseh

12

RJ19LM

RL86C

0.8

0.8

**COLUMBIA PAR CAR****Utility Vehicles**

Briggs &amp; Stratton Vanguard

Briggs &amp; Stratton Single Cyl.

9

OE013

RC12YC

RJ19LM

QC12YC / XC92YC

QJ19LM

0.8

0.8

**COMET****Chain Saws**

D-4

D-51

D-58

RCJ8

RH8C

RCJ8

0.8

0.8

0.8

**COMMERCIAL CLIPPER****Riding Mowers**

Kohler V-Twin

Kohler Twin

22,25

18,20

OE013

RC12YC

RV17YC

0.8

0.6

**COMPANION****Chainsaws**

MS1, MS2, RS1, RS2

RL86C

0.5



CC BHP

21



OPT.



mm

### CON-SOL

#### Lawn Mowers

All Models

RJ19LM

0.8

### CONSOLIDATED

#### Generators

D1430, D1850

D615, D925

G210, G415

G930

W89D

0.6

D89D

0.6

RD16

0.6

W14

0.6

### CONSTRUCTION MACHINERY CO.

#### Generators

10EL

10LS, 15DAL/20

15HK, 25HN

358RS

36JT

5G0

68AL/20

6G0

W3D/206, W3S/206

RH10C

0.6

D9

0.6

RD16

0.6

RJ6C

0.6

RD16

0.6

RJ12C

0.6

RJ6C

0.6

RJ12C

0.6

D9

0.6

### CONTOUR

#### Lawn Mowers

All Models

RJ19LM

0.8

### CONTREE

#### Pumps

Briggs & Stratton

5

RJ19LM

QJ19LM

0.8

Honda OHV

5.5,8

OE051

RN11YC

0.8

Tecumseh OHV

5.5

OE098

RN4C

0.8

#### Sprayers

Briggs & Stratton Single Cyl.

Honda OHV

5

OE006

RJ19LM

QJ19LM

0.8

RN9YC

0.8

### CONVERTIBLE

#### Mowers

Kohler V-Twin

17,20,22,25

OE013

RC12YC

0.8

Kawasaki V-Twin

17

RCJ8Y

0.8

Kawasaki OHV

17

OE051

RN11YC

0.8

### CONVEYORS PLUS

#### Power Equipment

Briggs & Stratton

5

RJ19LM

QJ19LM

0.8

### CO-OP

#### Power Equipment

Briggs & Stratton

RJ19LM

QJ19LM

0.8

### COOPER

#### Aerators

Echo

RCJ8

0.6

#### Chippers

Briggs & Stratton

5

RJ19LM

QJ19LM

0.8

#### Ditcher

Honda OHV

5

OE006

RN9YC

0.8

#### Edgers

Echo

RCJ8

0.6

#### Lawn Mowers

All Models

RJ19LM

0.8

#### Log Splitters

Briggs & Stratton

8

RJ19LM

QJ19LM

0.8

#### Power Equipment

Briggs & Stratton

Tecumseh

RJ19LM

QJ19LM

0.8

RJ19LM

0.8



CC BHP

21



OPT.



mm

## COOPER-PEGLER

### Sprayers

Briggs & Stratton	3.5,5		RJ19LM	QJ19LM	0.8
Honda OHV	3.5,5	OE006	RN9YC		0.8

## COPELAND

### Pumps, Compressors & Refrigeration Units

Briggs & Stratton			RJ19LM	QJ19LM	0.8
-------------------	--	--	--------	--------	-----

## CORNELIUS

### Pumps, Compressors & Refrigeration Units

T30R1405			RJ19LM		0.8
T30R1411			RJ8C		0.6
32-1505			RJ19LM		0.8

## CORNELL

### Log Splitters

			RCJ8		0.8
--	--	--	------	--	-----

## CORONADA

### Generators

All Models			D9		0.6
------------	--	--	----	--	-----

## COSCO

### Edgers

			RCJ8		0.6
--	--	--	------	--	-----

### Trimmers

			RDJ7J		0.6
--	--	--	-------	--	-----

## COUGAR

### Power Equipment

Briggs & Stratton	5		RJ19LM	QJ19LM	0.8
Tecumseh	5		RJ19LM		0.8

## COULTER-AUTOMATIC

### Pumps, Compressors & Refrigeration Units

1930 →			W14		0.6
→ 1930			W18		0.6

## COUNTRY CLIPPER

### Riding Mowers

Kohler Command Pro	20		OE013	RC12YC	0.8
Kohler Command Pro	25		OE013	RC12YC	0.8
Kohler Command Pro	27		OE013	RC12YC	0.8
Kohler Single Cyl.	17		OE013	RC12YC	0.8
Kohler V-Twin	18		OE013	RC12YC	0.8
Kohler V-Twin	22,23,25		OE013	RC12YC	0.8
Kohler V-Twin EFI	26		OE013	RC12YC	0.8
Kawasaki V-Twin	15,17			RCJ8Y	0.8
Briggs & Stratton	11,12.5			RJ19LM	QJ19LM
Briggs & Stratton Twin	14,16,18			RJ19LM	QJ19LM
Kawasaki	14		OE051	RN11YC	0.8
Kawasaki	23,25		OE051	RN11YC	0.8
Kawasaki V-Twin	19		OE051	RN11YC	0.8

## COVENTRY VICTOR

### Engines

AN-3, WN-3				RN5C	0.5
Midget				RL86C	0.5
Neptune AC4, 'N' Type AN4			OE098	RN4C	0.5
Other Models			OE098	RN4C	0.5



CC BHP

21



OPT.



mm

**CRAFTSMAN**

**Blowers**

79692			RCJ8		0.8
	Fuji 79691		OE086 RL82C		0.8

**Brushcutters**

271.281514, 610.281514			RCJ8		0.8
------------------------	--	--	------	--	-----

**Chain Saws**

2.5			RDJ6J		0.8
2.7			RCJ8		0.8
3.5			RDJ6J		0.8
3.6			RCJ8		0.8
4.5			RDJ6J		0.8
35269			RDJ7J		0.8
35363			RCJ8		0.8
35365			RDJ7J		0.8
35607			CJ6		0.8
35718			CJ6		0.8
35883			CJ6		0.8
35886			CJ6		0.8
35889			RCJ8Y		0.8
35904			CJ6		0.8
59820			RCJ8Y		0.8
59886			RCJ8		0.8
59918			RCJ8Y		0.8
358810			RCJ4		0.8
358840			RCJ4		0.8
358860			RCJ8		0.8
1.8, 1.9			RCJ8		0.8
1.9 Beaver			RDJ6J		0.8
2.0, 2.1			RCJ8		0.8
3.7, 31197			CJ6		0.8
3400, 3401, 3402, 34071, 3408, 34094, 3411, 3412, 3415, 3416, 3418, 3425, 3455, 3460, 3461, 3465, 3466, 3476, 3481, 35082, 35091, 35093, 35094, 35096 35138, 35147, 35148, 35171, 35177, 35187			RCJ8		0.8
35201, 35202, 35203, 352030, 35205, 35206, 352060, 35207, 352070, 35209, 352090, 35211, 35232, 352321, 352351, 35238, 35251, 35255, 35256, 35263, 35266, 35267			CJ6		0.8
35366, 35367, 35369, 35371			RCJ8		0.8
35372, 35373, 35375, 35376			CJ6		0.8
35481, 35483, 35484, 35487			RCJ8Y		0.8
35505, 35506, 35512, 35514, 35515, 35516			RCJ8		0.8
35608, 35609			RCJ8Y		0.8
35628, 35633			CJ6		0.8
357120, 357160			RCJ8		0.8
358356, 35881			RCJ8Y		0.8
35885, 358850			RCJ8Y		0.8
35887, 35889			CJ6		0.8
36096, 36212, 36235, 4.3			RCJ8		0.8
59716, 59741, 59816			RCJ8		0.8
Barracuda			CJ6		0.8
D44, D49			RJ8C		0.8

**Earth Drills**

	Tecumseh		RJ17LM		0.8
--	----------	--	--------	--	-----

**Generators**

	Briggs & Stratton		RJ19LM	QJ19LM	0.6
--	-------------------	--	--------	--------	-----

**Lawn Mowers**

	Briggs & Stratton OHV	6.5	OE013	RC12YC	QC12YC / XC92YC	0.5
	Briggs & Stratton	3,3,5,6		RJ19LM	QJ19LM	0.8
	Tecumseh	3,5,4		RJ19LM		0.8
	Tecumseh	5		RJ19LM		0.8
	Tecumseh OHV	4.5	OE098	RN4C		0.8
	Tecumseh OHV	5,6,75	OE098	RN4C		0.8
	Honda	5,5.5	OE006	RN9YC		0.8

**Power Equipment**

GT16	Tecumseh		OE086	RL82C		0.8
GT18	Onan B48M			RH18Y		0.8
GT19.9	Onan N52M			RS17YX		0.6





CC

BHP

21



OPT.



mm

**...CRAFTSMAN****...Power Equipment**

Tecumseh	2		RCJ6Y		0.8
Craftsman			RCJ8		0.8
Craftsman			RCJ8		0.8
Tecumseh	1.6		RCJ8Y		0.8
Briggs & Stratton			RJ19LM	QJ19LM	0.8
Briggs & Stratton	2.5,3,3.5,4,5		RJ19LM	QJ19LM	0.8

**Riding Equipment**

Briggs & Stratton Intek	6.5	OE013	RC12YC	QC12YC / XC92YC	0.5
Kohler V-Twin	22	OE013	RC12YC		1.0
Briggs & Stratton Vanguard V-Twin	14		RC14YC		0.8
Briggs & Stratton Vanguard V-Twin	18		RC14YC		0.8
Onan	16		RH8C		0.6
Briggs & Stratton	11,12		RJ19LM	QJ19LM	0.8
Briggs & Stratton	6		RJ19LM	QJ19LM	0.8
Briggs & Stratton Twin	18		RJ19LM	QJ19LM	0.8
Tecumseh	4,4.5		RJ19LM		0.8
Tecumseh	6,6.75		RJ19LM		0.8
Tecumseh	5		RJ8C		0.8
Tecumseh	8,10,12		RJ8C		0.8
Tecumseh OHV	16	OE086	RL82C		0.8
Tecumseh OHV	12		RL86C		0.8
Honda	5.5	OE051	RN11YC		0.8
Onan Twin	20		RS17YX		0.6
Kohler Twin	18,20		RV17YC		0.6

**Snow Removers**

Tecumseh 2-Cycle	3		RCJ8Y		0.8
Tecumseh 2-Cycle	4		RCJ8Y		0.8
Tecumseh	4		RJ19LM		0.8
Tecumseh	5,8,10		RJ19LM		0.8

**Trimmers**

795440			RCJ8		0.8
796131			CJ14		0.8
795340, 795410, 795420, 795430			CJ14		0.8
795451, 795453		OE086	RL82C		0.8
795490, 795510, 795520			CJ14		0.8
795800, 795900			RCJ8		0.8
79623, 79624		OE086	RL82C		0.8

**CRAMER TECHNIK****Power Equipment**

Briggs & Stratton	4,5.5,6.75		RJ19LM	QJ19LM	0.8
-------------------	------------	--	--------	--------	-----

**CREATIVE CURB****Power Equipment**

Honda	2.2,2.5		CJ14		0.8
Kohler	14		RH10C		0.8
Honda	20	OE051	RN11YC		0.8
Honda	5.5,6.5,8,13	OE051	RN11YC		0.8
Honda Twin	18		RV17YC		0.6

**CRITERION****Riding Mowers**

Briggs & Stratton Vanguard V-Twin	20		RC14YC		0.8
-----------------------------------	----	--	--------	--	-----

**CROSS****Power Equipment**

			RCJ8		0.8
--	--	--	------	--	-----

**CROWN****Mowers**

Commando 218, 220, 221, 221V, 220S			RJ17LM		0.7
Commando 418, 420, 421			RJ17LM		0.7



CC BHP

21



OPT.



mm

### CUB CADET

#### Edgers

Briggs & Stratton

RJ19LM

QJ19LM

0.8

#### Lawn Mowers

072R, 108R, 149R, 702R, 899E, 899R, P418, PS520, S621, SC621, SC621E

Briggs & Stratton

RJ19LM

0.8

#### Log Splitters

Briggs & Stratton

RJ19LM

QJ19LM

0.8

Tecumseh

RJ19LM

0.8

#### Mowers

55

RCJ8

0.8

RZT Riders

Briggs & Stratton Intek

17,22

OE013

RC12YC

QC12YC / XC92YC

0.8

#### Mowers, Riding Equipment

60

RJ8C

0.8

80

RCJ8

0.8

86

RJ8C

0.8

111

RCJ8

0.8

123

RH10C

0.8

182

RCJ8

0.8

482

RCJ8

0.8

582

RJ12C

0.8

682

RV15YC4

0.8

782

RV15YC4

0.8

800

RH10C

0.8

982

RJ8C

0.8

1030

RS14YC

0.8

1225

RJ19LM

0.8

1238

RJ19LM

0.8

1430

RJ19LM

0.8

1440

RV17YC

0.8

1641

RC14YC

0.8

1650

RC14YC

0.8

1730

RH10C

0.8

2082

RV17YC

0.8

100, 1000, 102

RV17YC

0.8

104, 105, 106, 107, 108, 109, 1100

RH10C

0.8

1200, 122

RH10C

0.8

124, 125, 1250, 126, 127, 128, 129

RH10C

0.8

1325, 1330

RH10C

0.8

1450, 147, 149

RC14YC

0.8

1861, 1862

RH10C

0.8

1863, 1864

RV17YC

0.8

2084, 2086, 2182, 2284

OE013

RC12YC

0.8

282, 382

RC12YC

0.8

4814R

RCJ8

0.8

4815F

RH10C

0.8

4816F

OE013

RC12YC

1.0

5416R, 5418F

RC14YC

0.8

70, 71, 72, 73

RC14YC

0.8

75, 76

RJ8C

0.8

81, 85

RCJ8

0.8

AGS2130

RCJ8

0.8

AGS2140

OE013

RC12YC

1.0

AGS2150, AGS2155

RL95YC

0.9

AGS2160, Grizzly 4016

OE013

RC12YC

1.0

HDS2135

RC14YC

0.8

HDS2145

OE013

RC12YC

1.0

HDS2155

RL95YC

0.9

HDS2165

OE013

RC12YC

1.0

HDS2185

RC14YC

0.8

OE013

RC12YC

1.0



CC

BHP

21



OPT.

mm

**...CUB CADET**

**...Mowers, Riding Equipment**

SRX95	Kawasaki			CJ14		0.8
	Briggs & Stratton Intek Extended Life Series	18.5,24	OE013	RC12YC	QC12YC / XC92YC	0.8
	Kohler OHV	12.5,13	OE013	RC12YC		1.0
	Kohler OHV	15	OE013	RC12YC		1.0
	Kohler V-Twin	18	OE013	RC12YC		0.8
	Kohler V-Twin	20,22,23,25,28	OE013	RC12YC		0.8
	Kubota	21	OE013	RC12YC		0.8
	Briggs & Stratton Vanguard			RC14YC		0.8
	Kawasaki	12.5		RCJ8		0.8
	Kawasaki	5.2		RCJ8		0.8
	Kawasaki Liquid-Cooled V-Twin	20,25,28		RCJ8		0.8
	Kawasaki V-Twin	17		RCJ8Y		0.8
	Kohler	10,12		RH10C		0.8
	Kohler	14		RH10C		0.8
	Kohler	16		RH10C		0.8
	Kohler	20		RH10C		0.8
	Briggs & Stratton Single Cyl.			RJ19LM	QJ19LM	0.8
	Briggs & Stratton Twin			RJ19LM	QJ19LM	0.8
	Kohler K181	8		RJ19LM		0.8
	Tecumseh			RJ8C		0.8
	Onan E140H	14		RL95YC		0.9
	Honda V-Twin OHV	20,24	OE051	RN11YC		0.8
	Kawasaki OHV	13,14,17	OE051	RN11YC		0.8
	Kawasaki OHV	3.7	OE051	RN11YC		0.8
	Kawasaki OHV	6.5,7.9,9,11.1	OE051	RN11YC		0.8
	Yanmar 322		OE006	RN9YC		0.6
	Onan 316, 318, 420			RS17YX		0.6
	Kohler Twin	17		RV17YC		0.6

**Power Equipment**

Briggs & Stratton	5,8			RJ19LM	QJ19LM	0.8
Tecumseh	8			RJ8C		0.8

**Pressure Washers**

Kohler	10			RH8C		0.8
Briggs & Stratton	6			RJ19LM	QJ19LM	0.8
Kohler	6	OE042		RN12YC		1.0

**Snow Removers**

1030E, 1030W				RJ8C		0.8
321, 520E, 520R				RCJ8Y		0.8
522E			OE098	RN4C		0.8
524, 524T				RJ8C		0.8
721E			OE098	RN4C		0.8
724E, 724TE				RJ8C		0.8
724WE			OE098	RN4C		0.8
826, 826T, 926E, 926TE				RJ8C		0.8
Tecumseh 2-Cycle	3			RCJ8Y		0.8
Briggs & Stratton				RJ19LM	QJ19LM	0.8
Tecumseh	5			RJ8C		0.8
Tecumseh	7,8,9,10			RJ8C		0.8
Tecumseh OHV	5.5	OE098		RN4C		0.8

**Tillers**

Briggs & Stratton				RJ19LM	QJ19LM	0.8
Tecumseh				RJ19LM		0.8

**Trimmers**

SE26, SE26-C, ST23, ST23-C, ST26, ST26-C, ST35, ST35-C				RCJ6Y		0.8
--	--	--	--	-------	--	-----

**Vacuums, Blowers**

Briggs & Stratton				RJ19LM	QJ19LM	0.8
-------------------	--	--	--	--------	--------	-----

**CULTILLER**

**Power Equipment**

All Models				RJ8C		0.6
------------	--	--	--	------	--	-----



CC BHP

21



OPT.



mm

**CUNNINGHAM**

**Lawn Mowers**

All Models				RJ19LM	0.8
------------	--	--	--	--------	-----

**Power Equipment**

(18mm)				RD16	0.8
(14mm)				RJ8C	0.8

**CURB-TEC**

**Augers**

CT-3000	Kohler	25		OE013	RC12YC	0.8
---------	--------	----	--	-------	--------	-----

**CURTIS**

**Pumps, Compressors & Refrigeration Units**

Briggs & Stratton (18mm)				RD16		0.6
Wisconsin				RD16		0.6
Kohler		10		RH10C		0.6
Briggs & Stratton (14mm)				RJ19LM	QJ19LM	0.8

**Refrigerator Compressors**

				RD16		0.6
--	--	--	--	------	--	-----

**CUSHMAN**

**Aerators**

GA 60		27		OE042	RN12YC	0.8
-------	--	----	--	-------	--------	-----

**Generators**

(18mm)				D9		0.6
(7/8"-18)				W10		0.6

**Lawn Mowers**

OMC 218				RF11YC		0.8
---------	--	--	--	--------	--	-----

**Mowers**

				RF11YC		0.8
--	--	--	--	--------	--	-----

**Turf Equipment**

898611	Mitsubishi	49		OE006	RN9YC	0.8
Envirojet 160				OE013	RC12YC	0.8
Groom Master		16			RC14YC	0.8
GT-1		14			RC14YC	0.8
Hawk				OE013	RC12YC	1.0
Jr. Turf-Truckster	V-Twin	18		OE013	RC12YC	0.8
Range Cat 775				OE013	RC12YC	0.8
Runabout	OMC	18			RF11YC	0.8
Sprinter				OE051	RN11YC	0.8
Truckster, Truckster/Haulster					RF11YC	0.8
Truckster/Haulster					RCJ8	0.8
					RJ8C	0.8
Turf-Truckster		34		OE051	RN11YC	0.8
		27		OE042	RN12YC	0.8
		22			RV15YC4	0.6
Turf-Truckster (Liquid V-Twin)		20			RCJ8	0.6
UTV-Max, UTV-Maxim, Vac Master					RC14YC	0.8
	Kohler V-Twin	18,25		OE013	RC12YC	0.8
	Briggs & Stratton Vanguard V-Twin	14,16,18			RC14YC	0.8
	Kawasaki Liquid-Cooled V-Twin	20			RCJ8	0.6
	OMC 218				RF11YC	0.8
	Kohler	12			RH10C	0.8
	Kohler	7,8			RJ19LM	0.8
	Kohler -, K181	7,8			RJ19LM	0.8
	Kohler -, K181	8			RJ19LM	0.8
		272	8.5	OE051	RN11YC	0.8
		327	27	OE042	RN12YC	0.8
	Daihatsu 3-Cyl.				RN14YC	0.8
	Mitsubishi	1060	49	OE006	RN9YC	0.8
		222	22		RV15YC4	0.6

**CYCLE COUNTRY**

**Power Equipment**

Briggs & Stratton		3.5,8.5,10.5,12.5			RJ19LM	QJ19LM	0.8
Honda		11		OE051	RN11YC		0.8





CC BHP

21



OPT.



mm

**CYCLO ACTION****Power Equipment**

Briggs & Stratton	5,8		RJ19LM	QJ19LM	0.8
Tecumseh	3.5		RJ19LM		0.8

**CYGNET TURF & EQUIPMENT****Power Equipment**

Wisconsin	18		RD16		0.6
Honda	5	OE006	RN9YC		0.8

**DACON****Lawn Mowers****All Models**

			RJ19LM		0.8
--	--	--	--------	--	-----

**DAIHATSU****Utility Vehicles**

Hijet	547	30	OE006	RN9YC	0.9
-------	-----	----	-------	-------	-----

**DANARM****Chain Saws****110, 125****1-36, 1-71, 2-36, 36AV, 55, 76**

			RJ8C		0.8
			CJ6		0.8

**Generators**

Briggs & Stratton			RJ19LM	QJ19LM	0.6
Robin			RL86C		0.6

**Trimmers****TM10C, TM20****TM30B****Tornado 18E, 24E, 33E, 40E, 50E****Whipper 16, 18E**

			RCJ8		0.6
			CJ14		0.6
			RCJ8		0.6
			RCJ8		0.6

**DANUSER****Power Equipment**

Kohler V-Twin	25		OE013	RC12YC	0.8
---------------	----	--	-------	--------	-----

**DASCO****Log Splitters**

Briggs & Stratton			RJ19LM	QJ19LM	0.8
-------------------	--	--	--------	--------	-----

**DAVEY****Pumps, Compressors & Refrigeration Units**

ABND	Wisconsin		RD16		0.6
GO198A			RJ8C		0.6
HXC, HXE	Hercules		W14		0.6
IXB	Hercules		RJ12C		0.6
JXD	Hercules		W14		0.6
JXLD, QXB, QXLD	Hercules		RJ12C		0.6
RXC, RXLD	Hercules		W14		0.6
UD-14A, UD-18A	IHC		W89D		0.6
VE4, VP4	Wisconsin		RD16		0.6
	Briggs & Stratton (18mm)		RD16		0.6
	Continental		RD16		0.6
	Kiekhaefer		RJ8C		0.8

**DAVID BRADLEY****Power Equipment**

(18mm)			RD16		0.8
(14mm)			RJ8C		0.8

**DAVIS****Lawn Mowers****All Models**

			RJ19LM		0.8
--	--	--	--------	--	-----

**Power Equipment**

Commando			RCJ8		0.8
----------	--	--	------	--	-----



CC BHP

21



OPT.



mm

**DAYTON**

**Chain Saws**

2Z-461, 2Z-462, 2Z-463, 2Z-573, 2Z-760,  
2Z-970, 2Z-971, 4Z-022, 4Z-023, 4Z-109

4Z-251

4Z-252

**Edgers**

**Lawn Mowers**

Tecumseh

**Lawn Rakes**

**Shredders**

Tecumseh

**Snow Removers**

All Models

**Tillers**

Briggs & Stratton

Tecumseh

**Tractors**

Briggs & Stratton

**Trimmers**

RCJ8

0.8

RCJ8Y

0.8

RCJ4

0.8

RCJ8

0.8

RJ8C

0.8

RCJ8

0.8

RJ8C

0.8

RJ19LM

0.8

RJ19LM

QJ19LM

0.8

RJ8C

0.8

RJ19LM

QJ19LM

0.8

RCJ8

0.8

**DE LAVAL**

**Pumps, Compressors & Refrigeration Units**

All Models

RW77N

0.4

**DEBRIS**

**Blowers**

Kawasaki

7.5

OE059

L92YC

0.8

Briggs & Stratton

RJ19LM

QJ19LM

0.8

**DECORATIVE CURBMAKING MACHIN**

**Concrete Borders**

Robin

6

RL86C

0.8

Robin

11

OE006

RN9YC

0.8

**DEEP ROCK**

**Augers**

Briggs & Stratton

8

RJ19LM

QJ19LM

0.8

Tecumseh

4

RJ19LM

0.8

Honda OHV

5

OE006

RN9YC

0.8

**DEINES**

**Lawn Mowers**

Onan

RH18Y

0.8

Tecumseh

RJ8C

0.8

**Turf Equipment**

Tecumseh

14

OE086

RL82C

0.8

Honda OHV

11

OE051

RN11YC

0.8

Kohler Twin

18,20

RV17YC

0.6

**DELCO-LITE**

**Generators**

1000W

RJ8C

0.6

15 Series A1

D14

0.6

1500W

(18mm)

D14

0.6

(14mm)

RJ8C

0.6

20 Series AB3

RJ8C

0.6

200W

UY6

0.6

25 Series AD1, 2500W

RJ8C

0.6

2B12, 2B6

UY6

0.6

400W, 50 Series AA1

RJ8C

0.6

50 Series HA1

D14

0.6



CC BHP

21



OPT.



mm

## ...DELCO-LITE

### ...Generators

5KW	Hercules			W14		0.6
60 Series AD1				D14		0.6
6G3				RJ8C		0.6
6KW	Hercules			W14		0.6
8 Series A3, 8 Series EAB3				RJ8C		0.6
8 Series EABW3, 8 Series ERBW3				D14		0.6
800W, AD1				RJ8C		0.6
B1				D14		0.6
B12				UY6		0.6
B3				RJ8C		0.6
B6				UY6		0.6
BK3				RJ8C		0.6
BP, C1				D14		0.6
C3, CK1, EB3				RJ8C		0.6
EBW3, ECW3, EW3, FA1				D14		0.6
G3				RJ8C		0.6
GW3, H1, HD1				D14		0.6
HD1, M3				RJ8C		0.6
RA1, RD1				D14		0.6
RD1				RJ8C		0.6

## DEMCO

### Centrifugal Pumps

Briggs & Stratton	3,5,8			RJ19LM	QJ19LM	0.8
Honda OHV	4		OE051	RN11YC		0.8
Honda OHV	8		OE051	RN11YC		0.8
Honda	5		OE006	RN9YC		0.8

### Sprayers

Briggs & Stratton	3.5,5,8			RJ19LM	QJ19LM	0.8
Honda OHV	4		OE051	RN11YC		0.8
Honda OHV	5.5,8		OE051	RN11YC		0.8
Honda OHV	5		OE006	RN9YC		0.8

## DERBI

### Chain Saws

3230, 5240				RCJ8		0.6
3835, 6240				CJ6		0.5

## DERBY

### Riding Mowers

Kohler	14,23		OE013	RC12YC		0.8
Briggs & Stratton	20,25			RC14YC		0.8

## DEUTZ ALLIS

### Turf Equipment

Kohler OHV	12.5		OE013	RC12YC		1.0
Briggs & Stratton Vanguard V-Twin	16			RC14YC		0.8
Kohler	14,16			RH10C		0.8
Briggs & Stratton	8,10,12			RJ19LM	QJ19LM	0.8
Briggs & Stratton Twin	14,16			RJ19LM	QJ19LM	0.8
Kohler Twin	17,18,20			RV17YC		0.6

## DEVILBISS

### Pumps, Compressors & Refrigeration Units

PG-D 503	Wrangler			L90C		0.6
PLE-501EG, PLE-502EG, PME-501EG, PME-502EG				RCJ8		0.6
Ranger 503	Honda G200			L90C		0.6
TAPE-5031EG				RL86C		0.6
UALE-5030EG				RCJ8		0.6
UANE-5031EG, UC-524EG, USC-521EG				RJ8C		0.6
VAPE-5030EG				RL86C		0.6
	Wisconsin			RD16		0.6
	Kohler	10		RH10C		0.6
	Briggs & Stratton			RJ19LM	QJ19LM	0.8
	Kohler	24		RJ19LM		0.6
	Kohler	8		RJ19LM		0.6



CC BHP

21



OPT.



## DEWEZE

### Blowers

Honda OHV	13	OE051	RN11YC	0.8
-----------	----	-------	--------	-----

### Garden Tractors

Kohler V-Twin	25	OE013	RC12YC	0.8
Onan Twin	20		RS17YX	0.6
Kohler Twin	20		RV17YC	0.6

## DIADEM

### Mulchers

Kohler	12,16		RH10C	0.8
Briggs & Stratton			RJ19LM	0.8

## DIDIER

### Log Splitters

Briggs & Stratton			RJ19LM	0.8
-------------------	--	--	--------	-----

## DINGO

### Power Equipment

Kohler V-Twin	20	OE013	RC12YC	0.8
Honda V-Twin	20	OE051	RN11YC	0.8

## DIRT KILLER

### Pressure Washers

Honda OHV	5.5,11,13	OE051	RN11YC	0.8
-----------	-----------	-------	--------	-----

## DISSTON

### Chain Saws

KB6AY, KB7AY			RJ6C	0.8
--------------	--	--	------	-----

## DITCH DEVIL

### Concrete Saws

Briggs & Stratton Vanguard	9		RC14YC	0.8
Robin	9		RCJ8Y	0.6
Robin	11		RL86C	0.6
Onan OHV	12.5		RL95YC	0.9
Honda	9,11,13	OE051	RN11YC	0.8

### Power Equipment

Continental F-163			RD16	0.8
Ford	192		RH10C	0.6
Onan NHC			RN5C	0.6

### Trenchers

Briggs & Stratton	3.5,5,8		RJ19LM	0.8
Robin	6,7,5		RL95YC	0.8
Honda OHV	5.5,8	OE051	RN11YC	0.8

## DITCH WITCH

### Power Equipment

Wisconsin	12.5		D21	0.6
Wisconsin	9		D21	0.6
Wisconsin	18,30,35,37		RD16	0.6
Wisconsin	7		RD16	0.6
Wisconsin	9.2		RD16	0.6
Kohler	14,18		RH10C	0.8
Wisconsin	4.6		RL86C	0.6
Honda OHV	11,12,13,24	OE051	RN11YC	0.8
Perkins G4-203		OE051	RN11YC	0.8
Wisconsin	60.5,65	OE042	RN12YC	0.6
Onan NHC		→1979	RN5C	0.8
Onan NHC		1979→	RS17YX	0.8

## DITCHER SAW

### Power Equipment

Homelite XL98C	5		CJ6	0.6
Homelite Super XL	3		RCJ6Y	0.6



CC BHP



OPT.

**DIXIE CHOPPER****Mowers, Vacuums**

Kohler OHV	6	OE013	RC12YC		0.8
Kohler V-Twin	20,22	OE013	RC12YC		0.8
Kohler V-Twin	25,26	OE013	RC12YC		0.8
Kohler	23		RH10C		0.8
Briggs & Stratton	5		RJ19LM	QJ19LM	0.8
Honda OHV	24	OE051	RN11YC		0.8
Kawasaki V-Twin	19,23,25	OE051	RN11YC		0.8
Onan Twin	24		RS17YX		0.8
Kohler	16		RV17YC		0.6
Kohler Twin	18,20		RV17YC		0.6

**DIXON****Lawn Mowers****All Models****Turf Equipment**

All Models			RJ19LM		0.8
Briggs & Stratton Intek	13.5	OE013	RC12YC	QC12YC / XC92YC	0.8
Briggs & Stratton Intek V-Twin	17	OE013	RC12YC	QC12YC / XC92YC	0.8
Briggs & Stratton OHV	14	OE013	RC12YC	QC12YC / XC92YC	0.8
Briggs & Stratton OHV	14.5	OE013	RC12YC	QC12YC / XC92YC	0.8
Briggs & Stratton Vanguard	15.5,16	OE013	RC12YC	QC12YC / XC92YC	0.8
Kohler OHV	14,15,16	OE013	RC12YC		1.0
Kohler V-Twin	18	OE013	RC12YC		0.8
Kohler V-Twin	20,22,23,25	OE013	RC12YC		0.8
Briggs & Stratton Intek OHV	18,20		RC14YC		0.8
Briggs & Stratton Vanguard V-Twin	14		RC14YC		0.8
Briggs & Stratton	10,10.5,12,13		RJ19LM	QJ19LM	0.8
Kohler Twin	20		RV17YC		0.6

**DOBBINS****Power Sprayers**

Briggs & Stratton			RJ19LM	QJ19LM	0.8
-------------------	--	--	--------	--------	-----

**Sprayers**

Briggs & Stratton			RJ19LM	QJ19LM	0.8
Tecumseh			RJ8C		0.8

**DOLMAR****Blowers**

311			RCJ7Y		0.8
PB250, PB500R			RCJ6Y		0.8

**Brush Cutter**

BC25, BC330			RDJ7Y		0.8
-------------	--	--	-------	--	-----

**Chain Saws**

109			RCJ6Y		0.5
110	13		RDJ7Y		0.5
111			RCJ6Y		0.5
115			RCJ6Y		0.5
116			RCJ7Y		0.8
120			RDJ7Y		0.5
100, 102	13		RDJ7Y		0.5
103, 105, 108			RCJ8		0.8
112, 113, 114			RCJ7Y		0.8
116Si			RCJ6Y		0.5
117, 118, 119			RCJ7Y		0.8
120Si			RCJ6Y		0.5
122, 123, 128, 133, 144, 152, 153, 166, 310			RCJ7Y		0.8
PS340, PS341			RDJ7Y		0.5
PS342			RCJ8Y		0.5
PS400, PS401			RDJ7Y		0.5
PS6000i, PS6800i, PS9000			RCJ6Y		0.8

**Cut-Off Saw**

143, 309-1, 343-1			RCJ7Y		0.5
PC6212, PC6214, PC7312, PC7314			RCJ6Y		0.5

**Drill**

311			RCJ7Y		0.8
-----	--	--	-------	--	-----

**Generators**

G5800, G6100R		OE098	RN4C		0.8
---------------	--	-------	------	--	-----



CC

BHP

21



OPT.



mm

**...DOLMAR**

**Power Equipment**

LT250				RDJ7Y	0.8
LT30, MS20C				RCJ6Y	0.8
MS2501				RDJ7Y	0.8
MS30C, MS30U, MS3200, MS3210, MS3300, MS3310, MS340, MS3400, MS4000, MS4010, MS4500, MS4510				RCJ6Y	0.8
PE250				RDJ7Y	0.8
<b>Pressure Washer</b>					
HP450				RCJ6Y	0.8
<b>Pressure Washers</b>					
HP450				RCJ6Y	0.8

**DORMAN**

**Pumps, Compressors & Refrigeration Units**

12S, 12STCAG, 12STCWG				D14N	0.4
3-DAG, 4-DAG, 6-DAG			OE108	RN3C	0.5

**DOSKO**

**Power Equipment**

Kohler V-Twin	20		OE013	RC12YC	0.8
Honda OHV	11,13		OE051	RN11YC	0.8
Honda V-Twin	18,20		OE051	RN11YC	0.8
Robin OHV	11		OE006	RN9YC	0.6
Onan Twin	20,24			RS17YX	0.6

**DOWNEASTER**

**Spreaders**

Sand	Briggs & Stratton	15		RJ19LM	QJ19LM	0.8
------	-------------------	----	--	--------	--------	-----

**DR POWERWAGON**

**Power Equipment**

Briggs & Stratton	5			RJ19LM	QJ19LM	0.8
Tecumseh	6			RJ19LM		0.8
Tecumseh	4			RJ8C		0.8

**DR TRIMMER/MULCHER**

**Lawn Mowers**

Briggs & Stratton	3,75,5			RJ19LM	QJ19LM	0.8
Tecumseh	3			RJ19LM		0.8
Tecumseh	6			RJ8C		0.8

**DSI**

**Power Equipment**

DS-40				RCJ7Y	0.8
-------	--	--	--	-------	-----

**DU-ALL**

**Cut-Off Saw**

Briggs & Stratton				RJ19LM	QJ19LM	0.8
-------------------	--	--	--	--------	--------	-----

**DUB-L-TIL (→ Magna)**

**DUERR**

**Power Equipment**

Wisconsin	12			RD16		0.6
Briggs & Stratton				RJ19LM	QJ19LM	0.8
Tecumseh				RJ8C		0.8

**DUNLAP**

**Lawn Mowers**

Power Product Engine				RJ12C		0.6
Briggs & Stratton				RJ19LM	QJ19LM	0.8

**DUO-THERM**

**Lawn Mowers**

All Models				RJ19LM		0.8
------------	--	--	--	--------	--	-----



CC BHP

21



OPT.

mm

## DUPLEX

### Generators

PE127			D14		0.6
QX			RJ12C		0.6

## DYNA

### Generators

Briggs & Stratton OHV	16	OE013	RC12YC	QC12YC / XC92YC	0.8
Briggs & Stratton Vanguard V-Twin			RC14YC		0.8
Kawasaki	3.1,5.2		RCJ8		0.8
Briggs & Stratton	5,8,11		RJ19LM	QJ19LM	0.8
Honda OHV	9,11	OE051	RN11YC		0.8
Tecumseh	18	OE098	RN4C		0.8
Onan Twin	24		RS17YX		0.6

## DYNA DIGGR

### Power Equipment

Tecumseh	2		RCJ6Y		0.8
Tecumseh	1.6		RCJ8Y		0.8

## DYNA MOW

### Lawn Mowers

All Models			RJ19LM		0.8
------------	--	--	--------	--	-----

### Riding Mowers

Kohler V-Twin	25	OE013	RC12YC		0.8
Kawasaki Liquid-Cooled V-Twin	20		RCJ8		0.6
Kawasaki Liquid-Cooled V-Twin	29	OE051	RN11YC		0.8
Kawasaki V-Twin	23	OE051	RN11YC		0.8
Ford 1.1, 1.3L		OE011	RS9YC		0.9

## DYNABLAST

### Generators

Honda OHV electric start	20	OE051	RN11YC		0.8
--------------------------	----	-------	--------	--	-----

### Pressure Washers

Honda OHV	5.5,6.5,13	OE051	RN11YC		0.8
-----------	------------	-------	--------	--	-----

## DYNA-FOG

### Foggers

All Models			RJ19LM		0.8
------------	--	--	--------	--	-----

## DYNAMARK

### Chain Saws

4201, 4221, 4222, 4223, 4241, 4242, 4243, 4244, 4421, 4422			RCJ7Y		0.8
--	--	--	-------	--	-----

### Garden Tractors, Tillers

Kawasaki Liquid-Cooled V-Twin	20		RCJ8		0.6
Briggs & Stratton	11,12,12.5		RJ19LM	QJ19LM	0.8
Briggs & Stratton Twin			RJ19LM	QJ19LM	0.8
Tecumseh			RJ8C		0.8

### Lawn Mowers

Briggs & Stratton	3.5,3.75,4.5		RJ19LM	QJ19LM	0.8
Tecumseh	3.5		RJ8C		0.6

### Snow Removers

All Other			RJ19LM		0.8
Tecumseh	4.5		RCJ8Y		0.6

## DYNAMIGHT (→ Winco)

## EAGER BEAVER

### Lawn Mowers

Briggs & Stratton			RJ19LM	QJ19LM	0.8
-------------------	--	--	--------	--------	-----



CC BHP

21



OPT.



mm

**EAGLESTAR**

**Snow Removers**

Tecumseh			RJ8C		0.8
----------	--	--	------	--	-----

**Tillers, Tractors**

Tecumseh			RCJ8Y		0.8
----------	--	--	-------	--	-----

**Turf Equipment**

Briggs & Stratton Vanguard V-Twin	16		RC14YC		0.8
Kawasaki	12.5		RCJ8		0.8
Briggs & Stratton	12		RJ19LM	QJ19LM	0.8
Briggs & Stratton Twin	18		RJ19LM	QJ19LM	0.8
Kawasaki OHV	14	OE051	RN11YC		0.8

**EARTH KING**

**Power Augers**

Briggs & Stratton			RJ19LM	QJ19LM	0.8
Tecumseh			RJ8C		0.8

**EARTHMASTER**

**Power Equipment**

R			RJ8C		0.8
S, SRR			RD16		0.8

**EARTHQUAKE**

**Crawling Dumpers, Log Splitter**

350H	Honda	5,9	OE051	RN11YC	0.8
507H	Honda	5,9	OE051	RN11YC	0.8
W2265	Briggs & Stratton	5.5,6.5		RJ19LM	QJ19LM

**Earth Drills**

5020	Briggs & Stratton	5		RJ19LM	QJ19LM	0.8
9800	Tecumseh	3.8		RJ19LM		0.8
8900E, 8902	Tecumseh	2		RCJ6Y		0.8
9000, 9200	Tecumseh	3		RJ17LM		0.8
9800H	Honda	5.5	OE051	RN11YC		0.8
Woodchuck 8900	Tecumseh	2		RCJ6Y		0.8
	Tecumseh	8		RJ8C		0.8

**Tillers**

5020	Briggs & Stratton	3.5,5,8		RJ19LM	QJ19LM	0.8
8070	Briggs & Stratton	8		RJ19LM	QJ19LM	0.8
5030T	Briggs & Stratton	5		RJ19LM	QJ19LM	0.8
5030T, 5050, 5070, 7050	Tecumseh OHV	5	OE098	RN4C		0.8

**EARTHWAY**

**Spreaders**

Honda GX31	1.5		Z9Y		0.8
------------	-----	--	-----	--	-----

**EASY AUGER**

**Post Hole Diggers**

Briggs & Stratton Vanguard	9		OE013	RC12YC	QC12YC / XC92YC	0.8
Briggs & Stratton	8			RJ19LM	QJ19LM	0.8
Honda OHV	8		OE051	RN11YC		0.8

**EASY LAWN**

**Blowers**

Robin OHV	8.5		OE059	L92YC		0.6
Briggs & Stratton Vanguard	9,13		OE013	RC12YC	QC12YC / XC92YC	0.8
Kohler V-Twin	18,20		OE013	RC12YC		0.8
Briggs & Stratton Vanguard V-Twin	14,16,18,20,22,23			RC14YC		0.8
Wisconsin	30,35			RD16		0.8
Kohler	23			RH10C		0.8
Briggs & Stratton	5,8			RJ19LM	QJ19LM	0.8
Honda V-Twin	20		OE051	RN11YC		0.8
Robin OHV	11.5,13.5,18,20.5,22,25		OE006	RN9YC		0.8





CC BHP

21



OPT.



mm

**EASY RAKE****Power Equipment**

Kohler OHV	6	OE013	RC12YC		0.8
Briggs & Stratton	3.5,5,8		RJ19LM	QJ19LM	0.8
Tecumseh	3.5		RJ19LM		0.8
Kawasaki	7.9		RJ8C		0.8
Honda OHV	4,5,5,8	OE051	RN11YC		0.8

**EASY SPLIT****Log Splitters**

Tecumseh			RJ8C		0.8
----------	--	--	------	--	-----

**EASY VAC****Turf Equipment**

Briggs & Stratton			RJ19LM	QJ19LM	0.8
-------------------	--	--	--------	--------	-----

**EASY WAY****Lawn Mowers****All Models**

			RJ19LM		0.8
--	--	--	--------	--	-----

**EATON****Chain Saws**

8767, 8768-9

			RJ8C		0.8
--	--	--	------	--	-----

8930, 8932-3

			RCJ8		0.8
--	--	--	------	--	-----

**Lawn Mowers**

Tecumseh			RJ17LM		0.8
----------	--	--	--------	--	-----

Briggs & Stratton			RJ19LM	QJ19LM	0.8
-------------------	--	--	--------	--------	-----

**Power Equipment**

Tecumseh			RJ17LM		0.8
----------	--	--	--------	--	-----

Briggs & Stratton			RJ19LM	QJ19LM	0.8
-------------------	--	--	--------	--------	-----

**ECHO****Blowers**

ES210	21		RCJ6Y		0.6
-------	----	--	-------	--	-----

ES230	23		RCJ6Y		0.6
-------	----	--	-------	--	-----

PB200, PB210	21		RCJ6Y		0.6
--------------	----	--	-------	--	-----

PB230LN	23		RCJ6Y		0.6
---------	----	--	-------	--	-----

PB260L	25		RCJ6Y		0.6
--------	----	--	-------	--	-----

PB410	40		RCJ6Y		0.6
-------	----	--	-------	--	-----

PB413, PB460LN	44		RCJ6Y		0.6
----------------	----	--	-------	--	-----

PB610, PB620	58		RCJ6Y		0.6
--------------	----	--	-------	--	-----

PB651, PB751, PB755	63		RCJ6Y		0.6
---------------------	----	--	-------	--	-----

**Chain Saws**

100			RCJ8		0.6
-----	--	--	------	--	-----

601			RCJ8		0.6
-----	--	--	------	--	-----

3900			RCJ6Y		0.6
------	--	--	-------	--	-----

4400			RCJ6Y		0.6
------	--	--	-------	--	-----

4500			RCJ6Y		0.6
------	--	--	-------	--	-----

5500			RCJ6Y		0.6
------	--	--	-------	--	-----

6700			RCJ6Y		0.6
------	--	--	-------	--	-----

8000			RCJ6Y		0.6
------	--	--	-------	--	-----

1001VL, 2800			RCJ7Y		0.6
--------------	--	--	-------	--	-----

280E			RCJ8Y		0.6
------	--	--	-------	--	-----

280EP			RCJ8		0.6
-------	--	--	------	--	-----

2900, 290EVL			RCJ7Y		0.6
--------------	--	--	-------	--	-----

290EVL			RCJ8Y		0.6
--------	--	--	-------	--	-----

290EVL, 3000			RCJ7Y		0.6
--------------	--	--	-------	--	-----

300EVL			RCJ8		0.6
--------	--	--	------	--	-----

			RCJ8Y		0.6
--	--	--	-------	--	-----

301, 302, 302S, 304, 315, 330			RCJ8		0.6
-------------------------------	--	--	------	--	-----

330EVL, 330EVL, 3400, 3450			RCJ7Y		0.6
----------------------------	--	--	-------	--	-----

351VL			RCJ8		0.6
-------	--	--	------	--	-----

4000, 4000EVL			RCJ7Y		0.6
---------------	--	--	-------	--	-----

400EVL			RCJ8Y		0.6
--------	--	--	-------	--	-----

410EVL			RCJ7Y		0.6
--------	--	--	-------	--	-----

440EVL, 440EVL			RCJ7Y		0.6
----------------	--	--	-------	--	-----

451VL, 452VL			RCJ8		0.6
--------------	--	--	------	--	-----

4600, 5000			RCJ6Y		0.6
------------	--	--	-------	--	-----



CC BHP

21



OPT.



mm

**...ECHO**

**...Chain Saws**

500EVL			RCJ8Y	0.6
510EVL			RCJ6Y	0.6
			RCJ7Y	0.6
550EVL			RCJ7Y	0.6
601EVL			RCJ7Y	0.6
601S, 601SVL, 602EVL			RCJ8	0.6
602VL			RCJ7Y	0.6
60S			RCJ8	0.6
610EVL, 620VL			RCJ7Y	0.6
650EVL			RCJ8	0.6
650EVL P			RCJ7Y	0.6
660EVL			RCJ6Y	0.6
660EVL P, 660VL			RCJ7Y	0.6
701SVL, 701VL			RCJ8	0.6
702EVL, 702VL, 750EVL			RCJ6Y	0.6
750EVL P			RCJ7Y	0.6
801, 802, 80Z			RCJ8	0.6
852EVL, 900EVL			RCJ7Y	0.6
CS306	30		RCJ6Y	0.6
CS330T, CS341, CS346	33		RCJ6Y	0.6
CS360T, CS370	36		RCJ6Y	0.6
CS440	45		RCJ6Y	0.6
CS520	50		RCJ6Y	0.6
CS670	67		RCJ6Y	0.6
CS8000	81		RCJ6Y	0.6
QV670	67		RCJ6Y	0.6
QV6700	81		RCJ6Y	0.6
QV675	67		RCJ6Y	0.6
			RCJ6Y	0.6
QV6750, QV8000	81		RCJ6Y	0.6
QV8050	81		RCJ6Y	0.6
S290			RCJ8	0.6

**Cut-Off Saw**

CSG6700			RCJ8Y	0.6
---------	--	--	-------	-----

**Drills**

ED2000, ED2000IA, EDR2100, EDR260			RCJ8Y	0.6
-----------------------------------	--	--	-------	-----

**Edgers**

PE200, PE201	21		RCJ6Y	0.6
PE230, PE231	23		RCJ6Y	0.6
PE260, PE261	25		RCJ6Y	0.6

**Generators**

2300			OE059	L92YC	0.6	
2600				RJ19LM	0.6	
3501, 4300, 4300E, 5500E			OE059	L92YC	0.6	
650, 750				RCJ7Y	0.6	
7600E			OE013	RC12YC	1.0	
EG-1200				RL86C	0.6	
EG-1500			OE059	L92YC	0.6	
EG-1800				RJ19LM	0.6	
EG-2400			OE059	L92YC	0.6	
EG-4600				RH10C	0.8	
EG-4601				RC14YC	0.8	
EG-550				RCJ7Y	0.6	
EG-5600E			OE013	RC12YC	1.0	
EG-5601, EG-7601				RC14YC	0.8	
	Briggs & Stratton Vanguard	9,11	OE013	RC12YC	QC12YC / XC92YC	0.8
	Kohler OHV	11,14	OE013	RC12YC		1.0
	Briggs & Stratton Vanguard V-Twin	16		RC14YC		0.8
	Kohler	8		RH10C		0.8
	Briggs & Stratton	5		RJ19LM	QJ19LM	0.6



CC BHP

21



OPT.



mm

**...ECHO****Hedge Trimmers**

HC1000, HC1001, HC140									
HC150		21							
HC1500									
HC150i, HC160									
HC160		21							
HC1600									
HC160A									
HC180		21							
HC200		21							
HC2000									
HC200AE									
HC2100									
HC210AE, HC210E									
HC230, HC231		23							
HC2400, HC2410, HCA2400									
HCA260		25							
HCR150									
SHC210		21							
SHC2100									
SHC212		21							
SHC2401									
SHC260		25							

**Lawn Mowers**

LM204, LM204P									
LM212, LM212P, LM212PS									
LM214, LM214P									
LMC212									

**Power Equipment**

80001C, 8000E	Briggs & Stratton	8							
CLS4600									
CSV5, CSV5S	Briggs & Stratton	5							
CSV8S	Briggs & Stratton	8							
DM9, MB400									
ES1000, ES2000, ES2100, ES2400									
GT100, GT1000									
GT1100									
GT140, GT140A, GT140B, GT160, GT160A, GT160AE, GT200									
GT2000, GT2000SB									
GT200A, GT200B, GT200BE, GT200CE, GT200i, GT200R									
GT2100, GT2101, GT2102, GT2103, GT2200									
GT230									
GT2400									
GTL140, GTL140A									
MR2500, PAS260, PE200, PE2000, PE2200, PE2201, PE230, PE2400, PE260, PE310									
PAS230, PAS231		23							
PAS260		25							
PB1000, PB1010									
PB200, PB202									
PB2100, PB210E, PB230LN, PB2400, PB260L, PB300E									
PB400, PB400E									
PB403, PB411									
PB4500									
PB4600, PB460LN									
PB46HT, PB46LN									
PB6000, PB602, PB603									
PB60HT									
PB650, PB750									
PB9, SHR200E									
REC600, RM303E									
SH3000	Briggs & Stratton	3							
SH5000	Briggs & Stratton	5							
SH8000	Briggs & Stratton	8							



CC

BHP

21



OPT.



mm

**...ECHO**

**...Power Equipment**

SH800R			RL86C	0.8
SHR2100			RCJ6Y	0.6
SRM140D, SRM140DA			RCJ8	0.6
SRM1500, SRM1500A, SRM1501			RCJ7Y	0.6
SRM200			RCJ8	0.6
SRM2000			RCJ7Y	0.6
SRM200AE, SRM200BE, SRM200CE, SRM200D, SRM200DA, SRM200DB, SRM202DA, SRM202FA			RCJ8	0.6
SRM2100, SRM2100SB			RCJ7Y	0.6
SRM210AE, SRM210E			RCJ8	0.6
SRM2110, SRM2200, SRM2201			RCJ7Y	0.6
SRM230			RCJ8	0.6
SRM2300, SRM2301, SRM2310, SRM2400, SRM2400SB, SRM2410, SRM2450, SRM2501, SRM2501S, SRM2502, SRM250E, SRM2510			RCJ7Y	0.6
SRM2601			RCJ8Y	0.6
SRM300			RCJ8	0.6
SRM3000, SRM3001			RCJ7Y	0.6
SRM300AE, SRM300AE/1, SRM300E, SRM300E/1			RCJ8	0.6
SRM3010			RCJ7Y	0.6
SRM302ADX			RCJ8	0.6
SRM3100, SRM3100S, SRM3110, SRM3400, SRM3800, SRM400AE, SRM400BE, SRM400E, SRM4600			RCJ7Y	0.6

**Pressure Washers**

HDP2001, HDP3001, TP2001, TP3000, TP3001			RL86C	0.6
WP1000, WP1500			RCJ7Y	0.6
WP2000, WP2001, WP3000			RL86C	0.6

**Pruners**

PPF210, PPF2100, PPF2110, PPF2400, PPT2100, PPT230, PPT2400, PPT260			RCJ7Y	0.6
PPF-210, PPF-211	21		RCJ6Y	0.6
PPF-230, PPF-231	23		RCJ6Y	0.6
PPF-260, PPF-261	25		RCJ6Y	0.6

**Snow Removers**

ST-1033E			RJ8C	0.8
ST-4500, ST-4500E		4.5	RCJ8Y	0.6
ST-5000, ST-5000E			RCJ8Y	0.6
ST-5024, ST-8027E			RJ8C	0.8
	Tecumseh 2-Cycle		RCJ8Y	0.6
	Tecumseh 4-Cycle		RJ8C	0.8

**Tillers**

TC2100			RCJ8Y	0.6
--------	--	--	-------	-----

**Trimmers**

GT200i, GT200R, GT201i, GT201R	21		RCJ6Y	0.6
GT251, GT251E	25		RCJ6Y	0.6
SRM210, SRM210i, SRM210SB, SRM211, SRM211i, SRM211SB	21		RCJ6Y	0.6
SRM230, SRM230S, SRM231, SRM231S	23		RCJ6Y	0.6
SRM251, SRM251E, SRM260, SRM260S, SRM261, SRM261S, SRM261T	25		RCJ6Y	0.6
SRM311, SRM311S, SRM311U	30		RCJ6Y	0.6
SRM340	34		RCJ6Y	0.6
SRM400U	43		RCJ6Y	0.6
SRS2100 Aggressor Tree Trimmer			RCJ8Y	0.6

**ECLIPSE**

**Lawn Mowers**

All Models			RJ19LM	0.8
------------	--	--	--------	-----

**ECONOMY**

**Garden Tractors**

	Kohler	14	RH10C	0.8
--	--------	----	-------	-----



CC BHP

21



OPT.



mm

**EDGE MASTER****Edgers**

Honda	4			RL86C	0.8
Honda	2.5			Z9Y	0.8

**EDKO****Brushcutters**

Convertible Till-Trac

RCJ8 0.8

**Lawn Mowers**

All Models

RJ19LM 0.8

**Log Splitters**

Briggs &amp; Stratton

RJ19LM QJ19LM 0.8

**Power Equipment**

8260BAV, 8260DAV, 8260LAV, 8260TA, 8320BAV, 8320LAV, 8350BAV, 8350LAV, 8405BAV, 8420BAV, 8460BAV, 8510BAV, 8725BAV, 8725LAV, 8725TA, 8726BAV, 8726LAV, 8726TA, 8735BAV, 8735LAV, 8740BAV, 8742BAV, 8746BAV, 8750PRO, 8753BAV, E8405BP, HT27, TR1540, TS330

RCJ7Y 0.6

Power Wheels, Walking Tractors

RCJ8 0.8

**Tillers**

RCJ8 0.8

**EDSON****Pumps**

Briggs &amp; Stratton

3,9

RJ19LM QJ19LM 0.8

**EFCO (EMAK)****Brushcutters**

8200, 8260, 8300, 8350, 8400

RCJ7Y 0.5

Jet 300, 301, 400, 401, 450AVS

RCJ7Y 0.5

Tiger 40, 40S, 50

RCJ7Y 0.5

TS 330, TS 355 Emak

RCJ7Y 0.6

**Brushcutters & Trimmers**

8200 Emak

23

RCJ7Y 0.6

8220 IC, 8260 IC, 8260(D) Emak

34

RCJ7Y 0.6

8300, 8300 IC Emak

31

RCJ7Y 0.6

8350, 8350 IC, 8355 Emak

34

RCJ7Y 0.6

8400, 8400 IC, 8405 Emak

38

RCJ7Y 0.6

8420, 8420 IC, 8425 Emak

41

RCJ7Y 0.6

8510, 8510 IC, 8515 Emak

50

RCJ7Y 0.6

STARK 26, 26 TR Emak

25

RCJ7Y 0.6

**Chain Saws**

935, 940, 951, 956, 962C, 971, 981

RCJ7Y 0.6

**Chainsaws**

131 Emak

30

1.5

RCJ7Y 0.6

138 Emak

38

RCJ7Y 0.6

146 Emak

46

RCJ7Y 0.6

151 Emak

50

RCJ7Y 0.6

156 Emak

57

4.2

RCJ7Y 0.6

162 Emak

62

4.8

RCJ7Y 0.6

170 Emak

71

RCJ7Y 0.6

180 Emak

81

RCJ7Y 0.6

199 Emak

101

RCJ7Y 0.6

131, 134, 135, 138, 141, 142, 146 Emak

(All)

RCJ7Y 0.6

134, 135 Emak

34

RCJ7Y 0.6

141, 142 Emak

42

RCJ7Y 0.6

151, 156, 162, 170, 180, 199 Emak

(All)

RCJ7Y 0.6

**Other Models**

RCJ7Y 0.6

**Cut-Off Saw**

1000TTA, 265TTA, 980TTA

RCJ7Y 0.6

**Drills**

TR 1540 Emak

38

1.8

RCJ7Y 0.6

**Mowers**

LR 43 PA Tecna

3.5

RJ17LM 0.6

LR 43 PB, LR 47 PB B&amp;S

3.8

RJ19LM QJ19LM 0.5

LR 47 PA, LR 47 PAX Tecna

3.7

RJ17LM 0.6



CC

BHP

21



OPT.



mm

**...EFCO (EMAK)**

**...Mowers**

LR 47 PBX, LR 47 TBX	B&S	5		RJ19LM	QJ19LM	0.5
MR 474 PB	B&S	5.5		RJ19LM	QJ19LM	0.5
MR 474 TB, MR 474 TBV	B&S	5.5		RJ19LM	QJ19LM	0.5
MR 474 TKV	Kawasaki	5		OE006	RN9YC	0.6
MR 534 TB,-TBV,-TBVE	B&S	5.5		RJ19LM	QJ19LM	0.5
MR 534 THV	Honda	5		OE042	RN12YC	0.7
MR 534 TK,-TKF,-TKV,-TKVF	Kawasaki	5		OE006	RN9YC	0.6

**Power Equipment**

310		31	1.4			
200, 220		23	0.8		RCJ7Y	0.6
260, 300					RCJ7Y	0.6
400, 410, 460		38	1.8		RCJ7Y	0.6

**Power Sprayers**

AT 2050, AT 2080	Emak				RCJ7Y	0.6
------------------	------	--	--	--	-------	-----

**Pumps**

PA 1030, PA 1040	Emak				RCJ7Y	0.6
PC 1050, PA 1100	Emak				RCJ7Y	0.6

**ELECTRO-MAGIC**

**Pressure Cleaners**

1800-5, 2000-6, 4700GED					RCJ8	0.6
-------------------------	--	--	--	--	------	-----

**ELECTRO-SPRAY**

**Sprayers**

Mist	Briggs & Stratton Vanguard V-Twin	16,20			RC14YC	0.8	
	Briggs & Stratton	8,11			RJ19LM	QJ19LM	0.8

**ELEPHANT-VAC**

**Vacuums**

	Briggs & Stratton Vanguard V-Twin	16,18			RC14YC	0.8	
	Briggs & Stratton	8,8.5			RJ19LM	QJ19LM	0.8

**ELGEE**

**Power Sweepers**

(LPG)	Briggs & Stratton	6			RJ19LM	QJ19LM	0.5
	Briggs & Stratton	8			RJ19LM	QJ19LM	0.5
	Honda	5.5		OE051	RN11YC		0.5
	Briggs & Stratton	6			RJ19LM	QJ19LM	0.8
	Briggs & Stratton	8			RJ19LM	QJ19LM	0.8
	Honda	5.5		OE051	RN11YC		0.8

**ELITE**

**Chain Saws**

	Briggs & Stratton Vanguard	9			RC14YC		0.8
	Robin	9			RCJ8Y		0.6
	Robin	11			RL86C		0.6
	Onan OHV	12.5			RL95YC		0.9
	Honda	9,11,13		OE051	RN11YC		0.8

**Concrete Saws, Trenchers**

	Briggs & Stratton Vanguard	9,13,16		OE013	RC12YC	QC12YC / XC92YC	0.8
	Kohler OHV	11,12.5		OE013	RC12YC		1.0
	Briggs & Stratton Vanguard V-Twin	18,20			RC14YC		0.8
	Briggs & Stratton	3.5,5			RJ19LM	QJ19LM	0.8
	Honda	6.5			RL86C		0.8
	Robin	5.5			RL86C		0.6
	Robin	6,7.5			RL95YC		0.6
	Honda OHV	5,5.5		OE051	RN11YC		0.8
	Honda OHV	8,9,11,13		OE051	RN11YC		0.8

**EMGLO**

**Compressors**

Diving	Honda OHV	8		OE051	RN11YC		0.8
	Honda OHV	5		OE006	RN9YC		0.80



CC BHP

21



OPT.



mm

## ENCORE

### Blowers, Edgers

Briggs & Stratton	3,5,8,11		RJ19LM	QJ19LM	0.8
Honda OHV	4	OE051	RN11YC		0.8

### Power Equipment

Honda	2.5		CJ14		0.8
Kohler OHV	14,22,25	OE013	RC12YC		1.0
Briggs & Stratton Vanguard V-Twin	16,18,20		RC14YC		0.8
Kawasaki	12.5		RCJ8		0.8
Kawasaki Liquid-Cooled V-Twin	20		RCJ8		0.8
Kawasaki Liquid-Cooled V-Twin, EFI	22		RCJ8		0.8
Kawasaki OHV	15		RCJ8Y		0.6
Briggs & Stratton	3,5,12		RJ19LM	QJ19LM	0.8
Tecumseh	8		RJ19LM		0.8
Honda	4		RL86C		0.8
Honda OHV	5.5,8,13	OE051	RN11YC		0.8
Kawasaki Liquid-Cooled V-Twin	27	OE051	RN11YC		0.8
Kawasaki OHV	14	OE051	RN11YC		0.8
Kawasaki V-Twin	17,19	OE051	RN11YC		0.8
Kawasaki V-Twin	21	OE051	RN11YC		0.8
Kawasaki V-Twin	23	OE051	RN11YC		0.8
Tecumseh	14	OE098	RN4C		0.8

## ENERGY MATE

### Garden Tractors

### Power Equipment

Easy Splitters	Tecumseh		RH10C		0.8
----------------	----------	--	-------	--	-----

## ENVIROBOOM

### Aerators

Kawasaki Liquid-Cooled V-Twin	20		RCJ8		0.6
-------------------------------	----	--	------	--	-----

### Sprayers

Briggs & Stratton, Tecumseh	5		RJ19LM	QJ19LM	0.8
-----------------------------	---	--	--------	--------	-----

## ENVIROJET

### Aerators

Kohler V-Twin	20,25	OE013	RC12YC		0.8
Briggs & Stratton Vanguard V-Twin	14,16,18		RC14YC		0.8

## ERING

### Power Equipment

5PSRX, MH-H15, T7613H, T9612S			RJ19LM		0.5
T102155H, T10217H, T106155S		OE013	RC12YC		0.5

## ESKA

### Lawn Mowers

All Models			RJ19LM		0.8
------------	--	--	--------	--	-----

### Snow Removers

All Models			RJ19LM		0.8
------------	--	--	--------	--	-----

### Tractors

Snow Tractors			RJ8C		0.6
---------------	--	--	------	--	-----

## ESKIMO

### Earth, Ice Drills

8900, 8902	Tecumseh	2	RCJ6Y		0.8
9000, 9200	Tecumseh	3	RJ17LM		0.8

### Tillers

5020	Briggs & Stratton	5	RJ19LM	QJ19LM	0.8
------	-------------------	---	--------	--------	-----



CC BHP

21



OPT.



mm

## ESTATE TRIMMER

### Mowers

Briggs & Stratton	12.5	RJ19LM	QJ19LM	0.8
-------------------	------	--------	--------	-----

### Trimmers

Briggs & Stratton Intek OHV	6	OE013	RC12YC	QC12YC / XC92YC	0.5
Briggs & Stratton	4,5		RJ19LM	QJ19LM	0.8

## EUROSYSTEMS

### Power Equipment

Briggs & Stratton			RJ19LM	QJ19LM	0.8
Tecumseh			RJ19LM		0.8
Robin			RL86C		0.8

## EVERRIDE

### Lawn Mowers

Kohler V-Twin Air Cooled 4-Cycle OHV	27	OE013	RC12YC		1.0
Kawasaki V-Twin 4-Cycle OHV	19,23,25	OE051	RN11YC		0.8

## EVERSHARP

### Lawn Mowers

All Models			RJ19LM		0.8
------------	--	--	--------	--	-----

## EVINRUDE

### Pumps

Centrifugal & Light Pressure			RD16		0.6
------------------------------	--	--	------	--	-----

## EXCEL

### Power Equipment

400		OE011	RS9YC		0.8
Kawasaki	14		L90C		0.6
Kohler Command Pro	13,15	OE013	RC12YC		0.8
Kohler Command Pro	18	OE013	RC12YC		0.8
Kohler Command Pro	22	OE013	RC12YC		0.8
Kohler Command Pro	25	OE013	RC12YC		0.8
Kohler V-Twin	20,22	OE013	RC12YC		0.8
Kohler V-Twin	25	OE013	RC12YC		0.8
Continental TC-56			RD16		0.8
Kohler	18		RH10C		0.8
Kohler	20		RH10C		0.6
Kohler	23		RH10C		0.6
Kohler Twin	23		RH10C		0.8
Briggs & Stratton Single Cyl.			RJ19LM	QJ19LM	0.8
Briggs & Stratton Twin	18		RJ19LM	QJ19LM	0.8
Kawasaki OHV	17,23	OE051	RN11YC		0.6
Ford 1.1L		OE049	RN11YC4		0.9
Ford 1.3L		OE011	RS9YC		0.9
Kohler Twin	18		RV17YC		0.6
Kohler Twin	20		RV17YC		0.6

## EX-CELL

### Pressure Washers

Briggs & Stratton Vanguard V-Twin	16		RC14YC		0.8
Briggs & Stratton	5,10		RJ19LM	QJ19LM	0.8
Honda OHV	6,5,13	OE051	RN11YC		0.8
Honda OHC	5	OE006	RN9YC		0.8

## EXCELLO

### Lawn Mowers

All Other			RJ8C		0.6
Power Product Engine			RJ12C		0.6





CC BHP

21



OPT.



mm

**EXMARK**

**Lawn Mowers**

Briggs & Stratton OHV	6.5	OE013	RC12YC	QC12YC / XC92YC	0.5
Kawasaki	5.5	OE051	RN11YC		0.8

**Riding Mowers**

Briggs & Stratton Intek	14.4,15.5,17	OE013	RC12YC	QC12YC / XC92YC	0.8
-------------------------	--------------	-------	--------	-----------------	-----

**Turf Equipment**

Kohler Command Pro	23		3071	XC12YC	0.8
Kohler Command Pro	26		3071	XC12YC	0.8
Briggs & Stratton OHV	6.5	OE013	RC12YC	QC12YC / XC92YC	0.5
Kohler OHV	12.5,13,14,15	OE013	RC12YC		1.0
Kohler V-Twin	18,20,22,23	OE013	RC12YC		0.8
Kohler V-Twin	25	OE013	RC12YC		0.8
Briggs & Stratton Vanguard V-Twin	16,18,20		RC14YC		0.8
Kawasaki	12.5		RCJ8		0.8
Honda GV400	11		RCJ8Y		0.8
Kawasaki FH150V	5.5		RCJ8Y		0.8
Kawasaki FH451V	15		RCJ8Y		0.8
Briggs & Stratton	8,8.5		RJ19LM	QJ19LM	0.8
Honda	13	OE051	RN11YC		0.8
Kawasaki OHV	14	OE051	RN11YC		0.8
Kawasaki OHV	17,19	OE051	RN11YC		0.8
Kawasaki V-Twin	21,23	OE051	RN11YC		0.8
Kawasaki Liquid-Cooled	27	OE042	RN12YC		0.8

**EXPERT**

**Lawn Mowers**

All Models			RJ19LM		0.8
------------	--	--	--------	--	-----

**E-Z BEEVER**

**Chippers**

Kohler V-Twin	25	OE013	RC12YC		0.8
Wisconsin			RD16		0.8
Ford 649 CSG	300		RF10C		0.8
Kohler	12,23		RH10C		0.8
Hercules G1600			RJ6C		0.6
Ford 423 LSG	140		RS12YC		0.9
Onan Twin	24		RS17YX		0.6

**E-Z LAWN**

**Power Equipment**

Briggs & Stratton			RJ19LM	QJ19LM	0.8
-------------------	--	--	--------	--------	-----

**E-Z MO**

**Lawn Mowers**

All Models			RJ19LM		0.8
Briggs & Stratton	8.5		RJ19LM	QJ19LM	0.8

**E-Z ROLL**

**Lawn Mowers**

Briggs & Stratton			RJ19LM	QJ19LM	0.8
Tecumseh			RJ8C		0.8

**Power Equipment**

Honda	2.2		CJ14		0.8
Tecumseh	2		RCJ6Y		0.8
Briggs & Stratton	5		RJ19LM	QJ19LM	0.8
Honda OHV	4	OE051	RN11YC		0.8
Honda OHV	5	OE006	RN9YC		0.8

**E-Z TRENCH**

**Bedscaoper**

Honda	9	OE051	RN11YC		0.8
-------	---	-------	--------	--	-----

**Trenchers**

Briggs & Stratton Intek	5.5	OE013	RC12YC	QC12YC / XC92YC	0.5
Briggs & Stratton Vanguard	6,9	OE013	RC12YC	QC12YC / XC92YC	0.8
Briggs & Stratton	5		RJ19LM	QJ19LM	0.8
Honda OHV	5.5,6.5,8	OE051	RN11YC		0.8
Honda OHV	5	OE006	RN9YC		0.8



CC BHP

21



OPT.



mm

### E-Z-GO

#### Utility Vehicles

Robin 2-Cycle			RL95YC	0.6
Robin OHC Twin	9,11		RL95YC	0.6
Robin EH35C		OE051	RN11YC	0.8
Robin EH29C			RN14YC	0.8
Robin Twin	8.5		RN14YC	0.8
Onan Twin	18,20		RS17YX	0.6

### F&N

#### Lawn Mowers

All Models			RJ19LM	0.8
------------	--	--	--------	-----

### F.M.C.

#### Lawn Vacuums

Wisconsin			RD16	0.8	
Onan BF			RH18Y	0.8	
Briggs & Stratton			RJ19LM	QJ19LM	0.8
Tecumseh		OE086	RL82C	0.8	
Kohler Twin	17		RV17YC	0.6	

#### Snow Removers

Tecumseh			RJ8C	0.8
----------	--	--	------	-----

#### Sprayers

Wisconsin VG4D			RD16	0.8
Kohler	12,18,23		RH10C	0.8
Kohler	7		RJ19LM	0.8
Wisconsin V460D		OE042	RN12YC	0.8

#### Tillers

Briggs & Stratton			RJ19LM	QJ19LM	0.8
-------------------	--	--	--------	--------	-----

### FOLEY

#### Lawn Mowers

All Models			RJ19LM	0.8
------------	--	--	--------	-----

### FAIRBANKS-MORSE

#### Generators

A	1		W14	0.6
ZC	6,8		W14	0.6
	(18mm)		D14	0.6
	(14mm)		RJ8C	0.6
	(7/8"-18)		W18	0.6

#### Lawn Mowers

All Models			RJ19LM	0.8
------------	--	--	--------	-----

### FALLS ROTO CLIPPER

#### Lawn Mowers

All Other			RJ19LM	0.8
Power Product Engine			RCJ8	0.8

### FARM ELECTRIC

#### Generators

All Models			25	0.6
------------	--	--	----	-----

### FARMER

#### Chain Saws

F55, F65			CJ6	0.8
----------	--	--	-----	-----

### FEDWAY

#### Lawn Mowers

Iron Horse			J11C	0.8	
Briggs & Stratton			RJ19LM	QJ19LM	0.8



CC BHP

21



OPT.



mm

## FELDMANN

### Ice, Post Hole Drills

80, 81 Plus, Models 70

Tecumseh

RCJ6Y

0.8

RJ8C

0.8

### Power Equipment

Briggs & Stratton

Tecumseh

RJ19LM

QJ19LM

0.8

RJ8C

0.8

## FERRIS

### Lawn Mowers

Kawasaki

5

RL86C

0.8

### Mowers

Kawasaki

5

OE059

L92YC

0.8

Briggs & Stratton Liquid-Cooled

31

OE013

RC12YC

QC12YC / XC92YC

0.5

Daihatsu

34

OE013

RC12YC

0.8

Kohler OHV

12.5

OE013

RC12YC

1.0

Kohler OHV

14,15

OE013

RC12YC

1.0

Kohler V-Twin

20,22,23,25,27

OE013

RC12YC

0.8

Briggs & Stratton Vanguard V-Twin

14,16,18,20

RC14YC

0.8

Kawasaki

12.5

RCJ8

0.8

Kawasaki Liquid-Cooled V-Twin

20

RCJ8

0.8

Kawasaki FH451V

15

RCJ8Y

0.8

Kohler

14

RH10C

0.8

Kawasaki -, FH680 V-Twin

21,23

OE051

RN11YC

0.6

Kawasaki -, FH680 V-Twin

23

OE051

RN11YC

0.6

Kawasaki OHV

13,14

OE051

RN11YC

0.8

Kawasaki OHV

17

OE051

RN11YC

0.8

Kawasaki V-Twin

21,23

OE051

RN11YC

0.6

Kawasaki V-Twin

25

OE051

RN11YC

0.6

Kawasaki Liquid-Cooled V-Twin

27

RN14YC

0.6

## FICHTEL & SACHS

### Brushcutters

Sachs

Kawasaki

RCJ8

0.8

### Chainsaws

Sachs KS30, KS31

OE086

RL82C

0.6

### Engines

Famo 1001-5A, 1001-6B, 1001-6C

RL78C

0.5

Famo 1001-5AGS, 1001-6BGS, 1001-6CGS

QL77JC4

0.6

Famo 1251-5A, 1251-5B

RL78C

0.5

Famo 1251-5AGS, 1251-5CMC, 1251-5EMC

QL77JC4

0.5

Famo 1251-5AL

OE086

RL82C

0.5

Famo 1251-6B, 1251-6C

RL78C

0.5

Famo 1251-BGS, 1251-4D, 1251-6DGS

QL77JC4

0.6

Famo 1252-7A

OE091

RN2C

0.6

Famo 2001, 2401-7A, 2501-5AMC, 2501-7A, 2551-7A

OE091

RN2C

0.6

Famo 50 (Saxonette)

RL86C

0.6

Famo 50-1 MAX, 50-1MB

OE086

RL82C

0.5

Famo 501-3BF, 501-3BKF

RL86C

0.6

Famo 501-4AKFX, 501-4BF, 501-4BKF, 501-4CKF

OE086

RL82C

0.5

Famo 50-1MI, 50-1MINI, 50-2C, 50-2DK, 50-2DNL

RL86C

0.6

Famo 502-1A, 502-1ACH, 502-1ADK

RL86C

0.6

Famo 502-1AKFX

OE086

RL82C

0.5

Famo 502-1ANL, 502-1AS, 502-1ASF, 502-1AX, 502-1B

RL86C

0.6

Famo 50-2KDK, 50-2KS, 50-2MAKSF, 50-2MANI, 50-2MASF

RL86C

0.6

Famo 50-2MAX, 50-2MLAX, 50-2MLB, 50-2MB

OE086

RL82C

0.5

Famo 50-2MLC, 50-2S

RL86C

0.6

Famo 503-2BLCH

RL86C

0.6

Famo 503-ABLCH

OE086

RL82C

0.5

Famo 50-3CN, 50-33, 50-3KFS

RL86C

0.6

Famo 50-3KHNL, 50-3KLH

OE086

RL82C

0.5

Famo 50-3LFH, 50-3LHX

RL78C

0.5

Famo 50-3LFS

RL86C

0.6

Famo 50-3LKH

OE086

RL82C

0.5

Famo 50-3LS, 50-3MAI

RL86C

0.6

Famo 50-3MAKFX

OE086

RL82C

0.5

Famo 50-3MAKSF, 50-3MANI, 50-3MAKI

RL86C

0.6

Famo 50-3MASF, 50-3MAX, 50-3MB, 50-3MKX

OE086

RL82C

0.5

Famo 50-3MLANL

RL86C

0.6



CC BHP



OPT.



**...FICHEL & SACHS**

**...Engines**

Famo 50-3MLFB, 50-3MLKB, 50-3MLFB, 50-3MLKAX				OE086	RL82C	0.5
Famo 50-3NL					RL86C	0.6
Famo 504-1A, 504-1ADK, 504-1ANL, 504-1B, 504-1BS					RL86C	0.6
Famo 504-1C, 504-2A, 504-2B					RL86C	0.6
Famo 50-4CFNL					RL86C	0.6
Famo 50-4FDX, 50-4EKF				OE086	RL82C	0.5
Famo 50-4LFHNL					RL78C	0.5
Famo 50-4LFNL, 50-5LKS					RL86C	0.6
Famo 50-4LKH, 50-4MLFANL, 50-4MLFB, 50-4MLKAX				OE086	RL82C	0.5
Famo 505-1A, 505-1B, 505-1C					RL86C	0.6
Famo 505-2AKS, 505-2AKSF, 505-2ANL					RL86C	0.6
Famo 505-2B, 505-2C, 505-2CK, 505-2D, 505-2DK					RL86C	0.6
Famo 506-4AKF					RL86C	0.6
Famo 50-6AGS					QL77JC4	0.6
Famo 50-6BGS					RL78C	0.5
Famo 50-6SW				OE091	RN2C	0.5
Famo 50ADX, 50ADLX, 50AEX, 50AMALX, 50AMAX				OE086	RL82C	0.5
Famo 50ALS, 50AMAI, AMASF					RL86C	0.6
Famo 50AML, 50AMLC, 50AMLS, 50AS, 50MC, 50-1MASF					RL86C	0.6
Famo 50S, 50SA, 80S					RL78C	0.5
Famo 50SW				OE091	RN2C	0.4
KC 27				OE098	RN4C	0.5
KM 48, 914A					RL86C	0.6
Sabo (SB) 97	(18mm)				D14	0.5
	(14mm)				RL86C	0.6
Sabo (SB) SB 102		102	2.8		RL86C	0.5
Sabo (SB) SB 123, SB 125, SB 150					RL86C	0.6
Sabo (SB) SB 126 (...-A, -B)		132	3.7		RL86C	0.5
Sabo (SB) SB 130		123	2.9, 3.3		RJ14YC	0.5
Sabo (SB) SB 130 L, SB 130 SL		123	2.9		RJ14YC	0.5
Sabo (SB) SB 135		123	3		RJ14YC	0.5
Sabo (SB) SB 140		142	3.4, 3.8		RJ14YC	0.5
Sabo (SB) SB 140 SL		142	3.5		RJ14YC	0.5
Sabo (SB) SB 151 (...-A, -B)		151	4.5		RL86C	0.5
Sabo (SB) SB 152		151	4.2		RL86C	0.5
Sabo (SB) SB 220		123	2.7		RJ14YC	0.5
Sabo (SB) SB 93		98	2.3		RL86C	0.5
Sachs 1004S, 1005S					D9	0.6
Sachs 175, 200, 1003, 1004					D9	0.5
Sachs 50				OE086	RL82C	0.6
Sachs 501				OE086	RL82C	0.5
Sachs 504 Series					RL86C	0.8
Sachs 505 Series					RL86C	0.8
Sachs 508 Series					RL86C	0.8
Sachs 50S, 80S				OE086	RL82C	0.6
Sachs 51, 75RM, 76RM, SB96					RL86C	0.6
Sachs SB130					RJ19LM	0.8
Sachs SB140					RJ19LM	0.8
Sachs SB151				OE086	RL82C	0.5
Stamo ST 102, ST 126, ST 151	Full load		3,6	OE086	RL82C	0.5
	Partial load		3,6		RL86C	0.5
Stamo ST 203	Partial load	202	6, 8.5		D14	0.5
	Full load	202	6, 8.5		D9	0.5
Stamo ST 204, ST 251	Partial load (18mm)		6, 9.7		D14	0.5
	Full load (18mm)		6, 9.7		D9	0.5
	Full load (14mm)		6, 9.7	OE086	RL82C	0.5
	Partial load (14mm)		6, 9.7		RL86C	0.5
Stamo ST 282		275	8.5, 11		D9	0.5
Stamo ST 30, ST 50	Full load				RL86C	0.5
	Partial load				RL86C	0.5
Stamo ST 301 A, SB 301 AB					RJ14YC	0.5
Stamo ST 75, ST 76	Full load	75	2.7	OE086	RL82C	0.5
	Partial load	75	2.7		RL86C	0.5
Stamo ST 96	Full load	93	3.7	OE086	RL82C	0.5
	Partial load	93	3.7		RL86C	0.5
<b>Mowers</b>						
Sachs					RL86C	0.5



CC BHP

21



OPT.



mm

**FIMCO****Sprayers**

Briggs & Stratton Intek	5.5		OE013	RC12YC	QC12YC / XC92YC	0.5
Briggs & Stratton	3.5,5			RJ19LM	QJ19LM	0.8
Tecumseh	3.5,5			RJ19LM		0.8
Honda OHV	5.5		OE051	RN11YC		0.8

**FINN****Power Equipment**

Kohler OHV	15		OE013	RC12YC		1.0
Kohler V-Twin	20,25		OE013	RC12YC		0.8
Briggs & Stratton Vanguard V-Twin	18			RC14YC		0.8
Kohler	8			RCJ8		0.6
Wisconsin W4-1770	35			RD16		0.8
Briggs & Stratton Twin	18			RJ19LM	QJ19LM	0.8
Honda OHV	11		OE051	RN11YC		0.8

**FINNELL****Power Equipment**

Onan				RH10C		0.6
------	--	--	--	-------	--	-----

**FIVENSON****Trimmers**

## Tree Tappers, Trimmers

				UY6		0.8
--	--	--	--	-----	--	-----

**FLEURELLE****Mowers**

BA 471 (Tecumseh centura 50 DX) Tecumseh 50 DX	163	4.5		RJ19LM		0.7
--	-----	-----	--	--------	--	-----

**FLO-MOW****Lawn Mowers**

Tecumseh				RJ17LM		0.6
Briggs & Stratton				RJ19LM	QJ19LM	0.8

**FLOWTRON****Log Splitters**

Briggs & Stratton				RJ19LM	QJ19LM	0.8
-------------------	--	--	--	--------	--------	-----

**FLYMO****Lawn Mowers**

JLO			OE059	L92YC		0.8
Tecumseh	2			RCJ6Y		0.8
Tecumseh				RJ17LM		0.8
Kirby KAV74				RJ18YC		0.8
Briggs & Stratton				RJ19LM	QJ19LM	0.8
Aspera				RJ8C		0.8

**Power Equipment**

GCT12, GCT15	Tecumseh	2		RCJ6Y		0.8
GCT20	JLO		OE059	L92YC		0.8
GCT21	Tecumseh	3.5		RJ17LM		0.8
	Briggs & Stratton			RJ19LM	QJ19LM	0.8
	Ducati		OE086	RL82C		0.8

**FMC****Lawn Mowers**

Briggs & Stratton				RJ19LM	QJ19LM	0.8
Tecumseh				RJ8C		0.8

**FORD****Chain Saws**

## Eagle I, II, Hawk

				RCJ8		0.8
--	--	--	--	------	--	-----

**Generators**

KOH-175	Briggs & Stratton			RJ19LM	QJ19LM	0.6
KOH-350	Kohler	8		RH10C		0.6
KOH-500	Kohler	12		RH10C		0.6

**Lawn Mowers**

Briggs & Stratton				RJ19LM	QJ19LM	0.8
-------------------	--	--	--	--------	--------	-----



CC BHP

21



OPT.



mm

**...FORD**

**Power Equipment**

960.1, 960.2

	Kohler OHV	12.5	OE013	RCJ8		0.8
	Kohler OHV	14	OE013	RC12YC		1.0
	Kohler V-Twin	16	OE013	RC12YC		1.0
	Kohler V-Twin	18	OE013	RC12YC		0.8
	Kohler	10,12		RH10C		0.8
	Kohler	14		RH10C		0.8
	Kohler	16		RH10C		0.8
	Kohler	20		RH10C		0.8
	Briggs & Stratton			RJ19LM	QJ19LM	0.8
	Tecumseh			RJ8C		0.8
	Kohler Twin	18		RV17YC		0.6
	Kohler Twin	20		RV17YC		0.6

**Pumps, Compressors & Refrigeration Units**

CH-4000	Briggs & Stratton	4		RJ19LM	QJ19LM	0.8
SP-150	Briggs & Stratton	3		RJ19LM	QJ19LM	0.8
SP-200	Kohler	4		RJ19LM		0.8

**Snow Removers**

	Briggs & Stratton			RJ19LM	QJ19LM	0.8
	Tecumseh			RJ8C		0.8

**FORESTER**

**Chain Saws**

CS-100, CS-350, CS-580

				CJ14		0.8
--	--	--	--	------	--	-----

**FORT**

**Engines**

	Briggs & Stratton	5,8		RJ19LM	QJ19LM	0.8
	Tecumseh	3.5		RJ8C		0.8

**FOX**

**Lawn Mowers**

All Models

				RJ19LM		0.8
--	--	--	--	--------	--	-----

**FRADAN**

**Blowers**

BB-50 Backpack  
BB-75 Backpack

				RJ6C		0.6
				RJ17LM		0.6
	Briggs & Stratton Vanguard	9	OE013	RC12YC	QC12YC / XC92YC	0.8
	Briggs & Stratton Vanguard V-Twin	14		RC14YC		0.8
	Briggs & Stratton	11		RJ19LM	QJ19LM	0.8
	Briggs & Stratton	5,8		RJ19LM	QJ19LM	0.8
	Honda OHV	9,13	OE051	RN11YC		0.8
	Kawasaki OHV	9	OE051	RN11YC		0.8
	Tecumseh OHV	5	OE098	RN4C		0.8

**Power Equipment**

BC-30, SE-30, ST-30

				CJ14		0.6
--	--	--	--	------	--	-----

**FRONTIER-TML (Quadra)**

**Chain Saws**

Einhell, F35, F35VIP, FB35, FB35VIP, Fercad, Green B, Mark I, Pioneer, Ranch, Rocky, Star Diffusion, V.I.P.

				CJ6		0.8
--	--	--	--	-----	--	-----

**FUEL-A-PLANE**

**Pumps, Compressors & Refrigeration Units**

All Models

				RH10C		0.6
--	--	--	--	-------	--	-----

**FULLER & JOHNSON**

**Generators**

All Other  
J

				W14		0.6
				25		0.6

**FUTURA**

**Log Splitters**

	Tecumseh			RJ8C		0.8
--	----------	--	--	------	--	-----



CC BHP

21



OPT.



mm

**G.I.**

**Power Equipment**

(18mm)  
(14mm)

RD16  
RJ8C

0.8  
0.8

**GAMBLE-ALDENS**

**Lawn Mowers**

All Models

RJ19LM

0.8

**GARDEN KING**

**Mowers**

All Models

RD16

0.6

**Tillers**

Briggs & Stratton 3.5,5  
Tecumseh OHV 5

RJ19LM QJ19LM  
OE098 RN4C

0.8  
0.8

**GARDEN MASTER**

**Tillers**

Briggs & Stratton 3.5,5,8

RJ19LM QJ19LM

0.8

**GARDEN PRIDE**

**Lawn Mowers**

All Models

RJ19LM

0.8

**Power Equipment**

Briggs & Stratton

RJ19LM QJ19LM

0.8

**GARDEN PRO**

**Garden Tractors**

Briggs & Stratton

RJ19LM QJ19LM

0.8

**GARDEN STAR**

**Tillers**

Tecumseh 3.5,5  
Tecumseh 8  
Briggs & Stratton 3.5,5,8  
Honda 5.5,8  
Tecumseh OHV 5,6

RJ17LM  
RJ17LM  
RJ19LM QJ19LM  
OE051 RN11YC  
OE098 RN4C

0.8  
0.8  
0.8  
0.8  
0.8

**GARD-EN-EZE**

**Power Equipment**

(18mm)  
Briggs & Stratton

RD16  
RJ19LM QJ19LM

0.8  
0.8

**GARDNER-DENVER**

**Pumps, Compressors & Refrigeration Units**

T55 Waukesha  
6M0-779 Buda  
All Other Hercules (7/8"-18)  
F-162, F-163, F-226, F-227 Continental  
GF6, GF638 Buda  
HXB, HXC, HXE Hercules  
K325, K369, K393, K428, L468, L525 Buda  
UC-135B IHC  
V104 Ford  
Buda (18mm)  
Wisconsin  
Caterpillar (18mm)  
Cushman (18mm)  
Ford 240,300  
Ford V-8  
Briggs & Stratton  
Hercules (14mm)  
Buda (14mm)  
Chrysler  
Clinton  
H&H  
Buda (7/8")  
Cushman (7/8"-18)  
Caterpillar (7/8"-18)  
Climax

RD16  
D9  
W14  
D14  
D23  
W18  
D23  
D18Y  
OE006 RN9YC  
D14  
D14  
D9  
D9  
RF11YC  
RH8C  
RJ19LM QJ19LM  
RJ6C  
RJ8C  
RJ8C  
RJ8C  
RJ8C  
W14  
W14  
W18  
W18

0.6  
0.6  
0.6  
0.8  
0.6  
0.6  
0.6  
0.6  
0.6  
0.6  
0.8  
0.8  
0.8  
0.6  
0.6  
0.8  
0.8  
0.8  
0.8  
0.6  
0.6  
0.6  
0.6



CC BHP



OPT.



# GARLOCK POWER WAGON

## Power Equipment

Briggs & Stratton	5	RJ19LM	QJ19LM	0.8
-------------------	---	--------	--------	-----

# GENCO

## Generators

All Models		W14		0.6
------------	--	-----	--	-----

# GEN-E-MOTOR (→ Pioneer)

# GENERAC

## Air Compressors

AP Series	OHV 1-Cyl.		RC14YC	0.8
MC1009			RJ19LM	0.8
MC1259		OE013	RJ19LM	0.8
	Briggs & Stratton Vanguard OHV	OE013	RC12YC	0.8
	Briggs & Stratton Vanguard V-Twin		RC14YC	0.8
	Briggs & Stratton		RJ19LM	0.8
	Briggs & Stratton	5	RJ19LM	0.8

## Centrifugal Pumps

WP2			RJ19LM	0.8
WP2T, WP3		OE013	RC12YC	0.8
	Briggs & Stratton Vanguard OHV	OE013	RC12YC	0.8
	Briggs & Stratton		RJ19LM	0.8

## Generators

04582, 05308	Generac OHVI	992	RC14YC	1.0
1850 Home & Away, 2500T			RJ19LM	0.8
3250XE, 3500XEP			OE098	0.8
C10000			RC14YC	0.8
C2400, C4000, C5000, C5000E			RJ19LM	0.8
C8000			RC14YC	0.8
EPS-12, EPS-20			OE049	0.9
EPS-25			OE006	0.8
EPS-8-AC			RC14YC	0.8
G1000, G1600			RCJ8	0.6
G2600			RL86C	0.6
G4000			RL95YC	0.6
Generac II	Vanguard V-Twin	16	RC14YC	0.8
	1.2L		OE006	0.9
IM60G			RJ12C	0.8
L4000, L4000E, L5000, L5000E			RJ19LM	0.8
MC Series	1-Cyl. OHV		OE013	0.8
	V-Twin		RC14YC	0.8
Mega 2500			RJ19LM	0.8
Mega 3000			OE098	0.8
MF6500			RC14YC	0.8
NP100G			OE006	0.6
NP45G, NP55G, NP65G			RC14YC	0.8
NP80G			OE006	0.6
R10000, R10000E, R3500XL			RC14YC	0.8
R4000			RL86C	0.6
R6000, R8000, R8000E			RC14YC	0.8
S1000			CJ6	0.6
S1500			RJ19LM	0.8
S1600			RL86C	0.6
S2400			RJ19LM	0.8
S2600			RL95YC	0.6
S4000			RJ19LM	0.8
			RJ8C	0.8
S4000E, S5000			RJ19LM	0.8
SG012			OE006	0.9
SG015			RS12YC	0.9
SG016			OE006	0.9
SG020			OE006	0.9
			RS12YC	0.9
SV1850, SV2400, SV4200, SVP5000, SVP5000E			RJ19LM	0.8







CC BHP

21



OPT.



mm

**...GENERAC**

**...Generators**

SVP500T			RJ8C		0.8	
SVT4200, SVT5000			RJ19LM		0.8	
XE Series, XL Series	1-Cyl. OHV		OE013	RC12YC	0.8	
XL Series	V-Twin			RC14YC	0.8	
	562SXL, MC40		OE059	L92YC	0.6	
	Briggs & Stratton Vanguard OHV		OE013	RC12YC	QC12YC / XC92YC	0.8
	Briggs & Stratton Vanguard V-Twin			RC14YC	0.8	
	Kawasaki	1.6,3		RCJ8	0.6	
	Wisconsin			RD16	0.8	
	Briggs & Stratton			RJ19LM	QJ19LM	0.8
	Tecumseh			RJ19LM		0.8
	Lauson			RJ8C		0.8
	Tecumseh			RJ8C		0.8
	TXP45			RJ8C		0.6
	Kawasaki	5		RL86C		0.6
	Robin			RL86C		0.6
	Opel	1000		RL87YC		0.6
	Opel	1100		RL87YC		0.6
	Nissan 1.2L		OE049	RN11YC4		0.9
	GM 2.5L		OE042	RN12YC		0.6
	Tecumseh OHV	6,6.5	OE098	RN4C		0.8
	1.0 & 1.2L		OE006	RN9YC		0.9
	Fiat 1.6L		OE006	RN9YC		0.8
	GM 5.7L, 7.4L			RV15YC4		0.9

**Pressure Washers**

CP Series	Briggs & Stratton Intek OHV	6	OE013	RC12YC	QC12YC / XC92YC	0.8
	Briggs & Stratton Vanguard OHV		OE013	RC12YC	QC12YC / XC92YC	0.8
	Briggs & Stratton 1-Cyl. OHV			RJ19LM	QJ19LM	0.8
MC Series			OE098	RN4C		0.8
	Briggs & Stratton Vanguard OHV		OE013	RC12YC		0.8
	Briggs & Stratton		OE013	RC12YC	QC12YC / XC92YC	0.8
	Tecumseh			RJ19LM	QJ19LM	0.8
	Tecumseh OHV		OE098	RN4C		0.8

**GENERAL**

**Generators**

	Kawasaki			RCJ8		0.6
--	----------	--	--	------	--	-----

**GENERAL EQUIPMENT**

**Air Ventilation Blowers**

	Briggs & Stratton	3.5		RJ19LM	QJ19LM	0.8
	Honda OHV	4	OE051	RN11YC		0.8

**Earth Drills**

	Robin	3		RJ12C		0.6
	Briggs & Stratton			RJ19LM	QJ19LM	0.8
	Tecumseh			RJ8C		0.8
	Chrysler			RL86C		0.6
	Honda OHV	5	OE006	RN9YC		0.8

**Pumps, Compressors & Refrigeration Units**

82005	Chrysler		OE086	RL82C		0.6
-------	----------	--	-------	-------	--	-----

**GEN-PRO**

**Generators**

GP105E				RC14YC		0.6
GP-110E	Kohler Twin	20		RV17YC		0.6
GP-150E, GP200E			OE006	RN9YC		0.9
GP2-30H, GP2-40H	Honda	8	OE051	RN11YC		0.8
GP2-50, GP2-50E	Briggs & Stratton Vanguard V-Twin			RC14YC		0.8
GP2-65EH, GP2-65H	Honda	11	OE051	RN11YC		0.8
GP-28H			OE051	RN11YC		0.8
GP2-90E	Briggs & Stratton Vanguard			RC14YC		0.8
GP-30				RC14YC		0.6
GP-40, GP-40E				RCJ8		0.6
GP-45, GP-45E				RJ19LM		0.8
GP-45H			OE051	RN11YC		0.8
GP-48, GP-48E				RCJ8		0.6



CC BHP

21



OPT.



mm

## ...GEN-PRO

### ...Generators

GP-50, GP-50E				RC14YC	0.6
GP-60				RCJ8	0.6
				RJ19LM	0.8
GP-60E				RCJ8	0.6
				RJ19LM	0.8
GP-60H, GP-70EH			OE051	RN11YC	0.8
GP-75E, GP-90E				RC14YC	0.6
GP-98E	Briggs & Stratton Twin	18		RJ19LM	0.8

## GIANNI FERRARI

### Riding Mowers

	Briggs & Stratton Vanguard V-Twin	16,18,20		RC14YC	0.8
--	-----------------------------------	----------	--	--------	-----

## GIANT

### Pressure Washers

	Honda OHV	13	OE051	RN11YC	0.8
--	-----------	----	-------	--------	-----

## GIANT BLO

(→ Giant-Vac)

## GIANT MOW

### Lawn Mowers

	Briggs & Stratton	5		RJ19LM	0.8
--	-------------------	---	--	--------	-----

### Mowers

	Briggs & Stratton Vanguard	9	OE013	RC12YC	QC12YC / XC92YC	0.8
	Kohler OHV	14	OE013	RC12YC		1.0
	Briggs & Stratton Vanguard V-Twin	18		RC14YC		0.8
	Kawasaki	12.5		RCJ8		0.8
	Honda GV400	11		RCJ8Y		0.8
	Briggs & Stratton	12.5		RJ19LM	QJ19LM	0.8
	Briggs & Stratton	8.5		RJ19LM	QJ19LM	0.8
	Kawasaki	13,14	OE051	RN11YC		0.8
	Kawasaki	9	OE051	RN11YC		0.8
	Tecumseh OHV	16	OE098	RN4C		0.8

## GIANT THATCH

(→ Giant-Vac)

## GIANT-VAC

### Lawn Mowers

	Briggs & Stratton	5		RJ19LM	QJ19LM	0.8
--	-------------------	---	--	--------	--------	-----

### Mowers

	Briggs & Stratton Intek	13.5	OE013	RC12YC	QC12YC / XC92YC	0.8
	Kawasaki	12.5		RCJ8		0.8

### Power Equipment

	Kawasaki	7.5	OE059	L92YC		0.8
	Briggs & Stratton Intek OHV	10	OE013	RC12YC	QC12YC / XC92YC	0.5
	Briggs & Stratton Intek OHV	5.5,6,6.5	OE013	RC12YC	QC12YC / XC92YC	0.5
	Briggs & Stratton Intek OHV	9	OE013	RC12YC	QC12YC / XC92YC	0.5
	Briggs & Stratton Vanguard	9	OE013	RC12YC	QC12YC / XC92YC	0.8
	Kohler Command OHV	15	OE013	RC12YC		0.8
	Kohler Command OHV	16	OE013	RC12YC		0.8
	Kohler V-Twin	20	OE013	RC12YC		0.8
	Kohler V-Twin	25	OE013	RC12YC		0.8
	Briggs & Stratton Vanguard V-Twin	16,18		RC14YC		0.8
	Kawasaki FH451 V-Twin OHV	15		RCJ8Y		0.8
	Wisconsin			RD16		0.8
	Ford	300		RF10C		0.8
	Kohler	16		RH10C		0.8
	Kohler	20		RH10C		0.8
	Kohler	23		RH10C		0.8
	Kohler M8	10,14		RH10C		0.8
	Kohler M8	8		RH10C		0.8
	Briggs & Stratton	11		RJ19LM	QJ19LM	0.8
	Briggs & Stratton	5		RJ19LM	QJ19LM	0.8
	Briggs & Stratton	8		RJ19LM	QJ19LM	0.8



CC BHP

21



OPT.



mm

**...GIANT-VAC**

**...Power Equipment**

Kohler K181	8		RJ19LM		0.8
Hercules G1600			RJ6C		0.8
Honda OHV	5,5,5,9,11,13	OE051	RN11YC		0.8
Kawasaki OHV	9	OE051	RN11YC		0.8
Kohler CS Pro	8.5		RN14YC		0.8
Tecumseh OHV	13,16	OE098	RN4C		0.8
Kohler Twin	16		RV17YC		0.6
Kohler Twin	18		RV17YC		0.6

**Tillers**

			RCJ8		0.8
--	--	--	------	--	-----

**GIERE**

**Tractors**

Turf, Snow	Briggs & Stratton Vanguard V-Twin OHV	16,18		RC14YC	0.8
------------	---------------------------------------	-------	--	--------	-----

**GILLETTE**

**Generators**

Briggs & Stratton Vanguard	5.5	OE013	RC12YC	QC12YC / XC92YC	0.8
Briggs & Stratton Vanguard	9	OE013	RC12YC	QC12YC / XC92YC	0.8
Kohler V-Twin	20	OE013	RC12YC		0.8
Briggs & Stratton Vanguard V-Twi	12.5,14,16,18,20		RC14YC		0.8
Briggs & Stratton	11		RJ19LM	QJ19LM	0.8
Briggs & Stratton	5		RJ19LM	QJ19LM	0.8
Briggs & Stratton	8		RJ19LM	QJ19LM	0.8
Robin			RL86C		0.6
Honda	5.5,8,11,13	OE051	RN11YC		0.8
Ford 1.1L		OE006	RN9YC		0.9

**GILSON**

**Lawn Mowers**

Tecumseh			RJ17LM		0.6
Briggs & Stratton			RJ19LM	QJ19LM	0.8

**Power Equipment**

OMC			RF11YC		0.8
Briggs & Stratton			RJ19LM	QJ19LM	0.8
Briggs & Stratton Twin			RJ19LM	QJ19LM	0.8
Lauson			RJ8C		0.6
Tecumseh			RJ8C		0.8

**Snow Removers**

OMC 2-Cycle			CJ14		0.6
Tecumseh 2-Cycle			RJ18YC		0.8
Briggs & Stratton			RJ19LM	QJ19LM	0.8
Lauson			RJ8C		0.8
Tecumseh 4-Cycle			RJ8C		0.8

**GIZMOW**

**Power Equipment**

Kohler Formula 2552	25	OE013	RC12YC		0.8
Kohler Formula 2752	27	OE013	RC12YC		0.8

**GLOBAL MARINE PUMPOUT**

**Waste Pumps**

Marine	Honda	2.5		CJ14	0.8
--------	-------	-----	--	------	-----

**GLOBE LIGHT**

**Generators**

All Models				W14	0.6
------------	--	--	--	-----	-----



CC BHP

21



OPT.



mm

**GNC INDUSTRIES****Sprayers**

Briggs & Stratton Intek	5.5	OE013	RC12YC	QC12YC / XC92YC	0.8
Robin	4,5,9		RL86C		0.8
Honda	5.5	OE051	RN11YC		0.8

**GOLDEN BOY****Lawn Mowers**

All Models			RJ19LM		0.8
------------	--	--	--------	--	-----

**Trimmers**

			RCJ8		0.8
--	--	--	------	--	-----

**GOLDEN STAR****Lawn Mowers**

Kawasaki	1.5		CJ6		0.8
	1,9,3,7		RL86C		0.6
Kawasaki	3.6		RL95YC		0.6
Kawasaki	5	OE051	RN11YC		0.8

**Mowers**

Kawasaki	6	OE059	L92YC		0.8
Kawasaki	3.6		RL95YC		0.6

**Power Equipment**

			RCJ8		0.6
--	--	--	------	--	-----

**Pumps, Compressors & Refrigeration Units**

All Models			RCJ8		0.6
------------	--	--	------	--	-----

**Tillers**

			RJ19LM		0.6
--	--	--	--------	--	-----

**GOLDONI****Power Equipment**

Acme			RL86C		0.8
------	--	--	-------	--	-----

**GOLF****Lawn Mowers**

Briggs & Stratton	3,5		RJ19LM	QJ19LM	0.8
-------------------	-----	--	--------	--------	-----

**Power Equipment**

Briggs & Stratton	2,3,5		RJ19LM	QJ19LM	0.8
-------------------	-------	--	--------	--------	-----

**GOODALL****Edgers**

			RCJ8		0.8
--	--	--	------	--	-----

**Garden Tractors, Rakes**

			RJ8C		0.8
--	--	--	------	--	-----

**Generators**

Briggs & Stratton, Kohler			RJ19LM	QJ19LM	0.6
Tecumseh			RJ8C		0.6

**Lawn Mowers**

Briggs & Stratton			RJ19LM	QJ19LM	0.8
Tecumseh			RJ8C		0.6

**Mowers**

Briggs & Stratton Vanguard V-Twin	14		RC14YC		0.8
Honda OHV	13	OE051	RN11YC		0.8
Kawasaki OHV	14	OE051	RN11YC		0.8

**Pumps**

Porta Pumps			RJ8C		0.6
-------------	--	--	------	--	-----

**Trimmers**

			RCJ8		0.8
--	--	--	------	--	-----

**GOOSSEN****Power Equipment**

Wisconsin	35		RD16		0.6
Honda OHV	11,13	OE051	RN11YC		0.8
Honda V-Twin	18,20	OE051	RN11YC		0.8



CC

BHP

21



OPT.

**GORDON SMITH****Pumps, Compressors & Refrigeration Units**

45				RD16	0.9
60				W16Y	0.8
70			OE042	RN12YC	0.8
75				RJ12C	0.9
90				RF11YC	0.9
100				RV12YC	0.9
125				RD16	0.9
150				RV12YC	0.9
160				D9	0.6
V465D	Wisconsin		OE042	RN12YC	0.6
	Ford	302		RV12YC	0.9
	Ford	400		RV12YC	0.9
	Ford	460		RV12YC	0.9

**GORILLA****Aerators**

	Briggs & Stratton	3,3.5		RJ8C	0.8
	Honda OHV	4	OE051	RN11YC	0.8

**GORMAN-RUPP****Pumps, Compressors & Refrigeration Units**

820	West Bend			RL86C	0.8
82003	Chrysler		OE086	RL82C	0.6
(LPG)	Ford	240		RF10C	0.5
	Ford	300		RF10C	0.5
	Ford	172		RH10C	0.5
	Ford	361		RH10C	0.5
AENLD, BKND	Wisconsin			RD16	0.8
CCKB	Onan			RH8C	0.6
S10D, S12D, S7D, S8D, THD, TJD	Wisconsin			RD16	0.8
UB-264, UV-549	IHC			RJ6C	0.6
V461D, V465D	Wisconsin		OE042	RN12YC	0.6
VE4D, VF4D, VG4D, VH4D	Wisconsin			RD16	0.8
	Briggs & Stratton Vanguard V-Twin			RC14YC	0.8
	Ford	240		RF10C	0.8
	Ford	300		RF10C	0.8
	Ford	330		RF10C	0.8
	Ford	200		RF11YC	1.3
	Ford	172		RH10C	0.8
	Ford	361		RH10C	0.8
	Kohler	8,12,14		RH10C	0.6
	Briggs & Stratton			RJ19LM	QJ19LM 0.8
	Kohler	4,7		RJ19LM	0.8
	Ford	104	OE051	RN11YC	0.6
	Honda OHV	5.5,8	OE051	RN11YC	0.8
	Ford	140		RS12YC	0.9
	Ford	370		RV12YC	0.9
	Kohler Twin	20		RV17YC	0.6

**GOULD****Pumps**

Gas Pump Model DU				RCJ8	0.6
-------------------	--	--	--	------	-----

**GRAHAM PAIGE****Tillers**

B17, B16				D14	0.8
----------	--	--	--	-----	-----

**GRAINGER****Chainsaws**

2Z573, 2Z760, 2Z970, 2Z971				RCJ8	0.6
4Z022, 4Z023				RCJ8	0.6

**GRAN PRIX****Lawn Mowers**

All Models				RJ19LM	0.8
------------	--	--	--	--------	-----

**Power Equipment**

Shredders				RCJ8	0.8
-----------	--	--	--	------	-----



CC BHP

21



OPT.



mm

## GRASS CRAFT

### Power Equipment

Tecumseh 2-Cycle	5		RJ19LM	0.8
Tecumseh 4-Cycle	5		RJ19LM	0.8

## GRASS CUT

### Lawn Mowers

All Models			RL86C	0.8
------------	--	--	-------	-----

## GRASS HOUND

### Lawn Mowers

All Models			RJ19LM	0.8
------------	--	--	--------	-----

## GRASS MASTER

### Lawn Mowers

Briggs & Stratton			RJ19LM	QJ19LM	0.8
-------------------	--	--	--------	--------	-----

## GRASS WAND

### Generators

500A			RCJ8	0.6
------	--	--	------	-----

### Lawn Mowers

All Models			RJ19LM	0.8
------------	--	--	--------	-----

## GRASSHOPPER

### Power Equipment

Kohler OHC Twin	18		OE013	RC12YC	1.0	
Kohler V-Twin	18,20,25,27		OE013	RC12YC	0.8	
Kubota	21,24.5,31,32		OE013	RC12YC	0.8	
Briggs & Stratton Vanguard V-Twin	14			RC14YC	0.8	
Briggs & Stratton Vanguard V-Twin	16			RC14YC	0.8	
Briggs & Stratton Vanguard V-Twin	18			RC14YC	0.8	
Kohler	12,16			RH10C	0.8	
Briggs & Stratton				RJ19LM	QJ19LM	0.8
Briggs & Stratton Twin	14			RJ19LM	QJ19LM	0.8
Briggs & Stratton Twin	16			RJ19LM	QJ19LM	0.8
Briggs & Stratton Twin	18			RJ19LM	QJ19LM	0.8
Kawasaki Liquid-Cooled V-Twin	27		OE042	RN12YC	0.6	
Onan Twin	20			RS17YX	0.6	

## GRASSWAND

### Power Equipment

Kawasaki OHV	17		OE051	RN11YC	0.8
--------------	----	--	-------	--------	-----

### Trimmers

Xenoah				CJ6	0.8
--------	--	--	--	-----	-----

## GRAVELY

### Lawn Mowers

24				RJ8C	0.6	
Pro 21 SCH	Robin OHV	6		RL87YC	0.6	
	Briggs & Stratton Intek	6.75	OE013	RC12YC	QC12YC / XC92YC	0.5
	Kohler Command Pro	27	OE013	RC12YC	0.5	
	Honda	5.5	OE051	RN11YC	0.8	
	Kawasaki	13,15,17	OE051	RN11YC	0.8	
	Kawasaki Air Cooled	19,21,23,25	OE051	RN11YC	0.8	
	Kawasaki OHV	25	OE051	RN11YC	0.8	

### Mowers

Kohler Command Pro	25,26		OE013	RC12YC	0.8
Kawasaki	13,15,17			RCJ8Y	0.8
Kawasaki Twin	19,23,25		OE051	RN11YC	0.6
Kawasaki Liquid-Cooled V-Twin	27		OE042	RN12YC	0.6

### Power Equipment

408				RJ8C	0.8	
500	Kohler	10,12		RH10C	0.8	
	Kohler	8		RJ19LM	0.8	
800	Kohler			RH10C	0.8	
	Onan B43M			RH8C	0.8	
	Onan B48M, BF			RH8C	0.8	
	Briggs & Stratton			RJ19LM	QJ19LM	0.8
	Onan B48G			RS17YX	0.8	



CC BHP



OPT.



**...GRAVELY**

**...Power Equipment**

100 Series	Kohler Twin	18		RV17YC	0.6
10A, 12				RH10C	0.8
150 Series	Kohler OHV	12.5,14,15	OE013	RC12YC	1.0
	Kawasaki	12.5		RCJ8	0.8
200 Series	Kohler OHV	15	OE013	RC12YC	1.0
	Kohler V-Twin	18,20	OE013	RC12YC	0.8
	Briggs & Stratton Vanguard V-Twin	16		RC14YC	0.8
	Kawasaki Liquid-Cooled V-Twin	20		RCJ8	0.6
300 Series	Kohler V-Twin	18,20,25	OE013	RC12YC	0.8
	Briggs & Stratton Vanguard V-Twin	16		RC14YC	0.8
424, 430				RH10C	0.8
5000 Series	Kohler	10,12		RH10C	0.8
	Kohler	8		RJ19LM	0.8
8000 Series	Kohler			RH10C	0.8
	Onan B43M			RH8C	0.8
	Onan B48M, BF			RH8C	0.8
	Briggs & Stratton			RJ19LM	QJ19LM 0.8
	Onan B48G			RS17YX	0.8
810, 812, 816				RH10C	0.8
816S				RCJ8	0.8
900, 9000 Series	Continental		OE059	L92YC	0.8
Commercial 10, Commercial 432				RH10C	0.8
Commercial 450				RH8C	0.8
Commercial 8				RJ8C	0.8
Convertible 7.6	Gravely			RH8C	0.8
Convertible 8	Kohler			RCJ8	0.8
G Series	Kohler OHV	14	OE013	RC12YC	1.0
	Briggs & Stratton Vanguard V-Twin	16		RC14YC	0.8
	Kohler Twin	16,18,20		RV17YC	0.6
Pro Aire 27			OE051	RN11YC	0.8
Pro Chip 618R, Pro Vac 1050, Promaster 260Z			OE013	RC12YC	0.8
Westchester				RH8C	0.9
	Kohler OHV	12.5	OE013	RC12YC	1.0
	Kohler OHV	14,15	OE013	RC12YC	1.0
	Kohler V-Twin	18	OE013	RC12YC	0.8
	Kohler V-Twin	20,22	OE013	RC12YC	0.8
	Kohler V-Twin	25	OE013	RC12YC	0.8
	Briggs & Stratton Vanguard V-Twin	12.5		RC14YC	0.8
	Briggs & Stratton Vanguard V-Twin	16,20,21		RC14YC	0.8
	Kawasaki	12.5		RCJ8	0.8
	Kawasaki Liquid-Cooled V-Twin	20		RCJ8	0.6
	Kohler	12		RH10C	0.8
	Kohler	14		RH10C	0.8
	Kohler	8		RH10C	0.8
	Kohler Twin	23		RH10C	0.8
	Briggs & Stratton Single Cyl.			RJ19LM	QJ19LM 0.8
	Briggs & Stratton Twin	16		RJ19LM	QJ19LM 0.8
	Kohler KT81	8		RJ19LM	0.8
	Robin OHV	8.5		RL87YC	0.6
	Honda OHV	4	OE051	RN11YC	0.8
	Kawasaki OHV	14	OE051	RN11YC	0.8
	Kawasaki OHV	25	OE051	RN11YC	0.8
	Robin OHV	4	OE098	RN4C	0.6
	Tecumseh OHV	12.5	OE098	RN4C	0.8
	Robin OHV	13.5,18,20, 20.5,22,25	OE006	RN9YC	0.6
	Kohler Twin	16,18		RV17YC	0.6
	Kohler Twin	20		RV17YC	0.6

**Snow Removers**

All Models				RJ19LM	0.8
------------	--	--	--	--------	-----

**GRAY**

**Generators**

All Models				RJ8C	0.6
------------	--	--	--	------	-----



CC BHP

21



OPT.



mm

**GRAZER**

**Mowers**

Kohler V-Twin	22	OE013	RC12YC	0.8	
Kubota		OE013	RC12YC	0.8	
Briggs & Stratton Vanguard V-Twin	18,20		RC14YC	0.8	
Briggs & Stratton	11		RJ19LM	QJ19LM	0.8
Briggs & Stratton	18		RJ19LM	QJ19LM	0.8
Briggs & Stratton Twin	12.5,16		RJ19LM	QJ19LM	0.8
Kohler Twin	18,20		RV17YC		0.6

**GREAT DANE**

**Riding Mowers**

Kohler Command OHV	15	OE013	RC12YC	0.8	
Kohler V-Twin	18,20,22,23,25	OE013	RC12YC	0.8	
Kohler V-Twin EFI	26,27,28	OE013	RC12YC	0.8	
Briggs & Stratton Vanguard V-Twin	16,18,20		RC14YC	0.8	
Kawasaki FB460V	12.5		RCJ8	0.8	
Briggs & Stratton	10.5		RJ19LM	QJ19LM	0.8
Kawasaki OHV	14,15,17,19	OE051	RN11YC	0.8	
Kawasaki V-Twin	23,25	OE051	RN11YC	0.8	

**GREEN ACRES**

**Lawn Mowers**

All Models			RJ19LM	0.8
------------	--	--	--------	-----

**Tillers, Tractors**

			RCJ8	0.8
--	--	--	------	-----

**GREEN MACHINE**

**Blowers**

2600			RCJ8	0.8
4600			J4C	0.8
3000hb			RDJ7J	0.8
4600bp, 4600K, 4600LP			RCJ8	0.8
8000, 9000			RJ19LM	0.8
Xenoah			RJ8C	0.8

**Chain Saws**

20			RDJ7Y	0.8
30, 33, 38			RCJ6Y	0.8
7100, 7200, 7400			RCJ8	0.8
7600, 7700			RCJ8Y	0.8

**Edgers**

1900e, 1900EM, 500e			RCJ8	0.8
---------------------	--	--	------	-----

**Lawn Mowers**

2100P, 2100SP			RL86C	0.6
500e			RCJ8	0.6
Robin OHV	6		RL86C	0.6

**Power Equipment**

1800			RDJ8J	0.8
2000			RCJ8	0.8
4000	(3/8" Reach)		RCJ8	0.8
	(1/2" Reach)		RL86C	0.8
4500	(3/8" Reach)		RCJ8	0.8
	(1/2" Reach)		RL86C	0.8
4800			CJ6	0.8
3000J			CJ6	0.8

**Pumps, Compressors & Refrigeration Units**

Port-a-Flo			RCJ8	0.6
------------	--	--	------	-----

**Trimmers**

1600			RDJ7J	0.8
1930			RDJ8J	0.8
1940			RDJ7Y	0.8
2230			RDJ7J	0.8
4500			J4C	0.8
1700, 1730, 1900, 1900E			RCJ8	0.8
1930M			RCJ8	0.8
1940M, 2000, 2100, 2200			RCJ8	0.8
2300 Series, 2400, 2400M3, 2500			RCJ8	0.8
2500LP, 2540LP			RCJ6Y	0.8





CC BHP

21



OPT.



mm

**...GREEN MACHINE****...Trimmers**

2600, 2600h, 2800, 2840, 3000, 3000b, 3000j  
 3000LP  
 3000M, 3000SS, 3040M, 3510, 3540  
 3800LP  
 4000, 4000b, 4000j  
 4000LP  
 4000M  
 4500LP

RCJ8 0.8  
 RCJ7Y 0.8  
 RCJ8 0.8  
 RCJ7Y 0.8  
 RCJ8 0.8  
 RCJ8Y 0.8  
 RCJ8 0.8  
 RCJ8Y 0.8  
 RJ19LM QJ19LM 0.8

Briggs &amp; Stratton

**GREEN TEAM****Lawn Mowers**

Briggs &amp; Stratton

5.5

RJ19LM QJ19LM 0.8

**Mowers**Briggs & Stratton  
Honda8.5,10.5  
9,13RJ19LM QJ19LM 0.8  
OE051 RN11YC 0.8**GREENS****Mowers**

Zephyr B & S  
 Villiers

RJ8C 0.7  
 OE086 RL82C 0.5

**GREGSON-CLARK****Pumps**Briggs & Stratton  
Honda16  
4,5.5,6.5,9,  
13,20RJ19LM QJ19LM 0.8  
OE051 RN11YC 0.8**Sprayers**

Honda

13

OE051 RN11YC 0.8

**Vacuums**

Honda

5.5

OE051 RN11YC 0.8

**GRILLO****Riding Equipment**

Briggs & Stratton Intek OHV  
 Kohler Command OHV  
 Briggs & Stratton Vanguard V-Twin

5.5  
 15  
 9,12.5,14,  
 16,18

OE013 RC12YC QC12YC / XC92YC 0.5  
 OE013 RC12YC 0.8  
 RC14YC 0.8

Briggs & Stratton  
Honda OHV8  
5

RJ19LM QJ19LM 0.8  
 OE051 RN11YC 0.8

**GRIMMER-SCHMIDT****Pumps, Compressors & Refrigeration Units**Ford  
Ford302  
351

RV12YC 0.9  
 RV12YC 0.9

**GRIP****Stump Cutters**

Stumpcutters

RCJ7Y 0.8

**GROBAN****Generators**

Briggs & Stratton Vanguard V-Twin  
 Briggs & Stratton Vanguard V-Twin  
 Ford  
 Briggs & Stratton  
 Briggs & Stratton Twin  
 Honda OHV  
 Honda OHV  
 Honda V-Twin  
 Honda OHV  
 Ford T.1L  
 Ford

16  
 18  
 300  
 5,8,11  
 18  
 13  
 8,11  
 18,20  
 5  
 460

RC14YC 0.8  
 RC14YC 0.8  
 RF10C 0.8  
 RJ19LM QJ19LM 0.8  
 RJ19LM QJ19LM 0.8  
 OE051 RN11YC 0.8  
 OE051 RN11YC 0.8  
 OE051 RN11YC 0.8  
 OE006 RN9YC 0.8  
 OE011 RS9YC 0.9  
 RV12YC 0.9



CC BHP

21



OPT.



mm

**GROOMER****Trimmers**

CJ14

0.8

**GROUND HOG****Earth Drills**

Briggs &amp; Stratton

RJ19LM

QJ19LM

0.8

Chrysler

RL86C

0.6

Robin EY18-3W

RL86C

0.6

**GROUNDSKEEPER****Power Equipment**

Kohler V-Twin

18

OE013

RC12YC

0.8

Wisconsin

30

RD16

0.6

Kohler Twin

23

RH10C

0.8

Briggs &amp; Stratton

8.5

RJ19LM

QJ19LM

0.8

**GROUNDSMAN****Turf Equipment**

Honda OHV

5.5,8

OE051

RN11YC

0.8

**GROW GEAR****Edger**

RCJ8

0.8

**Power Equipment**

Tanaka

RCJ8

0.8

**GUIN ROOT FEEDER****Power Equipment**

Kohler

10

RH10C

0.8

**GULF****Lawn Mowers**

Briggs &amp; Stratton

RJ19LM

QJ19LM

0.8

Tecumseh

RJ8C

0.8

**Plows**

Briggs &amp; Stratton

RJ19LM

QJ19LM

0.8

**GUTBROD****Mowers**

HB255REL, SB51R

RCJ8

0.5

HB40, HB40L, HB45, HB45E, B &amp; S

RCJ8

0.5

HB45LE, HB45REL

HB46-2T B &amp; S

RCJ8

0.5

HB46-4T Tecna

RCJ8

0.5

HB46R, HB55R

RCJ8

0.5

Prof 430G, 510 B &amp; S

RCJ8

0.5

Prof 510FSR Sachs

RCJ8

0.5

**Power Equipment**

140V4, 162MS4, 245H4,

245HL4, 245HR4

RJ17LM

0.5

**Tractors**

510EBS, 610EBS, 610EBS Tecumseh

RCJ8

0.5

BM100-2G, MB60-30, MB60-52

RCJ8

0.5

BM100-4BS, ZB100, BM700 B &amp; S

RCJ8

0.5

SR800

RL86C

0.5

**HABAN****Power Equipment**

Kohler

12

RH10C

0.8

Briggs &amp; Stratton

5,8,12.5

RJ19LM

QJ19LM

0.8

Kohler K181

8

RJ19LM

0.8

Tecumseh

5,8

RJ8C

0.8

**Snow Removers**

Briggs &amp; Stratton

RJ19LM

QJ19LM

0.8

Tecumseh

RJ8C

0.8

**Thatcher**

Tecumseh

2

RCJ8Y

0.8



CC BHP

21



OPT.



mm

**HAGIE****Sprayers**

8240	Chrysler	318	OE051	RN11YC	0.8
------	----------	-----	-------	--------	-----

**HAHN****Lawn Mowers**

All Models				RJ19LM	0.8
------------	--	--	--	--------	-----

**Power Equipment**

Kohler	8,16			RH10C	0.8	
Briggs & Stratton				RJ19LM	QJ19LM	0.8
Tecumseh				RJ19LM		0.8

**Snow Removers**

Kohler				RH10C		0.8
Briggs & Stratton				RJ19LM	QJ19LM	0.8
Tecumseh				RJ8C		0.8

**HAKA BOY****Tillers**

				D9		0.8
--	--	--	--	----	--	-----

**HAKO****Mowers**

Hakaboy 8611				D9		0.6
Hako Combinette, Hako Variette F & S				RL86C		0.6
Hakorette 150, 200				RL86C		0.6
Hakorette 5003, 5004, 5005, 5007				D9		0.6
Hakorette 5008, 5027, 5035				D9		0.6
Hakotrac 1200, 1400				RL86C		0.6
Hakotrac 2000				RH10C		0.6
Hakotrac 700, 1000				RJ8C		0.6
Rasentrac 800E				RJ8C		0.6
	JLO (18mm)			D9		0.6
	B & S			RCJ8		0.6
	JLO (14mm)		OE086	RL82C		0.6

**Multi-Purpose Machines**

Briggs & Stratton				RJ19LM	QJ19LM	0.8
-------------------	--	--	--	--------	--------	-----

**HALE FIRE PUMPS****Pumps, Compressors & Refrigeration Units**

15B, 15FC-B23, 15FD-B23, 15TA-B6, 20FD-B32				RCJ8		0.6
20FD-WTJ				RD16		0.6
20FS-C225			OE042	RN12YC		0.6
20FS-WVG4				RD16		0.6
20GA-B8, 20GP-B8, 20TA-B8				RCJ8		0.6
20TM-WS7				RD16		0.6
20TN-B13, 25FA-B23				RCJ8		0.6
25FA-WAENL, 25FR-WTJ				RD16		0.6
25FZZ-B23				RCJ8		0.6
25FZZ-WAENL, 30FC9-WTJ				RD16		0.6
30FS-C225			OE042	RN12YC		0.6
30FS-WG4				RD16		0.6
30FZA-B23				RCJ8		0.6
30FZA-WAENL				RD16		0.6
30GA-B8, 30GP-B8				RCJ8		0.6
30SA-W512				RD16		0.6
30TA-B23				RCJ8		0.6
30TA-WAENL				RD16		0.6
40FA-C318			OE051	RN11YC		0.6
40FA-F250				RF10C		0.6
40FC9-C225			OE042	RN12YC		0.6
40FC9-WVH4				RD16		0.6
40FC-F250				RF10C		0.6
40GC-B19				RCJ8		0.6
40TA-WVH4				RD16		0.6
45FA-C318			OE051	RN11YC		0.6
45FA-C413				RN5C		0.6
50FA-F250				RF10C		0.6
50FB2-C225			OE042	RN12YC		0.6
50FB3-C318			OE051	RN11YC		0.6



CC

BHP

21



OPT.



## ...HALE FIRE PUMPS

### ...Pumps, Compressors & Refrigeration Units

50FB3-C440				RJ12YC	0.6
50FR-C318			OE051	RN11YC	0.6
50FR-C413				RN5C	0.6
60FBI-C318			OE051	RN11YC	0.6
60FBI-C440				RJ12YC	0.6
60FR-C318			OE051	RN11YC	0.6
60FR-C413				RN5C	0.6
FA50-C225			OE042	RN12YC	0.6
FA50-C318			OE051	RN11YC	0.6
FB100-C440				RJ12YC	0.6
FB50-C225			OE042	RN12YC	0.6
FB50-C318, FB75-C318			OE051	RN11YC	0.6
FB75-C440				RJ12YC	0.6
V465D	Wisconsin		OE042	RN12YC	0.6

## HAMLIN

### Power Equipment

(18mm)				RD16	0.8
(14mm)				RJ8C	0.8

## HANNIBAL

### Lawn Mowers

All Models				RJ19LM	0.8
------------	--	--	--	--------	-----

## HARDI

### Sprayers

Briggs & Stratton	3.5,5			RJ19LM	QJ19LM	0.8
Honda OHV	3.5,5		OE006	RN9YC		0.8

## HARRY

### Lawn Mowers

Briggs & Stratton Intek OHV	6		OE013	RC12YC	QC12YC / XC92YC	0.5
Briggs & Stratton	3.5,3.75,4,4.5,5,5.5,6			RJ19LM	QJ19LM	0.8
Briggs & Stratton	6.5			RJ19LM	QJ19LM	0.8
Tecumseh	3.5,5			RJ8C		0.8
Honda OHV	5.5		OE051	RN11YC		0.8
Kawasaki	6		OE051	RN11YC		0.8
Honda	5		OE006	RN9YC		0.8

## HASTY VAC

### Vacuums

Briggs & Stratton Intek OHV	5.5,6.5		OE013	RC12YC	QC12YC / XC92YC	0.5
Briggs & Stratton Intek OHV	8		OE013	RC12YC	QC12YC / XC92YC	0.5
Briggs & Stratton	11			RJ19LM	QJ19LM	0.8
Briggs & Stratton	5			RJ19LM	QJ19LM	0.8
Briggs & Stratton	8			RJ19LM	QJ19LM	0.8
Honda	6.5		OE051	RN11YC		0.8

## HAUL MASTER

### Multi-Purpose Haulers

Briggs & Stratton Vanguard V-Twin	16			RC14YC		0.8
Briggs & Stratton	9			RJ19LM	QJ19LM	0.8

## HAULZALL

### Power Equipment

Honda OHV	5.5		OE051	RN11YC		0.8
Honda OHV	5		OE006	RN9YC		0.8

## HAYNES

### Drills

Little Beaver	Briggs & Stratton			RJ19LM	QJ19LM	0.8
	Clinton			RJ8C		0.6
	Kohler			RJ8C		0.8
	Robin EY18-3W			RL86C		0.8



CC BHP

21



OPT.



mm

**HAYTER****Mowers**

B & S				RCJ8		0.7
Kohler				RJ17LM		0.7
Tecumseh				RJ17LM		0.7

**HEALD****Garden Tractors**

Briggs & Stratton				RJ19LM	QJ19LM	0.8
Tecumseh				RJ8C		0.6

**HEARTH****Generators****All Models**

				RJ8C		0.6
--	--	--	--	------	--	-----

**HECKENDORN****Mowers**

Kubota				OE013	RC12YC	0.8
Briggs & Stratton Vanguard V-Twin	16				RC14YC	0.8
Wisconsin					RD16	0.9
Kohler					RH10C	0.8
Briggs & Stratton	10,16				RJ19LM	QJ19LM
Honda OHV	11,13			OE051	RN11YC	0.8
Wisconsin Twin	30				RN5C	0.9
Ford	67			OE006	RN9YC	0.9

**Power Equipment**

Kubota				OE013	RC12YC	0.8
Kohler K181	8				RJ19LM	0.8
Robin	7.5				RL87YC	0.6
Honda OHV	8,13			OE051	RN11YC	0.8

**HEFTY****Garden Tractors**

Briggs & Stratton				RJ19LM	QJ19LM	0.8
-------------------	--	--	--	--------	--------	-----

**HENDERSON****Lawn Mowers****All Models**

				RJ19LM		0.8
--	--	--	--	--------	--	-----

**HENKE****Shredders**

Kwikshredders	Kohler V-Twin	25		OE013	RC12YC	0.8
	Wisconsin	30			RD16	0.6
	Kohler Twin	20			RV17YC	0.6

**HERO****Airless Sprayers**

Honda OHV	4			OE051	RN11YC	0.8
-----------	---	--	--	-------	--------	-----

**HESSTON****Garden Tractors**

Kohler					RH10C	0.8
Briggs & Stratton					RJ19LM	QJ19LM

**HIGH WHEEL CHAMP****Lawn Mowers**

Briggs & Stratton					RJ19LM	QJ19LM
-------------------	--	--	--	--	--------	--------

**HIRTH****Mowers****240, 241**

					RL86C	0.6
--	--	--	--	--	-------	-----

**Power Equipment**

4	40	2			RCJ7Y	0.5
8	48	3.1		OE086	RL82C	0.5
151	141	5	(18mm)		D14	0.5
152	141	5			RL86C	0.5
263	383	28		OE098	RN4C	0.5
1440	133	4			RL86C	0.5





CC BHP

21



OPT.



mm

**...HIRTH****...Power Equipment**

2702	520	40		RL78C	0.5
102, 241				RL86C	0.5
84, 85, 112		(18mm)		D14	0.5

**HI-WAY****Power Equipment**

Kohler V-Twin	18,23		OE013	RC12YC	0.8
Wisconsin	30			RD16	0.6
Briggs & Stratton	8,8.5,11,16			RJ19LM	0.8
Briggs & Stratton Twin	18			RJ19LM	0.8

**HMC****Earth Drills**

Earth Drill	Zenoah			RCJ8	0.6
-------------	--------	--	--	------	-----

**Pumps, Compressors & Refrigeration Units**

Xenoah				RCJ8	0.6
--------	--	--	--	------	-----

**HOBART****Generators**

Kohler V-Twin	20		OE013	RC12YC	0.8
Wisconsin JD, THD, VF-4				RD16	0.6
Ford	200			RF10C	0.6
Ford	170			RF11YC	0.6
Chrysler Industrial 30, Industrial 32				RJ12C	0.6
Chrysler HB361 HB361				RJ12YC	0.6
IHC UV-549				RJ6C	0.8
Willys				RJ8C	0.6
Chrysler H170			OE042	RN12YC	0.6
Chrysler H225 H225			OE042	RN12YC	0.6
Chrysler HT413			OE042	RN12YC	0.6
Chrysler HB383 HB383				RN5C	0.6
Onan Twin	20			RS17YX	0.6
Chrysler H225 H225				RV12YC	0.6

**HODGES****Log Splitters**

Kohler	8,16			RH10C	0.8
--------	------	--	--	-------	-----

**Power Equipment**

Kohler OHV	14		OE013	RC12YC	0.8
Kohler OHV	5		OE013	RC12YC	0.8
Kohler V-Twin	18,20		OE013	RC12YC	0.8
Kohler V-Twin	18		OE013	RC12YC	0.8
Kohler V-Twin	20,22		OE013	RC12YC	0.8
Kohler V-Twin	25		OE013	RC12YC	0.8
Kohler	8			RH10C	0.8
Kohler	16			RH10C	0.8
Kohler	23			RH10C	0.8
Briggs & Stratton	5			RJ19LM	0.8
Tecumseh	3.5			RJ19LM	0.8
Honda OHV	5.5,8		OE051	RN11YC	0.8
Kohler Twin	16			RV17YC	0.6
Kohler Twin	20			RV17YC	0.6

**HOFFCO****Chain Saws**

D4				RCJ8	0.8
D51				RH8C	0.8
D58, S480				RCJ8	0.8
S510				RH8C	0.8
Super 510				RCJ8	0.8
Super 88				RH8C	0.8
T4, T58				RCJ8	0.8
Timberline T47				RJ8C	0.8
Timberline T81				RJ6C	0.8
West Bend				RH8C	0.8



CC BHP

21



OPT.

mm

**...HOFFCO****Ice, Earth Drills**

Hydra Drill	Tecumseh			RJ8C		0.8
PH1100				RCJ8		0.6
PH1700-A				RJ17LM		0.8
PH2000E	Tecumseh	5		RJ19LM		0.8
PH490				RCJ8Y		0.8
PH5000	Honda	5	OE051	RN11YC		0.8
PH973, PH977				RJ19LM		0.8
PH980				RJ17LM		0.8
	Power Products			RCJ8		0.8
	Tecumseh	2		RCJ8Y		0.8
	Briggs & Stratton			RJ19LM	QJ19LM	0.8
	Tecumseh	3,3,5,5		RJ19LM		0.8
	Honda	5	OE051	RN11YC		0.8

**Lawn Mowers**

	Robin			CJ6		0.8
	Briggs & Stratton			RJ19LM	QJ19LM	0.8
	Power Product Engine			RJ8C		0.8

**Power Equipment**

GT21, GT211A				RDJ8J		0.8
JP220F				CJ6		0.8
JP260A, JP260C				RDJ8J		0.8
JP300B, JP300C, JP300F, JP390A, JP390C				RCJ8		0.8
JP390F				CJ6		0.8
SE301, SE301F, WT250C, WT250F				RCJ8		0.8
WW88				RJ17LM		0.8
XL				RCJ8		0.8
	Robin			CJ6		0.8
	Fuji, Kawasaki, Kioritz			RCJ8		0.8
	McCulloch			RDJ8J		0.8
	Briggs & Stratton			RJ19LM	QJ19LM	0.8
	Power Products AV52			RJ8C		0.8
	Tecumseh			RJ8C		0.8

**Pumps, Compressors & Refrigeration Units**

	Fuji		OE086	RL82C		0.6
--	------	--	-------	-------	--	-----

**Tillers**

1493				RCJ8		0.8
6830-16				RJ12C		0.8
Aladdin	Fuji			CJ6		0.8
B16 Little Hoe				RCJ8Y		0.8
Big Li'l Hoe				RCJ8		0.8
BP550				RJ12C		0.8
Critter				RDJ8J		0.8
EC01R, EC02R				RCJ8		0.8
EC03				CJ6		0.8
F2/2, G1AH				RCJ8		0.8
GTX-R	Genie			CJ6		0.8
H1AH, HB220				RCJ8		0.8
HB250				RDJ7Y		0.8
HD				RH8C		0.8
Li'l Hoe				RCJ8Y		0.8
MP633				RCJ8		0.8
P Series AV250				RJ17LM		0.8
P1A, Power Scythe				RJ8C		0.8
Sickle Bar	Fuji			CJ6		0.8
Whiz Witch				RJ8C		0.8

**HOLT TRAILHOIST****Power Equipment**

	Kohler V-Twin	18	OE013	RC12YC		0.8
	Honda	13	OE051	RN11YC		0.8

**HOMART****Pumps, Compressors & Refrigeration Units**

	Wisconsin			RD16		0.6
	Briggs & Stratton			RJ19LM	QJ19LM	0.8
	Lauson			RJ8C		0.6



CC BHP



OPT.



## HOME PRO

### Lawn Mowers

Briggs & Stratton  
Tecumseh

RJ19LM QJ19LM  
RJ8C

0.8  
0.8

## HOME-GARD

### Generators

Kawasaki 3.1,5,2  
Briggs & Stratton 8,11

RCJ8  
RJ19LM QJ19LM

0.6  
0.6

## HOMELITE

### Chain Saws

150			RDJ7J	0.6
180			RDJ7Y	0.6
190			RDJ7J	0.6
240			RDJ7J	0.6
250			RCJ6Y	0.6
252			RDJ7Y	0.5
330			RDJ8J	0.6
340			RCJ6Y	0.6
410			RDJ7Y	0.6
450			RDJ6J	0.6
540			RDJ7Y	0.6
550			RDJ6J	0.6
8800			RCJ6Y	0.6
1050, 1130G			CJ6	0.6
192, 200			RDJ7Y	0.6
2100 Super			RCJ4	0.6
245 HG, 245 SL			RDJ7Y	0.5
290, 300			RCJ6Y	0.6
350, 35SL, 360			CJ6	0.6
650, 750			RCJ4	0.6
945, 955, Big Red SXL			CJ6	0.6
C72			RJ6C	0.6
CS40			RDJ7Y	0.6
CS50			RCJ7Y	0.6
D3300, D3350B, D3800, D3850B			RCJ6Y	0.6
DM20			CJ6	0.6
DM40			RDJ7Y	0.6
DM50			RDJ6J	0.6
DM54, Little Red XL, LX30			RDJ7Y	0.6
Mini Models			RDJ6J	0.6
MP38, MP88, Old Blue SXL, Super 1050, Super 1130G			CJ6	0.6
Super 2			RDJ7J	0.6
Super 2100S			CJ6	0.6
Super 240			RDJ7J	0.6
Super 3100G			CJ6	0.6
Super EZ, Super EZ-AO			RDJ6J	0.6
Super Wiz 55, Super Wiz 66			RJ6C	0.6
Super Wiz 80			RJ8C	0.6
Super XL-AO, V1944, V1955, V1123			CJ6	0.6
VI-Super-2, XL			RDJ7J	0.6
XL100A, XL12			RCJ8	0.6
XL123			CJ6	0.6
XL2			RDJ7J	0.6
XL660F, XL923			CJ6	0.6
XL923A			RCJ4	0.6
XL925, XL98D			CJ6	0.6
Z3330, Z3350, Z3350B, Z3850B			RCJ6Y	0.6
<b>Generators</b>				
176BI40A			RJ19LM	0.8
176R142A			RL87YC	0.6
178H148		OE051	RN11YC	0.8
178VI52			RC14YC	0.8
180HIE63		OE051	RN11YC	0.8
180R162, 180RIE62			RL86C	0.6
190HY50			RJ19LM	0.8
CG4800/178H148, CG5200, CG6300/180H163, CGE6300/180H1E63, CHY5000/190HHY50		OE051	RN11YC	0.8





CC BHP

21



OPT.



mm

**...HOMELITE**

**...Generators**

EH2500HD, EH4400HD, EH5500HD, EHE4400HD, EHE5500HD, EHRL4400HD				RJ19LM	0.8	
HG3500				RJ19LM	0.6	
HG50-1400, HG50-2000, HG50-2500				RL86C	0.6	
HG600				RCJ8Y	0.6	
HGE3500, HL2500, HL4400				RJ19LM	0.6	
HLE4400, LR2500, LR4400, LR5500, LRE4400, LRE5500, LRI2500, LRI4400, LRI5500, LRIE4400, LRIE5500				RJ19LM	0.8	
(18mm)				D14	0.6	
Briggs & Stratton Vanguard	9	OE013		RC12YC	QC12YC / XC92YC	0.8
Briggs & Stratton	10,11			RJ19LM	QJ19LM	0.8
Briggs & Stratton	5,7,8			RJ19LM	QJ19LM	0.8
Homelite				RJ6C		0.6
Robin	11			RL86C		0.6
Robin	7.6			RL87YC		0.6

**Pressure Washers**

221432				RJ19LM	0.6	
110SU1.5, 111B1, 111DP2-1A, 111DP3-1A, 111S1.5, 111S2, 120S3, 120TP3, 121TP2-1C				RJ19LM	0.6	
160TP4-1C				RC14YC	0.6	
20DPS-1, 20S1-1/2-1A				RJ8C	0.6	
250DP3				RJ12C	0.6	
250S2, 250TP2				RJ8C	0.6	
270S2-1, 270S2-1P, 270TP2-1				RCJ8	0.6	
36S, 37S				RJ12C	0.6	
8S				RJ8C	0.6	
9S3-1				RJ12C	0.6	
AP120				RDJ7Y	0.6	
AP125, AP215, AP220C, AP315, AP320, AP520				RJ19LM	0.6	
CBPW2500, CBPW3000, CBWPW2800		OE051		RN11YC	0.8	
CC200, CC205				RJ19LM	0.6	
CPW2000, CPW2800		OE051		RN11YC	0.8	
FP150				RCJ4	0.6	
FP250, HAC500B, HC-320, HC-520				RJ19LM	0.6	
HCP420, HCP630, HDP2, HDP3		OE051		RN11YC	0.8	
HPW1200B, HPW1550B, HPW2000B, HPW2250V				RJ19LM	0.6	
HPW3000B				RC14YC	0.6	
HPW305H		OE051		RN11YC	0.8	
HST-320, HST-520				RJ19LM	0.6	
HTP2, HTP3		OE051		RN11YC	0.8	
MB-1000				RDJ7Y	0.6	
P-100				RDJ7J	0.6	
PW1500, PW1750, PW2200				RJ19LM	0.6	
VTP4				RCJ8	0.6	
Waterbug				RDJ7J	0.6	
XLS1-1/2-1, XLS1-1/2-1H				RCJ8	0.6	
Briggs & Stratton Vanguard V-Twin				RC14YC	0.8	
Briggs & Stratton				RJ19LM	QJ19LM	0.8
Robin				RL86C	0.6	
Honda OHV		OE051		RN11YC	0.8	

**HOMELITE-JACOBSEN**

**Blowers**

111B, 111B1 Ventilating				RJ19LM	0.8
-------------------------	--	--	--	--------	-----

**Lawn Mowers**

HCM20, HCM20P5, HCM20P5G				RJ19LM	0.8	
HDS20V				RJ19LM	0.6	
HSB21, HSB21P5, HSB21P5EG, HSC20-2				RJ19LM	0.8	
HSD20				RJ19LM	0.6	
HSD20-2, HSD20P-2				RJ19LM	0.8	
HSD20P5				RJ19LM	0.6	
Briggs & Stratton				RJ19LM	QJ19LM	0.8

**Power Equipment**

23				RCJ8	0.6
24				RCJ8	0.6
28				RDJ7Y	0.6
				RDJ7Y	0.8



CC

BHP

21



OPT.



mm

**...HOMELITE-JACOBSEN****...Power Equipment**

33			RCJ8	0.6	
90			RDJ7J	0.6	
155			RDJ7J	0.8	
165			RDJ7Y	0.6	
200			RDJ7J	0.8	
260			RDJ7Y	0.6	
275			RDJ7J	0.8	
485			RDJ7J	0.8	
100, 120			RDJ7J	0.6	
155, 16, 160a			RDJ7Y	0.8	
175, 175bc			RDJ7J	0.8	
18, 180			RDJ7Y	0.8	
180, 180v, 19, 21, 22			RDJ7Y	0.6	
285bc			RDJ7J	0.8	
290, 380, 480, 680			RDJ7Y	0.8	
30, 310			RDJ7Y	0.6	
38, 40			RDJ7Y	0.6	
bp250, bx90, d25mhv, d30mha, d30mhv, hb100, hb180vgk			RDJ7Y	0.6	
d630cd, d730cdv, d830ca, d830cb, d830cd, d830sb, d830sba, d830sd, hbc18			RDJ7Y	0.6	
e200			RDJ7Y	0.6	
e300hd			RJ19LM	0.8	
e50-2			RCJ6Y	0.8	
FT5			RJ19LM	0.8	
hb280, hb390, hb390v			RDJ7Y	0.8	
hbc28			RDJ7Y	0.8	
hk18			RCJ8	0.6	
hlt15			RDJ7Y	0.8	
hpw1200b			RJ19LM	0.8	
ht17			RDJ7Y	0.6	
ht18			RCJ8	0.6	
htc12			RDJ7Y	0.8	
hx16, pbp3000, php3000			RDJ7Y	0.6	
mtc12			RJ17LM	0.8	
pbc3600			RDJ7Y	0.8	
pbc3800, pbc40000			RCJ6Y	0.8	
plt3200, plt3400			RDJ7Y	0.8	
pse3000			RDJ7Y	0.8	
pse3000, z25ehv			RDJ7Y	0.8	
re1030e, re1230e, re830, re830e, rt5			RJ19LM	0.8	
st150			RDJ7J	0.8	
st160, st175g			RDJ7Y	0.8	
st185bc, st385, st385bc			RDJ7J	0.8	
st400			CJ6	0.8	
st80			RDJ7J	0.6	
sx135			RDJ7Y	0.8	
SXL			CJ6	0.6	
xlbc4			CJ6	0.8	
Z625CDV, Z625SD, Z725CB, Z725CDV, Z725CEA, Z725SE, Z830SB, Z830SBA, Z885SD, Z625CD, Z725CA, Z725CE, Z825SD			RDJ7Y	0.6	
<b>Snow Removers</b>					
320, 320E, 420, 420E			RCJ8Y	0.9	
523, 624, 824			RJ19LM	0.8	
Sno-Blitz			CJ14	0.9	
Snowburst			RJ12C	0.8	
	Jacobsen		RJ12C	0.8	
	Tecumseh		RJ17LM	0.8	
	Briggs & Stratton		RJ19LM	0.8	
				QJ19LM	0.8

**HOMEMASTER****Sweepers**

Lawn			RJ8C	0.8
------	--	--	------	-----



CC BHP

21



OPT.



mm

## HOMESTEADER

### Garden Tractors

Kohler	16			RH10C		0.8
Briggs & Stratton				RJ19LM	QJ19LM	0.8

## HOMKO

### Lawn Mowers

All Models				RJ19LM		0.8
------------	--	--	--	--------	--	-----

### Snow Removers

All Models				RJ19LM		0.8
------------	--	--	--	--------	--	-----

## HONDA

### Chain Saws

iGX440	438	2008 →		OE005	RC9YC	0.8
	438	2008 →		OE005	RC9YC	0.8

### Edgers

HH31C, HHE31CA	4-Cycle			Z9Y		0.8
----------------	---------	--	--	-----	--	-----

### Engines

B25					P8Y	0.8	
F28					RL86C	0.8	
F400					RL86C	0.8	
G100		2.2			CJ14	0.8	
G100K1		2.5			CJ14	0.8	
G150		3.5			L90C	0.8	
G200		5			L90C	0.8	
G25					Z9Y	0.8	
G28					Z9Y	0.8	
G30		3.5			Z9Y	0.8	
G300		8		OE059	L92YC	0.8	
G35		3.5			Z9Y	0.8	
G40		4			RL86C	0.8	
G400		10			RL95YC	0.8	
G41		4			RL86C	0.8	
G42		4			RL86C	0.8	
G65		6.5			RL86C	0.8	
G80		6.5			RL86C	0.8	
GC135	OHC Horizontal	4		OE051	RN11YC	0.8	
GC160	OHC Horizontal	5		OE051	RN11YC	0.8	
GC160A	OHC Horizontal	160	5	2007 →	OE006	RN9YC	0.7
GC190	OHC Horizontal	6			OE051	RN11YC	0.8
GCV135	OHC Vertical	4.5			OE051	RN11YC	0.8
GCV160	OHC Vertical	160	5.5	2007 →	OE006	RN9YC	0.7
GCV160A	OHC Vertical	160	5.5	2007 →	OE006	RN9YC	0.7
GCV530	OHC Vertical V-Twin	16			OE051	RN11YC	0.8
GS190	OHC Horizontal	190	6	2007 →	OE006	RN9YC	0.7
GS65		6.5			RL86C	0.8	
GSV190	OHV Vertical	190	6.5	2006 →	OE006	RN9YC	0.7
GV150	2029059 > (Mag.)	3.5			RCJ8	0.8	
	2029059 > (CDI)	3.5			RCJ8Y	0.8	
	> 2029058 (Mag.)	3.5			RL86C	0.8	
	> 2029058 (CDI)	3.5			RL87YC	0.8	
GV200		4			RCJ8Y	0.8	
					RCJ8Y	0.8	
GV35		3.5			Z9Y	0.8	
GV400		11			RCJ8Y	0.8	
					RCJ8Y	0.8	
GX Series		118	3.5		OE051	RN11YC	
GX100	OHV Horizontal		3		Z9Y	0.8	
		98	2.8		Z9Y	0.6	
GX110	OHV Horizontal		3.5		OE051	RN11YC	0.8
GX120	OHV Horizontal		4		OE051	RN11YC	0.8
GX140	OHV Horizontal		5		OE051	RN11YC	0.8
GX160	OHV	160	5.5	2007 →	OE006	RN9YC	0.7
	OHV Horizontal		5.5		OE006	RN9YC	0.7
		163	4.8		OE006	RN9YC	0.7
GX200	OHV Horizontal		6.5		OE051	RN11YC	0.8
		196	5.5		OE006	RN9YC	0.7
GX22	Mini 4-Cycle OHC		1		Z9Y	0.8	





CC BHP



OPT.



**...HONDA**

**...Engines**

GX240	OHV Horizontal		8			OE051	RN11YC	0.8
		242	7.1			OE006	RN9YC	0.7
GX25	Mini 4-Cycle	25	1	2008→			RY4C	0.6
GX270	OHV Horizontal		9			OE051	RN11YC	0.8
	OHV	270	9	2007→		OE006	RN9YC	0.7
		270				OE006	RN9YC	0.7
GX31	Mini 4-Cycle OHC	31	1				Z9Y	0.6
GX340	OHV Horizontal		11			OE051	RN11YC	0.8
GX35	Mini 4-Cycle	35.8	1.3	2008→			RY4C	0.6
GX360	OHV Horizontal Liquid		13				RL95YC	0.8
GX390	OHV Horizontal		13			OE051	RN11YC	0.8
	OHV	390	13	2007→		OE006	RN9YC	0.7
GX610	OHV Horizontal V-Twin		18			OE051	RN11YC	0.8
GX610K1	OHV	614	18	2007→			RN14MC5	0.7
GX620	OHV Horizontal V-Twin		20			OE051	RN11YC	0.8
GX620K1	OHV	614	20	2007→			RN14MC5	0.7
GX640	OHV Horizontal V-Twin		20			OE051	RN11YC	0.8
GX670	OHV Horizontal V-Twin		24			OE051	RN11YC	0.8
	OHV	670	24	2007→			RN14MC5	0.7
	V-Twin	614	20.8				RN14MC5	0.7
GXH50	OHV Horizontal		2.5				Z9Y	0.8
		49	2.1				Z9Y	0.6
GXV120	OHV Vertical		4			OE051	RN11YC	0.8
GXV140	OHV Vertical		5			OE051	RN11YC	0.8
GXV160	OHV Vertical		5.5			OE051	RN11YC	0.8
GXV200	OHV Vertical		6.5			OE051	RN11YC	0.8
GXV240	OHV Vertical		8			OE051	RN11YC	0.8
GXV270	OHV Vertical		9			OE051	RN11YC	0.8
GXV340	OHV Vertical		11			OE051	RN11YC	0.8
GXV390	OHV Vertical		13			OE051	RN11YC	0.8
GXV50	OHV Vertical		2.5				Z9Y	0.8
GXV530	OHC Vertical V-Twin		16			OE051	RN11YC	0.8
	OHV Vertical V-Twin		16			OE051	RN11YC	0.8
	V-Twin	530				OE051	RN11YC	0.7
GXV610	OHV Vertical V-Twin		18			OE051	RN11YC	0.8
	V-Twin	614	16				RN14MC5	0.7
GXV620	OHV Vertical V-Twin		20			OE051	RN11YC	0.8
	V-Twin	614	17.8				RN14MC5	0.7
GXV670	OHV Vertical V-Twin		24			OE051	RN11YC	0.8
iGX440	4-Cycle OHC	440		2007→		OE005	RC9YC	0.7
	4-Cycle OHC	440		2007→		OE005	RC9YC	0.7

**Generators**

E100							Y82	0.6
E1000, E1500, E1500K1, E1500K2, E1500K3							RL86C	0.6
E1500K4							L90C	0.6
E2000						OE086	RL82C	0.6
E2500, E2500K1, E2500K2, E2500K3							RL86C	0.6
E2500K4							L90C	0.6
E300, E300C, E300K1, E300K2, E300K3							Y82	0.6
E3500, E3500K1, E3500K2							L90C	0.6
E40, E400							Y82	0.6
E4500, E4500K1						OE059	L92YC	0.6
E600							Z9Y	0.6
E80							Y82	0.6
E800A, E900							Z9Y	0.6
EB11000						OE051	RN11YC	0.6
EB2200X						OE006	RN9YC	0.6
EB2500XK1						OE051	RN11YC	0.6
EB3000							L90C	0.6
EB3000C, EB3500X, EB3500XK1, EB3800XA						OE051	RN11YC	0.6
EB4000							L90C	0.6
EB5000X, EB5000XK1, EB5000XK1A, EB6500SXA						OE051	RN11YC	0.6
ED1500, ED1000, ED1000A							RL86C	0.6
ED250							Y82	0.6
EG1000, EG1000A							L90C	0.6
EG1400X						OE051	RN11YC	0.6
						OE006	RN9YC	0.6



CC BHP

21



OPT.



mm

...HONDA

...Generators

EG1400XK1			OE051	RN11YC	0.6
			OE006	RN9YC	0.6
EG1400Z, EG1500				L90C	0.6
EG1500K3				RL86C	0.6
EG1500K4				L90C	0.6
EG2200X				L90C	0.6
			OE006	RN9YC	0.6
EG2500XK1, EG3500X, EG3500XK1, EG5000X, EG5000XK1			OE051	RN11YC	0.6
EG650				CJ14	0.6
EL5000				RL87YC	0.6
EL80				Y82	0.6
EM1600				L90C	0.6
EM1600X			OE006	RN9YC	0.6
EM1800			OE059	L92YC	0.6
EM1800X			OE006	RN9YC	0.6
EM1800XK1			OE051	RN11YC	0.6
EM2200			OE059	L92YC	0.6
EM2200X			OE006	RN9YC	0.6
EM2500XK1, EM2500XK1			OE051	RN11YC	0.6
EM3000			OE059	L92YC	0.6
EM3000C			OE051	RN11YC	0.6
EM3500SX				RL86C	0.6
EM3500X			OE051	RN11YC	0.6
EM400				Y82	0.6
EM4000			OE059	L92YC	0.6
EM400K1				Y82	0.6
EM500				RCJ8Y	0.6
EM5000			OE098	RN4C	0.6
EM5000SXK1, EM5000X			OE051	RN11YC	0.6
EM500K1, EM600				RCJ8Y	0.6
EM650				CJ14	0.6
EMS4000, EMS4500			OE059	L92YC	0.6
EN2500	Honda OHC	5	OE006	RN9YC	0.8
ER1500				L90C	0.6
ER400				Y82	0.6
ES3500				RL86C	0.6
ES3500K1, ES3500K2				L90C	0.6
ES4500, ES4500K1, ES6500, ES6500K1			OE059	L92YC	0.6
EU1000iA2				Z9Y	0.8
EU2000i, EU200i, EU3000is			OE051	RN11YC	0.6
EV4000				RL87YC	0.6
EV4010, EV6010, EVD4010			OE059	L92YC	0.6
EW140, EW171K1			OE051	RN11YC	0.6
EX1000				CJ14	0.6
EX2200			OE006	RN9YC	0.6
EX3300S, EX3300SK1			OE051	RN11YC	0.6
EX350				RCJ8	0.6
EX4500S, EX4500SK1A			OE051	RN11YC	0.6
EX5500, EX5500K1, EX5500K2A			OE059	L92YC	0.6
EX650				CJ14	0.6
EX700c				Z9Y	0.8
EX800			OE059	L92YC	0.6
EZ1400A	Honda OHV	4	OE051	RN11YC	0.8
EZ2500A	Honda OHV	5.5	OE051	RN11YC	0.8
EZ3500A	Honda OHV	8	OE051	RN11YC	0.8
EZ5000A	Honda OHV	11	OE051	RN11YC	0.8
	Honda OHV	13	OE051	RN11YC	0.8
<b>Lawn Mowers</b>					
HR17, HR173				CJ14	0.8
HR194, HR195			OE051	RN11YC	0.8
HR21	CDI To Serial# 2029058			L90C	1.0
	Standard Ignition To Serial# 2029058		OE059	L92YC	0.8
	Standard Ignition From Serial# 2029059			RCJ8	0.8
	CDI From Serial# 2029059			RCJ8Y	1.0
HR214			OE051	RN11YC	0.8
HR215, HR215K1HMA, HR215K1HXA, HR215K1SXA			OE006	RN9YC	0.8



CC

BHP

21



OPT.



**...HONDA**

**...Lawn Mowers**

HR216, HR216C, HRA214			OE051	RN11YC	0.8
HRA215			OE006	RN9YC	0.8
HRA216			OE051	RN11YC	0.8
HRB215, HRB215HXA, HRB215PXA, HRB215SDA, HRB215SXA			OE006	RN9YC	0.8
HRB217HXA, HRB217TDA			OE051	RN11YC	0.8
HRC215K1PDA, HRC215K1SDA			OE006	RN9YC	0.8
HRC216K1HXA, HRC216K1SXA			OE051	RN11YC	0.8
HRM195PA			OE006	RN9YC	0.8
HRM21				L90C	0.8
HRM215, HRM215HXA, HRM215K1, HRM215K2, HRM215PDA, HRM215PXA, HRM215SDA, HRM215SXA, HRR216DPA			OE006	RN9YC	0.8
HRR216K2PDA, HRR216K2SDA			OE051	RN11YC	0.8
HRR216S3DA, HRR216SDA			OE006	RN9YC	0.8
HRS21				L90C	0.8
HRS216K2PDA, HRS216K2SDA			OE051	RN11YC	0.8
HRS216PDA, HRS216SDA			OE006	RN9YC	0.8
HRT216K2TDA			OE051	RN11YC	0.8
HRT216S3DA, HRT216SDA			OE006	RN9YC	0.8
HRX217HXA, HRX217TDA, HRZ216TDA, HS1132TA/TAS, HS622TA			OE051	RN11YC	0.8
	Honda	2.4		CJ14	0.8
	Honda	5	OE051	RN11YC	0.8
	Honda OHV	3.5,4.5	OE051	RN11YC	0.8
	Honda OHV	5.5,11	OE051	RN11YC	0.8

**Mowers, Tractors**

H1011HSA, H1011RSA, H1011SA, H2013HSA, H2013SDA, H2113HDA, H2113SDA, H3011, 3013H, H4013, HH4118HDA, H4120HDA			OE051	RN11YC	0.8
H4514H				RL95YC	0.8
H4514HSA, H4518H, H4518HSA, H5013, H5013A2, H5013A4, H5518, HR4013SA			OE051	RN11YC	0.8
HRC215K1PDA, HRC215K1SDA			OE006	RN9YC	0.8
HRC216K1HXA, HRC216K1SXA, HRC217TDA, HRC7013, HRC7018, HRC7020, HRC7113TXA			OE051	RN11YC	0.8
HRR216K2PDA, HRR216K2SDA, HRR216K2TDA, HRS216K2PDA, HRS216K2SDA			OE006	RN9YC	0.8
HRX217HMA, HRX217HXA			OE051	RN11YC	0.8
HRZ216TDA			OE006	RN9YC	0.8
HT3810				CJ14	0.8
HT3813, HT4213				RL95YC	0.8
HTR3009, HTR3811, RT5000			OE051	RN11YC	0.8
	Honda OHV	5.5,11,13	OE051	RN11YC	0.8
	Honda V-Twin	18,20	OE051	RN11YC	0.8
	Honda OHV	5	OE006	RN9YC	0.8

**Power Equipment**

HP250				CJ14	0.6
HP400			OE051	RN11YC	0.8

**Snow Removers**

HS1132TA, HS1132TAS, HS1336			OE051	RN11YC	0.8
HS35				L90C	0.8
HS50				RL95YC	0.8
HS520A, HS520AS, HS521, HS521K1, HS522, HS55, HS55K1, HS55K2, HS621, HS621AS, HS622, HS622TA, HS624KITA, HS624KIWAS			OE051	RN11YC	0.8
HS70				L90C	0.8
HS724TA, HS724WA, HS80, HS80K1, HS828, HS828KITAS, HS828KIWAS, HS928TA, HS928TAS			OE051	RN11YC	0.8
	Honda OHV		OE051	RN11YC	0.8
	(10mm)			Z9Y	0.8



CC BHP

21



OPT.



mm

**...HONDA**

<b>Tillers</b>					
F200, F210			CJ14		0.8
F220, F28			Z9Y		0.8
F400			RL86C		0.8
F401A, F401A2, F401AD, F401K1, F401K2		OE051	RN11YC		0.8
F500			L90C		0.8
F501A1, F501A2, F501K1, F501K2, F501K2A1		OE051	RN11YC		0.8
FG100 Mini-Tiller			Z9Y		0.8
FG400A1		OE006	RN9YC		0.8
FG500A1		OE051	RN11YC		0.8
FR500			L90C		0.8
FR600, FR650		OE051	RN11YC		0.8
FR700			L90C		0.8
FR750, FR800		OE051	RN11YC		0.8
		OE051	RN11YC		0.8
<b>Trimmers</b>					
HHT25SLTA, HHT31S, HHT31TA, HHTUMK25, UMK422LNA, UMK422LTA, UMK431LNA, UMK431LTA, UMK431UNA, UMK431UNBA	4-Cycle		Z9Y		0.8
<b>Water Pumps</b>					
11, 4, 5.5, 8	Honda OHV	OE051	RN11YC		0.8
WA15			CJ14		0.8
WA20K1			L90C		0.8
WA20X		OE006	RN9YC		0.8
WA30			L90C		0.8
WA30X		OE006	RN9YC		0.8
WB15K2			CJ14		0.8
WB20T			L90C		0.8
WB20TDR		OE006	RN9YC		0.8
WB20XK1		OE051	RN11YC		0.8
WB30T			L90C		0.8
WB30TDR		OE006	RN9YC		0.8
WB30XK1, WD20XK1		OE051	RN11YC		0.8
WD30X		OE006	RN9YC		0.8
WD30XK1, WD30XK1C1, WDP20X, WDP30X, WH15XK1		OE051	RN11YC		0.8
WH20X		OE006	RN9YC		0.8
WH20XK1, WMP20X, WN20A, WN30A, WP20X, WP30X		OE051	RN11YC		0.8
WT20			L90C		0.8
WT20X, WT20XK1		OE006	RN9YC		0.8
WT20XK2		OE051	RN11YC		0.8
WT30			L90C		0.8
WT30X		OE051	RN11YC		0.8
		OE006	RN9YC		0.8
WT30XK1, WT30XK2, WT3XK1, WT3XK2, WT40XK1		OE051	RN11YC		0.8
WT40XK1		OE006	RN9YC		0.8
WT40XK21		OE051	RN11YC		0.8
WX10, WX10A2, WX10A4, WX15			Z9Y		0.8
	Honda	2,2,2.5	CJ14		0.8
	Honda OHV		OE006	RN9YC	0.8
	Honda OHV	5	OE006	RN9YC	0.8
	Honda Mini 4-Cycle	1.5	Z9Y		0.8





CC

BHP

21



OPT.

**HOUCHIN-RUHMANN****Edgers**

RCJ8

0.8

**HOWARD PRICE  
TURF EQUIPMENT****Mowers**

Kohler V-Twin

20,22,25

OE013

RC12YC

0.8

Kawasaki

12.5

RCJ8

0.8

Kawasaki OHV

14,17,23

OE051

RN11YC

0.8

Ford 1.1, 1.3L

OE011

RS9YC

0.9

**HOWARD ROTAVATOR****Power Equipment**

Wisconsin

RD16

0.8

Kohler

6.25

RJ19LM

0.8

Clinton

RJ8C

0.6

**HUDSON****Chain Saws**

Oscar 18, Oscar 28

Briggs &amp; Stratton

5.5

RJ19LM

QJ19LM

0.8

**Log Splitters**

Briggs &amp; Stratton

5.5,8,13

RJ19LM

QJ19LM

0.8

Briggs &amp; Stratton OHV V-Twin

16

RJ19LM

QJ19LM

0.8

Honda

11,24

OE051

RN11YC

0.8

**Sprayers**

Briggs &amp; Stratton

RJ19LM

QJ19LM

0.8

Kohler

RJ8C

0.8

Tecumseh

RJ8C

0.8

Robin

RL86C

0.8

**HUFFMAN****Garden Tractors**

RJ8C

0.8

**Lawn Mowers**

All Models

RJ19LM

0.8

**Power Equipment**

RJ8C

0.8

**Tillers**

RJ8C

0.8

**HUFFY****Lawn Mowers**

All Models

RJ19LM

0.8

**HURRICANE****Lawn Mowers**

All Models

RJ19LM

0.8

**Pressure Washers**

Tecumseh

10

RJ19LM

0.8

Honda OHV

5.5,11,13

OE051

RN11YC

0.8

**HURST****Power Equipment**

Jaws Of Life

UJ11G

0.8

**HUSKIE****Utility Vehicles**

Briggs &amp; Stratton Vanguard V-Twin

16

RC14YC

0.8





CC BHP



OPT.



## HUSQVARNA

### Aerators

AR19B	Briggs & Stratton	3.5		RJ19LM	QJ19LM	0.8
AR19H	Honda	4	OE051	RN11YC		0.8
AR25B	Briggs & Stratton	3.5		RJ19LM	QJ19LM	0.8
AR25H	Honda	4	OE051	RN11YC		0.8

### Chain Saws

T100CD, 136, 140, 140S, 141, 154, 16, 160CD, 160S, 160SG, 162FE, 162FG, 162SE, 162SG, 163S, 163SE, 165, 165R, 165RX, 18, 180S, 181, 185CD, 1R, 2100CD, 2100CDW				RCJ7Y		0.5
2101XP, 22R, 22RL, 238, 24, 240S, 240S, 240SE, 240SG, 242XP, 244, 245R, 245RX, 250PS, 254XP, 257, 260, 260CD, 261, 262XP, 263CD, 265RX, 266SE, 266SG, 266XP, 268, 26RCL, 272XP, 280CD, 280G, 280S, 281, 281XP, 285CD, 288XP, 3120XP, 3130, 32, 32R, 32RCL, 334T, 268K, 272K, 3120K, 371K				CJ6 RCJ7Y		0.5 0.5
A100			OE086	RCJ8Y RL82C		0.5 0.5
B77				RCJ7Y		0.5
Compact 35, Compact 37				CJ6		0.5
G90			OE086	RL82C		0.5
Husky 22, Husky 23				CJ6		0.5
Husky 246, Husky 33, Husky 34, Husky 35VR, Husky 36, Husky 36R, Husky 38, Husky 39R, Husky 40, Husky 41, Husky 42, Husky 44, Husky 45, Husky 49, Husky 50, Husky 51, Husky 55, Husky 66, Husky 77, Husky A65, Husky A77, Husky B65, L65, L77, Rancher 61, Ranch SM150				RCJ7Y		0.5
			OE086	RL82C		0.5

### Dethatcher

DT18B	Briggs & Stratton Intek	5.5	OE013	RC12YC	QC12YC / XC92YC	0.5
DT18H	Honda	5.5	OE051	RN11YC		0.8

### Lawn Mowers

50DK, 51				RJ19LM		0.8
510, 510MD			OE013	RC12YC		0.8
510MDT			OE098	RN4C		0.8
51MDT				RJ8C		0.6
560H			OE013	RC12YC		0.8
560HH			OE006	RN9YC		0.8
560HS			OE013	RC12YC		0.8
560HSH			OE006	RN9YC		0.8
560HST, 560HT			OE098	RN4C		0.8
560SR			OE013	RC12YC		0.8
56DH, 56DHS, 56H, 56HS				RJ19LM		0.8
56HST, 56HT				RJ8C		0.6
56SE, 56SFE				RJ19LM		0.8
580BBC, 580R, 580RS, 580RSE, 580RSW, 600C			OE013	RC12YC		0.8
6020MD, 6022CH, 6022SH				RJ19LM		0.8
6521RS, 6522CH, 6522SH			OE013	RC12YC		0.8
HTV1200, HTV1500, HTV2000				RJ17LM		0.8
HVT40				RCJ8Y		0.8
HVT52				RJ17LM		0.8
Royal48, Royal53S				RJ19LM		0.8
	Briggs & Stratton Intek OHV	6,6.5	OE013	RC12YC	QC12YC / XC92YC	0.5
	Kohler	27	OE013	RC12YC		0.8
	Kohler	23		RH10C		0.8
	Tecumseh	2,3.5		RJ17LM		0.8
		3.75,4,4.5,5,5.5,6,7		RJ19LM		0.8
	Tecumseh	6		RJ8C		0.6
	Honda GCV 160	5.5	OE051	RN11YC		0.8
	Kawasaki	25	OE051	RN11YC		0.6
	Kawasaki OHV		OE051	RN11YC		0.8
	Tecumseh OHV	6	OE098	RN4C		0.8
	Honda OHV	5	OE006	RN9YC		0.8

### Power Equipment

120L, 120LC, 120R, 122, 122L, 125L, 125LD, 125R, 125RJ, 132L, 132LD, 132R, 132RB, 132RJ				RCJ8Y		0.8
122HB, 132HBV				RCJ8Y		0.8
140B				RCJ8		0.8



CC BHP



OPT.



**...HUSQVARNA**

**...Power Equipment**

145BT/BE, 155BT, 165BT, 225B/BX			RCJ6Y	0.8
165RX			RCJ7Y	0.8
18H			RCJ8Y	0.8
18RL			RCJ6Y	0.8
21LCN			RCJ8Y	0.8
225E			RCJ7Y	0.8
225HBV			RCJ8	0.8
22HB, 235P, 250PS			RCJ7Y	0.8
22R, 22RL			RCJ6Y	0.8
232L, 232R/RD/RJ, 235R, 23LC, 240R, 240RBD, 244RX, 245R, 245RX, 250RX			RCJ7Y	0.8
25H			RCJ8	0.8
25H, 26H			RCJ8	0.8
25R, 25RL			RCJ6Y	0.8
265RX			RCJ7Y	0.8
26H			RCJ8	0.8
26LC, 26RLC			RCJ6Y	0.8
272S, 28HBV, 40B			RCJ7Y	0.8
322C, 322E, 322L, 322R			RCJ7Y	0.8
323c, 323E, 323Ex, 323L			RCJ6Y	0.8
323R, 324HE4, 325, 325C, 325CX, 325EX, 325HDA55 Hedge Trimmers, 325HE3, 325HS75, 325HS99 Hedge Trimmers, 325L/LX, 325P4 Pruner, 325RX/RJX, 326HD60x, 326HD75x, 326HDA55x, 326HE3x, 326HE4x, 326HS75x, 326HS99x			RCJ7Y	0.8
326L, 326LDx, 326Lx			RCJ6Y	0.8
326LX E-tech II, 326P4, 326P5x Pruner, 326Rx			RCJ7Y	0.8
32L, 32LC			RCJ6Y	0.8
32R, 32RLC, 39R			RCJ7Y	0.8
550CRTH			OE051 RN11YC	0.8
550CRTT			OE098 RN4C	0.8
650CRT	Briggs & Stratton Intek	6.5	OE013 RC12YC	QC12YC / XC92YC 0.5
CRT35, CRT50, CRT51, CRT52, CRT55			RJ19LM	0.8
CRT61			OE098 RN4C	0.8
CRT81, CRT83			RJ19LM	0.8
CT16A, CT20A			RCJ8Y	0.8
HVT1200, HVT1500			RCJ6Y	0.8
HVT2000			RJ17LM	0.8
HVT40			RCJ8Y	0.8
HVT52			RJ17LM	0.8
Iron Horse			RCJ7Y	0.8
LE309, LE359, LE389, LE389HD			RJ19LM	0.8
Mondo; Max, Mega			RCJ8Y	0.8
PS-50			RCJ7Y	0.8
T225R, T255R, T300			RJ19LM	0.8
	Briggs & Stratton		RJ19LM	QJ19LM 0.8
<b>Riding Mowers</b>				
1200-18H			RC14YC	0.8
970-12S, 970-15S, 970H-15S, 980H15-B			RJ19LM	0.8
GT200, GTH200, GTH220			OE013 RC12YC	1.0
GTH2250, GTH2550			OE013 RC12YC	0.8
LR110, LR120, LR121, LT130			RJ19LM	0.8
LT1538			OE013 RC12YC	1.0
LTH120			RJ19LM	0.8
LTH130, LTH145, LTH1742			OE013 RC12YC	1.0
Pro 15			RCJ8Y	0.8
ProFlex 21			RJ19LM	0.8
Rider 14 Pro			RC14YC	0.8
YT180, YTH150			OE013 RC12YC	1.0
YTH1542			OE013 RC12YC	0.8
YTH1542XP	Kawasaki	15	OE051 RN11YC	0.8
YTH160			OE013 RC12YC	1.0
YTH1746			OE013 RC12YC	0.8
YTH180, YTH1842			OE013 RC12YC	1.0
YTH1848XP			OE051 RN11YC	0.8



CC

BHP

21



OPT.

mm

**...HUSQVARNA**

**...Riding Mowers**

YTH2046, YTH2048  
YTH2242

Kohler Command Pro	13
Kohler Command Pro	15
Briggs & Stratton Intek	15.5
Briggs & Stratton Intek	17
Briggs & Stratton Intek	20
Briggs & Stratton Intek	22,25
Briggs & Stratton OHV	14.5
Briggs & Stratton Vanguard	13
Briggs & Stratton Vanguard	16
Kohler	28
Kohler OHV	12.5,13
Kohler OHV	14,15
Kohler V-Twin	18
Kohler V-Twin	20
Kohler V-Twin	22
Kohler V-Twin	25
Kohler V-Twin EFI	26
Briggs & Stratton Vanguard V-Twin	18
Briggs & Stratton Vanguard V-Twin	20
Kohler Aegis Liquid-Cooled	23
Kawasaki	12.5
Kawasaki V-Twin OHV	17
Briggs & Stratton	8.5,10,11,12, 12.5,13
Kawasaki Liquid-Cooled	27
Kawasaki OHV	14
Kawasaki OHV	18,21,23,25
Kohler Twin	18
Kohler Twin	20
Kohler Twin	21

OE013	RC12YC		0.8
OE013	RC12YC		1.0
	3071	XC12YC	0.8
	3071	XC12YC	0.8
OE013	RC12YC	QC12YC / XC92YC	0.8
OE013	RC12YC	QC12YC / XC92YC	0.8
OE013	RC12YC	QC12YC / XC92YC	0.8
OE013	RC12YC	QC12YC / XC92YC	0.8
OE013	RC12YC	QC12YC / XC92YC	0.8
OE013	RC12YC	QC12YC / XC92YC	0.8
OE013	RC12YC	QC12YC / XC92YC	0.8
OE013	RC12YC		0.8
OE013	RC12YC		1.0
OE013	RC12YC		1.0
OE013	RC12YC		0.8
OE013	RC12YC		0.8
OE013	RC12YC		0.8
OE013	RC12YC		0.8
OE013	RC12YC		0.8
	RC14YC		0.8
	RC14YC		0.8
	RC14YC		0.8
	RJ8		0.8
	RJ8Y		0.8
	RJ19LM	QJ19LM	0.8
OE051	RN11YC		0.8
OE051	RN11YC		0.8
OE051	RN11YC		0.8
	RV17YC		0.6
	RV17YC		0.6
	RV17YC		0.6

**Seeders**

SD18B	Briggs & Stratton Intek	5.5
SD18H	Honda	5.5

OE013	RC12YC	QC12YC / XC92YC	0.5
OE051	RN11YC		0.8

**Snow Removers**

1130STE	Tecumseh	11
5524ST	Tecumseh	5.5
8024STE	Tecumseh	10
9027STE	Tecumseh	9
ST1030EC	Tecumseh	10
ST20, ST20E	Tecumseh	4.5
ST21, ST21E, ST521, ST521E, ST522H	Tecumseh	5
ST523	Tecumseh	5,8
ST623C, ST624E	Tecumseh	6
ST723C, ST723R, ST724	Tecumseh	7
ST824E	Tecumseh	8
ST826E	Tecumseh	5,8
ST926EC, ST927E	Tecumseh	9

	RJ8C		0.8
	RJ8C		0.8
	RJ8C		0.8
	RJ8C		0.8
	RJ8C		0.8
	RJ8C		0.8
	RCJ8Y		0.8
	RCJ8Y		0.8
	RJ8C		0.8
	RJ8C		0.8
	RJ8C		0.8
	RJ8C		0.8
	RJ8C		0.8

**Sod Cutter**

SC18H	Honda	5.5
-------	-------	-----

OE051	RN11YC		0.8
-------	--------	--	-----

**Stump Cutters**

Honda OHV	13
-----------	----

OE051	RN11YC		0.8
-------	--------	--	-----

**Sweepers**

325LX

	RCJ8		0.8
--	------	--	-----

**Tractors**

GTH2554, GTH2754, LTH18542,  
LTH2248, YTH1942, YTH2348

OE013	RC12YC		0.8
-------	--------	--	-----

**Trimmers**

225H60, 225H-60, 225H75, 225H-75, 225HP,  
225L, 225L Lite, 225LD, 225R, 225RD, 225RJ

	RCJ7Y		0.8
--	-------	--	-----



CC BHP

21



OPT.



mm

## HUSS

### Power Equipment

Briggs & Stratton Vanguard	13	OE013	RC12YC	QC12YC / XC92YC	0.8
Kohler OHV	14	OE013	RC12YC		1.0
Briggs & Stratton Vanguard V-Twin	18,20		RC14YC		0.8
Kohler	12		RH10C		0.8
Briggs & Stratton	11,12,12.5		RJ19LM	QJ19LM	0.8
Kohler K181	8		RJ19LM		0.8

## HUSTLER

### Power Equipment

400

		OE011	RS9YC		0.8
Kohler Command Pro	13,15		3071	XC12YC	0.8
Kohler Command Pro	18		3071	XC12YC	0.8
Kohler Command Pro	22		3071	XC12YC	0.8
Kohler Command Pro	25		3071	XC12YC	0.8
Kawasaki	14		L90C		0.6
Kohler EFI	28	OE013	RC12YC		0.8
Kohler V-Twin	20,22	OE013	RC12YC		0.8
Kohler V-Twin	25	OE013	RC12YC		0.8
Continental TC-56			RD16		0.8
Kohler	18		RH10C		0.8
Kohler	20		RH10C		0.6
Kohler	23		RH10C		0.6
Kohler Twin	23		RH10C		0.8
Briggs & Stratton OHV	17.5		RJ19LM	QJ19LM	0.8
Briggs & Stratton Single Cyl.			RJ19LM	QJ19LM	0.8
Briggs & Stratton Twin	18		RJ19LM	QJ19LM	0.8
Honda V-Twin	16,18,20,24	OE051	RN11YC		0.8
Kawasaki FH601V V-Twin	19	OE051	RN11YC		0.6
Kawasaki OHV	15	OE051	RN11YC		0.6
Kawasaki OHV	17	OE051	RN11YC		0.6
Kawasaki OHV	23,25	OE051	RN11YC		0.6
Ford 1.1L		OE049	RN11YC4		0.9
Kawasaki	17	OE042	RN12YC		0.8
Ford 1.3L		OE011	RS9YC		0.9
Kohler Twin	18		RV17YC		0.6
Kohler Twin	20		RV17YC		0.6

### Turf Equipment

Honda	24	OE051	RN11YC		0.8
Kawasaki	15,19,23,25	OE042	RN12YC		0.8
Kawasaki Liquid-Cooled	27		RN14YC		0.8

## HWH

### Log Splitters

Briggs & Stratton			RJ19LM	QJ19LM	0.8
-------------------	--	--	--------	--------	-----

## HYDRA STORM

### Pressure Washers

Briggs & Stratton Intek	5.5	OE013	RC12YC	QC12YC / XC92YC	0.8
Briggs & Stratton Intek	5.5	OE013	RC12YC	QC12YC / XC92YC	0.5
Briggs & Stratton Vanguard OHV	13	OE013	RC12YC	QC12YC / XC92YC	0.8
Briggs & Stratton Vanguard OHV	9	OE013	RC12YC	QC12YC / XC92YC	0.8
Briggs & Stratton	11		RJ19LM	QJ19LM	0.8
Briggs & Stratton	5		RJ19LM	QJ19LM	0.8
Tecumseh	3.5		RJ8C		0.8
Tecumseh	8,10		RJ8C		0.8
Honda OHV	11,13	OE051	RN11YC		0.8
Honda OHV	5.5	OE051	RN11YC		0.8
Tecumseh OHV	5.5	OE098	RN4C		0.8
Honda OHV	5.5	OE006	RN9YC		0.8

## HYDRA-SPLITTER

### Log Splitters

Briggs & Stratton			RJ19LM	QJ19LM	0.8
-------------------	--	--	--------	--------	-----



CC BHP

21



OPT.



mm

**HYDRO MITE****Mulchers, Seeders, Sprayers**

Briggs & Stratton Single Cyl.			RJ19LM	QJ19LM	0.8
Honda OHV	5.5,13		OE051	RN11YC	0.8

**HYDRO TERRA****Mulchers, Seeders**

Kohler	16		RH10C		0.8
Briggs & Stratton	5		RJ19LM	QJ19LM	0.8

**HYDRO-TURF****Sprayers**

Briggs & Stratton Vanguard	9		OE013	RC12YC	QC12YC / XC92YC	0.8
Kohler OHV	6,8,12,5		OE013	RC12YC		0.8
Honda OHV	5.5,11		OE051	RN11YC		0.8
Honda OHV	5		OE006	RN9YC		0.8

**HYPRO****Water Pumps**

Briggs & Stratton	3,3.5,4,6,8, 10,11,12,14			RJ19LM	QJ19LM	0.8
Briggs & Stratton Twin	18			RJ19LM	QJ19LM	0.8
Honda OHV			OE051	RN11YC		0.8

**IBP****Power Equipment**

400				RJ8C		0.6
500				RCJ8		0.6
200, 300				RCJ8		0.6

**ICE KING****Ice Augers**

Tecumseh				RCJ8		0.8
----------	--	--	--	------	--	-----

**ICE-O-WAY****Power Equipment**

Sand, Salt	Briggs & Stratton	8.5,10.5		RJ19LM	QJ19LM	0.8
------------	-------------------	----------	--	--------	--------	-----

**IDEAL****Mowers**

(18mm)				RD16		0.6
(14mm)				RJ8C		0.6

**ILO-MOTOREN****Engines**

L 125		125	4.8		RL86C	0.5
L 152	ILO-tronic	148			RL86C	0.5
L 197		198			RL86C	0.5
L 252	ILO-tronic	247	8.5		RL86C	0.5
L 35		35	1.7		RL86C	0.5
L 372	ILO-tronic	372	12.8		RL86C	0.5
L 92, L 101		98			RL86C	0.5
RM 100	ILO-tronic	98	2.5		RL86C	0.5
RM 125		125	3.6		RL86C	0.5
RM 152, RM 162	ILO-tronic				RL86C	0.5
SP 40	ILO-tronic	35	1.7	OE086	RL82C	0.5
SP 80	ILO-tronic	58	3.1	OE086	RL82C	0.5

**Power Equipment**

G 49, V 49, GA 50					RL86C	0.5
LV 298, MM 25, MM 40					RL86C	0.5

**IMC****Air Compressors**

Honda OHV	5.5		OE051	RN11YC		0.8
-----------	-----	--	-------	--------	--	-----



CC BHP

21



OPT.



mm

### INDIAN

#### Chain Saws

40, 5-12, 547H

561H, 582H

Super 50

Super 5-12

Super 651

#### Snow Removers

All Models

#### Tillers

Rotary

### INDUSTRIAL ENGINEERING

#### Pumps

VA, VM High Pressure

### INDUSTRIAL PRODUCTS

#### Lawn Mowers

All Models

### INGERSOLL

#### Riding Equipment

Kohler V-Twin	20,22	OE013	RC12YC	0.8
Briggs & Stratton Vanguard V-Twin	12.5		RC14YC	0.8
Briggs & Stratton Vanguard V-Twin	14		RC14YC	0.8
Briggs & Stratton Vanguard V-Twin	16,18,20		RC14YC	0.8
Kohler	10,12,14		RH10C	0.8
Onan B43M, B48M, BF			RH18Y	0.6
Onan CCKA			RH8C	0.8
Briggs & Stratton Single Cyl.			RJ19LM	0.8
Briggs & Stratton Twin	12.5		RJ19LM	0.8
Briggs & Stratton Twin	14		RJ19LM	0.8
Briggs & Stratton Twin	16		RJ19LM	0.8
Tecumseh			RJ8C	0.8
Honda GX620	20	OE051	RN11YC	0.8
Onan Twin	16,18,20		RS17YX	0.6
Kohler Twin	18		RV17YC	0.6

### INGERSOLL-RAND

#### Pumps, Compressors & Refrigeration Units

24			RD16	0.6
315	Waukesha 140GS		RD16	0.6
12, 16A, 18			RD16	0.6
1KA315			W89D	0.9
2420F11G	Kohler		RH10C	0.6
3-R-30, 3-R-36			RJ8C	0.6
55, CR125, D60			RD16	0.6
D85			W14	0.6
ER210			RD16	0.6
G125	IHC UC-200		D15Y	0.6
G150, G175			D15Y	0.6
G175	IHC UC-200		D15Y	0.6
GH160	IHC C196		RJ12YC	0.6
GH85			RJ6C	0.6
GIH160		OE051	RN11YC	0.8
GK			RD16	0.6
GK105			W14	0.6
GKA160, GKA210, GKA315, GKA500, GKAC, GKRC, GKRC16			RD16	0.6
GKRC8			W14	0.6
GR105	Waukesha 140GS		RD16	0.6
GR250	Waukesha WAKO		RD16	0.6
GR85	Waukesha 140GS		RD16	0.6
GRA125, GRB125			RJ8C	0.6
GRR150	IHC UC-200		D15Y	0.6
GRR160	IHC UC-200		D15Y	0.6
	White-Hercules G2300		RJ6C	0.6



CC BHP

21



OPT.

mm

**...INGERSOLL-RAND**

**...Pumps, Compressors & Refrigeration Units**

GRR85	IHC UC-135B			D15Y	0.6
	White-Hercules G1600			RJ6C	0.6
GRRH85, GXL175				RJ6C	0.6
IK315, IKA210, IKA500, IKQ				W89D	0.9
K500, MF185				RD16	0.6
P100WF	Ford 2.3L			RS12YC	1.1
P-100-W-W				RJ8C	0.8
P-125-W-W	White G1600			RJ8C	0.8
P-175-W-W				RJ8C	0.8
T40				RD16	0.6
XL-SPL	Waukesha WAKO			RD16	0.6
	Kohler	12.5		RJ19LM	0.8
	Honda OHV	5.5,11	OE051	RN11YC	0.8
	Kawasaki OHV	11.5	OE051	RN11YC	0.8

**INTERMOTOR**

**Power Equipment**

IM 250, IM 251, IM 252	70			RL86C	0.7
IM 300, IM 301, IM 302	76			RL86C	0.7
IM 350, IM 351, IM 352	82			RL86C	0.7
LA 400, LA490, LA 510				RL86C	0.7
LGA 184, LGA 225	4, 5			RL86C	0.7
LKA 184, LKA 225				RL86C	0.7

**INTERNATIONAL**

**Blowers**

Briggs & Stratton, Tecumseh				RJ19LM	QJ19LM	0.8
-----------------------------	--	--	--	--------	--------	-----

**Chippers**

Briggs & Stratton, Tecumseh				RJ19LM	QJ19LM	0.8
-----------------------------	--	--	--	--------	--------	-----

**Edgers**

Briggs & Stratton, Tecumseh				RJ19LM	QJ19LM	0.8
-----------------------------	--	--	--	--------	--------	-----

**Lawn Mowers**

3309, 331, 3310, 3311, 3312, 3313, 3314, 3315, 3319, 332, 3320, 3321, 3322, 3323, 3324, 3325, 333, 334, 335				CJ14		0.8
Briggs & Stratton				RJ19LM	QJ19LM	0.8

**Log Splitters**

Briggs & Stratton, Tecumseh				RJ19LM	QJ19LM	0.8
-----------------------------	--	--	--	--------	--------	-----

**Power Equipment**

Cub Cadet	Kohler OHV			OE013	RC12YC	1.0	
	Briggs & Stratton Vanguard				RC14YC	0.8	
	Kawasaki	12.5			RCJ8	0.8	
	Kawasaki	5.2			RCJ8	0.8	
	Kawasaki Liquid-Cooled V-Twin	20			RCJ8	0.8	
	Kohler	10,12,14,16			RH10C	0.8	
	Kohler	20			RH10C	0.8	
	Briggs & Stratton				RJ19LM	QJ19LM	0.8
	Briggs & Stratton Twin				RJ19LM	QJ19LM	0.8
	Kohler K181	8			RJ19LM	0.8	
	Tecumseh				RJ8C	0.8	
	Kawasaki OHV	13,14,17		OE051	RN11YC	0.8	
	Kawasaki OHV	3.7		OE051	RN11YC	0.8	
	Kawasaki OHV	5.3,7.9,9,11.1		OE051	RN11YC	0.8	
	Yanmar 322			OE006	RN9YC	0.6	
	Onan 316, 318, 420				RS17YX	0.6	
	Kohler Twin	17			RV17YC	0.6	
Cub Cadet 100, 1000, 102					RH10C	0.8	
Cub Cadet 1030					RJ19LM	0.8	
Cub Cadet 104, 105, 106, 107, 108, 109, 1100					RH10C	0.8	
Cub Cadet 111					RCJ8	0.8	
Cub Cadet 1200, 122					RH10C	0.8	
Cub Cadet 1225					RJ19LM	0.8	
Cub Cadet 123					RH10C	0.8	
Cub Cadet 1238					RJ19LM	0.8	



CC

BHP

21



OPT.

**...INTERNATIONAL****...Power Equipment**

Cub Cadet 124, 125, 1250, 126, 127, 128, 129			RH10C		0.8
Cub Cadet 1325, 1330			RC14YC		0.8
Cub Cadet 1430			RV17YC		0.8
Cub Cadet 1440			RC14YC		0.8
Cub Cadet 1450, 147, 149			RH10C		0.8
Cub Cadet 1641		OE013	RC12YC		0.8
Cub Cadet 1650			RH10C		0.8
Cub Cadet 1730			RV17YC		0.8
Cub Cadet 182			RCJ8		0.8
Cub Cadet 1861, 1862, 2082			RV17YC		0.8
Cub Cadet 2182		OE013	RC12YC		0.8
Cub Cadet 282, 382, 482, 55			RCJ8		0.8
Cub Cadet 582			RJ12C		0.8
Cub Cadet 60			RJ8C		0.8
Cub Cadet 682			RV15YC4		0.8
Cub Cadet 70, 71, 72, 73			RJ8C		0.8
Cub Cadet 75, 76			RCJ8		0.8
Cub Cadet 782			RV15YC4		0.8
Cub Cadet 80			RCJ8		0.8
Cub Cadet 800			RH10C		0.8
			RJ8C		0.8
Cub Cadet 81, 85			RCJ8		0.8
Cub Cadet 86			RJ8C		0.8
Cub Cadet 982			RS14YC		0.8
Cub Cadet SRX95	Kawasaki		CJ14		0.8

**Snow Removers**

8			RCJ8		0.8
10			RCJ8		0.8
268, 328, 265			RJ19LM		0.8
	Tecumseh AH520		RJ18YC		0.8
	Briggs & Stratton		RJ19LM	QJ19LM	0.8

**Tillers**

	Briggs & Stratton, Tecumseh		RJ19LM	QJ19LM	0.8
--	-----------------------------	--	--------	--------	-----

**IPT****Pressure Pumps**

	Briggs & Stratton	5	RJ19LM	QJ19LM	0.8
	Honda OHV	5.5	OE051 RN11YC		0.8

**IRON & OAK****Power Equipment**

	Briggs & Stratton Intek	5.5	OE013 RC12YC	QC12YC / XC92YC	0.5
	Briggs & Stratton Vanguard	9	OE013 RC12YC	QC12YC / XC92YC	0.8
	Kohler OHV	11	OE013 RC12YC		1.0
	Briggs & Stratton	5	RJ19LM	QJ19LM	0.8
	Briggs & Stratton	8	RJ19LM	QJ19LM	0.8
	Tecumseh	3.8	RJ19LM		0.8
	Honda	5.5,8,11	OE051 RN11YC		0.8
	Tecumseh OHV	5,8	OE098 RN4C		0.8
	Honda OHV	5	OE006 RN9YC		0.8

**ISHIKAWAJIMA-SHIBAURA****Brushcutters**

B18, B20, B20DU, B24, B24DU			RCJ8Y		0.6
B30, B31DU, B35DU			RCJ8Y		0.6
H18D, H20D, H23D, H26D, H35D			RCJ7Y		0.6
SB19, SB24, SB30, SB40			RCJ8		0.7
SCK30D, SCY24, SCY24A			RCJ8		0.7

**ISLANDER****Lawn Mowers**

All Models			RJ19LM		0.8
------------	--	--	--------	--	-----





CC

BHP

21



OPT.

**J.C. PENNEY****Power Equipment**

709030, 709035

Briggs &amp; Stratton, Tecumseh

RCJ8

0.8

RJ19LM

QJ19LM

0.8

**JACKSON****Generators**

All Models

RD16

0.8

**Lawn Mowers**

All Models

RJ19LM

0.8

**Power Equipment**

Honda OHV

4,5.5

OE051

RN11YC

0.8

**JACOBSEN****Lawn Mowers**

Honda

4

RCJ8Y

0.8

Briggs &amp; Stratton

RJ19LM

QJ19LM

0.8

Jacobsen

RJ19LM

0.6

Clinton

RJ8C

0.6

Honda OHV

3.5

OE006

RN9YC

0.8

**Turf Equipment**

Briggs &amp; Stratton Extended Life Series

17.5

OE013

RC12YC

QC12YC / XC92YC

0.8

Briggs &amp; Stratton Intek V-Twin

18

OE013

RC12YC

QC12YC / XC92YC

0.8

Briggs &amp; Stratton Intek V-Twin

25

OE013

RC12YC

QC12YC / XC92YC

0.8

Briggs &amp; Stratton Vanguard V-Twin

16

RC14YC

0.8

Briggs &amp; Stratton Vanguard V-Twin

18

RC14YC

0.8

(18mm)

RD16

0.8

Ford

192

RH10C

0.9

Kohler

10,12,14,16,

18,23

RH10C

0.8

Kohler

8

RH10C

0.8

Briggs &amp; Stratton

RJ19LM

QJ19LM

0.8

Jacobsen

RJ19LM

0.8

Kohler K181

8

RJ19LM

0.8

Robin EY25W

RL86C

0.8

Honda OHV

4

OE051

RN11YC

0.8

Robin EH35C

OE051

RN11YC

0.8

Perkins G4-236

OE042

RN12YC

0.8

Robin EH29C

RN14YC

0.8

Ford

67

OE006

RN9YC

0.9

Honda OHV

3.5

OE006

RN9YC

0.8

Onan Twin

20

RS17YX

0.6

**Utility Vehicles**

2015

RS17YX

0.6

**JACTO****Sprayers**

PL50V

RCJ7Y

0.8

**JACUZZI****Air Compressors**

Briggs &amp; Stratton

RJ19LM

QJ19LM

0.8

**Contractors Pumps**

10M, 15M

RCJ8

0.6

20M, 25M, 30M

RD16

0.6

5M, 8M

RCJ8

0.6

**Pumps**

Jet 15ZJH, 17RM2

RCJ8

0.6

Series TZ, FTZ

Wisconsin 110D, THD

RD16

0.6

Series ZJY, ZJS

Wisconsin S8D

RD16

0.6

Briggs &amp; Stratton

RJ19LM

QJ19LM

0.8

**JAEGER****Pumps, Compressors & Refrigeration Units**

Stover

RD16

0.6

Wisconsin AG, AGH, VE4

RD16

0.8

(14mm)

RJ12C

0.6



CC BHP

21



OPT.



mm

## JAMAKA

### Lawn Mowers

Briggs & Stratton

RJ19LM

QJ19LM

0.8

## JARI

### Lawn Mowers

Clinton

RJ12C

0.6

Briggs & Stratton

RJ19LM

QJ19LM

0.8

Kohler, Tecumseh

RJ19LM

0.8

### Power Equipment

Briggs & Stratton

3,3,5,5

RJ19LM

QJ19LM

0.8

### Snow Removers

All Models

RJ19LM

0.8

## JENNEY

### Pressure Washers

1200, 1800, 3000, Series 900

Kohler

14

RJ19LM

0.8

Briggs & Stratton

RH10C

0.8

Kohler

4

RJ19LM

QJ19LM

0.8

RJ19LM

0.8

## JIFFY

### Ice Drills

Tecumseh

2

RCJ8Y

0.8

Tecumseh

3,3,5

RJ17LM

0.8

## JIFFY HYDRAULIC SEEDER

### Mulchers, Seeders

Kohler V-Twin

25

OE013

RC12YC

0.8

Kohler Twin

18

RV17YC

0.6

## JIM SAVAGE

### Chain Saws

Maxi 350, Pro 580, Super 100

RCJ8

0.8

## JOBU

### Brushcutters

RCJ8

0.8

### Chain Saws

25CVA, L35

RCJ8

0.8

L6, L8, L86S

RCJ7Y

0.8

LF50, LP6

RDJ6J

0.8

Micro 25

RCJ8

0.8

SL2, SL21

CJ6

0.8

SL3

RCJ8

0.8

## JOE BUILT

### Power Equipment

HD-500

4

RJ8C

0.8

## JOHN DEERE

### Chain Saws

8

CJ6

0.8

23

RCJ8

0.8

50

RCJ8

0.8

61

CJ6

0.8

81

CJ6

0.8

91

CJ6

0.8

9, 12, 14, 15, 17, 18, 19

CJ6

0.8

200CS

RCJ6Y

0.8

230CS

RCJ6Y

0.8

25EV

RCJ7Y

0.8

28, 30

RCJ8

0.8

300CS

RCJ7Y

0.8

350CS

CJ6

0.8

35EV

RCJ7Y

0.8

40V

RCJ8

0.8



CC BHP

21



OPT.



mm

**...JOHN DEERE**

**...Chain Saws**

450V, 46EV				RCJ7Y	0.8
50V				CJ6	0.8
51SV				RCJ7Y	0.8
550CS				RCJ6Y	0.8
55EV				RCJ7Y	0.8
65EV, 65SV, 66SV, 70V, 72				RCJ7Y	0.8
800V, 80EV				RCJ7Y	0.8
820, 840				RCJ6Y	0.8
CS36, CS40, CS46, CS52, CS56,				RCJ7Y	0.8
CS62, CS71, CS81, R70EV, S80, S82					

**Compressors**

A300				RCJ8	0.6
				RJ8C	0.6

**Cut-Off Saw**

380MS, 880MS				RCJ6Y	0.6
--------------	--	--	--	-------	-----

**Generators**

500				RCJ8	0.6
550				RCJ8	0.6
1000, 1400				RCJ8	0.6
1750W				RJ8C	0.6
1800, 225				RCJ8	0.6
250G				RJ19LM	0.6
3000W				RJ8C	0.6
325, 375				RCJ8	0.6
4000W				RJ8C	0.6
440G				RJ19LM	0.6
5000W			OE086	RL82C	0.6
550GE				RJ19LM	0.6
650, 750				RCJ8	0.6
DP6000	Kohler OHV	12		RH10C	0.6
G2500K	Kawasaki OHV	5.5	OE051	RN11YC	0.6
G4400K	Kawasaki OHV	8	OE051	RN11YC	0.6
G5500K, G5500KE	Kawasaki OHV	11	OE051	RN11YC	0.6

**Lawn Mowers**

12PB, 12SB				RJ19LM	0.8
14PT			OE051	RN11YC	0.8
14PZ				RJ19LM	0.8
14SB, 14SC, 14SE, 14ST, 14SX			OE051	RN11YC	0.8
14SZ				RJ19LM	0.8
20SR7				RCJ8	0.8
56, 57, 66, 68				RJ8C	0.8
F725, JA62, JA65				RJ19LM	0.8
JE75			OE051	RN11YC	0.8
JS60, JS61, JS63				RJ19LM	0.8
JX75, JX85			OE051	RN11YC	0.8
R72, S28, S92				RJ8C	0.8
	Kohler	13	OE013	RC12YC	0.8
	Tecumseh			RCJ7Y	0.8
	Kawasaki	3.8		RCJ8	0.8
	Kohler	23		RH10C	0.8
	Briggs & Stratton	4,6		RJ19LM	0.8
	Kawasaki	14,17,19,23,25	OE051	RN11YC	0.8
	Kawasaki OHV	4,5,5.3,6	OE051	RN11YC	0.8
	Kawasaki	27,29	OE042	RN12YC	0.6

**Log Splitters**

No. 5				RJ8C	0.8
-------	--	--	--	------	-----

**Portable Pumps**

15, 20				RJ8C	0.6
--------	--	--	--	------	-----

**Power Equipment**

48			OE051	RN11YC	0.8
52			OE051	RN11YC	0.8
113				RCJ8	0.8
130			OE051	RN11YC	0.8
162				RCJ8	0.8
170			OE051	RN11YC	0.8
172				RCJ8	0.8



CC

BHP



OPT.



**...JOHN DEERE**

**...Power Equipment**

185			OE051	RN11YC	0.8
265			OE051	RN11YC	0.8
345				CJ14	0.8
445				RCJ8	0.8
110G				RCJ7Y	0.8
14PZ				RJ19LM	0.8
145B, 145E, 145X			OE051	RN11YC	0.8
145Z				RJ19LM	0.8
175, 180			OE051	RN11YC	0.8
1800 Utility Vehicle				CJ14	0.8
20SR7				RCJ8	0.8
210G				RCJ7Y	0.8
213E, 21HC				RCJ8	0.8
21C, 21S				RCJ8Y	0.8
220A, 240			OE051	RN11YC	0.8
240G				RCJ7Y	0.8
245, 260			OE051	RN11YC	0.8
255, 305, 388				RCJ7Y	0.8
260G				RCJ7Y	0.8
285, 28V, 2LS, 300G				RCJ8	0.8
314F				RJ17LM	0.8
320, 325			OE051	RN11YC	0.8
350G				RCJ8	0.8
400, 425				CJ14	0.8
45BP				CJ6	0.8
518R				RJ19LM	0.8
5E				RCJ8	0.8
80G				RJ17LM	0.8
820R				RJ19LM	0.8
82G, 83G				CJ14	0.8
85G				RJ17LM	0.8
90G				RCJ7Y	0.8
AMT600				L90C	0.8
AMT622, AMT626			OE051	RN11YC	0.8
BC1600, C1200				RCJ6Y	0.8
BH30, BH40				RDJ7Y	0.8
BP40				CJ6	0.8
BP50				RCJ7Y	0.8
CS5				RJ19LM	0.8
CS8				RJ8C	0.8
Deluxe		14	OE051	RN11YC	0.8
		17	OE051	RN11YC	0.8
E35				RCJ8	0.8
F510, F525			OE051	RN11YC	0.8
F620, F625			OE013	RC12YC	0.8
F710			OE051	RN11YC	0.8
F725				CJ14	0.8
F910				RS14YC	0.8
F911				CJ14	0.8
F912			OE051	RN11YC	0.8
F930				RS14YC	0.8
F932, Gator 4x2			OE051	RN11YC	0.8
Gator 6x4				CJ14	0.8
GS25			OE051	RN11YC	0.8
GS30			OE013	RC12YC	1.0
GS45, GS75, GT242, GT262, GT275, GT325			OE051	RN11YC	0.8
GT345				CJ14	0.8
GX70, GX75, GX85, GX95			OE051	RN11YC	0.8
H265				RCJ8	0.8
HD45, HD75			OE051	RN11YC	0.8
K-Series		12.5		CJ14	0.8
		14	OE051	RN11YC	0.8
		17	OE051	RN11YC	0.8
		5	OE051	RN11YC	0.8
LT133, LT155			OE013	RC12YC	1.0
LT166				RC14YC	0.8
LX172, LX173, LX176			OE051	RN11YC	0.8
LX178				RCJ8	0.8



CC BHP

21



OPT.

mm

**...JOHN DEERE****...Power Equipment**

LX186			OE051	RN11YC		0.8
LX188				RCJ8		0.8
S1400				RCJ6Y		0.8
SE23, T105C, T105S, T23s, T26sb				RCJ8		0.8
SRX75			OE051	RN11YC		0.8
SRX95				CJ14		0.8
SST16	Briggs & Stratton Vanguard V-Twin	16,18	OE013	RC12YC	QC12YC / XC92YC	0.8
SST18	Briggs & Stratton Vanguard V-Twin	16,18	OE013	RC12YC	QC12YC / XC92YC	0.8
STX30, STX38, STX46			OE013	RC12YC		0.8
SX85	Briggs & Stratton	13		RJ19LM	QJ19LM	0.8
T30c, T30s, T30sb				RDJ7Y		0.8
T40sb, TB26sb, XT105, XT105SB, XT120, XT120SE, XT140, XT140B, XT140SB, XT170, XT170B, XT250B				RCJ8		0.8
	Kohler OHV	12.5,13	OE013	RC12YC		1.0
	Kohler OHV	15	OE013	RC12YC		1.0
	Kohler V-Twin	20,22,23,25	OE013	RC12YC		0.8
	Briggs & Stratton Vanguard V-Twin	16		RC14YC		0.8
	Kawasaki	3.1,5.2		RCJ8		0.8
	Kawasaki Liquid-Cooled V-Twin	14.5,16		RCJ8		0.8
	Kawasaki Liquid-Cooled V-Twin	18		RCJ8		0.8
	Kawasaki Liquid-Cooled V-Twin	19,20,22		RCJ8		0.8
	Kawasaki Liquid-Cooled V-Twin	23		RCJ8		0.8
	Kioritz			RCJ8		0.8
	Kohler	10,12		RH10C		0.8
	Kohler	14		RH10C		0.8
	Kohler	16		RH10C		0.8
	Kohler	20		RH10C		0.8
	Briggs & Stratton			RJ19LM	QJ19LM	0.8
	Briggs & Stratton Twin			RJ19LM	QJ19LM	0.8
	Kohler K181	8		RJ19LM		0.8
	Tecumseh			RJ8C		0.8
	Honda OHV	4	OE051	RN11YC		0.8
	Kawasaki	19	OE051	RN11YC		0.8
	Kawasaki	23	OE051	RN11YC		0.8
	Kawasaki OHV	17	OE051	RN11YC		0.8
	Kawasaki OHV	6,9,13,14	OE051	RN11YC		0.8
	Yanmar	20,28	OE051	RN11YC		0.8
	Honda OHV	5	OE006	RN9YC		0.8
	Onan 316, 318, 420			RS17YX		0.6
	Onan Twin	16,18,20		RS17YX		0.6
	Kohler Twin	17		RV17YC		0.6

**Pumps, Compressors & Refrigeration Units**

235AP, 235CP, 235CT, 250AP				RJ19LM		0.8
6076AFN30		150,200		RC78PYP		0.4
TA92				RH10C		0.6

**Snow Removers**

T026	- , Kioritz			RJ19LM		0.8
T032D				RJ8C		0.8
320, 321, 322, 520, 522, 524D, 526, 726, 732, 824, 826D				RJ19LM		0.8
828D				RJ8C		0.8
TRS21				RCJ8Y		0.8
TRS22, TRS24, TRS26, TRS27, TRS32, TRX24, TRX26				RJ8C		0.8
	Tecumseh 2-Cycle			RCJ8Y		0.8
	Briggs & Stratton			RJ19LM	QJ19LM	0.8
	Tecumseh 4-Cycle			RJ8C		0.8

**Trimmers**

EH2342, EH2659, H20D, H20S, PS2683				RCJ8		0.8
---------------------------------------	--	--	--	------	--	-----

**JOHNSON****Lawn Mowers**

	Briggs & Stratton			RJ19LM	QJ19LM	0.8
	Clinton, Continental			RJ8C		0.6



CC

BHP

21



OPT.

**JOLLY HOE****Lawn Mowers**

All Models

RJ19LM

0.8

**Power Equipment**

All Models

RCJ8

0.6

**JONSERED****Blowers**

BV32 Blower/Vac

RCJ7Y

0.8

**Chain Saws**

365

RCJ7Y

0.8

490

CJ6

0.8

820

RDJ7Y

0.8

830

RCJ6Y

0.8

840

RCJ7Y

0.8

041 Turbo, 111S, 2036, 2036 Turbo, 2040, 2040 Turbo, 2045, 2050, 2051, 2051 Turbo, 2054, 2055 CAT, 2055 Turbo, 2063, 2065, 2071 Turbo, 2071W, 2077, 2083 Turbo

RCJ7Y

0.8

2094, 2095 Turbo

RCJ8Y

0.8

2141 Turbo, 2145 Turbo, 2149 Turbo, 2149W Turbo, 2150 Turbo, 2159 Turbo, 2159W Turbo, 2163 Turbo, 2163W Turbo, 2165 Turbo, 2171 Turbo, 2171W Turbo

RCJ7Y

0.8

410, 420

RDJ7Y

0.8

435, 450, 451EV, 45ES

RCJ7Y

0.8

49SP

RCJ7Y

0.8

510, 510M

RDJ7Y

0.8

510SP

RCJ7Y

0.8

520SP

RDJ7Y

0.8

521EV, 525, 52ES, 535, 590, 621, 625 II,

RCJ7Y

0.8

630 Super II, 630S, 66E, 66ES, 670 Champ,

70E, 801

RCJ8Y

0.8

6000, Mini 600

2095 Turbo

RCJ7Y

0.8

90W, 910D, 910E, 920, 930S

CJ6

0.8

LT1J

RCJ7Y

0.5

M110

CJ6

0.8

M36, M361, M361AV

RCJ7Y

0.5

M50

RCJ7Y

0.8

M52, M60, M601, M62,

M621, M75, M751

RCJ7Y

0.5

M80

RCJ7Y

0.8

MK70, MK80, Pro 35, RS45, Super III

RCJ7Y

0.8

**Lawn Mowers**

Briggs &amp; Stratton

RJ19LM

QJ19LM

0.8

**Power Equipment**

BP2040C, BP40 Combi, BP40 Combi Cat, GR2026, GR2026CL, GR2026D, GR2026L, GR203020, GR2032D, GR2032L, GR2036, GR24, GR24L, GR26, GR26 Combi, GR260, GR26CL, GR26D, GR26L, GR28, GR28L, GR32, GR320, GR32D, GR32D CAT, GR32L, GR32L Cat, GR36, GR36 Cat, GR41, GR

RCJ7Y

0.8

Iron Horse

Honda OHV

5.5,9

OE051

RN11YC

0.8

**Pruners**

HP36

RCJ7Y

0.8

RCJ7Y

0.8

**Pumps, Compressors & Refrigeration Units**

WP25

RCJ7Y

0.8

**Riding Mowers**

LT13 Briggs &amp; Stratton

13

RJ19LM

QJ19LM

0.8

LT15 Briggs &amp; Stratton OHV

14.5

OE013

RC12YC

QC12YC / XC92YC

0.8

LT16 Briggs &amp; Stratton Intek OHV

15.5,18

OE013

RC12YC

QC12YC / XC92YC

0.8

LT18 Briggs &amp; Stratton Intek OHV

15.5,18

OE013

RC12YC

QC12YC / XC92YC

0.8

**Tillers**

RT5 Briggs &amp; Stratton OHV

5.5

OE013

RC12YC

QC12YC / XC92YC

0.8

**Wood Splitters**

Split 40

RCJ7Y

0.8



CC BHP

21



OPT.



mm

**JOY****Pumps, Compressors & Refrigeration Units**

All Other	Buda			W18	0.6
	Buda H-173 (18mm)			D21	0.6
	Buda HP-205 (18mm)			D21	0.6
	Case SE (18mm)			D21	0.6
	Buda HP-217, HP-234			D23	0.6
	Buda K-428			D23	0.6
	Buda LO-525 (18mm)			D23	0.6
	IHC UD-16			D89D	0.6
	IHC UD-9			D89D	0.6
	Buda HP-351			RD16	0.6
	Continental			RD16	0.6
	Buda H-173 (14mm)			RJ12C	0.6
	Buda HP-205 (14mm)			RJ12C	0.6
	Case SE (14mm)			RJ12C	0.6
	Hercules G-3400, GO-339			RJ6C	0.6
	Buda 4B-182, 6B-273			RJ8C	0.6
	Buda LO-525 (14mm)			RJ8C	0.6
	Buda BTH, ET-350			W14	0.6
	Buda JK-4, JL-877, JV-4, JV-6			W14	0.6
	Hercules HXE			W14	0.6
	IHC UD-1091			W89D	0.6
	IHC UD-18A, UD-24			W89D	0.6

**K & S****Edgers**

				RCJ8	0.8
--	--	--	--	------	-----

**Lawn Mowers**

	Briggs & Stratton			RJ19LM	QJ19LM	0.8
--	-------------------	--	--	--------	--------	-----

**Trimmers**

Trimall	Briggs & Stratton			RJ19LM	QJ19LM	0.8
	Power Products			RDJ8J		0.8

**K.E.W.****Pressure Cleaners**

	3002KB, 4203KB			OE059	L92YC	0.6
--	----------------	--	--	-------	-------	-----

**KAAZ****Brushcutters**

J & V Series				RCJ8		0.8
	Kawasaki	2.1		RJ8C		0.8

**Chain Saws**

	Kawasaki	1.2		RCJ8		0.8
	Kawasaki	1.8		RCJ8		0.8
	Mitsubishi T50			RCJ8		0.8
	Zenoah G3C, G4C, G5C			RL86C		0.8
	Kawasaki	1.3,1.5		CJ6		0.8
	Zenoah G2C, G2D			CJ6		0.8

**Power Equipment**

	Mitsubishi T12, T130			CJ6		0.8
	Kawasaki	6.5		RJ8C		0.8
	Kawasaki	5		RL86C		0.8
	Robin EY14, EY18, EY25			RL86C		0.8

**Pruners**

	Kawasaki	1.2		CJ6		0.8
--	----------	-----	--	-----	--	-----

**Sprayers**

	Kawasaki	3.4		RJ8C		0.8
--	----------	-----	--	------	--	-----

**Trimmers**

T10, Silver X, TM30B				RCJ8		0.8
	Kawasaki	1.2		CJ6		0.8



CC BHP

21



OPT.



mm

**KAN-DU STUMPER****Lawn Vacuums**

Briggs & Stratton			RJ19LM	QJ19LM	0.8
Honda			RL86C		0.8

**Power Equipment**

Honda	24		OE013	RC12YC	0.8
Kohler V-Twin	25		OE013	RC12YC	0.8
Briggs & Stratton Vanguard V-Twin	20			RC14YC	0.8
Kawasaki Liquid-Cooled V-Twin	20			RCJ8	0.8
Honda	13		OE051	RN11YC	0.8
Honda GXV270	9		OE051	RN11YC	0.8
Onan Twin	24			RS17YX	0.6

**KANGA LOADERS****Power Equipment**

Honda Liquid-Cooled V-Twin	16,20		OE013	RC12YC	0.8
----------------------------	-------	--	-------	--------	-----

**KARCHER****Pressure Pumps**

Briggs & Stratton Intek	6		OE013	RC12YC	QC12YC / XC92YC	0.8
Briggs & Stratton Vanguard OHV	9		OE013	RC12YC	QC12YC / XC92YC	0.8
Briggs & Stratton Vanguard V-Twin	16			RC14YC		0.8
Kawasaki	3			RCJ8		0.8
Briggs & Stratton 1-Cyl.				RJ19LM	QJ19LM	0.8
Tecumseh	3.8			RJ19LM		0.8
Honda OHV	11,13		OE051	RN11YC		0.8
Tecumseh OHV	5		OE098	RN4C		0.8
Honda OHV	5		OE006	RN9YC		0.8

**KATEX****Chain Saws**

KAT-10, KAT-25				RCJ8	0.8
KAT-34				RCJ8Y	0.8

**KATO****Lawn Mowers**

Honda G150				L90C	0.8	
Honda G200				L90C	0.8	
Briggs & Stratton				RJ19LM	QJ19LM	0.8
Kohler				RJ19LM		0.8

**KATOLIGHT****Generators**

One-cyl. Air Cooled D.C.				RJ8C	0.6	
4-Cyl. Liquid Cooled D.C.				RD16	0.6	
Continental F-162, M330, Y112, Y69				RD16	0.6	
2-Cyl. Liquid Cooled D.C.				RH10C	0.6	
Briggs & Stratton				RJ19LM	QJ19LM	0.6
Chrysler Industrial 32				RJ6C	0.6	
IHC U-450				RJ6C	0.6	
Chrysler Industrial 24				RN5C	0.6	

**KAWASAKI****Blowers**

KRB300A	26			RCJ7Y	
KRB650B, KRB650BC	45			RCJ6Y	
KRB750A, KRB750AC, KRB750B, KRB750BC	65			RCJ6Y	
KRH300AC	26			RCJ6Y	

**Edgers**

KEL27B	26			RCJ7Y	
--------	----	--	--	-------	--

**Engines**

DA	2-Cycle	5		RL86C	0.6	
FA130D	Side Valve 4-Cycle	129	3.1	RCJ8	0.6	
FA210D, R	Side Valve 4-Cycle		5.2	RCJ8	0.6	
FA210V	Side Valve 4-Cycle		5.2	RCJ8	0.6	
FA76D	Side Valve 4-Cycle		1.7	RCJ8	0.6	
FB460V	Side Valve 4-Cycle	460	12.5	RCJ8Y	0.6	
FC150V	OHV Vertical 4-Cycle	153	5	OE051	RN11YC	0.6





CC BHP



OPT.



...KAWASAKI

...Engines

Model	Engine Type	CC	BHP	Year	Code 1	Code 2	mm
FC180V	OHV Vertical 4-Cycle	182	6		OE051	RN11YC	0.6
FC290V	OHV Vertical 4-Cycle	286	9		OE051	RN11YC	0.8
FC400V	OHV Vertical 4-Cycle		13		OE051	RN11YC	0.8
FC401V	OHV Vertical 4-Cycle		13		OE051	RN11YC	0.8
FC420V	OHV Vertical 4-Cycle	423	14		OE051	RN11YC	0.8
FC540V	OHV Vertical 4-Cycle	535	17		OE051	RN11YC	0.6
FD440V	OHV Vertical 4-Cycle Liquid Cooled; V-Twin	437	14.5			RCJ8	0.6
FD501D	OHV Horizontal 4-Cycle V-Twin; >SN105502	437	16			RCJ8	0.6
	OHV Horizontal 4-Cycle V-Twin; >SN105501>	437	16		OE051	RN11YC	0.7
FD501V	OHV Vertical 4-Cycle V-Twin; >SN105534	437	17			RCJ8	0.6
	OHV Vertical 4-Cycle V-Twin; SN105533>	437	17		OE051	RN11YC	0.7
FD590V	OHV Vertical 4-Cycle Liquid Cooled; V-Twin	585	18			RCJ8	0.6
FD601V	OHV Vertical 4-Cycle Liquid Cooled; V-Twin		19		OE051	RN11YC	0.6
FD611D	OHV Horizontal 4-Cycle V-Twin; >SN254225		20			RCJ8	0.6
	OHV Horizontal 4-Cycle V-Twin; SN254224>		20		OE051	RN11YC	0.6
FD611V	OHV Vertical 4-Cycle V-Twin; >SN027683	585	20			RCJ8	0.6
	OHV Vertical 4-Cycle V-Twin; SN027682>	585	20		OE051	RN11YC	0.6
FD620D	OHV Horizontal 4-Cycle Liquid Cooled; V-Twin; (3/8")	617	20			RCJ8	1.0
	OHV Horizontal 4-Cycle Liquid Cooled; V-Twin; (3/4")	617	20			RN14YC	0.6
FD620V	OHV Horizontal 4-Cycle Liquid Cooled; V-Twin		20			RCJ8	1.0
FD641V	OHV Vertical 4-Cycle Liquid Cooled; V-Twin		21		OE051	RN11YC	0.6
FD661D	OHV Horizontal 4-Cycle Liquid Cooled; V-Twin; (3/8")	617	22			RCJ8	0.6
	OHV Vertical 4-Cycle Liquid Cooled; V-Twin; (3/4")	617	22		OE051	RN11YC	0.6
FD671D	OHV Horizontal 4-Cycle Liquid Cooled; V-Twin		23		OE042	RN12YC	0.6
FD680V	OHV Vertical 4-Cycle Liquid Cooled; V-Twin		23		OE051	RN11YC	0.6
FD711D	OHV Horizontal 4-Cycle Liquid Cooled; V-Twin	745	25		OE042	RN12YC	0.6
	OHV Horizontal 4-Cycle Liquid Cooled; V-Twin	745			OE042	RN12YC	0.6
	OHV Horizontal 4-Cycle Liquid Cooled; V-Twin		25		OE042	RN12YC	0.6
FD721V	OHV Vertical 4-Cycle Liquid Cooled; V-Twin		25		OE051	RN11YC	0.6
FD731V	OHV Vertical 4-Cycle	675	26	2008 →		RN14YC	0.6
FD750D	OHV Horizontal 4-Cycle Liquid Cooled; V-Twin		27		OE042	RN12YC	0.6
	OHV Horizontal 4-Cycle	745	27	2008 →		RN14YC	0.6
FD791D	OHV Horizontal 4-Cycle Liquid Cooled; V-Twin; DFI	745	29			RN14YC	0.6
FE120D	OHV Horizontal 4-Cycle	124	4		OE051	RN11YC	0.8
FE170D	OHV Horizontal 4-Cycle	171	5.5		OE051	RN11YC	0.8
FE250D	OHV Horizontal 4-Cycle	249	8		OE051	RN11YC	0.8
FE290D	OHV Horizontal 4-Cycle	286	9.5		OE051	RN11YC	0.8
FE350D	OHV Horizontal 4-Cycle	351	11.5		OE051	RN11YC	0.8
FE400D	OHV Horizontal 4-Cycle		13		OE051	RN11YC	0.8
FG150D	2-Cycle	151	3.6			RL95YC	0.6
FG200D	2-Cycle		5			RL95YC	0.6
FG270D	2-Cycle		6		OE059	L92YC	0.8
FG300D	2-Cycle		7.5			RL95YC	0.6
FH381V	OHV Vertical 4-Cycle V-Twin	431	13			RCJ8Y	0.6
FH430V	OHV Vertical 4-Cycle V-Twin	431	15	2008 →		RCJ8Y	0.6
FH451V	OHV Vertical 4-Cycle V-Twin	494	15			RCJ8Y	0.6
FH500V	OHV Vertical 4-Cycle V-Twin	494	17			RCJ8Y	0.8
FH531V	OHV Vertical 4-Cycle V-Twin	494	18			RCJ8Y	0.6
FH541V	OHV Vertical 4-Cycle V-Twin	585	17	2008 →		RCJ8Y	0.6
FH580V	OHV Vertical 4-Cycle	585	19	2008 →		RCJ8Y	0.6
FH580V KAI	OHV Vertical 4-Cycle	585	19	2008 →		RCJ8Y	0.6
FH601D	OHV Horizontal 4-Cycle V-Twin	675	19	2008 →		RN14YC	0.6
FH601V	OHV Vertical 4-Cycle V-Twin	675	19		OE051	RN11YC	0.6
FH641D	OHV Horizontal 4-Cycle V-Twin	675	21	2008 →		RN14YC	0.6
FH641V	OHV Vertical 4-Cycle V-Twin	675	21	2008 →		RN14YC	0.6
FH671D	OHV Horizontal 4-Cycle Liquid Cooled; V-Twin		23		OE042	RN12YC	0.6
FH680D	OHV Horizontal 4-Cycle V-Twin	675	23	2008 →		RN14YC	0.6
FH680V	OHV Vertical 4-Cycle V-Twin	675	23	2008 →		RN14YC	0.6
FH711D	OHV Horizontal 4-Cycle Liquid Cooled; V-Twin		25		OE042	RN12YC	0.6
FH721D	OHV Horizontal 4-Cycle Liquid Cooled; V-Twin	675	25	2008 →		RN14YC	0.6
FH721V	OHV Vertical 4-Cycle V-Twin	675	25			RN14YC	0.6
FH750D	OHV Horizontal 4-Cycle Liquid Cooled; V-Twin		27		OE042	RN12YC	0.6
FH781V	OHV Horizontal 4-Cycle		28		OE042	RN12YC	0.6
FH841V	OHV Horizontal 4-Cycle		30		OE042	RN12YC	0.6
FH900V	OHV Horizontal 4-Cycle		33		OE042	RN12YC	0.6
	OHV Horizontal 4-Cycle				OE042	RN12YC	0.6
FJ100D	OHV Horizontal 4-Cycle	98	3	2008 →		RL86C	0.8
FJ180V	OHV Vertical 4-Cycle	179	6		OE051	RN11YC	0.8





CC BHP



OPT.



...KAWASAKI

...Engines

FJ400D	OHV Horizontal 4-Cycle		13			OE051	RN11YC	0.8
FX1000V	OHV Vertical 4-Cycle	999	37	2008→		OE051	RN11YC	0.8
FX730V	OHV Vertical 4-Cycle			2008→			RN14YC	0.6
FX751V	OHV Vertical 4-Cycle	852	27	2008→			RN14YC	0.6
FX801V	OHV Vertical 4-Cycle	852	29	2008→			RN14YC	0.6
FX850V	OHV Vertical 4-Cycle	852	31	2008→			RN14YC	0.6
KF100D	2-Cycle		10				L90C	0.6
KF150	2-Cycle		14				L90C	0.6
KF200	2-Cycle		20				L90C	0.6
	2-Cycle						L90C	0.6
KF24	2-Cycle		2.4				RL86C	0.6
KF34	2-Cycle		3.4				RJ8C	0.6
KF53D	2-Cycle		5				RL86C	0.6
KF64	2-Cycle		6.5				RJ8C	0.8
KF68	2-Cycle		7				RJ8C	0.6
KF81	2-Cycle		8.1				RJ8C	0.8
KF82	2-Cycle		8.2				L90C	0.6
KT10	2-Cycle		1				CJ6	0.8
KT12AD/J	2-Cycle		1.2				RCJ8	0.8
KT15	2-Cycle		1.3				CJ6	0.8
KT17J	2-Cycle		1.5				CJ6	0.8
KT18	2-Cycle		1.8				RCJ8	0.8
KT28	2-Cycle		2.8				RCJ8	0.8
KT30	2-Cycle		2.1				RJ8C	0.8
KT43	2-Cycle		4				RL86C	0.8
TA22MX	2-Cycle		0.8				RCJ8	0.8
TA33MX	2-Cycle		1.2				CJ6	0.8
TA36MX	2-Cycle		2.3				RJ6C	0.8
TA51MX	2-Cycle		3.1				RCJ8	0.8
TD18	2-Cycle		0.6				RCJ8	0.8
TD24	2-Cycle		0.8				RCJ8	0.8
TD33	2-Cycle		1.2				RCJ8	0.8
TD40	2-Cycle		1.65				RCJ8	0.8
TD48	2-Cycle		2.9				RCJ8	0.8
TE40-MX	2-Cycle		2.4				RCJ8	0.8
TEX45	2-Cycle		3.2				RCJ6Y	0.8
TEX54	2-Cycle		3.7				RCJ8Y	0.8
TF22	2-Cycle		0.8				RCJ8	0.8
TG20	2-Cycle		0.7				RCJ8	0.8
TG24	2-Cycle		0.8				RCJ8	0.8
TG28	2-Cycle		1.6				RCJ8	0.8
TG33	2-Cycle		1.2				CJ6	0.8
TH23	2-Cycle		1.3				RCJ7Y	0.8
TH26	2-Cycle		1.5				RCJ7Y	0.8

Generators

6000	OHV					OE051	RN11YC	0.6
AS							RCJ8	0.6
GA1000A1, GA1400A1							RJ8C	0.6
GA1800A1, GA2300A, GA2800A, GA3200A						OE059	L92YC	0.6
GA550A1, GD550, GD700A, GD700A1, GD700A51							RCJ8	0.6
GE2200A1, GE2900A, GE4000, GE4300A, GE4500A, GE5000AS	OHV					OE051	RN11YC	0.6
KG1000, KG1100							RJ8C	0.6
KG1300						OE059	L92YC	0.6
KG1500, KG1600							RL86C	0.6
KG2300, KG2600, KG2900							RJ8C	0.6
KG4000A51, KG500, KG5000A53, KG600, KG700, KG750							RL86C	0.6
KG750B1, KG900							RJ8C	0.6
Ninja 700							RCJ8	0.6
Power Partner 4000	OHV					OE051	RN11YC	0.6





CC BHP

21



OPT.

mm

**...KAWASAKI**

**Hedge Trimmers**

KCL525A, KCL525AC, KCS525A, KCS525AC	26			RCJ6Y	
KHS1100B, KHS750B	22			RCJ7Y	
KHS750BC	22			RCJ6Y	
KHT600D, KHT600S	22			RCJ7Y	
KHT600SC	22			RCJ6Y	
KHT750D, KHT750S	22			RCJ7Y	
KHT750SC	22			RCJ6Y	

**Power Equipment**

KBL23A, KBL25A				RCJ8Y	0.8
KBL26A, KBL27A, KBL34A, KEL26A, KGT27A				RCJ7Y	0.8
KHD600A				CJ14	0.8
KHD600B				RCJ7Y	0.8
KHS1100A				CJ14	0.8
KHS1100B				RCJ7Y	0.8
KHS750A, KHS750AC				CJ14	0.8
KHT600D, KHT600S				RCJ7Y	0.8
KHT600SC				RCJ6Y	0.8
KHT750D, KHT750S				RCJ7Y	0.8
KHT750SC				RCJ6Y	0.8
KRB400A, KRB400B, KRB450BC, KRB700B				RCJ6Y	0.8
KTR27A				RCJ7Y	0.8

**Pumps**

Kawasaki OHV	4,5.5,8,9.5		OE051	RN11YC	0.8
--------------	-------------	--	-------	--------	-----

**Trimmers**

KBL27B, KBL27BC	26			RCJ7Y	
KGT26AC	25			RCJ7Y	
KGT37A, KTF27A, KTF27AC	26			RCJ7Y	
KTR26AC	25			RCJ6Y	

**Utility Vehicles**

3010, 3020				RN14YC	0.8
Mule 500 KAF300B1, Mule 520/550			OE051	RN11YC	0.8
Mule 1000 KAF450B1			OE083	RA6HC	0.8
Mule 2500 KAF620B1, Mule 2500 KAF620C1, Mule 2510 KAF620A1, Mule 2520 Turf				CJ14	0.8
Mule 3000				RN14YC	0.8

**KC TURF EQUIPMENT**

**Mowers**

Wisconsin	20			RD16	0.8
Kohler Twin	18			RV17YC	0.6

**KECO**

**Pumps**

Marine Pump-A-Head Jr.	Briggs & Stratton	3,3.5		RJ19LM	QJ19LM	0.8
------------------------	-------------------	-------	--	--------	--------	-----

**KEE**

**Lawn Mowers**

Briggs & Stratton				RJ19LM	QJ19LM	0.8
Kohler K181	8			RJ19LM		0.8
Honda OHV	5.5		OE051	RN11YC		0.8

**Power Equipment**

Honda	2,2,2.5			CJ14		0.8
Briggs & Stratton Intek OHV	6		OE013	RC12YC	QC12YC / XC92YC	0.5
	2			RCJ8Y		0.8
Briggs & Stratton	3,3.5,5,6			RJ19LM	QJ19LM	0.8
Briggs & Stratton	8,8.5			RJ19LM	QJ19LM	0.8
Honda OHV	4		OE051	RN11YC		0.8
Honda OHV	5.5		OE051	RN11YC		0.8
Honda OHV	5		OE006	RN9YC		0.8



CC

BHP

21



OPT.



mm

**KEES (→ Yazoo/Kees)****KEES, F.J.****Lawn Mowers**

Honda	2.2		RCJ7Y		0.8
Briggs & Stratton			RJ19LM	QJ19LM	0.8

**KETCHUM AQUA SEEDER****Power Equipment**

Wisconsin	37		RD16		0.8
Tecumseh	3.5		RJ19LM		0.8
Tecumseh	8		RJ8C		0.8
Robin	6		RL86C		0.6
Robin	8.5		RL87YC		0.6
Tecumseh OHV	14	OE098	RN4C		0.8
Tecumseh OHV	5	OE098	RN4C		0.8
Robin OHV	11,13.5,18, 20,22	OE006	RN9YC		0.8

**KIFCO****Power Equipment**

Self-Priming Skid	Honda OHV	8	OE051	RN11YC	0.8
-------------------	-----------	---	-------	--------	-----

**Pumps**

Booster	Honda OHV	5.5	OE051	RN11YC	0.8
---------	-----------	-----	-------	--------	-----

**KINCAID****Mulchers**

Kohler	18,20,22,25,27	OE013	RC12YC		0.8
Honda	13,18,20,24	OE051	RN11YC		0.8

**Mulchers, Seeders**

AgiGators	Honda GX390	13	OE051	RN11YC	0.8
	Robin OHV	18,25	OE006	RN9YC	0.6

**KINCO****Lawn Mowers**

All Models			RJ19LM		0.8
------------	--	--	--------	--	-----

**Power Equipment**

Briggs & Stratton			RJ19LM	QJ19LM	0.8
Tecumseh			RJ8C		0.8

**KING O'LAWN****Augers**

MK VII			RCJ8		0.8
--------	--	--	------	--	-----

**Chain Saws**

Mark II			RCJ8		0.6
---------	--	--	------	--	-----

**Lawn Mowers**

All Models			RJ19LM		0.8
------------	--	--	--------	--	-----

**Power Equipment**

Briggs & Stratton	3,3.5,3.75,5		RJ19LM	QJ19LM	0.8
Tecumseh	2.5,3,4		RJ8C		0.8

**KING TREE TAPPER****Power Equipment**

All Models			RJ12C		0.6
------------	--	--	-------	--	-----

**KINGSTON****Generators**

King Aurora			RJ12C		0.6
-------------	--	--	-------	--	-----



CC BHP

21



OPT.



mm

**KIORITZ**

**Engines**

55			RCJ7Y	0.8
78.6			RCJ7Y	0.8
24			RCJ7Y	0.8
16			RCJ8	0.8
44.3			RCJ8	0.8
35.2			RCJ8	0.8
30.1			RCJ8	0.8
14			RCJ8	0.8
13.8			RCJ8	0.8
21.2			RCJ8	0.8
20.1			RCJ8	0.8
20			RCJ8	0.8
39.7			RCJ8	0.8
21			RCJ8	0.8
30.8			RCJ8	0.8
49.9			RCJ8Y	0.8
28			RCJ8Y	0.8

**KLAUER**

**Snow Removers**

All Models

RJ19LM	0.8
--------	-----

**KLEEN KUT**

**Lawn Mowers**

All Models

RJ19LM	0.8
--------	-----

**KLOPPING-HARDIE**

**Thatchers**

RCJ8	0.8
------	-----

**KLUGE**

**Earth Augers**

Earth Augers

RCJ8	0.8
------	-----

**K-MART**

**Lawn Mowers**

All Models

RJ19LM	0.8
--------	-----

**KMI**

**Pressure Cleaners**

Briggs & Stratton	5,10,11		RJ19LM	QJ19LM	0.8
Robin	4.8,8,11		RL86C		0.6
Honda OHV	9,11,13	OE051	RN11YC		0.8

**KODIAK**

**Generators**

Honda GC160, GX160, GX270, GX390, GX620		OE051	RN11YC		0.8
---	--	-------	--------	--	-----

**KOHLER**

**Engines**

Aegis LH630	Liquid Cooled 4-Cycle; V-Twin; OHV	624	22		RC14YC	0.8
Aegis LH640	Liquid Cooled 4-Cycle; V-Twin; OHV	624	22		RC14YC	0.8
Aegis LH685	Liquid Cooled 4-Cycle; V-Twin; OHV	674	25		RC14YC	0.8
Aegis LH690	Liquid Cooled 4-Cycle; V-Twin; OHV	674	26		RC14YC	0.8
Aegis LH750	Liquid Cooled 4-Cycle; V-Twin; OHV		27		RC14YC	0.8
Aegis LH755	Liquid Cooled 4-Cycle; V-Twin; OHV	748	28		RC14YC	0.8
Aegis LH775	Liquid Cooled 4-Cycle; V-Twin; OHV; EFI	748	31		RC14YC	0.8
Aegis LV560	Liquid Cooled 4-Cycle; V-Twin; OHV		17		RC14YC	1.0
Aegis LV625	Liquid Cooled 4-Cycle; V-Twin; OHV	624	20		RC14YC	0.8
Aegis LV675	Liquid Cooled 4-Cycle; V-Twin; OHV		23		RC14YC	1.0
Aegis LV680	Liquid Cooled 4-Cycle; V-Twin; OHV	674	24		RC14YC	0.8
Command Pro CS12	4-Cycle; Single; OHV	357	12		RN14YC	0.8
Command Pro CS6	4-Cycle; Single; OHV	171	6		RN14YC	0.8
Command Pro CS8.5	4-Cycle; Single; OHV	250	8.5		RN14YC	0.8
Command/Command Pro CH1000	Horizontal; V-twin	999	40	2008 →	XC10YC	0.8
Command/Command Pro CH11	4-Cycle; Single; OHV	398	11		OE013 RC12YC	3071 1.0





CC BHP



OPT.



**...KOHLER**

**...Engines**

Model	Engine Type	CC	BHP	Year	OE	RC	OPT.	mm
Command/Command Pro CH11 (LPG)	Air Cooled, Single; OHV	398	11		OE041	RC12LYC		0.8
Command/Command Pro CH12.5	4-Cycle; Single; OHV	398	12.5		OE013	RC12YC	3071	1.0
Command/Command Pro CH13	4-Cycle; Single; OHV	398	13		OE013	RC12YC	3071	1.0
Command/Command Pro CH13 (LPG)	4-Cycle, Single; OHV	398	13		OE041	RC12LYC		1.0
Command/Command Pro CH14	4-Cycle; Single; OHV	398	14	2008 →	OE013	RC12YC	3071	1.0
Command/Command Pro CH14 (LPG)	Air Cooled, Single; OHV	398	14		OE041	RC12LYC		0.8
Command/Command Pro CH15	4-Cycle; Single; OHV	426	15	2007 →	OE013	RC12YC	3071	1.0
Command/Command Pro CH16	4-Cycle; Single; OHV	426	16	2008 →	OE013	RC12YC	3071	0.8
Command/Command Pro CH18	4-Cycle; V-Twin; OHV	624	18		OE013	RC12YC	3071	0.8
Command/Command Pro CH20	4-Cycle; V-Twin; OHV		20		OE013	RC12YC	3071	0.8
Command/Command Pro CH20 (LPG)	4-Cycle; V-Twin; OHV		20		OE013	RC12YC	3071	0.5
Command/Command Pro CH22	4-Cycle; V-Twin; OHV	674	22		OE013	RC12YC	3071	0.8
Command/Command Pro CH23	4-Cycle; V-Twin; OHV	674	22		OE013	RC12YC	3071	1.0
Command/Command Pro CH25	4-Cycle; V-Twin; OHV		25		OE013	RC12YC	3071	0.8
Command/Command Pro CH26	4-Cycle; V-Twin; OHV; EFI	725	26		OE013	RC12YC	3071	0.8
Command/Command Pro CH27	Air Cooled; V-Twin; OHV		27		OE013	RC12YC		1.0
Command/Command Pro CH430		426	13		OE081	RC8YCC4		1.0
Command/Command Pro CH5	OHV		5		OE013	RC12YC		1.0
Command/Command Pro CH6	4-Cycle; OHV	180	6		OE013	RC12YC	3071	1.0
Command/Command Pro CH730	4-Cycle; V-Twin; OHV	725	25		OE013	RC12YC	3071	0.8
Command/Command Pro CH740	4-Cycle; V-Twin; OHV	725	27		OE013	RC12YC	3071	0.8
Command/Command Pro CH745	OHV; EFI	725	28	2008 →		3071	XC12YC	0.8
	4-Cycle; V-Twin; OHV	725	28		OE013	RC12YC	3071	0.8
Command/Command Pro CH750	4-Cycle; V-Twin; OHV	747	30	2007 →	OE013	RC12YC	3071	0.8
Command/Command Pro CH940		999	34	2008 →		XC10YC		0.8
Command/Command Pro CH960		999	36	2008 →		XC10YC		0.8
Command/Command Pro CH980	V-Twin	999	38	2008 →		XC10YC		0.8
Command/Command Pro CS10	4-Cycle; Single; OHV	301	10			RN14YC		0.8
Command/Command Pro CS13 Hydro	4-Cycle; Single; OHV		13		OE013	RC12YC	3071	0.8
Command/Command Pro CS4	4-Cycle; Single; OHV	123	4			RN14YC		0.8
Command/Command Pro CV1000		999	40	2008 →		XC10YC		0.8
Command/Command Pro CV11	4-Cycle; Single; OHV	398	11	2008 →	OE013	RC12YC	3071	1.0
Command/Command Pro CV11 (LPG)	Air Cooled, Single; OHV	398	11		OE041	RC12LYC		0.8
Command/Command Pro CV12.5	4-Cycle; Single; OHV	398	12.5		OE013	RC12YC	3071	1.0
Command/Command Pro CV13	4-Cycle; Single; OHV	398	13		OE013	RC12YC	3071	1.0
Command/Command Pro CV13 (LPG)	4-Cycle, Single; OHV	398	13		OE041	RC12LYC		1.0
Command/Command Pro CV14	4-Cycle; Single; OHV	398	14		OE013	RC12YC	3071	1.0
Command/Command Pro CV14 (LPG)	Air Cooled, Single; OHV	398	14		OE041	RC12LYC		0.8
Command/Command Pro CV15	4-Cycle; Single; OHV	426	15	2007 →	OE013	RC12YC	3071	1.0
Command/Command Pro CV16	4-Cycle; Single; OHV	426	16	2008 →	OE013	RC12YC	3071	0.8
Command/Command Pro CV17	Air Cooled; V-Twin; OHV	561	17		OE013	RC12YC		0.8
Command/Command Pro CV18	4-Cycle; V-Twin; OHV	624	18		OE013	RC12YC	3071	0.8
Command/Command Pro CV20	4-Cycle; V-Twin; OHV	624	20		OE013	RC12YC	3071	0.8
	Air Cooled; V-Twin; OHV		20		OE013	RC12YC		0.8
Command/Command Pro CV22	4-Cycle; V-Twin; OHV	674	22		OE013	RC12YC	3071	0.8
Command/Command Pro CV23	4-Cycle; V-Twin; OHV	674	23		OE013	RC12YC	3071	0.8
Command/Command Pro CV25	4-Cycle; V-Twin; OHV		25		OE013	RC12YC	3071	0.8
Command/Command Pro CV26	4-Cycle; V-Twin; OHV; EFI	725	26		OE013	RC12YC	3071	0.8
Command/Command Pro CV3	Air Cooled, Single; OHV	426	13		OE013	RC12YC	3071	1.0
Command/Command Pro CV460	4-Cycle; OHV	460	16		OE013	RC12YC	3071	1.0
Command/Command Pro CV490	Air Cooled, Single; OHV	490	17		OE013	RC12YC	3071	1.0
Command/Command Pro CV492	Air Cooled, Single; OHV	490	18		OE013	RC12YC	3071	1.0
Command/Command Pro CV493	4-Cycle; Single; OHV	490	17		OE013	RC12YC	3071	1.0
Command/Command Pro CV730	4-Cycle; V-Twin; OHV	725	25	2008 →	OE013	RC12YC	3071	0.8
Command/Command Pro CV740	4-Cycle; V-Twin; OHV	725	27			3071	XC12YC	0.8
Command/Command Pro CV745	OHV; EFI	725	28	2008 →		3071	XC12YC	0.8
Command/Command Pro CV750		748	30	2008 →		3071	XC12YC	0.8
Command/Command Pro CV940		999	34	2008 →		XC10YC		0.8
Command/Command Pro CV960		999	36			XC10YC		0.8
Command/Command Pro CV980		999	38	2008 →		XC10YC		0.8



CC BHP



OPT.



**...KOHLER**

**...Engines**

Command/Command Pro XKE6	4-Cycle; OHV	180	6		OE013	RC12YC	3071	1.0
Courage Pro SV810		725	20	2008 →		XC12YC		0.8
Courage Pro SV820	V-Twin; OHV	725	23			XC12YC		0.8
Courage Pro SV830		725	25	2008 →		XC12YC		0.8
Courage Pro SV840		725	27	2008 →		XC12YC		0.6
Courage SV470	Air Cooled, Single; OHV	535	15		OE013	RC12YC		0.8
Courage SV480	Air Cooled, Single; OHV	535	16		OE013	RC12YC		0.8
Courage SV530	Air Cooled, Single; OHV	535	17		OE013	RC12YC		0.8
Courage SV540	Air Cooled, Single; OHV	535	18		OE013	RC12YC		0.8
Courage SV590	Air Cooled, Single; OHV	597	19		OE013	RC12YC		0.8
Courage SV600	Air Cooled, Single; OHV	597	20		OE013	RC12YC		0.8
Courage SV610		597	21	2008 →	OE013	RC12YC		0.8
Courage SV620		597	22	2008 →	OE013	RC12YC		0.6
Courage SV710		725	20	2008 →		XC12YC		0.8
Courage SV715		725	22	2008 →		XC12YC		0.8
Courage SV720		725	23	2008 →		XC12YC		0.8
Courage SV725		725	24	2008 →		XC12YC		0.8
Courage SV730		725	25	2007 →		XC12YC		0.6
Courage SV735		725	26	2008 →		XC12YC		0.8
Courage SV740		725	27	2008 →		XC12YC		0.8
Courage XT-6		173	3.5	2008 →	OE013	RC12YC		0.6
Courage XT-7		173	4.5	2008 →	OE013	RC12YC		0.6
K-Series K12			4			RJ12C		0.6
K-Series K121			5			RJ8C		0.6
K-Series K141			6.25			RJ19LM		0.6
K-Series K161			7			RJ19LM		0.6
K-Series K181			8			RJ19LM		0.6
K-Series K241			10			RH10C		0.8
K-Series K301			12			RH10C		0.8
K-Series K321			14			RH10C		0.8
K-Series K330			12.5			RJ19LM		0.8
K-Series K331			12.5			RJ19LM		0.8
K-Series K341			16			RH10C		0.8
K-Series K361			18			RH10C		0.8
K-Series K532			20			RH10C		0.8
K-Series K582	Twin		23			RH10C		0.8
K-Series K660			24			RJ19LM		0.8
K-Series K662			24			RJ19LM		0.8
K-Series K7			2.7			RJ12C		0.6
K-Series K90			4			RJ19LM		0.6
K-Series K91			4			RJ19LM		0.6
K-Series KT17	Twin		17			RV17YC		0.6
K-Series KT19	Twin		19			RV17YC		0.6
K-Series KT21	Twin		21			RV17YC		0.6
K-Series L161			7			RJ19LM		0.6
K-Series L181			8			RJ19LM		0.6
Magnum M10			10			RH10C		0.8
Magnum M12			12			RH10C		0.8
Magnum M14			14			RH10C		0.8
Magnum M16			16			RH10C		0.8
Magnum M18	Twin		18			RV17YC		0.6
Magnum M20	Twin		20			RV17YC		0.6
Magnum M8			8			RCJ8		0.6
	Extended Idle		8			RJ19LM		0.6
Magnum MV16	Twin		16			RV17YC		0.6
Magnum MV18	Twin		18			RV17YC		0.6
Magnum MV20	Twin		20			RV17YC		0.6
Triad TH16	Air Cooled; V-Twin; OHC		16		OE013	RC12YC		1.0
Triad TH18	Air Cooled; V-Twin; OHC		18		OE013	RC12YC		1.0
Triad TH520	Air Cooled; V-Twin; OHC		16		OE013	RC12YC		1.0
Triad TH575	Air Cooled; V-Twin; OHC		18		OE013	RC12YC		1.0
<b>Generators</b>								
1.5KW	Kohler K90					RJ8C		0.6
1.75MBFM						RCJ8		0.6
1.75MBM25, 1.75MM25						RJ8C		0.6
100KW						RD16		0.6
100KW (CNG)						D9		0.4



CC BHP

21



OPT.



mm

**...KOHLER**

**...Generators**

10KW	Hess			K97F		0.5
	FC (18mm)			RD16		0.8
	Waukesha 180GLB			RD16		0.6
15KW	Waukesha 185GLB			RD16		0.6
175MFM				RJ8C		0.6
1KW	D (18mm)			RD16		0.6
	Kohler K160			RJ8C		0.6
	D (7/8"-18)			W16Y		0.6
2.25MBFM25, 2.25MBFM45				RCJ8		0.6
2.25MBM25				RJ8C		0.6
2.5KW	Kohler K160			RJ8C		0.6
2.5MV55				RJ8C		0.6
25KW				RJ6C		0.6
25KW (LPG)				RJ6C		0.4
25R81				RJ6C		0.6
25R81 (LPG)				RJ6C		0.4
2KW	Kohler K241			RH10C		0.6
	Kohler L600			RJ12C		0.6
3.5KW	Kohler L600			RJ12C		0.6
	Kohler K331			RJ8C		0.6
3.5MBFM45, 3.5MBFM65, 3.5MBM25, 3.5MBM65				RCJ8		0.6
3.5MFM65, 3.5MM25, 3.5MM65				RJ8C		0.6
350 Watt	Kohler K7			RJ12C		0.6
35KW	Waukesha 195GL			RD16		0.8
3A-27				XMJ14		0.6
3MM25, 3MMV55, 4A-23				RJ8C		0.6
4CM21				RH10C		0.6
500 Watt	Kohler K90			RJ8C		0.6
50KW				RD16		0.6
50KW (CNG)				D9		0.4
5KW	FC (18mm)			RD16		0.8
	Kohler K21			RH10C		0.6
	Kohler K662			RJ12C		0.6
	Kohler L600			RJ12C		0.6
	Kohler L160			RJ8C		0.6
	FC (7/8"-18)			W16Y		0.6
5MBM25, 5MBM65				RCJ8		0.6
5MFM45				RJ8C		0.6
5MM25, 5MM65				RH10C		0.6
6.5KW	Kohler K662			RJ12C		0.6
7.5A-23				RJ8C		0.6
750 Watt	Kohler K12			RJ12C		0.6
75R81				RD16		0.6
800W	Briggs & Stratton For Fouling			D21		0.6
	Briggs & Stratton (18mm)			RD16		0.6
	Briggs & Stratton (14mm)			RJ19LM	QJ19LM	0.6
K161, K181, K330, K331, K660, K91				RJ8C		0.6
KT17, KT19, KT21				RV15YC4		0.6
L160, L161, L654				RJ8C		0.6
Marine 10C	Ford 1.1, 1.3L			OE011	RS9YC	0.9
Marine 12.5C	Ford 1.1, 1.3L			OE011	RS9YC	0.9
Marine 3.5CFZ, 4CZ	Honda Liquid	13			RL87YC	0.6
Marine 4EF	Kawasaki Liquid V-Twin	16			CJ14	0.6
Marine 5CFZ	Honda Liquid	13			RL87YC	0.6
Marine 5E	Kawasaki Liquid V-Twin	16			CJ14	0.6
Marine 6.5CZ	Honda Liquid	13			RL87YC	0.6
Marine 6EF, 7.3E	Kawasaki Liquid V-Twin	16			CJ14	0.6
Marine 8C	Ford 1.1, 1.3L			OE011	RS9YC	0.9
Marine 8E	Ford 1.1, 1.3L			OE011	RS9YC	0.9
	Wisconsin VH4D				RD16	0.6
	Daihatsu FE			OE042	RN12YC	0.6





CC BHP

21



OPT.



mm

**KOMATSU ZENOAU****Engines**

G1A	14.9			RCJ8	0.6
G1A6	14.9			RCJ8	0.6
G2A	22.5			RCJ8	0.6
G2A16	22.5			CJ6	0.6
G2C	22.5			CJ6	0.6
G2D	22.5			CJ6	0.6
G2D30	22.5			CJ6	0.6
G2E	25.4			RCJ8	0.6
G3C	31.7			RL86C	0.6
G3C76	31.7			RL86C	0.6
G3D10	31.7			RCJ8Y	0.6
G3D20	31.7			RCJ8Y	0.6
G4C	37.4			RL86C	0.6
G4C63	37.4			RL86C	0.6
G4C76	37.4			RL86C	0.6
G5C	52.5			RJ8C	0.6
G5E	52.5			RL86C	0.6
G5E2	52.5			RL86C	0.6
	17.2			RCJ8	0.6

**KROMER****Turf Equipment**

Athletic Field Maintainer	Kohler	8		RH10C	0.8
---------------------------	--------	---	--	-------	-----

**KUBOTA****Engines**

DF1005-E	31			OE013 RC12YC	0.8
DF1005-E (LPG)	31			OE013 RC12YC	0.5
DF752-E	23			OE013 RC12YC	0.8
DF752-E (LPG)	22			OE013 RC12YC	0.5
GH170-1	5.5			RL95YC	0.7
GH250	8			RL95YC	0.7
GH280	9			RL95YC	0.7
GH400	13			RL95YC	0.7
WG1005	996	32.4	2007 →	OE013 RC12YC	
WG1005-E	31			OE013 RC12YC	0.8
WG1005-E (LPG)	29.5			OE013 RC12YC	0.5
WG600-B	21			OE013 RC12YC	0.8
WG750-B	24.5			OE013 RC12YC	0.8
WG752	24.5		2007 →	RC14YC	0.8
WG752-E	23			OE013 RC12YC	0.8
WG752-E (LPG)	22			OE013 RC12YC	0.5
WG972	962	32.4	2007 →	OE013 RC12YC	0.6

**Generators**

450				CJ14	0.6
A1000, A1400, A2200, A3000, A3500, A5000, A650				OE059 L92YC	0.6
AE2200, AE3500, AE4500, AE6500				RL95YC	0.6
ARX2500, ARX4000				RL87YC	0.6
ARX5500, ARX5500B, ARX6500B				RL95YC	0.6
AV1600, AV2500, AV3800, AV4500, AV5500B, AV6500B				RL87YC	0.6

**Lawn Mowers**

	Honda OHV	5		OE006 RN9YC	0.8
--	-----------	---	--	-------------	-----

**Lawn Tractors**

AT25, AT55, AT60, AT70S, AT70SE				L90C	0.8
G2000, G2000S, G2460, G2460G				OE013 RC12YC	0.8
T1400H				RL95YC	0.8
T1460H				CJ14	0.6
T1560H				L90C	0.6
T1570, T1670	Liquid Cooled V-Twin			CJ14	0.6
T1700HX				OE051 RN11YC	0.8



CC BHP

21



OPT.



mm

## ...KUBOTA

### ...Lawn Tractors

T1760, TG1860	Liquid Cooled V-Twin			RCJ8	0.6
	Kawasaki	14		L90C	0.6
	Kubota WG600-B	21	OE013	RC12YC	0.8
	Kubota WG750-B	24.5	OE013	RC12YC	0.8
	Kubota WG600-B Servere Duty	21	OE005	RC9YC	0.8
	Kubota WG750-B Servere Duty	24.5	OE005	RC9YC	0.8
	Kawasaki	12.5		RCJ8	0.6
	Kawasaki Liquid-Cooled V-Twin	19		RCJ8	0.6
	Kubota T1770, T1870 Liquid-Cooled OHV	17,18		RCJ8	0.6
	Kawasaki	17	OE051	RN11YC	0.8
	Kohler Twin	19		RV17YC	0.6

### Pumps, Compressors & Refrigeration Units

GS130, GS200, GS288			OE059	L92YC	0.6
KGP15, KGP20, KGP20T, KGP30, KGP30T, KGP40, KGP40T				RL95YC	0.6
KVP20, KVP20S, KVP20T, KVP30, KVP30T, KVP40, KVP40T				RL87YC	0.6

## KUKER

### Sprayers

Briggs & Stratton, Tecumseh			RJ19LM	QJ19LM	0.8
-----------------------------	--	--	--------	--------	-----

## KUT-KWICK

### Lawn Mowers

Kohler			RH10C		0.8
Briggs & Stratton			RJ19LM	QJ19LM	0.8

### Mowers

Kohler V-Twin	23	OE013	RC12YC		0.8
Wisconsin			RD16		0.8
Kohler			RH10C		0.8
Briggs & Stratton			RJ19LM	QJ19LM	0.8
Onan Twin	20,24		RS17YX		0.8

## KWH

### Power Equipment

44	JLO		OE086	RL82C	0.5
66	Sachs		OE064	RL82YC	0.5
7-11, 79	Sachs			RL86C	0.5

## KWIK

### Thatcher

Briggs & Stratton	5		RJ19LM	QJ19LM	0.8
Honda OHV	5.5	OE006	RN9YC		0.8

## KWIK KERB

### Concrete Borders

Honda	2.5		CJ14		0.8
Honda OHV	5.5,8	OE051	RN11YC		0.8

## KWIK-TRENCH

### Trenchers

Briggs & Stratton	5		RJ19LM	QJ19LM	0.8
Wisconsin	4.6,5,5.5,6		RL86C		0.6
Wisconsin	7.5		RL87YC		0.6
Honda OHV	5.5,8	OE051	RN11YC		0.8
Honda OHV	5	OE006	RN9YC		0.8

## KWIK-WAY

### Power Equipment

Clinton			RH10C		0.8
Briggs & Stratton			RJ19LM	QJ19LM	0.8
Kohler			RJ19LM		0.8



CC BHP

21



OPT.

mm

## LA FONT

### Log Splitters

Kohler	23		RH10C		0.8
Briggs & Stratton			RJ19LM	QJ19LM	0.8
Onan NHC			RN5C		0.8

## LAMBERT

### Power Equipment

Briggs & Stratton	5		RJ19LM	QJ19LM	0.8
Tecumseh			RJ8C		0.8

### Snow Removers

Tecumseh			RJ19LM		0.8
----------	--	--	--------	--	-----

## LANCASTER

### Chain Saws

500			RH12		0.8
555			RCJ8		0.8
558			RJ6C		0.8
560			RCJ8		0.8
585			RH10C		0.8
600			RH12		0.8
645			RJ8C		0.8
650			RJ6C		0.8
655			RJ8C		0.8
658			RJ6C		0.8
670			RJ8C		0.8
200A			RJ8C		0.8
318A, 318PI			RJ12C		0.8
325, 350, 350A, 350B			RJ8C		0.8
400A			RJ12C		0.8
400B, 400S, 425, 440, 447, 450			RJ8C		0.8
50/1L			RCJ8		0.9
50HL			RCJ8		0.9
540, 547, 550			RJ8C		0.8
600HL, 60HL			RCJ8		0.9
700HL			RCJ8		0.9
Eight-20			OE086	RL82C	0.8
Mini Auto, Mini-Twelve				RCJ8	0.8
Six-10			OE086	RL82C	0.8
SLA/20				RCJ8	0.8

### Pumps

Mini-Pump			CJ14		0.6
-----------	--	--	------	--	-----

### Pumps, Compressors & Refrigeration Units

All Other			RJ8C		0.6
-----------	--	--	------	--	-----

## LANCO

### Tillers

Briggs & Stratton Vanguard V-Twin	12		RC14YC		0.8
Briggs & Stratton	8		RJ19LM	QJ19LM	0.8
Honda OHV	8,11		OE051	RN11YC	0.8

## LAND PRIDE

### Power Equipment

Briggs & Stratton Vanguard	9		OE013	RC12YC	QC12YC / XC92YC	0.8
Kohler OHV	6,11		OE013	RC12YC		1.0
Briggs & Stratton	5			RJ19LM	QJ19LM	0.8

### Riding Mowers

Kawasaki V-Twin	23		OE049	RN11YC4		1.0
-----------------	----	--	-------	---------	--	-----

## LANDA

### Pressure Washers

Briggs & Stratton Vanguard OHV	5.5,9		OE013	RC12YC	QC12YC / XC92YC	0.8
Briggs & Stratton Vanguard V-Twin	16			RC14YC		0.8
Briggs & Stratton Single-Cyl.				RJ19LM	QJ19LM	0.8
Honda OHV	5.5,8,9,11,13		OE051	RN11YC		0.8
Honda V-Twin	20		OE051	RN11YC		0.8
Honda OHV	5		OE006	RN9YC		0.8
Onan Twin	24			RS17YX		0.6



CC BHP

21



OPT.



mm

## LANDMARK

### Lawn Mowers

Tecumseh			RJ17LM		0.8
Briggs & Stratton			RJ19LM	QJ19LM	0.8

### Power Equipment

Tecumseh			RJ17LM		0.8
Briggs & Stratton			RJ19LM	QJ19LM	0.8

### Snow Removers

Tecumseh			RJ19LM		0.8
----------	--	--	--------	--	-----

## LANDMASTER

### Mowers

Staic, Saturn	B & S		RJ19LM	QJ19LM	0.7
---------------	-------	--	--------	--------	-----

## LANDONI

### Brushcutters

LF30CF, LF30CL, LF30ST, LF36S, LF36ST, LF38S			RCJ7Y		0.5
--	--	--	-------	--	-----

### Chainsaws

L-40			RCJ8		0.6
L-48E, L-48S			RCJ8Y		0.6
L-75, L-773			RDJ8J		0.6
L-771E, L-771S, L-772E, L-772L, L-772S			RCJ8Y		0.6
L-90			RL78C		0.6
L-98, L-110		OE086	RL82C		0.6

## LANDSCAPERS SUPPLY

### Aerators

Honda OHV	4		OE051	RN11YC	0.8
-----------	---	--	-------	--------	-----

## LARGO

### Power Equipment

Briggs & Stratton Vanguard	11,14,16,18		OE013	RC12YC	QC12YC / XC92YC	0.8
Honda	11,13		OE051	RN11YC		0.8

## LASER

### Lawn Tractors

L 120				RV12YC		0.6
L 80				RJ19LM		0.7
L 85, L 110			OE013	RC12YC		0.8

## LAUSON

### Engines

(Kerosene)	(18mm)			D21		0.8
	(14mm)			RJ12C		0.8
(LPG)	(14mm)			RJ8C		0.4
HH130			OE086	RL82C		0.8
HH140			OE086	RL82C		0.8
HH150			OE086	RL82C		0.8
HH160			OE086	RL82C		0.8
	(18mm)			RD16		0.8
	(14mm)			RJ8C		0.8
	(7/8")			W18		0.8

## LAWN CAD 2000

### Power Equipment

Briggs & Stratton	8			RJ19LM	QJ19LM	0.8
-------------------	---	--	--	--------	--------	-----

### Riding Mowers

Briggs & Stratton Vanguard V-Twin	16			RC14YC		0.8
-----------------------------------	----	--	--	--------	--	-----

## LAWN CHIEF

### Lawn Mowers

Briggs & Stratton	3.5,3.75,4.5			RJ19LM	QJ19LM	0.8
-------------------	--------------	--	--	--------	--------	-----

### Power Equipment

Briggs & Stratton Vanguard V-Twin	14			RC14YC		0.8
Tecumseh	1.6			RCJ8Y		0.8
Briggs & Stratton	3.5,5,10.5, 12,12.5			RJ19LM	QJ19LM	0.8
Briggs & Stratton Twin	18			RJ19LM	QJ19LM	0.8



CC BHP

21



OPT.



mm

**LAWN CRUISER****Lawn Mowers**

All Models

RJ19LM

0.8

**LAWN FLITE****Lawn Mowers**

Briggs &amp; Stratton

RJ19LM

QJ19LM

0.8

Lauson, Power Product Engine

RJ8C

0.8

**Tillers, Tractors**

Briggs &amp; Stratton

RJ19LM

QJ19LM

0.8

Briggs &amp; Stratton Twin

RJ19LM

QJ19LM

0.8

Tecumseh

RJ8C

0.8

**LAWN LEVELER****Rakes**

LL44

Honda

2.5

CJ14

0.8

**LAWN LION****Lawn Mowers**

All Models

RJ19LM

0.8

**LAWN MASTER****Lawn Mowers**

Briggs &amp; Stratton, Tecumseh

RJ19LM

QJ19LM

0.8

**Power Equipment**

Briggs &amp; Stratton Vanguard

4

OE013

RC12YC

QC12YC / XC92YC

0.5

Briggs &amp; Stratton

RJ19LM

QJ19LM

0.8

Tecumseh

RJ19LM

0.8

**LAWN ROV'R****Garden Tractors**

Briggs &amp; Stratton

RJ19LM

QJ19LM

0.8

Briggs &amp; Stratton Twin

RJ19LM

QJ19LM

0.8

Tecumseh

RJ8C

0.8

**Lawn Mowers**

All Models

RJ19LM

0.8

**LAWN ROWER****Lawn Mowers**

All Models

RJ19LM

0.8

**Power Equipment**

Tecumseh

RJ8C

0.8

**LAWN SCOUT****Lawn Mowers**

Briggs &amp; Stratton

RJ19LM

QJ19LM

0.8

Tecumseh

RJ8C

0.8

**LAWN-BOY****Lawn Mowers**

22270

Honda GSV190

190

OE049

RN11YC4

1.0

10682, 10683, 10684,

Tecumseh

195

RJ19LM

10685, 10686, 10687

10694, 10695, 10696, 10697

Honda GCV 160

160

5.5

OE006

RN9YC

10780, 10785

Tecumseh

195

RJ19LM

10795, 10796, 10797

Honda GCV 160

160

5.5

OE006

RN9YC

Goldpro Series

2-Cycle

6.5

RCJ8Y

0.8

Silver Series

4-Cycle

RJ19LM

QJ19LM

0.8

Silverpro Series

2-Cycle

6.5

RCJ8Y

0.8

Lawn-Boy Electronic Ignition

CJ14

0.9

Lawn-Boy Standard Ignition

CJ14

0.8

Lawn-Boy 4535 CT, 8290

RJ12C

0.8

Briggs &amp; Stratton

RJ19LM

QJ19LM

0.8

Tecumseh

RJ19LM

0.8

**Mowers**

Zero-Turn Z310

Briggs &amp; Stratton Intek

465

OE013

RC12YC

QC12YC / XC92YC

0.8

Zero-Turn Z320

Honda GXV530

390

OE051

RN11YC

0.8

Zero-Turn Z330

Briggs &amp; Stratton Intek

465

OE013

RC12YC

QC12YC / XC92YC

0.8



CC BHP



OPT.



**...LAWN-BOY**

Zero-Turn Z340, Z350	Honda GXV530	530	OE051	RN11YC	0.8
<b>Power Equipment</b>					
81245, 81250		530	OE013	RC12YC	
<b>Riding Equipment</b>					
61620, 61638, 61653				RDJ7Y	0.8
80040, 81180, 81182, 81191				RJ19LM	0.8
All Other				CJ14	0.8
	Power Products			RDJ7Y	0.8
	Briggs & Stratton	2,5,8,11,12, 12.5,13		RJ19LM	QJ19LM 0.8
	Briggs & Stratton Twin	16		RJ19LM	QJ19LM 0.8
	Tecumseh			RJ19LM	0.8
	Kohler Twin	18		RV17YC	0.6
<b>Snow Removers</b>					
120R, 1850, 1851, 1871, 1871				CJ14	0.8
320E, 320R				RCJ8Y	0.8
522R				RCJ8	0.8
824E				RJ19LM	0.8
Insight 34001, 34002				RJ19LM	0.8
ST1032				RJ19LM	0.8
ST320, ST320e				RCJ8Y	0.8
ST524				RCJ8	0.8
ST824, ST826				RJ19LM	0.8
	Lawn-Boy 2-Cycle			CJ14	0.6
	Tecumseh	5		RCJ8	0.8
	Tecumseh	3		RCJ8Y	0.8
	Briggs & Stratton			RJ19LM	QJ19LM 0.8
	Tecumseh	8		RJ19LM	0.8

**LAWNCRAFT**

<b>Lawn Mowers</b>					
All Models				RJ19LM	0.8
<b>Tillers</b>					
	Briggs & Stratton			RJ19LM	QJ19LM 0.8

**LAWN-CYCLE**

<b>Lawn Mowers</b>					
All Models				RJ19LM	0.8

**LAY-MOR**

<b>Sweepers</b>					
	Kohler	8		RH10C	0.8
	Briggs & Stratton	5		RJ19LM	QJ19LM 0.8
	Honda OHV	5.5,8	OE051	RN11YC	0.8
	Continental TM-27	61	OE006	RN9YC	0.9

**LAZY BOY**

<b>Lawn Mowers</b>					
All Models				RJ19LM	0.8
<b>Snow Removers</b>					
	Briggs & Stratton			RJ19LM	QJ19LM 0.8
<b>Tillers</b>					
	Briggs & Stratton			RJ19LM	QJ19LM 0.8

**LE ROI**

<b>Pressure Washers</b>					
100RG1				D15Y	0.6
105G1, 105G1T, 105G1U, 105G2	Magnito Ignition			RJ12C	0.6
125G1	(3/8" Reach) Magnito Ignition			RJ12C	0.6
	(3/8" Reach) Distributor Ignition			RJ18YC	0.6
	(3/4" Reach)			RN5C	0.6
125G2	(3/8" Reach) Magnito Ignition			RJ12C	0.6
	(3/8" Reach) Distributor Ignition			RJ18YC	0.6
125RG-1	(18mm)			RD16	0.6
	Ford			RH10C	0.6
	LeRoi			RN5C	0.6





CC BHP

21



OPT.



mm

**...LE ROI****...Pressure Washers**

125RG2, 125TA	(3/4" Reach)			RN5C		0.6
125TA	(3/8" Reach) Magnito Ignition			RJ12C		0.6
	(3/8" Reach) Distributor Ignition			RJ18YC		0.6
130RG1, 150RG1				D15Y		0.6
150RG2	(3/8" Reach) Magnito Ignition			RJ12C		0.6
	(3/8" Reach) Distributor Ignition			RJ18YC		0.6
	(3/4" Reach)			RN5C		0.6
				RN5C		0.6
160RG1, 175SG1, 250RG2				D15Y		0.6
60G1	Magnito Ignition			RJ12C		0.6
75RG1				RD16		0.6
85G1	(3/8" Reach) Magnito Ignition			RJ12C		0.6
	(3/8" Reach) Distributor Ignition			RJ18YC		0.6
	(3/4" Reach)			RN5C		0.6
85RG1				RD16		0.6
	Wisconsin VH4D			RD16		0.6
	Kohler	10,12		RH10C		0.6
	Onan NH, NHCV			RH8C		0.6

**LEAR****Generators**

Roper				CJ6		0.6
McCulloch				RDJ6J		0.6

**LED-O-LITE****Generators**

(1/2"-14 Pipe)				25		0.6
(18mm)				RD16		0.6
(7/8"-18)				W14		0.6

**LEE TILLERS****Tillers**

Tecumseh	1.6			RCJ8Y		0.8
Briggs & Stratton	3.5,5			RJ19LM	QJ19LM	0.8

**LEGUAN****Aerial Lift**

Honda	11,13			OE051	RN11YC	0.8
-------	-------	--	--	-------	--------	-----

**LESCO****Chain Saws**

LCS4500, LCS5100				RCJ6Y		0.8
------------------	--	--	--	-------	--	-----

**Lawn Mowers**

Honda OHV	5.5			OE051	RN11YC	0.8
Kawasaki OHV	5			OE051	RN11YC	0.8

**Pressure Washers**

Briggs & Stratton	5			RJ19LM	QJ19LM	0.8
-------------------	---	--	--	--------	--------	-----

**Snow Removers**

Tecumseh	5			RCJ8Y		0.8
Tecumseh	9			RJ19LM		0.8

**LESCO EQUIPMENT****Hedge Trimmers**

LHD1700				RCJ8Y		0.6
LHS3025				RCJ6Y		0.8
LHS3050				RCJ8Y		0.6
LHS4025				RCJ6Y		0.8
LHS4050, LST2100, LST2450				RCJ8Y		0.6

**Power Equipment**

LBB4200, LHB2100				RCJ8Y		0.6
LHB2500, LHB4400, LHE2500				RCJ6Y		0.8
Kohler	15			OE013	RC12YC	1.0
Kohler V-Twin	20,22,25			OE013	RC12YC	0.8
Briggs & Stratton Vanguard V-Twin	16				RC14YC	0.8
Kawasaki Liquid-Cooled V-Twin	20				RCJ8	0.8
Echo					RCJ8Y	0.6



CC

BHP

21



OPT.

**...LESCO EQUIPMENT****...Power Equipment**

Kawasaki V-Twin	17			RCJ8Y	0.6	
Kohler	8			RH10C	0.8	
Briggs & Stratton	3,5,8,14			RJ19LM	QJ19LM	0.8
Honda OHV	4,5,5,8,13			OE051	RN11YC	0.8
Kawasaki	13,14,17			OE051	RN11YC	0.8
Kawasaki V-Twin	19			OE051	RN11YC	0.8
Kawasaki V-Twin	21,23			OE051	RN11YC	0.8
Kohler OHV	14			OE049	RN11YC4	1.0
Onan Twin	18			RS17YX	0.6	
Kohler Twin	20			RV17YC	0.6	

**Trimmers**

LHD2400				RCJ6Y	0.8
LHE2475				RCJ8Y	0.6
LST2600				RCJ6Y	0.8

**LICKETY-CHIPPER****Power Equipment**

KPM-4				RJ8C	0.8	
WPM-4				RD16	0.8	
	Kohler			RJ19LM	0.8	
	Wisconsin			OE042	RN12YC	0.8

**LIL' BRUTE****Saws**

	Kohler	12,14,16		RH10C	0.8
--	--------	----------	--	-------	-----

**LIL' BUBBA****Augers**

	Honda OHV	4,5,5		OE051	RN11YC	0.8
--	-----------	-------	--	-------	--------	-----

**Concrete Borders**

	Honda GX100 OHV	3		Z9Y	0.8
--	-----------------	---	--	-----	-----

**LIMA****Lawn Mowers**

	Clinton			RH10C	0.6
	Lauson			RJ19LM	0.8

**LINAMAR****Engines**

LX Series	Horizontal Shaft	16		RS17YX	0.6
	Horizontal Shaft	20		RS17YX	0.6
	Horizontal Shaft	24		RS17YX	0.6
	Horizontal Shaft	18		RS17YX	0.6
LXV Series	Vertical Shaft	20		RS17YX	0.6
	Vertical Shaft	18		RS17YX	0.6
ZX Series	Horizontal Shaft	14		RL95YC	0.9
ZXV Series	Vertical Shaft	14		RL95YC	0.9

**LINCOLN****Pumps, Compressors & Refrigeration Units**

	Continental, Wisconsin			RD16	0.6	
	Briggs & Stratton			RJ19LM	QJ19LM	0.8

**LINDELL****Sweepers**

	Briggs & Stratton			RJ19LM	QJ19LM	0.8
--	-------------------	--	--	--------	--------	-----

**LINDIG****Chippers**

Series 900	Wisconsin VH4D			RD16	0.8	
	Wisconsin V465D			OE042	RN12YC	0.8

**Power Equipment**

Apache				RJ8C	0.8	
Concho, Kajon	Briggs & Stratton			RJ19LM	QJ19LM	0.8
Kajon	Kohler	4,10		RH10C	0.8	
KM-10	Briggs & Stratton			RJ19LM	QJ19LM	0.8





CC BHP

21



OPT.



mm

**...LINDIG**

**...Power Equipment**

KT15, KT15X				RD16		0.8
M-10, M-12, M-4, M-8				RJ8C		0.8
XR12130, XR16130	Ford	300		RF10C		0.8
XR1265	Ford	172		RH10C		0.8
XR16160	Ford	330		RF10C		0.8
XR930				RD16		0.8
XR965				OE042	RN12YC	0.8
	IHC UC-135B, UC-263, UD-221			D15Y		0.6
	Wisconsin	14,18,2,30		RD16		0.6
	Kohler	10,12,16,20		RH10C		0.8
	Briggs & Stratton			RJ19LM	QJ19LM	0.8
	Kohler K181	8		RJ19LM		0.8
	Tecumseh			RJ8C		0.8

**LINE-WARD**

**Power Equipment**

	Kohler	16		RH10C		0.8
--	--------	----	--	-------	--	-----

**LINK**

**Mowers**

24in. Flail Mower	Robin			RL86C		0.6
-------------------	-------	--	--	-------	--	-----

**LIT-R-BLO**

**Blowers**

	Kawasaki	7.5		OE059	L92YC	0.8
	Briggs & Stratton				RJ19LM	QJ19LM
	Tecumseh				RJ8C	0.8

**LITTER-VAC**

**Sweepers**

	Tecumseh			RJ8C		0.8
--	----------	--	--	------	--	-----

**LITTLE BEAVER**

**Earth Drills**

	Briggs & Stratton Vanguard V-Twin	16		RC14YC		0.8
	Tecumseh			RJ17LM		0.8
	Briggs & Stratton	5,7,8,11		RJ19LM	QJ19LM	0.8
	Kohler			RJ19LM		0.8
	Clinton			RJ8C		0.8
	Robin	5,7,11		RL86C		0.8
	Honda OHV	8,9,11		OE051	RN11YC	0.8
	Honda OHV	5		OE006	RN9YC	0.8

**LITTLE DAVID**

**Stump Removers**

Stump Removers				RJ8C		0.8
----------------	--	--	--	------	--	-----

**LITTLE GIANT**

**Power Equipment**

	(18mm)			RD16		0.6
	(14mm)			RJ8C		0.6

**LITTLE WONDER**

**Generators**

All Models				RCJ8		0.6
------------	--	--	--	------	--	-----

**Lawn Mowers**

	Briggs & Stratton			RJ19LM	QJ19LM	0.8
	Kohler			RJ8C		0.8

**Power Equipment**

Mantis	Kawasaki			RCJ8		0.8
	Briggs & Stratton			RJ19LM	QJ19LM	0.8
	Ohlsson & Rice			CJ14		0.8
	Kawasaki	7.5		OE059	L92YC	0.8
	Briggs & Stratton Vanguard	9		OE013	RC12YC	QC12YC / XC92YC
	Kohler Command Pro V-Twin	22,27		OE013	RC12YC	1.0
	Briggs & Stratton Vanguard V-Twin	16		RC14YC		0.8





CC

BHP

21



OPT.

**...LITTLE WONDER****...Power Equipment**

Echo				RCJ8		0.8
Kawasaki	3,4			RCJ8		0.8
Kioritz				RCJ8Y		0.8
Briggs & Stratton Single Cyl.				RJ19LM	QJ19LM	0.8
Kohler K181	4,8			RJ19LM		0.8
Honda OHV	9,13		OE051	RN11YC		0.8

**LLOYDS****Mowers**

Ariel	Honda			OE086	RL82C	0.6
Paladin	Honda			OE086	RL82C	0.6
Pennsylvania	Honda				RL86C	0.5

**LO-BLO****Air Brooms**

Wisconsin S8D				RD16		0.8
Clinton				RH10C		0.6
Kohler K331	10			RH10C		0.8
Kohler K331	14			RH10C		0.8
Briggs & Stratton				RJ19LM	QJ19LM	0.8
Kohler	4,7			RJ19LM		0.8
Kohler K321	14			RJ19LM		0.8
Kohler K321	8			RJ19LM		0.8
Tecumseh				RJ8C		0.8

**LOCKE****Lawn Mowers**

Briggs & Stratton				RJ19LM	QJ19LM	0.8
-------------------	--	--	--	--------	--------	-----

**Turf Equipment**

Briggs & Stratton Intek	6.5		OE013	RC12YC	QC12YC / XC92YC	0.5
Briggs & Stratton Vanguard (18mm)	5.5,6		OE013	RC12YC	QC12YC / XC92YC	0.5
Kohler				RD16		0.6
Kohler				RH10C		0.6
Briggs & Stratton				RJ19LM	QJ19LM	0.8
Honda OHV	5.5,8		OE051	RN11YC		0.8
Honda OHV	5		OE006	RN9YC		0.8

**LOFTNESS****Snow Removers**

A.T.V. Snowblower	Briggs & Stratton Vanguard V-Twin	18			RC14YC	0.8
-------------------	-----------------------------------	----	--	--	--------	-----

**LOMBARD****Chain Saws**

4					RJ8C	0.8
7					RJ8C	0.8
70					RCJ8	0.8
3, 30, 3-1/2, 34, 35, 36, 37, 3A					RCJ8	0.8
5, 5A					RCJ8	0.8
648, 650					RJ8C	0.8
660, 68, 69					RCJ8	0.8
AL42, AL51					CJ6	0.8
AP22, AP22-1, AP22D, AP22D-1, AP24, AP24D, AP42, AP42-1, AP42D, AP42D-AV, AP42SE					RCJ7Y	0.8
Automatic					CJ6	0.8
Comango					RCJ7Y	0.8
F54					RCJ8	0.8
L100					RJ12YC	0.8
L100, L30, L50, L55, L60, L70, L80, L90					RCJ8	0.8
Little Lightning, Deluxe, Super Deluxe					RCJ7Y	0.8
Pony					RDJ8J	0.8
Super AV					RCJ7Y	0.8
Super Comango					CJ6	0.8
Super Lightning					RCJ7Y	0.8



CC BHP

21



OPT.



mm

**LONMORE****Mowers**

Kohler OHV	15	OE013	RC12YC	1.0
Kawasaki OHV	14,20	OE051	RN11YC	0.8
Tecumseh OHV	16	OE098	RN4C	0.8

**LORAIN****Pumps, Compressors & Refrigeration Units**  
A9, Type 07

W85N 0.6

**LUCOLITE****Generators**  
All Models

W14 0.6

**LZDP****Power Equipment**  
P10DU, P350, P350-1

RL86C 0.7

**MACKINAW****Log Splitters**

Briggs &amp; Stratton RJ19LM QJ19LM 0.8

**MACLEODS****Power Equipment**

Briggs &amp; Stratton RJ19LM QJ19LM 0.8

**MAG****Power Equipment**

1017 SRL	4-Cycle	258	4	1971 → 1984	RL86C	0.5
1026 SRL	4-Cycle	258	6	1971 → 1987	RL86C	0.5
1029 SRL	4-Cycle	296	7		RL86C	0.5
1040 SRL	4-Cycle	391	9		RL86C	0.5
1045 SRL	4-Cycle	450	10		RL86C	0.5
2055 SRL	4-Cycle	258	12	1953 → 1984	OE086 RL82C	0.5

**MAGIC LINE****Garden Tractors**

Briggs &amp; Stratton RJ19LM QJ19LM 0.8

**MAGNA****Power Equipment**Briggs & Stratton RJ19LM QJ19LM 0.8  
Tecumseh RJ8C 0.8**MAGNUM DIAMOND****Chain Saws**

Briggs & Stratton	9,16,18	RC14YC	0.8
Wisconsin	37	RD16	0.6
Honda OHV	9,11,13	OE051 RN11YC	0.8
Wisconsin	65	OE042 RN12YC	0.6

**MAIBO****Pruners**

Briggs &amp; Stratton RJ19LM QJ19LM 0.8

**MAINLINE****Cultivator**

ML35 CJ6 0.8

**Lawn Mowers**Briggs & Stratton RJ19LM QJ19LM 0.8  
Acme RL86C 0.8**Snow Removers**

All Models L90C 0.8

**Turf Equipment**Acme 5,7,8,10 L90C 0.8  
Briggs & Stratton 5 RJ19LM QJ19LM 0.8



CC BHP

21



OPT.



mm

**MAKITA****Blowers**

RBL250			RCJ8	0.8
RBL500			RCJ6Y	0.8

**Centrifugal Pumps**

DBC340, EHW120			RCJ6Y	0.6
EW100R			RCJ8Y	0.6
EW200R, EW200TR, EW300R, EW300TR			RL86C	0.6
EW400TR			RL87YC	0.6

**Chain Saws**

DCS330S, DCS340, DCS341, DCS342, DCS390, DCS391, DCS400, DCS401, DCS430, DCS431, DCS5200i, DCS520i			RCJ8Y	0.6
DCS6800iFL/FW, DCS9000FL/FW			RCJ6Y	0.6

**Cut-Off Saw**

DPC6200, DPC6201, DPC7000, DPC7001, DPC7300, DPC7301, DPC9500, DPC9501			RCJ6Y	0.6
--	--	--	-------	-----

**Edgers**

RBE250			RCJ6Y	0.8
Stick Edger			RCJ8	0.8

**Generators**

G1200R, G2400R, G2410R, G3500R			RL86C	0.8
G3501R		OE059	L92YC	0.8
G3510R, G3511R			RL86C	0.8
G5500R, G5501R		OE059	L92YC	0.8
G5710R, G5711R		OE098	RN4C	0.8

**Trimmers**

DBC300, DBC301, DST300			RCJ6Y	0.8
EH561, EH760			CJ6	0.8
EM4251, RBC221, RBC230, RBC251, RBC252, RBC253, RBC255, RBC25A, RBC260, RBC261, RBC310, RBC311, RBC321, RBE250, RBL25A, RST250			RCJ8	0.8

**MALL****Generators**

(18mm)			RD16	0.6
(14mm)			RJ6C	0.6

**Pumps, Compressors & Refrigeration Units**

2-Cycle			RJ6C	0.6
4-Cycle			RJ8C	0.6

**MANG****Lawn Mowers**

Briggs & Stratton			RJ19LM	QJ19LM	0.8
Kohler	7		RJ19LM		0.8

**Mowers, Tillers**

Wisconsin AENL			RD16		0.8
Kohler	10		RHT0C		0.8
Briggs & Stratton			RJ19LM	QJ19LM	0.8
Kohler	7		RJ19LM		0.8
Robin EY25, EY44W			RL86C		0.8

**MANLEY****Power Equipment**

Blue Ox			D9		0.8
---------	--	--	----	--	-----

**MARAUDER****Lawn Mowers**

Iron Horse			RJ12C		0.6
Briggs & Stratton			RJ19LM	QJ19LM	0.8

**MARK****Pumps, Compressors & Refrigeration Units**

-20, -30, -40, QP-15			RL86C		0.6
QP-60			RJ8C		0.6



CC

BHP

21



OPT.



mm

**MARK MACHINE****Trimmers**

1930, 1940, 2130

2800, 2840, 3000M,

3040M, 4000M

RDJ8J

0.8

RCJ8

0.8

**MARUYAMA****Engines**

AE Series

31.8

RCJ8Y

0.6

22.5

RCJ8Y

0.6

25.4

RCJ8Y

0.6

50.2

RCJ8Y

0.6

41.5

RCJ8Y

0.6

**Power Equipment**

BC200, BC200C, BC201,

BC201C, BC2030

BC22H

RCJ8Y

0.6

BC2300, BC2320

BC23H

Z9Y

0.8

RCJ8Y

0.6

BC260, BC2600, BC260C, BC260H,

BC2620, BC2800, BC3020, BC320,

BC3200, BC320H, BC402M, BC4200H,

BC420H, BC480M, BC500H

BCGX22, BCGX31 (4-Cycle)

BCL2250, BCL2250C, BCL2550,

MC2300, MC2310, MC2320,

MC260, MC260C, MC260D,

MC260E, MC260S, MC260T,

MC261, MC2610, MC2620, MC321,

MC3210, ML23, ML23S, MT23

BL230

BL2600

BL400

BL4500

BL4500HA, BL4500SP

BL4600

BL471, BL480

BL4800, BL4801

BL5400SP, BL5400W, BL5500,

BL6700, BLL2600

ED2300, ED2320, ED260, ED261,

ED2610, ED2620, EHT2300D,

EHT2600D, EHT260D,

ETH2250DS, HT159, HT159L

HT210L

HT220, HT2200, HT220L, HT2210,

HT230, HT2300, HT2300D, HT2300DL,

HT2300L, HT230D, HT230L, HT2320,

HT2320D, HT242, HT242L

HT250, HT250L

HT260D

MD150DX

MD155DX, MD157, MD159, ML23H,

MS036, MS045D, MS046, MS055ED,

MS056, MS056E, MS068

MS153-50TH

MS153EMH, MS253-100TH,

MS253-50TH, MS253ECKFR

MS410-100TH, MS410EC-2MR

MS055D

RCJ8

0.6

RCJ6Y

0.8

RCJ8

0.6

RCJ6Y

0.8

CJ6

0.6

RCJ6Y

0.8

RCJ8

0.6

CJ6

0.6

RCJ6Y

0.8

RCJ8Y

0.6

RCJ8

0.6

RCJ8Y

0.6

RCJ8

0.6

RCJ8Y

0.6

RJ6C

0.6

RCJ8Y

0.6

CJ14

0.8

RL95YC

0.6

RCJ8

0.8

RCJ8Y

0.6

**Power Sprayers**

MS045D, MS046, MS055D,

MS055ED, MS056

MS153-50T, MS153EMH

MS253-50T

MS253ECH

MS253ECKFR

MS410EC-2MR

RCJ8Y

0.6

CJ14

0.8

RL95YC

0.8

OE051

RN11YC

0.8

RL95YC

0.6

RCJ8

0.8





CC BHP



OPT.



**...MARUYAMA**

Pumps		CC	BHP			mm
MS154-50P, MS154-50PTR, MS154PS100, MS154PS30, MS154PS50	Honda		2.2		CJ14	0.8
MS330-100P, MS330-100PBU, MS330PS100, MS330PS50	Honda		4		OE051 RN11YC	0.8
MS413-100P, MS413-200P, MS413PS100, MS413PS50	Honda		5.5		OE051 RN11YC	0.8
Water Pumps						
ML23P					RCJ8Y	0.8
MP2500E2, MP2520EZM					RCJ8	0.8
MP2532E2					RCJ8Y	0.8
MP4020E					RL95YC	0.6
MP4020EH					OE051 RN11YC	0.8
MP5020E					RL95YC	0.6
MP5020EH, MP8020EH					OE051 RN11YC	0.8

**MASE**

Generators		CC	BHP			mm
SX 2200	Robin		6		RL87YC	0.6

**MASPORT**

Tillers		CC	BHP			mm
	Briggs & Stratton				RJ19LM QJ19LM	0.8

**MASSEY-FERGUSON**

Chain Saws		CC	BHP			mm
190, 190A, 250					RDJ6J	0.8
370, 370A, 370AR					RCJ8	0.8
Garden Tractors						
MF1200, MF1450, MF1650					RH10C	0.8
MF1655					RH18Y	0.8
MF85					RCJ8	0.8
	Kohler Command V-Twin		20,23		OE013 RC12YC	0.8
	Briggs & Stratton Vanguard V-Twin		15,16		RC14YC	0.8

Lawn Mowers		CC	BHP			mm
All Models					RJ19LM	0.8

Snow Removers		CC	BHP			mm
MF305, MF308	Tecumseh				RJ8C RJ19LM	0.8

**MASTER**

Generators		CC	BHP			mm
LTG235, MG1500, MG2000, MG3000, MG4000					RJ8C	0.6
MGH3000, MGH4000, MGH4000BI, MGH5000, MGH5000BI, MGH6000, MGH6000BI, MGH7000, MGH7000BI					OE051 RN11YC	0.8
	(18mm)				D21	0.6
	Honda		5.5,8,9,11,13		OE051 RN11YC	0.8
	(7/8"-18)				W14	0.6

Pumps		CC	BHP			mm
5M, MK70, ML153, ML203, ML305, ML307, ML309					RJ8C	0.6

Pumps, Compressors & Refrigeration Units		CC	BHP			mm
10M, 17M					RD16	0.6
20M					D21	0.6
30M, 40M					RD16	0.6
40MW					RH10C	0.6
90MW	Ford		240		RF10C	0.6
	Ford		256		RN5C	0.6
ML4014					RD16	0.6
MR2D1, MR3D1					RJ8C	0.6



CC BHP

21



OPT.



mm

## MASTERCRAFT

### Lawn Mowers

Briggs & Stratton, Tecumseh

RJ19LM QJ19LM

0.8

### Riding Equipment

Briggs & Stratton Vanguard  
Briggs & Stratton

RC14YC  
RJ19LM QJ19LM

0.8  
0.8

### Snow Removers

Tecumseh 2-Cycle  
Tecumseh 4-Cycle  
Tecumseh

12

RCJ8Y  
RJ19LM  
RL86C

0.8  
0.8  
0.8

## MASTERCUT

### Lawn Mowers

Briggs & Stratton  
Tecumseh

RJ19LM  
RJ8C

0.8  
0.6

### Power Equipment

Briggs & Stratton

RJ19LM QJ19LM

0.8

### Snow Removers

Tecumseh  
Tecumseh

12

RJ19LM  
RL86C

0.8  
0.8

## MATELEST

### Chain Saws

MAT-101-10, MAT-101-12,  
MAT-106, MAT-EX

RCJ8

0.8

## MATIS

### Power Equipment

Echo

RCJ8Y

0.8

## MAVERICK

### Lawn Mowers

All Models

RJ19LM

0.8

## MAXIM

### Lawn Mowers

Briggs & Stratton  
Tecumseh  
Honda

5

OE006

RJ19LM  
RJ19LM  
RN9YC

0.8  
0.8  
0.8

### Power Equipment

Briggs & Stratton Intek Pro  
Briggs & Stratton Vanguard  
Briggs & Stratton Vanguard V-Twin  
Briggs & Stratton  
Briggs & Stratton  
Briggs & Stratton  
Tecumseh  
Honda OHV  
Robin

6,6.5  
5  
14,16,20  
3,3.5,5  
5.5,6  
8,8.5,12  
5,6  
4,5,5.5,8,13  
4,6,6

OE013  
OE013  
RC14YC  
RJ19LM  
RJ19LM  
RJ19LM  
RJ8C  
OE051  
OE006

RC12YC  
RC12YC  
RC12YC / XC92YC  
QJ19LM  
QJ19LM  
QJ19LM  
QJ19LM  
RN11YC  
RN9YC

0.5  
0.5  
0.8  
0.8  
0.8  
0.8  
0.8  
0.8  
0.6

### Snow Removers

Briggs & Stratton  
Honda OHV

3.75,4,6  
5

OE006

RJ19LM  
RN9YC

0.8  
0.8

## M-B

### Power Equipment

Briggs & Stratton Vanguard V-Twin  
Briggs & Stratton  
Honda OHV

18  
5,10  
5.5

OE051

RC14YC  
RJ19LM  
RN11YC

0.8  
0.8  
0.8

## M-C

### Lawn Mowers

All Models

RJ19LM

0.8

### Mowers

Lawn Genie  
Briggs & Stratton Vanguard  
Briggs & Stratton

16  
10,16

OE013

RC12YC  
RJ19LM  
QC12YC / XC92YC  
QJ19LM

0.8  
0.8







CC

BHP

21



OPT.

**...McCULLOCH****Edgers**II, III, III Super, IV HD, Mac 1385J,  
2815, 2827, 284S, 328GLE

RDJ8J

0.6

**Engines**

MC2106

RDJ8J

0.8

MC2108

RDJ8J

0.8

MC2109

RDJ8J

0.8

MC2110

RDJ8J

0.8

**Garden Tractors, Shredders, Tillers**

RCJ8

0.8

**Generators**

2300E, 3500E

RL87YC

0.6

800E

RCJ8Y

0.6

All Other

RCJ8

0.6

H-1500, H-2000, H-3000, HP-1200,

RJ8C

0.6

HP-2000, HP-3000, HP-3500,

HP-3500 Deluxe, HP-5000,

HP-5000 Deluxe, II, III, Mark I

Pro 1500E

RL87YC

0.6

Pro 600E

RCJ8Y

0.6

RA120, RA150, RA200, RA330, RA330ES

RCJ8

0.6

**Lawn Mowers**

All Models

RJ19LM

0.8

**Pumps, Compressors & Refrigeration Units**

150

RJ8C

0.6

200, 300, 400

RJ8C

0.6

All Other

RJ6C

0.6

Aqua Mac

21.2

RDJ8J

0.6

Pro Deluxe

21.2

RDJ8J

0.6

**Trimmers**

22

RDJ8J

0.6

2250

RDJ7Y

0.6

2360

RDJ7Y

0.6

1385L, -19

RDJ8J

0.6

2030, 2035, 2045, 2100

RDJ7Y

0.6

2335J

RCJ8

0.8

2380L

RDJ8J

0.6

2500, 2560HD, 2565AV

RDJ7Y

0.6

2635B, 2635GLE

RCJ8

0.8

2816, 2816B, 2817, 2818, 282, 2825,

RDJ8J

0.6

285, 287, 28c, 29, 32, 3225, 3227,

3227HD, 3227S, 327, 32bcs Dlx., 32HDS

3335L

RCJ8

0.8

3900, 4100

RDJ8J

0.6

4335B

RCJ8

0.8

DBC301, DBS300

RCJ6Y

0.8

Eager Beaver 280, 325, I, II, III, IV

RDJ8J

0.6

GHT2024, GHT2030

RCJ8

0.8

GHT30

RDJ7Y

0.6

RDJ8J

0.6

RDJ7Y

0.6

RDJ8J

0.6

RDJ7Y

0.6

RDJ8J

0.6

RCJ8

0.8

RCJ8

0.8

RDJ8J

0.6

RCJ6Y

0.8

RDJ8J

0.6

GLE2580AV

RDJ7Y

0.6

Mac 65, 80, 99, GHT17

RDJ8J

0.6

Pro Mac 2025

RDJ7Y

0.6

Pro Mac 2320L

RCJ8

0.8

Pro Mac 2510, Pro Mac 2560

RDJ7Y

0.6

Pro Mac 2635J

RCJ8

0.8

Pro Mac 3000

RDJ8J

0.6

Pro Mac DBC300

RCJ6Y

0.8

Pro Mac I, Pro-Scaper 28S, I &amp; II,

RDJ8J

0.6

Roadrunner I, S, Silver Eagle 28,

32bc, SL, Super, Super Mac 80, 85, SX

Titan 2000, 2310, 2560AV

RDJ7Y

0.6

Titan 3000, GHT24

RDJ8J

0.6

Titan GLE2380

RDJ7Y

0.6

Titan GPO22 Engine

RDJ8J

0.6



CC BHP

21



OPT.



mm

## McDONOUGH

### Lawn Mowers

All Models

RJ19LM

0.8

### Snow Removers

All Models

RJ19LM

0.8

## McGOWAN

### Pumps, Compressors & Refrigeration Units

Continental

RD16

0.6

Wisconsin

RD16

0.6

LeRoi

RJ12C

0.6

Briggs & Stratton

RJ19LM

QJ19LM

0.8

Clinton

RJ8C

0.6

## McLANE

### Lawn Mowers

Honda

2.5

CJ14

0.6

Honda G150

3.5

L90C

0.8

Briggs & Stratton

3.5,4,5,5.5,6

RJ19LM

QJ19LM

0.8

Kohler

4

RJ19LM

0.8

Honda

4

RL86C

0.8

Honda OHV

4

OE051

RN11YC

0.8

Honda OHV

5.5

OE051

RN11YC

0.8

Kawasaki

5

OE051

RN11YC

0.8

Honda OHV

5

OE006

RN9YC

0.8

Honda G130

3.5

Z9Y

0.8

### Power Equipment

Honda

2.2,2.5

CJ14

0.8

Briggs & Stratton

3.5,4,5,5.5,6

RJ19LM

QJ19LM

0.8

Kohler

4

RJ19LM

0.8

Tecumseh

5

RJ8C

0.8

Honda OHV

4

OE051

RN11YC

0.8

Honda OHV

5.5

OE051

RN11YC

0.8

Kawasaki OHV

5

OE051

RN11YC

0.8

Honda OHV

5

OE006

RN9YC

0.8

## M-E TILLER

### Power Equipment

(18mm)

RD16

0.6

(14mm)

RJ8C

0.6

## MEADE

### Lawn Mowers

All Models

RJ19LM

0.8

## MELEX

### Utility Vehicles

Briggs & Stratton Vanguard

9

OE013

RC12YC

QC12YC / XC92YC

0.8

## MELIN

### Power Equipment

15

RJ8C

0.8

30

RJ8C

0.8

45

RD16

0.8

20, 25

RD16

0.8

60, 75

RD16

0.8

## MENNING

### Sprayers

RCJ8

0.8

## MEP

### Lawn Mowers

Honda

2.5

CJ14

0.6

Briggs & Stratton 1-Cyl.

RJ19LM

QJ19LM

0.8

Tecumseh

3.5,3.8,4,5,5.5

RJ19LM

0.8

Tecumseh OHV

5.5

OE098

RN4C

0.8

Honda OHC

5.5

OE006

RN9YC

0.8

Honda OHV

5

OE006

RN9YC

0.8



CC BHP

21



OPT.



mm

**...MEP****Power Equipment**

Tecumseh	2			RCJ6Y		0.8
Briggs & Stratton	5,15			RJ19LM	QJ19LM	0.8
Tecumseh	3,5,3,8			RJ19LM		0.8
Tecumseh	6			RJ19LM		0.8
Tecumseh	4			RJ8C		0.8

**MERC-O-TRONIC****Generators**

				RJ8C		0.6
--	--	--	--	------	--	-----

**MERRY MAC****Power Equipment**

Kohler	8			RH10C		0.8
Briggs & Stratton	5,8			RJ19LM	QJ19LM	0.8
Honda OHV	5.5		OE051	RN11YC		0.8
Kawasaki OHV	5.3		OE051	RN11YC		0.8
Kohler Twin	16			RV17YC		0.6

**MERRY TILLER****Tillers**

Briggs & Stratton	3,3,5,5			RJ19LM	QJ19LM	0.8
Kohler	4			RJ19LM		0.8
Tecumseh				RJ19LM		0.8
Clinton				RJ8C		0.8
Robin EY18-3W				RL86C		0.8

**MEYERLITE****Generators****All Models**

				W14		0.6
--	--	--	--	-----	--	-----

**MICHAELS****Lawn Mowers**

Briggs & Stratton				RJ19LM	QJ19LM	0.8
Kohler	7			RJ19LM		0.8

**MICHIGAN POWER CLEANING****Pumps**

Briggs & Stratton Vanguard OHV	5.5		OE013	RC12YC	QC12YC / XC92YC	0.8
Briggs & Stratton Vanguard V-Twin	16,18			RC14YC		0.8
Briggs & Stratton	9,11			RJ19LM	QJ19LM	0.8
OHV	5.5,11		OE051	RN11YC		0.8

**MIDCO****Generators**

Wisconsin				D14		0.6
Briggs & Stratton, Lauson				RJ19LM	QJ19LM	0.6

**MIDCO PUMPS****Pumps, Compressors & Refrigeration Units****All Models**

				RJ8C		0.6
--	--	--	--	------	--	-----

**MIDDLESWORTH****Lawn Mowers**

Kohler				RH10C		0.8
Briggs & Stratton				RJ19LM	QJ19LM	0.8

**Power Equipment**

Briggs & Stratton	11			RJ19LM	QJ19LM	0.8
Honda OHV	11		OE051	RN11YC		0.8

**MIDLAND****Power Equipment**

2-Cycle (14mm)				CJ14		0.8
(18mm)				RD16		0.8
4-Cycle (14mm)				RJ8C		0.8





CC BHP

21



OPT.

**MIGHTY MAC****Power Equipment**

Briggs & Stratton Vanguard	5,5	OE013	RC12YC	QC12YC / XC92YC	0.8
Briggs & Stratton Vanguard	9	OE013	RC12YC	QC12YC / XC92YC	0.8
Briggs & Stratton Vanguard V-Twin	16		RC14YC		0.8
Kohler	12,16		RH10C		0.8
Briggs & Stratton	3,3,5,5		RJ19LM	QJ19LM	0.8
Briggs & Stratton	8		RJ19LM	QJ19LM	0.8
Tecumseh	3,5,8		RJ8C		0.8
Honda OHV	5,5	OE051	RN11YC		0.8
Kawasaki OHV	5,3	OE051	RN11YC		0.8
Honda OHV	5	OE006	RN9YC		0.8
Kohler Twin	16		RV17YC		0.6

**MIGHTY MOUSE****Garden Tractors**

Wisconsin			RD16		0.6
Briggs & Stratton			RJ19LM	QJ19LM	0.6

**MIGHTY MURC****Log Splitters**

Briggs & Stratton	5,8		RJ19LM	QJ19LM	0.8
Honda OHV	8	OE051	RN11YC		0.8
Tecumseh OHV	5	OE098	RN4C		0.8
Honda OHV	5	OE006	RN9YC		0.8

**MILBRADT****Mowers**

(18mm)			RD16		0.6
(14mm)			RJ8C		0.6

**MILLER STURDI-SAW****Chain Saws**

MCS-1	Honda OHV	8,13	OE051	RN11YC	0.8
MSM	Honda OHV	8,13	OE051	RN11YC	0.8
	Kohler	15	OE013	RC12YC	0.8
	Honda OHV	11	OE051	RN11YC	0.8

**MILWAUKEE****Mowers**

All Models			RD16		0.6
------------	--	--	------	--	-----

**MINARELLI****Engines**

C2				RL86C	0.8
G1			OE086	RL82C	0.8
P3A			OE086	RL82C	0.8
P3N			OE086	RL82C	0.8
P4			OE086	RL82C	0.8
P4A			OE086	RL82C	0.8
P4CS			OE098	RN4C	0.8
P4R			OE098	RN4C	0.8
P6			OE086	RL82C	0.8
P6/80			OE086	RL82C	0.8
P6CS			OE098	RN4C	0.8
P6R			OE098	RN4C	0.8
V1				RL86C	0.8
V1A				RL86C	0.8
V1K				RL86C	0.8
V2				RL86C	0.8

**MINAT****Blowers**

Briggs & Stratton	8		RJ19LM	QJ19LM	0.8
-------------------	---	--	--------	--------	-----





CC BHP

21



OPT.

**...MITSUBISHI****Pumps, Compressors & Refrigeration Units**

GM131P, GM181P, MP050, MP080

MP-100, MP-25, MP-40, MP-50, MP-80

MPT080, MPT100

OE051 RN11YC

0.8

RCJ8

0.6

OE051 RN11YC

0.8

**MITTS & MERRILL****Power Equipment**

M-11, M-12, M-7, M-8

Ford

300

RF10C

0.8

M-13, M-9

Ford

330

RF10C

0.8

M-2

Ford

172

RH10C

0.8

M-3, M-4, M-6

Ford

240

RF10C

0.8

**MI-T-VAC****Loaders, Sweepers**

Tecumseh

RCJ8

0.8

Briggs &amp; Stratton

RJ19LM

QJ19LM

0.8

Kohler

4,14

RJ19LM

0.8

**MITY MITE****Power Equipment**

Honda OHV

4,11

OE051 RN11YC

0.8

**Sprayers**

CJ6

0.6

RCJ8

0.8

**MK****Power Equipment**

MK1A, MK50

OE064 RL82YC

0.6

**MLW****Lawn Mowers**

Briggs &amp; Stratton

5

RJ19LM

QJ19LM

0.8

**MMB****Power Equipment**

MMB4

RL86C

0.7

**MO WING 50****Power Equipment**

Briggs &amp; Stratton

5

RJ19LM

QJ19LM

0.8

**MODERN****Power Equipment**

RJ8C

0.8

**MONARCH****Pumps, Compressors & Refrigeration Units**

10MG

RL86C

0.6

12MG, 12MGW, 17MG, 20MGA, 20MGS

RD16

0.6

2JAG, 2JG, 3JAG, 3JG

RCJ8

0.6

40MGTJ, 40MGV

RD16

0.6

5ACGF-6, 5ACGF-8, 5BSGF-8

RCJ8

0.6

73-2PWB, 73-2PWF, 73EDB, 73EDF, 74-2PWB,

RD16

0.6

74-2PWF, 772G, 772GW, 773GA, 773GBA,

773GBS, 774GTJ, 774GV, 776G

776GV

OE042 RN12YC

0.6

8MG

RCJ8

0.6

90MG

RD16

0.6

90MGV

OE042 RN12YC

0.6

ACG-4, ACG-5, ACG-6, AGG-4, AGG-5,

RCJ8

0.6

AGG-6, AOG-4, AOG-5, AOG-6,

BSG-4, BSG-5, BSG-6, BSG-8

BSG8R

RL86C

0.6

BSGF-6, BSGF-8, BVG-4,

RCJ8

0.6

BVG-5, BVG-6, BVG-8



CC BHP

21



OPT.



mm

**...MONARCH****...Pumps, Compressors & Refrigeration Units**

E12MG, E17MG, E20MGA, E20MGS, E40MG TJ, E40MGV, E772G, E772GW, E773GA, E773GBA, E773GBS, E774GTJ, E774GV, EFN20, EFN30, EFN40, EFS20, ENG30W, ENG37W, ENG8W, ENG9W, ENSPG8W, FFN20		RD16		0.6
FFN25		RCJ8		0.6
FFN30, FFN40		RD16		0.6
FFS15		RCJ8		0.6
FFS20		RD16		0.6
NG1.5L8S		RCJ8		0.6
NG16R		RJ8C		0.6
NG2.5L8S		RD16		0.6
NG2.5M9S	Wisconsin S14D	RD16		0.6
	Robin EY21W	RJ8C		0.6
NG2L8S, NG30W, NG37W, NG3L11S, NG4L13S		RD16		0.6
NG5B		RCJ8		0.6
NG8W, NG9W		RD16		0.6
NSPG5B		RCJ8		0.6
NSPG8W		RD16		0.6
PBG-12, PBG-6, PBG-8, PBGF-12, PBGF-6, PBGF-8		RCJ8		0.6

**MONARK****Lawn Mowers**

All Models		RJ19LM		0.8
------------	--	--------	--	-----

**MONDIAL****Chainsaws**

640, 645, 655 Cayman		RCJ7Y		0.5
640AV, 650, 657, 657S, 665		RCJ7Y		0.5

**MONO****Chain Saws**

249		RJ12YC		0.8
25-10, 25-14		RCJ8		0.8
47, 67		RJ8C		0.8
SL146, SL147		RCJ8		0.8
SL149		RJ12YC		0.8
SL245		RCJ8		0.8

**Lawn Mowers**

Briggs & Stratton		RJ19LM	QJ19LM	0.8
Lauson		RJ8C		0.8

**Power Equipment**

Briggs & Stratton		RJ19LM	QJ19LM	0.8
Lauson		RJ8C		0.8

**MONTGOMERY-WARD****Garden Tractors**

Briggs & Stratton		RJ19LM	QJ19LM	0.8
Briggs & Stratton Twin		RJ19LM	QJ19LM	0.8
Tecumseh		RJ8C		0.8

**Lawn Mowers**

Briggs & Stratton		RJ19LM	QJ19LM	0.8
Lauson		RJ8C		0.8

**MOORE****Power Equipment**

Farmette	Utilimotor	RH10C		0.8
	Briggs & Stratton, Kohler	RJ19LM	QJ19LM	0.8

**MOTO MORINI****Engines**

4M		RL86C		0.8
6M		RL86C		0.8
FM6M		RL86C		0.8





CC

BHP

21



OPT.

**...MOTO MORINI****...Engines**

M1			RN5C	0.8
M101			RN5C	0.8
MO			RN5C	0.8
MO3			RN5C	0.8
MO4			RN5C	0.8
S5			RL86C	0.8

**MOTO-MOWER****Mowers**

	(18mm)		RD16	0.6
	(14mm)		RJ8C	0.6

**MOTOR GENERATOR****Generators**

424, 595, 596, 597, 606, 609			RJ8C	0.6
619, 620, 621			RJ12C	0.8
622, 623, 624, 625, 626			RJ8C	0.6

**MOTOR JIKOV****Power Equipment**

9/11	4-Cycle OHV		RL86C	0.6
1453, 1454VA PE	2-Cycle		RL86C	0.6
SB 130, SB 140	2-Cycle, F&S		RJ14YC	0.5
SB 152	2-Cycle, F&S		RJ14YC	0.5

**MOTOR-TILLER HOE****Power Equipment**

	Briggs & Stratton		RJ19LM	QJ19LM	0.8
	Lauson		RJ8C		0.8

**MOTT****Lawn Mowers**

	Briggs & Stratton		RJ19LM	QJ19LM	0.8
--	-------------------	--	--------	--------	-----

**Power Equipment**

	Wisconsin TJD		RD16		0.8
	Briggs & Stratton		RJ19LM	QJ19LM	0.8

**MOUNTAIN LION****Utility Vehicles**

	Kohler V-Twin	25	OE013	RC12YC	0.8
--	---------------	----	-------	--------	-----

**MOUNTFIELD****Brushcutters**

AM180, MTL50			RCJ8Y		0.5
Multi-Trim 16, 18, 23, 24, 33, 40			RCJ8		0.6
Multi-Trim 31			RL86C		0.5

**Engines**

AG 2	Briggs & Stratton	5	RJ19LM	QJ19LM	0.7
ESE 20	Briggs & Stratton	4	RJ19LM	QJ19LM	0.7
FS45TL	Briggs & Stratton		OE005	RC9YC	0.7
SA18, SA30TL			RCJ8Y		0.6
TAG 3	Briggs & Stratton	4	RJ19LM	QJ19LM	0.7
TAG 6	Briggs & Stratton	11	RJ19LM	QJ19LM	0.7

**Mowers**

	Suzuki 4-Cycle		RCJ8Y		0.7
	B&S Aspera, Tecumseh		RJ19LM	QJ19LM	0.5
	Suzuki 4-Cycle		OE006	RN9YC	0.8

**MOW MOWER****Lawn Mowers**

All Models			RJ19LM		0.8
------------	--	--	--------	--	-----

**MOW WING****Lawn Mowers**

	Briggs & Stratton		RJ19LM	QJ19LM	0.8
--	-------------------	--	--------	--------	-----





CC BHP

21



OPT.



mm

**MOW-A-MAT****Lawn Mowers**

All Models

Briggs &amp; Stratton

RJ19LM

0.8

RJ19LM QJ19LM

0.8

**MOWAMATIC****Lawn Mowers**

Clinton VS200

RJ12C

0.6

**MOW-BLOW****Blowers**

Honda OHV

5.5,8

OE051

RN11YC

0.8

**MOW-CYCLE****Lawn Mowers**

All Models

RJ19LM

0.8

**MOW-MASTER****Lawn Mowers**

Clinton

Power Pak

Propulsion

RH10C

0.8

RJ8C

0.8

RJ8C

0.9

**MOW-MORE****Power Equipment**

All Models

RD16

0.8

**MOZ-ALL****Lawn Mowers**

All Models

RJ19LM

0.8

**MP PUMPS****Pumps**

Tecumseh

3.8

RJ19LM

0.8

Honda OHV

5.5

OE051

RN11YC

0.8

**MQ POWER****Generators**

EY-25, EY-40DS

Robin

RL86C

0.6

EY-40WS

Robin

L90C

0.6

Wisconsin

4.6

RL86C

0.6

Wisconsin

7.5

RL87YC

0.6

Wisconsin

11

RL95YC

0.6

Honda OHV

8,11

OE051

RN11YC

0.8

**Pumps**

Robin EY-28W, EY-44W

RL86C

0.6

Wisconsin

3.5,4.6

RL86C

0.6

Honda OHV

3.5

OE051

RN11YC

0.8

Honda OHV

5,8,11

OE006

RN9YC

0.8

**MSI****Riding Equipment**

Briggs &amp; Stratton Vanguard V-Twin

16,18

RC14YC

0.8

**MTA****Air Compressors, Pressure Washers**

Honda OHV

5.5,9,11,13

OE051

RN11YC

0.8

Honda V-Twin

18

OE051

RN11YC

0.8

**Cut-Off Saw**

309, 343

RCJ8Y

0.5

**Log Splitters**

Honda OHV

8

OE051

RN11YC

0.8

Honda OHV

5

OE006

RN9YC

0.8

**Welders**

D.C. Arc Welders

Honda

13

OE051

RN11YC

0.8





CC BHP

21



OPT.



mm

**MTD**

**Generators**

Briggs & Stratton			RJ19LM	QJ19LM	0.8
Briggs & Stratton Twin			RJ19LM	QJ19LM	0.8

**Snow Removers**

Tecumseh 2-Cycle	3		RCJ8Y		0.8
Tecumseh 2-Cycle	4.5		RCJ8Y		0.8
Tecumseh	4		RJ8C		0.8
Tecumseh	5,8,10		RJ8C		0.8
Tecumseh OHV	12		RL86C		0.8

**MTD PRO**

**Blowers**

BB45			RCJ6Y		0.8
F5, F8			RJ19LM		0.8
HB26			RCJ6Y		0.8

**Hedge Trimmers**

24HC, 30HC, 40HC			RCJ6Y		0.8
------------------	--	--	-------	--	-----

**Lawn Mowers**

Kawasaki OHV	5.5		OE051	RN11YC	0.8
--------------	-----	--	-------	--------	-----

**Power Equipment**

Kohler OHV	13		OE013	RC12YC	0.8
Kohler V-Twin	20,22,25		OE013	RC12YC	0.8
Briggs & Stratton Vanguard V-Twin	14			RC14YC	0.8
Briggs & Stratton Vanguard V-Twin	16			RC14YC	0.8
Briggs & Stratton Vanguard V-Twin	18			RC14YC	0.8
Briggs & Stratton Single Cyl.				RJ19LM	QJ19LM
Briggs & Stratton Twin	16			RJ19LM	QJ19LM
Briggs & Stratton Twin	18			RJ19LM	QJ19LM
Tecumseh				RJ8C	0.8
Kawasaki OHV	8,14		OE051	RN11YC	0.8
Tecumseh OHV	16		OE098	RN4C	0.8

**Sprayers**

SY50, SY50P			OE051	RN11YC	0.8
-------------	--	--	-------	--------	-----

**Trimmers**

81C62, 81C73, ST23, ST26, ST35				RCJ6Y	0.8
--------------------------------	--	--	--	-------	-----

**MULTI-CORE**

**Aerators**

Honda G200	5			L90C	0.8
------------	---	--	--	------	-----

**MURRAY**

**Lawn Mowers**

Briggs & Stratton, Tecumseh				RJ19LM	QJ19LM
-----------------------------	--	--	--	--------	--------

**Power Equipment**

Briggs & Stratton OHV	14.5		OE013	RC12YC	QC12YC / XC92YC
Briggs & Stratton "L" Head				RJ19LM	QJ19LM
Briggs & Stratton Twin	14			RJ19LM	QJ19LM
Briggs & Stratton Twin	18,18.5			RJ19LM	QJ19LM
Tecumseh				RJ8C	0.8
Tecumseh OHV	12		OE086	RL82C	0.8
Tecumseh OHV	16		OE086	RL82C	0.8
Tecumseh OHV	12.5		OE098	RN4C	0.8

**MUSTANG**

**Garden Tractors**

Briggs & Stratton	5,8			RJ19LM	QJ19LM
-------------------	-----	--	--	--------	--------

**Lawn Mowers**

Briggs & Stratton				RJ19LM	QJ19LM
-------------------	--	--	--	--------	--------

**MYERS**

**Sprayers**

Wisconsin VG4D				RD16	0.8
Kohler	16,23			RH10C	0.8
Briggs & Stratton				RJ19LM	QJ19LM
Kohler K181	8			RJ19LM	0.8



CC BHP

21



OPT.



mm

**NAC****Blowers, Brushcutters**

Kawasaki TG-Series

RCJ8

0.8

**Trimmers**

NX180, NX240, NX350

RCJ8

0.8

**NATIONAL MOWER****Mowers**

Kawasaki

7.5

OE059

L92YC

0.8

Briggs &amp; Stratton Vanguard V-Twin

16

RC14YC

0.8

Wisconsin

RD16

0.6

Kohler

12

RH10C

0.8

Briggs &amp; Stratton

3,10

RJ19LM

QJ19LM

0.8

**NAUDER****Chain Saws**

NAU-10, NAU-12

RCJ8

0.8

**NAUTAC****Brushcutters**

011F, 011R, 012R - RD, 026R, 026RF

RCJ7Y

0.5

028 Turbo, 030 Turbo, 1100T

RCJ7Y

0.5

Country DR02

Tecumseh (Tecnamotor)

3.5

RJ17LM

0.7

Country DR06

B &amp; S

5

RJ19LM

QJ19LM

0.7

Country DR06S

F &amp; S

6

RL86C

0.7

**Chainsaws**

170, 232, 236, 246, 252, 262

RCJ7Y

0.5

**Garden Tractors**

1296E (I, C)

B &amp; S

12

RJ19LM

QJ19LM

0.7

Club 13 Hydro (I, C)

B &amp; S

12

RJ19LM

QJ19LM

0.7

Club 14 (OHV)

Briggs &amp; Stratton

14

OE013

RC12YC

QC12YC / XC92YC

0.7

Club 14 Hydro (I, C bi-cyl.)

B &amp; S

14

RJ8C

0.7

Club 18 Hydro (I, C bi-cyl.)

B &amp; S

18

RJ8C

0.7

Open 10

B &amp; S

10

RJ19LM

QJ19LM

0.7

Open 12

B &amp; S

12

RJ19LM

QJ19LM

0.7

**Mowers**

5345 P 37 (Prisma 37)

Tecumseh (Tecnamotor)

RJ17LM

0.7

Fainway 435BA (SB 140SL)

F &amp; S

RJ19LM

0.7

Fainway 435FA, FAE (Prisma 37)

Tecumseh (Tecnamotor)

RJ17LM

0.7

Greenfee 375, 375A (Sprint 375)

B &amp; S

RJ19LM

QJ19LM

0.7

Greenway 500BS,

B &amp; S

RJ19LM

QJ19LM

0.7

BAD (Quantum 50)

Greenway 500KA (FC 150)

Kawasaki

OE006

RN9YC

0.7

Greenway 500S2A (SB 140SL)

F &amp; S

RJ12YC

0.7

XT 37 (Prisma 37)

Tecumseh (Tecnamotor)

RJ17LM

0.7

**NEVA****Power Equipment**

MB2K Neva

RL86C

0.7

**NEW ENGLANDER****Power Equipment**

Briggs &amp; Stratton

RJ19LM

QJ19LM

0.8

**NEW WAY****Mowers**

All Models

D21

0.6

**NEWSTRIPE****Power Equipment**

Briggs &amp; Stratton

3,5

RJ19LM

QJ19LM

0.8

Honda OHV

5.5

OE051

RN11YC

0.8

Honda OHV

3.5

OE006

RN9YC

0.8



CC BHP

21



OPT.



## NISSAN

### Generators

GX1000, GX1600				RCJ8		0.8
GX2600	Kawasaki	5		RL86C		0.8
GX4000	Kawasaki	7.5	OE059	L92YC		0.8

## NOGMATIC

### Chain Saws

4CV-All				RCJ8		0.8
6CV-All				RCJ8Y		0.8
NOG10, NOG12				RCJ8		0.8

## NOLTE

### Power Equipment →

Sand Cleaner BC1000	Honda	5.5	OE051	RN11YC		0.8
---------------------	-------	-----	-------	--------	--	-----

## NOMA

### Garden Tractors

Kohler OHV		15	OE013	RC12YC		1.0
Briggs & Stratton Vanguard V-Twin		16		RC14YC		0.8
Briggs & Stratton Vanguard V-Twin		18,20		RC14YC		0.8
Briggs & Stratton		12,12.5,13,14,15		RJ19LM	QJ19LM	0.8
Briggs & Stratton Twin		16.5,18		RJ19LM	QJ19LM	0.8
Tecumseh		12,15,16	OE086	RL82C		0.8
Tecumseh		16.5	OE098	RN4C		0.8
Kohler Twin		18,20		RV17YC		0.6

### Lawn Mowers

Briggs & Stratton		5		RJ19LM	QJ19LM	0.8
-------------------	--	---	--	--------	--------	-----

### Power Equipment

Tecumseh 2-Cycle		1.6		RCJ8Y		0.8
Briggs & Stratton		5,8		RJ19LM	QJ19LM	0.8
Tecumseh		3.5,8		RJ8C		0.8

### Snow Removers

Tecumseh		3,4,5,5		RJ19LM		0.8
Tecumseh		8,10,12		RJ8C		0.8

## NORM

### Power Equipment

Utilimotor				RH10C		0.8
	Briggs & Stratton			RJ19LM	QJ19LM	0.8
	Clinton			RJ8C		0.6

## NORTH STAR

### Generators

Honda OHV		9,13	OE051	RN11YC		0.8
-----------	--	------	-------	--------	--	-----

### Power Equipment

Briggs & Stratton		3.5,5,8		RJ19LM	QJ19LM	0.8
Tecumseh		5,10		RJ8C		0.8
Tecumseh		14	OE086	RL82C		0.8
Honda OHV		5.5,13	OE051	RN11YC		0.8
Honda V-Twin		18	OE051	RN11YC		0.8
Honda OHV		5	OE006	RN9YC		0.8

### Pressure Washers

Briggs & Stratton Vanguard OHV		9,13	OE013	RC12YC	QC12YC / XC92YC	0.8
Kohler V-Twin		18	OE013	RC12YC		0.8
Briggs & Stratton Vanguard V-Twin		16		RC14YC		0.8
Briggs & Stratton				RJ19LM	QJ19LM	0.8
Tecumseh		10		RJ19LM		0.8
Tecumseh		5		RJ19LM		0.8
Tecumseh		8		RJ8C		0.8
Robin				RL86C		0.6
Honda OHV		4	OE051	RN11YC		0.8
Honda OHV		5.5,6.5,11,13	OE051	RN11YC		0.8
Honda V-Twin		18	OE051	RN11YC		0.8
Tecumseh OHV		5.5	OE098	RN4C		0.8
Honda OHV		5	OE006	RN9YC		0.8



CC BHP

21



OPT.



mm

**NORTHERN PRO****Generators**

Kohler V-Twin	20,25	OE013	RC12YC		0.8
Briggs & Stratton Vanguard V-Twin	16,20		RC14YC		0.8
Briggs & Stratton			RJ19LM	QJ19LM	0.8
Honda OHV	8,9,13	OE051	RN11YC		0.8
Honda V-Twin	20	OE051	RN11YC		0.8

**NOVICO****Lawn Mowers**

Briggs & Stratton			RJ19LM	QJ19LM	0.8
-------------------	--	--	--------	--------	-----

**NOVO****Pumps**

AU Pressure			RD16		0.6
CA-33	(18mm)		D14		0.6
DV, DW Pressure			RJ12C		0.6
L9M-6C Pronto Pump			RJ19LM		0.6

**Pumps, Compressors & Refrigeration Units**

47			D14		0.6
133			D14		0.6
			RJ8C		0.6
3W2			RD16		0.6
4W, 4W2			RD16		0.6
66, 95			D14		0.6
A-16	(18mm)		D14		0.6
AD3W Diaphragm			RD16		0.6
All	(1/2"-14 Pipe)		25		0.6
BA-23			RJ6C		0.6
CW Series 33			D14		0.6
DA-33	(18mm)		D14		0.6
	(14mm)		RJ6C		0.6
L10M-2, L15M-3, L20M-3 Pronto Prime, L30M-4			RD16		0.6
L3M-1 1/2			RJ8C		0.6
L40M-4N Pronto Prime			RD16		0.6

**Snow Removers**

L7M-2 Pronto Prime			RD16		0.6
--------------------	--	--	------	--	-----

**O & R****Engines**

13A	Normal Service		CJ14		0.8
	Severe Service		RCJ8		0.8
13B	Normal Service		CJ14		0.8
	Severe Service		RCJ8		0.8
20A	Severe Service		CJ6		0.8
	Normal Service		RCJ8		0.8
Compact 1			UY6		0.8

**Generators**

All Models			RCJ8		0.6
------------	--	--	------	--	-----

**Pumps, Compressors & Refrigeration Units**

Online			RCJ8		0.6
--------	--	--	------	--	-----

**ODB****Vacuums**

Kohler	25	OE013	RC12YC		0.8
Honda	24	OE051	RN11YC		0.8

**OHLER****Pumps, Compressors & Refrigeration Units**

Wisconsin			RD16		0.6
Briggs & Stratton, Clinton			RJ19LM	QJ19LM	0.8

**OLATHE****Power Equipment**

Briggs & Stratton			RJ19LM	QJ19LM	0.8
-------------------	--	--	--------	--------	-----



CC BHP

21



OPT.



mm

**OLDHAM****Sprayers**

Briggs & Stratton Vanguard	9	OE013	RC12YC	QC12YC / XC92YC	0.8
Briggs & Stratton	5		RJ19LM	QJ19LM	0.8
Honda OHV	5.5	OE051	RN11YC		0.8

**OLEO - MAC (EMAK)****Brushcutters**

721, 727, 727S, 727T, 733, 740			RCJ7Y		0.5
733S, 433BP			RCJ7Y		0.5

**Chainsaws**

233, 234, 234F, 240, 244, 244F, 246FDL, 250A			RCJ7Y		0.5
251, 251B, 251 Super E1, 252, 252F, 254, 254F			RCJ7Y		0.5
260 Auto., 261, 264, 264F, 264FDLX, 264TTA			RCJ7Y		0.5
271, 272, 272F, 274TTA, 280, 281			RCJ7Y		0.5
284, 284F, 284TTA, 335, 340, 340F			RCJ7Y		0.5
350, 350S, 355, 355F, 460S, 460AS			RCJ7Y		0.7
480, 480S, 480AS, 481, 482, 482MP			RCJ7Y		0.5
930, 935, 935DF, 940, 942, 945, 945DF, 946			RCJ7Y		0.5
950, 950F, 950FS, 951, 999, 999F			RCJ7Y		0.5
AM150, AM180	1,8 3,5		RCJ7Y		0.5
S30, S50, S80, S100			RCJ7Y		0.5
SA18, SA30, SA30TL, SA45, SA45TL			RCJ7Y		0.5
SC21, SC23, SC33, SC55			RCJ7Y		0.5

**Power Equipment**

MTL30, MTL50, MTL80, MTL106	1,2 6,8		RCJ7Y		0.5
-----------------------------	---------	--	-------	--	-----

**OLYMPIA****Lawn Mowers**

All Models			RJ19LM		0.8
------------	--	--	--------	--	-----

**Tillers**

Briggs & Stratton			RJ19LM	QJ19LM	0.8
Tecumseh			RJ8C		0.8

**OLYMPIA ROSS****Fire Pumps**

Type-D			D14		0.6
--------	--	--	-----	--	-----

**OLYMPYK****Augers, Mixers**

AM150, AM18, AM180, AT2080, JET410, MTL30, TR1540			RCJ7Y		0.6
---	--	--	-------	--	-----

**Chain Saws**

234, 240, 244F, 251, 252, 254, 261, 264F, 264VS, 271, 272F, 284F, 355F, 480, 481, 482MP, 935DF, 935F, 941, 942, 945F, 946, 950F, 951, 962, 970, 980, 999, 999F, Super 251			RCJ7Y		0.8
---	--	--	-------	--	-----

**Cut-Off Saw**

1000TTA, 264TTA, 265TTA, 274TTA, 284TTA, 285TTA, 999TTA			RCJ7Y		0.8
---	--	--	-------	--	-----

**Power Equipment**

8260BA, 8260BAV, 8260DAV, 8260LA, 8260LAV, 8260TA, 8320BAV, 8320LAV, 8350BAV, 8350LAV, 8355HTV, 8405BD, 8405BP, 8420BAV, 8460BAV, 8510BAV, 8726, 8735, B200, B220, B220L, B260B, B260L, B300, B400, B450, TS310, TS330, TS410			RCJ7Y		0.6
---	--	--	-------	--	-----

**Water Pumps**

PA1030, PA1040, PA1100H, SA18, SA30, SA45			RCJ7Y		0.6
---	--	--	-------	--	-----

**OMC****Chain Saws**

All Models			RCJ8		0.8
------------	--	--	------	--	-----

**Power Equipment**

Briggs & Stratton (14mm)			RCJ8		0.8
Briggs & Stratton (18mm)			RD16		0.8
Kohler			RH10C		0.8



CC BHP

21



OPT.



mm

# ONAN

## Engines

0.3TL-212R/1A			RJ17LM	0.6
T0JC			RH8C	0.6
T5JC			RH8C	0.6
TB			D14	0.6
5JB			RH8C	0.6
AAE			RH8C	0.6
ACK			XEJ8	0.6
AH			RH8C	0.6
AK			RH8C	0.6
B43G			RS17YX	0.8
B48E			RS17YX	0.8
B48G			RS17YX	0.8
B48M			RH18Y	0.8
BH			RH8C	0.6
CK			RH8C	0.6
CUA			RH12	0.9
CW			D14	0.6
E125H	Elite OHV	12.5	RL95YC	0.9
	OHV		RL95YC	0.9
E125V	Elite OHV	12.5	RL95YC	0.9
	OHV		RL95YC	0.9
E140H	Elite OHV	14	RL95YC	0.9
	OHV		RL95YC	0.9
E140V	Elite OHV	14	RL95YC	0.9
	OHV		RL95YC	0.9
EC			RF11YC	0.6
ED			RF11YC	0.6
EF			RF11YC	0.6
EL			RH8C	0.6
GO			RJ8C	0.6
HC			D14	0.6
HK			D14	0.6
HN			D14	0.6
HQ			D14	0.6
HR			D14	0.6
IC			RJ6C	0.6
J120			RH8C	0.6
J30			RH8C	0.6
J60			RH8C	0.6
JA			RH8C	0.6
JB			RH8C	0.6
JC			RH8C	0.6
JT			D14	0.6
KA			RJ6C	0.6
KB			RJ6C	0.6
KKA			RH12	0.9
KR			RJ6C	0.6
LK-LKB			RH8C	0.6
MGO			RJ8C	0.6
MH			RH8C	0.8
MJC			XEJ8	0.6
MPG			RJ6C	0.6
MTK			D14	0.6
MUK			RJ8C	0.6
N-52M			RS17YX	0.8
NB			RH8C	0.8
NHA-MS			RN5C	0.8
NHB-MS			RN5C	0.8
NHC-MS		1979 →	RS17YX	0.6
NHC-MS (Early models)			RN5C	0.8
NHP			RN5C	0.8
NHP (LPG)			RN5C	0.4
OFA			XEJ8	0.6
OTC			RJ6C	0.6
P216G	Performer Twin	16	RS17YX	0.6
	Twin		RS17YX	0.6
P218G	Performer Twin	18	RS17YX	0.6
	Twin		RS17YX	0.6





CC BHP

21



OPT.



mm

**...ONAN**

**...Engines**

P218V	Performer Twin	18	RS17YX	0.6
	Twin		RS17YX	0.6
P220G	Performer Twin	20	RS17YX	0.6
	Twin		RS17YX	0.6
P220V	Performer Twin	20	RS17YX	0.6
	Twin		RS17YX	0.6
P224G	Performer Twin	24	RS17YX	0.6
	Twin		RS17YX	0.6
P226G	Performer Twin	26	RS17YX	0.6
	Twin		RS17YX	0.6
P240V	Performer Twin	20	RS17YX	0.6
	Twin		RS17YX	0.6

RCCK-MS			RH8C	0.8
T260			RS17YX	0.6
V45			D14	0.6
VB			XEJ8	0.6
W4A			D14	0.6
WAGS			D14	0.6

**Generators**

3.6			RN14YC	0.6
2.7 AJ Spec. K-N			RJ8	0.6
2.8 Micro			RL95YC	0.8
3.0 AJ			RS17YX	0.6
4.0 BF			RH18Y	0.6
4.0 BGD/E			RS17YX	0.6
4.0 Micro			RN14YC	0.6
4.0BFA			RH18Y	0.6
4000E			RL87YC	0.6
4CKM			RV17YC	0.8
5.0 BG, 5.0 BGA			RH18Y	0.6
5000E			RS17YX	0.6
5CKM			RV17YC	0.8
6.5 NH 3CR-16004N			RN5C	0.6
6.5 NH 3CR-16004P			RS17YX	0.6
6.5 NH Spec. A & D			RH8C	0.6
6.5 NH Spec. J & K			RN5C	0.6
6.5 NHE, 6000E			RS17YX	0.6
7CCKM21RV, 7CKM21RV, 7CM21RV			RH10C	0.8
AJ			RH8C	0.5
BF			RH18Y	0.8
BF Gimini			RH8C	0.5
BG			RH18Y	0.8
CCK Series	Light Service		RH10C	0.8
	CCKB-MS		RH8C	0.8
CCK Series (CNG)			J4C	0.4
Marine 2.5, 3.0 MAJB			RH8C	0.6
Marine 3.5			XMJ20	0.6
Marine 4.5			RS17YX	0.6
Marine 5.5, 6.5 MCCK			XMJ20	0.6
Marine 6.5 MCE			RS17YX	0.6
Marine 8.0, 9.0 MME		OE051	RN11YC	0.6
Marine MAJ, MCK, MJA, MJB, MJC, MKH			RH8C	0.6
Marquis I/III			RS17YX	0.6
NH Gimini			RH8C	0.5
NHD/E			RS17YX	0.6
Pro 4000			RL87YC	0.6
Pro 5000			RS17YX	0.6
	Honda OHV	9	OE051 RN11YC	0.6

**Pumps, Compressors & Refrigeration Units**

AJ-MC, CCK-MC, J60-13-MCHV, LK-MC			RH8C	0.6
-----------------------------------	--	--	------	-----

**Riding Mowers**

Onan Twin		16	RS17YX	0.6
-----------	--	----	--------	-----





CC BHP

21



OPT.

mm

## OPEM

### Chainsaws

130Z, 140Z, 142Z

140AV, 140H, 140S

145, 145AV, 145E, 146

157, 158, 165, 166

Jolly 155, 155AV, 156, K1, K2

RCJ8

0.5

RCJ8Y

0.5

RCJ8Y

0.5

RCJ8Y

0.5

RCJ8Y

0.5

## OREGON (→ Mang)

## ORLINE

### Chain Saws

Challenger Mark 11D, 11S, Mustang 129, 13, 149

Yard-Arm

RCJ8

0.8

CJ14

0.8

### Hedge Trimmers

Yard Arm

RCJ8

0.8

## OTTERBINE

### Pumps

Briggs & Stratton

8

RJ19LM

QJ19LM

0.8

## OUTDOOR POWER PRODUCTS

### Power Equipment

Briggs & Stratton Vanguard

15

OE013

RC12YC

QC12YC / XC92YC

0.8

Briggs & Stratton

5

RJ19LM

QJ19LM

0.8

Tecumseh

3.5,8,10

RJ8C

0.8

Tecumseh

16

OE098

RN4C

0.8

## OVER-LITE

### Generators

Onan CCK

Briggs & Stratton

Tecumseh

Robin

10

RH8C

RJ19LM

QJ19LM

RJ8C

RL86C

0.6

0.8

0.6

0.6

## OWEN

### Generators

(18mm)

(7/8"-18)

RD16

0.6

W14

0.6

## PACER

### Pumps

Briggs & Stratton Intek

5.5

OE013

RC12YC

QC12YC / XC92YC

0.8

Briggs & Stratton Intek

8

OE013

RC12YC

QC12YC / XC92YC

0.8

Briggs & Stratton Vanguard OHV

5.5

OE013

RC12YC

QC12YC / XC92YC

0.8

Briggs & Stratton Vanguard OHV

9

OE013

RC12YC

QC12YC / XC92YC

0.8

Briggs & Stratton

3,3.5,5

RJ19LM

QJ19LM

0.8

Briggs & Stratton

8

RJ19LM

QJ19LM

0.8

Tecumseh

7,8

RJ8C

0.8

Honda OHV

5.5,8

OE051

RN11YC

0.8

Kohler OHV

8.5

RN14YC

0.8

## PACIFIC HYDROSTAR

### Pressure Washers

Briggs & Stratton Vanguard V-Twin

16

RC14YC

0.8

Briggs & Stratton

5,11

RJ19LM

QJ19LM

0.8

Honda OHV

5.5,11,13

OE051

RN11YC

0.8

## PACIFIC PUMPER

### Pumps, Compressors & Refrigeration Units

5A

6Y-8

A

BE

GA

MK-2, MK-25

(18mm)

RJ8C

0.6

RJ12C

0.6

D9

0.6

RJ8C

0.6

RJ6C

0.6

D9

0.6



CC

BHP

21



OPT.



mm

**...PACIFIC PUMPER**

**...Pumps, Compressors & Refrigeration Units**

MK-26			OE086	RL82C		0.6
MK-2M, MK-3, MK-75				D9		0.6
MK-1				RJ6C		0.6
N, NY	(18mm)			D9		0.6
S				RJ8C		0.6
TJD-14S, TSA-8				RD16		0.6
TSA-8				RD16		0.8
U	(18mm)			D9		0.6
WA				RD16		0.8
WGC-4				RD16		0.6
WX				RD16		0.8
Y, YB, Z	(18mm)			D9		0.6
Z	(14mm)			RJ6C		0.6
	(7/8"-18)			W14		0.6
	Wisconsin			RD16		0.8
	Briggs & Stratton			RJ19LM	QJ19LM	0.8

**PAGE**

**Power Equipment**

	(18mm)			RD16		0.6
	(14mm)			RJ8C		0.6

**PALMER**

**Generators**

	(18mm)			RD16		0.6
	(7/8"-18)			W14		0.6
	(7/8"-18)			W89D		1.0

**PALMOR PRODUCTS**

**Power Equipment**

	Briggs & Stratton	5,8,11		RJ19LM	QJ19LM	0.8
--	-------------------	--------	--	--------	--------	-----

**PANTHER**

**Lawn Mowers**

All Models

				RJ19LM		0.8
--	--	--	--	--------	--	-----

**PARAGON**

**Log Splitters**

				RCJ8		0.8
--	--	--	--	------	--	-----

**PARAMOUNT**

**Blowers**

8014, 8021, GB150

				RCJ8		0.8
--	--	--	--	------	--	-----

				RCJ8Y		0.8
--	--	--	--	-------	--	-----

				RCJ8		0.8
--	--	--	--	------	--	-----

				RCJ8Y		0.8
--	--	--	--	-------	--	-----

**Trimmers**

PLT2145

				RCJ8Y		0.8
--	--	--	--	-------	--	-----

				CJ14		0.8
--	--	--	--	------	--	-----

**PARKER**

**Power Equipment**

	Briggs & Stratton Intek	6.5,10		OE013	RC12YC	QC12YC / XC92YC	0.5
	Briggs & Stratton Vanguard V-Twin	16			RC14YC		0.8
	Briggs & Stratton				RJ19LM	QJ19LM	0.8
	Kohler				RJ19LM		0.8
	Lauson				RJ19LM		0.6
	Tecumseh				RJ8C		0.8
	Honda OHV	5.5,8,11		OE051	RN11YC		0.8
	Kawasaki FE250D	8		OE051	RN11YC		0.8
	Kawasaki V-Twin	17		OE051	RN11YC		0.8
	Kohler Command Pro	8.5		OE042	RN12YC		1.0
	Honda OHV	5		OE006	RN9YC		0.8



CC BHP

21



OPT.



mm

**PARMI**

<b>Lawn Mowers</b>					
	Briggs & Stratton		RJ19LM	QJ19LM	0.8
<b>Riding Equipment</b>					
	Briggs & Stratton		RJ19LM	QJ19LM	0.8
<b>Snow Removers</b>					
	Briggs & Stratton		RJ19LM	QJ19LM	0.8

**PARTNER**

<b>Chain Saws</b>					
	T632		CJ6		0.8
	2055		CJ6		0.8
	T610, T611, T612, T613, T614, T616		RDJ8J		0.8
	T629, T630, T631		RJ6C		0.8
	T644, T645		RJ6C		0.8
	T646, T647, T655		CJ6		0.8
	T660, T661, T690		RJ6C		0.8
	T705, T712		RDJ8J		0.8
	330, 340, 350		RCJ7Y		0.8
	500, 5000		RDJ7Y		0.8
	933, 944, 946, 947		RDJ8J		0.8
	F55, F65		RCJ7Y		0.8
	K12		QL87YC		0.5
	K20, K40		RCJ7Y		0.8
	Mini-P, Mini-PA, Mini-PH		CJ6		0.8
	P100, P400		RCJ7Y		0.8
	P500, P5000		RDJ7Y		0.8
	P5000 Plus, P55, P70, P7000, P85		RCJ7Y		0.8
	Partner Mini III, IV		RDJ8J		0.8
	R12		QL87YC		0.5
	R16, R17, R18, R20, R30, R40, R417, R420, R421, R435, R44, R440, R517, R85, S50, S55, S65, TS S650		RCJ7Y		0.8
			RCJ7Y		0.5
<b>Cut-Off Saw</b>					
	K1200 II, K500 II, K650 Super, K700, K850 II		RCJ7Y		0.5

**PATHFINDER**

<b>Garden Tractors</b>					
	All Models		RJ19LM		0.8
<b>Lawn Mowers</b>					
	All Models		RJ19LM		0.8

**PATRIOT**

<b>Power Equipment</b>						
	Briggs & Stratton Intek	5.5,6.5	OE013	RC12YC	QC12YC / XC92YC	0.5
	Tecumseh	4.5		RCJ8Y		0.8
	Tecumseh	4		RJ8C		0.8
	Tecumseh	5		RJ8C		0.8
	Tecumseh	8,10		RJ8C		0.8
	Honda OHV	5.5,9	OE051	RN11YC		0.8
	Tecumseh OHV	5,6	OE098	RN4C		0.8

**PATZ**

<b>Power Equipment</b>						
	Kohler V-Twin	18	OE013	RC12YC		0.8
	Briggs & Stratton Vanguard V-Twin	14,18		RC14YC		0.8
	Honda OHV	11,13	OE051	RN11YC		0.8





CC

BHP

21



OPT.



**PECO**

**Chain Saws**

Honda	11,13	OE042	RN12YC		0.8
-------	-------	-------	--------	--	-----

**Power Equipment**

Briggs & Stratton Intek	5.5	OE013	RC12YC	QC12YC / XC92YC	0.5
Briggs & Stratton Vanguard	9,11	OE013	RC12YC	QC12YC / XC92YC	0.8
Kohler Command OHV	6	OE013	RC12YC		0.8
Kohler V-Twin	18	OE013	RC12YC		0.8
Kohler V-Twin	25	OE013	RC12YC		0.8
Kohler	20		RH10C		0.8
Kohler	8,12,16		RH10C		0.8
Briggs & Stratton	3,3.5,4,5		RJ19LM	QJ19LM	0.8
Briggs & Stratton	8		RJ19LM	QJ19LM	0.8
Tecumseh	4,5,6,8,10		RJ8C		0.8
Honda OHV	5.5,6.5,11,13	OE051	RN11YC		0.8
Kawasaki FC150V	5	OE051	RN11YC		0.8

**PEERLESS**

**Chain Saws**

D25			RCJ8		0.8
D55, D65			RJ8C		0.8
E10			CJ6		0.6
E75, E95			RCJ8		0.8

**PEKTRA**

**Mowers**

Briggs & Stratton	3.75,4,5,6		RJ19LM	QJ19LM	0.8
-------------------	------------	--	--------	--------	-----

**Power Equipment**

PF1ZT, PF2RT, PF3RTX			RDJ7Y		0.6
----------------------	--	--	-------	--	-----

**PEMCO**

**Lawn Mowers**

All Models			RJ19LM		0.8
------------	--	--	--------	--	-----

**Power Equipment**

			RCJ8		0.8
--	--	--	------	--	-----

**PENNCREST**

**Lawn Mowers**

All Models			RJ19LM		0.8
------------	--	--	--------	--	-----

**PENNINGTON**

**Lawn Mowers**

Briggs & Stratton, Clinton			RJ19LM	QJ19LM	0.8
----------------------------	--	--	--------	--------	-----

**Mowers**

Wisconsin			RD16		0.8
Kohler			RH10C		0.8
Onan			RH8C		0.8
Briggs & Stratton			RJ19LM	QJ19LM	0.8
Clinton			RJ8C		0.6

**PENNSYLVANIA**

**Power Equipment**

All Other			RJ8C		0.6
Clinton			RH10C		0.8

**PERFECTION**

**Generators**

All Models			W14		0.6
------------	--	--	-----	--	-----

**PERFORMANCE POWER PRO**

**Power Equipment**

All Models			RCJ8		0.8
------------	--	--	------	--	-----



CC BHP

21



OPT.

mm

## PERMA GREEN SUPREME

### Spreaders, Sprayers

Briggs & Stratton Intek	6,6.5	OE013	RC12YC	QC12YC / XC92YC	0.8
Robin	6		RL86C		0.6

## PHELPS

### Generators

Wisconsin			25		0.8
Lauson			RD16		0.6

## PHÖNIX

### Mowers

AM51B	B & S		RJ19LM	QJ19LM	0.7
BM104B	Tecna		RJ19LM	QJ19LM	0.7
BM104T	Tecna		RJ19LM	QJ19LM	0.7
BM200T	Tecna		RJ19LM	QJ19LM	0.7
PXR40	B & S		RJ19LM	QJ19LM	0.7
PXR45R	Tecna		RJ19LM	QJ19LM	0.7
PXR48	B & S		RJ19LM	QJ19LM	0.7
PXR48RHH	Honda	OE051	RN11YC		0.7
PXR48RV	B & S		RJ19LM	QJ19LM	0.7
PXR48RVE	B & S		RJ19LM	QJ19LM	0.7
PXR55RV	B & S		RJ19LM	QJ19LM	0.7
Twin Cut 12.5	B & S		RJ19LM	QJ19LM	0.7
Twin Cut 15.5	B & S		RJ19LM	QJ19LM	0.7
Twin Cut 16	B & S	OE013	RC12YC	QC12YC / XC92YC	0.7

### Power Equipment

PM21H			RCJ7Y		0.7
Primo 35, 500R, Quattro 500B	B & S		RJ19LM	QJ19LM	0.7

## PINCOR

### Generators

Briggs & Stratton			RJ19LM	QJ19LM	0.6
Robin EY21			RJ8C		0.6

### Lawn Mowers

Pincor 2-Cycle			RJ12C		0.9
Briggs & Stratton			RJ19LM	QJ19LM	0.8
Pincor 4-Cycle			RJ8C		0.6

## PIONEER

### Chain Saws

850			J4C		0.8
970			CJ6		0.8
1410			RCJ8		0.8
			CJ14		0.8
1420			RCJ8		0.8
			CJ14		0.8
1450			RCJ8		0.8
			CJ14		0.8
1850			RCJ4		0.8
1072, 1073			CJ6		0.8
1074, 1074E, 1074UB, 1100,			RCJ8		0.8
1110, 1120, 1130, 1150, 1160,					
1200, 1200A					
1410A			RCJ8		0.8
			CJ14		0.8
1520, 1560, 1750, 1770, 1771			CJ6		0.8
2071, 2073			CJ6		0.8
2200, 2270, 2400, 2460,			RCJ8		0.8
3071, 3200, 3270, 3270S					
400, 410, 450, 550, 600,			RJ8C		0.8
610, 620, 650, 700					
700G			J4C		0.8
750, 800			RJ8C		0.8
F			RJ12C		0.8
Farmlite			RCJ7Y		0.8
Farmsaw, Farmsaw II			RCJ8		0.8
G			RJ12C		0.8



CC

BHP

21



OPT.



mm

## ...PIONEER

### ...Chain Saws

HA, HB				RJ6C		0.8
HC				RJ8C		0.8
L				RD16		0.8
M				RJ12C		0.8
NU-17				RJ8C		0.8
One Man				RJ6C		0.8
P10				CJ6		0.8
P11				RCJ7Y		0.8
P12, P20				CJ6		0.8
P21, P21B, P21S, P21SB				RCJ8		0.8
P25, P26				CJ6		0.8
P26E, P28, P28B, P28E, P28S, P28SB				RCJ8		0.8
P30, P30S				CJ6		0.8
P35, P35S				RCJ8		0.8
P38, P39				RCJ7Y		0.8
P40				CJ6		0.8
P41				RCJ7Y		0.8
P41S				RCJ8		0.8
P42W				RCJ7Y		0.8
P50, P51, P51S				CJ6		0.8
P52W				RCJ7Y		0.8
P55, P55S				CJ6		0.8
P60, P62, P62W				RCJ7Y		0.8
RA				RJ8C		0.8
Sub-Zero 2400, Sub-Zero 2460				CJ14		0.8
Super, Super Twins, Twin				RJ6C		0.8

### Generators

700F	Heavy Service			J4C		0.6
	Light Service			RJ8C		0.6
700G	Heavy Service			J4C		0.6
	Light Service			RJ8C		0.6
	Wisconsin			RD16		0.6

### Lawn Mowers

	Briggs & Stratton			RJ19LM	QJ19LM	0.8
	Tecumseh			RJ8C		0.8

### Vacuums

	Honda V-Twin	18,20		OE051	RN11YC	0.8
--	--------------	-------	--	-------	--------	-----

## PISTON POWERED PRODUCTS

### Chain Saws

Super Saws				RDJ8J		0.8
------------	--	--	--	-------	--	-----

## PK

### Sprayers

	Briggs & Stratton Intek	5.5		OE013	RC12YC	QC12YC / XC92YC	0.5
	Briggs & Stratton Vanguard V-Twin	16			RC14YC		0.8
	Briggs & Stratton	3.5			RJ19LM	QJ19LM	0.8
	Briggs & Stratton	8,10			RJ19LM	QJ19LM	0.8
	Tecumseh	3			RJ8C		0.8

## PLANET JR.

### Power Equipment

	(18mm)				RD16		0.8
	(14mm)				RJ8C		0.8

## PLUGR

### Aerators

	Briggs & Stratton Intek	5,5,5,6.5		OE013	RC12YC	QC12YC / XC92YC	0.5
	Honda OHV	5.5		OE051	RN11YC		0.8

### Power Equipment

PLM1600	Briggs & Stratton Intek OHV	10		OE013	RC12YC	QC12YC / XC92YC	0.8
	Honda PLM1600	8		OE051	RN11YC		0.8



CC BHP

21



OPT.



mm

## PLUS POWER

### Compressors

T040W, 4090W, DEP5013, DEP8018

Wisconsin

3,5,8

RL86C

0.6

RL86C

0.6

### Generators

DLG1200, DLG2000, DLG3500, DLG3500S, DLG5000, DLG5000S

Wisconsin

3,4,8

RL86C

0.6

RL95YC

0.6

RL86C

0.6

Wisconsin

11

RL95YC

0.6

## POLARIS

### Generators

P1300, P2800, P4100, P6100

Robin EY15

3.5

RL86C

0.6

Robin

6,8.5

RL87YC

0.6

Robin EH34

11

OE006

RN9YC

0.6

### Mowers

Briggs & Stratton

10.5

RJ19LM

QJ19LM

0.8

### Pumps

PP205T, PPS205, PPS305, PPS305D, PPS305T

Robin

RL86C

0.6

OE098

RN4C

0.8

RL86C

0.6

RJ8C

0.6

### Sweepers

Briggs & Stratton Intek

6.5

OE013

RC12YC

QC12YC / XC92YC

0.5

### Utility Vehicles

Polaris  
(18mm)

425

OE013

RC12YC

0.7

OE005

RC9YC

0.7

## POLORON

### Garden Tractors

(18mm)

Briggs & Stratton

RD16

0.8

RJ19LM

QJ19LM

0.8

### Lawn Mowers

All Models

RJ19LM

0.8

### Snow Removers

All Models

RJ19LM

0.8

## PONY POWER

### Lawn Mowers

All Models

RJ19LM

0.8

## PORTA-SEEDER

### Power Equipment

Briggs & Stratton

5

RJ19LM

QJ19LM

0.8

## PORTO-PUMP

### Pumps

Camel Models, Standard

RD16

0.6

## POULAN

### Chain Saws

20  
92  
100  
355  
361  
2500  
2550  
2600  
2700  
2750  
2800  
2900  
3000  
3050

RCJ8

0.6

RCJ8

0.6

RCJ8

0.6

RCJ7Y

0.6

RCJ8

0.6

RCJ7Y

0.6

RCJ7Y

0.6

RCJ7Y

0.6

RCJ7Y

0.6

RCJ4

0.6

RCJ7Y

0.6

RCJ4

0.6

RCJ7Y

0.6



CC

BHP

21



OPT.



mm

**...POULAN****...Chain Saws**

3400			RCJ8Y		0.6
3450			RCJ4		0.6
3500			RCJ6Y		0.6
3600			RCJ6Y		0.6
3750			RCJ6Y		0.6
4200			RCJ4		0.6
4400			CJ6		0.6
4900			CJ6		0.6
5200			RCJ4		0.6
5400			CJ6		0.6
6900			CJ6		0.6
8510			RCJ4		0.6
180, 1800, 1950			RCJ7Y		0.6
200, 2000, 205, 2050			RCJ7Y		0.6
20D			RCJ8		0.6
2100, 2150, 2175, 2250, 2300, 2350, 2375, 2400, 2450			RCJ7Y		0.6
245A, 25			RCJ8		0.6
252A			RCJ8		0.6
25DA, 25SN			RCJ8		0.6
306, 306A, 306SA			RCJ8		0.6
3100, 3300, 3350			RCJ4		0.6
3700, 375			RCJ8Y		0.6
3800, 4000			RCJ8Y		0.6
405, 415			RCJ7Y		0.6
4200CVA			RCJ7Y		0.6
45-12 Multi-Purpose			RCJ4		0.6
5200CVA			RCJ8		0.6
52-12, 52-14			RCJ4		0.6
53A, 54			RJ8C		0.6
5500, 6000			RCJ4		0.6
6000CVA			RCJ7Y		0.6
71A, 72, 76			RCJ8		0.6
7700, 8500			CJ6		0.6
B520			CJ14		0.6
Bad Boy 3450			RCJ4		0.6
Bad Boy 3750			RCJ6Y		0.6
KS412			RCJ7Y		0.6
Micro MZ5, Micro XXV, Model XX			RCJ8		0.6
PP 225, PP190 Arborist, PP210, PP230, PP235, PP236, PP255, PP260			RCJ7Y		0.6
PP285			RCJ4		0.6
PP295			RCJ7Y		0.6
PP305			RCJ4		0.6
PP310, PP315			RCJ7Y		0.6
PP325			RCJ8Y		0.6
PP335, PP335 Predator, PP336			RCJ4		0.6
PP365			RCJ6Y		0.6
PP375			RCJ8Y		0.6
PP380			RCJ6Y		0.6
PP395			RCJ8Y		0.6
PP405, PP415, PP425, PP445, PP455, PP475, PP505, PP525, PP655, PPS23 Arbor Pro, PPS25DA, S23			RCJ7Y		0.6
S25, S25AV			RCJ8		0.6
S33			RJ8C		0.6
S6000			RCJ7Y		0.6
S68, S72, Super XXV			RCJ8		0.6
Wild Thing 2175, Wild Thing 2375			RCJ7Y		0.6
<b>Generators</b>					
PA1250, PA2250, PA35001, PA4000, PA5000-I, PA5000IES			RJ8C		0.6
<b>Lawn Mowers</b>					
PP20375, PP2255, PP2260, PP22R55, PP500, PP722, PP735, PP750, PP751, PP752, PP800M, PP835			RJ19LM		0.8
	Briggs & Stratton		RJ19LM	QJ19LM	0.8
	Tecumseh	6	RJ19LM		0.8





CC BHP

21



OPT.



mm

**POULAN PRO**

**Log Splitters**

15-AR, 19-24-8AR, 19-7,  
26-10, 26-TM, P-26-TM

RCJ8

0.8

**Power Equipment**

452MYB

RCJ8

0.8

PE3500, PP135, PP22,  
PP422, PP432

RCJ8Y

0.8

PL200, PL500, PP110

RCJ8Y

0.8

PP112

CJ14

0.8

PP113

RCJ8Y

0.8

PP114, PP115

CJ14

0.8

PP117

RCJ8Y

0.8

PP165, PP176

CJ14

0.8

PP185

RCJ8Y

0.8

PP196

CJ14

0.8

PP200

RCJ8

0.8

PP442

RCJ8

0.8

PPC22, PPC25, PPC31

CJ6

0.8

PPC25E

CJ6

0.8

PPFT3, PPFT35

RJ19LM

0.8

PPFTC14

RCJ8Y

0.8

PPRT3, PPRT5, PPRT55, PPRT8

RJ19LM

0.8

PT3000, PT6000, PT7000

RCJ8Y

0.8

**Riding Equipment**

420

RCJ8

0.8

440

CJ6

0.8

111, 117

CJ14

0.8

165, 175

RCJ8Y

0.8

2600, 2610, 2620

CJ14

0.8

770, 800, 900

RCJ8

0.8

PHT19

RCJ8Y

0.8

PP1036S, PP1136, PP11536, PP1242S,

RJ19LM

0.8

PP12538, PP12542, PP125H38,

PP125H42, PP125R38, PP12R38M

PP1338

OE098

RN4C

0.8

PP1442

OE013

RC12YC

1.0

PP14542, PP155H42

RJ19LM

0.8

PP1644

RV17YC

0.6

PP165H42

OE098

RN4C

0.8

PP16H44

RV17YC

0.6

PP16H46B

RC14YC

0.8

PP1844

RV17YC

0.6

PP1846

OE013

RC12YC

0.8

PP185

RCJ8Y

0.8

PP18H44

RV17YC

0.6

PP18H46

OE013

RC12YC

0.8

PP195

RCJ8Y

0.8

PP2050, PP20H50

RV17YC

0.6

PP22H50

OE013

RC12YC

0.8

PP442

RCJ8

0.8

Briggs & Stratton Intek V-Twin OHV

17,18

OE013

RC12YC

QC12YC / XC92YC

0.8

Kohler OHV

14

OE013

RC12YC

1.0

Kohler V-Twin

18

OE013

RC12YC

0.8

Briggs & Stratton Vanguard V-Twin

16

RC14YC

0.8

Briggs & Stratton Vanguard V-Twin

20

RC14YC

0.8

Briggs & Stratton

3,5,10,11,12,  
12.5

RJ19LM

QJ19LM

0.8

Tecumseh OHV

13,14.5,16.5

OE098

RN4C

0.8

Kohler Twin

16,18

RV17YC

0.6

Kohler Twin

20

RV17YC

0.6

**POULAN PUMPS**

**Pumps, Compressors & Refrigeration Units**

3H-151, 3H-5M, 3H-8M,  
5H-10M, 5H-173, 5H-212T

RCJ8

0.6



CC

BHP

21



OPT.

**POWER BEE**

Engines					
Series 580	U.S. Motor Power	4		RJ8C	0.8
Series 700	U.S. Motor Power	5		RJ8C	0.8
Series 820	U.S. Motor Power	8		RJ8C	0.8
	U.S. Motor Power	6.25		RJ8C	0.8

**POWER EASE**

Sprayers					
	Honda	4,5,5.5,6.5, 9,11,13,20		OE051 RJ11YC	0.8

**POWER KING**

Garden Tractors					
	Kohler V-Twin	18,20,22		OE013 RC12YC	0.8
	Kohler	12,14		RH10C	0.8
	Briggs & Stratton			RJ19LM	0.8
	Kohler Twin	16,17,18		RV17YC	0.6

**POWER MATIC**

Lawn Mowers					
All Models				RJ19LM	0.8

**POWER PAK**

Pumps, Compressors & Refrigeration Units					
All Models				RJ12C	0.6

**POWER PARTNER**

Generators					
4000, 6000	OHV			OE051 RJ11YC	0.6

**POWER PRINCE**

Edgers, Trimmers					
				RJ8C	0.8

**POWER PRODUCTS**

Engines					
AH36 Type 70				RCJ8	0.8
AH44				RCJ8	0.8
AH47				RJ8C	0.8
AH48				RCJ8	0.8
AH49				RCJ8	0.8
AH52				RJ8C	0.8
AH58				RJ8C	0.8
AH81				RJ8C	0.8
AV51				RJ8C	0.8

**POWER PRUNER**

Trimmers					
Tree PP1200, PP1250, PP1400, PP1600				RCJ8Y	0.8
Tree PP600				RDJ7Y	0.6
Tree PP800				RCJ7Y	0.6

**POWER TEK**

Power Equipment					
	Briggs & Stratton Intek OHV	5.5		OE013 RC12YC	QC12YC / XC92YC 0.5
	Kohler V-Twin	20,25		OE013 RC12YC	0.8
	Briggs & Stratton Twin	18		RJ19LM	QJ19LM 0.8
	Honda OHV	5.5,8		OE051 RJ11YC	0.8

**POWER TRAC**

Mowers, Utility Vehicles					
	Kohler	22		OE013 RC12YC	0.8
	Kohler V-Twin	18		OE013 RC12YC	0.8
	Kohler V-Twin	25		OE013 RC12YC	0.8
	Briggs & Stratton Vanguard V-Twin	18		RC14YC	0.8
	Briggs & Stratton Twin	18		RJ19LM	QJ19LM 0.8
	Tecumseh OHV	12.5		RL86C	0.8
	Robin OHV	18,22,25		OE006 RN9YC	0.6



CC BHP

21



OPT.



mm

## POWER TRIM

### Edgers

Honda	2.2	CJ14		0.8
Briggs & Stratton	2,3,3.5	RJ19LM	QJ19LM	0.8
Honda OHV	4	OE051	RN11YC	0.8
Honda OHV	3.5	OE006	RN9YC	0.8

## POWER WAGON

### Power Equipment

Briggs & Stratton	5	RJ19LM	QJ19LM	0.8
-------------------	---	--------	--------	-----

## POWERBOX

### Generators

Kohler Command Pro Air Cooled	11,13,15	OE013	RC12YC	0.8
Kohler Command Pro V-Twin	20,25,27	OE013	RC12YC	0.8

## POWERLITE

### Generators

(18mm)		D14		0.6
(14mm 7/16")		RH10C		0.6
(14mm 3/8")		RJ8C		0.6
(7/8"-18)		W14		0.6

## POWERMATE

### Generators

T500, 3000			RCJ8	0.6
PM1600, PM2800	OHV	OE006	RN9YC	0.6
PM3500		OE059	L92YC	0.6
PM4500			RCJ8Y	0.6
PM500			CJ6	0.6
PM800			RCJ8	0.6

## POWERMOW (Kees)

### Lawn Mowers

All Models			RJ19LM	0.8
------------	--	--	--------	-----

## POWR-PAK

### Generators

Briggs & Stratton	5,8,11	RJ19LM	QJ19LM	0.6
Briggs & Stratton Twin	16	RJ19LM	QJ19LM	0.6

## POYNTER

### Lawn Mowers

All Models			RJ19LM	0.8
------------	--	--	--------	-----

## PRECISION-BUILT

### Lawn Mowers

All Models			RJ19LM	0.8
------------	--	--	--------	-----

## PRESSURE QUEEN

### Pumps, Compressors & Refrigeration Units

All Models			RJ12C	0.6
------------	--	--	-------	-----

## PRO

### Lawn Mowers

All Other	Clinton		RJ8C	0.6
	Clinton	3.5	RH10C	0.8
	Briggs & Stratton		RJ19LM	QJ19LM
	Tecumseh		RJ8C	0.8

## PRO BLOW

### Blowers

Kohler	8		RH10C	0.8
Briggs & Stratton	8		RJ19LM	QJ19LM



CC BHP

21



OPT.



mm

### PRO CHOPPER

#### Power Equipment

Briggs & Stratton Vanguard V-Twin	16		RC14YC	0.8
Honda OHV	13	OE051	RN11YC	0.8

### PRO HIGH WHEEL

#### Mowers

Briggs & Stratton, Tecumseh			RJ19LM	QJ19LM	0.8
-----------------------------	--	--	--------	--------	-----

### PRO SERIES

#### Lawn Mowers

Briggs & Stratton			RJ19LM	QJ19LM	0.8
-------------------	--	--	--------	--------	-----

### PROBST

#### Sweepers

Honda OHV	5	OE006	RN9YC		0.8
-----------	---	-------	-------	--	-----

### PRO-MASTER

#### Lawn Mowers

Briggs & Stratton			RJ19LM	QJ19LM	0.8
Kohler	4		RJ19LM		0.8
Robin EY18W			RL86C		0.8

#### Power Equipment

Kohler OHV	14	OE013	RC12YC		1.0
Briggs & Stratton Vanguard V-Twin	16		RC14YC		0.8
Kawasaki	12.5		RCJ8		0.6
Briggs & Stratton			RJ19LM	QJ19LM	0.8
Kohler	4		RJ19LM		0.8
Honda OHV	4	OE051	RN11YC		0.8
Honda OHV	5.5	OE051	RN11YC		0.8
Kawasaki OHV	17	OE051	RN11YC		0.8
Honda OHV	3.5	OE006	RN9YC		0.8
Honda OHV	5	OE006	RN9YC		0.8
Kohler Twin	16,18,20		RV17YC		0.6

### PRO-STAR

#### Riding Mowers

Kohler Twin	18,20		RV17YC		0.6
-------------	-------	--	--------	--	-----

### PRO-VAC

#### Lawn Vacuums

Briggs & Stratton			RJ19LM	QJ19LM	0.8
Robin EY18-3W			RL86C		0.8

### PUG

#### Utility Vehicles

Kohler V-Twin	20	OE013	RC12YC		0.8
---------------	----	-------	--------	--	-----

### PULLMAN

#### Vacuums

			RCJ8		0.8
--	--	--	------	--	-----

### PUMPTEC

#### Pumps

Self-priming	Tecumseh	3.8		RJ19LM	0.8
--------------	----------	-----	--	--------	-----

### QUALCAST

#### Mowers

Briggs & Stratton			RJ19LM	QJ19LM	0.8
-------------------	--	--	--------	--------	-----

### QUICKSILVER

#### Generators

QS-4.0G, QS-6.5G, QS-8.0G			OE006	RN9YC	0.9
---------------------------	--	--	-------	-------	-----

### QUICK-SPLIT

#### Log Splitters

Briggs & Stratton			RJ19LM	QJ19LM	0.8
Tecumseh			RJ8C		0.8



CC BHP

21



OPT.

**QUINSTAR****Riding Mowers**

Briggs & Stratton Vanguard V-Twin	14		RC14YC		0.8
Briggs & Stratton	8,12		RJ19LM	QJ19LM	0.8

**RALLY****Lawn Mowers**

Briggs & Stratton	3.5,3.75,4,5		RJ19LM	QJ19LM	0.8
Tecumseh	3.5		RJ19LM		0.8

**Riding Equipment**

Briggs & Stratton OHV	14	OE013	RC12YC	QC12YC / XC92YC	0.8
Briggs & Stratton	10,11,12,12.5		RJ19LM	QJ19LM	0.8
Briggs & Stratton	3,3.5,5		RJ19LM	QJ19LM	0.8
Briggs & Stratton Twin	14,18		RJ19LM	QJ19LM	0.8
Tecumseh	12.5		RL86C		0.8

**RAM****Power Equipment**

Kohler	13	OE013	RC12YC		0.8
Kohler V-Twin	25	OE013	RC12YC		0.8
Wisconsin W4-1770	35		RD16		0.8
Kohler	12		RH10C		0.8
Kohler	16,20		RH10C		0.8
Briggs & Stratton	5,8		RJ19LM	QJ19LM	0.8
Honda OHV	8,13,20	OE051	RN11YC		0.8
Honda OHV	5	OE006	RN9YC		0.8

**RANGER****Riding Mowers**

Ranger V, Ranger VII

			RH10C		0.8
--	--	--	-------	--	-----

**RANSOMES****Lawn Mowers**

Briggs & Stratton	5		RJ19LM	QJ19LM	0.8
-------------------	---	--	--------	--------	-----

**Mowers**

1.1 L	Ford	OE049	RN11YC4		1.1
K 181	Kohler		RJ8C		0.8
K 301	Kohler		RH12		0.8
KT 21	Kohler		RV12YC		0.8
Matador, Mastiff, Multimower, Pedestrian, Flail			RL86C		0.5
N 52M	Onan		RS12YC		0.8
	Kawasaki		RCJ8		0.8
	B & S		RJ19LM	QJ19LM	0.8
	B & S	16	RJ8C		0.8

**RAPID MOWER****Lawn Mowers**

All Models

			RH10C		0.8
--	--	--	-------	--	-----

**RAPTOR****Utility Vehicles**

Kohler	14,25	OE013	RC12YC		0.8
Briggs & Stratton Vanguard V-Twin	14,16		RC14YC		0.8

**RAYCO****Power Equipment**

Kohler	13	OE013	RC12YC		0.8
Kohler V-Twin	20,25	OE013	RC12YC		0.8
Wisconsin W4-1770	34		RD16		0.8
Kohler	12		RH10C		0.8
Honda	9,13	OE051	RN11YC		0.8
Kohler Twin	20		RV17YC		0.6

**RB MANUFACTURING****Power Equipment**

Briggs & Stratton	3.5		RJ19LM	QJ19LM	0.8
-------------------	-----	--	--------	--------	-----





CC

BHP

21



OPT.

**RED BIRD****Lawn Mowers**

All Models

RJ19LM

0.8

**RED CAP****Lawn Mowers**

All Models

RJ19LM

0.8

**RED MAX****Augers**

AG230

RCJ8

0.6

AG431

RCJ8Y

0.6

**Blowers**

EB430, EB431, EB440, EB441,

EBA430, EBA431, EBA440

RJ6C

0.6

HB2300

RCJ6Y

0.6

HB260

RCJ8Y

0.6

HBZ2500, HBZ2600 Strato-Charged 2-Cycle

RY4C

0.6

**Chain Saws**

G300AVS, G300TS

RCJ8Y

0.8

G310TS

RCJ6Y

0.8

G450AVS, G455AVS,

G561AVS, G621AVS

RCJ7Y

0.6

GZ4000

Zenoah

RZ7C

0.5

PSZ2500

Zenoah

RY4C

0.5

**Edgers**

EDG230

RCJ8

0.6

HEZ2500F, HEZ2500S Strato-Charged 2-Cycle

RY4C

0.6

**Hedge Trimmers**

CH232, CH232L, CHT230

RCJ8

0.6

CHT2300, CHT2300L, CHT300

RCJ6Y

0.6

HT230

RCJ8

0.6

HT2300, HT2300L

RCJ6Y

0.6

HT231, HT232, HT232L

RCJ8

0.6

HTZ2400, HTZ2500, Strato-Charged 2-Cycle

RY4C

0.6

LRTZ2500, SRTZ2500

**Power Equipment**

BC200

RCJ8

0.6

BC2000, BC2001

RCJ6Y

0.6

BC2001DL

RCJ8Y

0.6

BC200DL

RCJ8

0.6

BC220, BC221

RCJ8Y

0.6

BC2300

RCJ6Y

0.6

BC2300DL, BC260

RCJ8Y

0.6

BC2600, BC2600DL

RCJ6Y

0.6

BC2600DL

RCJ8Y

0.6

BC260DL

RCJ8

0.6

BC261DL

RCJ7Y

0.6

BC262

RCJ8Y

0.6

BC340

RCJ6Y

0.6

BC340, BC340DL, BC341DL, BC342,

BC342DL, BC430DWM, BC440,

BC440DWM, BC441DWM, BC442

BC442 (C.A.R.B)

RCJ6Y

0.6

BC442DWM

RCJ8Y

0.6

BL220DL, BT17, BT200, BT2000

RCJ8

0.6

BT2000

RCJ6Y

0.6

BT220, BT221

RCJ8

0.6

EXZ2500S Strato-Charged 2-Cycle

RY4C

0.6

HE260, HE261, RE220

RCJ8Y

0.6

HE2600

RCJ6Y

0.6

SGC220

RCJ8Y

0.6

SGCZ2500S Strato-Charged 2-Cycle

RY4C

0.6

**Power Sweepers**

RMNBZ2500S, RMSZ2500S Strato-Charged 2-Cycle

RY4C

0.6

**Trimmers**

BCZ2500S, BCZ2600S Strato-Charged 2-Cycle

RY4C

0.6



CC BHP

21



OPT.



mm

## RED MULE

### Power Equipment

(18mm)  
(14mm)

RD16  
RJ8C

0.8  
0.8

## REDDY

### Heaters

RJ12YC

0.6

## RED-E

### Garden Tractors

(18mm)  
(14mm)

RD16  
RJ8C

0.6  
0.6

## RED-E-HOT

### Heaters

RH10C

0.6

## REDLINE

### Chain Saws

740PC, 840PC

RCJ7Y

0.8

### Pumps, Compressors & Refrigeration Units

SA18, SA30  
SA45

RCJ7Y  
RCJ8

0.8  
0.8

### Trimmers

RCJ6Y

0.8

## REED

### Earth Drills

Ford

RF10C

0.8

## REGENT

### Riding Mowers

Briggs & Stratton Vanguard V-Twin

16,18

RC14YC

0.8

## REINCO

### Power Equipment

Hydrograsser - Mulcher

Kohler OHV

14

OE013

RC12YC

1.0

Kohler V-Twin

20

OE013

RC12YC

0.8

Briggs & Stratton Vanguard V-Twin

18

RC14YC

0.8

Wisconsin

30,35

RD16

0.6

Ford

200

RF10C

0.8

Ford

240

RF10C

0.8

Ford

250

RF10C

0.8

Ford

300

RF10C

0.8

Ford

192

RH10C

0.6

Kohler

14

RH10C

0.8

Hercules G1600

RJ6C

0.6

Chrysler

318

OE042

RN12YC

0.9

Chrysler

360

OE042

RN12YC

0.9

Chrysler

105

OE006

RN9YC

0.6

Kohler Twin

20

RV17YC

0.6

## REINER

### Generators

CRF2, CRF3

ERF2, ERF3

Wisconsin

RL86C

0.6

RCJ8

0.6

RD16

0.6

## REMINGTON

### Chain Saws

812, 814, 816, 816AV, 840AV,  
850AV, 860AV, Jobmaster

Logger

Mighty-Mite 100, 200,  
300, 400, 500, 600

Mighty-Mite Auto, Bantam, Deluxe, Electric,  
Super Deluxe, Weekender, Outdoorsman

RCJ7Y

0.8

CJ6

0.8

RCJ7Y

0.8

CJ6

0.8



CC

BHP

21



OPT.



**...REMINGTON**

**...Chain Saws**

Outdoorsman II  
P5A, PL4, PL5, PL55A, PL6, PL6A, PL7, PL7A,  
Pow-R-Cut, Rancher, SL10, SL10A, SL11,  
SL11A, SL14, SL16, SL4A, SL5, SL55 Auto.,  
SL7, SL9, Sportsman  
Sportsman II  
Super 754  
Woodsmen  
Yardmaster

RCJ7Y  
CJ6

0.8  
0.8

**Generators**

All Models

RJ6C

0.6

**Lawn Mowers**

All Models

RJ19LM

0.8

**Pumps, Compressors & Refrigeration Units**

All Models

RJ6C

0.6

**Tillers**

Clodbuster

RCJ8

0.8

**REO**

**Lawn Mowers**

All Models

RJ19LM

0.8

**REX**

**Pumps, Compressors & Refrigeration Units**

40MW Continental

RD16

0.6

**RICH**

**Mowers**

Kohler V-Twin  
Kawasaki OHV

20,25  
17

OE013 RC12YC  
OE051 RN11YC

0.8  
0.8

**RIDE-A-MOWERS**

**Lawn Mowers**

All Models

RJ19LM

0.8

**RIDE-ON SPRAYER SPREADER**

**Mowers**

Robin OHV

6

RL86C

0.6

**RIDGID**

**Chain Saws**

305, 380, 590, 690, 850

RCJ8

0.8

**RING SAW CO.**

**Power Equipment**

Chrysler

RCJ8

0.8

**RISTON**

**Edgers**

RCJ8

0.6

**RITCHIE BESTWAY**

**Sprayers**

Kawasaki  
Briggs & Stratton  
Honda OHV  
Honda OHV

5.2  
5,11  
11  
5

RCJ8  
RJ19LM  
OE051 RN11YC  
OE006 RN9YC

QJ19LM

0.8  
0.8  
0.8  
0.8

**ROBCO**

**Pumps, Compressors & Refrigeration Units**

Rascal

RJ6C

0.6

**ROBERTSON**

**Lawn Mowers**

All Models

RJ19LM

0.8





CC BHP

21



OPT.

mm

**ROBIN-FUJI**

**Blowers**

FL231, FL251				RCJ8Y	0.6
FL40			OE086	RL82C	0.6
FL411				RCJ8Y	0.6
FL500				RCJ6Y	0.6

**Brushcutters**

NB02, NB02-2A/B				RCJ8	0.6
NB03, NB03-2D, NB034, NB04, NB04-2D/E/F			OE086	RL82C	0.6
NB16, NB211/A/AV/AW				RCJ8	0.6
NBT415				RCJ6Y	0.6

**Dusters**

FB04, FH03, FH03-3A, FH04, FH04-2A, NF03, NF03-2AD, NF04, NF04-SA/SB			OE086	RL82C	0.6
NF411BDM				RCJ8Y	0.6
NF500				RCJ8	0.6
PS04			OE086	RL82C	0.6
RS02, RS02B				RCJ8	0.6
RS03, RS03-3A, RS04, RS04-2A			OE086	RL82C	0.6
RS401				RCJ8	0.6
SDE041				RCJ8Y	0.6

**Engines**

EO20G	2-Cycle	1		RCJ8	0.6
EO2EHR	2-Cycle	1.1		RCJ8	0.6
EO2ER	2-Cycle	0.9		RCJ8	0.6
EO3ER	2-Cycle	1.8	OE086	RL82C	0.6
EO4ER	2-Cycle	2	OE086	RL82C	0.6
EO5-2	2-Cycle			RL86C	0.6
EO6	2-Cycle	2.5		RL86C	0.6
EO7	2-Cycle			RL86C	0.6
EO7-2	2-Cycle			RL86C	0.6
EO8	2-Cycle	3.3	OE086	RL82C	0.6
EO10	2-Cycle	4		RJ12C	0.6
EO10T	2-Cycle			RJ8C	0.6
EO10V	2-Cycle	4		RJ12C	0.6
EO12D	2-Cycle	4.1		RCJ8	0.6
EO13V	2-Cycle	4.2		RCJ8	0.6
EO16	2-Cycle			L90C	0.6
EO17	2-Cycle	6.5		L90C	0.6
EO25	2-Cycle			RL86C	0.6
EO25-2D	2-Cycle	12		RL95YC	0.6
EO37-3	2-Cycle			RL86C	0.6
EOH025	4-Cycle OHV	1.1		RCJ8	0.6
EOH035	4-Cycle OHV	1.6		RCJ8	0.6
EOH09	4-Cycle OHV	2.4		RCJ8	0.6
EOH12	4-Cycle OHV	4	OE098	RN4C	0.6
EOH12-2	4-Cycle OHV	4	OE098	RN4C	0.6
EOH17	4-Cycle OHV	6		RL87YC	0.6
EOH17-2	4-Cycle OHV	6		RL87YC	0.6
EOH18VX	4-Cycle OHV	6		RL86C	0.6
EOH18VX-2	4-Cycle OHV	6		RL86C	0.6
EOH25	4-Cycle OHV	8.5		RL87YC	0.6
EOH25-2	4-Cycle OHV	8.5		RL87YC	0.6
EOH30	4-Cycle OHV	9	OE006	RN9YC	0.6
EOH30V	4-Cycle OHV	9	OE006	RN9YC	0.6
EOH34	4-Cycle OHV	11	OE006	RN9YC	0.6
EOH34V	4-Cycle OHV	11	OE006	RN9YC	0.6
EOH36	4-Cycle OHV	11.5	OE006	RN9YC	0.6
EOH41	4-Cycle OHV	13.5	OE006	RN9YC	0.6
EOH43V	4-Cycle OHV		OE006	RN9YC	0.6
EOH63	4-Cycle OHV V-Twin	18	OE006	RN9YC	0.6
EOH63V	4-Cycle OHV V-Twin	18	OE006	RN9YC	0.6
EOH64	4-Cycle OHV V-Twin	20.5	OE006	RN9YC	0.6
EOH65	4-Cycle OHV V-Twin	22	OE006	RN9YC	0.6
EOH65V	4-Cycle OHV V-Twin	22	OE006	RN9YC	0.6
EOH72	4-Cycle OHV V-Twin	25	OE006	RN9YC	0.6
EOH72V	4-Cycle OHV V-Twin	25	OE006	RN9YC	0.6
EOX13	4-Cycle OHV	4.5		RL86C	0.6
EOX17	4-Cycle OHV	6		RL86C	0.6





CC BHP

21



OPT.



mm

**...ROBIN-FUJI**

**...Engines**

EX21	4-Cycle OHV	7	RL86C	0.6
EX27	4-Cycle OHV	9	RL86C	0.6
EY08	4-Cycle Side Valve	2	CJ14	0.6
EY10	4-Cycle Side Valve		RL86C	0.6
EY12W	4-Cycle Side Valve		RL86C	0.6
EY13	4-Cycle Side Valve		RL86C	0.6
EY13-2	4-Cycle Side Valve		RL86C	0.6
EY13-2K	4-Cycle Side Valve		L90C	0.6
EY14	4-Cycle Side Valve		RL86C	0.6
EY15	4-Cycle Side Valve	3.5	RL86C	0.6
EY15-3	4-Cycle Side Valve	3.5	RL86C	0.6
EY18	4-Cycle Side Valve		RL86C	0.6
EY18-2	4-Cycle Side Valve		RL86C	0.6
EY18W	4-Cycle Side Valve		RL86C	0.6
EY20	4-Cycle Side Valve	5	RL86C	0.6
EY20V	4-Cycle Side Valve	6	RL86C	0.6
EY21	4-Cycle Side Valve Twin	16	RL86C	0.6
EY23	4-Cycle Side Valve	6	RL95YC	0.6
EY25W	4-Cycle Side Valve		RL86C	0.6
EY25W (Kerosene)	4-Cycle Side Valve		L90C	0.6
EY27W	4-Cycle Side Valve		L90C	0.6
EY28	4-Cycle Side Valve	7.5	RL86C	0.6
EY33-2K	4-Cycle Side Valve		L90C	0.6
EY35	4-Cycle Side Valve	8.5	RL95YC	0.6
EY40	4-Cycle Side Valve	11	RL95YC	0.6
EY44	4-Cycle Side Valve	7.8	RL86C	0.6
EY45V	4-Cycle Side Valve	8.9	RCJ8Y	0.6
	4-Cycle Side Valve		RCJ8Y	0.6
KB31B	2-Cycle		RJ12C	0.6
KB41A	2-Cycle		RJ12C	0.6

**Generators**

RT300, RG10C, RG10DC, RG121C, RG121DC, RG15, RG15C, RG17, RG17D, RG201, RG201D, RG25, RG25D, RG301, RG33D, RG401, RG401D			RL86C	0.6
RGK161, RGK301			RL95YC	0.6
RGRG301D, RGRG33			RL86C	0.6
RGV12000, RGV12100		OE006	RN9YC	0.6
RGV1300			RL86C	0.6
RGV1300T		OE006	RN9YC	0.6
RGV2800, RGV4100, RGV4101			RL87YC	0.6
RGV6100, RGV7500		OE006	RN9YC	0.6
RGX2400, RGX3500			RL86C	0.6
RGX5500			RL95YC	0.6

**Hedge Trimmers**

HT02B			CJ6	0.6
HT200L			RCJ8Y	0.6
HT221			RCJ8	0.6
HT231, HT231L			RCJ8Y	0.6
HT750, HT750-40"			RCJ8	0.6

**Log Splitters**

Briggs & Stratton			RJ19LM	QJ19LM	0.8
-------------------	--	--	--------	--------	-----

**Power Equipment**

BE221, BE26X, BEH2500 (4 cycle), BH2500, BH2500A			RCJ8	0.6
BH3500, BH3500AU, 4-Cycle BH3600, BH3600AU			RCJ8	0.6
NB211C, NB231C, NB251, NB252, NB26, NB26AU, NB27, NB27AU, NB281, NB281AU, NB31, NB31AU			RCJ8	0.6
NB321, NB321AU			CJ6	0.6
NB351, NB411			RCJ8Y	0.6
NB50L, NBF020, NBF171, NBF251, NBF252			RCJ8	0.6
NBK411			RCJ8Y	0.6
NBKT415, NBT415			RCJ8	0.6



CC BHP

21



OPT.



mm

## ...ROBIN-FUJI

### Pumps

EC025GR

EC041ETR, EC04ER

PKV101, PKX201, PKX201H, PKX201ST,  
PKX201T, PKX301, PKX301ST

PT305T

PTG109

PTV205

PTV205H

PTV205ST

PTV205T, PTV305

PTV305D

PTV305ST, PTV405

PTV405T, RGV12000, RGV13000T

SD04, SD04-2B

SD04-2B

SD06, SD06-B

SDE04

SDE041

SDT250, SDT400

SP06B

### Tillers

Briggs & Stratton

## ROBUSH

### Log Splitters

## ROCKET

### Lawn Mowers

Briggs & Stratton

## ROCKVAC

### Vacuums

Honda

24

OE051

RN11YC

0.8

## ROILINE

### Pumps, Compressors & Refrigeration Units

AT14

## ROLOFF

### Power Equipment

Versa-Tool

## ROOF

### Lawn Mowers

Briggs & Stratton

5,8,8.5

RJ19LM

QJ19LM

0.8

Tecumseh

RJ8C

0.8

Kawasaki OHV

9

OE051

RN11YC

0.8

### Mowers, Trimmers

Piranha

Tecumseh

4,6

RJ19LM

0.8

Briggs & Stratton Intek OHV

6

OE013

RC12YC

QC12YC / XC92YC

0.5

Briggs & Stratton Vanguard

9

OE013

RC12YC

QC12YC / XC92YC

0.8

Wisconsin

RD16

0.8

Briggs & Stratton

10.5

RJ19LM

QJ19LM

0.8

Briggs & Stratton

5

RJ19LM

QJ19LM

0.8

Briggs & Stratton

8,8.5

RJ19LM

QJ19LM

0.8

Clinton

RJ8C

0.6

Kohler

RJ8C

0.8

Honda OHV

9

OE051

RN11YC

0.8

Kawasaki OHV

5,9

OE051

RN11YC

0.8



CC

BHP

21



OPT.

**ROOT****Chain Saws**

C110, C121

Lumber Jack

RDJ6J

0.8

RJ8C

0.8

**Garden Tractors**

RJ8C

0.8

**Lawn Mowers**

All Models

RJ19LM

0.8

**Tillers**

RCJ8

0.8

**ROOT-LOWELL****Sprayers**

Briggs &amp; Stratton

RJ19LM

QJ19LM

0.8

**ROPER****Chain Saws**

C11047, C12147

C332, C33237, C3327, C3327AR, C343,

C34337, C3437, C3437AR, C354, C35437

C6117, C6257, C6257AR, C6367,

C6367AR, ProAm 412, 414, 415

ProAm 615, 617

RDJ6J

0.8

CJ6

0.8

RDJ6J

0.8

CJ6

0.8

**Garden Tractors, Tillers**

Onan B48M, BF, BG

Briggs &amp; Stratton

Tecumseh

Onan N52

RH18Y

0.6

RJ8C

0.8

RJ8C

0.8

RS17YX

0.6

**Lawn Mowers**

All Models

RJ19LM

0.8

**Log Splitters**

RCJ8

0.8

**Snow Removers**

Briggs &amp; Stratton

Tecumseh

RJ19LM

QJ19LM

0.8

RJ8C

0.8

**ROTA-TRIM****Power Equipment**

Briggs &amp; Stratton

RJ19LM

QJ19LM

0.8

**ROTAVATOR****Power Equipment**

Wisconsin

Kohler

6.25

RD16

0.8

RJ19LM

0.8

**ROTH****Lawn Mowers**

All Models

RJ19LM

0.8

**ROTO CLIPPER****Lawn Mowers**

All Models

RJ19LM

0.8

**ROTOETTE****Power Equipment**

(18mm)

(14mm)

D14

0.8

RJ8C

0.8

**ROTO-HOE****Power Equipment**

Kohler M8

Briggs &amp; Stratton

Kohler K181

Tecumseh

8

4,5,8,11

8

5

RH10C

0.8

RJ19LM

QJ19LM

0.8

RJ19LM

0.8

RJ19LM

0.8

**Snow Removers**

Briggs &amp; Stratton

Tecumseh

RJ19LM

QJ19LM

0.8

RJ8C

0.8



CC BHP

21



OPT.

mm

**ROTOMATIC**

Lawn Mowers  
All Models

RJ19LM 0.8

**ROTOTILLER**

Power Equipment

(18mm) D14 0.8  
(14mm) RJ8C 0.8

**ROVER**

Lawn Mowers

Briggs & Stratton 3.75,4.5,5,5.5 RJ19LM QJ19LM 0.8

**ROW BUSTER**

Tillers

Briggs & Stratton RJ19LM QJ19LM 0.8

**ROYAL**

Generators  
Signal Unit

RD16 0.6

**ROYER**

Power Equipment

Briggs & Stratton RJ19LM QJ19LM 0.8

**RPM**

Lawn Mowers  
Rotoflo, Rototrim

Power Product Engine RJ19LM 0.8  
Iron Horse J11C 0.8  
Briggs & Stratton RJ12C 0.6  
Clinton RJ19LM QJ19LM 0.8  
RJ8C 0.6

**RUGG**

Lawn Mowers  
All Models

RJ19LM 0.8

**RYAN**

Turf Equipment

Briggs & Stratton Vanguard 5.5,6 OE013 RC12YC QC12YC / XC92YC 0.5  
Briggs & Stratton Vanguard 7.5 OE013 RC12YC QC12YC / XC92YC 0.5  
Kohler Command 18 OE013 RC12YC 1.0  
Kohler OHV 11 OE013 RC12YC 1.0  
Kohler V-Twin 18 OE013 RC12YC 0.8  
Wisconsin 7 RD16 0.6  
Power Products RDJ8J 0.8  
Kohler 12 RH10C 0.8  
Kohler 8 RH10C 0.8  
Briggs & Stratton 10,11 RJ19LM QJ19LM 0.8  
Briggs & Stratton 3,3.5,5 RJ19LM QJ19LM 0.8  
Briggs & Stratton 7 RJ19LM QJ19LM 0.8  
Kohler Magnum 8 RJ19LM 0.6  
Kawasaki 7 RJ8C 0.8  
Honda OHV 4,5.5 OE051 RN11YC 0.8  
Kawasaki OHV 8 OE051 RN11YC 0.8  
Cushman 327 33 OE042 RN12YC 0.8  
Kohler Twin 18 RV17YC 0.6

**RYAN (OMC)**

Lawn Mowers

Own CJ14 0.6  
Briggs & Stratton RJ19LM QJ19LM 0.8

**RYOBI**

Power Equipment

280r, 310BVr, 310r, 410r RDJ8J 0.8  
510r 4-Cycle RDZ19H 0.8





CC BHP

21



OPT.



mm

**...RYOBI**

**Trimmers**

1075r, 1079r, 1090r, 1090r (4-Cycle), 2065r	4-Cycle			<b>RDZ19H</b>	0.8
2075r, 2075RC, 2079r				<b>RCJ6Y</b>	0.8
2085r	4-Cycle			<b>RDZ19H</b>	0.8
2090r, 2090RC				<b>RCJ6Y</b>	0.8
700r, 705r, 710r, 720Er, 720r				<b>RDJ8J</b>	0.8
725r, 725rE				<b>RDJ7Y</b>	0.8
740r, 750r				<b>RDJ8J</b>	0.8
750r				<b>RDJ7Y</b>	0.8
760r, 765r, 766r, 767r, 768r				<b>RDJ8J</b>	0.8
768r				<b>RDJ7Y</b>	0.8
770rEB				<b>RDJ8J</b>	0.8
775r				<b>RDJ7Y</b>	0.8
780r				<b>RDJ8J</b>	0.8
780r, 790Pr, 790r				<b>RDJ7Y</b>	0.8
825r	4-Cycle			<b>RDZ19H</b>	0.8
855r, 865r				<b>RDJ8J</b>	0.8
875r, 890r (4-Cycle)	4-Cycle			<b>RDZ19H</b>	0.8
920Er, 920r, 925r, 960r, 970r, 975r, 990r				<b>RDJ7Y</b>	0.8
RD260, RD330, RD420				<b>RCJ8</b>	0.8
	Ryobi Pro-4-Mor			<b>RDZ19H</b>	0.8

**S & H**

**Power Equipment**

Honda G150	3			<b>L90C</b>	0.8	
Honda G200	5			<b>L90C</b>	0.8	
Briggs & Stratton				<b>RJ19LM</b>	QJ19LM	0.8
Kohler	4			<b>RJ19LM</b>	0.8	

**S & R PRO CHIP**

**Chippers**

Kohler V-Twin	18,25		<b>OE013</b>	<b>RC12YC</b>	0.8
Briggs & Stratton Vanguard V-Twin	18			<b>RC14YC</b>	0.8
Kawasaki Liquid-Cooled V-Twin	20			<b>RCJ8</b>	0.8
Honda OHV	18,20		<b>OE051</b>	<b>RN11YC</b>	0.8

**SABO**

**Power Equipment**

SB135L, SB140SL				<b>RJ14YC</b>	0.5
SB152				<b>RL86C</b>	0.5

**SABRE**

**Lawn Mowers**

M10, M21, M23				<b>RJ19LM</b>	0.8	
	Briggs & Stratton	5.5,6		<b>RJ19LM</b>	QJ19LM	0.8

**Lawn Tractors**

1338, 1438GS, 1538, 1538GS, 1538HS, 1542GS, 1542HS, 1546, 1642GS, 1642HS 1642HV			<b>OE013</b>	<b>RC12YC</b>	0.8	
1642HV, 1646, 1646HS			<b>OE013</b>	<b>RC14YC</b>	0.8	
1646HV			<b>OE013</b>	<b>RC12YC</b>	0.8	
				<b>RC14YC</b>	0.8	
1842GV, 1842HV, 2048HV				<b>RC14YC</b>	0.8	
2254HV, 2554HV			<b>OE013</b>	<b>RC12YC</b>	0.8	
	Briggs & Stratton Intek V-Twin	22	<b>OE013</b>	<b>RC12YC</b>	QC12YC / XC92YC	0.8
	Briggs & Stratton OHV	13,14,15	<b>OE013</b>	<b>RC12YC</b>	QC12YC / XC92YC	0.8
	Kohler V-Twin	25	<b>OE013</b>	<b>RC12YC</b>	0.8	
	Briggs & Stratton Vanguard V-Twin	16,18,20		<b>RC14YC</b>	0.8	

**SAK-VAC**

**Vacuums**

Kawasaki	5.2			<b>RCJ8</b>	0.8	
Briggs & Stratton	5			<b>RJ19LM</b>	QJ19LM	0.8



CC BHP

21



OPT.



mm

## SALSCO

### Power Equipment

Kawasaki		7.5		OE059	L92YC		0.8
Kohler OHV		12.5		OE013	RC12YC		1.0
Kohler V-Twin		20,25		OE013	RC12YC		0.8
Briggs & Stratton Vanguard V-Twin		16			RC14YC		0.8
Wisconsin		30,37,50			RD16		0.8
Ford	300				RF10C		0.6
Kohler		10,12			RH10C		0.8
Kohler		14			RH10C		0.8
Briggs & Stratton					RJ19LM	QJ19LM	0.8
Honda OHV		8,9,13		OE051	RN11YC		0.8
Wisconsin		65		OE042	RN12YC		0.6
Ford	140				RS12YC		0.8
Kohler Twin		16			RV17YC		0.6

## SALUT

### Power Equipment

Salut 5

RL86C 0.7

## SANBORN

### Pumps, Compressors & Refrigeration Units

Briggs & Stratton					RJ19LM	QJ19LM	0.8
-------------------	--	--	--	--	--------	--------	-----

## SARLO

### Brushcutters

BC8

RDJ7Y 0.8

### Lawn Mowers

Briggs & Stratton OHV		6.75		OE013	RC12YC	QC12YC / XC92YC	0.8
Briggs & Stratton		5,5.5			RJ19LM	QJ19LM	0.8
Briggs & Stratton		8,8.5,10.5,12.5			RJ19LM	QJ19LM	0.8
Kohler K181		4,8			RJ19LM		0.8
Honda		4		OE051	RN11YC		0.8
Kawasaki OHV		9		OE051	RN11YC		0.8
Honda OHV		5		OE006	RN9YC		0.8

### Mowers

Briggs & Stratton		5,5.5,8,8.5,10.5			RJ19LM	QJ19LM	0.8
Kohler		4,8			RJ19LM		0.8
Honda		13		OE051	RN11YC		0.8
Honda OHV		4		OE051	RN11YC		0.8
Kawasaki OHV		9,9.5		OE051	RN11YC		0.8
Honda OHV		5		OE006	RN9YC		0.8

### Trimmers

CS16, SS18

Briggs & Stratton Intek		6.75		OE013	RC12YC	QC12YC / XC92YC	0.8
-------------------------	--	------	--	-------	--------	-----------------	-----

## SATURN

### Lawn Mowers

Tecumseh		5			RCJ8		0.8
----------	--	---	--	--	------	--	-----

## SAVAGE

### Lawn Mowers

Clinton 2-Cycle					CJ14		0.6
Power Product Engine					RJ12C		0.6
Briggs & Stratton					RJ19LM	QJ19LM	0.8
Clinton 4-Cycle					RJ8C		0.6
Lauson					RJ8C		0.6

## SCAG

### Edgers

Briggs & Stratton		3.5			RJ19LM	QJ19LM	0.8
-------------------	--	-----	--	--	--------	--------	-----

### Riding Mowers

Kawasaki		14			L90C		0.6
Briggs & Stratton Vanguard Liquid-Cooled		31		OE013	RC12YC	QC12YC / XC92YC	0.5
Kohler OHV		6,12.5,13,14,15		OE013	RC12YC		1.0
Kohler V-Twin		18		OE013	RC12YC		0.8
Kohler V-Twin		20,22,23		OE013	RC12YC		0.8
Kohler V-Twin		25		OE013	RC12YC		0.8



CC BHP

21



OPT.



mm

**...SCAG**

**...Riding Mowers**

Briggs & Stratton Vanguard V-Twin	16		RC14YC		0.8
Briggs & Stratton Vanguard V-Twin	18,20		RC14YC		0.8
Kohler Aegis	23		RC14YC		0.8
Kawasaki	12.5		RCJ8		0.8
Kawasaki V-Twin	22		RCJ8		0.8
Briggs & Stratton	11,12		RJ19LM	QJ19LM	0.8
Briggs & Stratton Twin	18		RJ19LM	QJ19LM	0.8
Kawasaki	15	OE051	RN11YC		0.8
Kawasaki V-Twin	17,19,21	OE051	RN11YC		0.8
Kawasaki V-Twin	23	OE051	RN11YC		0.8
Kawasaki Liquid-Cooled V-Twin	27	OE042	RN12YC		0.6
Kohler Twin	18		RV17YC		0.6
Kohler Twin	20		RV17YC		0.6

**SCHRAMM**

**Compressors**

20			RD16		0.6
60			H14Y		0.8
105	Buda HP217		RD16		0.6
	IHC U-6		RD16		0.6
125			D15Y		0.8
	GOH		RH10C		0.6
210	Buda LS-525		RD16		0.6
	IHC UD-14A		W89D		0.6
315	Buda MS-766		RJ6C		0.6
	IHC PD-40, PD-80, UD-18A		W89D		0.6
600	IHC UD-1091, UD-24A		W89D		0.6
100 Pneumapower			H14Y		0.8
125 Pneumapower			D89D		0.6
			RD16		0.6
160 Pneumapower			D15Y		0.8
250 Unistage			RD16		0.6
35, 40 Pneumapower			RD16		0.6
600TC			W89D		0.6
75, 80, 85			H14Y		0.8
Fordair			RH10C		0.6
<b>Tractor</b>					
250, 250 Pneumatractor			W89D		0.6

**SCHWEISS**

**Power Equipment**

Kohler V-Twin	20	OE013	RC12YC		0.8
Kohler V-Twin	25	OE013	RC12YC		0.8
Kohler	23		RH10C		0.8
Briggs & Stratton	3,5,10		RJ19LM	QJ19LM	0.8
Briggs & Stratton Twin	18		RJ19LM	QJ19LM	0.8
Onan Twin	24		RS17YX		0.6
Kohler Twin	18,20		RV17YC		0.6

**SCORPION**

**Sprayers**

Honda	2.5		CJ14		0.8
Briggs & Stratton	3.7		RJ19LM	QJ19LM	0.8

**SCOTTS**

**Lawn Mowers**

F2105-040			RJ19LM		0.8
F2155-000		OE006	RN9YC		0.8
F2155-000, F2155-050, F2155-150				RJ19LM	0.8
Briggs & Stratton OHV	5	OE013	RC12YC	QC12YC / XC92YC	0.8
Briggs & Stratton "L" Head	3.5,4,4.5,5		RJ19LM	QJ19LM	0.8
Briggs & Stratton "L" Head	5.5		RJ19LM	QJ19LM	0.8
Honda OHV	5	OE006	RN9YC		0.8

**Power Equipment**

F1016-000			RCJ8Y		0.8
F3009-000, F4315-050, F4315-070				RJ19LM	0.8
Briggs & Stratton Intek OHV	17	OE013	RC12YC	QC12YC / XC92YC	0.8







CC

BHP

21



OPT.



## ...SCOTTS

### ...Power Equipment

Briggs & Stratton Intek Twin	20	OE013	RC12YC	QC12YC / XC92YC	0.8
Kohler OHV	16,20,23,25	OE013	RC12YC		0.8
Briggs & Stratton Vanguard			RC14YC		0.8
Tecumseh	1.6		RCJ8Y		0.8
Briggs & Stratton	15		RJ19LM	QJ19LM	0.8
Tecumseh	3.5,4		RJ19LM		0.8

## SCYTHETTE

### Lawn Mowers

#### All Models

RJ12C	0.8
-------	-----

## SD

### Power Equipment

#### SD1012

RL87YC	0.6
--------	-----

## SEAMAN

### Tillers

#### Rotary

RJ8C	0.8
------	-----

## SEARS (→ Craftsman)

## SELBRO

### Blowers

Briggs & Stratton Intek OHV	5	OE013	RC12YC	QC12YC / XC92YC	0.5
Briggs & Stratton Vanguard	16	OE013	RC12YC	QC12YC / XC92YC	0.8
Kohler V-Twin	25	OE013	RC12YC		1.0
Kohler	8		RH10C		0.8
Briggs & Stratton	8		RJ19LM	QJ19LM	0.8
Honda OHV	8,11,13	OE051	RN11YC		0.8
Kohler Twin	18		RV17YC		0.6

## SENSATION

### Lawn Mowers

#### All Other

Clinton			RH10C		0.6
Honda			L90C		0.8
Lauson			RCJ8		0.8
Clinton 501			RJ12C		0.6
Briggs & Stratton			RJ19LM	QJ19LM	0.8

### Mowers

Briggs & Stratton Vanguard V-Twin	16		RC14YC		0.8
Honda	4,5,5,11	OE051	RN11YC		0.8

### Power Equipment

Briggs & Stratton			RJ19LM	QJ19LM	0.8
-------------------	--	--	--------	--------	-----

## SENTINEL

### Lawn Mowers

Briggs & Stratton	3.5,3.75,4,5		RJ19LM	QJ19LM	0.8
-------------------	--------------	--	--------	--------	-----

### Power Equipment

Briggs & Stratton Vanguard			RC14YC		0.8
Tecumseh	1.6,3		RCJ8Y		0.8
Briggs & Stratton	12		RJ19LM	QJ19LM	0.8
Briggs & Stratton Twin	12.5,14,18		RJ19LM	QJ19LM	0.8

## SHARK

### Pressure Washers

Briggs & Stratton Quantum	6		RJ19LM	QJ19LM	0.8
Honda	5.5,6.5,9,11,13	OE051	RN11YC		0.8
Honda OHV	5	OE051	RN11YC		0.8

## SHARK TRIMMERS

### Trimmers

Honda	4,5,5	OE051	RN11YC		0.8
-------	-------	-------	--------	--	-----



CC BHP

21



OPT.



mm

## SHARPE

### Pumps, Compressors & Refrigeration Units

All Other		RJ8C	0.6
Wisconsin		RD16	0.6

## SHAW DU-ALL

### Power Equipment

A2, H2		RJ8C	0.8
HY8		RD16	0.8
Peppy Pal A1		RJ8C	0.8
R12T		RD16	0.8
R5		RJ8C	0.8
R7, R9		RD16	0.8
S28, S32		RD16	0.8
(7/8"-18)		W14	0.6

## SHINDAIWA

### Blowers

254, EB240, EB45, EB480, EB500, EB501		RCJ8	0.8
EB630		RCJ6Y	0.8

### Brushcutters

B40, B45, BP35, BP450, C230, C25, C250		RCJ8	0.8
C260		RCJ8Y	0.8
C27		RCJ8	0.8
C270		RCJ8Y	0.8
C35, C350, RC45		RCJ8	0.8

### Chain Saws

577		RCJ6Y	0.8
300S, 345, 350		RCJ8Y	0.8
357, 360, 377		RCJ6Y	0.8
415, 416, 450, 451		RCJ8Y	0.8
488P		RCJ6Y	0.8
500, 575, 577P, 680, 695		RCJ8Y	0.8
757C		RCJ6Y	0.8
E345, E350, E406, E440, E480,		RCJ8Y	0.8
E680AV, YB301, YB401, YB501,			
YB601, YB701, YB901			

### Cut-Off Saw

EC350		RCJ8	0.8
-------	--	------	-----

### Edgers

LE230, LE250, LE260		RCJ8	0.8
---------------------	--	------	-----

### Generators

G1000, G2000, G3000		RL86C	0.6
G4000		RL95YC	0.6

### Hedge Trimmers

22DH, DH230-30, DH230-40,		RCJ8	0.8
HT20-30, HT20-40, HT230-30, HT230-40			

### Power Equipment

PB230		RCJ8	0.8
PB27, PB270		RCJ8Y	0.8

### Trimmers

210, 220, 22F, 22T, F18, F20, F21,		RCJ8	0.8
F230, T18, T20, T230, T230 Limited,			
T230X, T25, T250			
T260, T260 Limited		RCJ8Y	0.8
T27, T270		RCJ8	0.8
T270		RCJ8Y	0.8
T350		RCJ8	0.8

### Water Pumps

GP25, GP45, GP450		RCJ8	0.6
-------------------	--	------	-----

## SHUR-SPLIT

### Log Splitters

Briggs & Stratton		RJ19LM	QJ19LM	0.8
Tecumseh		RJ8C		0.8



CC BHP

21



OPT.



mm

**SIGMA**

**Lawn Mowers**

Briggs & Stratton	3,5		RJ19LM	QJ19LM	0.8
Tecumseh	3		RJ19LM		0.8
Tecumseh	7		RJ8C		0.8
Kawasaki OHV	4,5	OE051	RN11YC		0.8

**SIGNATURE**

**Lawn Mowers**

Briggs & Stratton	4,4.75,5,5.5		RJ19LM	QJ19LM	0.8
-------------------	--------------	--	--------	--------	-----

**Power Equipment**

Briggs & Stratton Vanguard V-Twin	16,18,20		RC14YC		0.8
Tecumseh	1.6		RCJ8Y		0.8
Briggs & Stratton	11.5,14.5,15.5		RJ19LM	QJ19LM	0.8
Briggs & Stratton	3.5,5,8,10		RJ19LM	QJ19LM	0.8

**Snow Removers**

1029ET			RL86C		0.8
1031DE			RJ8C		0.8
320E, 320M, 521E, 521M			RCJ8Y		0.8
522E, 523M, 824E, 825DE, 825ET, 929DE			RJ8C		0.8
Tecumseh 2-Cycle	3,5		RCJ8Y		0.8
Tecumseh 4-Cycle	5,8,9,10		RJ8C		0.8
Tecumseh 4-Cycle	12		RL86C		0.8

**SIMPLICITY**

**Lawn Mowers**

Briggs & Stratton			RJ19LM	QJ19LM	0.8
Kohler			RJ19LM		0.8

**Power Equipment**

Briggs & Stratton Intek	14.5	OE013	RC12YC	QC12YC / XC92YC	0.8
Briggs & Stratton Intek	15.5	OE013	RC12YC	QC12YC / XC92YC	0.8
Briggs & Stratton Intek OHV	5.5,6,6.5,7	OE013	RC12YC	QC12YC / XC92YC	0.5
Briggs & Stratton Intek, Vanguard	17	OE013	RC12YC	QC12YC / XC92YC	0.8
Briggs & Stratton Liquid-Cooled	24.5	OE013	RC12YC	QC12YC / XC92YC	0.8
Briggs & Stratton OHV	13,14	OE013	RC12YC	QC12YC / XC92YC	0.8
Briggs & Stratton OHV	15.5	OE013	RC12YC	QC12YC / XC92YC	0.8
Briggs & Stratton OHV	18	OE013	RC12YC	QC12YC / XC92YC	0.8
Briggs & Stratton Vanguard	15	OE013	RC12YC	QC12YC / XC92YC	0.8
Briggs & Stratton Vanguard	20	OE013	RC12YC	QC12YC / XC92YC	0.8
Kohler OHV	12.5	OE013	RC12YC		1.0
Kohler OHV	14,15	OE013	RC12YC		1.0
Kohler V-Twin	18	OE013	RC12YC		0.8
Kohler V-Twin	20	OE013	RC12YC		0.8
Kohler V-Twin	23,25	OE013	RC12YC		0.8
Briggs & Stratton Vanguard	21,23		RC14YC		0.8
Briggs & Stratton Vanguard V-Twin	12.5		RC14YC		0.8
Briggs & Stratton Vanguard V-Twin	14		RC14YC		0.8
Briggs & Stratton Vanguard V-Twin	16		RC14YC		0.8
Briggs & Stratton Vanguard V-Twin	18		RC14YC		0.8
Briggs & Stratton Vanguard V-Twin	20		RC14YC		0.8
Kawasaki Liquid-Cooled V-Twin	15		RCJ8		0.6
Kawasaki Liquid-Cooled V-Twin	20		RCJ8		0.6
Kohler	10		RH10C		0.8
Kohler	14		RH10C		0.8
Kohler	16		RH10C		0.8
Kohler	23		RH10C		0.8
Onan CCKB			RH8C		0.8
Briggs & Stratton "L" Head			RJ19LM	QJ19LM	0.8
Tecumseh	5,8		RJ8C		0.8
Honda	16	OE051	RN11YC		0.8
Kawasaki OHV	17	OE051	RN11YC		0.8
Kohler Twin	17		RV17YC		0.6
Kohler Twin	20		RV17YC		0.6

**Snow Removers**

Briggs & Stratton	8		RJ19LM	QJ19LM	0.8
Tecumseh 4-Cycle			RJ19LM		0.8
Tecumseh	5,7,8,9,10		RJ8C		0.8
Tecumseh OHV		OE098	RN4C		0.8



CC BHP

21



OPT.



mm

## SIMPSON

### Log Splitters

4K				RCJ8		0.8
----	--	--	--	------	--	-----

### Pressure Washers

Briggs & Stratton Vanguard OHV	13	OE013	RC12YC	QC12YC / XC92YC	0.8
Briggs & Stratton Vanguard OHV	5.5	OE013	RC12YC	QC12YC / XC92YC	0.8
Briggs & Stratton Vanguard OHV	9	OE013	RC12YC	QC12YC / XC92YC	0.8
Kohler V-Twin	20,22	OE013	RC12YC		0.8
Briggs & Stratton Vanguard V-Twin	16,18		RC14YC		0.8
Briggs & Stratton	11		RJ19LM	QJ19LM	0.8
Briggs & Stratton	5		RJ19LM	QJ19LM	0.8
Briggs & Stratton	8,9		RJ19LM	QJ19LM	0.8
Robin W1-185			RL86C		0.6
Robin W1-390			RL86C		0.6
Robin W1-280			RL87YC		0.6
Honda OHV	5.5,6.5,9,11,13	OE051	RN11YC		0.8
Honda V-Twin	18,20	OE051	RN11YC		0.8
Kohler Twin	16,20		RV17YC		0.6

## SINGER

### Power Equipment

GBC2818				RDJ7Y		0.8
GBV28				RDJ8J		0.8
GC31, GT2815, GTE2818, GTS2816					RDJ7Y	0.8

## SKIBBE

### Sprayers

Briggs & Stratton				RJ19LM	QJ19LM	0.8
Honda OHV	3.5,5	OE006	RN9YC			0.8

## SKIL

### Alternators

Briggs & Stratton				RJ19LM	QJ19LM	0.6
-------------------	--	--	--	--------	--------	-----

### Chain Saws

1632				RJ6C		0.8
1641				RCJ8Y		0.8
1610, 1611, 1612, 1613, 1614, 1616				RDJ8J		0.8
1620, 1622, 1624				RCJ8		0.8
1629, 1630, 1631				RJ6C		0.8
1634, 1636				RCJ8		0.8
1644, 1645				RJ6C		0.8
1646, 1647				RJ6C		0.8
1660, 1661, 1690				RJ6C		0.8
1705, 1712, 933, 944, 946, 947, Partner Mini III, Partner Mini IV				RDJ8J		0.8

## SLOPE TRACTOR

### Garden Tractors

Ford	98	OE006	RN9YC		0.8
------	----	-------	-------	--	-----

### Power Equipment

Ford	192		RH10C		0.8
------	-----	--	-------	--	-----

## SMC

### Brushcutters

				RCJ8		0.6
--	--	--	--	------	--	-----

### Lawn Mowers

Kawasaki				CJ6		0.8
Kioritz				RCJ8		0.8

### Trimmers

				RCJ8		0.6
--	--	--	--	------	--	-----

## SMITH

### Pumps, Compressors & Refrigeration Units

Continental B-427, F-227, F-427				D14		0.6
Wisconsin VG4D				D14		0.6
Continental R-602				D9		0.6
Ford	302			RF10C		0.6
Ford	254			RH8C		0.6



CC BHP

21



OPT.

**...SMITH****...Pumps, Compressors & Refrigeration Units**Chrysler 15, 16, 16A, 22, 22A, 32, 8  
Hercules RXCRJ12C  
RJ8C0.6  
0.6**SMITHCO****Lawn Mowers**Briggs & Stratton  
Kohler K181  
Tecumseh

8

RJ19LM  
RJ19LM  
RJ8C

QJ19LM

0.8  
0.8  
0.8**Power Sprayers**Briggs & Stratton  
Kohler K181  
Robin EY21W  
Tecumseh

7,8

RJ19LM  
RJ19LM  
RJ8C  
RJ8C

QJ19LM

0.8  
0.8  
0.8  
0.8**Tractors**Kohler K181  
Honda OHV8  
5.5RJ19LM  
OE051 RN11YC0.8  
0.8**Turf Equipment**

Kohler V-Twin

25

OE013 RC12YC

0.8

**SMUCKER****Power Equipment**

Briggs &amp; Stratton

6

RJ19LM

QJ19LM

0.8

**SNAPPER****Generators**G30000 Briggs & Stratton Intek OHV  
G55000 Briggs & Stratton Intek OHV6.5  
10OE013 RC12YC  
OE013 RC12YCQC12YC / XC92YC  
QC12YC / XC92YC0.8  
0.8**Lawn Mowers**Robin  
Briggs & Stratton V-Twin ELS OHV  
Kohler OHV  
Briggs & Stratton Vanguard V-Twin  
Kawasaki OHV  
Robin  
Briggs & Stratton  
Tecumseh  
Honda OHV  
Robin OHV  
Kawasaki OHV  
Tecumseh OHV4.8  
18,20  
18  
21  
12.5  
4  
6,6.5  
5,5.5  
6L90C  
OE013 RC12YC  
OE013 RC12YC  
RC14YC  
RCJ8  
RJ12C  
RJ19LM  
RJ8C  
RL86C  
RL86C  
OE051 RN11YC  
OE098 RN4CQC12YC / XC92YC  
QC12YC / XC92YC0.6  
0.8  
0.8  
0.8  
0.8  
0.6  
0.8  
0.8  
0.8  
0.6  
0.8  
0.8**Power Equipment****Ground Cruiser**Kawasaki OHV  
Briggs & Stratton Intek OHV  
Briggs & Stratton OHV  
Briggs & Stratton Vanguard Single Cyl.  
Kohler OHV  
Kohler V-Twin  
Kohler V-Twin  
Kohler V-Twin  
Kubota  
Kubota  
Briggs & Stratton Vanguard V-Twin  
Kawasaki  
Robin 2-Cycle  
Kohler  
Onan B43M, B48M  
Tecumseh  
Briggs & Stratton  
Briggs & Stratton  
Briggs & Stratton  
Briggs & Stratton OHV  
Briggs & Stratton OHV  
Briggs & Stratton OHV  
Briggs & Stratton OHV  
Briggs & Stratton OHV  
Robin9.5  
6.5,6.75  
14  
16  
14,15  
18  
20  
22,23,25  
21  
23  
16,18  
12.5  
4  
18  
14  
13  
3.5,5,6  
8,9,10  
11,12  
13  
14,14.5,15  
7  
6,6.5,12OE051 RN11YC  
OE013 RC12YC  
OE013 RC12YC  
OE013 RC12YC  
OE013 RC12YC  
OE013 RC12YC  
OE013 RC12YC  
OE013 RC12YC  
OE013 RC12YC  
OE013 RC12YC  
RC14YC  
RCJ8  
RCJ8  
RH10C  
RH10C  
RH18Y  
RJ17LM  
RJ19LM  
RJ19LM  
RJ19LM  
RJ19LM  
RJ19LM  
RJ19LM  
RJ19LM  
RJ19LM  
RJ19LM  
RL86CQC12YC / XC92YC  
QC12YC / XC92YC  
QC12YC / XC92YC  
QC12YC / XC92YC0.8  
0.5  
0.8  
0.8  
1.0  
0.8  
0.8  
0.8  
0.8  
0.6  
0.8  
0.8  
0.8  
0.8  
0.8  
0.8  
0.8  
0.8  
0.8  
0.8  
0.8  
0.6



CC BHP

21



OPT.



mm

## ...SNAPPER

### ...Power Equipment

Wisconsin	4.6		RL86C		0.6
Honda OHV	5.5		OE051 RN11YC		0.8
Kawasaki OHV	14,17		OE051 RN11YC		0.8
Kawasaki OHV	5,9,9.5		OE051 RN11YC		0.8
Kawasaki V-Twin OHV	19,21,25		OE051 RN11YC		0.8
Kohler Magnum Twin	18		RV17YC		0.6
Kohler Magnum Twin	20		RV17YC		0.6

### Pressure Washers

Briggs & Stratton Intek OHV	6		OE013 RC12YC	QC12YC / XC92YC	0.8
Briggs & Stratton Vanguard	7.5,13		OE013 RC12YC	QC12YC / XC92YC	0.8

### Snow Removers

Briggs & Stratton			RJ19LM	QJ19LM	0.8
Tecumseh 4-Cycle			RJ19LM		0.8
Tecumseh			RJ8C		0.8
Tecumseh OHV		OE098	RN4C		0.8

## SNAPPIN' TURTLE

### Edgers, Trimmers

			RJ8C		0.8
--	--	--	------	--	-----

### Mowers

(18mm)			RD16		0.8
(14mm)			RJ19LM	QJ19LM	0.8

## SNG

### Spreaders

Kohler V-Twin	20		OE013 RC12YC		0.8
Briggs & Stratton Vanguard V-Twin	16		RC14YC		0.8
Kawasaki V-Twin	22		RCJ8		0.8
Honda	5.5,20		OE051 RN11YC		0.8
Kawasaki V-Twin	17		OE051 RN11YC		0.8

## SNO POWER

### Snow Removers

Tecumseh 2-Cycle			RCJ8Y		0.8
Tecumseh 4-Cycle			RJ19LM		0.8
Tecumseh	12		RL86C		0.8

## SNO-BLO

### Snow Removers

All Other			RJ8C		0.8
-----------	--	--	------	--	-----

Cushman			RD16		0.8
---------	--	--	------	--	-----

## SNOFLITE

### Snow Removers

Tecumseh			RJ19LM		0.8
----------	--	--	--------	--	-----

## SNOGO

### Snow Removers

All Models			W14		0.6
------------	--	--	-----	--	-----

## SNOW CHAMP

### Snow Removers

Tecumseh			RJ17LM		0.8
Briggs & Stratton			RJ19LM	QJ19LM	0.8

## SNOW CHIEF

### Snow Removers

Briggs & Stratton	5,14		RJ19LM	QJ19LM	0.8
Tecumseh	3,4,4.5,5		RJ19LM		0.8
Tecumseh	8,10		RJ8C		0.8

## SNOW FLITE

### Snow Removers

All Models			RJ19LM		0.8
------------	--	--	--------	--	-----



CC BHP

21



OPT.



mm

## SNOW KING

### Snow Removers

Tecumseh			RJ17LM		0.8
Briggs & Stratton			RJ19LM	QJ19LM	0.8

## SNOW TRAC

### Snow Removers

Tecumseh			RJ17LM		0.8
Briggs & Stratton			RJ19LM	QJ19LM	0.8

## SOLO

### Blowers

Mist			RJ17LM		0.8
------	--	--	--------	--	-----

### Chain Saws

603			RJ17LM		0.8
611			RJ17LM		0.6
626			RL86C		0.6
635			RJ17LM		0.6
640			RJ17LM		0.6
641			RJ17LM		0.8
642			RJ17LM		0.6
645			RJ17LM		0.6
650			RJ17LM		0.8
662			RJ17LM		0.8
101, 600 Mini, 600B			RJ17LM		0.6
605AV, 606AV, 610AV			RJ17LM		0.6
615AV, 616AV, 620AV			RJ17LM		0.6
630, 632			RJ17LM		0.6
633, 634			RJ17LM		0.8
635, 636, 639			RJ17LM		0.8
644, 644H			RJ17LM		0.8
650AV			RJ17LM		0.6
651, 651SP			RJ17LM		0.8
655AV, 660AV			RJ17LM		0.6
667, 667W, 670, 680, 680W, 690D, 690WD, 694			RJ17LM		0.8
Twin 100			RJ17LM		0.6

### Floating Pump

830			RL86C		0.6
-----	--	--	-------	--	-----

### Generators

837			RL95YC		0.5
-----	--	--	--------	--	-----

### Lawn Mowers

546			RJ19LM		0.8	
554			RJ19LM		0.8	
580			RL86C		0.8	
546HR			OE051	RN11YC	0.8	
546R/RS, 550			OE051	RJ19LM	0.8	
550HR			OE051	RN11YC	0.8	
550R/RS, 551R			OE051	RJ19LM	0.8	
552HR			OE051	RN11YC	0.8	
553S			OE051	RJ19LM	0.8	
553SL			OE051	RN11YC	0.8	
582, 585			OE051	RJ19LM	0.8	
All Other, Piano-581			OE086	RL82C	0.8	
	Briggs & Stratton	3,3,3,75,4,5,5,5	OE051	RJ19LM	QJ19LM	0.8
	Honda	4,5,5	OE051	RN11YC		0.8

### Mowers

518	Honda	4	OE051	RN11YC		0.8
546 HRM	Honda OHC Twin	3,4,5	OE051	RN11YC		0.8
548r	Briggs & Stratton	3,5,8	OE051	RJ19LM	QJ19LM	0.8
550 HRM	Honda OHC Twin	3,4,5	OE051	RN11YC		0.8
545, 545 r	Briggs & Stratton	3,5,8	OE051	RJ19LM	QJ19LM	0.8
585 HM	Honda OHC Twin	3,4,5	OE051	RN11YC		0.8
Pro-Mower 549				RL86C		0.8

### Power Equipment

522			RL86C		0.8	
	Briggs & Stratton	3.5	OE051	RJ19LM	QJ19LM	0.8
	Honda	4.5,6	OE051	RN11YC		0.8



CC BHP

21



OPT.



mm

**...SOLO**

**Riding Mowers**

Briggs & Stratton Intek	18,20	OE013	RC12YC	QC12YC / XC92YC	0.8
Briggs & Stratton	10.5,13,15.5		RJ19LM	QJ19LM	0.8

**Sprayers**

26			RL86C		0.8
400			RCJ8		0.8
415			RDJ7Y		0.8
419			RL86C		0.8
420			RDJ7Y		0.8
422			RCJ8Y		0.8
Minor 436, Rider 437			RL86C		0.8
100, 101 Multimot			CJ6		0.8
410, 410B, 412, 412B, 414			RL86C		0.8
423, 423B, 424, 436, 437, 439,			RL86C		0.8
439 Trac, 439/30 Trac, 439/50, 440					
440/441, 445			RCJ6Y		0.8
449, 449L, 459 Modular Unit			RL86C		0.8
471, 472			RCJ6Y		0.8
Combi Eng. & Mist Blower			RL86C		0.8

**Tillers**

505			RL86C		0.8
506			RCJ8		0.8
507, 510			RL86C		0.8
	Briggs & Stratton	3.5	RJ19LM	QJ19LM	0.8
	Honda	5	OE051	RN11YC	0.8
	Honda	1.5	Z9Y		0.8

**Trimmers**

664			RCJ7Y		0.8
117, 118, 119B, 119L, 120,			RCJ6Y		0.8
121B, 121L, 124, 126, 127					
127B, 127L, 128			RCJ8Y		0.8
129, 129BTS, 129L			RCJ6Y		0.8
130, 130H, 132, 134, 137, 140, 141, 152, 153				RCJ8Y	0.8
21L			RCJ6Y		0.8

**SOUTHLAND**

**Lawn Mowers**

Briggs & Stratton	3,3.5,3.75,4, 5,5.25,5.5,6		RJ19LM	QJ19LM	0.8
Tecumseh			RJ19LM		0.8

**SPARTAN**

**Brushcutters**

PC27			RJ8C		0.8
PCE24			RCJ8		0.8

**Chain Saws**

34, 34AV, Deluxe, Standard			RJ6C		0.8
----------------------------	--	--	------	--	-----

**Power Equipment**

PC35			RJ8C		0.8
------	--	--	------	--	-----

**Pumps, Compressors & Refrigeration Units**

SP30			CJ6		0.6
------	--	--	-----	--	-----

**Trimmers**

PC22, TR22			RCJ8		0.8
------------	--	--	------	--	-----

**SPEECO**

**Log Splitters**

Briggs & Stratton	5		RJ19LM	QJ19LM	0.8
-------------------	---	--	--------	--------	-----

**SPEDEX**

**Garden Tractors**

(18mm)			RD16		0.6
Kohler			RH10C		0.8
Briggs & Stratton			RJ19LM	QJ19LM	0.8
Briggs & Stratton Twin	14,16		RJ19LM	QJ19LM	0.8
Kohler Twin	18,20		RV17YC		0.6





CC BHP

21



OPT.

mm

## SPERRY-NEW HOLLAND

### Lawn Mowers

All Models

RJ19LM

0.8

### Snow Removers

All Models

RJ19LM

0.8

### Tillers, Tractors

Kohler

RH10C

0.8

Briggs & Stratton

RJ19LM

QJ19LM

0.8

## SPIEGEL

### Lawn Mowers

All Models

RJ19LM

0.8

### Tillers

RJ8C

0.8

## SPINAWAY

### Lawn Mowers

All Models

RJ19LM

0.8

### Power Equipment

All Models

RD16

0.8

## SPINTRIM

### Edgers, Trimmers

RDJ6J

0.8

## SPIRIT II

### Riding Mowers

Kohler V-Twin

20

OE013

RC12YC

0.8

Briggs & Stratton Vanguard V-Twin

14,16,18,20

RC14YC

0.8

Briggs & Stratton

12,12.5

RJ19LM

QJ19LM

0.8

## SPRAK

### Pressure Washers

Briggs & Stratton Vanguard OHV

13

OE013

RC12YC

QC12YC / XC92YC

0.8

Briggs & Stratton Vanguard OHV

9

OE013

RC12YC

QC12YC / XC92YC

0.8

Kohler V-Twin

18

OE013

RC12YC

1.0

Kohler V-Twin

20

OE013

RC12YC

1.0

Kohler V-Twin

25

OE013

RC12YC

1.0

Briggs & Stratton Vanguard V-Twin

16

RC14YC

0.8

Kohler

20

RH10C

0.6

Kohler

23

RH10C

0.6

Briggs & Stratton

11

RJ19LM

QJ19LM

0.8

Briggs & Stratton

5,8

RJ19LM

QJ19LM

0.8

Briggs & Stratton Twin

18

RJ19LM

QJ19LM

0.8

Honda OHV

5.5,8,11,13

OE051

RN11YC

0.8

Honda V-Twin

18,20

OE051

RN11YC

0.8

Honda OHV

5

OE006

RN9YC

0.8

## SPRAY CLEAN

### Pressure Washers

Briggs & Stratton

3.75

RJ19LM

QJ19LM

0.8

## SPREADER-MATE

### Spreaders

Honda OHV

5.5

OE051

RN11YC

0.8

## STANDARD

### Mowers

(1/2"-14 Pipe)

25

0.6

(18mm)

RD16

0.6

(14mm)

RJ8C

0.6

## STAR BLACK & DECKER

### Chainsaws

RDJ8J

0.6



CC

BHP

21



OPT.



mm

## STAR DIGGER

### Post Hole Digger

Briggs & Stratton	5		RJ19LM	QJ19LM	0.8
Honda	5.5		OE051	RN11YC	0.8

## STARK

### Mowers

Briggs & Stratton			RCJ8		0.6
-------------------	--	--	------	--	-----

## STEAM-JET

### Steam Cleaners

505			Y82		0.6
-----	--	--	-----	--	-----

## STEARNS

### Mowers

(18mm)			RD16		0.8
(14mm)			RJ19LM	QJ19LM	0.8

## STEINER

### Riding Equipment

Briggs & Stratton	16		OE013	RC12YC	QC12YC / XC92YC	0.8
Briggs & Stratton Extended Life Series	17.5		OE013	RC12YC	QC12YC / XC92YC	0.8
Briggs & Stratton Intek V-Twin	18,25		OE013	RC12YC	QC12YC / XC92YC	0.8
Kohler	27		OE013	RC12YC		0.8
Kohler V-Twin	20,22,25		OE013	RC12YC		0.8
Kubota	21,24,5,25		OE013	RC12YC		0.8
Honda OHV			OE051	RN11YC		0.8
Kawasaki	27		OE042	RN12YC		0.8
Onan Twin	16,20,24			RS17YX		0.6

### Utility Vehicles

Robin	11		RL95YC		0.6
-------	----	--	--------	--	-----

## STERLING

### Power Equipment

Kawasaki	7.5		OE059	L92YC		0.8
Briggs & Stratton	5,8			RJ19LM	QJ19LM	0.8

### Pumps, Compressors & Refrigeration Units

(18mm)			RD16		0.6
(7/8"-18)			W14		0.6

## STIGA

### Lawn Mowers

Briggs & Stratton	3.5,4,5		RJ19LM	QJ19LM	0.8
Honda	5		OE006	RN9YC	0.8

### Power Equipment

Briggs & Stratton Intek OHV	6		OE013	RC12YC	QC12YC / XC92YC	0.5
Briggs & Stratton Vanguard V-Twin	16,18			RC14YC		0.8
Briggs & Stratton	2,3,5,5			RJ19LM	QJ19LM	0.8
Briggs & Stratton	8.5,10.5,11.5,12.5			RJ19LM	QJ19LM	0.8

### Snow Removers

1130e, 320, 524, 929e, Snow Buster				RJ19LM		0.8
Briggs & Stratton	3,5,8,8.5,10.5			RJ19LM	QJ19LM	0.8

## STIHL

### Augers

020 Power Heads				RCJ6Y		0.5
085 Power Heads				RL87YC		0.5
BT106C				RCJ8Y		0.5
BT308, BT309				RL87YC		0.5
BT360				RCJ6Y		0.5

### Chain Saws

06				RL87YC		0.5
07				RL87YC		0.5





CC BHP

21



OPT.



mm

**...STIHL**

**...Power Equipment**

FS150, FS151, FS160, FS180, FS20, FS200, FS200AV, FS200AVE, FS202, FS202AV, FS220, FS280K FS353, FS353AV FS36 FS360AVEZ FS40 FS401, FS401AVE FS420 FS44, FS44J, FS44R FS48 FS50, FS51 FS52 FS56AVRE, FS60, FS61 FS62 FS65 FS66, FS72, FS74AVE, FS74AVRE, FS75, FS76AVE, FS76AVRE, FS80, FS80R, FS81, FS85, FS85R, FS86AVRE, FS88AVE, FS88AVRE FS90									RCJ6Y	0.5
									RL87YC	0.5
									RCJ8	0.5
									RCJ6Y	0.5
									RCJ8	0.5
									RCJ7Y	0.5
									RCJ6Y	0.5
									RCJ8	0.5
									RCJ6Y	0.5
									RCJ8	0.5
									RCJ6Y	0.5
									RCJ8	0.5
									RCJ8Y	0.5
KM110	4-MIX	31.4	1.3						RCJ8	0.5
KM55, MM55		27.2	1						RZ7C	0.5
									RCJ6Y	0.5

**Pressure Washers**

P840									RL86C	0.8
RB220K, RB400K							OE006		RN9YC	0.8

**Rakes**

Super Rake									RCJ8	0.5
------------	--	--	--	--	--	--	--	--	------	-----

**Trimmers**

FS100	4-MIX	31.4	1.3						RZ7C	0.7
FS110	4-MIX	31.4	1.3						RZ7C	0.5

**Turf Equipment**

KS43									RD16	0.6
S10									RCJ6Y	0.5

**STOW**

**Centrifugal Pumps**

Briggs & Stratton		5,8							RJ19LM	QJ19LM	0.8
Honda OHV		4,5,5,8					OE051		RN11YC		0.8

**STRUNK**

**Chain Saws**

All Other									RJ8C		0.8
Tall Timber									RCJ8		0.8

**Generators**

Briggs & Stratton									RJ19LM	QJ19LM	0.6
-------------------	--	--	--	--	--	--	--	--	--------	--------	-----

**Lawn Mowers**

All Models									RJ19LM		0.8
------------	--	--	--	--	--	--	--	--	--------	--	-----

**Pumps, Compressors & Refrigeration Units**

Briggs & Stratton		3,75							RJ19LM	QJ19LM	0.8
-------------------	--	------	--	--	--	--	--	--	--------	--------	-----

**STUMP MACHINE**

**Power Equipment**

Honda OHV		9,13					OE051		RN11YC		0.8
Kohler CS		10					OE051		RN11YC		0.8

**SUFFOLK**

**Lawn Mowers**

12" Colt					1959→1967				RJ8C		0.6
12" Super Colt									RJ8C		0.6
14" Series 1,1A,2,3,4,5,6,7									RJ8C		0.6
14" Super Punch									RJ8C		0.6
16" Demon de luxe									RJ8C		0.6
16" Suffolk									RJ8C		0.6
17" Super Punch 1,2,3,4,5,6									RJ8C		0.6



CC BHP

21



OPT.



mm

**...SUFFOLK****...Lawn Mowers**

19" Demon de luxe				RJ8C		0.6
19" Side Wheel Mower 1,2				RJ8C		0.6
19" Squire 1,2,3				RJ8C		0.6
All Models	Briggs & Stratton			RJ19LM		0.8
Pony 1,2				RL86C		0.6

**SUNBEAM****Lawn Mowers**

Victa				RJ8C		0.8
Briggs & Stratton				RJ19LM	QJ19LM	0.8
Tecumseh				RJ8C		0.8

**Power Equipment**

(18mm)				RD16		0.6
Briggs & Stratton				RJ19LM	QJ19LM	0.8
Tecumseh				RJ8C		0.8

**Snow Removers**

Briggs & Stratton				RJ19LM	QJ19LM	0.8
Tecumseh				RJ8C		0.8

**SUNSET****Pumps**

Briggs & Stratton	5			RJ19LM	QJ19LM	0.8
-------------------	---	--	--	--------	--------	-----

**SUPER SPLIT****Log Splitters**

Briggs & Stratton				RJ19LM	QJ19LM	0.8
-------------------	--	--	--	--------	--------	-----

**SUPERIOR****Power Equipment**

Briggs & Stratton				RJ19LM	QJ19LM	0.8
-------------------	--	--	--	--------	--------	-----

**SUTECH STEALTH****Lawn Mowers**

Honda	2.5			CJ14		0.6
Briggs & Stratton	4,8,10.5			RJ19LM	QJ19LM	0.8
Kawasaki	9		OE051	RN11YC		0.8

**Mowers**

Briggs & Stratton Intek OHV	6.5		OE013	RC12YC	QC12YC / XC92YC	0.5
Briggs & Stratton Vanguard	12.5		OE013	RC12YC	QC12YC / XC92YC	0.8
Briggs & Stratton	8,10.5			RJ19LM	QJ19LM	0.8
Kawasaki OHV	9		OE051	RN11YC		0.8

**Sweepers**

Honda	2.5			CJ14		0.6
-------	-----	--	--	------	--	-----

**SUZUKI****Generators**

SE1000, SE1200, SE1500, SE2500, SE3000				OE059	L92YC	0.6
SE300					Y82	0.6
SE3000AD				OE059	L92YC	0.6
SE500-A, SE700-A					RCJ8	0.6
SR 1500, SR 2000, SD 2000 R				OE006	RN9YC	0.8
SV 4000, SVW 140				OE042	RN12YC	0.8
SV1200, SV1400, SV1500, SV1800				OE006	RN9YC	0.6
SV2000, SV2200, SV2300				OE006	RN9YC	0.6
SV4000D				OE006	RN9YC	0.6
SW 140 S, SE 3800 S				OE059	L92YC	0.8
SX600, SX650R, SX800R				OE059	L92YC	0.6

**Power Equipment**

S 80					RL86C	0.8
------	--	--	--	--	-------	-----

**Power Equipment**

S 150 (../-R), S 200 (../-A,-R)				OE059	L92YC	0.8
S 250				OE059	L92YC	0.8
SD 650 R, SE700 A, 47 PB, VM 140					RCJ8Y	0.8
SE 1800 (-A, K, KL, L, LA)				OE006	RN9YC	0.8
SE 400, SE 500, SE 600, SE 800 (../-A,-T)					RCJ8Y	0.7



CC BHP

21



OPT.



mm

## ...SUZUKI

### ...Power Equipment

V 120, V 160, V 270

VM-OHV-B OHV

OE006 RN9YC 0.8

OE006 RN9YC 0.8

### Pumps

SP 20 (A), SPT 20, SP 30 (A)

RL87YC 0.8

### Snowthrowers

SS 552, SS 555 (ES)

OE006 RN9YC 0.8

SS 755

OE059 L92YC 0.8

SS 865 (-E/-ES), SS 980 (-E/-ES)

OE006 RN9YC 0.8

## SWEEPSTER

### Snow Removers

All Models

RJ19LM 0.8

### Sweepers, Thatchers

Wisconsin 30 RD16 0.6

Briggs & Stratton 5 RJ19LM QJ19LM 0.8

Robin 4.5 RL95YC 0.6

Honda OHV 5.5 OE051 RN11YC 0.8

Wisconsin 65 OE042 RN12YC 0.6

Honda OHV 5 OE006 RN9YC 0.8

Onan Twin 18 RS17YX 0.6

## SWISH-ERR

### Lawn Mowers

Robin 2-Cycle 4 RJ12C 0.6

Briggs & Stratton 3.5,3.75,8 RJ19LM QJ19LM 0.8

Tecumseh 4 RJ19LM 0.8

Robin 4-Cycle OHV 4 OE098 RN4C 0.8

### Log Splitters

Briggs & Stratton 6,8.5,9,10.5 RJ19LM QJ19LM 0.8

### Power Equipment

Briggs & Stratton Intek OHV 17.5 OE013 RC12YC QC12YC / XC92YC 0.8

Kohler OHV 14 OE013 RC12YC 1.0

Briggs & Stratton Vanguard V-Twin 14,16 RC14YC 0.8

Briggs & Stratton Vanguard V-Twin 18,20 RC14YC 0.8

Kawasaki 12.5 RCJ8 0.8

Briggs & Stratton 3.75,5,6,8, RJ19LM QJ19LM 0.8

12,12.5

Tecumseh OHV 10.5 RJ19LM 0.8

Tecumseh 5,6,10 RJ8C 0.8

Tecumseh OHV 13 OE098 RN4C 0.8

## SYCAMORE

### Lawn Mowers

Briggs & Stratton, Tecumseh RJ19LM QJ19LM 0.8

## T.I.P.

### Power Equipment

Honda OHV 5 OE006 RN9YC 0.8

## TAILGATE MULCHER

### Power Equipment

Honda V-Twin 20 CJ14 0.6

Kohler V-Twin 18 OE013 RC12YC 0.8

Kohler Twin 18 RV17YC 0.6

## TANAKA

### Augers

JEA-1C, JEA-2C

RJ8C 0.8

Q22, QIA-10

RCJ8 0.8

TEA-30

RJ6C 0.8

TEA-500, TED-262DH, TIA-302,

RCJ8 0.8

TIA-305, TIA-340

### Blowers

300 RCJ8 0.8

2400 RDJ7Y 0.8



CC

BHP

21



OPT.

**...TANAKA****...Blowers**

33A			RJ6C	0.8
450, 4600			RCJ8	0.8
JNBL-33			RJ6C	0.8
KTBL50			RJ8C	0.8
TBL-30, TBL-500, TBL-505			RCJ8	0.8
THB-2100			RDJ7Y	0.8
THB-2500			RCJ7Y	0.8
THB-300			RCJ8	0.8
ULNBL-3			RJ6C	0.8

**Brushcutters**

500			RCJ8Y	0.8
160, 162, 202, 205, 215, 220, 232, 240			RCJ8	0.8
240, 250			RCJ8Y	0.8
262, 265, 300, 322, 373, 422C, 425, 500			RCJ8	0.8
501, QUM-2, QUM-2N			RCJ8	0.8
Scythe JHJ-37			RJ12C	0.8
SP-351, SP-37, SP-411			RCJ8Y	0.8
SP-502, SUM-3, SUM-301, SUM-321, TBC-16			RCJ8	0.8
TBC-210			RDJ7Y	0.8
TBC-220			RCJ8Y	0.8
TBC-23, TBC-235			RCJ8	0.8
TBC-30			RJ6C	0.8
TBC-355			RCJ8	0.8
TBC-37			RJ8C	0.8
THT-16			RCJ8	0.8
THT-210			RCJ8Y	0.8
THT-212, TST-218			RCJ8	0.8

**Chain Saws**

EBC-1			RJ6C	0.8
ECS-290			RCJ8	0.8
ECS-3			RJ6C	0.8
ECS-300, ECS-307, ECS-320, ECS-330, ECS-3301, ECS-3351, ECS-35, ECS-350, ECS-3500B, ECS-351, ECS-355, ECS-356, ECS-357, ECS-35B, ECS-35E, ECS-370			RCJ8	0.8
ECS-4000B, ECS-405, ECS-415			RCJ8Y	0.8
ECS-5			RJ6C	0.8
ECS-505, ECS-506, ECS-650, ECS-655			RCJ8Y	0.8
ECV-4501			RCJ6Y	0.8
EHC-120, EHC-140, EHG-120			RCJ8	0.8
ES-650/20, ES-650/24, ESC-655			RCJ8Y	0.8

**Drills**

260, 262L, 262R, 265			RCJ8	0.8
TED-210			RCJ8Y	0.8
TED23, TED-232, TSD-23			RCJ8	0.8

**Edgers**

2410			RDJ7Y	0.8
TLE-500, TLE-550			RCJ8	0.8
TPE-2110			RDJ7Y	0.8
TPE-250			RCJ8Y	0.8

**Engines**

Pure Fire	2-Cycle	26	RCJ6Y	0.8
	2-Cycle	40	RCJ6Y	0.8
Pure Fire PF2600			RCJ6Y	0.8

**Generators**

DEG-600			RCJ8	0.6
DEG-600, LEG1200			RJ8C	0.6
QEG-250			RCJ8	0.6
			RJ8C	0.6
QEG-300			RCJ8	0.6
			RJ8C	0.6
REG-1000			RJ6C	0.6
REG-80			RJ8C	0.6
REG-800			RJ6C	0.6
SEG-100			RJ8C	0.6
SEG-221			RL86C	0.6





CC

BHP

21



OPT.



mm

**...TANAKA****Hedge Trimmers**

2120, 23, 230, 25

2510, 2520

262, PHT-15, THT200

THT-2100

THT-240

RCJ8

0.8

RCJ7Y

0.8

RCJ8

0.8

RCJ7Y

0.8

RCJ8

0.8

**Pumps, Compressors & Refrigeration Units**

JP-25, MCP-50, PCP-3

QCP-12, QCP-121

TCP-210

TCP-38, TCP-381

TCP-500, TCP-600

RJ6C

0.6

RCJ8

0.6

RCJ8Y

0.6

RJ8C

0.6

RL86C

0.6

**Sprayers**

KS-37, TMS-450

RJ8C

0.8

**Trimmers**

2410

2110, 2211, 2251

420PF, 430PF (Pure Fire)

4500, 5000, 7000S, AST-210,

AST-5000, AST-5770

TBC-200

TBC-2100, TBC-220

TBC-2400

TBC-250

TBC-2510

TBC-260PF

TBC-2800

TBC-300

TBC-3010

TBC-4000

TBC-4001

TBC-4110

TBC-4501

RDJ7Y

0.8

RCJ8Y

0.8

RCJ6Y

0.8

RCJ8Y

0.8

RCJ8

0.8

RCJ8Y

0.8

RDJ7Y

0.8

RCJ8Y

0.8

RCJ7Y

0.8

RCJ6Y

0.8

RDJ8J

0.8

RCJ8

0.8

CJ6

0.8

RCJ8Y

0.8

RCJ7Y

0.8

RCJ8

0.8

RCJ8Y

0.8

**TARAL****Augers**

JEA-L

PIA

TEA-30

RJ6C

0.8

RCJ8

0.8

CJ6

0.8

**Blowers**

JBL, KTBL-37, KTBL-50

RJ6C

0.8

**Drills**

PED-3

TED-23

RJ6C

0.8

CJ6

0.8

**Power Equipment**

50MP

7014F, 7020F, 7026TPG

MP5014, MPG5014, MPG5026

T7014, TG7014

RCJ8

0.8

RL86C

0.8

RCJ8

0.8

RL86C

0.8

**Sprayers**

JKS-37

RJ6C

0.8

**Trimmers**

TF22G

RCJ8Y

0.8

**TARGET****Pressure Washers**

Wisconsin

11

RL86C

0.6

Wisconsin

5

RL86C

0.6

Wisconsin

7.5

RL87YC

0.6

Honda OHV

5.5,8,13

OE051

RN11YC

0.8

**TAS****Engines**

D50G

J37

Q22

RJ6C

0.8

RJ6C

0.8

RCJ8

0.8





CC BHP

21



OPT.

mm

**...TAS**

**...Engines**

QC22				RCJ8	0.8
QEG300				RCJ8	0.8
RE11				RJ6C	0.8
T50				RCJ8	0.8
	37	2		CJ6	0.8
	16	0.8		CJ6	0.8
	23	1.2		CJ6	0.8
	30	1.6		CJ6	0.8
	31	1.6		CJ6	0.8

**TASK FORCE**

**Trimmers**

TF22G				RCJ8Y	0.8
-------	--	--	--	-------	-----

**TAYLOR-DUNN**

**Utility Vehicles**

Kohler	12,16			RH10C	0.8
Onan	14			RL95YC	0.9

**TECNAMOTOR (→ TECUMSEH)**

**TECUMSEH**

**Engines**

AH520	Horizontal 2-Cycle			RCJ8Y	0.8
AH600	Horizontal 2-Cycle	3		RCJ8Y	0.8
AV520	Vertical 2-Cycle	3		RJ17LM	0.8
AV600	Vertical 2-Cycle	3.5		RJ17LM	0.8
ECV100	Vertical 4-Cycle	3.9		RJ19LM	0.8
ECV105	Vertical 4-Cycle			RJ19LM	0.8
ECV110	Vertical 4-Cycle			RJ19LM	0.8
ECV120	Vertical 4-Cycle			RJ19LM	0.8
H22	Horizontal 4-Cycle	2.2		RJ8C	0.8
H25	Horizontal 4-Cycle	2.5		RJ8C	0.8
H30	Horizontal 4-Cycle	3		RCJ8	0.8
H35	Horizontal 4-Cycle	3.5		RCJ8	0.8
H40	Horizontal 4-Cycle	4		RCJ8	0.8
H50	Horizontal 4-Cycle	5		RJ17LM	0.8
H60	Horizontal 4-Cycle	6		RJ17LM	0.8
H70	Horizontal 4-Cycle	7		RJ17LM	0.8
H80	Horizontal 4-Cycle	8		RJ17LM	0.8
HH100	Horizontal 4-Cycle	10		RJ8C	0.8
HH120	Horizontal 4-Cycle	12		RJ8C	0.8
HH130	Horizontal 4-Cycle	13		OE086 RL82C	0.8
HH140	Horizontal 4-Cycle	14		OE086 RL82C	0.8
HH150	Horizontal 4-Cycle	15		OE086 RL82C	0.8
HH160	Horizontal 4-Cycle	16		OE086 RL82C	0.8
HH40	Horizontal 4-Cycle	4		RJ8C	0.8
HH50	Horizontal 4-Cycle	5		RJ8C	0.8
HH60	Horizontal 4-Cycle	6		RJ8C	0.8
HH70	Horizontal 4-Cycle	7		RJ8C	0.8
HH80	Horizontal 4-Cycle	8		RJ8C	0.8
HHM80	Horizontal 4-Cycle	8		RJ8C	0.8
HM100	Horizontal 4-Cycle	10		RJ17LM	0.8
HM70	Horizontal 4-Cycle	7		RJ17LM	0.8
HM80	Horizontal 4-Cycle	8		RJ17LM	0.8
HM85	Horizontal 4-Cycle	8.5		RJ17LM	0.8
HM90	Horizontal 4-Cycle	9		RJ17LM	0.8
HMSK100	Snow King 4-Cycle	10		RJ19LM	0.8
HMSK105	Snow King 4-Cycle	10.5		RJ19LM	0.8
HMSK110	Snow King 4-Cycle	11		RJ19LM	0.8
HMSK70	Snow King 4-Cycle	7		RJ19LM	0.8
HMSK80	Snow King 4-Cycle	8		RJ19LM	0.8
	Snow King 4-Cycle	8		RJ19LM	0.8
HMSK85	Snow King 4-Cycle	8.5		RJ19LM	0.8
HMSK90	Snow King 4-Cycle	9		RJ19LM	0.8
HMXL70	Horizontal 4-Cycle	7		RJ8C	0.8
HS40	Snow King 4-Cycle	4		RJ17LM	0.8



CC

BHP

21



OPT.



mm

**...TECUMSEH**

**...Engines**

HS50	Snow King 4-Cycle	5		RJ17LM	0.8
HSK30	Snow King 4-Cycle	3		RJ19LM	0.8
HSK300	Snow King 2-Cycle	2		RCJ8Y	0.8
HSK35	Snow King 4-Cycle	3.5		RJ19LM	0.8
HSK40	Snow King 4-Cycle	4		RJ19LM	0.8
HSK50	Snow King 4-Cycle	5		RJ19LM	0.8
HSK60	Snow King 4-Cycle	6		RJ19LM	0.8
HSK600	Snow King 2-Cycle	3		RCJ8Y	0.8
HSK635	Snow King 2-Cycle	3.5		RCJ8Y	0.8
HSK70	Snow King 4-Cycle	7		RJ19LM	0.8
HSK840	Snow King 2-Cycle	4		RCJ8Y	0.8
HSK845	Snow King 2-Cycle	4.5		RCJ8Y	0.8
HSK850	Snow King 2-Cycle	5		RCJ8Y	0.8
HSK860	Snow King 2-Cycle	6		RJ19LM	0.8
HSK870	Snow King 2-Cycle	7		RJ19LM	0.8
HSSK40	Snow King 4-Cycle	4		RJ8C	0.8
HSSK50	Snow King 4-Cycle	5		RJ8C	0.8
HT30	Horizontal 4-Cycle	3		RJ8C	0.8
HT35	Horizontal 4-Cycle	3.5		RJ8C	0.8
HXL35	Horizontal 4-Cycle	3.5		RJ8C	0.8
HXL840	Horizontal 2-Cycle	4.5		RCJ8Y	0.8
LAV25	Vertical 4-Cycle	2.5		RJ8C	0.8
LAV30	Vertical 4-Cycle	3		RJ8C	0.8
LAV35	Vertical 4-Cycle	3.5		RJ8C	0.8
LAV40	Vertical 4-Cycle	4		RJ8C	0.8
LAV50	Vertical 4-Cycle	5		RJ8C	0.8
LEV100	Vertical 4-Cycle	3.5		RJ19LM	0.8
	Vertical 4-Cycle	4.5		RJ19LM	0.8
	Vertical 4-Cycle	3.8		RJ19LM	0.8
LEV115	Vertical 4-Cycle	5		RJ19LM	0.8
	Vertical 4-Cycle	6		RJ19LM	0.8
	Vertical 4-Cycle	5.5		RJ19LM	0.8
LEV120	Vertical 4-Cycle	6		RJ19LM	0.8
LEV80	Vertical 4-Cycle			RJ19LM	0.8
LH195SA	Snow King 4-Cycle	5		RJ8C	0.8
LH195SP	Snow King 4-Cycle	5.5		RJ8C	0.8
LH318SA	Snow King 4-Cycle	8		RJ8C	0.8
LH358SA	Snow King 4-Cycle	10		RJ8C	0.8
	Snow King 4-Cycle	13		RJ8C	0.8
	Snow King 4-Cycle	12		RJ8C	0.8
LV148EA	Vertical 4-Cycle	4.5		RJ19LM	0.8
	Vertical 4-Cycle	4.24		RJ19LM	0.8
	Vertical 4-Cycle	3.5		RJ19LM	0.8
LV195EA	Vertical 4-Cycle	6.75		RJ19LM	0.8
	Vertical 4-Cycle	6.5		RJ19LM	0.8
	Vertical 4-Cycle	6		RJ19LM	0.8
	Vertical 4-Cycle	5		RJ19LM	0.8
OH120	Horizontal 4-Cycle	12	OE086	RL82C	0.8
OH140	Horizontal 4-Cycle	14	OE086	RL82C	0.8
OH160	Horizontal 4-Cycle	16	OE086	RL82C	0.8
OH180	Horizontal 4-Cycle	18	OE098	RN4C	0.8
OH195EA	Horizontal 4-Cycle	5	OE098	RN4C	0.8
	Horizontal 4-Cycle	6	OE098	RN4C	0.8
OH195EP	Horizontal 4-Cycle	6.5	OE098	RN4C	0.8
OH195SA	Snow King 4-Cycle	7	OE098	RN4C	0.8
	Snow King 4-Cycle	6	OE098	RN4C	0.8
	Snow King 4-Cycle		OE098	RN4C	0.8
OH195SP	Snow King 4-Cycle	7.5	OE098	RN4C	0.8
	Snow King 4-Cycle		OE098	RN4C	0.8
OH318EA	Horizontal 4-Cycle	9	OE098	RN4C	0.8
	Horizontal 4-Cycle	11	OE098	RN4C	0.8
OH318SA	Snow King 4-Cycle	11	OE098	RN4C	0.8
	Snow King 4-Cycle	8	OE098	RN4C	0.8
OHH45	Horizontal 4-Cycle	4.5	OE098	RN4C	0.8
OHH50	Horizontal 4-Cycle	5	OE098	RN4C	0.8
OHH55	Horizontal 4-Cycle	5.5	OE098	RN4C	0.8
OHH60	Horizontal 4-Cycle	6	OE098	RN4C	0.8
OHH65	Horizontal 4-Cycle	6.5	OE098	RN4C	0.8



CC

BHP

21



OPT.



mm

**...TECUMSEH****...Engines**

OHM110	Horizontal 4-Cycle	10		OE098	RN4C	0.8
OHM120	Horizontal 4-Cycle #220000>223999	12			RL86C	0.8
	Horizontal 4-Cycle #224000>	12		OE098	RN4C	0.8
OHSK100	Snow King 4-Cycle	10		OE098	RN4C	0.8
OHSK110	Snow King 4-Cycle >#222999	11			RL86C	0.8
	Snow King 4-Cycle #223000>	11		OE098	RN4C	0.8
OHSK120	Snow King 4-Cycle >#222999	12			RL86C	0.8
	Snow King 4-Cycle #223000>	12		OE098	RN4C	0.8
OHSK125	Snow King 4-Cycle	12.5		OE098	RN4C	0.8
OHSK130	Snow King 4-Cycle >#222999	13			RL86C	0.8
	Snow King 4-Cycle #223000>	13		OE098	RN4C	0.8
OHSK50	Snow King 4-Cycle	5		OE098	RN4C	0.8
OHSK55	Snow King 4-Cycle	5.5		OE098	RN4C	0.8
OHSK60	Snow King 4-Cycle	6		OE098	RN4C	0.8
OHSK65	Snow King 4-Cycle	6.5		OE098	RN4C	0.8
OHSK70	Snow King 4-Cycle	7		OE098	RN4C	0.8
OHSK75	Snow King 4-Cycle	7.5		OE098	RN4C	0.8
OHSK80	Snow King 4-Cycle	8		OE098	RN4C	0.8
OHSK90	Snow King 4-Cycle	9		OE098	RN4C	0.8
OHV110	Vertical 4-Cycle	11		OE098	RN4C	0.8
OHV115	Vertical 4-Cycle	11.5		OE098	RN4C	0.8
OHV120	Vertical 4-Cycle	12		OE098	RN4C	0.8
OHV125	Vertical 4-Cycle	12.5		OE098	RN4C	0.8
OHV13	Vertical 4-Cycle	13		OE098	RN4C	0.8
OHV130	Vertical 4-Cycle	13		OE098	RN4C	0.8
OHV135	Vertical 4-Cycle	13.5		OE098	RN4C	0.8
OHV14	Vertical 4-Cycle	14		OE098	RN4C	0.8
OHV140	Vertical 4-Cycle	14		OE098	RN4C	0.8
OHV145	Vertical 4-Cycle	14.5		OE098	RN4C	0.8
OHV15	Vertical 4-Cycle	15		OE098	RN4C	0.8
OHV150	Vertical 4-Cycle	15		OE098	RN4C	0.8
OHV155	Vertical 4-Cycle	15.5		OE098	RN4C	0.8
OHV16	Vertical 4-Cycle	16		OE098	RN4C	0.8
OHV160	Vertical 4-Cycle	16		OE098	RN4C	0.8
OHV165	Vertical 4-Cycle	16.5		OE098	RN4C	0.8
OHV17	Vertical 4-Cycle	17		OE098	RN4C	0.8
OHV170	Vertical 4-Cycle	17		OE098	RN4C	0.8
OHV175	Vertical 4-Cycle	17.5		OE098	RN4C	0.8
OMH90	Horizontal 4-Cycle	6		OE098	RN4C	0.8
OV195EA	Vertical 4-Cycle	7		OE098	RN4C	0.8
OV358EA	Vertical 4-Cycle	13		OE098	RN4C	0.8
	Vertical 4-Cycle	10		OE098	RN4C	0.8
	Vertical 4-Cycle	11		OE098	RN4C	0.8
	Vertical 4-Cycle	13.5		OE098	RN4C	0.8
OV490EA	Vertical 4-Cycle	15		OE098	RN4C	0.8
	Vertical 4-Cycle	14		OE098	RN4C	0.8
	Vertical 4-Cycle	18		OE098	RN4C	0.8
	Vertical 4-Cycle	17.5		OE098	RN4C	0.8
OV691EA	Vertical 4-Cycle	23		OE098	RN4C	0.8
	Vertical 4-Cycle	18		OE098	RN4C	0.8
	Vertical 4-Cycle	21		OE098	RN4C	0.8
OV691EP	Vertical 4-Cycle	23		OE098	RN4C	0.8
	Vertical 4-Cycle	25		OE098	RN4C	0.8
OVM120	Vertical 4-Cycle	12			RL86C	0.8
OVRM105	Vertical 4-Cycle	10.5		OE098	RN4C	0.8
OVRM120	Vertical 4-Cycle	12		OE098	RN4C	0.8
OVRM40	Vertical 4-Cycle	4		OE098	RN4C	0.8
OVRM50	Vertical 4-Cycle	5		OE098	RN4C	0.8
OVRM55	Vertical 4-Cycle	5.5		OE098	RN4C	0.8
OVRM60	Vertical 4-Cycle	6		OE098	RN4C	0.8
OVRM65	Vertical 4-Cycle	6.5		OE098	RN4C	0.8
OVRM905	Vertical 4-Cycle	4.5		OE098	RN4C	0.8
OVXL/C120	Vertical 4-Cycle Spec. #202700>202999	12			RL86C	0.8
	Vertical 4-Cycle #203000>	12		OE098	RN4C	0.8
OVXL120	Vertical 4-Cycle Spec. #202700>202999	12			RL86C	0.8
	Vertical 4-Cycle #203000>	12		OE098	RN4C	0.8
OVXL125	Vertical 4-Cycle Spec. #202700>202999	12.5			RL86C	0.8
	Vertical 4-Cycle #203000>	12.5		OE098	RN4C	0.8



CC

BHP

21



OPT.



mm

**...TECUMSEH**

**...Engines**

Model	Configuration	CC	BHP	OPT.	mm
TC200	Vertical 2-Cycle	1.6		RCJ8Y	0.8
TC300	Vertical 2-Cycle	2		RCJ8Y	0.8
TCH200	Horizontal 2-Cycle	1.6		RCJ8Y	0.8
TCH300	Horizontal 2-Cycle	2		RCJ6Y	0.8
TH098SA	Snow King 4-Cycle	3		RCJ8Y	0.8
TH139SA	Snow King 4-Cycle	4.5		RCJ8Y	0.8
	Snow King 4-Cycle	6.5		RCJ8Y	0.8
TH139SP	Snow King 4-Cycle	5		RCJ8Y	0.8
	Snow King 4-Cycle	7		RCJ8Y	0.8
TM049XA	Vertical 2-Cycle	2		RCJ8Y	0.8
TNT100	Vertical 4-Cycle	3.9		RJ19LM	0.8
TNT120	Vertical 4-Cycle	3.9		RJ19LM	0.8
TVM125	Vertical 4-Cycle	5		RJ8C	0.8
TVM140	Vertical 4-Cycle	6		RJ8C	0.8
TVM170	Vertical 4-Cycle	7		RJ8C	0.8
TVM195	Vertical 4-Cycle	8		RJ17LM	0.8
	Vertical 4-Cycle	9		RJ17LM	0.8
	Vertical 4-Cycle	8.5		RJ17LM	0.8
TVM220	Vertical 4-Cycle	10		RJ17LM	0.8
	Vertical 4-Cycle	10.5		RJ17LM	0.8
	Vertical 4-Cycle	9.5		RJ17LM	0.8
TVO85XA	Vertical 2-Cycle	3		RJ17LM	0.8
	Vertical 2-Cycle			RJ17LM	0.8
TVS100	Vertical 4-Cycle	3.9		RJ19LM	0.8
TVS105	Vertical 4-Cycle	4		RJ19LM	0.8
TVS115	Vertical 4-Cycle	4		RJ19LM	0.8
	Vertical 4-Cycle	5		RJ19LM	0.8
	Vertical 4-Cycle	5.5		RJ19LM	0.8
	Vertical 4-Cycle	4.5		RJ19LM	0.8
TVS120	Vertical 4-Cycle	6		RJ19LM	0.8
	Vertical 4-Cycle	5.5		RJ19LM	0.8
TVS600	Vertical 2-Cycle	3.5		RJ17LM	0.8
TVS75	Vertical 4-Cycle	3		RJ19LM	0.8
TVS840	Vertical 2-Cycle	4		RJ19LM	0.8
TVS90	Vertical 4-Cycle	3.5		RJ19LM	0.8
	Vertical 4-Cycle	4		RJ19LM	0.8
	Vertical 4-Cycle	3.8		RJ19LM	0.8
TVT591	Vertical 4-Cycle Twin Long Block			OE098 RN4C	0.8
TVXL105	Vertical 4-Cycle	4		RJ19LM	0.8
TVXL115	Vertical 4-Cycle	5		RJ19LM	0.8
TVXL170	Vertical 4-Cycle	7		RJ8C	0.8
TVXL195	Vertical 4-Cycle	8		RJ8C	0.8
TVXL220	Vertical 4-Cycle	10		RJ8C	0.8
TVXL840	Vertical 2-Cycle	5		RJ19LM	0.8
V40	Vertical 4-Cycle	4		RJ8C	0.8
V50	Vertical 4-Cycle	5		RJ8C	0.8
V60	Vertical 4-Cycle	6		RJ8C	0.8
V70	Vertical 4-Cycle	7		RJ8C	0.8
V80	Vertical 4-Cycle	8		RJ8C	0.8
VH100	Vertical 4-Cycle	10		RJ8C	0.8
VH40	Vertical 4-Cycle	4		RJ8C	0.8
VH50	Vertical 4-Cycle	5		RJ8C	0.8
VH60	Vertical 4-Cycle	6		RJ8C	0.8
VH70	Vertical 4-Cycle	7		RJ8C	0.8
VH80	Vertical 4-Cycle	8		RJ8C	0.8
VKS100	Vertical 4-Cycle	10		RJ19LM	0.8
VLV126	Vertical 4-Cycle	6.5		RJ17LM	0.8
	Vertical 4-Cycle	5.5		RJ17LM	0.8
	Vertical 4-Cycle	6		RJ19LM	0.8
	Vertical 4-Cycle	5		RJ19LM	0.8
VLV40	Vertical 4-Cycle	4		RJ19LM	0.8
VLV50	Vertical 4-Cycle	5		RJ19LM	0.8
VLV55	Vertical 4-Cycle	5.5		RJ19LM	0.8
VLV60	Vertical 4-Cycle	6		RJ19LM	0.8
VLV65	Vertical 4-Cycle	6.5		RJ19LM	0.8
VLV66	Vertical 4-Cycle	6.6		RJ19LM	0.8
VM100	Vertical 4-Cycle	10		RJ8C	0.8
VM70	Vertical 4-Cycle	7		RJ8C	0.8
VM80	Vertical 4-Cycle	8		RJ8C	0.8



CC

BHP

21



OPT.



mm

**TELEDYNE****Pumps, Compressors & Refrigeration Units**

Continental B-427

D9

0.6

**TEMPO****Lawn Mowers**

Briggs &amp; Stratton

RJ19LM

QJ19LM

0.8

**Tillers, Tractors**

Briggs &amp; Stratton

RJ19LM

QJ19LM

0.8

Briggs &amp; Stratton Twin

RJ19LM

QJ19LM

0.8

**TERRACARE****Power Equipment**

Briggs &amp; Stratton

3.5,5,8,8.5

RJ19LM

QJ19LM

0.8

Honda OHV

9

OE051

RN11YC

0.8

**TERRA-TILLER****Power Equipment**

All Models

RJ8C

0.6

**TERRILL****Chain Saws**

50

RJ12C

0.8

60

RH12

0.8

CS5, CS5A, CS5B, CS5C

RJ12C

0.8

CS6, CS7

RH12

0.8

FA

RJ12C

0.8

**THE BROADCASTER****Spreaders**

Honda OHV

5.5,8

OE051

RN11YC

0.8

**THE HAULER****Utility Vehicles**

Briggs &amp; Stratton Vanguard V-Twin

16

RC14YC

0.8

**THEO TURGEON****Snow Removers**

All Models

RJ19LM

0.8

**THERMO-KING****Pumps, Compressors & Refrigeration Units**

AM

RH8C

0.6

GTC-1

Hercules G1600

RJ88P

0.4

HK, KL, KW

RH8C

0.6

MWC, NWG

RD16

0.6

NWG (LPG)

D14

0.4

ROL

RH8C

0.6

SROL

XEJ8

0.6

UK, XKL, XROL

RH8C

0.6

Onan NHA

RN5C

0.6

**THOMAS****Pumps, Compressors & Refrigeration Units**

3052, 3062, T4100

RJ8C

0.6

T4200, T8200

RCJ8

0.6

**THOR****Generators**

Wisconsin

RD16

0.6

Clinton

RJ12C

0.6

**Log Splitters**

Briggs &amp; Stratton Vanguard

6

OE013

RC12YC

QC12YC / XC92YC

0.5

Briggs &amp; Stratton

3.5

RJ19LM

QJ19LM

0.8

**TIELBURGER****Lawn Mowers**

Briggs &amp; Stratton

RJ19LM

QJ19LM

0.8



CC

BHP

21



OPT.

**TIGER****Edgers**

Briggs &amp; Stratton

RJ19LM

QJ19LM

0.8

**Lawn Mowers**

Briggs &amp; Stratton

RJ19LM

QJ19LM

0.8

**TILLEX****Power Equipment**

All Models

RD16

0.6

**TILLISON****Mowers**

Honda OHV

13

OE051

RN11YC

0.8

**TILLIVATOR****Power Equipment**

All Models

RJ12C

0.6

**TILLSMITH****Tillers**

Tecumseh

1.6

RCJ8Y

0.8

Briggs &amp; Stratton

3.5,5,8

RJ19LM

QJ19LM

0.8

**TIMBER HARVESTER****Power Equipment**

Onan

24

RS17YX

0.6

**TIMBER WOLF****Utility Vehicles**

Kawasaki OHV

13,19,25

OE051

RN11YC

0.8

**TITAN****Power Equipment**

Kubota

21

OE013

RC12YC

0.8

Wisconsin

20

RD16

0.6

Honda OHV

4,5.5

OE051

RN11YC

0.8

Kohler Twin

18

RV17YC

0.6

**Pressure Washers**

Briggs &amp; Stratton

5,10

RJ19LM

QJ19LM

0.8

Honda OHV

4,5.5,11

OE051

RN11YC

0.8

**TMC****Power Augers**

Ice Master

CJ6

0.6

**TML****Augers**

TML-35

CJ6

0.8

**Generators**

All

34cc

CJ6

0.6

**TOM BOY****Tillers**

CJ6

0.8

**TOMSTAR PLUG'R****Aerators**

Kawasaki

3.1

RCJ8

0.8

Briggs &amp; Stratton

3.5

RJ19LM

QJ19LM

0.8

**TONDU****Brushcutters**

16, 22cc

CJ6

0.5

35cc

RCJ8

0.5

**Chainsaws**

30F, 35F, 42F

RCJ7Y

0.6



CC

BHP

21



OPT.



**TOPFLITE**

**Lawn Mowers**

Briggs & Stratton			RJ19LM	QJ19LM	0.8
Tecumseh			RJ8C		0.8

**Riding Equipment**

Briggs & Stratton			RJ19LM	QJ19LM	0.8
Tecumseh			RJ8C		0.8

**TOPSO**

**Chainsaws**

E501AV, E511AVB			RCJ8Y		0.5
E601AV, E611AVB			RCJ8Y		0.5
E700AV, E710AVB			RCJ8Y		0.5

**TORO**

**Blowers**

3091			RCJ7Y		0.8
30941			RCJ6Y		0.8
62901			RDJ7Y		0.6
Blower/Vacs			RCJ6Y		0.8
BP6900			RCJ6Y		0.8

**Cultivators**

			RDJ7Y		0.8
--	--	--	-------	--	-----

**Dethatchers**

Briggs & Stratton	5,8		RJ19LM	QJ19LM	0.8
-------------------	-----	--	--------	--------	-----

**Edgers**

53030			RCJ7Y		0.8
	Suzuki	2	L90C		0.8
	Suzuki	3.5	OE059 L92YC		0.8

**Generators**

T2500, T300D, T400D			RL95YC		0.6
---------------------	--	--	--------	--	-----

**Hedge Trimmers**

53040			RDJ7Y		0.6
-------	--	--	-------	--	-----

**Lawn Mowers**

20005, 20016, 20017, 20047, 20070, 20073 Recycler	195	6.5		RJ19LM	
20053, 20054, 20055, 20056, 20058 Super Recycler		6.5		RJ19LM	
20057 Super Recycler		6.75	OE013	RC12YC	

**Mowers**

Zero-Turn 74408, 74409 Z300	585			RCJ8Y	
	Briggs & Stratton OHV	5.5,6,6.5	OE013	RC12YC	QC12YC / XC92YC 0.5
	GTS 2-Cycle			RCJ8Y	0.8
	Lawn-Boy 2-Cycle	6.5		RCJ8Y	0.8
	Suzuki 2-Cycle			RCJ8Y	0.8
	Briggs & Stratton "L" Head			RJ19LM	QJ19LM 0.8
	Tecumseh			RJ19LM	0.8
	Kawasaki OHV	6	OE051	RN11YC	0.8
	Suzuki 4-Cycle	141	OE006	RN9YC	0.8

**Mowers, Riding Equipment**

Workman 3100			OE013	RC12YC	1.0
Workman 3200, Workman 4200				RN14YC	0.9
	Kohler Command Pro	15	OE013	RC12YC	0.8
	Kohler Command Pro	18	OE013	RC12YC	0.8
	Kohler Command Pro	20	OE013	RC12YC	0.8
	Kohler Command Pro	22	OE013	RC12YC	0.8
	Kohler Command Pro	25,26	OE013	RC12YC	0.8
	Kohler OHV	12.5,13	OE013	RC12YC	1.0
	Kohler OHV	14	OE013	RC12YC	1.0
	Kohler OHV	6	OE013	RC12YC	1.0
	Kohler V-Twin	17,18	OE013	RC12YC	0.8
	Kohler V-Twin	20	OE013	RC12YC	0.8
	Kohler V-Twin	22	OE013	RC12YC	0.8
	Kohler V-Twin	25	OE013	RC12YC	0.8
	Briggs & Stratton Vanguard			RC14YC	0.8
	Kawasaki	12.5		RCJ8	0.8
	Kawasaki Liquid-Cooled V-Twin	20,22		RCJ8	0.6





CC BHP

21



OPT.

mm

**...TORO**

**...Mowers, Riding Equipment**

Kioritz				RCJ8	0.8
Kawasaki FH451V, FH500V V-Twin OHV	15,17			RCJ8Y	0.8
Suzuki 2-Cycle (18mm)				RCJ8Y	0.8
Wisconsin AENLD				RD16	0.6
Kohler	10,12			RD16	0.8
Kohler	14			RH10C	0.8
Kohler	20			RH10C	0.8
Kohler Twin	23			RH10C	0.8
Briggs & Stratton	10.5			RJ19LM	QJ19LM
Briggs & Stratton "L" Head				RJ19LM	QJ19LM
Kohler K181	6.25,8			RJ19LM	0.8
Tecumseh				RJ19LM	0.8
Teledyne R839			OE064	RL82YC	0.8
Onan OHV	14			RL95YC	0.6
Kawasaki OHV	13,14		OE051	RN11YC	0.6
Kawasaki OHV	19		OE051	RN11YC	0.6
Kawasaki OHV	3.7		OE051	RN11YC	0.6
Kawasaki V-Twin	23,27		OE042	RN12YC	0.6
Mitsubishi	24,27			RN14YC	0.9
Onan NHB				RN5C	0.8
Ford 1.1L			OE006	RN9YC	0.9
Suzuki 4-Cycle			OE006	RN9YC	0.8
Onan B48G				RS17YX	0.8
Onan Twin	16,20,24			RS17YX	0.6
Ford 1.3L			OE011	RS9YC	0.9
Chevrolet	250			RV12C	0.8
Kohler Magnum Twin	18			RV17YC	0.6
Kohler Magnum Twin	20			RV17YC	0.6
Kohler Twin (7/8"-18)	16,17			RV17YC	0.6
				W14	0.6

**Pruners**

53035				RCJ7Y	0.8
-------	--	--	--	-------	-----

**Seeders**

Briggs & Stratton	5			RJ19LM	QJ19LM
-------------------	---	--	--	--------	--------

**Snow Removers**

72	Tecumseh	7		RJ8C	0.8
521				RJ8C	0.8
622	Tecumseh	6		RJ8C	0.8
1028	Tecumseh	10		RJ8C	0.8
1232	Tecumseh OHV	12		RL86C	0.8
824, 824 XL	Tecumseh	8		RJ8C	0.8
All Other	4-Cycle			RCJ8	0.8
CCR 1000	Tecumseh	3		RCJ8Y	0.8
CCR 2000	Tecumseh	4.5		RCJ8Y	0.8
CCR 2400	Tecumseh	4		RCJ8Y	0.8
CCR 2500	Tecumseh	5		RCJ8Y	0.8
CCR 3000 GTS	Suzuki	5		RCJ8Y	0.8
CCR Powerlite	Tecumseh	3		RCJ8Y	0.8
S-140, S-200				RJ18YC	0.8
S-521	Tecumseh	5		RJ18YC	0.8
S-620	Tecumseh	7		RCJ8Y	0.8

**Thatchers**

Briggs & Stratton	5			RJ19LM	QJ19LM
-------------------	---	--	--	--------	--------

**Tillers**

				RCJ8	0.8
--	--	--	--	------	-----

**Trimmers**

51620, 51638, 51652, 51653, 51660, 51675				RCJ8	0.8
51903, 51906, 51908, 51909, 51911, 51916, 51918				RDJ7Y	0.6
51918, 51920, 51926 OHV				RDZ19H	0.8
53002, 53003, 53010, 53011, 53020, 53030, 53040, 53201				RCJ7Y	0.8
TC1000, TC2000, TC3100, TC3500, TC5000				RCJ8	0.8





CC BHP

21



OPT.



mm

## ...TORO

### Turf Equipment

53041				RDJ7Y		0.6
Aerators	Briggs & Stratton	3,3.5		RJ19LM	QJ19LM	0.8
Aeroseeders	Briggs & Stratton Vanguard		OE013	RC12YC	QC12YC / XC92YC	0.8
Applicators	Kohler OHV	6	OE013	RC12YC		1.0
Debris Loaders	Onan			RS17YX		0.6
Dingo	Kohler Command Pro	20,25	OE013	RC12YC		0.8
Rake-O-Vac	Kohler Command V-Twin	22	OE013	RC12YC		0.8
	Kohler	23		RH10C		0.8
Sand Pro				RJ8C		0.8
Shredders				RCJ8		0.8
Sweepers	Briggs & Stratton Vanguard		OE013	RC12YC	QC12YC / XC92YC	0.8
	Kohler V-Twin		OE013	RC12YC		0.8
	Onan			RS17YX		0.6
Sweepers & Vacuums	Robin	22	OE006	RN9YC		0.8
	Kohler V-Twin	18	OE013	RC12YC		0.8
	Briggs & Stratton Vanguard V-Twin	18		RC14YC		0.8
	Tecumseh 4-Cycle			RJ17LM		0.8
	Briggs & Stratton Single Cyl.			RJ19LM	QJ19LM	0.8
	Onan Twin	20,24		RS17YX		0.6
<b>Vacuums</b>						
	Briggs & Stratton			RJ19LM	QJ19LM	0.8

## TOURNO

### Power Equipment

95	GCV 520 Honda		OE051	RN11YC		0.5
115	GCV 520 Honda		OE051	RN11YC		0.5

## TOW-A-VAC

### Vacuums

	Tecumseh			CJ14		0.8
	Kawasaki OHC Twin	16	OE013	RC12YC		0.8
	Kohler Command Pro	6	OE013	RC12YC		0.8
	Kohler OHV	16	OE013	RC12YC		0.8
	Briggs & Stratton Vanguard V-Twin	16,18		RC14YC		0.8
	Kohler	8		RJ19LM		0.6
	Honda OHV	6,8	OE051	RN11YC		0.8

## TRAC VAC

### Power Equipment

	Briggs & Stratton Intek	5.5	OE013	RC12YC	QC12YC / XC92YC	0.5
	Briggs & Stratton Vanguard	9	OE013	RC12YC	QC12YC / XC92YC	0.8
	Kohler OHV	6	OE013	RC12YC		0.8
	Briggs & Stratton Vanguard V-Twin	16		RC14YC		0.8
	Briggs & Stratton	11,16		RJ19LM	QJ19LM	0.8
	Briggs & Stratton	3.5,5,5.5		RJ19LM	QJ19LM	0.8
	Briggs & Stratton	8		RJ19LM	QJ19LM	0.8

## TRAIL MATE

### Edgers

	Briggs & Stratton			RJ19LM	QJ19LM	0.8
--	-------------------	--	--	--------	--------	-----

### Lawn Mowers

	Briggs & Stratton			RJ19LM	QJ19LM	0.8
--	-------------------	--	--	--------	--------	-----

## TRAMS

### Lawn Mowers

All Models				RJ19LM		0.8
------------	--	--	--	--------	--	-----

## TRANSIT

### Pumps

23"x36" Double Acting Stationary				W14		0.6
6"x9" Vertical	4-Cycle			W14		0.6

## TRENCH DOCTOR

### Trenchers

	Briggs & Stratton			RJ19LM	QJ19LM	0.8
--	-------------------	--	--	--------	--------	-----



CC BHP



OPT.



## TRENCH MASTER

### Power Equipment

Briggs & Stratton Vanguard	9	OE013	RC12YC	QC12YC / XC92YC	0.8
Briggs & Stratton	10		RJ19LM	QJ19LM	0.8
Briggs & Stratton	5,6,5,8		RJ19LM	QJ19LM	0.8
Wisconsin	6,7,5		RL86C		0.6
Honda OHV	4,5,5,6,5,8,9,10,11	OE051	RN11YC		0.8

## TRENCHERMAN

### Trenchers

Briggs & Stratton	5,8		RJ19LM	QJ19LM	0.8
-------------------	-----	--	--------	--------	-----

## TRENCH'N EDGE

### Trenchers

Rotary	Honda OHV	9,11	OE051	RN11YC	0.8
--------	-----------	------	-------	--------	-----

## TRIM RITE

### Power Equipment

Tecumseh	1.6		RCJ8Y		0.8
Briggs & Stratton	3.5,3,7,5,5		RJ19LM	QJ19LM	0.8

## TRIM-A-LAWN

### Lawn Mowers

U.S.			RCJ7Y		0.8
Briggs & Stratton			RJ19LM	QJ19LM	0.8
Tecumseh			RJ8C		0.8

### Trimmers

153001			RDJ7Y		0.6
154900			RCJ6Y		0.6
152501, 152525, 152536			RCJ8Y		0.6
153500, 153502, 153503, 153504, 153535			RCJ8Y		0.6
154902, 154949, 154950			RCJ8Y		0.6
154950LE, 154950LW			RCJ6Y		0.6

## TRIM-ALL

### Brushcutters, Trimmers

			RCJ8		0.8
--	--	--	------	--	-----

### Edgers

			RDJ8J		0.8
--	--	--	-------	--	-----

### Lawn Mowers

All Models			RJ19LM		0.8
------------	--	--	--------	--	-----

### Power Equipment

Mitsubishi			RCJ8		0.8
------------	--	--	------	--	-----

## TRIM-IT

### Edgers, Trimmers

			RCJ8		0.8
--	--	--	------	--	-----

## TRIMMER

### Mowers

Rotary	Briggs & Stratton	3,3,5,5		RJ19LM	QJ19LM	0.8
	Honda	4,5,5	OE051	RN11YC		0.8
	Briggs & Stratton	3,3,5,5		RJ19LM	QJ19LM	0.8
	Honda OHV	4,5,5	OE051	RN11YC		0.8

## TROMCA

### Brushcutters

200, 260, 260D			RCJ7Y		0.5
400A, 460AVS			RCJ7Y		0.5
8420, 8510, 8515			RCJ7Y		0.5
TE22F, TE22R, TE26, TE30, TE40, TE40GT, TE41			RCJ7Y		0.7

### Chainsaws

935F, 942, 946, 951, 999F			RCJ7Y		0.5
---------------------------	--	--	-------	--	-----



CC BHP

21



OPT.

mm

**...TROMCA**

**Mowers**

20805 ( Quantum )	B & S	4		RJ19LM	QJ19LM	0.7
20805 ( Quantum XTE )	B & S	5		RJ19LM	QJ19LM	0.7
LM 21SP2K ( FC180V )	Kawasaki		OE006	RN9YC		0.7
LM 21SP2S ( SB152 )	F & S			RL86C		0.7
LM 21SP3S ( ST204 )	F & S			D14		0.6
TR 346P ( Prisma 37 )	Tecumseh (Tecnamotor)			RJ17LM		0.7
TR 4431BS,	B & S			RJ19LM	QJ19LM	0.7
TRT 4431BS ( Sprint 375 )						
TR 500T ( Quantum XM40 )	B & S			RJ19LM	QJ19LM	0.7
TRT 443, TRP 443	B & S			RJ19LM	QJ19LM	0.7
( Quantum XM35 )						
TRT 4481BQ, TRT 4481BOD	B & S			RJ19LM	QJ19LM	0.7
( Quantum XTE50 )						
TRT 4481K ( FC150 )	Kawasaki		OE006	RN9YC		0.7
TRT 4481S ( SB140SL )	F & S			RJ12YC		0.7
TRT 5471BQ ( Quantum XTL50 )	B & S			RJ19LM	QJ19LM	0.7
TRT 5471BQD	B & S			RJ19LM	QJ19LM	0.7
( Quantum XTL50DE )						
TRT 5471S ( SB140SL )	F & S			RJ12YC		0.7
TRT 5531BQ ( Quantum XTL50 )	B & S			RJ19LM	QJ19LM	0.7
TRT 5531BQD	B & S			RJ19LM	QJ19LM	0.7
( Quantum XTL50DE )						

**Mowers, Brushcutters**

AS 21 165 ( AS Motor )		7		RL86C		0.7
AS 21AB, AS 21A81 ( AS Motor )		4.5		RL86C		0.7
AS 21BS ( Quantum )		5		RJ19LM		0.7
AS 22F ( AS Motor )		7		RL86C		0.7
AS 26A82, AS 26A92 ( AS Motor )		7		RL86C		0.7
AS 27A82, AS 27A92 ( AS Motor )		7		RL86C		0.7
AS 53B1, B1R ( AS Motor )		7		RL86C		0.7
Montana BQ5 ( XM 1/C )				RJ19LM		0.7

**TROY BILT**

**Edgers**

GFP	4-Cycle	26		RDZ4H		0.6
TBE515	4-Cycle	29		RDZ19H		0.8

**Lawn Mowers**

Briggs & Stratton Intek OHV	6.5	OE013	RC12YC	QC12YC / XC92YC	0.5
Briggs & Stratton	4,5,5,5		RJ19LM	QJ19LM	0.8
Tecumseh	5.5		RJ8C		0.8
Honda OHV	5.5	OE051	RN11YC		0.8

**Power Equipment**

Briggs & Stratton Extended Life Series V-Twin	22	OE013	RC12YC	QC12YC / XC92YC	0.8
Briggs & Stratton Extended Life Series V-Twin	25	OE013	RC12YC	QC12YC / XC92YC	0.8
Briggs & Stratton Intek OHV	18	OE013	RC12YC	QC12YC / XC92YC	0.5
Briggs & Stratton Intek OHV	5.5,6.5,10	OE013	RC12YC	QC12YC / XC92YC	0.5
Briggs & Stratton Intek V-Twin	20,21	OE013	RC12YC	QC12YC / XC92YC	0.8
Briggs & Stratton Intek V-Twin	24	OE013	RC12YC	QC12YC / XC92YC	0.8
Briggs & Stratton Vanguard	12.5,13,13.5,15	OE013	RC12YC	QC12YC / XC92YC	0.8
Kohler OHV	12.5,14	OE013	RC12YC		1.0
Kohler V-Twin	18,20	OE013	RC12YC		0.8
Briggs & Stratton Vanguard V-Twin	16		RC14YC		0.8
Briggs & Stratton Vanguard V-Twin	18		RC14YC		0.8
Briggs & Stratton Single Cyl.			RJ19LM	QJ19LM	0.8
Kohler	8		RJ19LM		0.8
Lauson, Tecumseh			RJ8C		0.8
Honda OHV	5.5	OE051	RN11YC		0.8
Honda	1.5		Z9Y		0.8

**Snow Removers**

42000, 42010, 42012, 42013				RJ19LM		0.8
	Tecumseh	4,5,8,10		RJ19LM		0.8

**Trimmers**

TB20CS	2-Cycle			RDJ7Y		0.6
TB465SS	4-Cycle			RDZ4H		0.6
TB525CS, TB575SS	4-Cycle	29		RDZ4H		0.6
TB70CS, TB90BC	2-Cycle			RDJ7Y		0.6



CC

BHP

21



OPT.



mm

**TRU-CUT**

**Mowers**

Rotary	Briggs & Stratton	3,5		RJ19LM	QJ19LM	0.8
	Honda	4		OE051	RN11YC	0.8
	Honda	5		OE006	RN9YC	0.8
	Briggs & Stratton	3,3,5,5		RJ19LM	QJ19LM	0.8
	Honda	4		OE051	RN11YC	0.8
	Honda	5.5		OE051	RN11YC	0.8
	Honda	3.5		OE006	RN9YC	0.8
	Honda	5		OE006	RN9YC	0.8

**Power Equipment**

Honda	2,2,2,5		CJ14		0.8
Robin	4.2		RCJ8		0.6
Briggs & Stratton	2,3,3,5,3,7,5,5		RJ19LM	QJ19LM	0.8
Honda OHV	4		OE051	RN11YC	0.8
Honda OHV	5.5		OE051	RN11YC	0.8
Honda OHV	3.5		OE006	RN9YC	0.8
Honda OHV	5		OE006	RN9YC	0.8

**TRUE-TEST**

**Lawn Mowers**

All Models				RJ19LM		0.8
------------	--	--	--	--------	--	-----

**TRU-KOOLER**

**Pumps, Compressors & Refrigeration Units**

Wisconsin				RD16		0.6
-----------	--	--	--	------	--	-----

**TSURUMI PUMP**

**Centrifugal Pumps**

Honda OHV	4,5,5,8,11		OE051	RN11YC		0.8
-----------	------------	--	-------	--------	--	-----

**TUFF**

**Pressure Washers**

Briggs & Stratton Vanguard	16,21			RC14YC		0.8
Honda	5,5,5,6,5		OE051	RN11YC		0.8
Honda V-Twin	20,24		OE051	RN11YC		0.8

**TUFF BILT**

**Garden Tractors**

Briggs & Stratton				RJ19LM	QJ19LM	0.8
Tecumseh				RJ8C		0.8

**TURBO TURF**

**Seeders**

Honda	3.5			CJ14		0.8
Kohler Command Pro	25,27		OE013	RC12YC		0.8
Briggs & Stratton Vanguard V-Twin	20			RC14YC		0.8
Wisconsin	30			RD16		0.6
Kohler	16			RH10C		0.8
Briggs & Stratton	3,5,5			RJ19LM	QJ19LM	0.8
Briggs & Stratton	8			RJ19LM	QJ19LM	0.8
Briggs & Stratton Intek OHV	6.5		OE051	RN11YC		0.8
Honda	4,5,5,8,9		OE051	RN11YC		0.8
Honda OHV	13		OE051	RN11YC		0.8
Honda V-Twin	20		OE051	RN11YC		0.8

**TURF BLAZER**

**Garden Tractors**

Kawasaki	12.5			RCJ8		0.8
Wisconsin Twin	18			RD16		0.8
Ford	192			RH10C		0.6
Kohler	18,23			RH10C		0.8
Kawasaki	14,17		OE051	RN11YC		0.8

**TURF CHAMP**

**Lawn Mowers**

Briggs & Stratton				RJ19LM	QJ19LM	0.8
-------------------	--	--	--	--------	--------	-----



CC BHP

21



OPT.



mm

## TURF CHOICE

### Sprayers

Briggs & Stratton	3.5		RJ19LM	QJ19LM	0.8
-------------------	-----	--	--------	--------	-----

## TURF KING

### Trimmers

TK2145

			RCJ8Y		0.8
--	--	--	-------	--	-----

## TURF MAKER

### Seeders

Kohler TH520 V-Twin	16		OE013	RC12YC	0.8
---------------------	----	--	-------	--------	-----

## TURF MASTER

### Riding Equipment

Briggs & Stratton			RJ19LM	QJ19LM	0.8
Tecumseh			RJ8C		0.8

### Snow Removers

Briggs & Stratton			RJ19LM	QJ19LM	0.8
Tecumseh			RJ8C		0.8

## TURF POWER

### Lawn Mowers

Briggs & Stratton, Tecumseh			RJ19LM	QJ19LM	0.8
-----------------------------	--	--	--------	--------	-----

### Riding Equipment

Briggs & Stratton Vanguard			RC14YC		0.8
Briggs & Stratton			RJ19LM	QJ19LM	0.8

## TURF TRACKER

### Mowers

Kohler Command	20		OE013	RC12YC	0.8
----------------	----	--	-------	--------	-----

## TURF VAC

### Turf Vacuums

Wisconsin			RD16		0.8
Kohler			RH10C		0.8
Briggs & Stratton			RJ19LM	QJ19LM	0.8
Ford 1.6L			OE006	RN9YC	0.8

## TURFCO

### Power Equipment

Briggs & Stratton Vanguard	6		OE013	RC12YC	QC12YC / XC92YC	0.8
Briggs & Stratton Vanguard	9		OE013	RC12YC	QC12YC / XC92YC	0.8
Kohler K-series	14,20			RH10C		0.6
Briggs & Stratton	10			RJ19LM	QJ19LM	0.8
Briggs & Stratton	3,3.5,5			RJ19LM	QJ19LM	0.8
Briggs & Stratton	8			RJ19LM	QJ19LM	0.8
Clinton				RJ8C		0.8
Honda OHV	4		OE051	RN11YC		0.8
Honda OHV	5.5,8,9		OE051	RN11YC		0.8
Honda OHV	5		OE006	RN9YC		0.8

## TURF-MITE

### Power Equipment

Ground Saws	Honda	4		OE051	RN11YC	0.8
-------------	-------	---	--	-------	--------	-----

## TURFTEK

### Power Equipment

Kohler V-Twin	18,20		OE013	RC12YC		0.8
Briggs & Stratton Vanguard V-Twin	16			RC14YC		0.8
Briggs & Stratton Vanguard V-Twin	18,20			RC14YC		0.8
Briggs & Stratton Single Cyl.	18			RJ19LM	QJ19LM	0.8
Briggs & Stratton Twin	14,16			RJ19LM	QJ19LM	0.8
Briggs & Stratton Twin	18			RJ19LM	QJ19LM	0.8
Honda OHV	13,18,20		OE051	RN11YC		0.8
Tecumseh	18		OE098	RN4C		0.8



CC BHP

21



OPT.



mm

**TURF-TIL**

Tillers						
	Tecumseh			RJ17LM	0.8	
	Briggs & Stratton			RJ19LM	QJ19LM	0.8

**TURF-TRIM**

Lawn Mowers						
	Briggs & Stratton			RJ19LM	QJ19LM	0.8

**U.S. ENGINES**

Engines					
	21/25 Series			RCJ7Y	0.8
	35/41 Series			RCJ8Y	0.8

**U.S. MOTORS**

Generators						
BxB, ZX, ZXB	Hercules			RH8C	0.6	
	Briggs & Stratton (18mm)			D14	0.6	
	Lauson (18mm)			D14	0.6	
	AMC	232	OE041	RC12LYC	0.9	
	AMC	258	OE041	RC12LYC	0.9	
	Own			RCJ8	0.8	
	Stover DV2			RH8C	0.6	
	Briggs & Stratton (14mm)			RJ19LM	QJ19LM	0.6
	Hercules Other (14mm)			RJ8C	0.6	
	Lauson (14mm)			RJ8C	0.6	
	AMC	304	OE042	RN12YC	0.9	
	AMC	360	OE042	RN12YC	0.9	
	Waukesha WAK			W10	0.6	
	Hercules (7/8"-18)			W14	0.6	

Pumps					
	USM-100-2 2"			RCJ8	0.8

**U.S.A.**

Pressure Washers						
	Briggs & Stratton	3.75		RJ19LM	QJ19LM	0.8

**U-CART**

Seeders					
	Robin	3.5		RL87YC	0.6

**ULTRA**

Lawn Mowers						
	Briggs & Stratton	4.75,5,5.5		RJ19LM	QJ19LM	0.8

Power Equipment						
	Tecumseh	1.6		RCJ8Y	0.8	
	Briggs & Stratton	3.5,5,8,13,15		RJ19LM	QJ19LM	0.8
	Briggs & Stratton Twin	18		RJ19LM	QJ19LM	0.8
	Tecumseh	8		RJ8C	0.8	
	Honda V-Twin	20	OE051	RN11YC	0.8	

**UNICORN**

Log Splitters					
				RCJ8	0.6

**UNITED**

Generators					
	All Models			W14	0.6

**UNIVERSAL**

Generators						
	Wisconsin			D14	0.6	
	Briggs & Stratton			RJ19LM	QJ19LM	0.6

Pumps, Compressors & Refrigeration Units					
	Aquamaster			RCJ8	0.6



CC BHP

21



OPT.



mm

**URAL****Power Equipment**

Ural 3

RL86C

0.7

**US MARINE (→ Chrysler Power Bee)****VAC-MASTER****Lawn Mowers**

Remote Control Model

OE051

RN11YC

0.8

**Sweepers**

Power Sweepers

RCJ8

0.8

**Welders**

Briggs &amp; Stratton Vanguard V-Twin

18

RC14YC

0.8

**VACUBOAT****Waste Pumps**

Marine

Honda

2.5

CJ14

0.8

Honda OHV

5.5

OE051

RN11YC

0.8

**VALLEY INDUSTRIES****Power Equipment**

Manure Handlers

Briggs &amp; Stratton Vanguard V-Twin

18

RC14YC

0.8

**VANDERMOLEN WINDMILL****Power Equipment**

22

CJ6

0.8

26

RL86C

0.8

28

RL86C

0.5

77

RL86C

0.8

312

RCJ8

0.8

848

RL86C

0.8

7-11

RL86C

0.5

1824Cr, 1832Cr

RCJ8

0.8

2324, 2330, 2360

RCJ8

0.8

5-11KT

RJ12C

0.8

540BT, 542BT, 542BTx, 55, 66

CJ6

0.8

8-11E

RJ6C

0.8

850BTx

RCJ8Y

0.8

856BT, 88

CJ6

0.8

AM16D

RCJ8

0.8

D15

RJ8C

0.8

D17

CJ6

0.8

D18

RJ8C

0.8

F1824Cr, F1832Cr, F1848Cr

RCJ8

0.8

F2330CrHD, F2330K, F2360CrHD

CJ14

0.8

Tarpen Power Unit

RJ8C

0.8

TD18, TD24, TD33, TDF18

RCJ8

0.8

Kohler

RH10C

0.8

Briggs &amp; Stratton

RJ19LM

QJ19LM

0.8

**Trimmers**

L1840F/G, L1840K, L1845G,

L2035G, L2415G, L2515K,

L2515X, L2540K, L2815G,

L2815G3, L2815K, L3335G3,

L3335G, L3335G1, L4320K, X3335G

RCJ8

0.8

**VANN****Log Splitters, Vacuums**

RJ8C

0.8

**VAP****Brushcutters**

CBT45, DB23, DB24, DB28,

DB33, DB47, DB49

RCJ7Y

0.5

**Chainsaws**

530, 535, 542, 548, 553, 570

RCJ7Y

0.5



CC BHP

21



OPT.



mm

**...VAP**

**Mowers**

46 T37 ( Prisma 37 )	Tecumseh (Tecnamotor)			RJ17LM		0.7
Border F4, F4A ( Prisma 37 )	Tecumseh (Tecnamotor)			RJ17LM		0.7
Boxer F2, F2A ( MV100S )	Tecumseh (Tecnamotor)			RJ17LM		0.7
Boxer F4A37, F4AE37 ( Prisma 37 )	Tecumseh (Tecnamotor)			RJ17LM		0.7
Pointer F4 .37 ( Prisma 37 )	Tecumseh (Tecnamotor)			RJ17LM		0.7
Springer B5A ( Quantum 50)	B & S			RJ19LM	QJ19LM	0.7
Springer F5A, F5AE (Synergie 40)	Tecumseh (Tecnamotor)			RJ19LM		0.7
Springer K5A, FC150	Kawasaki		OE006	RN9YC		0.7

**VARI-TRAC**

**Garden Tractors**

Tecumseh				RJ8C		0.8
----------	--	--	--	------	--	-----

**VAUGHN**

**Power Equipment**

(1/2"-14 Pipe)				25		0.6
(7/8"-18)				W14		0.6

**VECTRA**

**Lawn Mowers**

Briggs & Stratton	4,4,7,5,5,5.5			RJ19LM	QJ19LM	0.8
-------------------	---------------	--	--	--------	--------	-----

**Riding Mowers**

Briggs & Stratton	11.5,13,15			RJ19LM	QJ19LM	0.8
Briggs & Stratton Twin	16.5			RJ19LM	QJ19LM	0.8
Kohler Twin	20			RV17YC		0.6

**VEMCO**

**Lawn Mowers**

All Models				RJ19LM		0.8
------------	--	--	--	--------	--	-----

**VENTRAC**

**Riding Mowers**

Briggs & Stratton Liquid-Cooled 3-Cyl.	31		OE013	RC12YC	QC12YC / XC92YC	0.5
Kawasaki	19,25,27		OE051	RN11YC		0.8

**Utility Vehicles**

Tri-Wheeler	Briggs & Stratton	5		RJ19LM	QJ19LM	0.8
-------------	-------------------	---	--	--------	--------	-----

**VERMEER**

**Power Equipment**

Kohler OHV	11		OE013	RC12YC		0.8
Kohler OHV	13,15		OE013	RC12YC		0.8
Kohler V-Twin	25		OE013	RC12YC		1.0
Kohler V-Twin	23			RC14YC		1.0
Wisconsin	35			RD16		0.8
Wisconsin 4H4D, SD12				RD16		0.8
Wisconsin W4-1770	34			RD16		0.8
Ford 300 GF				RF10C		0.6
Ford	98			RH10C		0.6
Ford	134			RH10C		0.6
Ford	140			RH10C		0.6
Ford	172			RH10C		0.6
Ford	192			RH10C		0.6
Kohler	12			RH10C		0.8
Honda	9,11,13		OE051	RN11YC		0.8
Kawasaki FE350D	11.5		OE042	RN12YC		0.8
Wisconsin V465D			OE042	RN12YC		0.8
Kohler Command Pro	6			RN14YC		0.8
Onan NHB				RN5C		0.6
Ford 423 LSG				RS12YC		0.8
Chrysler	225			RV12YC		0.8
Kohler Magnum Twin	18			RV17YC		0.6
Kohler Twin	20			RV17YC		0.6

**VERTI-DRAIN**

**Aerators**

Honda	13		OE051	RN11YC		0.8
-------	----	--	-------	--------	--	-----





CC BHP

21



OPT.



mm

**VICTA****Lawn Mowers**

All Models

RJ19LM

0.8

**VIGOR****Engines**

VG173F-A	General Purpose	8	OE108	RN3C	0.8
VG173FD-A	General Purpose	8	OE108	RN3C	0.8
VG177F-A	General Purpose	9	OE108	RN3C	0.8
VG177FD-A	General Purpose	9	OE108	RN3C	0.8
VG182F-A	General Purpose	11	OE108	RN3C	0.8
VG182FD-A	General Purpose	11	OE108	RN3C	0.8
VG188F-A	General Purpose	13	OE108	RN3C	0.8
VG188FD-A	General Purpose	13	OE108	RN3C	0.8
VG1P64FV	General Purpose	5	OE006	RN9YC	0.8

**Mowers**

T39F				Z9Y	0.8
TE36F				RCJ8	0.8

**Water Pumps**

T39F				Z9Y	0.8
T52F				RCJ8Y	0.6
T68F, 168F-1, 177F			OE108	RN3C	0.8
TE40F-B, 1E43F				RL95YC	0.8

**Welders**

T52F				RCJ8Y	0.6
T68F, 168F-1, 173F, 182F, 188F			OE108	RN3C	0.8
TE45F				RL95YC	0.6

**VIKING****Garden Tractors**

Briggs & Stratton (18mm)				RD16	0.6	
Wisconsin				RD16	0.6	
Briggs & Stratton (14mm)				RJ19LM	QJ19LM	0.6

**VILLAGE 21****Log Splitters**

Briggs & Stratton				RJ19LM	QJ19LM	0.6
-------------------	--	--	--	--------	--------	-----

**VILLAGE BLACKSMITH****Augers, Foggers**

RCJ8 0.8

**VOGEL & NOOT****Mowers**

Bombardier Rotax				D14	0.5
MAG				J11C	0.5

**VOGT****Lawn Mowers**

All Models

RJ19LM 0.8

**VOLLRATH****Lawn Mowers**

All Models

RJ19LM 0.8

**VOLT MASTER****Generators, Welders**

Briggs & Stratton Vanguard	9	OE013	RC12YC	QC12YC / XC92YC	0.8
Kohler V-Twin	25	OE013	RC12YC		0.8
Briggs & Stratton Vanguard V-Twin	16		RC14YC		0.8
Briggs & Stratton	11		RJ19LM	QJ19LM	0.8
Briggs & Stratton	5,8		RJ19LM	QJ19LM	0.8
Briggs & Stratton Twin	16		RJ19LM	QJ19LM	0.8
Briggs & Stratton Twin	18		RJ19LM	QJ19LM	0.8
Honda OHV	5.5,8,11,13	OE051	RN11YC		0.8
Honda V-Twin	18	OE051	RN11YC		0.8
Onan Twin	24		RS17YX		0.6





CC

BHP

21



OPT.



mm

## VULCAN

### Lawn Mowers

Briggs & Stratton	3,5	RJ19LM	QJ19LM	0.8
Tecumseh	3.5	RJ19LM		0.8

## WACKER

### Centrifugal Pumps

PD2B			RJ19LM	0.8
PD3A		OE051	RN11YC	0.8
PD3B			RJ19LM	0.8
PG2	Robin		RL86C	0.6
	Honda OHV	OE051	RN11YC	0.8
PG3	Honda OHV	OE051	RN11YC	0.8
PG3, PG4	Robin		RL86C	0.6
PT2A		OE051	RN11YC	0.8
PT2B			RJ19LM	0.8
PT2R			RL86C	0.6
PT3A		OE051	RN11YC	0.8
PT3B			RJ19LM	0.8
PT3R			RL86C	0.6
PT3V			RC14YC	0.8
PT4B			RJ19LM	0.8

### Cut-Off Saw

BTS10			RCJ7Y	0.5
BTS1030L3, BTS1035L3	5.6		RCJ6Y	0.5
BTS11			RCJ7Y	0.5
BTS12, BTS13, BTS14, BTS9			RCJ7Y	0.5
BTS930L3, BTS935LS	4.5		RCJ6Y	0.5

### Generators

G 2.5A/B	Briggs & Stratton	5.5	RJ19LM	QJ19LM	0.8
	Honda	5.5	OE051	RN11YC	0.8
G 4.5A/B	Briggs & Stratton	10	RJ19LM	QJ19LM	0.8
	Honda	9	OE051	RN11YC	0.8
GH 3500E	Wisconsin	8	RL87YC		0.6
GS 5.5A/B	Briggs & Stratton	11	RJ19LM	QJ19LM	0.8
	Honda	11	OE051	RN11YC	0.8
GS 6.5A/B	Honda	13	OE051	RN11YC	0.8
HGG3/180/240			RJ8C		0.6

### Tampers, Trimmers

11, 12, 13, 14			RCJ7Y	0.5
BS700			RL86C	0.5
BTS10, BTS9			RCJ7Y	0.5
DS105Y, DS62Y			UJ11G	0.8

## WAJAX

### Ice Pumps

Typhon		OE086	RL82C	0.6
--------	--	-------	-------	-----

### Pumps, Compressors & Refrigeration Units

BE			RJ8C	0.6
MK-1			RJ6C	0.6
MK-2, MK-25			D9	0.6
MK-26		OE086	RL82C	0.6
MK-2M, MK-3, MK-75			D9	0.6
TSA-8			RD16	0.6
WA-7, WA-7S, WGC-4, WX			RD16	0.6
	Lauson		RJ8C	0.6
	Wajax		W14	0.6

## WALKER

### Riding Mowers

Kohler OHC Twin	16	OE013	RC12YC	0.8
Kohler V-Twin	16,18,20,25	OE013	RC12YC	0.8
Kohler V-Twin EFI	26	OE013	RC12YC	0.8
Kubota WG600-B	21	OE013	RC12YC	0.8
Kubota WG750-B	24.5	OE013	RC12YC	0.8
Kawasaki FH430V V-Twin OHV	15		RCJ8Y	0.6
Kohler	16		RH10C	0.8
Briggs & Stratton	11		RJ19LM	QJ19LM
Kawasaki OHV	11,11.5,13	OE051	RN11YC	0.8
Kohler Twin	16		RV17YC	0.6



CC BHP

21



OPT.



mm

**WAMBO****Pumps, Compressors & Refrigeration Units**

D200, P35, S170

RL86C

0.9

**WARD LAKESIDE****Lawn Mowers**

All Models

RJ19LM

0.8

**WARDS****Chain Saws**

24086

24148

24000A, 24001A, 24002A, 24002B,

24002C, 24003A, 24005A, 24005B,

24006A, 24006B, 24007A, 24007B,

24008A, 24008B, 24025A, 24025B,

24027A, 24028A, 24030A, 24031A,

24032A, 24033A, 24034A, 24035A,

24036A, 24036B, 24036C, 24036D,

24037A, 24038A, 24040A, 24040B,

24050A, 24052A, 24054A, 24056A

24060A

24062, 24064, 24066, 24068

24072A, 24075A, 24075B, 24075C

24078, 24084

24085A

24087A, 24089A, 24090A, 24094A,

24095A, 24096A

24100, 24102, 24103

30000A, 30004A, 30008A, 30012A,

30016A, 30020A, 30024A

RCJ7Y

0.8

RJ8C

0.8

CJ6

0.8

RCJ7Y

0.8

RJ6C

0.8

RCJ7Y

0.8

CJ6

0.8

RCJ7Y

0.8

CJ6

0.8

CJ6

0.8

RCJ8

0.8

CJ6

0.8

**Power Equipment**

Briggs &amp; Stratton

RJ19LM

QJ19LM

0.8

Tecumseh

RJ8C

0.8

**Snow Removers**

All Models

RJ19LM

0.8

**Tillers, Tractors**

Onan

RH18Y

0.8

Briggs &amp; Stratton

RJ19LM

QJ19LM

0.8

**Trimmers**

1926, 1927

1930, 1931, 1932

RCJ8

0.8

CJ14

0.8

**WARE****Riding Mowers**

Briggs &amp; Stratton Vanguard V-Twin

16

RC14YC

0.8

**WARRIOR****Trimmers**

Kawasaki

CJ14

0.5

Robin

RCJ8

0.6

**WATEROUS****Pumps**

11,18

Chrysler 82011, 82029

OE086

RJ19LM

0.8

RL82C

0.6

**WAUBAUSHENE****Pumps**

Honda

2.2,2.5

CJ14

0.8

**WAYNE****Power Equipment**

Chrysler

225

OE042

RN12YC

0.8

Chrysler

318

OE042

RN12YC

0.8

**Pumps, Compressors & Refrigeration Units**

All Models

RJ8C

0.6





CC BHP

21



OPT.



mm

**WEBB**

**Lawn Mowers**

All Models

RJ19LM

0.8

**Power Equipment**

Briggs & Stratton

RJ19LM

QJ19LM

0.8

**WEBSTER**

**Power Equipment**

Tecumseh

2

RCJ6Y

0.8

Tecumseh

1.6

RCJ8Y

0.8

**WECO**

**Generators**

All Models

D14

0.6

**WEED EATER**

**Edgers**

PE550, SB180, SE200

RCJ8Y

0.6

**Lawn Mowers**

Robin

CJ6

0.8

Kioritz

RCJ8

0.8

Briggs & Stratton

4,4.25,4.5,5,  
5.25,5.5,6

RJ19LM

QJ19LM

0.8

Tecumseh

RJ8C

0.8

**Mowers**

(18mm)

RD16

0.8

**Power Equipment**

599

RCJ8

0.8

1000

OE086

RL82C

0.8

6000

CJ14

0.8

1400, 1400T, 1500, 1600,

CJ14

0.8

1600T, 1700, 1700A, 1740, 1900

1920, 1925, 1960

RCJ8

0.8

4000, 5000

CJ14

0.8

609, 698, 920, 925, 940

RCJ8

0.8

BC2400, BC24B, BC24W

RCJ8Y

0.6

BC30B

CJ14

0.8

BC3100, XT200 Featherlite

RCJ8Y

0.6

BV165

RCJ8Y

0.8

BV1650, BV1800, BV2000 Barracuda,

RCJ8Y

0.6

FL1500 Featherlite

GBI20, GBI22

RCJ8Y

0.8

GBI22V

RCJ8Y

0.6

GBI30

RCJ8Y

0.8

GBI30V

CJ14

0.8

GE21

RCJ8Y

0.8

GHT17, GHT22

RCJ8Y

0.8

GHT180, GHT220 Excalibur

RCJ8Y

0.6

GT115T, GT116, GT117C, GT118KT,

CJ14

0.8

GT118T, GT119T, GT152

HP22, HP28, HP30

CJ14

0.8

LT7000, LT7500

RCJ8Y

0.8

PL200, PL500, Plus, Pro Trim,

RCJ8Y

0.6

Prolite, SST, TE400, Twist'N Edge,

UltraTrim, Wild Thing

SST45

CJ14

0.8

SV22, SV30 Barracuda

RCJ8Y

0.6

Twister

CJ14

0.8

XR100

CJ14

0.8

XR105, XR125, XR20

CJ14

0.8

XR200

RCJ8

0.8

XR30, XR50, XR70, XR75, XR80,

CJ14

0.8

XR90, XR95, XT100, XT125KT,

XT125T, XT20T

XT25, XT300

RCJ8Y

0.6

XT30D

CJ14

0.8

XT35, XT400

RCJ8Y

0.6

XT40T, XT50T

CJ14

0.8

XT55, XT600, XT65

RCJ8Y

0.6



CC BHP

21



OPT.



mm

**...WEED EATER**

XT85T, XT90

Briggs & Stratton OHV  
Kioritz  
Tecumseh  
Briggs & Stratton  
Briggs & Stratton Twin  
Kawasaki  
Fuji5,12.5,14.5  
16,18.5

	CJ14		0.8
OE013	RC12YC	QC12YC / XC92YC	0.8
	RCJ8		0.8
	RJ17LM		0.8
	RJ19LM	QJ19LM	0.8
	RJ19LM	QJ19LM	0.8
	RJ6C		0.8
OE086	RL82C		0.8

**Riding Mowers**WE12538  
WE14542  
WE1642, WE18542, WE185H42**Tillers**

WEF550, WER500

	RJ19LM		0.8
OE013	RC12YC		0.8
	RJ19LM		0.8
	RJ19LM		0.8

**WEGELE****Mowers**

Kohler OHV 13,15

OE013	RC12YC		1.0
-------	--------	--	-----

**WESCO****Generators**

All Models

	RD16		0.6
--	------	--	-----

**WEST BEND****Chain Saws**

All Models

	RCJ8		0.8
--	------	--	-----

**WESTERBEKE****Generators**

Marine 11, 12.5, 15, 20 KW	4-Cyl.
Marine 4 KW	2-Cyl.
Marine 4.5, 6.5	3-Cyl.
Marine 6.5	4-Cyl.
Marine 7 KW	3-Cyl.
Marine 8, 8.5 KW	4-Cyl.
Marine 9 KW	3-Cyl.

OE049	RN11YC4		0.9
OE006	RN9YC		0.9
OE049	RN11YC4		0.9
OE049	RN11YC4		0.9
OE006	RN9YC		0.9
OE049	RN11YC4		0.9
OE049	RN11YC4		0.9

**WESTHEFFER****Sprayers**

Honda OHV 5

OE006	RN9YC		0.8
-------	-------	--	-----

**WESTINGHOUSE****Generators**(18mm)  
(7/8"-18)

	D14		0.6
	W14		0.6

**WESTMAC****Trimmers**

	RCJ8		0.6
--	------	--	-----

**WESTWOOD****Power Equipment**

Gemini Tillers

	RJ8C		0.8
--	------	--	-----

**WHEEL HORSE****Lawn Mowers**

Briggs &amp; Stratton 3.5

	RJ19LM	QJ19LM	0.8
--	--------	--------	-----

**Power Equipment**

Kawasaki	12.5
Kohler	10,12,14,16
Kohler	20
Kohler	8
Onan B43M	
Briggs & Stratton	
Kohler K181	8
Tecumseh	
Renault	

	RCJ8		0.8
	RH10C		0.8
	RH10C		0.8
	RH10C		0.8
	RH18Y		0.8
	RJ19LM	QJ19LM	0.8
	RJ19LM		0.8
	RJ8C		0.8
	RL87YC		0.8



CC BHP

21



OPT.



mm

## ...WHEEL HORSE

### ...Power Equipment

Onan	12,5,14		RL95YC	0.6
Onan XLS			RS17YX	0.6
Kohler Twin	16,17,18		RV17YC	0.6

## WHEELBURRO

### Mowers

Briggs & Stratton	5		RJ19LM	QJ19LM	0.8
-------------------	---	--	--------	--------	-----

## WHEELER

### Lawn Mowers

Briggs & Stratton	3,5,3,75,4,5		RJ19LM	QJ19LM	0.8
Tecumseh	5		RJ8C		0.8

### Lawn Tractors

Briggs & Stratton			RJ19LM	QJ19LM	0.8
Tecumseh			RJ8C		0.8
Honda	13	OE051	RN11YC		0.6

## WHIPPER CLIPPER

### Power Equipment

Briggs & Stratton			RCJ8		0.8
Honda	4,5	OE051	RN11YC		0.8

## WHIRL CUT

### Lawn Mowers

All Models			RJ19LM		0.8
------------	--	--	--------	--	-----

## WHIRLER-GLIDE

### Lawn Mowers

All Models			RJ19LM		0.8
------------	--	--	--------	--	-----

## WHIRLYBIRD

### Trimmers

			RCJ8		0.6
--	--	--	------	--	-----

## WHITE

### Lawn Mowers

Briggs & Stratton	3,75,4,5,5,5,6		RJ19LM	QJ19LM	0.8
-------------------	----------------	--	--------	--------	-----

### Log Splitters

			RJ19LM		0.8
--	--	--	--------	--	-----

### Power Equipment

Briggs & Stratton Vanguard	15	OE013	RC12YC	QC12YC / XC92YC	0.8
Briggs & Stratton OHV	5		RC14YC		0.8
Briggs & Stratton Vanguard V-Twin	16		RC14YC		0.8
Briggs & Stratton Vanguard V-Twin	18,20		RC14YC		0.8
Briggs & Stratton	3,3,5,5		RJ19LM	QJ19LM	0.8
Briggs & Stratton	8,10,5,12,12,5,13		RJ19LM	QJ19LM	0.8
Briggs & Stratton Twin	16		RJ19LM	QJ19LM	0.8
Briggs & Stratton Twin	18		RJ19LM	QJ19LM	0.8
Tecumseh			RJ8C		0.8
Tecumseh OHV	5,13	OE098	RN4C		0.8
Onan			RS17YX		0.6

### Shredders

			RCJ8		0.8
--	--	--	------	--	-----

### Snow Removers

SB-1050			RJ8C		0.8
SB-50, SB-55			RCJ8Y		0.8
SB-550		OE098	RN4C		0.8
SB-750, SB-750T, SB-950, SB-950T			RJ8C		0.8
Tecumseh 2-Cycle	3		RCJ8Y		0.8
Tecumseh 2-Cycle	4.5		RJ19LM		0.8
Tecumseh 4-Cycle	5		RJ8C		0.8
Tecumseh 4-Cycle	8,9		RJ8C		0.8
Tecumseh 4-Cycle	12		RL86C		0.8
Tecumseh 4-Cycle OHV	5.5	OE098	RN4C		0.8



CC BHP

21



OPT.



mm

**WHITE MOTOR CO.****Chain Saws**

WM19, WM21, WM360

RCJ8

0.8

**WHITEHEAD****Power Equipment**

Chrysler

OE086

RL82C

0.8

**WHIZ-MOW****Lawn Mowers**

All Models

RH10C

0.8

**WHIZZ WITCH (→ Hoffco)****WIC****Mulchers**

Kohler

16

RH10C

0.8

**Power Equipment**L1845G, L2035G, L2415G,  
L2525X, L3335G, X3335G

RCJ8

0.8

**WIKOV****Power Equipment**

Briggs &amp; Stratton

10

RJ19LM

QJ19LM

0.8

Honda OHV

9

OE051

RN11YC

0.8

Kawasaki OHV

11.1

OE051

RN11YC

0.8

**Riding Mowers**

Kohler V-Twin OHV

18

OE013

RC12YC

1.0

Briggs &amp; Stratton Vanguard V-Twin

15

RC14YC

0.8

Briggs &amp; Stratton Vanguard V-Twin

16,18,20

RC14YC

0.8

Briggs &amp; Stratton

12,12.5

RJ19LM

QJ19LM

0.8

Briggs &amp; Stratton

15.5

RJ19LM

QJ19LM

0.8

Honda OHV

13

OE051

RN11YC

0.8

Honda V-Twin OHV

20

OE051

RN11YC

0.8

**WILLYSLITE****Generators**

All Models

W14

0.6

**WINCHARGER****Generators**

Wisconsin

D14

0.8

Briggs &amp; Stratton

RJ19LM

QJ19LM

0.6

Clinton

RJ8C

0.6

**WINCO****Generators**

Wisconsin THD

D9

0.5

Briggs &amp; Stratton Vanguard

9

OE013

RC12YC

QC12YC / XC92YC

0.8

Briggs &amp; Stratton Vanguard V-Twin

16,18

RC14YC

0.8

Kawasaki FA Series

RCJ8

0.6

Briggs &amp; Stratton

RJ19LM

QJ19LM

0.6

Tecumseh

8

RJ8C

0.8

Tecumseh

12

OE086

RL82C

0.5

Kawasaki

8.2

RL86C

0.8

Honda

5.5,9,11

OE051

RN11YC

0.8

Chrysler LH-318

OE042

RN12YC

0.8

Tecumseh

18

OE098

RN4C

0.5

Ford LSG-423

RS12YC

0.5

Ford

460

RV12YC

0.8

**WINDS****Power Equipment**

Kohler

10

RH10C

0.8



CC BHP



OPT.



**WINPOWER**

**Generators**

15000KES			OE013	RC12YC		0.8
4400E				RJ19LM		0.6
4400H, 4400HE			OE051	RN11YC		0.6
4400PRO, 5500E, 5500ES				RJ19LM		0.6
5500HE			OE051	RN11YC		0.6
5500PROS				RJ19LM		0.6
6500HE			OE051	RN11YC		0.6
8500ES/2				RC14YC		0.6
CD2500				RJ19LM		0.6
CHD11000KES			OE013	RC12YC		0.8
COV3000H, COV5500H			OE051	RN11YC		0.6
COV7500ES				RC14YC		0.6
EL2500			OE006	RN9YC		0.8
EL4400				RJ19LM		0.6
	Kohler V-Twin	22,25	OE013	RC12YC		0.8
	Briggs & Stratton Vanguard V-Twin	12.5,14,16		RC14YC		0.6
	Briggs & Stratton	5,8,11		RJ19LM	QJ19LM	0.6
	Robin			RL86C		0.6
	Honda OHV	5.5,8,11,13	OE051	RN11YC		0.6
	Wisconsin V465D		OE042	RN12YC		0.6
	Honda OHV	5	OE006	RN9YC		0.8

**WIS-CON TOTAL POWER**

**Engines**

ACN	Wisconsin Series	6		RD16		0.6
AEN	Wisconsin Series			RD16		0.6
	Wisconsin Series			RD16		0.6
AENL	Wisconsin Series	9.2		RD16		0.6
AENLD	Wisconsin Series	9		RD16		0.6
AFH	Wisconsin Series			RD16		0.6
AGH	Wisconsin Series			RD16		0.6
AGND	Wisconsin Series	12.5		D21		0.6
AHH	Wisconsin Series			RD16		0.6
BKN	Wisconsin Series	7		RD16		0.6
HS-7D	Wisconsin Series	7		RD16		0.6
HS-8D	Wisconsin Series	8		RD16		0.6
R11	Continental "R" Series	35		RL87YC		0.6
R14	Continental "R" Series	47		RL87YC		0.6
S-10D	Wisconsin Series	10.5		RD16		0.6
S-12D	Wisconsin Series	12.5		RD16		0.6
S-14D	Wisconsin Series	14		RD16		0.6
S-7D	Wisconsin Series	7.25		RD16		0.6
S-8D	Wisconsin Series	8.25		RD16		0.6
THD	Wisconsin Series	18		RD16		0.6
THDM	Wisconsin Series	18		RD16		0.6
TJD	Wisconsin Series	18.2		RD16		0.6
	Wisconsin Series	18		RD16		0.6
TM13	Continental "TM/TMD" Series	33.7	OE006	RN9YC		0.6
TM20	Continental "TM/TMD" Series	53.5	OE006	RN9YC		0.6
TM20 (LPG/GNG)	Continental "TM/TMD" Series	53.5	OE116	RN6YC		0.4
TM27	Continental "TM/TMD" Series	72	OE006	RN9YC		0.6
TM27 (LPG/GNG)	Continental "TM/TMD" Series	72.5	OE116	RN6YC		0.4
TRA-10D	Wisconsin Series	10		RD16		0.6
TRA-12D	Wisconsin Series	12		RD16		0.6
V-461D	Wisconsin Series	60.5	OE042	RN12YC		0.6
V-465D	Wisconsin Series	65	OE042	RN12YC		0.6
V-468D	Wisconsin Series	65.9	OE042	RN12YC		0.6
VE4D	Wisconsin Series	21.5		RD16		0.6
VF4D	Wisconsin Series	25		RD16		0.6
VG4D	Wisconsin Series	37		RD16		0.6
VH4D	Wisconsin Series	30		RD16		0.6
VH4DM	Wisconsin Series	30		RD16		0.6
W2-1250	Wisconsin Series	26		RD16		0.6
W2-880	Wisconsin Series	20		RD16		0.6
W4-1770	Wisconsin Series	35		RD16		0.6
WE 130	Wisconsin HDI Series	3		RL86C		0.6
WE 180	Wisconsin HDI Series	5		RL86C		0.6
WE 270	Wisconsin HDI Series	8		RL86C		0.6





CC BHP

21



OPT.



mm

**...WIS-CON TOTAL POWER**

**...Engines**

WE 400	Wisconsin HDI Series	11		OE059	L92YC		0.6
WE350	Wisconsin HDI Series	11		OE059	L92YC		0.6

**WISCONSIN-ROBIN**

**Engines**

EY18-3W	Horizontal Shaft	4.6			RL86C		0.6
EY18-3W (Kerosene)	Horizontal Shaft	4.6			L90C		0.6
EY21W	Horizontal Shaft	16.2			RJ8C		0.6
EY44W	Horizontal Shaft	10.5			RL86C		0.6
W1-080	Horizontal Shaft	1.8			RL87YC		0.6
W1-145	Horizontal Shaft	3.5			RL86C		0.6
W1-145V	Vertical Shaft	4			RL86C		0.6
W1-150	Horizontal Shaft	3.5			RL87YC		0.6
W1-185	Horizontal Shaft	4.6			RL86C		0.6
W1-185V	Vertical Shaft	5			RL86C		0.6
W1-230	Horizontal Shaft	5.5			RL95YC		0.6
W1-280	Horizontal Shaft	7.5			RL87YC		0.6
W1-340	Horizontal Shaft	9			RD16		0.6
W1-390	Horizontal Shaft	11			RL95YC		0.6
W1-450V	Vertical Shaft	12			RL86C		0.6
WL2-670	Liquid-Cooled	24			RD16		0.6
WL3-1000	Liquid-Cooled	33			RD16		0.6
W01-115	OHV Sovereign Series	3.3			RL86C		0.6
W01-150	OHV Sovereign Series	4.8			RL86C		0.6
W01-210	OHV Sovereign Series	7			RL86C		0.6
W01-300	OHV Sovereign Series	9			RL86C		0.6
W01-300V	OHV Sovereign Series	9			RL86C		0.6
W01-340	OHV Sovereign Series	11			RL86C		0.6
W01-340V	OHV Sovereign Series	11			RL86C		0.6
W01-430V	OHV Sovereign Series	13.5			RL86C		0.6
W01-560	OHV Sovereign Series	18			RL86C		0.6
W02-510	OHV Sovereign Series	16			RL86C		0.6
WT1-125V	Vertical Shaft	4			RL86C		0.6

**WITTE**

**Generators**

(18mm)				D14			0.6
(14mm)				RL86C			0.5

**WIZARD**

**Chain Saws**

010, 012, 014, 110, 112, 212, 314, 316, 420, 430, 430B, AV10, AV14, AV16					RJ8		0.8
AV18, B013					RJ8Y		0.8

**Lawn Mowers**

Propulsion VE901R					J11C		0.8
Clinton 4-Cycle					RJ8		0.6
Power Product Engine					RJ8		0.8
Clinton 2-Cycle					RH10C		0.6
Power Pak					RJ8C		0.6

**Power Equipment**

Briggs & Stratton					RJ19LM	QJ19LM	0.8
-------------------	--	--	--	--	--------	--------	-----

**Snow Removers**

Briggs & Stratton					RJ19LM	QJ19LM	0.8
Tecumseh					RJ8C		0.8

**WOERNER**

**Turf Equipment**

Kohler V-Twin	18,22			OE013	RC12YC		1.0
---------------	-------	--	--	-------	--------	--	-----

**WOLF**

**Riding Mowers**

Tecumseh OHV	6			OE098	RN4C		0.8
--------------	---	--	--	-------	------	--	-----

**Trimmers**

UV-EB					RJ8		0.6
UV-P				OE086	RL82C		0.6



CC BHP

21



OPT.



## WOOD PRO

### Chippers

Briggs & Stratton Vanguard	9	OE013	RC12YC	QC12YC / XC92YC	0.8
Kohler V-Twin	14,22	OE013	RC12YC		0.8
Briggs & Stratton Vanguard V-Twin	16,18		RC14YC		0.8
Briggs & Stratton Twin			RJ19LM	QJ19LM	0.8

## WOOD WACKER

### Chainsaws

B & S			RJ19LM	QJ19LM	0.7
-------	--	--	--------	--------	-----

### Power Equipment

Briggs & Stratton			RJ19LM	QJ19LM	0.8
-------------------	--	--	--------	--------	-----

## WOODCHUCK

### Chainsaws

172 cu.in	Ford		RH12		0.7
300, 330 cu.in	Ford		RF10C		0.7

## WOODLORD

### Trimmers

UV-EB			RCJ8		0.6
-------	--	--	------	--	-----

## WOOD-MIZER

### Chain Saws

Kohler V-Twin	13,15,20,25	OE013	RC12YC		0.8
---------------	-------------	-------	--------	--	-----

### Power Equipment

Kohler V-Twin	13,15,20,25	OE013	RC12YC		0.8
---------------	-------------	-------	--------	--	-----

## WOODS

### Power Equipment

Kawasaki Liquid-Cooled V-Twin	20		CJ14		0.6
Briggs & Stratton Intek V-Twin	20	OE013	RC12YC	QC12YC / XC92YC	0.8
Kohler V-Twin	18	OE013	RC12YC		0.8
Kohler V-Twin	20,25	OE013	RC12YC		0.8
Kubota WG600-B	21	OE013	RC12YC		0.8
Kubota WG750-B	24.5	OE013	RC12YC		0.8
Briggs & Stratton Vanguard V-Twin	12.5,14,16,18		RC14YC		0.8
Kohler	12,18		RH10C		0.8
Onan Twin	20		RS17YX		0.6
Kohler Twin	20		RV17YC		0.6

## WOODSMAN

### Log Splitters

Briggs & Stratton			RJ19LM	QJ19LM	0.8
-------------------	--	--	--------	--------	-----

## WOODWARDS

### Lawn Mowers

Briggs & Stratton			RJ19LM	QJ19LM	0.8
-------------------	--	--	--------	--------	-----

## WORCHESTER

### Lawn Mowers

Clinton 2-Cycle			RJ12C		0.8
Power Product Engine			RJ12C		0.6
Briggs & Stratton			RJ19LM	QJ19LM	0.8
Clinton 4-Cycle			RJ8C		0.6
Lauson			RJ8C		0.6

## WORK HORSE

### Power Equipment

Briggs & Stratton			RJ19LM	QJ19LM	0.8
Briggs & Stratton Twin			RJ19LM	QJ19LM	0.8

## WORTHINGTON

### Mowers

All Models			RD16		0.6
------------	--	--	------	--	-----

### Pumps, Compressors & Refrigeration Units

All Other	Wisconsin		RD16		0.8
	Continental, Hercules		W14		0.6



CC

BHP

21



OPT.



mm

**...WORTHINGTON****...Pumps, Compressors & Refrigeration Units**

NP	Briggs & Stratton			RJ19LM	QJ19LM	0.8
	LeRoi B-45, D-140, D-91			D14		0.6
	Wisconsin AK			D14		0.8
	Wisconsin TF			D14		0.8
	IHC UD-264, UD-350, UD-6, UD-6A, UD-9, UD-9A			D89D		0.6
	Continental R-602			D9		0.6
	Wisconsin 3AG			D9		0.6
	Caterpillar Starting Engs.			RD16		0.6
	Continental B-427, F-124, F-226			RD16		0.6
	Continental M-330			RD16		0.6
	Continental Y-91			RD16		0.6
	Wisconsin 10AG, 20AG, 30 AG			RD16		0.6
	Wisconsin 40AG, 7AG			RD16		0.6
	Continental G-193			RF9YC		0.6
	Ford	172		RH10C		0.6
	Hercules Starting Engs.			RH10C		0.6
	Hercules ZXB			RH10C		0.6
	Clinton 700			RJ12C		0.6
	Hercules G2300			RJ6C		0.6
	Hercules JXC (14mm)			RJ6C		0.6
	Hercules JXD (14mm)			RJ6C		0.6
	Hercules JX4D, JX4D3			RJ8C		0.6
	Hercules QXB, QXC			W10		0.6
	Hercules QXD, RXLD			W10		0.6
	Hercules HXA, HXB, HXDW			W14		0.6
	Hercules HXE, IXB, IXB-3			W14		0.6
	Hercules JXC (7/8"-18)			W14		0.6
	Hercules JXD (7/8"-18)			W14		0.6
	Hercules QXC			W14		0.6
	Hercules YXC-2			W14		0.6
	Wisconsin B-3, K			W14		0.8
	Hercules HXE			W18		0.6
	IHC UD-1091, UD-14, UD-14A, UD-18, UD-18A, UD-24			W89D		0.6

**WRIGHT****Chain Saws**

104, 104D, 111, 121, 122A, 122CVA, 136, 137A, 140, 141A				RCJ8		0.8
B316				RJ18YC		0.8
B520				CJ14		0.8
C40, C40D				RJ6C		0.8
C50, C50D, C50SG				RJ12C		0.8
C70, C70D, C70G				RJ6C		0.8
GS2016				RJ18YC		0.8
GS218, GS2520				RJ12C		0.8
GS4520, GS5020, GS5020A				CJ14		0.8

**WRIGHT STANDER****Mowers**

Kohler V-Twin	20,22	OE013	RC12YC	0.8
Briggs & Stratton Vanguard V-Twin	16,18,20		RC14YC	0.8
Kohler Liquid-Cooled V-Twin	23		RC14YC	0.8
Kawasaki OHV	15,17,19,23	OE051	RN11YC	0.8

**W-U****Power Carts**

Honda G300	8	OE059	L92YC	0.8
------------	---	-------	-------	-----

**W-W GRINDER****Log Splitters**

			RCJ8	0.8
--	--	--	------	-----

**Power Equipment**

BC245E			RCJ7Y	0.8
BC250DL, BC260DUM, BC260DWM			CJ6	0.8
BC324B			RL86C	0.8
BC340FI, BC430DWM, BC430FWM			RCJ7Y	0.8
FBC12, FBC26			RL86C	0.8



CC

BHP

21



OPT.



mm

**...W-W GRINDER****...Power Equipment**

FBC33			RJ19LM	0.8
	Wisconsin VH4D		RD16	0.8
	Briggs & Stratton		RJ19LM QJ19LM	0.8

**XENOAH****Chain Saws**

G320AV, G320AVS			RCJ8Y	0.8
G36AV, G36AVS			RCJ7Y	0.8
G380AV, G380AVS			RCJ8Y	0.8
G50AV, G560AV, G560AVS, G620AV, G620AVS			RCJ7Y	0.8

**YAMAHA****Engines**

MF150S			RL87YC	0.7
MF180A			RL87YC	0.7
MF180S			RL87YC	0.7
MF260A			RL87YC	0.7
MF260S			RL87YC	0.7
MF410S			RL87YC	0.7
YP10G		OE086	RL82C	0.6

**Generators**

EC2000, EC2800, EC4000DV, EC5000DVE, EF1000, EF1000A, EF1200, EF1400, EF1600, EF1800, EF2000, EF2400, EF2500, EF2600, EF2600A, EF2800, EF3800, EF3800DV, EF3800E, EF4000DV			RL87YC	0.6
EF4600DEX			RN14YC	0.6
EF5000DV			RL87YC	0.6
EF5000EA			RL95YC	0.6
EF600			RCJ8Y	0.6
EF6000DVE		OE051	RN11YC	0.6
EF6000EA			RL95YC	0.6
EF6600DEX			RN14YC	0.6
EFC1400, EFC2000, EFC2800			RL87YC	0.6
ET1500			RL86C	0.6
ET500, ET600, ET900			RN5C	0.6
YG2600			RL87YC	0.6
			RN14YC	0.6
YG300S, YG400D			RL87YC	0.6
YG4600D			RN14YC	0.6
YG500D, YG600D, YG600DE		OE051	RN11YC	0.6
YG6600D, YG6600DE			RN14YC	0.6

**Lawn Mowers**

YML 466	OHV		OE051 RN11YC	0.8
---------	-----	--	--------------	-----

**Riding Mowers**

YT3600		OE042	RN12YC	0.8
YT5700, YT6700, YT6800			RL87YC	0.8

**Snow Removers**

YS220			RL95YC	0.7
YS240 "Ricky"		OE042	RN12YC	0.7
YS524, YS624, YS828			RL95YC	0.7

**Utility Vehicles**

Yamahauler			RA8HC	0.8
------------	--	--	-------	-----

**Water Pumps**

YBP401D, YBP501ST, YBP801ST		OE059	L92YC	0.6
YP20			RL87YC	0.6
YP20G		OE086	RL82C	0.6
YP20GA			RL87YC	0.6
YP20GN		OE059	L92YC	0.6
YP20NT, YP20TA, YP30, YP30G, YP30GA, YP30NT, YP30TA, YP40TA			RL87YC	0.6
	Kubota		RL95YC	1.0



CC BHP

21



OPT.

mm

**YANKEE CLIPPER****Chain Saws**

110125			RJ8C		0.8
T-36 MKI			CJ6		0.8
T-36 MKII			RDJ8J		0.8
T-71-SS, 2-36-SS, 55LH, 55RH, 76			CJ6		0.8

**YANMAR****Generators**

YSG1300BE, YSG2000BE, YSG3000BE, YSG3800BE			OE059	L92YC	0.6
--	--	--	-------	-------	-----

**YARD MACHINES****Lawn Mowers**

Briggs & Stratton			RJ19LM	QJ19LM	0.8
Tecumseh			RJ19LM		0.8

**Power Equipment**

Briggs & Stratton OHV	14.5		OE013	RC12YC	QC12YC / XC92YC	0.8
Briggs & Stratton Vanguard V-Twin	16,20			RC14YC		0.8
Briggs & Stratton Single Cyl.				RJ19LM	QJ19LM	0.8
Tecumseh OHV	12.5		OE098	RN4C		0.8

**Trimmers**

41AD280, 41ADY28	2-Cycle	28		RDJ7Y		0.5
------------------	---------	----	--	-------	--	-----

**YARD MARVEL****Power Equipment**

Kohler OHV	5		OE013	RC12YC		1.0
Kawasaki	3.7			RCJ8Y		0.8
Briggs & Stratton	3,3.5,5,5.5			RJ19LM	QJ19LM	0.8
Kawasaki	3.4			RJ19LM		0.8
Kohler	4			RJ19LM		0.8
Robin	5			RL86C		0.8
Kawasaki	3.6			RL95YC		0.6
Honda OHV	5.5		OE051	RN11YC		0.8

**Snow Removers**

Briggs & Stratton				RJ19LM	QJ19LM	0.8
-------------------	--	--	--	--------	--------	-----

**YARD PRO****Lawn Mowers**

Briggs & Stratton	5,5.5,6			RJ19LM	QJ19LM	0.8
-------------------	---------	--	--	--------	--------	-----

**Power Equipment**

YGT18H46			OE013	RC12YC		0.8
YGT2046				RC14YC		0.8
YGT22H50			OE013	RC12YC		0.8
YP110, YP115, YP116, YP120, YP130				CJ14		0.8
YP1342				RJ19LM		0.8
YP140, YP145, YP150				CJ14		0.8
YP1542, YP15H42			OE013	RC12YC		0.8
YP160				CJ14		0.8
YP1846				RJ19LM		0.8
YP200				RCJ8		0.8
YRT55, YRT8, YRT9				RJ19LM		0.8
Kohler OHV	15		OE013	RC12YC		0.8
Kohler V-Twin	18,20,22		OE013	RC12YC		0.8
Briggs & Stratton Vanguard V-Twin	20			RC14YC		0.8
Briggs & Stratton	19			RJ19LM	QJ19LM	0.8
Briggs & Stratton	3.5,5,5.5,8,9,13,15			RJ19LM	QJ19LM	0.8
Briggs & Stratton Twin	18			RJ19LM	QJ19LM	0.8

**YARD SHARK****Power Equipment**

Briggs & Stratton Vanguard	9		OE013	RC12YC	QC12YC / XC92YC	0.8
Briggs & Stratton	5,8			RJ19LM	QJ19LM	0.8
Honda OHV	9		OE051	RN11YC		0.8





CC BHP

21



OPT.



mm

## YARD VAC

### Power Equipment

Briggs & Stratton Vanguard	9	OE013	RC12YC	QC12YC / XC92YC	0.8
Briggs & Stratton	5,8		RJ19LM	QJ19LM	0.8
Kohler	7		RJ19LM		0.8
Tecumseh	5		RJ19LM		0.8
Robin 2-Cycle			RL86C		0.8
Honda OHV	9	OE051	RN11YC		0.8

## YARDMAN

### Generators

5,8			RJ8C		0.6
-----	--	--	------	--	-----

### Lawn Mowers

Briggs & Stratton			RJ19LM	QJ19LM	0.8
Tecumseh			RJ8C		0.8

### Power Equipment

Briggs & Stratton OHV	14,15	OE013	RC12YC	QC12YC / XC92YC	0.8
Kohler OHV	14,15	OE013	RC12YC		1.0
Kohler V-Twin	20,22	OE013	RC12YC		0.8
Briggs & Stratton Vanguard V-Twin	18		RC14YC		0.8
Kohler	16		RH10C		0.8
Briggs & Stratton Single Cyl.			RJ19LM	QJ19LM	0.8
Briggs & Stratton Twin L-Head			RJ19LM	QJ19LM	0.8
Kohler	4		RJ19LM		0.8
Kawasaki			RJ8C		0.8
Tecumseh	3,5,3,75,4,5		RJ8C		0.8
Tecumseh	6,8		RJ8C		0.8
Robin			RL86C		0.8
Tecumseh	12,12.5		RL86C		0.8
Tecumseh OHV	16	OE098	RN4C		0.8
Tecumseh OHV	5,5.5	OE098	RN4C		0.8
Kohler Twin	18,20		RV17YC		0.6

### Snow Removers

140	Tecumseh	3		RCJ8Y	0.8	
20"	Tecumseh	5		RJ8C	0.8	
22"	Tecumseh	5.5		RJ19LM	0.8	
24"	Tecumseh	7		RJ8C	0.8	
26"	Tecumseh	9		RJ8C	0.8	
28"	Tecumseh	9.5,10		RJ8C	0.8	
28", 30"	Tecumseh	10,12		RJ8C	0.8	
	Tecumseh	9.5,10		RJ8C	0.8	
30"	Tecumseh	10,12		RJ8C	0.8	
611D	Tecumseh	5		RJ8C	0.8	
740F	Tecumseh	8		RJ8C	0.8	
E150	Tecumseh	4.5		RCJ8Y	0.8	
E640F, E644E	Tecumseh	8		RJ8C	0.8	
E660G	Tecumseh	10		RJ8C	0.8	
E9801	Tecumseh	12		RL86C	0.8	
	Briggs & Stratton			RJ19LM	QJ19LM	0.8

## YARDSMITH

### Lawn Mowers

All Models				RJ19LM	0.8
------------	--	--	--	--------	-----

## YARDSTER

### Lawn Mowers

All Models				RJ19LM	0.8
------------	--	--	--	--------	-----

## YARK BRONC

### Tractors

Briggs & Stratton				RJ19LM	QJ19LM	0.8
Tecumseh				RJ8C		0.8

## YAZOO/KEES

### Lawn Mowers

Kawasaki	12.5			CJ14	0.6
Briggs & Stratton Intek OHV	6	OE013	RC12YC	QC12YC / XC92YC	0.5
Briggs & Stratton	5,5.5,6		RJ19LM	QJ19LM	0.8
Briggs & Stratton	8.5,9		RJ19LM	QJ19LM	0.8
Robin EY18-3W, EY18W			RL86C		0.8



CC

BHP

21



OPT.



mm

**...YAZOO/KEES****...Lawn Mowers**

Kawasaki OHV	14	OE051	RN11YC		0.8
Kawasaki OHV	9	OE051	RN11YC		0.8

**Power Equipment**

23			CJ14		0.8
31			CJ14		0.8
301, 305			RJ19LM		0.8
ET300			RJ19LM		0.8
YBC16			CJ14		0.8
			D21		0.8
Wisconsin AGND					0.8
Briggs & Stratton Intek OHV	6	OE013	RC12YC	QC12YC / XC92YC	0.5
Kohler OHV	14	OE013	RC12YC		1.0
Kohler V-Twin	18	OE013	RC12YC		0.8
Kohler V-Twin	20,22	OE013	RC12YC		0.8
Kohler V-Twin	25	OE013	RC12YC		0.8
Briggs & Stratton Vanguard V-Twin	16,18,20		RC14YC		0.8
Kawasaki	12.5		RCJ8		0.8
Kawasaki Liquid-Cooled V-Twin	20		RCJ8		0.8
Honda GV400	11		RCJ8Y		0.8
Kawasaki V-Twin	17		RCJ8Y		0.8
Wisconsin TJD			RD16		0.8
Kohler Single Cyl.	18		RH10C		0.8
Kohler Twin	23		RH10C		0.8
Briggs & Stratton Single Cyl.			RJ19LM	QJ19LM	0.8
Robin EY18-3W			RL86C		0.8
Honda OHV	5.5	OE051	RN11YC		0.8
Kawasaki OHV	14	OE051	RN11YC		0.8
Kawasaki OHV	9	OE051	RN11YC		0.8
Kawasaki V-Twin OHV	19	OE051	RN11YC		0.8
Kohler Twin	20		RV17YC		0.6

**YELLOWBIRD****Tillers**

Briggs & Stratton			RJ19LM	QJ19LM	0.8
-------------------	--	--	--------	--------	-----

**YETTER ROTARY****Lawn Mowers**

All Models			RJ19LM		0.8
------------	--	--	--------	--	-----

**YORK****Lawn Mowers**

All Models			RJ19LM		0.8
------------	--	--	--------	--	-----

**Power Broom**

Briggs & Stratton	5		RJ19LM	QJ19LM	0.8
Honda	5.5	OE051	RN11YC		0.8

**Z-CART****Power Equipment**

Briggs & Stratton Vanguard V-Twin	18,20		RC14YC		0.8
Kawasaki V-Twin	17		RCJ8Y		0.8
Kawasaki V-Twin	19	OE051	RN11YC		0.8

**ZENOAH****Augers**

FAG10			RJ6C		0.8
-------	--	--	------	--	-----

**Blowers**

EB20			CJ6		0.8
EB40, EB43			RL86C		0.8

**Engines**

Comanchu G2000			RY4C		
G1A	14.9		RCJ8		0.8
	14.9		RCJ8		0.8
G1A6	14.9		RCJ8		0.8
	14.9		RCJ8		0.8
G1E	17.2		RCJ8		0.8
G2A	22.5		RCJ8		0.8
G2A16	22.5		CJ6		0.8
	22.5		CJ6		0.8





CC BHP



OPT.



## ...ZENOAH

### ...Engines

...G2A16	22.5			CJ6	0.8
	22.5			CJ6	0.8
G2C	22.5			CJ6	0.8
	22.5			CJ6	0.8
	22.5			CJ6	0.8
	22.5			CJ6	0.8
G2D	22.5			CJ6	0.8
	22.5			CJ6	0.8
	22.5			CJ6	0.8
	22.5			CJ6	0.8
G2D30	22.5			CJ6	0.8
	22.5			CJ6	0.8
	22.5			CJ6	0.8
	22.5			CJ6	0.8
G2E	25.4			RCJ8	0.8
G3C	31.7			RL86C	0.8
	31.7			RL86C	0.8
G3C76	31.7			RL86C	0.8
	31.7			RL86C	0.8
G3D10	31.7			RCJ8Y	0.8
	31.7			RCJ8Y	0.8
G3D20	31.7			RCJ8Y	0.8
	31.7			RCJ8Y	0.8
G4C	37.4			RL86C	0.8
	37.4			RL86C	0.8
	37.4			RL86C	0.8
G4C63	37.4			RL86C	0.8
	37.4			RL86C	0.8
	37.4			RL86C	0.8
G4C76	37.4			RL86C	0.8
	37.4			RL86C	0.8
	37.4			RL86C	0.8
G5C	52.5			RJ6C	0.8
G5E	52.5			RL86C	0.8
	52.5			RL86C	0.8
G5E2	52.5			RL86C	0.8
	52.5			RL86C	0.8

### Power Equipment

MD20AE				CJ6	0.8
MD40AE				RL86C	0.8

### Trimmers

BC153E1, BC174E				RCJ8	0.8
BC174E				RCJ8Y	0.8
BC234B, BC250DL				CJ6	0.8
BC254E				RCJ8Y	0.8
BC260DUM, BC260DWM				CJ6	0.8
BC324B				RL86C	0.8
BC430DWM, BC430FWM, BK340FI				RCJ8Y	0.8
FBC12, FBC26				RL86C	0.8
FBC33				RJ6C	0.8

### Water Pumps

PE25				CJ6	0.6
PE40				RL86C	0.6

## ZIPPER

### Riding Mowers

Briggs & Stratton Liquid-Cooled 3-Cyl.	31	OE013	RC12YC	QC12YC / XC92YC	0.5
Kohler V-Twin	18,20,22,25	OE013	RC12YC		0.8
Briggs & Stratton Vanguard V-Twin	14,18		RC14YC		0.8

## Z-SPRAY

### Sprayers

Kawasaki V-Twin	17		RCJ8Y		0.8
-----------------	----	--	-------	--	-----

## ZUNDAPP

685 015,-025,-035,-045,-055

RJ8C 0.6



# AG01

GB

Air Filter

F

Filtre à Air

E

Filtro de Aire

I

Filtro Aria

D

Luftfilter

RU

Воздушный Фильтр

PL

Filtr Powietrza

CZ

Vzduchový Filtr

H

Légszűrő



BHP

## All Manufacturers

Lawn Mowers

Briggs & Stratton Quantum® Series

3.4 > 6.5

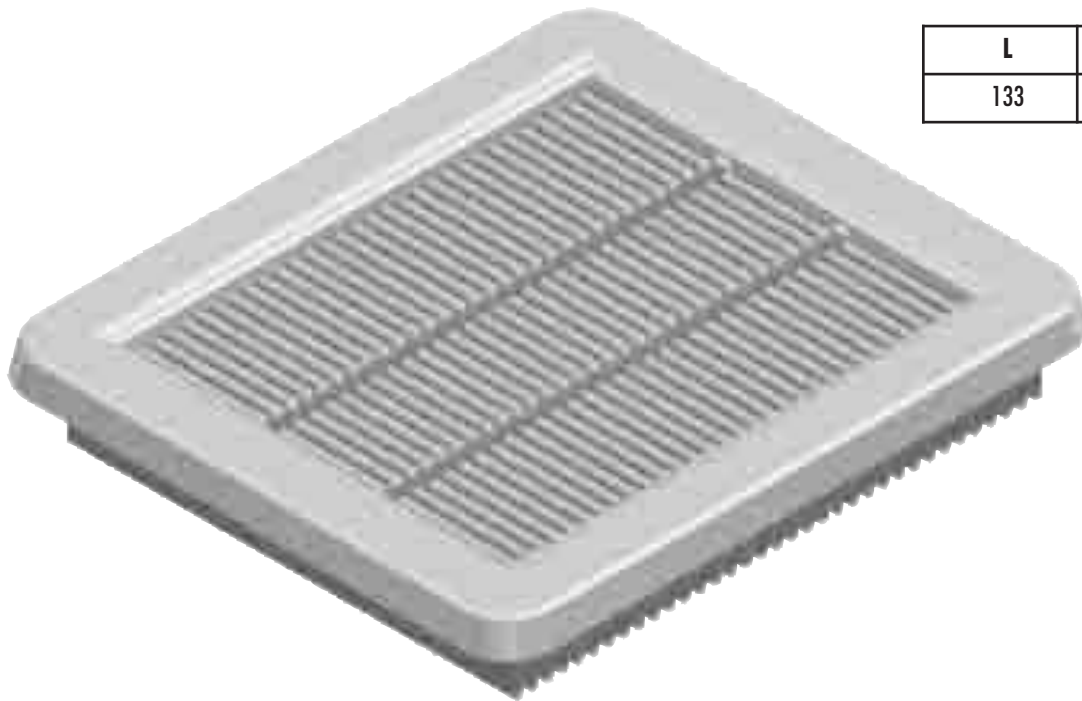

L	W	H
133	115	21.5





 **FEDERAL  
MOGUL**





CC

BHP

21

**ALLIS-CHALMERS****Combines**

A, C, E					
F	262 cid		OE042	RN5C	0.6
G	301 cid			RN12YC	0.6
G, L	350 cid	1972→1974		RN5C	0.6
K	250 cid (3/4" Reach)	1969→		RV8C	0.6
K, F	250 & 292 cid	1970→1974		RN5C	0.6
				RV8C	0.6

**Farm Machinery**

B-15, W-25, R				J11C	0.8
---------------	--	--	--	------	-----

**Tractors**

180, 190, 190 XT (LPG)			OE108	RN3C	0.5
B, C, CA, D-14, G, 1B, RC, S				RJ8C	0.8
B, C, CA, D-14, G, 1B, RC, S (LPG)				RJ6C	0.5
D-12, D-15 Series II				RJ12YC	0.6
D-17	(3/4" Reach)		OE051	RN11YC	0.6
	(3/8" Reach)			RJ8C	0.6
D-17 (LPG)	(3/8" Reach)			RJ6C	0.5
D-19				RN5C	0.6
D-19, D-17 (LPG)	(3/4" Reach)		OE108	RN3C	0.5
H-3, D-10, D-12, D-15, D-15 II (LPG)				RJ6C	0.5
H-4 Crawler, 170, 180, 190, 190 XT				RN5C	0.6
WC, WD, WF, WS, D-10, D-15, H-3				RJ8C	0.8
WC, WD, WF, WS, H-3 (LPG)				RJ6C	0.5
WD-45				RJ12YC	0.6

**AMERICAN****Crop Dryer**

				D89D	0.6
--	--	--	--	------	-----

**BEHLEN****Crop Dryer**

KA, M-30		1974→		W20	0.6
----------	--	-------	--	-----	-----

**Grain Dryer**

270, H, HL, HLX				W95D	0.6
-----------------	--	--	--	------	-----

**Heat Units**

M-20, M-45, M-60				W95D	0.6
T-500, T-1000, M-1				W95D	0.6

**CALDWELL****Crop Dryer**

		1974→		W95D	0.6
--	--	-------	--	------	-----

**CASE****Balers**

130, 133, 135, 140, 160, 177				RD16	0.6
200, 220, 230, 330T, 330W				RD16	0.6
NAP-2, NAP-3				RJ8C	0.6
NL, NCM, NC, MT, NT				RD16	0.6

**Combines**

1000	Herc.			RJ6C	0.6
1665	Chrysler (3/8" Reach)			RJ12YC	0.6
1010, 1060, 1160	Chrysler HB318 (3/8" Reach)			RJ12YC	0.6
1060, 1160 (LPG)	Case 284 cid			D14	0.5
1060, 1160, 1660	Chrysler LH318 (3/4" Reach)		OE051	RN11YC	0.6
600, 660, 1000, 1010	Case			RD16	0.6
700, 900, 960	Chrysler H225			RN5C	0.6
700, 900, 960 (LPG)	Chrysler H225			RN5C	0.5
77, 80, 88				RD16	0.6
800, 1000, 1010, 1060 (LPG)	Case			D14	0.5

**Forage Harvester**

C2, 200				RD16	0.6
---------	--	--	--	------	-----

**Tractors**

200, 430, 431, 435, 440, 441, 445, 470				D21	0.6
430, 530, 630 (LPG)				RD16	0.5
530, 531, 535, 540, 541, 545, 570, 610				D21	0.6
730, 731, 732, 733, 734, 740 (LPG)				D14	0.5
730, 731, 732, 733, 734, 740, 741, 742				D21	0.6



CC

BHP

21



mm

**...CASE****...Tractors**

741, 742, 743, 744, 830, 831 (LPG)

D14 0.5

743, 744, 770, 830, 831, 832, 833, 840

D21 0.6

832, 833, 840, 841, 842, 843, 930 (LPG)

D14 0.5

841, 842, 843, 870, 910, 930, 970

D21 0.6

D Series, LA Series (18mm)

D21 0.6

LH and LAH

K97F 0.6

S Series

RJ8C 0.6

Series C, D, L, LA, R (7/8"-18)

W14 0.8

V Series (18mm)

D21 0.6

**Windrowers**

1140, 1150 Case

RD16 0.6

650, 655, 950 Wisconsin 1050

RD16 0.6

820, 855, 950, 1155 Case

RD16 0.6

**CATERPILLAR****Combines**

All Other

W14 0.6

Ford

25 0.8

**Starting Engine**

(7/8"-18)

W14 0.6

**Tractors**

All (7/8"-18)

W14 0.6

**COCKSHUTT****Combines**

545 8-Cyl. (14mm)

RJ12YC 0.9

6-Cyl. (14mm)

RJ8C 0.9

25, 18 Pull Type (18mm)

RD16 0.8

430, 431, 525, 535, 542 (14mm)

RJ8C 0.9

7, 427, 428, 429 (14mm)

J11C 0.6

S.P. 109, 132, 137 (14mm)

RJ8C 0.6

**Tractors**

1250 Normal Service

QL82C 0.6

1350 Normal Service

RD16 0.6

1550 (LPG) Normal Service

RD16 0.5

1600, 1650, 1750, 1800, 1850 Normal Service

OE051 RN11YC 0.6

1600, 1650, 1750, 1800, 1850 (LPG) Normal Service

RN5C 0.5

1650, 1750, 1850 Series Light Service

OE042 RN12YC 0.6

550, 770, 1550 Normal Service

D21 0.6

**DAVID BROWN****Tractors**

3800, 4600

OE051 RN11YC 0.6

**FMC****Farm Machinery**

Kohler

20,23

RH12 0.8

**FORD****Balers**

6-Cyl. &amp; V-8

1966→1974

RF10C 0.8

**Combines**

6-Cyl. &amp; V-8

1966→1974

RF10C 0.8

**Farm Machinery**

200, 250, 300 &amp; 330 cid

1975→1978

RF10C 0.9

361, 391, 477 &amp; 534 cid

1975→1978

RF10C 0.9

428 cid

1975→1978

RF10C 0.5

134, 172 &amp; 192 cid

1975→1978

RH12 0.9

**Hay Baler**

350

RD16 0.8

**Tractors**

(LPG) 6-Cyl.

1961→1967

RF10C 0.5

4-Cyl.

1952→1964

RH10C 0.5

8N, 9N

RH12 0.6

TT

25 0.6



CC

BHP

21

**...FORD****...Tractors**

104 cid		1975→1978	OE051	RN11YC	0.9
6-Cyl.		1961→1967		RF10C	0.8
4-Cyl.		1952→1964		RH12	0.8
3 & 4-Cyl.		1965→1977		RN5C	0.6
158, 175, 201, 250 & 256 cid		1975→1978		RN5C	0.9
158, 175 & 201 cid (7/8"-18)		1979→1982		RN5C	0.9
				W18	0.6

**GRAVELY****Farm Machinery**

9000GMT	Continental R Series			QL87YC	0.6
---------	----------------------	--	--	--------	-----

**HABCO****Crop Dryer**

W95D 1.0

**HAHN****Farm Machinery**

Go-Boy H-650			OE042	RN12YC	0.6
Hi-Boy H-300				D21	0.6

**HARRIS****Combines**

SPH 88, 98	Herc. JXLD			RJ8C	0.6
SPH 98, SP108, SP808	Herc. G0339			RJ6C	0.6

**HEFTY****Farm Machinery**

F, G, LNT	Continental R839-46			QL87YC	0.6
-----------	---------------------	--	--	--------	-----

**HESSTON****Windrowers**

110	Wisconsin VH4D			RD16	0.6
280	Ford 134 cid			RH12	0.6
500	Ford 172 cid			RH12	0.6
	Wisconsin V461D		OE042	RN12YC	0.6
6200	Chrysler	1976→1977		RN5C	0.9
6400	Chrysler	1975→1977		RN5C	0.9
6600	Chrysler	1974→1977		RN5C	0.9
420, 520, 620	Chrysler			RN5C	0.6

**HINES****Farm Machinery**

G	Continental R800-46			QL87YC	0.6
H1600	Kohler	16		RH12	0.8
Hi-G	Continental R800-46			QL87YC	0.6

**HOMESTEADER****Farm Machinery**

H1100	B&S			RJ19LM / QJ19LM	0.9
H1600	Kohler			RH12	0.8

**HUSTLER****Farm Machinery**

Kohler 16 RH12 0.8

**Spray Rigs**

Tecumseh RJ8C 0.9

**INGERSOLL****Loader Tractor**

Onan (Twin) 18 RS17YX 0.6



CC

BHP

21



mm

**INTERNATIONAL****Balers**

50, 50AW, 50T, 55T

RD16 0.6

55W, 56T, 56W, 57

RD16 0.6

**Carrier**

660 High, 770, 780

RD16 0.6

**Combines**

303 (14mm)

RJ12YC 0.6

127, 140, 141, 151, 181, 203, 205

RD16 0.6

303, 315, 403, 403HS, 503, 615, 715

RD16 0.6

52R, 64, 76, 91, 93, 101, 105

RD16 0.6

815, 915 (LPG)

J4C 0.5

**Cotton Pickers**

214, 214A, 220, 220A, 414 (18mm)

RD16 0.6

214, 214A, 220, 414 (14mm)

RJ12YC 0.6

416, 420, 422, 616, 622 (14mm)

RJ12YC 0.6

(18mm)

RD16 0.6

All Models (LPG) (18mm)

RD16 0.5

**Crawler Tractors**

T-340A, I-500, I-600

D21 0.6

T-4, T-5, T-340

D21 0.6

**Farm Machinery**

4000

AMC 258 Serial #6005 on

AMC 232 To Serial #2701

AMC 232 Serial #2701 on

AMC 258 Serial #6004

OE042 RFN14LY 0.9

OE156 RN12YC 0.9

OE156 RN13LYC 0.9

OE156 RN13LYC 0.9

5000 &amp; 5500

HB 225

RV12YC 0.9

**Field Harvester**

20C, 36

RJ8C 0.6

**Hayswather**

225

RD16 0.6

**Wheel Tractors**

284

OE042 RN12YC 0.6

140HC, 200, 230, 240, 300, 330, 340, 350

D18Y 0.6

2405, 2410, 2412, 2424, 2444, 2500

D18Y 0.6

2504, 2510, 2514, 3400, 3500, 3514

D18Y 0.6

2756, 2806, 2856, 3616, 3800, 3850

D21 0.6

3414, BC-144 Perkins

L90C 0.6

354, B-414

L90C 0.6

400, 404, 424, 444, 450, 453, 454

D18Y 0.6

460, 464, 504, 544, 574, 674, 2400

D18Y 0.6

560, 606, 656, 660, 706, 756, 766

D21 0.6

806, 826, 856, 2606, 2656, 2707

D21 0.6

9, Super 9, 400, 450, 600, 650

D89D 0.6

All Models (LPG)

D21 0.5

Cub, Cub Lo-Boy, 154, 184, 185

D18Y 0.6

HV, M, M-TA, M-TAV, MV, O-4, OS-4, O-6

D18Y 0.6

I-666, I-666 Hydro, Hydro 70

D21 0.6

I-686, I-686 Hydro, Hydro 86

D21 0.6

MD, Super MD, 6, Super 6

D89D 0.6

OS-6, W4, W6, W6TA, 100, 130, 140

D18Y 0.6

Series A, A-1, AV, AV-1, B, BN, C, H

D18Y 0.6

WD9, Super WD9

D89D 0.6

**Windrowers**

161, 163, 201

RD16 0.6

210, 230, 275, 375

RD16 0.6

**ITC****Tractors**

Kohler (V-Twin)

20,25

OE013 RC12YC 0.8

Onan (Twin)

20,24

RS17YX 0.6

**JOHN DEERE****Balers**

Deere

RH12 0.6

Continental

RD16 0.6

Wisconsin

RD16 0.6



CC

BHP

21

**...JOHN DEERE****Beet Harvester**

200, 200A

RH12

0.6

**Combines**

105 (14mm)

RH12

0.6

105, 362, 6602, 7700 (18mm)

RD16

0.6

11A, 12A, 25, 30, 40 (18mm)

RD16

0.6

11A, 12A, 25, 30, 40  
Deere  
Herc. (14mm)

RH12

0.6

RJ8C

0.6

RH10C

0.4

11A, 12A, 25, 30, 40 (LPG)

202, 303, 3300, 4400, 6600 (14mm)

1969 →

OE051

RN11YC

0.6

(14mm)

1970 → 1974

RV8C

0.9

33, 35, 36, 40, 45, 55, 65, 95 (7/8"-18)

W14

0.6

45, 55, 65, 90 Herc. (3/8" Reach, 14mm)

RJ8C

0.6

45, 55, 65, 95 ((3/4" Reach, 14mm)

OE051

RN11YC

0.6

(7/16" Reach, 14mm)

RH12

0.6

45, 55, 65, 95 (LPG) (7/16" Reach)

RH10C

0.4

(3/4" Reach)

RN5C

0.4

5A, 7A, 9, 11A, 12A, 17, 25, 30 (7/8"-18)

W14

0.6

**Cotton Pickers**

8

RJ8C

0.6

699

OE051

RN11YC

0.6

699 (LPG)

RN5C

0.4

99, 299, 499

RH12

0.6

99, 299, 499 (LPG)

RH10C

0.4

**Crop Dryer**

88

W95D

1.0

**Forage Harvester**

Continental

RD16

0.6

Wisconsin

RD16

0.6

**Grain Dryer**

458 (CNG)

RD16

0.8

458 (LPG)

W95D

1.0

**Peanut Combine**

111 (14mm)

RH12

0.6

**Tractors**

1010, 2010 (LPG)

RH10C

0.4

1020, 1520, 2020, 2030, 2510, 2520 (14mm)

OE051

RN11YC

0.6

108, 111 (14mm)

RCJ8

0.6

200, 208, 210, 212, 214, 216 (14mm)

RH10C

0.6

2520, 3010, 3020, 4000, 4010 (LPG)

D14

0.4

3010, 3020, 4000, 4010 (18mm)

RD16

0.6

312, 314, 316, 317, 400 (14mm)

RH10C

0.6

40, 320, 330 (14mm)

RJ12C

0.6

4020, 4230 (18mm)

RD16

0.6

4020, 4230 (LPG)

D14

0.4

4030, 322, F912, F932 (14mm)

OE051

RN11YC

0.6

420, 430, 440, 1010, 2010 (14mm)

RH10C

0.6

50, 60, 70, 520, 530 (LPG)

D21

0.4

520, 530, 620, 630, 720, 730 (18mm)

D21

0.8

60, 70, 100, 110, 112, 120, 140 (14mm)

RH10C

0.6

620, 630, 720, 730 (LPG)

D21

0.4

70, 80, 720, 730, 820, 830 Cranking

RJ8C

0.6

A, AR-AO, B, BR-BO, D, G (7/8"-18)

W18

0.8

A, AR-AO, B, G, H, 50, 60, 70 (18mm)

D21

0.8

FE-1 (14mm)

OE042

RN12YC

0.6

L Series (7/8"-18)

W14

0.6

L, LA-LI, M (14mm)

RH10C

0.6

R Series Cranking

D21

0.6

**Windrowers**

Chrysler HB225 Thru 1974

OE051

RN11YC

0.6

Deere (3/4" Reach)

OE051

RN11YC

0.6

Deere (7/16" Reach)

RH12

0.6

Chrysler HB225 1975

RV12YC

0.6

Continental

RD16

0.6

Wisconsin

RD16

0.6





CC

BHP

21

**LENNOX**Crop Dryer  
SH2

RH18Y 0.9

**LIL' RED**Farm Machinery  
(LPG)Ford 4-Cyl.  
Ford 4-Cyl.RH10C 0.5  
RH12 0.8**MASSEY-FERGUSON****Balers**

RD16 0.6

**Combines**

35, SP Clipper, 50 Clipper

RD16 0.6

**Corn Picker**

RD16 0.6

**Farm Machinery**

26, 27, 27L, 60SP, 60PT, 70, 72

80, 82, 90, 92S.P., 92 Super

MF-300 S.P.

MF-410 S.P.

Chevrolet 292

Chevrolet 292

Chevrolet 292

Chevrolet 327

Chevrolet 350

Continental

Chrysler

Chevrolet 350

Chevrolet 350

1969→

1970→1974

1975→

1969→1970

1973→

1971→1972

RJ8C 0.6

RJ8C 0.6

RN5C 0.6

RN5C 0.9

RV12YC 0.9

RV8C 0.9

RJ6C 0.6

RJ6C 0.9

RJ6C 0.6

RN5C 0.6

RV12C 0.9

RV12YC 0.9

**Forage Clipper**

RD16 0.6

**Swather**

RD16 0.6

**Tractors**

97 (LPG)

F40, 44, 55, 333, 444, 555

MF1100

MF1100 (LPG)

MF135 Deluxe &amp; Vineyard

MF135 Special

MF135, MF150

MF150

MF165

MF165 (LPG)

MF165, MF255

MF175-180

MF180, MF175, MF265

MF2135

MF230, MF235, MF245

MF50, MF65, MF85, MF88, MF90

PA, CH, 25

TE20, TO35, F35, MF35

TEA20

TO20, TO30, 203, 101 Jr., 102 Jr.

Waukesha F-320G

Waukesha F-320G

Continental

Continental Z134

Perkins 3/8" Reach

Perkins 3/4" Reach

Continental Z145 (Heavy)

Continental Z145 (Normal)

Continental G-176

Continental GB-176

Perkins

Continental G-206

Continental GB-206

Perkins

Continental Z134

Continental Z145

OE042

D14 0.5

D21 0.6

RD16 0.6

D14 0.5

D21 0.6

D21 0.6

RJ8C 0.6

RN12YC 0.6

D14 0.6

RD16 0.6

D21 0.6

RD16 0.5

RJ8C 0.6

D21 0.6

RD16 0.6

RJ8C 0.6

D21 0.6

RD16 0.6

D21 0.6

W14 0.6

D21 0.6

L90C 0.6

D21 0.6

**Windrowers**

RD16 0.6

**MASSEY-HARRIS****Tractors**

11 Pony, 16 Pacer, 21 Colt, 22, 22K

23, 23K, 30, 30K, 33

44 Special, 333, 444, 555 (LPG)

D21 0.6

D21 0.6

RD16 0.5



CC

BHP

21

**MEYER****Hay Dryer**

RJ18YC 0.6

**MINNEAPOLIS-MOLINE****Balers**

103, 520, 620, 720

RD16 0.8

**Combines**4296 V-8  
6-Cyl.

RJ12YC 0.9

RJ8C 0.9

RD16 0.8

RJ8C 0.9

RD16 0.8

RJ8C 0.9

RD16 0.8

RJ8C 0.9

RJ12YC 0.9

RD16 0.6

RD16 0.8

**Forage Harvester**Forage Harvesters 840 Chrysler  
G.M.

RJ12YC 0.9

OE098 RN4C 0.9

**Tractors**335, 445, 2-4-5 Star Crawler (14mm)  
(18mm)

RJ8C 0.6

RD16 0.6

D14 0.4

D9 0.4

D21 0.6

D14 0.4

RD16 0.6

D14 0.4

D9 0.4

RD16 0.6

W10 0.6

D21 0.6

RJ8C 0.6

RD16 0.6

D14 0.4

**NEW HOLLAND****(→ Sperry-New Holland)****NEW IDEA****Farm Machinery**

701, 703	Chevrolet 292 cid	1969 →	RN5C	0.9
	Chevrolet 292 cid	1970 → 1974	RV12YC	0.9
	Chevrolet 292 cid	1975 →	RV8C	0.9
702, 704	GMC 401 cid (3/4" Reach)	1960 → 1968	OE051 RN11YC	0.8
	GMC 401 cid	1971 → 1972	OE051 RN11YC	0.9
	GMC 401 cid (3/8" Reach)	1960 → 1968	RJ6C	0.8
	GMC 401 cid	1969 → 1970	RN5C	0.9

**OLIVER****Balers**100, 101, 103, 520, 620, 720 RD16 0.8  
8, 50, 60, 60T, 60W, 62T, 62W RD16 0.8**Combines**

5555	V-8 (3/4" Reach, 14mm)	OE051	RN11YC	0.9
	V-8 (3/8" Reach, 14mm)		RJ12YC	0.9
30, 33SP, 35, 40	(18mm)	OE051	RD16	0.6
	(7/8"-18)		W14	0.6
430, 431, 525, 535	(14mm)	OE051	RJ8C	0.6
	V-8 (3/4" Reach, 14mm)		RN11YC	0.9
542, 545, 5542	V-8 (3/8" Reach, 14mm)	OE051	RJ12YC	0.9
	6-Cyl. (14mm)		RJ8C	0.9
6, 10, 15, 20, 22, 25	(18mm)	OE051	RD16	0.6
	(7/8"-18)		W14	0.6



CC

BHP

21



mm

**...OLIVER****Crawler Tractors**

35, 40, 40-30, 55, 80	(7/8"-18)			W14	0.6
35, 40, 40-30, 55, 80, OC-4-3G	(14mm)			RJ6C	0.6
AD, BD, DD (Diesel Starting)	(14mm)			RJ8C	0.6
AG, CG, DG, EG, EH, EHG, EN, FG	(14mm)			RJ6C	0.6
	(7/8"-18)			W14	0.6
AG-6	(18mm)			D21	0.6
BG, BGS, OC-3, OC-4, OC-12	(14mm)			RJ8C	0.6
BG, BGS, OC-3, OC-4, OC-12, A, E	(7/8"-18)			W14	0.6
GG, HG, 15, 20, 20C, 25, 30G	(14mm)			RJ6C	0.6
	(7/8"-18)			W14	0.6
OC-6	(18mm)			RD16	0.6

**Forage Harvester**

Forage Harvester 840	Chrysler			RJ12YC	0.9
	G.M. 478 cid		OE098	RN4C	0.9

**Wheel Tractors**

99	6-Cyl., 440, 550, 660 (18mm)			D21	0.6
1250	(14mm)			L90C	0.6
1600, 1650, 1655, 1750, 1755	(14mm)		OE051	RN11YC	0.6
1600, 1650, 1655, 1750, 1755 (LPG)			OE098	RN4C	0.5
18-28, 28-44, 80, 90, 99	4-Cyl. (7/8"-18)			W14	0.6
60KD, 66KD, 70KD, 77KD, 70, 77	(18mm)			D21	0.6
770, 880, 950, 1550, 1555	(18mm)			D21	0.6
80HC, 99HC	(7/8"-18)			W10	0.6
80KD, 90KD, 900	(7/8"-18)			W14	0.6
88, 88KD, 166, 177, 188, 199	(18mm)			D21	0.6
All 1800 Series 1850, 1855	(14mm)		OE051	RN11YC	0.6
All 1800 Series, 1850, 1855 (LPG)			OE098	RN4C	0.5
HC Mdl. 55, 60, 66	(18mm)			D21	0.6
Super 77, 88, 770, 880, 1550 (LPG)				D21	0.5

**PEERLESS****Grain Dryer**

			OE006	RN9YC	0.9
--	--	--	-------	-------	-----

**POWER TRAC****Tractors**

Kohler	14		OE013	RC12YC	0.8
Kohler (V-Twin)	18,20		OE013	RC12YC	0.8
Kohler (V-Twin)	22,25		OE013	RC12YC	0.8
B&S (Twin)	18			RJ19LM / QJ19LM	0.8
Ford 67 cid	45		OE006	RN9YC	0.9
Kohler (Twin)	18			RV17YC	0.6

**SATOH****Farm Machinery**

S550G		1973→1974	OE098	RN4C	0.8
S650G		1974→	OE098	RN4C	0.8

**SIMPLICITY****Farm Machinery**

4040	Onan CCKA			RH10C	0.6
4041	Onan CCKB			RH10C	0.6

**SKIBBE****Field Sprayers**

				RCJ8	0.6
--	--	--	--	------	-----

**SPEICHER****Trenchers**

Chevrolet 261 cid				RJ6C	0.6
GMC 401 cid (3/8" Reach)				RJ6C	0.6
Chevrolet 235 cid				RJ8C	0.6
Chevrolet 292 cid				RN5C	0.6
GMC 401 cid (3/4" Reach)				RN5C	0.6



CC

BHP

21

**SPERRY-NEW HOLLAND**

<b>Balers</b>					
	Ford 361 cid			RF10C	0.9
	Ford 240 & 300 cid			RF9YC	0.9
	Ford 134 & 172 cid			RH12	0.6
	Wisconsin V460D, V461D, V465D		OE042	RN12YC	0.8
	Ford 460 cid			RV12YC	0.9
	Wisconsin THD, TJD			RD16	0.8
	Wisconsin VG4D, VH4D, VR4D			RD16	0.8
<b>Combines</b>					
	Ford 361 & 391 cid			RF10C	0.9
	Ford 240 & 300 cid			RF9YC	0.8
<b>Harvesters</b>					
	Ford 391 cid			RF10C	0.9
<b>Haybine</b>					
	Ford 200 cid			RF11YC	0.9
	Ford 134 cid			RH12	0.6
	Wisconsin VG4D			RD16	0.8
<b>Loaders</b>					
	Ford 200 cid			RF11YC	0.9
	Ford 192 cid			RH12	0.6
	Kohler	23		RH12	0.9
	Wisconsin V465D		OE042	RN12YC	0.8
	Wisconsin TJD, VG4D, VH4D			RD16	0.8
<b>Speedrowers</b>					
	Ford 200 & 250 cid			RF11YC	0.9
	Ford 172 cid			RH12	0.6
	Ford 256 cid			RN5C	0.6
<b>Trenchers</b>					
	Kohler	16		RH12	0.6
	Wisconsin TJD, VG4D			RD16	0.8
<b>Windrowers</b>					
	Chrysler 225 cid			RV12YC	0.9

**STRONGLAND**

<b>Farm Machinery</b>					
	Kohler (V-Twin)	20		OE013	RC12YC 0.8
	B&S Vanguard (V-Twin)	18,20			RC14YC 0.8
	Onan (Twin)	24			RS17YX 0.6

**TORO**

<b>Farm Machinery</b>					
ME, Series 5	Continental F-227			D21	0.6
Series 6	Chevrolet 250 cid			RV17YC	0.9
	Ford 6-Cyl. OHV			RH12	0.6

**VERSATILE**

<b>Swather</b>					
400	Ford 200 cid		1972→1984	RF11YC	0.9
4400	Ford 200 cid		1978→1984	RF11YC	0.9

**WHITE**

<b>Farm Machinery</b>					
2-70			1975→1977	OE051	RN11YC 0.6

**WICHITA**

<b>Farm Machinery</b>					
270R	Continental R800-46			QL87YC	0.6



 **FEDERAL  
MOGUL**





CC

BHP

21

**A. L. POWELL CO.****Construction Machinery**

All Models

RD16

0.6

**ABI CONTRACTOR****Compact Loaders & Backhoes**

Kohler (V-Twin)

25

OE013

RC12YC

0.8

Honda (V-Twin)

20

OE051

RN11YC

0.8

**ADAMS GRADER****Construction Machinery**

Buda H-199, H-198

D14

0.6

IHC U-264, U-281

D14

0.6

IHC U-4, IU-4, U-6, U-264

D14

0.6

IHC UD-9, UD-9A, UD-16, UD-350

D89D

0.6

Continental

RD16

0.6

Wisconsin AFH, AGH, AHH

RD16

0.6

Chrysler 30

RJ8C

0.6

IHC U-9 (Distillate)

W10

0.6

Case LI

W14

0.6

IHC 1-12, 1-14, 1-30, U-9

W14

0.6

IHC U-10, U-14, U-21

W14

0.6

IHC PD-40, UD-14, UD-14A

W89D

0.6

**AIRCO****Welders**

Hornet Special

Hercules

RJ12C

0.6

Hornet Special &amp; Wasp

Wisconsin

RD16

0.8

**ALLIS-CHALMERS****Construction Machinery**

B70 Plow

RJ6C

0.6

D-17

(3/8" Reach)

RJ12C

0.6

(3/4" Reach)

RN5C

0.6

UD9, UD9A, TD9, UD16

D89D

0.6

WD45

RJ8C

0.6

IHC U-4, U-6

RD16

0.6

Wisconsin AFH, AGH

RD16

0.6

IHC U-9

1942→1954

W10

0.6

W10

0.6

**Front End Loader**

TL545G

(14mm)

RN5C

0.6

**Graders**

D

RJ8C

0.6

**Tractors & Lift Trucks**

1-40, 1-60, 1-400, 1-600, 615

(14mm)

RJ6C

0.6

190, 190 XT

(14mm)

RN5C

0.6

190, 190 XT (LPG)

(14mm)

OE108

RN3C

0.5

706B

(14mm)

OE051

RN11YC

0.6

ACC-40, ACC-45, ACC-50, ACC-55

4-Cylinder Continental F163 (18mm)

RD16

0.6

ACC-70C, ACC-80, ACC-100, ACC-120

6-Cylinder Continental F245 (18mm)

RD16

0.6

ACP-150, ACC-60, ACC-60C, ACC-70

6-Cylinder Continental F245 (18mm)

RD16

0.6

ACP-165, ACP-180, ACP-200, ACP-225

6-Cylinder Ford 300 cid (18mm)

RF10C

0.6

ACP-20, ACP-25, ACP-30,

4-Cylinder Continental F163 (18mm)

RD16

0.6

ACP-40, ACP-50

6-Cylinder Continental F245 (18mm)

RD16

0.6

ACP-60, ACP-70, ACP-80,

6-Cylinder Continental F245 (18mm)

RD16

0.6

ACP-110, ACP-130

4-Cylinder Continental F163 (18mm)

RD16

0.6

ACP-60C, ACC-20, ACC-25,

4-Cylinder Continental F163 (18mm)

RD16

0.6

ACC-30, ACC-35

6-Cylinder Ford 300 cid (18mm)

RD16

0.6

Chore Boy

6-Cylinder Ford 300 cid (18mm)

RD16

0.6

G153, G230, G262

(14mm)

RN5C

0.6

H4 Crawler

(14mm)

RN5C

0.6

Series 500 &amp; 600

(14mm)

RJ6C

0.6

T6, TL16

(14mm)

RJ8C

0.6



CC

BHP

21

mm  
**...ALLIS-CHALMERS****...Tractors & Lift Trucks**

TL10, TL12, TL14	(14mm)			RN5C	0.6
	A-C (14mm)			J11C	0.6
	Buda (14mm)			J11C	0.6
	IHC 6-Cylinder Ford 300 cid (18mm)			RD16	0.6
	6-Cylinder Ford 300 cid (18mm)			RD16	0.6
	Waukesha (18mm)			RD16	0.6
	6-Cylinder Ford 300 cid (18mm)			RD16	0.6
	Wisconsin (18mm)			RD16	0.6
	Onan (14mm)			RH10C	0.6
	B&S (14mm)			RJ19LM / QJ19LM	0.6
	IHC & Waukesha (14mm)			RJ8C	0.6

**ALTAMATIC****Tractors & Lift Trucks**

Volkswagen				QL86C	0.6
------------	--	--	--	-------	-----

**AMERICAN****Construction Machinery**

Waukesha 195GK				D14	0.6
Continental B-427, M330, M333				RD16	0.6
Waukesha 135GK				RH8C	0.6

**Tractors & Lift Trucks**

Econobile				RD16	0.6
-----------	--	--	--	------	-----

**AMERICAN COLEMAN****Aircraft Tow Truck**

MB-4				RJ12C	0.6
------	--	--	--	-------	-----

**Tractors & Lift Trucks**

Deck Spotter I Yard Jockey				RV12YC	0.6
----------------------------	--	--	--	--------	-----

**ANCHOR****Mixers**

All				W14	0.6
-----	--	--	--	-----	-----

**ARROW****Scooter Loader**

				RD16	0.6
--	--	--	--	------	-----

**ATHEY****Force Feed Loader**

				RH10C	0.6
--	--	--	--	-------	-----

**Graders**

172				RH10C	0.6
-----	--	--	--	-------	-----

**Loaders**

Ford 223 cid		1956→1962		RF10C	0.6
Ford 240 cid				RF10C	0.6
Ford 172 cid				RH10C	0.6
Ford 6-Cyl.		1958→		RH10C	0.6
Ford V-8 Thru 1958				RH8C	0.6

**Loaders**

240				RF10C	0.6
223				RF11YC	0.6

**AUSTIN-WESTERN****Compactors**

RV20, RV24				RH10C	0.6
RV20, RV24	Ford			RF9YC	0.6

**Construction Machinery**

510				RJ6C	0.8
(CNG)	IHC U-4, IU-4			D14	0.4
	LeRoi D-471			D14	0.4
(LPG)	IHC BD-240, BD-264, UB-264, S-240			RJ8C	0.4
	IHC SD-240, U-269, UV-345			RJ8C	0.4
105, 110, 410P				RF9YC	0.6



CC

BHP

21

**...AUSTIN-WESTERN****...Construction Machinery**

210P			RH10C	0.6
Buda HP-326, HP-351, M-M, RE			D14	0.6
IHC GRD-233 (18mm)			D14	0.6
IHC U-4, IU-4			D14	0.6
Wisconsin AFH			D14	0.6
IHC UD-6, UD-9, UD-16, WD-9			D89D	0.6
Buda K-325, K-369, K-393, K-428			RD16	0.6
Wisconsin	37		RD16	0.6
Ford 223, 272 & 292 cid			RF10C	0.6
Ford J, JH, JD5-4005			RF10C	0.6
Ford 332 & 240 cid			RF11YC	0.6
Ford 172 cid			RH10C	0.6
Ford JD			RH8C	0.6
IHC U-406, UV-549			RJ6C	0.6
IHC BD-240, BD-264, UB-264, S-240			RJ8C	0.6
IHC SD-240, U-269, UV-345			RJ8C	0.6
Buda DW-6, KT-281, KTU, YTU			W14	0.6
Case			W14	0.6
Hart-Parr			W14	0.6
Hercules H, WXC			W14	0.6
Waukesha FSU, WAHU, XAHU			W14	0.6
IHC PD-40, UD-14, UD-14A, WD-40			W89D	0.6

<b>Cranes</b>				
210, 220, 410	Ford		RF10C	0.6
	IHC		RJ8C	0.6

<b>Graders</b>				
No. 88	Buda K-393		D14	0.6
No. 99	Buda K-393		RD16	0.6

<b>Rollers</b>				
3 Wheel 83, 102, 122	IHC UV304		RJ8C	0.6
83, 102, 122	Ford		RF9YC	0.6
	IHC UV-266		RJ6C	0.6
PR-11	IHC		RJ6C	0.6
T53, T84, T104	Ford		RF9YC	0.6
	IHC UV-266		RJ6C	0.6
Tandem Rollers 84, 103			RJ8C	0.6

<b>Sweepers</b>				
40B, 70			RJ8C	0.6

**AUTOMATIC**

<b>Tractors &amp; Lift Trucks</b>				
	Continental F-162		D14	0.6

**AUTOMOTIVE**

<b>Tractors &amp; Lift Trucks</b>				
GLF, GLT, GMF	Dynamotive		RD16	0.6
GLF, GLT, GMF (LPG)	Dynamotive		D14	0.5

**AVERY-RO-TRAK**

<b>Construction Machinery</b>				
	(7/8"-18)		W18	0.6

**BADGER**

<b>Construction Machinery</b>				
	IHC W-9		W14	0.6

**BAKER**

<b>Tractors &amp; Lift Trucks</b>				
FGA-030, 050, 070, FGD-020, 025	(14mm)		RJ8C	0.6
FGD-030, 040, 050, 060, 070, 080	(18mm)		RD16	0.6
	(14mm)		RJ8C	0.6
FGF-020, 025, FIA-030, FID-020, 025	(14mm)		RJ8C	0.6
FGF-030, 040, 050, 060, 070	(18mm)		RD16	0.6
FID-030, 040, 050, 060, 070, 080	(18mm)		RD16	0.6
	(14mm)		RJ8C	0.6
FIF-020, 025, FJD-060, 070, 080	(14mm)		RJ8C	0.6
FIF-030, 040, 050, 060, 070	(18mm)		RD16	0.6





CC

BHP

21

**...BAKER****...Tractors & Lift Trucks**

FJD-040, 060, 070, 080, FJG-040	(18mm)			<b>RD16</b>	0.6
FJF-030, 040, 050, 060, 070	(18mm)			<b>RD16</b>	0.6
FLD, FLF-020, FLD-060, T-10A, TJF-100	(14mm)			<b>RJ6C</b>	0.6
FMD-030, 040, 050, 060, 070, 080	(18mm)			<b>RD16</b>	0.6
	(14mm)			<b>RJ8C</b>	0.6
FMF-030, 040, 050, 060, 070, Y112	(18mm)			<b>RD16</b>	0.6
T10A, TJF-100	(14mm)			<b>RJ6C</b>	0.6
Tiger Series	(18mm)			<b>RD16</b>	0.6

**BANTAM****Construction Machinery**

Chrysler H-318				<b>RJ12YC</b>	0.6
Chevrolet 235 cid				<b>RJ6C</b>	0.6
GMC 302 cid				<b>RJ6C</b>	0.6

**BARBER-GREEN****Conveyers, Loaders, Mixers**

Waukesha 6 GAKU				<b>D14</b>	0.6
Wisconsin AG-5, AM-4				<b>D14</b>	0.6
Buda (18mm)				<b>RD16</b>	0.6
LeRoi (18mm)				<b>RD16</b>	0.6
Wisconsin AC-4 (18mm)				<b>RD16</b>	0.6
LeRoi (14mm)				<b>RJ8C</b>	0.6
Wisconsin AC-4 (14mm)				<b>RJ8C</b>	0.6
Buda (7/8"-18)				<b>W14</b>	0.6
Climax R41				<b>W14</b>	0.6
Continental H-9				<b>W14</b>	0.6
Fuller & Johnson NB				<b>W14</b>	0.6
Hercules				<b>W14</b>	0.6
LeRoi (7/8"-18)				<b>W14</b>	0.6

**Pavers**

SA35, SA40				<b>RJ8C</b>	0.6
SA41, SB41				<b>RJ6C</b>	0.6

**BARCO****Hammers**

M1				<b>J4C</b>	0.9
----	--	--	--	------------	-----

**Rammers**

30-550				<b>W18</b>	0.6
BR-5				<b>W18</b>	0.8

**BARTELL****Vibratory Plate Compactors**

Wisconsin	3.5,4.5			<b>QL86C</b>	0.6
B&S Vanguard	5.5		<b>OE013</b>	<b>RC12YC</b>	0.8
B&S	3.5			<b>RJ19LM / QJ19LM</b>	0.8
Honda	4,5,5		<b>OE051</b>	<b>RN11YC</b>	0.8
Honda	3.5,5		<b>OE006</b>	<b>RN9YC</b>	0.8

**BAY CITY****Shovels**

10, 15, 18, 20, 25, 30, 32, 37, 42	(18mm)			<b>RD16</b>	0.6
	(14mm)			<b>RJ8C</b>	0.6
	(7/8"-18)			<b>W14</b>	0.6
45, 150, 190CW, 450, T40, T50, T51	(7/8"-18)			<b>W14</b>	0.6
45, 150, 250CW, 150CW, T40, T50, T51	(14mm)			<b>RJ8C</b>	0.6
45, 52, 55, 62, 65, 150, 180	(18mm)			<b>RD16</b>	0.6
450, 151-T41, 300, 40U, 64U	(14mm)			<b>RJ8C</b>	0.6
650, T60, T61, T66	(18mm)			<b>RD16</b>	0.6
T60, T61, T66	(7/8"-18)			<b>W14</b>	0.6
IHC PA100 (7/8"-18)				<b>W14</b>	0.6

**BELL****Tractors & Lift Trucks**

Prime Mover				<b>RD16</b>	0.6
-------------	--	--	--	-------------	-----



CC

BHP

21

**BEST****Concrete Mixers, Floor Saws, Plate Compactors, Stompers & Trowels**

Robin EC10			RJ12C	0.6
Honda OHV	5,5,8,13		OE051 RN11YC	0.8

**BIG BEN****Structural Panel Movers**

Kohler (V-Twin)	25		OE013 RC12YC	0.8
-----------------	----	--	--------------	-----

**BILLY GOAT****Blowers**

B&S Vanguard (V-Twin)	16		RC14YC	0.8
B&S	5,8,11		RJ19LM / QJ19LM	0.8
Honda	8,11		OE051 RN11YC	0.8

**Pavement Equipment**

Slot Machines	Honda	11	OE051 RN11YC	0.8
Wire Brushes	Honda	4	OE051 RN11YC	0.8

**BLAW-KNOX****Construction Machinery**

Ford 91 V-4			QL82C	0.6
Continental F-162, F-186, F-224, F-226, Y-112			RD16	0.6
Ford 172 cid			RH10C	0.6
Chrysler 30-133			RJ12C	0.6
Chrysler 6, T-116			RJ8C	0.6
Hercules IXB-5, QXB-5, QXD-5 (14mm)			RJ8C	0.6
Hercules JXC			RJ8C	0.6
Hercules IXB-5, QXB-5, QXD-5 (7/8"-18)			W18	0.6

**Finishers**

SW-100, SW-150			RD16	0.6
----------------	--	--	------	-----

**Pavers**

PF35			OE051 RN11YC	0.6
PR120, 195W			RF10C	0.6
PR180			RJ6C	0.6
PR65			RH10C	0.6

**BOBCAT (→ Melroe)****BOLENS****Tractors & Lift Trucks**

GK Model 960			RD16	0.6
--------------	--	--	------	-----

**BOSWORTH****Conveyors**

All Models			RJ12C	0.6
------------	--	--	-------	-----

**BOXER****Skid-Steers**

Honda (V-Twin)	24		OE042 RN12YC	0.8
----------------	----	--	--------------	-----

**BRADLEY-EDLUND****Conveyors**

All Models			RJ6C	0.6
------------	--	--	------	-----

**BRADLEY-REPUBLIC****Construction Machinery**

(18mm)			D23	0.6
(7/8"-18)			W14	0.6

**BRYANT****Heaters**

All Models			UY6	0.6
------------	--	--	-----	-----



CC

BHP

21

**BUCKEYE****Construction Machinery**

Other Buda	D21	0.6
Continental	RD16	0.6
Chrysler	RJ12C	0.6
LeRoi	RJ12C	0.6
Buda 6B-230	RJ6C	0.6
IHC	RJ6C	0.6
Hercules	W14	0.6

**BUCYRUS-ERIE****Drills**

(CNG)	Waukesha 6MZA	RD16	0.4
(CNG/LPG)	Hercules GO-298	RJ6C	0.4
1W	IHC U-1, UC-60	RD16	0.6
20W	Hercules IXA	RJ12C	0.6
20W, 21W	(18mm)	RD16	0.6
22T, 27T	Hercules QXB	RJ12C	0.6
22W	IHC U-169, U-164	RD16	0.6
24L	(18mm)	RD16	0.6
	(7/8"-18)	RD16	0.6
28L	Waukesha 135-GKU	RH10C	0.6
28L, 48L	Buda 893	RD16	0.6
29T	(7/8"-18)	RD16	0.6
29T	Buda HP326, HP298	RD16	0.6
36L	Waukesha 140-GK, 145-GK (18mm Hds.)	RD16	0.6
	Waukesha 140-GK, 145-GK (14mm Hds.)	RH10C	0.6
48L	Waukesha 6-WAKU, 6-NKU	RD16	0.6
60L	Buda HP326	RD16	0.6
60L (CNG)	Buda HP326	D9	0.4
	Buda L525	D21	0.6
	Waukesha 6MZA	D9	0.4
	Buda GF638	RD16	0.6
	Buda HP205	RD16	0.6
	LeRoi D91P7	RD16	0.6
	Waukesha 6MZR	RD16	0.6
	Buda 4B182	RJ12C	0.6
	Hercules QXB	RJ12C	0.6
	Buda LO525	RJ6C	0.6
	Hercules GO-298	RJ6C	0.6
	Waukesha XAHU	W14	0.6

**Hydrocranes**

H3, H5	Ford 6-Cyl.	RF11YC	0.9
--------	-------------	--------	-----

**Shovels**

10B	Buda HP260	RD16	0.6
10B, 15B, 22B, 20W, 21W	(7/8"-18)	W14	0.6
11B	Continental F-186	RD16	0.6
15B	Hercules GO298	RJ6C	0.6
15B, 22B	Buda K428	D21	0.6
15P	Buda HP351	RD16	0.6
1W	IHC UC-60	D21	0.6
20W	Hercules LXA	RJ12C	0.6
22B	Buda L525	D21	0.6
22W	Hercules	RJ8C	0.6
22W, 22T, 27T	Buda HP217	RD16	0.6
28L	Waukesha 135GK	RJ19LM	0.6
30B	Waukesha 140GKU	RJ12C	0.6
35C	Ford 300 cid	RF10C	0.6
36L	Buda 6M0-893	RD16	0.6
	Buda LO525	RJ12C	0.6
	Waukesha 145GK	RJ6C	0.6
45C	Ford 361 & 390 cid	RF10C	0.6
48L	Waukesha 2WAKU	RD16	0.6
60L	A-C HP326	D21	0.6
6B-230, 6B-272	Buda	RJ12C	0.6
	Caterpillar D-315, D-318 (18mm)	RD16	0.6
	Buda 4B182	RJ12C	0.6
	Buda 6B230, 6B273	RJ12C	0.6
	Hercules QXB	RJ12C	0.6
	Caterpillar D-315, D-318 (7/8"-18)	W14	0.6
	IHC UD-14A	W89D	0.6



CC

BHP

21

**BUD CORPORATION**

Earth Rammer

RJ8C

0.6

**BUDA (→ Allis-Chalmers)****BUFFALO SPRINGFIELD**

Construction Machinery

Buda HP-351

D14

0.6

Buffalo-Waukesha BK, BL, MZ

D14

0.6

Continental B-427, F-162, F-163, F-226

RD16

0.6

Continental F-227, M-330, Y-112

RD16

0.6

Waukesha 6BZ

RD16

0.6

Ford 240 &amp; 300 cid

RF11YC

0.6

Hercules IXA (14mm)

RJ8C

0.6

Hercules JXC, JXD, JXLD, QXD, QXD5, QXLD

RJ8C

0.6

Hercules IXA (7/8"-18)

W14

0.6

Hercules NXB

W14

0.6

LeRoi R, RA

W14

0.6

Waukesha XAH

W14

0.6

Waukesha SRK, SRKR, SRL

W18

0.6

**BURCH**

Construction Machinery

B&amp;S (18mm)

RD16

0.6

LeRoi D-91

RD16

0.6

Wisconsin ABN

RD16

0.6

Ford 134

RH10C

0.6

Kohler

4

RJ12C

0.6

B&amp;S (14mm)

RJ19LM /

QJ19LM

0.8

Continental AU-7

RJ8C

0.6

**BURRO**

Construction Machinery

Waukesha 6MZR &amp; Other (18mm)

RD16

0.6

Hercules JXD, RXLD (14mm)

RJ12C

0.6

All Other Hercules (7/8"-18)

W14

0.6

Hercules L, G, E, WXC3

W14

0.6

Waukesha 6MZ &amp; Other (7/8"-18)

W14

0.6

Wisconsin (7/8"-18)

W14

0.6

Buda

W16Y

0.6

**BURROWS**

Construction Machinery

Hercules

W14

0.6

Wisconsin

W18

0.6

**BURTON**

Conveyors

Novo CW

RD16

0.6

**BUTLER**

Front End Loader

RD16

0.6

**BYERS**

Construction Machinery

(18mm)

RD16

0.6

(7/8"-18)

W14

0.6

**BYRON JACKSON**

Construction Machinery

All Models

RD16

0.6



CC

BHP

21



mm

**CAMBRIDGE ENGINEERING****Heater Igniters**

M115G, M115GA, T115G, T115GA			J99	0.6
R215G, T215G, T215GA			J99	0.6
T3700, M4500, T4500			J99	0.6
T4000, M4700			J99	0.6

**CASE****Front End Loader**

W7E (18mm)			RD16	0.6
------------	--	--	------	-----

**Skid-Steers**

1818			RS17YX	0.6
1825			RN5C	0.6
1835C			OE042 RN12YC	0.6
	(18mm)		RD16	0.6
	(14mm)		RJ8C	0.6
Teledyne TM20		48	OE042 RN12YC	0.6
Nissan A12		25	RN5C	0.6
Onan (Twin)		18	RS17YX	0.6
	(7/8"-18)		W14	0.8

**Tractors & Lift Trucks**

644 (14mm)			RH10C	0.6
646 (14mm)			RH8C	0.6
210, 310, 320, 420, 430 (18mm)			RD16	0.6
420, 520, 620 (7/8"-18)			W14	0.6
450, 500, 500LK, 520, 530 (18mm)			RD16	0.6
580B, 600, 620, 680, 800GT (18mm)			RD16	0.6
CI, DI, LAI, LI, RI, VAI, VI (18mm)			RD16	0.6
CI, DI, LAI, RI, VAI, VI (7/8"-18)			W14	0.6
G148B, G188 (18mm)			RD16	0.6
LI, SI, VI (14mm)			RJ8C	0.6
M3, MB3, W3, W5, W7, W8 (18mm)			RD16	0.6
W10 Terraloader (18mm)			RD16	0.6
W8B, W9, W9A, W9B, W10B (18mm)			RD16	0.6

**Uni-loader**

1530, 1537, 1816B (18mm)			D14	0.6
1830, 1835, 1845 (18mm)			RD16	0.6

**CATERPILLAR****Earth Movers**

DW10, DW-20, DW-21	Starting Engine (14mm)		RJ12C	0.6
--------------------	------------------------	--	-------	-----

**Graders**

12, 14, 16, 30, 42, 44	Starting Engines (18mm)		RD16	0.6
12, 14, 16, 30, 44	Starting Engines (7/8"-18)		W14	0.6
12, 30, 42, 44, 48	Starting Engines (14mm)		RJ18YC	0.6
42, 48	Starting Engines (7/8"-18)		W14	0.6
42, 48 (Diesel Starting)	(18mm)		D14	0.6
48, 66, 77, 112, 212	Starting Engines (18mm)		RD16	0.6
66, 77, 112, 212, 666	Starting Engines (14mm)		RJ18YC	0.6
	Starting Engines (7/8"-18)		W14	0.6

**Pipelayers**

561, 571A, 572E, 583H			RJ18YC	0.8
-----------------------	--	--	--------	-----

**Shovels**

2, 4, 6	Starting Engine (14mm)		RJ12C	0.6
---------	------------------------	--	-------	-----

**Starting Engines**

1404	Hercules G1600 (14mm)		RJ88P	0.6
(Diesel Starting)	(18mm)		RD16	0.6
	(7/8"-18)		W16Y	0.6
12E, 12F, 14C, 14D, 16, 112E, 112F	(14mm)		RJ12YC	0.6
561B, 922, 944, 955, 955H, 966, 977H	(14mm)		RJ12YC	0.6
922, 924	(18mm)		RD16	0.6
933, 955, 977, 988	(14mm)		RJ18YC	0.6
Auto Patrol 10, 11	(7/8"-18)		W14	0.6
Auto Patrol 10, 11 (Diesel Starting)	Diesel Starting (18mm)		D14	0.6
Auto Patrol 11 (Diesel Starting)	(7/8"-18)		W14	0.6
D2, D4, D6, D7, D8, D9	(18mm)		RD16	0.6
D2, D4, D6, D7, D8, D9, RD4, DW15	(14mm)		RJ18YC	0.6
D4C, D6B	(14mm)		RJ12YC	0.6



CC

BHP

21

**...CATERPILLAR****...Starting Engines**

DW10, DW15, DW20, DW21	(18mm)			RD16	0.6
DW20, DW21, 824, 834	(14mm)			RJ18YC	0.6
RD4, 824, 834, F163, F227	(18mm)			RD16	0.6

**Tractors & Lift Trucks**

T30B, T40B, T50B, T60B				RJ12YC	0.6
T30D, TC60D	Peugeot		OE006	RN9YC	0.6
T35B, T45B, T55B, V30C				RJ12YC	0.6
V35C, V40C, V45C, V50C				RJ12YC	0.6
V40D, V50D	Peugeot		OE006	RN9YC	0.6
V80E 6.5 AMP			OE042	RN12YC	0.6

**Wheel Tractors**

619C, 621, 630, 631, 632, 633, 641				RJ18YC	0.8
650, 651, 657, 660, 666, 824, 834				RJ18YC	0.8

**CENTAUR****Tractors & Lift Trucks**

LeRoi D-226, D-140, 105, G1-1T (18mm)				RD16	0.6
LeRoi D-226, D-140, 105, G1-1T (14mm)				RJ12C	0.6
LeRoi TRP, D-133				W14	0.6

**CHAMP****Tractors & Lift Trucks**

(LPG)	Chrysler			RJ8C	0.4
	Perkins G4-236		OE051	RN11YC	0.6
	Chrysler			RJ8C	0.6
	Continental			RD16	0.6

**CHARLES (→ Ditch Witch)****CHOREMASTER****Hole Diggers**

A-1034, A-1035, A-1036				RJ8C	0.6
P, Q, A-1009, A-1033				RJ8C	0.6

**CLARK****Car Loader**

Clarkat (LPG)	(18mm)			RD16	0.4
	(18mm)			D21	0.6

**Cranes**

510	IHC UV-549			RJ6C	0.8
630	IHC UV-549			RJ6C	0.8
210, 220, 410	IHC UB-264			RJ8C	0.8
Cranes 105, 110	Ford 240 cid			RF11YC	0.8
Cranes 210P	Ford 240 cid			RF11YC	0.8
	Ford 172 cid			RH10C	0.6

**Planeloader**

Clarktor 75 (Shielded)	(14mm)			XEJ8	0.6
	(14mm)			RJ8C	0.6

**Rollers**

83, 102, 122	IHC UV-266			RJ6C	0.6
PR14	Ford 223 cid			RF10C	0.8
T84, T104	IHC UV-266			RJ6C	0.6

**Sweepers**

40	IHC BD-240			RJ8C	0.6
70	IHC BD-264			RJ8C	0.8

**Tractors & Lift Trucks**

C500, 60, 70, S80, 80, 90, S100	(14mm)		OE042	RN12YC	0.6
C500, 60, 70, S80, 80, 90, S100 (LPG)	(14mm)		OE042	RN12YC	0.4
C500-20, 25, 30, 40, 55, 60	(18mm)			RD16	0.6
C500-70, 70, 100, 120, F163	(18mm)			RD16	0.6
C500-Y20, 25, 30, 40, 55, 60	(18mm)			RD16	0.6
C500-Y70, 80, 100, 130, 150	(18mm)			RD16	0.6
CL20, 30, 40, 50	(18mm)			D21	0.6
CL20, 30, 40, 50, 180 (LPG)	(18mm)			RD16	0.4
Clark 75 Unshielded, Series 71H	(14mm)			RJ8C	0.6
Clarkette, Utilitruc (LPG)	(18mm)			RD16	0.4



CC

BHP

21



mm

**...CLARK****...Tractors & Lift Trucks**

Clarklift C60, C70, C80	(18mm)			<b>RD16</b>	0.6
Clarktor 4 (LPG)	(7/8"-18)			<b>W14</b>	0.4
Clarktor 6, 120, CFV, CY	(14mm)			<b>RJ8C</b>	0.6
Clarktor 6, Clipper, Tractor, Utilitrac	(18mm)			<b>D21</b>	0.6
Clipper, Tractor (LPG)	(18mm)			<b>RD16</b>	0.4
GCS12, 15, 20, 25, 30, 175	Mitsubishi 4G32 (14mm)			<b>RN14YC</b>	0.6
GCS12, 15, 20, 25, 30, 175 (LPG)	Mitsubishi 4G32 (14mm)			<b>RN14YC</b>	0.4
GCS17, 20, 22, 25, 27, 30	(18mm)			<b>RD16</b>	0.6
GCS17, 20, 22, 25, 27, 30	Mitsubishi 4G54 (14mm)			<b>RN14YC</b>	0.6
GCS17, 20, 22, 25, 27, 30 (LPG)	(18mm)			<b>RD16</b>	0.4
GCS17, 20, 22, 25, 27,30 (LPG)	Mitsubishi 4G54 (14mm)			<b>RN14YC</b>	0.4
GPS12, 15	Mitsubishi 4G52 (14mm)			<b>RN14YC</b>	0.6
GPS12, 15 (LPG)	Mitsubishi 4G52 (14mm)			<b>RN14YC</b>	0.4
GPS20, 22, 25, 27, 30	(18mm)			<b>RD16</b>	0.6
GPS20, 22, 25, 27, 30	Mitsubishi 4G54 (14mm)			<b>RN14YC</b>	0.6
GPS20, 22, 25, 27, 30 (LPG)	Mitsubishi 4G54 (14mm)			<b>RN14YC</b>	0.4
GPS20, 22, 25, 27, 30 (LPG)	(18mm)			<b>RD16</b>	0.4
IT 50, 60, 70, 80	(14mm)			<b>RN5C</b>	0.6
IT 50, 60, 70, 80	Ford (14mm)			<b>RF10C</b>	0.6
Ranger 150, 200, 300, YL350	(14mm)			<b>RJ6C</b>	0.6
Series 71	Hercules (14mm)			<b>RJ8C</b>	0.6
Series 71F	Ford (18mm)			<b>RF11YC</b>	0.6
Series 81	Hercules (14mm)			<b>RJ6C</b>	0.6
Y60, 70, S80, 100CD	Perkins 236 cid (14mm)		<b>OE042</b>	<b>RN12YC</b>	0.6
Y60, 70, S80, 100CD (LPG)	Perkins 236 cid (14mm)		<b>OE042</b>	<b>RN12YC</b>	0.4
Yardlift 150, Clark-Ross Y200	(14mm)			<b>RJ8C</b>	0.6
Yardlift 20, 40, 60, 100 (LPG)	(18mm)			<b>RD16</b>	0.4
Yardlift 20, 40, 60, 100, 180	(18mm)			<b>D21</b>	0.6
Yardlift 260, YL150, HYL150	(14mm)			<b>RJ8C</b>	0.6

**CLARK-ROSS****Tractors & Lift Trucks**

Continental F-6209-134				<b>RD16</b>	0.6
Hercules JXLD-122				<b>RD16</b>	0.6
Hercules JXC-110C, QXC-3-121B				<b>RJ6C</b>	0.6

**CLEAVER-BROOKS****Construction Machinery**

Model ZZ	B&S (18mm)			<b>RD16</b>	0.8
	LeRoi D140			<b>D14</b>	0.6
	Waukesha			<b>W14</b>	0.6

**CLETRAC****Tractors & Lift Trucks**

All Models	(7/8"-18)			<b>W14</b>	0.6
FG				<b>W18</b>	0.6
	(18mm)			<b>D14</b>	0.6
	(14mm)			<b>RJ8C</b>	0.6

**CLEVELAND****Formgraders**

Wisconsin THDU				<b>RD16</b>	0.6
B&S				<b>RJ19LM / QJ19LM</b>	0.8
Hercules JXC, OOB (14mm)				<b>RJ8C</b>	0.6
Lauson				<b>RJ8C</b>	0.8
Hercules JXC, OOB (7/8"-18)				<b>W14</b>	0.6
Waukesha XAH, XAK				<b>W18</b>	0.6

**Trenchers**

Buda HP-326				<b>D14</b>	0.6
Caterpillar D-8800				<b>D14</b>	0.6
IHC UD-350, UD-281, UD-370				<b>D89D</b>	0.6
IHC UD-6A, UD-9, UD-9A, UD-264				<b>D89D</b>	0.6
Buda HP-217				<b>RD16</b>	0.6
Caterpillar D-318 (18mm)				<b>RD16</b>	0.6
Continental				<b>RD16</b>	0.6
Wisconsin AEN, AEND, VH4D				<b>RD16</b>	0.6
Caterpillar D-318 (14mm)				<b>RJ12C</b>	0.6



CC

BHP

21

**...CLEVELAND****...Trenchers**

B&S			RJ19LM / QJ19LM	0.8
Hercules JX4D, F0226, G0-226, G0-339			RJ8C	0.6
Hercules JXD (14mm)			RJ8C	0.6
Hercules JXD (18mm)			W14	0.6
IHC UD-14A			W89D	0.6

**COCKSHUTT****Tractors & Lift Trucks**

2-44, 2-44-L, 2-44-LL			D14	0.6
2-44FL, 2-62, 2-62-L, 2-62-15			D14	0.6
2-78, 2-78-L, 2-78-15, 2-78-17, 2-105			RN14YC	0.6
4-78, 4-78-L, 4-78-15, 4-78-17, 4-105			RN14YC	0.6

**COLSON****Tractors & Lift Trucks**

(18mm)			RD16	0.6
(14mm)			RJ12C	0.6

**COLUMBUS****Heaters**

W14 0.6

**CON-O-LIFT****Marine Trailer Hoists**

Honda OHV	5.5,8,11	OE051	RN11YC	0.8
-----------	----------	-------	--------	-----

**CONSTRUCTION MACHINERY CO.****Mixers**

LeRoi (18mm)			RD16	0.6
Wisconsin AP4			RD16	0.6
Hercules ZXB			RH10C	0.6
Hercules IXB-5			W14	0.6
LeRoi (7/8"-18)			W14	0.6

**CONTINENTAL****Tractors & Lift Trucks**

F135, F163, F227			RD16	0.6
T247, T371 (LPG)			RD16	0.5

**CRAB****Tractors**

RD16 0.6

**CRANE CARRIER CORP.****Construction Machinery**

IHC RD450, RD501			RJ6C	0.6
IHC BD282, BD308			RJ8C	0.6
Waukesha 145GC, F817G			RJ8C	0.6

**CRESCENT****Tractors & Lift Trucks**

Ready Power H, P			D14	0.6
------------------	--	--	-----	-----

**CURBMASTER****Construction Machinery**

Wisconsin VH4D			D16J	0.8
Wisconsin	65	OE042	RN12YC	0.8

**CUSHMAN****Tractors & Lift Trucks**

Haulster	OMC M109, M218		RF11YC	0.6
		18	RF11YC	0.6
	Kohler	12	RH10C	0.8
	Kohler (K181)	8	RJ19LM	0.8
		22	RV15YC4	0.6
Haulster (LPG)	OMC M109		RF11YC	0.5





CC

BHP

21

**...CUSHMAN****...Tractors & Lift Trucks**

Minute-Miser

(18mm, gasket seat)  
(18mm, tapered seat)  
(14mm)  
(7/8"-18)RCJ8 0.6  
RD16 0.6  
RF11YC 0.6  
RH10C 0.6  
W14 0.6**CUTTLER****Pavers & Rollers**

Continental

RD16 0.6

**DAEWOO****Tractors & Lift Trucks**

G35S, G40S (LPG)

GM 4.3L V-6

RV9YC 0.6

**DAVIS****Backhoes & Ditchers**

Wisconsin AGND, THD, TJD, S12D, VG4D, VH4

Clinton

Ford 172 cid

Kohler

10,12,14,23

Other Onan

B&amp;S

RD16 0.6  
RH10C 0.6  
RH10C 0.6  
RH10C 0.6  
RH10C 0.6  
RJ19LM /  
QJ19LM 0.8

Kohler (K181)

8

Wisconsin V460D, V465D

Ford 201 cid

Onan NHC

OE042

RJ19LM 0.6  
RN12YC 0.6  
RN5C 0.6  
RN5C 0.6**Trencher**

Task Force 700

RD16 0.6

**DAY****Pulverizer**

IHC PD-40

W89D 0.6

**DEFA (→ Master)****DIADEM****Construction Machinery**

316

B&amp;S

Kohler

RCJ8 0.6  
RH10C 0.6

427

Kohler

RCJ8 0.6

**DIG-IT****Backhoes**

Compact Backhoes

B&amp;S Vanguard

9

Kohler (V-Twin)

18

Kohler

8

Kohler (Twin)

18

OE013

OE013

RC12YC 0.8  
RC12YC 0.8  
RJ19LM 0.6  
RV17YC 0.6**DIGMOR****Loaders**

VW Eng.

QL86C 0.6

**DIGZ-ALL****Construction Machinery**

B&amp;S

Wisconsin

Kohler

RCJ8 0.6  
RD16 0.6  
RJ8C 0.6**DITCH WITCH****Cable Layers**

T00SX Plow

B&amp;S

RJ19LM /  
QJ19LM 0.8**Compactors**

DR-190

Robin WI-185

QL86C 0.6



CC

BHP

21

**...DITCH WITCH****Tampers**

DR-50	Robin EC-8G			QL86C	0.6
DR-65	Robin EC-10G			RJ8C	0.6

**DOMARK****Construction Machinery**

All Models				D14	0.6
------------	--	--	--	-----	-----

**DOTMAR****Construction Machinery**

Wisconsin AENL				D14	0.6
Wisconsin AEN				RD16	0.6

**DROTT****Construction Machinery**

85 RM2 Go Devil	Continental			RD16	0.6
-----------------	-------------	--	--	------	-----

**DYNAHOE****Construction Machinery**

All Models				RD16	0.6
------------	--	--	--	------	-----

**Tractors & Lift Trucks**

Continental F-244				RD16	0.6
-------------------	--	--	--	------	-----

**DYNAPAC****Construction Machinery**

CM-10, CM-20, CG-11, CK-20				RD16	0.8
CM-21, CK-11, CC-10, DD-18, CG-08				RD16	0.8
CO-16, CG-09				RH12	0.8

**EAGLE****Crushers**

Continental				RD16	0.6
-------------	--	--	--	------	-----

**EAGLE LIFT****Aerial Lifts**

B&S Vanguard	9		OE013	RC12YC	0.8
Kohler OHV	6		OE013	RC12YC	0.8
B&S Vanguard (V-Twin)	16			RC14YC	0.8
Honda OHV	8,13		OE051	RN11YC	0.8

**EARTHWORM****Construction Machinery**

Wisconsin AKN				RD16	0.6
---------------	--	--	--	------	-----

**EATON****Tractors & Lift Trucks**

3/4 Ton	Perkins G4-203		OE051	RN11YC	0.6
---------	----------------	--	-------	--------	-----

**EDCO****Concrete Saws, Slab Surface Grinders & Power Trowels**

Robin	5,11			QL86C	0.6
Wisconsin	11			QL86C	0.6
Wisconsin	9,18,35			RD16	0.8
Kohler	14,16			RH10C	0.8
B&S	5,8			RJ19LM / QJ19LM	0.8
Kohler	8			RJ19LM	0.8
Honda OHV	8,9,11		OE051	RN11YC	0.8
Wisconsin	65		OE042	RN12YC	0.8
Honda OHV	5		OE006	RN9YC	0.8
Kohler (Twin)	20			RV17YC	0.6



CC

BHP

21



mm

**ELGIN SWEEPER****Construction Machinery**

20			W14	0.8
30	(14mm)		RJ8C	0.8
	(7/8"-18)		W14	0.8
81			RJ8C	0.8
A, D			W18	0.8
Junior			W10	0.8
Pelican, White Wing, Whirlwind			RJ8C	0.8
Roadrunner	IHC 392 cid		RJ8C	0.8
	IHC BB-264		RJ12YC	0.8
	IHC BD-240, BD-264, V-345, UV-345		RJ8C	0.8

**Sweepers**

Eductor	Ford 300 cid		RF11YC	0.8
	(7/8"-18)		W14	0.8

**ELWELL-PARKER****Construction Machinery**

GEP-6			RD16	0.6
GF-26, GF-30			RJ8C	0.6

**Tractors & Lift Trucks**

	Continental F-162, F-163		RD16	0.6
	Hercules		W14	0.6

**ERICKSON****Platform Truck**

F5W, F7, MCH			D21	0.6
--------------	--	--	-----	-----

**Power Carts**

Front End Loader			RD16	0.6
------------------	--	--	------	-----

**Rack Runner**

			D21	0.6
--	--	--	-----	-----

**Tractors & Lift Trucks**

825	Onan NHC		RN5C	0.6
1237	Continental		D21	0.6
E-Z Loader			RJ8C	0.6

**ESSICK (→ Huber)****ETNYRE****Construction Machinery**

	Waukesha 180GKB		D14	0.5
	Hercules IXB		RD16	0.6
	LeRoi D-140 (18mm)		RD16	0.6
	Wisconsin		RD16	0.5
	Ford 223 & 240 cid		RF10C	0.8
	Ford 4 Cyl. & V-8		RH10C	0.6
	Ford D172 & 172 cid		RH10C	0.6
	B&S		RJ19LM / QJ19LM	0.8
	IHC U-372, U-430		RJ6C	0.8
	Hercules IXLB		RJ8C	0.5
	Hercules QXC-5		RJ8C	0.6
	IHC UB-220		RJ8C	0.8
	LeRoi D-140 (14mm)		RJ8C	0.6

**EUCLID****Construction Machinery**

1KG, 1KGT, 1MGT, 12W, 22W, 52W, 62W			W14	0.6
2FGT			W10	0.6
4FGT			RD16	0.6
	Hall Scott 400 (Exhaust)		D14	0.6
	Hall Scott 400 (Intake)		RD16	0.6



CC

BHP

21

**EVANS****Masonry & Concrete Saws**

McCulloch 710			RDJ6J	0.6
Kohler	14		RH10C	0.6
Kohler (K181)	8		RJ19LM	0.6
McCulloch 710A			RJ8C	0.6
Wisconsin	65	OE042	RN12YC	0.6

**EVERETTE****Drills**

All Models			RD16	0.6
------------	--	--	------	-----

**EVERREADY****Concrete Saws**

All Other	Wisconsin		RD16	0.6
	B&S		RJ19LM / QJ19LM	0.8
	Wisconsin V460D, V461D	OE042	RN12YC	0.6

**EXPEDITER****Tractors & Lift Trucks**

All Models			RD16	0.8
------------	--	--	------	-----

**FAIRFIELD****Conveyors**

Wisconsin			RD16	0.6
B&S			RJ19LM / QJ19LM	0.8

**FARQUHAR****Construction Machinery**

All Models			RD16	0.6
------------	--	--	------	-----

**FASI VERDINI****Cement Cutters & Finishers**

Honda	4,5,5,13	OE051	RN11YC	0.8
-------	----------	-------	--------	-----

**FELKER****Concrete Cutters**

665		OE042	RN12YC	0.8
100, 200, 254, 367			RD16	0.6

**FINN****Skid-Steers**

Kohler (V-Twin)	25	OE013	RC12YC	0.8
-----------------	----	-------	--------	-----

**FINNELL****Industrial Scrubbers**

Onan			RH8C	0.6
------	--	--	------	-----

**FITCHBURG****Saws**

C-6, C-12, C-15,	AMC 232 cid	OE042	RN12YC	0.8
TW-6, TWC-612	AMC	OE042	RN12YC	0.8
TWC-915	AMC 304 & 360 cid	OE042	RN12YC	0.8

**FLEX-PLANE****Construction Machinery**

Wisconsin 4GAP, VP-4, VG-4D			RD16	0.6
Wisconsin AFH, AHH, TF, TH, THD			RD16	0.6
Ford 134 & 172 cid			RH10C	0.6
B&S 61102			RJ19LM / QJ19LM	0.8
Hercules IXB5			RJ8C	0.6
Hercules IXB, NXB			W14	0.6

**FLINK****Spreader**

LMC			RD16	0.8
-----	--	--	------	-----



CC

BHP

21

mm  
**FORD****Compact Loader**

CL20

CL30

CL40

RN5C

0.6

D16J

0.6

OE051 RN11YC

0.6

**Tractors & Lift Trucks**

104 cid

200, 240, 300 &amp; 330 cid

250 cid Thru 1964

262, 292 &amp; 332 cid

361, 391, 401, 477 &amp; 534 cid

144, 170 cid

223 &amp; 272 cid

351W, 360 &amp; 390 cid

134, 172 &amp; 192 cid

158, 175, 201 &amp; 256 cid

250 cid 1965 &amp; Up

2600, 3600, 4600 &amp; 6600 cc

98 cid

351C cid

460 cid

OE051 RN11YC

0.6

RF10C

0.6

RF10C

0.6

RF10C

0.8

RF10C

0.8

RF11YC

0.9

RF11YC

0.6

RF11YC

0.6

RH10C

0.6

RN5C

0.6

RN5C

0.6

RN5C

0.6

OE006 RN9YC

0.6

RV12YC

0.6

RV12YC

0.6

**FRASER****Heaters**

25

0.6

**FRINK****Rotobrooms**

All Models

RD16

0.6

**FULLER-JOHNSON****Construction Machinery**

(18mm)

(7/8"-18)

RD16

0.6

W14

0.6

**FULTON****Tractors & Lift Trucks**

20

60

White G1600

Wisconsin V465D

80

27-40, 42

OE042 RH10C

0.6

OE042 RN12YC

0.6

OE042 RN12YC

0.6

RF9YC

0.6

RD16

0.6

**GALION****Cranes, Graders, Rollers**

Continental F-226, M330

Hercules ZXB

IHC U-264, U-281A

IHC U-4, U-6, U-9, UC-263

Wisconsin AH

IHC UD-16, UD-16A, UD-264

IHC UD-525, UD-554

IHC UD-6, UD-6A, UD-9, UD-9A

Continental F-162, Y-122

Wisconsin VF-4, VG4D, P-4

IHC U-264-6, U-370, U-450

IHC U-372, U-450

IHC UB-220, UB264

Hercules QXCS

Oliver 35, 50

A-C

Case

Hercules IXB, JXC, WXC3, WXLB

Hercules WXL3, JXD3

IHC 1-14, U-9

McCormick-Deering

Oliver 44

IHC 1-30

IHC PD-40, UD-14, UD-14A

IHC UD-350, UD-370

D14

0.6

D14

0.6

D14

0.6

D14

0.6

D14

0.6

D89D

0.6

D89D

0.6

D89D

0.6

RD16

0.6

RD16

0.6

RJ6C

0.6

RJ6C

0.6

RJ8C

0.6

W10

0.6

W10

0.6

W14

0.6

W14

0.6

W14

0.6

W14

0.6

W14

0.6

W14

0.6

W14

0.6

W18

0.6

W89D

0.6

W89D

0.6



CC

BHP

21

**GAR WOOD****Construction Machinery**

Buda K-369, K-393, K-428			D23	0.6
Buda L-528, 6DT-691			D23	0.6
Buda HP-260, HP-326			RD16	0.6
Caterpillar D-315			RD16	0.6
Chevrolet			RJ6C	0.6
Chrysler			RJ6C	0.6
IHC			RJ6C	0.6
Buda 6B-230			RJ8C	0.6
LeRoi			RJ8C	0.6
(7/8"-18)			W14	0.6

**GAR-BRO****Power Carts**

Gladden 75			RJ8C	0.6
------------	--	--	------	-----

**Tractors & Lift Trucks**

1200			RN5C	0.6
1000, 1400			RJ8C	0.6

**Truck**

Willys			RJ8C	0.6
Morris Minor			RN5C	0.6

**GARDNER****Mixers**

(Diesel Starting)	Caterpillar (18mm)		RD16	0.6
	Caterpillar (7/8"-18)		W14	0.6

**GEHL****Power Box Pavers**

Kohler (V-Twin)	25	OE013	RC12YC	0.8
Wisconsin	30		RD16	0.6

**Skid-Steers**

HL2500			RH8C	0.6	
HL2500A, HL2600, HL3000			RN5C	0.6	
HL4300			RD16	0.6	
HL4500		OE006	RN9YC	0.6	
HL4700 (LPG)		OE006	RN9YC	0.4	
SL3510, SL4510		OE006	RN9YC	0.6	
	Onan (Twin)	20	RS17YX	0.6	
	Ford 1.1 & 1.3L		OE011	RS9YC	0.9

**GENERAC****Welders**

Generac 562SXL		OE059	L92YC	0.6
B&S Vanguard (V-Twin)			RC14YC	0.8
B&S (Twin)			RJ19LM / QJ19LM	0.8
B&S One-Cylinder			RJ19LM / QJ19LM	0.8
Tecumseh			RJ8C	0.6
Generac 1.0 & 1.2L		OE006	RN9YC	0.6

**GENERAL****Tractors & Lift Trucks**

Perkins G4-203		OE051	RN11YC	0.6
----------------	--	-------	--------	-----

**GENERAL EQUIPMENT****Surface Grinders & Planers**

Honda	5.5,11	OE051	RN11YC	0.8
-------	--------	-------	--------	-----

**GERLINGER****Tractors & Lift Trucks**

Continental T6427			D14	0.6
Ford F, J, L			RF10C	0.6
Ford 8RNN			RH8C	0.6
Hercules GO-298, GO-339			RJ8C	0.6
Hercules JXD, JXLD			RJ8C	0.6
Perkins G4-203		OE006	RN9YC	0.6



CC

BHP

21

**GILSON****Concrete Mixers**

RCJ8 0.6

**GLUM****Vibrators**

B&amp;S Vanguard (V-Twin)

20

RC14YC 0.8

**GORMAN-RUPP****Construction Machinery**

3402	(14mm) (7/8"-18)		RJ8C	0.6
3602			W14	0.6
3102, 3601, 3602, 6201, 6301			W10	0.6
3201, 3202, 3203, 3205, 3301			RJ8C	0.6
3302, 3303, 33TF, 3401, 3403			RD16	0.6
3609, 3801			RD16	0.6
53M-TFD, 53H-VF4D, 54A-VG-4D			RJ6C	0.6
54B-6FB, 54M-134, 54M-CJ3A			RJ8C	0.6
54B-Ind. 30			RJ8C	0.6
54E-6FB, 55A-265, 55A-Ind. 16A			RJ8C	0.6
55A-JG, 55M-JB			RH10C	0.6
55M-Ind. 20A, 55M-Ind. 24A, 55H-503			RJ6C	0.6
55M-Ind. 56			RJ8C	0.6

**GREGOR****Tractors & Lift Trucks**

Continental F-162, F-163			RD16	0.6
Ford 172 cid			RH10C	0.6
Hercules			W14	0.6

**GUPTILL****Construction Machinery**

All Models			RJ6C	0.6
------------	--	--	------	-----

**H&B****Construction Machinery**

B&S			RJ19LM / QJ19LM	0.8
-----	--	--	--------------------	-----

**Loaders**

Moto-Loader	Wisconsin		RD16	0.8
-------------	-----------	--	------	-----

**Moto-Loader**

A-C			RJ8C	0.8
-----	--	--	------	-----

**Pavers**

Moto-Paver 15A, 32	Chrysler		RJ8C	0.8
Moto-Paver 8, 14, 14A	Chrysler		RJ8C	0.8

**HAISS****Loaders**

Oliver 188, 199			D14	0.6
LeRoi D-91			RD16	0.6
Waukesha			RD16	0.6
Wisconsin			RD16	0.6
Hercules G3-400			RJ6C	0.6
LeRoi (14mm)			RJ8C	0.6

**HALL-SCOTT****Drills**

2296-0			RD16	0.6
All Other Models			W14	0.6
Crabs			D14	0.6
Crabs (Distillate)			D23	0.6

**HANDY-VAN****Tractors & Lift Trucks**

All Models			RD16	0.6
------------	--	--	------	-----



CC

BHP

21

**HANSON****Construction Machinery**

31, 41				RD16	0.6
	Buda HP-326			RD16	0.6
	Caterpillar D-311, D-315			RD16	0.6
	Waukesha 6BZ, 195GK			RD16	0.6
	Ford 6-Cyl. & V-8			RH10C	0.6
	Ford 215 & 226 cid			RH8C	0.6
	Hercules RXC			RJ8C	0.6

**HARLEY-DAVIDSON****Tractors & Lift Trucks**

Utilicar, DC			OE042	RN12YC	1.0
Utilicar, GE				RH10C	0.6

**HARLO****Handler**

Kohler				RH10C	0.8
--------	--	--	--	-------	-----

**HEFTY****Tractors & Lift Trucks**

A-616	B&S			RJ19LM / QJ19LM	0.8
-------	-----	--	--	-----------------	-----

**HENDRICKSON****Crane Carriers**

				RJ8C	0.6
--	--	--	--	------	-----

**H-H****Construction Machinery**

All Models				RJ8C	0.9
------------	--	--	--	------	-----

**HITCO****Tractors & Lift Trucks**

Wilys				RJ12C	0.8
Chevrolet				UY6	0.9

**HOBART****Machinery**

CSG 649	Ford 300 cid			RF10C	0.8
LSG 423	Ford 140 cid			RS14YC	1.1
LSG 633	Ford 200 cid			RF11YC	0.9

**Tractors & Lift Trucks**

IHC UV549				RJ6C	0.8
-----------	--	--	--	------	-----

**Welders**

All Other Merc. Engs.				RJ12C	0.6
Champ 140				RJ19LM / QJ19LM	0.8

**Champion 16, Champion Combo**

G-213, G-203				RS17YX	0.6
G-400, G-412, G-3010				D16J	0.8
GCF-350, GCCF-510, GF-250, GF-303				RN5C	0.9
GR-303-S				RF10C	0.9
SG-180				RF11YC	0.6
	Continental (18mm)			RH10C	0.6
	Wilys (18mm)			RD16	0.6
	Wisconsin			RD16	0.6
	Hercules ZXB			RD16	0.6
	B&S	9		RH10C	0.6
				RJ19LM / QJ19LM	0.8
	Chrysler C-36, DU, T40, T-98			RJ6C	0.6
	Chrysler T-118, 502, 7, 12			RJ6C	0.6
	Chrysler C-9, C-15, 5A, 8A			RJ8C	0.6
	Chrysler 30, 32			RJ8C	0.6
	Wilys MB, SRS			RJ8C	0.6
	Chrysler (3/4" Reach)			RJ8C	0.6
	Onan (Twin)	16,18		RN5C	0.6
	Continental (7/8"-18)			RS17YX	0.6
	Wilys (7/8"-18)			W14	0.6
				W18	0.6





CC

BHP

21



mm

**HONDA****Tampers & Welder/Generators**

EW140, EW171, EW171S		OE051	RN11YC	0.6
EW170			L90C	0.6
LT524			CJ14	0.8
LT624		OE051	RN11YC	0.8

**HOUGH****Construction Machinery**

Hercules 2000			D14	0.6
IHC G-153			D14	0.6
Waukesha 180-GKB, 180-GLB			D14	0.6
Waukesha FC-281			D14N	0.6
IHC G-301 (Light Service)			D21	0.6
IHC UD-9, UD-264			D89D	0.6
IHC G-301			RD16	0.6
Waukesha FC, 190-GLS			RD16	0.6
Hercules JXC, JX4C, JXD, JXLD QXD3, QXLD			RJ6C	0.6
Hercules WXLC			RJ6C	0.6
IHC UD-345, G-372			RJ6C	0.6
Hercules QXD			RJ8C	0.6
IHC U-240, G-263, G264			RJ8C	0.6
IHC U-9			W10	0.6

**Payloaders**

H25	Waukesha 180GLB		RD16	0.6
H25B	Waukesha 180GKB		RD16	0.6
H30	IHC U-240		RJ8C	0.6
H30B	IHC G263		RD16	0.6
H30R	Hercules QXD3		RJ12C	0.6
H50B	IHC G301		RD16	0.6
H60, H65	IHC G372		RJ8C	0.6
H70	IHC U-372		RJ6C	0.6
H90	Hercules		RJ12C	0.6
HA	Waukesha FC281		RD16	0.6
HAH	Hercules JX4C3		RJ12C	0.6
HAH-E	Hercules JX4D		RJ12C	0.6
HF, HH, HM, HO	Hercules		RJ12C	0.6
HR, HU, TM	Hercules		RJ12C	0.6
MC4	IHC V549		RJ6C	0.6
T150 (LPG)	Hercules JXLD12		RJ6C	0.5
T225	IHC V549		RJ6C	0.6
T245	Hercules HXLEF		RD16	0.6
T40	Continental FS-162		RD16	0.6
T50, 60, 120, 150	Hercules		RJ12C	0.6
	Waukesha FC281		RJ12C	0.6

**Tractors & Lift Trucks**

T120F, T150			RJ8C	0.6
T180, T225			RJ8C	0.6
T30A, T50LA, P40			RD16	0.6

**HUBER****Construction Machinery**

IHC UD-16			D89D	0.6
Buda H260, H298, HP205, 217			RD16	0.6
Buda HP260, HP326, K369, K428			RD16	0.6
Caterpillar D-3400, D-4400			RD16	0.6
Continental F-162, F-226, F-245			RD16	0.6
Wisconsin			RD16	0.6
Ford 172 & 192 cid			RH10C	0.6
Hercules G2000, G3400, L237			RJ6C	0.6
A-C 6B273			RJ8C	0.6
Hercules G-339, IYB, G1600			RJ8C	0.6
Hercules GO-173, 226, 339, GO-198			RJ8C	0.6
Hercules IXB, IXB-3, JXD, QXB5, WXE			RJ8C	0.6

**HUNTER****Heaters**

PH-20-6, DH-20-7 Heaters			J99	0.6
--------------------------	--	--	-----	-----



CC

BHP

21

**HURST****Construction Machinery**

Jaws of Life

RJ8C

0.6

**HYDRA MAC****Skid-Steers**

12C	Ford 98 cid Eng.
12C II	Chrysler H-105
20C	Ford 172 cid
20C II	Mazda 121 cid
5C	Tecumseh HH-160
6C	Onan B48
8C	Onan NHCV, NHC
Big Mac 18	Ford 172 cid
Mini Mac 5	Tecumseh HH-160
Mitey Mac 8, 8A	Onan NH
Mitey Mac 8B	Onan NHC
Mitey Mac II-10	Ford 98 cid

OE006	RN9YC	0.6
OE006	RN9YC	0.6
	RH10C	0.6
OE006	RN9YC	0.6
	QL82C	0.6
	RH18Y	0.6
	RN5C	0.6
	RH10C	0.6
	QL82C	0.6
	RH8C	0.6
	RN5C	0.6
OE006	RN9YC	0.6

**HYDRAXCAVATOR****Construction Machinery**

Continental

RD16

0.6

**HYSTER****Carrier**

S60, S70, S80

RD16

0.9

**Straddle Carriers**

Chrysler 53

RN5C

0.6

**Tractors & Lift Trucks**

20C150-SC180-TC200	Hercules
BC, BT, BK10, H20E, H25E, H30E	
H100-120B, H100-140C	
H100-150C, H360-460A	
H110-150F, H150-275H, H300A	
H110F, H130F, H150F, H200-H400	
H111-150F, H150-250E	
H150-225E, > 191268	
H150-225E, 191269 >	
H20-30E, H60-80B, H60-80C	
H250-300A, 191269 >	
H250A, H250-300A, > 191268	
H30-60F, KD, M3, M200-300E	
H30H, H30-60H, H40H	
H35XL	Mazda 4-Cyl.
H360-400A, H360-620B	
H60C, H70C, H80C	
H700-800A, M200-300F (3/4" Rch.)	
HC50, HE50, H50H, H60H	
KD Krane	
KE Krane	
M2, M3, MD Carrier, MH	
M200-300F, XF60-VA70-ZA80	(3/8" Reach)
M200-400H	
MH3 Carrier	
P125-180A, > 191268	
P125-180A, 191269 >	
P150-P200B	
P40-P50A	
P60-80A, KE, QC20, QN20, YT40	
P60A-P80A, KE	
QC20, QN20, QT20	
RC150, SC180, TC200	Chrysler 3/8" Rch. Chrysler 3/4" Rch. Hercules 3/4" Rch.
RT100, RT120, RT150, VA70, XA60, ZA80	
S&H Series	Continental
S125A-S150A	
S20-30A, S30-50B, S30-50C, S60-100A	
S20A-S30A	

	RJ8C	0.6
	RD16	0.6
	RD16	0.6
	RD16	0.6
	RV17YC	0.9
	RV8C	0.9
	RV8C	0.9
	RJ8C	0.6
OE051	RN11YC	0.6
	RD16	0.6
OE051	RN11YC	0.6
	RJ8C	0.6
	RJ8C	0.6
	RH10C	0.6
	RN14YC	0.8
	RN5C	0.6
	RD16	0.6
	RN5C	0.6
	RH10C	0.6
	RJ8C	0.6
	RD16	0.6
	RJ12C	0.6
	RJ8C	0.6
OE051	RN11YC	0.6
	RD16	0.6
	RJ8C	0.6
OE051	RN11YC	0.6
	RV8C	0.9
	RV12YC	0.9
	RD16	0.6
	RD16	0.6
	RD16	0.9
	RJ8C	0.6
	RN5C	0.6
	RN5C	0.6
	RJ12C	0.6
	RD16	0.6
	RD16	0.6
	RD16	0.6
	RD16	0.6



CC

BHP

21

**...HYSTER****...Tractors & Lift Trucks**

S30-60ES, S70B-S100B				RV8C	0.9
S30C, S40C, S50C			OE042	RN12YC	0.6
S30E, S40E D2D1501 >				RV12C	0.6
S30E, S40E D2D4302 >				RV17YC	0.6
S40C-S50C				RD16	0.6
S50E, S60E D2D1501 >				RV12C	0.6
S50E, S60ES D2D4302 >				RV17YC	0.6
S60-100E, S125-150A				RD16	0.6
S60B, S70B, S80B, S100B				RV12C	0.6
S60E, S70E	Chevrolet 250 cid			RV17YC	0.6
S80E, S100E	Chevrolet 250 cid			RV17YC	0.6
Turret Tug UC30, UE30				RD16	0.6
Turret Tug YC40, YE40, YT40				RD16	0.6
	Wisconsin	37		D16J	0.6
	Ford 172 & 192 cid			RH10C	0.6
	GMC 250 cid (3/8" Rch.)			RJ6C	0.6
	GM 151 cid (Brazil)		OE042	RN12YC	0.6
	GMC 250 cid (3/4" Rch.)			RN5C	0.6
	GMC 153 cid			RV17YC	0.6
	GMC 250 cid (Tapered Seat)			RV17YC	0.6
	GMC 350 cid			RV17YC	0.6

**INGERSOLL****Backhoe Loader**

Onan (Twin)	18			RS17YX	0.6
-------------	----	--	--	--------	-----

**Loaders/Backhoes**

Honda	20		OE051	RN11YC	0.8
Onan (Twin)	18			RS17YX	0.6

**INSLEY EXAVATORS****Construction Machinery**

IHC UD-9A				D89D	0.6
Caterpillar D-311, D-315, D-318				D9	0.6
Buda H205, H298, HP260, HP298, HP326				RD16	0.6
Waukesha 6BA, 6MZA, 6ZKA, 195, 195GK				RD16	0.6
Waukesha 140GKB				RH8C	0.6
Hercules (14mm)				RJ12C	0.6
Chrysler 12, 12A				RJ6C	0.6
Ford V-8				RJ6C	0.6
Chrysler 14, 14A				RJ8C	0.6
M-M 425-6A (High Comp.)				W10	0.6
Hercules (7/8"-18)				W14	0.6
M-M 425-6A (Low Comp.)				W14	0.6
Buda KTU				W18	0.6

**INTERNATIONAL****Backhoe Loader**

3444				L90C	0.6
4120	Kohler			RH10C	0.8
4125				RH8C	0.6
4130	Onan NHC			RN5C	0.6
4135				RN5C	0.6
4140	Chrysler/Ford		OE006	RN9YC	0.6
4150	Ford			RH10C	0.6
	Mazda		OE006	RN9YC	0.6
3400A, 3500A, 3514, 3600A				D15Y	0.6
3616, 3800, 3850				D15Y	0.6

**Crawler Tractors**

T0-20, 20				W20	0.6
T-20, T-35, T-40				W14	0.6
T-340				D9	0.6
T-6				D15Y	0.6
T-6 (Shielded)				XED16	0.6
TA-40, T-9				W10	0.6
TD-14, TD-14A, TD-18, TD-18A				W89D	0.6
TD-15	(18mm)			D89D	0.6
	(7/8"-18)			W89D	0.6



CC

BHP

21

**...INTERNATIONAL****...Crawler Tractors**

TD-20, TD-24, TD-35, TD-40

TD-6, TD-9 Shielded

TD-6, TD-9 Starting Engs.

W89D

0.6

ED89D

0.6

D89D

0.6

**Fork Lift**

400 Series, I-4000, 4500A, 4500B, I-8000

444, 3444, 7000

D15Y

0.6

L90C

0.6

**Wheel Tractor**

01/09/1998

1-30, 1-40, IA-40

1D-40 Starting Engine

20, 30, 15-30, 22-36

A, Super A, 1-4, 1-6 Shielded

A, Super A, 1-4, 1-6, 2424

ID-6, ID-9 Shielded

ID-6, ID-9 Starting Engine

IK-40, 1-12, 1-14

Industrial Cub

W10

0.6

W14

0.6

W89D

0.6

W20

0.6

XED16

0.6

D15Y

0.6

ED89D

0.6

D89D

0.6

W14

0.6

D15Y

0.6

**INTERNATIONAL HARVESTER****Construction Machinery**

C-281

D-281-4, D-350, D-461, D-691, D-1091

IK40, 1-12, 1-14, 1-30, 1-40

TD14, TD14A, TD18, TD18A

TD20, TD24, TD35, TD40

D14

0.6

W89D

0.6

W14

0.6

W89D

0.6

W89D

0.6

**Crawler Tractors**

(Light Service)

T340A, T500, T600

T4, T5, T340

T6

T9, T20, T35, T40, TA40

D21

0.6

RD16

0.6

RD16

0.6

D18Y

0.6

W14

0.6

**IOWA****Construction Machinery**

IHC UC-301

Continental F-245

Ford 240 cid

Ford 256 cid

D15Y

0.6

RD16

0.6

RF10C

0.6

RN5C

0.6

**ISCO****Shuttle Wagon**

RF10C

0.6

**JACKSON****Tampers**

Wisconsin

Ford

Kohler

(7/8"-18)

6.25

RD16

0.6

RF11YC

0.8

RJ19LM

0.8

W14

0.6

**JAEGER****Tractors & Lift Trucks**

LP12 Auto Scoop

RD16

0.6

**JOHN DEERE****End Loader**

JD-24

RD16

0.6

**Loaders**

JD145S, 705S

RN5C

0.6

**Skid-Steers**

60

70, JD14, 90, 125

JD24, JD24A, 170

RH8C

0.6

RD16

0.6

RD16

0.6

**Tractors & Lift Trucks**

3010, 4010, JD500

440, 1010, 2010 Series

D14

0.6

RH10C

0.6



CC

BHP

21

**...JOHN DEERE****...Tractors & Lift Trucks****840 Starting Engine**

JD300, JD300B, JD301, JD301A, JD302

JD302A, JD310, JD350, JD350B, JD350C

**RN11YC** 0.6

JD380, JD400, JD401A, JD401B

JD401C, JD410, JD440

JD480, JD480A, JD440B, JD544

JD600, JD500A, JD500B

**Trenchers**

JD-11

JD-21

**JUMBO****Construction Machinery**

(18mm)

(14mm)

**KALAMAZOO****Tractors & Lift Trucks**

Continental 4163

Wisconsin (18mm)

Ford 172 cid

Wisconsin V461D

**KAL-TRUK****Tractors & Lift Trucks**

All Models

**KAMAK****Cement Mixers**

B&amp;S

**KD****Tractors & Lift Trucks**

355

Ford 158 cid

452

Ford 201 cid

**KELLOGG AMERICAN****Construction Machinery**

(18mm)

(14mm)

**KERRICK****Construction Machinery**

Onan

B&amp;S

Clinton 1100

Clinton C-700

Kohler

**KEYSTONE****Drills**

50

Hercules

50, 60

Continental

80, 18A

Buda

**KING****Hoists**

(14mm)

(18mm)

RJ8C 0.6

OE051 RN11YC 0.6

OE051

OE051 RN11YC 0.6

OE051 RN11YC 0.6

OE051 RN11YC 0.6

D14 0.6

RJ8C 0.6

RH10C 0.6

D14 0.6

RJ8C 0.6

D14 0.6

D9 0.6

RH10C 0.6

RN14YC 0.6

RD16 0.6

RJ19LM / QJ19LM 0.8

RN5C 0.6

RN5C 0.6

D14 0.6

RJ19LM 0.6

RH8C 0.6

RJ19LM / QJ19LM 0.8

RJ6C 0.6

RJ8C 0.6

RJ8C 0.6

RD16 0.6

RD16 0.6

RD16 0.6

RJ8C 0.6

RD16 0.6





CC

BHP

21

**KLEECO****Marine Mobile Hoists**

Ford CSG649 300 cid	RF10C	0.8
Hercules G1600, G2300, G3400	RJ6C	0.8
Ford LSG423 140 cid	RS12YC	0.9
Ford LSG875 460 cid	RV12YC	0.9

**KOEHRING (→ Master)****KOLBERG****Conveyers & Stackers**

IHC VC135, VC153	D15Y	0.6
Ford 300 cid	RF10C	0.6
Ford 134, 172 & 192 cid	RH10C	0.6

**KOMATSU****Tractors & Lift Trucks**

FG10H-1, FG15H-1, FG10S-1, FG15S-1	RN5C	0.6
FG20-7, FG25-7, FG20S-3, FG25S-3	RN5C	0.6
FG30-7, FG30S-3, FG35-2, FG40-2	RN5C	0.6
FG50-2, FG60-2, FG50-3, FG60-3, FG70-3	RN5C	0.6

**KRANE KAR****Construction Machinery**

Continental 162, 224, 226	RD16	0.6
Ford	RF10C	0.8
Chrysler H318	RJ12YC	0.9
Chrysler 30, 31, 33	RJ6C	0.9
Chrysler HT361, HT48	RN5C	0.8

**KWICK-TOTER****Tractors & Lift Trucks**

All Models	RD16	0.6
------------	------	-----

**KWIK-MIX****Construction Machinery**

(18mm)	RD16	0.6
(14mm)	RJ8C	0.6

**KYSOR LEADER EVAPORATOR CO.****Construction Machinery**

Power Prod. AH47	RJ8C	0.6
------------------	------	-----

**L&A PRODUCTS****Steam Cleaners**

Kohler	10	RH10C	0.6
B&S	16	RJ19LM / QJ19LM	0.8
Kohler	8	RJ19LM	0.6

**LA PLANT-CHOATE****Starting Engines**

Continental	D14	0.6
Willys	RJ6C	0.6

**LAWNBOY****Space Heaters**

Models 53400, 53401	RN13LYC	1.3
---------------------	---------	-----

**LAYTON****Rollers**

Onan CCK, NH	RH8C	0.5
Tecumseh HH-100, HH-120	RJ8C	0.6
Onan NHC	RN5C	0.6

**LESSMAN****Shovels**

HFT0	Ford	RH10C	0.6
------	------	-------	-----



CC

BHP

21

**LEYLAND****Construction Machinery**

All Models

D14

0.6

**LIFT DYNAMICS****Tractors & Lift Trucks**

Scorpion

Ford 300 cid

RF10C

0.6

**LIMA****Construction Machinery**

All Other Models

W14

0.6

All Others

W14

0.6

Buda L-525

D23

0.6

Waukesha

K97F

0.5

**Shovels**

101

Models 34, 302, 303

W18

0.6

Models 405, 503, 550

W18

0.6

Models 601, 602, 701, 801

W18

0.6

**LINCOLN ELECTRIC****Welders**

225

Wisconsin THD

RD16

0.6

225 Lincwelder

Onan CCK

RH10C

0.6

Classic I, III

OE006

RN9YC

0.6

Power Arc 4000

RJ19LM /  
QJ19LM

0.8

Ranger 8

Kohler

18

OE013

RC12YC

1.0

Onan

16

RS17YX

0.6

Ranger 8 (LPG)

Onan

16

RS17YX

0.5

Ranger 9

Onan

18

RS17YX

0.6

SA200, SAF300

Continental

RD16

0.6

SAE300, SAE400

Continental

RD16

0.6

SAE600

Hercules G3400

RJ8C

0.6

Weldanpower 125

RJ19LM /  
QJ19LM

0.8

Weldanpower 130, 150 AC, 150 AC/DC

RH10C

0.6

Buda (18mm)

D14

0.6

Wisconsin

D16J

0.6

Kohler (Twin)

18

OE013

RC12YC

1.0

Kohler

10

RH10C

0.8

Onan CCK

RH8C

0.6

B&amp;S

8,9

RJ19LM /  
QJ19LM

0.8

Hercules (14mm)

RJ6C

0.6

White

RJ6C

0.6

Wisconsin TM27

OE006

RN9YC

0.6

Onan (Twin)

16,18

RS17YX

0.6

Onan Performer

16

RS17YX

0.6

Continental

RD16

0.6

Buda (7/8"-18)

W14

0.6

Hercules (7/8"-18)

W14

0.6

Waukesha

W14

0.6

**LINK BELT****Shovels**

58 Series

RD16

0.6

68 Series

W14

0.6

88 Series

Waukesha 140GK

RD16

0.6

Waukesha 135GZ

RH10C

0.6

98 Series

RD16

0.6

**LINN****Construction Machinery**

(14mm)

RJ6C

0.6

(7/8"-18)

W14

0.6

**LIQUID RED DIAMOND****Welders**

(18mm)

RD16

0.6

(14mm)

RH10C

0.6



CC

BHP

21

**LITTLEFORD****Construction Machinery**

(18mm)			RD16	0.6
Ford (14mm)			RH10C	0.6
Lauson			RJ19LM	0.6

**Pavers**

Paver Finisher BTF80			RD16	0.6
----------------------	--	--	------	-----

**Sprayers**

Roller S54V, Spraymaster			RD16	0.6
--------------------------	--	--	------	-----

**LOADKING****Tractors & Lift Trucks**

Ford 317			RH10C	0.6
Reo			RJ6C	0.6

**LOMBARD****Welders**

Welder			J4C	0.6
--------	--	--	-----	-----

**LONDON CONCRETE****Construction Machinery**

(18mm)			RD16	0.6
(14mm)			RJ8C	0.6

**LOOMIS****Well Drills**

All Models			RD16	0.6
------------	--	--	------	-----

**LORAIN (→ Thew)****LULL****Tractors & Lift Trucks**

800	Onan NHC		RN5C	0.6
1200	Continental Y-112		D21	0.6
T10G2, T10G4			RJ6C	0.6

**M.B.W.****Compactors**

Wisconsin			D16J	0.6
Robin			QL86C	0.6
Kohler	12		RH10C	0.6
Kohler	4,7		RJ19LM	0.6
Chrysler			RJ8C	0.6

**Screeds**

Screed	B&S		RJ19LM / QJ19LM	0.8
--------	-----	--	-----------------	-----

**M.H.F. WORK BULL****Tractors & Lift Trucks**

202C, 204, 302, 304, 356, 404, 1001			RD16	0.6
-------------------------------------	--	--	------	-----

**M.J.TAYLOR****Asphalt Maintenance Equipment**

Model 300 Sprayer	Honda	5.5	OE051	RN11YC	0.8
Model 550 Sprayer	Kohler	10		RH10C	0.8
T-2000	B&S	8		RJ19LM / QJ19LM	0.8
T-211 Paver	Honda (V-Twin)	20	OE051	RN11YC	0.8
T-240 Vibratory Roller	B&S (Twin)	18		RJ19LM / QJ19LM	0.8

**M.R.S.****Construction Machinery**

IHC UD-9, UD-16			D89D	0.6
IHC UD-18A			W89D	0.6

**MacDONALD****Tractors & Lift Trucks**

All Models			RJ8C	0.6
------------	--	--	------	-----





CC

BHP

21

**MAGINNISS****Construction Machinery**

Continental				<b>RD16</b>	0.6
Wisconsin ABNL, ACND, AENS, AKN				<b>RD16</b>	0.6
Wisconsin AKS, TE, TF, THD				<b>RD16</b>	0.6
Ford 172 cid				<b>RH10C</b>	0.6

**MAGNUM****Wheel Barrow**

Badger Buggy	Honda		13	<b>OE051</b>	<b>RN11YC</b>	0.8
--------------	-------	--	----	--------------	---------------	-----

**MAGNUM DIAMOND****Pavement Saws**

Wisconsin			37		<b>RD16</b>	0.6
Wisconsin			65	<b>OE042</b>	<b>RN12YC</b>	0.6

**MAHATO****Lift Trucks & Skid-Steers**

Continental			50		<b>RD16</b>	0.6
Kohler			8		<b>RJ19LM</b>	0.6
Onan (Twin)			18		<b>RS17YX</b>	0.6

**MAHTO****Mason Tenders**

Kohler			8		<b>RJ19LM</b>	0.6
--------	--	--	---	--	---------------	-----

**Power Buggys**

Honda			13	<b>OE051</b>	<b>RN11YC</b>	0.8
-------	--	--	----	--------------	---------------	-----

**MALL TOOL****Construction Machinery**

B&S (18mm)					<b>D14</b>	0.6
Own 5, 6, 7, 7G, 7H, 8, 14G					<b>D14</b>	0.6
Wisconsin AKN					<b>RD16</b>	0.6
Kohler			4		<b>RJ12C</b>	0.6
2-cycle (14mm)					<b>RJ6C</b>	0.6
4-cycle (14mm)					<b>RJ8C</b>	0.6
B&S (14mm)					<b>RJ8C</b>	0.6
Own DJ, 10, 11, 12, 12A, 2MG					<b>RJ8C</b>	0.6

**MANITOWOC****Speedcranes**

Waukesha 135, 145GKB					<b>RH8C</b>	0.6
Hercules HXB, HXE					<b>W18</b>	0.6

**MANO MFG. CO.****Construction Machinery**

Chrysler 61010, 86010					<b>QL82C</b>	0.8
-----------------------	--	--	--	--	--------------	-----

**MARION****Shovels**

Model 331	Buda L-525				<b>RD16</b>	0.6
Model 33M	Buda K-428				<b>RD16</b>	0.6
Model 342	Buda LO-525				<b>RJ6C</b>	0.6
Model 372 & 382	Buda JK-6				<b>W14</b>	0.6

**MARK****Rollers**

					<b>QL86C</b>	0.6
--	--	--	--	--	--------------	-----

**MARKLIFT****Tractors & Lift Trucks**

Onan					<b>RH8C</b>	0.6
------	--	--	--	--	-------------	-----

**MARSHALLTOWN****Power Trowels**

B&S					<b>RJ19LM / QJ19LM</b>	0.8
-----	--	--	--	--	------------------------	-----



CC

BHP

21

**MASSEY-FERGUSON****Lift Trucks & Skid-Steers**

MF20C, MF30B, MF202, 204

RD16

0.6

**Loaders**

MF40

Perkins 152, (3/8" Reach)

RJ8C

0.6

Perkins 152, (3/4" Reach)

OE098

RN4C

0.6

MF711B

Wisconsin VH4D

D16J

0.8

**Tractors & Lift Trucks**

2135, 2200

Continental Z134

RD16

0.6

MF20, MF20 Turf, MF40, MF2200

&gt;152UA15061A (3/8" Reach)

RJ8C

0.6

152UA15061A&gt; (3/4" Reach)

OE042

RN12YC

0.6

MF2500

Perkins AG3-152 &gt;152UA15061A (3/8" Reach)

RJ8C

0.6

Perkins AG3-152 152UA15061A&gt; (3/4" Reach)

OE042

RN12YC

0.6

MF4500

Continental Z145

RD16

0.6

MF6500

Perkins AG4-236 152UA15061A&gt; (3/4" Reach)

OE051

RN11YC

0.6

Perkins AG4-236 &gt;152UA15061A (3/8" Reach)

RJ8C

0.6

**Turf Tractors**

MF20

Perkins 152, (3/8" Reach)

RJ8C

0.6

Perkins 152, (3/4" Reach)

OE098

RN4C

0.6

MF30

Perkins 212, (3/8" Reach)

RJ8C

0.6

Perkins 212, (3/4" Reach)

OE051

RN11YC

0.6

**MASTER****Compactors**

B100000G

RH10C

0.6

C12C

D16J

0.6

P2000, P5000

RJ8C

0.6

T10000 A

L90C

0.6

Chrysler

RH8C

0.6

**Heaters (Oil Fired)**

30, 30A, 50A

OE042

RN12YC

1.1

**Pavers**

B&amp;S Model A

D14

0.6

Buda 6MO-970

D14

0.6

Buda HP205, HP217

D14

0.6

Waukesha 6 WAK, 140G, 145GS, 195-GKA

D14

0.6

Buda HP326, K-428, L515

D23

0.6

Waukesha WAK, WAL

RD16

0.6

Wisconsin (18mm)

RD16

0.6

Waukesha 140GZB

RH8C

0.6

Buda L0515

RJ6C

0.6

Chrysler C-36

RJ6C

0.6

Hercules HXC

RJ6C

0.6

Buda 6B273

RJ8C

0.6

LeRoi D-201, D-176

RJ8C

0.6

Waukesha 135GKB

RJ8C

0.6

Waukesha 6SRKR, 6SRKU, 6SRLR

W10

0.6

Case LAE, LIM

W14

0.6

LeRoi D-133, SRP, XRP

W14

0.6

Waukesha 6RBR, 6SRK, 6SRL, XAH

W14

0.6

Wisconsin (7/8"-18)

W14

0.6

**Power Screeds**

AVS

D16J

0.6

SWS-2

RJ8C

0.6

**Power Trowels**

29GT, EC34, F36B, F46B, RF3B3

RJ8C

0.6

**Rollers**

TVR26, TVR30

RH10C

0.6

**Vibrators**

20U

RJ8C

0.6

23U, PMR2500, PMR2502

D16J

0.6

(18mm)

RD16

0.6

Chrysler

RH10C

0.6

(14mm)

RJ8C

0.6

(7/8"-18)

W14

0.6



CC

BHP

21

**MAXIMAN****Skid-Steers**

B&S Vanguard (V-Twin)	16		RJ14YC	0.8
Honda OHV	13	OE042	RN12YC	0.8

**M-B GRADERS****Construction Machinery**

IHC U-4, U-6, IU-6			D14	0.6
IHC UD-6			D89D	0.6
Wisconsin			RD16	0.6
Onan CKSA			RH8C	0.6
Lauson			RJ19LM	0.6
M-M 283-4A (High Comp.)			W10	0.6
M-M 283-4A (Low Comp.)			W14	0.6

**McCULLOCH****Construction Machinery**

15-M			RJ8C	0.6
<b>Drills</b>				
Mac GPD			RDJ8J	0.8
Titan GPD 22			RDJ8J	0.8
<b>Earth Drills</b>				
99			RJ8C	0.6
<b>Fire Pump</b>				
7FP Normal Service			RJ8C	0.6
7FP Severe Service			RJ6C	0.6
<b>Welders</b>				
W1-A1, A2 170 Amp. Welder			J4C	0.6

**MEAD****Tractors & Lift Trucks**

MM			RJ8C	0.6
Speed Cat			RD16	0.6

**MELROE****Lift Trucks & Skid-Steers**

(LPG)	Onan CCK		RH10C	0.5	
	Kohler	24	RJ19LM	0.5	
98 cid	Ford Industrial		OE006	RN9YC	0.6
M440, M444				RH8C	0.6
M500				RJ8C	0.6
M500 (LPG)				RJ6C	0.4
	Onan CCK			RH10C	0.6
	Kohler	24		RJ19LM	0.8
	Mitsubishi	36	OE049	RN11YC4	1.1
	Wisconsin VH4D			RD16	0.6
	Kohler	14,23		RH10C	0.8
	Mitsubishi 4G32			RN14YC	0.6
	Kohler (Twin)	16,18		RV17YC	0.6

**MERCURY****Tractors & Lift Trucks**

A460GT, A460PT	Ford			RH8C	0.6
Banty	(18mm)			RD16	0.6
	(7/8"-18)			W18	0.6
Superhuskie, Huskie				RJ8C	0.6

**MICHIGAN****Tractor Shovels**

Waukesha 135GZ				RH8C	0.6
Waukesha F265G			OE051	RN11YC	0.6
Waukesha F283K			OE042	RN12YC	0.6
Continental F-244, F-226				RD16	0.6
Waukesha 180GKB, 190GLB				RD16	0.6

**Tractor-Shovel**

Series II	Waukesha 135-GZ			RH8C	0.6
	Waukesha F-283G		OE042	RN12YC	0.6
	Continental F-224			RD16	0.6



CC

BHP

21

**MIGHTY MAN**

<b>Borers</b>					
Mighty Mole M470, M1800				D16J	0.6
<b>Graders</b>					
	(18mm)			RD16	0.6
	(14mm)			RJ8C	0.6

**MIKASA**

<b>Tamping Rammers</b>					
MTR-60L				QL86C	0.8

**MILLER**

<b>Concrete Saws &amp; Concrete Buggies</b>						
	Honda OHV	8,11,13		OE051	RN11YC	0.8
<b>Curbers</b>						
Curbiler	Honda (MC250)	4		OE051	RN11YC	0.8

**MILLER ELECTRIC**

<b>Welders</b>						
AD-225-L	Kohler	24		RJ19LM	0.8	
AEA-200, AEA-200-E	Onan CCK			RH10C	0.6	
AEA-200-L, AEA-200-LE	Onan CCK			RH10C	0.6	
AEAB-200-LE	Onan CCK			RH10C	0.6	
AEAD-200, AEAD-200-E	Onan CCK			RH10C	0.6	
AEAD-200-L, AEAD-200-LE	Onan CCK			RH10C	0.6	
Bantam 2, 2E	Wisconsin S12, Big 20G			RD16	0.6	
Big 40G				OE006	RN9YC	0.6
Blue Star 180K	Kohler			OE013	RC12YC	1.0
Bobcat 225G Plus					RS17YX	0.6
Memco Bantam	Kohler	14			RJ19LM	0.8
Miller Legend, Trailblazer 250G					RS17YX	0.6
Roughneck 2					QL82C	0.8
Trailblazer I, II, III, IV	Wisconsin	37			RD16	0.6
Trailblazer, J Series Jeep F4					RJ8C	0.8
	Tecumseh	16			QL82C	0.8
	Wisconsin	28			RD16	0.6
	Onan B48M				RH18Y	0.6
	Wisconsin TM20			OE006	RN9YC	0.6
	Onan (Twin)	16,18,20			RS17YX	0.6
	Onan Performer				RS17YX	0.6

**MINNEAPOLIS-MOLINE**

<b>Graders</b>					
GTB, GTG, UTG				W14	0.6
<b>Tractors &amp; Lift Trucks</b>					
(LPG)	Taunis (Germany)			QL82YC	0.4
MY40, MY60				D14	0.6

**MI-T-M**

<b>Washer</b>					
			2004→	RCJ8	0.6

**MITSUBISHI**

<b>Off-Road Utility Vehicle</b>						
Mighty Mits		30		OE051	RN11YC	0.9
<b>Tractors &amp; Lift Trucks</b>						
FG-10, -15, -20, -25, -30					RN14YC	0.6
FG-35, -40				OE042	RN12YC	0.6

**MITTS & MERRILL**

<b>Saws</b>						
M-13, M-9	Ford 330 cid				RF10C	0.8
M-2	Ford 172 cid				RH10C	0.8
M-3, M-4, M-6	Ford 240 cid				RF10C	0.8
M-7, M-8, M-11, M-12	Ford 300 cid				RF10C	0.8



CC

BHP

21

**MI-T-VAC****Construction Machinery**

B&amp;S

RJ19LM /  
QJ19LM

0.8

Tecumseh

RJ8C

0.8

**MIXERMOBILE****Construction Machinery**

Ford

RH10C

0.6

Chrysler 6-Cyl.

RJ6C

0.9

Chrysler V-8 (3/8" Reach)

RJ6C

0.9

**Foldway Lift**

Chrysler

RJ6C

0.6

**Tower Crane**

Ford V-8

RH8C

0.6

**Tractors & Lift Trucks**

B

RD16

0.6

D, L, M, ER, HR

RJ8C

0.6

E, F, H, K

RJ12C

0.6

**MOBILIFT (→ White Mobilift)****MOBILOADER****Caterpillar Tractor**

D-4

D9

0.6

**Construction Machinery**

Caterpillar Tractor D-4

D14

0.6

**MODWELL****Tracked Carriers**

Brush Pick-up

Ford 200 cid

RF11YC

0.6

RN35, RN75, RN110

Ford 300 cid

RF10C

0.6

Ford 240 cid

RF11YC

0.6

GM 478 cid

OE098

RN4C

0.6

Snowpacer

Ford 200 cid

RF11YC

0.6

**MONARCH****Concrete Mixers**

TOXG, TOXWG, 11XG, 11XWG

RCJ8

0.6

4-SGW, 5-SGW, 6-SGW, 6-SRGW

QL86C

0.6

C3-SD, C6-SDBS, 4-SG, 6-SG

RCJ8

0.6

C6-SD

D16J

0.6

M10GW, SM10GW

QL86C

0.6

**MORRISON****Material Spreaders, Power Buggys, Screens & Sprayers**

B&amp;S Vanguard

13

OE013

RC12YC

0.8

B&amp;S Vanguard (V-Twin)

16,18

RC14YC

0.8

B&amp;S

3

RJ19LM /

0.8

QJ19LM

Honda OHV

5.5,8,11,13

OE051

RN11YC

0.8

Honda OHV

5

OE006

RN9YC

0.8

**MORRISON-PELSUE****Space Heaters**

ACH

QL87YC

1.3

ACM, PE-1, PEG-3

L20V

PE-1A, PEG-3A

RCJ4

1.3

PEG-8, PEG-12, ACM

L20V

PEG-8A, PEG-12A

RCJ4

1.3

**MOTO PAVER****Construction Machinery**

All Models

RJ8C

0.6

**MOTO-BUG****Tractors & Lift Trucks**

Wisconsin AK

D14

0.6



CC

BHP

21

**MOTO-TRUC**Tractors & Lift Trucks  
Ready Power Z & W

RJ12C 0.6

**MQ POWER**Compactors, Finishers, Rammers, Rollers & Welders  
Gladden 75

Robin EC17F			RJ8C	0.6
Robin EC08G, EC12D, ET-40D			L90C	0.6
Robin EY-20W, EY27, EY-280W			QL86C	0.6
Robin EY-44W			QL86C	0.6
Wisconsin	4.6		QL86C	0.6
Wisconsin	7.5		QL87YC	0.6
B&S 3-Cyl. (liquid cooled)	31	OE013	RC12YC	0.8
Kohler (V-Twin)	20,25	OE013	RC12YC	0.8
B&S Vanguard (V-Twin)	16,18		RC14YC	0.8
Wisconsin AKN & BKN			RD16	0.6
Robin EC08GH, EC10G			RJ12C	0.6
B&S	3,5,7,8		RJ19LM / QJ19LM	0.8
Wisconsin	11		RL95YC	0.6
Honda OHV	8,11	OE051	RN11YC	0.8
Honda OHV	5	OE006	RN9YC	0.8
Onan (Twin)	24		RS17YX	0.6
Kohler (Twin)	20		RV17YC	0.6

**Concrete Pumps**

OE042 RN12YC 0.8

**Power Buggys**

Wisconsin D16J 0.6

**MTA****D.C. Arc Welders**

Honda OHV 13 OE051 RN11YC 0.8

**MULLER****Construction Machinery**

Wisconsin			RD16	0.6
B&S			RJ19LM / QJ19LM	0.8

**MULTI-FOOTE****Pavers**

Buda			RD16	0.6
Continental 31R			RD16	0.6
Hercules YXC, YXC3			W14	0.6
Waukesha SRK			W14	0.6

**MUNCIE****Construction Machinery**

OB1, OB32C, OB63, CM3, Bicycle D14 0.6

**Utility Engines**

OB16, UM3 D14 0.6

**MUSTANG****Skid-Steers**

Onan (Twin) 20,24 RS17YX 0.6

**NAMCO****Tractors & Lift Trucks**

Onan CCK, CCKB			RH10C	0.6
Onan NHBV			RN5C	0.6

**NAPCO****Tractors & Lift Trucks**

44PG-1000, 42PG-1000 RD16 0.6



CC

BHP

21

**NATIONAL CARBON****Ovens**

(1/2"-14 Pipe)

25

0.6

**NELSON****Loaders**

All Other Models

RD16

0.6

K-5, KR-5

RD16

0.6

P-10, Q-10, R-10

RJ12C

0.6

**NEVARR****Vibratory Plate Compactors**

Honda

5.5

OE051

RN11YC

0.8

**NEW HOLLAND****Skid-Steers**

L-250

Onan (Twin)

20

OE011

RS9YC

0.9

L-464

OE011

RS9YC

0.9

LS120

Onan

18

RS17YX

0.6

**NISSAN****Tractors & Lift Trucks**

All Models (LPG)

OE098

RN4C

0.4

D11, DK11, D11K

RN5C

0.6

F01, F02, B02

H20

RN5C

0.6

F03, B01, B02

J15

RN5C

0.6

H30 P

RN5C

0.6

H20, H21, H30, J15

RN5C

0.6

**NODWELL****Brush Pick-up**

GM 478 cid

OE098

RN4C

0.6

**Construction Machinery**

RN35, RN75, RN110

Ford 240

RF9YC

0.6

Ford 300 &amp; 330 cid

RF10C

0.6

Ford 200 cid

RF11YC

0.6

Ford 200 cid (Heavy Service)

RF9YC

0.6

**Tracked Carriers**

Snowpacer

GM 478 cid

OE098

RN4C

0.6

**NORTHWEST****Shovels**

All Other

(14mm)

RJ12C

0.6

(18mm)

RD16

0.6

(7/8"-18)

W14

0.6

Model 4

RD16

0.6

Model 41

Continental R-602

RD16

0.6

Models 25-D, 41-D

Continental B-427

D14

0.6

Models 5, 6, 85

Waukesha 135GZU

W18

0.6

IHC PD-40, PD-80

RD16

0.6

W89D

0.6

**NOVO****Construction Machinery**

A-16, CA-33, DA-33

(18mm)

RD16

0.6

All

(1/2"-14 Pipe)

25

0.6

BA-23, DA-33

(14mm)

RJ6C

0.6

CW Series 33, 47, 66, 95, 133

RD16

0.6

CWR Series 47, 66, 95, 133

RJ8C

0.6

**OHIO****Locomotive Cranes**

(18mm)

RD16

0.6

(7/8"-18)

W14

0.6



CC

BHP

21

**OK CHAMPION****Sewer Cleaners**

8-R6, 9-R6, 23-R6	B&S			RJ19LM / QJ19LM	0.8
	LeRoi B45			RD16	0.6
	Wisconsin AFN, AHH, TF, TH, VG4D			RD16	0.6
	Continental AU7			RJ8C	0.6
	Onan			RJ8C	0.6

**OLATHE****High Lifts**

RCJ8 0.6

**OLIVER****Crawlers**

2-44, 2-44L, 2-44LL, 2-44FL				RD16	0.6
2-62, 2-62L, 2-62-15				RD16	0.6
2-78, 2-78L, 2-78-15			OE051	RN11YC	0.6
2-78-17, 4-78, 4-78L			OE051	RN11YC	0.6
4-78-15, 4-78-17, 2-105, 4-105			OE051	RN11YC	0.6

**Tractors & Lift Trucks**

550	Normal Service			RD16	0.6
2-63	Waukesha F232G Normal Service			RD16	0.6
2-44, 2-44-L, 2-44-LL	Severe Service			D14	0.6
	Normal Service			RD16	0.6
2-44-FL, 2-62, 2-62-L, 2-62-15	Severe Service			D14	0.6
	Normal Service			RD16	0.6
263FL	Chrysler HB225 Normal Service		OE042	RN12YC	0.6
	Chrysler HB225 Severe Service			RN5C	0.6
2-78, 2-78-L, 2-78-15, 2-78-17, 2-105	Normal Service		OE051	RN11YC	0.6
4-78, 4-78-L, 4-78-15, 4-78-17, 4-105	Normal Service		OE051	RN11YC	0.6
550; 263	Waukesha F232G Severe Service			D14	0.6

**OMC****Mowers**

1980 → RF11YC 0.6

**Tractors & Lift Trucks**

Haulster (CNG)			1983 →	RF11YC	0.6
Truckster (18mm)			1953 → 1961	RF11YC	0.6
Truckster/Haulster (14mm)			1968 → 1980	RCJ8	0.6
	(18mm)		1961 → 1980	RF11YC	0.6
	(14mm)		1967 →	RJ8C	0.6
Kohler		12		RH10C	0.8
Kohler (K181)		8		RJ19LM	0.8

**ORTAS****Backhoes**

Kohler OHV 11,14 OE013 RC12YC 0.8

**Diggers**

Pussy Cat Minidigger OE013 RC12YC 0.8

**ORTON****Cranes, Shovels**

40	Caterpillar D-17000			W18	0.6
25, 30	(18mm)			RD16	0.6
25, 30	Caterpillar D-13000			W14	0.6
Other	(7/8"-18)			W14	0.6
	Waukesha 6TL			RD16	0.6
	Hercules DX			W18	0.6
	IHC PD-40			W89D	0.6

**OSBORNE****Fire Fighter**

RD16 0.6

**OSGOOD****Construction Machinery**(18mm) RD16 0.6  
(7/8"-18) W14 0.6





CC

BHP

21



mm

**OTTAWA****Hydra Hammers**Wisconsin  
FordRD16  
RF11YC0.8  
0.9**Tractors & Lift Trucks**FA-8 Yard Hustler  
Tracto-LiftRF10C  
RD160.6  
0.6**OUT CLAW****Pickup Backhoes**

Honda OHV

11

OE051

RN11YC

0.8

**P&H EXCAVATORS****Construction Machinery**Ford (18mm)  
Continental Y-91  
Waukesha (18mm)  
Ford (14mm)  
Chrysler 12  
Waukesha (7/8"-18)  
LeRoiD14  
RD16  
RD16  
RH8C  
RJ6C  
W14  
W180.6  
0.6  
0.6  
0.6  
0.6  
0.6  
0.6**PAGE****Construction Machinery**

(7/8"-18)

W18

0.6

**PAPEC****Construction Machinery**Ford 330 cid  
Ford 223 cidRF10C  
RF11YC0.8  
0.9**PARKERLIFT****Tractors & Lift Trucks**

Onan

RH8C

0.6

**PARMANCO****Drills**

All Models

RD16

0.6

**PARSONS****Ditchers, Backfillers**

All Other

(7/8"-18)  
Caterpillar D-8800  
Waukesha 6BZ, 6BZU, 6MZA, 6MZAU  
IHC UD-9, UD-9A  
Caterpillar D-318  
Waukesha 140GS, 140GKU, 140SU  
Waukesha 145GKU, 195GKU  
Wisconsin VP4  
Hercules JX4C  
IHC U-9  
IHC UD-14A, UD-18AW14  
D14  
D14  
D89D  
RD16  
RD16  
RD16  
RD16  
RJ8C  
W10  
W89D0.6  
0.6  
0.6  
0.6  
0.6  
0.6  
0.6  
0.6  
0.6  
0.6  
0.6**PARTNER****Hydraulic Power Packs**

HP38

14,16

RJ19LM /  
QJ19LM

0.8

HP40

16

OE013

RC12YC

0.8

HP40 MARK II

16

OE013

RC12YC

0.8

**PAYLOADER (→ Hough)****PECO****Concrete Saws**

Honda

11,13

OE051

RN11YC

0.8



CC

BHP

21

**PETTIBONE MERCURY****Tractors & Lift Trucks**GA-45A, -55A, -60A, GS/GA-30, -40, -50  
GSO/GA-60J, -70J, -80J  
GS4-20, GSO/GA-60,-70,-80, -100, -120RD16 0.6  
RD16 0.6  
RD16 0.6**PLUS POWER****Vibratory Plate Compactors**DPV90  
Wisconsin 5 QL86C 0.6  
QL86C 0.6**POLECAT****Aerial Lifts**

Kohler (V-Twin) 18 OE013 RC12YC 0.8

**PORTO-ARC****Multi-Purpose Saws**

52-12, 52-14, 45-12 RCJ4 0.6

**Welders**

Onan CK RH10C 0.6

**POWER CURBER****Curbers**Wisconsin AENL, S12D, TJD D16J 0.8  
Wisconsin AGND D21 0.8  
Kohler 18 RH10C 0.6**POWERMATE****Welders**

Powerweld 140 RCJ8 0.6

**POW-R-LINE****Construction Machinery**M-30, M-60 Wisconsin 37 RD16 0.6  
M-60 Wisconsin V460 OE042 RN12YC 0.6  
T-100 D21 0.8  
T-200, T-300 RD16 0.6  
T-400 Ford RH10C 0.6  
T-600 Ford RF9YC 0.6**POW-R-SPADE****Construction Machinery**

Wisconsin AGND RD16 0.6

**PRIME MOVER****Construction Machinery**LD-50 Ford 172 cid RH10C 0.6  
Wisconsin D16J 0.6  
Kohler (K181) 8 RJ19LM 0.6**Tractors & Lift Trucks**LL-40 Ford 172 cid 1978→ RH10C 0.6  
Wisconsin RD16 0.6  
Kohler RJ8C 0.8**QUICK WAY****Shovels**105A, 125A RD16 0.6  
85A D23 0.6  
E, L W14 0.6  
JS, E2, J2, L2, S2, S3 D9 0.6  
IHC U-4 D21 0.6  
IHC U-9 W14 0.6**RACINE****Compactors, Drills & Saws**Anchor-Fast, Hydra-Quad, Octa-Gun RD16 0.8  
Presser 1100 B&S RJ19LM / QJ19LM 0.8  
Presser 1300 Wisconsin 18 RD16 0.6



CC

BHP

21

mm  
**...RACINE****...Compactors, Drills & Saws**

Presser 240G	Ford V104		OE006	RN9YC	0.6
Racine 101 2-Cycle				RJ8C	0.6
Rail Drill, Rail Saw				RJ8C	0.6
Rammer 117, Rapak 101				RD16	0.6
Ratamp				RD16	0.6
Repar 2-Cycle				RD16	0.6
Repar 4-Cycle				RH10C	0.6
Spadak, Spade, Unit Tamper				RJ8C	0.6
	Clinton 4-cycle			RH10C	0.6
	B&S 4-cycle			RJ19LM / QJ19LM	0.8
	Jacobsen 321			RJ8C	0.6

**RACO****Drills**

	(18mm)			RD16	0.6
	(14mm)			RJ8C	0.6

**RAMROD****Skid-Loaders**

	Kohler	23		RH10C	0.8
--	--------	----	--	-------	-----

**Skid-Steers**

	B&S Vanguard (V-Twin)			RC14YC	0.8
--	-----------------------	--	--	--------	-----

**RANGER****Tractors & Lift Trucks**

V				RH10C	0.6
VII				RH10C	0.6

**RANSOME****Mixers & Pavers**

	LeRoi B-45, D-226 (18mm)			D14	0.6
	Continental FA-162, M-330			RD16	0.6
	Hercules HXE (18mm)			RD16	0.6
	LeRoi D-91, D-140			RD16	0.6
	LeRoi VRP206			RD16	0.6
	Wisconsin ABN, AK, AKN, TF, VF-4			RD16	0.6
	Hercules RXLD (14mm)			RH10C	0.6
	B&S			RJ19LM / QJ19LM	0.8
	Continental G-193			RJ6C	0.6
	Chrysler 6A			RJ8C	0.6
	LeRoi B-45, D-226 (14mm)			RJ8C	0.6
	Hercules IXB, IXB-5, JX4D3, QXB			W14	0.6
	Hercules QXC, QXC-5, QXD, QXD-5			W14	0.6
	Hercules RXLD (7/8"-18)			W14	0.6
	IHC LB			W14	0.6
	Hercules HXE (7/8"-18)			W18	0.6

**REDDY****Heaters**

M-30, M-50A			OE042	RN12YC	0.6
	(18mm)			RD16	0.6

**RED-E-HOT****Heaters**

				RH10C	0.6
--	--	--	--	-------	-----

**RELIANCE****Construction Machinery**

	IHC UD-9A			D89D	0.6
	A-C (14mm)			RJ8C	0.6
	A-C (7/8"-18)			W10	0.6



CC

BHP

21

**REMINGTON****Construction Machinery**

44"				RCJ8	0.6
<b>Saws</b>					
Pow-R-Cut Saw				CJ6	0.6
<b>Screeds, Trowels</b>					
Screed, Power Trowel 28" & 34"				RJ8C	0.6
<b>Vibrators</b>					
Wisconsin				D16J	0.6
B&S				RJ19LM / QJ19LM	0.8

**REX PAVERS****Construction Machinery**

Waukesha 6GAK, 6GAL				D14	0.6
Waukesha 6MZU, 135GKU				D14	0.6
B&S (18mm)				RD16	0.6
Continental F-140, F-186, F-4140				RD16	0.6
Continental F-6186, F-4162, F-6226				RD16	0.6
Hercules IXB-5				RD16	0.6
Waukesha 145GK, 145GS, 195GKU				RD16	0.6
Waukesha 6BZU, FCU, 140GS				RD16	0.6
Wisconsin (18mm)				RD16	0.6
B&S (14mm)				RJ19LM / QJ19LM	0.8
Kohler	4			RJ19LM	0.8
Lauson				RJ19LM	0.6
Chrysler 30, 30A, 32				RJ8C	0.6
Chrysler 5, 6A, 8, 8A				RJ8C	0.6
Hercules IXLB				RJ8C	0.6
LeRoi D-226				RJ8C	0.6
Wisconsin (14mm)				RJ8C	0.6
Waukesha XAHU				W14	0.6
IHC UD-264				W89D	0.6

**RICHARDS CO.****Pipe Benders**

MUB-10	B&S	5		RJ19LM / QJ19LM	0.8
--------	-----	---	--	-----------------	-----

**RIISE****Oil Drillers**

RD16 0.6

**ROME GRADERS****Construction Machinery**

101	IHC			W14	0.6
103	IHC			RD16	0.6
104, 203, 301	IHC			W89D	0.6
201, 202	IHC			W18	0.6
201, 202, 203,	Oliver			W10	0.6
201, 202, 301	Case			W14	0.6
301, 302, 303,	Oliver			W10	0.6
302, 303	Case			W14	0.6
	IHC			W89D	0.6

**ROSS****Tractors & Lift Trucks**

Continental F-4162, F-6209, F-6226, Y-112				RD16	0.6
Hercules JXLD				RD16	0.6
Wisconsin				RD16	0.6
Ford				RH8C	0.6
Hercules JXC, QXC-3, QXC-5 (14mm)				RJ6C	0.6
Hercules JXC, QXC-3, QXC-5 (14mm)				RJ6C	0.6
Hercules QXC-5, OOC (7/8"-18)				W10	0.6
Hercules JXC, JXD, WXC-2, WXL-3 (7/8"-18)				W14	0.6



CC

BHP

21



mm

**ROUSTABOUT****Construction Machinery**

Ford 7HNN, 8MNN

RH10C

0.6

**RPC CORP. (→ Speedloader)****S&L CRANES****Construction Machinery**

Case D1 (18mm)

IHC 1-6

(7/8"-18)

D9

0.6

D9

0.6

W14

0.6

**Cranes****Lodover**

IHC TD-9, UD-9

D89D

0.6

**SALSBURY****Tractors & Lift Trucks****All Models**

RD16

0.6

**SANDERSON CYCLONE****Drills****All Other Models**

1937→1940

W18

0.6

W10

0.6

**SCHRAMM****Construction Machinery****125 Pneumatic****125, 250 Pneumatractor****250 Pneumatic**

K97F

0.6

RD16

0.6

W89D

0.6

**Crawlers****60 Crawler**

RH10C

0.6

**SCHWARZE****Sweepers**

Wisconsin

30

RD16

0.6

**SCHWITZER-CUMMINS****Tractors & Lift Trucks****Load Dispatcher**

RD16

0.6

**SCOOT-CRETE****Tractors & Lift Trucks**

Wisconsin ANLD, TJD

Kohler

10,20

Kohler (K181)

8

RD16

0.8

RH10C

0.8

RJ19LM

0.8

**SEAMAN****Construction Machinery**

Waukesha 6BZ, 6MZAU

Continental B-427, M-330

Wisconsin VH4

Ford 172 cid

D14

0.6

RD16

0.6

RD16

0.6

RH10C

0.6

**SECO****Fire Truck**

RD16

0.6

**SERVICE CASTER****Tractors & Lift Trucks****All Models**RJ19LM /  
QJ19LM

0.6

**SHOP MULE****Tractors & Lift Trucks****A21****A3V, A3VU2, A14V****J233, J233PLD**

RD16

0.6

D21

0.6

RJ19LM /  
QJ19LM

0.8

**Spotter**

Chrysler LH318

Chrysler HB225

OE042

J11C

0.6

RN12YC

0.9

RV12YC

0.9



CC

BHP

21

**SILENT HOIST****Tractors & Lift Trucks**

A, AJ, AN, AXH, AYH, AZH

AX, AY, AZ, CD, CDH

CD, FK-5, FK-6

(18mm)

(14mm)

CDY, FK, FK-3, FK-10

(18mm)

(14mm)

FK7-1/2, FK8, FK12, FK15

Liftruck Model 20

Continental F-4162, F-6226, F-6244

Ford 292 &amp; 300 cid

Chrysler IND-30, 31, 33

Chrysler H318

Hercules JX4D3

Chrysler LH318

Chrysler HT361, HT413

Ford 351W cid

D9

0.6

RJ8C

0.6

D9

0.6

RJ12C

0.6

D14

0.6

RJ8C

0.6

RJ8C

0.6

RD16

0.6

RD16

0.6

RF10C

0.8

RJ12C

0.6

RJ12YC

0.9

RJ19LM

0.6

OE042

RN12YC

0.9

RN5C

0.8

RV12YC

0.9

**SKAGIT HOISTS****Construction Machinery**

Caterpillar Starting (18mm)

Waukesha 145GK, 145GS, WAK

Waukesha FC, BZ, MZA, 140GK

Wisconsin VP-4

Ford 6 &amp; 8 Cyl. (18mm)

Ford 6 &amp; 8 Cyl. (14mm)

Ford 4-Cyl.

Waukesha ICK

Hercules IXB5, JXD

Hercules QXC5, RXLD, WXLC

Caterpillar Starting (7/8"-18)

Hercules HXC, HXE

D9

0.6

D9

0.6

D9

0.6

RD16

0.6

RF10C

0.6

RH10C

0.6

RH8C

0.6

RJ6C

0.6

RJ8C

0.6

W10

0.6

W14

0.6

W18

0.6

**SKIL****Compactors**

(18mm)

(14mm)

D16J

0.6

RCJ8

0.6

**Concrete Screeds, Power Trowels**

(18mm)

(14mm)

D16J

0.6

RCJ8

0.6

**Construction Machinery**

2910-T2-00, 2911-T2-00 (14mm)

2911-T1, 2912-T1, 2913-T1 (14mm)

2912-T2-00, 2913-T2-00 (14mm)

30-550, 2900-T1 (7/8"-18)

BR-5 (7/8"-18)

CJ6

0.6

J4C

0.6

CJ6

0.6

W18

1.7

W18

1.5

**Generators, Alternators, Vibrators**

(18mm)

(14mm)

D16J

0.6

RCJ8

0.6

**Hammers**

628-T1, 628-T2 (14mm)

M1, 2910-T1 (14mm)

RCJ8

0.6

J4C

0.9

**SMITH-MOBILE****Concrete Mixers**

J11C

0.6

**SMITHWELL****Welders**

All Other Models

G-2

25

0.6

W18

0.6

**SNOGO****Snow Removers**

FLMU, MTR

LTR And All Others

W10

0.6

W14

0.6



CC

BHP

21

mm  
**SOUTH BEND****Construction Machinery**Continental  
WisconsinRD16 0.6  
RD16 0.6**SPEARS-WELLS****Construction Machinery**IHC U-1, U-2A  
Continental Y-112  
Wisconsin  
Ford 6 Cyl. & V-8 (18mm)  
Ford 6 Cyl. & V-8 (14mm)  
B&S  
  
Hercules WXL-3 (14mm)  
Hercules WXL-3 (7/8"-18)D14 0.6  
RD16 0.6  
RD16 0.6  
RF10C 0.6  
RH8C 0.6  
RJ19LM /  
QJ19LM 0.8  
RJ8C 0.6  
W10 0.6**SPEEDLIFT****Tractors & Lift Trucks**

All Models

RJ12C 0.6

**SPEEDLOADER****Straddle Cranes**C1100, I-600-T  
C500, C502, C750, I-400-T  
I-800-TRF11YC 0.6  
RJ6C 0.6  
RF9YC 0.6**SPERRY-NEW HOLLAND****Loaders**L250  
L325, 778  
L35, 225, 425, 445  
L775  
L7791984→  
1979→1982  
1975→1982  
1982→  
1982→

OE051

RS12YC 0.6  
RH10C 0.6  
RD16 0.6  
RN11YC 0.6  
RF10C 0.6**SPRAY KOTE****Asphalt Maintenance Equipment**

Asphalt Sprayers

RCJ8 0.6

**STANCO****Construction Machinery**

Ford 262 cid

RF10C 0.6

**STERLING****Earth Borers**8-Cyl.  
6-Cyl.1955→  
1955→RF11YC 0.6  
RF9YC 0.6**STONE****Compactors**Kohler  
B&S  
  
Chrysler  
Robin EY21W  
Robin  
Honda OHV  
Honda OHV  
Robin  
Kohler (Twin)8  
5  
  
7.5  
8,9,11  
5  
4.6  
20

OE051

OE006

OE006

RH10C 0.8  
RJ19LM /  
QJ19LM 0.8  
RJ8C 0.6  
RJ8C 0.6  
RL95YC 0.6  
RN11YC 0.8  
RN9YC 0.8  
RN9YC 0.6  
RV17YC 0.6**STOW****Compactors, Concrete Saws & Mixers**Robin  
Robin  
Robin  
B&S Vanguard  
B&S Vanguard (V-Twin)  
Wisconsin1.5  
2.5  
3.3,4,11  
9  
16  
9.2,18,35

OE013

CJ14 0.6  
QL82C 0.6  
QL86C 0.6  
RC12YC 0.8  
RC14YC 0.8  
RD16 0.6



CC

BHP

21

**...STOW****...Compactors, Concrete Saws & Mixers**

Kohler	8,12,14,16	RH10C	0.8
Robin	3	RJ12C	0.6
B&S	3,7,5,7	RJ19LM / QJ19LM	0.8
B&S	8,10	RJ19LM / QJ19LM	0.8
Robin	7.5	RL95YC	0.6
Honda OHV	4,5,5,8	OE051 RN11YC	0.8
Honda OHV	9,11,13	OE051 RN11YC	0.8
Wisconsin	65	OE042 RN12YC	0.8
Robin	4.6	OE006 RN9YC	0.6

**SWEEPSTER****Power Broom**

C-36	B&S	RJ19LM / QJ19LM	0.8
------	-----	-----------------	-----

**Sweepers**

TP-60 Street Sweeper	Wisconsin	RD16	0.6
----------------------	-----------	------	-----

**SYNTRON****Vibrators**

Own PB-55, RD-55		D14	0.6
Own PB-51		RD16	0.6
Wisconsin AKN, AKS, BKN		RD16	0.6

**TAMPO****Construction Machinery**

HC		RD16	0.6
	Oliver 66, Super 66, Super 88	D14	0.6
	Chrysler 6A	RJ6C	0.6

**TARGET****Concrete & Cut-Off Saws, Groovers, & Scarifiers**

Super Quickie	2-Cycle	OE042 RN12YC	0.8
	Honda	CJ14	0.8
	Wisconsin	QL86C	0.6
	Wisconsin	QL87YC	0.6
	2,3,5,7,5		
	B&S Vanguard	OE013 RC12YC	0.8
	9	OE013 RC12YC	0.8
	Kohler OHV	RC14YC	0.8
	14		
	B&S Vanguard (V-Twin)	RD16	0.8
	16		
	Wisconsin	RD16	0.8
	9,18,35,37		
	Kohler	RH10C	0.8
	8,14,16		
	McCulloch 795L	RJ8C	0.6
	Honda OHV	OE051 RN11YC	0.8
	5,5,8,13		
	Wisconsin	OE042 RN12YC	0.8
	65		
	Kohler (Twin)	RV17YC	0.6
	20		

**TAYLOR****Tractors & Lift Trucks**

TC200-300	Ford	RF9YC	0.6
	Chrysler	OE042 RN12YC	0.6
TY100-150		RF9YC	0.6
Yardster All Models		RF10C	0.6

**TCM****Fork Lift**

Nissan A15, H20, H30		RN5C	0.6
----------------------	--	------	-----

**TECHNOID****Tractors & Lift Trucks**

Wilkra		RJ8C	0.6
--------	--	------	-----

**TENNANT****Floor Cleaners**

36	(18mm)	RD16	0.6
	(14mm)	RH10C	0.6
42JS		RJ8C	0.6





CC

BHP

21



mm

**...TENNANT****...Floor Cleaners**

86, 86DP, 90

8GLP/DP, 90LP

C, G, J, K, K4, L

T100

Ford 4-cyl.

RD16

0.6

D9

0.6

RD16

0.6

RJ6C

0.6

OE011

RS9YC

0.9

**TERRAMITE****Backhoe Loader**

T5

B&amp;S (Single)

RJ19LM /

0.8

QJ19LM

B&amp;S (Twin)

18

RJ19LM /

0.8

QJ19LM

Kohler (V-Twin)

20

OE013

RC12YC

0.8

B&amp;S Vanguard (V-Twin)

20

RC14YC

0.8

Honda (V-Twin)

20

OE051

RN11YC

0.8

Kohler (Twin)

20

RV17YC

0.6

**Roller Screeds**

B&amp;S Vanguard

18

RC14YC

0.8

Honda

4

OE051

RN11YC

0.8

**THEW****Construction Machinery**

L30, L69, L70, L78, L80, L82

(18mm)

RD16

0.6

L40, L80

(14mm)

RJ8C

0.6

L80, L81, L87

(18mm)

K97F

0.5

MC104, MC110, SP110

(14mm)

RH10C

0.6

MC254, MC254W

(14mm)

RJ8C

0.6

MC254, MC254W Carrier, TL20

(14mm)

RJ6C

0.6

MC254, MS254W, SP254, SP254W

(18mm)

RD16

0.6

MC414 Carrier

(18mm)

RD16

0.6

MC414 Turntable

(18mm)

D14

0.6

MC424, MC424W, SP242 Turntable

(18mm)

RD16

0.6

MC424, MC424W, SP424

(14mm)

RCJ8

0.6

MC425, MC415W, MC524

(14mm)

RCJ8

0.6

MC504, MC504W Carrier

(18mm)

D18Y

0.6

(14mm)

RH8C

0.6

MC524, MC530

Waukesha 145GKB (14mm)

RH10C

0.6

MC875, TSP875

(14mm)

RJ12C

0.6

ML-153, ML-309

(18mm)

RD16

0.6

SP254, SP254W, SP424 Turntable

(14mm)

RJ12C

0.6

SP254W Turntable, SP414

(18mm)

RD16

0.6

SP524 Turntable Cat. D-318

(14mm)

RCJ8

0.6

TL20

(18mm)

RD16

0.6

Continental 6427 (18mm)

RD16

0.6

Waukesha 140GK (18mm)

D18Y

0.6

Waukesha 140GK, 140GZB (14mm)

RH10C

0.6

Waukesha 817G, 135GZ, 150GZ, 195GZ (14mm)

RJ12C

0.6

Waukesha SRKR (18mm)

W14

0.6

**THEW-LORAIN****Front End Loader**

RD16

0.6

**THOMAS****Paint Sprayer**

RCJ8

0.6

**THOR POWER TOOLS****Screeds, Trowels**

Screeds, Trowels

RJ8C

0.6

**Tampers**

RH10C

0.6

**Vibrators**

(18mm)

RD16

0.6

(14mm)

RJ8C

0.6



CC

BHP

21

**TORO****Tractors & Lift Trucks**

Parkmaster

RV12YC

0.9

**TOW MOTOR****Tractors & Lift Trucks**

1404

Hercules G1600

RJ12YC

0.6

Waukesha

J11C

0.6

Ford 8-Cyl.

RF10C

0.6

Ford 6-Cyl.

RF11YC

0.6

IHC 8-Cyl.

RJ12YC

0.6

IHC 6-Cyl.

RJ6C

0.6

Caterpillar 1404

RJ8C

0.6

Perkins G4-236

OE042

RN12YC

0.6

Continental

RD16

0.6

**TOW-MITE****Tractors & Lift Trucks**

All Models

RJ8C

0.6

**TOYOTA****Tractors & Lift Trucks**

02-2FG32, 02-2FG35, 02-2FG40 2F

RN14YC

0.8

02-FG32, 02-FG35, 02-FG40

RN14YC

0.8

2FG50, 2FG60

2F

RN14YC

0.8

2FGC10, 2FGC15, 3FGC20, 3FGC25

4P

RN14YC

0.8

40-2FG20, 40-2FG30, 40-2FGC10

5R

RN14YC

0.8

40-2FGC15, 40-3FG10, 40-3FG15

5R

RN14YC

0.8

40-3FG20, 40-3FG25, 40-3FGC10

5R

RN14YC

0.8

40-3FGC15, 40-3FGC20, 40-3FGC25

5R

RN14YC

0.8

40-4FG10, 40-4FG14, 40-4FG15, FGC305R

RN14YC

0.8

40-4FG18, FG10, FG15, FG20, FG25

5R

RN14YC

0.8

4FG10, 4FG14, 4FG15, FG18, FG20

4P

RN14YC

0.8

60-3FG20, 60-3FG23, 60-3FG25

5P

RN14YC

0.8

60-4FG10, 60-4FG14, 60-4FG15

5P

RN14YC

0.8

60-FG18, 62-3FG20, 62-3FG23

5P

RN14YC

0.8

62-3FG25

5P

RN14YC

0.8

All Models

3Y

RN14YC

0.8

4Y

RN14YC

0.8

FG23, FG25, FGA7, FGA9

4P

RN14YC

0.8

FG30, FGC10, FGC15, FGC20, FGC25

5R

RN14YC

0.8

FG7, 2FG7, 2FG9, 3Y

3P

RN14YC

0.8

TG10

3P

OE042

RN12YC

0.8

**TRACTO-LOADER****Construction Machinery**

A-C, W-201, WD, W-226

RJ8C

0.6

A-CB, B-125, WF

RJ12C

0.6

**Tractors & Lift Trucks**

TL-10, 11, 12

A-C W226

RJ8C

0.6

A-C G226

RN5C

0.6

TL-16

RJ8C

0.8

TL-6

RJ8C

0.8

**TRANSITER****Tractors & Lift Trucks**

All Models

RJ19LM /  
QJ19LM

0.8

**TROJAN****Construction Machinery**

114, 134, LH75, LCM100, LT400

RJ8C

0.8

124, 134A, 154, 164, 164A, 204, 204A

RJ6C

0.6

**TROWBRIDGE****Conveyors**

RD16

0.6



CC

BHP

21

**TRUCK MAN****Tractors & Lift Trucks**

B&S & Continental 18mm			RD16	0.6
Wisconsin			RD16	0.6
Ford			RH8C	0.6
B&S 14mm			RJ19LM / QJ19LM	0.8
Kohler	4		RJ19LM	0.8

**TUCKER****Tractors & Lift Trucks**

Sno-Cat			RJ8C	0.6
Chrysler 318 & 360 cid			OE042 RN12YC	0.9

**U-CART****Concrete Mixers**

Honda OHV	8		OE051 RN11YC	0.8
-----------	---	--	--------------	-----

**UNIT CRANE & SHOVEL****Construction Machinery**

Continental B-247, F-245			RD16	0.6
GM V-6 351 cid			OE051 RN11YC	0.8

**UNITOW****Tractors & Lift Trucks**

All Models			RD16	0.6
------------	--	--	------	-----

**UNIVERSAL****Construction Machinery**

All Models			W14	0.6
------------	--	--	-----	-----

**VIBRO-TAMPER****Construction Machinery**

Ford 6-Cyl.			RH8C	0.6
-------------	--	--	------	-----

**VIKING****Conveyors**

Wisconsin			RD16	0.6
-----------	--	--	------	-----

**WACKER****Construction Machinery**

B3000, B5000			RJ19LM / QJ19LM	0.8
BHF30S Breaker			RL86C	0.6
BPS2550A		OE059	L92YC	0.9
BPU2440A, BPU2950A, BPU3345A		OE006	RN9YC	0.8
BS45Y, BS60Y, BS62Y			RL86C	0.6
BS65Y, BS105Y, BS700			RL86C	0.6
BTS12, BTS13, BTS14			RCJ7Y	0.5
BTS9, BTS10, BTS11			RCJ7Y	0.5
CT36A, CT48A		OE051	RN11YC	0.8
CT36B, CT46B			RJ19LM / QJ19LM	0.8
G2400E, G3000E, G4000E, G5000E			RJ8C	0.6
G6000E, GH3500E			QL86C	0.6
GVR75Y, GVR100, GVR151, GVR220Y			UJ11G	1.0
RD880V			RC14YC	0.8
RS800A, RSS800A, W74A		OE051	RN11YC	0.8
VPG100K, VPK1350, BPS2660B			RJ8C	0.6
VPG155/160B, VPB1960, VPB1750			RCJ8	0.8
VPG160A, VPA1340, VPA1350, VPA1740		OE006	RN9YC	0.8
VPG160R, VPR1340, VPR1350, VPR1740			RCJ8	0.6
VPG1750, BPS2550R, BPU3345R			QL86C	0.6
B&S Vanguard (V-Twin)	16		RC14YC	0.8
B&S	5,8		RJ19LM / QJ19LM	0.8
Wacker WM 80			RL86C	0.6
Honda	5.5,8,11		OE051 RN11YC	0.8



CC

BHP

21

**WAGNER****Construction Machinery**

Scoopmobile

RJ12C

0.9

Towermobile

RH10C

0.6

**WAGNERMOBILE****Tractors & Lift Trucks**

All Models

RJ8C

0.6

**WALDON****Construction Machinery**

5000, 5200

Wisconsin

37

D16J

0.6

IHC 172GF

D15Y

0.6

Wisconsin

65

OE042

RN12YC

0.6

5000, 5200, 6000

Ford 172 cid

RH10C

0.6

**Tractors & Lift Trucks**

5000

Wisconsin VG4D

RD16

0.8

IHC C175

D18Y

0.6

Ford 172 cid

RH10C

0.6

Wisconsin V465D

OE042

RN12YC

0.8

6000

Ford 172 &amp; 192 cid

RH10C

0.6

Perkins 4-203

RN5C

0.6

4000, 4500, 5000

Continental F-163

RD16

0.6

**WAYNE****Cranes**

70

Continental

RD16

0.6

Waukesha

RH10C

0.6

All

(14m)

RH10C

0.6

(7/8"-18)

W14

0.6

Buda (18mm)

D9

0.6

Wisconsin

RD16

0.6

Buda (14mm)

RH10C

0.6

Ford

RH8C

0.6

Hercules JXD, JX4D, RXC

RJ8C

0.6

Waukesha SRK

W14

0.6

Buda (7/8"-18)

W16Y

0.6

**Hay Baler**

350

RD16

0.6

**WHIRLER-GLIDE****Construction Machinery**

2-63, 2-63-15

232 cid

RD16

0.6

2-63FL

225 cid

OE042

RN12YC

0.6

2-63L, 2-63FL

232 cid

RD16

0.6

AG

(18mm)

RD16

0.6

DG, HG

(14mm)

RJ6C

0.6

OC12 BGS

RJ12C

0.6

OC3, OC4

RJ12C

0.6

OC3, OC4 (Distillate)

RJ19LM /

QJ19LM

0.6

OC4G

(14mm)

RJ6C

0.6

OC6

RD16

0.6

**WHITE****Asphalt Maintenance Equipment**

L-6, L-20

RD16

0.6

**Construction Machinery**

2-63-15

White

RD16

0.6

2-63-FL

Chrysler

OE042

RN12YC

0.6

White

RD16

0.6

L-12, T-2

RD16

0.6

L-8, T-1

RJ8C

0.6

B&amp;S (14mm)

RJ19LM /

QJ19LM

0.8

B&amp;S (18mm)

RD16

0.6

Continental F-226, M271

RD16

0.6

Wisconsin ACN, BKN

RD16

0.6

Wisconsin S7D, VH4

RD16

0.6



CC

BHP

21

**...WHITE****Crawlers**

AG, AG6			RD16	0.6
BGS, OC-3, OC-4, OC-12			RJ8C	0.6
DG, HG	(14mm) (7/8"-18)		RJ6C	0.6
			W14	0.6
OC-4-3G			RJ6C	0.6
OC-6			D14	0.6

**Tractors & Lift Trucks**

2-115, 4-115, 2-144, 4-144			OE051	RN11YC	0.6
2-44, 2-44-L, 2-44-LL, 2-44-13				RD16	0.6
2-44-13LL, 2-44-FL, 2-62, 2-62-L				RD16	0.6
2-62-15, 2-62-FL, 2-63-L, 2-63-15				RD16	0.6
2-78, 2-78-L, 2-78-15, 2-78-17			OE051	RN11YC	0.6
4-78, 4-78-L, 4-78-15, 4-78-17			OE051	RN11YC	0.6
4-78-FL, 2-105, 4-105			OE051	RN11YC	0.6

**Vibrators**

M-12, M-13				RD16	0.6
M-8, M-9				RJ19LM / QJ19LM	0.6

**WHITE MOBILIFT****Tractors & Lift Trucks**

All Models				RJ8C	0.6
MA20, 25, 30, 30B, 30S, 35, 40, 45, 50				RD16	0.6
MA20, 25, 30, 30B, 30S, 35, 40, 45, 50 (LPG)				RD16	0.4
MA20B, 25B	Continental Y112			RD16	0.6
MA30, MA30S, MA35				RD16	0.6
MA30, MA30S, MA35 (LPG)				RD16	0.4
MA30B	Continental Y112			RD16	0.6
MA40, MA45, MA50, MA55 (LPG)				RD16	0.4
MA40, MA45, MA50, MA55, MA60				RD16	0.6
MA60, 70, 80, 90, 100, 120 (LPG)				RD16	0.4
MA60H, 70H, 80H, 90H, 100H				RD16	0.6
MA60H, 70H, 80H, 90H, 100H (LPG)				RD16	0.4
MA70, 80, 90, 100, 120				RD16	0.6
MSA20, 25, 30, 35				RD16	0.6
MSA20, 25, 30, 35 (LPG)				D9	0.4
MSB20, 25, 30, 35	Ford 104 cid Ford 91 cid		OE051	RN11YC	0.6
				QL87YC	0.6
MSB20, 25, 30, 35 (LPG)	(1/2" Reach) (3/4" Reach)			QL82YC	0.4
			OE006	RN9YC	0.4
MY100, 120, 140				RN5C	0.6
MY100, 120, 140, 160, 180 (LPG)				RN5C	0.4
MY160H, 180H, 200H, 220H, 300 (LPG)			OE051	RN11YC	0.4
MY20, 25, 30, 40, 40C, 50, 60, 70 (LPG)				RJ8C	0.4
MY20, 25, 30, 40C				RJ12YC	0.6
MY200, 220, 240, 260 (LPG)			OE051	RN11YC	0.4
MY40, MY50, MY60	Chrysler 225 (1975-74)			RN14YC	0.9
MY40, MY50, MY60, MY70	M-M 220			RD16	0.6
MY70, MY80B	Chrysler 225 (1981-76)			RV12YC	0.9
MYA40, 50, 60, 70				D14	0.6
MYA40, 50, 60, 70 (LPG)				D9	0.4
MYB40, 50, 60, 70, 80 (LPG)		→1975 1975→	OE042	RN12YC	0.4
				RV12YC	0.4
MYC160, 180, 200, 220, 240, 260			OE051	RN11YC	0.6
MYC160H, 180H, 200H, 220H, MYC300			OE051	RN11YC	0.6
WC20, 25, 30, 30S, 35, 40, 45, 50, 55, 60				RD16	0.6
WC20, 25, 30, 30S, 35, 40, 45, 50, 55, 60 (LPG)				RD16	0.4

**WHITEMAN****Concrete Finishers**

Robin EY27				QL86C	0.6
Wisconsin	4.6			QL86C	0.6
Wisconsin	7.5			QL87YC	0.6
B&S 3-Cyl. (liquid cooled)	31		OE013	RC12YC	0.8
Kohler (V-Twin)	20,25		OE013	RC12YC	0.8
B&S Vanguard (V-Twin)	16,18			RC14YC	0.8
Wisconsin AKN & BKN				RD16	0.6



CC

BHP

21

**...WHITEMAN****...Concrete Finishers**

B&S	3,5,7,8		RJ19LM / QJ19LM	0.8
Gladden 75			RJ8C	0.6
Wisconsin	11		RL95YC	0.6
Honda OHV	8,11	OE051	RN11YC	0.8
Honda OHV	5	OE006	RN9YC	0.8
Onan (Twin)	24		RS17YX	0.6
Kohler (Twin)	20		RV17YC	0.6

**Concrete Pumps**

OE042	RN12YC	0.8
-------	--------	-----

**Power Buggys**

Robin EY27			QL86C	0.6
			RJ12C	0.6

**Power Buggys**

Wisconsin			D16J	0.6
-----------	--	--	------	-----

**Tractors & Lift Trucks**

(18mm)			RD16	0.6
(14mm)			RJ12C	0.6

**WIGGINS****Tractors & Lift Trucks**

W66-WT, W86-WT, W106-WT

Ford 300 cid			RF10C	0.6
--------------	--	--	-------	-----

			RF10C	0.6
--	--	--	-------	-----

**WILKRA****Tractors & Lift Trucks**

All Models

			RJ8C	0.6
--	--	--	------	-----

**WINK****Earth Drills**

			QL82C	0.6
--	--	--	-------	-----

**WORTHINGTON****Tractors & Lift Trucks**

All Models

			RD16	0.6
--	--	--	------	-----

**Truck Mixers**

All Models

			RJ8C	0.6
--	--	--	------	-----

**YALE****Tractors & Lift Trucks**

(CNG)	LeRoi D-471		D9	0.4
G10P, G54P			RJ12C	0.6
G51C, G54C, 52 Series			RD16	0.6
G83	Chrysler H-225, > E25,2034	OE042	RN12YC	0.6
	Chrysler H-225, E252035 >		RV12YC	0.6
KG51, KGP51, G10P, Y-18 (LPG)			RJ8C	0.4
KG51, KGP51, G10P, Y-18, G54P			J11C	0.6
Lift King	IHC		D21	0.6
Y18, Lift King	Chrysler IND-31		RJ12C	0.6
Yard King			RJ8C	0.6
	Ford K-292		RF11YC	0.6
	Chrysler Ind. 30		RJ12C	0.6
	Chrysler H-318		RJ12YC	0.6
	IHC V345		RJ8C	0.6
	Mazda 1985cc		RN14YC	0.6
	Continental F-124, F-162, F-163		RD16	0.6
	IHC UC135B		RD16	0.6

**YARDSTER****Tractors & Lift Trucks**

All Models

			RF10C	0.6
--	--	--	-------	-----



 **FEDERAL  
MOGUL**



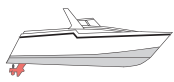

CC

BHP

POWER  
SPORT**ACTIVE THUNDER (→ Mercruiser)****AERO MARINE**

265 Series		5	1969→1970		RJ12YC		0.8	
265, 320 Series		7.5	1971→	*	RV15YC4	8018	0.8	
304, 360 Jet	1250				OE006	RN9YC	8415	0.8
320, 350, 375, 165CR		9	1966→1970			RN5C	8339	0.8
375 Series	850		1970→1971	*		RV15YC4	8018	0.8
427 Jet, 454 Series				*		RV15YC4	8018	0.8
455, 240 Series		5, 7				RJ12YC		0.8
482 Series		5, 7			OE006	RN9YC	8415	0.8

**AERO TEK (→ Mercruiser)****ALBEMARLE (→ Mercruiser & Volvo Penta)****AMECO**

302 & 351W cid	Ford					RF11YC		0.8
----------------	------	--	--	--	--	--------	--	-----

**AMERICAN CHALLENGER**

Eagle 400, 600, 800						RV12YC	8018	0.5
---------------------	--	--	--	--	--	--------	------	-----

**AMERICAN OFFSHORE (→ Mercruiser)****AMERICAN SKIER (→ Mercruiser)****APACHE (→ Mercruiser)****ARRIVA (→ Mercruiser)****AVANTI (→ Mercruiser)****AVON (→ Yamaha)****BAHA CRUISERS (→ Mercruiser & Volvo Penta)****BAJA (→ Mercruiser)****BARR (Conversions)**

194, 230 & 250 cid	Chevrolet 6-cyl.	899	1962→1969			RN14YC	8405	0.9
230 cid	Chevrolet 6-cyl.	900	1970→	*		RV15YC4	8018	0.9
250 cid	Chevrolet 6-cyl.	900	1979→1984	*		RV15YC4	8018	0.9
	Chevrolet 6-cyl.	900	1970→1978			RV92YC		0.9
283 cid	Chevrolet V-8	1100	1955→1967			RJ14YC		0.9
292 cid	Chevrolet 6-cyl.	1100	1963→1969			RN5C	8339	0.9
	Chevrolet 6-cyl.	1071	1970→1990	*		RV15YC4	8018	0.9
302 cid	Chevrolet V-8	1100	1967→1969			RJ14YC		0.9
307 cid	Chevrolet V-8	1100	1968→1970			RJ14YC		0.9
	Chevrolet V-8	1100	1971→1973			RV92YC		0.9
327 cid	Chevrolet V-8	1176	1961→1969			RJ12YC		0.9
350 & 400 cid	Chevrolet V-8	1176	1971→1990	*		RV15YC4	8018	0.9
350 & 455 cid 2-bbl.	Oldsmobile	780	1968→1970			RJ14YC		0.8
350 cid	Oldsmobile	777	1971→1974			RJ14YC		1.0
350 cid 2-bbl.	Chevrolet V-8	1199	1967→1970			RJ14YC		0.8
350 cid 4-bbl.	Oldsmobile	779	1968→1970			RJ14YC		0.8
	Chevrolet V-8	1176	1970→			RJ14YC		0.9
383 cid 2-bbl.	Chrysler	700	1960→1971			RJ18YC		0.9
383 cid 4-bbl.	Chrysler	700	1968→1971			RJ14YC		0.9
383 cid Hi-Perf.	Chrysler	700	1966→1967			RJ14YC		0.9
400 & 430 cid	Buick	750	1967→1969	*		RV15YC4	8018	0.8
400 cid	Chevrolet V-8	1500	1970→			RJ14YC		0.9
413 cid	Chrysler	700	1963→1965			RJ18YC		0.9
413 cid Hi-Perf.	Chrysler	700	1963→1965			RJ14YC		0.9
413 cid Two 4-bbl.	Chrysler	750	1963→1964			RJ14YC		0.9
427 cid	Chevrolet V-8		1971→1972			RV12YC	8018	0.9
	Chevrolet V-8		1973→1990	*		RV15YC4	8018	0.9
440 cid	Chrysler	750	1972→1979			RJ14YC		0.9
	Chrysler	750	1966→1971			RJ14YC		0.9
	Chrysler	777	1966→1971			RJ14YC		0.9
454 cid	Chevrolet V-8	650	1979→1989	*		RV15YC4	8018	0.9
455 cid	Oldsmobile	900	1976→1978			RJ18YC		1.0



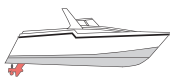

CC

BHP

21

POWER  
SPORTmm  
**... BARR (Conversions)**

	Buick	782	1970 →	*	RV15YC4	8018	0.8
	Buick	891	1971 → 1974		RV92YC		0.9
455 cid 2-bbl.	Oldsmobile	1165	1971 →		RJ18YC		1.0
455 cid 4-bbl.	Oldsmobile	1165	1970 → 1971		RJ14YC		1.0
	Oldsmobile	1050	1972 → 1974		RJ18YC		1.0
455 cid Hi-Perf.	Oldsmobile	1165	1972 → 1974		RJ14YC		1.0
389 cid	Pontiac	1165	1960 → 1967		RJ14YC		0.9
421 cid	Pontiac	1192	1963 → 1966		RJ14YC		0.9
428 cid	Pontiac		1967 → 1969	7.5	RJ14YC		0.9
400 cid	Pontiac	1165	1967 → 1971		RJ14YC		0.9
455 cid 4-bbl.	Pontiac		1970 → 1971	9	RJ18YC		0.9
455 cid 2-bbl.	Pontiac		1971 →	8	RJ18YC		0.9
400 & 455 cid	Pontiac	1165	1972 → 1974		RV92YC		1.0

**BAYLINER (→ Mercruiser)****BERKELEY**

302 & 351 cid	(14mm)	718	1974 → 1990		RV12YC	8018	0.9
	(18mm)	718	1974 → 1977		RF11YC		0.9
350 & 454 cid	Chevrolet	650	1976 → 1990	*	RV15YC4	8018	0.9
460 cid	Ford	650	1976 → 1990		RV12YC	8018	0.9
455 cid	Oldsmobile	718	1968 → 1976		RJ18YC		1.0

**BERTRAM (→ Crusader & Marine Power)****BLACK THUNDER (→ Mercruiser)****BLACK WATCH (→ Crusader & Mercruiser)****BLACKFIN (→ Crusader)****BLUE WATER (→ Mercruiser)****BMW**

G-130-I, G-130-S, B130		951		OE006	RN9YC	8415	0.6
G-190-I, G-190-S, B190		951			RN14YC	8405	0.6
G-220-I, G-220-S, B220		951			RN14YC	8405	0.6

**BOMBARDIER**

All Models			1974 → 1982	*	RV15YC4	8018	0.9
AT, TT, TJ, AJ	(14mm, 3/8" Reach)				RJ14YC		0.9
	(14mm, Taper Seat)			*	RV15YC4	8018	0.9
Sail Drive 15S10G, 15S10S, 15S11C				OE064	RL82YC	8814	1.1
Sail Drive 15S13A, 15S14M				OE064	RL82YC	8814	1.1
Sea Drive 1.6L 115-SD					QL77JC4	8883	0.8
Sea Drive 1.8L					QL77JC4	8883	0.8
Sea Drive 2.0L 140-SD					QL77JC4	8883	0.8
Sea Drive 2.5L					UL77V		
Sea Drive 2.6L 190-SD					UL77V		
Sea Drive 2.7L 225-SD					QL77JC4	8883	0.8
Sea Drive 3.0L 225-SD					QL77JC4	8883	0.8
Sea Drive 3.6L 275-SD					QL77JC4	8883	0.8
Sea Drive 4.0L 275-SD					QL77JC4	8883	0.8
Stern Drive 2.3L Cobra			1987 → 1990		RS12YC	8401	0.9
Stern Drive 3.0L Cobra			1993 → 1994		RS12YC	8401	1.1
			1987 → 1992	*	RV15YC4	8018	1.1
Stern Drive 3.0L Cobra HO			1990 → 1995		RS12YC	8401	1.1
Stern Drive 3.0L SX Cobra			1996 →		RS12YC	8401	1.1
Stern Drive 4.3L Cobra			1986 → 1995	*	RV15YC4	8018	0.9
Stern Drive 4.3L Cobra HO			1990 → 1991	*	RV15YC4	8018	0.9
			1993 → 1994	*	RV15YC4	8018	1.1
Stern Drive 4.3L Stringer Models			1978 → 1986	*	RV15YC4	8018	0.9
Stern Drive 4.3L SX Cobra	(Short Reach .460") Tag NCA		1996 →	*	RV15YC4	8018	0.9
	(Short Reach .708") Tag NCS		1996 →		RS12YC	8401	0.9
Stern Drive 5.0L Cobra (Carb.)			1986 → 1995	*	RV15YC4	8018	0.9
Stern Drive 5.0L Cobra (Carb.) HO			1989 → 1995	*	RV15YC4	8018	0.9
Stern Drive 5.0L Cobra EFI			1994 → 1995		RS12YC	8401	1.1
			1993 →	*	RV15YC4	8018	1.1
Stern Drive 5.0L SX Cobra (Carb.)			1996 →	*	RV15YC4	8018	0.9
Stern Drive 5.0L SX Cobra (EFI)			1996 →		RS12YC	8401	1.1

\* Leaded fuel use RV8C



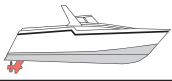

CC

BHP

21

POWER  
SPORT**... BOMBARDIER**

Stern Drive 5.7L Cobra, King		1986→1992	*	RV15YC4	8018	0.9	
Stern Drive 5.7L SX Cobra		1996→	*	RV15YC4	8018	0.9	
Stern Drive 5.8L Cobra (Carb.)		1989→1995	*	RV15YC4	8018	0.9	
Stern Drive 5.8L Cobra EFI		1992→1995	OE011	RS9YC	8304	1.1	
Stern Drive 5.8L King Cobra HO EFI		1993→1995	OE011	RS9YC	8304	1.1	
Stern Drive 5.8L SX Cobra (Carb.)		1996→	*	RV15YC4	8018	0.9	
Stern Drive 5.8L SX Cobra (EFI)		1996→	OE011	RS9YC	8304	1.1	
Stern Drive 7.4L Cobra (Carb.)		1990→1995	*	RV15YC4	8018	1.1	
Stern Drive 7.4L Cobra HO (Carb.)		1991→1993	*	RV15YC4	8018	1.1	
Stern Drive 7.4L King Cobra EFI		1995→	*	RV15YC4	8018	1.1	
Stern Drive 7.4L SX Cobra		1996→	*	RV15YC4	8018	1.1	
Stern Drive 7.5L Cobra		1986→1990	*	RV15YC4	8018	0.9	
Stern Drive 8.2L King Cobra		1992→1994	*	RV15YC4	8018	1.1	
Stern Drive 8.2L SX Cobra		1996→	*	RV15YC4	8018	1.1	
Stern Drive All Models	(14mm, Taper Seat) (18mm, Taper Seat)	1973→1985	*	RV15YC4	8018	0.9	
				RF10C		0.8	
Stern Drive All Other Models	(3/4" Reach)			RN5C	8339	0.9	
Stern Drive CU, SU Series				RN5C	8339	0.9	
Stern Drive DU 89 cid		88-90		J4C		0.8	
Stern Drive GU, VU Series 153 cid		120		RN5C	8339	0.9	
Stern Drive HU Series 225 cid		155		RJ14YC		0.9	
Stern Drive JU, WU Series 250 cid		165	*	RV15YC4	8018	0.9	
Stern Drive KU Series 283 cid		185		RJ14YC		0.9	
Stern Drive LU Series 153 cid		100		RN5C	8339	0.9	
Stern Drive NU Series	1600	80-90		OE006	RN9YC	8415	0.6
Stern Drive Stringer Models		1978→1986	*	RV15YC4	8018	0.9	
Stern Drive TU-14, -15, -16 300 cid		200		RJ14YC		0.9	
Stern Drive TU-17 Up 283 & 307 cid		210		RJ14YC		0.9	
Stern Drive TU-20, -21			*	RV15YC4	8018	0.9	
Stern Drive XU-20C			*	RV15YC4	8018	0.9	
Stern Drive XU-20S				RJ14YC		0.9	
Turbojet 115	Jet Drive	1994→1999	OE086	RL82C	8883	0.8	
Turbojet 90	Jet Drive	1994→1999	OE086	RL82C	8883	0.8	

**BOUNTY (→ Volvo Penta)****BRAND EX (→ Mercruiser & PCM) BRAVO (→ Mercruiser & Volvo Penta)****BRENDELLA SKI BOATS (→ Mercruiser & PCM)****BRITISH SEAGULL**

ST110	1494	1979→1981		RD16		0.9
-------	------	-----------	--	------	--	-----

**BRUCKMANN (→ Crusader & Mercruiser)****BRYANT (→ Mercruiser)****CABO (→ Crusader)****CALIBER (→ Mercruiser)****CAMPION (→ Volvo Penta)****CARAVELLE (→ Mercruiser & Volvo Penta)****CARIBBEAN YACHTS (→ Mercruiser)****CAROLINA CLASSIC (→ Mercruiser & Volvo Penta)****CARRERA (→ Mercruiser)****CARVER (→ Crusader & Volvo Penta)****CASTOLDI**

2261E	639	1974→		RN5C	8339	0.9
2264E	644	1974→	OE042	RN12YC	8405	0.9
2614E	768	1974→	OE006	RN9YC	8415	0.6
	1966	113	1974→	RF9YC		0.9

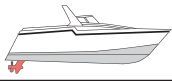

CC

BHP

21

POWER  
SPORT**CAT HARBOR (→ Crusader)****CELEBRITY (→ Mercruiser & Volvo Penta)****CENTURY (→ Mercruiser & Yamaha)****CHALLENGER (→ Mercruiser)****CHAPARRAL (→ Mercruiser, Volvo Penta & Yamaha)****CHECKMATE (→ Mercruiser)****CHEVROLET**

194, 230 & 250 cid	6-Cyl. Engines	789		1962 → 1969		RN14YC	8405	0.9
230 cid	6-Cyl. Engines	789		1970 →	*	RV15YC4	8018	0.8
250 cid	6-Cyl. Engines	1231		1979 → 1984	*	RV15YC4	8018	0.9
	6-Cyl. Engines		120	1970 → 1978		RV92YC		0.9
283 cid	V-8 Engines	428		1955 → 1967		RJ14YC		0.9
292 cid	6-Cyl. Engines		125	1963 → 1969		RN5C	8339	0.9
	6-Cyl. Engines		120	1970 → 1990	*	RV15YC4	8018	0.9
302 cid	V-8	428		1967 → 1969		RJ14YC		0.9
307 cid	V-8	432		1968 → 1970		RJ14YC		0.9
	V-8	432		1971 → 1973		RV92YC		0.9
327 cid	V-8	432		1961 → 1969		RJ12YC		0.9
350 & 400 cid	V-8	432		1971 → 1990	*	RV15YC4	8018	0.9
350 cid 2-bbl.	V-8	432		1967 → 1970		RJ14YC		0.8
350 cid 4-bbl.	V-8	432		1970 →		RJ14YC		0.9
400 cid	V-8	701		1970 →		RJ14YC		0.9
427 cid	V-8	701		1973 → 1990	*	RV15YC4	8018	0.9
	V-8			1971 → 1972		RV9YC		0.9
454 cid	V-8			1979 → 1990		RV12YC	8018	0.9

**CHRIS-CRAFT (Also → Volvo Penta)**

181 & 153 Thru Serial No. 603191		1200				RN5C	8339	0.9
181 From Serial No. 603192		1200				RV9YC		0.9
225 Series		1200				RJ14YC		0.9
283, 302, 307 & 327	Gasket Heads	1200				RJ12YC		0.6
305, GLV, K Series		760		1977 → 1986	*	RV15YC4	8018	0.9
307, 350 & 454	(Taper)	1200				RV9YC		0.9
307, GLV, K		760	215	1975 → 1976		RV92YC		0.9
350 Hi-Perf.		1200				RV12YC	8018	0.9
350 Q Series		800		1979 → 1991	*	RV15YC4	8018	0.9
350, FLV Hi-Perf.		760	300	1975 → 1986	*	RV15YC4	8018	0.9
350, GLV, K Series		760	250	1975 → 1986	*	RV15YC4	8018	0.9
427, 431 Series		1300				RF9YC		0.8
430 Series			18			RF11YC		0.8
A, B, BA, C, H, K, KB	Aluminum Heads	800				RH10C		0.7
	Regular Heads	800				RJ8C		0.7
KBL, KC, KFL, KL, KLC	Aluminum Heads	1000				RH10C		0.7
	Regular Heads	1000				RJ8C		0.7
LC, LD, M, MB, MBL	Aluminum Heads	1100				RH10C		0.7
	Regular Heads	1100				RJ8C		0.7
MC, MCL, ML, W, WB	Aluminum Heads	1200				RH10C		0.7
	Regular Heads	1100				RJ8C		0.7
	OMC Cobra	3000			*	RV15YC4	8018	0.9
	OMC Cobra	4300			*	RV15YC4	8018	0.9
	EFI OMC Cobra	5000			*	RV15YC4	8018	0.9
	FL	5000			*	RV15YC4	8018	1.1
	OMC Cobra	5000			*	RV15YC4	8018	0.9
	GS	5700			*	RV15YC4	8018	1.1
	GSi	5700				RS12YC	8401	1.1
	TBI/Carb.	5700			*	RV15YC4	8018	0.9
	EFI OMC Cobra	5800			OE011	RS9YC	8304	0.9
	EFI OMC King Cobra	5800			OE011	RS9YC	8304	0.9
	OMC Cobra	5800			OE011	RS9YC	8304	0.9
	EFI OMC Cobra	7400			*	RV15YC4	8018	0.9
	Gi	7400			*	RV15YC4	8018	1.1
	OMC Cobra	7400			*	RV15YC4	8018	0.9
	MPI/Carb.	8200			*	RV15YC4	8018	0.9

\* Leaded fuel use RV8C



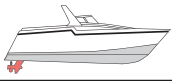

CC

BHP

POWER  
SPORT**CHRYSLER**

LM-318A, LM-318AC, LM-318B	V-8 273 & 318 cid:	45		OE042	RN12YC	8405	0.9
LM-318BC, LM-318BJ, LM-318BT	V-8 Engines 273 & 318 cid:	45		OE042	RN12YC	8405	0.9
LM-318BV, LM-318D	V-8 Engines 273 & 318 cid:	60		OE042	RN12YC	8405	0.9
LM-340B, LM-340BJ	V-8 Engines 340 & 360 cid:	75.2		OE006	RN9YC	8415	0.9
LM-340BT, LM-340BV	V-8 Engines 340 & 360 cid:			OE006	RN9YC	8415	0.9
M122A	4-cyl.	25		OE086	RL82C	8883	0.9
M-170	6-cyl.	27.7			RN5C	8339	0.9
M-183B	6-cyl.	28		OE086	RL82C	8883	0.8
M-225A, M-225D, M-225GD	6-cyl.	35			RN5C	8339	0.9
M-225D	6-cyl.	28			RN5C	8339	0.9
	6-cyl.	30	1975 → 1979		RV9YC		0.9
M-265, M-265A	6-cyl.	40			RJ8C		0.9
M-273A, M-273B, M-273BT	V-8 Engines 273 & 318 cid:	43.7		OE042	RN12YC	8405	0.9
M-318A, M-318B	V-8 Engines 273 & 318 cid:	75			RJ14YC		0.9
M-318C, M-318GD	V-8 Engines 273 & 318 cid:	75			RJ14YC		0.9
M-360A, M-360B, M-360BC	V-8 Engines 340 & 360 cid:	2.2		OE042	RN12YC	8405	0.9
M-360BJ, M-360BT, M-360BV	V-8 Engines 340 & 360 cid:	1.2		OE042	RN12YC	8405	0.9
M-383B, M-383BV	V-8 Engines 383, 413 & 426 cid:	3.0			RJ14YC		0.9
M-400B, M-400BV, M-400S	V-8 Engines 400 & 440 cid:	1.6			RJ14YC		0.9
M-413B, M-413D	V-8 Engines 383, 413 & 426 cid:	3.0			RJ14YC		0.9
M-413E	V-8 Engines 383, 413 & 426 cid:	3.0			RN5C	8339	0.9
M-426B, M-426D, M-426SKI	V-8 Engines 383, 413 & 426 cid:	3.5			RJ14YC		0.9
M44, M44-3		4.0			RJ8C		0.9
M-440B, M-440BJ, M-440BV	V-8 Engines 400 & 440 cid:	2.5			RJ14YC		0.9
M-440D, M-440S	V-8 Engines 400 & 440 cid:	3.0			RJ14YC		0.9
M45, M45S, M45-3, M45S-3		4.5			RN5C	8339	0.9
M45SP-3, M-81		5.0			RN5C	8339	0.9
M460B	V-8 Engines 460 cid	4.0			RV12YC	8018	0.9
M46-3, M46S-3, M46-4	6-cyl.	40			RJ8C		0.9
M47-3, M47S-3, M47-4	6-cyl.	40			RJ8C		0.9
M-80		5.0			RJ14YC		0.9
M91D, M91F	4-cyl.	25		OE006	RN9YC	8415	0.9

**CHRYSLER VOLVO**

110, 115, 120, 130, 165, 170		5.5		OE086	RL82C	8883	0.7
------------------------------	--	-----	--	-------	-------	------	-----

**CIGARETTE (→ Mercruiser)****CLIMAX**

302 & 351 cid		7.0			RF10C		0.8
460 cid		7.0			RF14YC		0.8
98 cid		7.0		OE006	RN9YC	8415	0.8

**CLIPPER (→ Volvo Penta)****COBALT (→ Mercruiser, Bombardier & Volvo Penta)****COBIA (→ Mercruiser, Volvo Penta & Yamaha)****COECLES HARBOR (→ Mercruiser)****COMMANDER (→ Mercruiser)****CON-O-LIFT**

Marine Hydraulic Trailers	Honda OHV	5.5		OE051	RN11YC	8415	0.8
---------------------------	-----------	-----	--	-------	--------	------	-----

**CONQUEST (→ Mercruiser & Volvo Penta)****CORAL (→ Bombardier & Volvo Penta)****CORNELL**

Marine Hoists	Wisconsin.	2.5			RD16		0.6
	Ford 300 cid	2.3			RF10C		0.8
	Chrysler 225 cid	2			RV92YC		0.9

**CORRECT CRAFT (→ PCM)****CRANCHI (→ Volvo Penta)****CREST (→ Mercruiser)**

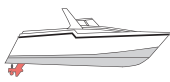

CC

BHP

21

POWER  
SPORT**CRESTLINER (→ Mercruiser & Volvo Penta)****CROSBY (→ Crusader)****CROWN LINE (→ Mercruiser & Volvo Penta)****CRUISERS (→ Crusader, Mercruiser & Volvo Penta)****CRUSADER**

280	Boat Builder Series	9.9		RN5C	8339	0.9
185, 190, 220, 230, 250	Boat Builder Series	8		RJ12YC		0.6
229 cid V6		4	1981 → 1984	RV12YC	8018	0.9
		4.5	1979 → 1980	RV9YC		0.9
262 cid Carb.	XI & Xli Series	25		RV9YC		0.9
262 cid V6		5	1985 → 1998	RV9YC		0.9
292 cid Model 185		5	1971 → 1980	RV9YC		0.9
305 cid	Champion Series	10		RV12YC	8018	0.9
	XI & Xli Series	25		RV12YC	8018	0.9
305 cid Model 220, 190		5	1976 → 1996	RV12YC	8018	0.9
307 cid Model 210		6	1971 → 1980	RV9YC		0.9
350 cid	Champion Series	14		RV12YC	8018	0.9
	XI & Xli Series	28		RV12YC	8018	0.9
350 cid HT	Champion Series	14		RV12YC	8018	0.9
	XI & Xli Series	28		RV12YC	8018	0.9
350 cid Model 270		6	1971 → 1998	RV12YC	8018	0.9
427 cid Model 427		6.5	1968 → 1980	RV9YC		0.9
454 cid	Champion Series	15		RV12YC	8018	0.9
	XI & Xli Series	30		RV12YC	8018	0.9
	XI & Xli Series	30		RV12YC	8018	0.9
454 cid HO	XI & Xli Series	35		RV12YC	8018	0.9
454 cid Model 350		8	1972 → 1980	RV9YC		0.9
454 cid V8		7.5	1981 → 1998	RV12YC	8018	0.9
5.7L Plus EFI (350cid)	Classic Series	15		RS12YC	8401	1.1
5.7L Plus MPI (350 cid)	Classic Series	15		RS12YC	8401	1.1
502 cid	XI & Xli Series	35		RV12YC	8018	0.9
502 cid V8		8	1989 → 1998	RV12YC	8018	0.9
7.4L HO-MPI (454cid)	Classic Series	18		RV12YC	8018	1.1
7.4L MPI (454cid)	Classic Series	15		RS12YC	8401	1.1
8.2L MPI (502 cid)	Classic Series	18		RV12YC	8018	1.1
CS 100, 150, 165, 280	Boat Builder Series	9.9		RN5C	8339	0.8
CS 180, 220, 250; CM Cadillac	Boat Builder Series	9.9		RJ12YC		0.8
CS 185, 220, 250	Charger Series	15		RJ12YC		0.6
CS 280	Charger Series	15		RN5C	8339	0.9
CS 320	Boat Builder Series	10		RN5C	8339	0.8
	Charger Series	15		RN5C	8339	0.9
Models: 170J, 185, 200J, 210	Boat Builder Series	9.9		RJ12YC		0.6
Models: 230, 230J	Boat Builder Series	9.9		RJ12YC		0.6
Platinum Series	5.7L Plus MPI (350 cid)	20		RS14PYP5		1.1
	7.4L MPI (454cid)	20		RS14PYP5		1.1

**CUTTER (→ Mercruiser)****CUYUNA**

Model 430LC	Jet Drive	40		OE108	RN3C	8904	0.8
-------------	-----------	----	--	-------	------	------	-----

**DAYTONA**

Models 100, 150		40		RN5C	8339	0.9
Models 200, 300		40		RJ12YC		0.9
Models 400, 400 Turbo		40		RN5C	8339	0.9
Models 427, 427 Turbo		40		RN5C	8339	0.9

**DELTA STAR (→ Mercruiser & Volvo Penta)****DONZIE (→ Mercruiser & Volvo Penta)****DORAL (→ Mercruiser & Volvo Penta)****DREAM CRUISER (→ Volvo Penta)****DYNAFOIL**

	Xenoh G440-BW	432	48		RN5C	8339	0.6
--	---------------	-----	----	--	------	------	-----

\* Leaded fuel use RV8C



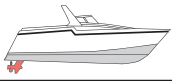

CC

BHP

21

POWER  
SPORT**DYNASTY (→ Mercruiser, Bombardier, Volvo Penta & Yamaha)****EASTERN (→ Mercruiser)****EBBTIDE (→ Mercruiser, Bombardier, Volvo Penta & Yamaha)****EGG HARBOR (→ Crusader)****ELIMINATOR (→ Crusader, Marine Power & Mercruiser)****ENVISION (→ Mercruiser)****ERCOA (→ Mercruiser)****EUROLINE (→ Mercruiser)****EVINRUDE**

CU, SU 153 cid		110-120			RN5C	8339	0.9	
DU 89 cid		88-90			J4C		0.8	
HU 225 cid		150-155			RJ14YC		0.9	
KU 283 cid		185			RJ12YC		0.9	
NU	1600	80 & 90			OE006	RN9YC	8415	0.6
TU-14, -15, -16 300 cid		200				RJ14YC		0.9
TU-17 & Up 283 & 307 cid		210				RJ14YC		0.9

**EXCEL (→ Mercruiser & Volvo Penta)****FALCON (→ Mercruiser & Volvo Penta)****FARALLON (→ Volvo Penta)****FLAGSHIP**

181 cid 125FMC	High Performance	60				RV9YC		0.9
181 cid 145FEFI	High Performance	65				RS12YC	8401	0.8
181FL	Transdrive, Inboard & V-drive	150	1975→1977	*		RV15YC4	8018	0.9
262 cid 200FMC	High Performance Engines	65				RV9YC		0.9
262 cid 235FEFI	High Performance Engines	65				RV9YC		0.9
262 cid 250FEFI Gen 1+ E Vortec	High Performance Engines	65				RS12YC	8401	0.9
280E	Transdrive, Inboard & V-drive	150	1975→1977			RV9YC		0.9
292 cid	Transdrive, Inboard & V-drive	150	1971→1974			RV12YC	8018	0.9
305 cid	Transdrive, Inboard & V-drive	150	1977→1993			RV9YC		1.1
305 cid 225FMC	High Performance Engines	65				RV9YC		0.9
307 & 350 cid	Transdrive, Inboard & V-drive	150	1971→1974			RV9YC		0.9
350 & 454 cid	Transdrive, Inboard & V-drive	150	1975→1993			RV9YC		1.1
350 cid 260FMC, 300FMC	High Performance Engines	65				RV9YC		0.9
350 cid 295FAS	High Performance Engines	105	1975→1993			RV9YC		0.9
350 cid 300FEFI	High Performance Engines	70				RV9YC		0.9
350 cid 320FEFI Gen 1+	High Performance Engines	70				RS12YC	8401	0.9
350 cid 335, 380FAS	High Performance Engines	110	1975→1993			RV9YC		0.9
350 cid 355FEFI Gen 1+ K Vortec	High Performance Engines	70				RS12YC	8401	0.9
350 cid TC400-1	High Performance Engines	112	1975→1993			RV9YC		0.9
350 cid TC450-1	High Performance Engines	115	1975→1993			V63C		0.9
350 cid TC500-1	High Performance Engines	115	1975→1993			V63C		0.9
427 & 454 cid	Transdrive, Inboard & V-drive	155	1971→1974			RV9YC		0.9
454 cid 370FMC, 375FEFI	High Performance Engines	70				RV9YC		0.9
454 cid 425FEFI	High Performance Engines	75				RV9YC		0.9
454 cid 450FAJ	High Performance Engines	115	1975→1993			RV9YC		0.9
454 cid 450FAS	High Performance Engines	115	1975→1993			RV9YC		0.9
454 cid 485FEFI	High Performance Engines	75				V63C		0.9
454 cid 500FAW	High Performance Engines	80				V63C		0.9
454 cid 525FAS	High Performance Engines	80				V63C		0.9
454 cid TC500-1	High Performance Engines	115	1975→1993			V63C		0.9
454 cid TC550-1	High Performance Engines	115	1975→1993			RV9YC		0.9
454 cid TC600-1	High Performance Engines	115	1975→1993			V63C		0.9
454 cid TC650	High Performance Engines	115	1975→1977			V63C		0.9
460 cid TC800	High Performance Engines	115	1975→1977			V57C		0.9
460, 454 & 400 cid 550FAS	High Performance Engines	115	1975→1977			RV9YC		0.9
460, 454, 400 cid 550FAJ	High Performance Engines	115	1975→1977			RV9YC		0.9
466 cid 675FAJ (Normal)	High Performance Engines	130	1975→1981			RV9YC		0.9
466 cid 675FAJ (Racing)	High Performance Engines	135	1975→1977			V57C		0.9
466 cid 675FAS (Normal)	High Performance Engines	135	1975→1981			RV9YC		0.9

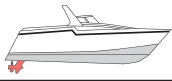

CC

BHP

POWER  
SPORT**... FLAGSHIP**

466 cid 675FAS (Racing)	High Performance Engines	140	1975→1977	V57C		0.9
466 cid TC700-I-O	High Performance Engines	120	1975→1981	V57C		0.9
466 cid TCX950	High Performance Engines	125	1975→1981	V57C		0.9
490 cid 500FAJ	High Performance Engines	150	1975→1981	RV9YC		0.9
490 cid 500FAS	High Performance Engines	140	1975→1981	RV9YC		0.9
502 cid 380FMC, 400FMC	High Performance Engines	85		RV9YC		0.9
502 cid 400FEFI	High Performance Engines	85		* RV15YC4	8018	0.9
502 cid 450FEFI Gen VI	High Performance Engines	85		V63C		0.9
502 cid 475FEFI	High Performance Engines	88		V63C		0.9
502 cid 500FEFI Gen VI	High Performance Engines	90		V63C		0.9
502 cid 515FEFI	High Performance Engines	90		V63C		0.9
502 cid 600FSEFI Supercharged	High Performance Engines	90		V63C		0.9
510 cid 525FEFI	High Performance Engines	90		V63C		0.9
510 cid 550FEFI	High Performance Engines	90		V63C		0.9
510 cid 650FASI	High Performance Engines	90		V63C		0.9
510 cid 850FASIF	High Performance Engines	100		V63C		0.9
540 cid 625FEFI	High Performance Engines	100		V63C		0.9
540 cid 700FSEFI Supercharged	High Performance Engines	100		V63C		0.9
572 cid 800FSEFI Supercharged	High Performance Engines	100		V63C		0.9
575 cid 675FEFI	High Performance Engines	105		V63C		0.9
Model 155 (292 cid)	Transdrive, Inboard & V-drive	175		RN5C	8339	0.9
Model 300 (427 cid)	Transdrive, Inboard & V-drive	155		RN5C	8339	0.9

**FORD**

104 cid		175		OE051	RN11YC	8415	0.9
158 & 201 cid		175			RN5C	8339	0.9
172 cid		175			RH10C		0.9
250 cid		175			RF10C		0.9
302, 351 & 460 cid		185			RV12YC	8018	0.9
302, 351W & 427 cid		185			RF9YC		0.9
427 & 429 cid		200	1975→1989		RV12YC	8018	0.9
477 cid		200			RF10C		0.9
		200	1977→1981		RZF10		0.9
534 cid		200	1976→		RF10C		0.9
		200	1976→		RZF10		0.9
67 & 98 cid		175		OE006	RN9YC	8415	0.9

**FORESTER (→ Mercruiser & Volvo Penta)****FORMULA (→ Mercruiser, Bombardier & Volvo Penta)****FOSTER**

Bumper Boats	Honda OHV	4		OE051	RN11YC	8415	0.8
--------------	-----------	---	--	-------	--------	------	-----

**FOUNTAIN (→ Mercruiser)****FOUR WINNS (→ Bombardier & Volvo Penta)****G.W. INVADER (→ Mercruiser, Volvo Penta & Yamaha)****GALAXIE (→ Mercruiser)****GEKKO (→ Mercruiser & PCM)****GENESIS (→ Mercruiser & Volvo Penta)****GLASSTREAM (→ Mercruiser & Volvo Penta)****GLASTRON (→ Mercruiser & Volvo Penta)****GODFREY (→ Mercruiser & Volvo Penta)****GOFF**

GMP 225		1	1969→1973		RJ14YC		0.9
GMP 455		1.5 - 2	1961→1970		RJ14YC		0.8
		1.2	1971→1972		RJ14YC		1.0
		1.1	1973→		RJ18YC		1.0

\* Leaded fuel use RV8C



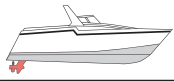

CC

BHP

POWER  
SPORT**GRAYMARINE**

Four 140, 162	Express Series	4			<b>D9</b>		0.6
Four 22, 52, 112	Lugger Series	2			<b>RD16</b>		0.6
Four 40, 75, 80, 85TD, 140, 162	Lugger Series	2			<b>D14</b>		0.6
Four 45	Phantom Series	6			<b>RJ8C</b>		0.6
Four 50	Fireball Series	15			<b>RJ8C</b>		0.6
Four 52, 112	Express Series	4			<b>D14</b>		0.6
Four 62	Phantom Series	7.5			<b>D9</b>		0.6
Four 69, Seascout 45, 91	Lugger Series	3 - 5.2			<b>RJ12C</b>		0.9
Four 75, 85, 86, 162, 620, 750	Phantom Series	9			<b>D14</b>		0.6
Four 90	Fireball Series	18			<b>D14</b>		0.6
Sea Scout 91	Express Series	6			<b>RJ12C</b>		0.9
Six 115, 135, 200	Phantom Series	10			<b>D6</b>		0.6
Six 116, 150, Super 330	Fireball Series	20			<b>D9</b>		0.5
Six 118, 120, 122, 135, 136, 150, 165	Phantom Series	10			<b>D14</b>		0.6
Six 121, 186; Super 117, Super 427	Express Series	5.5			<b>D9</b>		0.6
Six 140, 160	Fireball Series	20			<b>D9</b>		0.5
Six 175, 185	Phantom Series	14-18			<b>D14</b>		0.6
Six 232, Stern Drive	Fireball Series	20-25		<b>OE006</b>	<b>RN9YC</b>	<b>8415</b>	0.6
Six 51, 121, 186, 226, 330	Lugger Series	3			<b>RD16</b>		0.6
Six 70, 80, 100, 109, 109TD, 110, 116	Phantom Series	9.5			<b>D14</b>		0.6
Six 71, 77	Lugger Series	3.3			<b>D9</b>		0.6
Six 71, 77, 80, 111, 427	Express Series	4			<b>D14</b>		0.6
Six 88, 90, 103, 104, 112, 125	Phantom Series	9.7			<b>D9</b>		0.6
Six 91, 224	Express Series	5			<b>D6</b>		0.6
Six 91, 244	Lugger Series	4			<b>D14</b>		0.6
V-8 Models 170, 175, 178, 178B, 188	Fireball Series	25			<b>RJ12YC</b>		0.6
V-8 Models 195, 215, 220, 225, 238	Fireball Series	25			<b>RJ12YC</b>		0.6
V-8 Models 260, 280, 310, 427	Fireball Series	25			<b>RJ12YC</b>		0.6
V-8 Models 304, 360	Fireball Series	25			<b>RN14YC</b>	<b>8405</b>	0.6
V-8 Models C, CF, CH, 135, 138, 138A	Fireball Series	20-25			<b>RJ12YC</b>		0.6

**GUARDIAN MARINE**

Chevrolet 454 cid		30		*	<b>RV15YC4</b>	<b>8018</b>	0.9
Ford 302 & 351W cid		25			<b>RV12YC</b>	<b>8018</b>	0.9
Ford 460 cid		28			<b>RV12YC</b>	<b>8018</b>	0.9
Oldsmobile 455 cid		33-40			<b>RJ14YC</b>		1.0

**HACKER CRAFT (→ Crusader)****HALLETT (→ Mercruiser)****HARBOR MASTER (→ Mercruiser)****HARDIN MARINE**

H240J, H240V Gasket Seat			1969 → 1990		<b>RJ14YC</b>		0.9
H240J, H240V Tapered Seat			1969 → 1990		<b>RV12YC</b>	<b>8018</b>	0.9
H295J, H295V			1969 → 1976		<b>RJ14YC</b>		0.9
H300J, H300V			1977 → 1990		<b>RJ14YC</b>		0.9
H305I, H350I, H454I	90		1979 → 1990	*	<b>RV15YC4</b>	<b>8018</b>	0.9
H320J, H320V	100		1979 → 1990	*	<b>RV15YC4</b>	<b>8018</b>	0.9
H320TC			1978 → 1990		<b>V63C</b>		0.7
H324J, H324V			1975 → 1976		<b>RJ14YC</b>		0.9
H325J, H325V		3.5, 5.0	1969 → 1976		<b>RJ14YC</b>		0.8
H345J, H345V		7.5, 9.9	1969 → 1976		<b>RJ14YC</b>		0.8
H405TC			1978 → 1990		<b>V63C</b>		0.7
H455J (ET), H455V (ET)			1976 →		<b>RJ14YC</b>		0.9
HM225I	40		1983 → 1990	*	<b>RV15YC4</b>	<b>8018</b>	0.9
HM225J, HM225V, H225IO			1980 → 1986	*	<b>RV15YC4</b>	<b>8018</b>	0.9
HM225TS, HM260TS, HM280TS			1983 → 1990	*	<b>RV15YC4</b>	<b>8018</b>	0.9
HM260I, HM280I	50		1983 → 1990		<b>RV12YC</b>	<b>8018</b>	0.9
HM260J, HM260V, H260IO			1980 → 1986	*	<b>RV15YC4</b>	<b>8018</b>	0.9
HM280J, HM280V, H280I			1980 → 1986	*	<b>RV15YC4</b>	<b>8018</b>	0.9
HM333I, HM425, HM405I	60		1983 → 1990		<b>RV12YC</b>	<b>8018</b>	0.9
HM333J, HM333V	80		1976 → 1990	*	<b>RV15YC4</b>	<b>8018</b>	0.9
HM400, HM430	75		1983 → 1990		<b>RV12YC</b>	<b>8018</b>	0.9
HM405J, HM405V			1974 → 1990	*	<b>RV15YC4</b>	<b>8018</b>	0.9



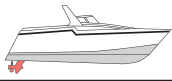

CC

BHP

21

POWER  
SPORT

mm

**HARMAN HOUSE**

Chevrolet 350 cid Engs.		15.0			RV12YC	8018	1.0
Chevrolet 454 cid Engs.		3.5, 5		*	RV15YC4	8018	0.9
Ford 460 cid Engs.		7			RV12YC	8018	0.9

**HARRIS FLOTEBOTE & FLOTEDEK (→ Mercruiser & Volvo Penta)****HARRIS KAYOT (→ Volvo Penta)****HOLIDAY MANSION (→ Crusader, Mercruiser, PCM & Volvo Penta)****HOVER AIR AMERICA**

3 Plus 1	4.3L Mercruiser		7.5, 8	*	RV15YC4	8018	0.9
----------	-----------------	--	--------	---	---------	------	-----

**HURRICANE (→ Mercruiser & Volvo Penta)****HUSTLER (Also, → Mercruiser)**

Model 350, 375, 450, 525, 585					RV9YC		0.9
-------------------------------	--	--	--	--	-------	--	-----

**HYDRODYNE (→ Indmar, Mercruiser & PCM)****IMC**

Jet & Personal Watercraft		1300	5, 7.5		OE091	RN2C	8904	0.8
		850	5.5, 7.5		OE091	RN2C	8904	0.8

**IMP (→ Mercruiser)****IMPERIAL (→ Mercruiser)****INDMAR**

Cadillac 4.6L MPI Northstar		3.5, 5, 7			RS14PYP5		1.3
Chevrolet 4.3L EFI		4			RV12YC	8018	0.9
Chevrolet 400 cid Engs.		85			RV12YC	8018	1.1
Chevrolet 5.0L Carb. Engs.		5			RV12YC	8018	1.1
Chevrolet 5.7 Gen+ Carb. Engs.		5		OE011	RS9YC	8304	0.8
Chevrolet 5.7 Gen+ EFI		9.9		OE011	RS9YC	8304	1.1
Chevrolet 5.7 Gen+ HO EFI		7.5		OE011	RS9YC	8304	0.8
Chevrolet 5.7L Carb. Engs.		25			RV12YC	8018	1.1
Chevrolet 5.7L EFI Engs.		9.9			RV12YC	8018	1.1
Chevrolet 5.7L EFI HO Engs.		15		OE011	RS9YC	8304	1.1
Chevrolet 5.7L HO Carb. Engs.		35		OE011	RS9YC	8304	1.1
Chevrolet 5.7L LT-1 EFI Engs.		15		OE011	RS9YC	8304	1.1
Chevrolet 7.4L & 8.2L Engs.		40	1998→2002	OE011	RS9YC	8304	1.1
Chevrolet 7.4L Carb. Engs.		50			RV12YC	8018	1.1
Chevrolet 7.4L EFI Engs.		50			RV12YC	8018	1.1
Chevrolet 7.4L HO Carb. Engs.		50			RV12YC	8018	1.1
Chevrolet 7.4L HO EFI Engs.		60			RV12YC	8018	1.1
Chevrolet 8.2L EFI		70			RV12YC	8018	1.1
Chevrolet 8.2L HO EFI		75			RV12YC	8018	1.1
Ford 5.0L Engs.		90			RV12YC	8018	1.1
Ford 5.0L HO Engs.		90			RV12YC	8018	1.1
Ford 5.8L Engs.		120			RV12YC	8018	1.1
Ford 5.8L HO Engs.		120		OE011	RS9YC	8304	1.1
Ford 7.5L Engs.		125			RV12YC	8018	1.1
Oldsmobile 350 & 403 cid Engs.		150	1976→1982		RJ18YC		1.0
Oldsmobile 455 cid Engs.		150	1975→1976		RJ18YC		1.0

**INFINITY (→ Mercruiser)****INTERCEPTOR**

144, 170 Side Draft Carb.		9.2			RF14YC		0.8
170 Down Draft Carb.		3, 5			RF10C		0.8
200, 256, 272, 289, 292, 312, 352		3, 5, 5.5, 12, 15, 25			RF10C		0.8
390, 302		35, 40, 60			RF11YC		0.8
427 Normal Operation		300			RF10C		0.8
		400			RF11YC		0.8
V-4 104, V-6 122		6		OE064	RL82YC	8814	0.8

**INVADER (→ Mercruiser & Volvo Penta)**

\* Leaded fuel use RV8C



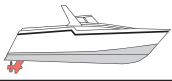

CC

BHP

21

POWER  
SPORT**JOHNSON**

CU, SU 153 cid		110-120			RN5C	8339	0.9
DU 89 cid		88-90			J4C		0.8
HU 225 cid		150-155			RJ14YC		0.9
KU 283 cid		185			RJ12YC		0.9
NU	1600	80-90		OE006	RN9YC	8415	0.6
TU-14, -15, -16 300 cid		200			RJ14YC		0.9
TU-17 & Up 283 & 307 cid		210			RJ14YC		0.9

**KAYOT (→ Mercruiser, Bombardier & Volvo Penta)****KERMATH**

Sea Pup, Sea Twin					RJ12C		0.6
-------------------	--	--	--	--	-------	--	-----

**KING**

350 cid		240	1971→1973		RJ14YC		1.0
454 cid		450	1973→1986	*	RV15YC4	8018	0.9
455 cid		270	1971→1973		RJ18YC		1.0
		325	1972→1973		RJ14YC		1.0
		410	1972→1973		RJ14YC		0.9

**LA. SKIER (→ PCM)****LARSON (→ Mercruiser & Volvo Penta)****LEHMAN ECON-O-POWER**

155 cid (Capri)	Ford 6-Cyl.	20	1972→1973	OE006	RN9YC	8415	0.9
170 cid	Ford 6-Cyl.	25	1960→1973		RF10C		0.9
200, 240, 250 & 300 cid	Ford 6-Cyl.	30	1960→1973		RF10C		0.9
256 cid	Ford V-8	35	1954→		RH12		0.9
260 & 289 cid	Ford V-8	40	1963→1968		RF10C		0.9
292 & 312 cid	Ford V-8	45	1956→1962		RF11YC		0.9
302 & 351 cid	Ford V-8 (18mm)	75	1968→1973		RF10C		0.9
302 cid	Ford V-8 (14mm)	50	1969→1971		RV9YC		0.9
307 cid	Chevrolet	135	1971→1973		RV92YC		0.9
350 cid	Chevrolet	150	1973→1988	*	RV15YC4	8018	0.9
400 cid	Chevrolet	200	1971→1973	*	RV15YC4	8018	0.9
400, 350, 327, 307 & 283 cid	Chevrolet	225	1957→1970		RJ12YC		0.9
428, 427, 410 & 390 cid	Ford V-8	90	1958→1968		RF10C		0.9
460 & 429 cid	Ford V-8 (18mm)	130	1968→1973		RF10C		0.9
460, 429 & 351 cid	Ford V-8 (14mm)	115	1970→1973		RV12YC	8018	0.9

**LITTLE HARBOR (→ Crusader, Mercruiser & Volvo Penta)****LUHRS (→ Crusader, Mercruiser & Marine Power)****MAGIC (→ Mercruiser)****MAINSHIP (→ Crusader & Marine Power)****MALIBU (→ Indmar & Mercruiser)****MARADA (→ Mercruiser & Volvo Penta)****MARES (→ Mercruiser & Volvo Penta)****MARIAH (→ Mercruiser, Volvo Penta & Yamaha)****MARINE DRIVES SYSTEMS (MDS)**

Stern Drive Models 85, 110				OE064	RL82YC	8814	0.6
----------------------------	--	--	--	-------	--------	------	-----

**MARINE POWER**

262		200, 225		*	RV15YC4	8018	0.9
350		260, 300, 325	1992→2002	*	RV15YC4	8018	0.9
454		340, 390, 440	1992→2002	*	RV15YC4	8018	0.9
502		410, 475		*	RV15YC4	8018	0.9
540		550			RV12YC	8018	0.9
181	Gasket Seat		1975→1978		RN5C	8339	0.9
	Taper Seat (.460" Reach)		1975→1991	*	RV15YC4	8018	0.9
	Taper Seat (.708" Reach)		1992→2002		RS12YC	8401	0.9
229 cid V-6	GM			*	RV15YC4	8018	0.9

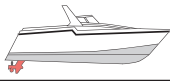

CC

BHP

POWER  
SPORT**... MARINE POWER**

250 cid V-6	GM				RV92YC		0.9
262 cid V-6	GM			*	RV15YC4	8018	0.9
292 cid	GM (Gasket Seat)				RN5C	8339	0.9
	GM (Taper Seat)			*	RV15YC4	8018	0.9
302 cid	Ford				RV12YC	8018	0.9
305 cid	GM			*	RV15YC4	8018	0.9
318 cid	Chrysler			OE042	RN12YC	8405	0.9
327 cid	GM				RJ12YC		0.9
350 cid	GM			*	RV15YC4	8018	0.9
350 Premium		294	1996 → 1997		RS12YC	8401	0.9
351W cid	Ford				RF9YC		0.9
360 cid	Chrysler			OE042	RN12YC	8405	0.9
4.3L Vortec		225	1998 → 2002		RS12YC	8401	0.9
440 cid	Chrysler				RJ14YC		0.9
454 cid	GM				RV12YC	8018	0.9
454, B, BM		330	1975 → 1991	*	RV15YC4	8018	0.9
460 cid	Ford				RV12YC	8018	0.9
5.7L Vortec		325	1998 → 2002		RS12YC	8401	0.9
502 500X			1999 → 2002	*	RV15YC4	8018	0.9
502 700X		700	2000 →	*	RV15YC4	8018	0.9
7.4L Vortec MPI		325, 340	1998 → 2002	*	RV15YC4	8018	0.9

**MARINETEK**

181 cid 3.0L HO	GM	18	1990 → 1997		RS12YC	8401	1.1
229 cid	GM	20	1980 → 1984	*	RV15YC4	8018	0.9
250 cid	GM	20	1970 → 1980	*	RV15YC4	8018	0.9
262 cid	GM	20	1985 → 1992	*	RV15YC4	8018	0.9
302 cid	Ford	15	1968 → 1974		RF9YC		0.9
	Ford	15	1975 → 1980		RV12YC	8018	0.9
	Ford	15	1981 → 1995	*	RV15YC4	8018	0.9
305 cid	GM	25	1976 → 1995	*	RV15YC4	8018	0.9
318 cid	Chrysler	14	1966 → 1974		RJ14YC		0.9
	Chrysler	14	1975 → 1988	OE042	RN12YC	8405	0.9
350 cid	GM	25	1967 → 1970		RJ14YC		0.9
	GM	25	1971 → 1995	*	RV15YC4	8018	0.9
350 cid HO	GM	25	1987 → 1995		RV12YC	8018	0.9
351 cid	Ford	15	1969 → 1974		RF9YC		0.9
	Ford	15	1975 → 1987		RV12YC	8018	0.9
360 cid	Chrysler	15	1975 → 1988	OE042	RN12YC	8405	0.9
454 cid	GM	28	1973 → 1987	*	RV15YC4	8018	0.9
454 cid Gen V	GM	25	1992 → 1993		RV12YC	8018	0.9
454 cid HO	GM	28	1984 → 1991		RV12YC	8018	0.9
460 cid	Ford	18	1973 → 1974		RF9YC		0.9
	Ford	15	1975 → 1987		RV12YC	8018	0.9

**MASTERCRAFT (→ Indmar)****MAXUM (→ Mercruiser)****MB SPORTS (→ PCM)****MEDITERRANEAN (→ Crusader)****MERCUISER**

198	GM V-8 305, 327 & 350	10		*	RV15YC4	8018	0.9
215	Ford V-8 302 & 351 cid	6			RF10C		0.8
225	GM V-8 305, 327 & 350	10			J4C		0.9
	Ford V-8 302 & 351 cid	7.5			RF10C		0.8
233	Ford V-8 302 & 351 cid (14mm)	9		*	RV15YC4	8018	0.9
	Ford V-8 302 & 351 cid (18mm)	9.5			RF10C		0.8
255	Ford V-8 302 & 351 cid	9.7		*	RV15YC4	8018	0.9
	GM V-8 305, 327 & 350	18		*	RV15YC4	8018	0.9
260	GM V-8 305, 327 & 350	20		*	RV91MC		0.9
330	GM V-8 427, 454 & 502 cid			*	RV15YC4	8018	0.9
340	GM V-8 427, 454 & 502 cid			*	RV15YC4	8018	0.9
350	GM V-8 427, 454 & 502 cid				V63C		0.9
390	GM V-8 427, 454 & 502 cid				XEN14		0.9
470	Mercury Marine 4-Cyl. 224 cid	6			RV9YC		0.9
228, 230	GM V-8 305, 327 & 350	14-18		*	RV15YC4	8018	0.9
250 2317201-2797056	GM V-8 305, 327 & 350	15			J4C		1.0

\* Leaded fuel use RV8C



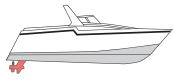

CC

BHP



POWER SPORT

**... MERCUISER**

270	GM V-8 305, 327 & 350 (Gasket)	20				J4C	0.8
	GM V-8 305, 327 & 350 (Taper)	20-25			*	RV15YC4	8018
>325 2762441	GM V-8 427, 454 & 502 cid	90				N19V	
325 2762442>	GM V-8 427, 454 & 502 cid	100				V63C	0.9
350 Mag (Carb)	GM V-8 350 & 454 cid Ski Engines	28			*	RV91MC	1.0
350 Mag EFI >0F799999	GM V-8 350 & 454 cid Ski Engines	30			*	RV91MC	1.0
350 Mag EFI Gen+ 0F800000>	GM V-8 350 & 454 cid Ski Engines	40				RS12YC	8401
350 Mag EFI/MP >0F799999	GM V-8 350 & 454 cid Ski Engines	33-40			*	RV91MC	1.0
350 Mag MPI >0F799999	GM V-8 350 & 454 cid Ski Engines	35			*	RV91MC	1.0
350 Mag MPI Gen+ 0L002008>	GM V-8 305, 327 & 350	25				RS12YC	8401
350 Mag MPI Gen+ 0L002600>	GM V-8 350 & 454 cid Ski Engines	40				RS12YC	8401
400 Jet	GM V-8 427, 454 & 502 cid				*	RV15YC4	8018
454 EFI/MP	GM V-8 350 & 454 cid Ski Engines	75			*	RV15YC4	8018
454 MPI	GM V-8 350 & 454 cid Ski Engines	80			*	RV15YC4	8018
5.0L	GM V-8 305, 327 & 350	20-25			*	RV91MC	0.9
5.7L >0L000000	GM V-8 305, 327 & 350	25			*	RV91MC	1.0
5.7L Comp >0L000000	GM V-8 350 & 454 cid Ski Engines	50			*	RV91MC	1.0
5.7L Comp Gen+ 0L002005>	GM V-8 350 & 454 cid Ski Engines	60				RS12YC	8401
5.7L EFI Gen+	GM V-8 305, 327 & 350	25				RS12YC	8401
5.7L Gen+ 0L002003>	GM V-8 305, 327 & 350	25				RS12YC	8401
7.4L	GM V-8 427, 454 & 502 cid				*	RV15YC4	8018
7.4L EFI	GM V-8 427, 454 & 502 cid				*	RV15YC4	8018
7.4L EFI/MP	GM V-8 427, 454 & 502 cid				*	RV15YC4	8018
7.4L MPI (L29) 0L002006>	GM V-8 427, 454 & 502 cid					RS12YC	8401
7.4L MPI >0L000000	GM V-8 427, 454 & 502 cid				*	RV15YC4	8018
7.4LX MPI	GM V-8 427, 454 & 502 cid					RS12YC	8401
8.2L Carb.	GM V-8 427, 454 & 502 cid				*	RV15YC4	8018
8.2L MPI	GM V-8 427, 454 & 502 cid	2			*	RV15YC4	8018
Black Scorpion 0F800000>	GM V-8 350 & 454 cid Ski Engines	40				RS12YC	8401
MX 6.2 MPI Horizon	GM V-8 427, 454 & 502 cid				OE011	RS9YC	8304
Scorpion 377	GM V-8 350 & 454 cid Ski Engines	40				RS12YC	8401
Sportjet 120	Jet Drive	3	1995 →			QL77JC4	8883
Sportjet 120XR	Jet Drive	3.3	1996 → 1999			QL77JC4	8883
Sportjet 175XR2	Jet Drive	3.5	1997 → 1999			QL77JC4	8883
Sportjet 90	Jet Drive	2.5	1993 → 1995			QL77JC4	8883
Sportjet 95XR	Jet Drive	3	1996 → 1999			QL77JC4	8883
Stern Drive 1000SC Race (542 cid)	GM V-8 502, 540 & 572 cid	5.5				N19V	
Stern Drive 110	GM 4-Cyl. 153 cid	40				RN5C	8339
Stern Drive 120 >3825578	GM 4-Cyl. 153 cid	40				RN5C	8339
Stern Drive 120 3825579>	GM 4-Cyl. 153 cid	40			*	RV15YC4	8018
Stern Drive 140	GM 6-Cyl. 194, 230 & 292 cid	50				RN5C	8339
Stern Drive 140 >3826282	GM 4-Cyl. 181 cid	40				RN5C	8339
Stern Drive 140 3826283>	GM 4-Cyl. 181 cid	40			*	RV15YC4	8018
Stern Drive 150	GM 6-Cyl. 194, 230 & 292 cid	50				RN5C	8339
Stern Drive 160	GM 6-Cyl. 194, 230 & 292 cid	55				RN5C	8339
Stern Drive 165 >2771483	GM 6-Cyl. 194, 230 & 292 cid	55				RN5C	8339
Stern Drive 165 2771484>	GM 6-Cyl. 194, 230 & 292 cid	55			*	RV15YC4	8018
Stern Drive 175, 185	GM V-6 262 cid	60			*	RV15YC4	8018
Stern Drive 185	GM V-6 229 cid	60			*	RV15YC4	8018
Stern Drive 190	GM V-8 283, 327, 305 & 350 cid	88				RJ12YC	0.9
Stern Drive 2.5L	GM 4-Cyl. 153 cid	40			*	RV15YC4	8018
Stern Drive 200	GM 6-Cyl. 194, 230 & 292 cid	55				RN5C	8339
Stern Drive 205	GM V-6 262 cid	60			*	RV15YC4	8018
Stern Drive 215	Ford V-8 302 & 351 cid	70				RF10C	0.8
Stern Drive 225	Ford V-8 302 & 351 cid	75				RF10C	0.8
Stern Drive 225 >2278646	GM V-8 283, 327, 305 & 350 cid	90				J4C	0.9
Stern Drive 225 2278647>	GM V-8 283, 327, 305 & 350 cid	90				RJ12YC	0.9
Stern Drive 228, 230	GM V-8 283, 327, 305 & 350 cid	90			*	RV91MC	0.9
Stern Drive 233	Ford V-8 302 & 351 cid (14mm)	80			*	RV15YC4	8018
	Ford V-8 302 & 351 cid (18mm)	80				RF10C	0.8
Stern Drive 250 >2639854	GM V-8 283, 327, 305 & 350 cid	90				J4C	0.8
Stern Drive 250 4768000>	GM V-8 283, 327, 305 & 350 cid	100			*	RV15YC4	8018
Stern Drive 255	GM V-8 283, 327, 305 & 350 cid	100			*	RV15YC4	8018
Stern Drive 255 >4175498	Ford V-8 302 & 351 cid	85				RF10C	0.8
Stern Drive 255 4175499>	Ford V-8 302 & 351 cid (14mm)	85			*	RV15YC4	8018
	Ford V-8 302 & 351 cid (18mm)	85				RF10C	0.8
Stern Drive 260	GM V-8 283, 327, 305 & 350 cid	100			*	RV91MC	0.9
Stern Drive 262 Mag EFI Gen+ 0F803800-0L000000	GM V-6 262 cid	60				RS12YC	8401
Stern Drive 270	GM V-8 283, 327, 305 & 350 cid Gasket Heads	105				J4C	0.8
	GM V-8 283, 327, 305 & 350 cid (Taper)	105				V63C	0.9

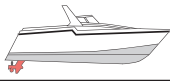

CC

BHP

**... MERCURISER**

Stern Drive 280	GM V-8 283, 327, 305 & 350 cid	110		*	RV15YC4	8018	0.9	
Stern Drive 3.0L >0F353100	GM 4-Cyl. 181 cid	40		*	RV15YC4	8018	0.9	
Stern Drive 3.0L 0L010042>	GM 4-Cyl. 181 cid	45			RS12YC	8401	0.9	
Stern Drive 3.0LX	GM 4-Cyl. 181 cid	48			RS12YC	8401	0.9	
Stern Drive 3.7L	Mercury Marine 4-Cyl. 224 cid	50			RV12YC	8018	0.9	
Stern Drive 3.7LX	Mercury Marine 4-Cyl. 224 cid	50			RV12YC	8018	0.9	
Stern Drive 300 Tempest	GM V-8 283, 327, 305 & 350 cid	112		*	RV15YC4	8018	0.9	
Stern Drive 320 EFI	GM V-8 283, 327, 305 & 350 cid	115		*	RV15YC4	8018	0.9	
Stern Drive 325 >2761141	GM V-8 427, 454 & 482 cid	150			N19V			
Stern Drive 325 3043030>	GM V-8 427, 454 & 482 cid	150			V63C		0.9	
Stern Drive 330	GM V-8 427, 454 & 482 cid	150		*	RV15YC4	8018	0.9	
Stern Drive 330 (B-W)	GM V-8 427, 454 & 482 cid	150		*	RV15YC4	8018	0.9	
Stern Drive 350 Mag (Carb)	GM V-8 283, 327, 305 & 350 cid	115		*	RV91MC		1.0	
Stern Drive 350 Mag EFI Gen+ 0F800500>	GM V-8 283, 327, 305 & 350 cid	115			RS12YC	8401	1.1	
Stern Drive 350 Mag EFI/MP >0F602199	GM V-8 283, 327, 305 & 350 cid	115		*	RV91MC		1.0	
Stern Drive 350 Mag MPI Gen+ 0F602000>	GM V-8 283, 327, 305 & 350 cid	115			RS12YC	8401	1.1	
Stern Drive 350 Mag MPI Gen+ 0L604000>	GM V-8 283, 327, 305 & 350 cid	115			RS12PYP	8401	0.9	
Stern Drive 370, 400	GM V-8 427, 454 & 482 cid	150		*	RV15YC4	8018	0.9	
Stern Drive 377 Scorpion 0L416146>	GM V-8 283, 327, 305 & 350 cid	115			RS12YC	8401	1.1	
Stern Drive 390	GM V-8 427, 454 & 482 cid	155			XEN14		0.9	
Stern Drive 4.3 Gen+ 0L010065>	GM V-6 262 cid	65			RS12YC	8401	1.1	
Stern Drive 4.3L >0F802999	GM V-6 262 cid	60		*	RV15YC4	8018	1.0	
Stern Drive 4.3L MPI	GM V-6 262 cid	60	2002 →	*	RV15YC4	8018	1.0	
Stern Drive 4.3LH Gen+ 0L010044>	GM V-6 262 cid	65			RS12YC	8401	1.1	
Stern Drive 4.3LL EFI Gen+ 0L012009>	GM V-6 262 cid	65			RS12YC	8401	1.1	
Stern Drive 4.3LX >0F802999	GM V-6 262 cid	65		*	RV15YC4	8018	1.0	
Stern Drive 4.3LX Gen+ 0F803000-0L000000	GM V-6 262 cid	65			RS12YC	8401	1.1	
Stern Drive 4.3LXH Gen+ 0F803000-0L000000	GM V-6 262 cid	65			RS12YC	8401	1.1	
Stern Drive 400 Cyclone	GM V-8 427, 454 & 482 cid	155		*	RV15YC4	8018	0.9	
Stern Drive 420	GM V-8 427, 454 & 482 cid	175		*	RV15YC4	8018	0.8	
Stern Drive 440 Cyclone	GM V-8 427, 454 & 482 cid	175		*	RV15YC4	8018	0.9	
Stern Drive 454 Mag Alpha	GM V-8 427, 454 & 482 cid	185		*	RV15YC4	8018	1.0	
Stern Drive 454 Mag Bravo	GM V-8 427, 454 & 482 cid	200		*	RV15YC4	8018	0.9	
Stern Drive 454 Mag EFI/MP	GM V-8 427, 454 & 482 cid	200		*	RV15YC4	8018	1.0	
Stern Drive 454 Mag MPI	GM V-8 427, 454 & 482 cid	200		*	RV15YC4	8018	1.0	
Stern Drive 460 Cyclone	GM V-8 427, 454 & 482 cid	200			V63C		0.9	
Stern Drive 470, 165, 170	Mercury Marine 4-Cyl. 224 cid	48			RV12YC	8018	0.9	
Stern Drive 475 Turbo	GM V-8 427, 454 & 482 cid	200			V63C		0.9	
Stern Drive 485	Mercury Marine 4-Cyl. 224 cid	48			RV12YC	8018	0.9	
Stern Drive 488, 180, 190	Mercury Marine 4-Cyl. 224 cid	50			RV12YC	8018	0.9	
Stern Drive 5.0L >0L000000	GM V-8 283, 327, 305 & 350 cid	115		*	RV91MC		0.9	
Stern Drive 5.0L EFI Gen+ 0L012052	GM V-8 283, 327, 305 & 350 cid	115			RS12YC	8401	1.1	
Stern Drive 5.0L Gen+ 0L015751	GM V-8 283, 327, 305 & 350 cid	115			RS12YC	8401	1.1	
Stern Drive 5.0L MPI	GM V-8 283, 327, 305 & 350 cid	115			RS12YC	8401	1.1	
Stern Drive 5.0LX	GM V-8 283, 327, 305 & 350 cid	120		*	RV91MC		0.9	
Stern Drive 5.7L >0L000000	GM V-8 283, 327, 305 & 350 cid	125		*	RV91MC		1.0	
Stern Drive 5.7L EFI >0L000000	GM V-8 283, 327, 305 & 350 cid	130		*	RV91MC		1.0	
Stern Drive 5.7L EFI Gen+ 0L010035>	GM V-8 283, 327, 305 & 350 cid	140			RS12YC	8401	1.1	
Stern Drive 5.7L Gen+ 0L010037>	GM V-8 283, 327, 305 & 350 cid	135			RS12YC	8401	1.1	
Stern Drive 5.7LX	GM V-8 283, 327, 305 & 350 cid	140		*	RV91MC		1.0	
Stern Drive 5.7LX EFI	GM V-8 283, 327, 305 & 350 cid	140		*	RV91MC		1.0	
Stern Drive 5.7LX EFI Gen+	GM V-8 283, 327, 305 & 350 cid	150			RS12YC	8401	1.1	
Stern Drive 502 Mag (Carb.)	GM V-8 502, 540 & 572 cid	3.3		*	RV15YC4	8018	1.0	
Stern Drive 502 Mag EFI/MP	GM V-8 502, 540 & 572 cid	4		*	RV15YC4	8018	1.0	
Stern Drive 502 Mag MPI	GM V-8 502, 540 & 572 cid	4		*	RV15YC4	8018	1.0	
Stern Drive 60	MCM Renault 4-Cyl. Engines	35			OE086	RL82C	8883	0.6
Stern Drive 600SC	GM V-8 502, 540 & 572 cid	4			V63C		0.9	
Stern Drive 7.4L Alpha	GM V-8 427, 454 & 482 cid	235		*	RV15YC4	8018	0.9	
Stern Drive 7.4L Bravo	GM V-8 427, 454 & 482 cid	250		*	RV15YC4	8018	1.0	
Stern Drive 7.4L MPI (L29) 0L010003>	GM V-8 427, 454 & 482 cid	275			RS12YC	8401	1.1	
Stern Drive 7.4L TR 0B771113-0C407646	GM V-8 427, 454 & 482 cid	250		*	RV15YC4	8018	0.9	
Stern Drive 7.4LX EFI	GM V-8 427, 454 & 482 cid	300		*	RV15YC4	8018	1.0	
Stern Drive 7.4LX MPI	GM V-8 427, 454 & 482 cid	3600		*	RV15YC4	8018	1.0	
Stern Drive 80	MCM Renault 4-Cyl. Engines	35			OE006	RN9YC	8415	0.6
Stern Drive 800SC	GM V-8 502, 540 & 572 cid	4			V63C		0.9	
Stern Drive 888 >4169596	Ford V-8 302 & 351 cid	70			RF10C		0.8	
Stern Drive 888 4169597>	Ford V-8 302 & 351 cid (14mm)	70		*	RV15YC4	8018	0.8	
	Ford V-8 302 & 351 cid (18mm)	70			RF10C		0.8	
Stern Drive 898, 200	GM V-8 283, 327, 305 & 350 cid	90		*	RV91MC		0.9	

\* Leaded fuel use RV8C



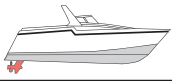

CC

BHP

21

POWER  
SPORT**... MERCUISER**

Stern Drive 90	MCM Renault 4-Cyl. Engines	35		OE006	RN9YC	8415	0.8
Stern Drive HP425	GM V-8 427, 454 & 482 cid	175		*	RV15YC4	8018	0.9
Stern Drive HP450	GM V-8 427, 454 & 482 cid	185		*	RV15YC4	8018	1.0
Stern Drive HP465	GM V-8 502, 540 & 572 cid	1		*	RV15YC4	8018	0.9
Stern Drive HP500 (502 cid)	GM V-8 502, 540 & 572 cid	1.1		*	RV15YC4	8018	1.0
Stern Drive HP500 Bulldog (540 cid)	GM V-8 502, 540 & 572 cid	1.5 - 2			V63C		0.9
Stern Drive HP500 EFI (502 cid)	GM V-8 502, 540 & 572 cid	1.2		*	RV15YC4	8018	1.0
Stern Drive HP525 SC	GM V-8 427, 454 & 482 cid	225			V63C		0.9
Stern Drive HP525SC (454 cid)	GM V-8 502, 540 & 572 cid	2			V63C		0.9
Stern Drive HP575	GM V-8 502, 540 & 572 cid	2			V63C		0.9
Stern Drive HP600SC Bobtail (502 cid)	GM V-8 502, 540 & 572 cid	3 - 5.2			V63C		0.9
Stern Drive HP800SC (572 cid)	GM V-8 502, 540 & 572 cid	3			V63C		0.9

**MID-JET (→ Volvo Penta)****MIRAGE (→ Mercruiser & Volvo Penta)****MISTY HARBOR (→ Mercruiser)****MONARK (→ Mercruiser)****MONTEREY (→ Mercruiser, Volvo Penta & Yamaha)****MOOMBA (→ Indmar, Mercruiser & PCM)****NAUSET (→ Crusader, Mercruiser, Bombardier & Volvo Penta)****NAUTICA (→ Mercruiser)****NAUTIQUES (→ PCM)****NAVIGATOR (→ Mercruiser & Volvo Penta)****NISSAN MARINE**

HA120		8	1987→1989		RN5C	8339	0.9
-------	--	---	-----------	--	------	------	-----

**NORDIC (→ Mercruiser)****NOR-TECH (→ Mercruiser)****NOVURANIA (→ Volvo Penta)****O.M.C (→ Bombardier)****OBSESSION (→ Mercruiser)****OCEAN EXPRESS (→ Mercruiser)****OLYMPIC (→ Volvo Penta)****OSPREY (→ Indmar, Mercruiser & Volvo Penta)****OUTERLIMITS (→ Mercruiser)****PACKARD (→ Crusader & Flagship)****PALMER-GREENWICH**

M196, M265, M392, M549		90			RJ12YC		0.8
M345B, M392B		90			RJ12YC		0.8
M-60, P-60		65			D15Y		0.8
MKIV-115, M304, M345 Light Service		75			RJ18YC		0.8
MKIV-115, M304, M345 Normal Service		70			RJ12YC		0.8
MKVI-150 Light Service		75			RJ18YC		0.8
MKVI-150 Normal Service		75			RJ12YC		0.8
MKVIII 200, 225 Light Service		85			RJ18YC		0.8
MKVIII 200, 225 Normal Service		75-80			RJ12YC		0.8
MKVIII 275, 300 Light Service		90			RJ18YC		0.8
MKVIII 275, 300 Normal Service		80			RJ12YC		0.8
P302, P351		100			RF11YC		0.8
PA190, PA220, PA255		105			RF10C		0.8
PA350		115			RV12YC	8018	0.8

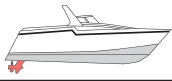

CC

BHP

21

POWER  
SPORT

... PALMER-GREENWICH							
PB-V-215 (V-8)		115		OE086	RL82C	8883	0.9
PW27	(14mm)	115			RJ14YC		0.8
	(18mm)	115			D21		0.8
Y304, Y345, Y392		125			RJ12YC		0.8
PANTERA (→ Mercruiser)							
PANTHER							
400 Plus-C, 500 Plus		150	1976→1980	*	RV15YC4	8018	0.9
400 Plus-F		150	1976→1980		RV12YC	8018	0.9
500 Plus-7		150	1978→1980		V63C		0.9
F-110, F-140		135	1978→1980	*	RV15YC4	8018	0.9
F-185, F-235, M-360		135	1976→1980		RN14YC	8405	0.9
M-454, M405		140	1976→1980	*	RV15YC4	8018	0.9
M-460		140	1976→1980		RV12YC	8018	0.9
PCM							
302, 351 & 460 cid	(14mm)	200		*	RV15YC4	8018	0.9
	(18mm)	200			RF10C		0.8
305, 350 & 454 cid		200		*	RV15YC4	8018	0.9
5.7L HO MPI		150			RS12YC	8401	0.9
5.7L HO Ski TBI		275		*	RV15YC4	8018	0.9
5.8L Carb.		260			RV9YC		0.9
5.8L HO MPI		310			RS12YC	8401	0.9
7.4L Carb.		175		*	RV15YC4	8018	0.9
7.4L HO TBI		350		*	RV15YC4	8018	0.9
7.4L MPI		200			RS12YC	8401	0.9
Models 150, 200, 220, 229		200		*	RV15YC4	8018	0.9
Models 230, 250, 280, 350		200		*	RV15YC4	8018	0.9
PEN YAN (→ Mercruiser)							
PERFORMANCE JET SYSTEMS							
Viper 5000, 6000, 7000HT		225		OE108	RN3C	8904	0.8
Viper 8000, 9000HT		225		OE108	RN3C	8904	0.8
PHOENIX (→ Crusader & Mercruiser)							
PIAGGIO BERKELEY							
KS150, KS200		225		OE098	RN4C	8339	0.6
PLAY CRAFT (→ Mercruiser)							
PMC							
225 cid (Gasket Seat)	Chrysler	250			RN5C	8339	0.9
225 cid (Tapered Seat)	Chrysler	250			RV9YC		0.9
229 cid V-6	GM	7.5		*	RV15YC4	8018	0.9
250 cid	GM	9			RV92YC		0.9
302, 351 & 460 cid	Ford (14mm)	300		*	RV15YC4	8018	0.9
	Ford (18mm)	3.5			RF10C		0.8
305, 350 & 454 cid	GM	45		*	RV15YC4	8018	0.9
307 cid (Gasket Seat)	GM	14			RJ14YC		0.9
307 cid (Tapered Seat)	GM	9.5		*	RV15YC4	8018	0.9
318 cid	Chrysler	260		OE042	RN12YC	8405	0.9
340 cid	Chrysler	265		OE006	RN9YC	8415	0.9
350 cid EFI	GM	28		*	RV15YC4	8018	0.9
360 cid	Chrysler	275		OE042	RN12YC	8405	0.9
390 cid	Ford	4			RF11YC		0.8
4.3L V-6	GM	45		*	RV15YC4	8018	0.9
440 cid	Chrysler	300			RJ14YC		0.9
5.8L HO EFI	Ford	4		OE011	RS9YC	8304	0.9
POWERPLAY (→ Mercruiser)							
POWERQUEST (→ Mercruiser & Volvo Penta)							
PREMIER (→ Mercruiser)							
PRINCECRAFT (→ Bombardier & Volvo Penta)							

\* Leaded fuel use RV8C



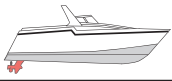

CC

BHP

21

POWER  
SPORT**PROFILE (→ Mercruiser)****PRO-LINE (→ Mercruiser & Volvo Penta)****PURSUIT (→ Crusader, Mercruiser & Volvo Penta)****REDLINE**

302 cid	3.6		RV12YC	8018	0.9
350 cid Alum. Head	4	OE013	RC12YC	8071	0.9
351 cid	4		RV12YC	8018	0.9
351 cid EFI, MAG & HO	4		RS12YC	8401	0.9
460 cid	4		RV12YC	8018	0.9
460 cid MAG	4		RV12YC	8018	0.9

**REGAL (→ Mercruiser & Volvo Penta)****REGENCY (→ Mercruiser & Volvo Penta)****RENDEZVOUS (→ Mercruiser)****RENKEN (→ Mercruiser)****REVLEY**

Models R225, R300, R401	6		RJ14YC		0.9
-------------------------	---	--	--------	--	-----

**RINKER (→ Mercruiser)****RIVERA (→ Mercruiser & Volvo Penta)****ROYALE (→ Mercruiser)****SABER (→ Mercruiser)****SCARAB (→ Mercruiser)****SEA RAY (→ Mercruiser)****SEA SPORT (→ Mercruiser & Volvo Penta)****SEA SPRITE (→ Mercruiser & Volvo Penta)****SEALINE (→ Mercruiser)****SEAMASTER (Also, → Mercruiser & Volvo Penta)**

300, 534	9.8		RF10C		0.8
----------	-----	--	-------	--	-----

**SEA-PRO (→ Mercruiser & Volvo Penta)****SEASWIRL (→ Bombardier & Volvo Penta)****SHAMROCK (→ Indmar & PCM)****SIERRA (→ Yamaha)****SILVER HAWK (→ Mercruiser)****SILVERTON YACHT (→ Crusader, Mercruiser & Volvo Penta)****SKAG ORCA (→ Mercruiser, Bombardier & Volvo Penta)****SKI CENTURION (→ Mercruiser)****SKI CHALLENGER (→ Mercruiser)****SKI RAY (→ Mercruiser)****SKI SUPREME (→ Mercruiser)****SKIPJACK (→ Crusader, Mercruiser & Volvo Penta)****SKIPPER LINER (→ Mercruiser)****SMOKER CRAFT (→ Mercruiser)**



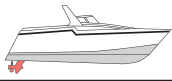

CC

BHP

21

POWER  
SPORT

<b>SONIC USA (→ Mercruiser)</b>							
<b>SPECTRE (→ Mercruiser)</b>							
<b>SPECTRUM (→ Mercruiser)</b>							
<b>SPLENDOR (→ Mercruiser)</b>							
<b>SPORT CHUTES (→ Mercruiser &amp; Volvo Penta)</b>							
<b>SPORT CRAFT (→ Crusader, Mercruiser, Bombardier, Volvo Penta)</b>							
<b>STAMAS YACHT (→ Crusader, Mercruiser &amp; Volvo Penta)</b>							
<b>STARBUCK BOATS</b>							
	Chevrolet 350 cid	40		*	RV15YC4	8018	0.9
	Chevrolet 454 cid	40			RV12YC	8018	0.9
<b>STARCRAFT (→ Mercruiser)</b>							
<b>STINGRAY (→ Mercruiser)</b>							
<b>SUMMERSET (→ Mercruiser &amp; Volvo Penta)</b>							
<b>SUN RUNNER YACHTS (→ Mercruiser)</b>							
<b>SUNBIRD (→ Bombardier &amp; Volvo Penta)</b>							
<b>SUNRAY (→ Mercruiser)</b>							
<b>SUNSATION (→ Mercruiser)</b>							
<b>SUNSEEKER (→ Mercruiser)</b>							
<b>SUPERBOATS (→ Mercruiser)</b>							
<b>SUPRA (→ Indmar, Mercruiser &amp; PCM)</b>							
<b>SURF HUNTER (→ Volvo Penta)</b>							
<b>SYLVAN (→ Mercruiser &amp; Volvo Penta)</b>							
<b>TAHOE (→ Mercruiser)</b>							
<b>TAHOE PONTOONS (→ Mercruiser)</b>							
<b>TALON (→ Mercruiser)</b>							
<b>TANKERS (→ Crusader)</b>							
<b>THOMPSON (→ Mercruiser &amp; Volvo Penta)</b>							
<b>TIARA YACHTS (→ Crusader)</b>							
<b>TIGE (→ Marine Power, Mercruiser &amp; PCM)</b>							
<b>TOYOTA MOTOR SPORTS</b>							
	Epic VT300i 4.0L V-8	75		OE134	RC12PYP	8071	1.1
<b>TROJAN (→ Crusader &amp; Mercruiser)</b>							
<b>TRULINE (→ Mercruiser &amp; Volvo Penta)</b>							
<b>TURBO-MARINE</b>							
	Ford 104 cid Engs.	75	1973→	OE006	RN9YC	8415	0.6
	Ford 302 cid V-8 Escort	75	1973→		RF10C		0.7
	Kohler K-399-2	80	1971→1973		D9		0.5
<b>ULTIMATE (→ Mercruiser)</b>							

\* Leaded fuel use RV8C



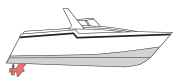

CC

BHP

POWER  
SPORT**UNIVERSAL**

Atomic 1, 2, 4, Atomic Stevedore		80			RJ8C		0.9
Bullet, Arrow, Bluefin		85			RJ8C		0.8
Colt		90			RJ8C		0.7
Knight, Tarpon, Marlin		90			RJ8C		0.8
LEV, LEVH Little King		188			RJ6C		0.7
NKEY Big King		277			RF11YC		0.9
Sabre 198 cid		140			RJ14YC		0.9
Strato-King		90			RJ6C		0.7
Super Sabre 225 cid		155			RJ14YC		0.9
Z-Drive, Elf		105			RJ8C		0.8

**US MARINE**

181F 3.0L		115			RN5C	8339	0.9
305K 5.0L		115			RV12YC	8018	0.9
350K 5.7L		125		*	RV15YC4	8018	0.9
454 7.5L		135		*	RV15YC4	8018	0.9

**VALMET (Vire)**

Sailboat Auxiliary		6, 7			OE086	RL82C	8883	0.5
--------------------	--	------	--	--	-------	-------	------	-----

**VELOCITY (→ Mercruiser)****VIP (→ Mercruiser)****VOLVO PENTA**

80	Aq Series		140			RJ6C		0.6
90	Aq Series		140			RL86C		0.6
140	B/bb Series	2500			OE006	RN9YC	8415	0.9
180	Aq Series		200			RJ12YC		0.6
261	B/bb Series		80		*	RV15YC4	8018	0.9
100, A	B/bb Series	2500				RL86C		0.6
105A, 110, 115A, 120	Aq Series		150		OE064	RL82YC	8814	0.6
115A, B, 165A	B/bb Series	2500			OE064	RL82YC	8814	0.6
120 (B21)	Aq Series		150		OE018	RN7YC	8332	0.9
125 A, B, 145	Aq Series		150		OE018	RN7YC	8332	0.9
130, A, B, C, D	Aq Series		150		OE064	RL82YC	8814	0.6
131, A, B, C, D	Aq Series		150		OE018	RN7YC	8332	0.9
140, A, 145A, B	Aq Series		175		OE018	RN7YC	8332	0.9
145, A	B/bb Series	2500			OE018	RN7YC	8332	0.9
150, A, B	Aq Series		175			RJ14YC		0.9
151 A, B, C	Aq Series		175		OE018	RN7YC	8332	0.9
165 A	Aq Series		175		OE064	RL82YC	8814	0.6
16A, 16C	B/bb Series	2500				RJ18YC		0.6
170, A, B, C	Aq Series		200		OE064	RL82YC	8814	0.6
170A, B, C	B/bb Series	3000			OE064	RL82YC	8814	0.6
171 A, C	Aq Series		200		OE006	RN9YC	8415	0.9
175, 175A	Aq Series		200		*	RV15YC4	8018	0.9
18A, 18C, 30B	B/bb Series	2500			OE086	RL82C	8883	0.6
190 Ford	Aq Series		200		*	RV15YC4	8018	0.6
190A Ford	Aq Series		200		*	RV15YC4	8018	0.6
200, A, B, C, D, F	Aq Series		220		*	RV15YC4	8018	0.6
205A	Aq Series		225		*	RV15YC4	8018	0.9
210A From Serial No. 177315 on	Aq Series		225			RV9YC		0.6
210A Thru Serial No. 177314	Aq Series		225			RJ12YC		0.6
211A, 211/DP, 231/DP, 271/DP	Aq Series		225		*	RV15YC4	8018	0.9
225, A, B, C	B/bb Series	3000			*	RV15YC4	8018	0.9
225, A, C	Aq Series		225		*	RV15YC4	8018	0.6
225D 305 cid	Aq Series		225		*	RV15YC4	8018	0.9
225E, F	Aq Series		250		*	RV15YC4	8018	0.9
230A	Aq Series		250		OE018	RN7YC	8332	0.9
231A	B/bb Series	3400			*	RV15YC4	8018	0.9
231A, B	Aq Series		275		*	RV15YC4	8018	0.9
240A Ford	Aq Series		300		*	RV15YC4	8018	0.6
25, 70	B/bb Series	2500				RJ6C		0.6
255B, 280A	Aq Series		300		*	RV15YC4	8018	0.6
260, A, B	Aq Series	2000			*	RV15YC4	8018	0.9
260, A, B, C	B/bb Series		50-65		*	RV15YC4	8018	0.9
271A, B, C, D	Aq Series	2000			*	RV15YC4	8018	0.9
290, A, B	Aq Series	2000			*	RV15YC4	8018	0.9
3.0L GS	Sx Cobra Series					RS12YC	8401	1.1

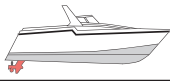

CC

BHP

POWER  
SPORT**... VOLVO PENTA**

		CC	BHP	21		POWER SPORT	mm	
311, A, B	Aq Series	2000			*	RV15YC4	8018	0.9
4.3L GIPNCA (.460" Reach)	Duoprop Series		125		*	RV15YC4	8018	1.1
	Sx Cobra Series				*	RV15YC4	8018	1.1
4.3L GIPNCS (.708" Reach)	Sx Cobra Series		1.7, 2			RS12YC	8401	1.1
	Duoprop Series		3.9-4			RS12YC	8401	1.1
430, 531	Aq Series	2000			*	RV15YC4	8018	0.9
5.0L Fi	Duoprop Series		10-20			RS12YC	8401	1.1
	Sx Cobra Series					RS12YC	8401	1.1
5.0L FL	Duoprop Series		6-7.5		*	RV15YC4	8018	0.9
	Sx Cobra Series				*	RV15YC4	8018	0.9
5.0L Gi Gen 1+	Duoprop Series		50-65			RS12YC	8401	1.1
	Sx Cobra Series					RS12YC	8401	1.1
5.0L GL Gen 1+	Duoprop Series		35			RS12YC	8401	1.1
	Sx Cobra Series					RS12YC	8401	1.1
5.7L Gi			9.8		*	RV15YC4	8018	0.9
	Duoprop Series		95-110		*	RV15YC4	8018	1.1
	Sx Cobra Series				*	RV15YC4	8018	1.1
5.7L GL	Sx Cobra Series		2.5		*	RV15YC4	8018	0.9
	Duoprop Series		3.9		*	RV15YC4	8018	0.9
5.7L GLi	Sx Cobra Series		3.5		*	RV15YC4	8018	1.1
	Duoprop Series		6-10		*	RV15YC4	8018	1.1
5.7L GS	Sx Cobra Series		4		*	RV15YC4	8018	0.9
	Duoprop Series		15		*	RV15YC4	8018	0.9
5.7L GS Gen 1+	Sx Cobra Series		4			RS12YC	8401	0.9
	Duoprop Series		35			RS12YC	8401	0.9
5.7L GSi Gen 1+	Sx Cobra Series		5			RS12YC	8401	1.1
	Duoprop Series		35-40			RS12YC	8401	1.1
5.7L GSi, GXi			9.8			RS12YC	8401	1.5
5.8L Fi, FSi	Sx Cobra Series		6		OE011	RS9YC	8304	1.1
	Sx Cobra Series		5		*	RV15YC4	8018	1.1
5.8L FL	Duoprop Series		20-25		*	RV15YC4	8018	1.1
			9.9		*	RV15YC4	8018	0.9
5.8L FL/HS1						RV15YC4	8018	0.9
5.8L FSi	Duoprop Series		35-45		OE011	RS9YC	8304	1.1
5.8L FSi/HS1			9.9		OE011	RS9YC	8304	1.1
500A, 501A,	Aq Series	2500			*	RV15YC4	8018	0.9
570A, 571A, 572, 740A	Aq Series	2500			*	RV15YC4	8018	0.9
7.4L DPX 385	Dpx Series		100		*	RV15YC4	8018	1.1
7.4L Gi L29	Sx Cobra Series		8			RS12YC	8401	1.1
	Duoprop Series		70			RS12YC	8401	1.1
7.4L Gi L29 (Platinum Eng.)			15			RS12PYP	8401	1.1
7.4L Gi L29 (Standard Eng.)			12			RS12YC	8401	1.1
7.4L Gi, GL	Duoprop Series		50-60		*	RV15YC4	8018	1.1
7.4L GL, Gi	Sx Cobra Series		8		*	RV15YC4	8018	0.9
7.4L GL, Gi/HS1			12		*	RV15YC4	8018	0.9
7.4L GSi	Duoprop Series		65-85		*	RV15YC4	8018	1.1
70 Sustained High Speed	B/bb Series	2500				J4C		0.6
8.1L Gi/Gsi			18			RS15LYC		1.5
8.1L Gi/Gxi			15			RS15LYC		1.5
8.2L DPX 415	Dpx Series		110		*	RV15YC4	8018	1.1
8.2L DPX 500	High HP		80			V63C		0.9
8.2L DPX 525	High HP		80			V63C		0.9
8.2L GL/HS1			18		*	RV15YC4	8018	0.9
8.2L GSi	Duoprop Series		80		*	RV15YC4	8018	1.1
8.8L DPX 600	High HP		80			V63C		0.9
95, 95A, 100	Aq Series		150		OE064	RL82YC	8814	0.6
C5, C10, C23	C Series		95			RD16		0.6
Kerosene Eng.s.: AQ60F, BB30F, MB18F	M Series		25			L90C		0.9
MB10, MB10A	M Series		90-100		OE059	L92YC		0.6
MB20A, M20B, MB20C	M Series		5-7.5			RL87YC		0.6
MB250S (Sail Drive)	M Series		16			P8Y		0.6
MB36A, MB36B	M Series		10-15			RJ12YC		0.6
Ocean 4.3L OSi-XDP	GM V-6		31	2002 →		RS12YC	8401	1.5
Ocean 5.0L OSi-XPD	GM V-8		35-40	2002 →		RS12YC	8401	1.5
Ocean 5.7L OSi-XDP	GM V-8		45	2002 →		RS12YC	8401	1.5
Ocean 5.7L OSXi-XDP	GM V-8		60-70	2002 →		RS12YC	8401	1.5
Ocean 8.1L OSi-XDP	GM V-8					RS12YC	8401	1.5
Pjx Water Jet	4.3L Gi (.708" Reach)					RS12YC	8401	1.1
	4.3L GS (.708" Reach)					RS12YC	8401	1.1
PZ-200 I/O M series	Chevrolet 305 cid		22		*	RV15YC4	8018	0.9

\* Leaded fuel use RV8C



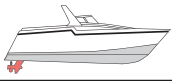

CC

BHP

21

POWER  
SPORT**VORTEX (→ Indmar)****VOYAGER (→ Mercruiser)****WAKE CHALLENGER (→ Mercruiser)****WARLOCK (→ Mercruiser)****WAUKESHA**

302/2	185			RF10C		0.9
302/2a	165			RF10C		0.9
460/4	350			RV12YC	8018	0.9
WRA, WLA, 302/2b	155			RF10C		0.9
WRB, WLB	185			RF10C		0.9
WRC, WLC, 302/4	215			RF10C		0.9
WRD, WLD, 351/4	255			RF10C		0.9
WRE, WLE	165			RF10C		0.9
WRF, WLF	350			RV12YC	8018	0.9

**WEBBCRAFT (→ Mercruiser)****WELLCRAFT (→ Mercruiser & Volvo Penta)****WINDY (→ Volvo Penta)****YAMAHA**

3.0L L4	110	1991→1994	*	RV15YC4	8018	0.9
4.3L V-6	180	1989→1994	*	RV15YC4	8018	0.9
5.0L V-8	210	1989→1994	*	RV15YC4	8018	0.9
5.7L V-8	240	1989→1994	*	RV15YC4	8018	0.9
7.4L V-8	300	1993→1994	*	RV15YC4	8018	0.9
AR210	140	2003→2005		QL78C	8883	0.6
AR230	3.5, 5	2003→2005		G57C	8654	0.8
LX210	120	2003→2005		QL78C	8883	0.6
SR230	5, 7, 7.5	2003→2005		G57C	8654	0.8
SX230	9.9, 15	2003→2005		G57C	8654	0.8

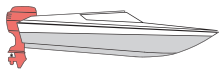

CC

BHP

21

POWER  
SPORTmm  
**AERO MARINE**

AM4000		4	1970 → 1973	RJ18YC		0.9
AM5000M, AM5000E		5	1970 → 1972	RH12		0.9
AM7750M, AM7500E		7.5	1970 → 1973	RJ12C		0.9
AM9000		9	1971 → 1973	RJ12C		0.6
Jet Pak	850		1971 → 1973	RJ14YC		0.9

**AIRBOY**

120				RH12		0.8
90 (OMC)	1250			RF14YC		0.8

**ALDENS (Pathfinder)**

All Models Except 1186		5, 7	1968 → 1969	RJ12C		0.9
All Models,	1235		1961 → 1967	RJ12C		0.8
Model 1186		7	1969 →	RJ14YC		0.9
		5, 7	1970 → 1971	RJ14YC		0.9

**ALSPORT**

(14mm)	1235			QL82C	8883	0.5
(14mm)	1235			QL82C	8883	0.5
(18mm)				RD16		0.5

**ANZANI (British)**

Minor, Pilot				L90C		0.5
Super-Single				D21		0.5

**APACHE**

J5	300			RJ12C		0.8
J9	400			RJ12C		0.8

**ARCHIMEDES-PENTA (→ Volvo Penta)****ARROW**

550				RJ14YC		0.8
-----	--	--	--	--------	--	-----

**BARRACUDA**

650		1961 → 1962		RJ12C		0.9
744		1962 →		RJ12C		0.9
750		1961 →		RJ12C		0.9
750		1962 →		RJ12C		0.9

**BEAVER**

782				RJ12C		0.6
891				CJ14		0.6
899				RJ14YC		0.6

**BLUEJET**

900		1963 →		CJ14		0.9
900		1961 →		RJ12C		0.9

**BOMBARDIER**

200-250HP V6 DI 90°				QC10WEP		
---------------------	--	--	--	---------	--	--

**BRIGGS & STRATTON**

900				OE013	RC12YC	8071	0.5
-----	--	--	--	-------	--------	------	-----

**BRITISH SEAGULL**

Century	1176		1956 → 1970	D21		0.6
Century Plus	1100		1957 → 1970	D21		0.6
Forty Minus, Forty Fthwght	1100		1955 → 1981	D21		0.6
Forty Plus	1100		1956 → 1981	D21		0.6
Silver Century	1100		1966 → 1981	D21		0.6
Silver Century Plus	1100		1966 → 1981	D21		0.6
	1071			D21		0.6

**CARNITS**

1176				QL82C	8883	0.6
------	--	--	--	-------	------	-----

**CHIEF**

J-200, J-300, J-350	1500			CJ14		0.8
J-400, J-500, J-700				CJ14		0.8
J5	1176			CJ14		0.8

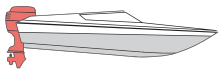
**CC****BHP****POWER  
SPORT****...CHIEF**

J9	1199			RJ12C		0.8
K-150			1976→1979	CJ14		0.6
K-150, K-200, K-300	650			CJ14		0.8
K-201	700		1976→1979	RJ12C		0.6
K-350	700		1976→1979	CJ14		0.6
K-400, K-990	700			CJ14		0.8
K-500, K-700, K-750	700			CJ14		0.8
	700		1974→1975	RJ14YC		0.8
K-505, K-550, K-751	750		1976→1979	RJ14YC		0.6
K-753, K-900	750		1976→1979	RJ14YC		0.6

**CHRYSLER**

(Mag. Ign.)		55	1969→1981	QL82C	8883	1.0
	951		1971→1978	QL82C	8883	1.0
(Std. Ign.)		55	1967→1976	QL82C	8883	1.0
Sailor 150	1165		1980→	QL86C		0.8
		7.5	1979→1984	QL86C		0.8
		8	1971→1978	QL86C		0.8
		9	1965→	RH12		0.8
		60	1974→1976	QL82C	8883	1.0
		60	1984→	QL82C	8883	1.0
		65	1977→1978	QL82C	8883	1.0
		70	1969→1973	QL82C	8883	1.0
		70	1979→1980	QL82C	8883	1.0
		75	1968→	QL82C	8883	1.0
		75	1974→1984	QL82C	8883	1.0
		75	1966→1967	RJ12C		1.0
		120	1975→1976	QL82C	8883	1.0
		120	1977→	QL82C	8883	1.0
		125	1981→1986	QL82C	8883	1.0
	428		1970→1977	QL82C	8883	1.0
	428		1972→1973	QL82C	8883	1.0
	432		1972→1976	QL82C	8883	1.0
	432		1978→1984	QL82C	8883	1.0
	580		1966→1967	RJ12C		0.8
	639		1965→	RJ12C		1.0
	644		1984→1986	QL82C	8883	1.0
	650		1968→1986	QL86C		0.8
	650		1974→1978	QL86C		0.8
	718		1971→1973	QL86C		0.8
	718		1974→1984	QL86C		0.8
	718		1979→	QL86C		0.8
	750		1980→1984	QL86C		0.8
	768		1978→1983	QL82C	8883	1.0
	777		1965→1969	RH12		0.8
	777		1967→1970	RH12		0.8
	779		1976→1986	QL86C		0.8
	780		1968→	QL86C		0.8
	782		1968→1982	QL86C		1.0
	782		1965→1967	RJ12C		1.0
	785		1969→1973	QL82C	8883	1.0
	785		1973→1984	QL86C		1.0
	789		1968→1974	QL82C	8883	1.0
	789		1983→1984	QL82C	8883	1.0
	896		1983→1984	QL82C	8883	1.0
	900		1974→1976	L90C		0.8
	951		1986→	QL82C	8883	1.0
	951		1968→1984	QL86C		1.0
	951		1968→1977	QL86C		1.0
	951		1973→1982	QL86C		1.0
	951		1978→1984	QL86C		1.0
	951		1965→1967	RJ12C		1.0
	1000		1974→1977	QL82C	8883	1.0
	1050		1969→1970	QL86C		0.8
	1100		1975→1976	QL82C	8883	1.0
	1100		1977→1983	QL82C	8883	1.0
	1100		1980→1984	QL82C	8883	1.0
	1165		1968→	QL86C		0.8
	1165		1971→1977	QL86C		0.8

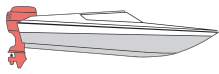

CC

BHP

POWER  
SPORT**...CHRYSLER**

1165	1978 →	QL86C		0.8
1165	1979 →1982	QL86C		0.8
1165	1965 →1967	RH12		0.8
1192	1969 →1970	QL86C		0.8
1231	1978 →1982	QL82C	8883	1.0
1494	1982 →1983	QL82C	8883	1.0
1494	1982 →1986	QL86C		1.0
1494	1965 →1967	RJ12C		1.0
1494	1965 →1966	RJ12C		1.0

**CLINTON**

AJ-9, BJ-9, J-200, J-300	432		CJ14	0.8	
J-350, J-400, J-500, J-700	701		CJ14	0.8	
J5	432		CJ14	0.8	
J7, J8	432		RH12	0.8	
J9	432		RJ12C	0.8	
K-500, K-700, K-750	701		CJ14	0.8	
K-505, K-550		1976 →1991	RJ14YC	0.6	
K-750		1976 →1984	RJ14YC	0.6	
	500	1974 →1975	RJ14YC	0.8	
K-751, K-753	500	1976 →1991	RJ14YC	0.6	
K-900	650	1976 →1991	RJ14YC	0.6	
W-100, W-140, W-250	650		QL82C	8883	0.6

**COAST-TO-COAST**

650	1965 →	RJ12C		0.9
-----	--------	-------	--	-----

**COLT**

650	1963 →	RJ12C		0.9
700	1963 →	CJ14		0.9

**COMMODORE**

700		RH12		0.8
700		RH12		0.8
700		RJ12C		0.8

**CRUISE 'N CARRY**

Xenoah Eng.	700		RJ12C	0.6
	700	1981 →1987	CJ14	0.6
	700	1984 →1988	RJ12C	0.6
	700		RL95YC	0.6

**CUYUNA**

760		OE108	RN3C	8904	0.8
-----	--	-------	------	------	-----

**DYNAFOIL**

Xenoah (3/4" Rch)	340		RN5C	8339	0.8	
Xenoah (3/4" Rch)	440		OE091	RN2C	8904	0.8

**ELGIN**

6001	800		RH12		0.8
6006	1000		RH12		0.8
6012	1200		RJ12C		1.0
6070		28	RJ12C		1.0
6091	800		CJ14		0.8
58563	1000		RH12		0.8
59011	1200		RH12		0.8
59421		30	RH12		1.0
59451		35	RH12		1.0
59891	1200		RH12		1.0
58321, 58331	760		RH12		0.8
58431, 59791	1200		RH12		0.8
58801, 58891, 59561	1200		RH12		1.0
58991, 59881	1200		RH12		1.0
59421, 594001, 594011		40	RJ12C		1.0
59461, 59471, 594031		40	RJ12C		1.0
59661, 59671		18	RJ12C		1.0
59861, 59871		25	RH12		1.0
6002, 6003	760		RH12		0.8
6005, 6068	1100		RH12		0.8

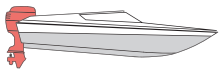

CC

BHP

POWER  
SPORT**...ELGIN**

6008, 6060, 6061		1100			RH12	0.8
6009, 6010		1100			RH12	0.8
6013, 6014, 6015, 6069		1300			RJ12C	1.0
6025, 6028, 6032			25		RJ12C	1.0
6033, 6035			27.7		RJ12C	1.0
6034, 6036, 6037, 6038			28		RJ12C	1.0
6040, 6043, 6047			40		RJ12C	1.0
6052, 6053			43.7		RJ12C	1.0
6054, 6055, 6056, 6057			45		RJ12C	1.0
6060 thru 6063			60		RJ12C	1.0
6062, 6063			45		RJ12C	1.0
6064, 6065			75		RJ12C	1.0
6066, 6067		1200			CJ14	0.8
6072, 6073			75.2		RJ12C	1.0
6074, 6075, 6076, 6077			75		RJ12C	1.0
6092, 60900		800			CJ14	0.8

**ELLIOTT**

		21.1			CJ14	0.8
		40	2.2		RCJ8Y	0.8

**ESKA**

1707, 1747				1970→1974	RJ14YC	0.8
1777, 1790				1970→1974	RJ14YC	0.8
			1.2	1977→1978	RJ12C	0.6
			1.6	1987→	CJ14	0.6
			2.5	1977→1987	CJ14	0.6
			3.0	1961→	RJ12C	0.8
			3.0	1967→1969	RJ12C	0.8
			3.0	1975→1976	RJ14YC	0.8
			3.0	1980→	RJ14YC	0.8
			3.5	1977→1984	RJ14YC	0.8
			4.0	1963→	RJ12C	0.8
			4.0	1977→1978	RJ14YC	0.8
			4.5	1975→1976	RJ14YC	0.8
			5.0	1970→1987	RJ14YC	0.8
			5.0	1961→1969	RJ6C	0.8
			5.5	1975→1976	RJ14YC	0.8
			6.0	1963→	RJ12C	0.8
			7.0	1967→	RJ12C	0.8
			7.0	1968→	RJ12C	0.8
			7.0	1969→	RJ14YC	0.8
			7.5	1970→1987	RJ14YC	0.8
			9.5	1970→1974	RJ14YC	0.8
			9.9	1976→1987	RJ14YC	0.8
			14	1970→1974	RJ14YC	0.8
			15	1976→1987	RJ14YC	0.8

**EVINRUDE**

10E, 10EL, 10R, 10RL	Standard Ignition	10		1975→1976	QL77JC4	8883	0.8
	Standard Ignition (18mm)			1939→1950	D9		0.8
	1-Cyl.			1991→1998	QL87YC		0.8
	1-Cyl.	2.3		1991→1997	QL87YC		0.8
	1-Cyl.	3.3		1991→2001	QL87YC		0.8
	1-Cyl.	5		1998→2001	QL77JC4	8883	0.8
1R	Standard Ignition	1		1968→1970	RJ8C		0.8
20R, 20RL	Standard Ignition	20		1973→	RJ8C		0.8
20R, 25R	Standard Ignition	20-25		1969→1972	RJ8C		0.8
20RL, 25RL	Standard Ignition	20-25		1971→1972	RJ8C		0.8
25E, 25EL	Standard Ignition	25		1972→	RJ8C		0.8
25E, 25EL, 25R, 25RL	Standard Ignition	25		1973→1974	RJ8C		0.8
	Standard Ignition	25		1975→1976	RJ8C		0.8
	2-Cyl.	3		1989→2001	QL86C		0.8
	2-Cyl.	4		1989→2001	QL86C		0.8
	2-Cyl.	20		1978→1998	QL82C	8883	0.8
	2-Cyl.	25		1977→1998	QL82C	8883	0.8
	2-Cyl.	25		1977→	QL82C	8883	0.8
	2-Cyl.	30		1978→1998	QL82C	8883	0.8
	2-Cyl.	35		1977→1997	QL77JC4	8883	0.8



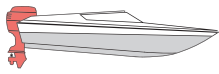

CC

BHP

POWER  
SPORT

mm

**...EVINRUDE**

		CC	BHP	21		POWER SPORT	mm
	2-Cyl.		40	1980 → 1988	QL77JC4	8883	0.8
	2-Cyl.		40	1989 → 1998	QL78YC	8883	0.8
	2-Cyl.		48	1980 → 1988	QL77JC4	8883	0.8
	2-Cyl.		48	1989 → 1997	QL78YC	8883	0.8
	2-Cyl.		50	1980 → 1988	QL77JC4	8883	0.8
	2-Cyl.		50	1989 → 1998	QL78YC	8883	0.8
	2-Cyl.		55	1976 → 1989	QL77JC4	8883	0.8
	2-Cyl.		60	1980 → 1985	QL77JC4	8883	0.8
	2-Cyl. COM		55	1994 → 1995	QL78YC	8883	0.8
	2-Cyl. DELUXE		4	1989 → 2001	QL86C		0.8
2R	Standard Ignition		2	1971 → 1984	RJ8C		0.8
	2-Stroke		6	1977 → 1998	QL86C		0.8
33R, 33E, 40ES	Standard Ignition		33-40	1965 → 1971	RJ8C		0.8
	3-Cyl.		25	1995 → 1998	QL86C		0.8
	3-Cyl.		35	1995 → 2001	QL86C		0.8
	3-Cyl.		50	1995 → 1998	QL78YC	8883	0.8
	3-Cyl.		55	1968 → 1969	QL77JC4	8883	0.8
	3-Cyl.		60	1970 → 1971	QL77JC4	8883	0.8
	3-Cyl.		65	1972 → 1973	QL77JC4	8883	0.8
49 cid	3-Cyl.		60	1975 → 1989	QL77JC4	8883	0.8
	3-Cyl.		70	1975 → 1989	QL77JC4	8883	0.8
	3-Cyl.		75	1975 → 1989	QL77JC4	8883	0.8
56 cid	3-Cyl.		60	1989 → 1993	QL77JC4	8883	0.8
	3-Cyl.		60	1994 → 1998	QL78YC	8883	0.8
	3-Cyl.		70	1989 → 1993	QL77JC4	8883	0.8
	3-Cyl.		70	1994 → 1998	QL78YC	8883	0.8
40E, 40EL, 40R, 40RL	Standard Ignition		40	1974 →	QL77JC4	8883	0.8
	Standard Ignition		40	1975 → 1976	QL77JC4	8883	0.8
40R, 40E, 40EL, 40RL	Standard Ignition		40	1969 → 1973	RJ8C		0.8
LV4 D.I.	4-Cyl.		100	2004 → 2007	QC12PEPB		0.8
4R, 4W	Standard Ignition		4	1969 → 1976	RJ8C		0.8
6R, 6RL	Standard Ignition		6	1971 → 1976	RJ8C		0.8
9R, 9RL, 9E, 9EL	Standard Ignition		9	1974 →	QL77JC4	8883	0.8
Air Buoy Diving Unit	Standard Ignition				CJ14		0.6
Aquanaut Diving Unit	Standard Ignition		2	1966 → 1970	CJ14		0.8
CD, JH	Standard Ignition			1954 → 1968	RJ8C		0.8
Commercial			6.5	1981 → 1993	QL77JC4	8883	0.8
			8	1977 → 2001	QL86C		0.8
			10	1992 → 1993	QL77JC4	8883	0.8
			10	1994 → 2003	QL82C	8883	0.8
			14	1981 → 1991	QL77JC4	8883	0.8
			15	1992 → 1993	QL77JC4	8883	0.8
			15	1993 → 2001	QL82C	8883	0.8
			25	1981 → 1998	QL16V		
			45	1986 → 2003	QL16V		
			55	1986 → 2003	QL16V		
			100	1984 → 1998	QL16V		
			115	1975 → 1984	QL77JC4	8883	0.8
			185	1990 → 1993	QL77JC4	8883	0.8
			200	1992 →	QL16V		
			200	1993 → 1998	QL78YC	8883	0.8
Commercial (43 cid)			40	1981 → 1990	UL81C		0.8
Commercial (45 cid)			40	1984 → 2003	QL16V		
Commercial	3-Cyl.		65	1994 → 1995	QL78YC	8883	0.8
Commercial CV6			155	1989 → 1992	QL16V		
Commercial HC LC			65	1988 → 1997	QL16V		
			65	1984 → 1987	QL77JC4	8883	0.8
Commercial LV6			150	1993 → 1998	QL78YC	8883	0.8
CV4			88	1979 → 1997	QL82C	8883	0.8
			90	1979 → 1998	QL82C	8883	0.8
			110	1979 → 1997	QL82C	8883	0.8
			112	1979 → 1997	QL82C	8883	0.8
			115	1979 → 1998	QL82C	8883	0.8
CV6			150	1978 → 1987	QL16V		
			150	1988 → 1991	QL77JC4	8883	0.8
			155	1978 → 1987	QL16V		
			175	1988 → 1991	QL77JC4	8883	0.8
DI			115	2006 →	QC12PEPB		0.8

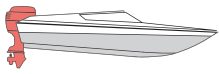

CC

BHP

POWER  
SPORT**...EVINRUDE**

E-TEC 115		115	2007→2007	QC10PEPB		0.7
		115	2008→	QC10WEP		0.7
E-TEC 115 HO		115	2008→	QC10WEP		0.7
E-TEC 130		130	2009→	QC10WEP		0.7
E-TEC 150		150	2007→2007	QC10PEPB		0.7
		150	2008→	QC10WEP		0.7
E-TEC 150 HO		150	2008→	QC10WEP		0.7
E-TEC 175		175	2007→2007	QC10PEPB		0.7
		175	2008→	QC10WEP		0.7
E-TEC 200		200	2005→2006	QC10PEPB		0.7
		200	2007→2007	QC10PEPB		0.7
		200	2007→	QC10WEP		0.7
E-TEC 200 HO		200	2005→2006	QC10PEPB		0.7
		200	2007→2008	QC10WEP		0.7
		200	2008→	QC8WEP		0.7
E-TEC 225		225	2005→2006	QC10PEPB		0.7
		225	2007→	QC10WEP		0.7
E-TEC 225 HO		225	2005→2006	QC10PEPB		0.7
		225	2007→2008	QC10WEP		0.7
		225	2008→	QC8WEP		0.7
E-TEC 25		25	2009→	QC10WEP		0.7
E-TEC 250		250	2005→2006	QC10PEPB		0.7
		250	2007→	QC10WEP		0.7
E-TEC 250 HO		250	2005→2006	QC10PEPB		0.7
		250	2007→2008	QC10WEP		0.7
		250	2008→	QC8WEP		0.7
E-TEC 30		30	2009→	QC10WEP		0.7
E-TEC 300		300	2008→	QC8WEP		0.7
E-TEC 40		40	2008→	QC10WEP		0.7
		40	2004→2005	QC12PEP		0.7
		40	2006→2007	QC12PEPB		0.7
E-TEC 50		50	2008→	QC10WEP		0.7
		50	2004→2005	QC12PEP		0.8
		50	2006→2007	QC12PEPB		0.7
E-TEC 60		60	2008→	QC10WEP		0.7
		60	2004→2005	QC12PEP		0.8
		60	2006→2007	QC12PEPB		0.7
E-TEC 65		65	2008→	QC10WEP		0.7
		65	2005→2006	QC12PEP		0.8
E-TEC 75		75	2008→	QC10WEP		0.7
		75	2004→2005	QC12PEP		0.7
		75	2006→2007	QC12PEPB		0.7
E-TEC 90		90	2008→	QC10WEP		0.7
		90	2004→2005	QC12PEP		0.7
		90	2006→2007	QC12PEPB		0.7
FD, FDE	Standard Ignition		1956→1968	RJ8C		0.8
Intruder LV4		115	1995→1998	QL78YC	8883	0.8
Intruder LV6		150	1991→1998	QL78YC	8883	0.8
		175	1991→1998	QL78YC	8883	0.8
Jet		25	1995→1998	QL82C	8883	0.8
		40	1992→2003	QL78YC	8883	0.8
		50	1993→2001	QL78YC	8883	0.8
Jet CV4		65	1992→1997	QL82C	8883	0.8
		80	1979→1998	QL82C	8883	0.8
Jet LV6		105	1993→2003	QL78YC	8883	0.8
JHF, JWF	Standard Ignition		1967→1968	RJ8C		0.8
JR		2	1971→1990	RJ6C		0.8
Jr., Colt		2	1971→1990	RJ8C		0.8
JW	Standard Ignition		1952→1968	RJ8C		0.8
Kero		15	1995→1998	UL77V		
LD	Standard Ignition		1965→1968	RJ8C		0.8
LV4		90	1995→1998	QL78YC	8883	0.8
		120	1985→1997	QL78YC	8883	0.8
		130	1985→1998	QL78YC	8883	0.8
		140	1985→1997	QL78YC	8883	0.8
LV4 Commercial		105	1997→2003	QL78YC	8883	0.8
LV4 Ficht		90	1998→1999	7712		0.9
		90	2000→2005	XC12PEPB		0.9
		115	1998→1999	7712		0.8
		115	2000→2005	XC12PEPB		0.8

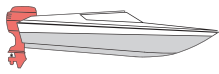

CC

BHP

POWER  
SPORT**...EVINRUDE**

LV6 Ficht	Pinned head	150	1997 → 1999		XC12PEPB		0.8
LV6 Ficht, D.I.		135	2001 →		XC12PEPB		0.8
LV6 Ficht, D.I.		150	2001 →		XC12PEPB		0.8
		175	2001 →		XC12PEPB		0.8
		200	1999 → 2006		QC12PEPB		0.8
		225	1999 → 2006		QC12PEPB		0.8
		250	2001 → 2006		QC12PEPB		0.8
	Pinned head	175	1997 → 1999		XC12PEPB		0.8
		175	1997 → 1999		7712		0.8
Magneto	Standard Ignition	1.2	1986 → 1990		RJ8C		0.8
MFE 55 (Multi-Fuel-Engine)		55	2008 →		QC10WEP		0.7
MQ	Standard Ignition		1964 → 1968		RJ8C		0.8
RD, RDE, RDS, RJE, RK	Standard Ignition		1951 → 1968		RJ8C		0.8
RX	Standard Ignition		1962 → 1968		RJ8C		0.8
RXE	Standard Ignition		1965 → 1968		RJ8C		0.8
SC	Standard Ignition		1968 →		RJ8C		0.8
SPL		48	1994 → 1997		QL78YC	8883	0.8
TN, AD, QD, V4H, V4ML	Standard Ignition		1952 → 1966		RJ8C		0.8
Turbojet CV4		90	1994 → 1997		QL82C	8883	0.8
		115	1994 → 1998		QL82C	8883	0.8
Ultra, Excel		4	1987 → 1988		QL77JC4	8883	0.8
V-4		65	1968 →		QL77JC4	8883	0.8
		100	1979 → 1980		QL77JC4	8883	0.8
	Standard Ignition	60	1964 → 1967		RJ8C		0.8
	Standard Ignition	75	1960 → 1965		RJ8C		0.8
V-4 Backtroller		85	1994 → 1995		QL82C	8883	0.8
V4, V4A, V4M	Standard Ignition	4	1958 → 1967		RJ8C		0.8
V4S, VX, VXH	Standard Ignition	4	1958 → 1967		RJ8C		0.8
V-6		200	1986 → 1993		QL77JC4	8883	0.8
		225	1986 → 1993		QL77JC4	8883	0.8
V-8		250	1985 → 1998		QL78YC	8883	0.8
		300	1985 → 1997		QL78YC	8883	0.8
Vindicator LV6		200	1994 → 1998		QL78YC	8883	0.8
		225	1994 → 1998		QL78YC	8883	0.8
	4-Stroke	30	2000 → 2004		RA8HC	8810	0.8
	4-Stroke	200	2004 →	OE005	RC9YC		0.7
	4-Stroke	225	2004 →	OE005	RC9YC		0.7
	4-Stroke	211	1995 → 1998		RP10HC		0.8
	4-Stroke 3-Cyl. SOHC	25	2001 →		RA8HC	8810	0.8
	4-Stroke 3-Cyl. SOHC	30	2001 → 2004		RA8HC	8810	0.8
	4-Stroke 4-Cyl. DOHC	90	2003 →	OE005	RC9YC		0.8
	4-Stroke 4-Cyl. DOHC	115	2003 →	OE005	RC9YC		0.8
	4-Stroke 4-Cyl. DOHC	140	2003 →	OE005	RC9YC		0.8
	4-Stroke DOHC	815	1999 → 2004		RA8HC	8810	0.9
	4-Stroke DOHC	815	1999 → 2004		RA8HC	8810	0.9
	4-Stroke OHC	5	2002 →	OE006	RN9YC	8415	0.8
	4-Stroke OHC	6	2005 →	OE006	RN9YC	8415	0.8
	4-Stroke OHC	15	1995 →		RA8HC	8810	0.8
	4-Stroke OHC	60	2002 → 2004		RA8HC	8810	0.9
	4-Stroke OHC	128	2002 →	OE006	RN9YC	8415	0.8
	4-Stroke OHC	128	1997 → 2001		RP10HC		0.7
	4-Stroke OHC	128	1997 → 2004		RP10HC		0.7
	4-Stroke OHC	211	1998 →		RP10HC		0.7
	4-Stroke OHC	302	2003 →		RA8HC	8810	0.8
	4-Stroke OHC	305	1995 → 2003		RA8HC	8810	0.8
	4-Stroke OHC	1298	1998 →	OE006	RN9YC	8415	0.9
		1.5	1968 → 1970		J6C		0.8
		15	1977 → 1992		QL77JC4	8883	0.8
		50	1971 → 1975		QL77JC4	8883	0.8
		85	1968 → 1980		QL77JC4	8883	0.8
		100	1967 → 1972		QL77JC4	8883	0.8
		115	1969 → 1970		QL77JC4	8883	0.8
		115	1973 → 1979		QL77JC4	8883	0.8
		125	1971 → 1972		QL77JC4	8883	0.8
		135	1973 → 1984		QL16V		
		140	1973 → 1984		QL16V		
		175	1977 → 1987		QL16V		
		200	1976 → 1983		QL16V		
		235	1978 → 1985		QL16V		

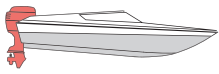

CC

BHP

POWER  
SPORT

mm

**... EVINRUDE**

...

Standard Ignition	4	1981→1984	QL77JC4	8883	0.8
	2	1991→2001	QL87YC		0.8
	2.5	1987→1988	QL86C		0.8
	3.5	2002→	QL87YC		0.8
	4	1988→	QL77JC4	8883	0.8
	4	1977→1987	QL86C		0.8
	4.5	1980→1985	QL86C		0.8
	5	1990→1997	QL86C		0.8
	7.5	1977→1997	QL86C		0.8
	8	1977→1998	QL86C		0.8
	9.9	1977→2001	QL82C	8883	0.8
	14	1988→1989	QL77JC4	8883	0.8
	15	1994→1998	QL82C	8883	0.8
	20	1978→1993	QL82C	8883	0.8
	28	1978→1997	QL82C	8883	0.8
	85	1986→1993	QL77JC4	8883	0.8
	115	1986→1993	QL77JC4	8883	0.8
	275	1985→1988	QL82YC	8814	0.8
	3600	1985→1986	QL77JC4	8883	0.8
Standard Ignition	1.1	1946→1947	RH12		0.8
Standard Ignition	3	1952→1968	RJ8C		0.8
Standard Ignition	3 - 5.2	1952→1974	RJ8C		0.8
Standard Ignition	3.3	1948→1951	RJ8C		0.8
Standard Ignition	5.5	1954→1964	RJ8C		0.8
Standard Ignition	7.5	1952→1958	RJ8C		0.8
Standard Ignition	9.7	1942→1949	RD16		0.8
Standard Ignition	10	1952→1963	RJ8C		0.8
Standard Ignition	14-18	1950→1972	RJ8C		0.8
Standard Ignition	15	1954→1956	RJ8C		0.8
Standard Ignition	18	1957→1973	RJ8C		0.8
Standard Ignition	25	1952→1955	RJ8C		0.8
Standard Ignition	30	1956→1971	RJ8C		0.8
	18	1957→1973	RJ8C		0.8
Standard Ignition	5	1965→1968	RJ8C		0.8
Standard Ignition	6	1965→1976	RJ8C		0.8
Standard Ignition	9.5	1964→1973	RJ8C		0.8
Standard Ignition	20	1966→1973	RJ8C		0.8
Standard Ignition	28	1962→1964	RJ8C		0.8
Standard Ignition	35	1957→1959	RJ8C		0.8
Standard Ignition	40	1960→1973	RJ8C		0.8
Standard Ignition	50	1958→1959	RJ8C		0.8
Standard Ignition	80	1966→1967	RJ8C		0.8
Standard Ignition	90	1964→1965	RJ8C		0.8
Standard Ignition	80	1966→1967	RJ8C		0.8
Standard Ignition	1.5 - 2	1968→1970	RJ8C		0.8
Standard Ignition	100	1966→	RJ8C		0.8
	4	1969→1976	RJ8C		0.8
Standard Ignition	25	1969→1976	RJ8C		0.8
	9.9	1974→1976	UL81C		0.8
	15	1974→1976	UL81C		0.8
	35	1976→	UL81C		0.8
	40	1974→1976	UL81C		0.8
	115	1985→	UL77V		
	185	1977→1987	UL77V		

**EXPLORER**

	3.5, 5.0	1981→1984	RJ14YC		0.8
	7.5, 9.9	1981→1984	RJ14YC		0.8
	15.0	1981→1984	RJ14YC		0.8

**FEDERAL**

	3.5, 5	1971→1972	RJ14YC		0.9
	7	1971→1972	RJ14YC		0.9

**FIAT NAUTICA**

	3.5, 6, 8, 12, 14, 24		QL86C		0.9
--	--------------------------	--	-------	--	-----



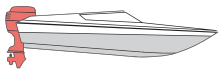

CC

BHP

21

POWER  
SPORT**HANSON MARINE ENGINES**

Montana Troller	85		OE013	RC12YC	8071	0.9
-----------------	----	--	-------	--------	------	-----

**HOMELITE (→ Fisher-Pierce)****HONDA**

B75, BF75	7.5			P10Y		0.6
BF100	9.9			P10Y		0.6
BF2A, BF2D, BF20F	2			CJ14		0.6
OHC 4-Stroke BF115	115			RC9MC4		0.8
OHC 4-Stroke BF130	130			RC9MC4		0.8
OHC 4-Stroke BF135	135			RC9MC4		0.8
OHC 4-Stroke BF150	150			RC9MC4		0.8
OHC 4-Stroke BF15A	15			P8Y		0.6
OHC 4-Stroke BF20A	20		OE083	RA6HC	8809	0.7
OHC 4-Stroke BF25A	25			RA8HC	8810	0.7
OHC 4-Stroke BF30A	30			RA8HC	8810	0.7
OHC 4-Stroke BF35A	35			RA8HC	8810	0.7
OHC 4-Stroke BF40A	40			RA8HC	8810	0.7
OHC 4-Stroke BF45A	45			RA8HC	8810	0.6
OHC 4-Stroke BF50A	50			RA8HC	8810	0.7
OHC 4-Stroke BF75A	75			RA8HC	8810	0.7
OHC 4-Stroke BF8A	8.0			P10Y		0.6
OHC 4-Stroke BF9.9A	9.9			P10Y		0.6
OHC 4-Stroke BF90A	90			RA8HC	8810	0.7
OHV 4-Stroke	2			Z9Y		0.6
OHV 4-Stroke BF5	5		OE051	RN11YC	8415	0.6
OHV 4-Stroke BF50	5		OE051	RN11YC	8415	0.6
SOHC 4-Stroke BF200	200	2002→2004		RC9MC4		0.8
SOHC 4-Stroke BF225	225	2002→2004		RC9MC4		0.8

**J.C. PENNEY**

	3.0	1974→1980		RJ14YC		0.8
	3.5	1978→1979		RJ14YC		0.8
	5.0	1979→		RJ14YC		0.8
	5.5	1975→1976		RJ14YC		0.8
	5.5	1977→1978		RJ14YC		0.8
	7.5	1975→1979		RJ14YC		0.8
	9.9	1975→1979		RJ14YC		0.8
	15	1975→1977		RJ14YC		0.8

**JOHNSON**

10E, 10EL, 10R, 10RL	Standard Ignition	10	1975→1976	QL77JC4	8883	0.8
	Standard Ignition (18mm)		1939→1950	D9		0.8
	1-Cyl.		1991→2001	QL87YC		0.8
	1-Cyl.	2.3	1991→1997	QL87YC		0.8
	1-Cyl.	3.3	1991→2001	QL87YC		0.8
	1-Cyl.	5	1998→2001	QL77JC4	8883	0.8
1R	Standard Ignition	1	1968→1970	RJ8C		0.8
200, 225, 250 90° V6 (incl.HO)			2008→	QC10WEP		
20R, 20RL	Standard Ignition	20	1973→	RJ8C		0.8
20R, 25R	Standard Ignition	20-25	1969→1972	RJ8C		0.8
20RL, 25RL	Standard Ignition	20-25	1971→1972	RJ8C		0.8
25E, 25EL	Standard Ignition	25	1972→	RJ8C		0.8
25E, 25EL, 25R, 25RL	Standard Ignition	25	1973→1974	RJ8C		0.8
	Standard Ignition	25	1975→1976	RJ8C		0.8
	2-Cyl.	3	1989→2001	QL86C		0.8
	2-Cyl.	4	1989→2001	QL86C		0.8
	2-Cyl.	20	1978→1998	QL82C	8883	0.8
	2-Cyl.	25	1977→2004	QL82C	8883	0.8
	2-Cyl.	25	1977→	QL82C	8883	0.8
	2-Cyl.	30	1978→2002	QL82C	8883	0.8
	2-Cyl.	35	1977→1997	QL77JC4	8883	0.8
	2-Cyl.	40	1980→1988	QL77JC4	8883	0.8
	2-Cyl.	40	1989→2002	QL78YC	8883	0.8
	2-Cyl.	48	1980→1988	QL77JC4	8883	0.8
	2-Cyl.	48	1989→1997	QL78YC	8883	0.8
	2-Cyl.	50	1980→1988	QL77JC4	8883	0.8
	2-Cyl.	55	1976→1989	QL77JC4	8883	0.8
	2-Cyl.	60	1980→1985	QL77JC4	8883	0.8
	2-Cyl. 2-Stroke	50	1989→2004	QL78YC	8883	0.8
Com	2-Cyl.	55	1994→1995	QL78YC	8883	0.8

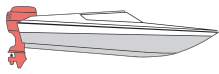

CC

BHP

POWER  
SPORT

mm

**...JOHNSON**

		CC	BHP	21		POWER SPORT	mm
DeLuxe	2-Cyl.		4	1989→2001		QL86C	0.8
2R	Standard Ignition		2	1971→1984		RJ8C	0.8
	2-Stroke		6	1977→2004		QL86C	0.8
	2-Stroke		8	1977→2004		QL86C	0.8
33R, 33E, 40ES	Standard Ignition		33-40	1965→1971		RJ8C	0.8
	3-Cyl.		25	1995→2001		QL86C	0.8
	3-Cyl.		35	1995→2001		QL86C	0.8
	3-Cyl.		50	1995→1998		QL78YC	8883 0.8
	3-Cyl.		55	1968→1969		QL77JC4	8883 0.8
	3-Cyl.		60	1970→1971		QL77JC4	8883 0.8
	3-Cyl.		65	1972→1973		QL77JC4	8883 0.8
49 cid	3-Cyl.		60	1975→1989		QL77JC4	8883 0.8
	3-Cyl.		70	1975→1989		QL77JC4	8883 0.8
	3-Cyl.		75	1975→1989		QL77JC4	8883 0.8
56 cid	3-Cyl.		60	1989→1993		QL77JC4	8883 0.8
	3-Cyl.		60	1994→1998		QL78YC	8883 0.8
	3-Cyl.		70	1989→1993		QL77JC4	8883 0.8
	3-Cyl.		70	1994→2001		QL78YC	8883 0.8
40E, 40EL, 40R, 40RL	Standard Ignition		40	1974→		QL77JC4	8883 0.8
	Standard Ignition		40	1975→1976		QL77JC4	8883 0.8
40R, 40E, 40EL, 40RL	Standard Ignition		40	1969→1973		RJ8C	0.8
4R, 4W	Standard Ignition		4	1969→1976		RJ8C	0.8
	4-Stroke		8	1996→1998		RP10HC	0.7
	4-Stroke		200	2004→	OE005	RC9YC	0.7
	4-Stroke		225	2004→	OE005	RC9YC	0.7
	4-Stroke	211	9.9	1995→1998		RP10HC	0.8
	4-Stroke 2-Cyl. SOHC		9.9	2002→2004		RA8HC	8810 0.9
	4-Stroke 3-Cyl. SOHC		25	2001→		RA8HC	8810 0.8
	4-Stroke 3-Cyl. SOHC		30	2001→2004		RA8HC	8810 0.8
	4-Stroke 4-Cyl. DOHC		90	2003→	OE005	RC9YC	0.8
	4-Stroke 4-Cyl. DOHC		115	2003→	OE005	RC9YC	0.8
	4-Stroke 4-Cyl. DOHC		140	2003→	OE005	RC9YC	0.8
	4-Stroke 4-Cyl. SOHC		60	2002→		RA8HC	8810 0.8
	4-Stroke 4-Cyl. SOHC		70	1998→	OE006	RN9YC	8415 0.8
	4-Stroke DOHC		40	1999→2004		RA8HC	8810 0.8
	4-Stroke DOHC		50	1999→2004		RA8HC	8810 0.8
	4-Stroke OHC		5	2002→	OE006	RN9YC	8415 0.8
	4-Stroke OHC		6	2005→	OE006	RN9YC	8415 0.8
	4-Stroke OHC		15	1995→		RA8HC	8810 0.8
	4-Stroke OHC	128	4	2002→	OE006	RN9YC	8415 0.8
	4-Stroke OHC	128	5	1997→2001		RP10HC	0.7
	4-Stroke OHC	128	6	1997→2004		RP10HC	0.7
	4-Stroke OHC	211	8	1998→		RP10HC	0.7
	4-Stroke OHC	302	9.9	2003→		RA8HC	8810 0.8
	4-Stroke OHC	305	9.9	1995→2003		RA8HC	8810 0.8
6R, 6RL	Standard Ignition		6	1971→1976		RJ8C	0.8
9R, 9RL, 9E, 9EL	Standard Ignition		9	1974→		QL77JC4	8883 0.8
Air Buoy Diving Unit	Standard Ignition					CJ14	0.6
Aquanaut Diving Unit	Standard Ignition		2	1966→1970		CJ14	0.8
CD, JH	Standard Ignition			1954→1968		RJ8C	0.8
Commercial			6.5	1981→1993		QL77JC4	8883 0.8
			8	1977→2001		QL86C	0.8
			10	1992→1993		QL77JC4	8883 0.8
			10	1993→2003		QL82C	8883 0.8
			14	1981→1991		QL77JC4	8883 0.8
			15	1992→1993		QL77JC4	8883 0.8
			15	1993→2001		QL82C	8883 0.8
			25	1981→2004		QL16V	
			45	1986→2001		QL16V	
			55	1986→2003		QL16V	
			100	1984→2001		QL16V	
			115	1975→1984		QL77JC4	8883 0.8
			185	1990→1993		QL77JC4	8883 0.8
			200	1992→		QL16V	
			200	1993→1998		QL78YC	8883 0.8
Commercial (43 cid)			40	1981→1990		UL81C	0.8
Commercial (45 cid)			40	1984→2003		QL16V	
Commercial	3-Cyl.		65	1994→1995		QL78YC	8883 0.8
Commercial CV6			155	1989→1992		QL16V	
Commercial HC LC			65	1988→2003		QL16V	

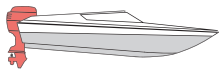

CC

BHP

POWER  
SPORT**...JOHNSON**

		CC	BHP	21		POWER SPORT	mm
<b>Commercial LV6</b>			65	1984 → 1987	QL77JC4	8883	0.8
CV4			150	1993 → 1998	QL78YC	8883	0.8
			88	1979 → 1997	QL82C	8883	0.8
			90	1979 → 1998	QL82C	8883	0.8
			110	1979 → 1997	QL82C	8883	0.8
			112	1979 → 1997	QL82C	8883	0.8
			115	1979 → 1998	QL82C	8883	0.8
CV6			150	1978 → 1987	QL16V		
			150	1988 → 1991	QL77JC4	8883	0.8
			155	1978 → 1987	QL16V		
			175	1988 → 1991	QL77JC4	8883	0.8
DI			115	2006 →	QC12PEPB		0.8
E-Tec 40, 50, 60				2008 →	QC10WEP		
E-Tec 65, 75, 90 Commercial				2008 →	QC10WEP		
Fast Strike LV4			115	1995 → 2004	QL78YC	8883	0.8
Fast Strike LV6			150	1991 → 2004	QL78YC	8883	0.8
			175	1991 → 2004	QL78YC	8883	0.8
FD, FDE	Standard Ignition			1956 → 1968	RJ8C		0.8
Jet			25	1995 → 1998	QL82C	8883	0.8
			40	1992 → 2003	QL78YC	8883	0.8
			50	1993 → 2004	QL78YC	8883	0.8
	2-Cyl.		20	1999 → 2001	QL82C	8883	0.8
	2-Cyl.		30	1999 → 2001	QL78YC	8883	0.8
	3-Cyl.		40	1999 → 2001	QL78YC	8883	0.8
Jet CV4			65	1992 → 1997	QL82C	8883	0.8
			80	1979 → 2001	QL82C	8883	0.8
Jet LV6			105	1993 → 2003	QL78YC	8883	0.8
JHF, JWF	Standard Ignition			1967 → 1968	RJ8C		0.8
Jr., Colt			2	1971 → 1990	RJ8C		0.8
JW	Standard Ignition			1952 → 1968	RJ8C		0.8
Kero			15	1995 → 1998	UL77V		
LD	Standard Ignition			1965 → 1968	RJ8C		0.8
LV4			120	1985 → 2004	QL78YC	8883	0.8
			130	1985 → 2003	QL78YC	8883	0.8
			140	1985 → 2003	QL78YC	8883	0.8
LV4 Commercial			105	1997 → 2003	QL78YC	8883	0.8
LV4 Ficht			90	1998 → 1999	7712		0.8
			90	2000 → 2005	XC12PEPB		0.8
			115	1998 → 1999	7712		0.8
			115	2000 → 2005	XC12PEPB		0.8
LV6			250	1999 → 2001	QL16V		
LV6 Ficht	Pinned Head		150	1997 → 1998	XC12PEPB		0.8
LV6 Ficht, D.I.			135	2001 →	XC12PEPB		0.8
LV6 Ficht, D.I.			150	2001 →	XC12PEPB		0.8
			175	2001 →	XC12PEPB		0.8
			200	1999 → 2006	QC12PEPB		0.8
			225	1999 → 2006	QC12PEPB		0.8
			250	2001 → 2006	QC12PEPB		0.8
	Pinned Head		175	1997 → 1999	XC12PEPB		0.8
			175	1997 → 1999	7712		0.8
Magneto	Standard Ignition		1.2	1986 → 1990	RJ8C		0.8
MQ	Standard Ignition			1964 → 1968	RJ8C		0.8
RD, RDE, RDS, RJE, RK	Standard Ignition			1951 → 1968	RJ8C		0.8
RX	Standard Ignition			1962 → 1968	RJ8C		0.8
RXE	Standard Ignition			1965 → 1968	RJ8C		0.8
SC	Standard Ignition			1968 →	RJ8C		0.8
SPL			48	1994 → 1997	QL78YC	8883	0.8
TN, AD, QD, V4H, V4ML	Standard Ignition			1952 → 1966	RJ8C		0.8
Turbojet CV4			90	1994 → 1997	QL82C	8883	0.8
			115	1994 → 1998	QL82C	8883	0.8
Ultra, Excel			4	1987 → 1988	QL77JC4	8883	0.8
V-4			65	1968 →	QL77JC4	8883	0.8
			100	1979 → 1980	QL77JC4	8883	0.8
	Standard Ignition		60	1964 → 1967	RJ8C		0.8
	Standard Ignition		75	1960 → 1965	RJ8C		0.8
V-4 Backtroller			85	1994 → 1995	QL82C	8883	0.8
V4, V4A, V4M	Standard Ignition		4	1958 → 1967	RJ8C		0.8
V4S, VX, VXH	Standard Ignition		4	1958 → 1967	RJ8C		0.8
V-6			200	1986 → 1993	QL77JC4	8883	0.8
			225	1986 → 1993	QL77JC4	8883	0.8

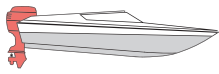

**CC****BHP****POWER  
SPORT****...JOHNSON**

V-8	250	1985 → 1997	QL78YC	8883	0.8
	300	1985 → 1997	QL78YC	8883	0.8
Venom LV6	200	1994 → 2003	QL78YC	8883	0.8
	225	1994 → 2003	QL78YC	8883	0.8
	15	1977 → 1992	QL77JC4	8883	0.8
	50	1971 → 1975	QL77JC4	8883	0.8
	85	1968 → 1980	QL77JC4	8883	0.8
	100	1967 → 1972	QL77JC4	8883	0.8
	115	1969 → 1970	QL77JC4	8883	0.8
	115	1973 → 1979	QL77JC4	8883	0.8
	125	1971 → 1972	QL77JC4	8883	0.8
	135	1973 → 1984	QL16V		
	140	1973 → 1984	QL16V		
	175	1977 → 1987	QL16V		
	200	1976 → 1983	QL16V		
	235	1978 → 1985	QL16V		
Standard Ignition	4	1981 → 1984	QL77JC4	8883	0.8
	2	1991 → 2001	QL87YC		0.8
	2.5	1987 → 1988	QL86C		0.8
	3.5	2002 →	QL87YC		0.8
	4	1988 →	QL77JC4	8883	0.8
	4	1977 → 1987	QL86C		0.8
	4.5	1980 → 1985	QL86C		0.8
	5	1990 → 1997	QL86C		0.8
	7.5	1977 → 1997	QL86C		0.8
	9.9	1977 → 2001	QL82C	8883	0.8
	14	1988 → 1989	QL77JC4	8883	0.8
	15	1994 → 2001	QL82C	8883	0.8
	20	1978 → 1993	QL82C	8883	0.8
	28	1978 → 1997	QL82C	8883	0.8
	85	1986 → 1993	QL77JC4	8883	0.8
	115	1986 → 1993	QL77JC4	8883	0.8
	275	1985 → 1988	QL82YC	8814	0.8
	3600	1985 → 1986	QL77JC4	8883	0.8
Standard Ignition	1.1	1946 → 1947	RH12		0.8
Standard Ignition	3	1952 → 1968	RJ8C		0.8
Standard Ignition	3 - 5.2	1952 → 1974	RJ8C		0.8
Standard Ignition	3.3	1948 → 1951	RJ8C		0.8
Standard Ignition	5.5	1954 → 1964	RJ8C		0.8
Standard Ignition	7.5	1952 → 1958	RJ8C		0.8
Standard Ignition	9.7	1942 → 1949	RD16		0.8
Standard Ignition	10	1952 → 1963	RJ8C		0.8
Standard Ignition	14-18	1950 → 1972	RJ8C		0.8
Standard Ignition	15	1954 → 1956	RJ8C		0.8
Standard Ignition	18	1957 → 1973	RJ8C		0.8
Standard Ignition	25	1952 → 1955	RJ8C		0.8
Standard Ignition	30	1956 → 1971	RJ8C		0.8
	18	1957 → 1973	RJ8C		0.8
Standard Ignition	5	1965 → 1968	RJ8C		0.8
Standard Ignition	6	1965 → 1976	RJ8C		0.8
Standard Ignition	9.5	1964 → 1973	RJ8C		0.8
Standard Ignition	20	1966 → 1973	RJ8C		0.8
Standard Ignition	28	1962 → 1964	RJ8C		0.8
Standard Ignition	35	1957 → 1959	RJ8C		0.8
Standard Ignition	40	1960 → 1973	RJ8C		0.8
Standard Ignition	50	1958 → 1959	RJ8C		0.8
Standard Ignition	80	1966 → 1967	RJ8C		0.8
Standard Ignition	90	1964 → 1965	RJ8C		0.8
	80	1966 → 1967	RJ8C		0.8
Standard Ignition	1.5 - 2	1968 → 1970	RJ8C		0.8
Standard Ignition	100	1966 →	RJ8C		0.8
	4	1969 → 1976	RJ8C		0.8
Standard Ignition	25	1969 → 1976	RJ8C		0.8
	9.9	1974 → 1976	UL81C		0.8
	15	1974 → 1976	UL81C		0.8
	35	1976 →	UL81C		0.8
	40	1974 → 1976	UL81C		0.8
	115	1985 →	UL77V		
	185	1977 → 1987	UL77V		

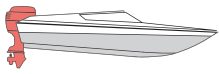

CC

BHP

21

POWER  
SPORT**K & P (→ Mini Motor)****K-MART****MARINER**

		CC	BHP	21		POWER SPORT	mm
			3.5, 5, 7	1970→		RJ14YC	0.9
			5, 7	1971→		RJ14YC	0.9
<b>MARINER</b>							
25			25	1985→2001		QL78YC	8883 1.0
60			60	1991→2004		QL78YC	8883 1.0
642			3.5			QL86C	1.0
664			28			QL82C	8883 1.0
100 EFI	4-Stroke				OE135	REC14PYC	
105 Jet			105	1995→1999		QL6VC	
115 EFI	4-Stroke				OE135	REC14PYC	
135 V-6			135	2000→2001		QL78YC	8883 1.0
135 V-6, Marathon, W135			135	1986→1999		QL6VC	
140 Jet			140	1995→1999		QL6VC	
15A, 15C (651, 684), K15 (669)			15			QL82C	8883 0.6
15B (662,664)			15			QL82C	8883 0.6
15C (682), Marathon (684) CDI			15			QL82C	8883 1.0
			15			QL82C	8883 1.0
2.5L Carb. V-6			245	1995→		QL6VC	
2.5L Drag EFI V-6			300	1997→1998		QL76V	
2.5L EFI V-6			260	1995→1998		QL6VC	
			265	1997→		QL6VC	
20 Jet			20	1995→2001		QL78YC	8883 1.0
20A (653), 20C (6A9)			20			QL86C	0.6
25A (648), 25B (690)			25			QL77JC4	8883 0.6
25C (695)			25			QL77JC4	8883 0.6
2A (646), 2B (6A1)			2			QL86C	0.6
	2-Cyl.		8	1987→2004		L92LCC	1.0
	2-Cyl.		15	1989→2002		L92LCC	1.0
	2-Cyl.		20	1985→2004		QL78YC	8883 1.0
	2-Stroke		4	1990→2004		QL82YC	8814 1.0
	2-Stroke		5	1990→2004	OE064	RL82YC	8814 1.0
	2-Stroke		6	1992→2004		L92LCC	1.0
3.0L EFI V-6			250	1997→2004		QL77CC	0.9
3.0L EFI/Carb. V-6			225	1995→2004		QL77CC	0.9
3.0L Super Magnum EFI V-6			300	1997→1998		QL77CC	0.9
3.4L V-6			250	1989→1990		QL6VC	
			275	1991→1994		QL6VC	
30 Jet			30	1995→2001		QL78YC	8883 1.0
30, Marathon 30	2-Cyl.		30	1995→2002		QL78YC	8883 1.0
30A (689)			30			QL82C	8883 1.0
	3-Cyl.		50	1986→1990		QL78V	
	3-Cyl.		60	1984→1990		QL76V	
	3-Cyl.		70	1987→2000		QL78V	
	3-Cyl.	849	50	1991→2004		QL78YC	8883 1.0
	3-Cyl. 2-Stroke		75	1987→2001		QL78V	
40	2-Cyl. & 3-Cyl. 2-Stroke		40	1998→2001		QL78YC	8883 1.0
	4-Cyl.		40	1989→1997		QL78V	
40, Marathon 40	2-Cyl.		40	1995→2004		QL78YC	8883 1.0
40A(676A), 40B (675B)			40			QL78C	8883 0.6
40C (6E9), W40 (676A)			40			QL78C	8883 1.0
45 BoDensee			45	1995→2004		RA8HC	8810 0.9
45 Jet			45	1995→2001		QL78YC	8883 1.0
48, W48 (670)			48			QL82C	8883 1.0
4A (6E0)			4			QL82C	8883 0.6
	4-Cyl.		45	1986→1989		QL78V	
	4-Cyl.		50	1980→1985		QL78V	
	4-Cyl.		75-80			QL78V	
	4-Cyl.		100	1988→1999		QL78YC	8883 1.0
	4-Cyl.		125	1994→2002		QL78YC	8883 1.0
	4-Cyl. 2-stroke		90	1987→2001		QL78V	
	4-Cyl. 2-stroke		115	1989→2002		QL78YC	8883 1.0
	4-Cyl. 4-Stroke DOHC		75	2000→2004	OE148	REC10YC4	1.1
	4-Cyl. 4-Stroke DOHC		90	2000→2004	OE148	REC10YC4	1.1
MFI	4-Cyl. 4-Stroke DOHC		115	2000→2004	OE148	REC10YC4	1.0

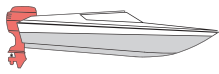

CC

BHP

POWER  
SPORT**...MARINER**

		CC	BHP				mm
	4-Stroke		4	1999 → 2004		RA8HC	0.9
	4-Stroke		5	1999 → 2004		RA8HC	0.9
	4-Stroke		6	2000 → 2004		RA8HC	0.9
55E S/N >004040			55			QL78C	0.6
55E S/N 004041 >			55			QL78C	1.0
55EL S/N >315378			55			QL78C	0.6
55EL S/N 315379 >			55			QL78C	1.0
5B (661), 5C (6E3)			5			QL82C	0.6
60 (6F0)			60			QL78C	1.0
60 Big Foot	3-Cyl.		60	1995 → 2004		QL78YC	1.0
60E S/N >000780	2-Cyl.		60			QL78C	0.6
60E S/N 000781 >	2-Cyl.		60			QL78C	1.0
60EL S/N >302050	2-Cyl.		60			QL78C	0.6
60EL S/N 302051 >	2-Cyl.		60			QL78C	1.0
65 Jet			65	1995 → 2001		QL78V	
6B (678)			6			QL82C	0.6
6C (6H8), 6D (6H6)			6			QL82C	1.0
	6-Cyl.		90			QL76V	
	6-Cyl.		115			QL76V	
	6-Cyl.		140			QL76V	
75 EFI	4-Stroke				OE135	REC14PYC	
8 BoDensee			8	1995 → 2004		Z9Y	0.7
80 EFI	4-Stroke				OE135	REC14PYC	
80 Jet			80	1995 → 2001		QL78YC	1.0
8A (647, 655)			8			QL82C	0.6
8B, W8 (677)			8			QL82C	0.6
8C (6G1)			8			QL82C	1.0
9.9	2-Cyl.		9.9	1995 → 2004		L92LCC	1.0
9.9C (682)			9.9			QL82C	0.6
9.9C (682) CDI			9.9			QL82C	1.0
90 EFI	4-Stroke				OE135	REC14PYC	
Big Foot	4-Stroke		15	1998 → 2004		RA8HC	0.9
	4-Stroke		25	1998 → 2004		RA8HC	0.9
	4-Stroke		30	2000 → 2004		RA8HC	0.9
	4-Stroke		50	1995 → 2004		RA8HC	0.9
Big Foot D896	4-Stroke		40	1998 → 2004		RA8HC	0.9
Big Foot, Sail Power	4-Stroke		9.9	1995 → 2004		Z9Y	0.7
K15 (6M7), K15C (6K4)			15			QL82C	1.0
K25 (6A4), W25 (648)			25			QL82C	0.6
K40 (6F5), W40, W40 (6F6)			40	1984 → 2001		QL82C	0.6
K8 (680)			8			QL86C	0.6
M55 (663)			55			QL82C	1.0
Magnum EFI V-6, 175 SKI			175	1989 → 1999		QL6VC	
			175	2000 → 2001		QL78YC	1.0
Magnum EFI V-6, II, III			150	1985 → 1999		QL6VC	
			150	2000 → 2001		QL78YC	1.0
Magnum EFI V-6, V200			200	1989 → 2004		QL6VC	
			200	2000 → 2001		QL78YC	1.0
Magnum EFI, V220			220	1987 → 1988		QL6VC	
Magnum, Marathon			10	1991 → 2004		QL78YC6	1.5
Marathon 15			15	1992 → 2002		L92LCC	1.0
Marathon 15 (684)			15			QL82C	0.6
Marathon 25 (648)			25			QL77JC4	1.0
Marathon 25 (694), (695)			25			QL77JC4	1.0
Marathon 25	2-Cyl.		25	1993 → 2002		QL78YC	1.0
Marathon 30 (698B)			30			QL82C	0.6
Marathon 40 (6F6)			40	1985 → 1994		QL78C	1.0
Marathon 55			55	1991 → 2004		QL78YC	1.0
Marathon 60	3-Cyl.		60	1995 → 2004		QL78YC	1.0
Marathon 75	3-Cyl. 2-Stroke		75	1991 → 2004		QL78V	
Marathon 8 (677)			8			QL82C	0.6
Marathon V-6			3	1996 → 1999		QL77JC4	0.9
			225	1994 → 2001		QL77CC	0.9
OptiMax DFI V-6			115	2000 → 2004		QC12GMC	1.0
			135	1996 → 2002		QC12GMC	1.0
			150	1997 → 2002		QC12GMC	1.0
			200	1997 → 2004		QC12GMC	1.0
			225	1998 → 2004		QC12GMC	1.0

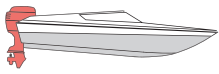

CC

BHP

POWER  
SPORT**...MARINER**

Super Magnum EFI V-6		150	1997→1999	QL6VC		
		200	1997→1999	QL6VC		
		200	2000→2001	QL78YC	8883	1.0
		225	1997→1999	QL6VC		
V-6, V150, W150		150	1979→1999	QL6VC		
		150	2000→2001	QL78YC	8883	1.0
V-6, V175		175	1978→1999	QL6VC		
W15 (684)		15		QL82C	8883	1.0
W25 (694), W25 (695)		25		QL77JC4	8883	0.6
W30 (689A), W30 (689B)		30		QL82C	8883	1.0
W55 (663)		55		QL78C	8883	1.0
		2.5	1989→2004	QL87YC		1.0
		3	1990→1992	QL86C		1.0
		3.3	1993→2004	QL87YC		1.0
		9.9	1987→1994	QL78YC	8883	1.0
		85		QL78V		
		200	1980→1988	QL6VC		

**McCULLOCH**

590/630				RJ12C		0.8
Electric Start		45		RJ12C		0.8
Manual Start		28		RJ12C		0.8
		45		RJ12C		0.8
	Long Shaft	4	1964→1969	RH12		0.9
		3.5	1964→1969	RH12		0.9
		4		RJ14YC		0.9
		7.5	1964→1969	RH12		0.9
		9		RJ12C		0.9
		9.5		RJ12C		0.9
		14		RJ12C		0.9
		75		RJ12C		0.8

**MERCURY**

39	Standard Ignition	3.9	1960→1966	RJ8C		0.6
150	Standard Ignition	15	1960→1966	RJ8C		0.6
350	Standard Ignition	35	1967→1969	QL82C	8883	0.8
700	Standard Ignition	70	1960→1966	RJ6C		0.6
800	Standard Ignition	80	1966→1969	QL76V		
1 Cyl. 2-Stroke	Thunderbolt Ignition	4	1988→2004	QL82YC	8814	1.0
	Thunderbolt Ignition	5	1988→2004	OE064 RL82YC	8814	1.0
1 Cyl. 4-Stroke	Thunderbolt Ignition	4	2000→2004	RA8HC	8810	0.9
	Thunderbolt Ignition	5	2000→2004	RA8HC	8810	0.9
	Thunderbolt Ignition	6	2000→2004	RA8HC	8810	0.9
10 Sea Pro	Thunderbolt Ignition	10	1991→2004	OE135 QL78YC6		1.5
100 EFI 4-Stroke				OE135 REC14PYC		
1000BP, 1000SS	Standard Ignition	100	1966→1969	QL76V		
105 Jet	Thunderbolt Ignition	105	1995→1998	QL6VC		
110, 200	Standard Ignition	10-20	1967→1969	QL82C	8883	0.8
1100, 1100SS	Standard Ignition	110	1966→1969	QL76V		
115 EFI 4-Stroke				OE135 REC14PYC		
1250BP, 1250SS	Standard Ignition	125	1966→1969	QL76V		
135 V-6	Thunderbolt Ignition	135	1986→1999	QL6VC		
	Thunderbolt Ignition	135	2000→	QL82YC	8814	1.0
140 Jet	Thunderbolt Ignition	140	1995→1999	QL6VC		
15 Sea Pro 2-Cyl.	Thunderbolt Ignition	15	1995→2004	L92LCC		1.0
1-Cyl.	Thunderbolt Ignition	2.5	1993→2004	QL87YC		1.0
	Thunderbolt Ignition	3.3	1993→2004	QL87YC		1.0
2 Cyl. 4-Stroke	Thunderbolt Ignition	30	1999→2004	RA8HC	8810	0.9
20 Jet 2-Cyl.	Thunderbolt Ignition	20	1995→2004	QL78YC	8883	1.0
200, 250	Standard Ignition	20-25	1960→1966	RJ6C		0.6
25 Sea Pro 2-Cyl.	Thunderbolt Ignition	25	1993→2002	QL78YC	8883	1.0
2-Cyl 2-Stroke.	Thunderbolt Ignition	6	1986→2003	L92LCC		1.0
2-Cyl.	Thunderbolt Ignition	8	1986→2004	L92LCC		1.0
	Thunderbolt Ignition	40	1995→2004	QL78YC	8883	1.0
2-Cyl. 2-Stroke	Thunderbolt Ignition	9.9	1995→2004	L92LCC		1.0
	Thunderbolt Ignition	15	1989→2004	L92LCC		1.0
	Thunderbolt Ignition	20	1986→2003	QL78YC	8883	1.0
	Thunderbolt Ignition	25	1980→2004	QL78YC	8883	1.0
	Thunderbolt Ignition	30	1995→2003	QL78YC	8883	1.0

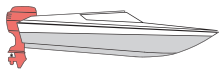

CC

BHP

POWER  
SPORT**...MERCURY**

2-Cyl. 4-Stroke	Thunderbolt Ignition	9.9	2000→2004		RA8HC	8810	0.9
3.0L Sea Pro V-6	Thunderbolt Ignition	225	1995→2004		QL77CC		0.9
3.4L	Thunderbolt Ignition	250	1989→1990		QL6VC		
30 Jet 3-Cyl.	Thunderbolt Ignition	30	1995→1997		QL78V		
	Thunderbolt Ignition	30	1998→2001		QL78YC	8883	1.0
30 Sea Pro 2-Cyl.	Thunderbolt Ignition	30	1995→2004		QL78YC	8883	1.0
300, 400	Standard Ignition	35-45	1960→1966		RJ6C		0.6
350 (1966)	Standard Ignition	35	1960→1966		J4C		0.6
350 (Thru 1965)	Standard Ignition	35-40	1960→1966		RJ6C		0.6
39, 40	Standard Ignition	3.9-4	1967→1969		L90C		0.8
3-Cyl.	Thunderbolt Ignition	40	1997→2004		QL78YC	8883	1.0
	Thunderbolt Ignition	60	1991→2002		QL78YC	8883	1.0
3-Cyl. 2-Stroke	Thunderbolt Ignition	75	1987→2004		QL78V		
	Thunderbolt Ignition	90	1987→2004		QL78V		
4 Cyl.	Thunderbolt Ignition	75	1984→1986		QL78V		
40 Sea Pro	Thunderbolt Ignition	40	1995→2004		QL78YC	8883	1.0
45 BoDensee 4-Cyl.	Thunderbolt Ignition	45	1995→2004		RA8HC	8810	0.9
45 Jet 3-Cyl.	Thunderbolt Ignition	45	1995→2003		QL78YC	8883	1.0
4-Cyl.	Thunderbolt Ignition	40	1988→1997		QL78V		
	Thunderbolt Ignition	100	1988→1999		QL78YC	8883	1.0
	Thunderbolt Ignition	125	1994→2004		QL78YC	8883	1.0
4-Cyl. 2-Stroke	Thunderbolt Ignition	115	1989→2004		QL78YC	8883	1.0
4-Cyl. 4-Stroke DOHC 75	Thunderbolt Ignition	75	2000→2004	OE148	REC10YC4		1.1
4-Cyl. 4-Stroke DOHC 90	Thunderbolt Ignition	90	2000→2004	OE148	REC10YC4		1.1
4-Cyl. MFI 4-Stroke DOHC	Thunderbolt Ignition	115	2000→2004	OE148	REC10YC4		1.0
50 3-Cyl. 2-Stroke	Thunderbolt Ignition	50	1991→2004		QL78YC	8883	1.0
500, 600	Standard Ignition	50-60	1960→1966		RJ6C		0.6
500M, 500S, 650S	Standard Ignition	50-65	1967→1969		QL82C	8883	0.8
500SS, 650SS	Standard Ignition	50-65	1966→1969		QL76V		
55 Sea Pro	Thunderbolt Ignition	55	1992→2004		QL78YC	8883	1.0
60 4-Cyl. 4-Stroke	Thunderbolt Ignition	60	2001→2004		RA8HC	8810	0.9
60 Big Foot 3-Cyl.	Thunderbolt Ignition	60	1995→2004		QL78YC	8883	1.0
60 Sea Pro 3-Cyl.	Thunderbolt Ignition	60	1991→2004		QL78YC	8883	1.0
60, 100, 110	Standard Ignition	6-10	1960→1966		RJ8C		0.6
60, 75	Standard Ignition	6-7.5	1967→1969		QL86C		0.8
65 Jet	Thunderbolt Ignition	65	1995→2004		QL78V		
650, 650S, 850	Standard Ignition	65-85	1960→1966		J4C		0.6
6-Cyl.	Thunderbolt Ignition	90	1978→1986		QL76V		
	Thunderbolt Ignition	115	1970→1988		QL76V		
6-Cyl. 2-Stroke 150 EFI	Thunderbolt Ignition	150	2000→2004		QL82YC	8814	1.0
75 EFI 4-Stroke				OE135	REC14PYC		
75 Sea Pro 2-Stroke	Thunderbolt Ignition	75	1990→2001		QL78V		
8 BoDensee	Thunderbolt Ignition	8	1995→2004		Z9Y		0.7
80 EFI 4-Stroke				OE135	REC14PYC		
80 Jet	Thunderbolt Ignition	80	1995→2004		QL78YC	8883	1.0
800E S/N 1403610	Standard Ignition	80	1960→1966		J4C		0.6
800E S/N 1403611	Standard Ignition	80	1960→1966		J4C		0.6
800EL S/N 1405606	Standard Ignition	80	1960→1966		J4C		0.6
800EL S/N 1405607	Standard Ignition	80	1960→1966		J4C		0.6
90 EFI 4-Stroke				OE135	REC14PYC		
900, 1000	Standard Ignition	90-100	1960→1966		J4C		0.6
950, 1100	Standard Ignition	95-110	1967→1969		QL82C	8883	0.8
950, 950SS	Standard Ignition	95	1966→1969		QL76V		
Big Foot 4-Cyl. 4-Stroke	Thunderbolt Ignition	50	1995→2004		RA8HC	8810	0.9
Big Foot 4-Stroke	Thunderbolt Ignition	15	1998→2004		RA8HC	8810	0.9
	Thunderbolt Ignition	25	1997→2004		RA8HC	8810	0.9
Big Foot D706 4-Stroke	Thunderbolt Ignition	40	1998→2004		RA8HC	8810	0.9
Big Foot, Sail Power 4-Stroke	Thunderbolt Ignition	9.9	1995→2004		Z9Y		0.7
Duece High EFI	Thunderbolt Ignition	2000	200	1997→	QL6VC		
EFI Offshore	Thunderbolt Ignition	2500	280	2002→	QL77JC4	8883	0.9
EFI Sport, EFI SS	Thunderbolt Ignition	2500	280	2002→	QL77JC4	8883	0.9
F1 EFI	Thunderbolt Ignition	2000	280	1997→1999	QL76V		
Offshore	Thunderbolt Ignition	2500	260	1995→1998	QL6VC		
	Thunderbolt Ignition	2500	260	1999→	QL77CC		0.9
OptiMax 200 XS V6	Thunderbolt Ignition	200	2002→2004		QC12GMC		1.0
Optimax 200XS	Thunderbolt Ignition	2500	200	2000→2004	QC12GMC		1.0
	Thunderbolt Ignition	3000	200	2000→2004	QC12GMC		1.0
OptiMax 225XS V-6 2-Stroke	Thunderbolt Ignition	225	2003→2004		QC12GMC		1.0

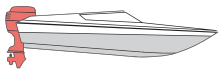

**CC****BHP****POWER  
SPORT****...MERCURY**

OptiMax DFI V-6	Thunderbolt Ignition		115	2000→2004	QC12GMC	1.0
	Thunderbolt Ignition		135	1996→2004	QC12GMC	1.0
	Thunderbolt Ignition		150	1996→2004	QC12GMC	1.0
	Thunderbolt Ignition		175	2001→2004	QC12GMC	1.0
	Thunderbolt Ignition		200	1996→2004	QC12GMC	1.0
	Thunderbolt Ignition		225	1996→2004	QC12GMC	1.0
Pro Max 300X V6	Thunderbolt Ignition		300	2002→2004	QL77PP	
S3000 EFI	Thunderbolt Ignition	2500	300	1997→1999	QL6VC	
SS Drag EFI	Thunderbolt Ignition	2500	265	1997→	QL6VC	
SST 120 EFI	Thunderbolt Ignition	2000	200	1997→1999	QL76V	
V-6	Thunderbolt Ignition		150	1978→1999	QL6VC	
	Thunderbolt Ignition		175	1976→1999	QL6VC	
	Thunderbolt Ignition		200	1978→2002	QL6VC	
	Thunderbolt Ignition		200	2000→2002	QL82YC	8814 1.0
	Thunderbolt Ignition		225	1994→2001	QL77CC	0.9
	Thunderbolt Ignition		10	1998→	QL78YC6	1.5
XR10	Thunderbolt Ignition	2000	200	1997→1999	QL76V	
XR2 SS EFI	Thunderbolt Ignition		150	1985→2002	QL6VC	
XR2, XR4, XR6 V-6	Thunderbolt Ignition		220	1987→1988	QL6VC	
XRi	Thunderbolt Ignition		150	1993→2002	QL6VC	
XRi EFI V-6	Thunderbolt Ignition		175	1991→2002	QL6VC	
	Thunderbolt Ignition		175	2000→2004	QL82YC	8814 1.0
	Thunderbolt Ignition		200	1997→2002	QL6VC	
	Thunderbolt Ignition		200	2000→2002	QL82YC	8814 1.0
	Thunderbolt Ignition		225	1995→2004	QL77CC	0.9
	Thunderbolt Ignition		250	1995→2003	QL77CC	0.9
	Thunderbolt Ignition		2.2	1984→1989	QL87YC	1.0
	Thunderbolt Ignition		4	1970→1974	QL78V	
	Thunderbolt Ignition		4	1986→1987	QL78V	
	Thunderbolt Ignition		4	1976→1979	QL86C	1.3
	Thunderbolt Ignition		4.5	1975→1985	QL78V	
	Thunderbolt Ignition		7.5	1979→1985	QL77JC4	8883 1.0
	Thunderbolt Ignition		7.5	1970→1978	QL78V	
	Thunderbolt Ignition		9.8	1979→1985	QL77JC4	8883 1.0
	Thunderbolt Ignition		9.8	1970→1978	QL78V	
	Thunderbolt Ignition		9.9	1986→1994	QL78YC	8883 1.0
	Thunderbolt Ignition		10	1991→1996	QL78YC6	1.5
	Thunderbolt Ignition		18	1980→1985	QL77JC4	8883 1.0
	Thunderbolt Ignition		20	1970→1981	QL78V	
	Thunderbolt Ignition		35	1984→1991	QL76V	
	Thunderbolt Ignition		40	1970→1983	QL76V	
	Thunderbolt Ignition		45	1986→1989	QL78V	
	Thunderbolt Ignition		50	1970→1990	QL76V	
	Thunderbolt Ignition		60	1984→1990	QL76V	
	Thunderbolt Ignition		65	1970→1976	QL76V	
	Thunderbolt Ignition		70	1977→1983	QL76V	
	Thunderbolt Ignition		70	1987→1989	QL78V	
	Thunderbolt Ignition		80	1969→1972	QL76V	
	Thunderbolt Ignition		80	1978→1989	QL78V	
	Thunderbolt Ignition		85	1973→1977	QL76V	
	Thunderbolt Ignition		135	1970→1971	QL76V	
	Thunderbolt Ignition		140	1970→1980	QL76V	
	Thunderbolt Ignition		150	1973→1977	QL76V	
	Thunderbolt Ignition		225	1980→1981	QL6VC	
	Thunderbolt Ignition		275	1989→1994	QL6VC	
	Thunderbolt Ignition		300	1980→1983	QL6VC	
	Thunderbolt Ignition	2000	150	1999→	QL6VC	
	Thunderbolt Ignition	2500		1991→	QL76V	
	Thunderbolt Ignition	2500	150	1999→	QL6VC	
	Thunderbolt Ignition	2500	245	1995→1996	QL6VC	
	Thunderbolt Ignition	3000	300	1997→1999	QL77CC	0.9
	Thunderbolt Ignition	3400		1984→1988	QL6VC	
			5-7.5	1959→	RJ8C	0.6
			10-15	1959→	RJ8C	0.6
			16	1959→	RJ6C	0.6
			22	1959→	RJ6C	0.6
			25	1959→	RJ6C	0.6
			31	1959→	RJ6C	0.5
			35-40	1959→	RJ6C	0.6

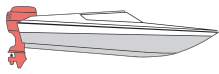

CC

BHP

POWER  
SPORT**...MERCURY**

	45	1959 →		RJ6C		0.6
	60-70	1959 →		RJ6C		0.6
Thunderbolt Ignition	3.0	1990 → 1992	OE064	RL82YC	8814	1.0
Thunderbolt Ignition	3.5	1983 → 1985	OE064	RL82YC	8814	1.0
Thunderbolt Ignition	3.6	1980 → 1982	OE064	RL82YC	8814	1.0
Thunderbolt Ignition	4	1980 → 1982	OE064	RL82YC	8814	0.9

**MID-JET**

M-2, M-3				RJ12C		0.8
M-4				QL82C	8883	0.8

**MIGHTY MITE III**

800	1.7, 2			RJ12C		0.6
-----	--------	--	--	-------	--	-----

**MINI MOTOR (K & P)**

Aqua Bug		1972 → 1973		CJ14		0.8
Aqua Bug II		1973 →		RDJ7J		0.6
Mini Motor		1969 → 1973		CJ14		0.8

**MONARK-CRESCENT (→ VOLVO PENTA)****MONO**

M-50				RJ12C		0.8
M-5A, M-6A				RJ12C		0.8
M-75				RJ14YC		0.8

**MOTO ATTREZZI**

Mac 10 (Wankel)				QL86C		0.6
-----------------	--	--	--	-------	--	-----

**NISSAN**

1-Cyl.	2.5	1985 → 2004		RL95YC		1.0
	3.5	1985 → 2004		QL87YC		1.0
	4	1994 →		QL82YC	8814	1.0
	5	1985 → 2002		QL82YC	8814	1.0
1-Cyl. OHV 4-Stroke	4	2000 → 2004		RA8HC	8810	0.6
	5	1999 → 2004		RA8HC	8810	0.6
	6	2001 → 2004		RA8HC	8810	0.6
2 Cyl.	12	1985 → 1987		QL82C	8883	1.0
2-Cyl.	8	1985 → 2003		RL95YC		1.0
	9.8	1985 → 2003		RL95YC		1.0
	9.9	1985 → 1998		QL87YC		1.0
	12	1994 →		QL82C	8883	1.0
	15	1985 → 2001		QL82YC	8814	1.0
	18	1986 → 2003		QL82YC	8814	1.0
	25	1986 → 2002		QL82YC	8814	1.0
	30	1986 → 2002		QL82YC	8814	1.0
	35	1994 → 1995		QL82C	8883	1.0
	40	1985 → 1998		QL82C	8883	1.0
	55	1985 → 1986		QL78C	8883	1.0
	60	1987 → 1995		QL78C	8883	1.0
2-Cyl. OHV 4-Stroke	9.9	2000 → 2004		RA8HC	8810	0.6
	15	2000 → 2004		RA8HC	8810	0.6
	18	2001 → 2004		RA8HC	8810	0.6
	25	2002 → 2004		RA8HC	8810	0.6
2-Cyl. SOHC 4-Stroke	8	2004 →		RA8HC	8810	0.6
	9.8	2004 →		RA8HC	8810	0.6
3-Cyl.	40	1993 → 2003		QL82C	8883	1.0
	45	1994 → 1995		QL82C	8883	1.0
	50	1988 → 2002		QL78C	8883	1.0
	70	1986 → 2002		QL78C	8883	1.0
	90	1988 → 2002		QL78C	8883	1.0
3-Cyl. (A) TLDI	70	2002 → 2003	OE013	RC12YC	8071	1.0
	90	2001 → 2003	OE013	RC12YC	8071	1.0
3-Cyl. (B) TLDI	70	2003 → 2004	OE041	RC12LYC		1.0
	90	2003 → 2004	OE041	RC12LYC		1.0
3-Cyl. 40 TLDI	40	2003 → 2004		QL82C	8883	1.0
3-Cyl. 4-Stroke	25	2003 → 2004		QL82YC	8814	1.0
	30	2003 → 2004		QL82C	8883	1.0
3-Cyl. 50 TLDI	50	2001 → 2004		QL78C	8883	1.0

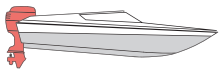

CC

BHP

POWER  
SPORT**...NISSAN**

4-Cyl.	120	1990→2004	QL78C	8883	1.0
	140	1990→2004	QL78C	8883	1.0
70 TLDI	70	2003→2004	QL78C	8883	1.0

**OTASCO**

	3.5, 5	1969→	RJ12C		0.9
	5, 7	1968→	RJ12C		0.9
	5, 7, 7.5	1970→1974	RJ14YC		0.9
	7	1969→	RJ12YC		0.9
	9.9, 15	1970→1974	RJ14YC		0.9

**OTTERBINE**

(B&S Eng.) Jet Drive	2		RJ19LM		0.6
----------------------	---	--	--------	--	-----

**OUTBOARD JET**

J55, J55B	5.5		RJ12C		0.8
-----------	-----	--	-------	--	-----

**OUTBOARD MARINE (Bombardier)**

1.6L, 1.8L Sea Drive		1984→1992	QL77JC4	8883	1.0
1.6L, 2.5L Sea Drive		1983→	QL76V		
1AA, 2.6L Sea Drive		1981→1983	QL76V		
1AB, 2.5L Sea Drive		1981→1983	QL76V		
2.0L, 3.0L Sea Drive		1990→1992	QL77JC4	8883	1.0
2.6L, 2.7L Sea Drive		1984→1990	QL77JC4	8883	1.0
3.6L Sea Drive		1984→1990	QL77JC4	8883	1.0
4.0L Sea Drive		1990→1991	QL77JC4	8883	1.0

**PEERLESS**

J5			CJ14		0.8
J9			RJ12C		0.8

**PENTA (→ Volvo Penta)****PERKINS**

14mm Heads	35	1961→	QL86C		0.9
18mm Heads	35	1959→1960	RD16		0.9
	4.5, 6.5	1962→1965	RJ12C		0.7
	6	1959→1961	RJ12C		0.7
	16	1959→1961	RH12		0.7
	18	1962→1965	RH12		0.7
	30, 40	1962→1965	QL86C		0.9
	40	1959→1961	QL86C		0.9

**SCOTT (McCulloch)**

Custom	75.2	1961→	RJ12C		0.9
Fishing Scott	7.5	1961→1963	RH12		0.7
Fleet, Power Scott	14	1962→1963	RJ12C		0.9
Flying Scott	75	1962→1963	RJ12C		0.9
Royal Scott	45	1962→1963	RJ12C		0.9
	45	1962→1963	RJ12C		0.9
Scotty	3.5	1961→1962	RH12		0.7
Sports Scott	28	1962→1963	RJ12C		0.9
	3.6, 6,	1959→1963	RH12		0.7
	10	1959→1961	RH12		0.7
	12	1959→1960	RJ12C		0.9
	25	1959→1960	RJ12C		0.9
	27.7, 14.1	1961→	RJ12C		0.9
	40	1959→1960	RJ12C		0.9
	43.7		RJ12C		0.9
	60	1959→1960	RJ12C		0.9

**SEA-BEE (Goodyear)**

All Models		1946→1959	RJ12C		0.8
		1960→	RJ12C		0.8

**SEABREEZE**

	7	1966→	CJ14		0.9
--	---	-------	------	--	-----



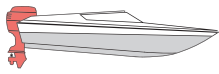

CC

BHP

POWER  
SPORT**SEACO**

4.5, 7.5

1973 → 1974

RJ14YC

0.9

5.5

1975 →

RJ14YC

0.9

9.9, 15

1973 → 1974

RJ14YC

0.9

**SEAGULL (→ British Seagull)****SEA-KING (Montgomery-Ward)**

9.2 CID Eng.

7.5

1979 → 1980

RJ14YC

0.6

2

1979 → 1980

RJ12C

0.6

3.5

1979 → 1980

CJ14

0.6

3.5

1964 → 1970

RH12

0.8

4

1979 → 1984

QL86C

0.8

5

1967 →

RJ12C

0.9

5.8

1964 → 1970

RH12

0.8

5.9

1979 → 1980

RJ14YC

0.6

6

1972 → 1976

QL82C

8883

0.8

6

1967 → 1971

RH12

0.8

7

1969 →

RJ14YC

0.9

7.5

1976 →

QL82C

8883

0.8

7.5

1979 → 1983

QL86C

0.8

9

1964 → 1965

RH12

0.8

9.2

1966 → 1969

RJ12C

0.8

9.6

1968 → 1974

QL82C

8883

0.8

9.9

1983 → 1984

QL82C

8883

0.8

10

1974 → 1976

QL82C

8883

0.8

15

1974 → 1984

QL82C

8883

0.8

20

1968 → 1974

QL82C

8883

0.8

20

1964 → 1967

RJ12C

0.8

25

1974 → 1976

QL82C

8883

0.8

35

1968 → 1979

QL82C

8883

0.8

55

1968 → 1974

QL82C

8883

0.8

80

1964 → 1967

RJ12C

0.8

**SEARS**

5927

12.0

RH12

1.0

5941

35.0

RJ12C

1.0

6015

14.0

RJ12C

1.0

6091

3.5

1966 →

CJ14

0.8

3.5

CJ14

0.8

581508

15.0

QL87YC

0.8

581754

7.5

QL87YC

0.8

582591

25.0

QL82C

8883

0.8

585122

1.2

CJ14

0.6

585270

4.0

RJ14YC

0.8

585280

3.5

RJ14YC

0.8

586240

9.9

RJ14YC

0.8

586340

15.0

RJ14YC

1.0

587506

5.0

RJ14YC

0.9

601951

5.5

RJ14YC

0.9

602151

15.0

QL87YC

0.8

581490, 581491

15.0

QL87YC

0.8

581494, 581495

15.0

QL87YC

0.8

581496, 581497

15.0

QL87YC

0.8

581498, 581500

15.0

QL87YC

0.8

581501, 581503

15.0

QL87YC

0.8

581504, 581505

15.0

QL87YC

0.8

581506, 581507

15.0

QL87YC

0.8

581740, 581741

7.5

QL87YC

0.8

581750, 581751

7.5

QL87YC

0.8

581980, 581981

9.9

QL87YC

0.8

581985, 581986

9.9

QL87YC

0.8

581987, 581988

9.9

QL87YC

0.8

581990, 581991

9.9

QL87YC

0.8

581993, 581994

9.9

QL87YC

0.8

581995, 581996

9.9

QL87YC

0.8

581997, 581998

9.9

QL87YC

0.8

58241, 58250

2.0

RJ12C

0.8

582500, 582501

25.0

QL82C

8883

0.8

58510, 59860, 59861

3.5

RJ12C

0.9

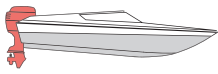
**CC****BHP****POWER  
SPORT****mm****...SEARS**

58511, 58512	3.6		RJ12C	0.9
585120, 585121	1.2		RJ12C	0.6
58513, 58514	3.6		RJ14YC	0.9
58520, 59670	5.0		RJ12C	0.9
58521, 58610, 58620	5.0		QL87YC	0.8
585210, 585211, 585220	3.0		RJ14YC	0.8
585230, 585240, 585241	3.5		RJ14YC	0.8
58530, 585860, 585861	7.0		RJ14YC	0.9
58531, 58532, 58830	7.0		RJ14YC	0.9
58540, 58541	3.0		RJ14YC	0.9
585410, 585411	5.0		RJ12C	0.9
58542, 58550	3.5		RJ14YC	0.9
585420, 585430, 585440	5.0		RJ14YC	0.8
58543, 58544	3.0		RJ14YC	0.9
585431, 585441	5.0		RJ14YC	0.8
585460, 585470	5.0		QL87YC	0.8
58560, 59862	3.5		RJ14YC	0.9
58580, 585250	4.0		RJ14YC	0.9
585810, 585840, 595890	7.5		RJ14YC	0.8
585811, 585831, 585931	7.5		RJ14YC	0.8
585830, 585920	7.5		RJ14YC	0.8
585840, 585932	7.5		RJ14YC	0.8
585870, 59450	7.5		RJ14YC	0.9
585880, 585911, 586111	7.5		RJ14YC	0.8
585930, 586120	7.5		RJ14YC	0.8
586210, 586211	9.9		RJ14YC	0.9
586220, 586230, 586231	9.9		RJ14YC	0.8
586310, 586311	15.0		RJ14YC	1.0
586320, 586330, 586331	15.0		RJ14YC	1.0
58710, 58711	9.9		RJ14YC	0.9
587150, 587151	15.0		QL87YC	0.8
58720, 58721	10.5		RJ14YC	1.0
58749, 58750	5.0		QL87YC	0.8
587490, 587491	5.0		QL87YC	0.8
587493, 587494	5.0		QL87YC	0.8
587495, 587496	5.0		QL87YC	0.8
587500, 587501	5.0		QL87YC	0.8
587502, 587503	5.0		QL87YC	0.8
587504, 587505	5.0		QL87YC	0.8
58760, 58761	15.0		RJ14YC	1.0
587990, 587991	9.9		QL87YC	0.8
58820, 58880	7.5		RJ14YC	0.9
58821, 58881	7.5		RJ14YC	0.9
58850, 58891	7.5		RJ14YC	0.9
58870, 59440, 59480	7.0		RJ14YC	0.8
58882, 58890	7.5		RJ14YC	0.9
58960, 58961, 59520	5.0		RJ14YC	0.8
58962, 58990	5.0		RJ14YC	0.9
58970, 58971	4.8		RJ14YC	0.9
58991, 58992	5.0		RJ14YC	0.9
59310, 59311	5.0		RJ14YC	0.9
59430, 59431, 59432	5.5		RJ14YC	0.9
59460, 59461, 59462	4.5		RJ14YC	0.9
59463, 59564	4.5		RJ14YC	0.9
59490, 586110	7.5		RJ14YC	0.9
59491, 585910	7.5		RJ14YC	0.9
59671, 59672	5.0		RJ12C	0.9
59673, 59680	5.0		RJ14YC	0.9
6001, 60000	3.6		RH12	0.8
6003, 60020, 60030	3.5		RH12	0.8
6004, 6005, 60060, 59433, 59980, 585710	6.0		RH12	0.8
60070, 60090, 60100	7.5		RH12	0.8
6008, 6010, 6012	7.5		RH12	0.8
6013, 60140, 60150	14.1		RJ12C	1.0
6033, 6035	27.7		RJ12C	1.0
6037, 6038, 60340, 60360	28.0		RJ12C	1.0
60370, 60380	28.0		RJ12C	1.0
6044, 6045, 6050, 6051	43.7		RJ12C	1.0
60540, 60550	45.0		RJ12C	1.0

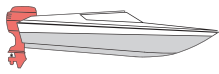

CC

BHP

POWER  
SPORT**...SEARS**

6056, 6057, 6058	45.0			RJ12C		1.0
6070, 6071	75.2			RJ12C		1.0
6076, 6077	75.2			RJ12C		1.0
6078, 60740, 60750	75.0			RJ12C		1.0
6094, 59501, 59900	3.5			CJ14		0.8
	5.0			RJ14YC		0.8

**SKIPPER**

3.0	1962→1967			RJ12C		0.9
-----	-----------	--	--	-------	--	-----

**SOLO**

55, 70	1986→			QL82C	8883	0.8
--------	-------	--	--	-------	------	-----

**SPIRIT**

2	1977→1978			L90C		0.6
2	1979→1981			L90C		0.8
3.5	1979→1981			QL87YC		0.8
4.5	1976→1977			QL86C		0.6
5	1978→1981			QL87YC		0.8
7.5				QL86C		0.6
8	1980→1981			QL87YC		0.8
9	1976→1981			QL86C		0.6
9.9	1976→1980			QL86C		0.6
16	1976→1981			QL86C		0.6
20	1979→1981			QL82C	8883	1.0
20	1976→1978			QL86C		0.6
25	1976→1981			QL82C	8883	1.0
40	1980→1981			QL78C	8883	1.0
50	1977→1981			QL78C	8883	1.0
65	1977→1981			QL78C	8883	1.0
85	1979→1981			QL78C	8883	1.0

**SPRITE**

J5				CJ14		0.8
----	--	--	--	------	--	-----

**STAR**

35	1984→			QL82C	8883	1.0
50	1984→			QL82C	8883	1.0
75	1984→			QL78C	8883	1.0
90	1984→			QL78C	8883	1.0

**SUZUKI**

DF115 4-Stroke 4-Cyl.	115	2001→2004	OE005	RC9YC		0.9
DF140 4-Stroke 4-Cyl.	140	2002→2004	OE005	RC9YC		0.9
DF15 4-Stroke 2-Cyl.	15	1997→2004		RA8HC	8810	1.0
DF25 4-Stroke 3-Cyl.	25	2000→2004		RA8HC	8810	0.8
DF30 4-Stroke 3-Cyl.	30	2000→2004		RA8HC	8810	0.8
DF4 (4-Stroke OHV)	4.0	2003→2004	OE006	RN9YC	8415	0.8
DF40 4-Stroke 3-Cyl.	40	1999→2004		RA8HC	8810	0.8
DF50 4-Stroke 3-Cyl.	50	1999→2004		RA8HC	8810	0.8
DF6 (4-Stroke OHV)	6.0	2003→2004	OE006	RN9YC	8415	0.8
DF60 4-Stroke 4-Cyl.	60	1998→2004	OE006	RN9YC	8415	1.0
DF70 4-Stroke 4-Cyl.	70	1998→2004	OE006	RN9YC	8415	1.0
DF9.9 4-Stroke 2-Cyl.	9.9	1997→2004		RA8HC	8810	1.0
DF90 4-Stroke 4-Cyl.	90	2001→2004	OE005	RC9YC		0.9
DT100 V-4	100	1989→2001		QL78C	8883	1.0
DT115 Carb. 4-Cyl.	115	1981→1997		QL78C	8883	1.0
DT115S EFI 4-Cyl.	115	1996→2001		QL78C	8883	1.0
DT140 Carb. 4-Cyl.	140	1981→1996		QL78C	8883	1.0
DT140 EFI 4-Cyl.	140	1998→2001		QL78C	8883	1.0
DT15	15	1983→1988		QL86C		0.8
DT150 Carb. V-6	150	1986→1994		QL78C	8883	1.0
DT150, DT150S EFI V-6	150	1993→2003		QL78C	8883	1.0
DT15C 2-Cyl.	15	1989→1997		QL82C	8883	1.0
DT175 V-6	175	1987→1992		QL78C	8883	1.0
DT2	2	1977→1996		L90C		0.8
DT2.2	2.2	1997→		L90C		0.8
DT20	20	1977→1988		QL82C	8883	1.0
DT200 Carb. V-6	200	1986→1993		QL78C	8883	1.0
DT200 EFI V-6	200	1986→2001		QL78C	8883	1.0

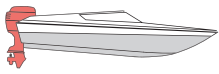

CC

BHP

POWER  
SPORT**...SUZUKI**

DT225 EFI V-6	225	1990→2003	QL78C	8883	1.0
DT25 2-Cyl.	25	1977→1987	QL82C	8883	1.0
DT25C 3-Cyl.	25	1989→2000	QL82C	8883	1.0
DT3.5	3.5	1979→1984	QL87YC		0.8
DT30C 3-Cyl.	30	1988→1997	QL82C	8883	1.0
DT35	35	1989→	QL82C	8883	1.0
DT4	4.0	1985→1998	QL87YC		0.8
DT4.5	4.5	1977→	QL86C		0.8
DT40 2-Cyl.	40	1980→1998	QL78C	8883	1.0
DT5	5	1978→1983	QL87YC		0.8
DT50	50	1977→1984	QL78C	8883	1.0
DT55 3-Cyl.	55	1985→1997	QL78C	8883	1.0
DT5Y	5	1999→2001	QL82YC	8814	1.0
DT6 2 Cyl.	6.0	1984→1985	QL87YC		0.8
	6.0	1986→2002	QL87YC		1.0
DT60	60	1983→1984	QL78C	8883	1.0
DT65 2-Cyl.	65	1978→1982	QL78C	8883	1.0
DT65 3-Cyl.	65	1985→1997	QL78C	8883	1.0
DT7.5	7.5	1977→1979	QL86C		0.8
DT75 3-Cyl.	75	1983→1997	QL78C	8883	1.0
DT8 2-Cyl.	8.0	1980→1987	QL87YC		0.8
DT85 3-Cyl.	85	1979→1995	QL78C	8883	0.9
	85	1996→2000	QL78C	8883	1.0
DT8C (Sail) 2-Cyl.	8.0	1988→1997	QL87YC		0.8
DT9	9.9	1977→1982	QL86C		0.8
	9.9	1983→1987	QL86C		0.8
DT9.9C (Sail) 2-Cyl.	9.9	1977→1997	QL86C		0.8
DT9.9C 2-Cyl.	9.9	1988→1997	QL82C	8883	0.8
DT90 V-4	90	1989→1997	QL78C	8883	1.0
Jet	35	1989→	QL78C	8883	1.0
	40	1995→1996	QL78C	8883	1.0
	55	1995→1997	QL78C	8883	1.0
	60	1989→	QL78C	8883	1.0
	85	1995→1997	QL78C	8883	1.0
	100	1989→1991	QL78C	8883	1.0
Jet EFI 4-Cyl.	140	1997→	QL78C	8883	1.0
T16	16	1977→1982	QL86C		0.8

**TANAKA**

Bumble Bee		1992→	RDJ6J		0.6
TOB-120, 120B, 120C	1.2	1982→1997	RCJ8		0.6
TOB-150	1.5		RCJ8		0.6
TOB-175	1.75	1982→1991	RCJ8		0.6
TOB-25	2.5	1973→1979	RCJ8		0.6
TOB-300	3.0	1982→1999	RCJ8		0.6
TOB-550, 550L	5.5	1984→1987	QL82YC	8814	0.6

**TAS (→ Tanaka)****TERRY TROLLER**

T4T			RJ12C		0.6
T5T			RH12		0.6

**TOHATSU**

B13B, B9B	5-8		QL86C		0.8
B18C, B18D	9.8-12		QL86C		0.8
B40A, B30C	20-25		QL86C		1.0
M115A, M115A2 4-Cyl.	115		QL78C	8883	1.0
M120A 4-Cyl.	120		QL78C	8883	1.0
M12B	12		QL82C	8883	0.8
M13 2-Cyl.	13		QL82C	8883	0.8
M140A, M140A2 4 Cyl.	140		QL78C	8883	1.0
M15A, M15B2, C 2-Cyl.	15		QL82C	8883	0.8
M15D2	15		QL82YC	8814	0.8
M16	16		QL82C	8883	0.8
M18A, M18C2, D 2-Cyl.	18		QL82C	8883	0.8
M18E2	18		QL82YC	8814	0.8
M2.5A	2.5	1980→2003	QL87YC		0.8
M20	20		QL82C	8883	0.8

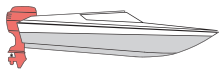

CC

BHP

POWER  
SPORT**...TOHATSU**

M25C, M25C2, M25C3 2-Cyl.	25		QL82C	8883	1.0
M3.5A, M3.5B	3.5		QL87YC		0.8
M30A, M30A3, M30A4 2-Cyl.	30		QL82C	8883	1.0
M35A	35		QL82YC	8814	1.0
M40C 2-Cyl.	40		QL87YC		1.0
M40D, M40D2 3-Cyl.	40		QL82C	8883	1.0
M50C, M50D, M50D2 3-Cyl.	50		QL78C	8883	1.0
M55A 3-Cyl.	55		QL78C	8883	1.0
M5B, M5BS	5		QL82YC	8814	0.8
M60A, B 3-Cyl.	60		QL78C	8883	1.0
M70A, M70A2, B, C 3-Cyl.	70		QL78C	8883	1.0
M8A, M8B 2-Cyl.	8		RL95YC		0.8
M9.8B 2-Cyl.	9.8		QL82YC	8814	1.0
M9.9B2, C 2-Cyl.	9.9		QL82C	8883	0.8
M90A 3-Cyl.	90		QL78C	8883	1.0
MFS15A 2-Cyl. OHV	15	2000→2003	RA8HC	8810	0.6
MFS4A 1-Cyl. OHV	4	2002→2003	RA8HC	8810	0.6
MFS5A, M5C 1-Cyl. OHV	5	1999→2003	RA8HC	8810	0.6
MFS9.9A 2-Cyl. OHV	9.9	2000→2003	RA8HC	8810	0.6

**TOMOS**

4, 5	OE059	L92YC	0.8
------	-------	-------	-----

**TRITON**

4, 5.5, 7.5		RJ12YC	0.8
-------------	--	--------	-----

**VIKING**

All models except 9 h.p.

		RJ12C	1.0
3.5	1965→1971	RH12	0.8
6	1965→1971	RH12	0.8
9	1965→	RH12	0.8
9.2	1966→1970	RJ12C	0.8
9.6	1968→1971	QL82C	8883
15	1965→1971	RH12	0.8
20	1968→1971	QL82C	8883
20, 35, 50		RJ12C	1.0
35	1968→1971	QL82C	8883
55	1968→1971	QL82C	8883

**VOLVO PENTA**

39	1975→1979	QL82C	8883	1.0
51	1975→1979	QL82C	8883	1.0
60	1978→1979	QL82C	8883	1.0
90	1975→1979	QL86C		1.0
140	1975→1979	QL86C		1.0
200	1976→1979	QL78C	8883	1.0
250	1975→	QL78C	8883	1.0
252		QL82YC	8814	1.0
350	1975→1976	QL78C	8883	1.0
450	1975→1976	QL78C	8883	1.0
600	1975→1976	QL78C	8883	1.0
700	1975→1979	QL78C	8883	1.0
35, 39, 40, 50, 50a, 360		QL82C	8883	1.0
450, 550X		QL78C	8883	1.0
600, 700		QL78C	8883	1.0
80, 90, 120, 140		QL86C		1.0
U22		QL82C	8883	1.0

**VOYAGER**

1VA, 2VA, 1VB, V2L, V4GS, V2LL, V2N		RD16		0.8
V3LGS, V3NGS, V4NGS, V3LLGS, V4LLGS		RJ12C		0.8
V6LLGS, V6NGS		RJ12C		0.8
3, 5	1961→	RJ12C		0.8

**VOYAGEUR (→ Fiat-Nautica)****WARDS (→ Sea-King)**

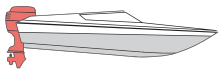

CC

BHP

POWER  
SPORT**WEST BEND**

2	1950→1961	RH12	0.8
3.5	1962→1965	RH12	0.8
6	1961→	RH12	0.8
6	1963→1965	RH12	0.8
7.5	1956→1963	RH12	0.8
8	1960→	RH12	0.8
9	1962→1965	RH12	0.8
10	1962→1965	RH12	1.0
12	1958→1963	RH12	1.0
16	1958→1960	RH12	1.0
18	1960→1962	RJ12C	1.0
20	1961→1965	RJ12C	1.0
25	1956→1963	RH12	1.0
30	1956→1963	RH12	1.0
35	1958→1960	RH12	1.0
35	1964→1965	RJ12C	1.0
40	1958→1960	RH12	1.0
40	1961→1962	RJ12C	1.0
45	1961→1965	RJ12C	1.0
50	1964→1965	RJ12C	1.0
80	1961→1965	RJ12C	1.0

**WESTERN AUTO (→ Wizard)****WHITE AUTO STORES (Seahawk)**

4.5, 5.5	1975→	RJ14YC	0.8
5, 7, 7.5	1972→1974	RJ14YC	0.8
7.5	1975→	RJ14YC	0.8
9.9, 15	1972→1974	RJ14YC	1.0

**WHITEHEAD (→ Fiat-Nautica)****WITJO**

3, 5	1961→	RJ12C	0.8
------	-------	-------	-----

**WIZARD**

OC1575, OC1585	15	RH12	0.8
OC3585	35	RD16	1.0
OC575, OC585	5.5	RJ12C	0.8
WA25, WA25E	25	RJ12C	1.0
WD3, WD3S	3.2	RJ12C	0.8
WD4, WD4S	6	RJ12C	0.8
WF4, WG4	6	RJ12C	0.8
WF7, WG7	10	RJ12C	1.0
WH6, WH6-1, WH6A	5	RJ12C	0.8
WH7, WG7A, WJ7	10	RJ12C	1.0
WK7, WM7, WM7A	10	RJ12C	1.0
WN7, WN7A	12	RJ12C	1.0
	3.0, 5.5	RJ14YC	0.8
	3.5	RH12	0.8
	3.5, 5, 7	RJ14YC	0.8
	3.5, 6	RH12	0.8
	4.5, 5.5	RJ14YC	0.8
	5	RJ12C	0.8
	5.0, 5.5	RJ14YC	0.8
	6	RH12	0.8
	7	RJ14YC	0.8
	7.5	RJ14YC	0.8
	7.5, 10	RH12	0.8
	7.5, 9.9	RJ14YC	0.8
	7.5, 9.9	RJ14YC	0.8
	7.5, 9.9	RJ14YC	0.8
	9	RH12	0.8
	9.2	RJ12C	0.8
	9.9	RJ14YC	0.8
	12, 14, 25	RJ12C	1.0
	20	QL82C	8883 1.0
	20	RJ12C	1.0
	40, 60	RJ12C	1.0

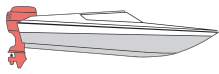

CC

BHP

POWER  
SPORT**YAMAHA**

	CC	BHP	21		POWER SPORT	mm	
20		20	1996 → 1997		QL82C	8883	1.0
30		30	1984 → 2002		QL82C	8883	1.0
40		40	1984 → 2004		QL82C	8883	1.0
70		70	1984 → 2004		QL78C	8883	1.0
140	Jet Drive	200	1987 → 1995		QL78C	8883	1.0
150		150	1984 → 1995		QL78C	8883	1.0
115, P115, 115SW		115	1984 → 2005		QL78C	8883	1.0
130, 130SW		130	1989 → 2002		QL78C	8883	1.0
15 (2-Stroke)		15	1984 → 2004		QL82C	8883	1.0
150 VMAX		150	1997 → 2002		QL78C	8883	1.0
150, L150, 150SW, P150 (Carb)		150	1996 → 2004		QL82C	8883	1.0
150SW, P150 (EFI)		150	1999 → 2005		QL82C	8883	1.0
175 VMAX		175	1992 → 2002		QL78C	8883	1.0
175, 175SW		175	1984 → 2000		QL78C	8883	1.0
200 VMAX		200	1991 → 2005		QL78C	8883	1.0
200, 200SW (Carb. & EFI)		200	2000 → 2005		QL78C	8883	1.0
225 EFI V76, SW, VMAX		225	1998 → 2005		QL77JC4	8883	1.0
225, 225SW, L225, 3.1L, V76X		225	1994 → 1999		QL77JC4	8883	1.0
225, V6 Excel, 2.1L 90 Degree V6		225	1987 → 1999		QL78C	8883	1.0
25 2-Cyl. (2-Stroke)		25	1984 → 2004		QL82C	8883	1.0
25 3-Cyl. (2-Stroke)		25	1984 → 2004		QL82C	8883	1.0
250 EFI V76, SW, VMAX		250	1998 → 1999		QL77JC4	8883	1.0
250, 250SW, L250		250	1990 → 1999		QL78C	8883	1.0
2-cyl. (2-Stroke)		8	1986 → 2004		L90C		0.6
2-cyl. (2-Stroke)		9	1984 → 2004		L90C		0.6
50, Pro		50	1984 → 1997		QL78C	8883	1.0
9.9 (2-Stroke)		9.9	1984 → 2004		QL82C	8883	1.0
B115 Inshore		115	1984 → 1999		QL78C	8883	1.0
B90, C90		90	1984 → 2004		QL78C	8883	1.0
C130, S130		130	1994 → 2003		QL77JC4	8883	1.0
C70	C Line	70	2000 →		QL78C	8883	1.0
D150 (Carb.)		150	1998 → 1999		QL82C	8883	1.0
D150 (EFI)		150	1999 →		QL82C	8883	1.0
DX150 (EFI)		150	1999 → 2003		QL82C	8883	1.0
F100 (4-Stroke)		100	1999 → 2002	OE148	REC10YC4		1.1
F115, LF115 (EFI) (4-Stroke)		115	2000 → 2005	OE148	REC10YC4		1.1
F15 (4-Stroke)		15	1999 → 2005		RA8HC	8810	1.0
F150, LF150 (4-Stroke)		150	2004 → 2005	OE148	REC10YC4		1.1
F2.5 (4-Stroke)		2.5	2003 → 2005		QL86C		0.8
F200 (4-Stroke)		200	2002 → 2005	OE148	REC10YC4		1.1
F225 (EFI)		225	2002 → 2005	OE148	REC10YC4		1.1
F25, T25 (4-Stroke)		25	1998 → 2005		RA8HC	8810	0.9
F250 (EFI)		250	2005 →	OE148	REC10YC4		1.1
F30 (4-Stroke)		30	2001 → 2005		RA8HC	8810	0.9
F4 (4-Stroke)		4	1999 → 2005		QL86C		0.6
F40 (4-Stroke)		40	1999 → 2005		RA8HC	8810	1.0
F50, T50 (4-Stroke)		50	1995 → 2005		RA8HC	8810	1.0
F6 (4-Stroke)		6	1986 → 2005		QL82C	8883	1.0
F60, T60 (4-Stroke)		60	2002 → 2005		RA8HC	8810	1.0
F75 (4-Stroke)		75	2003 → 2005	OE148	REC10YC4		1.1
F8, T8 (4-Stroke)		8	2001 → 2005		QL82C	8883	1.0
F80 (4-Stroke)		80	1999 → 2002	OE148	REC10YC4		1.1
F9.9, T9.9 (4-Stroke)		9.9	1985 → 2005		Z9Y		0.6
F90 (4-Stroke)		90	2003 → 2005	OE148	REC10YC4		1.1
L130		130	1989 → 2002		QL78C	8883	1.0
L150, 150SW		150	1986 → 1995		QL78C	8883	1.0
L200		200	1986 → 1998		QL78C	8883	1.0
L225, LX225 (EFI)		225	2000 → 2002		QL77JC4	8883	1.0
L250, LX250 (EFI)		250	1998 → 2002		QL77JC4	8883	1.0
LX150 (EFI)		150	1999 → 2003		QL78C	8883	0.6
LX200 (EFI)		200	1999 → 2000		QL78C	8883	1.0
LZ150 (MPDI)		150	2000 → 2004	OE013	RC12YC	8071	1.1
LZ200 (MPDI)		200	2000 → 2004	OE039	RC9YC4		1.0
P175		175	1994 → 1996		QL78C	8883	1.0
Pro 50		50	1987 → 1996		QL78C	8883	1.0
Pro 60		60	1991 → 1999		QL78C	8883	1.0
Pro 75		75	1996 → 1999		QL78C	8883	1.0
Pro V 150, P150		150	1986 → 1998		QL78C	8883	1.0
PX150 (EFI)		150	1999 →		QL78C	8883	0.6

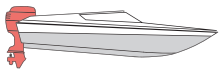

CC

BHP

21

POWER  
SPORT**...YAMAHA**

S225, SX225 (EFI)	225	2000→2002		QL77JC4	8883	1.0
S250, SX250 (EFI)	250	1998→2002		QL77JC4	8883	1.0
SX150 (EFI)	150	1999→2003		QL78C	8883	0.6
SX200 (EFI)	200	1999→2000		QL78C	8883	1.0
V150 V6 - 2.6L	150	2004→		QL82C	8883	1.0
V-6 Special	220	1984→1986		QL78C	8883	1.0
VX150 (EFI)	150	2000→	OE013	RC12YC	8071	1.1
VX200 (EFI)	200	2000→2004		QL78C	8883	1.0
VX225 (EFI)	225	2000→2004		QL77JC4	8883	1.0
VX250	250	2004→		QL77JC4	8883	1.0
VX250, V Max EFI OX66	250	2002→2005		QL77JC4	8883	1.0
VZ150 (EFI)	150	2000→2004	OE013	RC12YC	8071	1.1
VZ200	200	2004→	OE005	RC9YC		1.0
VZ225	225	2003→2004	OE013	RC12YC	8071	1.0
Z150 (MPDI)	150	2000→2004	OE013	RC12YC	8071	1.1
Z175, VZ175 (HPDI)	175	2001→2004	OE005	RC9YC		1.0
Z200 (MPDI)	200	2000→2004	OE039	RC9YC4		1.0
Z250, LZ250, VZ250	250	2002→2004	OE013	RC12YC	8071	1.0
Z300, LZ300, VZ300	300	2004→	OE013	RC12YC	8071	1.0
	2	1984→2002		L90C		0.6
	3	1988→2002		QL86C		1.0
	4	1984→1999		QL86C		0.6
	5	1984→2002		QL82C	8883	0.6

**ZUNDAPP**

	5			QL86C		0.6
--	---	--	--	-------	--	-----





CC

BHP

21

POWER  
SPORT

mm

**ALMAR**

Chevrolet 350 & 454 cid			7.5			RV12YC	8018	1.0
Chevrolet 4.3L			5		*	RV15YC4	8018	1.0
Ford 302, 351 & 460 cid			9			RV12YC	8018	1.0
Ford 351 cid Mag & HO	850					RS12YC	8401	1.0
OMC Turbojet 115			4			QL77JC4	8883	0.8

**ARMADA**

Wild One	Mercury Sportjet 120XR	1250				QL77JC4	8883	1.0
----------	------------------------	------	--	--	--	---------	------	-----

**AVON**

3.46 Jet R.I.B.	Yamaha		60			QL78C	8883	1.0
SE 320 Jet	Yamaha		83			QL78C	8883	1.0
SE 320 Jet dl	Yamaha		83			QL78C	8883	1.0
SE 400 Jet dl	Yamaha		83			QL78C	8883	1.0

**BAJA**

Blast/Splash	Mercury Sportjet 120XR	1235				QL77JC4	8883	1.0
	Mercury Sportjet 90	1235				QL77JC4	8883	1.0
	Mercury Sportjet 95XR	1235				QL77JC4	8883	1.0

**BAYLINER**

Jazz	Mercury Sportjet 175XR2					QL77JC4	8883	1.0
Jazz/Reflexx	Mercury Sportjet 120XR					QL77JC4	8883	1.0
	Mercury Sportjet 90					QL77JC4	8883	1.0

**BAYSTALKER**

Twinjet	3-Cyl.	300	70			QL78C	8883	0.6
---------	--------	-----	----	--	--	-------	------	-----

**BLADE**

Nomad		440	115			QL77JC4	8883	0.8
		400	70			QL78C	8883	0.6

**BLUE-FIN**

Wave	Mercury Sportjet 90	550				QL77JC4	8883	1.0
------	---------------------	-----	--	--	--	---------	------	-----

**BOSTON WHALER**

Range 14 & 15	OMC Turbojet 115	650				QL77JC4	8883	0.8
Range 18	Redline 302 cid	744				RV12YC	8018	1.0
	Redline 351 cid HO	750				RS12YC	8401	1.0

**BUCCANEER**

Splash	Mercury Sportjet 120XR	782				QL77JC4	8883	1.0
	Mercury Sportjet 90	750				QL77JC4	8883	1.0
	OMC Turbojet 115	891				QL77JC4	8883	0.8

**CARIBE**

	Mercury Sportjet 120XR	900				QL77JC4	8883	1.0
	Mercury Sportjet 90	899				QL77JC4	8883	1.0

**CHECKMATE**

Playmate/Sport	Mercury Sportjet 120XR	900				QL77JC4	8883	1.0
	Mercury Sportjet 175XR2	1071				QL77JC4	8883	1.0
	Mercury Sportjet 90	900				QL77JC4	8883	1.0

**CLASSIC JET CRAFT**

	Mercury Sportjet 90	1100				QL77JC4	8883	1.0
--	---------------------	------	--	--	--	---------	------	-----

**CUTTER**

Craze	Mercury Sportjet 120XR	1100				QL77JC4	8883	1.0
	Mercury Sportjet 175XR2	1100				QL77JC4	8883	1.0
	Mercury Sportjet 95	1100				QL77JC4	8883	1.0

**DELTA JET**

	Mercury Sportjet 120XR	1100				QL77JC4	8883	1.0
	Mercury Sportjet 175XR2	1176				QL77JC4	8883	1.0

**DONZI**

Medallion	Mercury Sportjet 120XR	1176				QL77JC4	8883	1.0
	Mercury Sportjet 90	1176				QL77JC4	8883	1.0

\* Leaded fuel use RV8C



CC

BHP

21

POWER  
SPORT**DORAL TOP**

Splash	Mercury Sportjet 120XR	1500			QL77JC4	8883	1.0
	Mercury Sportjet 95XR	1199			QL77JC4	8883	1.0

**DYNASTY**

Assault	Mercury Sportjet 175XR2				QL77JC4	8883	1.0
Cyclone	Mercury Sportjet 120XR				QL77JC4	8883	1.0
	Mercury Sportjet 175XR2	650			QL77JC4	8883	1.0
Jet Storm	Mercury Sportjet 120XR	700			QL77JC4	8883	1.0
	Mercury Sportjet 175XR2	700			QL77JC4	8883	1.0
	Mercury Sportjet 90	700			QL77JC4	8883	1.0
Spree	Mercury Sportjet 120XR	700			QL77JC4	8883	1.0
	Mercury Sportjet 175XR2	700			QL77JC4	8883	1.0

**E-1 SPLASH**

Tohatsu	750	70			QL78C	8883	1.0
---------	-----	----	--	--	-------	------	-----

**EKLER WATERSPORTS**

Jet'n Spray	Yamaha	650			QL78C	8883	0.6
	Yamaha	700			QL78C	8883	0.6

**ELIMINATOR**

Chevy 454 cid	777				RV12YC	8018	1.0
---------------	-----	--	--	--	--------	------	-----

**EMERALD BAY**

Banshee XS		777	50		OE091	RN2C	8904	1.0
		779	80		OE091	RN2C	8904	1.0

**EPIC PERFORMANCE**

Sport Jet	Mercury Sportjet 120XR	900			QL77JC4	8883	1.0
	Mercury Sportjet 90	780			QL77JC4	8883	1.0

**EUROLINE**

Cyclone	Indmar 350 cid	1050	270		RV12YC	8018	1.1
	Mercury Sportjet 120XR	1165			QL77JC4	8883	1.0
	Mercury Sportjet 175XR2	1165			QL77JC4	8883	1.0
	Mercury Sportjet 90	1165			QL77JC4	8883	1.0
	Mercury Sportjet 95XR	1165			QL77JC4	8883	1.0
	OMC Turbojet 115		7.5		QL77JC4	8883	0.8
Cyclone Sport	Mercury Sportjet 120XR	1165			QL77JC4	8883	1.0
	Mercury Sportjet 175XR2	1192			QL77JC4	8883	1.0
	Mercury Sportjet 95XR	1165			QL77JC4	8883	1.0
Twister	Mercury Sportjet 175XR2		8		QL77JC4	8883	1.0

**EXOTIC MARINE**

Panther 16V	Mercury Sportjet 120XR		9		QL77JC4	8883	1.0
-------------	------------------------	--	---	--	---------	------	-----

**FORESTER**

Splash	Mercury Sportjet 90	580			QL77JC4	8883	1.0
--------	---------------------	-----	--	--	---------	------	-----

**FOUR WINNS**

Fling	OMC Turbojet 115	650			QL77JC4	8883	0.8
	OMC Turbojet 90	650			QL77JC4	8883	0.8

**FUN JET**

3-Cyl.	718	70			QL78C	8883	1.0
--------	-----	----	--	--	-------	------	-----

**GREEN HERON BOAT WORKS**

Jet Skiff	Mercury Sportjet 90	718			QL77JC4	8883	1.0
-----------	---------------------	-----	--	--	---------	------	-----

**HOBIE**

915S	Mercury Sportjet 90	718			QL77JC4	8883	1.0
	Mercury Sportjet 95XR	782			QL77JC4	8883	1.0
Jet 15	Mercury Sportjet 90	782			QL77JC4	8883	1.0

**HOBLE**

Power Skiff	Mercury Sportjet 90	785			QL77JC4	8883	1.0
-------------	---------------------	-----	--	--	---------	------	-----

**HOVER AIR AMERICA**

Slingshot		951	50		OE091	RN2C	8904	1.0
-----------	--	-----	----	--	-------	------	------	-----

\* Leaded fuel use RV8C



CC

BHP

21

POWER  
SPORT

mm

**HUMBOLT MARINE SERVICES**

Falcon	OMC Turbojet 115	951			QL77JC4	8883	0.8
Jet Sled	Mercury Sportjet 90	951			QL77JC4	8883	1.0

**HYDROFORCE**

	Mercury Sportjet 120XR	951			QL77JC4	8883	1.0
	Mercury Sportjet 90	951			QL77JC4	8883	1.0

**JET NAUTICA**

Smuggler	Mercury Sportjet 120XR	1494			QL77JC4	8883	1.0
	Mercury Sportjet 90	1494			QL77JC4	8883	1.0

**JET SKATE**

	Brute	1494	50	OE108	RN3C	8904	0.9
--	-------	------	----	-------	------	------	-----

**JET SPORT**

Cyclone	Mercury Sportjet 120XR		60		QL77JC4	8883	0.8
	Mercury Sportjet 90		55		QL77JC4	8883	0.8
Spree/Storm	Mercury Sportjet 120XR		60		QL77JC4	8883	0.8
	Mercury Sportjet 90		55		QL77JC4	8883	0.8

**JET STAR**

	Suzuki		65		QL82C	8883	0.8
--	--------	--	----	--	-------	------	-----

**JET-N-SPRAY**

650XL/650XTC	Yamaha Twin	951	50		QL78C	8883	1.0
	Yamaha Twin	951	63		QL78C	8883	1.0

**JET-SLED**

	OMC Turbojet 115	1494			QL77JC4	8883	0.8
--	------------------	------	--	--	---------	------	-----

**KLAMATH**

XL JET 17	OMC Turbojet 115		70		QL77JC4	8883	1.0
-----------	------------------	--	----	--	---------	------	-----

**MARLIN**

Marlin 150	Mercury Sportjet 120XR		70		QL77JC4	8883	1.0
------------	------------------------	--	----	--	---------	------	-----

**MASSEY INDUSTRIES**

Cruise 20	Mercuriser 5.7 EFI Alpha		75	*	RV91MC		1.0
E-1 Twin Jet	Mercury Sportjet 120XR		75		QL77JC4	8883	1.0
	Mercury Sportjet 90		75		QL77JC4	8883	1.0

**MID-JET**

Marauder	Mercury Sportjet 120XR	644			QL77JC4	8883	1.0
	Mercury Sportjet 90	639			QL77JC4	8883	1.0

**NAUTICA**

Rib Jet	Mercury Sportjet 120XR	785			QL77JC4	8883	1.0
	Mercury Sportjet 175XR2	896			QL77JC4	8883	1.0
	Mercury Sportjet 90	768			QL77JC4	8883	1.0
Rib Jet Yamaha		1000	80		QL77JC4	8883	1.0

**NORTH RIVER**

	Mercuriser 5.7L Alpha	1100		*	RV91MC		1.0
--	-----------------------	------	--	---	--------	--	-----

**NORTHSTAR**

	Mercury Sportjet 120XR	789			QL77JC4	8883	1.0
	Mercury Sportjet 175XR2	789			QL77JC4	8883	1.0
	Mercury Sportjet 90	1100			QL77JC4	8883	1.0
	Mercury Sportjet 95XR	1100			QL77JC4	8883	1.0
	OMC Turbojet 115		120		QL77JC4	8883	0.8
	OMC Turbojet 90	1231			QL77JC4	8883	0.8
	Twin OMC Turbojet 115		120		QL77JC4	8883	0.8

**NOVURANIA**

Jet 230	OMC Turbojet 115	428			QL77JC4	8883	0.8
	OMC Turbojet 90		125		QL77JC4	8883	0.8

**NU-WAVE**

Sidewinder	Mercury Sportjet 120XR	432			QL77JC4	8883	1.0
	Mercury Sportjet 90	428			QL77JC4	8883	1.0
	Mercury Sportjet 95XR	432			QL77JC4	8883	1.0

\* Leaded fuel use RV8C



CC

BHP

21

POWER  
SPORT**PERFORMANCE JET SYSTEMS**

Viper 5000		432	50		OE091	RN2C	8904	0.6
Viper 6000		432	60		OE091	RN2C	8904	0.6
Viper 7000HT		432	70		OE091	RN2C	8904	0.6
Viper 8000HT		432	80		OE091	RN2C	8904	0.6
Viper 9000HT		701	90		OE091	RN2C	8904	0.6

**PLAY CRAFT**

Screamer	Mercury Sportjet 120XR					QL77JC4	8883	1.0
	Mercury Sportjet 90	701				QL77JC4	8883	1.0

**PRO-LINE**

Stalker 153	Mercury Sportjet 90					QL77JC4	8883	1.0
-------------	---------------------	--	--	--	--	---------	------	-----

**REGAL**

Rush	Mercury Sportjet 120XR	500				QL77JC4	8883	1.0
	Mercury Sportjet 90	500				QL77JC4	8883	1.0
Rush XR2	Mercury Sportjet 175XR2	650				QL77JC4	8883	1.0

**RENKEN**

Rascal	Mercury Sportjet 120XR	650				QL77JC4	8883	1.0
--------	------------------------	-----	--	--	--	---------	------	-----

**REVMASTER MARINE**

Jet Star	Mercury Sportjet 120XR	650				QL77JC4	8883	1.0
	Mercury Sportjet 90	650				QL77JC4	8883	1.0

**RICHLINE**

RW 175 SJ	Mercury Sportjet 120XR	700				QL77JC4	8883	1.0
	Mercury Sportjet 90	700				QL77JC4	8883	1.0
RW 186 SJ	Mercury Sportjet 120XR	700				QL77JC4	8883	1.0
	Mercury Sportjet 90	700				QL77JC4	8883	1.0

**RINKER**

Eracer	Mercury Sportjet 120XR	700				QL77JC4	8883	1.0
Rocket	Mercury Sportjet 120XR	700				QL77JC4	8883	1.0

**SCARAB**

19 Jet	Mercuriser 4.3L	700			*	RV15YC4	8018	0.9
--------	-----------------	-----	--	--	---	---------	------	-----

**SEA RAY**

Sea Rayder/F14	Mercury Sportjet 120XR		43.7			QL77JC4	8883	1.0
	Mercury Sportjet 90		40			QL77JC4	8883	1.0
Sea Rayder/F16	Mercury Sportjet 120XR		45			QL77JC4	8883	1.0
	Mercury Sportjet 90		45			QL77JC4	8883	1.0
Sea Rayder/F16XR	Mercury Sportjet 175XR2		60			QL77JC4	8883	1.0

**SEA SKATE**

	2Si		25		OE108	RN3C	8904	0.9
	2Si		50		OE108	RN3C	8904	0.9
	2Si		70		OE108	RN3C	8904	0.9
	Brute		50		OE091	RN2C	8904	0.9

**SEA SPRITE**

1300/1600	Mercury Sportjet 120XR		1.2			QL77JC4	8883	1.0
	Mercury Sportjet 90		2.2			QL77JC4	8883	1.0

**SEA-DOO**

1998 Challenger	Rotax Twin	760	85		OE091	RN2C	8904	0.6
1998 Sportster	Rotax	1200	85		OE091	RN2C	8904	0.6
Challenger	Rotax Twin	700	101		OE091	RN2C	8904	0.6
	Rotax Twin	800	85		OE091	RN2C	8904	1.0
Challenger 1800	Mercury EFI	760	240			QL78C	8883	0.6
	Mercury M2	760	210			L76V		
	Rotax Twin	760	110		OE091	RN2C	8904	0.6
	Rotax Twin	760	85		OE091	RN2C	8904	0.6
Challenger 2000	Mercury EFI	800	240			QL78C	8883	0.6
	Mercury M2	800	210			L76V		
Explorer	Rotax Twin	1000	72		OE091	RN2C	8904	0.6
Islandia	Mercury EFI	1100	240			QL78C	8883	0.6
	Mercury M2	1000	210			L76V		
Speedster	Rotax Twin	1200	110		OE091	RN2C	8904	0.6

\* Leaded fuel use RV8C



CC

BHP

21

POWER  
SPORT**...SEA-DOO**

Speedster SK	Mercury EFI	1100	240		QL78C	8883	0.6
	Mercury M2	1100	210		L76V		
Sportster	Rotax Twin	1200	85		OE091 RN2C	8904	0.6
	Rotax Twin	1200	85		OE091 RN2C	8904	0.6
Sportster 1800	Mercury M2	1200	210		L76V		
	Rotax Twin	1200	85		OE091 RN2C	8904	0.6
Utopia 185	Mercury M2	1200	200		OE013 RC12YC	8071	1.0
	Mercury M2	1300	210		L76V		
	Mercury M2		250		OE013 RC12YC	8071	1.0
Utopia 205	Mercury M2 EFI		240		QL78C	8883	1.0
	Mercury M2		200		OE013 RC12YC	8071	1.0
	Mercury M2		210		L76V		
	Mercury M2		250		OE013 RC12YC	8071	1.0
X-20	Mercury M2 EFI		240		QL78C	8883	1.0
	Mercury M2		250		OE013 RC12YC	8071	1.0
	Mercury M2 EFI		240		QL78C	8883	1.0

**SEA-PRO**

Renegade	Mercury Sportjet 120XR		40		QL77JC4	8883	1.0
	Mercury Sportjet 90		40		QL77JC4	8883	1.0

**SEASWIRL**

Squirt	OMC Turbojet 115		1.6		QL77JC4	8883	0.8
--------	------------------	--	-----	--	---------	------	-----

**SHOCKWAVE**

Zoom	OMC Turbojet 115		2.5		QL77JC4	8883	0.8
------	------------------	--	-----	--	---------	------	-----

**SOS EXPRESS**

Jet Express	Yamaha		70		QL78C	8883	0.6
-------------	--------	--	----	--	-------	------	-----

**SPRINT**

Sprint 17	302 cid Redline		3.0		RV12YC	8018	1.0
	350 cid Redline		3.0		OE013 RC12YC	8071	1.0

**STARBUCK BOATS**

	Chevrolet 350 cid		3.0	*	RV91MC		1.0
	Chevrolet 454 cid		3.5		RV12YC	8018	1.0

**SUGAR SAND**

4 + 2	Mercury Sportjet 175XR2		4.0		QL77JC4	8883	1.0
Heat XR	Mercury Sportjet 95XR		4.0		QL77JC4	8883	1.0
Heat XRS	Mercury Sportjet 120XR		4.5		QL77JC4	8883	1.0
Mirage	Mercury Sportjet 120XR		5.5		QL77JC4	8883	1.0
	Mercury Sportjet 175XR2		6.0		QL77JC4	8883	1.0
	Mercury Sportjet 90		5.0		QL77JC4	8883	1.0
	Mercury Sportjet 95XR		5.0		QL77JC4	8883	1.0
Tango	Mercury Sportjet 175XR2		7.0		QL77JC4	8883	1.0

**SUNBIRD**

Sizzler	OMC Turbojet 115		7.0		QL77JC4	8883	0.8
---------	------------------	--	-----	--	---------	------	-----

**SUNRAY**

Shadow	Mercury Sportjet 120XR		7.5		QL77JC4	8883	1.0
	Mercury Sportjet 90		7.0		QL77JC4	8883	1.0

**TENDER JET**

	Mercury Sportjet 175XR2		9.5		QL77JC4	8883	1.0
	Mercury Sportjet 95XR		9.9		QL77JC4	8883	1.0

**TRACKER**

Pro 18 Jet	Mercury Sportjet 90		14		QL77JC4	8883	1.0
------------	---------------------	--	----	--	---------	------	-----

**TRULINE**

Screamer	Mercury Sportjet 120XR				QL77JC4	8883	1.0
	Mercury Sportjet 90		15		QL77JC4	8883	1.0

**TWO RIVERS MARINE**

RC120 18	Mercury Sportjet 120XR		2		QL77JC4	8883	1.0
RC9016	Mercury Sportjet 90				QL77JC4	8883	1.0

\* Leaded fuel use RV8C



CC

BHP

21

POWER  
SPORT**ULTRANAUTICS**

Jet Fisher 1660L Suzuki		60		QL78C	8883	0.6
Jet Fisher 1670B Tohatsu		70		QL78C	8883	0.6
Jet Star 1250, 1260 Suzuki		60		QL78C	8883	0.6
River Jet 1670 Tohatsu		70		QL78C	8883	0.6

**VORTEX (→ Indmar Under Inboard/Stern Drive)****VOYAGER MARINE**

Scratch	Mercury Sportjet 120XR	4		QL77JC4	8883	1.0
	Mercury Sportjet 175XR2	4		QL77JC4	8883	1.0

**WAVECUTTER**

GPX-950	Mercury Sportjet 120XR	4		QL77JC4	8883	1.0
	Mercury Sportjet 95XR	4		QL77JC4	8883	1.0

**WELDCRAFT (→ Panther & Redline Under Inboard/Stern Drive)****WETT VET**

	Mercury Sportjet 120XR	4		QL77JC4	8883	1.0
--	------------------------	---	--	---------	------	-----

**WHALER**

Rage 14	OMC Turbojet 90	4.5		QL77JC4	8883	0.8
Rage 15	OMC Turbojet 115	5		QL77JC4	8883	0.8

**WILSON**

	Mercury Sportjet 120XR	5		QL77JC4	8883	1.0
--	------------------------	---	--	---------	------	-----





**YAMAHA**

Exciter 135	Single EXS 1200	135		QL78C	8883	0.6
Exciter 220	Twin EXT 1100	110		QL78C	8883	0.6
Exciter 270	Twin EXT 1200	135		QL78C	8883	0.6
LS2000	Twin EXT 1200	135		QL78C	8883	0.6
LX2000	Twin	130		QL78C	8883	0.6
XR1800	Twin	155	OE091	RN2C	8904	0.6

**ZODIAC**

Projet	Yamaha Twin	50		QL78C	8883	0.6
Projet II	OMC Turbojet 115			QL77JC4	8883	0.8
Projet Maxie	OMC Turbojet 115			QL77JC4	8883	0.8

\* Leded fuel use RV8C

		CC	BHP			POWER SPORT	
<b>AQUABUG</b>							
Aquabug 120			1.2			RJ12C	0.8
Superbug 175			1.75			RJ12C	0.8
Superbug 300			3			RJ12C	0.8
<b>AQUAJET</b>							
WX-Series		1250			OE091	RN2C	8904
		850			OE091	RN2C	8904
<b>AQUASCOOTER</b>							
	JLO					L90C	0.6
<b>DOLPHIN</b>							
Mark 7 Auxiliary			12			RN5C	8339
<b>FREEDOM IND/AQUA-JET</b>							
Solution Sx1		432			OE098	RN4C	8339
<b>FUN BOATS</b>							
Pump'r			60			QL78C	8883
<b>HONDA</b>							
AquaTrax F-12, F12X, R-12X (4-Stroke)		1235		2002 → 2005		G57C	8654
AquaTrax R-12 (4-Stroke)		1235		2004 → 2005		G57C	8654
GPScape		1235		2005 →		G57C	8654
<b>HYDRO-DISC</b>							
			50		OE091	RN2C	8904
<b>JET BREEZE</b>							
Hurricane			50		OE091	RN2C	8904
<b>KAWASAKI (Jet-Ski)</b>							
1100 Zxi		1071		2003 →	OE091	RN2C	8904
1200 STX-R		1176		2002 → 2005	OE091	RN2C	8904
750 SXi Pro		744		2002 →	OE091	RN2C	8904
JB650, JF650, JL650, JS650		650		1986 → 1996	OE006	RN9YC	8415
Jet Mate					OE098	RN4C	8339
JH1100		1100		2000 → 2001	OE006	RN9YC	8415
JH1100, JT1100		1100		1996 → 1999	OE006	RN9YC	8415
JH1100-B Ultra 130 DI		1100		2001 → 2004	OE005	RC9YC	
JH1200A, B		1176		2000 → 2004	OE091	RN2C	8904
JH750, JS750, JT750		750		1992 → 1999	OE006	RN9YC	8415
JH900, JT900		900		1995 → 1999	OE006	RN9YC	8415
JS300, JS300SX		300		1986 → 1991	OE098	RN4C	8339
JS400, JS400A		400		1974 → 1976	OE098	RN4C	8339
JS440		440		1977 → 1992	OE098	RN4C	8339
JS550		550		1982 → 1995	OE006	RN9YC	8415
JS750		750		1998 → 2002	OE006	RN9YC	8415
JS800A, SX-R		782		2003 → 2005	OE091	RN2C	8904
JT1100C, 1100DI		1100		2000 → 2001		RC12MC4	
JT1100-G STX DI		1100		2003 →	OE005	RC9YC	
JT1500 STX-15F		1500		2004 → 2005		G57C	8654
JT900		900		2000 → 2002	OE006	RN9YC	8415
JT900-B4 STS		899		2002 →	OE091	RN2C	8904
JT900-C2 STX		891		2002 →	OE091	RN2C	8904
JT900-D STX		900		2003 → 2005	OE091	RN2C	8904
STX12F (4-Stroke)		1199		2003 → 2005	OE091	RN2C	8904
Ultra 150		1176		2002 → 2005	OE091	RN2C	8904
<b>NAUTICA</b>							
	Mercury		120			QL77JC4	8883
	Mercury		90			QL77JC4	8883



CC

BHP

21

POWER  
SPORT**POLARIS**

500 + EFI				→2004		RC7PYCBX		
600 + EFI				→2004		RC7PYCBX		
700 + EFI				→2004		RC7PYCBX		
800 + EFI				→2004		RC7PYCBX		
Deluxe, Virage		700		1998→1999	OE116	RN6YC	8902	0.7
Freedom		700		2002→2004	OE116	RN6YC	8902	0.6
Genesis		1165		1999→2004	OE116	RN6YC	8902	0.7
Genesis	Ficht Fuel Inj. (FFI)	1165		1999→2004		QC10WEP		0.7
Hurricane		700		1996→1998	OE116	RN6YC	8902	0.7
MSX 110, SO Turbo (4-Stroke)		750		2003→2004	OE005	RC9YC		1.1
MSX 140	Ficht Fuel Inj.	1192		2003→2004		QC10WEP		0.7
MSX 150, HO Turbo (4-Stroke)		750		2003→2004	OE005	RC9YC		1.1
Octane (Carb.)		777		2002→2004		QN84		0.7
Pro 1200		1165		2000→2001	OE116	RN6YC	8902	0.7
Pro 785		779		1999→2000	OE091	RN2C	8904	0.7
SL-650, STD		650		1992→1995	OE018	RN7YC	8332	0.7
SL-700, SLR-700, SLH-700, SLTH-700		700		1996→2001	OE116	RN6YC	8902	0.7
SL-750, SLT-750		750		1993→1995	OE018	RN7YC	8332	0.7
SL-780, SLT-780, SLX-780		780		1996→1998	OE116	RN6YC	8902	0.7
SL-900		900		1996→1998	OE116	RN6YC	8902	0.7
SLF-1050, SLTX-750		1050		1996→1999	OE116	RN6YC	8902	0.7
SLX-1165		1165		2000→2001	OE116	RN6YC	8902	0.7
Virage		700		2000→2004	OE116	RN6YC	8902	0.6
Virage I	Ficht Fuel inj.	777		2002→2004		QC10WEP		0.7
Virage TX		1165		2000→2002	OE116	RN6YC	8902	0.7
Virage TXi	Ficht Fuel Inj.	1165		2001→2002		QC10WEP		0.7

**POWER BOARD**

Tohatsu Engs.			5			QL82C	8883	0.6
---------------	--	--	---	--	--	-------	------	-----

**POWERSKI**

Igniter 2000 Jetboard			8		OE091	RN2C	8904	0.6
-----------------------	--	--	---	--	-------	------	------	-----

**PROGRESSIVE POWER CORP.**

Formula Micro			9			RCJ8Y		0.6
---------------	--	--	---	--	--	-------	--	-----

**SEA-DOO (Bombardier)**

5852/XP		650			OE006	RN9YC	8415	0.6
GS, GSi, GTi, GTS, SP		718	65		OE006	RN9YC	8415	0.6
GSX RFI, GTX, SPX, XP		782			OE018	RN7YC	8332	0.6
GTI, GTI LE		718		2002→	OE091	RN2C	8904	0.6
GTS, GTX, SP, SPi, XP		580			OE116	RN6YC	8902	0.6
GTX		951		2002→2005	OE091	RN2C	8904	0.5
GTX 4-Tec (4-stroke)		1494		2002→2004	OE083	RA6HC	8809	0.7
GTX 4-Tec Supercharged (4-stroke)		1494		2002→2004	OE083	RA6HC	8809	0.8
GTX DI		951		2002→2004		RC12MC4		0.9
GTX LTD, GSX LTD & XP Supersport XP LTD		951			OE091	RN2C	8904	0.6
GTX RFI		782				RN4YC	8339	0.6
GTX, SPX		650			OE006	RN9YC	8415	0.6
HX, SPX, XP		718	85		OE006	RN9YC	8415	0.6
LRV DI		951	130	2002→2004		RC12MC4		0.9
RX DI		951		2002→2004		RC12MC4		0.9
RX, RXX		951		2002→	OE091	RN2C	8904	0.5
RXP Supercharged (4-Stroke)		1494		2004→2005	OE083	RA6HC	8809	0.8
RXT (4Stroke)	Rotax	1494		2005→	OE083	RA6HC	8809	0.8
XP		951		2002→	OE091	RN2C	8904	0.5
XP 785		785			OE018	RN7YC	8332	0.6
	Rotax 18mm Heads		55			RD16		0.9





**SEAFASH**

	Suzuki		55			QL82C	8883	0.8
--	--------	--	----	--	--	-------	------	-----

**SKIDADDLE**

Aquajet			60		OE098	RN4C	8339	0.8
---------	--	--	----	--	-------	------	------	-----



		CC	BHP			POWER SPORT	
<b>SKI-FREE</b>							
2-Cycle Engs.			40		OE108	RN3C	8904 0.9
<b>SKI-WHEEE</b>							
Ski Tow	Kohler K440-2LC		65		OE091	RN2C	8904 0.8
<b>SOS EXPRESS</b>							
Tide Rider	Cuyuna		45		OE108	RN3C	8904 0.9
<b>SURF-JET</b>							
Fuji/Subaru Engs.		260	15			QL82C	8883 0.6
<b>THUNDER JET</b>							
F-14, F-15			75		OE108	RN3C	8904 0.9
F-II 700, F-II 800			75		OE108	RN3C	8904 0.9
<b>TIDE RIDER</b>							
Cuyuna Engs.			45		OE108	RN3C	8904 0.9
<b>TIGERSHARK</b>							
Montego		644		1993→1994	OE091	RN2C	8904 0.8
TS1000		1000		1997→1999	OE091	RN2C	8904 0.8
TS1100L F/I		1100		1999→2000	OE134	RC12PYP	8071 0.7
TS1100R		1100		1999→2000	OE091	RN2C	8904 0.7
TS1100RI		1100		2000→	OE134	RC12PYP	8071 0.7
TS770		768		1997→2000	OE091	RN2C	8904 0.8
TS800RI		785		2000→	OE091	RN2C	8904 0.8
TS900		896		1995→1999	OE091	RN2C	8904 0.8
		639		1993→1999	OE018	RN7YC	8332 0.8
<b>ULTRANAUTICS</b>							
Seafish ST, XL, XP Suzuki		789				QL78C	8883 0.6
Wetbike	Suzuki	789				QL78C	8883 0.6
	Mercury	1231				QL76V	
<b>WAVE RYDER</b>							
	Suzuki		120			QL78C	8883 0.6
<b>WETBIKE</b>							
	Spirit		120			QL78C	8883 0.8
	Suzuki		125			QL82C	8883 0.8
<b>WETJET</b>							
428		428			OE091	RN2C	8904 0.9
432		432			OE091	RN2C	8904 0.9
428 L/C		428			OE091	RN2C	8904 0.9
432 Brut		432			OE091	RN2C	8904 0.8
Duo 200		432	50	1994→1995	OE091	RN2C	8904 0.9
Special Edition Brut		432			OE091	RN2C	8904 0.8
Sport Brut		432			OE091	RN2C	8904 0.8
Sport II Brut		432			OE091	RN2C	8904 0.8
T-7 Duo 300, ZX		701	75	1995→1997		QL78C	8883 0.9
T-8 Kraze		701	85	1996→1997		QL78C	8883 0.9
<b>WILD CAT</b>							
Brute Engs.			50		OE091	RN2C	8904 0.9
			75		OE091	RN2C	8904 0.9









CC







BHP





21

POWER  
SPORT**YAMAHA**

	CC	BHP	21		POWER SPORT	mm	
FX1 FX700	700				QL82YC	8814	0.6
FX160	1100				G57C	8654	0.8
GP1200	1200			OE091	RN2C	8904	0.6
Super Jet SJ650	650				QL82YC	8814	0.6
Super Jet SJ700, SJ700A	700				QL82YC	8814	0.6
SUV1200	1200				QL78C	8883	0.6
Wave Blaster II WB760	760				QL82YC	8814	0.6
Wave Raider Deluxe RA700, RA700B	700				QL82YC	8814	0.6
Wave Raider RA1100	1100				QL82YC	8814	0.6
Wave Raider RA700	700				QL82YC	8814	0.6
Wave Raider RA760	760				QL82YC	8814	0.6
Wave Runner FX 140 (4-Stroke)	1000				G57C	8654	0.8
Wave Runner FX Cruiser (4-Stroke)	1000				G57C	8654	0.6
Wave Runner GP 1200	1200				QL78C	8883	0.6
Wave Runner GP1300R	1300			OE091	RN2C	8904	1.1
Wave Runner GP760	760				QL82YC	8814	0.6
Wave Runner GP800	800			OE091	RN2C	8904	0.6
Wave Runner GP800W, R	800			OE091	RN2C	8904	0.6
Wave Runner XL800, XLT800	800			OE091	RN2C	8904	0.6
Wave Venture WVT1100	1100				QL82YC	8814	0.6
Wave Venture WVT700, WVT700B	700				QL82YC	8814	0.6
Wave Venture WVT760	760				QL82YC	8814	0.6
Waveblaster WB700, WB700A	700				QL82YC	8814	0.6
Wavejammer WJ500	500				QL82YC	8814	0.6
Waverunner III WRA650	650				QL82YC	8814	0.6
Waverunner III, III GP WRA700, WRA700, WRA700A	700				QL82YC	8814	0.6
Waverunner LX WR650	650				QL82YC	8814	0.6
Waverunner Pro VXR WRB700, XL700	700				QL82YC	8814	0.6
Waverunner VXR, T WRB650	650				QL82YC	8814	0.6
Waverunner WR500	500				QL82YC	8814	0.6
XA1200	1200			OE091	RN2C	8904	0.6
XL1200	1200			OE091	RN2C	8904	0.6
XL1200W	1200				QL78C	8883	0.6
XL760W	760				QL82YC	8814	0.6
XLT1200	1200			OE091	RN2C	8904	1.1

		CC	BHP					
<b>AIRMASTER</b>	Kohler (V-Twin)	1235	25		OE013	RC12YC	8071	0.8

		CC	BHP					
<b>AEROCRUISER</b>								
SA1100			4		OE091	RN2C	8904	0.9
<b>AIR CYCLE</b>								
Model 410						D6		0.8
<b>HOVERCRAFT CONCEPTS</b>								
Aerocruiser	Rotax		64		OE091	RN2C	8904	0.8
	Cuyana		50		OE108	RN3C	8904	0.6
<b>HOVERTECHNICS</b>								
	4.3L V-6					RV9YC		0.9
	Yamaha		50			QL78C	8883	0.6
<b>SCAT</b>								
HP-12	Rotax		64		OE091	RN2C	8904	0.8
Intruder	Rotax		52		OE091	RN2C	8904	0.8
Liberator	Rotax		64		OE091	RN2C	8904	0.8
Mirage	Rotax		43		OE091	RN2C	8904	0.8

		CC	BHP					
<b>ALIEN</b>	Twin Kawasaki	750	4		OE091	RN2C	8904	0.8





 **FEDERAL  
MOGUL**



**21****POWER SPORT****ALOUETTE**

250cc	Super Brute				<b>QN19V</b>		
340cc	340			<b>OE091</b>	<b>RN2C</b>	<b>8902</b>	0.5
	Brute				<b>QN19V</b>		
	Sno Duster G34B			<b>OE108</b>	<b>RN3C</b>	<b>8902</b>	0.5
440cc	Super Brute				<b>QN19V</b>		
	440			<b>OE091</b>	<b>RN2C</b>	<b>8902</b>	0.5
	Brute				<b>QN19V</b>		
	Sno Brute K440-2AS				<b>QN19V</b>		
	Super Brute				<b>QN19V</b>		

**AMF**

399cc	399			<b>OE091</b>	<b>RN2C</b>	<b>8902</b>	0.5
440cc	440			<b>OE091</b>	<b>RN2C</b>	<b>8902</b>	0.5

**ARCTIC CAT**

59cc	AA06A5 Kitty Cat	Suzuki	1981 →		<b>RL86C</b>		0.5
	AA06A6 Kitty Cat	Suzuki	1985 →		<b>RL86C</b>		0.5
	AB06A1, A2, A8, A9 Kitty Cat	Suzuki	1986 → 1990		<b>RL86C</b>		0.7
	A006A3, A4, A5, A6, A7, A8 Kitty Cat	Suzuki	1991 → 1999		<b>RL86C</b>		0.7
	T5B060S, T6A Other Models	Suzuki			<b>RL86C</b>		0.8
60cc	AA06A1	Kawasaki			<b>RL86C</b>		0.6
	AA-06A1	Spirit			<b>RL87YC</b>		0.6
	AA-06A2, A3, A4	Spirit			<b>RL86C</b>		0.5
	AA06A2, A4	Kawasaki			<b>RL86C</b>		0.5
120cc	AA12A1 Z120, Z120 Sno Pro	Suzuki	2001 → 2004	<b>OE006</b>	<b>RN9YC</b>	<b>8415</b>	0.8
	ZR120, Fan, Single	Suzuki	2003 → 2005	<b>OE006</b>	<b>RN9YC</b>	<b>8415</b>	0.8
245cc	T1A 250 R1A Other Models	Suzuki		<b>OE091</b>	<b>RN2C</b>	<b>8902</b>	0.8
	T1B 250 RS	Free Air Sports			<b>C57</b>		0.4
	T1C 250 F1A Other Models	Suzuki		<b>OE108</b>	<b>RN3C</b>	<b>8902</b>	0.8
	T1D 250 F1 Other Models	Suzuki		<b>OE108</b>	<b>RN3C</b>	<b>8902</b>	0.8
	T7C 250 FR2	Free Air Sports			<b>C57</b>		0.4
	T7C 250 FX Other Models	Suzuki			<b>C57</b>		0.8
250cc	AA25L2	Racing			<b>C57</b>		0.5
	AA-25L2	Spirit		<b>OE091</b>	<b>RN2C</b>	<b>8902</b>	0.6
	AB25F1	Kawasaki		<b>OE091</b>	<b>RN2C</b>	<b>8902</b>	0.6
	AB-25F1, F2	Spirit		<b>OE108</b>	<b>RN3C</b>	<b>8902</b>	0.5
	AB25F3, F4	Kawasaki		<b>OE091</b>	<b>RN2C</b>	<b>8902</b>	0.5
	AB-25F3, F4	Spirit		<b>OE091</b>	<b>RN2C</b>	<b>8902</b>	0.5
	K250-2RLC	Kohler			<b>QN19V</b>		
275cc	AA28F1, F2, F3	Kawasaki		<b>OE091</b>	<b>RN2C</b>	<b>8902</b>	0.6
	AA-28F1, F2, F3, F4, F5	Spirit		<b>OE108</b>	<b>RN3C</b>	<b>8902</b>	0.6
	AA28F4, F5	Kawasaki		<b>OE091</b>	<b>RN2C</b>	<b>8902</b>	0.5
	Jaguar 2000T Other Models	Suzuki		<b>OE108</b>	<b>RN3C</b>	<b>8902</b>	0.5
	Lynx 2000S, T Other Models	Suzuki		<b>OE108</b>	<b>RN3C</b>	<b>8902</b>	0.5
290cc	T1A 290 R1A, FA, F1 Other Models	Suzuki		<b>OE091</b>	<b>RN2C</b>	<b>8902</b>	0.5
	T1C 290 RS1 Other Models	Suzuki		<b>OE091</b>	<b>RN2C</b>	<b>8902</b>	0.5
	T7A 290 RX Other Models	Suzuki			<b>C57</b>		0.5
292cc	KT150, B Other Models	Suzuki			<b>D6</b>		0.8
	T1C 295 RS1A	Free Air Sports			<b>C57</b>		0.4
	T4B 292 S1A Other Models	Suzuki			<b>QL77JC4</b>	<b>8883</b>	0.8
	T4C 292 S1, S1A Other Models	Suzuki			<b>QL78C</b>	<b>8883</b>	0.8
	T7A 290 RS	Free Air Sports			<b>QC59</b>		0.4
	TB 292 S Other Models	Suzuki			<b>QL77JC4</b>	<b>8883</b>	0.8
295cc	KM24 Wankel, 1/2" Reach Other Models	Suzuki		<b>OE086</b>	<b>RL82C</b>		0.5
	KM24 Wankel, 3/4" Reach Other Models	Suzuki		<b>OE108</b>	<b>RN3C</b>	<b>8902</b>	0.5
336cc	T1B 340 S1 Other Models	Suzuki		<b>OE108</b>	<b>RN3C</b>	<b>8902</b>	0.8
	T1C 340 S1, S2 Other Models	Suzuki		<b>OE108</b>	<b>RN3C</b>	<b>8902</b>	0.8
339cc	3000 Puma	Suzuki		<b>OE108</b>	<b>RN3C</b>	<b>8902</b>	0.7
	340 Panther	Suzuki	1998 → 2000	<b>OE091</b>	<b>RN2C</b>	<b>8902</b>	0.7
	340, Deluxe Jaguar	Suzuki	1998 → 1999	<b>OE091</b>	<b>RN2C</b>	<b>8902</b>	0.7
	AF34A6, A7, A8, A9 Puma	Suzuki	1987 → 1990	<b>OE108</b>	<b>RN3C</b>	<b>8902</b>	0.7
	AG34A1, A2 Puma	Suzuki	1991 → 1992	<b>OE108</b>	<b>RN3C</b>	<b>8902</b>	0.7
	AG34A1, A2, A3 Lynx	Suzuki	1991 → 1993	<b>OE091</b>	<b>RN2C</b>	<b>8902</b>	0.7
	AG34A4-A Cheetah	Suzuki	1994 →	<b>OE091</b>	<b>RN2C</b>	<b>8902</b>	0.7
	AG34A5 Cheetah	Suzuki	1995 →	<b>OE091</b>	<b>RN2C</b>	<b>8902</b>	0.7
	AG34A6 Bearcat 340	Suzuki	1996 → 2000	<b>OE091</b>	<b>RN2C</b>	<b>8902</b>	0.7
	Deluxe AF34A8, A9 Puma	Suzuki	1989 → 1990	<b>OE108</b>	<b>RN3C</b>	<b>8902</b>	0.7
	Deluxe AG34A1, A2 Lynx	Suzuki	1991 → 1992	<b>OE108</b>	<b>RN3C</b>	<b>8902</b>	0.7
	Mountain Cat Other Models	Suzuki			<b>RL86C</b>		0.5

**POWER SPORT****...ARCTIC CAT**

...339cc	Puma, Deluxe, 2-UP AG34A6 Puma	Suzuki	1994→1997	OE091	RN2C	8902	0.7	
	T1A 340 F1	Free Air Sports			C57		0.4	
	T1A 340 FA, R1A Other Models	Suzuki			C57		0.5	
	T1A 340 S1 Other Models	Suzuki		OE108	RN3C	8902	0.5	
	T1B 340 RS	Free Air Sports			C57		0.4	
	T1C 340 RS1 Other Models	Suzuki		OE091	RN2C	8902	0.5	
	T1C 340 RS1A	Free Air Sports			QC59		0.4	
	T1C 340 S2A Other Models	Suzuki		OE091	RN2C	8902	0.5	
	T1D 340 A2A Other Models	Suzuki		OE108	RN3C	8902	0.5	
	T1D 340 F1 Other Models	Suzuki		OE108	RN3C	8902	0.5	
	T7A 340 RX Other Models	Suzuki			C57		0.5	
	T7C 340 FR1	Free Air Sports			C57		0.4	
	T7C 340 FR2	Free Air Sports			C57		0.4	
	T7C 340 RX	Free Air Sports			C57		0.4	
	TC 340 A Other Models	Suzuki		OE091	RN2C	8902	0.5	
	340cc	AA34F1, F2	Kawasaki		OE091	RN2C	8902	0.6
		AA-34F1, F2, F3, F4, F5	Spirit		OE108	RN3C	8902	0.6
		AA34F3, F4, F5	Kawasaki		OE091	RN2C	8902	0.5
		AAE23L2, AF34A1, A2	Kawasaki		OE091	RN2C	8902	0.5
		AB34F1	Kawasaki		OE091	RN2C	8902	0.6
AB-34F1		Spirit		OE091	RN2C	8902	0.5	
AC-34L2		Spirit		OE091	RN2C	8902	0.6	
AC34L2, AD34L1		Racing			C57		0.5	
AD-34L1		Spirit		OE091	RN2C	8902	0.6	
AE-34L2		Spirit		OE091	RN2C	8902	0.6	
AF-34A1, A2		Spirit		OE108	RN3C	8902	0.6	
Sno Pro 55 h.p.		Racing			C57		0.5	
367cc		AA37A1, A3 Z 370	Fan Suzuki	1999→2004	OE091	RN2C	8902	0.7
	AA37A3 Pantera 370	Suzuki	2001→	OE091	RN2C	8902	0.7	
398cc	T1A 400 F1	Free Air Sports			C57		0.4	
	T1A 400 FA, F1A Other Models	Suzuki			C57		0.8	
	T1A 400 S1 Other Models	Suzuki		OE108	RN3C	8902	0.8	
	T1B 400 S, S1 Other Models	Suzuki		OE108	RN3C	8902	0.8	
	T7A 400 RS	Free Air Sports			C57		0.4	
	T7B 400 RS1A	Free Air Sports			C57		0.4	
431cc	4000 AG44A2, A6 Jag 440, Jag Deluxe	Suzuki	1981→	OE091	RN2C	8902	0.7	
	440 AG44A8, A9 Jag 440, Jag Deluxe	Suzuki	1987→1988	OE091	RN2C	8902	0.7	
	AD44A4 Super Jag	Suzuki	1992→	OE091	RN2C	8902	0.7	
	AD-44L1	Spirit		OE091	RN2C	8902	0.5	
	AFS Jag 440, Jag Deluxe	Suzuki	1989→1992	OE091	RN2C	8902	0.7	
	AFS-LT, AWS, Z Jag 440, Jag Deluxe	Suzuki	1993→1994	OE091	RN2C	8902	0.7	
	AG44A1 Trail Cat	Suzuki	1981→	OE091	RN2C	8902	0.7	
	AG44A2 Panther 440	Fan Suzuki	1981→	OE091	RN2C	8902	0.7	
	AG44A3, A6 Panther 440	Fan Suzuki	1984→1985	OE091	RN2C	8902	0.7	
	AG44A7 Jag 440, Jag Deluxe	Suzuki	1986→	OE091	RN2C	8902	0.7	
	AG44A8, A9 Super Jag	Suzuki	1987→1988	OE091	RN2C	8902	0.7	
	AK44A1, A2, A3, A4 Panther 440	Fan Suzuki	1989→1993	OE091	RN2C	8902	0.7	
	AK44A1, A2-A, A3, A4 Jag 440, Jag Deluxe	Suzuki	1989→1992	OE091	RN2C	8902	0.7	
	AK44A1-A, A2, A3 Super Jag	Suzuki	1989→1991	OE091	RN2C	8902	0.7	
	AK44A5, A5-B, A6-A, A6-B, A7-A Jag 440, Jag Deluxe	Suzuki	1993→1995	OE091	RN2C	8902	0.7	
	AK44A6-B Cheetah 440	Suzuki	1994→	OE091	RN2C	8902	0.7	
	AK44A7-B, A8-B Bearcat 440-II, Z440	Fan Suzuki	1996→2000	OE091	RN2C	8902	0.7	
	AK44A8-B Jag 440, Jag Deluxe	Suzuki	1996→1999	OE091	RN2C	8902	0.7	
	AS44A4 Panther 440	Fan Suzuki	1997→2002	OE091	RN2C	8902	0.7	
	AS44A4, AT44L6 Z 440, ZR 440	Fan Suzuki	1998→2004	OE091	RN2C	8902	0.7	
	AU44A4 Z 440 Sno Pro	Suzuki	2001→	OE091	RN2C	8902	0.7	
	Deluxe AK44A3, A4 Panther 440	Fan Suzuki	1991→1994	OE091	RN2C	8902	0.7	
	Deluxe AK44A5-A, A6-A, A7-A, A8-B Panther 440	Fan Suzuki	1991→1996	OE091	RN2C	8902	0.7	
	436cc	AH44L2 Pantera	Suzuki	1985→	OE091	RN2C	8902	0.5
		AH44L3, L4, L5, L6 Pantera	Suzuki	1986→1989	OE091	RN2C	8902	0.7
		AH44L4, L5 El Tigre 5000	Suzuki	1987→1988	OE091	RN2C	8902	0.7
		AJ44K3, K4 Cheetah, Cheetah Touring	Suzuki	1991→1992	OE091	RN2C	8902	0.7
AJ44L2, L3, L4 Prowler, 2-UP, Z		Suzuki	1990→1992	OE091	RN2C	8902	0.7	
AJ44L2-A Pantera		Suzuki	1990→	OE091	RN2C	8902	0.7	
AJ44L3, L4 Pantera		Suzuki	1991→1992	OE091	RN2C	8902	0.7	
AJ44L5 Cheetah, Cheetah Touring		Suzuki	1993→	OE091	RN2C	8902	0.7	
AL44L3, L4 Cougar, Cougar Mountain Cat		Suzuki	1993→1993	OE091	RN2C	8902	0.7	
AL44L3, L4 Prowler, 2-UP, Z		Suzuki	1993→1994	OE091	RN2C	8902	0.7	
AL44L5 Jag		Liquid Suzuki	1996→	OE091	RN2C	8902	0.7	



**POWER SPORT****...ARCTIC CAT**

Capacity	Model	Manufacturer	Year Range	OE Part	Part Number	Price	Length (mm)	
...436cc	AL44L5 Panther	Liquid Suzuki	1996 →	OE091	RN2C	8902	0.7	
	AM44L3 Prowler, 2-UP, Z	Suzuki	1993 →	OE091	RN2C	8902	0.7	
	AN44L2, L3, Z440, ZR440 Prowler, 2-UP, Z	Suzuki	1994 → 1996	OE091	RN2C	8902	0.7	
	T1A 440 F2	Free Air Sports			C57		0.4	
	T1A 440 FA, R1A Other Models	Suzuki			C57		0.8	
	T1A 440 S1 Other Models	Suzuki		OE108	RN3C	8902	0.8	
	T1B 440 D1A Other Models	Suzuki			QN19V			
	T1B 440 S, S1 Other Models	Suzuki		OE108	RN3C	8902	0.8	
	T1C 440 S1A, S2A Other Models	Suzuki		OE108	RN3C	8902	0.8	
	T1D 440 A2A Other Models	Suzuki		OE108	RN3C	8902	0.8	
	T7 440 FR1	Free Air Sports			C57		0.4	
	T7 440 FR2	Free Air Sports			C57		0.4	
	T7A 440 RS1	Free Air Sports			C57		0.4	
	T7A 440 RX	Free Air Sports			C57		0.4	
	T7A 440 RX Other Models	Suzuki			C57		0.8	
	T7B 440 RS1A	Free Air Sports			C57		0.4	
	TA 440 B, C, A Other Models	Suzuki		OE091	RN2C	8902	0.8	
	ZL440	Liquid Suzuki	1997 → 2000	OE091	RN2C	8902	0.7	
	437cc	AR44L1 ZR440	Liquid Suzuki	1996 → 1998	OE091	RN2C	8902	0.7
		440cc	AB44F1	Kawasaki		OE091	RN2C	8902
	AB-44F1, F2		Spirit		OE108	RN3C	8902	0.5
	AB44F2, AC44A1		Kawasaki		OE091	RN2C	8902	0.6
	AC-44A1, A2, A3		Spirit		OE108	RN3C	8902	0.5
AC44A2, A3	Kawasaki			OE091	RN2C	8902	0.5	
AD44L1, AF44L2	Kawasaki			OE091	RN2C	8902	0.5	
AE44L2	Racing				C57		0.5	
AE-44L2	Spirit			OE091	RN2C	8902	0.5	
AF-44L1, L2	Spirit			OE091	RN2C	8902	0.5	
AG-44A1	Spirit			OE108	RN3C	8902	0.5	
Sno Pro 70 h.p.	Racing				C57		0.5	
497cc	AS50L2, L3, AT50L3, L5 ZL500, ZL500 EFI		Liquid Suzuki	1998 → 2002	OE091	RN2C	8902	0.7
	AS50L2, L3, AT50L3, L5, AU50L5 ZR500, ZR500 EFI		Liquid Suzuki	1998 → 2002	OE091	RN2C	8902	0.7
	AT50L3 Powder Special 500 EFI		Liquid Suzuki	1999 → 2000	OE091	RN2C	8902	0.7
	AT50L5 Mountain Cat 500		Suzuki	2001 → 2002	OE091	RN2C	8902	0.7
499cc	AS50L2, L3, AT50L3, L5, AU50L5 F5 Firecat		Liquid Suzuki	2003 → 2005	OE091	RN2C	8902	0.7
	M5		Liquid Twin Suzuki	2005 →	OE091	RN2C	8902	0.7
500cc	Sabercat 500, LX		Liquid Suzuki	2004 → 2005	OE091	RN2C	8902	0.7
	AB-50A1		Spirit		OE108	RN3C	8902	0.5
	AB50A1, A2	Kawasaki		OE091	RN2C	8902	0.6	
	AB-50A2, A3, A4	Spirit		OE091	RN2C	8902	0.6	
	AB50A3, A4	Kawasaki		OE091	RN2C	8902	0.5	
	AC50F1, F2	Kawasaki		OE091	RN2C	8902	0.6	
	AC-50F1, F2	Spirit		OE091	RN2C	8902	0.6	
	AD50F5 El Tigre 5000	Suzuki	1981 →	OE091	RN2C	8902	0.5	
	AD-50F1, F2, F3, F4, F5	Spirit		OE091	RN2C	8902	0.5	
	AD50F3, F4, F5	Kawasaki		OE091	RN2C	8902	0.5	
	AD50F6	Kawasaki			C57		0.5	
	AE-50A1, A2, A3	Spirit		OE091	RN2C	8902	0.5	
	AE50A1, A6	Kawasaki		OE091	RN2C	8902	0.5	
	AF-50A1	Spirit		OE091	RN2C	8902	0.6	
	AH-50L1	Spirit		OE091	RN2C	8902	0.5	
	AH50L1, AL50A1	Kawasaki		OE091	RN2C	8902	0.5	
	AH50L2 El Tigre 6000	Suzuki	1981 →		QC59		0.5	
	AH50L3 El Tigre	Suzuki	1984 →		QC59		0.5	
	AH50L5 El Tigre 6000	Suzuki	1985 →		QC59		0.5	
	AL-50A1	Spirit		OE091	RN2C	8902	0.5	
	AL50A2 Pantera	Suzuki	1981 →	OE091	RN2C	8902	0.5	
	AL50A4 Cougar	Suzuki	1985 →	OE091	RN2C	8902	0.7	
	AL50A5, A6, A7 Panther	Suzuki	1986 → 1988	OE091	RN2C	8902	0.7	
	AM50A2, A3, A4 Cheetah, Touring	Fan Suzuki	1986 → 1990	OE091	RN2C	8902	0.7	
	AM50A2, A3, A4 Cougar	Suzuki	1986 → 1990	OE091	RN2C	8902	0.7	
	AM50A5, A6 Cheetah, Touring	Fan Suzuki	1986 → 1990	OE091	RN2C	8902	0.7	
	AM50A5, A6 Cougar	Suzuki	1986 → 1990	OE091	RN2C	8902	0.7	
	529cc	AA53L1 Cheetah	Liquid Suzuki	1986 →		QC59		0.7
		AA53L1 El Tigre 6000	Suzuki	1986 →		QC59		0.7
		AA53L2, L3 Cheetah	Liquid Suzuki	1987 → 1988		QC59		0.7
		AA53L2, L3, L4 El Tigre 6000	Suzuki	1987 → 1989	OE006	RN9YC	8415	0.7
		AB53L1 El Tigre EXT	Suzuki	1989 →	OE091	RN2C	8902	0.7
		AB53L2, L6, L7 El Tigre EXT	Suzuki	1990 → 1992	OE091	RN2C	8902	0.7
AB53L6, L7 EXT		Suzuki	1991 → 1992	OE091	RN2C	8902	0.7	



**POWER SPORT****...ARCTIC CAT**

550cc	AA55L1, L2 EXT Special	Suzuki	1991 → 1992	OE091	RN2C	8902	0.7
	AA55L4 Cheetah	Suzuki	1994 →	OE091	RN2C	8902	0.7
	AA55L5, L6, CB55L2 Bearcat 550 Wide Track	Liquid Suzuki	1995 → 2003	OE091	RN2C	8902	0.7
	AA55L7, L8, L9, CB55L2 Panther 550	Liquid Suzuki	1997 → 2005	OE091	RN2C	8902	0.7
	AB55L2, L3 EXT 550, Mountain Cat	Carb./Efi Suzuki	1993 →	OE091	RN2C	8902	0.7
	AB55L2, L3 Pantera	Efi Suzuki	1993 → 1995	OE091	RN2C	8902	0.7
	AL55L5, L6 Cougar, Deluxe, 2-UP, Cougar Mountain Cat	Liquid Suzuki	1995 → 1998	OE018	RN7YC	8332	0.7
	CB55L2 ZL 550	Suzuki	2001 → 2004	OE091	RN2C	8902	0.7
570cc	Bearcat 570	Fan Twin Suzuki	2005 →	OE091	RN2C	8902	0.7
	Mountain Cat, Panther, Z	Suzuki	2002 → 2005	OE091	RN2C	8902	0.7
580cc	AA58L2, L3, L4 EXT 580, 580Z, Deluxe, Mountain Cat	Carb./Efi Suzuki	1993 → 1999	OE091	RN2C	8902	0.7
	AA58L4, AC58L5C ZR580	Carb./Efi Liquid Suzuki	1994 → 1997	OE091	RN2C	8902	0.7
	AB58L2, L3, L4 EXT, EXT Mountain Cat	Efi Liquid Suzuki	1994 → 1998	OE091	RN2C	8902	0.7
	AB58L3, L4 L5, L6, L7 Pantera 580	Efi Liquid Suzuki	1995 → 2002	OE091	RN2C	8902	0.7
	AC58L5-C EXT Powder Special	Carb./Efi Liquid Suzuki	1996 → 1997	OE091	RN2C	8902	0.7
594cc	AA60L2 ZRT600	Liquid Suzuki	1996 → 2002		RN4YC	8904	0.7
	AG60L7 EXT 600 Triple Touring	Liquid Suzuki	1997 → 2001	OE091	RN2C	8902	0.7
	Powder Extreme EXT 600 Triple Touring	Liquid Suzuki	1997 → 1998	OE091	RN2C	8902	0.7
599cc	AA60L5, AB60L5, L3, AD60L1 Powder Special	Carb./Efi Suzuki	1998 → 2001	OE091	RN2C	8902	0.7
	AB60L3, AD60L3, AD60L5 ZL600	Carb./Efi Suzuki	1998 → 2003	OE091	RN2C	8902	0.7
	AB60L3, AD60L3, AD60L5 ZR600	Carb./Efi Suzuki	1998 → 2003	OE091	RN2C	8902	0.7
	AF60L5, AD60L5 Mountain Cat 600	Suzuki	2001 → 2004	OE091	RN2C	8902	0.7
	F6 Firecat, EXT Carb./EFI	Liquid Suzuki	2004 → 2005	OE091	RN2C	8902	0.7
	M6	Liquid Twin Suzuki	2005 →	OE091	RN2C	8902	0.7
	Sabercat 600 EXT, LX Carb./EFI	Liquid Suzuki	2004 → 2005	OE091	RN2C	8902	0.7
644cc	T8A 650 RX	Free Air Sports			C57		0.4
650cc	AA65L1 Wildcat 650, Special	Suzuki	1988 →		C57		0.5
	AA65L2 Wildcat 650, Special	Suzuki	1989 →		C57		0.7
	AA65L3 Wildcat 650, Special	Suzuki	1990 →	OE091	RN2C	8902	0.7
658cc	AA65L1, L2 Bearcat Wild Track EFI	Liquid 4-Cycle Suzuki	2003 → 2005	OE005	RC9YC		0.7
660cc	T660 Touring, T660 Turbo	Suzuki	2004 → 2005	OE005	RC9YC		0.7
698cc	AA65L1, L2 F7 Firecat	Carb. Efi Suzuki	2003 → 2005	OE091	RN2C	8902	0.7
	M7	Liquid Twin Suzuki	2005 →	OE091	RN2C	8902	0.7
	Sabercat 700 EXT, LX EFI	Liquid Suzuki	2004 → 2005	OE091	RN2C	8902	0.7
700cc	AB70L7, L8 Powder Special 700	Liquid Suzuki	1999 → 2000	OE091	RN2C	8902	0.7
	AB70L7, L8 ZR700	Liquid Suzuki	1999 → 2000	OE091	RN2C	8902	0.7
	AC70L1, L2, L3 Wildcat 700, Touring, Mountain Cat	Carb./Efi Suzuki	1991 → 1993	OE091	RN2C	8902	0.7
	AC70L3, L4, L5, L6 Wildcat 700, Touring, Mountain Cat	Carb./Efi Suzuki	1993 → 1996	OE091	RN2C	8902	0.7
	AD70L1, L5 ZR700	Suzuki	1994 → 1995	OE091	RN2C	8902	0.7
	ZL700, ZR700 ZL700	Liquid Suzuki	2000 →	OE091	RN2C	8902	0.7
785cc	AA78L1 ZR800 EFI SS, esr	Liquid Suzuki	2003 → 2004	OE091	RN2C	8902	0.7
	AA80L1, AA80L2, L7, AA ZL800, ZR800, ZRT800	Liquid Suzuki	1995 → 2003	OE091	RN2C	8902	0.7
794cc	AA80L5 Pantera 800, Mountain Cat 800	Liquid Suzuki	1998 → 2002	OE091	RN2C	8902	0.7
862cc	AA80L1, L2, 3,4,5,6,7 Mountain Cat 900 1M, EFI	Liquid Suzuki	2003 → 2004	OE091	RN2C	8902	0.7
	AA80L1, L2, 3,4,5,6,7 ZR900	Liquid Suzuki	2003 → 2004	OE091	RN2C	8902	0.7
	King Cat 900 1M	Liquid Suzuki	2004 → 2005	OE091	RN2C	8902	0.7
896cc	AA90L1, L2, L3, L4 Thundercat 900, Mountain Cat	Liquid Suzuki	1993 → 1997	OE091	RN2C	8902	0.6
999cc	AA10L1, L2, L3, L4 Thundercat 1000, Mountain Cat	Liquid Suzuki	1998 → 2002	OE091	RN2C	8902	0.6
	AA10L3, AA10L4 Pantera 1000	Liquid Suzuki	2000 → 2001	OE091	RN2C	8902	0.6

**BLADE**

600cc	1W-X		2002 →	OE091	RN2C	8902	0.7
	6x2		2001 →	OE091	RN2C	8902	0.7
	Striker X		2002 →	OE091	RN2C	8902	0.7
700cc	1W-X		2002 →	OE091	RN2C	8902	0.7
	7x2		2000 →	OE091	RN2C	8902	0.7
	7x2		2001 →	OE091	RN2C	8902	0.7
	Hylander X		2002 →	OE091	RN2C	8902	0.7
	Striker X		2002 →	OE091	RN2C	8902	0.7
800cc	1W-X		2002 →	OE091	RN2C	8902	0.7
	8x2		2001 →	OE091	RN2C	8902	0.7
	Hylander X		2002 →	OE091	RN2C	8902	0.7
	Striker X		2002 →	OE091	RN2C	8902	0.7

**BOA SKI**

40cc	T1B 440 D1A				QN19V		
292cc	MKI 292			OE091	RN2C	8902	0.6
340cc	MKIII 340			OE091	RN2C	8902	0.6
	T1B 440 D1A				QN19V		
440cc	MKII 440			OE091	RN2C	8902	0.6

**21****POWER  
SPORT****BOLENS**

292cc	292, 295, R295	Gutbrod	<b>OE086</b>	<b>RL82C</b>		0.6
315cc	315	Gutbrod	<b>OE086</b>	<b>RL82C</b>		0.6
336cc	340, R340	Gutbrod	<b>OE086</b>	<b>RL82C</b>		0.6
396cc	399, R399	Gutbrod		<b>QL78C</b>	<b>8883</b>	0.6
438cc	440, R440	Gutbrod		<b>QL78C</b>	<b>8883</b>	0.6

**BOMBARDIER  
(→ Ski-Doo)****BROOTEN**

294cc	LC29		<b>OE108</b>	<b>RN3C</b>	<b>8902</b>	0.6
335cc	LC34		<b>OE108</b>	<b>RN3C</b>	<b>8902</b>	0.6
	LC43		<b>OE108</b>	<b>RN3C</b>	<b>8902</b>	0.6
439cc	LC44		<b>OE108</b>	<b>RN3C</b>	<b>8902</b>	0.6

**BSE**

247cc	Cadet 250	1973→1975	<b>OE086</b>	<b>RL82C</b>		0.5
	Sonic 245	1976→		<b>QL78C</b>	<b>8883</b>	0.5
	Spirit 250 M	1976→1978		<b>D9</b>		0.5
250cc	Spirit	1979→1983		<b>D9</b>		0.5
	Spirit M	1980→1982		<b>D9</b>		0.5
269cc	Mirage I	1980→1982	<b>OE091</b>	<b>RN2C</b>	<b>8902</b>	0.4
294cc	Capri 295 S, B	1974→		<b>QL78C</b>	<b>8883</b>	0.5
	Capri 296	1973→		<b>QL78C</b>	<b>8883</b>	0.5
	F 296	1973→		<b>QL78C</b>	<b>8883</b>	0.5
	Futura 295	1974→	<b>OE108</b>	<b>RN3C</b>	<b>8902</b>	0.5
	Mirage 300	1978→1979	<b>OE086</b>	<b>RL82C</b>		0.5
295cc	Nuvik 300 T	1976→1977		<b>QL78C</b>	<b>8883</b>	0.5
	Nuvik 305, E	1975→		<b>QL78C</b>	<b>8883</b>	0.5
336cc	Capri 340 B, S	1973→		<b>QL78C</b>	<b>8883</b>	0.5
	F 340	1973→		<b>QL78C</b>	<b>8883</b>	0.5
	Zephyr 340	1973→		<b>QL78C</b>	<b>8883</b>	0.5
337cc	Sonic 340	1977→1978	<b>OE091</b>	<b>RN2C</b>	<b>8902</b>	0.5
339cc	Futura 340	1974→1975		<b>QL78C</b>	<b>8883</b>	0.5
	Nuvik 340	1975→1979		<b>QL78C</b>	<b>8883</b>	0.5
	Nuvik 340E	1976→1979		<b>QL78C</b>	<b>8883</b>	0.5
	Super Sonic 340 L/C	1979→1980	<b>OE091</b>	<b>RN2C</b>	<b>8902</b>	0.5
	Super Sonic L/C	1980→1981	<b>OE091</b>	<b>RN2C</b>	<b>8902</b>	0.5
368cc	Futura 300	1982→	<b>OE108</b>	<b>RN3C</b>	<b>8902</b>	0.4
	Mirage II, II E	1980→1983	<b>OE091</b>	<b>RN2C</b>	<b>8902</b>	0.4
	Mirage Special	1980→1982	<b>OE091</b>	<b>RN2C</b>	<b>8902</b>	0.4
377cc	Mirage III	1985→	<b>OE091</b>	<b>RN2C</b>	<b>8902</b>	0.5
399cc	Futura 400, 400E	1977→1979	<b>OE091</b>	<b>RN2C</b>	<b>8902</b>	0.5
	Grand Sport TS 400	1974→1975	<b>OE091</b>	<b>RN2C</b>	<b>8902</b>	0.5
	S 399	1973→	<b>OE091</b>	<b>RN2C</b>	<b>8902</b>	0.5
435cc	Capri 440 B, S	1973→	<b>OE086</b>	<b>RL82C</b>		0.5
	Zephyr 440	1973→	<b>OE086</b>	<b>RL82C</b>		0.5
436cc	Chimo 440	1974→1975	<b>OE091</b>	<b>RN2C</b>	<b>8902</b>	0.5
	Futura 440	1974→1975	<b>OE091</b>	<b>RN2C</b>	<b>8902</b>	0.5
	Grand Sport 440, TS	1974→1975	<b>OE091</b>	<b>RN2C</b>	<b>8902</b>	0.5
437cc	F 440	1973→	<b>OE086</b>	<b>RL82C</b>		0.5
	Futura 440	1974→1979		<b>D6</b>		0.5
	Futura 440 E	1976→1979		<b>D6</b>		0.5
	Futura 444 L/C	1978→1979	<b>OE108</b>	<b>RN3C</b>	<b>8902</b>	0.5
	Nuvik 440, 440E	1977→		<b>D6</b>		0.5
	S 440	1973→	<b>OE091</b>	<b>RN2C</b>	<b>8902</b>	0.5
	Ultra Sonic 454	1981→1982	<b>OE091</b>	<b>RN2C</b>	<b>8902</b>	0.5
	Ultra Sonic LC	1980→	<b>OE091</b>	<b>RN2C</b>	<b>8902</b>	0.5
462cc	Futura 464 LC	1981→1982	<b>OE108</b>	<b>RN3C</b>	<b>8902</b>	0.4
	Futura LC 464 E	1980→	<b>OE108</b>	<b>RN3C</b>	<b>8902</b>	0.4
497cc	Futura 500, 500E	1980→1982	<b>OE091</b>	<b>RN2C</b>	<b>8902</b>	0.4
	Futura 500, 500E	1980→1983	<b>OE091</b>	<b>RN2C</b>	<b>8902</b>	0.4
	Grand Prix Special	1979→1981	<b>OE091</b>	<b>RN2C</b>	<b>8902</b>	0.4
	Grand Prix Special MX	1981→	<b>OE091</b>	<b>RN2C</b>	<b>8902</b>	0.4

**21****POWER  
SPORT****mm**  
**CANADIAN  
CURTISS WRIGHT**

248cc	248			D9		0.6
290cc	290/1		OE086	RL82C		0.6
	290/2, /3			QL78C	8883	0.6
339cc	340/1		OE086	RL82C		0.6
	340/2, /3, /4			QL78C	8883	0.6
	340/5 Deere Models		OE091	RN2C	8902	0.6
398cc	400/1, /2, /3			QL78C	8883	0.6
	400/21			QL78C	8883	0.6
	400/22 Deere Models		OE091	RN2C	8902	0.6
	400/4			QL78C	8883	0.6
438cc	440/1, /3, /4			QL78C	8883	0.6
	440/21			QL78C	8883	0.6
	440/22 Deere Models		OE091	RN2C	8902	0.6
	440/22 Merc. Models		OE108	RN3C	8902	0.6
	440/5 Deere Models		OE108	RN3C	8902	0.6

**CHAPARRAL**

242cc	25C		OE108	RN3C	8902	0.5
292cc	295		OE108	RN3C	8902	0.5
	292, 292SS		OE108	RN3C	8902	0.5
339cc	340, 340SS		OE091	RN2C	8902	0.5
	SSX 340		OE091	RN2C	8902	0.5
394cc	400, SE 3/4" Reach		OE091	RN2C	8902	0.5
	400, SS 1/2" Reach			QL78C	8883	0.5
438cc	440, SS 1/2" Reach			QL78C	8883	0.5
	440, SS 3/4" Reach		OE091	RN2C	8902	0.5
	SSX 440		OE091	RN2C	8902	0.5
440cc	SSX 440 Racing			QL55		0.5
650cc	SSX 650 Racing			QL55		0.5

**EVINRUDE**

399cc	400			UL77V		
	400, 400S	1976 → 1976		QL76V		
436cc	440			UL77V		
	440, 440S	1976 → 1976		QL76V		
646cc	650, 650S	1976 → 1976		QL76V		
	650, 650S			UL77V		

**HARLEY-DAVIDSON (AMF)**

398cc	T1B 440 D1A			QN19V		
440cc	T1B 440 D1A			QN19V		
	T1B 440 D1A			QN19V		

**HIRTH**

180cc	110R			D14		0.5
199cc	60R			D14		0.5
246cc	81R, 82R			D14		0.5
250cc	250 Twin		OE091	RN2C	8902	0.5
292cc	193R			D9		0.5
	261R		OE091	RN2C	8902	0.5
	261R3, R4		OE108	RN3C	8902	0.5
	56R			D9		0.5
300cc	190R, 191R			D14		0.5
	52R, 53R			D14		0.5
	54R, 55R			D14		0.5
317cc	192R			D14		0.5
338cc	194R			D9		0.5
	260R, R3, R4	14mm	OE091	RN2C	8902	0.5
339cc	260R	18mm		D6		0.5
340cc	278RO, 279RO			D6		0.5
372cc	160R, 200R			D6		0.5
399cc	210R, 271R, R3, R4, RO			D6		0.5
	277RO, R3, R4			D6		0.5
438cc	211R, 270R, 273R			D9		0.5
440cc	273R, 276R3, R4, RO			D6		0.5
493cc	180R 2-Cyl.			D6		0.5
	220R, 275R			D9		0.5



**21****POWER SPORT****...HIRTH**

600cc	170R			<b>D6</b>		0.5	
634cc	171R			<b>D6</b>		0.5	
647cc	231R			<b>QL77JC4</b>	<b>8883</b>	0.5	
650cc	172R40/41	Free Air		<b>D6</b>		0.5	
	280R, 281RO			<b>OE108</b>	<b>RN3C</b>	<b>8902</b>	0.5
	280R, RS	18mm			<b>RD16</b>		0.5
	280R, RS	14mm		<b>OE091</b>	<b>RN2C</b>	<b>8902</b>	0.5
793cc	230R 3-Cyl. Free Air			<b>QL77JC4</b>	<b>8883</b>	0.5	

**ITALJET**

47.6cc	JC5A, JC5B		1970→1979	<b>OE086</b>	<b>RL82C</b>		0.6
	M5A, M5B		1973→1979	<b>OE086</b>	<b>RL82C</b>		0.6
	MM5A, MM5B		1969→1981	<b>OE086</b>	<b>RL82C</b>		0.6
49.6cc	JC5C, JC5D		1980→1981	<b>OE086</b>	<b>RL82C</b>		0.6
	M5C, M5D		1980→1981	<b>OE086</b>	<b>RL82C</b>		0.6
49.7cc	CX50R		1978→	<b>OE108</b>	<b>RN3C</b>	<b>8902</b>	0.6
	PR50		1980→1981	<b>OE108</b>	<b>RN3C</b>	<b>8902</b>	0.6
	RX50		1979→	<b>OE108</b>	<b>RN3C</b>	<b>8902</b>	0.6
	SX50		1978→	<b>OE086</b>	<b>RL82C</b>		0.6
	X50R		1977→		<b>QL78C</b>	<b>8883</b>	0.6
	X50S		1977→		<b>OE086</b>	<b>RL82C</b>	
49.9cc	KS50		1979→	<b>OE086</b>	<b>RL82C</b>		0.6

**JLO-ROCKWELL**

100cc	L99, F100-1				<b>RL87YC</b>		0.5
148cc	L152				<b>D6</b>		0.5
192cc	L197				<b>D6</b>		0.5
223cc	L227, L230, F250-1				<b>D6</b>		0.5
247cc	L252	18mm			<b>D6</b>		0.5
	L252	14mm		<b>OE108</b>	<b>RN3C</b>	<b>8902</b>	0.5
285cc	2F-295-1, -2			<b>OE108</b>	<b>RN3C</b>	<b>8902</b>	0.5
292cc	L292, L295, F295-1				<b>D6</b>		0.5
	L295/70	18mm			<b>D6</b>		0.5
	L295/70	14mm		<b>OE108</b>	<b>RN3C</b>	<b>8902</b>	0.5
	R295			<b>OE108</b>	<b>RN3C</b>	<b>8902</b>	0.5
296cc	L297, L300				<b>D6</b>		0.5
337cc	L340			<b>OE108</b>	<b>RN3C</b>	<b>8902</b>	0.5
	L340/70	18mm			<b>D6</b>		0.5
	L340/70	14mm		<b>OE108</b>	<b>RN3C</b>	<b>8902</b>	0.5
	R340			<b>OE108</b>	<b>RN3C</b>	<b>8902</b>	0.5
339cc	2F-340-1, -3, -5, -6			<b>OE108</b>	<b>RN3C</b>	<b>8902</b>	0.5
	LR340/2	18mm			<b>D9</b>		0.5
	LR340/2	14mm		<b>OE108</b>	<b>RN3C</b>	<b>8902</b>	0.5
396cc	L395				<b>D6</b>		0.5
398cc	2F-400-1, -3, -4			<b>OE108</b>	<b>RN3C</b>	<b>8902</b>	0.5
	2F-400-6, -7, -8			<b>OE108</b>	<b>RN3C</b>	<b>8902</b>	0.5
	L399/2, LR399/2			<b>OE108</b>	<b>RN3C</b>	<b>8902</b>	0.5
428cc	2F 440-3			<b>OE091</b>	<b>RN2C</b>	<b>8902</b>	0.5
434cc	2F-440-2, -5, -7			<b>OE108</b>	<b>RN3C</b>	<b>8902</b>	0.5
	2F-440-8, -9			<b>OE108</b>	<b>RN3C</b>	<b>8902</b>	0.5
	LR440/2	18mm			<b>D6</b>		0.5
	LR440/2	14mm		<b>OE108</b>	<b>RN3C</b>	<b>8902</b>	0.5
594cc	LB600/2				<b>D6</b>		0.5
739cc	L760/2, LR760/2				<b>D6</b>		0.5

**JOHN DEERE**

292cc	300 Green Machine		1976→1977	<b>OE108</b>	<b>RN3C</b>	<b>8902</b>	0.5
338cc	340 Spitfire		1978→1979	<b>OE108</b>	<b>RN3C</b>	<b>8902</b>	0.5
339cc	340 Cyclone		1977→1978		<b>C57</b>		0.5
	340 Cyclone		1976→		<b>QN19V</b>		
	340 Liquifire		1976→		<b>QN19V</b>		
	340 Trailfire F/C		1979→	<b>OE108</b>	<b>RN3C</b>	<b>8902</b>	0.5
	400 Green Machine		1977→		<b>C57</b>		0.5
	400 Green Machine		1976→		<b>QN19V</b>		
	Liquidator 340		1976→1978		<b>QN19V</b>		
	Liquifire 340		1977→1978		<b>C57</b>		0.5
	Snowfire		1983→1984	<b>OE108</b>	<b>RN3C</b>	<b>8902</b>	0.5
	Spitfire		1980→1983	<b>OE108</b>	<b>RN3C</b>	<b>8902</b>	0.8
	Sprintfire		1983→1984	<b>OE091</b>	<b>RN2C</b>	<b>8902</b>	0.5



21



POWER SPORT



### ...JOHN DEERE

...339cc	Trailfire		1982 → 1983	OE108	RN3C	8902	0.8
	Trailfire 340		1980 → 1981	OE108	RN3C	8902	0.8
436cc	440 Trailfire F/C		1979 →	OE108	RN3C	8902	0.5
	Liquifire		1980 → 1984	OE091	RN2C	8902	0.5
	Sportfire		1980 → 1984	OE091	RN2C	8902	0.5
	Trailfire 440		1980 → 1981	OE108	RN3C	8902	0.5
	Trailfire LX		1982 → 1984	OE108	RN3C	8902	0.5
438cc	440 Cyclone		1977 → 1978		C57		0.5
	440 Cyclone		1976 →		QN19V		
	440 Liquifire		1977 →		C57		0.5
	440 Liquifire		1976 →		QN19V		
	440 Liquifire L/C		1978 →		C57		0.5
	300, 500		1974 → 1975	OE108	RN3C	8902	0.5
	400, 500, 600		1972 → 1973	OE086	RL82C		0.5
	400, 600, 800		1974 → 1975	OE091	RN2C	8902	0.5
	JDX4		1972 → 1973	OE108	RN3C	8902	0.5
	JDX4, X6		1974 → 1975	OE091	RN2C	8902	0.5
	JDX8		1972 → 1973		QL78C	8883	0.5
	JDX8 > Ser. No. 20000		1974 → 1975		QL78C	8883	0.5
	JDX8 from Ser. No. 20001 >		1974 → 1975	OE091	RN2C	8902	0.5
	TIB 440 D1A		1974 → 1975		QN19V		

### JOHNSON

399cc	JX400		1976 → 1976		QL76V		
	JX400				UL77V		
	SR400		1976 → 1976		QL76V		
436cc	JX440		1976 → 1976		QL76V		
	JX440				UL77V		
	SR440		1976 → 1976		QL76V		
646cc	JX650		1976 → 1976		QL76V		
	JX650, 650S				UL77V		
	SR650		1976 → 1976		QL76V		

### KAWASAKI

338cc	SST	Sb340-A1	1977 →	OE091	RN2C	8902	0.8
339cc	Astro	Sa340-A1 Sev.	1977 →	OE091	RN2C	8902	0.8
	Astro	Sa340-A1 Norm.	1977 →	OE108	RN3C	8902	0.8
	Drifter 340, F/A		1979 → 1981	OE108	RN3C	8902	0.8
	Invader 340		1978 → 1980	OE091	RN2C	8902	0.6
	Inviter 340		1978 →	OE108	RN3C	8902	0.8
433cc	SST	Sb440-A1	1977 →	OE091	RN2C	8902	0.8
436cc	Astro	Sa440-A1 Sev.	1977 →	OE091	RN2C	8902	0.8
	Astro	Sa440-A1 Norm.	1977 →	OE108	RN3C	8902	0.8
	Drifter 440		1979 → 1981	OE091	RN2C	8902	0.6
	Intriguer 440		1978 →	OE091	RN2C	8902	0.8
	Intruder 440		1978 → 1982	OE091	RN2C	8902	0.8
	Invader 440		1978 → 1981	OE091	RN2C	8902	0.6
	LTD 440		1981 → 1982	OE091	RN2C	8902	0.6
550cc	Interceptor		1982 →	OE091	RN2C	8902	0.6

### KOHLER

220cc	K250-1AM			OE091	RN2C	8902	0.5
247cc	K250-2FA			OE091	RN2C	8902	0.5
250cc	K250-RLC				QN19V		
290cc	K295-2SS, 2RS				C57		0.5
	K295-2T			OE091	RN2C	8902	0.5
292cc	K295-2AX			OE091	RN2C	8902	0.5
	K295-2AX, 2T	John Deere		OE108	RN3C	8902	0.5
294cc	K295-1T				D9		0.5
309cc	K309-1T	20 H.P.			D6		0.5
335cc	K335-1T				D9		0.5
338cc	K340-2AX, -2FA			OE091	RN2C	8902	0.5
	K340-2SS				C57		0.5
	K340-2T				QL78C	8883	0.5
	TIB 440 D1A				QN19V		
339cc	K340-2AS				QN19V		
	K340-RLC				QN19V		
398cc	K399-2AX			OE091	RN2C	8902	0.5
	K399-2T				D9		0.5



**21****POWER  
SPORT**

<b>...KOHLER</b>							
...398cc	RK399-2AX		OE091	RN2C	8902	0.5	
	RK399-2T			D6		0.5	
429cc	T1B 440 D1A			QN19V			
	K440-2SS, -3RS 1/2" Rch.			QL77JC4	8883	0.5	
	K440-2SS, -3RS 3/4" Rch.			C57		0.5	
436cc	K440-2AS	1975 →		QN19V			
	K440-RLC			QN19V			
	SK440-2LC			QN19V			
	SK440-2LC	Cdi	1975 →				
	T1B 440 D1A	Mag. Ign.	1975 →	OE091	RN2C	8902	0.5
	T1B 440 D1A		1974 → 1974		QN19V		
	T1B 440 D1A		1975 → 1975		QN19V		
437cc	T1B 440 D1A			QN19V			
	K440-2AX		OE091	RN2C	8902	0.5	
	K440-2T			D9		0.5	
539cc	RK440-2T			D6		0.5	
	K539-2			D6		0.5	
644cc	K181			RJ8C		0.5	
	K645-3SS, -3RS 1/2" Rch.			QL77JC4	8883	0.5	
	K645-3SS, -3RS 3/4" Rch.			C57		0.5	
<b>MASSEY-FERGUSON</b>							
294cc	Chinook 300	1977 →	OE091	RN2C	8902	0.6	
339cc	Whirlwind 340	1977 →	OE091	RN2C	8902	0.6	
428cc	Storm 440	1977 →	OE108	RN3C	8902	0.6	
	Whirlwind 440	1977 →	OE108	RN3C	8902	0.6	
<b>MERCURY</b>							
250cc	250 S/T	1976 → 1976		QN19V			
338cc	340 S/R		OE108	RN3C	8902	0.5	
	340 S/R	For Fouling	OE098	RN4C		0.5	
339cc	340 S/T, T/T	1976 → 1976		QN19V			
	T1B 440 D1A			QN19V			
399cc	220			UL18V			
436cc	440 S/T, T/T	1976 → 1976		QN19V			
	T1B 440 D1A			QN19V			
438cc	440 S/R, M/X		OE108	RN3C	8902	0.5	
439cc	250			UL18V			
644cc	Hurricane	1972 → 1975		D6		0.5	
	Hurricane	1973 → 1975		QL76V			
	Hurricane, MK I, II			QL76V			
<b>MOTO-SKI (→ BSE)</b>							
<b>OMC</b>							
362cc	M215			RJ8C		0.8	
399cc	M228			RJ8C		0.8	
	M232, M232E			J4C		0.8	
	M235, M237			J4C		0.8	
	M242			UL77V			
	M225, M225C			RJ8C		0.8	
437cc	M226W, M226E			RJ8C		0.8	
	M227			J4C		0.8	
	M229W, M229E			J4C		0.8	
	M230, M230E			J4C		0.8	
	M231W, M231E			RJ8C		0.8	
	M233, M233E			J4C		0.8	
	M234E, M236			J4C		0.8	
	M238, M239E			J4C		0.8	
	M241E, M245			J4C		0.8	
	M273			UL77V			
	646cc	M244			UL77V		
	<b>ONTARIO</b>						
340cc	Super Shark 340		OE108	RN3C	8902	0.6	
400cc	Shark 400		OE108	RN3C	8902	0.6	
440cc	Shark 440		OE108	RN3C	8902	0.6	
	Super Shark 440		OE108	RN3C	8902	0.6	

**POLARIS**

Capacity	Model	Year	OE Part	Part Number	Price	mm
120cc	Indy 120	2002 → 2004	OE098	RN4C		0.7
	XCR 120	2000 → 2002	OE098	RN4C		0.7
164cc	EC16P			RN5C		0.5
175cc	EC17P, PM		OE098	RN4C		0.5
244cc	EC25PM-01	1978 → 1978	OE091	RN2C	8902	0.5
	EC25PM-01	1979 → 1980	OE108	RN3C	8902	0.5
	EC25PS	1979 → 1979	OE108	RN3C	8902	0.5
	Gemini 244	1980 → 1981	OE108	RN3C	8902	0.5
	Gimini Star	1987 → 1991	OE108	RN3C	8902	0.5
	Indy Starlite, GT	1991 → 1995	OE091	RN2C	8902	0.5
	Longtrack	1988 →	OE108	RN3C	8902	0.5
	Star	1983 → 1990	OE108	RN3C	8902	0.5
	Star Trak	1988 → 1990	OE108	RN3C	8902	0.5
	250cc	EC25PC, EC25PL		OE091	RN2C	8902
EC25PT-05				C57		0.5
EC25PT-06			OE091	RN2C	8902	0.5
EC25PT-07		1979 → 1979	OE091	RN2C	8902	0.5
Gemini 250		1980 →	OE091	RN2C	8902	0.5
294cc	EC29P, PM		OE098	RN4C		0.5
	EC29PF		OE108	RN3C	8902	0.5
	EC29PR			C57		0.5
	EC29PS	1980 → 1980	OE091	RN2C	8902	0.5
	EC29PS	1981 →	OE108	RN3C	8902	0.5
333cc	EC34PL	1980 → 1980	OE091	RN2C	8902	0.5
	EC34PL-04, -05	1979 → 1983		C57		0.5
	EC34PM-03	1979 → 1981	OE108	RN3C	8902	0.8
	EC34PM-03, -04	1980 → 1980	OE091	RN2C	8902	0.8
335cc	EC34P, PM		OE098	RN4C		0.5
	EC34PF, PC		OE108	RN3C	8902	0.5
336cc	EC34PR			C57		0.5
	EC34PS		OE091	RN2C	8902	0.5
	EC34PT-06			C57		0.5
	EC34PT-07	1980 →	OE091	RN2C	8902	0.5
339cc	Thru 1979 EC34PT-05		OE091	RN2C	8902	0.5
	EC34PQ		OE108	RN3C	8902	0.5
	Indy 340 Edge, Edge Classic	2003 → 2005	OE091	RN2C	8904	0.7
	Indy 340, Touring	1999 → 2005	OE091	RN2C	8904	0.7
	Indy Lite Touring	1998 → 1999	OE091	RN2C	8904	0.7
	Indy Lite, GT, 340 Deluxe	1984 → 2002	OE091	RN2C	8904	0.7
	Sprint E/S	1984 → 1991	OE108	RN3C	8902	0.5
372cc	EC37P		OE098	RN4C		0.5
396cc	EC39PF		OE108	RN3C	8902	0.5
398cc	EC40P, PM		OE098	RN4C		0.5
	EC40PF		OE108	RN3C	8902	0.5
	EC40PS		OE091	RN2C	8902	0.5
	Indy 400	1987 → 1991	OE091	RN2C	8904	0.5
430cc	Indy 400 Pro X LC	2003 → 2004	OE091	RN2C	8902	0.5
432cc	EC44-2PM-2100, 3100	1983 → 1987	OE091	RN2C	8902	0.5
	EC44-2PM-500, 1100	1981 → 1983	OE091	RN2C	8902	0.5
	EC44-2PM-5000, 5100	1981 → 1987	OE091	RN2C	8902	0.5
	EC44PM-01	1978 → 1978	OE091	RN2C	8902	0.5
	EC44PM-01, -02, -03	1979 → 1981	OE108	RN3C	8902	0.5
	EC44PQ		OE108	RN3C	8902	0.5
	EC44PS, PT			C57		0.5
	EC44PT-05	1979 → 1980	OE091	RN2C	8902	0.5
	EC44PT-05	1978 → 1978	OE091	RN2C	8902	0.5
	Indy 440	1992 → 1998	OE108	RN3C	8904	0.7
	Indy Sport	1991 → 1999	OE091	RN2C	8904	0.7
	Indy Sport GT	1991 → 1992	OE091	RN2C	8904	0.5
	Indy Sport Touring	1995 → 1999	OE091	RN2C	8904	0.7
Indy Super Sport	1994 → 1997	OE091	RN2C	8904	0.5	
Indy Tran Sport	1995 → 1999	OE091	RN2C	8904	0.7	
Indy XCF	1998 →	OE091	RN2C	8902	0.5	
Longtrail	1987 → 1994	OE091	RN2C	8904	0.5	
436cc	EC44P, PM		OE098	RN4C		0.5
	EC45PL-01, -02, -03	1994 →	OE091	RN2C	8902	0.6
438cc	440 Pro X	2003 → 2004		RN57YCC	8900	0.7
	Indy 440 XCR	1995 → 1998	OE091	RN2C	8902	0.7
	Indy 440 XCR	1999 → 2001		RN57YCC	8900	0.7
	Indy XCF	1999 →	OE006	RN9YC	8415	0.5



**21****POWER SPORT****...POLARIS**

Capacity	Model	Year	OE	Part	Price	Gap	
439cc	EC43PF		OE108	RN3C	8902	0.6	
	EC43PR			C57		0.5	
440cc	440 L/C, SKS	1995→1996	OE108	RN3C	8902	0.6	
	440 Pro XR	2005→		RN57YCC	8900	0.6	
	440 XCR SP	1995→1996	OE091	RN2C	8902	0.6	
	Indy XCF	1997→	OE091	RN2C	8902	0.7	
488cc	500 Indy, Classic	2006→	OE108	RN3C	8904	0.7	
	EC50P		OE098	RN4C		0.5	
	Edge, Indy 500	2003→2005	OE108	RN3C	8904	0.7	
	Indy 500	1997→2004	OE108	RN3C	8904	0.7	
	Indy 500 Classic	1989→1992	OE108	RN3C	8904	0.5	
	Indy 500 EFI	1993→1997	OE108	RN3C	8904	0.7	
	Indy 500 RMK	1996→1999	OE108	RN3C	8904	0.7	
	Indy 500 SKS	1989→1997	OE108	RN3C	8904	0.7	
	Indy 500 SP	1987→1992	OE091	RN2C	8904	0.5	
	Indy 500 Wide Trak	1990→1993	OE091	RN2C	8904	0.5	
	Indy 500, Super Trak	1989→1997	OE108	RN3C	8904	0.7	
	Indy Classic Touring	1993→2004	OE108	RN3C	8904	0.7	
	Indy Classic, 500	1993→2004	OE108	RN3C	8904	0.7	
	Indy Super Sport	1997→1998	OE091	RN2C	8904	0.7	
	Indy Trail Touring, 500 RMK	1996→1999	OE108	RN3C	8904	0.7	
	Indy Trail, Deluxe	1987→1999	OE091	RN2C	8904	0.7	
	Indy Wide Trak GT	1994→1997	OE091	RN2C	8904	0.7	
	Indy Wide Trak LX	1994→2004	OE108	RN3C	8904	0.7	
	500cc	500 + EFI			RC7PYCBX		0.8
		500 SKS	1995→1996	OE108	RN3C	8904	0.7
500 XP SC		2006→		RN57YCC	8900	0.6	
EC51PL-01		1979→	OE091	RN2C	8902	0.7	
EC51PL-02		1980→1982	OE091	RN2C	8902	0.7	
EC51PS, PT			OE091	RN2C	8902	0.7	
Indy 500 RMK Liquid		2000→2004	OE091	RN2C	8904	0.7	
Indy 500 XC		1999→2005		RN57YCC	8900	0.7	
Indy 500 XC SP, Aniv.		1999→2005		RN57YCC	8900	0.7	
530cc		EC54P, PM		OE091	RN2C	8902	0.5
		EC54PF		OE108	RN3C	8904	0.5
	Indy 550 Classic	2002→2005	OE091	RN2C	8902	0.7	
544cc	Indy 550 Pro X	2004→2005	OE091	RN2C	8902	0.7	
	Indy Sport, Trail Touring	2000→2004	OE006	RN9YC	8415	0.7	
	Indy Super Sport, Trail RMK	1999→2004	OE006	RN9YC	8415	0.7	
	Indy XLT	1993→1994	OE091	RN2C	8902	0.5	
579cc	600 Classic Edge	2000→2004		RN57YCC	8900	0.7	
	600 Pro X	2003→2004		RN57YCC	8900	0.7	
	Indy 600 RMK, XC	1998→1999	OE091	RN2C	8902	0.7	
	Indy 600 XC SP, Aniv.	1999→2004		RN57YCC	8900	0.7	
597cc	600 Triumph	2000→	OE091	RN2C	8904	0.7	
	Indy 600 XC	1997→	OE091	RN2C	8904	0.7	
	Indy 600 XCR, SE	1995→1997	OE091	RN2C	8904	0.7	
	Indy 600 XLT	1984→1987	OE091	RN2C	8904	0.5	
	Indy XLT Limited	1997→1998	OE108	RN3C	8904	0.7	
	Indy XLT LTD Special	1995→1999	OE108	RN3C	8904	0.7	
	Indy XLT RMK	1996→1997	OE108	RN3C	8904	0.7	
	Indy XLT SKS	1995→1997	OE108	RN3C	8904	0.7	
	Indy XLT Touring	1995→1999	OE108	RN3C	8904	0.7	
	Indy XLT, Classic	1995→1999	OE108	RN3C	8904	0.7	
	600 RMK, Classic, Fusion, Touring	2006→		RN57YCC	8900	0.7	
	599cc	600 + EFI			RC7PYCBX		0.8
600 RMK, XC		2000→2005		RN57YCC	8900	0.7	
600 Touring		2000→2005		RN57YCC	8900	0.7	
Indy 600 XCR SE		1996→	OE091	RN2C	8904	0.7	
Indy 600 XCR SP		1997→1998		C57		0.5	
648cc	Indy 650	1988→1992	OE091	RN2C	8902	0.5	
	Indy 650 RXL, SKS	1991→	OE091	RN2C	8902	0.5	
	Indy 650 SKS	1988→1991	OE091	RN2C	8902	0.5	
	Indy RXL	1992→1997	OE091	RN2C	8902	0.7	
	Indy RXL SKS	1992→	OE091	RN2C	8902	0.5	
	Indy RXL Tour	1994→1995	OE091	RN2C	8902	0.5	
	Indy SKS	1992→	OE091	RN2C	8902	0.5	
649cc	EC65P		OE091	RN2C	8902	0.6	
	EC65PR			C57		0.5	



**POWER SPORT**

<b>...POLARIS</b>						
650cc	RXL LT, Touring		1995 →	OE091	RN2C	8902 0.6
679cc	Indy 700 XRC		1998 →	OE091	RN2C	8902 0.7
	Indy Ultra		1997 → 1998	OE091	RN2C	8902 0.7
	Indy Ultra RMK		1996 →	OE091	RN2C	8902 0.6
	Indy Ultra SP, SKS		1996 → 1997	OE091	RN2C	8902 0.7
	Indy Ultra SPX, SPX SE		1997 →	OE091	RN2C	8902 0.7
	Indy Ultra Touring		1997 → 1998	OE091	RN2C	8902 0.7
700cc	700 + EFI				RC7PYCBX	0.8
	700 Classic	Liquid	2001 → 2005		RN57YCC	8900 0.7
	700 SKS, RMK	Liquid	2000 → 2004		RN57YCC	8900 0.7
	700 Switchback	Liquid	2004 →		RN57YCC	8900 0.7
	700 XC Aniv.	Liquid	2000 → 2005		RN57YCC	8900 0.7
	700 XC SP	Liquid	2000 → 2005		RN57YCC	8900 0.7
	Indy 700 Pro X		2003 → 2004		RN57YCC	8900 0.7
	Indy 700 Pro X2	Liquid	2004 →		RN57YCC	8900 0.7
	Indy 700 SKS, RMK, XCR	Liquid	1997 → 2004	OE091	RN2C	8902 0.7
	Indy 700 XC, XC SP	Liquid	1999 → 2004		RN57YCC	8900 0.7
740cc	EC74P			OE098	RN4C	0.5
744cc	EC744X			OE098	RN4C	0.5
	Indy Storm		1993 →	OE091	RN2C	8902 0.5
750cc	750 FS Classic		2006 →		RC7YC3	0.9
	750 FS Touring		2006 →		RC7YC3	0.9
	750 FST Classic		2006 →		RC7YC3	0.9
	750 FST Switchback		2006 →		RC7YC3	0.9
	750 FST Touring		2006 →		RC7YC3	0.9
	FST Classic, Switchback, Touring w/Turbo		2005 →		RC7PYCBX	0.8
	FST Classic, Switchback, Touring w/Turbo		2006 →		RC7PYCBX	0.8
	FST Classic, Switchback, Touring w/Turbo		2007 →		RC7PYCBX	0.8
755cc	700 RMK, Classic, Fusion, Touring		2005 →		RN57YCC	8900 0.7
	700 RMK, Classic, Fusion, Touring		2006 →		RN57YCC	8900 0.7
784cc	Frontier Classic, EdgeTouring	Liquid	2003 → 2004		RC7YC3	0.9
	Frontier Touring		2005 →		RC7YC3	0.9
792cc	EC80P			OE098	RN4C	0.5
	EC80PL-01. -05		1994 →	OE091	RN2C	8902 0.5
794cc	800 LE	Liquid	2000 → 2001		RN57YCC	8900 0.7
	800 Pro X		2003 → 2004		RN57YCC	8900 0.7
	800 Pro X2, R	Liquid	2004 →		RN57YCC	8900 0.7
	800 RMK, SKS	Liquid	2000 → 2005		RN57YCC	8900 0.7
	800 Switchback	Liquid	2004 → 2005		RN57YCC	8900 0.7
	800 XC SP	Liquid	2000 → 2005		RN57YCC	8900 0.7
	800 XCR	Liquid	1999 → 2003	OE006	RN9YC	8415 0.7
	Indy Storm		1994 → 1998	OE091	RN2C	8902 0.7
	Indy Storm RMK		1996 → 1997	OE091	RN2C	8902 0.7
	Indy Storm SE		1997 →	OE091	RN2C	8902 0.7
	Indy Storm SKS PT		1994 → 1996	OE108	RN3C	8902 0.6
	Indy Vertical Escape [Liquid]		2003 →	OE091	RN2C	8902 0.7
795cc	EC79P			OE091	RN2C	8902 0.6
	TX Starfire Racing	All			C57	0.5
800cc	800 + EFI				RC7PYCBX	0.8
866cc	900 Fusion		2005 →		RN57YCC	8900 0.7
	900 Fusion		2006 →		RN57YCC	8900 0.7
	900 RMK		2005 →		RN57YCC	8900 0.7
	900 RMK		2006 →		RN57YCC	8900 0.7

## ROCKWELL (→ JLO-Rockwell)

## ROTAX (→ Ski-Doo)

## RUPP

250cc	250 Magnum Nitro				QN19V QN19V	
295cc	TR295, Sport				QL78C	8883 0.5
	TR295S				QL77JC4	8883 0.5
340cc	340 Magnum, Nitro				QN19V	
	G34B			OE108	RN3C	8902 0.5
	T1B 440 D1A				QN19V	
	TR				QL78C	8883 0.5
	TR340S				QL77JC4	8883 0.5

**21****POWER  
SPORT****...RUPP**

400cc	TR400S			QL77JC4	8883	0.5
	TR400S	Slow Speed	1971 →	QL78C	8883	0.5
440cc	440 Nitro			QN19V		
	K440-2AS Rally			QN19V		
	Magnum			OE108	RN3C	8902
	T1B 440 D1A				QN19V	
	TR			OE086	RL82C	0.5
	TR440-2, TR440S-2				QL77JC4	8883
	Thru 1975 All CDI Systems				L20V	0.5

**SACHS**

291cc	SA2-290			OE091	RN2C	8902	0.5
293cc	SA290C				QL78C	8883	0.5
	SA290R				QL77JC4	8883	0.5
	SA290SS				QL77JC4	8883	0.5
295cc	KM24 Wankel 1/2" Reach			OE086	RL82C		0.5
	KM24 Wankel 3/4" Reach			OE098	RN4C		0.5
300cc	KM914 Wankel			OE086	RL82C		0.5
334cc	SA340C				QL77JC4	8883	0.5
336cc	SA340R				QL77JC4	8883	0.5
338cc	SA2-340RX			OE091	RN2C	8902	0.5
339cc	SA2-340, SA2-340C			OE091	RN2C	8902	0.5
431cc	SA2-440RX			OE091	RN2C	8902	0.5
437cc	SA2-440, -440C, 1/2" Rch.				QL77JC4	8883	0.5
	SA2-440, -440C, 3/4" Rch.			OE091	RN2C	8902	0.5
	SA2-440R			OE108	RN3C	8902	0.5
	SA2-441			OE091	RN2C	8902	0.5
647cc	SA3-650RX			OE091	RN2C	8902	0.5

**SCORPION (Cuyuna)**

295cc	Li'l Whip		1977 → 1978	OE091	RN2C	8902	0.5
	Li'l Whip		1979 →	OE098	RN4C		0.5
340cc	340 TK		1980 →	OE098	RN4C		0.5
	Whip		1979 →	OE098	RN4C		0.5
	Whip Normal Serv.		1977 → 1978	OE108	RN3C	8902	0.5
	Whip Severe Serv.		1977 → 1978	OE091	RN2C	8902	0.5
400cc	Range Whip		1977 → 1978	OE108	RN3C	8902	0.5
	Sting		1979 →	OE108	RN3C	8902	0.5
440cc	440 TK		1980 →	OE108	RN3C	8902	0.5
	Range Whip Sting, TK		1977 → 1978	OE108	RN3C	8902	0.5
	Sidewinder		1981 →	OE091	RN2C	8902	0.5
	Sting		1979 →	OE108	RN3C	8902	0.5
	Sting		1980 →	OE108	RN3C	8902	0.5
	Whip		1977 → 1978	OE108	RN3C	8902	0.5
	Whip		1979 → 1980	OE108	RN3C	8902	0.5
	Whip TK, TKX		1979 →	OE108	RN3C	8902	0.5

**SKI-DOO**

120cc	Mini Z w/Honda 4 h.p. OHV		1998 → 2005	OE006	RN9YC	8415	0.8
247cc	Elan 250 Deluxe		1973 → 1979	OE086	RL82C		0.5
248cc	Citation		1985 → 1991	OE091	RN2C	8902	0.4
	Citation LS, LSE		1985 → 1988	OE091	RN2C	8902	0.4
	Safari Citation, E		1989 → 1991	OE091	RN2C	8902	0.4
	Tundra, LT, LTS		1985 → 1992	OE091	RN2C	8902	0.4
250cc	Elan		1971 → 1996		D14		0.5
	Elan 250		1971 → 1975		D14		0.5
	Elan 250		1980 → 1989		D14		0.5
	Elan 250 SS		1973 →		QL78C	8883	0.4
	Elan 250 T		1973 → 1979	OE086	RL82C		0.4
	Elan E		1971 → 1976		D14		0.5
	Elan M		1976 → 1984		D14		0.5
	Olympique 250	10 H.P.	1964 → 1968		D9		0.4
	T'NT 250 RV		1976 →	OE091	RN2C	8902	0.4
268cc	Skandic Tundra		2003 → 2005	OE091	RN2C	8902	0.5
	Tundra		1993 →	OE091	RN2C	8902	0.5
	Tundra II		1994 →	OE091	RN2C	8902	0.5
	Tundra II LT		1994 → 1995	OE091	RN2C	8902	0.5
269cc	Citation 3500		1980 → 1984	OE091	RN2C	8902	0.4
	Skandic 277		1983 →	OE091	RN2C	8902	0.4

**POWER SPORT****...SKI-DOO**

...269cc	Tundra 280		2002 → 2005	<b>OE091</b>	<b>RN2C</b>	<b>8902</b>	0.5	
	Tundra II LT		1996 → 1999	<b>OE091</b>	<b>RN2C</b>	<b>8902</b>	0.5	
	Tundra R		1998 → 2000	<b>OE091</b>	<b>RN2C</b>	<b>8902</b>	0.5	
292cc	Elan 292 SS		1972 →		<b>QL78C</b>	<b>8883</b>	0.4	
	T'NT 292, SS		1970 → 1972		<b>D6</b>		0.4	
293cc	Elan 300		1975 →		<b>QL78C</b>	<b>8883</b>	0.4	
	T'NT 294		1973 → 1974		<b>QL78C</b>	<b>8883</b>	0.4	
	T'NT 294	Fan	1974 →		<b>QL78C</b>	<b>8883</b>	0.4	
	T'NT 294S		1973 →		<b>QL78C</b>	<b>8883</b>	0.4	
294cc	Citation 300		1978 → 1979	<b>OE086</b>	<b>RL82C</b>		0.6	
295cc	Olympique 300, E	Twin	1975 → 1977	<b>OE086</b>	<b>RL82C</b>		0.6	
	Olympique 300 T	Twin	1978 →	<b>OE086</b>	<b>RL82C</b>		0.6	
299cc	Olympique 300, S	Single	1967 → 1978		<b>D14</b>		0.6	
335cc	Olympique 335, E		1970 → 1973		<b>D9</b>		0.4	
	Scandic 337		1973 →		<b>D6</b>		0.4	
	T'NT 340		1970 → 1974		<b>D6</b>		0.4	
	T'NT 340 FA	Cdi	1973 → 1978	<b>OE091</b>	<b>RN2C</b>	<b>8902</b>	0.4	
	T'NT 340 S		1970 → 1973		<b>D6</b>		0.4	
	T'NT 340 RV		1976 →	<b>OE091</b>	<b>RN2C</b>	<b>8902</b>	0.4	
337cc 339cc	Blizzard 6500		1978 →		<b>C57</b>		0.4	
	Blizzard 7500 Plus		1980 → 1981		<b>C57</b>		0.4	
	Everest 340, 340E		1977 → 1979		<b>QL78C</b>	<b>8883</b>	0.4	
	Olympique 340, 340E		1973 → 1979		<b>QL78C</b>	<b>8883</b>	0.4	
	Olympique 340S, 340ES		1973 →		<b>QL78C</b>	<b>8883</b>	0.4	
	T'NT 340 FA		1973 → 1978		<b>QL78C</b>	<b>8883</b>	0.4	
	T'NT 340 S		1973 →		<b>QL78C</b>	<b>8883</b>	0.4	
	T'NT 340, E	Fan	1970 → 1976		<b>QL78C</b>	<b>8883</b>	0.4	
	RV 340 FA		1978 →	<b>OE091</b>	<b>RN2C</b>	<b>8902</b>	0.5	
	Touring E		1995 →	<b>OE091</b>	<b>RN2C</b>	<b>8902</b>	0.5	
	345cc 363cc 368cc	Formula Deluxe 380	Fan	2000 → 2002	<b>OE091</b>	<b>RN2C</b>	<b>8902</b>	0.5
		Formula S, Electric		1996 → 2000	<b>OE091</b>	<b>RN2C</b>	<b>8902</b>	0.5
Grand Touring 380F		Fan	2002 → 2003	<b>OE091</b>	<b>RN2C</b>	<b>8902</b>	0.5	
Legend 380F		Fan	2002 → 2005	<b>OE091</b>	<b>RN2C</b>	<b>8902</b>	0.5	
MX Z 380F		Fan	2001 → 2005	<b>OE091</b>	<b>RN2C</b>	<b>8902</b>	0.5	
Safari 377 E, L, DL			1984 → 1988		<b>C57</b>		0.5	
Safari L, LE, DL			1990 → 1994		<b>RN4YC</b>	<b>8904</b>	0.5	
Safari Saga			1989 →	<b>OE091</b>	<b>RN2C</b>	<b>8902</b>	0.5	
Safari Scout/E			1989 → 1992	<b>OE091</b>	<b>RN2C</b>	<b>8902</b>	0.5	
Skandic 377, E, R			1982 → 1987	<b>OE091</b>	<b>RN2C</b>	<b>8902</b>	0.4	
Skandic 380			1995 → 2000	<b>OE091</b>	<b>RN2C</b>	<b>8902</b>	0.4	
Skandic II 377, R			1992 → 1994	<b>OE091</b>	<b>RN2C</b>	<b>8902</b>	0.5	
Touring E, E LT		2	1996 → 2000		<b>RN4YC</b>	<b>8904</b>	0.5	
Touring LE			1995 →	<b>OE091</b>	<b>RN2C</b>	<b>8902</b>	0.5	
369cc		Citation 4500, E		1980 → 1983	<b>OE091</b>	<b>RN2C</b>	<b>8902</b>	0.4
		Citation SS		1980 → 1983	<b>OE091</b>	<b>RN2C</b>	<b>8902</b>	0.4
		Nordik		1982 → 1983	<b>OE086</b>	<b>RL82C</b>		0.4
386cc		Olympique 370		1968 → 1969	<b>OE086</b>	<b>RL82C</b>		0.4
399cc		Alpine 399 ER, R		1971 →		<b>D14</b>		0.5
		Alpine 399 ER, R		1970 →	<b>OE086</b>	<b>RL82C</b>		0.4
	Nordic 399, E		1971 →		<b>D14</b>		0.5	
	Nordic 399, E		1970 →	<b>OE086</b>	<b>RL82C</b>		0.4	
	Olympique 399, E, ES, S		1970 → 1972	<b>OE086</b>	<b>RL82C</b>		0.4	
	Olympique 400 S		1973 → 1974		<b>QL77JC4</b>	<b>8883</b>	0.4	
	Olympique 400, E, ES		1973 → 1974		<b>QL77JC4</b>	<b>8883</b>	0.4	
	T'NT 396 FA		1973 →	<b>OE091</b>	<b>RN2C</b>	<b>8902</b>	0.4	
	T'NT 399		1969 → 1970	<b>OE086</b>	<b>RL82C</b>		0.4	
	T'NT 400 FA	Cdi	1972 → 1974	<b>OE091</b>	<b>RN2C</b>	<b>8902</b>	0.4	
	MZ ZX 440	Fan	2003 →	<b>OE091</b>	<b>RN2C</b>	<b>8902</b>	0.5	
	436cc 437cc	Skandic LT		2003 → 2005	<b>OE091</b>	<b>RN2C</b>	<b>8902</b>	0.5
Blizzard 9500 Plus			1980 → 1982		<b>C57</b>		0.4	
Elite 440 ER			1973 → 1975		<b>D14</b>		0.4	
Elite 444 E		Liquid	1980 → 1981	<b>OE108</b>	<b>RN3C</b>	<b>8902</b>	0.4	
Everest 440 E			1974 → 1979		<b>D6</b>		0.4	
Everest 440 SL			1974 →		<b>D6</b>		0.4	
Everest 440, E		Fan	1975 → 1979		<b>D6</b>		0.5	
Everest 444 E		Liquid	1978 → 1979	<b>OE091</b>	<b>RN2C</b>	<b>8902</b>	0.4	
MX Z 440		Fan	1996 → 2001	<b>OE091</b>	<b>RN2C</b>	<b>8902</b>	0.4	
MX Z 440		Liquid	1996 → 1997	<b>OE091</b>	<b>RN2C</b>	<b>8902</b>	0.4	
Nordic 440, E, ES, S			1972 →		<b>D6</b>		0.4	





### ...SKI-DOO

Capacity	Model	Year	OE	Part	Price	mm	
...437cc	Nordik 50	1988→1991	OE091	RN2C	8902	0.4	
	Olympique 440	1973→		D6		0.4	
	Olympique 440	1977→		D6		0.4	
	Safari 447, GL	1984→1986	OE108	RN3C	8902	0.4	
	Safari LX, LXE	1990→1991	OE091	RN2C	8902	0.4	
	T'NT 440 E	1974→1975		D6		0.5	
	T'NT 440 S	1971→1973		D6		0.5	
	T'NT 440, E	1977→1978		D6		0.5	
	T'NT FA	1974→1975	OE091	RN2C	8902	0.4	
	T'NT FA	1977→	OE091	RN2C	8902	0.4	
	Touring LE	1996→2000	OE091	RN2C	8902	0.4	
	Valmont 440 ER	1972→		D6		0.5	
	462cc	Grand Touring 470	1995→	OE091	RN2C	8902	0.4
463cc	Elite 464 E	Liquid	1981→	OE091	RN2C	8902	0.4
	Elite 464 ER	Liquid	1982→		QL78C	8883	0.4
	Everest 464, E	Liquid	1980→1983	OE108	RN3C	8902	0.4
	Formula LT, MX, MXZ		1985→1990	OE091	RN2C	8902	0.4
	Formula MX Series		1991→1995	OE091	RN2C	8902	0.5
	Formula MXZ, ST		1993→1994	OE091	RN2C	8902	0.5
	Formula SS, SP		1985→1991	OE108	RN3C	8902	0.4
	Safari GLX, LCE	Liquid	1990→1992	OE108	RN3C	8902	0.5
	SS 25 462	Liquid	1984→	OE108	RN3C	8902	0.4
	Summit 470		1994→	OE091	RN2C	8902	0.5
	496cc	Alpine II	1995→	OE091	RN2C	8902	0.5
		Skandic 380	1996→	OE091	RN2C	8902	0.4
		Skandic 500, WT	1995→	OE091	RN2C	8902	0.4
Skandic II, 503R, RSLT		1993→1994	OE091	RN2C	8902	0.5	
Touring SLE		1995→	OE091	RN2C	8902	0.4	
497cc	Alpine 503, ER	1983→1987	OE108	RN3C	8902	0.4	
	Alpine II	1988→1994	OE091	RN2C	8902	0.5	
	Blizzard 5500, MX	1980→1984	OE091	RN2C	8902	0.4	
	Escapade, Stratos, E	1987→1988	OE006	RN9YC	8415	0.4	
	Everest 500, 500E	1980→1983	OE091	RN2C	8902	0.4	
	Formula Deluxe 500	Fan	1999→2001	OE091	RN2C	8902	0.5
	Formula SL		1996→1999	OE116	RN6YC	8339	0.4
	Nordik 60		1988→1991	OE108	RN3C	8902	0.4
	Safari 503 Rally E		1993→	OE091	RN2C	8902	0.5
	Safari 503, R		1988→	OE091	RN2C	8902	0.4
	Safari Cheyenne		1989→1991	OE091	RN2C	8902	0.4
	Safari Voyageur Escapade		1989→		RN4YC	8904	0.4
	Skandic 500, WT		1996→2004	OE091	RN2C	8902	0.4
	Skandic 503		1987→	OE091	RN2C	8902	0.4
	Skandic Mountain SP		1996→	OE091	RN2C	8902	0.4
	Skandic SWT		1997→2005	OE091	RN2C	8902	0.4
	Touring SLE		1996→2000	OE091	RN2C	8902	0.4
499cc	Formula Deluxe 500	Fan	1997→1998	OE091	RN2C	8902	0.5
	Formula Deluxe 500	Liquid	1999→2001	OE091	RN2C	8902	0.5
	Formula SLS		1996→	OE091	RN2C	8902	0.4
	Grand Touring 500	Liquid	1996→1999	OE091	RN2C	8902	0.5
	Grand Touring Sport 500	Liquid	2001→2005	OE091	RN2C	8902	0.5
	GSX Sport 500SS	Liquid	2004→2005	OE091	RN2C	8902	0.5
	Legend Sport 500	Liquid	2002→2005	OE091	RN2C	8902	0.5
	MX Z 500	Liquid	1998→2005	OE091	RN2C	8902	0.5
	Skandic Wide Trak	Liquid	1997→2000	OE091	RN2C	8902	0.5
	Summit 500, GT500	Liquid	1996→1999	OE091	RN2C	8902	0.4
	Touring 500 LC	Liquid	2000→	OE091	RN2C	8902	0.5
	503cc	Formula S, SL	1995→		RN4YC	8904	0.4
	507cc	Alpine IV	1990→		RA8HC		0.7
521cc	Blizzard 9700	1983→1984	OE108	RN3C	8902	0.4	
	Formula Plus Series	1985→1991	OE091	RN2C	8902	0.4	
	Safari GL	Liquid	1985→1986	OE108	RN3C	8902	0.4
553cc	Grand Touring 550	Fan	2003→2005	OE091	RN2C	8902	0.5
	Legend 550	Fan	2003→2005	OE091	RN2C	8902	0.5
	Summit 550 (Fan)		2003→2005	OE091	RN2C	8902	0.5
	Formula STX LT	2, Z	1994→1995	OE091	RN2C	8902	0.5
580cc	Formula Deluxe 583	Liquid	1997→1999	OE091	RN2C	8902	0.5
	Formula Mach 1, XTC		1989→1990	OE116	RN6YC	8339	0.4
	Formula Plus Series		1992→1993	OE091	RN2C	8902	0.5
	Formula Plus X		1993→	OE091	RN2C	8902	0.5



POWER  
SPORT



...SKI-DOO							
...581cc	Formula STX LT (2) Z583	Liquid	1996 → 1998	OE091	RN2C	8902	0.5
	Grand Touring 580, XTC		1994 → 1996	OE091	RN2C	8902	0.5
	Grand Touring 583		1997 → 1999	OE091	RN2C	8902	0.5
	MX Z 583		1996 → 1998	OE091	RN2C	8902	0.5
	Summit 583		1994 → 1998	OE091	RN2C	8902	0.5
582cc	Formula Plus Series		1992 → 1993	OE091	RN2C	8902	0.5
594cc	GSX Limited, Sport 600 HO		2004 → 2005	OE091	RN2C	8902	0.5
	MX Z 600 HO Sport		2003 → 2005	OE091	RN2C	8902	0.5
	MX ZX 600 HO RER		2003 → 2005	OE091	RN2C	8902	0.5
	MXZ 600 HO Renegade		2003 → 2005	OE091	RN2C	8902	0.5
	Summit 600 HO Adrenaline		2003 → 2005	OE091	RN2C	8902	0.5
597cc	Formula Deluxe 600	Liquid	2000 → 2001	OE091	RN2C	8902	0.5
	Formula Z 600	Liquid	2000 →	OE091	RN2C	8902	0.5
	Grand Touring 600	Liquid	2000 → 2005	OE091	RN2C	8902	0.5
	Skandic SUV		2003 → 2005	OE091	RN2C	8902	0.5
	Skandic WT 600	Liquid	2001 → 2005	OE091	RN2C	8902	0.5
	Summit 600, MX Z 600	Liquid	1999 → 2005	OE091	RN2C	8902	0.5
598cc	Formula III 600, 600 LT	Liquid	1996 → 1999	OE018	RN7YC	8332	0.5
617cc	Formula Mach 1 Series		1991 → 1993	OE091	RN2C	8902	0.5
635cc	Alpine 640 ER		1973 → 1977		D14		0.5
	Alpine 640 ER		1979 → 1981		D14		0.5
	Alpine 640 ER		1970 → 1972		D9		0.5
	Alpine 640 ER		1978 →	OE086	RL82C		0.5
	Alpine 640 ER		1982 →	OE091	RN2C	8902	0.5
	Nordic 640 E, ER, ES		1970 → 1974		D9		0.5
	T'NT 640, S		1970 → 1971		D9		0.5
	Valmont 640 ER		1971 → 1972		D9		0.5
643cc	Formula Mach 1, 1X		1992 →	OE091	RN2C	8902	0.5
669cc	Formula Deluxe 670	Liquid	1999 →	OE091	RN2C	8902	0.4
	Formula III 700	Liquid	1998 → 1999	OE091	RN2C	8902	0.4
	Formula SS		1995 → 1996	OE091	RN2C	8902	0.4
	Formula Z 670	Liquid	1998 →	OE091	RN2C	8902	0.4
	Grand Touring SE		1994 → 1996	OE091	RN2C	8902	0.5
	Mach I		1993 → 1996	OE091	RN2C	8902	0.5
	Mach I XTC, II		1993 →	OE091	RN2C	8902	0.5
	MX Z 670 H.O.	Liquid	1997 → 1999	OE091	RN2C	8902	0.5
	Summit 670, X	Liquid	1995 → 1999	OE091	RN2C	8902	0.5
	T'NT 669		1969 →		D9		0.5
697cc	Grand Touring 700 SE		2003 → 2005	OE091	RN2C	8902	0.5
	Grand Touring 700 Sport		2003 → 2005	OE091	RN2C	8902	0.5
	Legend 700 Sport, SE		2003 → 2005	OE091	RN2C	8902	0.5
	MX Z 700 Adrenaline		2003 → 2005	OE091	RN2C	8902	0.5
	Summit 700 Adrenaline		2003 → 2005	OE091	RN2C	8902	0.5
	Summit 700 X		2003 → 2005	OE091	RN2C	8902	0.5
698cc	Formula Deluxe 700	Liquid	2000 →	OE091	RN2C	8902	0.5
	Formula Z 700	Liquid	2000 →	OE091	RN2C	8902	0.5
	Legend Sport, GS 700	Liquid	2002 → 2004	OE091	RN2C	8902	0.5
	MX Z 700	Liquid	2000 → 2005	OE091	RN2C	8902	0.5
	Summit 700	Liquid	2000 → 2005	OE091	RN2C	8902	0.5
699cc	Formula III 700	Liquid	1998 → 2000	OE091	RN2C	8902	0.5
	Grand Touring 700	Liquid	1998 → 2000	OE091	RN2C	8902	0.5
	Grand Touring SE		1997 → 2000	OE091	RN2C	8902	0.5
	Mach 1	Liquid	1997 → 1999	OE091	RN2C	8902	0.5
771cc	Other Blizzard Series, 14mm Hds.				C57		0.5
	T'NT 775, S		1971 → 1972		D6		0.5
774cc	Formula Mach Z, Z LT		1993 → 1996		C57		0.5
776cc	Blizzard Series	14mm	1970 → 1971		C57		0.5
796cc	Grand Touring SE	Liquid	1999 → 2005	OE091	RN2C	8902	0.5
	Mach Z 800		2001 →	OE091	RN2C	8902	0.5
	Mach Z, LT	Liquid	1997 → 2005		C57		0.5
797cc	Blizzard Series	14mm	1971 → 1973		C57		0.5
799cc	GSX Limited 800 HO		2004 → 2005	OE091	RN2C	8902	0.5
	Legend SE 800	Liquid	2002 → 2005	OE091	RN2C	8902	0.5
	MX ZX Renegade, RER		2003 → 2005	OE091	RN2C	8902	0.5
	Summit Highmark 151 800 HO		2004 → 2005	OE091	RN2C	8902	0.5
	Summit Sport 800, High Mark, X	Liquid	2001 → 2005	OE091	RN2C	8902	0.5
800cc	Grand Touring SE 800	Liquid	2002 → 2005	OE091	RN2C	8902	0.5
	MXZ Renegade, Sport, Trail 800		2001 → 2005	OE091	RN2C	8902	0.5



**21****POWER  
SPORT****...SKI-DOO**

989cc	Grand Touring V- 1000 Sport	4-Cycle	2003→2005		RA8HC		0.5
	Legend Sport V-1000 Sport	4-Cycle	2003→2005		RA8HC		0.5
1500cc	Elite	4-Cycle	2004→2005	OE073	RA4HC	8809	0.5

**SKIROULE**

300cc	Scamp KB300			OE091	RN2C	8902	0.5
	Scamp KS300			OE091	RN2C	8902	0.5
340cc	Laser 340				QN19V		
	Ultra 340				QN19V		
440cc	Laser 440				QN19V		
	Laser 440 Plus				QN19V		
447cc	Ultra 447				QN19V		

**SNO JET**

292cc	S292		1974→1974	OE091	RN2C	8902	0.5
	Y292		1974→1974	OE108	RN3C	8902	0.5
295cc	Y295			OE108	RN3C	8902	0.5
338cc	S338		1972→1972	OE091	RN2C	8902	0.6
	S338		1973→1974	OE108	RN3C	8902	0.6
	Y338		1970→1970		QL78C	8883	0.5
	Y338		1973→1974		QL78C	8883	0.6
	Y338		1975→1976	OE086	RL82C		0.6
	Y338		1972→	OE086	RL82C		0.6
340cc	SX340				C57		0.8
	Y340			OE086	RL82C		0.8
433cc	S433		1974→	OE091	RN2C	8902	0.8
	S433		1972→1972	OE091	RN2C	8902	0.8
	S433		1973→	OE108	RN3C	8902	0.8
	S433E				C57		0.8
440cc	Y433			OE086	RL82C		0.8
	440			OE091	RN2C	8902	0.8
	SX440				C57		0.8
	Y440			OE086	RL82C		0.8

**SNO-RUNNER**

134cc	6000SR, 6001SR 134cc				L90C		0.6
	6002SR, 6003SR 134cc				RL86C		0.6
	Chrysler 82030		1980→1982		RL86C		0.6

**SOLO**

180cc	206			OE086	RL82C		0.6
220cc	209			OE086	RL82C		0.6
340cc	216				QL78C	8883	0.6
440cc	217				QL78C	8883	0.6

**SPIRIT  
(→ Arctic Cat/Suzuki)****SPORTCRAFT**

134cc	w/Chrysler 82017 Eng.				RL86C		0.6
-------	-----------------------	--	--	--	-------	--	-----

**SUZUKI**

292cc	292				QL78C	8883	0.8
336cc	340				QL78C	8883	0.8
359cc	360	Sm10			QL78C	8883	0.8
395cc	XR400, 400				QL78C	8883	0.8
432cc	XR440			OE086	RL82C		0.8



## YAMAHA

Capacity	Model	Year	Part No.	Part No.	Price	Stroke	
79cc	Snoscoot, SV80	1988 → 1990		QL78C	8883	0.8	
123cc	Snowsport, SV125	1990 → 1991		QL78C	8883	0.8	
246cc	Bravo, BR250	1982 → 1988		QL78C	8883	0.8	
	Bravo, BR250	1989 →	OE108	RN3C	8902	0.8	
	Bravo, LT, BR250T	1990 → 2001		QL78C	8883	0.6	
	ET250	1977 → 1981	OE086	RL82C		0.8	
292cc	GP246F	1974 →	OE086	RL82C		0.8	
	GP292, SS	1972 → 1974	OE091	RN2C	8902	0.8	
	GP300	1978 →	OE091	RN2C	8902	0.8	
	GS300	1977 → 1978		RN5C		0.8	
	SL292	1971 → 1973	OE098	RN4C		0.8	
	SM292	1973 → 1974	OE098	RN4C		0.8	
	SR292	1973 →	OE098	RN4C		0.8	
	SS292		OE091	RN2C	8902	0.8	
	294cc	Enticer, ET300	1983 → 1984	OE091	RN2C	8902	0.8
		ET300	1979 → 1981	OE091	RN2C	8902	0.8
Inviter, CF300		1986 → 1990	OE108	RN3C	8902	0.8	
337cc	Enticer, ET340	1982 → 1988	OE091	RN2C	8902	0.8	
	ET340	1978 → 1980	OE091	RN2C	8902	0.8	
	Excel III, EC340	1981 →	OE091	RN2C	8902	0.8	
	Excel III, EC340	1983 → 1988		RN4YC	8904	0.8	
	Ovation LE, CS340	1989 → 1990	OE091	RN2C	8902	0.8	
338cc	Ovation LE, CS340	1992 → 1999	OE091	RN2C	8902	0.8	
	EX340	1976 → 1978	OE091	RN2C	8902	0.8	
	GP338	1973 → 1974	OE091	RN2C	8902	0.8	
	GPX338F	1974 → 1975	OE091	RN2C	8902	0.8	
	GS340	1976 → 1977	OE086	RL82C		0.8	
	S340F		OE091	RN2C	8902	0.8	
	SL338	1970 → 1974	OE086	RL82C		0.5	
	SRX340	1976 →	OE091	RN2C	8902	0.8	
	SS338	1970 →	OE091	RN2C	8902	0.8	
	348cc	SL350	1968 →		QL78C	8883	0.5
SL352				QL78C	8883	0.5	
396cc	GP396	1971 →		QL78C	8883	0.5	
	SL396	1970 →		QL78C	8883	0.5	
	SS396	1970 →	OE091	RN2C	8902	0.5	
	SW396	1971 →		QL78C	8883	0.5	
408cc	Enciter II, LT, ET410	1992 → 1995	OE091	RN2C	8902	0.8	
	Enticer LTR, ET400	1989 → 1990	OE116	RN6YC	8339	0.8	
433cc	EL433	1973 →	OE086	RL82C		0.5	
	EW433	1972 → 1973	OE086	RL82C		0.5	
	EX440	1976 → 1981	OE091	RN2C	8902	0.5	
	GP433	1972 → 1974	OE091	RN2C	8902	0.5	
	GP440	1976 → 1977	OE091	RN2C	8902	0.5	
	GPX433	1974 → 1975	OE091	RN2C	8902	0.5	
	PR440	1976 →	OE091	RN2C	8902	0.5	
	SL433	1972 → 1974	OE086	RL82C		0.5	
	SR433	1971 → 1973	OE091	RN2C	8902	0.5	
	SS433	1971 →	OE091	RN2C	8902	0.5	
	SS440	1977 →	OE091	RN2C	8902	0.5	
	SW433	1971 → 1973	OE086	RL82C		0.5	
	TL433	1974 →	OE086	RL82C		0.5	
	TW433	1974 →	OE086	RL82C		0.5	
	437cc	SR437E		OE091	RN2C	8902	0.5
SRX440		1981 →	OE091	RN2C	8902	0.5	
SS440		1980 → 1985	OE091	RN2C	8902	0.5	
439cc	SRX440	1976 → 1980	OE091	RN2C	8902	0.5	
485cc	Phazer, 500, Mountain Lite, SS, Elec., PZ480	1984 → 2001		RN4YC	8904	0.8	
	Venture XL, TR Elec., VT480	1991 → 2001	OE091	RN2C	8902	0.8	
493cc	VMax, VX500	1994 → 1995	OE006	RN9YC	8415	0.8	
494cc	SX500R	2000 → 2001	OE091	RN2C	8902	0.8	
	Venture 500, VT500	1997 → 2001	OE091	RN2C	8902	0.8	
	VMax 500 SX	1999 → 2001	OE091	RN2C	8902	0.8	
	VMax 500 XT, XTC, VX500	1996 → 2001	OE091	RN2C	8902	0.8	
	VMax 500 XTC Deluxe	1998 → 2001	OE091	RN2C	8902	0.8	
	535cc	SR540	1980 → 1991	OE091	RN2C	8902	0.8
VK540		1988 → 1991	OE091	RN2C	8902	0.8	
VK540, II, III		1993 → 2005	OE091	RN2C	8902	0.8	
VMax, VMX540		1983 → 1987	OE091	RN2C	8902	0.8	



**21****POWER  
SPORT****...YAMAHA**

...535cc	XL540		1985→1990	<b>OE091</b>	<b>RN2C</b>	<b>8902</b>	0.8	
	XLV		1979→	<b>OE091</b>	<b>RN2C</b>	<b>8902</b>	0.8	
545cc	EC540D		1980→	<b>OE091</b>	<b>RN2C</b>	<b>8902</b>	0.8	
569cc	Exciter EX570		1987→1993	<b>OE006</b>	<b>RN9YC</b>	<b>8415</b>	0.8	
593cc	Mountain Max 600	Liquid	2000→2002	<b>OE091</b>	<b>RN2C</b>	<b>8902</b>	0.8	
	SX 600R	Liquid	2000→2004	<b>OE091</b>	<b>RN2C</b>	<b>8902</b>	0.8	
	SX Venom, SX Venom ER		2004→2005	<b>OE091</b>	<b>RN2C</b>	<b>8902</b>	0.8	
	Venture 600	Liquid	1999→2005	<b>OE091</b>	<b>RN2C</b>	<b>8902</b>	0.8	
	VMax 600 SX, VX600		1998→2001	<b>OE091</b>	<b>RN2C</b>	<b>8902</b>	0.8	
	VMax 600 XTC Deluxe		1998→2003	<b>OE091</b>	<b>RN2C</b>	<b>8902</b>	0.8	
	VMax 600 XTC, XT		1998→2001	<b>OE091</b>	<b>RN2C</b>	<b>8902</b>	0.8	
	598cc	Mountain Max 600, MM600		1997→2002	<b>OE091</b>	<b>RN2C</b>	<b>8902</b>	0.8
		SRX600		1998→1999	<b>OE091</b>	<b>RN2C</b>	<b>8902</b>	0.8
Venture 600, VT600			1997→	<b>OE091</b>	<b>RN2C</b>	<b>8902</b>	0.8	
Venture 600, VT600			1998→	<b>OE091</b>	<b>RN2C</b>	<b>8902</b>	0.8	
VMax 600 SX, VX600			1998→	<b>OE091</b>	<b>RN2C</b>	<b>8902</b>	0.8	
VMax 600 SX, VX600			1994→1997		<b>RN4YC</b>	<b>8904</b>	0.8	
VMax 600 XTC Deluxe			1998→	<b>OE091</b>	<b>RN2C</b>	<b>8902</b>	0.8	
VMax 600 XTC, XT			1998→1999	<b>OE091</b>	<b>RN2C</b>	<b>8902</b>	0.8	
VMax 600 XTC, XT			1994→1997		<b>RN4YC</b>	<b>8904</b>	0.8	
643cc		EW643			<b>OE108</b>	<b>RN3C</b>	<b>8902</b>	0.8
		GP643		1972→1973	<b>OE108</b>	<b>RN3C</b>	<b>8902</b>	0.8
	SR643		1972→1973	<b>OE091</b>	<b>RN2C</b>	<b>8902</b>	0.8	
	696cc	Mountain Viper		2003→2005	<b>OE091</b>	<b>RN2C</b>	<b>8902</b>	0.8
SRX 700, Mountain SRX 700			1998→2002		<b>C57</b>		0.8	
SX Viper, ER		Liquid	2002→2005	<b>OE091</b>	<b>RN2C</b>	<b>8902</b>	0.8	
SXR700			2001→	<b>OE091</b>	<b>RN2C</b>	<b>8902</b>	0.8	
698cc	Mountain Max 700, MM700		1998→2004		<b>RN4YC</b>	<b>8904</b>	0.8	
	Venture 700		1998→2004	<b>OE091</b>	<b>RN2C</b>	<b>8902</b>	0.8	
	VMax 700 SX, VX700		1997→2001	<b>OE091</b>	<b>RN2C</b>	<b>8902</b>	0.8	
	VMax 700 XTC, Deluxe, XT		1997→2002	<b>OE091</b>	<b>RN2C</b>	<b>8902</b>	0.8	
743cc	VMax-4, VX750		1993→1994	<b>OE091</b>	<b>RN2C</b>	<b>8902</b>	0.8	
750cc	VMax-4, VX750		1992→	<b>OE091</b>	<b>RN2C</b>	<b>8902</b>	0.8	
791cc	Mountain Max, MM800		1997→	<b>OE091</b>	<b>RN2C</b>	<b>8902</b>	0.8	
	VMax, VX800		1995→1997	<b>OE091</b>	<b>RN2C</b>	<b>8902</b>	0.8	
973cc	RS Rage, Venture		2005→		<b>G59C</b>		0.7	
	Vector, Vector Mountain		2005→		<b>G59C</b>		0.7	
998cc	RX Warrior	4-Cycle	2004→2005		<b>G57C</b>		0.7	
	RX-1 Mountain	4-Cycle	2003→2005		<b>G57C</b>		0.7	
	RX-1, ER	4-Cycle	2003→2005		<b>G57C</b>		0.7	



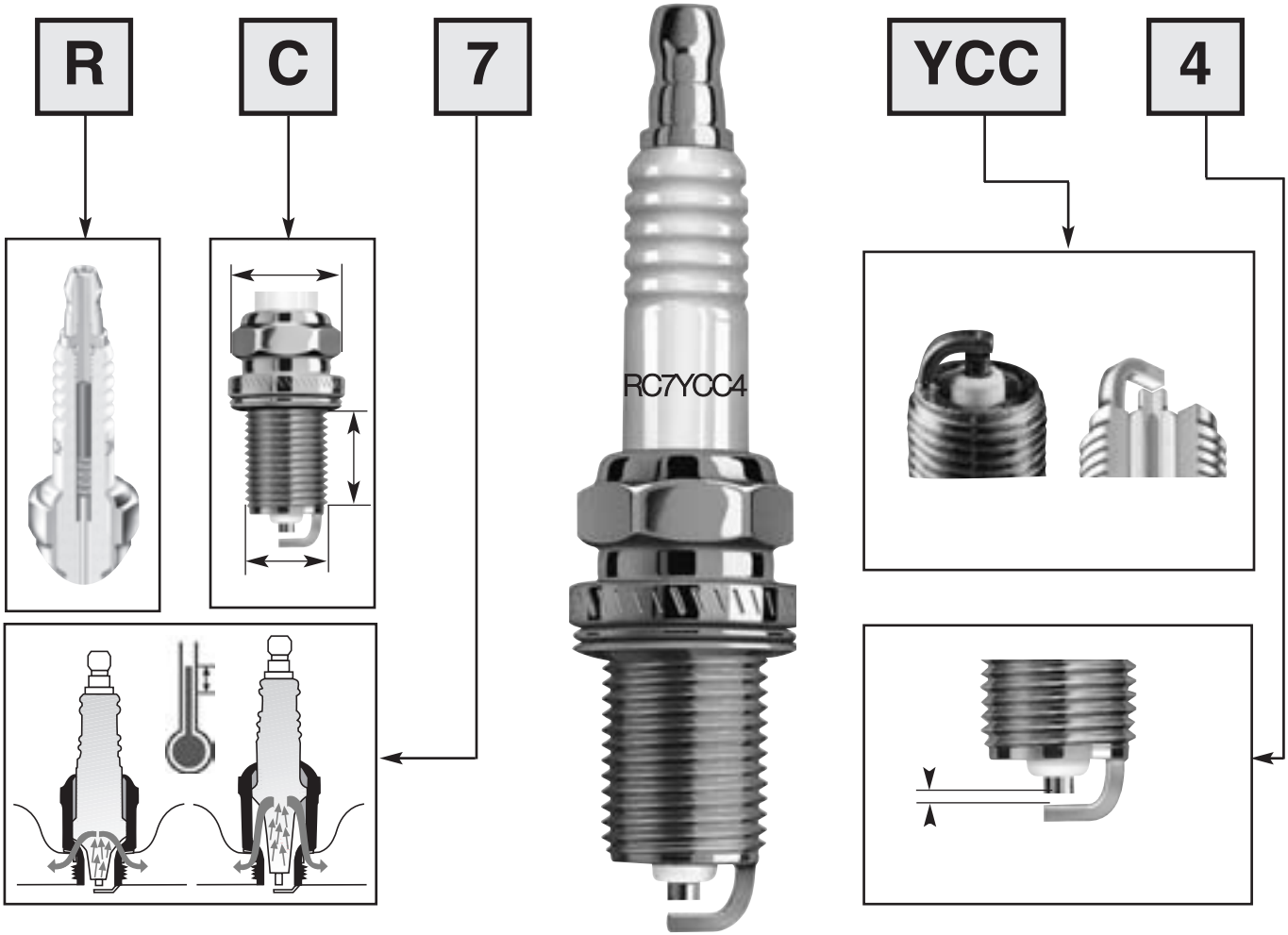

**R** **C** **7** **YCC** **4**

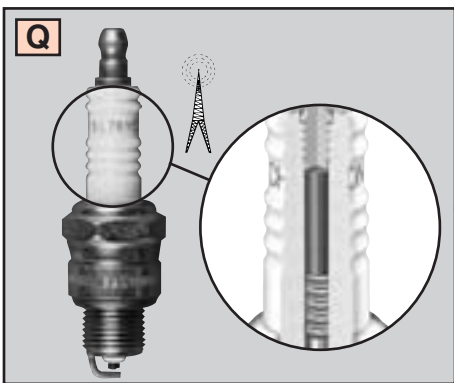

Resistor  
Resistance  
Widerstand/  
Resistor  
Resistore  
Resistencia  
Weerstand  
Resistència  
ΑΝΤΙΣΤΑΣΗ

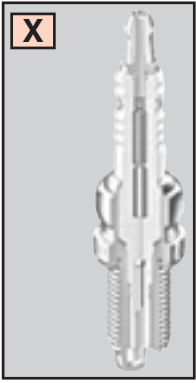
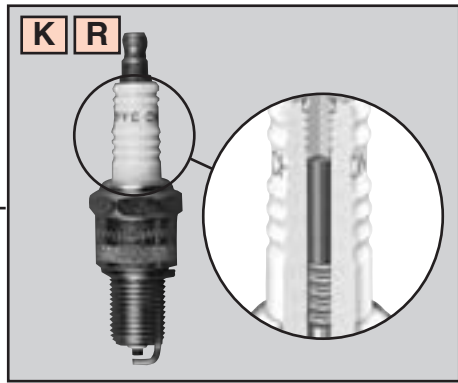

Suppressor  
Resistor

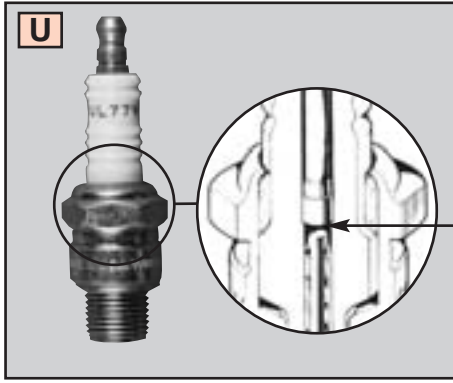

Auxiliary gap  
Ecartement auxillaire  
Elektrodenabstand  
Scarica auxiliare  
Seperación auxiliar  
Extra onderbreking  
Folga auxiliar  
ΔΙΑΚΕΝΟ

# R C 7 YCC 4

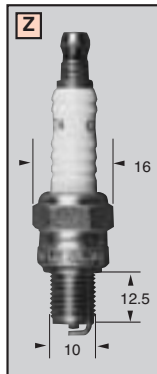
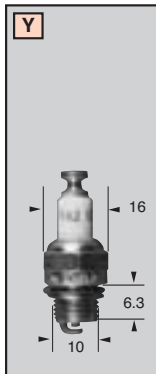
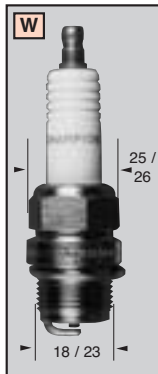
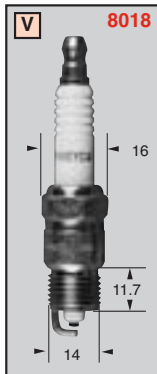
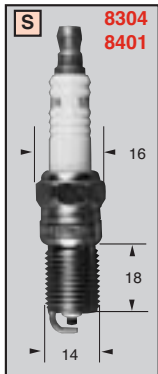
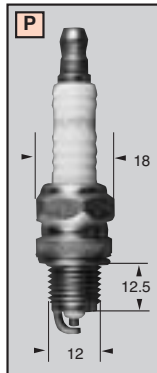
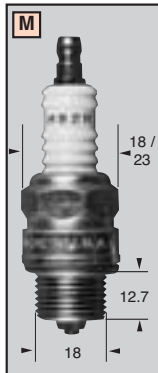
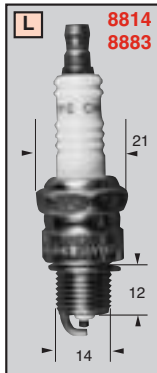
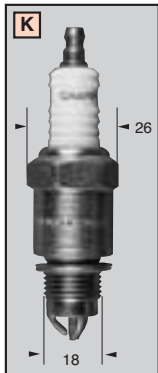
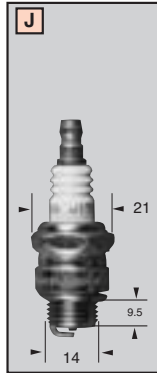
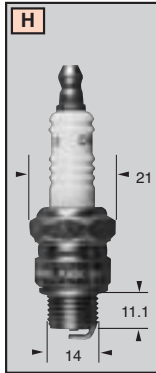
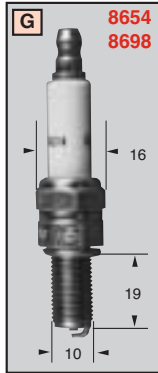
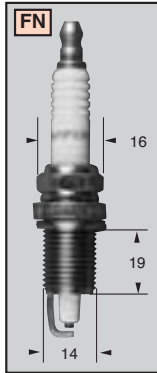
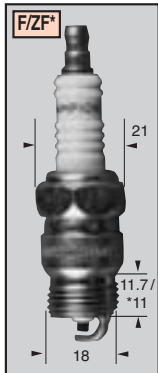
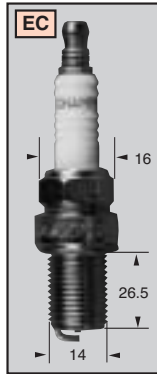
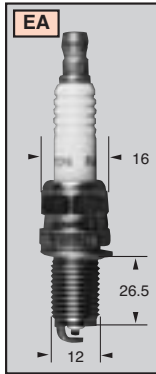
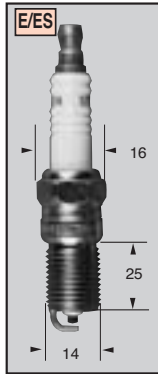
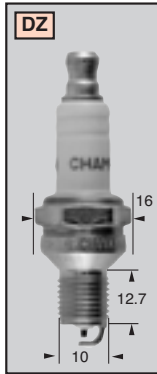
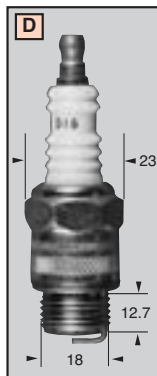
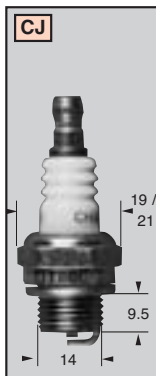
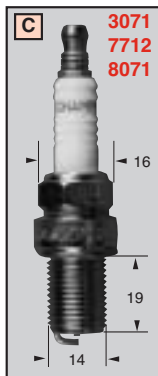
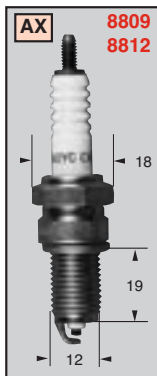
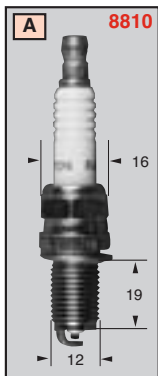

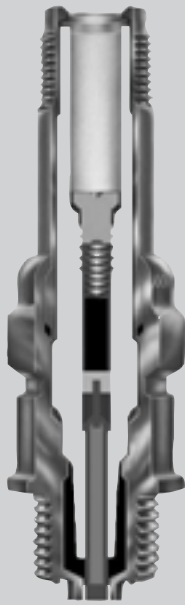

ED	RHM	XEJ
HW	RHN	XEN
REM	RHW	XMJ
REW	RML	XML
RHB	XED	XMN

Shielded  
Blindé  
Blindado  
Protegido  
Geschirmte  
Schermato  
Gepantserde

R C 7 YCC 4

1 - ...

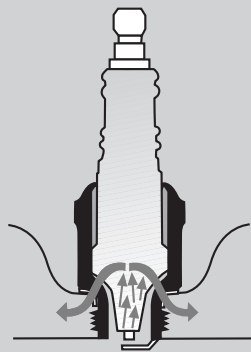

... - 379

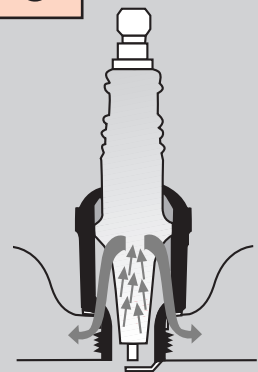
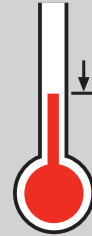

# R C 7 YCC 4

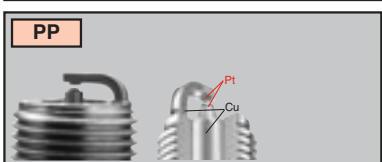
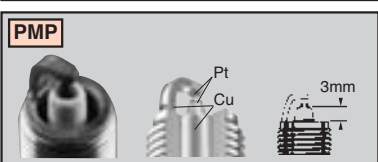
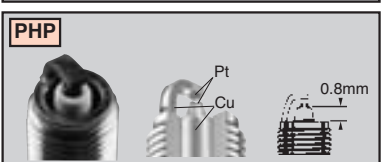
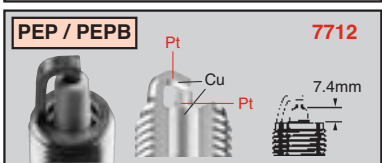
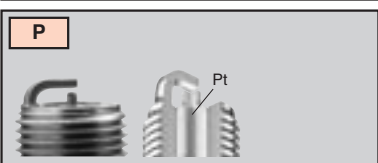
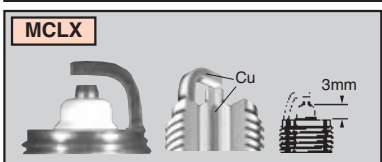
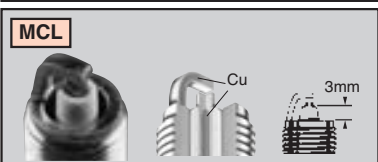
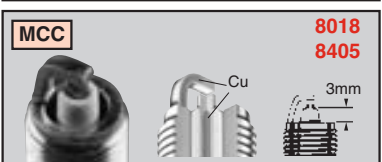
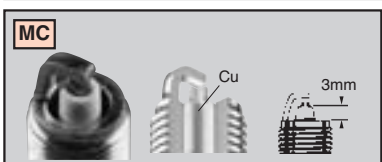
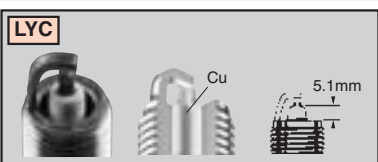
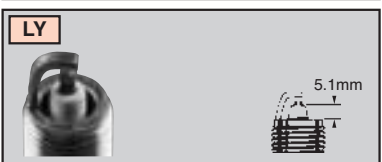
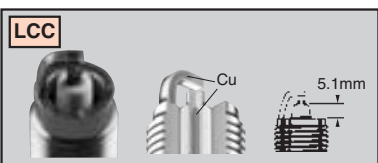
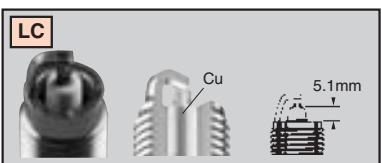
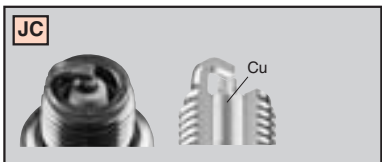
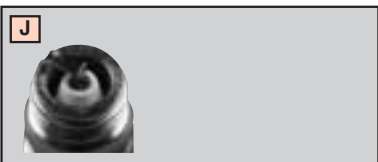
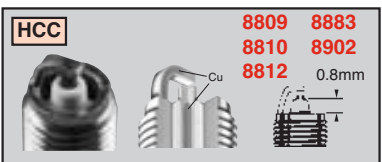
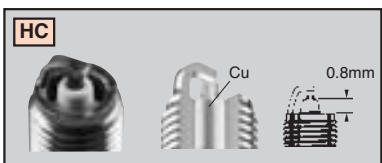
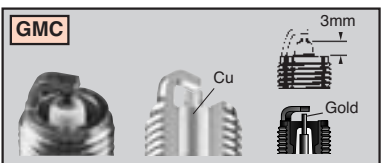
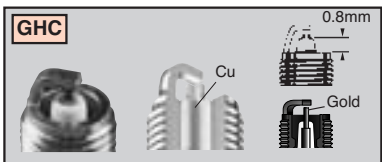
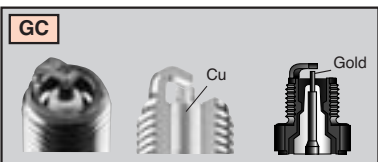
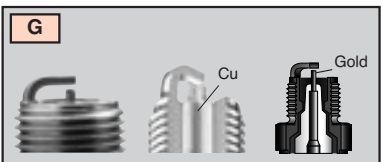
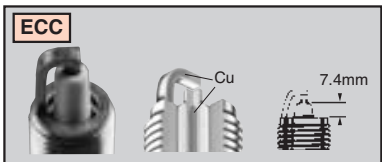
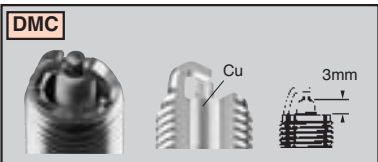
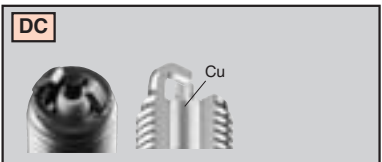
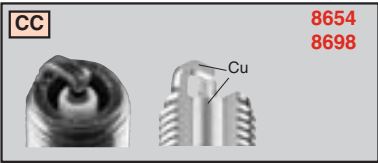
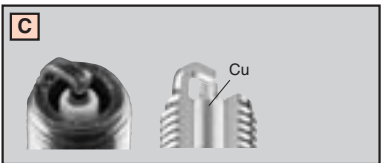
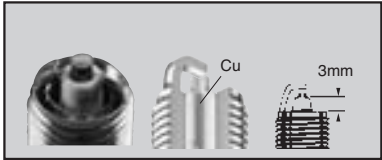
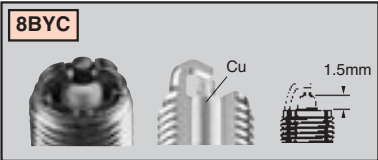
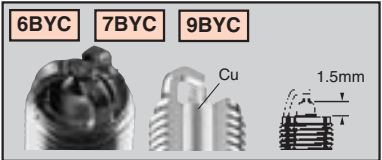

# R C 7 YCC 4

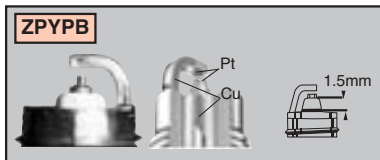
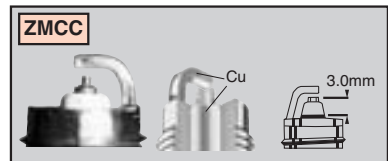
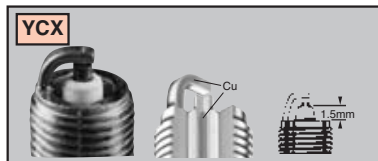
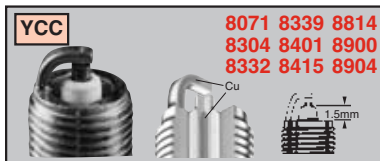
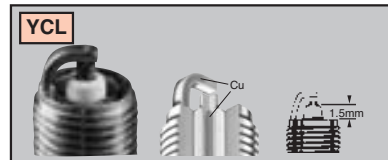
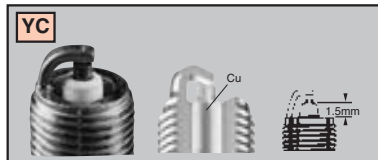
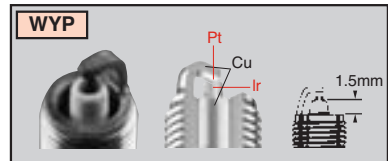
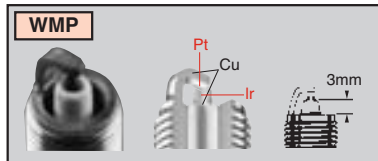
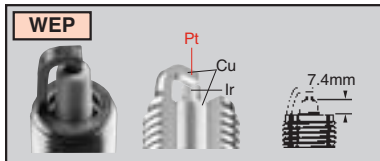
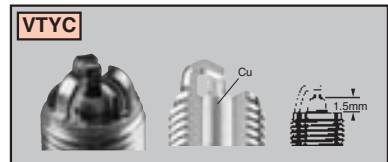
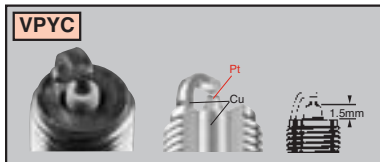
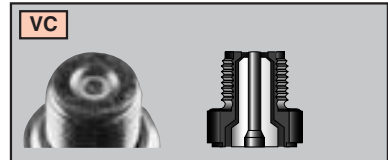
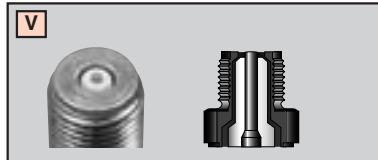
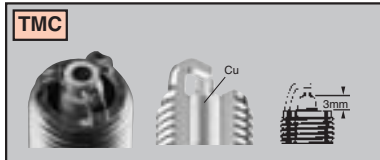
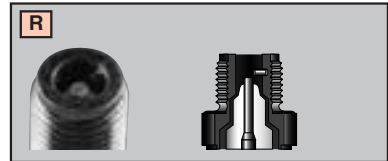
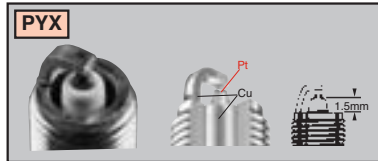
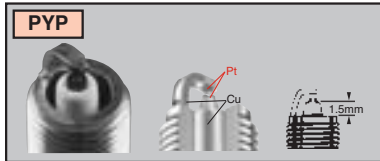
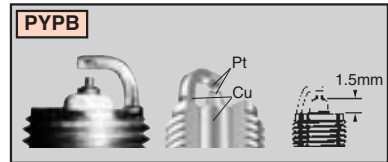
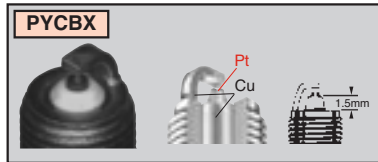
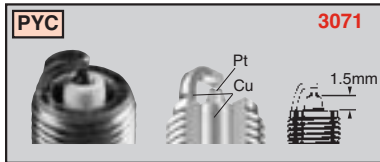

# R C 7 YCC 4

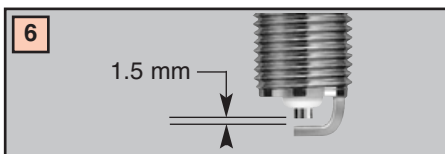
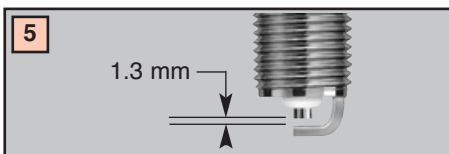
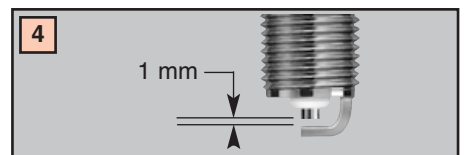
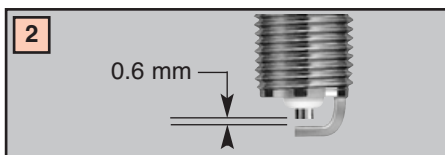
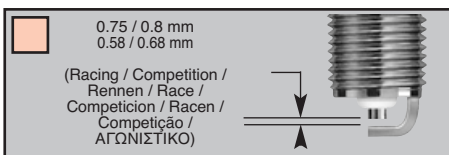

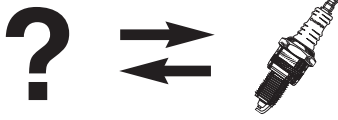

**(GB)**

**CAUTION**

Do not use this chart unless you are unable to find your vehicle or equipment listed in the application sections of this catalogue

**(D)**

**ACHTUNG**

Verwenden Sie nicht diese Tabelle, wenn keine Zuordnung für Ihr Fahrzeug (Boot) oder Ihren motor in den Empfehlungslisten dieser Kataloge aufgeführt ist.

**(E)**

**PRECAUCION**

solamente utilice los cruces de referencias si la aplicacion requerida no esta incluida en el catalogo (seccion aplicaciones)

**(F)**





**ATTENTION**

Ne pas utiliser ce tableau sauf si vous n'êtes pas en mesure de trouver votre bateau ou matériel dans les listes d'applications de ce catalogue.

**(I)**

**ATTENZIONE**

non usare questa tabella a meno che il vostro motore non sia elencato nella sezione applicazioni di questo catalogo

AC DELCO 		...AC DELCO 		...AC DELCO 		...AC DELCO 	
10	RV8C	43XLS	N12YC	C41CXL	N7YC	CR44NS	OE065
40TS	RV9YC	43XLS	N9YC	C41CXL	OE010	CR44NS	RN14YC
41-103	OE029	43XLS	OE001	C41CXL	OE087	CR45	RH10C
41-103	RES9PYP4	43XLS	OE015	C42CLTS	OE050	CR83T	RF10C
41-105	OE029	440XLS	N6YC	C42CLTS	S7YC	FR1LS	OE005
41-105	RES9PYP4	440XLS	OE087	C42CXL	N9YC	FR1LS	OE039
41-907	OE039	44CF	L86C	C42CXL	OE001	FR1LS	RC9YC
41-907	RC9YC4	44CF	OE037	C42N	N4C	FR1LS	RC9YC4
41-913	OE039	44F	L86C	C42N	OE079	FR2CLS	OE005
41-913	RC9YC4	44F	OE037	C43N	N5C	FR2CLS	RC9YC
41-932	RS14PYP5	44FFS	L92YC	C43N	OE074	FR2LS	OE005
41-954	OE029	44FFS	OE059	C44N	N5C	FR2LS	RC9YC
41-954	OE031	44N	N5C	C44N	OE074	FR3CLS	OE013
41-954	RES9PYP4	44N	OE074	C44NS	N11YC	FR3CLS	RC12YC
41-954	RES9YCC4	44NS	N12YC	C44NS	OE065	FR3LM	OE041
41-993	RS14PYP5	44NS	OE015	C44NS	RN14YC	FR3LM	RC12LYC
41CXLS	N7YC	44NS	RN14YC	C44S	J12YC	FR3LS	OE013
41CXLS	OE010	44S	J12YC	C44XL	N4C	FR3LS	RC12YC
41TS	RV9YC	44XL	N5C	C44XL	N5C	FR3LS6	RC12YC5
41XL	N2C	44XL	OE074	C44XL	OE074	FR4LE	OE041
41XL	OE040	44XLO	N12YC	C44XL	OE079	FR4LE	RC12LYC
41XLS	N9YC	44XLO	OE015	C45L	H10C	FR5LS	OE013
41XLS	OE001	44XLO	RN14YC	C73	W10	FR5LS	RC12YC
42	L82C	44XLS	N12YC	C75	W14	M42FF	L82C
42-6FS	L87YC	44XLS	OE015	C77	W16Y	M43FF	L86C
42-6FS	OE007	44XLS	RN14YC	C77L	W18	M43FF	OE037
42CF	L86C	45F	L86C	C82	D9	M43FF	RL86C
42CF	OE037	45F	OE037	C83	D9	M43S	J12YC
42CXL	N9YC	45FFS	L92YC	C85S	D15Y	M45FF	L86C
42CXL	OE001	45FFS	OE059	C85TS	RF11YC	M45FF	OE037
42FS	L82YC	45L	H10C	C86	D14	MR42FF	OE086
42FS	OE038	45NS	RN14YC	C86S	D18Y	MR42FF	RL82C
42LTS	OE011	45XL	N5C	C88	D21	MR43FF	L86C
42LTS	RS9YC	45XL	OE074	C88L	D23	MR43FF	OE037
42S	J12YC	45XLS	RN14YC	CFR1CLS	OE110	MR43LTS	RS12YC
42TS	RV12YC	46F	L86C	CFR1CLS	RC6YC	MR43T	RV8C
42XL	N3C	46F	OE037	CFR1CLS(black)	OE043	MR44C	RJ6C
42XL	OE068	46FFS	L92YC	CFR1CLS(black)	RC7YC	R40TS	RV9YC
42XLS	N11YC	46FFS	OE059	CFR2CLS	OE043	R41CF	RL78C
42XLS	N9YC	46N	N5C	CFR2CLS	RC7YC	R41CLS	OE018
42XLS	OE001	46N	OE074	CFR2CLS(black)	OE005	R41CLS	RN7YC
42XLS	OE065	46TS	RV17YC	CFR2CLS(black)	RC9YC	R41CXL	OE091
43CLS	N11YC	46XL	N5C	CR42LTS	OE011	R41CXL	RN2C
43CLS	OE065	46XL	OE074	CR42LTS	RS9YC	R41CXL	OE018
43CXL	N11YC	46XLS	RN14YC	CR42N	OE098	R41CXL	RN7YC
43CXL	OE065	47XL	N5C	CR42N	RN4C	R41TS	RV9YC
43FS	L87YC	47XL	OE074	CR42TS	RV12YC	R41XL	OE091
43FS	OE007	83TS	F9YC	CR43	RJ6C	R41XL	RN2C
43N	N4C	83TS	RF9YC	CR43CXLS	OE051	R41XLS	OE018
43N	N5C	90414815	EON2	CR43CXLS	RN11YC	R41XLS	RN7YC
43N	OE074	90414815	OE066	CR43K	RJ6C	R42CF	OE086
43N	OE079	90414815	RC9MCC	CR43L	RH8C	R42CF	RL82C
43S	J12YC	B403	UJ11G	CR43N	OE098	R42CFS	OE064
43XL	N4C	B44S	J12YC	CR43N	RN4C	R42CFS	RL82YC
43XL	N5C	BR42TS	RV12YC	CR43N	RN5C	R42CLTS	OE011
43XL	OE074	C41CXL	N279YC	CR44N	RN5C	R42CLTS	RS12YC
43XL	OE079	C41CXL	N6YC	CR44NS	N11YC	R42CLTS	RS9YC



...AC DELCO	CHAMPION	...AC DELCO	CHAMPION	AUTOLITE	CHAMPION	...AUTOLITE	CHAMPION
R42CTS	RV12YC	R45SX	RJ12YC6	103	OE011	402	RN3C
R42CTS	RV9YC	R45XL	RN5C	103	OE020	403	OE098
R42CXL	OE098	R45XLS	RN14YC	103	OE131	403	OE108
R42CXL	OE108	R46LTS	RS12YC	103	RS9PYP4	403	RN3C
R42CXL	RN3C	R46LTS	RS14YC	103	RS9YC	403	RN4C
R42CXL	RN4C	R46N	N5C	103	RS9YCC	404	OE098
R42CXLS	OE006	R46N	OE074	104	RS12YC	404	RN4C
R42CXLS	RN9YC	R46S	RJ18YC	105	RS12YC	404	RN5C
R42F	OE086	R46SX	RJ18YC8	106	RS14YC	405	RN5C
R42F	RL82C	R46SZ	RJ18YC6	12	RV9YC	4054	N2C
R42LTS	OE009	R46TS	RV17YC	13	RV9YC	4054	OE040
R42LTS	RS12YC	R46TSX	RV17YC6	14	RV12YC	4055	N3C
R42LTS	S9YC	R46XL	N5C	15	RV12YC	4055	OE068
R42TS	RV12YC	R46XL	OE074	203	RV12YC	4056	N4C
R42TS	RV9YC	R46XLS	RN14YC	23	RV9YC	4056	OE079
R42TSM	RV12YC	R47S	RJ18YC	24	RV12YC	406	RN5C
R42TSM	RV9YC	R47SX	RJ18YC	258	CJ14	4114	L87YC
R42XL	OE108	R47SX	RJ18YC6	2594	N3C	4114	OE007
R42XL	RN3C	R83CT	RF10C	2594	OE068	4132	OE083
R42XLS	OE006	R83CTS	RF9YC	2612	N2C	4132	RA6HC
R42XLS	RN9YC	R83T	RF10C	2612	OE040	4133	OE083
R42XLS6	OE006	R83TS	RF9YC	2614	N2C	4133	RA6HC
R42XLS6	OE048	R84TS	RF11YC	2614	OE040	414	L86C
R42XLS6	RN9YC	R84TSX	RF11YC	2615	N4C	414	OE037
R42XLS6	RN9YC4	R85T	RF10C	2615	OE079	415	L86C
R43	RJ6C	R85TS	RF14YC	2616	N5C	415	OE037
R43C	RJ6C	R86T	RF10C	2616	OE074	4163	OE083
R43CXL	OE098	R86TS	RF14YC	2656	L86C	4163	RA6HC
R43CXL	RN4C	S404XLG	C57R	2656	OE037	4164	OE083
R43CXL	RN5C	S408XLG	C59R	273	L82YC	4164	RA6HC
R43CXLS	OE049	S40F	L82C	273	OE038	417	L86C
R43CXLS	RN11YC4	S41XL	N2C	274	L87YC	417	OE037
R43LTS	RS12YC	S41XL	OE040	274	OE007	4253	N9YC
R43LTSX	RS12YC	S41XLR	OE091	2755	OE083	4253	OE001
R43XL	RN5C	S41XLR	RN2C	2755	RA6HC	4265	OE042
R43XLS	OE042	S42F	L82C	3136	UY6	4265	RN12YC
R43XLS	RN12YC	S42XL	N3C	3176	N5C	44	RF9YC
R44	RJ8C	S42XL	OE068	3176	OE074	483	OE011
R44CF	RL86C	S42XLR	OE108	32	RF9YC	483	OE020
R44CXL	RN5C	S42XLR	RN3C	33	RF9YC	483	OE131
R44CXLS	OE051	S438XLS	N6YC	3303	RV9YC	483	RS9PYP4
R44CXLS	RN11YC	S438XLS	OE087	34	RF9YC	483	RS9YC
R44CXLS	RN14YC	S43XL	N5C	3895	OE041	483	RS9YCC
R44F	L86C	S43XL	OE074	3895	RC12LYC	51	N6YC
R44F	OE037	S43XLR	RN5C	3922	OE039	51	N6YCC
R44LT	OE011	S44F	L86C	3922	OE080	51	OE084
R44LT	RS9YC	S44F	OE037	3922	RC7YC4	51	OE087
R44LTS	RS12YC	S44XL	N5C	3922	RC9YC4	52	N7YC
R44LTS	RS14YC	S44XL	OE074	3923	OE039	52	OE010
R44LTSM	RS13LYC	S45F	L86C	3923	RC9YC4	5224	OE013
R44N	RN5C	S45F	OE037	3924	OE013	5224	RC12YC
R44NS	OE042	S82F	D9	3924	RC12YC	53	N9YC
R44NS	RN12YC	S83F	D9	393	N3C	53	OE001
R44NS	RN14YC	S85F	D14	393	N4C	535	L86C
R44SX	RJ12YC6			393	OE068	535	OE037
R44XL	RN5C			393	OE079	54	N11YC
R44XLS	RN14YC			394	N5C	54	OE065
R44XLSE	OE156	<b>ALM</b>		394	OE074	55	N12YC
R44XLSE	RN13LYC	ALM 19	J19LM	395	N5C	55	OE015
R44XLSM	OE156	ALM 8	CJ8	395	OE074	56	RN14YC
R44XLSM	RN13LYC			396	N5C	57	RN14YC
R45	RJ8C	<b>ATLAS</b>		396	OE074	605	RS12YC
R45LS	RH10C			397	N5C	63	OE006
R45LTS6	RS14YC6			397	OE074	63	RN9YC
R45NS	OE042			402	OE091	64	OE049
R45NS	RN12YC			402	OE108	64	OE101
R45NS	RN14YC			402	RN2C	64	RN11YC4



...AUTOLITE		CHAMPION
64	RN11YCC4	
65	OE042	
65	RN12YC	
66	RN14YC	
67	RN14YC	
704	RV9YC	
724	RV9YC	
725	RV12YC	
745	RF9YC	
764	RS12YC	
765	RS12YC	
766	RS14YC	
767	RS14YC	
865	RS12YC	
893	N9YC	
893	OE001	
94	OE011	
94	OE020	
94	OE131	
94	RS9PYP4	
94	RS9YC	
94	RS9YCC	
AGPR22P	OE145	
AGPR22P	RC89PYC	
AGRF22D1	OE131	
AGRF22D1	RS9PYP4	
AGRF22PP	OE131	
AGRF22PP	RS9PYP4	
AGSF22PPJ	OE131	
AGSF22PPJ	RS9PYP4	
AWSF22FS	OE131	
AWSF22FS	RS9PYP4	
BERU		CHAMPION
12-5DU	OE083	
12-5DU	RA6HC	
12VR-8SE	OE130	
12VR-8SE	REA8MCL	
14 F-6 DPUR021	OE136	
14 F-6 DPUR021	RC8PYP	
14 F-8DUR	KC10PYPB4	
14 F-8DUR	OE191	
14 FGH-7 DTURX	OE032	
14 FGH-7 DTURX	RC8VTYC4	
14 FGH-8 DTURXO	OE032	
14 FGH-8 DTURXO	RC8VTYC4	
14 FGR-8 MQPU	OE175	
14 FGR-8 MQPU	REC10PYC4	
14 FR-7 DPU3	OE136	
14 FR-7 DPU3	RC8PYP	
14 FR-8 NQU213	OE178	
14 FR-8 NQU213	REC9MCLX	
14-10A	L86C	
14-10A	OE037	
14-10B	L92YC	
14-10B	OE059	
14-10DU	N12YC	
14-10DU	OE015	
14-4A1	L82C	
14-4CS1	C53R	
145	L86C	
145	OE037	
145/14	L86C	
145/14	OE037	
145/14/3	N5C	

...BERU		CHAMPION
145/14/3	OE074	
145/18	D14	
145/18K	F9YC	
145/18K	OE054	
145/18K	RF7YC	
145/3	N5C	
145/3	OE074	
14-5A	L82C	
14-5AU	OE086	
14-5AU	RL82C	
14-5BU	L82YC	
14-5BU	OE038	
14-5D	N6YC	
14-5D	OE087	
14-5DTU	N6BYC	
14-5DTU	OE109	
14-5DU	N6YC	
14-5DU	OE087	
14-5DUU	N6YCC	
14-5DUU	OE084	
14-6BU	L82YC	
14-6BU	OE038	
14-6DTU	C6BYC	
14-6DTU	N6BYC	
14-6DTU	OE076	
14-6DTU	OE109	
14-6DU	N279YC	
14-6DU	N7YC	
14-6DU	N9YC	
14-6DU	OE001	
14-6DU	OE010	
14-7 DU0	N7BYC	
14-7 DU0	OE012	
14-7AU	L86C	
14-7AU	OE037	
14-7BU	L87YC	
14-7BU	L92YC	
14-7BU	OE007	
14-7BU	OE059	
14-7CU	N4C	
14-7CU	N5C	
14-7CU	OE074	
14-7CU	OE079	
14-7DTU	N7BYC	
14-7DTU	N9BYC	
14-7DTU	OE012	
14-7DTU	OE044	
14-7DU	N9YC	
14-7DU	OE001	
14-8 LUR	OE060	
14-8 LUR	RN9LCC	
14-8A	L86C	
14-8A	OE037	
14-8AU	L86C	
14-8AU	OE037	
14-8B	L92YC	
14-8B	OE059	
14-8BU	L92YC	
14-8BU	OE059	
14-8C	N5C	
14-8C	OE074	
14-8DTU	N9BYC	
14-8DTU	N9BYC4	
14-8DTU	OE028	
14-8DTU	OE044	
14-8DU	N11YC	
14-8DU	N12YC	

...BERU		CHAMPION
14-8DU	OE015	
14-8DU	OE065	
14-9DU	N11YC	
14-9DU	OE065	
14A	L82YC	
14A	L87YC	
14A	OE007	
14A	OE038	
14F-5DU	C6YCC	
14F-5DU	C7YC	
14F-5DU	OE017	
14F-5DU	OE075	
14F-6DTU	C6BYC	
14F-6DTU	OE076	
14F-6DU	C7YC	
14F-6DU	C7YCC	
14F-6DU	OE017	
14F-6DU	OE058	
14F-6DUOR	OE043	
14F-6DUOR	RC7YC	
14F-6DUOR	C7YCC	
14F-6DUOR	OE058	
14F-6HTPRX02	KC8ZPYPB4	
14F-6HTPRX02	OE176	
14F-7DPUR02	OE136	
14F-7DPUR02	RC8PYP	
14F-7DPURX2	KC8WYP4	
14F-7DPURX2	OE181	
14F-7DU	C9YC	
14F-7DU	C9YCC	
14F-7DU	OE003	
14F-7DU	OE023	
14F-7DU0	C9YCC	
14F-7DU0	OE023	
14F-7HUR2	KC8ZMCC	
14F-7HUR2	OE177	
14F-7LDUR	OE026	
14F-7LDUR	RC8DMC	
14F-7LDUR4	OE026	
14F-7LDUR4	RC8DMC	
14F-8DU0	C11YCC	
14F-8DU0	OE057	
14F-8DU4	C11YCC	
14F-8DU4	OE057	
14F-8LDUR	OE019	
14F-8LDUR	RC10DMC	
14F-8LUR	OE066	
14F-8LUR	RC9MCC	
14F-9DU0	OE013	
14F-9DU0	RC12YC	
14FGH-6DTUR	OE032	
14FGH-6DTUR	RC8VTYC4	
14FGH-7DTURX	OE032	
14FGH-7DTURX	RC8VTYC4	
14FGH-8DPURX2	KC10PYPB4	
14FGH-8DPURX2	OE191	
14FGR-6DDU	OE120	
14FGR-6DDU	RC89TMC	
14FGR-6KQU	OE120	
14FGR-6KQU	RC89TMC	
14FGR-8CTU	OE120	
14FGR-8CTU	RC89TMC	
14FGR-8DQU7	OE120	
14FGR-8DQU7	RC89TMC	
14FLR-8LDUX	OE019	
14FLR-8LDUX	RC10DMC	
14FR-5DPUX	OE136	





...BERU		CHAMPION
14FR-5DPUX	OE144	
14FR-5DPUX	RC87PYC	
14FR-5DPUX	RC8PYP	
14FR-5DTU	OE043	
14FR-5DTU	RC7YC	
14FR-5DU	OE110	
14FR-5DU	RC6YC	
14FR-6BPUX	OE145	
14FR-6BPUX	RC89PYC	
14FR-6DPUX	OE145	
14FR-6DPUX	RC89PYC	
14FR-6DU	C9YC	
14FR-6DU	OE003	
14FR-6DU	OE005	
14FR-6DU	OE014	
14FR-6DU	OE043	
14FR-6DU	RC7YC	
14FR-6DU	RC7YCC	
14FR-6DU	RC9YC	
14FR-6DUX	OE056	
14FR-6DUX	OE080	
14FR-6DUX	RC7YC4	
14FR-6DUX	RC7YCC4	
14fr-6ldu	OE021	
14FR-6LDU	OE026	
14fr-6ldu	RC7BMC	
14FR-6LDU	RC8DMC	
14FR-6LDU3	OE102	
14FR-6LDU3	RC87YCC	
14FR-7DPU3	OE136	
14FR-7DPU3	RC8PYP	
14FR-7DU	OE002	
14FR-7DU	OE005	
14FR-7DU	RC9YC	
14FR-7DU	RC9YCC	
14FR-7DU2	OE033	
14FR-7DU2	OE034	
14FR-7DU2	RC87YCL	
14FR-7DU2	RC8YCL	
14FR-7DUX	OE024	
14FR-7DUX	OE039	
14FR-7DUX	RC9YC4	
14FR-7DUX	RC9YCC4	
14FR-7KDU	OE026	
14FR-7KDU	RC8DMC	
14FR-7KPU	OE124	
14FR-7KPU	RC10PYP4	
14FR-7KPUV	OE124	
14FR-7KPUV	RC10PYP4	
14FR-7KPUX	OE136	
14FR-7KPUX	RC8PYP	
14FR-7KU	OE066	
14FR-7KU	RC9MCC	
14FR-7KU0	OE066	
14FR-7KU0	RC9MCC	
14FR-7KU0	OE089	
14FR-7KU0	RC9MCC4	
14FR-7LUDU	OE026	
14FR-7LDU	RC8DMC	
14FR-7LUX	OE089	
14FR-7LUX	RC9MCC4	
14FR-7MU2	OE178	
14FR-7MU2	REC9MCLX	
14FR-8DPU2	OE145	
14FR-8DPU2	RC89PYC	





...BERU	CHAMPION	...BERU	CHAMPION	...BERU	CHAMPION	...BERU	CHAMPION
14FR-8DU	OE013	14KR-7DU	OE011	18-8A	D14	Z16	RC9YC4
14FR-8DU	OE016	14KR-7DU	OE020	18K7BU	OE054	Z17	OE009
14FR-8DU	OE088	14KR-7DU	RS9YC	18K7BU	RF7YC	Z17	S9YC
14FR-8DU	RC10YC	14KR-7DU	RS9YCC	18K-7BU	OE054	Z171	KC8WYP4
14FR-8DU	RC10YCC	14KR-8DPUOV	OE131	18K-7BU	RF7YC	Z171	OE181
14FR-8DU	RC12YC	14KR-8DPUOV	RS9PYP4	18K8B	OE054	Z18	OE009
14FR-8HU	OE041	14KR-8MUV	OE031	18K8B	RF7YC	Z18	S9YC
14FR-8HU	RC12LYC	14KR-8MUV	RES9YCC4	18K-8B	F9YC	Z183	OE035
14FR-8KU	OE089	14R-5DU	OE116	18K-8BU	RF9YC	Z183	REC9YCL
14FR-8KU	RC9MCC4	14R-5DU	RN6YC	200/3A	N7YC	Z184	OE178
14FR-8KUO	OE089	14R-6DU	OE008	200/3A	OE010	Z184	REC9MCLX
14FR-8KUO	RC9MCC4	14R-6DU	OE018	225	L82YC	Z194	OE102
14FR-8LDU	OE019	14R-6DU	RN7YC	225	OE038	Z194	RC87YCC
14FR-8LDU	RC10DMC	14R-6DU	RN7YCC	225/14	L82C	Z2	N9BYC4
14FR-8LDU3	OE019	14R-6DUX	OE117	225/14A	L82YC	Z2	OE028
14FR-8LDU3	RC10DMC	14R-6DUX	RN7YC4	225/14A	OE038	Z20	OE006
14FR-8LU2	OE089	14R-7BU	OE064	225/3A	N6YC	Z20	RN9YC
14FR-8LU2	RC9MCC4	14R-7BU	RL82YC	225/3A	OE087	Z200	KC8ZMCC
14FR-8MU2	OE035	14R-7CU	OE098	260/14	L82C	Z200	OE177
14FR-8MU2	REC9YCL	14R-7CU	RN4C	260/14/35	C59R	Z203	OE089
14G-8DTU	N9BMC	14R-7DU	OE004	95/14	L92YC	Z203	RC9MCC4
14G-8DTU	OE100	14R-7DU	OE006	95/14	OE059	Z23	OE043
14GH-7DTUR	N7BMC	14R-7DU	RN9YC	S5	N7YC	Z23	RC7YC
14GH-7DTUR	OE025	14R-7DU	RN9YCC	S5	OE010	Z238	OE145
14GH-7DTUR	OE095	14R-7DUX	OE047	S7	N7YC	Z238	RC89PYC
14GH-7DTUR	RN8VTYC4	14R-7DUX	OE048	S7	OE010	Z24	OE014
14GH-8DTUR	OE027	14R-7DUX	RN9YC4	UX56	EON5	Z24	RC7YCC
14GH-8DTUR	RN10VTYC4	14R-7DUX	RN9YCC4	UX79	EON6	Z25	OE050
14GH-8DTURX	OE027	14R-8DU	OE006	UXF79	EON1	Z25	S7YC
14GH-8DTURX	RN10VTYC4	14R-8DU	OE042	UXF79	EON2	Z27	OE018
14GR-8DTU	N9BMC	14R-8DU	OE051	UXK56	EON1	Z27	RN7YC
14GR-8DTU	OE100	14R-8DU	RN11YC	UXK56	EON2	Z3	OE060
14K-5DU	OE050	14R-8DU	RN12YC	UXK79	EON3	Z3	RN9LCC
14K-5DU	OE090	14R-8DU	RN9YC	Z1	N11YC	Z30	OE110
14K-5DU	S6YC	14R-8DU	OE004	Z1	OE065	Z30	RC6YC
14K-5DU	S7YC	14R-8DU4	OE004	Z10	L82YC	Z31	OE090
14K-6BU	OE067	14R-8DUX	OE049	Z10	OE038	Z31	S6YC
14K-6BU	S7YCC	14R-8DUX	OE113	Z100	C11YCC	Z32	OE054
14K-6DU	OE009	14R-8DUX	RN10YC4	Z100	OE057	Z32	RF7YC
14K-6DU	OE050	14R-8DUX	RN11YC4	Z11	OE006	Z4	C9YC
14K-6DU	S7YC	14R-9DU	OE042	Z11	RN9YC	Z4	OE003
14K-6DU	S9YC	14R-9DU	OE045	Z116	OE026	Z42	N6YC
14K-7DU	OE009	14R-9DU	RN11YCC	Z116	RC8DMC	Z42	OE087
14K-7DU	OE011	14R-9DU	RN12YC	Z119	OE004	Z45	OE043
14K-7DU	RS9YC	14Z-3CU	N2C	Z119	RN9YCC	Z45	RC7YC
14K-7DU	S9YC	14Z-3CU	N3C	Z12	N7BYC	Z5	C11YCC
14K-7DUO	OE036	14Z-3CU	OE040	Z12	OE012	Z5	OE057
14K-7DUO	S9YCC	14Z-3CU	OE068	Z120	OE032	Z52	C6BYC
14K-8DU	OE072	14Z-3CU	OE108	Z120	RC8VTYC4	Z52	OE076
14K-8DU	S10YCC	14Z-3CU	RN3C	Z121	OE032	Z60	OE021
14K-8DU/DUO	OE072	14Z-4AU	L82C	Z121	RC8VTYC4	Z60	RC7BMC
14K-8DU/DUO	S10YCC	175	L86C	Z122	KC10PYPB4	Z61	N7BYC
14K-8DUO	OE072	175	L87YC	Z122	OE191	Z61	OE012
14K-8DUO	OE099	175	OE007	Z123	OE019	Z63	C9YC
14K-8DUO	S10YCC	175	OE037	Z123	OE026	Z63	OE003
14K-8DUO	S12YC	175/14	L86C	Z123	RC10DMC	Z67	OE020
14K-8DUO	OE072	175/14	OE037	Z123	RC8DMC	Z67	RS9YCC
14K-8DUO	S10YCC	175/14A	L87YC	Z129	OE120	Z7	OE072
14K-9DU	OE099	175/14A	OE007	Z129	RC89TMC	Z7	S10YCC
14K-9DU	S12YC	175/18	D9	Z14	OE026	Z72	OE016
14K-DUO	OE072	175/18K	OE054	Z14	RC8DMC	Z72	RC10YCC
14K-DUO	S10YCC	175/18K	RF7YC	Z145	OE120	Z74	OE019
14KR-6BU	RV9YC	175/3A	N9YC	Z145	RC89TMC	Z74	RC10DMC
14KR-6DPUV02	OE131	175/3A	OE001	Z15	OE002	Z79	OE013
14KR-6DPUV02	RS9PYP4	18-4A1	D9	Z15	RC9YCC	Z79	RC12YC
14KR-6ZPPV	OE029	18-5A	D9	Z16	OE039	Z8	OE051
14KR-6ZPPV	RES9PYP4	18-7A	D9	Z16	RC8YC4	Z8	RN11YC



...BERU 		...BOSCH 		...BOSCH 		...BOSCH 	
Z9	OE048	DR7BC	OE054	F8KTCR	OE120	FR5DPP332	OE146
Z9	RN9YC4	DR7BC	RF7YC	F8KTCR	RC89TMC	FR5DPP332	RC8PYPB4
Z90	OE032	DR8BC	OE054	F8LCR	C9YCC	FR5DTC	OE026
Z90	RC8VTC4	DR8BC	RF7YC	F8LCR	OE023	FR5DTC	RC8DMC
Z91	OE027	DR8BC	RF9YC	F8LTCR	EON2	FR6D+	EON1
Z91	RN10VTC4	DR9BC	RF11YC	F8LTCR	OE120	FR6DC	C7YC
Z92	OE027	F03DAR	OE005	F8LTCR	RC89TMC	FR6DC	C7YCC
Z92	RN10VTC4	F03DAR	RC9YC	F9DCO	C11YCC	FR6DC	OE017
Z95	OE011	F04DAR	OE013	F9DCO	OE057	FR6DC	OE043
Z95	RS9YC	F04DAR	RC12YC	FGR5KQE	OE120	FR6DC	OE058
Z97	OE029	F08DC	C55C	FGR5KQE	RC89TMC	FR6DC	RC7YC
Z97	RES9PYP4	F3CS	QC59C-ST	FGR5KQEO	OE120	FR6DC+	OE043
Z98	OE026	F5DC	C6YCC	FGR5KQEO	RC89TMC	FR6DC+	RC7YC
Z98	RC8DMC	F5DC	OE075	FGR6HQEO	KC8ZMCC	FR6DC2	OE014
Z99	OE039	F5DPO	OE126	FGR6HQEO	OE177	FR6DC2	RC7YCC
Z99	RC9YC4	F5DPO	RC6PYP	FGR6KQE	OE120	FR6DCX	OE056
		F5DTC	C6BYC	FGR6KQE	RC89TMC	FR6DCX	OE080
		F5DTC	OE076	FGR7DQE	OE120	FR6DCX	RC7YC4
		F6DC	C7YC	FGR7DQE	RC89TMC	FR6DCX	RC7YCC4
		F6DC	C7YCC	FGR7DQE+	OE120	FR6DDC	OE026
		F6DC	OE017	FGR7DQE+	RC89TMC	FR6DDC	RC8DMC
		F6DC	OE058	FGR7DQP	OE120	FR6DP	OE141
		F6DCOR	OE043	FGR7DQP	RC89TMC	FR6DP	RC10PYC
		F6DCOR	RC7YC	FGR7KQE	OE120	FR6DP1	OE141
		F6DTC	C6BYC	FGR7KQE	RC89TMC	FR6DP1	RC10PYC
		F6DTC	OE076	FGR7KQEO	OE120	FR6DPP22	OE136
		F6LTCR	OE032	FGR7KQEO	RC89TMC	FR6DPP22	RC8PYP
		F6LTCR	RC8VTC4	FGR8KQE	OE120	FR6DPP22U	OE136
		F7DC	C9YC	FGR8KQE	RC89TMC	FR6DPP22U	RC8PYP
		F7DC	C9YCC	FGR8KQEO	OE120	FR6DPP332X	OE136
		F7DC	OE003	FGR8KQEO	RC89TMC	FR6DPP332X	RC8PYP
		F7DC	OE023	FGR8MQPE	OE175	FR6DPP33X	OE136
		F7DCO	C9YC	FGR8MQPE	REC10PYC4	FR6DPP33X	RC8PYP
		F7DCO	OE003	FLR8LDCU	OE019	FR6DTCW	OE077
		F7DCOR	OE024	FLR8LDCU	RC10DMC	FR6DTCW	RC7BYC4
		F7DCOR	RC9YCC4	FLR8LDCU+	EON2	FR6KD 0	OE102
		F7DPER	OE136	FLR8LDCU+	OE019	FR6KD 0	RC87YCC
		F7DPER	RC8PYP	FLR8LDCU+	RC10DMC	FR6KDO	OE102
		F7DPP222T	OE136	FLR8LDU+	OE019	FR6KDO	RC87YCC
		F7DPP222T	RC8PYP	FLR8LDU+	RC10DMC	FR6KDC	OE014
		F7DTC	C6BYC	FQR7ME	OE178	FR6KDC	RC7YCC
		F7DTC	OE076	FQR7ME	REC9MCLX	FR6KDEO	OE102
		F7HER2	KC8ZMCC	FQR8DE	KC10PYPB4	FR6KDEO	RC87YCC
		F7HER2	OE177	FQR8DE	OE191	FR6KPP332S	OE136
		F7HPP2	KC8ZPYPB4	FQR8LEU2	OE089	FR6KPP332S	RC8PYP
		F7HPP2	OE176	FQR8LEU2	RC9MCC4	FR6KTC	OE120
		F7HPP222	KC8ZPYPB4	FR 8 KTC	OE032	FR6KTC	RC89TMC
		F7HPP222	OE176	FR 8 KTC	RC8VTC4	FR6LDC	OE021
		F7HPP222U	KC8ZPYPB4	FR 8 SPP 332	OE175	FR6LDC	RC7BMC
		F7HPP222U	OE176	FR 8 SPP 332	REC10PYC4	FR6LTC	OE120
		F7KTCR	OE032	FR10DC	OE013	FR6LTC	RC89TMC
		F7KTCR	RC8VTC4	FR10DC	RC12YC	FR6MPP332	OE175
		F7LCOR2	EON2	FR10DCX	OE041	FR6MPP332	REC10PYC4
		F7LCOR2	OE024	FR10DCX	RC12LYC	FR78	EON2
		F7LCOR2	RC9YCC4	FR56	EON2	FR78	OE033
		F7LDCR	OE026	FR5DC	OE110	FR78	RC87YCL
		F7LDCR	RC8DMC	FR5DC	RC6YC	FR78NX	EON9
		F7LTCR	OE032	FR5DCX	OE056	FR78X	EON1
		F7LTCR	RC8VTC4	FR5DCX	RC7YCC4	FR78X	EON2
		F8DC	C11YCC	FR5DP	OE136	FR78X	OE033
		F8DC	OE057	FR5DP	RC8PYP	FR78X	RC87YCL
		F8DC4	C11YCC	FR5DP1X	OE136	FR7D+	EON1
		F8DC4	OE057	FR5DP1X	RC8PYP	FR7DC	C9YCC
		F8DPER	KC10PYPB4	FR5DPP22	OE146	FR7DC	OE002
		F8DPER	OE191	FR5DPP22	RC8PYPB4	FR7DC	OE005
		F8DPP332	KC10PYPB4	FR5DPP22U	OE146	FR7DC	OE023
		F8DPP332	OE191	FR5DPP22U	RC8PYPB4	FR7DC	OE127

  

BMW 	
12129071003	OE120
12129071003	RC89TMC

BONON 	
A6RTC	RZ98C
A6TC	Z9Y
A7RTC	Z9Y
A7TC	Z9Y
D6RTC-9	RA8HC
D7RTC-9	8812
D8RTC	8809
F6RTC	OE006
F6RTC	RN9YC
F6TC	N7YC
F6TC	OE010
K6RF	OE088
K6RF	RC10YC
L6RTC	RCJ7Y
L6TC	CJ8Y
L7RTC	RCJ7Y
L7T	CJ8
L7TC	CJ7Y
T1137C	Z9Y

BOSCH 	
0 242 255 509	RN79PYP17
7301	RB77WPC
7301	RB77WPCC
7305	RB77WPC
7305	RB77WPCC
7306	RB77WPC
7306	RB77WPCC
7311	RN79G
7312	RL85G
7313	RN5C
7320	RC78PYP
7320	RC78WP
7320	RC78WYP
D8BC	F9YC
DR10BC	RF11YC
DR10GCO	RF14LC
DR6BC	OE054
DR6BC	RF7YC



...BOSCH		CHAMPION	...BOSCH		CHAMPION	...BOSCH		CHAMPION	...BOSCH		CHAMPION
FR7DC	RC8YC		FR7KTC	RC8VTC4		FR8KDC	RC8DMC		HR5DC	S7YC	
FR7DC	RC9YC		FR7LC2	OE066		FR8KTC	OE120		HR6BC	RV9YC	
FR7DC	RC9YCC		FR7LC2	OE089		FR8KTC	RC89TMC		HR6DC	OE050	
FR7DC+	OE002		FR7LC2	RC9MCC		FR8LC	OE066		HR6DC	OE067	
FR7DC+	OE005		FR7LC2	RC9MCC4		FR8LC	RC9MCC		HR6DC	S7YC	
FR7DC+	OE034		FR7LCX	OE066		FR8LCX	OE089		HR6DC	S7YCC	
FR7DC+	RC8YCL		FR7LCX	OE089		FR8LCX	OE114		HR6DC+	OE050	
FR7DC+	RC9YC		FR7LCX	RC9MCC		FR8LCX	RC11LCC4		HR6DC+	S7YC	
FR7DC+	RC9YCC		FR7LCX	RC9MCC4		FR8LCX	RC9MCC4		HR6DPP33V	OE183	
FR7DCO	OE093		FR7LD+	EON1		FR8LDC	OE019		HR6DPP33V	RS8WYP5	
FR7DCO	RC89YCC		FR7LDC	OE026		FR8LDC	RC10DMC		HR78	EON3	
FR7DC2	OE002		FR7LDC	OE085		FR8LPX	OE089		HR78	OE020	
FR7DC2	RC9YCC		FR7LDC	RC8DMC		FR8LPX	RC9MCC4		HR78	RS9YCC	
FR7DC9	OE033		FR7LDC	RC9BMC		FR8ME	OE035		HR78X	EON3	
FR7DC9	RC87YCL		FR7LDC+	OE026		FR8ME	RC9YCL		HR78X	OE020	
FR7DCX	OE024		FR7LDC+	RC8DMC		FR8SC+	OE178		HR78X	RS9YCC	
FR7DCX	OE039		FR7LDCU	OE026		FR8SC+	RC9MCLX		HR7D+	EON3	
FR7DCX	RC9YC4		FR7LDCU	RC8DMC		FR8SE0	OE178		HR7DC	OE009	
FR7DCX	RC9YCC4		FR7LTC	OE120		FR8SE0	RC9MCLX		HR7DC	OE011	
FR7DCX+	EON2		FR7LTC	RC89TMC		FR8SPP332	OE175		HR7DC	OE020	
FR7DCX+	OE039		FR7ME	OE178		FR8SPP332	RC10PYC4		HR7DC	RS9YC	
FR7DCX+	RC9YC4		FR7ME	RC9MCLX		FR91X	EON2		HR7DC	RS9YCC	
FR7DE	OE034		FR7NPP33	OE190		FR9DC	OE013		HR7DC	S9YC	
FR7DE	RC8YCL		FR7NPP33	RC10WYPB4		FR9DC	RC12YC		HR7DC+	OE011	
FR7DP	OE145		FR7NPP332	OE190		FR9HC	RFN14LY		HR7DC+	OE020	
FR7DP	RC89PYC		FR7NPP332	RC10WYPB4		FRDPP10	OE136		HR7DC+	RS9YC	
FR7DPP+	OE136		FR7SE	OE035		FRDPP10	RC8PYP		HR7DC+	RS9YCC	
FR7DPP+	RC8PYP		FR7SE	RC9YCL		H2CS	S59C-ST		HR7DCX	OE011	
FR7DPP22U	OE124		FR8D+	EON1		H3CS	OE090		HR7DCX	OE020	
FR7DPP22U	OE136		FR8D+	OE088		H3CS	S6YC		HR7DCX	RS9YC	
FR7DPP22U	OE146		FR8D+	RC10YC		H56	EON3		HR7DCX	RS9YCC	
FR7DPP22U	RC10PYP4		FR8DC	OE013		H5DC	OE090		HR7DPP22	OE131	
FR7DPP22U	RC8PYP		FR8DC	OE016		H5DC	S6YC		HR7DPP22	RS9PYP4	
FR7DPP22U	RC8PYPB4		FR8DC	OE088		H5DC0	OE090		HR7KPP33+	OE131	
FR7DPP33	OE136		FR8DC	RC10YC		H5DC0	S6YC		HR7KPP33+	RS9PYP4	
FR7DPP33	RC8PYP		FR8DC	RC10YCC		H6DC	OE050		HR7MPP+	EON4	
FR7DPP332	OE079		FR8DC	RC12YC		H6DC	OE067		HR7MPP+	OE029	
FR7DPP332	RC8WYP4		FR8DC+	OE016		H6DC	S7YC		HR7MPP+	RS9PYP4	
FR7DTC	OE120		FR8DC+	OE088		H6DC	S7YCC		HR7MPP+V	OE029	
FR7DTC	RC89TMC		FR8DC+	RC10YC		H7DC	OE009		HR7MPP+V	RS9PYP4	
FR7HC+	KC8ZMCC		FR8DC+	RC10YCC		H7DC	S9YC		HR7MPP22U	OE029	
FR7HC+	OE177		FR8DC0	OE016		H7DC0	OE036		HR7MPP22U	RS9PYP4	
FR7HCOX	OE089		FR8DC0	RC10YCC		H7DC0	S9YCC		HR7MPP22V	OE029	
FR7HCOX	RC9MCC4		FR8DCX	OE062		H7DC0	OE036		HR7MPP22V	RS9PYP4	
FR7HE2	KC8ZMCC		FR8DCX	OE063		H7DC0	S9YCC		HR7MPP302X	OE029	
FR7HE2	OE177		FR8DCX	RC10YC4		H8DC	OE036		HR7MPP302X	RS9PYP4	
FR7HPP22	KC8ZPYPB4		FR8DCX	RC10YCC4		H8DC	OE072		HR8BC	RV9YC	
FR7HPP22	OE176		FR8DCX+	EON2		H8DC	S10YCC		HR8D+	EON3	
FR7HPP222	KC8ZPYPB4		FR8DCX+	OE063		H8DC	S9YCC		HR8DC	RS12YC	
FR7HPP222	OE176		FR8DCX+	RC10YC4		H8DC0	OE072		HR8DC+	RS12YC	
FR7HPP33+	KC8ZPYPB4		FR8DE	OE030		H8DC0	OE099		HR8DCX	RS12YC	
FR7HPP33+	OE176		FR8DE	RC8BYC		H8DC0	S10YCC		HR8DCX	RS14YC6	
FR7HPP332W	KC8ZPYPB4		FR8DP1X	OE134		H8DC0	S12YC		HR8DCY	RS14YC6	
FR7HPP332W	OE176		FR8DP1X	RC12PYP		H8DC0	OE072		HR8DPP15V	OE131	
FR7KC	OE093		FR8DPP33	KC10PYPB4		H8DC0	S10YCC		HR8DPP15V	RS9PYP4	
FR7KC	RC89YCC		FR8DPP33	OE191		H9DC	OE099		HR8DPP22U	OE131	
FR7KCW	OE093		FR8DPX	OE013		H9DC	S12YC		HR8DPP22U	RS9PYP4	
FR7KCW	RC89YCC		FR8DPX	RC12YC		H9DC0	OE099		HR8DPP22-U	OE131	
FR7KCX	OE093		FR8HC	OE041		H9DC0	S12YC		HR8DPP22-U	RS9PYP4	
FR7KCX	RC89YCC		FR8HC	RC12LYC		HGR7KQC	OE020		HR8MVC+	OE031	
FR7KPP33+	OE136		FR8HDC	OE120		HGR7KQC	RS9YCC		HR8MVC+	RS9YCC4	
FR7KPP33+	RC8PYP		FR8HDC	RC89TMC		HLR8STEX	OE029		HR8MEV	OE031	
FR7KPP332	OE136		FR8HP	OE041		HLR8STEX	RS9PYP4		HR8MEV	RS9YCC4	
FR7KPP332	RC8PYP		FR8HP	RC12LYC		HR10BCY	RV15YC6		HR91GX	RV15YC4	
FR7KPP33U+	OE146		FR8KCU	OE039		HR5DC	OE050		HR91Y0	RS14YC6	
FR7KPP33U+	RC8PYPB4		FR8KCU	RC9YC4		HR5DC	OE133		HR9DC	RS12YC	
FR7KTC	OE032		FR8KDC	OE026		HR5DC	RS6YCC		HR9DCX	RS12YC	



...BOSCH	CHAMPION	...BOSCH	CHAMPION	...BOSCH	CHAMPION	...BOSCH	CHAMPION
HR9DCY	RS14YC6	W5DC	OE084	W9DC	N12YC	WR78X	RN9YCC
HS8E	DJ8J	W5DC	OE087	W9DC	OE015	WR7AC	RL86C
M10AC	D16	W5DP0	N3C	W9DC	OE065	WR7B+	EON6
M4AC	D6	W5DP0	OE068	W9ECO	J17LM	WR7BC	OE064
M5AC	D9	W5DTC	N6BYC	W9LC	N12YC	WR7BC	RL82YC
M7AC	D9	W5DTC	OE109	W9LC	OE015	WR7BC+	OE064
M8AC	D14	W6BC	L82YC	WC7D	OE045	WR7BC+	RL82YC
UR2CC	OE092	W6BC	OE038	WC7D	RN11YCC	WR7CC	OE098
UR2CC	RG4HC	W6DC	N7YC	W06CS	C53R	WR7CC	RN4C
UR3AS	RZ96C	W6DC	OE010	W07CS	C53R	WR7D+	EON5
UR5DC	RG6YC	W6DTC	N6BYC	W08CS	C53R	WR7DC	OE006
UR6DE	OE092	W6DTC	N7BYC	WR10FCY	RJ18YC6	WR7DC	RN9YC
UR6DE	RG4HC	W6DTC	OE012	WR10LC	OE042	WR7DC+	OE006
USR7AC	RZ7C	W6DTC	OE109	WR10LC	RN12YC	WR7DC+	RN9YC
VR7SE	OE130	W7AC	L86C	WR10LCV	RN14MC5	WR7DC2	OE004
VR7SE	REA8MCL	W7AC	OE037	WR11EO	RJ8C	WR7DC2	RN9YCC
VR8SC	OE130	W7BC	L87YC	WR11F	RJ14YC	WR7DCX	OE047
VR8SC	REA8MCL	W7BC	OE007	WR3CC	OE091	WR7DCX	OE048
VR8SE	OE130	W7CC	N4C	WR3CC	RN2C	WR7DCX	RN9YC4
VR8SE	REA8MCL	W7CC	N5C	WR3KI332	RN79PYP17	WR7DCX	RN9YCC4
VR8SEW	OE130	W7CC	OE074	WR4AC	OE086	WR7DCX+	OE047
VR8SEW	REA8MCL	W7CC	OE079	WR4AC	RL82C	WR7DCX+	OE048
W07AS	QL55	W7DC	N9YC	WR4CC	OE108	WR7DCX+	RN9YC4
W08AS	QL57	W7DC	OE001	WR4CC	RN3C	WR7DCX+	RN9YCC4
W10AC	L86C	W7DCR	OE006	WR56	EON5	WR7DP	OE006
W10AC	OE037	W7DCR	RN9YC	WR5AC	OE086	WR7DP	RN9YC
W10D	N12YC	W7DCX	N9YC	WR5AC	RL82C	WR7DS	OE006
W10D	OE015	W7DCX	OE001	WR5CC	OE108	WR7DS	RN9YC
W10DC	N12YC	W7DTC	N7BYC	WR5CC	RN3C	WR7DTC	N9BYC
W10DC	OE015	W7DTC	OE012	WR5D+	EON6	WR7DTC	OE044
W10DCX	N12YC	W7EC	J8C	WR5DC	OE116	WR7KI33S	OE195
W10DCX	OE015	W7FC	J12YC	WR5DC	RN6YC	WR7KI33S	RN8WYP
W10FC	J12YC	W7LTCR	OE025	WR5DC+	OE116	WR7LC	OE060
W2CC	N2C	W7LTCR	RN8VTYC4	WR5DC+	RN6YC	WR7LC	OE097
W2CC	OE040	W8AC	L86C	WR5DP	OE116	WR7LC	RN7LCC
W2D	C59YC	W8AC	OE037	WR5DP	RN6YC	WR7LC	RN9LCC
W3AC	L77JC4	W8BC	L92YC	WR5DS	OE116	WR7LT+	EON5
W3CC	N2C	W8BC	OE059	WR5DS	RN6YC	WR7LTC	N7BMC
W3CC	OE040	W8CC	N5C	WR6BC	OE064	WR7LTC	OE025
W3CP	N2G	W8CC	OE074	WR6BC	RL82YC	WR7LTC	OE095
W3CP	OE125	W8DC	N11YC	WR6D+	EON5	WR7LTC	RN8VTYC4
W3D	N6YC	W8DC	OE065	WR6DC	OE008	WR7LTC+	OE025
W3D	OE087	W8DC0	N9YC	WR6DC	OE018	WR7LTC+	RN8VTYC4
W3DP	N6YC	W8DC0	OE001	WR6DC	RN7YC	WR8AC	L86C
W3DP	OE087	W8DTC	N9BYC	WR6DC	RN7YCC	WR8AC	OE037
W3DP0	N6YC	W8DTC	N9BYC4	WR6DC+	OE018	WR8BC	L92YC
W3DP0	OE087	W8DTC	OE028	WR6DC+	RN7YC	WR8BC	OE059
W3DP2	N6YCC	W8DTC	OE044	WR6DC2	OE008	WR8BC+	L92YC
W3DP2	OE084	W8DTC1,0mmEA	N9BYC4	WR6DC2	RN7YCC	WR8BC+	OE059
W4AC	L82C	W8DTC1,0mmEA	OE028	WR6DCX	OE117	WR8CC	RN5C
W4CC	N3C	W8EC	J6C	WR6DCX	RN7YC4	WR8D+	EON6
W4CC	OE068	W8FC	J12YC	WR6DP	OE018	WR8DC	OE045
W4CP	N3G	W8LCR	OE060	WR6DP	RN7YC	WR8DC	OE051
W4CP	OE078	W8LCR	RN9LCC	WR6DPO	N7BYC	WR8DC	RN11YC
W4CS	N3G	W8LDCR	N9BMC	WR6DPO	OE012	WR8DC	RN11YCC
W4CS	OE078	W8LDCR	OE100	WR6DTC	N7BYC	WR8DC+	OE045
W4DPO	N3G	W8LTCR	OE025	WR6DTC	OE012	WR8DC+	OE051
W4DPO	OE078	W8LTCR	OE027	WR6FC	RJ6C	WR8DC+	RN11YC
W5AC	L82C	W8LTCR	RN10VTYC4	WR78	EON5	WR8DC+	RN11YCC
W5BC	L82YC	W8LTCR	RN8VTYC4	WR78	EON6	WR8DC04	OE048
W5BC	OE038	W9AC	L86C	WR78	OE006	WR8DC04	RN9YC4
W5CC	N3C	W9AC	OE037	WR78	RN9YC	WR8DC4	OE045
W5CC	OE068	W9ACO	L86C	WR78+	EON5	WR8DC4	RN11YCC
W5CS	N3G	W9ACO	OE037	WR78G	OE064	WR8DCX	OE049
W5CS	OE078	W9CC	N5C	WR78G	RL82YC	WR8DCX	OE101
W5DC	N6YC	W9CC	OE074	WR78X	EON6	WR8DCX	OE113
W5DC	N6YCC	W9DC	N11YC	WR78X	OE004	WR8DCX	RN10YC4



...BOSCH	CHAMPION	BOSNA	CHAMPION	...CHRYSLER	CHAMPION	...CITROEN	CHAMPION
WR8DCX	RN11YC4	F.85	L82YC	4727114	RN14PMP5	96 363 93380	REC9YCL
WR8DCX	RN11YCC4	F.85	L86C	4796779	OE124	96.024.607	C7YCC
WR8DCX+	OE049	F.85	OE037	4796779	RC10PYP4	96.024.607	OE058
WR8DCX+	RN11YC4	F.85	OE038	56028189	OE128	96.024.614	C9YCC
WR8DP	OE051			56028189	RC12LC4	96.024.614	OE023
WR8DP	RN11YC			56028236AA	OE154	96.070.663	OE016
WR8EC	RJ8C			56028236AA	RC12MCC4	96.070.663	RC10YCC
WR8LC	OE051			56041402AB	OE115	96.088.669	OE014
WR8LC	RN11YC			56041402AB	RC12ECC	96.088.669	RC7YCC
WR8LC+	OE051			A1005N02	OE004	96.089.220	OE002
WR8LC+	RN11YC			A1005N02	RN9YCC	96.089.220	RC9YCC
WR8LP	OE051			A1005N04	OE101	96.096.685	OE021
WR8LP	RN11YC			A1005N04	RN11YCC4	96.096.685	RC7BMC
WR8LT+	EON6					96.381.273.80	OE034
WR8LTC+	OE027					96.381.273.80	RC8YCL
WR8LTC+	RN10VTYC4					96024607	C7YCC
WR91	EON6					96024607	OE058
WR91V	OE105					96024614	C9YCC
WR91V	RN14PMP5					96024614	OE023
WR91VO	OE105					96070663	EON2
WR91VO	RN14PMP5					96070663	OE016
WR91X	EON6					96070663	RC10YCC
WR91X	OE004					96088669	OE014
WR91X	RN9YCC					96088669	RC7YCC
WR9D+	EON6					96089220	EON2
WR9DC	OE042					96089220	OE002
WR9DC	RN12YC					96089220	RC9YCC
WR9DC+	OE042					96096685	OE021
WR9DC+	RN12YC					96096685	RC7BMC
WR9DCX	OE042					9638127380	OE034
WR9DCX	RN12YC					9638127380	RC8YCL
WR9DX	OE042					9639814380	OE034
WR9DX	RN12YC					9639814380	RC8YCL
WR9HC	OE156					9650889380	OE178
WR9HC	RN13LYC					9650889380	REC9MCLX
WS8F	CJ8Y					MYC.000007R	OE043
WSR6F	RCJ6Y					MYC.000007R	RC7YC
X4C	OE083					MYC.000279N	N279YC
X4C	RA6HC					MYC000006N	N6YC
X4CS	A57C-ST					MYC000006N	OE087
X5DC	A6HC					MYC000006R	OE110
X5DC	OE132					MYC000006R	RC6YC
X5DTC	A6HC					MYC000007R	OE043
X5DTC	OE132					MYC000007R	RC7YC
XR2CS	OE073					MYC000279N	N7YC
XR2CS	RA4HC					MYC000279N	OE010
XR3CPO	A59GC					ZB.9000.064.U	C9YCC
XR3CPO	OE103					ZB.9000.064.U	OE023
XR5DC	OE073					ZB.9000.065.U	L82C
XR5DC	RA4HC					ZB9000060U	N7YC
Y5DDC	A59GC					ZB9000060U	OE010
Y5DDC	OE103					ZB9000061	OE067
Y6DC	A6HC					ZB9000061	S7YCC
Y6DC	OE132					ZB9000061U	OE050
YR5DDE	OE073					ZB9000061U	S7YC
YR5DDE	RA4HC					ZB9000062U	OE009
YR7DC+	OE186					ZB9000062U	S9YC
YR7DC+	RA8YCX4					ZB9000063U	C7YCC
YR7DE	OE052					ZB9000063U	OE058
YR7DE	OE073					ZB9000064U	C9YCC
YR7DE	RA4HC					ZB9000064U	OE023
YR7DE	RA4HCX					ZB900061U	OE050
						ZB900061U	S7YC
						ZB900063U	C7YCC
						ZB900063U	OE058
						ZB900064U	C9YCC
						ZB900064U	OE023



### ...CITROEN



ZC.9862.093.U	<b>N9YC</b>
ZC.9862.093.U	<b>OE001</b>
ZC.9862.094.U	<b>OE050</b>
ZC.9862.094.U	<b>S7YC</b>
ZC9862093U	<b>N9YC</b>
ZC9862093U	<b>OE001</b>
ZC9862094U	<b>OE050</b>
ZC9862094U	<b>S7YC</b>
ZC9862095U	<b>OE009</b>
ZC9862095U	<b>S9YC</b>

### CUMMINS



4010981	<b>RB77WPCC</b>
4090121	<b>RB77WPCC</b>
4098162	<b>RB77WPCC</b>

### DAIHATSU



9004851106	<b>OE039</b>
9004851106	<b>RC9YC4</b>

### DENSO



D12	<b>OE005</b>
D12	<b>RC9YC</b>
D2	<b>OE006</b>
D2	<b>RN9YC</b>
D20	<b>OE019</b>
D20	<b>RC10DMC</b>
D21	<b>OE063</b>
D21	<b>RC10YC4</b>
D22	<b>OE002</b>
D22	<b>RC9YCC</b>
D4	<b>N9YC</b>
D4	<b>OE001</b>
D7	<b>OE011</b>
D7	<b>RS9YC</b>
D76	<b>OE120</b>
D76	<b>RC89TMC</b>
D8	<b>N12YC</b>
D8	<b>OE015</b>
FK20HR11	<b>OE190</b>
FK20HR11	<b>REC10WYPB4</b>
GE3-1	<b>RN79G</b>
GE3-1	<b>RN79PYP17</b>
GE5-1	<b>RC78WYP15</b>
GI3-1A	<b>RB75WPCC</b>
GI3-3A	<b>RB77WPCC</b>
GK3-1	<b>RC78WYP11</b>
IK16	<b>OE180</b>
IK16	<b>RC10WYP4</b>
IK20	<b>OE179</b>
IK20	<b>RC8WYP4</b>
IK20G	<b>OE179</b>
IK20G	<b>RC8WYP4</b>
IK22	<b>OE179</b>
IK22	<b>RC8WYP4</b>
IKH16	<b>OE190</b>
IKH16	<b>REC10WYP4</b>
IKH20	<b>OE178</b>
IKH20	<b>REC9MCLX</b>
IQ16	<b>3071</b>
IT20	<b>OE183</b>

### ...DENSO



IT20	<b>RS8WYP5</b>
ITV16	<b>OE189</b>
ITV16	<b>RES9WYP5</b>
ITV20	<b>OE189</b>
ITV20	<b>RES9WYP5</b>
IU22	<b>P-RG7C</b>
IU24	<b>P-RG7C</b>
IW16	<b>OE195</b>
IW16	<b>RN8WYP</b>
IW31	<b>QN84</b>
IXU22	<b>OE187</b>
IXU22	<b>RA7WHP</b>
IXU24	<b>OE187</b>
IXU24	<b>RA7WHP</b>
J16ARU11	<b>OE114</b>
J16ARU11	<b>RC11LCC4</b>
J16CRU	<b>OE060</b>
J16CRU	<b>RN9LCC</b>
K16GPRU11	<b>RC12MC4</b>
K16HPRU11	<b>OE035</b>
K16HPRU11	<b>REC9YCL</b>
K16PRU	<b>OE013</b>
K16PRU	<b>OE016</b>
K16PRU	<b>OE088</b>
K16PRU	<b>RC10YC</b>
K16PRU	<b>RC10YCC</b>
K16PRU	<b>RC12YC</b>
K16PRU11	<b>OE062</b>
K16PRU11	<b>OE063</b>
K16PRU11	<b>OE088</b>
K16PRU11	<b>RC10YC</b>
K16PRU11	<b>RC10YC4</b>
K16PRU11	<b>RC10YCC4</b>
K16PRU11	<b>RC12YC5</b>
K16PRZU11	<b>OE145</b>
K16PRZU11	<b>RC89PYC</b>
K16PSR-B8	<b>OE180</b>
K16PSR-B8	<b>RC10WYP4</b>
K16PU	<b>OE088</b>
K16PU	<b>RC10YC</b>
K16RU	<b>EON2</b>
K16RU	<b>OE066</b>
K16RU	<b>OE093</b>
K16RU	<b>RC89YCC</b>
K16RU	<b>RC9MCC</b>
K16RU11	<b>OE063</b>
K16RU11	<b>OE154</b>
K16RU11	<b>RC10YC4</b>
K16RU11	<b>RC12MCC4</b>
K16TNR59	<b>OE026</b>
K16TNR59	<b>RC8DMC</b>
K16TR11	<b>OE019</b>
K16TR11	<b>RC10DMC</b>
K20BR510	<b>OE032</b>
K20BR510	<b>RC8VTYC4</b>
K20CRL11	<b>OE089</b>
K20CRL11	<b>RC9MCC4</b>
K20HRU11	<b>OE035</b>
K20HRU11	<b>OE178</b>
K20HRU11	<b>REC9MCLX</b>
K20HRU11	<b>REC9YCL</b>
K20PBR	<b>OE120</b>
K20PBR	<b>RC89TMC</b>
K20PBR510	<b>OE120</b>
K20PBR510	<b>RC89TMC</b>
K20PRL11	<b>RC12YC5</b>
K20PRU	<b>OE002</b>

### ...DENSO



K20PRU	<b>OE033</b>
K20PRU	<b>OE034</b>
K20PRU	<b>OE127</b>
K20PRU	<b>RC87YCL</b>
K20PRU	<b>RC8YC</b>
K20PRU	<b>RC8YCL</b>
K20PRU	<b>RC9YCC</b>
K20PRU11	<b>OE024</b>
K20PRU11	<b>RC8YC4</b>
K20PRU11	<b>RC9YCC4</b>
K20PRZU11	<b>OE141</b>
K20PRZU11	<b>OE144</b>
K20PRZU11	<b>RC10PYC</b>
K20PRZU11	<b>RC87PYC</b>
K20RU	<b>OE066</b>
K20RU	<b>RC9MCC</b>
K20RU11	<b>OE089</b>
K20RU11	<b>RC9MCC4</b>
K20TNR	<b>OE030</b>
K20TNR	<b>RC8BYC</b>
K20TNR5	<b>OE120</b>
K20TNR5	<b>RC89TMC</b>
K20TNR510	<b>OE120</b>
K20TNR510	<b>RC89TMC</b>
K20TNR59	<b>OE120</b>
K20TNR59	<b>RC89TMC</b>
K20TR11	<b>OE019</b>
K20TR11	<b>RC10DMC</b>
K20TXR	<b>OE019</b>
K20TXR	<b>OE026</b>
K20TXR	<b>OE030</b>
K20TXR	<b>OE085</b>
K20TXR	<b>RC10DMC</b>
K20TXR	<b>RC8BYC</b>
K20TXR	<b>RC8DMC</b>
K20TXR	<b>RC9BMC</b>
K22PB	<b>C6BYC</b>
K22PB	<b>OE076</b>
K22PBR7	<b>OE077</b>
K22PBR7	<b>RC7BYC4</b>
K22PBRS	<b>OE021</b>
K22PBRS	<b>OE077</b>
K22PBRS	<b>OE118</b>
K22PBRS	<b>RC7BMC</b>
K22PBRS	<b>RC7BYC</b>
K22PBRS	<b>RC7BYC4</b>
K22PRU	<b>OE110</b>
K22PRU	<b>RC6YC</b>
K22PRU11	<b>OE080</b>
K22PRU11	<b>OE110</b>
K22PRU11	<b>RC6YC</b>
K22PRU11	<b>RC7YC4</b>
K22PRZU	<b>C6VPYC</b>
K22PRZU	<b>OE129</b>
K22PURZU11	<b>OE144</b>
K22PURZU11	<b>RC87PYC</b>
K22TNR5	<b>OE021</b>
K22TNR5	<b>RC7BMC</b>
KJ16CRL11	<b>OE089</b>
KJ16CRL11	<b>RC9MCC4</b>
KJ20CRL11	<b>RC12MC4</b>
KJ20CRL	<b>OE089</b>
KJ20CRL	<b>RC9MCC4</b>
KJ20CRL11	<b>OE089</b>
KJ20CRL11	<b>RC9MCC4</b>
KJ20DRM11	<b>OE026</b>
KJ20DRM11	<b>RC8DMC</b>

### ...DENSO



M14	<b>D14</b>
M17	<b>D14</b>
M22	<b>D9</b>
M24S	<b>D6</b>
MA16PRU	<b>RF9YC</b>
MA20PRU	<b>OE054</b>
MA20PRU	<b>RF7YC</b>
MA20RU	<b>RF10C</b>
P16	<b>OE029</b>
P16	<b>RES9PYP4</b>
P16R	<b>OE042</b>
P16R	<b>RN12YC</b>
P16R13	<b>OE105</b>
P16R13	<b>RN14PMP5</b>
P18	<b>OE131</b>
P18	<b>RS9PYP4</b>
P20PR8	<b>OE018</b>
P20PR8	<b>RN7YC</b>
P20R11	<b>OE048</b>
P20R11	<b>RN9YC4</b>
PK16PR11	<b>OE124</b>
PK16PR11	<b>RC10PYP4</b>
PK16PRL11	<b>OE138</b>
PK16PRL11	<b>RC11PYPB4</b>
PK16R8	<b>OE134</b>
PK16R8	<b>RC12PYP</b>
PK20PR11	<b>OE146</b>
PK20PR11	<b>RC8PYPB4</b>
PK20PRL11	<b>OE146</b>
PK20PRL11	<b>RC8PYPB4</b>
PK20PRP11	<b>OE080</b>
PK20PRP11	<b>RC7YC4</b>
PK20PRP8	<b>OE136</b>
PK20PRP8	<b>RC8PYP</b>
PK20PTRS9	<b>OE136</b>
PK20PTRS9	<b>RC8PYP</b>
PK20R11	<b>OE134</b>
PK20R11	<b>RC12PYP</b>
PK20R13	<b>OE134</b>
PK20R13	<b>RC12PYP</b>
PK20R8	<b>OE134</b>
PK20R8	<b>RC12PYP</b>
PK20TR11	<b>OE134</b>
PK20TR11	<b>RC12PYP</b>
PK22PR8	<b>OE126</b>
PK22PR8	<b>RC6PYP</b>
PKJ16CR8	<b>OE136</b>
PKJ16CR8	<b>RC8PYPB</b>
PKJ16CRL11	<b>OE146</b>
PKJ16CRL11	<b>RC8PYPB4</b>
PKJ20CRL11	<b>OE146</b>
PKJ20CRL11	<b>RC8PYPB4</b>
PQ16R	<b>OE013</b>
PQ16R	<b>RC12YC</b>
PQ20R	<b>OE134</b>
PQ20R	<b>RC12PYP</b>
PT16EPRL13	<b>RS12PYP</b>
PT16VR13	<b>OE029</b>
PT16VR13	<b>RES9PYP4</b>
Q16PRU	<b>3071</b>
Q16PRU11	<b>RC12YC5</b>
Q16PRZU11	<b>OE134</b>
Q16PRZU11	<b>RC12PYP</b>
Q16PU11	<b>RC12YC5</b>
Q16RU	<b>OE013</b>
Q16RU	<b>RC12YC</b>
Q16RU11	<b>RC12YC5</b>



...DENSO	CHAMPION	...DENSO	CHAMPION	...DENSO	CHAMPION	...DENSO	CHAMPION
Q16U11	C11YCC	SK20RP13	OE134	VK20G	OE179	W16ESU	N5C
Q16U11	OE057	SK20RP13	RC12PYP	VK20G	RC8WYP4	W16ESU	OE074
Q20PRU	OE002	SKJ16CRA8	OE194	VK20PRZ11	OE179	W16ETRS	OE027
Q20PRU	OE005	SKJ16CRA8	RC12WMP4	VK20PRZ11	RC8WYP4	W16ETRS	RN10VTYC4
Q20PRU	OE016	SKJ16DRM11	OE194	VK22	OE179	W16EXRU	OE051
Q20PRU	RC10YCC	SKJ16DRM11	RC12WMP4	VK22	RC8WYP4	W16EXRU	RN11YC
Q20PRU	RC9YC	SKJ20DRM11	OE179	VKB16	OE184	W16EXRU11	OE049
Q20PRU	RC9YCC	SKJ20DRM11	RC8WYP4	VKB16	RC10WMP2	W16EXRU11	RN11YC4
Q20PRU11	OE024	SKJ20DRM11S	OE179	VKB20	OE185	W16EXRU13	OE049
Q20PRU11	OE039	SKJ20DRM11S	RC8WYP4	VKB20	RC8WMP2	W16EXRU13	RN11YC4
Q20PRU11	RC9YC4	SKJ20DRM13	OE194	VKH16	OE190	W16EXRUA	OE051
Q20PRU11	RC9YCC4	SKJ20DRM13	RC12WMP4	VKH16	REC10WYP4	W16EXRUA	RN11YC
Q20PU	C9YC	SKJ20RP13	OE134	VQ16	3071	W16EXU	N11YC
Q20PU	C9YCC	SKJ20RP13	RC12PYP	VW16	OE195	W16EXU	OE065
Q20PU	OE003	SVK20RZ8	OE179	VW16	RN8WYP	W16EXU13	OE049
Q20PU	OE023	SVK20RZ8	RC8WYP4	VXU22	OE187	W16EXU13	RN11YC4
Q20PU11	OE039	SXU22PR9	OE187	VXU22	RA7WHP	W16FPRU	L92YC
Q20PU11	RC9YC4	SXU22PR9	RA7WHP	VXU24	OE187	W16FPRU	OE059
Q20RU11	OE039	T16EPRU	OE099	VXU24	RA7WHP	W16FPU	L92YC
Q20RU11	RC9YC4	T16EPRU	RS12YC	W14EPRU	OE042	W16FPU	OE059
Q22PRU	OE014	T16EPRU	S12YC	W14EPRU	RN12YC	W16FSR	RL86C
Q22PRU	OE043	T16PRU	RV12YC	W14EPU	N12YC	W16FSU	L86C
Q22PRU	RC7YC	T16VRU10	OE031	W14EPU	OE015	W16FSU	OE037
Q22PRU	RC7YCC	T16VRU10	RE59YCC4	W14EXRU	OE042	W16LS	H10C
Q22PRU11	OE056	T20EP	OE067	W14EXRU	RN12YC	W16PRU	RJ12YC
Q22PRU11	OE080	T20EP	S7YCC	W14EXU	N12YC	W16PRU15	RJ18YC6
Q22PRU11	RC7YC4	T20EPRU	OE011	W14EXU	OE015	W17ESU	N5C
Q22PRU11	RC7YCC4	T20EPRU	OE020	W14FPUL	L92YC	W17ESU	OE074
Q22PU	C6YCC	T20EPRU	RS9YC	W14FPUL	OE059	W17EWU	N9YC
Q22PU	C7YC	T20EPRU	RS9YCC	W14FRU	RL86C	W17EWU	OE001
Q22PU	C7YCC	T20EPRU15	OE011	W14FU	L86C	W17FU	L86C
Q22PU	OE017	T20EPRU15	RS9YC	W14FU	OE037	W17FU	OE037
Q22PU	OE058	T20EPU	OE009	W14L	H12	W20EBPRS	OE027
Q22PU	OE075	T20EPU	OE036	W14LMRUS	RJ17LM	W20EBPRS	RN10VTYC4
Q22PU11	OE080	T20EPU	OE072	W14LMUS	J17LM	W20EKPRS11	OE006
Q22PU11	RC7YC4	T20EPU	S10YCC	W14MPRU10	RCJ8Y	W20EKPRS11	RN9YC
QJ16AARU	OE114	T20EPU	S9YC	W14PRU	RJ14YC	W20EKRS11	OE006
QJ16AARU	RC11LCC4	T20EPU	S9YCC	W14US	J8C	W20EKRS11	RN9YC
QJ16ARU	OE115	T20MU	DJ8J	W16EPB10	N9BYC4	W20EPB	N9BYC
QJ16ARU	RC12ECC	T20PRU	RV9YC	W16EPB10	OE028	W20EPB	N9BYC4
QJ16ARU11	OE128	T22EPU	OE050	W16EPRS11	OE049	W20EPB	OE028
QJ16ARU11	RC12LC4	T22EPU	OE090	W16EPRS11	RN11YC4	W20EPB	OE044
QJ16HRU	OE041	T22EPU	S6YC	W16EPRU	OE042	W20EPB10	N9BYC4
QJ16HRU	RC12LYC	T22EPU	S7YC	W16EPRU	OE045	W20EPB10	OE028
QJ16HRU	RFN14LY	U20EPR9	OE092	W16EPRU	OE051	W20EPBRS	OE025
QJ6ARU11	OE114	U20EPR9	RG4HC	W16EPRU	RN11YC	W20EPBRS	RN8VTYC4
QJ6ARU11	RC11LCC4	U20FSR-U	RZ98C	W16EPRU	RN11YCC	W20EPRU	OE111
SK16PRA11	OE193	U22ESRN	RG96C	W16EPRU	RN12YC	W20EPRU	RN10YC
SK16PRA11	RC12WYP4	U22ESR-N	8698	W16EPRU10	OE049	W20EPRU10	OE048
SK16R11	OE146	U22FSR-U	RZ96C	W16EPRU10	RN11YC4	W20EPRU10	RN9YC4
SK16R11	RC8PYPB4	U22FS-U	RZ96C	W16EPRU11	OE049	W20EPRU11	OE047
SK20BR11	OE188	U24ESR-N	8698	W16EPRU11	OE101	W20EPRU11	OE048
SK20BR11	RC8WMP4	U24ESR-N	RG94C	W16EPRU11	OE113	W20EPRU11	RN9YC4
SK20HR11	OE190	U24ESR-NB	RG94C	W16EPRU11	RN10YC4	W20EPRU11	RN9YCC4
SK20HR11	REC10WYPB4	U24ESRNZU	OE122	W16EPRU11	RN11YC4	W20EPU	L87YC
SK20PRA11	OE193	U24ESRNZU	RG4PHP	W16EPRU11	RN11YCC4	W20EPU	N9YC
SK20PRA11	RC12WYP4	U24FER9	RGU94C	W16EPU	N11YC	W20EPU	OE001
SK20PRA8	OE179	U24FSR-U	RZ94C	W16EPU	N12YC	W20EPU	OE007
SK20PRA8	RC8WYP4	U27ESRN	RG92C	W16EPU	OE015	W20EPZU	N4C
SK20PRL11	KC8WYP4	U27ESR-N	8654	W16EPU	OE065	W20EPZU	OE079
SK20PRL11	OE181	U27ETR	8654	W16ESL	N11YC	W20ESL	N9YC
SK20PRL9	KC8WYP4	U27ETR	RG92DC	W16ESL	OE065	W20ESL	OE001
SK20PRL9	OE181	U27FER9	RGU92C	W16ESRL	OE051	W20ESL11	N7YC
SK20R11	OE182	VK16	OE180	W16ESRL	RN11YC	W20ESL11	OE010
SK20R11	RC89WYP4	VK16	RC10WYP4	W16ESRL11	OE049	W20ESRL	OE006
SK20RP11	OE134	VK20	OE179	W16ESRL11	RN11YC4	W20ESRL	RN9YC
SK20RP11	RC12PYP	VK20	RC8WYP4	W16ESRU	RN5C	W20ESRL11	OE048



...DENSO	CHAMPION	...DENSO	CHAMPION	...DENSO	CHAMPION	EYQUEM	CHAMPION
W20ESRL11	RN9YC4	W22ESRU	OE098	W9PRU15	RJ18YC6	1000L	N2C
W20ESRU	RN5C	W22ESRU	RN4C	W9PRU20	RJ18YC6	1000L	OE040
W20ESU	N5C	W22ESU	N3C	WU14EU	N5C	406	L86C
W20ESU	OE074	W22ESU	N4C	WU14EU	OE074	406	OE037
W20ESZU	N4C	W22ESU	OE068	WU9EU	N5C	4065	L86C
W20ESZU	OE079	W22ESU	OE079	WU9EU	OE074	4065	OE037
W20ETL	N9BMC	W22ESZU	N3C	X20ESU	RA8HC	500	L86C
W20ETL	OE100	W22ESZU	OE068	X20EU	RA8HC	500	OE037
W20ETRL	N9BMC	W22ETRL	N7BMC	X22EPR-U9	8812	550S	L92YC
W20ETRL	OE100	W22ETRL	OE095	X22EPR-U9	RAX96YC	550S	OE059
W20ETRS	OE006	W22EU	N5C	X22EPRZU9	RA8HC	580LS	N12YC
W20ETRS	RN9YC	W22EU	OE074	X22EPU9	OE083	580LS	OE015
W20ETS	N9YC	W22EXRU	OE018	X22EPU9	RA6HC	600LS	N11YC
W20ETS	OE001	W22EXRU	RN7YC	X22EPZU9	RA8HC	600LS	OE065
W20EXRU	OE006	W22EXU	N7YC	X22ESR-U	8812	600S	L87YC
W20EXRU	RN9YC	W22EXU	OE010	X22ESR-U	RAX96C	600S	OE007
W20EXRU11	OE048	W22FPRU	OE064	X22ESU	RA8HC	705L	N5C
W20EXRU11	RN9YC4	W22FPRU	RL82YC	X22EU	RA8HC	705L	OE074
W20EXU	N9YC	W22FPU	L82YC	X22SZU	RA8HC	705S	L87YC
W20EXU	OE001	W22FPU	OE038	X24EPR-U9	8809	705S	OE007
W20EXU13	N9YC	W22FRU	L82YC	X24EPR-U9	RAX94YC	707LS	N9YC
W20EXU13	OE001	W22FRU	OE038	X24EPRZU9	OE083	707LS	OE001
W20FPRU	OE064	W22FSR	OE086	X24EPRZU9	RA6HC	753LJS	OE009
W20FPRU	RL82YC	W22FSR	RL82C	X24EPZU9	OE083	753LJS	S9YC
W20FPU	L87YC	W22FSRU	OE086	X24EPZU9	RA6HC	755	L82C
W20FPU	OE007	W22FSRU	RL82C	X24ESR-U	8809	755L	N4C
W20FP-U	L87YC	W22FSU	L82C	X24ESR-U	RAX94C	755L	OE079
W20FP-U	OE007	W22FSZU	L86C	X24ESU	A6HC	755LJS	OE009
W20FSU	L86C	W22FSZU	OE037	X24ESU	OE132	755LJS	S9YC
W20FSU	OE037	W22FU	L86C	X24ESZU	A6GC	755LS	N9YC
W20FSZU	L86C	W22FU	OE037	X24ESZU	OE083	755LS	OE001
W20FSZU	OE037	W22MPUS	CJ7Y	X24ESZU	OE112	755SX	L82YC
W20FTU	L82YC	W22MU	CJ6	X24ESZU	RA6HC	755SX	OE038
W20FTU	OE038	W22MUS	CJ6	X27EPR-U9	8809	755X	L82C
W20MPRU	RCJ8Y	W24EPRU	OE116	X27EPR-U9	RAX92YC	800LS	N7YC
W20MPU	CJ8Y	W24EPRU	RN6YC	X27EPRZU9	OE083	800LS	OE010
W20MRU	RCJ8	W24EPU	N6YC	X27EPRZU9	RA6HC	803LJS	OE050
W20MUS	CJ8	W24EPU	N6YCC	X27EPZU9	OE083	803LJS	OE090
W20SRU	RJ6C	W24EPU	OE084	X27EPZU9	RA6HC	803LJS	S6YC
W21ESL11	N7YC	W24EPU	OE087	X27ESR-U	8809	803LJS	S7YC
W21ESL11	OE010	W24ESRU	OE108	X27ESR-U	RAX92C	803LJSP	OE133
W21ESRL11	OE018	W24ESRU	RN3C	X27ESZU	A59GC	803LJSP	RS6YCC
W21ESRL11	RN7YC	W24ESU	N3C	X27ESZU	OE083	805L	N3C
W22EPB	N6BYC	W24ESU	OE068	X27ESZU	OE103	805L	OE068
W22EPB	N7BYC	W24ESZU	N3G	X27ESZU	RA6HC	805LJSP	OE133
W22EPB	OE012	W24ESZU	OE078	X27ETR	8809	805LJSP	RS6YCC
W22EPB	OE109	W24EU	N3C	X27ETR	RAX92DC	805LP	N3G
W22EPRS11	OE049	W24EU	OE068	X31ESZU	OE073	805LP	OE078
W22EPRS11	RN11YC4	W24FSR	RL78C	X31ESZU	RA4HC	850	L82C
W22EPRU	OE008	W24FSU	L78C	XE20HRU9	OE130	850LS	N6YC
W22EPRU	OE018	W25EN	C59R	XE20HRU9	REA8MCL	850LS	OE087
W22EPRU	RN7YC	W27EN	C59R	XU22EPRU	OE083	C32LS	N12YC
W22EPRU	RN7YCC	W27ESRU	OE091	XU22EPRU	OE186	C32LS	OE015
W22EPRU11	OE117	W27ESRU	RN2C	XU22EPRU	RA6HC	C42S	L87YC
W22EPRU11	RN7YC4	W27ESU	N2C	XU22EPRU	RA8YCX4	C42S	OE007
W22EPU	L82YC	W27ESU	OE040	XU24EPRU	OE083	C52LJS	OE009
W22EPU	N7YC	W27ESZU	N2G	XU24EPRU	RA6HC	C52LJS	S9YC
W22EPU	OE010	W27ESZU	OE125	XU27EPRU	OE073	C52LS	N9YC
W22EPU	OE038	W27FSR	QL77JC4	XU27EPRU	RA4HC	C52LS	OE001
W22EPZU	N3C	W27FSU	L77JC4	XU27EPRZU	OE073	C62LJS	OE050
W22EPZU	OE068	W29EN	C57R	XU27EPRZU	RA4HC	C62LJS	OE090
W22ESL	N7YC	W31EN	C53R	ZT20EPR11	OE183	C62LJS	S6YC
W22ESL	OE010	W34EN	C53R	ZT20EPR11	RS8WYP5	C62LJS	S7YC
W22ESL11	N9YC	W9EXRU	RN14YC			C62LS	N7YC
W22ESL11	OE001	W9EXU	RN14YC			C62LS	OE010
W22ESRL	OE018	W9LMRUS	RJ19LM			C62LS3X	N9BYC
W22ESRL	RN7YC	W9LMUS	J19LM			C62LS3X	OE044





**...ISOLATOR**

FM.14-175/2	N9YC
FM.14-175/2	OE001
M.14-125	L86C
M.14-125	OE037
M.14-145	L86C
M.14-145	OE037
M.14-175	L86C
M.14-175	OE037
M.14-225/2	N4C
M.14-225/2	OE079
M.14-240/2	N3C
M.14-240/2	OE068
PM.14-145	L92YC
PM.14-145	OE059
PM.14-200	L82YC
PM.14-200	OE038
PM.14-225	L82YC
PM.14-225	OE038

**ISUZU**

97125969	OE124
97125969	RC10PYP4

**JAGUAR**

EAC008584	OE011
EAC008584	RS9YC
EAC8915	OE006
EAC8915	RN9YC
EAC8916	OE051
EAC8916	RN11YC
EAC8917	OE051
EAC8917	RN11YC
EBC004021	OE011
EBC004021	RS9YC
EBC11480	OE002
EBC11480	RC9YCC
NAB3850DA	OE011
NAB3850DA	RS9YC
NCA3850DA/2	OE144
NCA3850DA/2	RC87PYC
SPE1007	OE133
SPE1007	RS6YCC

**JENBACHER**

314322	RB75N
314322	RB75PP
314322	RB77WPCC
436782	RB77WPCC

**JENN FENG**

9111-310002	RDJ7Y
9295-310502	RDJ7Y

**JF**

D7	RA8HC
D8TC	A6HC
D8TC	OE132

**...JF**

E5TC	L95YC
E6TC	L87YC
E6TC	OE007
E7C	L82C
E7RTC	OE064
E7RTC	RL82YC
F5TC	RN14YC
F6TC	N12YC
F6TC	OE015
F7RTC	OE006
F7RTC	RN9YC
F7TC	N9YC
F7TC	OE001
F7TJC	RN10YC
G3TC	J12YC
G3TC	RJ14YC
G5RC	J11C
G6	J6C
G6	J8C
K6RTC	OE005
K6RTC	RC9YC
K6TC	C9YC
K6TC	OE003
K7DC	C9YC
K7DC	OE003
L6	RCJ8
L7	CJ8
L7T	CJ8Y
L9	CJ6
L9T	CJ6Y
N6	DJ8J
N9	DJ6J
T5RTC	RF9YC

**KIA**

18841 11051	OE035
18841 11051	REC9YCL

**KOHLER**

25132145	XC12YC
----------	--------

**LAND ROVER**

4550157	OE180
4550157	RC10WYP4
ERR3799	OE045
ERR3799	RN11YCC
ERR743	N9YC
ERR743	OE001
ETC7244	OE042
ETC7244	RN12YC
LR005253	OE180
LR005253	RC10WYP4
RTC3570	N12YC
RTC3570	OE015
RTC3571	N9YC
RTC3571	OE001
RTC3573	L92YC
RTC3573	OE059

**LODGE**

25HL	N6YC
25HL	OE087
25HLD	C6BYC
25HLD	C6YCC
25HLD	OE075
25HLD	OE076
25HLD	OE110
25HLD	RC6YC
25HLE	N6YC
25HLE	OE087
25HLNY	N7YC
25HLNY	OE010
2HL	N7BYC
2HL	N7YC
2HL	OE010
2HL	OE012
2HLDR	OE014
2HLDR	OE030
2HLDR	OE043
2HLDR	RC7YC
2HLDR	RC7YCC
2HLDR	RC8BYC
2HLE	N4C
2HLE	N9YC
2HLE	OE001
2HLE	OE079
2HLN	N3C
2HLN	OE068
2HLNY	N7YC
2HLNY	OE010
3HLN	N2C
3HLN	OE040
3HLNY	N6YC
3HLNY	OE087
HBLT	OE009
HBLT	OE036
HBLT	S9YC
HBLT	S9YCC
HL	N9BYC
HL	N9YC
HL	OE001
HL	OE044
HLD	C9YC
HLD	C9YCC
HLD	OE003
HLD	OE023
HLT	OE050
HLT	OE067
HLT	S7YC
HLT	S7YCC
L6Y	N9YC
L6Y	OE001

**MAGNETI****MARELLI**

45LDC	C11YCC
45LDC	OE057
6LC1R	OE063
6LC1R	RC10YC4
6LCR	OE088
6LCR	RC10YC
6LDCR	OE016
6LDCR	RC10YCC
75LDC1R	OE081
75LDC1R	RC8YCC4

**...MAGNETI****MARELLI**

75LMCR	OE030
75LMCR	RC8BYC
7LC	C9YC
7LC	OE003
7LC1R	OE039
7LC1R	RC9YC4
7LCR	OE005
7LCR	RC9YC
7LDC	C9YCC
7LDC	OE023
8LC	C7YC
8LC	OE017
8LC1R	OE080
8LC1R	RC7YC4
8LCR	OE043
8LCR	RC7YC
8LDC	C7YCC
8LDC	OE058
9LC	C6YCC
9LC	OE075
9LCR	OE110
9LCR	RC6YC
9LMC	C6BYC
9LMC	OE076
CW5N	L86C
CW5N	OE037
CW6NP	L87YC
CW6NP	OE007
CW78LPR	OE018
CW78LPR	RN7YC
CW7NP	L82YC
CW7NP	OE038
CW7NPR	OE064
CW7NPR	RL82YC
CW8LPR	OE018
CW8LPR	RN7YC
CW8NP	L82YC
CW8NP	OE038
F45LCR	OE051
F45LCR	RN11YC
F45LDCR	OE045
F45LDCR	RN11YCC
F4LC	N12YC
F4LC	OE015
F4LCR	OE042
F4LCR	RN12YC
F6LMC1R	OE027
F6LMC1R	RN10VTYC4
F6NC	L87YC
F6NC	OE007
F75LMC1R	OE025
F75LMC1R	RN8VTYC4
F7LC	N9YC
F7LC	OE001
F7LC1R	OE048
F7LC1R	RN9YC4
F7LCR	OE006
F7LCR	RN9YC
F7LDC1R	OE047
F7LDC1R	RN9YCC4
F7LDCR	OE004
F7LDCR	RN9YCC
F7LMC	N9BYC
F7LMC	OE044
F7LMC1	N9BYC4
F7LMC1	OE028

**...MAGNETI****MARELLI**

F7LSC	N9BMC
F7LSC	OE100
F7NC	L82YC
F7NC	OE038
F7NCR	OE064
F7NCR	RL82YC
F8LC	N7YC
F8LC	OE010
F8LCR	OE018
F8LCR	RN7YC
F8LDCR	OE008
F8LDCR	RN7YCC
F8LNCR	OE097
F8LNCR	RN7LCC
F8LSC	N7BMC
F8LSC	OE095
F9LC	N6YC
F9LC	OE087
F9LDC	N6YCC
F9LDC	OE084
F9LDCR	OE094
F9LDCR	RC6YCC
FC7N	L82C
FC7NR	OE086
FC7NR	RL82C
FL7LCR	OE006
FL7LCR	RN9YC
FL7MCR	N7BYC
FL7MCR	OE012
FL8LCR	OE018
FL8LCR	RN7YC
L10BPCPR	OE122
L10BPCPR	RG4PHP
L10CR	OE073
L10CR	RA4HC
L10DCR	OE052
L10DCR	RA4HCX
L6LPYCR	OE144
L6LPYCR	RC87PYC
L6LSCR	OE019
L6LSCR	RC10DMC
L75LMC1R	OE032
L75LMC1R	RC8VTYC4
L75LSCR	OE026
L75LSCR	RC8DMC
L7LCR	OE005
L7LCR	RC9YC
L7LDC1R	OE024
L7LDC1R	RC9YCC4
L7LDCR	OE002
L7LDCR	RC9YCC
L7LNCR	OE066
L7LNCR	RC9MCC
L7SCR	OE021
L7SCR	RC7BMC
L8LCR	OE043
L8LCR	RC7YC
L8LDC1R	OE056
L8LDC1R	RC7YCC4
L8LDCR	OE014
L8LDCR	RC7YCC
L9LPCPR	OE126
L9LPCPR	RC6PYP
L9LSPYC	C6VPYC
L9LSPYC	OE129
T70LDC	OE036

**...MAGNETI****MARELLI**

T70LDC	S9YCC
T7LC	OE009
T7LC	S9YC
T7LCR	OE011
T7LCR	RS9YC
T7LDCR	OE020
T7LDCR	RS9YCC
T8LC	OE050
T8LC	S7YC
T8LDC	OE067
T8LDC	S7YCC
TW78LP	OE050
TW78LP	S7YC
TW7LP	OE009
TW7LP	S9YC
V10CR	OE092
V10CR	RG4HC

**MAN**

51259230046	RN79PYP17
-------------	-----------

**MARCHAL**

34HS	N3C
34HS	OE068
34S	L82C
36	L86C
36	OE037
4N	L82C
5H	N3C
5H	OE068
5HA	N9YC
5HA	OE001
5N	L82YC
5N	OE038
6N	L86C
6N	OE037
9H	N9YC
9H	OE001
GT34	N9YC
GT34	OE001
GT35H	N9YC
GT35H	OE001

**MAZDA**

BP1118110	OE063
BP1118110	RC10YC4
BP121810	RC8YC4

**MEGA**

SE10H	H10C
-------	------

**MERCEDES**

003 159 97 03	KC8WYP4
003 159 97 03	OE181
003.159.23.03	OE036

**...MERCEDES**

003.159.23.03	S9YCC
003.159.24.03	OE072
003.159.24.03	S10YCC
003.159.59.03	OE067
003.159.59.03	S7YCC
003.159.60.03	C9YCC
003.159.60.03	EON2
003.159.60.03	OE023
003.159.71.03	C11YCC
003.159.71.03	EON2
003.159.71.03	OE057
004.159.20.03	KC10PYPB4
004.159.20.03	OE191
004.159.26.03	KC10PYPB4
004.159.26.03	OE191
004.159.30.03	KC10PYPB4
004.159.30.03	OE191
004.159.36.03	KC10PYPB4
004.159.36.03	OE191
A0031596603	KC10PYPB4
A0031596603	OE191
A0031597503	OE032
A0031597503	RC8VTYC4
A0031597603	OE032
A0031597603	RC8VTYC4
A0031598103	KC10PYPB4
A0031598103	OE191
A0031599403	KC10PYPB4
A0031599403	OE191
A0041591903	KC10PYPB4
A0041591903	OE191
A0041592003	KC10PYPB4
A0041592003	OE191
A0041592603	KC10PYPB4
A0041592603	OE191
A0041593003	KC10PYPB4
A0041593003	OE191
A0041593603	KC10PYPB4
A0041593603	OE191

**MITSUBISHI**

MN119487	OE179
MN119487	RC8WYP4
MR984943	OE179
MR984943	RC8WYP4

**MOPAR**

2098360	N12YC
2098360	OE015
2444870	RJ14YC
2642475	RJ14YC
2642913	J12YC
3438334	RJ14YC
3874934	RV15YC4
4091678	RV17YC
4091713	OE042
4091713	RN12YC
4091933	RJ12YC
4091936	RJ14YC
4091938	RV9YC
4106117	OE006
4106117	RN9YC
4106122	N9YC

**...MOPAR**

4106122	OE001
4106129	OE051
4106129	RN11YC
4141705	RV12YC
4289155	RV17YC
4289165	RF10C
4318130	N11YC
4318130	OE065
4318131	OE049
4318131	RN11YC4
4318134	RS12YC
4318135	RV12YC
4318138	RFN14LY
4339413	RV15YC4
4339415	RV17YC
4339416	RV17YC6
4339420	RV12C
4339425	RJ12YC
4339427	RF11YC
4339428	RV18YC6
4339429	RJ9YC
4339430	RF9YC
4339487	N7YC
4339487	OE010
4339491	J8C
4339492	RV8C
4419643	CJ8
4504278	OE011
4504278	RS9YC
4504279	OE039
4504279	RC9YC4
4504290	H10C
4609040	OE128
4609040	RC12LC4
4609079	RC12YC5
4671057	OE005
4671057	RC9YC
4686083	RN14MC5
4727114	OE105
4727114	RN14PMP5
4796779	OE124
4796779	RC10PYP4
4864454	3071
4864455	3071
4864462	OE013
4864462	RC12YC
4864463	OE049
4864463	RN11YC4
4864464	RFN14LY
4864465	RC9MC4
5213693	OE042
5213693	RN12YC
5234975	OE011
5234975	RS9YC
5369556	OE039
5369556	RC9YC4
56006240	OE013
56006240	RC12YC
56027108	RC9MC4
56027275	OE041
56027275	RC12LYC
82300312	OE108
82300312	RN3C
82300313	OE039
82300313	RC9YC4
82300314	RC12YC5
82300316	OE156

**...MOPAR**

82300316	<b>RN13LYC</b>
82300317	<b>RN14YC</b>
82300318	<b>RS14LC</b>
82300319	<b>RS14YC</b>
82300320	<b>RS14YC6</b>
82300321	<b>RS15LYC</b>
82300322	<b>RV15YC6</b>
82300323	<b>RF18YC</b>
82300324	<b>RV19YC6</b>
82300325	<b>RS17YX</b>
82300326	<b>RF10C</b>

**MOTORCRAFT**

1Y00-18-110	<b>OE051</b>
1Y00-18-110	<b>RN11YC</b>
1Y01-18-110	<b>OE006</b>
1Y01-18-110	<b>RN9YC</b>
1Y03-18-110	<b>OE049</b>
1Y03-18-110	<b>RN11YC4</b>
1Y06-18-110	<b>OE088</b>
1Y06-18-110	<b>RC10YC</b>
1Y07-18-110	<b>OE002</b>
1Y07-18-110	<b>RC9YCC</b>
1Y09-18-110	<b>OE063</b>
1Y09-18-110	<b>RC10YC4</b>
1Y0A-18-110	<b>OE024</b>
1Y0A-18-110	<b>RC9YCC4</b>
1Y0B-18-110	<b>OE080</b>
1Y0B-18-110	<b>RC7YC4</b>
1Y0F-18-110	<b>OE083</b>
1Y0F-18-110	<b>RA6HC</b>
1Y0G-18-110	<b>OE089</b>
1Y0G-18-110	<b>RC9MCC4</b>
1Y0H-18-110	<b>OE089</b>
1Y0H-18-110	<b>RC9MCC4</b>
1Y0K-18-110	<b>OE049</b>
1Y0K-18-110	<b>RN11YC4</b>
1Y0L-18-110	<b>OE114</b>
1Y0L-18-110	<b>RC11LCC4</b>
1YR1-18-110	<b>OE002</b>
1YR1-18-110	<b>RC9YCC</b>
1YR7-18-110	<b>OE002</b>
1YR7-18-110	<b>RC9YCC</b>
1YR9-18-110	<b>OE063</b>
1YR9-18-110	<b>RC10YC4</b>
1YRA-18-110	<b>OE024</b>
1YRA-18-110	<b>RC9YCC4</b>
1YRF-18-110	<b>OE083</b>
1YRF-18-110	<b>RA6HC</b>
1YRG-18-110	<b>OE089</b>
1YRG-18-110	<b>RC9MCC4</b>
1YRH-18-110	<b>OE089</b>
1YRH-18-110	<b>RC9MCC4</b>
AE22C	<b>L82YC</b>
AE22C	<b>OE038</b>
AE32	<b>L87YC</b>
AE32	<b>OE007</b>
AE32C	<b>L82YC</b>
AE32C	<b>OE038</b>
AE4	<b>L86C</b>
AE4	<b>OE037</b>
AE42	<b>L92YC</b>
AE42	<b>OE059</b>
AE4C	<b>L86C</b>
AE4C	<b>OE037</b>

**...MOTORCRAFT**

AE4X	<b>L86C</b>
AE4X	<b>OE037</b>
AE6	<b>L86C</b>
AE6	<b>OE037</b>
AE62	<b>L92YC</b>
AE62	<b>OE059</b>
AE8	<b>L86C</b>
AE8	<b>OE037</b>
AER22	<b>OE086</b>
AER22	<b>RL82C</b>
AER2X	<b>OE086</b>
AER2X	<b>RL82C</b>
AF12	<b>RV9YC</b>
AF22	<b>RV9YC</b>
AF32	<b>RV12YC</b>
AF42	<b>RV12YC</b>
AF42C	<b>RV12YC</b>
AG040	<b>OE006</b>
AG040	<b>RN9YC</b>
AG12	<b>N7YC</b>
AG12	<b>OE010</b>
AG12C	<b>N7YC</b>
AG12C	<b>OE010</b>
AG1C	<b>N3C</b>
AG1C	<b>OE068</b>
AG1CX	<b>N3C</b>
AG1CX	<b>OE068</b>
AG1X	<b>N3C</b>
AG1X	<b>OE068</b>
AG2	<b>N4C</b>
AG2	<b>OE079</b>
AG22	<b>N9YC</b>
AG22	<b>OE001</b>
AG224	<b>N9YC</b>
AG224	<b>OE001</b>
AG22C	<b>N9YC</b>
AG22C	<b>OE001</b>
AG25	<b>N9YC</b>
AG25	<b>OE001</b>
AG2C	<b>N4C</b>
AG2C	<b>OE079</b>
AG2X	<b>N4C</b>
AG2X	<b>OE079</b>
AG3	<b>N5C</b>
AG3	<b>OE074</b>
AG32	<b>N11YC</b>
AG32	<b>OE065</b>
AG32A	<b>N11YC</b>
AG32A	<b>OE065</b>
AG32C	<b>N11YC</b>
AG32C	<b>N12YC</b>
AG32C	<b>N9YC</b>
AG32C	<b>OE001</b>
AG32C	<b>OE015</b>
AG32C	<b>OE065</b>
AG3C	<b>N5C</b>
AG3C	<b>OE074</b>
AG3X	<b>N5C</b>
AG3X	<b>OE074</b>
AG4	<b>N5C</b>
AG4	<b>OE074</b>
AG42	<b>N12YC</b>
AG42	<b>OE015</b>
AG42C	<b>N12YC</b>
AG42C	<b>OE015</b>
AG5	<b>N5C</b>
AG5	<b>OE074</b>

**...MOTORCRAFT**

AG7	<b>N5C</b>
AG7	<b>OE074</b>
AG701	<b>N2C</b>
AG701	<b>OE040</b>
AG901C	<b>N3C</b>
AG901C	<b>OE068</b>
AG902	<b>N6YC</b>
AG902	<b>OE087</b>
AGF12	<b>OE011</b>
AGF12	<b>OE050</b>
AGF12	<b>RS9YC</b>
AGF12	<b>S7YC</b>
AGF12C	<b>OE050</b>
AGF12C	<b>S7YC</b>
AGF22	<b>OE009</b>
AGF22	<b>S9YC</b>
AGF22C	<b>OE009</b>
AGF22C	<b>S9YC</b>
AGFS22CM1	<b>OE131</b>
AGFS22CM1	<b>RS9PYP4</b>
AGP12C	<b>C7YC</b>
AGP12C	<b>OE017</b>
AGP22C	<b>C9YC</b>
AGP22C	<b>OE003</b>
AGPR12C	<b>OE043</b>
AGPR12C	<b>RC7YC</b>
AGPR22C	<b>OE005</b>
AGPR22C	<b>RC9YC</b>
AGPR22CD	<b>OE043</b>
AGPR22CD	<b>RC7YC</b>
AGPR22P	<b>OE145</b>
AGPR22P	<b>RC89PYC</b>
AGPR32C1	<b>OE043</b>
AGPR32C1	<b>RC7YC</b>
AGPR902C	<b>OE110</b>
AGPR902C	<b>RC6YC</b>
AGPS22C	<b>OE005</b>
AGPS22C	<b>RC9YC</b>
AGPS22CD	<b>OE043</b>
AGPS22CD	<b>RC7YC</b>
AGPS22P1	<b>OE136</b>
AGPS22P1	<b>RC8PYP</b>
AGPS22PP1	<b>OE136</b>
AGPS22PP1	<b>RC8PYP</b>
AGR12	<b>OE018</b>
AGR12	<b>RN7YC</b>
AGR12C	<b>OE018</b>
AGR12C	<b>RN7YC</b>
AGR1X	<b>OE108</b>
AGR1X	<b>RN3C</b>
AGR21	<b>OE098</b>
AGR21	<b>RN4C</b>
AGR22	<b>OE006</b>
AGR22	<b>RN9YC</b>
AGR22C	<b>OE006</b>
AGR22C	<b>RN9YC</b>
AGR2C	<b>OE098</b>
AGR2C	<b>RN4C</b>
AGR2X	<b>OE098</b>
AGR2X	<b>RN4C</b>
AGR31	<b>RN5C</b>
AGR32	<b>OE049</b>
AGR32	<b>RN11YC4</b>
AGR32C	<b>OE006</b>
AGR32C	<b>OE042</b>
AGR32C	<b>OE051</b>
AGR32C	<b>RN11YC</b>

**...MOTORCRAFT**

AGR32C	<b>RN12YC</b>
AGR32C	<b>RN9YC</b>
AGR3X	<b>RN5C</b>
AGR41	<b>RN5C</b>
AGR42	<b>OE042</b>
AGR42	<b>RN12YC</b>
AGR42C	<b>OE042</b>
AGR42C	<b>RN12YC</b>
AGRF12C	<b>OE050</b>
AGRF12C	<b>S7YC</b>
AGRF2	<b>OE011</b>
AGRF2	<b>RS9YC</b>
AGRF22	<b>OE011</b>
AGRF22	<b>RS9YC</b>
AGRF22C	<b>OE011</b>
AGRF22C	<b>RS9YC</b>
AGRF22D1	<b>OE131</b>
AGRF22D1	<b>RS9PYP4</b>
AGRF22DD1	<b>OE131</b>
AGRF22DD1	<b>RS9PYP4</b>
AGRF22P1	<b>OE029</b>
AGRF22P1	<b>RES9PYP4</b>
AGRF22PP	<b>OE131</b>
AGRF22PP	<b>RS9PYP4</b>
AGRF22PP1	<b>OE131</b>
AGRF22PP1	<b>RS9PYP4</b>
AGRF32	<b>RS12YC</b>
AGRF42	<b>RS12YC</b>
AGRF52	<b>RS12YC</b>
AGS1C	<b>OE108</b>
AGS1C	<b>RN3C</b>
AGS22C	<b>OE006</b>
AGS22C	<b>RN9YC</b>
AGS2C	<b>OE098</b>
AGS2C	<b>RN4C</b>
AGS32C	<b>OE042</b>
AGS32C	<b>RN12YC</b>
AGS3C	<b>RN5C</b>
AGS42C	<b>OE042</b>
AGS42C	<b>RN12YC</b>
AGS4C	<b>RN5C</b>
AGSF2	<b>OE011</b>
AGSF2	<b>RS9YC</b>
AGSF22C	<b>OE011</b>
AGSF22C	<b>RS9YC</b>
AGSF22PP	<b>OE131</b>
AGSF22PP	<b>RS9PYP4</b>
AGSF22PPJ	<b>OE131</b>
AGSF22PPJ	<b>RS9PYP4</b>
AGSF32C	<b>RS12YC</b>
AGSF32W	<b>RS14YC6</b>
AGSP33C	<b>OE043</b>
AGSP33C	<b>RC7YC</b>
ARF22	<b>RV9YC</b>
ARF32	<b>RV12YC</b>
ARF32M	<b>RV12YC</b>
ARF42	<b>RV12YC</b>
ASF22C	<b>RV9YC</b>
ASF32	<b>RV12YC</b>
ASF32C	<b>RV12YC</b>
ASF32CM	<b>RV12YC</b>
ASF32M	<b>RV12YC</b>
ASF34	<b>RV12YC</b>
ASF42	<b>RV12YC</b>
ASF42C	<b>RV12YC</b>
ASWF32F	<b>OE131</b>
ASWF32F	<b>RS9PYP4</b>



<b>...MOTORCRAFT</b>		<b>CHAMPION</b>
AV4	<b>L86C</b>	
AV4	<b>OE037</b>	
AWSF22C	<b>OE011</b>	
AWSF22C	<b>RS9YC</b>	
AWSF22FS	<b>OE131</b>	
AWSF22FS	<b>RS9PYP4</b>	
AWSF32	<b>RS12YC</b>	
AWSF32C	<b>RS12YC</b>	
AWSF32F	<b>RS12PYP</b>	
AWSF32P	<b>RS12PYP</b>	
AWSF32PP	<b>RS12PYP</b>	
AWSFA32C	<b>RS12YC</b>	
AYFS092FEC	<b>OE029</b>	
AYFS092FEC	<b>RES9PYP4</b>	
AYFS22C	<b>OE031</b>	
AYFS22C	<b>RES9YCC4</b>	
AYFS22CB	<b>OE031</b>	
AYFS22CB	<b>RES9YCC4</b>	
AYFS22F1	<b>OE029</b>	
AYFS22F1	<b>RES9PYP4</b>	
AYFS22PP	<b>OE029</b>	
AYFS22PP	<b>RES9PYP4</b>	
AYFS32CJ	<b>OE031</b>	
AYFS32CJ	<b>RES9YCC4</b>	
AYRF22PP	<b>OE029</b>	
AYRF22PP	<b>OE031</b>	
AYRF22PP	<b>RES9PYP4</b>	
AYRF22PP	<b>RES9YCC4</b>	
AZFS22C	<b>OE029</b>	
AZFS22C	<b>OE031</b>	
AZFS22C	<b>RES9PYP4</b>	
AZFS22C	<b>RES9YCC4</b>	
BF12	<b>RF9YC</b>	
BF22	<b>RF9YC</b>	
BF32	<b>RF9YC</b>	
BFS32C	<b>OE054</b>	
BFS32C	<b>RF7YC</b>	
BRF22C	<b>OE054</b>	
BRF22C	<b>RF7YC</b>	
BRF22CX	<b>OE054</b>	
BRF22CX	<b>RF7YC</b>	
BRF32	<b>RF9YC</b>	
BRF32C	<b>RF9YC</b>	
BRF32X	<b>RF9YC</b>	

<b>NCOSP</b>		<b>CHAMPION</b>
D7	<b>RA8HC</b>	
D8TC	<b>A6HC</b>	
D8TC	<b>OE132</b>	
E5TC	<b>L95YC</b>	
E6TC	<b>L87YC</b>	
E6TC	<b>OE007</b>	
E7C	<b>L82C</b>	
E7RTC	<b>OE064</b>	
E7RTC	<b>RL82YC</b>	
F5TC	<b>RN14YC</b>	
F6TC	<b>N12YC</b>	
F6TC	<b>OE015</b>	
F7RTC	<b>OE006</b>	
F7RTC	<b>RN9YC</b>	
F7TC	<b>N9YC</b>	
F7TC	<b>OE001</b>	
F7TJC	<b>RN10YC</b>	
G3TC	<b>J12YC</b>	
G3TC	<b>RJ14YC</b>	

<b>...NCOSP</b>		<b>CHAMPION</b>
G5RC	<b>J11C</b>	
G6	<b>J6C</b>	
G6	<b>J8C</b>	
K6RTC	<b>OE005</b>	
K6RTC	<b>RC9YC</b>	
K6TC	<b>C9YC</b>	
K6TC	<b>OE003</b>	
K7DC	<b>C9YC</b>	
K7DC	<b>OE003</b>	
L6	<b>RCJ8</b>	
L7	<b>CJ8</b>	
L7T	<b>CJ8Y</b>	
L9	<b>CJ6</b>	
L9T	<b>CJ6Y</b>	
N6	<b>DJ8J</b>	
N9	<b>DJ6J</b>	
T5RTC	<b>RF9YC</b>	

<b>NEWSTAR</b>		<b>CHAMPION</b>
A6TC	<b>Z6</b>	
A7TC	<b>Z6</b>	
B7RC	<b>OE092</b>	
B7RC	<b>RG4HC</b>	
C6TC	<b>P8Y</b>	
C8C	<b>P7</b>	
C8RC	<b>P7</b>	
D6TC	<b>A6HC</b>	
D6TC	<b>OE132</b>	
D8C	<b>A6GC</b>	
D8C	<b>OE112</b>	
D8RTC	<b>OE083</b>	
D8RTC	<b>RA6HC</b>	
D8TC	<b>OE083</b>	
D8TC	<b>RA6HC</b>	
DK7RTC	<b>OE073</b>	
DK7RTC	<b>RA4HC</b>	
E10C	<b>UL81C</b>	
E11C	<b>L78C</b>	
E12C	<b>L77JC4</b>	
E4C	<b>L90C</b>	
E4RTC	<b>RL95YC</b>	
E5C	<b>L90C</b>	
E6C	<b>L86C</b>	
E6C	<b>OE037</b>	
E6RC	<b>RL86C</b>	
E6TC	<b>L92YC</b>	
E6TC	<b>OE059</b>	
E7C	<b>L86C</b>	
E7C	<b>OE037</b>	
E7RC	<b>RL86C</b>	
E7RTC	<b>RL87YC</b>	
E7TC	<b>L87YC</b>	
E7TC	<b>OE007</b>	
E8C	<b>L82C</b>	
E8RTC	<b>OE064</b>	
E8TC	<b>RL82YC</b>	
E8TC	<b>L82YC</b>	
E8TC	<b>OE038</b>	
E9C	<b>L82C</b>	
E9RC	<b>OE086</b>	
E9RC	<b>RL82C</b>	
F10RC	<b>OE108</b>	
F10RC	<b>RN3C</b>	
F10TC	<b>QC59YC-ST</b>	
F11C	<b>N2C</b>	

<b>..NEWSTAR</b>		<b>CHAMPION</b>
F11C	<b>OE040</b>	
F11RC	<b>OE091</b>	
F11RC	<b>RN2C</b>	
F4C	<b>N21</b>	
F4RLC-11	<b>RN16YC5</b>	
F4TC	<b>N16YC</b>	
F5FC	<b>OE156</b>	
F5FC	<b>RN13LYC</b>	
F5LC	<b>N12YC</b>	
F5LC	<b>OE015</b>	
F5RFC	<b>OE156</b>	
F5RFC	<b>RN13LYC</b>	
F5RTC	<b>OE042</b>	
F5RTC	<b>RN12YC</b>	
F5RTC-15	<b>OE042</b>	
F5RTC-15	<b>RN12YC</b>	
F5TC	<b>N11YC</b>	
F5TC	<b>OE065</b>	
F6C	<b>N5C</b>	
F6C	<b>OE074</b>	
F6RC	<b>RN5C</b>	
F6RTC	<b>OE051</b>	
F6RTC	<b>RN11YC</b>	
F6RTC-10	<b>OE049</b>	
F6RTC-10	<b>RN11YC4</b>	
F6TC	<b>N11YC</b>	
F6TC	<b>OE065</b>	
F6TC-10	<b>N11YC</b>	
F6TC-10	<b>OE065</b>	
F6TJC	<b>N9BYC</b>	
F6TJC	<b>OE044</b>	
F7C	<b>N4C</b>	
F7C	<b>OE079</b>	
F7RC	<b>OE098</b>	
F7RC	<b>RN4C</b>	
F7RLC	<b>OE060</b>	
F7RLC	<b>RN9LCC</b>	
F7RLC-10	<b>OE060</b>	
F7RLC-10	<b>RN9LCC</b>	
F7RTC	<b>OE006</b>	
F7RTC	<b>RN9YC</b>	
F7RTC-10	<b>OE048</b>	
F7RTC-10	<b>RN9YC4</b>	
F7TC	<b>N9YC</b>	
F7TC	<b>OE001</b>	
F7TJC	<b>N9BYC</b>	
F7TJC	<b>OE044</b>	
F8RTC	<b>OE018</b>	
F8RTC	<b>RN7YC</b>	
F8RTC-10	<b>OE117</b>	
F8RTC-10	<b>RN7YC4</b>	
F8TC	<b>N7YC</b>	
F8TC	<b>OE010</b>	
F9C	<b>N3C</b>	
F9C	<b>OE068</b>	
F9RC	<b>OE108</b>	
F9RC	<b>RN3C</b>	
F9RTC	<b>OE116</b>	
F9RTC	<b>RN6YC</b>	
F9TC	<b>N6YC</b>	
F9TC	<b>OE087</b>	
F9TJC	<b>N6BYC</b>	
F9TJC	<b>OE109</b>	
G2RC	<b>RJ12C</b>	
G4C	<b>J11C</b>	
G4RTC	<b>RJ14YC</b>	
G4RTC-15	<b>RJ14YC</b>	

<b>..NEWSTAR</b>		<b>CHAMPION</b>
G4RTC-20	<b>RJ14YC</b>	
G4TC	<b>RJ14YC</b>	
G5C	<b>J8C</b>	
G5RC	<b>RJ8C</b>	
G6C	<b>J6C</b>	
G6RTC	<b>RJ12YC</b>	
G6RTC-15	<b>RJ12YC</b>	
G6TC	<b>J12YC</b>	
G7C	<b>J6C</b>	
G7RC	<b>RJ6C</b>	
G7RTC	<b>RJ12YC</b>	
G7TC	<b>J12YC</b>	
G9C	<b>J4C</b>	
GL3C	<b>J19LM</b>	
GL3RC	<b>RJ19LM</b>	
GL5C	<b>J17LM</b>	
GL5RC	<b>RJ17LM</b>	
K12C	<b>QC59C-ST</b>	
K4RTC	<b>RC14YC</b>	
K4RTC-10	<b>RC14YC</b>	
K5FC	<b>OE041</b>	
K5FC	<b>RC12LYC</b>	
K5RFC	<b>RFN14LY</b>	
K5RTC	<b>OE013</b>	
K5RTC	<b>RC12YC</b>	
K5RTC-11	<b>RC12YC5</b>	
K6RFC	<b>OE041</b>	
K6RFC	<b>RC12LYC</b>	
K6RLC-10	<b>OE114</b>	
K6RLC-10	<b>RC11LCC4</b>	
K6RTC	<b>OE088</b>	
K6RTC	<b>RC10YC</b>	
K6RTC-10	<b>OE063</b>	
K6RTC-10	<b>RC10YC4</b>	
K6TC	<b>C11YCC</b>	
K6TC	<b>OE057</b>	
K7LC	<b>OE066</b>	
K7LC	<b>RC9MCC</b>	
K7LKC	<b>OE085</b>	
K7LKC	<b>RC9BMC</b>	
K7RLC	<b>OE066</b>	
K7RLC	<b>RC9MCC</b>	
K7RLC-10	<b>OE089</b>	
K7RLC-10	<b>RC9MCC4</b>	
K7RTC	<b>OE005</b>	
K7RTC	<b>RC9YC</b>	
K7RTC-10	<b>OE039</b>	
K7RTC-10	<b>RC9YC4</b>	
K7RTJC	<b>OE118</b>	
K7RTJC	<b>RC7BYC</b>	
K7RTKC	<b>OE085</b>	
K7RTKC	<b>RC9BMC</b>	
K7TC	<b>C9YC</b>	
K7TC	<b>OE003</b>	
K8RTC	<b>OE043</b>	
K8RTC	<b>RC7YC</b>	
K8RTC-10	<b>OE080</b>	
K8RTC-10	<b>RC7YC4</b>	
K8RTJC	<b>OE118</b>	
K8RTJC	<b>RC7BYC</b>	
K8RTKC	<b>OE021</b>	
K8RTKC	<b>RC7BMC</b>	
K8TC	<b>C7YC</b>	
K8TC	<b>OE017</b>	
K9RTC	<b>OE110</b>	
K9RTC	<b>RC6YC</b>	
K9TC	<b>C6YCC</b>	



..NEWSTAR		CHAMPION
K9TC	OE075	
L2C	CJ14	
L5C	CJ8	
L6C	CJ6	
L6RC	RCJ8	
L6RTC	RCJ8Y	
L6TC	CJ8Y	
L7C	CJ6	
L7RTC	RCJ7Y	
L7TC	CJ7Y	
L8C	CJ4	
L8RC	RCJ4	
L8TC	CJ6Y	
L9RTC	RCJ6Y	
N6C	DJ8J	
N7C	DJ7J	
N7TC	DJ7Y	
N8C	DJ6J	
P4RTC	RV17YC	
P4RTC-10	RV17YC	
P4RTC-15	RV17YC6	
P4RTC-20	RV17YC6	
P5RC	RV12C	
P5RC-15	RV12C	
P5RTC	RV15YC4	
P5RTC-10	RV15YC4	
P5RTC-15	RV15YC6	
P5RTC-20	RV15YC6	
P5TC	RV15YC4	
P6RC	RV12C	
P6RTC	RV12YC	
P6RTC-15	RV12YC	
P6TC	RV12YC	
P7RTC	RV9YC	
P8TC	V12YC	
Q12C	S59C-ST	
Q5RTC	RS14YC	
Q5RTC-15	RS14YC6	
Q6TC	OE099	
Q6TC	S12YC	
Q7RTC	OE011	
Q7RTC	RS9YC	
Q7RTC-15	OE011	
Q7RTC-15	RS9YC	
Q7TC	OE009	
Q7TC	S9YC	
Q7TC-15	OE009	
Q7TC-15	S9YC	
Q8TC	OE050	
Q8TC	S7YC	
Q9TC	OE090	
Q9TC	S6YC	
T4TC	RF14YC	
T5RTC	RF11YC	
T5RTC-10	RF11YC	
T5TC	RF11YC	
T6RTC	RF9YC	
T6RTC-10	RF9YC	
T6RTC-11	RF9YC	
T6TC	RF9YC	
T7C	F10C	
T7RC	RF10C	
T7TC	OE054	
T7TC	RF7YC	
T8TC	F7YC	
T8TC	OE061	
U10C	D9	

..NEWSTAR		CHAMPION
U4C	D16	
U7C	D14	
U9C	D14	
UK10C	D9	
UK4C	D16	
UK4RC	RD16	
UK4TC	D16	
UK6C	D14	
UK6RC	D14	
UK6RTC	D15Y	
UK6TC	D15Y	
UK7C	D9	
<b>NGK</b>		
A6	D14	
A6FS	RF10C	
A7	D14	
A7FS	RF10C	
A7FS22C	OE029	
A7FS22C	RES9PYP4	
A7FS22PP1	OE029	
A7FS22PP1	RES9PYP4	
A8	D9	
AGFS22C1	OE011	
AGFS22C1	RS9YC	
AP6FS	F7YC	
AP6FS	OE061	
AP6FVG	F7YC	
AP6FVG	OE061	
AP7FS	F7YC	
AP7FS	OE061	
APR5FS	RF11YC	
APR6FS	OE054	
APR6FS	RF7YC	
APR6FSVP4	OE054	
APR6FSVP4	RF7YC	
APR6FVG4	OE054	
APR6FVG4	RF7YC	
B10SEGV	QN84	
B10EG	N2C	
B10EG	OE040	
B10EGV	N2G	
B10EGV	OE125	
B10ES	C57	
B10EV	N2G	
B10EV	OE125	
B10EVX	N2G	
B10EVX	OE125	
B10HS	QL55	
B10HV	QL55	
B10HVX	QL55	
B2	RJ12C	
B2LM	J19LM	
B4	J11C	
B4ES	N5C	
B4ES	OE074	
B4H	L90C	
B4LM	J17LM	
B5EB	N5C	
B5EB	OE074	
B5ES	N5C	
B5ES	OE074	
B5EV	N5C	
B5EV	OE074	
B5HS	L86C	

...NGK		CHAMPION
B5HS	OE037	
B6EB	N5C	
B6EB	OE074	
B6EBL	N5C	
B6EBL	OE074	
B6EFS	OE009	
B6EFS	S9YC	
B6ES	N5C	
B6ES	OE074	
B6EV	OE098	
B6EV	RN4C	
B6HS	L86C	
B6HS	OE037	
B6HS10	L86C	
B6HS10	OE037	
B6HSA	L86C	
B6HSA	OE037	
B6HVX	L86C	
B6HVX	OE037	
B6L	H8C	
B6S	J8C	
B7EB	N4C	
B7EB	OE079	
B7ECS	OE018	
B7ECS	RN7YC	
B7ES	N4C	
B7ES	OE079	
B7EV	N4C	
B7EV	OE079	
B7EVX	N4C	
B7EVX	OE079	
B7HS	L82C	
B7HS10	L82YC	
B7HS10	OE038	
B7S	J6C	
B8SEGV	N2G	
B8SEGV	OE125	
B8ECS	N2C	
B8ECS	OE040	
B8EFS	S59C-ST	
B8EG	N3G	
B8EG	OE078	
B8EGP	N3G	
B8EGP	OE078	
B8EGV	N3G	
B8EGV	OE078	
B8ES	N3C	
B8ES	OE068	
B8EV	N3G	
B8EV	OE078	
B8EVX	N3G	
B8EVX	OE078	
B8HCS	L78C	
B8HS	L78C	
B8HVX	L77JC4	
B8S	J4C	
B9SEGV	QN84	
B9EG	N2G	
B9EG	OE125	
B9EGV	N2G	
B9EGV	OE125	
B9ES	N2C	
B9ES	OE040	
B9EV	N2C	
B9EV	OE040	
B9EVX	N2G	
B9EVX	OE125	

...NGK		CHAMPION
B9HCS	L77JC4	
B9HS	L77JC4	
B9HS10	L77JC4	
B9HVX	L77JC4	
BCP4ES11	C11YCC	
BCP4ES11	OE057	
BCP5E	C9YCC	
BCP5E	OE023	
BCP5ES	C9YC	
BCP5ES	OE003	
BCP5ET	C9YCC	
BCP5ET	OE023	
BCP5EV	C9YCC	
BCP5EV	OE023	
BCP5EVX	C9YCC	
BCP5EVX	OE023	
BCP6E	C9YCC	
BCP6E	EON2	
BCP6E	OE023	
BCP6ES	C9YC	
BCP6ES	C9YCC	
BCP6ES	OE003	
BCP6ES	OE023	
BCP6ET	OE032	
BCP6ET	RC8VTYC4	
BCP6EV	C9YCC	
BCP6EV	OE002	
BCP6EV	OE023	
BCP6EV	RC9YCC	
BCP6EVX	C9YCC	
BCP6EVX	OE023	
BCP7ES	C7YC	
BCP7ES	OE017	
BCP7ET	C6BYC	
BCP7ET	OE076	
BCP7EV	C7YCC	
BCP7EV	OE058	
BCP7EVX	C7YCC	
BCP7EVX	OE058	
BCPR4ES	OE013	
BCPR4ES	RC12YC	
BCPR4ES11	RC12YCS	
BCPR4EY11	RC12YCS	
BCPR5E	OE088	
BCPR5E	RC10YC	
BCPR5E11	OE062	
BCPR5E11	OE063	
BCPR5E11	RC10YC4	
BCPR5E11	RC10YCC4	
BCPR5E1X11	OE180	
BCPR5E1X11	RC10WYP4	
BCPR5EP11	OE141	
BCPR5EP11	RC10PYC	
BCPR5EP8	OE141	
BCPR5EP8	RC10PYC	
BCPR5ES	OE088	
BCPR5ES	RC10YC	
BCPR5ES11	OE063	
BCPR5ES11	RC10YC4	
BCPR5EY	OE005	
BCPR5EY	RC9YC	
BCPR5EY11	OE039	
BCPR5EY11	RC9YC4	
BCPR5EYN11	OE039	
BCPR5EYN11	RC9YC4	
BCPR6E	EON2	
BCPR6E	OE005	



...NGK	CHAMPION	...NGK	CHAMPION	...NGK	CHAMPION	...NGK	CHAMPION
BCPR6E	RC9YC	BK7EKU	RC7BMC	BKR5EYA11	OE093	BKR6EY	RC9YCC
BCPR6E11	OE024	BKR4E	OE013	BKR5EYA11	RC89YCC	BKR6EY11	OE080
BCPR6E11	RC9YCC4	BKR4E	RC12YC	BKR5EZ	OE033	BKR6EY11	RC7YC4
BCPR6EIX11	OE179	BKR4E11	RC12YC5	BKR5EZ	RC87YCL	BKR6EYA	OE002
BCPR6EIX11	RC8WYP4	BKR4EVX	OE134	BKR6E	OE002	BKR6EYA	RC9YCC
BCPR6EP11	OE145	BKR4EVX	RC12PYP	BKR6E	OE005	BKR6EYA11	OE024
BCPR6EP11	RC89PYC	BKR4EY	RC12YC5	BKR6E	OE024	BKR6EYA11	RC9YCC4
BCPR6EPN8	OE024	BKR5E	OE016	BKR6E	RC9YC	BKR6EZ	OE033
BCPR6EPN8	OE145	BKR5E	OE088	BKR6E	RC9YCC	BKR6EZ	OE034
BCPR6EPN8	RC89PYC	BKR5E	RC10YC	BKR6E	RC9YCC4	BKR6EZ	RC87YCL
BCPR6EPN8	RC9YCC4	BKR5E	RC10YCC	BKR6E11	OE024	BKR6EZ	RC8YCL
BCPR6ES	OE002	BKR5E11	OE062	BKR6E11	RC8YC4	BKR6EZB	KC10PYPB4
BCPR6ES	OE005	BKR5E11	OE063	BKR6E11	RC9YCC4	BKR6EZB	OE191
BCPR6ES	RC9YC	BKR5E11	RC10YC4	BKR6E11VG4	OE024	BKR7E	OE043
BCPR6ES	RC9YCC	BKR5E11	RC10YCC4	BKR6E11VG4	RC9YCC4	BKR7E	RC7YC
BCPR6ES11	OE039	BKR5EIX	OE180	BKR6EIX	OE179	BKR7E11	OE080
BCPR6ES11	RC9YC4	BKR5EIX	RC10WYP4	BKR6EIX	RC8WYP4	BKR7E11	RC7YC4
BCPR6ESVP4	OE005	BKR5EIX11	OE180	BKR6EIX11	OE179	BKR7EIX	OE179
BCPR6ESVP4	RC9YC	BKR5EIX11	RC10WYP4	BKR6EIX11	RC8WYP4	BKR7EIX	RC8WYP4
BCPR6ET	OE021	BKR5EK	OE019	BKR6EK	OE026	BKR7EKC	OE026
BCPR6ET	RC7BMC	BKR5EK	RC10DMC	BKR6EK	RC8DMC	BKR7EKC	RC8DMC
BCPR6EVG4	OE024	BKR5EKB	OE019	BKR6EK11	OE026	BKR7EKC	OE026
BCPR6EVG4	RC9YCC4	BKR5EKB	RC10DMC	BKR6EK11	RC8DMC	BKR7EKC	RC8DMC
BCPR6EY	OE002	BKR5EKB11	OE019	BKR6EK11	RC8YC4	BKR7EKC	C6VPYC
BCPR6EY	RC9YCC	BKR5EKB11	RC10DMC	BKR6EKB11	OE026	BKR7EKC	OE129
BCPR6EY11	OE024	BKR5EKC	OE030	BKR6EKB11	RC8DMC	BKR7EN11	OE080
BCPR6EY11	RC9YCC4	BKR5EKC	RC8BYC	BKR6EKC	OE016	BKR7EN11	RC7YC4
BCPR6EYN11	OE039	BKR5EKC	OE085	BKR6EKC	OE030	BKR7ES11	OE080
BCPR6EYN11	RC9YC4	BKR5EKC	OE085	BKR6EKC	RC10YCC	BKR7ES11	RC7YC4
BCPR7E	EON1	BKR5EKC	OE030	BKR6EKC	RC8BYC	BKR7EVX	OE014
BCPR7E	OE043	BKR5EKC	RC8BYC	BKR6EKC	RC8BYC	BKR7EVX	RC7YCC
BCPR7E	RC7YC	BKR5EKC	OE030	BKR6EKC	OE026	BKR7EVX	OE056
BCPR7E11	OE080	BKR5EKC	RC8BYC	BKR6EKC	OE102	BKR7EVX11	RC7YCC4
BCPR7E11	RC7YC4	BKR5EKC	OE030	BKR6EKC	RC87YCC	BKR7EVX11	RC7YCC4
BCPR7E11	RC7YC4	BKR5EKC	RC8BYC	BKR6EKC	RC8DMC	BKR7EY11	OE080
BCPR7ER	OE013	BKR5EKC	OE030	BKR6EKC	OE123	BKR7EY11	RC7YC4
BCPR7ER	RC12YC	BKR5EKC	RC8BYC	BKR6EKC	RC8TYC	BKR7EY11	RC7YC4
BCPR7ER	OE014	BKR5EKC	OE030	BKR6EKC	OE026	BKR8EIX	OE126
BCPR7ES	OE043	BKR5EKC	RC9YC4	BKR6EKC	RC8TYC	BKR8EIX	RC6PYP
BCPR7ES	RC7YC	BKR5EKC	OE124	BKR6EKC	RC8DMC	BKRUR6ET	OE120
BCPR7ES	RC7YCC	BKR5EKC	RC10PYP4	BKR6EKC	OE019	BKRUR6ET	RC89TMC
BCPR7ES11	OE080	BKR5EKC	RC89TMC	BKR6EKC	RC10DMC	BKUR5ET	OE120
BCPR7ES11	RC7YC4	BKR5EKC	OE039	BKR6EKC	OE085	BKUR5ET	RC89TMC
BCPR7ET	OE043	BKR5EKC	RC9YC4	BKR6EKC	RC9BMC	BKUR5ET10	OE120
BCPR7ET	RC7YC	BKR5EKC	OE124	BKR6EKC	OE026	BKUR5ET10	RC89TMC
BCPR7EY	OE043	BKR5EKC	RC10PYP4	BKR6EKC	RC8DMC	BKUR6EK	OE120
BCPR7EY	RC7YC	BKR5EKC	OE124	BKR6EKC	OE080	BKUR6EK	RC89TMC
BCPR7EY11	OE080	BKR5EKC	RC10PYP4	BKR6EKC	RC7YC4	BKUR6ET	OE032
BCPR7EY11	RC7YC4	BKR5EKC	RC89TMC	BKR6EKC	OE136	BKUR6ET	OE120
BCPR7EYN11	OE080	BKR5EKC	OE063	BKR6EKC	RC8PYP	BKUR6ET	RC89TMC
BCPR7EYN11	RC7YC4	BKR5EKC	RC10YC4	BKR6EKC	OE136	BKUR6ET	RC8VTC4
BCPR9ES11	OE110	BKR5EKC	OE063	BKR6EKC	RC8PYP	BKUR6ET10	OE032
BCPR9ES11	RC6YC	BKR5EKC	RC10YC4	BKR6EKC	OE146	BKUR6ET10	RC8VTC4
BCR8ES	OE164	BKR5EKC	OE002	BKR6EKC	RC8PYPB4	BKUR6ETB	OE120
BCR8ES	RC61YC-ST	BKR5EKC	RC9YCC	BKR6EKC	OE136	BKUR6ETB	RC89TMC
BCRES27Y	OE114	BKR5EKC	OE024	BKR6EKC	RC8PYP	BKUR6ETB10	OE120
BCRES27Y	RC11LCC4	BKR5EKC	RC9YCC4	BKR6EKC	OE120	BKUR6ETB10	RC89TMC
BE529Y11	OE156	BKR5EKC	OE005	BKR6EKC	RC89TMC	BKUR7ET	OE032
BE529Y11	RN13LYC	BKR5EKC	OE016	BKR6EKC	OE043	BKUR7ET	RC8VTC4
BK5EKU	OE085	BKR5EKC	RC10YCC	BKR6EKC	RC7YC	BM4A	CJ14
BK5EKU	RC9BMC	BKR5EKC	RC9YC	BKR6EKC	OE080	BM6A	CJ8
BK5ESZ	OE026	BKR5EKC	OE062	BKR6EKC	RC7YC4	BM6F	DJ8J
BK5ESZ	RC8DMC	BKR5EKC	OE063	BKR6EKC	OE120	BM7A	CJ6
BK6E	C9C	BKR5EKC	RC10YC4	BKR6EKC	RC89TMC	BM7F	DJ6J
BK6E	OE003	BKR5EKC	RC10YCC4	BKR6EKC	OE120	BMR2A	CJ14
BK6E11	C7YC	BKR5EKC	OE093	BKR6EKC	RC89TMC	BMR4A	CJ14
BK6E11	OE017	BKR5EKC	RC89YCC	BKR6EKC	OE002	BMR6A	RCJ8
BK7EKU	OE021	BKR5EKC	OE093	BKR6EKC	RC9YCC	BMR6F	RDJ8J
		BKR5EKC	RC89YCC	BKR6EY	OE002	BMR7A	CJ6



...NGK	CHAMPION	...NGK	CHAMPION	...NGK	CHAMPION	...NGK	CHAMPION
BP2E	RN14YC	BP6HSA	OE007	BP5EA11	OE045	BPR6ES	OE004
BP2ES	RN14YC	BP6HSA	OE038	BP5EA11	OE048	BPR6ES	OE006
BP4	RJ14YC	BP6S	J12YC	BP5EA11	RN11YCC	BPR6ES	RN9YC
BP4ES	N11YC	BP7EFS	OE050	BP5EA11	RN9YC4	BPR6ES	RN9YCC
BP4ES	OE065	BP7EFS	S7YC	BPR5EAL	OE006	BPR6ES11	OE048
BP4EY	N12YC	BP7ES	N279YC	BPR5EAL	RN9YC	BPR6ES11	RN9YC4
BP4EY	OE015	BP7ES	N7YC	BP5EAL11	OE048	BPR6EVG	OE004
BP4HS	L92YC	BP7ES	OE010	BP5EAL11	RN9YC4	BPR6EVG	RN9YCC
BP4HS	OE059	BP7EVX	N7YC	BP5EFS	RS12YC	BPR6EVG4	OE004
BP5E	EON6	BP7EVX	OE010	BPR5EFS	RS12YC	BPR6EVG4	RN9YCC
BP5E	N9YC	BP7EY	N7YC	BPR5EIX	OE195	BPR6EY	OE006
BP5E	OE001	BP7EY	OE010	BPR5EIX	RN8WYP	BPR6EY	RN9YC
BP5EAL	N11YC	BP7FS	RV9YC	BP5EIX	OE027	BPR6EY11	OE047
BP5EAL	OE065	BP7HS	L87YC	BP5EIX	RN10VTC4	BPR6EY11	OE048
BP5EFS	OE099	BP7HS	OE007	BP5EIX	OE004	BPR6EY11	RN9YC4
BP5EFS	S12YC	BP7HS10	L87YC	BP5EIX	RN9YCC	BPR6EY11	RN9YCC4
BP5ES	N11YC	BP7HS10	OE007	BPR5ES	OE006	BPR6EY	RV9YC
BP5ES	N12YC	BP8ES	N6YC	BPR5ES	OE051	BPR6H	OE064
BP5ES	N9YC	BP8ES	OE087	BPR5ES	OE111	BPR6H	RL82YC
BP5ES	OE001	BP8EVX	N3G	BPR5ES	RN10YC	BPR6HIX	OE064
BP5ES	OE015	BP8EVX	OE078	BPR5ES	RN11YC	BPR6HIX	RL82YC
BP5ES	OE065	BP8HN10	L78YC	BPR5ES	RN9YC	BPR6HS	OE064
BP5ESA	N12YC	BP8HS	L82YC	BPR5ES	OE048	BPR6HS	RL82YC
BP5ESA	OE015	BP8HS	OE038	BPR5ES11	OE049	BPR6HS10	OE064
BP5ESZ	N11YC	BP8HS10	L82YC	BPR5ES11	OE113	BPR6HS10	RL82YC
BP5ESZ	OE065	BP8HS10	OE038	BPR5ES11	RN10YC4	BPR6HSA	RL87YC
BP5ET	N9BYC	BP8HS15	L82YC	BPR5ES11	RN11YC4	BPR7E	OE018
BP5ET	OE044	BP8HS15	OE038	BPR5ES11	RN9YC4	BPR7E	RN7YC
BP5ET10	N9BYC4	BP9EV	C59YC	BPR5ES15	OE048	BPR7EA9	P-RA7HC
BP5ET10	OE028	BPM6A	CJ8Y	BPR5ES15	RN9YC4	BPR7ES	OE008
BP5EVX	N9YC	BPM6F	DJ7Y	BPR5EV	OE111	BPR7ES	OE018
BP5EVX	OE001	BPM7A	CJ7Y	BPR5EV	RN10YC	BPR7ES	RN7YC
BP5HS	L92YC	BPM7Y	CJ7Y	BPR5EVX	OE192	BPR7ES	RN7YCC
BP5HS	OE059	BPM8Y	CJ6Y	BPR5EVX	RN10PYP4	BPR7ES11	OE117
BP5S	J12YC	BPMR4A	RJ8Y	BPR5EY	OE006	BPR7ES11	RN7YC4
BP6E	EON3	BPMR6A	RJ7Y	BPR5EY	OE111	BPR7EVG4	OE008
BP6E	N9YC	BPMR6F	RDJ7Y	BPR5EY	RN10YC	BPR7EVG4	RN7YCC
BP6E	OE001	BPMR6Y	RJ8	BPR5EY	RN9YC	BPR7EY	OE018
BP6EF	OE009	BPMR7A	RJ7Y	BPR5EY11	OE048	BPR7EY	RN7YC
BP6EF	S9YC	BPMR7Y	RJ7Y	BPR5EY11	OE113	BPR7HS	OE064
BP6EFS	OE009	BPMR8Y	RJ6Y	BPR5EY11	RN10YC4	BPR7HS	RL82YC
BP6EFS	OE036	BPR2E	RN14YC	BPR5EY11	RN9YC4	BPR7HS10	OE064
BP6EFS	S9YC	BPR2ES	RN14YC	BPR5EY11	RV15YC4	BPR7HS10	RL82YC
BP6EFS	S9YCC	BPR4ES	OE042	BPR5FS11	RS12YC	BPR8ES	OE116
BP6EFS13	OE009	BPR4ES	OE051	BPR5HS	RL95YC	BPR8ES	RN6YC
BP6EFS13	S9YC	BPR4ES	RN11YC	BPR6E	EON6	BPR8HS	OE064
BP6ES	N9YC	BPR4ES	RN12YC	BPR6E	OE006	BPR8HS	RL82YC
BP6ES	OE001	BPR4ES11	OE049	BPR6E	RN9YC	BPR9ES	RN57YCC
BP6ESZ	N9YC	BPR4ES11	RN11YC4	BPR6EF	EON3	BPR9EVX	RN57YCC
BP6ESZ	OE001	BPR4ESL11	OE049	BPR6EF	OE011	BPSESZ	N11YC
BP6ET	N7BYC	BPR4ESL11	RN11YC4	BPR6EF	RS9YC	BPSESZ	OE065
BP6ET	N9BYC	BPR4EVX	OE042	BPR6EFIX11	OE183	BZ8HN10	QL78YC
BP6ET	OE012	BPR4EVX	RN12YC	BPR6EFIX11	RS8WYP5	BZ8HS10	QL78YC
BP6ET	OE044	BPR4EY11	OE049	BPR6EFIX15	OE183	BZ8HS15	QL78YC6
BP6EVG4	N9YC	BPR4EY11	RN11YC4	BPR6EFIX15	RS8WYP5	BR10ECMVX	QN84
BP6EVG4	OE001	BPR4FS	RV15YC4	BPR6EFS	OE011	BR10EG	RN57YCC
BP6EY	N9YC	BPR4FS11	RV15YC4	BPR6EFS	OE020	BR10EIX	RN1C
BP6EY	OE001	BPR4FS15	RV15YC6	BPR6EFS	RS9YC	BR10ES	RN1C
BP6FS	RV12YC	BPR4HS	RL95YC	BPR6EFS	RS9YCC	BR10ET	QN84
BP6HS	L82YC	BPR4S	RJ18YC	BPR6EFG	OE020	BR10EV	QC57
BP6HS	L87YC	BPR4S15	RJ18YC6	BPR6EFG	RS9YCC	BR2LM	RJ19LM
BP6HS	OE007	BPR4S20	RJ18YC8	BPR6EIX	OE195	BR4ES	RN5C
BP6HS	OE038	BPR5E	EON6	BPR6EIX	RN8WYP	BR4HS	RL86C
BP6HS10	L87YC	BPR5E	OE006	BPR6EIX11	OE195	BR4LM	RJ17LM
BP6HS10	OE007	BPR5E	OE111	BPR6EIX11	RN8WYP	BR5ES	RN5C
BP6HSA	L82YC	BPR5E	RN10YC	BPR6EIX11	OE018	BR5FS	RV12C
BP6HSA	L87YC	BPR5E	RN9YC	BPR6EKN	RN7YC	BR5HS	RL86C





...NGK	CHAMPION	...NGK	CHAMPION	...NGK	CHAMPION	...NGK	CHAMPION
BR6EB	RN5C	BUHW	L76V	CR8EVX	RG94C	DCR8EIX	OE187
BR6EF	OE011	BUHW2	L78V	CR8HS	RZ94C	DCR8EIX	RA7WHP
BR6EF	RS9YC	BUHX	L76V	CR8HSA	RZ94C	DIMR8A10	RG94C
BR6ES	RN5C	BUHXW1	UL77V	CR8HVX	RZ94C	DP7EA9	A6HC
BR6FS	RV8C	BUR5ET	OE027	CR9E	8654	DP7EA9	OE132
BR6FS	RV91MC	BUR5ET	RN10VTYC4	CR9E	RG92C	DP9EA9	8809
BR6HS	RL86C	BUR5ET10	OE027	CR9EB	8654	DP9EA9	RAX92YC
BR6HS10	RL86C	BUR5ET10	RN10VTYC4	CR9EB	RG92C	DPR6EA9	RA8HC
BR6HSA	RL86C	BUR5ET10A	OE027	CR9EH9	RGU92C	DPR7EA9	8812
BR6S	RJ8C	BUR5ET10A	RN10VTYC4	CR9EHVX	RGU92C	DPR7EA9	RAX96YC
BR7EB	OE098	BUR6EFSZ	OE020	CR9EIA9	OE122	DPR8EA9	8809
BR7EB	RN4C	BUR6EFSZ	RS9YCC	CR9EIA9	RG4PHP	DPR8EA9	OE073
BR7EF	OE011	BUR6ET	EON5	CR9EIX	OE122	DPR8EA9	RA4HC
BR7EF	RS9YC	BUR6ET	OE025	CR9EIX	RG4PHP	DPR8EA9	RAX94YC
BR7EFS	OE011	BUR6ET	RN8VTYC4	CR9EK	8654	DPR8EV9	OE083
BR7EFS	RS9YC	BUR6ET10	OE025	CR9EK	RG92DC	DPR8EV9	RA6HC
BR7ES	OE098	BUR6ET10	RN8VTYC4	CR9EKB	8654	DPR8EVX	OE083
BR7ES	RN4C	BUR6ETVP4	OE025	CR9EKB	RG92DC	DPR8EVX	RA6HC
BR7HIX	OE086	BUR6ETVP4	RN8VTYC4	CR9EKPA	8654	DPR9EA9	8809
BR7HIX	RL82C	BUZ8H	QL6VC	D6EA	RA8HC	DPR9EA9	RAX92YC
BR7HS	OE086	BUZHW	QL76V	D7EA	A6HC	DPR9EV9	OE073
BR7HS	RL82C	BUZHW2	QL78V	D7EA	OE132	DPR9EV9	RA4HC
BR7HS10	OE086	BZ7HS10	QL77JC4	D7ES	A6HC	DPR9Z	OE073
BR7HS10	RL82C	C6HSA	Z9Y	D7ES	OE132	DPR9Z	RA4HC
BR7HS10/BR7HS	OE086	C7E	G59C	D7EV	A6GC	DR4HS	P10Y
BR7HS10/BR7HS	RL82C	C7HSA	Z9Y	D7EV	OE112	DR5HS	P10Y
BR8ECM	QN86	C8E	G59C	D7EVX	A6GC	DR5HS	RP10HC
BR8ECMVX	QN86	C8E	G63	D7EVX	OE112	DR6HS	P8Y
BR8ECS	OE091	C8EH9	RGU94C	D8EA	8809	DR7EA	OE083
BR8ECS	RN2C	C8HSA	Z9Y	D8EA	RAX94C	DR7EA	RA6HC
BR8EG	OE108	C9E	G55C	D8EV	A6GC	DR7ES	OE083
BR8EG	RN3C	C9E	G57C	D8EV	OE112	DR7ES	RA6HC
BR8EIX	8904	CM6	Y82	D8EVX	A6GC	DR8EA	8809
BR8ES	OE108	CMR5H	RZ7C	D8EVX	OE112	DR8EA	RAX94C
BR8ES	RN3C	CMR6A	RY4C	D9EA	RAX92C	DR8EB	8809
BR8ES11	OE108	CMR6H	RZ7C	D9EV	A59C	DR8ES	RAX92C
BR8ES11	RN3C	CMR7A	RY4C	D9EVX	RAX92C	DR8ESL	RAX94C
BR8EV	OE108	CMR7H	RZ7C	DCPR6E	RA8HC	DR8EVX	RAX94C
BR8EV	RN3C	CPR6EA9	RG6YC	DCPR7E	OE083	DR9EA	8809
BR8EVX	OE108	CPR6EB9	RG6YCA	DCPR7E	RA6HC	DR9EA	RAX92C
BR8EVX	RN3C	CPR8E	RG6YC	DCPR7E	RA8HC	FR2A-D	OE042
BR8HCS10	8883	CPR8EA9	8698	DCPR7EIX	OE083	FR2A-D	RN12YC
BR8HIX	8883	CPR8EA9	RG94C	DCPR7EIX	OE187	FR4	OE013
BR8HS	RL78C	CPR9EA9	OE092	DCPR7EIX	RA6HC	FR4	RC12YC
BR8HS10	RL78C	CPR9EA9	RG4HC	DCPR7EIX	RA7WHP	FR45	RC12YC5
BR8HSA	RL78C	CR10EK	8654	DCPR7EN	OE186	FR51	OE041
BR9ECM	QN84	CR10EK	RG92DC	DCPR7EN	RA8YCX4	FR51	RC12LYC
BR9ECS	OE091	CR4HSB	Z9Y	DCPR7EN10	OE186	GR4	OE042
BR9ECS	RN2C	CR5HS	Z9Y	DCPR7EN10	RA8YCX4	GR4	RN12YC
BR9EG	OE091	CR5HSB	Z9Y	DCPR7EVX	OE083	GR55	OE048
BR9EG	RN2C	CR6E	RG96C	DCPR7EVX	RA6HC	GR55	RN9YC4
BR9EIX	8904	CR6HS	RZ98C	DCPR8E	OE083	IFR5A11	OE180
BR9ES	OE091	CR6HSA	RZ98C	DCPR8E	RA6HC	IFR5A11	RC10WYP4
BR9ES	RN2C	CR7E	RG96C	DCPR8EA	OE083	IFR5E11	OE180
BR9ET	QN84	CR7EB	RG96C	DCPR8EA	RA6HC	IFR5E11	RC10WYP4
BR9EV	OE091	CR7EKA	RZ96C	DCPR8EKC	OE052	IFR5G11	OE180
BR9EV	RN2C	CR7EKB	RG6YC	DCPR8EKC	RA4HCX	IFR5G11	RC10WYP4
BR9EVX	OE091	CR7HS	RZ96C	DCPR8EN	OE186	IFR5J11	OE180
BR9EVX	RN2C	CR7HSA	RZ96C	DCPR8EN	RA8YCX4	IFR5J11	RC10WYP4
BR9EYA	OE091	CR8E	RG94C	DCPR8EN10	OE186	IFR5N10	OE180
BR9EYA	RN2C	CR8EB	RG94C	DCPR8EN10	RA8YCX4	IFR5N10	RC10WYP4
BR9HS	QL77JC4	CR8EH9	RGU94C	DCPR9E	OE073	IFR5T11	OE180
BR9HS10	QL77JC4	CR8EH9S	RGU94C	DCPR9E	RA4HC	IFR5T11	RC10WYP4
BRE527Y11	OE114	CR8EHVX9	RGU94C	DCPR9EVX	OE073	IFR5T8N	OE180
BRE527Y11	RC11LCC4	CR8EIB10	RG94C	DCPR9EVX	RA4HC	IFR5T8N	RC10WYP4
BU8H	L6VC	CR8EK	8698	DCR7EIX	OE187	IFR6A11	OE146
BUH	L76V	CR8EK	RG94C	DCR7EIX	RA7WHP	IFR6A11	OE182

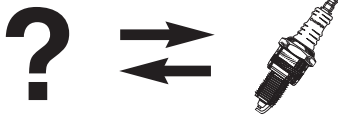

...NGK	CHAMPION	...NGK	CHAMPION	...NGK	CHAMPION	...NGK	CHAMPION
IFR6A11	RC89WYP4	IZFR5F11	OE194	PFR5G11E	OE146	PGR6A	OE018
IFR6A11	RC8PYPB4	IZFR5F11	RC12WMP4	PFR5G11E	RC8PYPB4	PGR6A	RN7YC
IFR6A11T	OE188	IZFR5G	OE184	PFR5G13E	OE146	PGR7A	OE113
IFR6A11T	RC8WMP4	IZFR5G	RC10WMP2	PFR5G13E	RC8PYPB4	PGR7A	RN10YC4
IFR6B11	OE193	IZFR5J	QC12PEPB	PFR5J11	OE124	PKR7A	OE187
IFR6B11	RC12WYP4	IZFR5K	OE194	PFR5J11	RC10PYP4	PKR7A	RA7WHP
IFR6D10	KC8WYP4	IZFR5K	RC12WMP4	PFR5L11	OE124	PKR9B	OE073
IFR6D10	OE181	IZFR5K11	OE194	PFR5L11	RC10PYP4	PKR9B	RA4HC
IFR6E11	OE193	IZFR5K11	RC12WMP4	PFR5N11	OE124	PLFR5A11	OE175
IFR6E11	RC12WYP4	IZFR6B	OE185	PFR5N11	RC10PYP4	PLFR5A11	REC10PYC4
IFR6J11	OE179	IZFR6B	RC8WMP2	PFR5R11	KC10PYPB4	PLFR6A11	OE175
IFR6J11	RC8WYP4	IZFR6F11	OE184	PFR5R11	OE191	PLFR6A11	REC10PYC4
IFR6S	OE179	IZFR6F11	RC10WMP2	PFR6A11	OE146	PMR7A	OE122
IFR6S	RC8WYP4	IZFR6H11	OE194	PFR6A11	RC8PYPB4	PMR7A	RG4PHP
IFR6T11	OE182	IZFR6H11	RC12WMP4	PFR6B	OE136	PMR8A	OE122
IFR6T11	RC89WYP4	IZFR6J	QC10WEP	PFR6B	RC8PYP	PMR8A	RG4PHP
IFR7F-6D	OE179	IZFR6K11	OE194	PFR6B11	OE136	PMR8B	OE122
IFR7F-6D	RC8WYP4	IZFR6K11	RC12WMP4	PFR6B11	RC8PYP	PMR8B	RG4PHP
IFR7F-D	OE179	IZFR6K11S	OE194	PFR6B11C	OE136	PTR4B15	RS12PYP
IFR7F-D	RC8WYP4	IZFR6K11S	RC12WMP4	PFR6B11C	RC8PYP	PTR4G15	RS14PYP5
IFR7G11KS	OE180	IZFR7M	QC8WEP	PFR6E10	OE146	PTR5A10	OE029
IFR7G11KS	RC10WYP4	IZKR7B	OE187	PFR6E10	RC8PYPB4	PTR5A10	RES9PYP4
IFR7U	OE179	IZKR7B	RA7WHP	PFR6G	OE136	PTR5A13	EON4
IFR7U	RC8WYP4	JR8B	8809	PFR6G	RC8PYP	PTR5A13	OE029
IGR7A	OE195	JR8B	RAX94C	PFR6G11	OE136	PTR5A13	RES9PYP4
IGR7A	RN8WYP	JR9B	8809	PFR6G11	RC8PYP	PTR5C13	RS12PYP
IGR7AG	OE195	JR9B	RAX92DC	PFR6G13E	OE136	PTR5D10	OE131
IGR7AG	RN8WYP	KR7A1	OE187	PFR6G13E	RC8PYP	PTR5D10	RS9PYP4
IJR8B9	8809	KR7A1	RA7WHP	PFR6G9	OE136	PTR5D13	OE131
IKR7A	OE187	KR8B1	OE187	PFR6G9	RC8PYP	PTR5D13	RS9PYP4
IKR7A	RA7WHP	KR8B1	RA7WHP	PFR6H10	OE136	PTR5F13	OE131
IKR7B	OE187	KR9C1	OE073	PFR6H10	RC8PYP	PTR5F13	RS9PYP4
IKR7B	RA7WHP	KR9C1	RA4HC	PFR6J11	OE136	PTR6D13	OE131
IKR7C	OE187	LFR4A11	OE135	PFR6J11	RC8PYP	PTR6D13	RS9PYP4
IKR7C	RA7WHP	LFR4A11	REC14PYC	PFR6N11	OE136	PTR6F13	OE131
ILFR6A	OE190	LFR5A11	OE148	PFR6N11	OE146	PTR6F13	RS9PYP4
ILFR6A	REC10WYPB4	LFR5A11	REC10YC4	PFR6N11	RC8PYP	PZFR5D11	KC8ZPYPB4
ILFR6B	OE190	LFR5AAA	OE035	PFR6N11	RC8PYPB4	PZFR5D11	OE176
ILFR6B	REC10WYPB4	LFR5AAA	REC9YCL	PFR6Q	OE136	PZFR5F11	OE184
ILFR6J11K	OE190	LFR5A1X11	OE190	PFR6Q	RC8PYP	PZFR5F11	RC10WMP2
ILFR6J11K	REC10WYPB4	LFR5A1X11	REC10WYPB4	PFR6T10G	OE136	PZFR5N11TG	KC8ZPYPB4
ILTR5A-13G	OE189	LFR5AP11	OE175	PFR6T10G	RC8PYP	PZFR5N11TG	OE176
ILTR5A-13G	RES9WYP5	LFR5AP11	REC10PYC4	PFR6TG	OE136	PZFR6B	OE136
ILTR5B	OE189	LFR5B	OE035	PFR6TG	RC8PYP	PZFR6B	RC8PYPB
ILTR5B	RES9WYP5	LFR5B	REC9YCL	PFR6U11G	OE136	PZFR6F	OE146
ILTR5C	OE189	LFR6A11	OE148	PFR6U11G	RC8PYP	PZFR6F	RC8PYPB4
ILTR5C	RES9WYP5	LFR6A11	REC10YC4	PFR7B	OE136	PZFR6F11	OE146
ILTR6A13G	OE189	LFR6B	OE035	PFR7B	RC8PYP	PZFR6F11	RC8PYPB4
ILTR6A13G	RES9WYP5	LFR6B	REC9YCL	PFR7G	OE136	PZFR6J11	KC8ZPYPB4
ILTR6A8G	OE189	LFR6C11	OE035	PFR7G	RC8PYP	PZFR6J11	OE176
ILTR6A8G	RES9WYP5	LFR6C11	REC9YCL	PFR7G11	OE136	R0045J-10	G54V
ILTR6B	OE189	LFR6D	OE035	PFR7G11	RC8PYP	R0045J-11	G54V
ILTR6B	RES9WYP5	LFR6D	REC9YCL	PFR7G11S	OE136	R017-8	G63
ILZFR5B	OE190	LR8B	RZ94C	PFR7G11S	RC8PYP	R21610	A53R
ILZFR5B	REC10WYPB4	LZKAR7A	OE130	PFR7G9	OE136	R2270	QA55V
ILZFR6A11	OE190	LZKAR7A	REA8MCL	PFR7G9	RC8PYP	R2349	QA55V
ILZFR6A11	REC10WYPB4	LZTR4A11	RE14MCC5	PFR7H10	OE146	R4118S-95	QN84
ILZFR6CK	OE190	PFR4G11	OE134	PFR7H10	RC8PYPB4	R6021E-95	QN84
ILZFR6CK	REC10WYPB4	PFR4G11	RC12PYP	PFR7M	OE136	R6252E-9	QN84
ILZFR6D11	OE190	PFR5B	OE136	PFR7M	RC8PYP	R6252K-105	QC57
ILZFR6D11	REC10WYPB4	PFR5B	RC8PYPB	PFR7Q	OE136	R6254E-105	QC57
IRIMAC8	OE187	PFR5B11	OE146	PFR7Q	RC8PYP	R6918B-8	OE108
IRIMAC8	RA7WHP	PFR5B11	RC8PYPB4	PFR7ZTG	RC7PYCBX	R6918B-8	RN3C
ITR6F13	OE183	PFR5G	OE124	PGR5A	OE042	R7376-10	QN84
ITR6F13	RS8WYP5	PFR5G	RC10PYP4	PGR5A	RN12YC	TR42	RS13LYC
IZFR5B	OE184	PFR5G11	OE124	PGR5C11	OE042	TR51	RS10LC
IZFR5B	RC10WMP2	PFR5G11	RC10PYP4	PGR5C11	RN12YC	TR55	OE131





### ...NISSAN



22401AU075	<b>REC10YC4</b>
22401AX015	<b>OE175</b>
22401AX015	<b>REC10PYC4</b>
22401AX075	<b>OE175</b>
22401AX075	<b>REC10PYC4</b>
22401M7715	<b>N9YC</b>
22401M7715	<b>OE001</b>
22401V5016	<b>OE039</b>
22401V5016	<b>RC9YC4</b>
22401W8915	<b>N11YC</b>
22401W8915	<b>OE065</b>
22401W8916	<b>N9YC</b>
22401W8916	<b>OE001</b>

### OPEL



12 14 011	<b>OE120</b>
12 14 011	<b>RC89TMC</b>
12 14 015	<b>EON2</b>
12 14 015	<b>OE019</b>
12 14 015	<b>RC10DMC</b>
12 14 031	<b>OE089</b>
12 14 031	<b>RC9MCC4</b>
12 14 149	<b>OE004</b>
12 14 149	<b>RN9YCC</b>
12.140.15	<b>OE019</b>
12.140.15	<b>RC10DMC</b>
12.141.49	<b>OE004</b>
12.141.49	<b>RN9YCC</b>
12.144.62	<b>EON2</b>
12.144.62	<b>OE124</b>
12.144.62	<b>RC10PYP4</b>
12.147.00	<b>L82YC</b>
12.147.00	<b>OE038</b>
12.147.01	<b>OE064</b>
12.147.01	<b>RL82YC</b>
12.147.02	<b>OE018</b>
12.147.02	<b>RN7YC</b>
12.148.00	<b>L82YC</b>
12.148.00	<b>OE038</b>
12.148.01	<b>OE064</b>
12.148.01	<b>RL82YC</b>
12.148.02	<b>OE018</b>
12.148.02	<b>RN7YC</b>
12.148.03	<b>OE117</b>
12.148.03	<b>RN7YC4</b>
90.414.815	<b>OE066</b>
90.414.815	<b>RC9MCC</b>
90414815	<b>EON2</b>
90414815	<b>OE066</b>
90414815	<b>RC9MCC</b>
90542918	<b>OE019</b>
90542918	<b>RC10DMC</b>
91132086	<b>OE019</b>
91132086	<b>RC10DMC</b>
93 176 801	<b>OE089</b>
93 176 801	<b>RC9MCC4</b>
97125969	<b>OE124</b>
97125969	<b>RC10PYP4</b>

### PAL



Super.G7Y	<b>OE009</b>
Super.G7Y	<b>S9YC</b>
Super.G8Y	<b>OE050</b>

### ...PAL



Super.G8Y	<b>S7YC</b>
Super.L7Y	<b>N11YC</b>
Super.L7Y	<b>OE065</b>
Super.N7	<b>L86C</b>
Super.N7	<b>OE037</b>
Super.N7Y	<b>L87YC</b>
Super.N7Y	<b>OE007</b>
Super.N8	<b>L82C</b>
Super.N8Y	<b>L82YC</b>
Super.N8Y	<b>OE038</b>

### PEUGEOT



5960 F7	<b>OE035</b>
5960 F7	<b>REC9YCL</b>
5960.15	<b>OE034</b>
5960.15	<b>RC8YCL</b>
5960.83	<b>OE130</b>
5960.83	<b>REA8MCL</b>
5960.84	<b>OE130</b>
5960.84	<b>REA8MCL</b>
596013	<b>OE035</b>
596013	<b>REC9YCL</b>
596015	<b>OE034</b>
596015	<b>RC8YCL</b>
596016	<b>OE178</b>
596016	<b>REC9MCLX</b>
596017	<b>OE035</b>
596017	<b>REC9YCL</b>
596057	<b>OE178</b>
596057	<b>REC9MCLX</b>
596058	<b>OE178</b>
596058	<b>REC9MCLX</b>
596075	<b>OE178</b>
596075	<b>REC9MCLX</b>
596086	<b>OE178</b>
596086	<b>REC9MCLX</b>
5962 5C	<b>OE035</b>
5962 5C	<b>REC9YCL</b>
5962 5M	<b>OE035</b>
5962 5M	<b>REC9YCL</b>
5962.14	<b>OE050</b>
5962.14	<b>OE067</b>
5962.14	<b>S7YC</b>
5962.14	<b>S7YCC</b>
5962.15	<b>OE009</b>
5962.15	<b>S9YC</b>
5962.16	<b>N9YC</b>
5962.16	<b>OE001</b>
5962.61	<b>OE009</b>
5962.61	<b>S9YC</b>
5962.63	<b>OE050</b>
5962.63	<b>OE067</b>
5962.63	<b>S7YC</b>
5962.63	<b>S7YCC</b>
5962.65	<b>N9YC</b>
5962.65	<b>OE001</b>
5962.90	<b>L87YC</b>
5962.90	<b>OE007</b>
5962.92	<b>OE090</b>
5962.92	<b>S6YC</b>
5962.94	<b>N7YC</b>
5962.94	<b>OE010</b>
5962.95	<b>N7YC</b>
5962.95	<b>OE010</b>
5962.96	<b>L82C</b>

### ...PEUGEOT



5962.C5	<b>C7YCC</b>
5962.C5	<b>OE058</b>
5962.C6	<b>C9YCC</b>
5962.C6	<b>OE023</b>
5962.F6	<b>C7YCC</b>
5962.F6	<b>OE058</b>
5962.F8	<b>C9YCC</b>
5962.F8	<b>OE023</b>
5962.G8	<b>N279YC</b>
5962.G8	<b>N7YC</b>
5962.G8	<b>OE010</b>
5962.H5	<b>L92YC</b>
5962.H5	<b>OE059</b>
5962.H6	<b>OE043</b>
5962.H6	<b>RC7YC</b>
5962.J1	<b>EON2</b>
5962.J1	<b>OE016</b>
5962.J1	<b>RC10YCC</b>
5962.K1	<b>OE014</b>
5962.K1	<b>RC7YCC</b>
5962.K4	<b>EON2</b>
5962.K4	<b>OE002</b>
5962.K4	<b>RC9YCC</b>
5962.K7	<b>OE021</b>
5962.K7	<b>RC7BMC</b>
5962.R3	<b>EON2</b>
5962.W9	<b>OE034</b>
5962.W9	<b>RC8YCL</b>
596214	<b>OE050</b>
596214	<b>S7YC</b>
596215	<b>OE009</b>
596215	<b>S9YC</b>
596216	<b>N9YC</b>
596216	<b>OE001</b>
59625E	<b>OE035</b>
59625E	<b>REC9YCL</b>
596261	<b>OE009</b>
596261	<b>S9YC</b>
596263	<b>OE050</b>
596263	<b>S7YC</b>
596265	<b>N9YC</b>
596265	<b>OE001</b>
59627R	<b>OE034</b>
59627R	<b>RC8YCL</b>
59627W	<b>OE178</b>
59627W	<b>REC9MCLX</b>
596288	<b>N6YC</b>
596288	<b>OE087</b>
596289	<b>N6YC</b>
596289	<b>OE087</b>
596290	<b>L87YC</b>
596290	<b>OE007</b>
596292	<b>OE090</b>
596292	<b>S6YC</b>
596293	<b>OE090</b>
596293	<b>S6YC</b>
596294	<b>N7YC</b>
596294	<b>OE010</b>
596295	<b>N7YC</b>
596295	<b>OE010</b>
5962C5	<b>C7YCC</b>
5962C5	<b>OE058</b>
5962C6	<b>C9YCC</b>
5962C6	<b>OE023</b>
5962F6	<b>C7YCC</b>
5962F6	<b>OE058</b>
5962F8	<b>C9YCC</b>

### ...PEUGEOT



5962F8	<b>OE023</b>
5962G8	<b>N7YC</b>
5962G8	<b>OE010</b>
5962H4	<b>OE110</b>
5962H4	<b>RC6YC</b>
5962H5	<b>L92YC</b>
5962H5	<b>OE059</b>
5962H6	<b>OE043</b>
5962H6	<b>RC7YC</b>
5962J1	<b>OE016</b>
5962J1	<b>RC10YCC</b>
5962K1	<b>OE014</b>
5962K1	<b>RC7YCC</b>
5962K4	<b>OE002</b>
5962K4	<b>RC9YCC</b>
5962K7	<b>OE021</b>
5962K7	<b>RC7BMC</b>
5962R3	<b>OE085</b>
5962R3	<b>RC9BMC</b>
96 363 933	<b>OE035</b>
96 363 933	<b>REC9YCL</b>
96 363 93380	<b>OE035</b>
96 363 93380	<b>REC9YCL</b>
96.381.273.80	<b>OE102</b>
96.381.273.80	<b>RC87YCC</b>
9638127380	<b>OE102</b>
9638127380	<b>RC87YCC</b>
9650889380	<b>OE178</b>
9650889380	<b>REC9MCLX</b>

### PIAGGIO



P1M	<b>N1C</b>
P2M	<b>N2C</b>
P2M	<b>OE040</b>
P4M	<b>N4C</b>
P4M	<b>OE079</b>
P82M	<b>L82C</b>
P86M	<b>L86C</b>
P86M	<b>OE037</b>
RP1M	<b>RNTC</b>
RP2M	<b>OE091</b>
RP2M	<b>RN2C</b>
RP4HM	<b>OE092</b>
RP4HM	<b>RG4HC</b>

### PORSCHE



99917012900	<b>A59GC</b>
99917012900	<b>OE103</b>
99917012990	<b>A59GC</b>
99917012990	<b>OE103</b>
99917020190	<b>OE026</b>
99917020190	<b>RC8DMC</b>
99917020490	<b>OE120</b>
99917020490	<b>RC89TMC</b>
99917020491	<b>OE120</b>
99917020491	<b>RC89TMC</b>
99917020791	<b>OE120</b>
99917020791	<b>RC89TMC</b>
99917021890	<b>OE120</b>
99917021890	<b>RC89TMC</b>
99917021990	<b>OE120</b>
99917021990	<b>RC89TMC</b>
99917022190	<b>OE136</b>
99917022190	<b>RC8PYP</b>

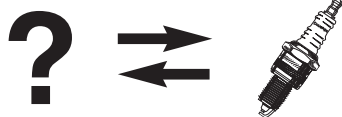

PROTON		...RENAULT		...RENAULT		...RENAULT	
MS851237E	OE039	77.01.414.025	OE001	7701366267	L87YC	89.33.003.862	RC9YC
MS851237E	RC9YC4	77.01.414.026	OE090	7701366267	OE007	8933003862	OE005
<b>RENAULT</b>		77.01.414.026	S6YC	7701366268	N7YC	8933003862	RC9YC
600.104.0356	OE021	77.01.414.027	OE050	7701366268	OE10		
600.104.0356	RC7BMC	77.01.414.027	S7YC	7701366269	N9YC		
6001040356	OE021	77.01.414.028	OE050	7701366269	OE001	<b>ROLLS ROYCE</b>	
6001040356	RC7BMC	77.01.414.028	OE067	7701366270	OE009	706882	RN79WW
77.00.273.462	EON2	77.01.414.028	S7YC	7701366270	S9YC		
77.00.273.462	OE016	77.01.414.028	S7YCC	7701366533	L86C		
77.00.273.462	RC10YCC	77.01.414.030	OE011	7701366533	OE037		
77.00.273.698	EON2	77.01.414.030	RS9YC	7701366539	N12YC		
77.00.273.698	OE141	77.01.414.032	OE042	7701366539	OE015	<b>ROVER</b>	
77.00.273.698	RC10PYC	77.01.414.032	RN12YC	7701414021	L87YC	ERR0743	OE006
77.00.565.155	N2G	77.01.414.032	L82YC	7701414021	OE007	ERR0743	RN9YC
77.00.565.155	OE125	77.01.414.036	OE038	7701414022	L92YC	ERR3799	OE045
77.00.714.540	OE011	77.01.414.037	L82C	7701414022	OE059	ERR3799	RN11YCC
77.00.714.540	RS9YC	77.01.414.038	OE009	7701414023	N9YC	NLP000030	OE120
77.00.722.095	OE050	77.01.414.038	S9YC	7701414023	OE001	NLP000030	RC89TMC
77.00.722.095	OE067	77.01.414.039	C9YCC	7701414024	N7YC	NLP000040	OE136
77.00.722.095	S7YC	77.01.414.040	OE023	7701414024	OE010	NLP000040	RC8PYP
77.00.722.095	S7YCC	77.01.414.040	OE043	7701414025	N9YC	NLP10003	OE002
77.00.724.821	N9YC	77.01.414.040	RC7YC	7701414025	OE001	NLP10003	RC9YCC
77.00.724.821	OE001	77.01.414.056	OE009	7701414026	OE090	NLP10004	OE014
77.00.725.302	OE042	77.01.414.056	S9YC	7701414026	S6YC	NLP10004	RC7YCC
77.00.725.302	RN12YC	77.01.414.065	C6YCC	7701414027	OE050	NLP100190	OE136
77.00.727.383	OE006	77.01.414.066	OE075	7701414027	S7YC	NLP100190	RC8PYP
77.00.727.383	RN9YC	77.01.414.066	S59C-ST	7701414028	OE050	NLP100260	OE006
77.00.733.422	L92YC	77.01.742.094	OE018	7701414028	S7YC	NLP100260	RN9YC
77.00.733.422	OE059	77.01.742.094	RN7YC	7701414030	OE011	NLP100290	OE146
77.00.736.149	OE090	7700 500 180	OE033	7701414030	RS9YC	NLP100290	RC8PYPB4
77.00.736.149	S6YC	7700 500 180	RC87YCL	7701414031	OE006	NLP100320	OE138
77.00.736.150	OE050	7700113267	OE135	7701414031	RN9YC	NLP100320	RC11PYPB4
77.00.736.150	S7YC	7700113267	REC14PYC	7701414032	OE042	NLP1004	OE014
77.00.742.094	OE018	7700500155	OE033	7701414032	RN12YC	NLP1004	RC7YCC
77.00.742.094	RN7YC	7700500155	RC87YCL	7701414036	L82YC		
77.00.868.864	OE008	7700500168	OE026	7701414036	OE038	<b>SEAT</b>	
77.00.868.864	RN7YCC	7700500168	RC8DMC	7701414038	OE009	SE021919000B	C7YC
77.01.366.084	N3G	7700565155	N2G	7701414038	S9YC	SE021919000B	OE017
77.01.366.084	OE078	7700565155	OE125	7701414039	C9YCC	SE127919000A	OE006
77.01.366.087	N279YC	7700714540	OE011	7701414039	OE023	SE127919000A	RN9YC
77.01.366.087	N7YC	7700714540	RS9YC	7701414040	OE043		
77.01.366.087	OE010	7700722095	OE050	7701414040	RC7YC		
77.01.366.267	L87YC	7700722095	S7YC	7701414056	OE009		
77.01.366.267	OE007	7700724821	N9YC	7701414056	S9YC		
77.01.366.268	N7YC	7700724821	OE001	7701414065	C6YCC		
77.01.366.268	OE010	7700725302	OE042	7701414065	OE075	<b>SKODA</b>	
77.01.366.269	N9YC	7700725302	RN12YC	7701742094	OE018	101000049AC	OE145
77.01.366.269	OE001	7700727383	OE006	7701742094	RN7YC	101000049AC	RC89PYC
77.01.366.270	OE009	7700727383	RN9YC	82.00.020.796	OE033	101000049AD	OE144
77.01.366.270	S9YC	7700732626	N6YC	82.00.020.796	RC87YCL	101000049AD	RC87PYC
77.01.366.533	L86C	7700732626	OE087	82.00.034.236	OE135	101000060AA	OE145
77.01.366.533	OE037	7700733422	L92YC	82.00.034.236	REC14PYC	101000060AA	RC89PYC
77.01.366.539	N12YC	7700733422	OE059	8200020796	OE033	BBC057009	L87YC
77.01.366.539	OE015	7700736149	OE090	8200020796	RC87YCL	BBC057009	OE007
77.01.414.021	L87YC	7700736149	S6YC	8200021856	OE033	BBC057010	C9YC
77.01.414.021	OE007	7700736150	OE050	8200021856	RC87YCL	BBC057010	OE003
77.01.414.022	L92YC	7700736150	S7YC	8200030765	OE130	BBC057012	OE005
77.01.414.022	OE059	7700742094	OE018	8200033622	REA8MCL	BBC057012	RC9YC
77.01.414.023	N9YC	7700852522	RN7YC	8200033622	OE033		
77.01.414.023	OE001	7700852522	OE036	8200034236	RC87YCL		
77.01.414.024	N279YC	7700868864	S9YCC	8200034236	OE135	<b>SMART</b>	
77.01.414.024	N7YC	7700868864	OE008	8200046337	REC14PYC	Q0003085V005000000	OE102
77.01.414.024	OE010	7701366084	RN7YCC	8200046337	OE143	Q0003085V005000000	RC87YCC
77.01.414.025	N9YC	7701366084	N3G	820030765	RC8PYCB		
		7701366087	OE078	820030765	OE130		
		7701366087	N7YC	820030765	REA8MCL		
			OE010	89.33.003.862	OE005		



## SOGEDAC

**CHAMPION**

CC10	OE009
CC10	S9YC
CC8	OE050
CC8	S7YC
CF10	C7YCC
CF10	OE058
CF11	C9YCC
CF11	OE023
CP10	N9YC
CP10	OE001
XC10	OE009
XC10	S9YC
XC6	OE050
XC6	S7YC
XP10	N9YC
XP10	OE001
XP4	N6YC
XP4	OE087
XP6	N7YC
XP6	OE010
XPC7	L86C
XPC7	OE037

## STITT

**CHAMPION**

407L	OE086
407L	RL82C
407XL	OE039
407XL	RC9YC4
R407L	OE086
R407L	RL82C
R407XL	OE039
R407XL	RC9YC4
RF407L	RV12YC

## SUBARU

**CHAMPION**

22401-AA371	OE124
22401-AA371	RC10PYP4
22401AA540	RC8YC4

## TORCH

**CHAMPION**

A6RTC	RZ98C
A6TC	Z9Y
A7RTC	Z9Y
A7TC	Z9Y
D6RTC-9	RA8HC
D7RTC-9	8812
D8RTC	8809
F6RTC	OE006
F6RTC	RN9YC
F6TC	N7YC
F6TC	OE010
K6RF	OE088
K6RF	RC10YC
L6RTC	RCJ7Y
L6TC	CJ8Y
L7RTC	RCJ7Y
L7T	CJ8
L7TC	CJ7Y
T1137C	Z9Y

## TOYOTA

**CHAMPION**

90919-01166	OE066
90919-01166	RC9MCC
90919-01176	OE093
90919-01176	RC89YCC
90919-01187	OE134
90919-01187	RC12PYP
90919-01192	OE019
90919-01192	RC10DMC
90919-01193	OE019
90919-01193	RC10DMC
90919-01210	OE182
90919-01210	RC89WYP4

## UNIPART

**CHAMPION**

GSP2001	OE002
GSP2001	RC9YCC
GSP2002	OE004
GSP2002	OE006
GSP2002	RN9YC
GSP2002	RN9YCC
GSP2003	OE002
GSP2003	OE005
GSP2003	RC9YC
GSP2003	RC9YCC
GSP2005	OE024
GSP2005	OE039
GSP2005	RC9YC4
GSP2005	RC9YCC4
GSP2006	OE011
GSP2006	OE020
GSP2006	RS9YC
GSP2006	RS9YCC
GSP2007	C7YC
GSP2007	C7YCC
GSP2007	OE002
GSP2007	OE017
GSP2007	OE058
GSP2007	RC9YCC
GSP2009	N7YC
GSP2009	OE010
GSP2010	N7BYC
GSP2010	OE012
GSP2011	OE029
GSP2011	RES9PYP4
GSP2024	N6YC
GSP2024	OE087
GSP2029	OE064
GSP2029	RL82YC
GSP2033	OE054
GSP2033	RF7YC
GSP2037	OE080
GSP2037	RC7YC4
GSP2038	OE027
GSP2038	RN10VTYC4
GSP2055	OE136
GSP2055	RC8PYP
GSP2071	OE041
GSP2071	RC12LYC
GSP2116	OE043
GSP2116	RC7YC
GSP4256	L82C
GSP4256	L82YC
GSP4256	OE038
GSP4266	L86C
GSP4266	OE037

## ...UNIPART

**CHAMPION**

GSP4342	N6YC
GSP4342	OE087
GSP4347	N6BYC
GSP4347	OE109
GSP4352	N7YC
GSP4352	OE010
GSP4356	L82YC
GSP4356	OE038
GSP4357	N7BYC
GSP4357	OE012
GSP4362	N9YC
GSP4362	OE001
GSP4366	L87YC
GSP4366	OE007
GSP4367	N9BYC
GSP4367	OE044
GSP4372	N11YC
GSP4372	OE065
GSP4376	L92YC
GSP4376	OE059
GSP4382	N12YC
GSP4382	OE015
GSP4452	OE018
GSP4452	RN7YC
GSP44523	OE025
GSP44523	RN8VTYC4
GSP4456	OE064
GSP4456	RL82YC
GSP4462	OE006
GSP4462	RN9YC
GSP44623	OE027
GSP44623	RN10VTYC4
GSP4472	OE051
GSP4472	RN11YC
GSP4482	OE042
GSP4482	RN12YC
GSP4543	OE090
GSP4543	S6YC
GSP4547	C6BYC
GSP4547	OE076
GSP4552	C7YC
GSP4552	OE017
GSP4553	OE050
GSP4553	S7YC
GSP4562	C9YC
GSP4562	OE003
GSP4563	OE009
GSP4563	S9YC
GSP4573	OE099
GSP4573	S12YC
GSP4642	OE110
GSP4642	RC6YC
GSP4652	OE043
GSP4652	RC7YC
GSP46522	OE026
GSP46522	RC8DMC
GSP46523	OE032
GSP46523	RC8VTYC4
GSP4657	OE021
GSP4657	RC7BMC
GSP4662	OE005
GSP4662	RC9YC
GSP46622	EON2
GSP46622	OE019
GSP46622	RC10DMC
GSP46623	EON2
GSP4663	OE011

## ...UNIPART

**CHAMPION**

GSP4663	RS9YC
GSP4664	RV9YC
GSP4854	OE054
GSP4854	RF7YC
GSP6452	OE008
GSP6452	RN7YCC
GSP6462	OE004
GSP6462	RN9YCC
GSP6468	OE047
GSP6468	RN9YCC4
GSP6472	OE045
GSP6472	RN11YCC
GSP6563	OE036
GSP6563	S9YCC
GSP65721	C11YCC
GSP65721	EON2
GSP65721	OE057
GSP6651	OE031
GSP6651	RE7YCC
GSP6651	RES9YCC4
GSP6652	OE014
GSP6652	RC7YCC
GSP66527	OE146
GSP66527	RC8PYPB4
GSP6658	OE056
GSP6658	RC7YCC4
GSP6662	EON2
GSP6662	OE002
GSP6662	RC9YCC
GSP6663	OE020
GSP6663	OE131
GSP6663	RS9PYP4
GSP6663	RS9YCC
GSP6668	EON2
GSP6668	OE024
GSP6668	RC9YCC4
GSP6682	EON2
GSP6692	EON2
GSP6692	OE066
GSP6692	RC9MCC
GSP6962	OE066
GSP6962	RC9MCC
GSP7662	EON2
GSP7662	OE024
GSP7662	RC9YCC4
GSP7664	EON2
GSP7664	OE089
GSP7664	RC9MCC4
GSP9652	OE136
GSP9652	RC8PYP

## VAG

**CHAMPION**

101.000.007.AA	N6BYC
101.000.007.AA	OE109
101.000.007.AB	N7BYC
101.000.007.AB	OE012
101.000.007.AC	N9BYC4
101.000.007.AC	OE028
101.000.007.AD	N9BYC
101.000.007.AD	OE044
101.000.026.AA	N9BMC
101.000.026.AA	OE100
101.000.026.AB	N7BMC
101.000.026.AB	OE095
101.000.045.AA	C6VYPC
101.000.045.AA	OE129



VALEO		...VALEO		...VOLKSWAGEN		...VOLVO	
4N	L82C	F80H	C9YC	101905603B	OE177	8642660	OE120
5N	L87YC	F80H	OE003	101905617	KC8ZMCC	8642660	RC89TMC
5N	OE007	F80Hb	C9YC	101905617	OE177	8642661	OE120
64H	N6YC	F80Hb	OE003	101905620	KC8ZPYPB4	8642661	RC89TMC
64H	OE087	RF74H	OE043	101905620	OE176	9146775	OE120
64Hb	N6YC	RF74H	RC7YC			9146775	RC89TMC
64Hb	OE087	RF74H3	OE021			917910	OE136
67HP	N3G	RF74H3	RC7BMC	<b>VOLVO</b>		917910	RC8PYP
67HP	OE078	RF74LZD	OE178	1306604	N7YC	9179100	OE136
6N	L86C	RF74LZD	REC9MCLX	1306604	OE010	9179100	RC8PYP
6N	OE037	RF82HZ2Y	OE019	1306605	N9YC	9202064	EON2
70H	N7YC	RF82HZ2Y	RC10DMC	1306605	OE001	9202064	OE120
70H	OE010			1346541	OE006	9202064	RC89TMC
70Hb	N7YC	<b>VAUXHALL</b>		1346541	RN9YC	RF80H3	OE120
70Hb	OE010	91132006	OE019	1357826	L82YC	RF80H3	RC89TMC
76H	N9YC	91132006	RC10DMC	1357826	OE038	X9146775	OE120
76H	OE001			1357827	L82YC	X9146775	RC89TMC
76Hb	N9YC	<b>VOLKSWAGEN</b>		1357827	OE038		
76Hb	OE001	101 000 033 AA	OE032	1357828	L87YC		
7H	N6YC	101 000 033 AA	RC8VTYC4	1357828	OE007		
7H	OE087	101 000 033 AF	OE032	1367015	OE018	<b>WAUKESHA</b>	
84H	N9YC	101 000 033 AF	RC8VTYC4	1367015	RN7YC	60999F	RM77N
84H	OE001	101 000 041 AC	OE032	1367526	N9YC	60999H	RHM77N
84Hb	N9YC	101 000 041 AC	RC8VTYC4	1367526	OE001	60999T	RB77WPC
84Hb	OE001	101 000 051 AA	OE032	1367527	N7YC	60999Z	RB77CC
88H	L87YC	101 000 051 AA	RC8VTYC4	1367527	OE010	69919D	RB77WPCC
88H	OE007	101 000 054 AD	OE120	1367528	OE006		
88Hb	L87YC	101 000 054 AD	RC89TMC	1367528	RN9YC		
88Hb	OE007	101.000.007.AA	N6BYC	1367528	OE018		
8H	N9YC	101.000.007.AB	N7BYC	1367529	OE018		
8H	OE001	101.000.007.AB	OE012	1367529	RN7YC		
9H	N11YC	101.000.007.AC	N9BYC4	270746-1	OE006		
9H	OE065	101.000.007.AD	OE028	270746-1	RN9YC		
C60H	OE090	101.000.017.AA	C6BYC	270747-9	OE018		
C60H	S6YC	101.000.017.AA	OE076	270747-9	RN7YC		
C60Hb	OE090	101.000.026.AA	N9BMC	271409-5	OE006		
C60Hb	S6YC	101.000.026.AA	OE100	271409-5	RN9YC		
C64H	OE050	101.000.026.AB	N7BMC	271415-2	OE018		
C64H	S7YC	101.000.026.AB	OE095	271415-2	RN7YC		
C64Hb	OE050	101.000.045.AA	C6VPYC	271603-3	OE043		
C64Hb	S7YC	101.000.045.AA	OE129	271603-3	RC7YC		
C64HP	OE133	101.905.611	OE136	271636-3	OE005		
C64HP	RS6YCC	101.905.611	RC8PYP	271636-3	RC9YC		
C68H	OE009	101000035AH	OE124	271727-0	OE005		
C68H	S9YC	101000035AH	RC10PYP4	271727-0	RC9YC		
C68Hb	OE009	101000063AA	OE136	272207	OE120		
C68Hb	S9YC	101000063AA	RC8PYP	272207	RC89TMC		
C7H	OE050	101000068AA	KC8ZMCC	3213327-4	OE097		
C7H	OE090	101000068AA	OE177	3213327-4	RN7LCC		
C7H	S6YC	101905600	KC8ZPYPB4	3343929-0	OE116		
C7H	S7YC	101905600	OE176	3343929-0	RN6YC		
F68H3	OE110	101905600A	KC8ZPYPB4	3344315-1	OE051		
F68H3	RC6YC	101905600A	OE176	3344315-1	RN11YC		
F70H	C7YC	101905601B	KC8ZMCC	334444720	OE060		
F70H	OE017	101905601B	OE177	334444720	RN9LCC		
F70Hb	C7YC	101905601E	OE177	3344472-0	OE060		
F70Hb	OE017	101905601E	KC8ZMCC	3344472-0	RN9LCC		
F72H	C7YC	101905601F	OE177	3344473-8	OE060		
F72H	OE017	101905603B	KC8ZMCC	3344473-8	RN9LCC		
F72H3	OE021			3344898-6	OE097		
F72H3	RC7BMC			3344898-6	RN7LCC		
F72Hb	C7YC			3344899-4	OE097		
F72Hb	OE017			3344899-4	RN7LCC		
F74H	C7YC			3517629	OE043		
F74H	OE017			3517629	RC7YC		
F74Hb	C7YC			3517980	OE005		
F74Hb	OE017			3517980	RC9YC		

**Federal-Mogul Corporation  
Central Distribution Centre**

Prins Boudewijnlaan 7 • B-2550 Kontich • Belgium  
Phone +32 (0) 3450 8310 • Fax +32 (0) 3450 8338

**Federal-Mogul Italy Srl  
Aftermarket Division**

Via Enrico Fermi 8 • 37135 Verona • Italy  
Phone +39 045 828 13 11 • Fax +39 045 828 14 00

**Federal-Mogul Friction Products GmbH  
Federal-Mogul Aftermarket**

Klosterstraße 16 • D-51709 Marienheide • Germany  
Phone +49 (0) 2264-89 0 • Fax +49 (0) 2264-89 270

**Federal-Mogul Aftermarket UK Limited**

Greyhound Drive • Bradford • BD7 1NQ • England  
Phone +44 (0) 1274 723481 • Fax +44 (0) 1274 848282

**Federal-Mogul Ibérica S.L.**

Avda.1ª del Parc Logístic, no 5 - 7 • Políg. Zona Franca • 08040 Barcelona • Spain  
Phone +34 902 33 76 36 • Fax +34 902 21 31 23

**Federal-Mogul Aftermarket España S.A.**

Mario Roso de Luna, 41. Nave 6 • Polígono Fin de Semana • 28022 Madrid • Spain  
Phone +34 91 746 1900 • Fax +34 91 746 1890

**Federal-Mogul Aftermarket France**

60-62, rue Danjou • 92517 Boulogne-Billancourt Cedex • France  
Phone +33 (0) 1 46 94 27 00 • Fax +33 (0) 1 46 94 27 01

**Service Commande:**

Phone +33 (0) 810 000 29 • Fax +32 (0) 345 080 26

**Federal-Mogul Aftermarket  
Southern Africa (PTY) Ltd**

33 Western Boulevard • City West • Johannesburg • South Africa  
Phone +27 11 630 3000 • Fax +27 11 630 3212

**Federal-Mogul Aftermarket Turkey**

Meclisi, Mebusan Caddesi, No: 133 • Fındıklı - İstanbul 80040 • Turkey  
Phone +90 212 292 6313 • Fax +90 212 292 6260





