

TravelMate 4650
TravelMate 4150
Service Guide

Service guide files and updates are available on the ACER/CSD web; for more information, please refer to <http://csd.acer.com.tw>

PRINTED IN TAIWAN

Revision History

Please refer to the table below for the updates made on TravelMate 4650 and TravelMate 4150 service guide.

Date	Chapter	Updates

Copyright

Copyright © 2005 by Acer Incorporated. All rights reserved. No part of this publication may be reproduced, transmitted, transcribed, stored in a retrieval system, or translated into any language or computer language, in any form or by any means, electronic, mechanical, magnetic, optical, chemical, manual or otherwise, without the prior written permission of Acer Incorporated.

Disclaimer

The information in this guide is subject to change without notice.

Acer Incorporated makes no representations or warranties, either expressed or implied, with respect to the contents hereof and specifically disclaims any warranties of merchantability or fitness for any particular purpose. Any Acer Incorporated software described in this manual is sold or licensed "as is". Should the programs prove defective following their purchase, the buyer (and not Acer Incorporated, its distributor, or its dealer) assumes the entire cost of all necessary servicing, repair, and any incidental or consequential damages resulting from any defect in the software.

Acer is a registered trademark of Acer Corporation.

Intel is a registered trademark of Intel Corporation.

Pentium and Pentium II/III are trademarks of Intel Corporation.

Other brand and product names are trademarks and/or registered trademarks of their respective holders.

Conventions

The following conventions are used in this manual:

SCREEN MESSAGES	Denotes actual messages that appear on screen.
NOTE	Gives bits and pieces of additional information related to the current topic.
WARNING	Alerts you to any damage that might result from doing or not doing specific actions.
CAUTION	Gives precautionary measures to avoid possible hardware or software problems.
IMPORTANT	Reminds you to do specific actions relevant to the accomplishment of procedures.

Preface

Before using this information and the product it supports, please read the following general information.

1. This Service Guide provides you with all technical information relating to the BASIC CONFIGURATION decided for Acer's "global" product offering. To better fit local market requirements and enhance product competitiveness, your regional office MAY have decided to extend the functionality of a machine (e.g. add-on card, modem, or extra memory capability). These LOCALIZED FEATURES will NOT be covered in this generic service guide. In such cases, please contact your regional offices or the responsible personnel/channel to provide you with further technical details.
2. Please note WHEN ORDERING FRU PARTS, that you should check the most up-to-date information available on your regional web or channel. If, for whatever reason, a part number change is made, it will not be noted in the printed Service Guide. For ACER-AUTHORIZED SERVICE PROVIDERS, your Acer office may have a DIFFERENT part number code to those given in the FRU list of this printed Service Guide. You MUST use the list provided by your regional Acer office to order FRU parts for repair and service of customer machines.

Chapter 1	System Specifications	1
	Features	1
	Mainboard Placement	5
	Top View	5
	Bottom View	6
	Block Diagram	8
	Outlook View	9
	Front View	9
	Close Front View	10
	Left View	11
	Right View	12
	Rear View	13
	Bottom View	14
	Using the Keyboard	15
	Lock Keys and Embedded Numic Keypad	15
	Windows Key	16
	Hot Keys	17
	Special Keys	20
	Indicators	21
	Launch Keys	22
	Touchpad	23
	Touchpad Basics	23
	Using a computer security lock	25
	Using System Utilities	26
	Acer eManagement	26
	Launch Manager	27
	Audio	28
	Ejecting the optical (CD or DVD) drive tray	29
	Using a Computer Security Lock	30
	System Power Management	31
	Hardware Specifications and Configurations	32
 Chapter 2	 System Utilities	 43
	BIOS Setup Utility	43
	Buttons	44
	Application Launch Buttons	44
	Power Button	44
	Power Button Over-ride	44
	Lid Switch	44
	Hard Disk Password Function/ Password on boot function	45
	Valid Password Characters	45
	Information	46
	Main	48
	Advanced	49
	Security	51
	Boot	52
	Exit	53

Table of Contents

Chapter 3	<i>Machine Disassembly</i>	55
	General Information	56
	Removing the Battery Pack	57
	Removing the HDD and ODD Module	58
	Removing the RAM	58
	Removing the Keyboard	58
	Removing the Wireless and LCD Panel	59
	Removing the Thermal and Bluetooth Module	59
	Removing the Upper Case	59
	Removing the Touchpad	60
	Removing the FAN	61
	Removing the Thermal Module and CPU	61
	Removing the MDC	62
	Removing the Wireless, Speaker and PCMCIA	62
	Removing the LCD Panel	63
	Removing the HDD and ODD	65
Chapter 4	<i>Troubleshooting</i>	66
	System Check Procedures	67
	External Diskette Drive Check	67
	External CD-ROM Drive Check	67
	Keyboard or Auxiliary Input Device Check	67
	Memory Check	68
	Power System Check	68
	Check the Power Adapter	69
	Check the Battery Pack	70
	Touchpad Check	70
	PhoenixBIOS POST Tasks and Beep Codes	71
	Index of Error Messages	72
	POST Code	75
	Index of Symptom-to-FRU Error Message	76
	Intermittent Problems	79
	Undetermined Problems	80
	Use NAPP CD to Build Master Hard Disc Drive	81
Chapter 5	<i>Jumper and Connector Locations</i>	88
	Top View	88
	Rear View	89
	VGA Board	91
	Power SW/B	92
	TouchPad Board	93
	Hot Swap ODD Board	94
	DVI Board	95
	Clear CMOS	96

Table of Contents

Chapter 6	<i>FRU (Field Replaceable Unit) List</i>	97
	Exploded Diagram	98
	Parts	100
Appendix A	<i>Model Definition and Configuration</i>	113
Appendix B	<i>Test Compatible Components</i>	114
	Microsoft Windows XP(Home/Professional) Environment Test	115
Appendix C	<i>Online Support Information</i>	118

Table of Contents

System Specifications

Features

This computer was designed with the user in mind. Here are just a few of its many features:

Performance

- Intel® 915PM/915GM PCI Express chipset
- Intel® Pentium® M processor 730/740/750/760/770 (2MB L2 cache, 1.6/1.73/1.86/2.0/2.13 GHz, 533 MHz FSB)
- CPU Package is uFPGA 478 Package
- Integrated Intel® PRO/Wireless 2200GB network connection (dual-mode 802.11b/g) Wi-Fi CERTIFIED™ solution, supporting Acer SignalUp wireless technology

Memory

- 256MB or 512MB of DDR II 400/533 memory
- Onboard with two 200-pin +1.8V DDR II soDIMM connector, supporting DDR memories card. Maximum up gradable to 2GB by two 1GB soDIMM module
- Support 64MB/128MB VGA memory for NV43M/NV44MV
- Adjustable 128MB UMA VGA memory share from North Bridge

Display

- 15" XGA TFT LCD, supporting 1024x768 pixel resolution, 16.7 million colours (for TravelMate 4150 series)
- 15" SXGA TFT LCD, supporting 1400x1050 pixel resolution, 16.7 million colours (for TravelMate 4650 series)

Graphics

- nVIDIA® GeForce™ Go 6600 graphics processing unit (GPU) with 64MB or 128MB of DDR Video RAM , supporting PCI Express™ and Microsoft® DirectX® 9.0 (for TravelMate 4650 series)
- nVIDIA® GeForce™ Go 6200 graphics processing unit (GPU) with TurboCache™ technology supporting 128MB video memory supporting PCI Express™ and Microsoft® DirectX® 9.0 (for TravelMate 4150 series)
- Intel® 915GM integrated 3D graphics, featuring Intel® Graphics Media Accelerator 900 and up to 128MB of video memory, supporting Microsoft® DriectX® 9.0 (for TravelMate 4650/4150 series)
- Dual independent display support
- External resolution/refresh rate
 - 2048x1536: 85/75/70/66/60 Hz
 - 1600x1200: 120/100/85/75/60 Hz
 - 1280x1024: 180/160/120/100/90/85/75/70/60 Hz
 - 1024x768: 200/160/150/120/100/90/85/75/72/70/60 Hz
 - 800x600: 200/160/120/100/90/85/75/72/70/60 Hz
- MPEG-2/DVD hardware-assisted capability

-
- S-video/TV-out (NTSC/PAL) support

Audio

- Realtek ALC250 for AC'97 CODEC
- 16-bit AC'97 stereo audio
- Dual speakers and one internal microphone
- Separate audio ports for headphone-out , and line-in/microphone-in devices
- 20-bit Stereo DAC (Digital-to-Analog Converters) and 18-bit ADC (Analog-to-Digital Converters) resolution
- Built-in 7-band digital hardware equalizer to optimize speaker response
- Support S/PDIF output
- Stereo output with 6-bit volume control
- Mono output with 5-bit volume control
- Headphone output with 50mW/20Ohm amplifier
- Three analog line-level stereo inputs with 5-bit volume control: LINE_IN, CD, AUX
- Two analog line-level mono inputs: PCBEEP, PHONE-IN
- High quality differential CD input

Storage

- 40/60/80/100 GB (4200 rpm) or 60GB (5400 rpm) P- ATA/100 hard disc drive
- One internal optical drive (DVD-Dual double layer, DVD-Super Multi double layer, or DVD/CD-RW combo drive)
- AcerMedia Bay for hot-swappable optical drive modules(for TravelMate 4650 series)
 - DVD-Super Multi double layer
 - DVD Dual double layer
 - DVD/CD-RW combo
- Optical drive options (for TravelMate 4150 series)
 - DVD Dual double layer
 - DVD/CD-RW combo
- 6-in-1 card reader supporting
 - Smart Media (SM)
 - Secure Digital (SD)
 - MultiMedia Card (MMC)
 - Memory Stick[®] (MS)
 - Memory Stick PRO[™] (MS-Pro)
 - xD-Picture Card[™]

Communication

- 56Kbps ITU V.92 modem with PTT approval, Wake-On-Ring ready
- 10/100/1000 Mbps Fast Ethernet; Wake-on-LAN ready (for TravelMate 4650 series)
- 10/100 Mbps Fast Ethernet; Wake-on-LAN ready (for TravelMate 4150 series)
- Integrated Intel® PRO/Wireless 2200GB network connection (dual-mode 802.11b/g) Wi-Fi CERTIFIED™ solution, supporting Acer SignalUp wireless technology
- Integrated Bluetooth® support (manufacturing option)

I/O Ports

- Four USB 2.0 ports
- IEEE 1394 port
- Ethernet (RJ-45) port
- Modem (RJ-11) port
- External display (VGA) port
- S-video/TV-out (NTSC/PAL) port
- Microphone/Line-in jack
- Headphones/Speaker/Line-out port
- Infrared (FIR) port
- PC Card slot (one Type II)
- 6-in-1 card reader (SM/MS/MS-Pro/MMC/SD/xD-Picture card™)
- DC-in jack for AC adaptor
- DVI-D port (for TravelMate 4650 series)
- 124-pin Acer ezDock connector (for TravelMate 4650 series)

Battery

- ACPI 1.0b CPU power management standard supports Standby and Hibernation power-saving modes
- 65W, 8 cell Li-ion battery pack
- optional 42W 6 cell Li-ion 2nd battery pack (for TravelMate 4650)
- 5-hour battery life on Intel 915GM models
- 2.5-hour rapid charge; 3.5-hour charge-in-use
- 3 pin 65W AC adaptor

Keyboard and pointing device

- Acer FineTouch™ keyboard with a 5-degree curve, 88/89-key Windows keyboard
- Ergonomically-centered touchpad pointing device with 4-way internet function

Weight (with battery)

- 6.26 lbs (2.84 Kg)

Dimension

- 336.4(W) x 284.5 (D) x 32.0/34.5 (H) mm (14.29 x 10.46 x 1.2/1.35 inches)

Environment

- Temperature
 - Operating : 5°C-35°C
 - Non-operating : -20°C~65°C
- Humidity (non-condensing)
 - Operating : 20% - 80%
 - Non-Operating : 20% - 80% RH

System Compliance

- ACPI 1.0b
- Mobile PC 2001
- DMI 2.0
- Wi-Fi®
- Cisco Compatible Extensions version 3 (CCX-V3)

Options

- 256MB/512MB/1GB DDR II 533MHz memory upgrades modules
- Additional 65W AC adaptor
- Additional eight-cell Li-ion battery pack
- External USB floppy drive
- Second 6-cell battery pack (AcerMedia Bay, for TravelMate 4650 series)
- DVD-Super Multi double layer drive (AcerMedia Bay, for TravelMate 4650 series)
- Acer ezDock (for TravelMate 4650 series)

NOTE: The specifications listed above are for reference only. The exact configuration of your PC depends on the model purchased.

Mainboard Placement

Top View

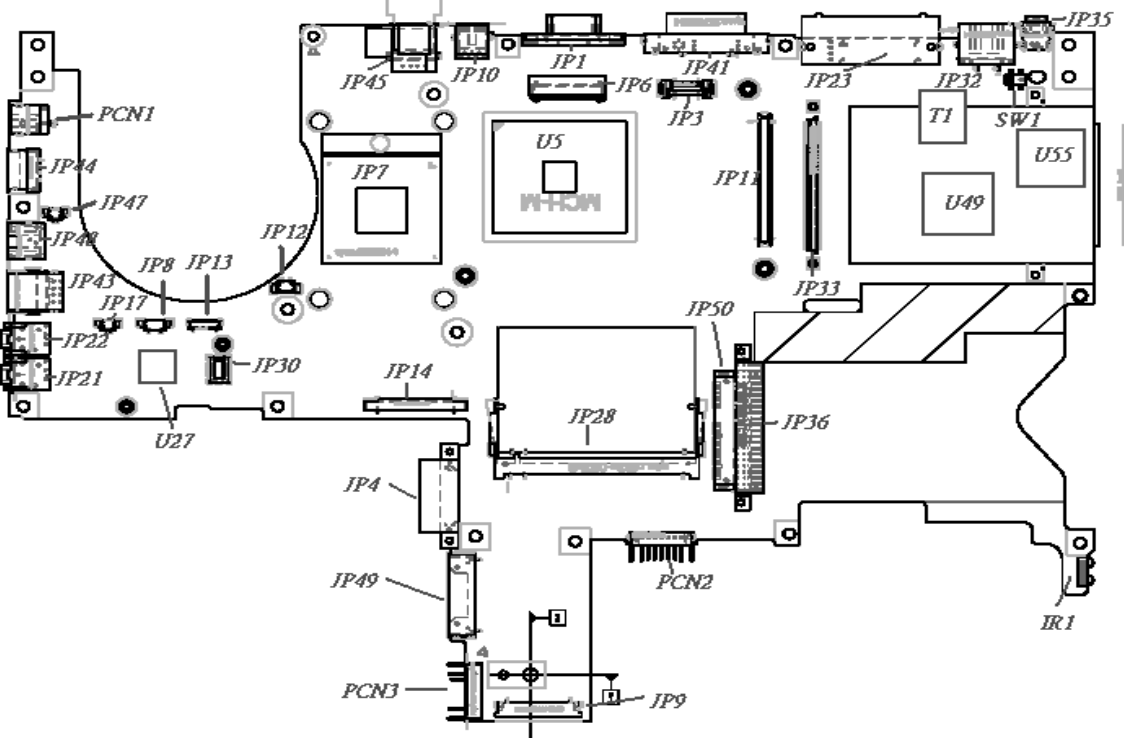

Bottom View

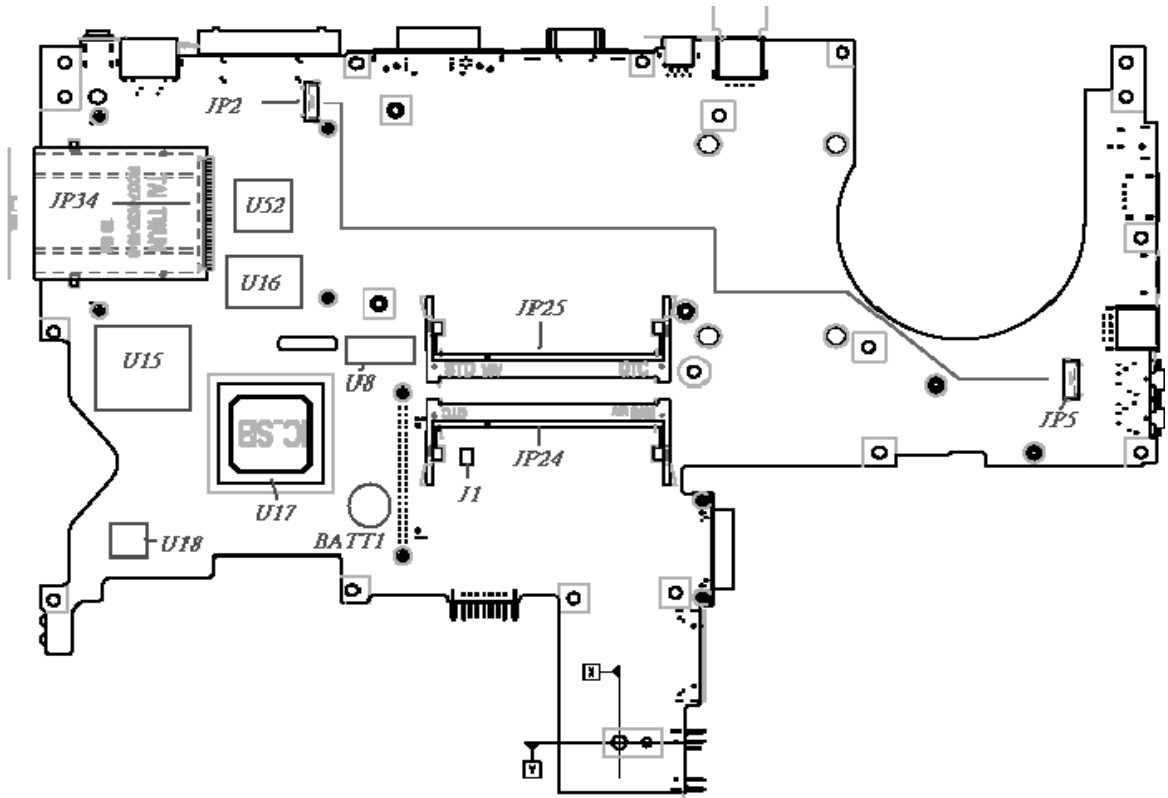

ITEM	DESCRIPTION	ITEM	DESCRIPTION
JP1	CRT CONN	JP30	MDC CONN
JP2	DOCKING SPR CONN	JP32	RJ45 CONN
JP3	SWITCH CONN	JP33	CARDBUS CONN
JP4	ODD CONN (FIX)	JP34	5 IN 1 SOCKET
JP5	DOCKING SPR CONN	JP35	1394 CONN
JP6	LCD CONN	JP36	HDD CONN
JP7	CPU SOCKET	JP41	DVI-D CONN
JP8	SPEAKER CONN	JP43	DUAL USB CONN
JP9	TP/B CONN	JP44/JP45	USB CONN
JP10	S-VIDEO CONN	JP47	RJ11 TO MDC CONN
JP11	VGA /B CONN	JP48	RJ11 CPMM
JP12	FAN CONN	JP49	ODD CONN (SWAP)
JP13	BT CONN	JP50	SATA CONN
JP14	KB CONN	PCN1	DC JACK
JP15	ROM SOCKET	PCN2	MAIN BAT
JP17	MIC CONN	PCN3	2nd BAT
JP21	MIC JACK	SW1	LID SWITCH
JP22	HEADPHONE JACK	BATT1	BATTERY
JP23	DOCKIND CONN	J1	CLEAR CMOS
JP24/JP25	DIMM SLOT	IR1	IR CONN
JP28	MINI PCI SLOT		

Chipset	Chipset Description
U5	NB CHIPSET
U27	AUDIO CODEC
U49	LAN CHIP
U55	1394 CHIP
T1	LAN TRANSFORMER
U8	CLK GEN
U15	EC CHIP
U16	ROM SOCKET
U17	SB CHIP
U18	SUPER I/O
U52	5 IN 1 CHIP

Block Diagram

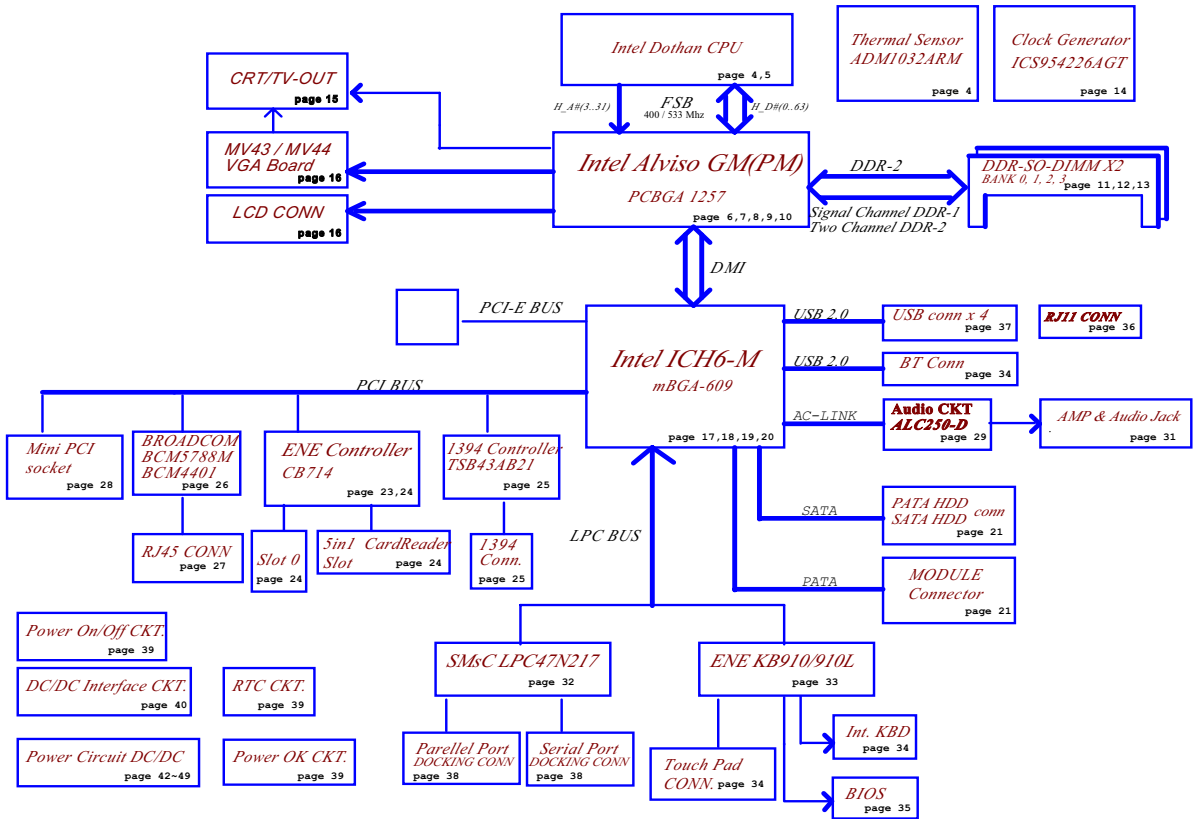

Outlook View

A general introduction of ports allow you to connect peripheral devices, as you would with a desktop PC.

Front View

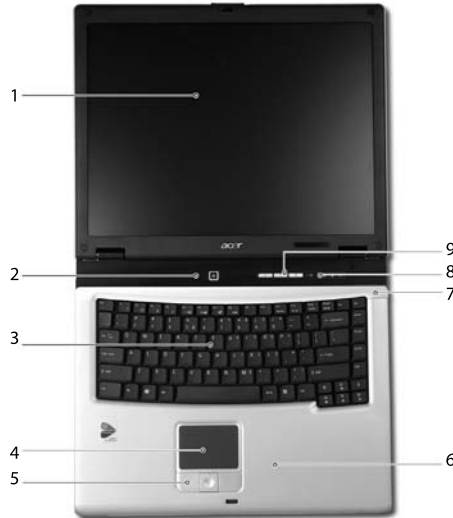

#	Item	Description
1	Display screen	Also called Liquid-Crystal Display (LCD), displaying computer output.
2	Power button	Turns the computer on and off
3	Keyboard	Inputs data into your computer.
4	Touchpad	Touch-sensitive pointing device which functions like a computer mouse.
5	Click buttons (Left, center and right)	The left and right buttons function like the left and right mouse buttons; the center button serves as a 4-way scroll button.
6	Palmrest	Comfortable support area for your hands when you use the computer.
7	Microphone	Internal microphone for sound recording.
8	Status indicators	Light-Emitting Diodes (LEDs) that turn on and off to show the status of the computer's functions and components.
9	Launch keys	Buttons for launching frequently used programs.



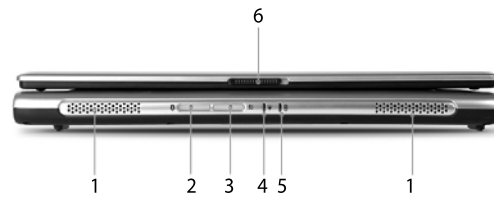



Closed Front View



#	Item	Description
1	Speakers	Left and right speakers deliver stereo audio output.
2	Bluetooth communication button/indicator	Press to enable/disable Bluetooth function. Lights to indicate the status of Bluetooth communications (manufacturing option).
3	Wireless communication button/indicator	Press to enable/disable Wireless function. Lights to indicate the status of wireless LAN communications.
4	Power indicator	Lights when the computer is on.
5	Battery indicator	Lights when the battery is being charged.
6	Latch	Locks and releases the lid.



Left View



No.	Icon	Item	Description
1		Security keylock	Connects to a Kensington-compatible computer security lock.
2		Power jack	Connects to an AC adaptor.
3/5		USB 2.0 port	Connects to Universal Serial Bus (USB) 2.0 devices (e.g., USB mouse, USB camera).
4		Modem Jack (RJ-11)	Connects to a phone line.
6		Speaker-out/line-out/ headphone jack	Connects to audio line-out devices (e.g., speakers, headphones).
7		Line-in/mic-in jack	Accepts inputs from external microphones.
8		Optical drive	Internal optical drive; accepts CDs or DVDs depending on the optical drive type.
9		Optical drive eject button	Ejects the optical drive tray from the drive.

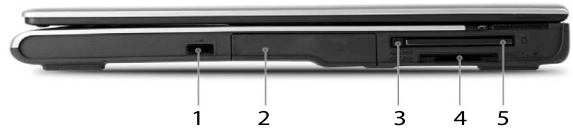





Right View

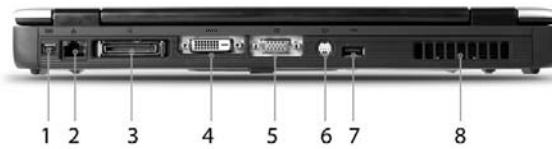

#	Icon	Item	Description
1		Infrared port	Interfaces with infrared devices (e.g., infrared printer and IR-aware computer).
2		Hard disk bay	Houses the computer's hard disk (secured by a screw).
3		PC Card slot eject button	Ejects the PC Card from the slot.
4		6-in-1 card reader	Accepts MS, MS PRO, MMC, SD, SM, and xD-Picture cards. NOTE: Only one card can operate at any given time.
5		PC Card Slot	Connects to one Type II CardBus PC Card.

Rear View



#		Item	Description
1		IEEE 1394 port	Connects to IEEE 1394 devices.
2		Network jack	Connects to an Ethernet 10/100/1000-based network (for selected models).
3		124-pin Acer ezDock connector (for TravelMate 4650 Series)	Connects to Acer ezDock.
4		DVI-D port (for TravelMate 4650 Series)	Supports digital video connections.
5		External display port	Connects to a display device (e.g., external monitor, LCD projector).
6		S-video port	Connects to a television or display device with S-video input.
7		USB 2.0 port	Connects to Universal Serial Bus (USB) 2.0 devices (e.g., USB mouse, USB camera).
8		Ventilation slots	Enable the computer to stay cool, even after prolonged use.

Bottom View



#	Item	Description
1	Memory compartment	Houses the computer's main memory.
2	Hard disk bay	Houses the computer's hard disk (secured by a screw).
3	Battery release latch	Unlatches the battery to remove the battery pack.
4	Battery bay	Houses the computer's battery pack.
5	Cooling fan	Helps keep the computer cool. NOTE: Do not cover or obstruct the opening of the fan.
6	AcerMedia Bay (for TravelMate 4650 Series)	Houses an optical drive module or a second battery pack.
7	AcerMedia Bay release latch (for TravelMate 4650 Series)	Unlatches the AcerMedia module for removal of module.

Using the Keyboard

The keyboard has full-sized keys and an embedded keypad, separate cursor keys, two Windows keys and twelve function keys.

Lock keys and embedded numeric keypad

The keyboard has three lock keys which you can toggle on and off.



The computer features three lock keys, each with its own status indicator light.









Lock Key	Description
Caps Lock	When Caps Lock is on, all alphabetic characters are typed in uppercase.
Num lock <Fn+F11>	When Num Lock is on, the embedded keypad is in numeric mode. The keys function as a calculator (complete with the arithmetic operators +, -, *, and /). Use this mode when you need to do a lot of numeric data entry. A better solution would be to connect an external keypad.
Scroll lock <Fn+F12>	When Scroll Lock is on, the screen moves one line up or down when you press the up or down arrow keys respectively. Scroll Lock does not work with some applications.

The embedded numeric keypad functions like a desktop numeric keypad. It is indicated by small characters located on the upper right corner of the keycaps. To simplify the keyboard legend, cursor-control key symbols are not printed on the keys.

Desired access	Num Lock on	Num Lock off
Number keys on embedded keypad	Type numbers in a normal manner.	
Cursor-control keys on embedded keypad	Hold <Shift> while using cursor-control keys.	Hold <Fn> while using cursor-control keys.
Main keyboard keys	Hold <Fn> while typing letters on embedded keypad.	Type the letters in a normal manner.

Windows Key

The keyboard has two keys that perform Windows-specific functions.







Key		Description
	Windows Key	<p>Pressed alone, this key has the same effect as clicking on the Windows Start button; it launches the Start menu. It can also be used with other keys to provide a variety of functions:</p> <ul style="list-style-type: none"><  > + <Tab> Activates the next Taskbar button.<  > + <E> Opens the My Computer window.<  > + <F1> Opens Help and Support.<  > + <M> Minimises all windows.<Shift> + <  > + <M> Undoes the minimise all windows<  > + <M> Action.<  > + <R> Opens the Run dialog box.
	Application Key	<p>This key has the same effect as clicking the right mouse button; it opens the application's context menu.</p>







Hot Keys





The computer employs hot keys or key combinations to access most of the computer's controls like screen brightness, volume output and the BIOS utility.

To activate hot keys, press and hold the <Fn> key before pressing the other key in the hot key combination.



Hot Key	Icon	Function	Description
Fn+F1	?	Hot Key Help Menu	This key will cause a help message to appear on the display device that describes the definition and functionality of the unit hot keys. It is preferred to have the key activate a graphical display.
Fn+F2		Launch Acer eSettings	Launches the Acer eSettings in the eManager set by the Acer Empowering Key 
Fn+F3		Acer ePowerManagement	Launches the Acer ePowerManagement in the eManager set by the Acer Empowering Key 
Fn+F4	Z ^z	SleepButton in ACPI mode	In ACPI mode, the OS provides two buttons for sleep function. One is the Power On button and the other is the Sleep Button. °Fn+F4° is assigned as the Sleep button in ACPI mode. User can set the action of the Sleep Button on the Power Management property.
Fn+F5		Launch Display Mode Menu (DMM)	Follow DMM Specification except in OS other than 32-bit Windows
Fn+F6		Display blank (backlight off)	This key will cause the LCD back light to be turned off. This provides both a quick security feature and some power savings. The LCD back light can also be turned off via an APM timer. The LCD back light will be turned on again when any of the following events occur : <ol style="list-style-type: none"> 1. Any key pressed 2. Pointing device movement

Hot Key	Icon	Function	Description
Fn+F7		Touchpad On/Off	This key will cause the internal touchpad pointing device to be disabled/enabled . This is to prevent accidental system wake-ups from standby. Pressing this key a second time will re-enable the touch pad pointing device. BIOS check Internal AuxDev if not exist then BIOS empty return.
Fn+F8		Speaker On/Off	This key will cause the audio output to the speakers to muted or disabled. Pressing this key a second time will re-enable the audio output to the speakers.
Fn+F11		Numlock	<p>The Num-Lock feature is a standard AT keyboard feature. For Acer machines, Numlock is off by default and when the NumLock is on, the internal keyboard will act as numeric key padlock.</p> <p>If an external keyboard or keypad is present, then the NumLock will have the following definitions:</p> <ul style="list-style-type: none"> <input type="checkbox"/> NumLock is on, when the system boots with external keyboard or numeric keypad. The external keyboard/keypad NumLock status is on and internal keyboard overlay numeric keys are disabled. <input type="checkbox"/> NumLock key can be typed on/off via the internal keyboard (Fn+F11) or the external keyboard/keypad, but NumLock affects the external keyboard/keypad only. <input type="checkbox"/> The NumLock shift state (NumLock is off) is NOT used for the cursor movement by the internal keyboard numeric keys. <input type="checkbox"/> The state of the NumLock is not changed by the attachment/removal (hot plug) of the external keyboard/keypad. <p>This is to support the attachment of an external numeric keypad. The user may use the internal keyboard for full alphabet typing, and the external keypad for numeric entry.</p> <p>The state of the NumLock is not changed by the attachment/removal of the external keyboard (hot plug).</p>
Fn+F12		Scroll Lock	The Scroll Lock is a standard AT keyboard feature.
Fn+ 		Volume up	These keys can increase or decrease the brightness of the LCD back light. This function should be handled by the Analog function within the keyboard controller. Brightness will step up/down one unit as each time these keys are pressed.
Fn+ 		Volume down	Decreases the sound volume.

Hot Key	Icon	Function	Description
Fn+ 		Brightness up	These keys can increase or decrease the brightness of the LCD back light. This function should be handled by the Analog function within the keyboard controller. Brightness will step up/down one unit as each time these keys are pressed.
Fn+ 		Brightness down	
Fn+F10		Enter D2D recovery during POST Launch Acer eRecovery in OS	Enter D2D recovery during POST Launch Acer eRecovery in OS.

Special Keys

You can locate the Euro symbol and the US dollar sign at the upper center and/or bottom-right of your keyboard. To type:



The Euro symbol

1. Open a text editor or word processor.
2. Either directly press the **Euro** symbol at the bottom-right of the keyboard, or hold **<Alt Gr>** and then press the **Euro** symbol at the upper-center of the keyboard.

The US dollar sign

1. Open a text editor or word processor.
2. Either directly press the dollar sign at the bottom-right of the keyboard, or hold **<Shift>** and then press the dollar sign at the upper-center of the keyboard.







NOTE: This function varies according to the language settings.

Indicators

The computer has three easy-to-read status icons on the upper-right above the keyboard, and four indicators at the front panel.



The power, battery, and wireless communication status indicators are visible even when the LCD display is closed.

Icon	Item	Description
	Caps Lock	Lights when Caps Lock is activated.
	Num Lock	Lights when Num Lock is activated.
	Media activity	Lights when the hard disk or optical drive is active.
	Bluetooth indicator	Lights to indicate the status of Bluetooth communications.
	Wireless indicator	Lights to indicate the status of wireless LAN communications.
	Power indicator	Lights when the computer is on.
	Battery indicator	Lights when the battery is being charged.

NOTE: 1. Charging : the light shows amber when the battery is charging.

2. Fully Charged : light shows green when in AC mode.

Launch Keys

Located at the upper-right above the keyboard are four buttons. These buttons are called launch keys. They are designated as mail, Web browser, Acer Empowering Key " *e* ", and one user programmable button.

Press the Empowering Key " *e* " to run the Acer eManager. The mail and Web browser are default for Email and Internet programs, but can be reset by users. To set the Web browser, mail and programmable keys, run the Acer Launch Manager.



Launch Key	Default Application
<i>e</i>	Acer eManager (user-programmable)
P	User-programmable
Web browser	Internet browser (user-programmable)
Mail	Email application (user-programmable)

Touchpad

The built-in touchpad is a pointing device that senses movement on its surface. This means the cursor responds as you move your finger on the surface of the touchpad. The central location on the palmrest provides optimum comfort and support.



Touchpad Basics

The following items teach you how to use the touchpad:



- Move your finger across the touchpad (2) to move the cursor.
- Press the left (1) and right (4) buttons located on the edge of the touchpad to perform selection and execution functions. These two buttons are similar to the left and right buttons on a mouse. Tapping on the touchpad is the same as clicking the left button.
- Use the 4-way scroll (3) button to scroll up or down and move left or right a page. This button mimics your cursor pressing on the right scroll bar of windows applications.

Function	Left button (1)	Right button (4)	Main touchpad (2)	Center button (3)
Execute	Click twice quickly		Tap twice (at the same speed as double-clicking a mouse button).	
Select	Click once		Tap once	
Drag	Click and hold, then use finger to drag the cursor on the touchpad.		Tap twice (at the same speed as double-clicking a mouse button); hold a	
Access context menu		Click once		
Scroll				Click and hold the up/down/left/right

NOTE: Keep your fingers dry and clean when using the touchpad. Also keep the touchpad dry and clean. The touchpad is sensitive to finger movement, hence, the lighter the touch, the better the response. Tapping harder will not increase the touchpad's responsiveness.

Using a computer security lock

A security keylock notch, located on the rear of the computer, lets you connect a Kensington-compatible computer security lock.







Wrap a computer security lock cable around an immovable object such as a table or handle of a locked drawer. Insert the lock into the notch and turn the key to secure the lock. Some keyless models are also available.

Using System Utilities

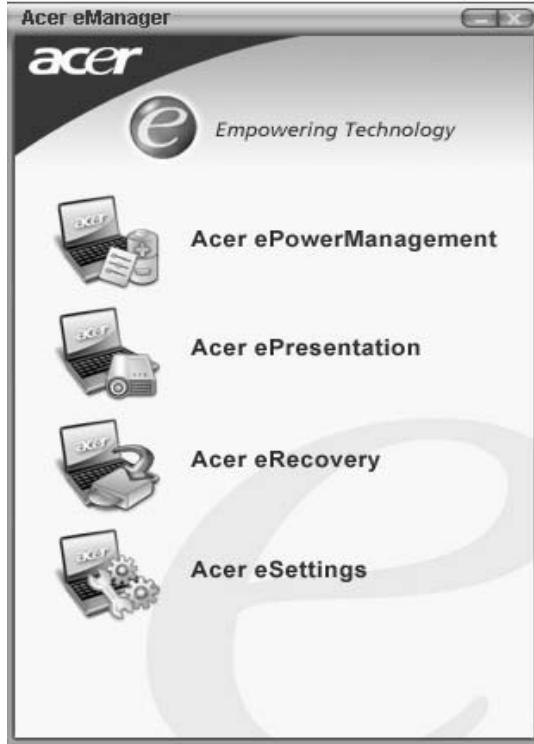
Acer eManager

Innovative Acer eManager software is designed for easy access to frequently used functions. At the press of Acer Empowering Key " *e* ", the Acer eManager user interface appears, featuring four main settings: Acer ePowerManagement, Acer ePresentation, Acer eRecovery and Acer eSettings.



Icon	Item	Description
	Acer ePowerManagement	It provides a central location from where to control all your PC's power schemes and maximise battery life.
	Acer ePresentation	Simplifies resolution settings when connecting to a projector.
	Acer eRecovery	Creates backups and recovers system configurations reliably.
	Acer eSettings	Makes managing system settings and security easy.

Launch Manager

Launch Manager allows you to set the four launch keys located above the keyboard.

You can access the Launch Manager by clicking on **Start, All Programs**, and then **Launch Manager** to start the application.

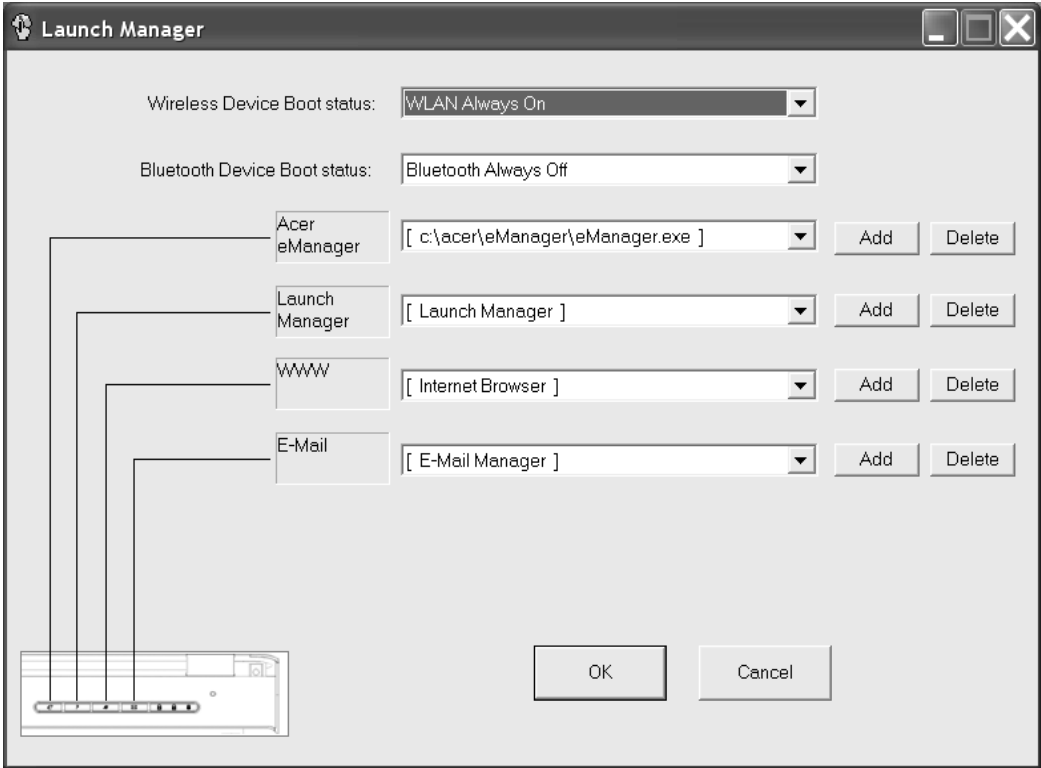

Audio

The computer comes with 16-bit high-fidelity AC'97 stereo audio, and dual stereo speakers.



Adjusting the Volume

Adjusting the volume on the computer is as easy as pressing some buttons.

Ejecting the optical (CD or DVD) drive tray

To eject the optical drive tray when the computer is turned on, press the drive eject button.



When the power is off, you can eject the drive tray using the mechanical eject hole.

Using a Computer Security Lock

A security keylock notch, located on the left hand side of the computer, lets you connect a Kensington compatible computer security lock.



Wrap a computer security lock cable around an immovable object such as a table or handle of a locked drawer. Insert the lock into the notch and turn the key to secure the lock. Some keyless models are also available.

System Power Management

The overall system can be in one of five system power states as described below:

Legacy Mode	ACPI mode	Power Management
Off	Mech. Off (G3)	All devices in the system are turned off completely.
	Soft Off (G2/S5)	OS initiated shutdown. All devices in the system are turned off completely.
On	Working (G0/S0)	Individual devices such as the CPU and hard disk may be power managed in this state.
	S3 Sleeping State	CPU set power down VGA Suspend PCMCIA Suspend Audio Power Down Hard Disk Power Down CD-ROM Power Down Super I/O Low Power mode
	S4 Sleeping State	Also called Hibernate state. System Saves all system states and data onto disk prior to power off the whole system.

Hardware Specifications and Configurations

Processor

Item	Specification
CPU type	Intel® Pentium® M Processor 730/740/750/760/770 at 1.6 ~2.13 GHz or higher, FSB 533MHz Intel® Pentium® M Processor 310/320/330/340/350 at 1.2~1.3GHz or higher, FSB 400MHz
CPU package	Micro FC-PGA package CPU
CPU core voltage	Depend on DVI
CPU I/O voltage	1.2V

System Board Major Chips

Item	Controller
System core logic	Intel® 915PM / ICH6-M Intel® 915GM / ICH6-M
Super I/O controller	SMsC LPC47N217
Audio controller	ICH6-M
Video controller	Integrated VGA solution for 915GM External VGA card for 915PM
Hard disk drive controller	ICH6-M
Keyboard controller	ENE KB910
AC97' controller	ALC250
IrDA controller	SMsC LPC47N217
Card Reader controller	ENE CB714
1394 controller	TI TSB43AB21
DDR-soDIMM controller	915PM/915GM
GIGA LAN controller	BCM5788
10/100MB LAN controller	BCM4401

BIOS

Item	Specification
BIOS vendor	Insyde
BIOS Version	N/A
BIOS ROM type	Flash ROM
BIOS ROM size	512KB
BIOS package	32 lead of TSSOP
BIOS password control	Set by setup manual

Item	Specification
Cache controller	Built-in CPU
Cache size	2 MB
1st level cache control	Always enabled
2nd level cache control	Always enabled
Cache scheme control	Always enabled

System Memory

Item	Specification
Memory Controller	915PM/915GM
Memory Type	DDRII soDIMM
Memory Size	256MB/512MB
Dimm Slot Number	2
Supports Memory Size Per Slot	1024 MB
Supports Maximum Memory Size	2GB by two 1GB soDIMM module
Supports Dimm Type	DDR Synchronous DRAM
Supports Dimm Speed	533MHz
Supports Dimm Voltage	1.8V
Supports Dimm Package	200-pin
Supports 64MB/128MB for	NV43M/NV44MV
Adjustable 128MB UMA VGA share from	(North Bridge) ICH-6M
Memory Module Combinations	You can install memory modules in any combinations as long as they match the above specifications.

LAN Interface

Item	Specification
Supports LAN protocol	10/100/1000 Mbps Fast Ethernet connection (for TM 4650 series) 10/100 Mbps Fast Ethernet connection (for TM 4150 series)
LAN connector type	RJ45
Wireless LAN	Integrated Intel PRO/Wireless 2200BG network connection (dual-mode 802.11b/g) Wi-Fi CERTIFIED™ solution, supporting Acer SignalUp wireless technology
LAN connector location	Rear Side

Modem

Item	Specification
Data modem data baud rate (bps)	56K ITU
Supports modem/bluetooth protocol	V.92 AC-Link modem with PTT approval Wake-on-Ring ready
Modem connector type	RJ11
Modem connector location	Left Side

VGA

Notice	Discreat	UMA
Chipset for suitable VGA type	915PM	915GM

USB Port

Item	Specification
USB compliancy level	2.0
OHCI	USB 2.0
Number of USB port	4
Location	Left Side *3 Rear Side *1

Audio Port

Item	Specification
Audio Controller	AC' 97 Codec
Audio onboard or optional	Built-in
Mono or Stereo	Stereo
Resolution	20 bit stereo Digital to analog converter 18 bit stereo Analog to Ditial converter
Sampling rate	48 KHz
Internal microphone	Yes
Internal speaker / Quantity	Yes / 2

PCMCIA Port

Item	Specification
PCMCIA controller	ENE CB714
Supports card type	Type II
Number of slots	One
Access location	Right Side
Supports ZV (Zoomed Video) port	No
Supports 32 bit CardBus	Yes

Keyboard

Item	Specification
Keyboard controller	KB 910
Keyboard vendor & model name	Standard keyboard w launch button embeded
Total number of keypads	<input type="checkbox"/> Acer FineTouch™ keyboard with 5-degree curve, 88/89-key Windows keyboard <input type="checkbox"/> Ergonomically-centerd touchpad pointing device with 4-way Internet scroll function
Touchpad with 4-way integrated scroll button	Yes
12 function keys	<input type="checkbox"/> four cursor keys <input type="checkbox"/> two Windows keys <input type="checkbox"/> Hotkey controls <input type="checkbox"/> embedded numeric keypad <input type="checkbox"/> international language support
Four easy-launch buttons	<input type="checkbox"/> Internet browser <input type="checkbox"/> email with LED <input type="checkbox"/> Empowering key <input type="checkbox"/> one user-programmable button
Two front access LED buttons	<input type="checkbox"/> WLAN LED button <input type="checkbox"/> Bluetooth LED button

Battery

Item	Specification
Vendor & model name	Sony/Panasonic/Sanyo
Battery Type	Li-ion
Pack capacity	65Wh
Cell voltage	3.7V/cell/4300mAh,4400mAh,4500mAh High discharge rate
Number of battery cell	8-cell(65W)
Package configuration	
Pin 1	BATT+: Battery+, Battery Positive Terminal
Pin 2	ID : Identify Pin
Pin 3	B/I : Battery-In Pin
Pin 4	TS : Connect to Thermister
Pin 5	SMD : SMBus data interface I/O pin
Pin 6	SMC : SMBus clock interface I/O pin
Pin 7	GND : Battery Negative Terminal

15" LCD Panel

Item	Specification		
Vendor/Model	AU B150XG01 V2	AU B150PG03	Samsung LTN150XB
Resolution (pixel)	XGA (1024 x 768)	SXGA (1400 x 1050)	XGA (1,024 x 768)
Active Area (mm)	304.1 x 228.1	304.5 x 228.4	304.5 x 228.4
Pixel Pitch (mm)	0.297	0.218	0.279
Number of Colors	262K	262K	262K
Color Saturation (NTSC%)	45	45	45
View Angle (H/V)	80 / 40	80 / 40	20/40/45/45
Brightness (cd/m2) (5 points average)	180	200	160
Contrast Ratio	300 : 1	300 : 1	250:1
Response Time (ms) (at 25°C)	25	25	45
Power Consumption (W)	5.6	5.9	N/A
Interface	1ch LVDS	2ch LVDS	2ch LVDS
Supply Voltage (V)	3.3	3.3	N/A
Backlight	1 CCFL	1 CCFL	N/A
Outline Dimensions (mm)	317.3 x 242.0 x 5.7	317.3 x 242.0 x 6.0	317.3 x 242.0 x 6.2
Weight (g)	550	575	585

AC Adapter

Item	Specification
Vendor & model name	Delta 3-pin, 19V 3.95A, 64W Hipro 3-pin, 19V 3.95A, 65W Lite-on 3-pin, 19V 3.95A, 60W
Details	65W 8-cell Li-ion battery pack 42W 6-cell Li-ion 2 nd battery pack <ul style="list-style-type: none"> <input type="checkbox"/> 5-hour battery life on Intel 915GM models <input type="checkbox"/> 3.5-hour charge-in-use <input type="checkbox"/> 2.5-hour rapid charge
Input Requirements	
Maximum input current (A, @100Vac, full load)	1.8A max@3.5A/100Vac and 240 Vac
Nominal frequency (Hz)	47 - 63
Frequency variation range (Hz)	47 - 63
Nominal voltages (Vrms)	90 - 264
Inrush current	The maximum inrush current will be less than 50A and 100A when the adapter is connected to 100Vac(60Hz) and 240Vac(50Hz) respectively.
Efficiency	High efficiency 85% minimum, at 100~240Vac AC input, full load, warm-up condition.
Output Ratings (CV mode)	
DC output voltage	Offers constant voltage 19.0V output source with 150W max output power capacity.
Noise + Ripple	300mvp-pmax (20MHz bandwidth) for resistor load
Output current	0 A (min.) 3.5A (max.)
Output Ratings (CC mode)	
DC output voltage	18.0 ~ 20.0
Constant output	7.9A
Dynamic Output Characteristics	
Start-up time	3 sec. (@115 Vac and 230Vac full load)
Hold up time	5ms min. (@115 Vac input, full load)
Over Voltage Protection (OVP)	25V
Short circuit protection	Output can be shorted without damage, and auto recovery
Electrostatic discharge (ESD)	15kV (at air discharge) 8kV (at contact discharge)
Dielectric Withstand Voltage	
Primary to secondary	4242 Vdc for 1 second-
Leakage current	60uA at 240Vac/60Hz
Regulatory Requirements	1. FCC class B requirements (USA) 2. VDE class B requirements (German) 3. VCCI classII requirements (Japan)

Power Management

ACPI Mode	Power Management
Mech. Off (G3)	All devices in the system are turned off completely.
Soft Off (G2/S5)	OS initiated shutdown. All devices in the system are turned off completely.
Working (G0/S0)	Individual devices such as the CPU and hard disk may be power managed in this state.
Sleeping State (S3)	CPU Power Down VGA Power Down PCMCIA Suspend Audio Power Down Hard Disk Power Down Super I/O Power Down
Sleeping State (S4)	Also called Hibernate state. System saves all system states and data onto the disk prior to power off the whole system.

Dimensions and Weight

Item	Details
Deminsions	336.4 x 284.5 x 32 mm (with ID)-34.5 mm
Weight	2.84kg(6.26 lbs) 15°® SXGA+, 8-cell Li-Ion Battery / DVD burner (With ID)

Environmental Requirements

Item	Specification
Temperature	
Operating	0°C ~ +40°C
Non-operating	-20 ~ +65°C (storage package)
Humidity	
Operating	20% ~ 80% without condensation
Altitude	Operating sea level 0 to 10,000ft
	Storage sea level 0 to 40,000ft

TOSHIBA			
Model Name	MK4025GAS ,KA100A, 40GB	MK6025GAS 60GB	MK8025GAS, 8MB, 80GB
Data Storage Physical			
Per drive, formatted	40.007GB	60.0116GB	80.012GB
Data Heads	2	4	4
Number of Disks	1	2	2
Logical Configuration			
Heads	16	16	16
Cylinders	16,383	16,383	16,383
User Sectors/Track at zone 0	63	63	63
Logical Blocks (LBA)	78,140,160	117,210,240	156,301,488
Data Transfer Rate			
Max transfer rate to host	100MB/sec	100MB/sec	100MB/sec
Seek Time			
Track-to-track	2ms	2ms	2ms
Average	12ms	12ms	12ms
Maximum	22ms	22ms	22ms
Model Name	MK4025GAS ,KA100A, 40GB	MK6025GAS 60GB	MK8025GAS, 8MB, 80GB
Nominal Power Requirements			
Logic	+5V(±5 %)	+5V(±5 %)	+5V(±5 %)
Start	4.7watts	5.0watts	4.7watts
Seeking	2.6watts	2.9watts	2.6watts
Reading/Writing	2.3watts	2.5watts	2.3watts
Idle	0.9watts	1.05watts	0.9watts
Standby	0.25watts	0.25watts	0.25watts
Sleep	0.1watts	0.1watts	0.1watts
Other			
Rotational Speed	4,200rpm	5,400rpm	4,200rpm
Average Latency	7.14ms	5.56ms	7.14ms
Interface	ATA-2/3/4/5/6	ATA-5	ATA-2/3/4/5/6
Buffer	8MB	16MB	8MB
Physical & Environmental Specs			
Dimensions/Weight:			
Height	0.37" (9.5mm)	0.37" (9.5mm)	0.37"(9.5mm)
Width	2.75" (69.85mm)	2.75" (69.85mm)	2.75" (69.85mm)
Depth	3.94" (100mm)	3.94" (100mm)	3.94"(100mm)
Weight	3.35 oz (94g)	3.56 oz (101g)	3.49 oz (99g)
Ambient Temperature:			
Operating	41° - 131° F (5 to 55° C)	41° - 131° F (5 to 55° C)	41° - 131° F (5 to 55° C)

Non-Operating	-4° - 140° F (-20 to 60° C)	-4° - 140° F (-20 to 60° C)	-4° - 140° F (-20 to 60° C)
Shipping	-40° - 158° F (-40 to 70° C)	-40° - 158° F (-40 to 70° C)	-40° - 158° F (-40 to 70° C)
Vibration and Shock			
Operating Vibration	9.8 M/S ² (1.0G), 5 - 500 Hz	9.8 M/S ² (1.0G), 5 - 500 Hz	9.8 M/S ² (1.0G), 5 - 500 Hz
Operating Shock	200g	200g	200g
Non-Operating Shock	800g	800g	800g
Reliability Characteristics			
Error Rates			
Non-recoverable	1 in 10 ¹³ bits	1 in 10 ¹³ bits	1 in 10 ¹³ bits
Seek	1 in 10 ⁶ seeks	1 in 10 ⁶ seeks	1 in 10 ⁶ seeks
Other			
Preventive Maintenance	None	None	None
MTTF (Power on hours)	300,000	300,000	300,000
Product Life	5 years or 20,000 power ON hours	5 years or 20,000 power ON hours	5 years or 20,000 power ON hours

HGST				
Model Name	Moraga+ HTS424040M9AT0 0 13G1132, 40GB, 4200rpm	Moraga IC25N060ATMR04-0 08K0634, 60GB, 4200rpm	Moraga IC25N080ATMR04-0 08K635 80GB, 4200rpm	Moraga HTS541060G9AT0 0, 60GB, 5400rpm
Configuration				
Interface	ATA-6	ATA-6	ATA-6	ATA-6
Capacity (GB) ¹	40	60	80	60
Sector size (bytes)	512	512	512	512
Recording zones	16	16	16	16
Data heads (physical)	2	3	4	3
Data disks	1	2	2	2
Max. areal density (Gbits/sq.inch)	70	70	70	70
Performance				
Data buffer (MB)	2	8	8	8
Rotational speed (RPM)	4,200	4,200	4,200	5,400
Latency average (ms)	7.1	7.1	7.1	5.5
Media transfer rate (Mbits/sec, max)	350	350	350	493
Interface transfer rate (MB/sec, max)	100MB/sec Ultra DMA mode-5	100MB/sec Ultra DMA mode-5	100MB/sec Ultra DMA mode-5	100 Ultra DMA mode-5
Seek time (read, typical)				
Average (ms)	12	12	12	12
Track to track (ms)	2.5	2.5	2.5	2.5
Full track (ms)	23	23	23	23
Power				
Requirement	+5VDC(±5 %)	+5VDC(±5 %)	+5VDC(±5 %)	+5VDC(±5 %)
Dissipation Startup current (peak, max.)	4.7 W	4.7 W	4.7 W	5.0W
Seek (avg.)	2.3 W	2.3 W	2.3 W	NA
Read (avg.)	2.1 W	2.1 W	2.1 W	2.0W
Write (avg.)	2.2 W	2.2 W	2.2 W	2.0W
Performance idle (avg.)	1.85 W	1.85 W	1.85 W	NA
Active idle (avg.)	0.85 W	0.85 W	0.85 W	0.85W
Low power idle (avg.)	0.65 W	0.65 W	0.65 W	0.60W
Standby (avg.)	0.25 W	0.25 W	0.25 W	0.2W
Sleep	0.1 W	0.1 W	0.1 W	0.1W

HGST				
Power consump. efficiency index (W/GB)	0.016	0.011	0.008	NA
Physical size				
Height (mm)	9.5	9.5	9.5	9.5
Width (mm)	70	70	70	70
Depth (mm)	100	100	100	100
Weight - typical (g)	95	99	99	102
Environmental characteristics				
Operating				
Ambient temperature	5° to 55° C	5° to 55° C	5° to 55° C	5° to 55° C
Relative humidity (non-condensing)	8% - 90%	8% - 90%	8% - 90%	NA
Maximum wet bulb (non-condensing)	29.4° C	29.4° C	29.4° C	NA
Shock (half sine wave)	200G/2ms	200G/2ms	200G/2ms	300 G / 2ms, 160G / 1ms
Vibration (random (RMS))	0.67 G (5 - 500 Hz)	0.67 G (5 - 500 Hz)	0.67 G (5 - 500 Hz)	NA
Swept sine	1 G 0 - P (5 - 500 Hz)	1 G 0 - P (5 - 500 Hz)	1 G 0 - P (5 - 500 Hz)	NA
Non-operating				
Ambient temp	-40° to 65° C	-40° to 65° C	-40° to 65° C	-40° to 65° C
Relative humidity (non-condensing)	5% - 95%	5% - 95%	5% - 95%	NA
Maximum wet bulb (non-condensing)	40° C	40° C	40° C	NA
Shock (half sine wave)	800Gs/1ms	800Gs/1ms	800Gs/1ms	1000 G / 1 ms
Vibration (random (RMS))	3.01 G (5 - 500 Hz)	3.01 G (5 - 500 Hz)	3.01 G (5 - 500 Hz)	NA
Acoustics (A-Weighted Sound Power (Bels))				
Idle (typ.)	2.0	2.3	2.3	2.5
Op (typ.)	2.4	2.7	2.7	2.7
Idle (max.)	2.3	2.6	2.6	NA
Op (max.)	2.6	2.9	2.9	NA

System Utilities

BIOS Setup Utility

The BIOS Setup Utility is a hardware configuration program built into your computer's BIOS (Basic Input/Output System).

Your computer is already properly configured and optimized, and you do not need to run this utility. However, if you encounter configuration problems, you may need to run Setup. Please also refer to Chapter 4 Troubleshooting when problem arises.

To activate the BIOS Utility, press **F2** during POST (when "Press <F2> to enter "Setup" message is prompted on the bottom of screen).

The setup screen displays BIOS as follows: Navigating the BIOS Utility

Function	Item
Information	Display the system informations
Main	Allows the user to specify standard IBM PC AT system parameters
Advanced	Provides advanced settings of the system
Security	Provides security settings of the system
Boot	Allows the user to specify the boot options
Exit	Allows the user to save CMOS setting and exit Setup

During setup, all Fn function keys and power saving functions are disabled.

There are five menu options: Main, Advanced, Security, Boot and Exit.

Buttons

Application Launch Buttons

Launch Keys	Description
Launch Button P	<Launch manager>
Launch Button e	<Launch eManager>
Specific Keys	
Wireless Button	Wireless enable/disable
E-mail Button	Launch Outlook Express
Bluetooth Button	Enable/disable bluetooth
Internet Button	Launch Internet Explorer

NOTE: Detail description and definition of application Launch Buttons, please reference the External spec.

Power Button

The activity of the power button is as follows:

- If power button is pressed for less than 1 second then nothing happens.
- If power button is pressed for more than 1 second but less than 4 seconds then system would execute User Requested OFF before the system entered into OS.
- If power button is pressed for more than 4 seconds then the notebook will be powered off by power button over-ride feature.
- If OS is running in ACPI mode, the power button acts as the sleep button, and let OS controls the policy of power button which is defined in Power Option under the OS.

Power Button Over-ride

Holding down the Power Button for 4 seconds will cause an unconditional transfer to the Off state without notifying the operating system.

If press power button for less than 4 seconds, the system will enter suspend to RAM or OFF state according to OS power option setting.

Lid Switch

This section describes the expected behavior of the system when the lid is opened or closed by the user.

If the system is running under legacy mode:

- Closing the lid will turn off LCD backlight.

If the system is running under ACPI mode:

- The operating system will determine what action to take when the lid is closed. (Windows does not define Lid Open action in Power Option control panel)
- The function of lid close will follow the OS setting in power management (Nothing, standby, Hibernate or Power off). However, if the setting is nothing, the backlight must still be turned off when the lid is closed.
- Lid Open action does not resume the system from S3, S4, and S5.

Hard Disk Password Function/ Password on boot function

This feature allows the user to set the password to prevent any unauthorized access to the internal hard disk.

- If the original HDD come from other machine with password protected, the system just show " Enter HDD password []"

User is required to enter HDD password when system boot up.

- If user enter the wrong password, it will pop out message "Setup Warning, Invalid Passwrod".....
- If the password is correct, system will continue to boot up into OS.
- "Password on boot"
 - Password on boot is "Disabled", the system will NOT POP any password prompt windows during POST.
 - If Password on boot is set to "Enabled" , the system will POP "Enter password" prompt windows during POST. No matter the user key in "Supervisor Password" or "User Password", the system will be unlocked.

Valid Password Characters

Valid Password Characters:

Symbol Character	Symbol Name
A-Z	Alphabets A through Z (Not Case Sensitive)
0-9	Numerical Characters
-	Dash
=	Equal Sign
[Left Bracket
]	Right Bracket
.	Period
,	Comma
;	Semi-Colon
/	Slash
\	Back-slash

Information

Insyde Software SCU		May 20, 2003 5:40:09 AM		
Main	Advanced	Security	Boot	Exit
<div style="display: flex; justify-content: space-between;"> <div style="border: 2px solid blue; padding: 5px; width: 45%;"> <p>-----Devices-----</p> <p>Product Name = TravelMate 4150</p> <p>Manufacture Name = Acer</p> <p>BIOS Version = V1.00</p> <p>VGA Version = 3104</p> <p>HDD Model Name = HITACHI_DK23EA-40-(PM)</p> <p>HDD Serial Number = 123456789</p> <p>ATAPI Model Name = UJDA740 DVD/CDROM-(SM)</p> <p>Serial Number = (32 bytes)</p> <p>Asset Tag Number = (32 bytes)</p> <p>UUID = (16 bytes)</p> </div> <div style="border: 2px solid blue; padding: 5px; width: 45%;"> <p>-----System-----</p> <p>CPU = Intel® Pentium ® 4</p> <p>CPU speed = 2.0 GHz</p> <p>L2 Cache = 2048 KB</p> <p>-----Memory-----</p> <p>System Memory = 640 KB</p> <p>Extended Memory = 256MB</p> <p>VGA Memory = 128 MB</p> </div> </div>				
<p>Setup system date, time. Enable boot logo and get system information.</p>				

Parameter	Description
Product Name	This field will show the product name
Manufacture Name	This field will show manufacturer name
BIOS Version	This field reports the BIOS version of system
VGA Version	This field reports the VGA version of the system
HDD Model Name	This item will show the Model name of HDD installed on Primary IDE master. The hard disk model name is automatically detected by the system. If there is no hard disk present or unknown type, "None" should be shown on the field.
HDD Serial Number	This item will show the Serial number of HDD installed on Primary IDE master. If no Hard disk or other devices are installed on Primary IDE master, then it will display a blank line
ATAPI Model Name	This field shows the ATAPI Model Name for you
Serial Number	This item will show the Serial number of system
Asset Tag	This item will show the Asset Tag number of the system
UUID	This will be visible only when there is an internal LAN device present
System Memory	This field reports the memory size of system base memory. The size is fixed to 640KB.
Extended Memory	This field reports the memory size of the extended memory in the system. Extended Memory size = Total memory size - 1 MB

Parameter	Description
Video Memory	VGA Memory size : Discrete = 64 or 128MB (depends on actual VRAM size) TurboCache = 32MB (actual TurboCache VRAM size) Intel 915 DVMT: selectable between the following: <ol style="list-style-type: none"><li data-bbox="586 348 1075 379">1. 64MB (8MB pre-allocated + 56MB DVMT)<li data-bbox="586 389 1268 449">2. 128MB (8MB pre-allocated + 128DVMT). This is the default value.<li data-bbox="586 459 1253 520">3. Max DVMT (160MB on 256MB system memory, 224MB on 512MB and above system memory).

Main

This menu provides you the information of the system.

Insyde Software SCU		May 20, 2003 5:40:09 AM		
Main	Advanced	Security	Boot	Exit
Date and Time				
v Quiet Boot				
v LCD Auto DIM				
_ Network Boot				
_ F12 Boot Menu				
v D2D Recovery				
<p>Enable or disable the F12 key for Boot Menu during POST <Space> for select</p>				

Parameter	Description
Date and Time	The hours are displayed with 24 hours format. The values set in these two fields take effect immediately.
Quiet Boot	Customer Logo display will be shown during POST when it is selected.
LCD Auto DIM	Enabled: LCD brightness will automatically lower to save more power when AC is not present. Disabled: LCD brightness will NOT automatically lower to save more power when AC is not present.
Network Boot	When this is selected, Boot from LAN feature is enabled. When this is not selected, Boot from LAN feature is then disabled
F12 Boot Menu	When this is selected, users can modify device boot priority by pressing <F12> key during POST. When this is not selected, device boot priority will not be adjustable during POST
D2D Recovery	Allow user to enable/disable the Disk-to-Disk recovery Enabled: Enable D2D Recovery/eRecovery Disabled: Disable D2D Recovery/eRecovery Help note: Enable Acer disc-to-disc system recovery via Alt+F10 key during POST. Options: Enable or Disable

Advanced

The Advanced screen contains parameters involving your hardware devices. It also provides advanced settings of the system.

Insyde Software SCU		May 20, 2003 5:40:09 AM		
Main	Advanced	Security	Boot	Exit
	Infrared Port (FIR)	<div style="border: 1px solid black; padding: 5px;"> <p style="text-align: center;">-----FIR Ports-----</p> <div style="display: flex; justify-content: space-between;"> <div style="border: 1px solid black; padding: 5px; width: 45%;"> <p>-----FIR I/O settings---</p> <input type="checkbox"/> Disabled <input type="checkbox"/> COM1,3F8,IRQ4 <input checked="" type="checkbox"/> COM2,2F8,IRQ3 <input type="checkbox"/> COM3,3E8,IRQ4 <input type="checkbox"/> COM4,2E8,IRQ3 </div> <div style="border: 1px solid black; padding: 5px; width: 45%;"> <p>-Mode Setting for IRDA-</p> <input type="checkbox"/> Normal (16550) <input type="checkbox"/> IrDA (HPSIR) <input type="checkbox"/> ASK IR <input checked="" type="checkbox"/> FAST IR </div> </div> <div style="border: 1px solid black; padding: 5px; width: 45%; margin-top: 10px;"> <p>DMA Setting For FIR</p> <input type="checkbox"/> DMA1 <input checked="" type="checkbox"/> DMA2 <input type="checkbox"/> DMA3 </div> </div>		
	∨ Legacy USB Support			
<div style="display: flex; justify-content: center; gap: 20px;"> OK Cancel </div>				
<p><Tab> <Right> <Left> for block select. <Up> <Down> for item select. <Enter> for accept. <Cancel> <Esc> for reject. <Alt> activates accelerators. <Space> for Enable or Disable.</p>				

Insyde Software SCU		May 20, 2003 5:40:09 AM		
Main	Advanced	Security	Boot	Exit
	Infrared Port (FIR)			
	∨ Legacy USB support			
<p>Legacy USB keyboard, Floppy Drive, USB Mouse Support <Space> for Enable or Disable</p>				

The table below describes the parameters in the screen. Settings in **boldface** are the default and suggested parameter settings.

	Description	Option
Infrared Port (FIR)		
FIR I/O Settings	Sets the base I/O address and IRQ for Infrared port.	Disabled COM1, 3F8, IRQ4 COM2, 2F8, IRQ3 COM3, 3E8, IRQ4 COM4, 2E8, IRQ3
DMA Setting for Fast IR	Sets a DMA channel for the printer to operate in ECP mode. This parameter is enabled only if Mode is set to ECP	DMA1, DMA2 , DMA3
Mode Setting for IrDA	Normak (16550), IrDA (HPSIR), ASK IR, FAST IR	
Legacy USB Support		
Legacy USB Support	Disabled: Disable support for Legacy Universal Serial Bus. Enabled: Enable support for Legacy Universal Serial Bus.	

Security

The Security screen contains parameters that help safeguard and protect your computer from unauthorized use.

Insyde Software SCU		May 20, 2003 5:40:09 AM	
Main	Advanced	Security	Boot
			Exit
	Set User Password		
	Set Supervisor Password		
	_ Lock HardDisk Drive		
		-----Set Supervisor password-----	
		Enter old Supervisor password:	
		Enter new Supervisor Password:	
		Verify new Supervisor Password:	
		[] Boot System	
		OK	Cancel

Enter new password. Password will NOT be displayed

If password on boot is required, the password must be set otherwise it cannot be enabled.

The formats of the password are as follows:

- Length 10 characters
- Characters Alphanumeric keys only. The shift status i.e. Ctrl, Shift, Alt and Capital are ignored.

The table below describes the parameters in this screen. Settings in **boldface** are the default and suggested parameter settings.

Parameter	Description
Set User Password	Defines whether a password is required or not while the events defined in this group happened. The following sub-options are all requires the Supervisor password for changes and should be grayed out if the user password was used to enter setup. When you set Supervisor password already and then you reboot and into BIOS setup manual by User password, the set Supervisor password, Boot device and Lock Hard Drive will be disable. Allows the user to specify whether or not a password is required to boot.
Set Supervisor Password	
Lock Hard Disk Drive	Set the password to lock the hard disk drive

Boot

This menu allows the user to decide the order of boot devices to load the operating system. Bootable devices includes the distette drive in module bay, the onboard hard disk drive and the CD-ROM in module bay and onboard LAN device.

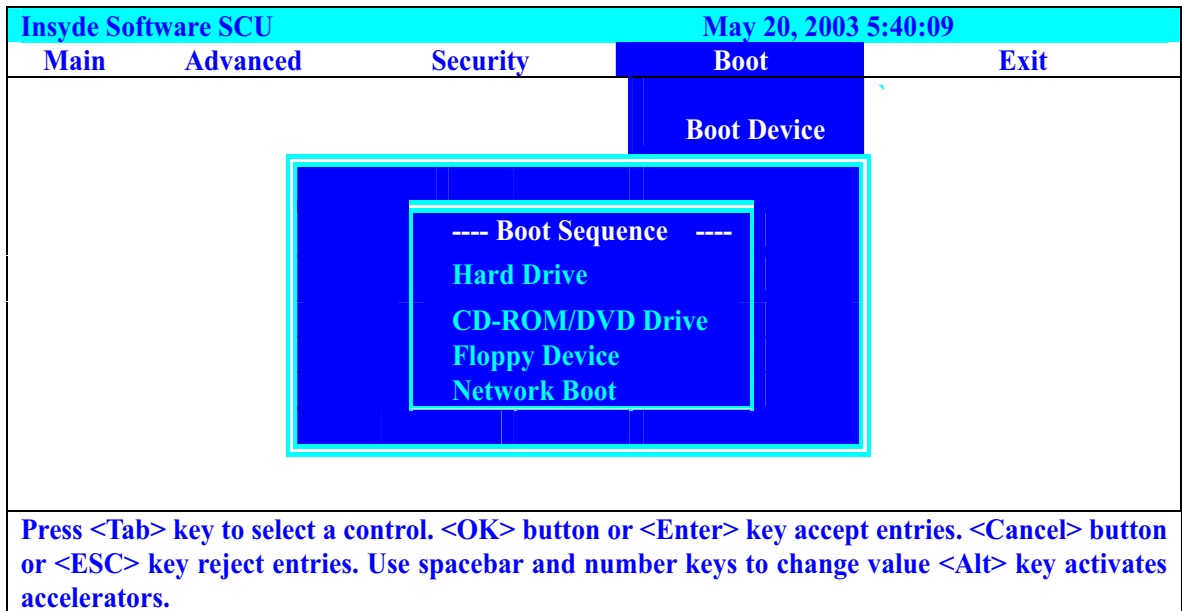

Default boot sequence should be the following:

1. Hard Drive
2. CD-ROM/DVD Drive
3. Floppy Drive
4. Network Boot (since only 3 items are available, if above 3 items are invalid, a boot menu should be shown when boot.)

Exit

The Exit screen contains parameters that help safeguard and protect your computer from unauthorized use.

Insyde Software SCU				Nov 26, 2003 5:40:09	
Main	Advanced	Security	Boot	Exit	
<div style="border: 2px solid cyan; padding: 10px; text-align: center;"> <p>-----Exit Saving Changes-----</p> <p>Press <OK> to save the current Setup parameters to CMOS RAM.</p> <p>The system will reboot!!!</p> <p><input type="button" value="OK"/> <input type="button" value="Cancel"/></p> </div>				Exit Saving Changes	
				Exit Discarding Changes	
				Load Setup Defaults	
				Discard Changes	
<p><Tab> <Right> <Left> for block select. <Up> <Down> for item select. <Enter> for accept. <Cancel> <Esc> for reject. <Alt> activates accelerators. <Space> for Enable or Disable.</p>					

Insyde Software SCU				May 20, 2003 5:40:09	
Main	Advanced	Security	Boot	Exit	
<div style="border: 2px solid cyan; padding: 10px; text-align: center;"> <p>-----Exit Discarding Changes-----</p> <p>Press <OK> to Exit the SCU.</p> <p>The current settings will not be saved!!!</p> <p><input type="button" value="OK"/> <input type="button" value="Cancel"/></p> </div>				Exit Saving Changes	
				Exit Discarding Changes	
				Load Setup Defaults	
				Discard Changes	
<p><Tab> <Right> <Left> for block select. <Up> <Down> for item select. <Enter> for accept. <Cancel> <Esc> for reject. <Alt> activates accelerators. <Space> for Enable or Disable.</p>					

Insyde Software SCU				May 20, 2003 5:40:09
Main	Advanced	Security	Boot	Exit
<div style="border: 2px solid cyan; padding: 10px; text-align: center;"> <p>-----Load Setup Default-----</p> <p>Do you wish to change the current setup to the system default values?</p> <p>OK Cancel</p> </div>				Exit Saving Changes
				Exit Discarding Changes
				Load Setup Defaults
				Discard Changes
<p><Tab> <Right> <Left> for block select. <Up> <Down> for item select. <Enter> for accept. <Cancel> <Esc> for reject. <Alt> activates accelerators. <Space> for Enable or Disable.</p>				

Insyde Software SCU				May 20, 2003 5:40:09
Main	Advanced	Security	Boot	Exit
<div style="border: 2px solid cyan; padding: 10px; text-align: center;"> <p>-----Discard Changes-----</p> <p>Do you wish to restore the current setup to the original custom values?</p> <p>OK Cancel</p> </div>				Exit Saving Changes
				Exit Discarding Changes
				Load Setup Defaults
				Discard Changed
<p><Tab> <Right> <Left> for block select. <Up> <Down> for item select. <Enter> for accept. <Cancel> <Esc> for reject. <Alt> activates accelerators. <Space> for Enable or Disable.</p>				

Machine Disassembly and Replacement

This chapter contains step-by-step procedures on how to disassemble the notebook computer for maintenance and troubleshooting.

To disassemble the computer, you need the following tools:

- Wrist grounding strap and conductive mat for preventing electrostatic discharge
- Small Philips screw driver
- Philips screwdriver
- Plastic flat head screw driver
- Tweezers

NOTE: The screws for the different components vary in size. During the disassembly process, group the screws with the corresponding components to avoid mismatch when putting back the components. When you remove the stripe cover, please be careful not to scrape the cover.

General Information

Before You Begin

Before proceeding with the disassembly procedure, make sure that you do the following:

1. Turn off the power to the system and all peripherals.
2. Unplug the AC adapter and all power and signal cables from the system.
3. Remove the battery pack.

NOTE: The screws used to secure bottom case and upper case are more than one type. Please group same type of screw together as you disassemble the system for service purpose. The image below is for your reference. Please pay attention to the explanation below.

Removing the Battery Pack

1. Unlock the battery lock.
2. Slide the battery latch as shown then remove the battery pack.



Removing the HDD and ODD Module

1. Remove the one screw holding the HDD cover.
2. Detach the HDD module then remove it.
3. Press the latch and detach the ODD module from the system.



Removing the RAM

1. Remove the one screw that secure the RAM door and remove it away.
2. Pop up the memory then remove it.



Removing the Keyboard

1. Pull the strip cover.
2. Remove the two screws to release the keyboard. Pull the keyboard forward and turn it over.
3. Release the tab to disconnect the FFC then take the entire keyboard out from the system



4. Remove the one screw to release the power switch board from the system.
5. Detach the power switch board.



Removing the Wireless and LCD Panel

1. Disconnect the one Antenna cable from the Wireless board.
2. Disconnect the LED cable with the flat screw driver from the VGA board.

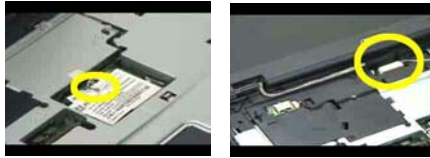

3. Remove the two screws located on the bottom side to detach the LED panel.
4. Remove another two screws located on top cover to detach the LED Panel.
5. Detach the LED panel out from the system.



Removing the Thermal and Bluetooth Module

1. Remove the two screws to detach the thermal door
2. Disconnect the bluetooth cable from the bluetooth module
3. Remove the one screw to release the bluetooth module
4. Detach the bluetooth module out from the thermal door



Removing the Upper Case

1. Remove the 3 screws located on the upper side to detach the upper case
2. Remove another 17 screws located on the bottom side to detach the upper case



3. Disconnect the microphone cable from the mainboard.



4. Disconnect the DVI cable from the mainboard.



5. Detach the upper case to the system
6. Pull the upper case forward



7. Release both side tabs to disconnect the touchpad board cable from the mainboard



Removing the Touchpad

1. Disconnect the touchpad cable from the touchpad board
2. Remove the two screws to loosen the touchpad board



3. Push forward to detach the touchpad support plate
4. Remove the two screws to loosen the touchpad support plate
5. Detach the support plate from here
6. Disconnect the touchpad cable from the trace board
7. Detach the trace board from here



Removing the FAN

1. Disconnect the system fan cable
2. Remove the two screws to release the system fan from here
3. Detach the system fan out from the system



Removing the Thermal Module and CPU

1. Remove the 4 screws to release the CPU thermal module accordingly
2. Detach the CPU thermal module out from the system



3. Detach the VGA board out from the system
4. Remove the 3 screws to release the VGA thermal module
5. Separate the thermal module from the VGA board



6. Anit-clockwise the direction with a flat screw driver to loosen the CPU
7. Detach the CPU out from the system

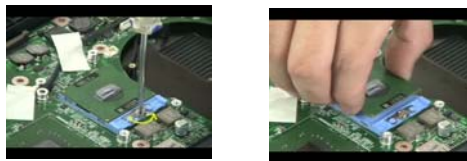

Removing the MDC

1. Disconnect the MDC cable from the mainboard
2. Remove the two screws to loosen the DMC board
3. Detach the MDC from the system
4. Disconnect the MDC cable from the MDC board

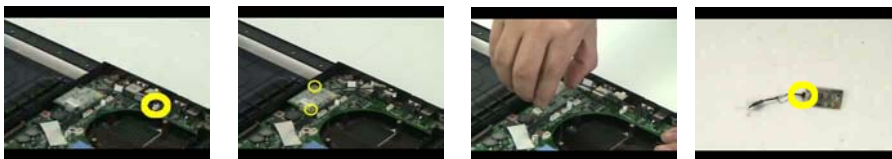

Removing the Wireless, Speaker and PCMCIA

1. Pop up the tabs on both side to take the Wilreless out from here

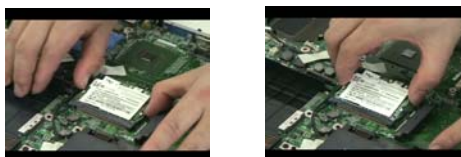

-
2. Remove the one screw located on each speaker then detach the speakers out from the system



3. Press down the button to release the PCMCIA dummy card then pull the dummy card out from the system



4. Remove the one screw to loosen the mainboard
5. Push outward of the side before releasing the mainboard out from the chassis



Removing the LCD Panel

1. Detach the upper LCD rubbers
2. Detach the LCD mylars from the lower side



3. Detach the front bezel out from the LCD module
4. Disconnect the LCD power cable from here
5. Disconnect the LCD coaxial cable from here

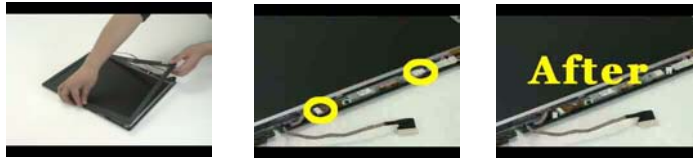

6. Detach the inverter board out from the position
7. Remove the one screw on each side to detach the LCD panel from the case
8. Lift up the panel then take it out from the case



9. Remove the one screw on each side to detach the antenna from the case
10. Gently to tear the tabs that fasten the antenna cables from the case
11. Then detach the antenna cables from the case



12. Remove the four screws on this side to detach the left bracket
13. Remove the four screws on another side to detach the bracke



14. Tear the tab before you disconnect the LCD wire
15. Take the LCD wire from here



Removing the HDD and ODD

1. Remove the two screws on each side
2. Detach the HDD bracket from the HDD unit



3. Remove the two screws located on both side to detach the ODD unit from bracket
4. Push backward to release the ODD bracket from the ODD unit



5. Remove the two screws to release ODD board from the rear of the ODD unit
6. Detach the ODD board from the rear side of ODD



Troubleshooting

Use the following procedure as a guide for computer problems.

NOTE: The diagnostic tests are intended to test only Acer products. Non-Acer products, prototype cards, or modified options can give false errors and invalid system responses.

1. Obtain the failing symptoms in as much detail as possible.
2. Verify the symptoms by attempting to re-create the failure by running the diagnostic test or by repeating the same operation.

System Check Procedures

External Diskette Drive Check

Do the following to isolate the problem to a controller, driver, or diskette. A write-enabled, diagnostic diskette is required.

NOTE: Make sure that the diskette does not have more than one label attached to it. Multiple labels can cause damage to the drive or cause the drive to fail.

Do the following to select the test device.

1. Boot from the diagnostics diskette and start the diagnostics program.
2. See if FDD Test is passed as the program runs to FDD Test.
3. Follow the instructions in the message window.

If an error occurs with the internal diskette drive, reconnect the diskette connector on the system board.

If the error still remains:

1. Reconnect the external diskette drive/DVD-ROM module.
2. Replace the external diskette drive/CD-ROM module.
3. Replace the main board.

External CD-ROM Drive Check

Do the following to isolate the problem to a controller, drive, or CD-ROM. Make sure that the CD-ROM does not have any label attached to it. The label can cause damage to the drive or can cause the drive to fail.

Do the following to select the test device:

1. Boot from the diagnostics diskette and start the diagnostics program.
2. See if CD-ROM Test is passed when the program runs to CD-ROM Test.
3. Follow the instructions in the message window.

If an error occurs, reconnect the connector on the System board. If the error still remains:

1. Reconnect the external diskette drive/CD-ROM module.
2. Replace the external diskette drive/CD-ROM module.
3. Replace the main board.

Keyboard or Auxiliary Input Device Check

Remove the external keyboard if the internal keyboard is to be tested.

If the internal keyboard does not work or an unexpected character appears, make sure that the flexible cable extending from the keyboard is correctly seated in the connector on the system board.

If the keyboard cable connection is correct, run the Keyboard Test.

If the tests detect a keyboard problem, do the following one at a time to correct the problem. Do not replace a non-defective FRU:

1. Reconnect the keyboard cables.
2. Replace the keyboard.
3. Replace the main board.

The following auxiliary input devices are supported by this computer:

- Numeric keypad
- External keyboard

If any of these devices do not work, reconnect the cable connector and repeat the failing operation.

Memory check

Memory errors might stop system operations, show error messages on the screen, or hang the system.

1. Boot from the diagnostics diskette and start the doagmpstotics program (please refer to main board).
2. Go to the diagnostic memory in the test items.
3. Press F2 in the test items.
4. Follow the instructions in the message window.

NOTE: Make sure that the DIMM is fully installed into the connector. A loose connection can cause an error.

Power System Check

To verify the symptom of the problem, power on the computer using each of the following power sources:

1. Remove the battery pack.
2. Connect the power adapter and check that power is supplied.
3. Disconnect the power adapter and install the charged battery pack; then check that power is supplied by the battery pack.

If you suspect a power problem, see the appropriate power supply check in the following list:

- "Check the Power Adapter" on page 69
- "Check the Battery Pack" on page 70

Check the Power Adapter

Unplug the power adapter cable from the computer and measure the output voltage at the plug of the power adapter cable. See the following figure

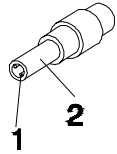

Pin 1: +19 to +20.5V
Pin 2: 0V, Ground

1. If the voltage is not correct, replace the power adapter.
2. If the voltage is within the range, do the following:
 - Replace the System board.
 - If the problem is not corrected, see “Undetermined Problems” on page 80.
 - If the voltage is not correct, go to the next step.

NOTE: An audible noise from the power adapter does not always indicate a defect.

3. If the power-on indicator does not light up, check the power cord of the power adapter for correct continuity and installation.
4. If the operational charge does not work, see “Check the Battery Pack” on page 70.

Check the Battery Pack

To check the battery pack, do the following:

From Software:

1. Check out the Power Management in control Panel
2. In Power Meter, confirm that if the parameters shown in the screen for Current Power Source and Total Battery Power Remaining are correct.
3. Repeat the steps 1 and 2, for both battery and adapter.
4. This helps you identify first the problem is on recharging or discharging.

From Hardware:

1. Power off the computer.
2. Remove the battery pack and measure the voltage between battery terminals 1(+) and 6(ground). See the following figure

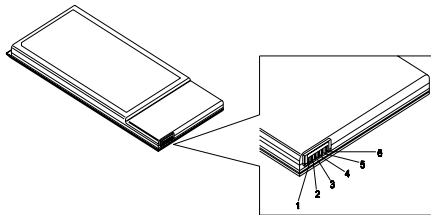

3. If the voltage is still less than 7.5 Vdc after recharging, replace the battery.

To check the battery charge operation, use a discharged battery pack or a battery pack that has less than 50% of the total power remaining when installed in the computer.

If the battery status indicator does not light up, remove the battery pack and let it return to room temperature. Re-install the battery pack.

If the charge indicator still does not light up, replace the battery pack. If the charge indicator still does not light up, replace the DC/DC charger board.

Touchpad Check

If the touchpad doesn't work, do the following actions one at a time to correct the problem. Do not replace a non-defective FRU:

1. Reconnect the touchpad cables.
2. Replace the touchpad.
3. Replace the system board.

After you use the touchpad, the pointer drifts on the screen for a short time. This self-acting pointer movement can occur when a slight, steady pressure is applied to the touchpad pointer. This symptom is not a hardware problem. No service actions are necessary if the pointer movement stops in a short period of time.

Power-On Self-Test (POST) Error Message

The POST error message index lists the error message and their possible causes. The most likely cause is listed first.

NOTE: Perform the FRU replacement or actions in the sequence shown in FRU/Action column, if the FRU replacement does not solve the problem, put the original part back in the computer. Do not replace a non-defective FRU.

This index can also help you determine the next possible FRU to be replaced when servicing a computer.

If the symptom is not listed, see “Undetermined Problems” on page 80.

The following lists the error messages that the BIOS displays on the screen and the error symptoms classified by function.

NOTE: Most of the error messages occur during POST. Some of them display information about a hardware device, e.g., the amount of memory installed. Others may indicate a problem with a device, such as the way it has been configured.

NOTE: If the system fails after you make changes in the BIOS Setup Utility menus, reset the computer, enter Setup and install Setup defaults or correct the error.

Index of Error Messages

Error Code List

Error Codes	Error Messages
006	Equipment Configuration Error Causes: 1. CPU BIOS Update Code Mismatch 2. IDE Primary Channel Master Drive Error (The causes will be shown before "Equipment Configuration Error")
010	Memory Error at xxxx:xxx:xxxh (R:xxxh, W:xxxh)
070	Real Time Clock Error
071	CMOS Battery Bad
072	CMOS Checksum Error
110	System disabled. Incorrect password is specified.
<No error code>	Battery critical LOW In this situation BIOS will issue 4 short beeps then shut down system, no message will show.
<No error code>	Thermal critical High In this situation BIOS will shut down system, not show message.

Error Message List

Error Messages	FRU/Action in Sequence
Failure Fixed Disk	Reconnect hard disk drive connector. "Load Default Settings" in BIOS Setup Utility. Hard disk drive System board
Stuck Key	see "Keyboard or Auxiliary Input Device Check" on page 67.
Keyboard error	see "Keyboard or Auxiliary Input Device Check" on page 67.
Keyboard Controller Failed	see "Keyboard or Auxiliary Input Device Check" on page 67.
Keyboard locked - Unlock key switch	Unlock external keyboard
Monitor type does not match CMOS - Run Setup	Run "Load Default Settings" in BIOS Setup Utility.
Shadow RAM Failed at offset: nnnn	BIOS ROM System board
System RAM Failed at offset: nnnn	DIMM System board
Extended RAM Failed at offset: nnnn	DIMM System board
System battery is dead - Replace and run Setup	Replace RTC battery and Run BIOS Setup Utility to reconfigure system time, then reboot system.
System CMOS checksum bad - Default configuration used	RTC battery Run BIOS Setup Utility to reconfigure system time, then reboot system.
System timer error	RTC battery Run BIOS Setup Utility to reconfigure system time, then reboot system. System board

Error Message List

Error Messages	FRU/Action in Sequence
Real time clock error	RTC battery Run BIOS Setup Utility to reconfigure system time, then reboot system. System board
Previous boot incomplete - Default configuration used	Run "Load Default Settings" in BIOS Setup Utility. RTC battery System board
Memory size found by POST differed from CMOS	Run "Load Default Settings" in BIOS Setup Utility. DIMM System board
Diskette drive A error	Check the drive is defined with the proper diskette type in BIOS Setup Utility See "External Diskette Drive Check" on page 67.
Incorrect Drive A type - run SETUP	Check the drive is defined with the proper diskette type in BIOS Setup Utility
System cache error - Cache disabled	System board
CPU ID:	System board
DMA Test Failed	DIMM System board
Software NMI Failed	DIMM System board
Fail-Safe Timer NMI Failed	DIMM System board
Device Address Conflict	Run "Load Default Settings" in BIOS Setup Utility. RTC battery System board
Allocation Error for device	Run "Load Default Settings" in BIOS Setup Utility. RTC battery System board
Failing Bits: nnnn	DIMM BIOS ROM System board
Fixed Disk n	None
Invalid System Configuration Data	BIOS ROM System board
I/O device IRQ conflict	Run "Load Default Settings" in BIOS Setup Utility. RTC battery System board
Operating system not found	Enter Setup and see if fixed disk and drive A: are properly identified. Diskette drive Hard disk drive System board

Error Message List

No beep Error Messages	FRU/Action in Sequence
No beep, power-on indicator turns off and LCD is blank.	Power source (battery pack and power adapter). See "Power System Check" on page 68. Ensure every connector is connected tightly and correctly. Reconnect the DIMM. LED board. System board.
No beep, power-on indicator turns on and LCD is blank.	Power source (battery pack and power adapter). See "Power System Check" on page 68. Reconnect the LCD connector Hard disk drive LCD inverter ID LCD cable LCD Inverter LCD System board
No beep, power-on indicator turns on and LCD is blank. But you can see POST on an external CRT.	Reconnect the LCD connectors LCD inverter ID LCD cable LCD inverter LCD System board
No beep, power-on indicator turns on and a blinking cursor shown on LCD during POST.	Ensure every connector is connected tightly and correctly System board
No beep during POST but system runs correctly.	Speaker System board

POST Code

Code	Beeps	For Boot Block in Flash ROM
E0h		Initialize the chipset
E1h		Initialize the bridge
E2h		Initialize the CPU
E3h		Initialize the system timer
E4h		Initialize system I/O
E5h		Check force recovery boot
E6h		Checksum BIOS ROM
E7h		Go to BIOS
E8h		Set Huge Segment
E9h		Initialize Multi Processor
EAh		Initialize OEM special code
EBh		Initialize PIC and DMA
ECh		Initialize Memory type
EDh		Initialize Memory size
EEh		Shadow Boot Block
EFh		System memory test
F0h		Initialize interrupt vectors
F1h		Initialize Run Time Clock
F2h		Initialize video
F3h		Initialize System Management Mode
F4h	1	Output one beep before boot
F5h		Boot to Mini DOS
F6h		Clear Huge Segment
F7h		Boot to Full DOS

Index of Symptom-to-FRU Error Message

LCD-Related Symptoms

Symptom / Error	Action in Sequence
LCD backlight doesn't work LCD is too dark LCD brightness cannot be adjusted LCD contrast cannot be adjusted	Enter BIOS Utility to execute "Load Setup Default Settings", then reboot system. Reconnect the LCD connectors. Keyboard (if contrast and brightness function key doesn't work). LCD inverter ID LCD cable LCD inverter LCD System board
Unreadable LCD screen Missing pels in characters Abnormal screen Wrong color displayed	Reconnect the LCD connector LCD inverter ID LCD cable LCD inverter LCD System board
LCD has extra horizontal or vertical lines displayed.	LCD inverter ID LCD inverter LCD cable LCD System board

Indicator-Related Symptoms

Symptom / Error	Action in Sequence
Indicator incorrectly remains off or on, but system runs correctly	Reconnect the inverter board Inverter board System board

Power-Related Symptoms

Symptom / Error	Action in Sequence
Power shuts down during operation	Power source (battery pack and power adapter). See "Power System Check" on page 68. Battery pack Power adapter Hard drive & battery connection board System board
The system doesn't power-on.	Power source (battery pack and power adapter). See "Power System Check" on page 68. Battery pack Power adapter Hard drive & battery connection board System board
The system doesn't power-off.	Power source (battery pack and power adapter). See "Power System Check" on page 68. Hold and press the power switch for more than 4 seconds. System board
Battery can't be charged	See "Check the Battery Pack" on page 70. Battery pack System board

PCMCIA-Related Symptoms

Symptom / Error	Action in Sequence
System cannot detect the PC Card (PCMCIA)	PCMCIA slot assembly System board
PCMCIA slot pin is damaged.	PCMCIA slot assembly

Memory-Related Symptoms

Symptom / Error	Action in Sequence
Memory count (size) appears different from actual size.	Enter BIOS Setup Utility to execute "Load Default Settings, then reboot system. DIMM System board

Speaker-Related Symptoms

Symptom / Error	Action in Sequence
In Windows, multimedia programs, no sound comes from the computer.	Audio driver Speaker System board
Internal speakers make noise or emit no sound.	Speaker System board

Power Management-Related Symptoms

Symptom / Error	Action in Sequence
The system will not enter hibernation	Keyboard (if control is from the keyboard) Hard disk drive System board
The system doesn't enter hibernation mode and four short beeps every minute.	See "Hibernation Mode" on page 34. Press Fn+F4 and see if the computer enters hibernation mode. Touchpad Keyboard Hard disk connection board Hard disk drive System board
The system doesn't enter standby mode after closing the LCD	See "Hibernation Mode" on page 34. LCD cover switch System board
The system doesn't resume from hibernation mode.	See "Hibernation Mode" on page 34. Hard disk connection board Hard disk drive System board
The system doesn't resume from standby mode after opening the LCD.	See "Hibernation Mode" on page 34. LCD cover switch System board
Battery fuel gauge in Windows doesn't go higher than 90%.	Remove battery pack and let it cool for 2 hours Refresh battery (continue use battery until power off, then charge battery) Battery pack System board

Power Management-Related Symptoms

Symptom / Error	Action in Sequence
System hangs intermittently.	Reconnect hard disk/CD-ROM drives. Hard disk connection board System board

Peripheral-Related Symptoms

Symptom / Error	Action in Sequence
System configuration does not match the installed devices.	Enter BIOS Setup Utility to execute "Load Default Settings", then reboot system. Reconnect hard disk/CD-ROM/diskette drives.
External display does not work correctly.	Press Fn+F5, LCD/CRT/Both display switching System board
USB does not work correctly	System board
Print problems.	Ensure the "Parallel Port" in the "Onboard Devices Configuration" of BIOS Setup Utility is set to Enabled. Onboard Devices Configuration Run printer self-test. Printer driver Printer cable Printer System Board
Serial or parallel port device problems.	Ensure the "Serial Port" in the Devices Configuration" of BIOS Setup Utility is set to Enabled. Device driver Device cable Device System board

Keyboard/Touchpad-Related Symptoms

Symptom / Error	Action in Sequence
Keyboard (one or more keys) does not work.	Reconnect the keyboard cable. Keyboard System board
Touchpad does not work.	Reconnect touchpad cable. Touchpad board System board

Modem-Related Symptoms

Symptom / Error	Action in Sequence
Internal modem does not work correctly.	Modem phone port modem combo board System board

NOTE: If you cannot find a symptom or an error in this list and the problem remains, see "Undetermined Problems" on page 80.

Intermittent Problems

Intermittent system hang problems can be caused by a variety of reasons that have nothing to do with a hardware defect, such as: cosmic radiation, electrostatic discharge, or software errors. FRU replacement should be considered only when a recurring problem exists.

When analyzing an intermittent problem, do the following:

1. Run the advanced diagnostic test for the system board in loop mode at least 10 times.
2. If no error is detected, do not replace any FRU.
3. If any error is detected, replace the FRU. Rerun the test to verify that there are no more errors.

Undetermined Problems

The diagnostic problems does not identify which adapter or device failed, which installed devices are incorrect, whether a short circuit is suspected, or whether the system is inoperative.

Follow these procedures to isolate the failing FRU (do not isolate non-defective FRU).

NOTE: Verify that all attached devices are supported by the computer.

NOTE: Verify that the power supply being used at the time of the failure is operating correctly. (See “Power System Check” on page 68):

1. Power-off the computer.
2. Visually check them for damage. If any problems are found, replace the FRU.
3. Remove or disconnect all of the following devices:
 - Non-Acer devices
 - Printer, mouse, and other external devices
 - Battery pack
 - Hard disk drive
 - DIMM
 - CD-ROM/Diskette drive Module
 - PC Cards
4. Power-on the computer.
5. Determine if the problem has changed.
6. If the problem does not recur, reconnect the removed devices one at a time until you find the failing FRU.
7. If the problem remains, replace the following FRU one at a time. Do not replace a non-defective FRU:
 - System board
 - LCD assembly

Use NAPP CD to Build Master Hard Disc Drive

CD to Disk Recovery

1. Prepare NAPP CD, Recovery CD and System CD.
2. Put NAPP CD into the optical drive. Then boot up the system.
3. The system will ask you if you want to build NAPP Master HDD. Please press any key to continue.

```
=====
                        The HDD Must bigger then 20GB.
=====

Do you want to build NAPP Master HDD?
press any key to continue or Ctrl-C to exit
_
```

4. NAPP CD will start to preload the system, please click [Y].

```
Acer NAPP Preload Selector for Acer System Version 1.4.0.1
Copyright 2003 Acer Inc.

=====

This will preload your system. Are you sure?[Y,N]?
```

-
5. Select CD to Disk Recovery.

```
Method Selector
=====
1. Disk To Disk Recovery
2. CD to Disk Recovery
X. Quit

Please select your Choose...[1,2,x]?
```

6. Put the Recovery CD to the optical drive. This step is to create image files to the system, you do not have to put the Recovery CD to the optical drive in order. Place one Recovery CD to the drive at one time till you finish all Recovery CDs.

```
Please Insert Any Recovery CD

Please Press Any Key to Continue.
Press any key to continue...
_
```

After you place the Recovery CD to the optical drive, you will see the display below.

```
Please Wait for COPYING .....  
X:\images \70E40101.HDD
```

7. Then insert the System CD to the optical drive.

```
Please Insert the System CD  
  
Please Press Any Key to Continue.  
Press any key to continue...  
_
```

8. You will see the screen displaying "PASS" when the system has built NAPP Master hard disc drive.



Disk to Disk Recovery

1. Prepare NAPP CD, Recovery CD and System CD.
2. Put NAPP CD into the optical drive. Then boot up the system.
3. The system will ask you if you want to build NAPP Master HDD. Please press any key to continue.



4. NAPP CD will start to preload the system, please click [Y].

```
Acer NAPP Preload Selector for Acer System Version 1.4.0.1
Copyright 2003 Acer Inc.

=====

This will preload your system. Are you sure?[Y,N]?
```

- 5. Select Disk to Disk Recovery. Then choose Single Language or Multi-Languages Recovery.
NOTE: For Multi-Languages Recovery, not more than five languages could be loaded to the system.

```
Method Selector
=====
1. Single Language Recovery
2. Multi-Languages Recovery
X. Quit

Please select your Choose...[1,2,x]?
```

- 6. Put the Recovery CD to the optical drive. This step is to create image files to the system, you do not have to put the Recovery CD to the optical drive in order. Place one Recovery CD to the drive at one time till you finish all Recovery CDs.

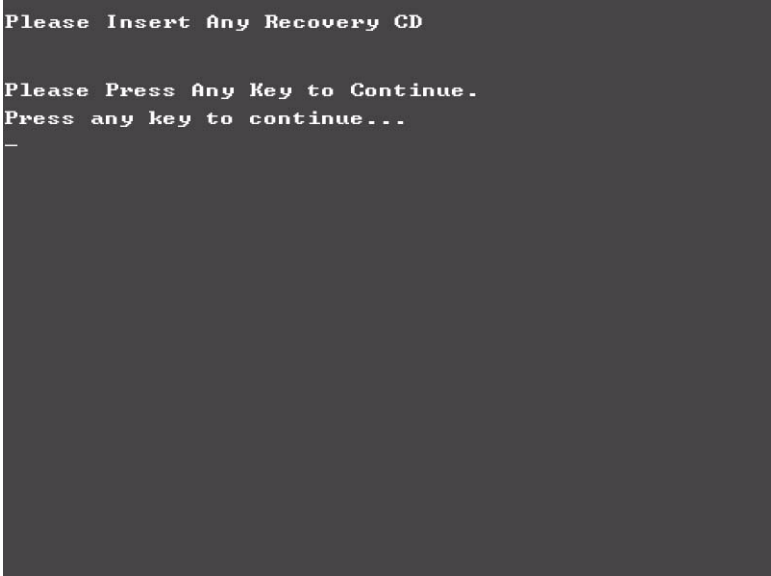

```
Please Insert Any Recovery CD

Please Press Any Key to Continue.
Press any key to continue...
_
```

After you place the Recovery CD to the optical drive, you will see the display below.



```
Please Wait for COPYING .....
X:\images \70E40I01.HDD
```

7. Then insert the System CD to the optical drive.

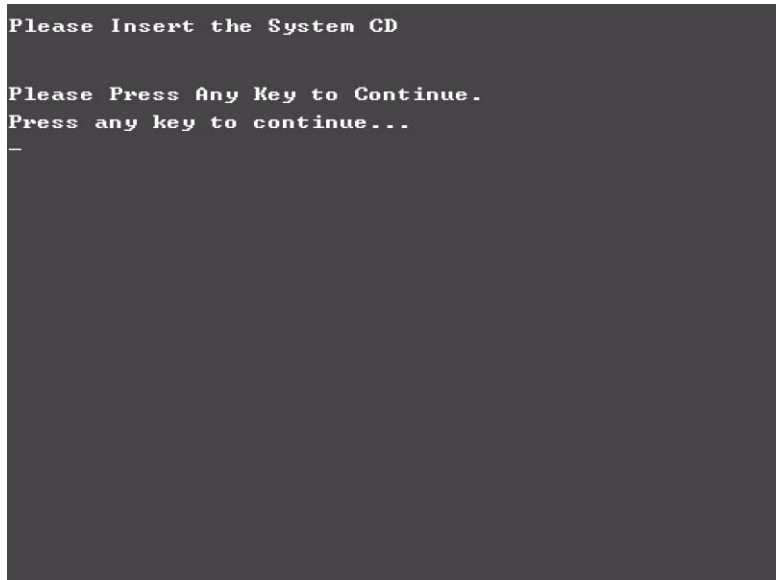

- 8. You will see the screen displaying "PASS" when the system has buit NAPP Master hard disc drive.



Jumper and Connector Locations

Top View

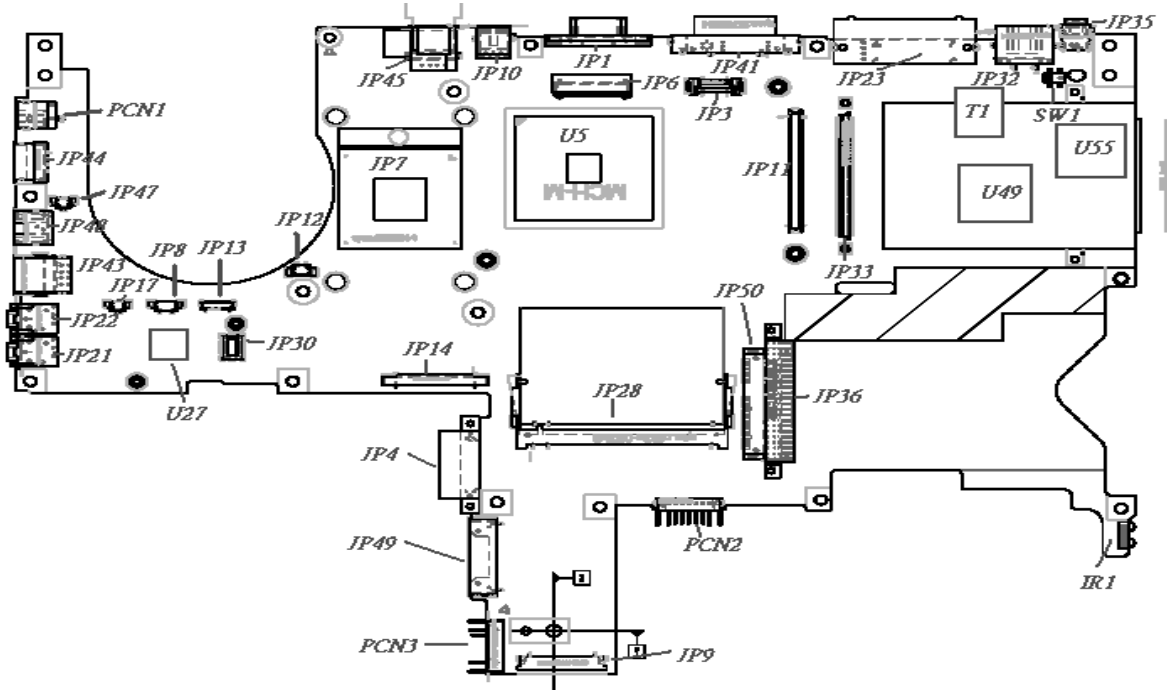

Rear View

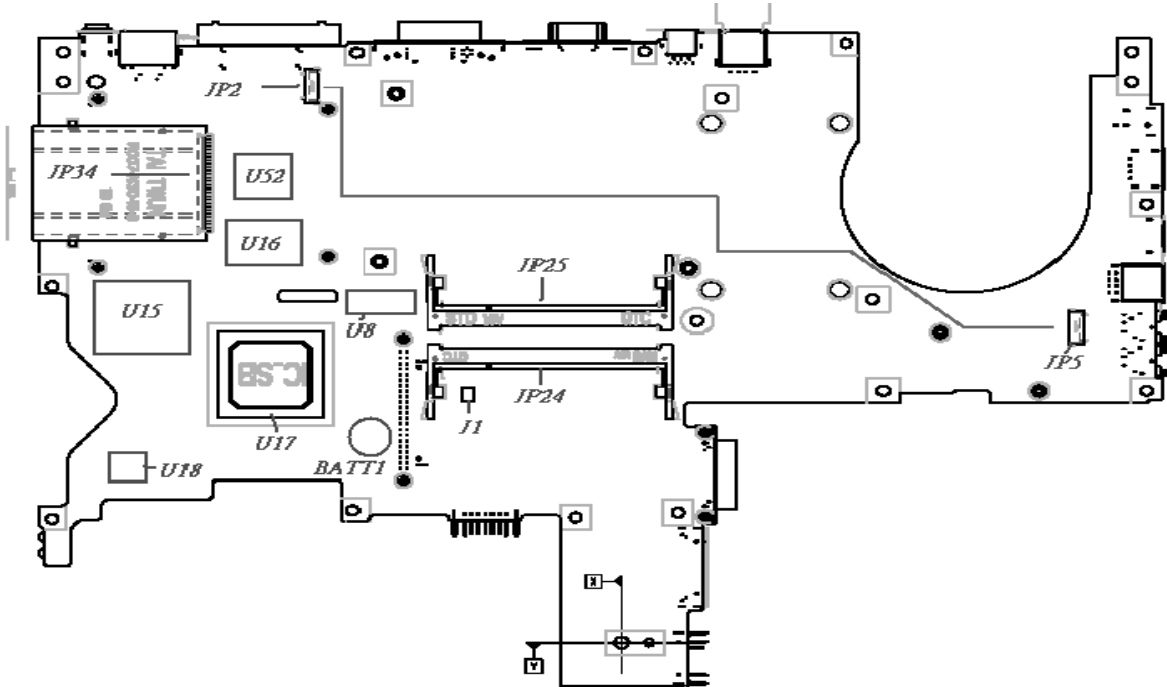

ITEM	DESCRIPTION	ITEM	DESCRIPTION
JP1	CRT CONN	JP30	MDC CONN
JP2	DOCKING SPR CONN	JP32	RJ45 CONN
JP3	SWITCH CONN	JP33	CARDBUS CONN
JP4	ODD CONN (FIX)	JP34	5 IN 1 SOCKET
JP5	DOCKING SPR CONN	JP35	1394 CONN
JP6	LCD CONN	JP36	HDD CONN
JP7	CPU SOCKET	JP41	DVI-D CONN
JP8	SPEAKER CONN	JP43	DUAL USB CONN
JP9	TP/B CONN	JP44/JP45	USB CONN
JP10	S-VIDEO CONN	JP47	RJ11 TO MDC CONN
JP11	VGA /B CONN	JP48	RJ11 CPMM
JP12	FAN CONN	JP49	ODD CONN (SWAP)
JP13	BT CONN	JP50	SATA CONN
JP14	KB CONN	PCN1	DC JACK
JP15	ROM SOCKET	PCN2	MAIN BAT
JP17	MIC CONN	PCN3	2nd BAT
JP21	MIC JACK	SW1	LID SWITCH
JP22	HEADPHONE JACK	BATT1	BATTERY
JP23	DOCKIND CONN	J1	CLEAR CMOS
JP24/JP25	DIMM SLOT	IR1	IR CONN
JP28	MINI PCI SLOT		

Chipset	Chipset Description
U5	NB CHIPSET
U27	AUDIO CODEC
U49	LAN CHIP
U55	1394 CHIP
T1	LAN TRANSFORMER
U8	CLK GEN
U15	EC CHIP
U16	ROM SOCKET
U17	SB CHIP
U18	SUPER I/O
U52	5 IN 1 CHIP

VGA Board

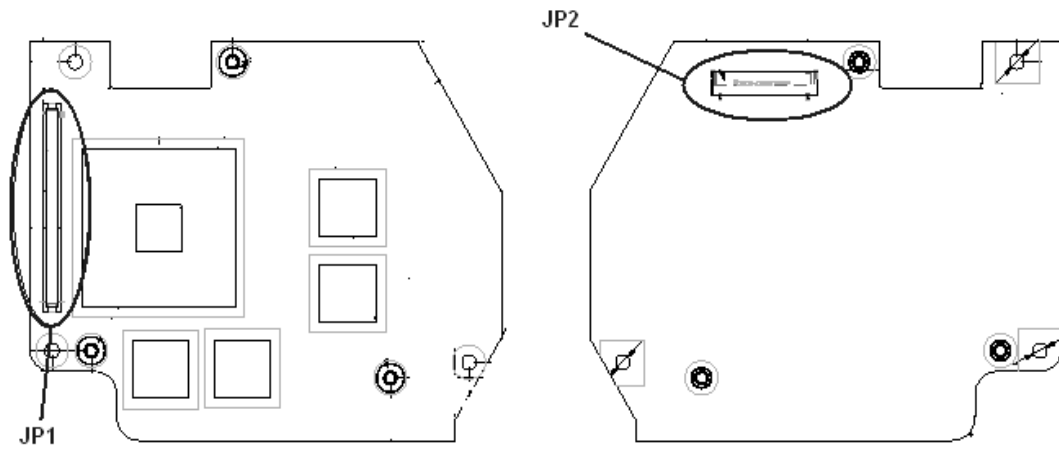

Item	Description
JP1	VGA Board to MB connector
JP2	LCD Connector

Power SW/B

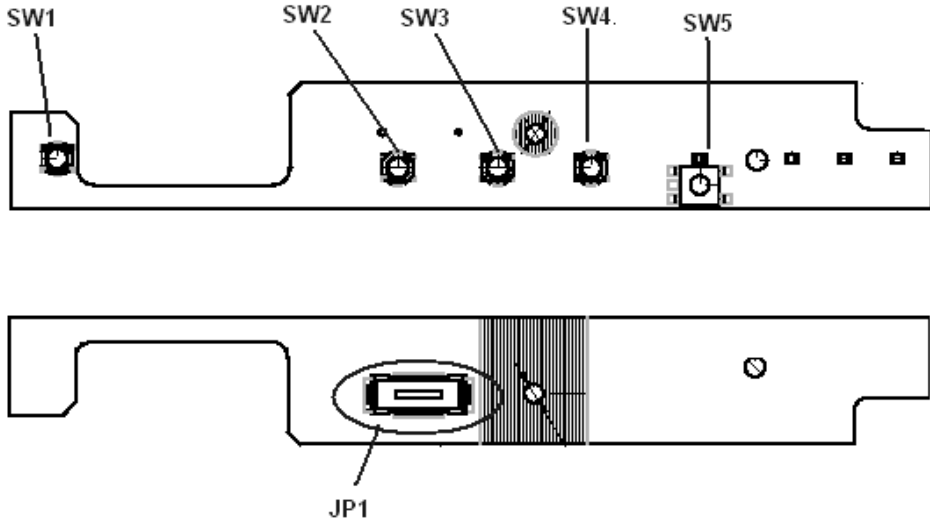

Item	Description
JP1	Power Board to MB Connector
SW1	Power Switch
SW2	e-Manager
SW3	Launch Manager Switch
SW4	Internet Switch
SW5	E-mail Switch

TouchPad Board

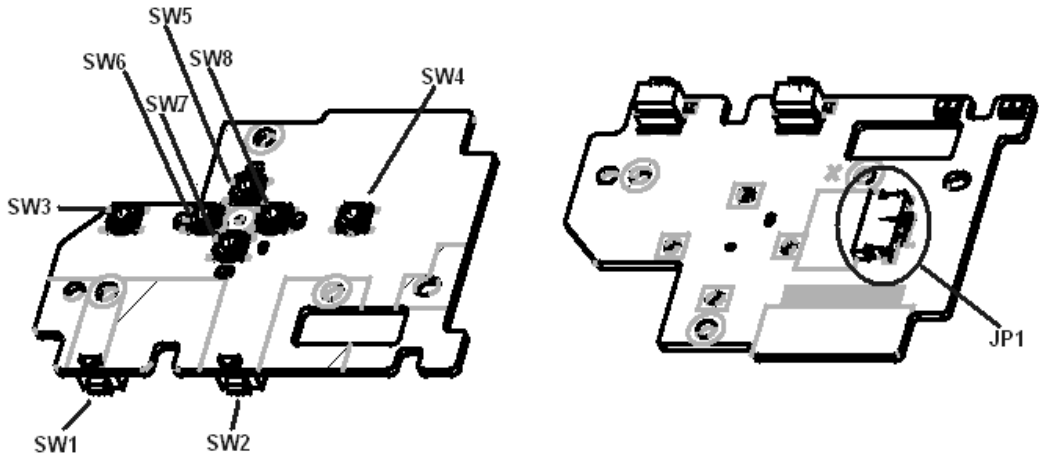

Item	Description
JP1	Trace-Pad Board Connector
SW1	B/T Switch
SW2	Wireless Switch
SW3	Left Bottom
SW4	Right Bottom
SW5	Scroll-Up
SW6	Scroll-Left
SW7	Scroll-Bottom
SW8	Scroll-Right

Hot Swap ODD Board

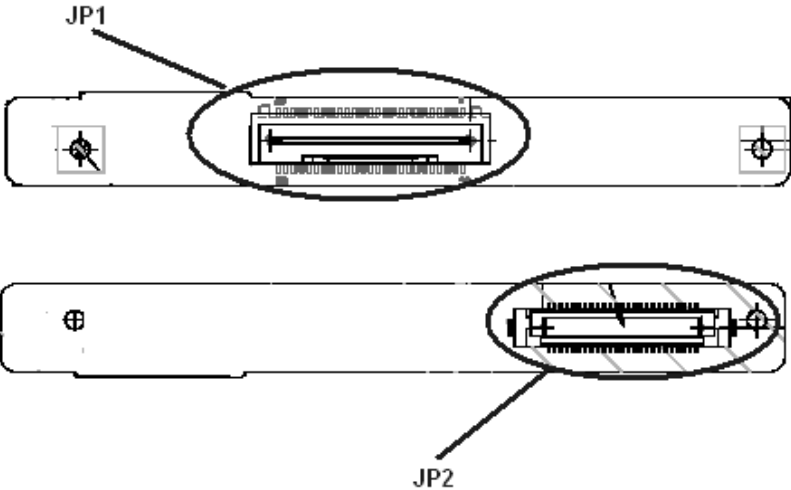

Item	Description
JP1	Hot-Swap
JP2	ODD device Connector

DVI Board

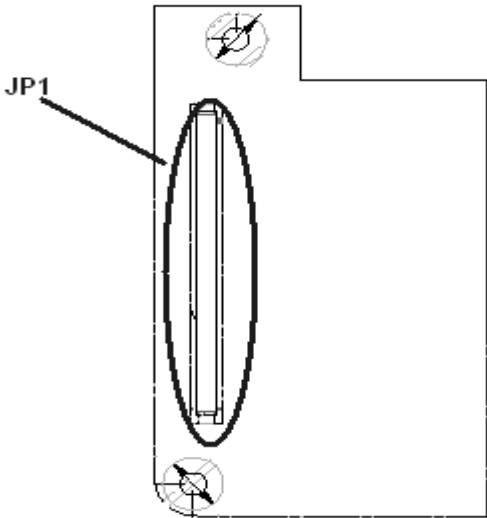

Item	Description
JP1	DVI Board Connector

Clear CMOS

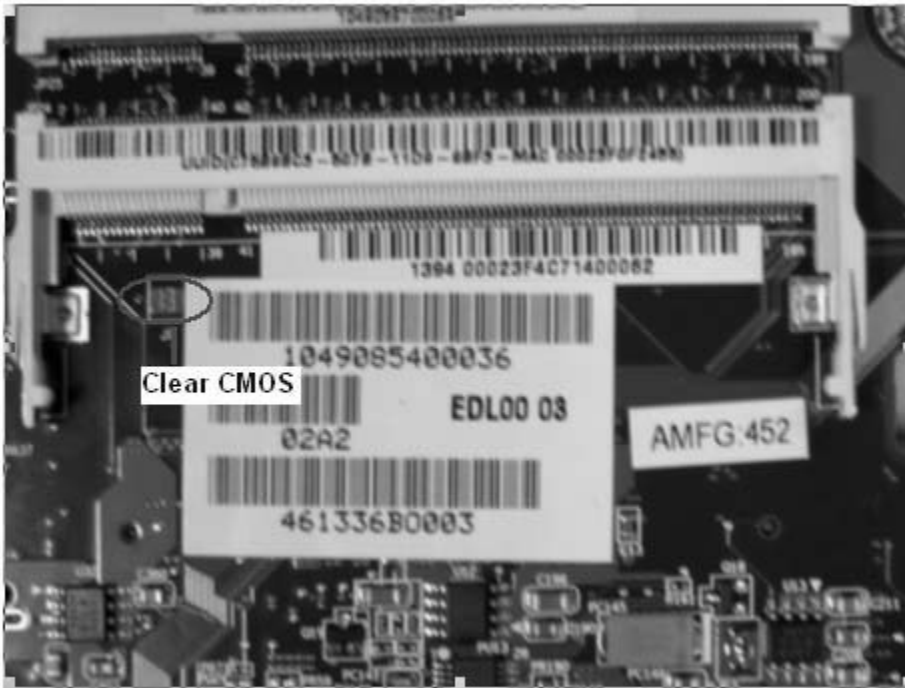

FRU (Field Replaceable Unit) List

This chapter gives you the FRU (Field Replaceable Unit) listing in global configurations of TravelMate 4650 and TravelMate 4150. Refer to this chapter whenever ordering for parts to repair or for RMA (Return Merchandise Authorization).

Please note that WHEN ORDERING FRU PARTS, you should check the most up-to-date information available on your regional web or channel. For whatever reasons a part number change is made, it will not be noted on the printed Service Guide. For ACER AUTHORIZED SERVICE PROVIDERS, your Acer office may have a DIFFERENT part number code from those given in the FRU list of this printed Service Guide. You MUST use the local FRU list provided by your regional Acer office to order FRU parts for repair and service of customer machines.

NOTE: To scrap or to return the defective parts, you should follow the local government ordinance or regulations on how to dispose it properly, or follow the rules set by your regional Acer office on how to return it.

Exploded Diagram

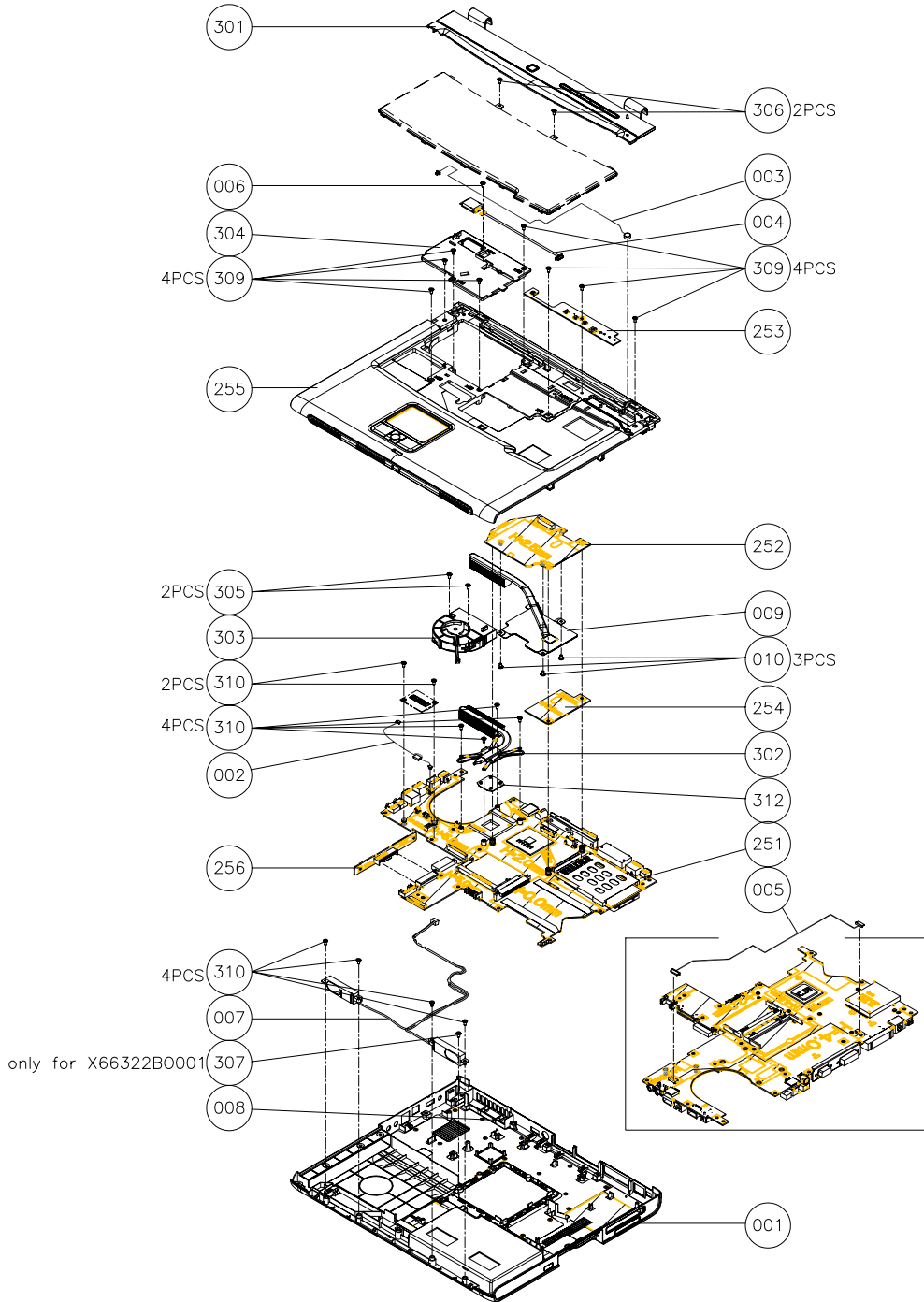

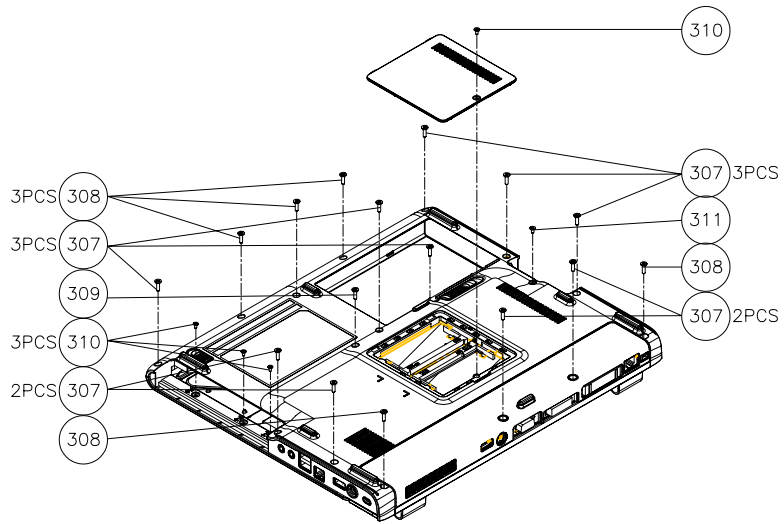







Illustration	Part Name	Description	Acer P/N
ADAPTER			
	ADAPTER 3 PIN 65W DELTA SADP-65KB BEF	ADAPTER 3 PIN 65W DELTA SADP-65KB BEF	AP.06501.006
	ADAPTER 3 PIN 65W LITEON PA-1650-02CO	ADAPTER 3 PIN 65W LITEON PA-1650-02CO	AP.06503.007
	ADAPTER 3 PIN 65W HIPRO HP-OK066B13QT	ADAPTER 3 PIN 65W HIPRO HP-OK066B13QT	AP.0650A.001
BATTERY			
	BATTERY LI-ION 8 CELLS-SANYO UR18650F	BATTERY LI-ION 8 CELLS-SANYO UR18650F	BT.00803.005
	BATTERY LI-ION 8 CELLS-PANASONIC CGR18650CE	BATTERY LI-ION 8 CELLS-PANASONIC CGR18650CE	BT.00805.001
	BATTERY LI-ION 8 CELLS-SONY US18650G5	BATTERY LI-ION 8 CELLS-SONY US18650G5	BT.00804.004
BOARD			
	MODEM BOARD	ZL1A MODEM BOARD ASSY S.P.	54.T75V5.001
	BLUETOOTH CARD WNC 91.BU513.002	BLUETOOTH CARD WNC 91.BU513.002	54.T75V5.002
	MINI PCI WIRELESS BOARD 802.11 b/g INTEL WM3B2200/CH11	MINI PCI WIRELESS BOARD 802.11 b/g INTEL WM3B2200/CH11	KI.CAX01.008
	MINI PCI WIRELESS BOARD 802.11 a/b/g INTEL WM3B2915 (US SKU)	WIRELESS LAN BOARD (802.11a/b/g) INTEL EU	KI.CAX01.010
	MINI PCI WIRELESS BOARD 802.11 a/b/g INTEL WM3B2915 (EU SKU)	WIRELESS LAN BOARD (802.11a/b/g) INTEL NA	KI.CAX01.009







Illustration	Part Name	Description	Acer P/N
	MINI PCI WIRELESS BOARD 802.11 a/b/g INTEL WM3B2915 (RW SKU)	WIRELESS LAN BOARD (802.11a/b/g) INTEL RW	KI.CAX01.011
	T/P BOARD W/FFC CABLE	T/P BOARD W/FFC CABLE	55.T75V5.001
	LAUNCH BOARD	LAUNCH BOARD	55.T75V5.002
	VGA BOARD MV43M 64MB	VGA BOARD MV43M 64MB	55.T76V5.001
	VGA BOARD MV44M 32MB	VGA BOARD MV44M 32MB	55.T76V5.002
	DVI BOARD	DVI BOARD	55.T75V5.004
	LCD INVERTER	LCD INVERTER	19.T75V5.001
CABLE			
	FFC CABLE T/P TO T/P BOARD	FFC CABLE T/P TO T/P BOARD	50.T75V5.001
	BLUETOOTH CABLE	BLUETOOTH CABLE	50.T75V5.002
	POWER CORD US 3 PIN	POWER CORD US 3 PIN	27.T75V5.001
	POWER CORD EC 3 PIN	POWER CORD EC 3 PIN	27.T75V5.002
	POWER CORD UK 3 PIN	POWER CORD UK 3 PIN	27.T75V5.003
	POWER CORD ITALIAN 3 PIN	POWER CORD ITALIAN 3 PIN	27.T75V5.004
	POWER CORD AUS 3 PIN	POWER CORD AUS 3 PIN	27.T75V5.005
	POWER CORD CHINA 3 PIN	POWER CORD CHINA 3 PIN	27.T75V5.006



Illustration	Part Name	Description	Acer P/N
	POWER CORD DENMARK 3 PIN	POWER CORD DENMARK 3 PIN	27.T75V5.007
	POWER CORD SWISS 3 PIN	POWER CORD SWISS 3 PIN	27.T75V5.008
	POWER CORD AF 3 PIN	POWER CORD AF 3 PIN	27.T75V5.009
	LCD WIRE CABLE - 14 IN.	LCD WIRE CABLE - 14 IN.	50.T75V5.004
	LCD WIRE CABLE - 15 IN. XGA	LCD WIRE CABLE - 15 IN. XGA	50.T75V5.005
	LCD WIRE CABLE - 15 IN. SXGA	LCD WIRE CABLE - 15 IN. SXGA	50.T75V5.006
CASE/COVER/BRACKET ASSEMBLY			
	MIDDLE COVER W/ BUTTON	MIDDLE COVER W/ BUTTON	42.T75V5.001
	UPPER CASE W/FRONT COVER , MIC	UPPER CASE W/FRONT COVER , MIC	60.T75V5.001
	LOWER CASE W/O DUCKING W/RAM DOOR , SPEAKER	LOWER CASE W/O DUCKING W/RAM DOOR , SPEAKER	60.T76V5.001
	4 - WAY BUTTON	4 - WAY BUTTON	42.T75V5.002
	TP SUPPORT PLATE	TP SUPPORT PLATE	33.T75V5.001

Illustration	Part Name	Description	Acer P/N
	RAM DOOR	RAM DOOR	42.T75V5.003
	KB COVER	KB COVER	42.T75V5.004
	PCMCIA DUMMY CARD	PCMCIA DUMMY CARD	42.T75V5.005
	LCD PANEL WITH LOGO W/ANTENNA	LCD PANEL WITH LOGO W/ANTENNA	60.T75V5.004
	LCD BEZEL - 14 IN.	LCD BEZEL - 14 IN.	60.T75V5.005
	LCD BEZEL - 15 IN.	LCD BEZEL - 15 IN.	60.T75V5.006
	LCD BRACKET W/HINGE 14 IN. SET	LCD BRACKET W/HINGE 14 IN. SET	6K.T75V5.001
	LCD BRACKET W/HINGE 15 IN. SET	LCD BRACKET W/HINGE 15 IN. SET	6K.T75V5.002



Illustration	Part Name	Description	Acer P/N
COMMUNICATION MODULE			
	ANTENNA ASSY	ANTENNA ASSY	50.T75V5.003
MISCELLANEOUS			
	LCD RUBBER	LCD RUBBER	47.T75V5.001
	LCD SCREW PAD	LCD SCREW PAD	47.T75V5.002
CPU/PROCESSOR			
	INTEL PENTIUM M 1.6G 2M 533FSB uFCPGA2 SL86G C-1 STEPPING	INTEL DOTHAN 730 (1.6GHZ/2M/FSB5330)	KC.N0001.730
	INTEL PENTIUM M 1.73G 2M 533FSB uFCPGA2 SL7SA C-1 STEPPING	INTEL DOTHAN 740 (1.73GHZ/2M/FSB5330)	KC.N0001.740
	INTEL PENTIUM M 1.87G 2M 533FSB uFCPGA2 SL7S9 C-1 STEPPING	INTEL DOTHAN 750 (1.87GHZ/2M/FSB5330)	KC.N0001.750

Illustration	Part Name	Description	Acer P/N
	INTEL PENTIUM M 2.0G 2M 533FSB uFCPGA2 SL7SM C-1 STEPPING	INTEL DOTHAN 760 (2.0GHZ/2M/FSB5330)	KC.N0001.760
	INTEL PENTIUM M 2.13G 2M 533FSB uFCPGA2 SL7SL C-1 STEPPING	INTEL DOTHAN 770 (2.13GHZ/2M/FSB5330)	KC.N0001.770

OPTICAL DISK DRIVE MODULE

	DVD/CDRW COMBO MODULE 24X QSI SBW- 243 SWAP	DVD/CDRW COMBO MODULE 24X QSI SBW- 243	6M.T75V5.001
	DVD/CDRW COMBO DRIVE 24X QSI SBW-243 G BASE	DVD/CDRW COMBO DRIVE 24X QSI SBW-243 G BASE	KO.02403.007
	DVD/CDRW COMBO 24X MODULE HLDS GCC- 4243N SWAP	DVD/CDRW COMBO 24X MODULE HLDS GCC- 4243N	6M.T75V5.002
	DVD/CDRW COMBO 24X DRIVE HLDS GCC- 4243N G BASE	DVD/CDRW COMBO 24X DRIVE HLDS GCC- 4243N G BASE	KO.02405.005
	DVD DUAL MODULE PIONEER DVR-K15RA SWAP	DVD DUAL MODULE PIONEER DVR-K15RA	6M.T75V5.003
	DVD DUAL DRIVE PIONEER DVR-K15RA G BASE	DVD DUAL DRIVE PIONEER DVR-K15RA G BASE	KU.00805.006
	DVD DUAL MODULE 8X LITEON SOSW-833S SWAP	DVD DUAL MODULE 8X LITEON SOSW-833S	6M.T75V5.004
	DVD DUAL 8X DRIVE LITEON SOSW-833S G BASE	DVD DUAL 8X DRIVE LITEON SOSW-833S G BASE	KU.00804.012
	DVD DUAL MODULE PANASONIC UJ- 840BQB2 SWAP	DVD DUAL MODULE PANASONIC UJ- 840BQB2	6M.T75V5.005
	DVD DUAL 8X DRIVE PANASONIC UJ- 840BQB2 G BASE	DVD DUAL 8X DRIVE PANASONIC UJ- 840BQB2 G BASE	KU.00807.010



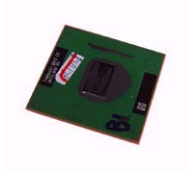
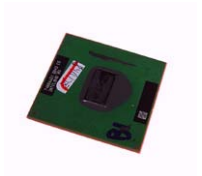

Illustration	Part Name	Description	Acer P/N
	DVD SUPER MULTI MODULE 8X HLDS GMA-4080N SWAP	DVD SUPER MULTI MODULE 8X HLDS GMA-4080N	6M.T75V5.006
	DVD SUPER MULTI 8X DRIVE HLDS GMA-4080N G BASE	DVD SUPER MULTI 8X DRIVE HLDS GMA-4080N G BASE	KU.0080D.006
CASE/COVER/BRACKET ASSEMBLY			
	DVD DUAL BEZEL	DVD DUAL BEZEL	42.T75V5.008
	DVD/CDRW COMBO BEZEL	DVD/CDRW COMBO BEZEL	42.T75V5.007
	OPTICAL DEVICE HOLDER	OPTICAL DEVICE HOLDER	42.T75V5.006
	OPTICAL DEVICE BOARD	OPTICAL DEVICE BOARD	55.T75V5.005
	HDD CARRIER	HDD CARRIER	60.T75V5.003
HDD/HARD DISK DRIVE			
	HDD SEAGATE 40G 4200rpm ST94019A, 2MB F/W:3.05	HDD SEAGATE 40G 4200rpm ST94019A, 2MB F/W:3.05	KH.04001.010
	HDD 40GB 4200PRM HGST MORAGA HTS424040M9AT0013G1 132	HDD 40GB 4200PRM HGST MORAGA HTS424040M9AT0013G1 132	KH.04007.012
	HDD 40GB TOSHIBA PLUTO MK4025GAS KA100A	HDD 40GB TOSHIBA PLUTO MK4025GAS KA100A	KH.04004.005
	HDD 60GB 2.5IN. 4200RPM SEAGATE N2 ST960821A F/W 3.01	HDD 60GB 2.5IN. 4200RPM SEAGATE N2 ST960821A F/W 3.01	KH.06001.002



Illustration	Part Name	Description	Acer P/N
	HDD 60GB 2.5IN. 4200RPM TOSHIBA PLUTO MK6025GAS(ROHS) F/W KA200A	HDD 60GB 2.5IN. 4200RPM TOSHIBA PLUTO MK6025GAS(ROHS) F/W KA200A	KH.06004.004
	HDD 60GB 2.5IN. 4200RPM HGST MORAGA IC25N060ATMR04-0 08K0634 F/S:AD4A	HDD 60GB 2.5IN. 4200RPM HGST MORAGA IC25N060ATMR04-0 08K0634 F/S:AD4A	KH.06007.006
	HDD 80GB 2.5IN. 4200RPM TOSHIBA PLUTO MK8025GAS F/W KA023	HDD 80GB 2.5IN. 4200RPM TOSHIBA PLUTO MK8025GAS F/W KA023	KH.08004.003
	HDD 80GB 2.5IN. 4200RPM HGST MORAGA IC25N080ATMR04-0 08K635 FW:AD4A	HDD 80GB 2.5IN. 4200RPM HGST MORAGA IC25N080ATMR04-0	KH.08007.007
	HDD 80GB 2.5IN. 4200RPM SEAGATE N2 ST9808210A F/W 3.01	HDD 80GB 2.5IN. 4200RPM SEAGATE N2 ST9808210A F/W 3.01	KH.08001.012
	HDD 100GB 2.5IN. 4200RPM TOSHIBA PLUTO MK1031GAS F/W AA20	HDD 100GB 2.5IN. 4200RPM TOSHIBA PLUTO MK1031GAS F/W AA20	KH.10004.001
	HDD 100GB 2.5IN. 4200RPM SEAGATE N2 ST9100822A F/W 3.01	HDD 100GB 2.5IN. 4200RPM SEAGATE N2 ST9100822A F/W 3.01	KH.10001.001
KEYBOARD			
	KEYBOARD DARFON CZECH	KEYBOARD DARFON CZECH	KB.T5902.012
	KEYBOARD DARFON CHINESE	KEYBOARD DARFON CHINESE	KB.T5902.001
	KEYBOARD DARFON THAI	KEYBOARD DARFON THAI	KB.T5902.003
	KEYBOARD DARFON HEBREW	KEYBOARD DARFON HEBREW	KB.T5902.023
	KEYBOARD DARFON KOREA	KEYBOARD DARFON KOREA	TBD
	KEYBOARD DARFON ARABIC	KEYBOARD DARFON ARABIC	KB.T5902.018
	KEYBOARD DARFON US INTERNATIONAL	KEYBOARD DARFON US INTERNATIONAL	KB.T5902.002
	KEYBOARD DARFON RUSSIAN	KEYBOARD DARFON RUSSIAN	KB.T5902.014
	KEYBOARD DARFON UK	KEYBOARD DARFON UK	KB.T5902.005
	KEYBOARD DARFON SWEDEN	KEYBOARD DARFON SWEDEN	KB.T5902.015
	KEYBOARD DARFON FRENCH	KEYBOARD DARFON FRENCH	KB.T5902.007

Illustration	Part Name	Description	Acer P/N
	KEYBOARD DARFON PORTUGUESE	KEYBOARD DARFON PORTUGUESE	KB.T5902.011
	KEYBOARD DARFON HL	KEYBOARD DARFON HL	TBD
	KEYBOARD DARFON BRAZILIAN PORTUGUESE	KEYBOARD DARFON BRAZILIAN PORTUGUESE	KB.T5902.019
	KEYBOARD DARFON SWISS/G	KEYBOARD DARFON SWISS/G	KB.T5902.008
	KEYBOARD DARFON DANISH	KEYBOARD DARFON DANISH	KB.T5902.017
	KEYBOARD DARFON ITALIAN	KEYBOARD DARFON ITALIAN	KB.T5902.006
	KEYBOARD DARFON BELGIUM	KEYBOARD DARFON BELGIUM	KB.T5902.009
	KEYBOARD DARFON GERMAN	KEYBOARD DARFON GERMAN	KB.T5902.004
	KEYBOARD DARFON GREEK	KEYBOARD DARFON GREEK	KB.T5902.021
	KEYBOARD DARFON CANADIAN FRENCH	KEYBOARD DARFON CANADIAN FRENCH	KB.T5902.020
	KEYBOARD DARFON NORWEGIAN	KEYBOARD DARFON NORWEGIAN	KB.T5902.016
	KEYBOARD DARFON HUNGARIAN	KEYBOARD DARFON HUNGARIAN	KB.T5902.013
	KEYBOARD DARFON SPANISH	KEYBOARD DARFON SPANISH	KB.T5902.010
	KEYBOARD DARFON LA	KEYBOARD DARFON LA	TBD
	KEYBOARD DARFON ICE LAND	KEYBOARD DARFON ICE LAND	TBD
	KEYBOARD DARFON TURKISH	KEYBOARD DARFON TURKISH	KB.T5902.022
	KEYBOARD DARFON JAPAN	KEYBOARD DARFON JAPAN	TBD
	LCD		
	ASSY LCD MODULE 14 IN. XGA AU (B141XG10) WIRELESS	ASSY LCD MODULE 14 IN. XGA AU (B141XG10) WIRELESS	6M.T75V5.011
	ASSY LCD MODULE 14 IN. XGA CMO (N141XB0L01) WIRELESS	ASSY LCD MODULE 14 IN. XGA CMO (N141XB0L01) WIRELESS	6M.T75V5.012
	ASSY LCD MODULE 14 IN. XGA TOPPOLY (TD141TGCD2) WIRELESS	ASSY LCD MODULE 14 IN. XGA TOPPOLY (TD141TGCD2) WIRELESS	6M.T75V5.013
	ASSY LCD MODULE 15 IN. XGA LG (LP150X08-A3) WIRELESS	ASSY LCD MODULE 15 IN. XGA LG (LP150X08-A3) WIRELESS	6M.T75V5.014
	ASSY LCD MODULE 15 IN. XGA CMO (N150X3-L07) WIRELESS	ASSY LCD MODULE 15 IN. XGA CMO (N150X3-L07) WIRELESS	6M.T75V5.015

Illustration	Part Name	Description	Acer P/N
	ASSY LCD MODULE 15 IN. XGA SAM (LTN150XB-L03-C00) WIRELESS	ASSY LCD MODULE 15 IN. XGA SAM (LTN150XB-L03-C00) WIRELESS	6M.T75V5.016
	ASSY LCD MODULE 15 IN. XGA AU (B150XG01 V.2) WIRELESS	ASSY LCD MODULE 15 IN. XGA AU (B150XG01 V.2) WIRELESS	6M.T75V5.017
	ASSY LCD MODULE 15 IN. XGA HIT (TX38D81VC1CAB Rev.C) WIRELESS	ASSY LCD MODULE 15 IN. XGA HIT (TX38D81VC1CAB Rev.C) WIRELESS	6M.T75V5.018
	ASSY LCD MODULE 15 IN SXGA AU (B15PG03) WIRELESS	ASSY LCD MODULE 15 IN SXGA AU (B15PG03) WIRELESS	6M.T75V5.019
	ASSY LCD MODULE 15 IN SXGA SAM WIRELESS	ASSY LCD MODULE 15 IN SXGA SAM WIRELESS	6M.T75V5.020
	LCD 14 IN. XGA AU (B141XG10)	LCD 14 IN. XGA AU (B141XG10)	LK.14105.012
	LCD 14 IN. XGA CMO (N141XB-L01)	LCD 14 IN. XGA CMO (N141XB-L01)	LK.1410D.003
	LCD 14 IN. XGA TOPPOLY (TD141TGCD2)	LCD 14 IN. XGA TOPPOLY (TD141TGCD2)	LK.14101.003
	LCD 15 IN. XGA LG (LP150X08-A3)	LCD 15 IN. XGA LG (LP150X08-A3)	LK.15008.016
	LCD 15 IN. XGA CMO (N150X3-L07)	LCD 15 IN. XGA CMO (N150X3-L07)	LK.1500D.006
	LCD 15 IN. XGA SAM (LTN150XB-L03-C00)	LCD 15 IN. XGA SAM (LTN150XB-L03-C00)	LK.15006.007
	LCD 15 IN. XGA AU (B150XG01 V.2)	LCD 15 IN. XGA AU (B150XG01 V.2)	LK.15005.001
	LCD 15 IN. XGA HIT (TX38D81VC1CAB Rev.C)	LCD 15 IN. XGA HIT (TX38D81VC1CAB Rev.C)	LK.15004.009
	LCD 15 IN. SXGA AU (B15PG03)	LCD 15 IN. SXGA AU (B15PG03)	LK.15008.008
LCD 15 IN SXGA SAM	LCD 15 IN SXGA SAM	LK.1500D.003	
MAINBOARD			
	MAINBOARD 915PM DISCRETE GIGA 5 IN 1 W/PCMCIA SLOT W/O CPU MEMORY	MAINBOARD 915PM DISCRETE GIGA 5 IN 1 W/PCMCIA SLOT W/O CPU MEMORY	LB.T8402.001
	MAINBOARD 915GM UMA GIGA 5 IN 1 W/ PCMCIA SLOT W/O CPU MEMORY	MAINBOARD 915GM UMA GIGA 5 IN 1 W/ PCMCIA SLOT W/O CPU MEMORY	LB.T7502.001

Illustration	Part Name	Description	Acer P/N
PCMCIA SLOT/PC CARD SLOT			
	PCMCIA SLOT	PCMCIA SLOT	22.T75V5.001
MEMORY			
	MEMORY MICRON 256MB/ 533MHZ, MT8HTF3264HDY-53EB2	MEMORY MICRON 256MB/ 533MHZ, MT8HTF3264HDY-53EB2	KN.25604.023
	MEMORY IFX 256MB/ 533MHZ, HYS64T32000HDL-3.7-A	MEMORY IFX 256MB/ 533MHZ, HYS64T32000HDL-3.7-A	KN.25602.023
	MEMORY ELPIDA 256MB/ 533MHZ, U33256AGEPQ662A	MEMORY ELPIDA 256MB/ 533MHZ, U33256AGEPQ662A	KN.25609.003
	MEMORY SAMSUNG DDRII 256MB/533MHZ M470T3354BG0-CD5	MEMORY SAMSUNG DDRII 256MB/533MHZ M470T3354BG0-CD5	KN.2560B.011
	MEMORY MICRON 512MB/ 533MHZ, MT8HTF6464HDY-53EA2	MEMORY MICRON 512MB/ 533MHZ, MT8HTF6464HDY-53EA2	KN.51204.015
	MEMORY IFX 512MB/ 533MHZ, HYS64T64020HDL-3.7-A	MEMORY IFX 512MB/ 533MHZ, HYS64T64020HDL-3.7-A	KN.51202.021
	MEMORY ELPIDA 512MB/ 533MHZ, U33512AGEPQ672A	MEMORY ELPIDA 512MB/ 533MHZ, U33512AGEPQ672A	KN.51209.004
	MEMORY SAMSUNG DDRII 512MB/533MHZ M470T6554BG0-CD5	MEMORY SAMSUNG DDRII 512MB/533MHZ M470T6554BG0-CD5	KN.5120B.008
	MEMORY IFX 1GB/533 MHZ, HYS64T128021HDL-3.7- A	MEMORY IFX 1GB/533 MHZ, HYS64T128021HDL-3.7- A	KN.1GB02.012
FAN			
	FAN ASSY	FAN ASSY	23.T75V5.001
HEATSINK			
	THERMAL MODULE	THERMAL MODULE	
	CPU HEATSINK	CPU HEATSINK	

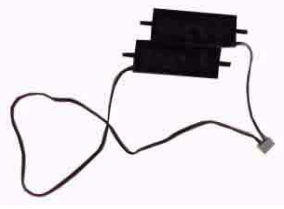





Illustration	Item	Description	Acer P/N
SPEAKER			
	SPEAKER SET	ZL1A SPEAKER ASSY S.P.	23.T50V7.001
HEATSINK			
	THERMAL MODULE	ZL2 CPU HEATSINK ASSY	60.T63V7.003
POINTING DEVICE			
	TOUCHPAD	TOUCHPAD	54.T75V5.001
SPEAKER			
	SPEAKER SET (R&L) 2W	SPEAKER SET (R&L) 2W	23.T75V5.003
MISCELLANEOUS			
	NAME PALTE - TM4650	NAME PALTE - TM4650	47.T75V5.005
	MIC	MIC	23.T75V5.004
	RUBBER FOOT - BIG	RUBBER FOOT - BIG	47.T75V5.003

Illustration	Item	Description	Acer P/N
	RUBBER FOOT - SMALL	RUBBER FOOT - SMALL	47.T75V5.004
SCREW			
	SCREW, M2.5*3(Ni-NL)	SCREW, M2.5*3(Ni-NL)	86.T75V5.001
	SCREW, M2.5*3(NL)	SCREW, M2.5*3(NL)	86.T75V5.002
	SCREW, M2.5*4(NL)	SCREW, M2.5*4(NL)	86.T75V5.003
	SCREW, M2.5*6(NL)	SCREW, M2.5*6(NL)	86.T75V5.004
	SCREW, M2.5*10(NL)	SCREW, M2.5*10(NL)	86.T75V5.005
	SCREW, M2.5*18(NL)	SCREW, M2.5*18(NL)	86.T75V5.006
	SCREW, M2*3(NL)	SCREW, M2*3(NL)	86.T75V5.007
	SCREW, M2.0*3(Ni-NL) HEAD SIZE 3.0	SCREW, M2.0*3(Ni-NL) HEAD SIZE 3.0	86.T75V5.008
	SCREW, M2*4	SCREW, M2*4	86.T75V5.009
	SCREW, M2*6	SCREW, M2*6	86.T75V5.010
	SCREW, M2*10(Ni)	SCREW, M2*10(Ni)	86.T75V5.011
	SCREW, M3*4(NL)	SCREW, M3*4(NL)	86.T75V5.012
	SCREW, D-SUB NUT	SCREW, D-SUB NUT	86.T75V5.013

Model Definition and Configuration

TravelMate4650 Series

Model Number	CPU	LCD	VGA Chip	Memory1	Memory2	HDD	Optical	Card Reader	Wireless LAN	Blue-tooth	Battery	Adapter
TM4652LCi	PM 740	N15 SXG A+	UMA	SO256MB I15	SO256MB I15	N60GB 4.2K	NCB24X	6 in 1	INT2200 BG_MW	WNC_USB_B RM	8CELL 2.2	65W
TM4651LCi	PM 730	N15 SXG A+	UMA	SO256MB I14	SO256MB I14	N60GB 4.2K	NCB24X	6 in 1	INT2200 BG_MW	WNC_USB_B RM	8CELL 2.2	65W
TM4651LMi	PM 730	N15 SXG A+	UMA	SO256MB I14	SO256MB I14	N60GB 4.2K	NSM8X	6 in 1	INT2200B G_MW	NA	8CELL 2.2	65W
TM4652LCi	PM 740	N15 SXG A	UMA	SO256MB I15	SO256MB I15	N60GB 4.2K	NCB24X	6 in 1	INT2200B G_MW	NA	8CELL 2.2	65W

TravelMate 4150 Series

Model Number	CPU	LCD	VGA Chip	Memory1	Memory2	HDD	Optical	Card Reader	Wireless LAN	Blue-tooth	Battery	Adapter
TM4152LMi	PM 740	N15 XGA	UMA	SO256MB I15	SO256MB I15	N60GB 4.2K	NDU8X	6 in 1	INT2200B G_MW	NA	8CELL 2.2	65W
TM4152LCi	PM 740	N15 XGA	UMA	SO256MB I15	SO256MB I15	N60GB 4.2K	NCB24X	6 in 1	INT2200B G_MW	NA	8CELL 2.2	65W
TM4151LMi	PM 730	N15 XGA	UMA	SO256MB I14	SO256MB I14	N60GB 4.2K	NDU8X	6 in 1	INT2200B G_MW	NA	8CELL 2.2	65W
TM4151NLC	PM 730	N15 XGA	UMA	SO256MB I14	NA	N60GB 4.2K	NCB24X	6 in 1	INT2200B G_MW	NA	8CELL 2.2	65W
TM4152NLCi	PM 740	N15 XGA	UMA	SO256MB I14	NA	N60GB 4.2K	NCB24X	6 in 1	INT2200B G_MW	NA	8CELL 2.2	65W
TM4152 NLMi	PM 740	N15 XGA	UMA	SO256MB I14	NA	N60GB 4.2K	NCB24X	6 in 1	INT2200B G_MW	NA	8CELL 2.2	65W
TM4152NLCi	PM 740	N15 XGA	UMA	SO256MB I14	NA	N60GB 4.2K	NCB24X	6 in 1	INT2200B G_MW	NA	8CELL 2.2	65W

Test Compatible Components

This computer's compatibility is tested and verified by Acer's internal testing department. All of its system functions are tested under Windows XP Home environment.

Refer to the following lists for components, adapter cards, and peripherals which have passed these tests.

Regarding configuration, combination and test procedures, please refer to the TravelMate 4650,

TravelMate 4150 Compatibility Test. Report released by the Acer Mobile System Testing Department.

Microsoft Windows XP (Home/Professional) Environment Test

Vendor	Type	Description
CPU		
Intel	Pentium M 770 (2.13G 2M 533FSB) Pentium M 760 (2.0G 2M 533FSB) Pentium M 750 (1.87G 2M 533FSB) Pentium M 740 (1.73G 2M 533FSB) Pentium M 730 (1.6G 2M 533FSB)	
AU	15XGA	15.0" XGA B150XG01 V2
	15SXGA	15.0" SXGA+ B150PG03 NEC. driver IC
Samsung	15XGA	15.0" XGA LTN150XB-L03-C00
CMO	15XGA	15.0" XGA N150X3-L07
	15SXGA	15.0" SXGA+ IDT N150P2-L04
LG	15XGA	15.0" XGA LP150X08-A3 MAKE IN CHINA
Hitachi	15XGA	15.0" XGA TX38D81VC1CAB. REV.C
HDD		
HGST	2.5"40G4200	HTS424040M9AT00 13G1132 Moraga+
	2.5"60G4200	IC25N060ATMR04-0 08K0634 Moraga
	2.5"80G4200	IC25N080ATMR04-0 08K635 Moraga
	2.5"60G5400	HTS541060G9AT00 Moraga+
TOSHIBA	2.5"40G4200	MK4025GAS ,KA100A Pluto(RohS)
	2.5"60G4200	MK6025GAS Pluto(RohS)
	2.5"80G4200	MK8025GAS, 8MB Pluto(RohS)
	2.5"100G4200	MK1031GAS (RohS) (CTU - Jan.)
	2.5"60G5400	MK6026GAX, 16MB Proteus(RohS)
Seagate	2.5"40G4200	ST94019A, 2MB N1
	2.5"60G4200	ST960821A N2(RohS)
	2.5"80G4200	ST9808210A N2(RohS)
	2.5"100G4200	ST9100822A (RohS)
ODD		
QSI	Combo	QSI SBW-243 ,Gbase
HLDS	Combo	HLDS GCC-4243N ,Gbase
	Super multi(DL)	HLDS GMA-4080N, Gbase
Pioneer	DVD-Dual(DL)	Pioneer DVR-K15RA, Gbase
Lite-on	DVD-Dual(DL)	LiteOn SOSW-833S, Gbase
Panasonic	DVD-Dual(DL)	Panasonic UJ-840BQB2, Gbase
Memory		
Infineon	DDRII 533/256MB	HYS64T32000HDL-3.7-A
	DDRII 533/512MB	HYS64T64020HDL-3.7-A
	DDRII 533/1GB	HYS64T128021HDL-3.7-A 128x64 CL4(.11u/G)
Micron	DDRII 533/256MB	MT8HTF3264HDY-53EB3
	DDRII 533/512MB	MT8HTF6464HDY-53EA3
Samsung	DDRII 533/256MB	M470T3354BG0-CD5/ BZ0-CD5(Pb-free)
	DDRII 533/512MB	M470T6554BG0-CD5/BZ0-CD5(Pb-free)

Vendor	Type	Description
Elpida	DDRII 533/256MB	U33256AGEPQ662A
	DDRII 533/512MB	U33512AGEPQ672A
BATTERY		
Sony	LI+2.2MAH 8C	Sony Li-ion Normal 8cell 4S2P 4300mAh
Sanyo	LI+2.2MAH 8C	Sanyo Li-ion Normal 8cell 4S2P 4400mAh
	LI+1.9MAH 6C	2nd battery follows Kingfisher's Spec. Sanyo 6cell 3S2P 3800mAh 1.9Ahr Prismatic
Panasonic	LI+2.2MAH 8C	Panasonic Li-ion Normal 8cell 4S2P 4500mAh
ADAPTER		
Liteon	Adapter 65W	65W,Lite-On NB Adapter PA-1650-02CO, 19V, 3 pins
Delta	Adapter 65W	65W adapter Delta NB Adapter 65W,SADP-65KB BFE
Hipro	Adapter 65W	65W Hipro NB Adapter 65W,HP-OK066B13QT

Online Support Information

This section describes online technical support services available to help you repair your Acer Systems. If you are a distributor, dealer, ASP or TPM, please refer your technical queries to your local Acer branch office. Acer Branch Offices and Regional Business Units may access our website. However some information sources will require a user i.d. and password. These can be obtained directly from Acer CSD Taiwan.

Acer's Website offers you convenient and valuable support resources whenever you need them.

In the Technical Information section you can download information on all of Acer's Notebook, Desktop and Server models including:

- Service guides for all models
- User's manuals
- Training materials
- Bios updates
- Software utilities
- Spare parts lists
- TABs (Technical Announcement Bulletin)

For these purposes, we have included an Acrobat File to facilitate the problem-free downloading of our technical material.

Also contained on this website are:

- Detailed information on Acer's International Traveler's Warranty (ITW)
- An overview of all the support services we offer, accompanied by a list of telephone, fax and email contacts for all your technical queries.

We are always looking for ways to optimize and improve our services, so if you have any suggestions or comments, please do not hesitate to communicate these to us.