



**KOMPAKTZYLINDER
ISO 21287**



Wir bewegen mehr als Luft



Inhalt

	Seite
Kompaktzylinder mit Federrückstellung	3
KPEM_ Feder kopfseitig	4
KPEMZ_ Feder deckelseitig	5
Kompaktzylinder doppelt wirkend	6
KPDM_ doppelt wirkender Zylinder	7
KPDM_B ... mit durchgehender Kolbenstange	8
KPDMIF ... mit externer Verdrehsicherung	9
Sonderausführungen	11
Anbauteile für Kompaktzylinder	12
Übersicht	12, 13
MF Bodenflansch	14
MS1 Fußbefestigung	14
MP4 Schwenkbefestigung	14
MK Gabelbefestigung	15
MP2 Gabelbefestigung	15
MP6 Schwenkbefestigung	16
AM7 Lagerbock	16
US Lagerbock mit Gelenklager	16
MT4N Schwenkzapfenbefestigung	17
L Schwenklager	17
GS Gelenkkopf	17
GF Gabelgelenk	17
FK Ausgleichkupplung	17
Näherungsschalter	
M60RV2 Reedschalter 2-adrig	18
M60RS3 Reedschalter 3-adrig	19
M60GMP Elektronischer Näherungsschalter	20

Kompaktzylinder ISO 21287

einfachwirkend
Ø20 bis 100 mm



KPEM
Feder kopfseitig



KPEMZ
Feder deckelseitig

- Anschlußbild für Befestigungselemente entsprechend DIN ISO 15552
- Kompakte Bauweise spart Platz
- Nuten am Zylinderrohr ermöglichen direkte Befestigung der Magnetschalter M60



Standardmodelle

Ø	Kolbenstangen Ø	Anschluß	Verschleiß-teilsatz
20	10	M5	ET-KPEM-20
25	10	M5	ET-KPEM-25
32	12	G1/8	ET-KPEM-32
40	16	G1/8	ET-KPEM-40
50	16	G1/8	ET-KPEM-50
63	16	G1/8	ET-KPEM-63
80	20	G1/8	ET-KPEM-80
100	25	G1/8	ET-KPEM-100

Ø	KPEM Theoretische Kräfte (N) bei 6 bar		KPEMZ Theoretische Kräfte (N) bei 6 bar	
	ausfahrend	Feder	einfahrend	Feder
20	150	38	104	38
25	253	42	206	42
32	429	53	362	53
40	684	70	617	70
50	1103	75	983	75
63	1769	100	1650	100
80	2864	150	2679	150
100	4500	210	4210	210

Technische Kenngrößen

Allgemeine Kenngrößen	
Medium	gefilterte, geölte oder ungeölte Druckluft
Funktion	einfachwirkend mit Magnetkolben Feder kopfseitig KPEMI – Kolbenstange mit Innengewinde, KPEM – Kolbenstange mit Außengewinde inkl. Mutter Feder deckelseitig KPEMIZ – Kolbenstange mit Innengewinde, KPEMZ – Kolbenstange mit Außengewinde inkl. Mutter
Betriebsdruck	2 ... 10 bar
Temperaturbereich	-20 °C * ... +80 °C * Bei Minustemperaturen bitte Luftbeschaffenheit beachten.
Hublängen	Standard 5 mm, 10 mm, 15 mm, 20 mm, 25 mm, 30 mm, 35 mm, 40 mm, 50 mm, 60 mm, Sonderhublängen auf Anfrage
Werkstoffe	Profilrohr: Aluminium eloxiert; Enddeckel: Aluminiumdruckguss, lackiert; Kolbenstange: Edelstahl rostfrei (AISI 303); Dichtungen: Polyurethan und Nitrilkautschuk

Typenschlüssel

KPEM **-* / *** / HT**

Wirkungsweise Kennung

Feder kopfseitig	ohne
Feder deckelseitig	Z
Mit Innengewinde	I

Zylinder Ø (mm) Kennung

20	20
25	25
32	32
40	40
50	50
63	63
80	80
100	100

Sonderausführung

HT für Ausführung bis 180°C

Hub (mm)

max. 60 mm

Achtung: Nicht benutzte Stellen bitte aufrücken.
Kombinationen der alternativen Ausführungen auf Anfrage.

KPEM... Ø 20 bis 100 mm



KPEMI Zylinder mit Feder kopfseitig
Kolbenstange mit Innengewinde

KPEM Zylinder mit Feder kopfseitig
Kolbenstange mit Aussengewinde

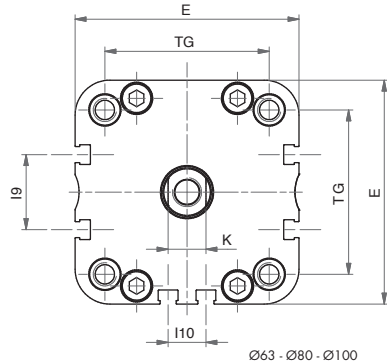
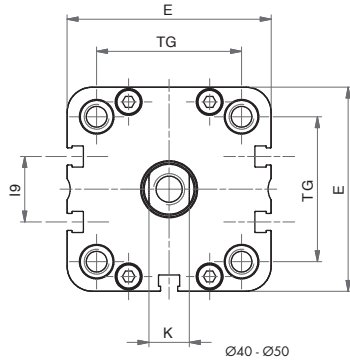
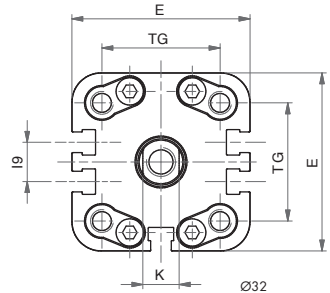
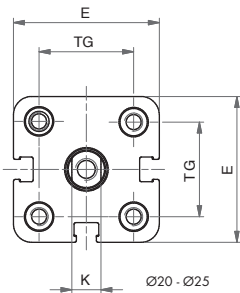
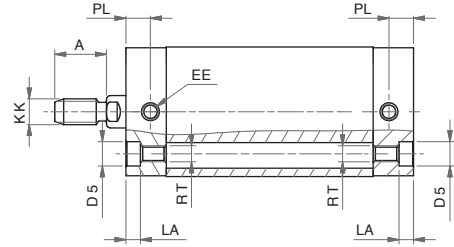
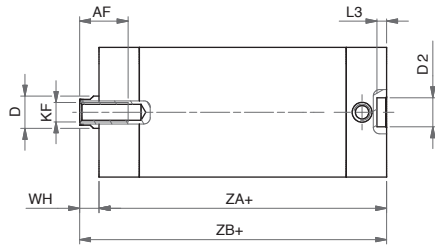

Abmessungen									
Ø	20	25	32	40	50	63	80	100	
A	16	16	19	19	22	22	28	28	
AF	15	15	16	16	17	17	20	20	
Ø D	10	10	12	12	16	16	20	25	
Ø D2	9	9	9	9	12	12	12	12	
Ø D5	7,5	7,5	9	9	10,5	10,5	13,5	13,5	
E	36	40	49	54,5	65,5	77	95,5	113,5	
EE	M5	M5	G1/8	G1/8	G1/8	G1/8	G1/8	G1/8	
I9	-	-	10,8	12,8	21	25,8	30	50	
I10	-	-	-	-	-	13	18	35	
K	8	8	10	10	13	13	17	22	
KF	M6	M6	M8	M8	M10	M10	M12	M12	
KK	M8	M8	M10 x 1,25	M10 x 1,25	M12 x 1,25	M12 x 1,25	M16 x 1,5	M16 x 1,5	
LA	4,5	4,5	5	5	5	5	3	3	
L3	3	3	3	3	4	4	4	4	
PL	7,5	7,5	7,5	8	8	7,5	8	10,5	
RT	M5	M5	M6	M6	M8	M8	M10	M10	
TG	22	26	32,5	38	46,5	56,5	72	89	
WH	6,5	6	6,5	7	8	8	9	10	
ZA+	37*	39*	44*	45*	45*	49*	54*	67*	
ZB+	43,5*	45*	50,5*	52*	53*	57*	63*	77*	

+ plus Hublänge (mm)

* für Hübe 35, 40, 50, 60 mm / für Ø 20 mm plus 10 mm / für Ø 25, 32, 40, 50, 63 mm plus 20 mm / für Ø 80 bis 100 mm plus 30 mm

KIEM... Ø 20 bis 100 mm

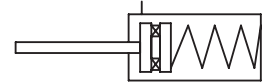

KPEMIZ Zylinder mit Feder deckelseitig
Kolbenstange mit Innengewinde

KPEMZ Zylinder mit Feder deckelseitig
Kolbenstange mit Aussengewinde

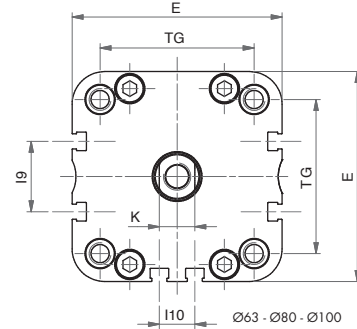
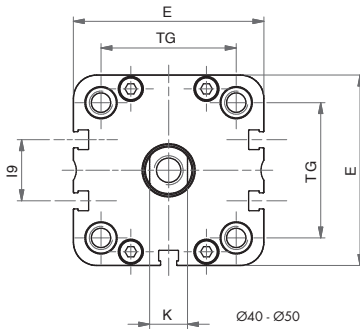
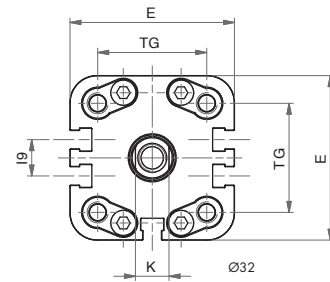
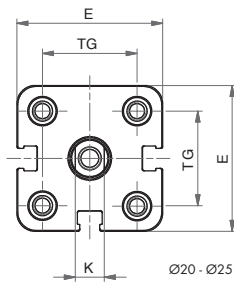
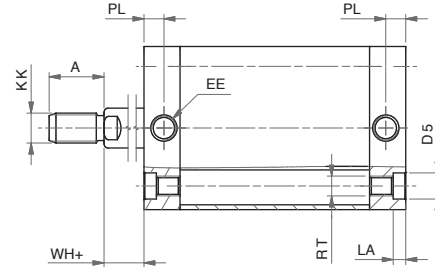
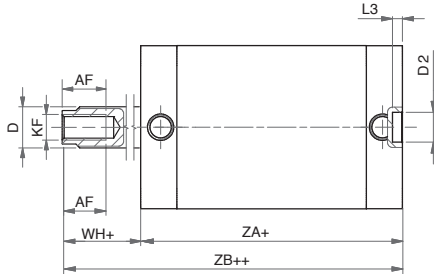

Abmessungen

	20	25	32	40	50	63	80	100
Ø	20	25	32	40	50	63	80	100
A	16	16	19	19	22	22	28	28
AF	15	15	16	16	17	17	20	20
Ø D	10	10	12	12	16	16	20	25
Ø D2	9	9	9	9	12	12	12	12
Ø D5	7,5	7,5	9	9	10,5	10,5	13,5	13,5
E	36	40	49	54,5	65,5	77	95,5	113,5
EE	M5	M5	G1/8	G1/8	G1/8	G1/8	G1/8	G1/8
I9	-	-	10,8	12,8	21	25,8	30	50
I10	-	-	-	-	-	13	18	35
K	8	8	10	10	13	13	17	22
KF	M6	M6	M8	M8	M10	M10	M12	M12
KK	M8	M8	M10 x 1,25	M10 x 1,25	M12 x 1,25	M12 x 1,25	M16 x 1,5	M16 x 1,5
LA	4,5	4,5	5	5	5	5	3	3
L3	3	3	3	3	4	4	4	4
PL	7,5	7,5	7,5	8	8	7,5	8	10,5
RT	M5	M5	M6	M6	M8	M8	M10	M10
TG	22	26	32,5	38	46,5	56,5	72	89
WH+	6,5	6	6,5	7	8	8	9	10
ZA+	37*	39*	44*	45*	45*	49*	54*	67*
ZB++	43,5*	45*	50,5*	52*	53*	57*	63*	77*

+ plus Hublänge (mm) / ++ plus 2xHublänge (mm)

* für Hübe 35, 40, 50, 60 mm / für Ø 25, 32, 40, 50, 63 mm plus 20 mm / für Ø 80 bis 100 mm plus 20 mm

Kompaktzylinder ISO 21287

doppeltwirkend
KPDM
 Ø 20 bis 100 mm

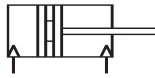

- Anschlußbild für Befestigungselemente entsprechend DIN ISO 15552
- Kompakte Bauweise spart Platz
- Nuten am Zylinderrohr ermöglichen direkte Befestigung der Magnetschalter M60

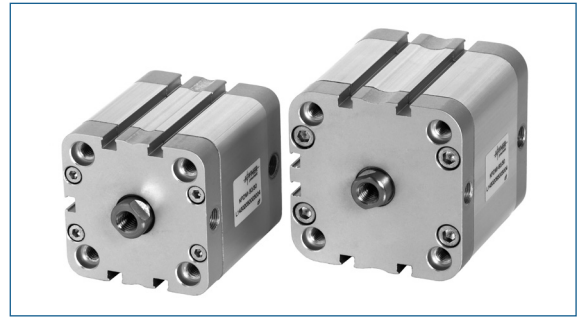

Standardmodelle

Ø	Kolbenstangen Ø	Anschluß	Verschleiß-teilsatz
20	10	M5	ET-KPDM-20
25	10	M5	ET-KPDM-25
32	12	G1/8	ET-KPDM-32
40	16	G1/8	ET-KPDM-40
50	16	G1/8	ET-KPDM-50
63	16	G1/8	ET-KPDM-63
80	20	G1/8	ET-KPDM-80
100	25	G1/8	ET-KPDM-100

Ø	KPDM Theoretische Kräfte (N) bei 6 bar	
	Druck	Zug
20	188	142
25	295	248
32	482	415
40	754	687
50	1178	1058
63	1869	1750
80	3014	2829
100	4710	4420

Technische Kenngrößen

Allgemeine Kenngrößen	
Medium	gefilterte, geölte oder ungeölte Druckluft
Funktion	doppeltwirkend, Magnetkolben, Endlagenpuffer KPDMI Kolbenstange mit Innengewinde, KPDM Kolbenstange mit Außengewinde inkl. Mutter
Betriebsdruck	1 ... 10 bar
Temperaturbereich	-20 °C * ... +80 °C * Bei Minustemperaturen bitte Luftbeschaffenheit beachten.
Hublängen	Standard: 5 mm, 10 mm, 15 mm, 20 mm, 25 mm, 30 mm, 40 mm, 50 mm, 60 mm, 70 mm, 75 mm, 80 mm, 90 mm, 100 mm, 125 mm, 160 mm, 200 mm, 250 mm; ab Ø 32: 300 mm, 350 mm, 400 mm; Sonderhublängen auf Anfrage. Ab 100 mm Hub werden Führungseinheiten empfohlen.
Werkstoffe	Profilrohr: Aluminium eloxiert; Enddeckel: Aluminiumdruckguss, lackiert; Kolbenstange: Edelstahl rostfrei (AISI 303); Dichtungen: Polyurethan und Nitrilkautschuk

Typenschlüssel

Wirkungsweise	Kennung
Mit Innengewinde	I
Durchgehende Kolbenstange	B
Verdrehgesicherte Kolbenstange (Ø 20 – 100)	F

KPDM *****-*** / *** / ****

Zylinder Ø (mm)	Kennung
20	20
25	25
32	32
40	40
50	50
63	63
80	80
100	100

Sonderausführungen
 siehe Seite 11

Hublängen (mm)

Achtung: Nicht benutzte Stellen bitte aufrücken.
 Kombinationen der alternativen Ausführungen auf Anfrage.

Kompaktzylinder ISO 21287

doppeltwirkend

KPDM

Ø 20 bis 100 mm

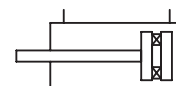

KPDMI Kolbenstange mit Innengewinde

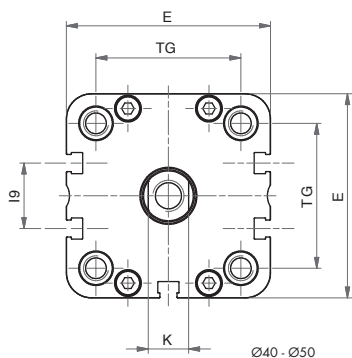
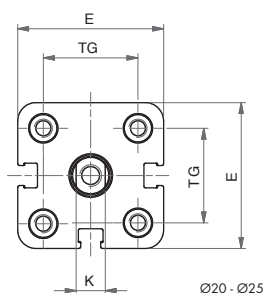
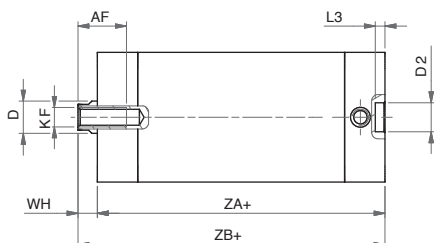

KPDM Kolbenstange mit Aussengewinde

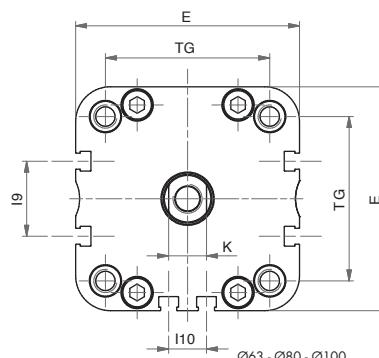
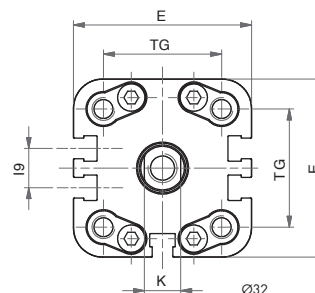
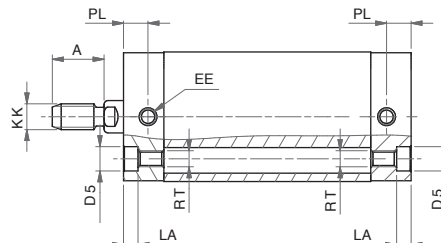

Abmessungen

Ø	20	25	32	40	50	63	80	100
A	16	16	19	19	22	22	28	28
AF	15	15	16	16	17	17	20	20
Ø D	10	10	12	12	16	16	20	25
Ø D2	9	9	9	9	12	12	12	12
Ø D5	7,5	7,5	9	9	10,5	10,5	13,5	13,5
E	36	40	49	54,5	65,5	77	95,5	113,5
EE	M5	M5	G1/8	G1/8	G1/8	G1/8	G1/8	G1/8
I9	-	-	10,8	12,8	21	25,8	30	50
I10	-	-	-	-	-	13	18	35
K	8	8	10	10	13	13	17	22
KF	M6	M6	M8	M8	M10	M10	M12	M12
KK	M8	M8	M10 x 1,25	M10 x 1,25	M12 x 1,25	M12 x 1,25	M16 x 1,5	M16 x 1,5
LA	4,5	4,5	5	5	5	5	3	3
L3	3	3	3	3	4	4	4	4
PL	7,5	7,5	7,5	8	8	7,5	8	10,5
RT	M5	M5	M6	M6	M8	M8	M10	M10
TG	22	26	32,5	38	46,5	56,5	72	89
WH	6,5	6	6,5	7	8	8	9	10
ZA+	37	39	44	45	45	49	54	67
ZB+	43,5	45	50,5	52	53	57	63	77

+ plus Hublänge (mm)

Kompaktzylinder ISO 21287

doppeltwirkend mit durchgehender Kolbenstange

KPDM_B...

Ø20 bis 100 mm

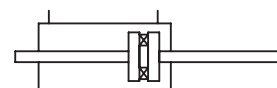

KPDMIB Kolbenstange mit Innengewinde

KPDMB Kolbenstange mit Aussengewinde

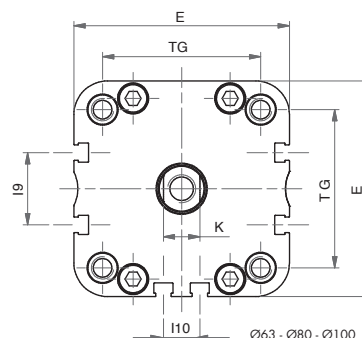
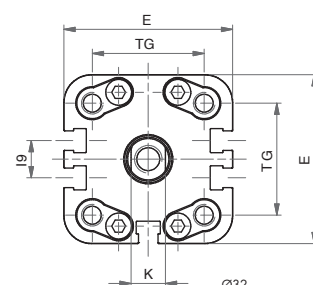
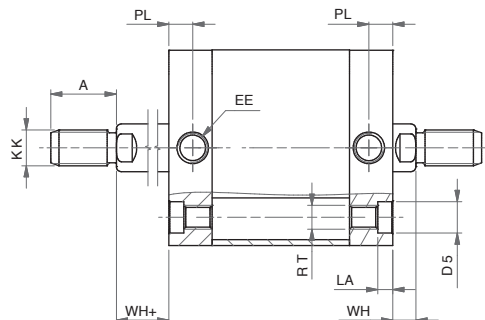
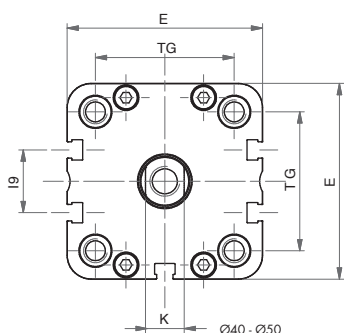
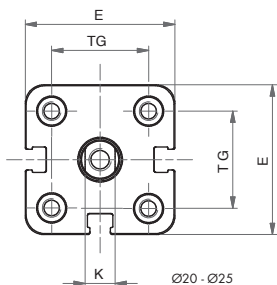
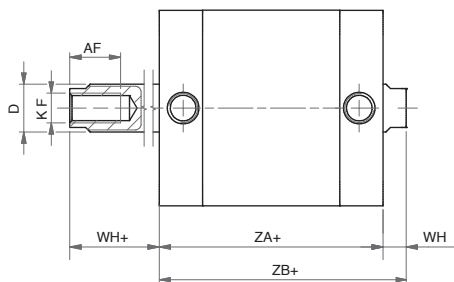

Abmessungen

Ø	20	25	32	40	50	63	80	100
A	16	16	19	19	22	22	28	28
AF	15	15	16	16	17	17	20	20
Ø D	10	10	12	12	16	16	20	25
Ø D5	7,5	7,5	9	9	10,5	10,5	13,5	13,5
E	36	40	49	54,5	65,5	77	95,5	113,5
EE	M5	M5	G1/8	G1/8	G1/8	G1/8	G1/8	G1/8
I9	-	-	10,8	12,8	21	25,8	30	50
I10	-	-	-	-	-	13	18	35
K	8	8	10	10	13	13	17	22
KF	M6	M6	M8	M8	M10	M10	M12	M12
KK	M8	M8	M10x1,25	M10x1,25	M12x1,25	M12x1,25	M16x1,5	M16x1,5
LA	4,5	4,5	5	5	5	5	3	3
PL	7,5	7,5	7,5	8	8	7,5	8	10,5
RT	M5	M5	M6	M6	M8	M8	M10	M10
TG	22	26	32,5	38	46,5	56,5	72	89
WH	6,5	6	6,5	7	8	8	9	10
WH+	6,5	6	6,5	7	8	8	9	10
ZA+	37	39	44	45	45	49	54	67
ZB+	43,5	45	50,5	52	53	57	63	77

+ plus Hublänge (mm)

Kompaktzylinder ISO 21287

doppeltwirkend mit verdrehgesicherter Kolbenstange
KPDMIF...
 Ø20 bis 100 mm

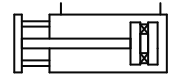

KPDMIF Kolbenstange mit Innengewinde

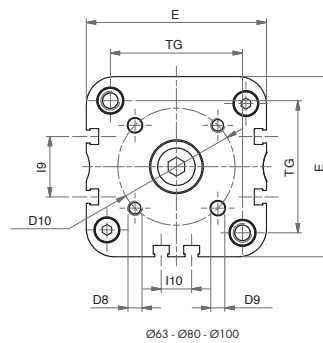
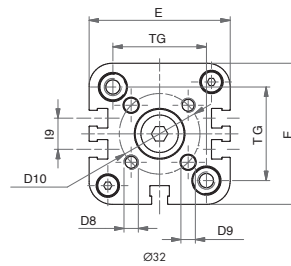
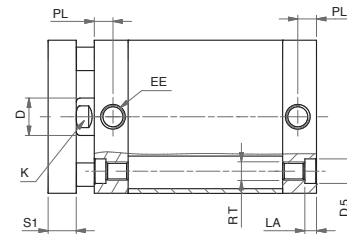
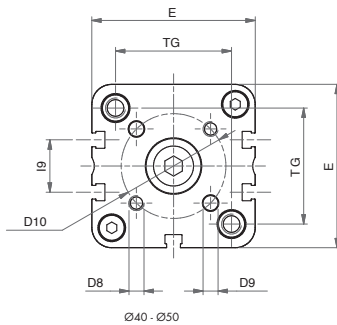
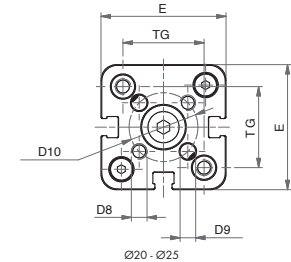
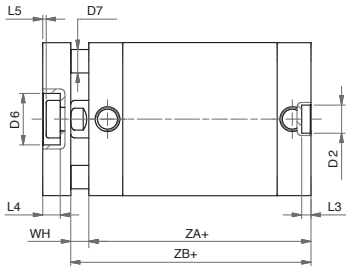

Abmessungen

Ø	20	25	32	40	50	63	80	100
Ø D	10	10	12	12	16	16	20	25
Ø D2	9	9	9	9	12	12	12	12
Ø D5	7,5	7,5	9	9	10,5	10,5	13,5	13,5
Ø D6	11	14	17	17	22	22	28	30
Ø D7	5	6	6	8	10	10	14	14
D8	M4	M5	M5	M5	M6	M6	M8	M10
Ø D9	4	5	5	5	6	6	8	10
Ø D10	17	22	28	33	42	50	65	80
E	36	40	49	54,5	65,5	77	95,5	113,5
EE	M5	M5	G1/8	G1/8	G1/8	G1/8	G1/8	G1/8
I9	-	-	10,8	12,8	21	25,8	30	50
I10	-	-	-	-	-	13	18	35
K	8	8	10	10	13	13	17	22
LA	4,5	4,5	5	5	5	5	3	3
L3	3	3	3	3	4	4	4	4
L4	5	5	6,5	6,5	7,5	7,5	9	10
L5	1	1	1,5	1,5	1,5	1,5	2	3
PL	7,5	7,5	7,5	8	8	7,5	8	10,5
RT	M5	M5	M6	M6	M8	M8	M10	M10
S1	8	8	10	10	12	12	14	14
TG	22	26	32,5	38	46,5	56,5	72	89
WH	6,5	6	6,5	7	8	8	9	10
ZA+	37	39	44	45	45	49	54	67
ZB+	43,5	45	50,5	52	53	57	63	77

+ plus Hublänge (mm)

Kompaktzylinder ISO 21287

doppeltwirkend mit verdrehgesicherter Kolbenstange

KPDMIF...

Ø 20 bis 100 mm

Zulässige Drehmomente

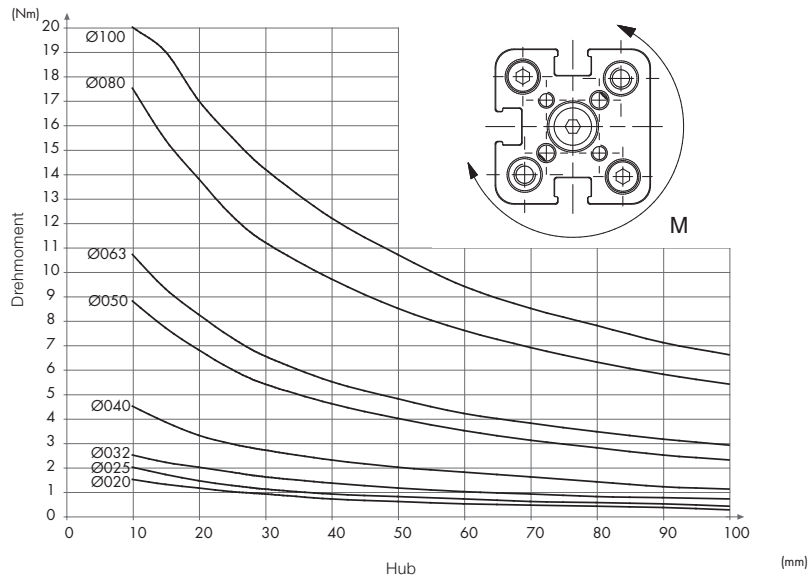

Kompaktzylinder ISO 21287

Sonderausführungen, lieferbar auf Anfrage

■ Doppelt wirkend, mit durchgehender, verdrehgesicherter Kolbenstange

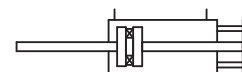

■ Tandemzylinder für doppelte Kraft – TM

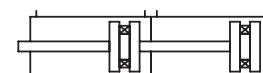
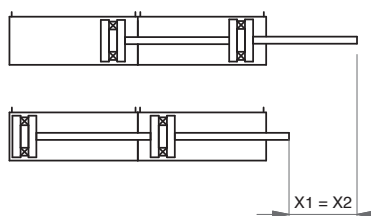

■ Tandem – 3-Stellungszylinder – PM

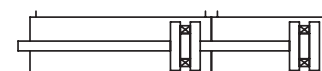
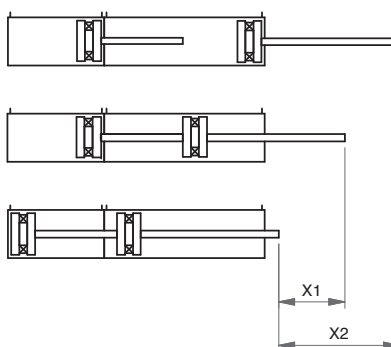

■ Tandem – 4-Stellungszylinder – CM

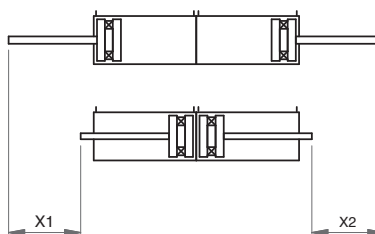

■ Zylinder komplett aus Edelstahl – VES

■ Zylinder für Tieftemperaturanwendungen – TT

Einsatz bei Umgebungs- und Mediumtemperatur von bis zu $-30\text{ }^{\circ}\text{C}$

■ Zylinder für Hochtemperaturanwendungen – HT

Einsatz bei Umgebungs- und Mediumtemperatur von bis zu $+180\text{ }^{\circ}\text{C}$

■ Kompaktzylinder nach UNITOP

Anbauteile für Kompaktzylinder ISO 21287

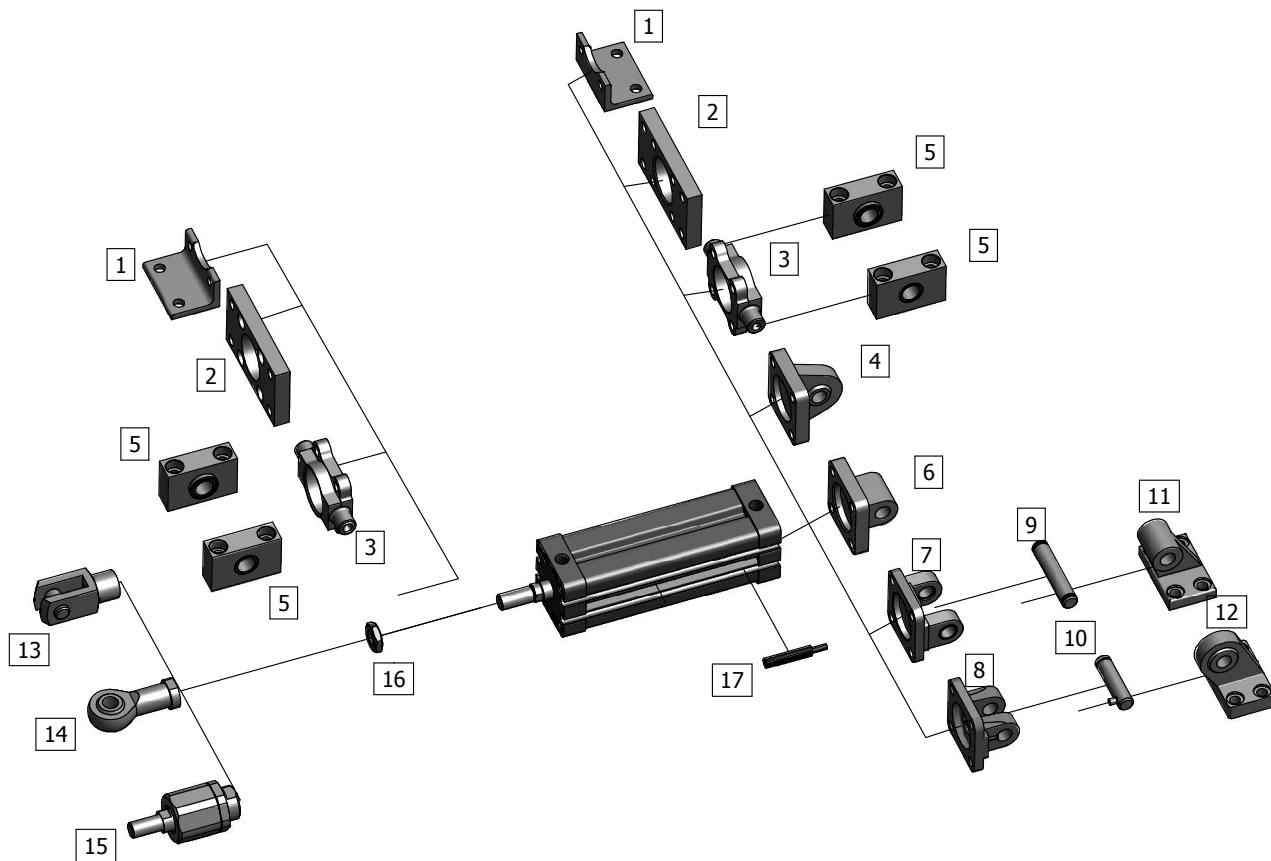









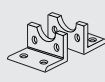

Position	Befestigungselement / Zubehör	Bezeichnung
1	Fußbefestigung – paarweise	MS1
2	Flanschbefestigung	MF1
3	Schwenkzapfenbefestigung	MT4N
4	Schwenkflansch mit sphärischer Lagerung	MP6
5	Lagerbock	AT4
6	Schwenkbefestigung	MP4
7	Gabelbefestigung	MP2
8	Gabelbefestigung	AB6
9	Bolzen	AA4
10	Bolzen	AA6
11	Lagerbock	AB7
12	Lagerbock sphärisch	US
13	Gabelgelenk	GF
14	Gelenkkopf	GS
15	Flexible Kupplung	FK
16	Kolbenstangenmutter	DS
17	Nährungsschalter	M60

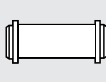
Kompaktzylinder ISO 21287 KPEM..., KPDM...





Ø 20 bis 100 mm

Befestigungselemente

Ø	Typ MF1 u. 2	Typ MS1	Typ MP4	Typ AB6	Typ MP2	Typ AA4
						
20	MF1/2-20	MS1-20	MP4-20	–	–	–
25	MF1/2-25	MS1-25	MP4-25	–	–	–
32	MF1/2-32	MS1-32	MP4-32	AB6-32	MP2-32	S-32
40	MF1/2-40	MS1-40	MP4-40	AB6-40	MP2-40	S-40
50	MF1/2-50	MS1-50	MP4-50	AB6-50	MP2-50	S-50
63	MF1/2-63	MS1-63	MP4-63	AB6-63	MP2-63	S-63
80	MF1/2-80	MS1-80	MP4-80	AB6-80	MP2-80	S-80
100	MF1/2-100	MS1-100	MP4-100	AB6-100	MP2-100	S-100

Ø	Typ AA6	Typ MP6	Typ AB7	Typ US	Typ MT4N	Typ L
						
20	–	–	–	–	–	–
25	–	–	–	–	–	–
32	SK-32	MP6-32	AB7-32	US-32	MT4N-32	L-32
40	SK-40	MP6-40	AB7-40	US-40	MT4N-40	L-40
50	SK-50	MP6-50	AB7-50	US-50	MT4N-50	L-50
63	SK-63	MP6-63	AB7-63	US-63	MT4N-63	L-63
80	SK-80	MP6-80	AB7-80	US-80	MT4N-80	L-80
100	SK-100	MP6-100	AB7-100	US-100	MT4N-100	L-100

Befestigungselemente für Zylinderserie (Kolbenstange mit Aussengewinde)

Ø	Typ GS	Typ GF	Typ FK	Typ Mutter		
						
20	GS-M8	GF-M8	FK-M8	DS-M8		
25	GS-M8	GF-M8	FK-M8	DS-M8		
32	GS-M10x1,25	GF-M10x1,25	FK-M10x1,25	DS-M10x1,25		
40	GS-M10x1,25	GF-M10x1,25	FK-M10x1,25	DS-M10x1,25		
50	GS-M12x1,25	GF-M12x1,25	FK-M12x1,25	DS-M12x1,25		
63	GS-M12x1,25	GF-M12x1,25	FK-M12x1,25	DS-M12x1,25		
80	GS-M16x1,5	GF-M16x1,5	FK-M16x1,5	DS-M16x1,5		
100	GS-M16x1,5	GF-M16x1,5	FK-M16x1,5	DS-M16x1,5		

Befestigungselemente für KPEM..., KPDM...

MF1 – Bodenflansch, MF2 Kopfflansch, Aluminium, Stahl auf Anfrage

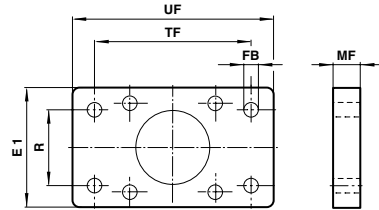
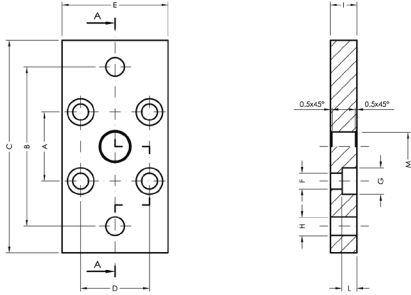

Typ	Ø	A ±0,2	B ±0,2	C ±0,2	D ±0,2	E ±0,2	F H13	G H13	H H13	I ±0,2	L ±0,2	M H11	kg
MF1/2-20	20	22	55	70	22	36	5,5	10	6,6	10	5,4	12	0,06
MF1/2-25	25	26	60	76	26	40	5,5	10	6,6	10	5,4	12	0,07

Typ	Ø	E1	Ø FB	MF	R	TF	UF	kg
MF1/2-32	32	50	7	10	32	64	80	0,25
MF1/2-40	40	55	9	10	36	72	90	0,35
MF1/2-50	50	65	9	12	45	90	110	0,70
MF1/2-63	63	75	9	12	50	100	125	0,80
MF1/2-80	80	100	12	16	63	126	154	1,35
MF1/2-100	100	120	14	16	75	150	186	2,20

MS1 – Fußbefestigung, Stahl, verzinkt

Typ	Ø	C ±0,2	B ±0,2	D Ø ±0,3	E ±1	F ±1	G H13	H ±0,2	I ±0,2	S ±0,5	T ±0,3	R H15	U	Z H13	kg
MS1-20	20	22,0	22	36	22	22	5,4	16,0	16	4	17	10,0	2	6,6	0,03
MS1-25	25	26,0	26	40	22	23	5,4	17,0	16	4	19	11,0	2	6,6	0,04
MS1-32	32	32,5	32	45	35	30	7,0	15,75	24	4	32	15,0	11	7,0	0,07
MS1-40	40	38,0	36	52	36	30	7,0	17,0	28	4	36	17,5	15	9,0	0,08
MS1-50	50	46,5	45	65	47	36	9,0	21,75	32	5	45	20,0	16	9,0	0,17
MS1-63	63	56,5	50	75	45	35	9,0	21,75	32	5	50	22,5	18	9,0	0,19
MS1-80	80	72,0	63	95	55	47	11,0	27,0	41	6	63	22,5	17	12,0	0,38
MS1-100	100	89,0	75	115	57	53	11,0	26,5	41	6	71	27,5	24	14,0	0,45

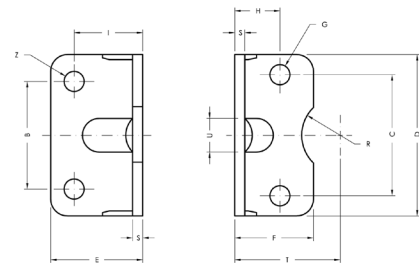

Maße nach ISO 15552, nicht ISO 21287.

MP4 – Schwenkbefestigung mit Buchse, Aluminium

Typ	Ø	A ±0,2	L	D H13	R H15	N ±0,5	G	S H11	F	C ±0,2	Q F7	M H9	T max	B	kg
MP4-20	20	22,0	34	5,0	11	2,6	6	12	3	20	10	8	8	16	0,02
MP4-25	25	26,0	38	5,0	11	2,6	6	12	3	20	10	8	8	16	0,03
MP4-32	32	32,5	45	6,6	11	5,5	9	30	5	22	12	10	10	26	0,05
MP4-40	40	38,0	52	6,6	11	5,5	9	35	5	25	14	12	12	28	0,08
MP4-50	50	46,5	65	9,0	15	6,5	11	40	5	27	14	12	12	32	0,12
MP4-63	63	56,5	75	9,0	15	6,5	11	45	5	32	18	16	16	40	0,21
MP4-80	80	72,0	95	11,0	18	10,0	14	45	5	36	18	16	12	50	0,42
MP4-100	100	89,0	115	11,0	18	10,0	14	55	5	41	23	20	20	60	0,67

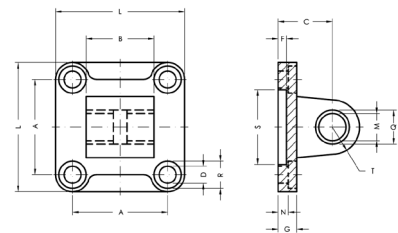

Befestigungselemente für KPEM..., KPDM...

AB6 – Gabelbefestigung, Aluminium, Verdrehsicherung

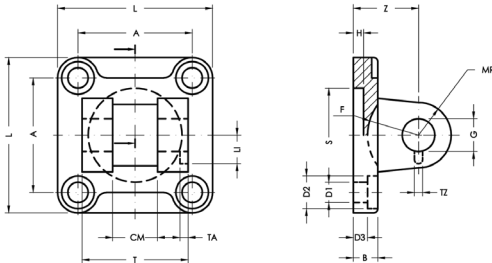

Typ	Ø	L ±0,5	T d12	CM H14	A ±0,2	Z ±0,2	H +1 0	B	D3 ±0,5	S H12	G F7	MR +1 0	D1 +0,4 -0,2	D2	TA +0,2 0	TZ +0,2 0	LI +0,3 0	F min	kg
AB6-32	32	45	34	14	32,5	22	5	9	5,5	30	10	10	6,6	11	3	3,3	11,5	17	0,04
AB6-40	40	52	40	16	38,0	25	5	9	5,5	35	12	12	6,6	11	4	4,3	12,0	20	0,07
AB6-50	50	65	45	21	46,5	27	5	11	6,5	40	16	14	9,0	15	4	4,3	14,0	22	0,11
AB6-63	63	75	51	21	56,5	32	5	11	6,5	45	16	18	9,0	15	4	4,3	14,0	25	0,19
AB6-80	80	95	65	25	72,0	26	5	14	10,0	45	20	20	11,0	18	4	4,3	16,0	30	0,38
AB6-100	100	115	75	25	89,0	41	5	14	10,0	55	20	22	11,0	18	4	6,3	16,0	32	0,61

MP2 – Gabelbefestigung mit Buchse, Aluminium

Typ	Ø	A ±0,2	L	D H13	R H13	N ±0,5	B	S H11	F	Z ±0,2	G H9	M max	CM H14	T h14	kg
MP2-32	32	32,5	45	6,6	11	5,5	9	30	5	22	10	10	26	45	0,05
MP2-40	40	38,0	52	6,6	11	5,5	9	35	5	25	12	12	28	52	0,07
MP2-50	50	46,5	65	9,0	15	6,5	11	40	5	27	12	12	32	60	0,12
MP2-63	63	56,5	75	9,0	15	6,5	11	45	5	32	16	16	40	70	0,19
MP2-80	80	72,0	95	11,0	18	10,0	14	45	5	36	16	16	50	90	0,38
MP2-100	100	89,0	115	11,0	18	10,0	14	55	5	41	20	20	60	110	0,62

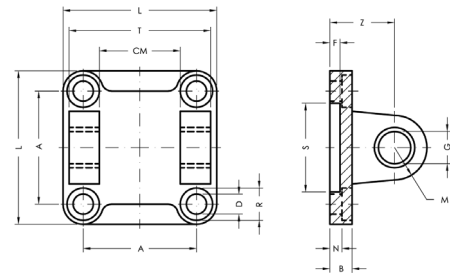

AA4-Bolzen mit Sicherung für Gabelbefestigung MP2

Typ	Ø	EK ₁₇	EL +0,3 0	L	kg
AA4-32	32	10	46	53	0,03
AA4-40	40	12	53	60	0,05
AA4-50	50	12	61	68	0,06
AA4-63	63	16	71	78	0,12
AA4-80	80	16	91	98	0,15
AA4-100	100	20	111	118	0,29

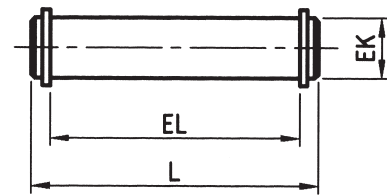

AA6-Bolzen mit Verdrehsicherung für Gabelbefestigung AB6

Typ	Ø	EK ₁₇	d ₄ H12	l ₁ +0,5 -0,3	l ₂ 0 -1	l ₃	l ₄ 0 -0,5	kg
AA6-32	32	10	3	32,5	4,5	41	14	0,03
AA6-40	40	12	4	38,0	6,0	48	16	0,04
AA6-50	50	16	4	43,0	6,0	54	20	0,08
AA6-63	63	16	4	49,0	6,0	60	20	0,10
AA6-80	80	20	4	63,0	6,0	75	24	0,19
AA6-100	100	20	4	73,0	6,0	85	24	0,20

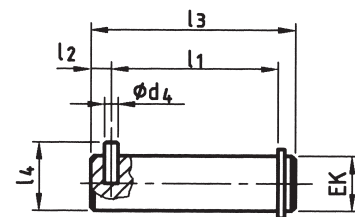

Befestigungselemente für KPEN..., KPDM...

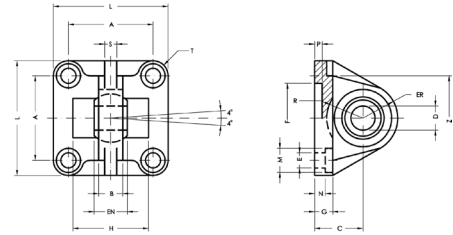

MP6 – Schwenkbefestigung mit Kugelgelenk, Aluminium

Typ	Ø	A ±0,2	B max	C JS 15	D H 7	EN -8,1	ER max	F H 11	G	E H 13	L	M H 13	N ±0,5	P	H ±0,5	R ±0,2	S	Z	T	Kg
MP6-32	32	32,5	10,5	22	10	14	16,0	30	9	6,6	45	11	5,5	5	-	-	4	32,5	6,25	0,06
MP6-40	40	38,0	12,0	25	12	16	19,0	35	9	6,6	52	11	5,5	5	-	-	6	39,0	7,00	0,10
MP6-50	50	46,5	15,0	27	16	21	21,0	40	11	9,0	65	15	6,5	5	51	18	8	47,0	9,25	0,18
MP6-63	63	56,5	15,0	32	16	21	24,0	45	11	9,0	75	15	6,5	5	-	-	8	52,0	9,25	0,24
MP6-80	80	72,0	18,0	36	20	25	28,5	45	14	11,0	95	18	10,0	5	72	24	10	67,0	11,50	0,47
MP6-100	100	89,0	18,0	41	20	25	30,0	55	14	11,0	115	18	10,0	5	-	-	10	77,0	13,00	0,65

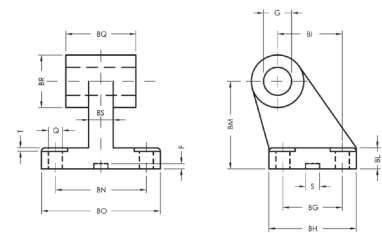

AB7 – Lagerbock starr, breit, Aluminium

Typ	Ø	Q H 13	M H 13	BG JS 14	BH max	BI JS 14	BL	BM JS 15	BN JS 14	BO max	BS max	BR max	T max	G H 9	S +0,5 0	F +0,5 0	BQ	Kg
AB7-32	32	6,6	11	18	31	21	8	32	38	51	10	20	1,6	10	10,5	3	26	0,06
AB7-40	40	6,6	11	22	35	24	10	36	41	54	15	22	1,6	12	10,5	3	28	0,14
AB7-50	50	9,0	15	30	45	33	12	45	50	65	16	26	1,6	12	10,5	3	32	0,14
AB7-63	63	9,0	15	35	50	37	14	50	52	67	16	30	1,6	16	10,5	3	40	0,20
AB7-80	80	11,0	18	40	60	47	14	63	66	86	20	30	2,5	16	10,5	3	50	0,31
AB7-100	100	11,0	18	50	70	55	17	71	76	96	20	38	2,5	20	10,5	3	60	0,66

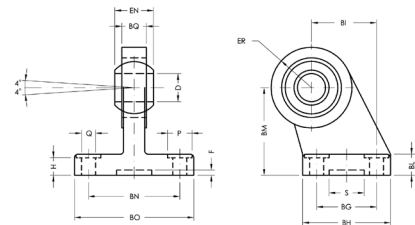

US – Lagerbock mit Gelenklager, Stahl

Typ	Ø	Q H 13	P H 13	BG JS 14	BH max	BI JS 15	BL	BM JS 15	BN JS 14	BO max	EN -8,1	ER max	BQ max	D H 7	H +0,5 0	S H 13	F	Kg
US-32	32	6,6	11	18	31	21	10	32	38	51	14	15	10,5	10	8,5	20	3	0,18
US-40	40	6,6	11	22	35	24	10	36	41	54	16	18	12,0	12	8,5	20	3	0,27
US-50	50	9,0	15	30	45	33	12	45	50	65	21	20	15,0	16	10,5	20	3	0,46
US-63	63	9,0	15	35	50	37	12	50	52	67	21	23	15,0	16	10,5	20	3	0,55
US-80	80	11,0	18	40	60	47	14	63	66	86	25	27	18,0	20	11,5	20	3	0,97
US-100	100	11,0	18	50	70	55	15	71	76	96	25	30	18,0	20	12,5	20	3	1,33

Befestigungselemente für KIEM..., KIDM...

MT4N – Schwenzapfenbefestigung (vorne oder hinten), Stahl

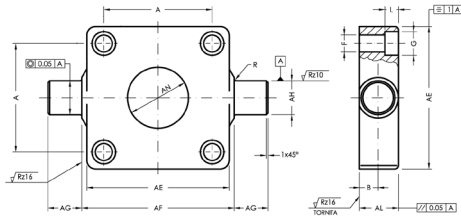

Typ	Ø	AE _{max}	AL _{max}	AH _{e9}	AG _{h14}	AF _{H11}	AN _{H11}	A _{±0,2}	B _{+0,2 0}	F _{H13}	G _{H13}	L _{+0,5 0}	B _{0 -0,3}	kg
MT4N-32	32	46	14	12	12	50	30	32,5	6,5	6,5	-	6	1,0	0,14
MT4N-40	40	59	19	16	16	63	35	38,0	9,0	6,5	10,5	6	1,6	0,38
MT4N-50	50	69	19	16	16	75	40	46,5	9,0	8,5	13,5	8	1,6	0,51
MT4N-63	63	84	24	20	20	90	45	56,5	11,5	8,5	13,5	8	1,6	1,04
MT4N-80	80	102	24	20	20	110	45	72,0	11,5	10,5	16,5	10	1,6	1,57
MT4N-100	100	125	29	25	25	132	55	89,0	14,0	10,5	16,5	10	2,0	3,00

L – Schwenklager für Schwenzapfenbefestigung, Paar, Aluminium

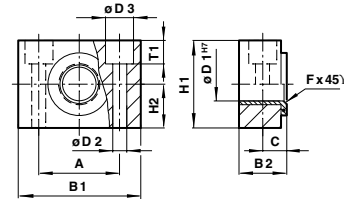

Typ	Ø	A	B1	B2	C	Ø D1	Ø D2	Ø D3	fx45°	H1	H2	T1	kg
L-32	32	32	46	18,0	10,5	12	6,6	11	1,0	30	15	6,6	0,11
L-40	40	36	55	21,0	12,0	16	9,0	15	1,6	36	18	9,0	0,16
L-50	50	36	55	21,0	12,0	16	9,0	15	1,6	36	18	9,0	0,16
L-63	63	42	65	23,0	13,0	20	11,0	18	1,6	40	20	11,0	0,23
L-80	80	42	65	23,0	13,0	20	11,0	18	1,6	40	20	11,0	0,23
L-100	100	50	75	28,5	16,0	25	14,0	20	2,0	50	25	13,0	0,42

GS – Gelenkkopf

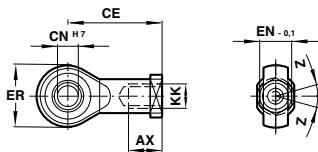

Typ	Ø	KK	AX	CE	Ø CN	EN _{-0,1}	ER	Z	kg
GS-M-20	20	M8	16	36	8	12	24	5°	0,05
GS-M-25	25	M8	16	36	8	12	24	5°	0,05
GS-M-32	32	M10x1,25	20	43	10	14	28	13°	0,09
GS-M-40	40	M10x1,25	20	43	10	14	28	13°	0,09
GS-M-50	50	M12x1,25	22	50	12	16	32	13°	0,12
GS-M-63	63	M12x1,25	22	50	12	16	32	13°	0,12
GS-M-80	80	M16x1,5	28	64	16	21	42	15°	0,23
GS-M-100	100	M16x1,5	28	64	16	21	42	15°	0,23

GF – Gabelgelenk

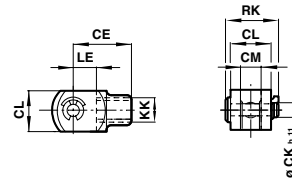

Typ	Ø	KK	CE	Ø CK _{h11}	CL	CM	LE	RK	kg
GF-M-20	20	M8	32	8	16	8	16	21,6	0,06
GF-M-25	25	M8	32	8	16	8	16	21,6	0,06
GF-M-32	32	M10x1,25	40	10	20	10	20	26,0	0,09
GF-M-40	40	M10x1,25	40	10	20	10	20	26,0	0,09
GF-M-50	50	M12x1,25	48	12	24	12	24	31,0	0,15
GF-M-63	63	M12x1,25	48	12	24	12	24	31,0	0,15
GF-M-80	80	M16x1,5	64	16	32	16	32	39,5	0,35
GF-M-100	100	M16x1,5	64	16	32	16	32	39,5	0,35

FK – Ausgleichkupplung

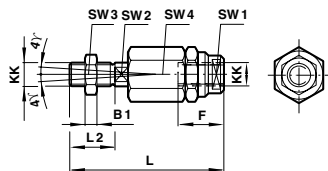

Typ	Ø	KK	B1	F	L _{±2}	L2	SW1	SW2	SW3	SW4	kg
FK-M-20	20	M8	4	14	55	16	10	7	13	17	0,06
FK-M-25	25	M8	4	14	55	16	10	7	13	17	0,06
FK-M-32	32	M10x1,25	5	23	70	20	19	12	17	30	0,23
FK-M-40	40	M10x1,25	5	23	70	20	19	12	17	30	0,23
FK-M-50	50	M12x1,25	6	30	77	24	19	12	19	30	0,23
FK-M-63	63	M12x1,25	6	30	77	24	19	12	19	30	0,23
FK-M-80	80	M16x1,5	8	32	108	32	30	19	24	41	0,65
FK-M-100	100	M16x1,5	8	32	108	32	30	19	24	41	0,65

Näherungsschalter mit Reed-Kontakt – 2-adrig M60RV2

- Direkte Montage in entsprechende Profilluten
- Kompakte Schalter mit LED-Anzeige
- Alternative Ausführungen sichern Anwendungsvielfalt

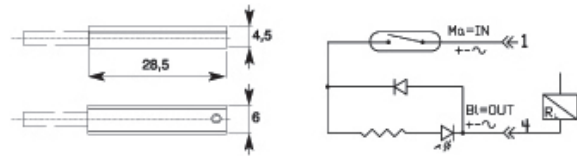
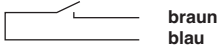

Technische Kenngrößen

Allgemeine Kenngrößen	
Wirkungsweise	PNP-Ausgang mit LED (gelb)
Betriebsspannung (U _b)	10 ... 240V AC/DC
Schaltstrom	400 mA bei 25 °C
Schaltleistung	10 W/8 VA max.
Achtung: Ein Überschreiten der angegebenen Maximalwerte für Kontaktbelastung, Schaltstrom und Schaltspannung führt zu einer verringerten Lebensdauer.	
Gerätetemperatur	-25 °C ... +90 °C
Schutzart	IP 67 (DIN 40050)
Standard Kabellänge	3 m
Material	Gehäuse: PA; Kabel: PVC, PUR auf Anfrage

Typenschlüssel:

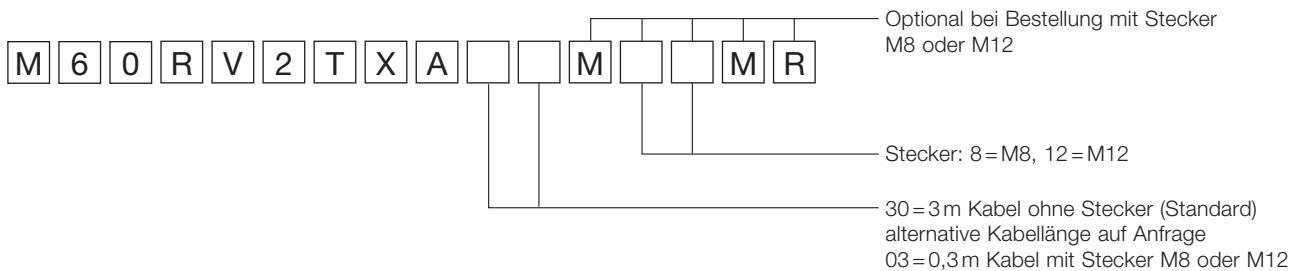

Näherungsschalter mit Reed-Kontakt – 3-adrig M60RS3

- Direkte Montage in entsprechende Profilluten
- Kompakte Schalter mit LED-Anzeige
- Alternative Ausführungen sichern Anwendungsvielfalt

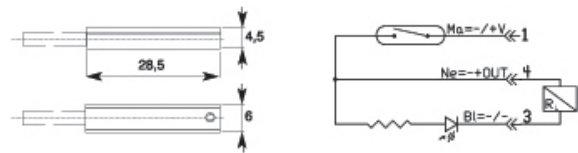
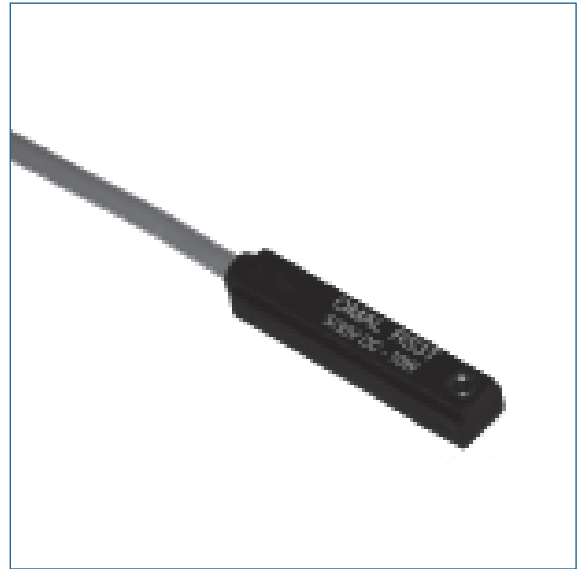
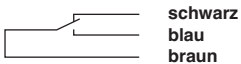

Technische Kenngrößen

Allgemeine Kenngrößen	
Wirkungsweise	PNP-Ausgang mit LED (gelb)
Betriebsspannung (U _b)	5 ... 30V DC
Schaltstrom	400mA bei 25 °C
Schaltleistung	10W
Achtung: Ein Überschreiten der angegebenen Maximalwerte für Kontaktbelastung, Schaltstrom und Schaltspannung führt zu einer verringerten Lebensdauer.	
Gerätetemperatur	-25 °C ... +90 °C
Schutzart	IP 67 (DIN 40050)
Standard Kabellänge	3 m
Material	Gehäuse: PA; Kabel: PVC, PUR auf Anfrage

Typenschlüssel:

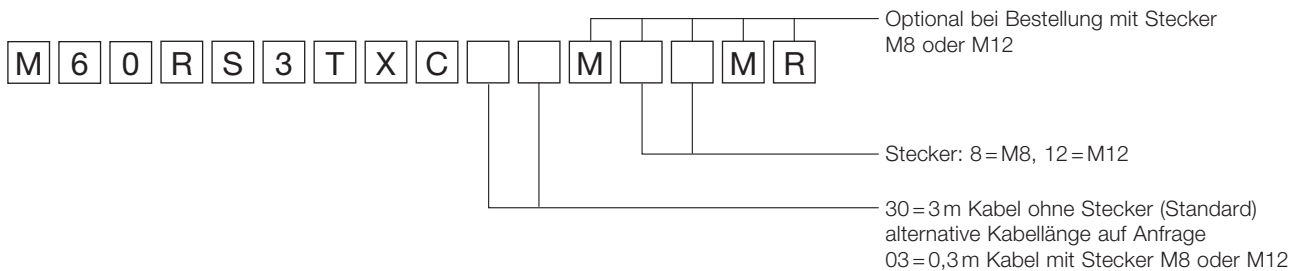

Näherungsschalter Elektronisch

M60GMP

- Direkte Montage in entsprechende Profilmuten
- Zuverlässige, schnelle Reaktionszeiten
- Verschleißfrei
- Stoß- und schwingungsfest
- LED-Anzeige standardmäßig

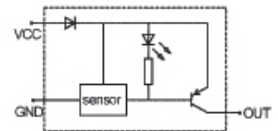
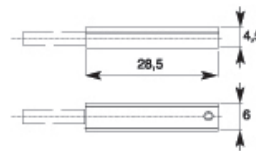
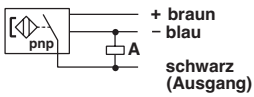

Technische Kenngrößen

Allgemeine Kenngrößen	
Wirkungsweise	PNP-Ausgang mit LED (gelb)
Betriebsspannung (U _b)	5 ... 30 V DC
Schaltstrom (siehe Diagramm)	150 mA max.
Schaltzeit	< 0,5 ms
Gerätetemperatur	-25 °C ... +90 °C
Schutzart	IP 67 (DIN 40050)
Kabellänge	3 m
Material	Gehäuse: PA; Kabel: PVC, PUR auf Anfrage

Typenschlüssel:

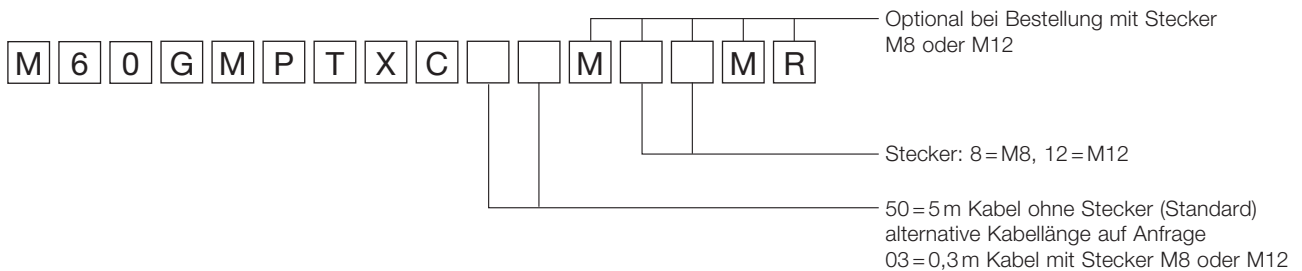

JOYNER pneumatic GmbH

Im Netzbrunnen 6 · D-70825 Korntal-Münchingen
 Telefon +49 (0) 7150 91312-0 · Telefax +49 (0) 7150 91312-10
 Internet: www.joyner.de · e-mail: info@joyner.de

DAS JOYNER-GESAMTPROGRAMM...



Rundzylinder



Zylinder ISO 15552



Kompaktzylinder
ISO 21287



Universal- und
Spannzylinder



Kolbenstangenlose
Linear-Zylinder



Ventilinsel
Verkettungssysteme



Kolbenschieber-
Ventilprogramm



NAMUR-Ventilprogramm



Manuell- und mechanisch
betätigte Ventile



K-Ringe und Komplettkolben

Wir bewegen mehr als Luft

BADEN-WÜRTTEMBERG

Kellerer Pneumatic GmbH

Im Netzbrunnen 6
 D-70825 Korntal-Münchingen
 Telefon +49 (0) 7150 94854-0
 Telefax +49 (0) 7150 94854-19
 e-mail: info@kellerer-pneumatic.de

NORDBADEN, SAAR, PFALZ

Hekomatic

Drucklufttechnische Anlagen GmbH
 Marconistraße 17-21
 D-68309 Mannheim
 Telefon +49 (0) 621 722963
 Telefax +49 (0) 621 722964
 e-mail: hekomatic@t-online.de

NORDRHEIN-WESTFALEN, NORDHESSEN, SÜD-NIEDERSACHSEN, SACHSEN-ANHALT

JOYNER pneumatic GmbH

Schimmelbuschstraße 9
 D-40699 Erkrath
 Telefon +49 (0) 2104 3035-40
 Telefax +49 (0) 2104 3035-55
 e-mail: erkath@joyner.de

BAYERN

JOYNER pneumatic GmbH

Im Netzbrunnen 6
 D-70825 Korntal-Münchingen
 Telefon +49 (0) 7150 91312-0
 Telefax +49 (0) 7150 91312-10
 e-mail: info@joyner.de

HESSEN

Walter Schmidt Ingenieurbüro GmbH

Hungener Straße 5
 D-60389 Frankfurt/Main
 Telefon +49 (0) 69 5962072
 Telefax +49 (0) 69 5962074
 e-mail: walter_schmidt_
 ingbuerogmbh_fm@hotmail.com

NORDDEUTSCHLAND

Wille GmbH Ingenieurbüro für Drucklufttechnik

Norderoog 4
 D-28259 Bremen
 Telefon +49 (0) 421 57636-0
 Telefax +49 (0) 421 57636-30
 e-mail: info@wille-gmbh.de

