



**PROCEEDINGS OF
V. INTERNATIONAL
AGRICULTURAL, BIOLOGICAL,
LIFE SCIENCE CONFERENCE
AGBIOL 2023**

18-20 SEPTEMBER 2023

EDIRNE, TURKEY



**PROCEEDINGS OF
V. INTERNATIONAL
AGRICULTURAL, BIOLOGICAL,
LIFE SCIENCE CONFERENCE
AGBIOL 2023**

**18-20 SEPTEMBER 2023
EDİRNE, TURKEY**

**Organized by
Trakya University**

**ISBN #:
978-605-73041-6-2**

WELCOME NOTES

You are welcome to our V. AGBIOL Conference that is organized by Trakya University. The aim of our conference is to present scientific subjects of a broad interest to the scientific community, by providing an opportunity to present their work as oral or poster presentations that can be of great value for global science arena. Our goal was to bring three communities, namely science, research and private investment together in a friendly environment of Edirne, Turkey in order to share their interests and ideas and to get benefit from the interaction with each other.

In September 2018, we organized the first AGBIOL Conference with more than 700 scientists and researchers from all over the world with over 800 scientific papers. Due to COVID-19 situation, II. AGBIOL 2020 has organized fully on-line event which was one of the biggest online conferences in recent years in the world with 499 papers and 1133 authors with 333 oral and 166 e-poster presentations from 55 countries. Due to COVID-19 situation, AGBIOL 2021 was organized online again. AGBIOL 2022 conference was organized with a worldwide participation from 44 countries over 522 papers contributed by over 1300 authors.

There is a worldwide participation from 33 countries 833 papers contributed by over 2000 authors with 522 oral and 311 poster presentations in AGBIOL 2023.

The AGBIOL 2023 will be normal participation as well as with online participation in Trakya University Balkan Congress Center in Edirne, Turkey on 18-20 September, 2023. The program will include oral talks by invited prominent scientists and oral and e poster presentations by participants in selected topics from the submitted ABSTRACTs focusing on Agriculture, Biology and Life Sciences topics.

With care for our nature and environment, we aim the green congress, meaning that as little as possible papers will be used. ABSTRACT book will be published in electronic book and will be distributed to the participants on flash memory stick as well as by e mail for online participants. All the e-posters should be prepared in electronic form and then submit to via the conference e mail and will exhibit in electronical poster boards as well as in online e poster hall in our web page during the conference.

The participants with paid conference fee will be able to access all the normal and virtual presentation talks in each session, as well as to visit the virtual poster hall via preliminary provided participant ID and codes. The selected ABSTRACTs will be published in the Conference ABSTRACT and Proceedings Book. Participants might send us their full papers, which based on their preferences will be published either in our Conference ABSTRACT and Proceedings Book or in selected International Indexed Scientific Journals.

Conference Topics:

Agriculture, Forestry, Life Sciences, Agricultural Engineering, Aquaculture and Biosystems, Animal Science, Biomedical science, Biochemistry and Molecular Biology, Biology, Bioengineering, Biomaterials, Biomechanics, Biophysics, Bioscience, Biotechnology, Botany, Chemistry, Chemical Engineering, Earth Sciences, Environmental Science, Food Science, Genetics and Human Genetics, Medical Science, Machinery, Pharmaceutical Sciences, Physics, Soil Science.

We would like to thank all of you for joining this conference and we would like to give also special thanks to our sponsors and collaborators for giving us a big support to organize this event.

Prof Dr Yalcin KAYA
Head of the Organizing Committee

ORGANIZING COMMITTEE

Prof. Dr. Yalcin KAYA	Trakya University, Turkey	Chair
Assoc Prof. Dr. Necmi BEŞER	Trakya University, Turkey	Co-Chair
Emrah AKPINAR	Trakya University, Turkey	Secretary
Prof. Dr. Viliana VASSILEVA	Inst. of Forage Crops, Plevna, Bulgaria	Member
Prof. Dr. Ioannis TOKATLIDIS	Trakia Democritus University, Greece	Member
Prof Dr Mohamed RAMDANI	University of Mohamed V Agdal, Maroc	Member
Assoc. Prof. Dr. Natiga NABIYEVA	Genetic Resources Inst. of NAS, Azerbaijan	Member
Dr Maria PACUREANU	NARDI Fundulea Institute, Romania	Member
M. İbrahim YILMAZ	Trakya Agricultural Research Institute	Member

INVITED SPEAKERS

ASST PROF DR MARIANA PETKOVA – Plovdiv Agricultural University, Bulgaria

PROF DR ENDER MAKINECI - Istanbul University-Cerrahpasa, Turkey

PROF DR RAPHAEL SANDALTZOPOULOS - Democritus Univ. of Thrace, Greece

PROF DR APOSTOLOS KIRITSAKIS - International Hellenic Univ, Greece

EDITOR OF THE PROCEEDING BOOK

Prof Dr Yalcin KAYA, Assoc Prof Dr Necmi BESER

SCIENTIFIC COMMITTEE

<u>NAME</u>	<u>INSTITUTION</u>	<u>COUNTRY</u>
Acad. Prof. Dr. Atanas ATANASSOV	Joint Genomic Center - Sofia	Bulgaria
Prof Dr Amel MIILA	ENSV, Alger	Algeria
Prof. Dr. Miguel CANTAMUTTO	IINTA Hilario Ascasubi Institute,	Argentina
Prof. Dr Zhao JUN	Inner Mongolia Agricultural Un.	China
Prof. Dr. Renata HORN	University of Rostock	Germany
Prof. Dr. Mulpuri SUJATHA	Indian Inst of Oilseeds Res.	India
Prof. Dr Lara HANNA WAKIM	Holy Spirit University	Lebanon
Prof. Dr Semra HASACEBI	Trakya University	Turkey
Prof Dr Velibor SPALEVIC	University of Montenegro	Montenegro
Prof Dr Charles BRENNAN	RMIT University	Australia
Prof. Dr. Saeed RAUF	University of Sargodha	Pakistan
Prof. Dr. h.c. Radu E. SESTRAS	Un of Agric.Vet Med Cluj-Napoca	Romania
Prof. Dr. Dejana PANKOVIC	Educon University	Serbia
Prof Dr Leonardo VELASCO	Inst. for Sustainable Agric. CSIC	Spain
Prof. Dr. Mehmet Emin CALISKAN	Nigde OmerHalisdemir University	Turkey
Prof. Dr. Ahmet ULUDAG	Onsekizmart University	Turkey
Prof. Dr Ahu ALTINKUT UNCUOGLU	Marmara University	Turkey
Prof. Dr. Metin TUNA	Namık Kemal University	Turkey
Prof. Dr. Sezen ARAT	Namık Kemal University	Turkey
Prof. Dr. Coskun GULSER	Ondokuzmayis University	Turkey
Prof. Dr. Metin AYDOĞDU	Trakya University	Turkey
Prof. Dr. Ismail CAKMAK	Sabancı University	Turkey
Prof. Dr. Yaroslav BLUME	National Academy of Sciences	Ukraine
Prof. Dr. Nurhan T. DUNFORD	Oklahoma State University	USA
Prof. Dr. Mahmut TOR	University of Worcester	England
Prof. Dr Ozlem TOKUSOGLU	Celal Bayar University	Turkey
Prof. Dr Mustafa TAN	Trakya University	Turkey
Assoc Prof. Dr. Gökhan KAÇAR	Trakya University	Turkey
Assoc Prof. Dr. Süleyman KÖK	Trakya University	Turkey
Assoc. Prof. Dr Zizis VRYZAS	Democritus University of Thrace	Greece
Assoc. Prof Dr Ina ZIVATKAUSKIENE	University of Applied Sciences	Lithuania
Assoc. Prof. Dr. Nooduan MUANGSAN	Suranaree Univ. of Technology	Thailand
Asst. Prof. Dr. Sarra JRIBI	University of Carthage	Tunisia
Asst. Prof. Dr. Buket AŞKIN	Kırklareli University	Turkey
Asst. Prof. Dr. Hayati ARDA	Trakya University	Turkey
Asst. Prof. Dr. Güzin TUNCA ALPASLAN	Trakya University	Turkey
Asst. Prof. Dr. Nihan Bilge KAMER	Trakya University	Turkey
Asst. Prof. Dr. Mehmet YABAŞ	Malatya Turgut Özal University	Turkey
Dr Veli PEKCAN	Trakya Agric. Research Institute	Turkey

CONTENTS

WELCOME NOTES.....	3
ORGANIZING COMMITTEE.....	4
SCIENTIFIC COMMITTEE.....	5
ECO-DENDROMETROC STUDY OF <i>PINUS HALEPENSIS</i> MILL. IN THE FOREST OF TERNI (WESTERN ALGERIA)	14
DETERMINATION OF SOME WILD PLANT SPECIES CONSUMED AS VEGETABLES IN FETHİYE (MUĞLA).....	21
RATIONAL USE OF PASTURES USING REMOTE SENSING ON THE LANDS OF NORTHERN KAZAKHSTAN	30
THE ROLE OF DNA METHYLATION IN SHEEP' EMBRYONIC DEVELOPMENT	36
BDELLOVIBRIO BACTERIOVORUS IN BIOFILM AND MICROBIOLOGICALLY INFLUENCED CORROSION INHIBITION	43
POTENTIAL APPLICATION OF CANNABIS AND CANNABIS DERIVED COMPOUNDS AGAINST BIOFILM.....	53
TOMATO RESISTANCE GENES MI AGAINST TO THE ROOT KNOT NEMATODE (<i>MELOIDOGYNE</i> SPP.) AND MOLECULAR APPROACHES.	60
EUNIS HABITATS OF HIGH ANTHROPOGENIC IMPACT IN THE WATERSHED OF THE MIDDLE SECTION OF THE DEVOLL RIVER.....	70
ANTIBIOTIC SUSCEPTIBILITY OF E. COLI AGENT ISOLATED FROM CALF DIARRHEA AND MASTITIS CASES IN SOME REGIONS OF TURKEY	79
ANTIMICROBIAL ACTIVITY OF NEW CREAM FORMULATIONS: <i>Hylocereus polyrhizus</i> AQUEOUS EXTRACTS AND <i>Limosilactobacillus fermentum</i> MA-7.....	85
APPLICATION OF LIPOSOMAL ENCAPSULATED ANTIMICROBIAL BIOACTIVE COMPONENTS IN FOOD PRODUCTS AS NATURAL PRESERVATION	90
IMPACT OF HESPERIDIN AGAINST GENOTOXIC RISKS CAUSED BY SODIUM FLUORIDE IN MICE LEYDIG.....	97
PHYTOSANITARY PRACTICES AND OPERATOR EXPOSURE LEVELS	106
EFFECTS OF THE PLANT-GROWTH-PROMOTING RHIZOBACTERIA (PGPRS) ON EXPRESSION OF SALT STRESS RELATED GENES IN TOMATO PLANTS UNDER DROUGHT STRESS CONDITIONS.....	113
ASSESSING THE IMPACT OF IRRIGATION WATER SALINITY ON MINERAL COMPOSITION IN DIFFERENT PART OF TOMATO.....	130
INVESTIGATION OF THE EFFECT OF PHAGE APPLICATION ON ANTIBIOTIC RESISTANCE LEVELS OF MULTIDRUG-RESISTANT ESCHERICHIA COLI ISOLATES	137
A PRELIMINARY STUDY ON THE EFFECTS OF MANURE AND ADDITIONAL PHOSPHORUS FERTILIZER IN DIFFERENT RATIO ON FOUR-WINGED SALT BUSH	144
AGRONOMIC PROPERTIES AND L-DOPA CONTENT OF BROAD BEAN (<i>Vicia faba</i> L.) GROWN IN DIFFERENT WEED DENSITY.....	158
BIOLOGICAL AND PHYSICO-CHEMICAL INVESTIGATION OF CERTAIN STATIONS OF TUNCA RIVER	166

REGRESSION ANALYSIS BETWEEN AGRICULTURAL PRODUCTS AND ATMOSPHERIC CONDITIONS	175
THE EFFECTS OF LUTEOLIN ON ACRYLAMIDE INDUCED OXIDATIVE DAMAGE IN 3T3 EMBRYONIC FIBROBLAST CELLS	183
COMPARATIVE METHODS FOR DETECTION OF SUBCLINICAL MASTITIS AT DAIRY COWS IN ORDER TO IMPROVE MILK QUALITY	192
CURRENT BIOTECHNOLOGICAL BREEDING METHODS AND APPLICATIONS IN HEMP (<i>Cannabis sativa</i> L.)	200
DETERMINATION OF ANTIMICROBIAL ACTIVITY OF TOPICAL CREAM DEVELOPED WITH PLANT EXTRACT AND PROBIOTIC	207
DETERMINING THE APPROACH AND EXPECTATIONS ACCORDING TO THE PROFILE OF ENTERPRISERS IN RURAL DEVELOPMENT SUPPORT: THE EXAMPLE OF THE WEST MEDITERRANEAN	213
DETERMINATION OF SUPPORT PREFERENCES OF ENTREPRENEURS UTILIZING SUPPORTS POLICIES FOR RURAL DEVELOPMENT BY CONJOINT ANALYSIS.....	225
ASSESSMENT OF PHENOLIC CONTENTS IN BASIL GROWN INDOORS AND OUTDOOR CONDITIONS	237
EVALUATING THE IMPACT OF STRAW MULCH ON LOW-INPUT ULTIVATION OF TWO PARSLEY VARIETIES (<i>PETROSELINUM CRISPUM</i> (Mill.) Fuss).....	242
PHENOTYPIC AND GENOTYPIC RESISTANCE OF MERCURY AMONG <i>Escherichia coli</i> ISOLATES FROM VEGETABLES.....	257
EFFECT OF USING PROBIOTICS SUPPLEMENTED WHEAT INSTEAD OF CORN IN THE DIET ON PERFORMANCE AND SLAUGHTERING CHARACTERISTICS OF BROILERS	264
DETERMINATION OF THE HARVEST TIME OF SILAGE CORN IN HIGH ALTITUDE REGIONS	271
EVOLUTION OF AMPELOGRAPHIC TECHNIQUES FOR CHARACTERIZATION BETWEEN VINE GRAPE VARIETIES.....	279
DETERMINATION OF YIELD PROTEIN CHARACTERISTICS IN DIFFERENT BEAN CULTIVARS	292
THE IMPORTANCE OF LENTIL GRAIN QUALITY IN HUMAN NUTRITION	298
THE EVALUATION OF SOME DROUGHT INDICES IN SUNFLOWER HYBRIDS IN DRY CONDITIONS	305
FEASIBILITY OF SAFFRON (<i>Crocus sativus</i> L.) CULTIVATION IN AEGEAN REGION, TÜRKİYE	316
HEAVY METAL RESISTANCE OF <i>Staphylococcus aureus</i> ISOLATES FROM SEAWATER FISH.....	322
THE FLORISTIC VALUES OF ‘NARTË - PISHË PORO’ PROPOSED NATURA 2000 SITE IN ALBANIA	329
BIODIVERSITY AND TROPHIC STRUCTURE OF INVERTEBRATE ASSEMBLAGES ASSOCIATED WITH RED ALGAE <i>TITANODERMA TROCHANTER</i> AND <i>ELLISOLANDIA ELONGATA</i> BEDS.....	343
PRELIMINARY STUDY ON HEALTH INDICATORS OF UNWEANED CALVES FED WITH A PREBIOTIC BASED ON <i>SACCHAROMYCES CEREVISIAE</i> (AVIATOR®).....	358

INFLUENCE OF DIETARY SUPPLEMENTATION OF SACCHAROMYCES CEREVISIAE (A-Max Ultra®) ON GROWTH AND DIGESTIBILITY OF WEANED CALVES.....	364
DIVERSITY OF BENTHIC MACROMOLLUSCAN COMMUNITIES ON THE ROCKY SHORES OF EASTERN KARABURUNI PENINSULA, VLORE, ALBANIA	368
DETERMINATION OF INDICATOR BENTHIC MACROINVERTEBRATES IN LÜLEBURGAZ STREAM (KIRKLARELİ, TÜRKİYE).....	379
PRELIMINARY CHARACTERIZATION OF <i>METSCHNIKOWIA PULCHERRIMA</i> STRAINS FOR FUTURE APPLICATIONS IN WINE BIOTECHNOLOGY	385
THE IMPORTANCE OF BIODEGRADABILITY OF PLASTICS USED IN AGRICULTURE	393
NOVEL APPLICATION OF POMEGRANATE PEELS-CHITOSAN AS A PRETREATMENT FLOCCULANT FOR ENHANCED SAND FILTRATION AND EFFICIENT REMOVAL OF HEAVY METALS FROM WASTEWATE.....	401
SEROLOGICAL ANALYSES OF VIRUSES PRESENCE ON TOMATO COLLECTION FROM THE GENE BANK OF THE REPUBLIC OF SRPSKA.....	410
APPLICATION OF LIPOSOMAL ENCAPSULATED ANTIMICROBIAL BIOACTIVE COMPONENTS IN FOOD PRODUCTS AS NATURAL PRESERVATION	416
EFFECTS OF AQUAFABA AS ALTERNATIVE PLANT ADDITIVE ON PHYSICAL, TEXTURAL AND SENSORY CHARACTERISTICS OF EGGLESS TURKISH PASTA (ERİŞTE).....	423
BIBLIOMETRIC ANALYSIS OF POLLEN CONTAMINATION DETERMINATION IN SEED ORCHARDS WITH MOLECULAR MARKERS.....	428
HARD SEED FRUIT GENE RESOURCES OF TÜRKİYE AND MOLECULAR CHARACTERIZATION STUDIES.....	437
MORPHOLOGICAL CHARACTERISTICS OF GIANT STINGING NETTLE (<i>Girardinia Diversifolia</i>) IN GİRESUN ECOLOGICAL CONDITIONS.....	446
EFFECT OF BASAL MEDIA ON GROWTH AND EXOPOLYSACCHARIDES PRODUCTION BY ARONIA MELANOCARPA (MICHX.) ELLIOTT CELL SUSPENSION CULTURE	451
SOME TECHNOLOGICAL PROPERTIES AND BIOACTIVE COMPONENTS OF LEAVENED AND UNLEAVENED FLATBREADS SUBSTITUTED WITH GERMINATED MILLET FLOUR.....	458
INVESTIGATION OF MORPHOMETRIC VARIATIONS <i>ON PTEROCHLOROIDES PERSICAE</i> (CHOLODKOVSKY, 1898) (HEMIPTERA: APHIDIDAE) DEPENDS ON HOST PLANT PREFERENCES	466
EFFECT OF CAULIFLOWER POWDER ON THE CHEMICAL AND FUNCTIONAL PROPERTIES OF GLUTEN-FREE SNACK PRODUCT	471
DETERMINATION OF MOLECULAR MARKER FOR SEEDLING EMERGENCE IN WATERMELON.....	476
HERBAL TEA PRODUCTION TECHNOLOGY AND CURRENT APPROACHES.....	487
ANTIMICROBIAL ACTIVITY OF A NEW DEVELOPED CREAM FORMULATION WITH NATURAL ADDITIVES: <i>Citrus medica</i> L. var. <i>sarcodactylis</i> FRUIT ETHANOL EXTRACT AND PROBIOTIC	503

INVESTIGATION OF CORNELIAN CHERRY FRUIT AS A NATURAL ADDITIVE IN THE INDUSTRY	508
THE INFLUENCE OF CLIMATIC FACTORS ON THE BIOECOLOGY OF THE HYBRID SPARROW (PASSER DOMESTICUS X P. HISPANIOLENSIS) IN THE BOUIRA (ALGERIA)	514
T0BACCO BREEDING FOR LEAVES AND YIELD	522
INVESTIGATING PARTICIPATORY LEARNING AS A TOOL TO ENGAGE STUDENTS AND TO RAISE THEIR AWARENESS ABOUT FOOD WASTE ISSUE.....	530
THE INFLUENCE OF GRASS CARP ON THE SPECIES COMPOSITION AND BIOMASS OF PHYTOPLANKTON.....	537
COMPARATIVE RESISTANCE OF STORED CEREALS AND PULSE TO <i>Sitophilus zeamais</i> MOTSCHULSKY (COLEOPTERA: CURCULIONIDAE)	542
SUSTAINABILITY ASSESSMENT OF ANIMAL HUSBANDRY IN TURKEY.....	550
EVALUATION OF ORGANIC LIVESTOCK FARMING EFFICIENCY IN TURKEY WITH DATA ENVELOPMENT ANALYSIS	557
HEAVY METAL RESISTANCE OF MULTIDRUG RESISTANT <i>Staphylococcus aureus</i> ISOLATED FROM MEAT	564
ROOT ROT DISEASES CAUSED BY FUNGAL PATHOGENS IN PEA AND THEIR CONTROL POSSIBILITIES.....	572
EVALUATION OF SURFACE WATER AND SEDIMENT MICROPLASTICS OF SULTANSUYU DAM LAKE (MALATYA) IN TURKEY	583
ENRICHMENT OF GRAIN LEGUME GENETIC RESOURCES COLLECTION THROUGH BILATERAL PROJECT BETWEEN BULGARIA AND CHINA	589
EFFECT OF PH-SHIFT TREATMENT AND ULTRASONICATION ON THE PHYSICAL STABILITY AND PROPERTIES OF HEMP SEED MILK	599
THE EFFECT OF DIFFERENT DRYING METHODS ON SOME CHEMICAL AND BIOACTIVE COMPONENTS OF ORANGE AND BLACK CARROT POWDERS	612
NUTRITIONAL VALUE AND UTILIZATION POSSIBILITIES OF BULGUR INDUSTRY BY-PRODUCTS IN CEREAL PRODUCTS	621
UTILIZATION OF DILL, PARSLEY AND GREEN ONION POWDERS IN THE CRACKER FORMULATION	625
BIOACTIVE COMPAUNDS IN COMMON MEDLAR FRUITS (<i>Mespilus germanica</i> L.) IN DEPENDANCE OF RIPENESS STATE	631
CHIA SEEDS (<i>Salvia hispanica</i> L.) IN DIETETIC REGIMES.....	639
STUDY OF BIOFILM FORMATION IN <i>Pseudomonas Savastanoi</i> BY MICROTITER PLATE	648
EVALUATION OF SACCHAROMYCES AND NON-SACCHAROMYCES YEASTS ISOLATED FROM ALBANIAN AUTOCHTHONOUS GRAPE VARIETIES FOR CRAFT BEER PRODUCTION.....	652
UV LIGHT-DRIVEN PHOTOCATALYTIC DEGRADATION OF METHYLENE BLUE USING TiO₂, ZnO, and SnO₂ as CATALYSTS: A COMPARATIVE STUDY	664
RECENT TRENDS AND FUTURE PROSPECTS ON THE POLYMERIC-BASED CATALYSTS FOR PHOTOCATALYTIC DEGRADATION	673

POTENTIAL FOR RAINWATER HARVESTING IN LAYING HEN HOUSE: THE CASE OF BURSA	680
RED DRAGON FRUIT: ALTERNATIVE USE OF FRUIT EXTRACTS IN VARIOUS INDUSTRIES.....	685
RISKS RELATED TO PHYTOSANITARY PRACTICES OF APPLE GROWERS IN THE KHENCHELA REGION -ALGERIA	692
SCREENING OF POLYPHENOL OXIDASE ENZYME IN LYCOPEN-RICH FRUITS.....	698
LETHAL EFFECTS OF LAUREL, SENNA AND FENNEL PLANT EXTRACTS ON <i>TENEbrio MOLITOR</i>.....	703
THE IMPORTANCE OF LAUREL PLANT EXTRACT IN FIGHTING HARMFUL INSECTS	709
INFLUENCE OF POWDERS OBTAINED FROM DIFFERENT PARTS OF STINGING NETTLE (<i>URTICA DIOICA L.</i>) ON TECHNOLOGICAL PROPERTIES AND BIOACTIVE COMPONENTS OF NOODLES	717
STUDY OF THE ANTIOXIDANT ACTIVITY OF EXTRACTS OF CONES OF <i>CUPRESSUS SEMPERVIRENS</i>	725
THE EFFECT OF DIFFERENT PROBIOTIC MIXTURES ADDED TO THE LAYING HENS DIET ON PERFORMANCE AND EGG QUALITY PROPERTIES	731
THE EFFECTS OF DIFFERENT ROW SPACING ON AGRICULTURAL CHARACTERISTICS OF SAFFLOWER (<i>Carthamus tinctorius L.</i>) GROWN IN DRY CONDITIONS	740
COMPARISON OF TOTAL PHENOLIC AND TOTAL FLAVONOID CONTENTS OF BOTH AQUEOUS AND METHANOLIC EXTRACTS OF <i>MARRUBIUM VULGARE L.</i>.....	753
EXPERIMENTS ON REVEALING EFFECTS OF DIFFERENT MEDIA STRENGTH, AND SUCROSE-DEPENDENT IN ADVENTITIOUS ROOT CULTURES OF RADISH (<i>Raphanus Sativus L.</i>).....	759
RECENT OBSERVATIONS ON <i>TURSIOPS TRUNCATUS</i> (DELPHINIDAE) AT THE SEA-CAGE FISH FARMS IN THE TURKISH AEGEAN SEA	768
DYNAMICS OF THE APHID POPULATION ON TOBACCO IN PRILEP REGION	772
STUDY OF THE ADHESIVE BEHAVIOR OF <i>ESCHERICHIA COLI</i> AND <i>STAPHYLOCOCCUS AUREUS</i> ON GLASS	779
ASHWAGANDHA (<i>Withania somnifera</i>) AS A MEDICINAL PLANT	788
WHITE OLEANDER: INVESTIGATION OF POTENTIAL USAGE IN AQUACULTURE AND COSMETICS INDUSTRIES	793
PREPARATION AND COMPARISON OF WATER-SOLUBLE MAGNETIC NANOPARTICLES MODIFIED WITH DIFFERENT FLUORESCENT DYES.....	799
CYTOTOXICITY OF ORANGE PEEL (<i>Citrus sinensis</i>) ESSENTIAL OIL NANOEMULSIONS ON THE RAINBOW TROUT GONADAL CELLS	807
SPATIAL-TEMPORAL ANALYSIS OF TEMPERATURE VALUES IN THE THRACE REGION USING INNOVATIVE TREND METHOD	817
PHYTOCHEMICAL ANALYSIS AND IDENTIFICATION OF BIOACTIVE COMPOUNDS IN SPINACH LEAVES (<i>Spinacia oleracea L.</i>).....	830

EFFECT OF SALINITY STRESS ON BIOCHEMICAL, GROWTH, AND YIELD CHARACTERISTICS OF WHEAT	840
COMPARATIVE ANALYSIS OF BIOFILM MORPHOTYPES OF TYPE 1 FIMBRIAE N-TERMINAL DOMAIN DISRUPTED MUTANT AND WILD-TYPE STRAIN IN <i>SALMONELLA</i> TYPHIMURIUM.....	850
SYNTHETIC SOIL CONDITIONERS USED IN SOIL REMEDIATION: A REVIEW	857
CHANGES IN THE SOIL PROPERTIES OF AGRICULTURAL LANDS AROUND ORGANIZED INDUSTRIAL ZONE CAUSED BY INDUSTRY IN VAN, TÜRKIYE.....	862
EFFECTS OF CYCOCEL (CCC) DOSES AND APPLICATION STAGES ON SEED YIELD AND YIELD COMPONENTS OF MUNG BEAN (<i>Vigna radiata</i> (L.) Wilczek)	868
DETERMINATION OF LOW TEMPERATURE RESISTANCE IN <i>LOLIUM PERENNE</i> L. GENOTYPES COLLECTED FROM HIGH ALTITUDE REGION	876
THE EFFECTIVENESS OF TWO DIFFERENT GNRH ANALOGUES WITH OR WITHOUT BETA CAROTENE + VITAMIN-E USED IN OVULATION SYNCHRONIZATION IN HOLSTEIN HEIFERS.....	884
EFFECTS OF DIFFERENT ETHANOL CONCENTRATIONS IN PEPPER (<i>Capsicum annuum</i>) EXPOSED TO SALINITY	893
THE DYNAMIC DUO: EXPLORING THE SYNERGISTIC EFFECTS OF SOIL INVERTASE ACTIVITY AND BIOCHAR	899
WHEAT BIOFORTIFICATION IN TURKEY: CURRENT STATUS, CHALLENGES, AND PROMISING OPPORTUNITIES	906
INNOVATIVE IRRIGATION MANAGEMENT IN AEROBIC RICE CULTIVATION: A COMPREHENSIVE REVIEW OF TECHNOLOGIES AND PRACTICES.....	914
ASSESSMENT OF AGRICULTURAL USE OF SLUDGE IN THE CONTEXT OF CIRCULAR ECONOMY (CE) APPROACH.....	924
INVESTIGATION OF HUMAN ACTIVITIES IN THE COASTAL AREA AND ITS IMPACT ON BEACH LITTER IN THE SOUTHEAST BLACK SEA.....	930
GASTROINTESTINAL HELMINTS OF CATTLE IN SEMI INTENSIVE BREEDING AT BELGRADE AREA	941
EFFECT OF MUSHROOM EXTRACTS ON COLOR CHANGE AND SOME CHEMICAL PROPERTIES OF DEHYDRATED SOUPS.....	947
A REVIEW OF THE RELATIONSHIP BETWEEN CANCER CASES-ENVIRONMENTAL CARCINOGENS AND POLLUTING AGENTS IN TURKISH THRACE REGION	957
CRISPR/CAS9 BASED GENOME EDITING STRATEGIES IN HONEY BEES.....	980
STRUCTURAL CHARACTERISTICS OF ZEEN OAK (<i>QUERCUS CANARIENSIS</i>) (NORTHEASTERN ALGERIA)	987
STRUCTURE OF CORK OAK (<i>QUERCUS SUBER</i>) STANDS IN THE ZOUAGHA FOREST (NORTHEAST ALGERIA).....	993
ECOTOXICOLOGICAL RISK ASSESSMENT OF POTENTIALLY TOXIC ELEMENTS IN WATER OF FLUVIAL HABITATS LOCATED IN GELIBOLU PENINSULA (TÜRKIYE)	1000
LEVELS OF POTENTIALLY TOXIC ELEMENTS AND ECOTOXICOLOGICAL WATER QUALITY ASSESSMENT OF RIVERINE ECOSYSTEMS IN BIGA PENINSULA, TÜRKIYE	1006

TREND ANALYSIS OF PRECIPITATION PARAMETERS IN EDIRNE PROVINCE USING MANN-KENDALL AND SEN'S SLOPE ESTIMATOR TESTS (1982-2021)	1012
ADAPTATION OF GREEN OAK TO ENVIRONMENTAL CONDITIONS IN ALGERIA. 1024	
SEASONAL EFFECT ON ALEPPO PINE PHYSIOLOGY	1030
DETERMINATION OF HEAT STRESS BY TEMPERATURE-HUMIDITY INDEX IN ENRICHED CAGE SYSTEM LAYING HENS: A BURSA CASE STUDY	1036
ENVIRONMENTAL EFFECTS OF OFFSHORE AND ONSHORE WIND POWER PLANTS AND THE CAPACITY OF WIND ENERGY IN TURKEY	1041
ASSESSMENT OF METHANE EMISSIONS FROM BALAKHANI LANDFILL USING LANDGEM MODEL	1050
INFLUENCE OF ROOT RESTRICTION ON YIELD AND FRUIT QUALITY IN 'HAFIF ÇUKURGOBEK' LOQUAT TREES	1058
EFFECTS OF ROOT RESTRICTION ON VEGETATIVE GROWTH AND PHENOLOGICAL CHARACTERISTICS IN LOQUAT (<i>Eriobotrya japonica</i> Lindl.) TREES	1063
THE EFFECT OF ACIDIFIED BIOCHAR APPLICATIONS ON SOME MACRO-ELEMENT CONTENTS OF A CALCAREOUS SOIL	1069
EFFECTS OF MANURE ON STRUCTURAL STABILITY OF A SANDY CLAY LOAM SOIL	1075
EVALUATING THE PERFORMANCE OF LOGISTIC REGRESSION MODEL IN PREDICTING SOIL QUALITY INDEX FOR PADDY FIELDS.....	1080
THE COMMUNICATION LEVEL WITH THE SOURCES OF AGRICULTURAL TECHNOLOGY INFORMATION BY FARMERS IN ZOMMAR REGION / NINEVEH GOVERNORATE / IRAQ.....	1086
DESIGN OF A SELF BALANCING SINGLE WHEEL ROBOT	1095
DESIGN OF A TWO-WHEELED SELF-BALANCING ROBOT CONTROLLED BY VOICE	1106
DETERMINATION OF THE PROPERTIES OF A POLYMERIC GEL AS A DRUG CARRIER MATERIAL VIA MOLECULAR SIMULATIONS	1123
MECHANICAL PROPERTIES AND PROTEIN ADSORPTION OF POLYURETHANE COATINGS WITH DUAL HYDROPHILIC/HYDROPHOBIC DANGLING CHAINS	1131
MOLLUSCS FROM HIMARA COAST, IONIAN SEA, ALBANIA.....	1137
ALGAL COENOSSES OF SHALLOW ROCKY COASTS OF THE ADRIATIC SEA IN ALBANIA	1147
SOME ENDANGERED ENDEMIC PLANTS IN THRACE REGION: A REMOTE SENSING APPROACH WITH UAV IMAGERY.....	1156
CONTRIBUTIONS TO <i>BLACINAE</i> (<i>HYMENOPTERA: BRACONIDAE</i>) FAUNA OF CENTRAL ANATOLIA REGION IN TURKEY	1164
A REVIEW OF AGATHIDINAE PARASITIDS ASSOCIATED WITH <i>LEPIDOPTERA</i> (<i>HYMENOPTERA: BRACONIDAE</i>) IN TURKEY WITH A SUMMARY OF HOST BUTTERFLY FAMILIES AND THEIR HOST PLANTS	1166
CYTOLOGICAL EVALUATIONS AND A METHODOLOGICAL APPROACH TO OBSERVE APOPTOTIC EFFECT OF NISO₄ ON <i>Allium cepa</i> L. ROOT GERMINATION BY USING EB/AO FLUORESCENCE STAINING	1178

SEISMIC ISOLATION OF A MECHANICAL FIRE INSTALLATION FOR DIFFERENT STANDARDS.....	1191
CURRENT BIOTECHNOLOGICAL BREEDING METHODS AND APPLICATIONS IN HEMP (<i>Cannabis sativa</i> L.)	1200
GERMINATION METHODS AND APPLICATIONS IN GIANT NETTLE (<i>Girardinia diversifolia</i>).....	1207
REVERSIBLE HEMATOLOGICAL AND BIOCHEMICAL TOXIC EFFECTS OF AZOXYSTROBIN AND DIFENCONAZOLE MIXTURE EXPOSURES IN OREOCHROMIS NILOTICUS UNDER INCREASED HEAT STRESS.....	1216
THE USE OF WIND ENERGY IN PROVIDING CLIMATIC ENVIRONMENTAL CONDITIONS OF BARNs FOR SMALL CATTLE	1224
POSSIBILITIES OF USING WIND ENERGY FROM RENEWABLE ENERGY SOURCES FOR AGRICULTURAL PURPOSES IN WATER BUFFALO BARNs AND ENVIRONMENTAL EFFECTS.....	1237
PARTICIPANT LIST	1246
AGBIOL 2023 CONFERENCE STUDENT ORGANIZING TEAM.....	1259
OUR SPONSORS	1260

ECO-DENDROMETRIC STUDY OF *PINUS HALEPENSIS* MILL. IN THE FOREST OF TERNI (WESTERN ALGERIA)

BOUCIF Ouarda El Wahida¹, RACHED-KANOUNI Malika¹, CHOUIER Norhane¹

1 Laboratory of natural substances, biomolecules and biotechnological applications, Department of Natural and Life Sciences, Faculty of Exact Sciences and Natural and Life Sciences, Larbi Ben M'Hidi University, Oum El Bouaghi, Algeria.

Corresponding author: fatibiosnv@gmail.com

ABSTRACT

A precise knowledge of existing forest resources, as well as their evolution, should focus essentially on the floristic composition and on the structure of valuable species. This study aims to evaluate the productivity of *Pinus halepensis* and its evolution in the forest of Terni Monts Tlemcen (Algeria). For this study, four plots were randomly selected. Stationary data and dendrometric measurements were carried out on all the trees of each plot in order to assess the floristic diversity of this forest. The inventories carried out on 368 trees made it possible to determine 7 species distributed in 6 genera and 4 families of which the Fabaceae is the dominant one. The average values of the highest diversity indices are H' (1.3) and D (0.60). The highest percentage of Aleppo pine is 29% in plot 3. The average density of Aleppo pine stems is 75 individuals/ha, representing an average basal area of 0.84 m²/ha and an average volume of 5.12 m³/ha. These results will enable the decision maker and concession holders to implement a better sustainable forest management strategy.

Keywords: Forest, *Pinus halepensis*, diversity, dendrometric, management strategy.

INTRODUCTION

Algeria is the largest country on the African continent after Sudan. This geographical location gives it a particular climatic and ecological diversity. This vast territory is very diversified by its climate, its relief, its soils and its natural vegetation (Letreuch Belarouci, 1995). Algeria has one of the most diverse and original flora of the Mediterranean basin where it has 3139 species divided into 150 families. The Aleppo pine (*Pinus halepensis* Mill.) is considered as a main and essential component of the Mediterranean forest and represents a high value forest capital by the majority of countries around the Mediterranean and more particularly in Algeria (Boudy, 1950; Nahal, 1962).

In Algeria, the Aleppo pine covers 35% of the wooded areas in the north, i.e. around 850,000 ha. It forms significant forests with variable ecological values (Bentouati and Baritea, 2006; Guit et al., 2015). It is largely located in its natural state in the eastern and central regions of the country, mainly on the Atlas, Tellian and Saharan mountains (Guit et al., 2015). This species, which is present in all bioclimatic stages, from the coast to the Saharan Atlas, finds its optimum growth mainly in semi-arid zones (Kadik, 2005; Djerrad, 2016). Its great plasticity and robust temperament have made it a pioneering species for major reforestation (Quèzel, 2000; Kadik, 2005; Guit et al., 2015; Djerrad, 2016). Aleppo pine wood can be used, after removal of the resin, for the manufacture of paper pulp (Nahal, 1962; Soltani, 2016) Pine buds, very resinous, also have a medicinal use, as balsamics and diuretics, transformed in particular into syrups and lozenges (Zenzen, 2016). Our work consists in inventorying the stand of *Pinus halepensis* in the forest of Tessaïra Mramet region of Terni Monts de Tlemcen (Algeria) using

dendrometric measurements. Knowledge of the dendrometric parameters of forest species in plantations is an important element for decision-making, particularly those relating to management interventions for this species and to enhance it.

MATERIALS AND METHODS

Presentation of the study area

The Tlemcen region is located in the west of the country, it falls under the semi-arid bioclimatic stage with cold winters. The forest of Tessera Mramet region of Terni is located between the coordinates (34.758209°/ 34.773545°) of north latitude and (-1.326612°/ -1.348188°) of west longitude (Figure 1). It extends over an area of 1379 ha, consists entirely of maquis of which 647 ha are dense and 732 ha are clear (B.N.E.D.E.R, 2008).

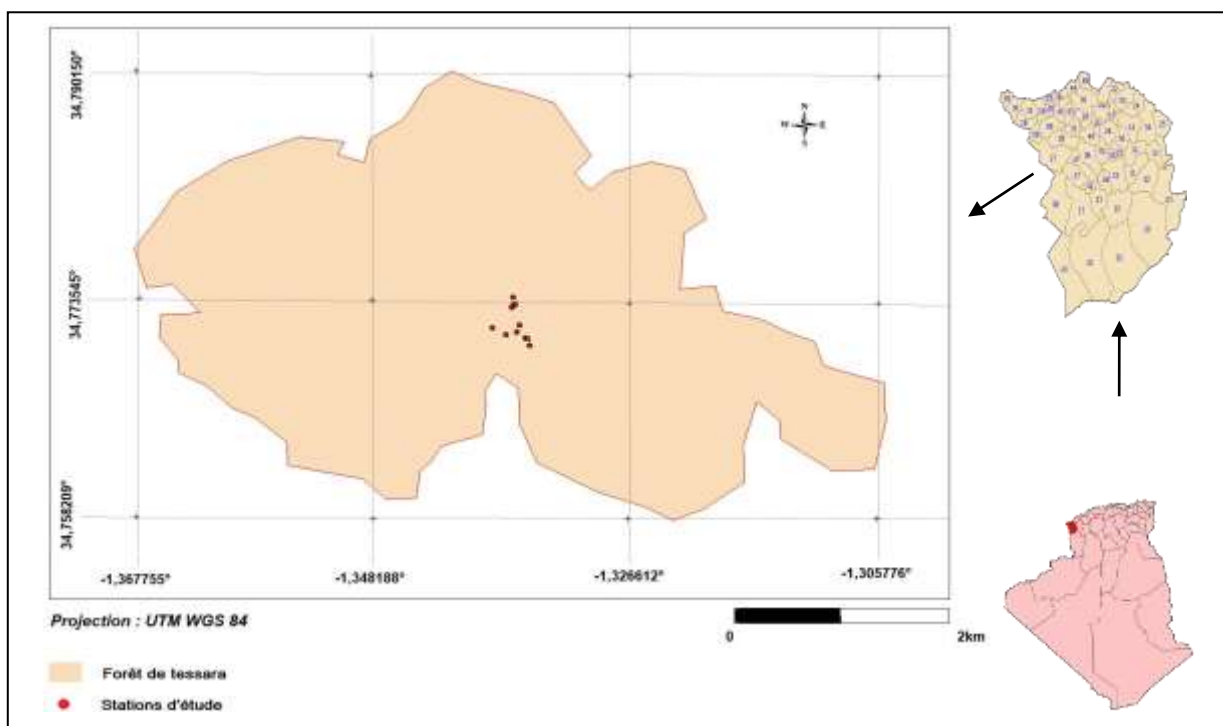

Data gathering

The dendrometric characterization is carried out by means of a forest inventory on the stands of 4 square plots of 0.09 ha in the study area where station and dendrometric data are collected at the level of each sampling unit. Inside each of them, the diameter at breast height (dbh) and the total height are measured for each individual. Height is the most important characteristic for measuring or estimating volume. The study of the heights makes it possible to appreciate the fertility of the stations. The inventory of regeneration to concern woody plants with a diameter of less than 5 cm.

Data processing

The data collected is processed and the parameters concerned are:

- Basal area is a good indicator of site richness. It is calculated by the following ratio:

$$g = c^2/4\pi \text{ (c: circumference at 1.30m).}$$

- The total basal area is the sum of the cross-sections at 1.30m from the ground of all the trees in the stand, it is expressed in square meters, reduced to the hectare (Rondeux,1999).
- The density corresponds to the number of trees on a given surface per hectare (N/ha).

$$N=ni/s$$

ni: number of trees in a plot; s: area of the plot in ha.

- Average height is used to calculate the productivity and the average volume m³/ha of the Aleppo pine stand. Their uses are becoming increasingly widespread in the practice of the forestry profession (Lecomte, 2008). The arithmetic mean height of the stand is determined by the following mathematical equation:

$$H= \Sigma hi/Nt$$

H: average height (m); hi: total height of a tree; Nt: Number of trees measured.

- Diversity indices used for the analysis of the state of each plot:

- Species richness

One of the first indices of diversity is species richness (SR). This index assesses the number of tree species in the stand (Parde and Bouchon, 1988). Although it makes it possible to distinguish diversity according to the number of species, it does not give any information on the weight of each species in the mixture (Gonçalves et al., 2010).

- Shannon index

Shannon Index (H') is an example of a distance-independent algorithm (Shannon, 1948). This index is undoubtedly the index most used to describe the diversity of species. It makes it possible to express diversity by taking into account the number of species and the abundance of individuals within each of these species. Thus, a community dominated by a single species will have a lower coefficient than a community in which all species are codominant (Grall and Coïc, 2006). If only one species is recorded in the plot, the Shannon H' index is equal to zero. For k species with equal proportions, H' corresponds to ln (Pi) (Keren et al., 2020). It derives from information theory and measures the entropy of a sample, or the “saturation” of the community. The index (H') is given by the formula:

$$H' = \sum_{i=1}^{RS} Pi \ln Pi$$

Pi: ni/N; RS: total number of species; ni: number of individuals of a species in the sample; N: total number of individuals of all species in the sample.

- Equity Index

The evenness index (E) is the ratio between the calculated diversity H' and the maximum theoretical diversity H'max which is represented by the log₂ of the total richness S (Blondel, 1979). This index varies from zero to 1 (Barbero et al., 1987). An equitability equal to 1 corresponds to a community whose numbers are perfectly evenly distributed between the

species, i.e. where all the species have the same number of individuals. Evenness is 0 when a single species dominates. Thus, equitability takes into account the potential absolute diversity of the community represented by H'_{max} , thus reflecting the capacity of the system to support S species represented with equivalent proportions. This index measures equitability in relation to a theoretical equal distribution for all species:

$$E = H'/H'_{max}$$

H'_{max} : $\log S$ (number of species)

▪ Simpson's diversity index (D) is obtained by the formula:

$$D = \sum f_i^2 \text{ and } f_i = n_i/N$$

N_i : number of individuals of the given species; N : total number of individuals.

The maximum diversity being represented by the value 1, and the minimum diversity by the value zero (Rita, 2000).

RESULTS AND DISCUSSION

The inventory carried out at the level of the study forest made it possible to determine 7 species (*Quercus ilex*, *Pinus halepensis*, *Juniperus oxycedrus*, *Cupressus sempervirens*, *Abies alba*, *Rosa canina*, *Quercus canariensis*) divided into 6 genera and grouped into 4 families. Holm oak is the dominant woody species. The most represented families are the Fagaceae followed by the Cupressaceae. The results of this study showed that the Aleppo pine stands have percentages that vary from 21% in plot 1 to 29% in plot 3 (Figure 2).

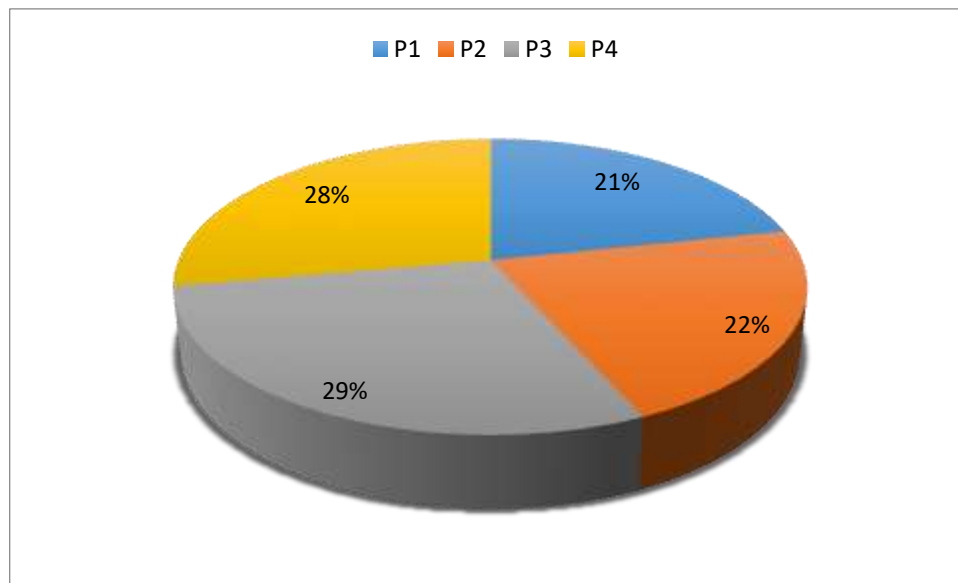

Figures 2. Aleppo pine frequency from four plots.

The average values of species richness, Shannon diversity index, and Pielou evenness are presented in Table 1.

Table 1. Diversity indices.

Plots	RS	H'	E	D
P1	43	0.9	0.43	0.23
P2	81	1.3	0.32	0.29
P3	50	1	0.41	0.25
P4	194	0.72	0.6	0.13
Average	92	0.98	0.13	0.225

According to the previous results, the studied forest massif is not very diversified. The Shannon index varies from 0.72 to 1.3. The values of the diversity index of Simpson are variable, its minimum is recorded for P2 (0.32) and its maximum for P4 (0.60), this difference explains that the floristic diversity is low in this forest where the most dominant species takes the high potential. Evenness tends towards 0, which explains the dominance of a single species (holm oak). We can conclude from these data that this forest is in a state of weakness and very advanced degradation due to the lack of species caused mainly by anthropogenic pressure and the impact of climate change which has been in place for a long time.

According to the results in Table 2, the average density of Aleppo pine at stand level is 75 individuals/ha with an average basal area of 0.84 m²/ha and a volume of 2.66 m³.

Table 2. dendrometric parameters of the study plots.

Parameters	P1	P2	P3	P4	Average
N/ha	33	55	44	167	75
G (m ² /ha)	0.68	0.18	0.39	2.12	0.84
D (cm)	16.24	6.05	10.35	13.2	11.46
H (m)	7.06	3.97	5.62	6.04	5.67
V (m ³)	2.49	0.37	1.13	6.65	2.66

The analysis of the average diameter and height, which are respectively 11.45cm and 5.67m, indicates that the Aleppo pine stand in this forest is dominated by young individuals. The analysis of the dendrometric parameters shows that the plots are characterized by a low density due to the increase in competition between the trees, especially in relation to environmental resources. The average density of Aleppo pine is 75 individuals/ha. This density is lower compared to that of the forest of Hamimet (Oum El Bouaghi), which is around 378 individuals/ha (Yahi et al., 2021) and that of Chettaba (Constantine) which is 442 individuals/ha (Rached-Kanouni et al., 2020). Structural characteristics are major indicators for measuring the qualitative and quantitative evolution of forest stands (Oosterhoon and Kappelle, 2000). The population density of Aleppo pine in the Terni forest is low compared to other forests in Algeria. The difference in stand densities could be related to the ecological characteristics of the study environments, including soil types, topography, climate, cover and especially the altitudinal gradient (Rabiou et al., 2015 ; Rached-Kanouni et al., 2020). We note that this pine is in good condition, with the absence of insect attacks such as the pine processionary caterpillar.

CONCLUSION

The national forest of Tessera Mramet Terni Monts Tlemcen is considered as a forest area not very rich in terms of biological diversity, it is in the form of matorral. This forest is composed

mainly of holm oak which is currently in a much degraded state by fires, anthropogenic pressures. It is also composed of Aleppo pine which is a very interesting reforestation species in terms of wood production, soil protection and the development of other products. The objective of this study is to know the current state of the Aleppo pine in the national forest of Tessera Mramet. The results show that the density, the specific richness, the basal area and the volume of Aleppo pine are low in this forest. It is important to take these results into consideration for the proposal of a management plan necessary for the management of this stand, in particular through silvicultural work for improvements and the protection of this stand against environmental problems.

REFERENCES

- Letreuch Belarouci, N., 1995. Reflection on forest development: areas with production potential. The object. OPU. Algiers 69p.
- Boudy, P., 1950. North African forest economy, volume 2 (Monograph and treatment of forest species). Edit. Larose, Paris, France, 619p.
- Nahal, I., 1962. The Aleppo pine, Taxonomic, phytogeographical, ecological and Sylvicultural study. Annals of the National School of Waters and Forests. 19 (4): 533-627.
- Bentouati, A., Bariteau, M., 2006. Reflection on the decline of the Atlas cedar of the Aurès (Algeria). Mediterranean Forest, XXVII (4): 317-322.
- Guit, B., Nedjimi, B., Guibal, F., Chakali, G., 2015. Dendroecology of Aleppo pine (*Pinus halepensis* Mill.) according to site parameters in the Senalba forest massif (Djelfa – Algeria). Journal of ecology. (Earth Life), 70: 32-43. <http://hdl.handle.net/2042/56308>
- Kadik, L., 2005. Phytosociological and phytoecological study of Aleppo pine formations (*Pinus halepensis* mill) of the Algerian semi-arid bioclimatic stage. Doctoral thesis in natural sciences. USTHB. Alger. 350p.
- Djerrad, Z., 2016. Phytoecological study of Aleppo pine (*Pinus halepensis* Mill.) provenances from the central part of the Saharan Atlas, comparison of morphological and chemical variability with the semi-arid eastern Algerian pine forests. Doctoral thesis in natural sciences. USTHB, Fac. Sc. Biol., Algiers. 182p.
- Quèzel, P., 2000. Taxonomy and biogeography of Mediterranean pines (*Pinus halepensis* and *P. brutia*). In: Ne'eman G, Trabaud L, editors. Ecology, Biogeography and Management of *Pinus halepensis* and *P. brutia* Forest Ecosystems in the Mediterranean Basin Backhuys, Leiden. The Netherlands. 1-12.
- Nahal, I., 1962. The Aleppo pine, Taxonomic, phytogeographical, ecological and Sylvicultural study. Annals of the National School of Water and Forests; 19 (4): 533-627.
- Soltani, A., 2016. Typology and Fertility of Aleppo pine stations in the Benjloud forest (Saida), dissertation, master in forestry, univ. Tlemcen, 141 p.
- Zenzen, W., 2016. Use of S.I.G for the analysis of the structure of the Ouennougha forest in the Wilaya of Bordj Bou Arréridj, dissertation, master in forestry, univ. Tlemcen 60p.
- B.N.E.D.E.R., 2008. National forest inventory study, report on the characterization of forest formations (Wilaya of Tlemcen).
- Rondeux, J., 1999. Measuring forest stands. Gembloux, Belgium, Les Presses agronomiques, Gembloux, 522 p.
- Lecomte, H., 2008. Dendrometry, Preparation for accession to the degree of graduate in forestry. Training Department.
- Parde, J., Bouchon, J., 1988. Dendrometry. 2nd ed. E.N.G.R.E.F. , Nancy. 328p
- Gonçalves, C. C., Paiva, P. C., A., Dias, E. S., Siqueira, F. G., Henrique, F., 2010. Evaluation of the cultivation of *Pleurotus sajor-caju* (Fries) Sing. on cotton textile mill waste for mushroom production and animal feeding. Ciencia e Agrotecnologia, 34 (1): 220-225.

- Shannon, C.E., 1948. "A Mathematical Theory of Communication". In: The Bell System Technical Journal 27: 379–423.
- Grall, J., Coïc, N., 2006. Synthesis of methods for evaluating the quality of benthos in coastal environments. European University Institute of the Sea. University of Western Brittany Laboratory of Marine Environmental Sciences. 7-86.
- Keren, S., Svoboda, M., Janda, P., Nagel, T.A., 2020. Relationships between Structural Indices and Conventional Stand Attributes in an Old-Growth Forest in Southeast Europe. *Forests*, 11(1): 4. <https://doi.org/10.3390/f11010004>.
- Blondel, J., 1979. Biology and ecology. Ed. Masson, Paris, 173 p.
- Barbero, M., Bonin, G., Loisel, R., Quézel, P., 1987. Incidence of exogenous factors on the regeneration of *Pinus halepensis* after fires. *Ecologia Mediterranea*. 13:51-56.
- Rita B. (2000). Analysis of the spatial distribution of objects in a landscape. Registration form, Ecosystem Management Lab (GECOS), Lausanne, 18p.
- Yahi, D., Redjaimia, L., Haddad, A., Zerrouki, A., Rached-Kanouni, M., 2021. Valorization and characterization of the forest of el Hamimet (Alegria).. SGEM International Multidisciplinary Scientific GeoConference EXPO Proceedings Section ecology and environmental studies.
- Rached-Kanouni, M., Hani, I., Bousba, R., Beldjazia, A., Khammar, H., 2020. Structural variability of Aleppo pine stands in two forests in northeastern Algeria. *Biodiversitas* 21(6): 2848-2853. <https://doi.org/10.13057/biodiv/d210663>.
- Oosterhoon, M., Kappelle, M., 2000. Vegetation structure and composition along an interior-edge-exterior gradient in a Costa Rica montane cloud forest. *For. School. Manage.* 126: 291-307. [https://doi.org/10.1016/S0378-1127\(99\)00101-2](https://doi.org/10.1016/S0378-1127(99)00101-2)
- Rabiou, H., Diouf, A., Bationo, B.A., Segla, K.N., Adjonou, K., Kokutse, A.D., Radji, K., Kokou, R., Mahamane, A., Saadou, M., 2015. Structure of natural populations of *Pterocarpus erinaceus* Poir. In the Sudanese domain, in Niger and Burkina Faso. *Woods and forests of the tropics*. 325(3):72-83. <https://doi.org/10.19182/bft2015.325.a31274>

DETERMINATION OF SOME WILD PLANT SPECIES CONSUMED AS VEGETABLES IN FETHİYE (MUĞLA)

Ömer Faruk COŞKUN

¹*Hatay Mustafa Kemal University, Faculty of Agriculture, Department of Horticulture, Hatay, Turkey*

**Corresponding author's e-mail: omerfaruk.coskun@mku.edu.tr*

ABSTRACT

Some plants that spread spontaneously in nature and are not cultivated are important in terms of human nutrition and their contribution to the economy locally. There are many plant species that grow naturally in Fethiye and its surrounding vegetation and are considered as vegetables. In this study, the plants considered as vegetables, the general characteristics and consumption patterns of these plants were determined by conducting field studies in Fethiye and its surroundings. In the region, 27 plant species belonging to 15 families, which are most evaluated as vegetables, were identified. The families with the highest number of species are Brassicaceae, Polygonaceae and Amaranthaceae. Seasonally, these plants are collected by the public, mostly in the spring, they are sold in the markets and consumed. Some of these plants are dried, frozen, canned, but most of them are consumed raw. Determining the wild plant diversity adapted to the natural environment will provide important benefits in the studies on plant breeding in the future.

Keywords: Fethiye, vegetable, wild plants

INTRODUCTION

Turkiye is one of the countries rich in plant diversity. Turkiye's geographical structure and different ecological conditions are the most important factors of this diversity. Turkiye is the primary or secondary homeland of many plant species. Wild relatives of many cultivated plant species have found wide distribution. Changes in climate and topography in Turkiye have also led to an increase in habitat types and thus the rate of endemism. Turkiye has 9.222 plant species and a total of 12.006 taxa, with 2.981 endemic species and 3.778 endemic taxa. Until 2011, the number of taxa in the flora of Turkiye increased to 12.755 (Kayıkçı et al., 2012). Studies to determine this genetic resource richness of Turkiye are increasing rapidly.

Since ancient times, human beings have benefited from the plants around them in various ways. Since ancient times, some plant species have grown spontaneously in nature and have been used as food by humans. Humans have collected and consumed plants as food throughout history (Turner et al., 2011). These plants, which grow in the natural environment and are not exposed to any human intervention, have also become important in terms of their medicinal effects (Sekeroğlu et al., 2005). However, lifestyle changes have led to reductions in the collection and use of wild plants. This situation causes a decrease in traditional knowledge about wild plants considered as vegetables (Luczaj et al., 2012; Menendez-Baceta et al., 2017).

In Türkiye, which has a rich plant diversity, many wild plant species are collected and consumed as vegetables by the public. Awareness of plants considered as vegetables in the world and in Türkiye has increased recently. It is important to maintain the plant collection traditions related to the plants considered as vegetables in order to ensure food safety and sustainability. The names and characteristics of wild plants, which are considered as vegetables, have been transferred from generation to generation through oral and written sources.

Wild plants considered as vegetables are an important part of the Mediterranean food culture (Łuczaj and Pieroni, 2016). Muğla city is very rich in terms of endemic plants as well as having a high plant diversity. There are 1219 taxa and 1164 species within the provincial borders of Muğla. Of these, 238 of the species are endemic (Davis et al., 1965-1985; Güner et al., 2000). There is an important wealth of information in terms of ethnobotany in the province of Muğla. However, factors such as migration, developing technologies, and changes in people's diets cause a decrease in the knowledge of new generations about wild plants growing in nature. For this reason, it is important to determine the plant varieties that are considered as vegetables and their consumption patterns. This study was carried out with the aim of determining the plants that are widely distributed in Fethiye (Muğla) and its surroundings and considered as the most consumed vegetable.

MATERIAL AND METHOD

This work was carried out in 2023 in Fethiye district of Muğla province, which is located in the Aegean Region of Türkiye, and in the surrounding districts. Scanning was carried out in the area between 0 and 2000 meters altitude, including the coastal and highland regions. In addition, information on the subject was obtained from people who lived in that region for a long time. The types of plants consumed as vegetables in the place where they are found, the local names given to the plant and the way they are consumed are recorded.

RESULTS AND DISCUSSION

The list of plants identified from the research area is given in alphabetical family order.

Amaranthaceae

Amaranthaceae family is a crowded family in terms of the number of genera. Many species belonging to the family are widely produced as vegetables or are harvested seasonally from their growing areas. It is mostly seen in degraded lands, near wetlands, by the roadside and sometimes in vacant fields. It is common in Africa, Asia, Europe, North and South America (Gelin et al., 2003). *Amaranthus* sp. about 10 of the species in the genus are considered as vegetables, cereals and ornamental plants. In Fethiye and its surroundings, this family member is one of the most common types evaluated as 3 types of vegetables. *Amaranthus retroflexus* L. (horozibiği) is now grown in some regions for its vegetable value. Young leaves are consumed raw or cooked. *Chenopodium album* L. (sirken) is distributed in destroyed lands, seaside, roadside and fields. This plant, which shows a wide distribution area all over the world, grows especially in agricultural lands in and around Fethiye. Its leaves are consumed raw and cooked. *A. retroflexus* and *C. album* are also fast-growing weeds in agricultural areas and are subject to

agricultural struggle in aquaculture. *Salicornia europaea* L. (deniz börülcesi) is distributed along the sea coasts of the European continent. This plant, which is consumed raw or cooked, has found a growing area on the coast of Fethiye.

Amaryllidaceae

Most of the species belonging to the family consist of perennial, rhizome, tuber and bulbous plants. Leaves are located at the base or stem. There are onions, garlic and leeks among the cultivated vegetable species belonging to this family. There are also important ornamental plants belonging to this family. Many sulfur compounds in *Allium* species show antimicrobial (Casella et al., 2013), and immunomodulatory (Kumar and Brijeshlata, 2012) activities. There are plants belonging to this family, which are considered to be vegetables that spread spontaneously in nature. *Allium subhirsutum* L. (körmen), one of the plant species considered as a vegetable belonging to this family in and around Fethiye, is an important plant species with important medicinal properties. It is seen especially in high areas on bushes, stony, rocky and slopes.

Apiaceae

It is a family characterized by species that are usually combined umbrella or rarely umbrella. There are many types of vegetables grown in this family. The Apiaceae family includes many vegetable products rich in flavonoids, carotenoids, vitamins and minerals (Que et al., 2019). Carrots, parsley, dill and celery are the most important vegetables of this family. Among the members of this family, *Conium maculatum* L. (baldıran) and *Oenanthe pimpinelloides* L. (kazayağı) are among the wild plants that are considered as vegetables and spread around Fethiye. *C. maculatum* is distributed around forests and wetlands. The leaves are consumed by cooking. *O. pimpinelloides* also grows on the edge of marshes and wetlands. Some species of the genus *Oenanthe* are poisonous.

Araceae

Members of this family are usually rhizome and tuberous perennial plants. There are important ornamental plants (*Arum* sp., *Dracunculus* sp.) in the family. Many species of this family are toxic to humans. In the southern parts of Türkiye, *Colocasia esculenta* (Gölevez) is a plant species that is both cultivated and self-propagating in nature and considered as a root vegetable collected by the public. Some species belonging to the subfamily Lemnoideae, which are also in this family, are consumed by humans as vegetables in some parts of the world. It includes plant species that are likely to have significant vegetable potential for Türkiye (Coşkun, 2022). Members of this subfamily include aquatic plants that make up the smallest flowering plants in the world. Duckweed species have been observed in some aquatic areas (Girdev plateau) belonging to Fethiye and its surroundings. This plant, which is consumed as an important vegetable in some parts of the world, grows naturally in the region.

Asparagaceae

It is a family that includes perennial, rhizome, tuberous or bulbous species. Leaves can be at the base or on the stem. These family members include important vegetables and ornamental plants. *Asparagus officinalis* is a vegetable species cultivated in significant quantities in the world. *Asparagus acutifolius*, on the other hand, spreads naturally in a large part of Türkiye. In addition, *A. acutifolius* is used as a diuretic and antineuralgic in traditional medical treatments (Marc et al., 2008; Fenga et al., 2016). In Fethiye and its surroundings, *A*

acutifolius has found a distribution area in nature. It is collected by the people in Fethiye and its surroundings and sold in village markets and is generally consumed by frying or boiling.

Brassicaceae

The Brassicaceae family consists of annual, biennial or perennial herbaceous plants, shrubs and small trees. The Brassicaceae family can be found almost everywhere in the world. There are many field and garden plant species in this family. It is one of the plant families with the highest number of species in the Flora of Türkiye. The Brassicaceae family is represented by approximately 676 taxa in Türkiye (Güner et al., 2012). Cabbage, cauliflower, broccoli, radish, arugula and cress are the economically valuable vegetable species in this family. In this family, there are many plant species that grow spontaneously in nature and these species are consumed as vegetables. In Fethiye and its surroundings, *Nasturtium officinale* R.Br. (su teresi), *Raphanus raphanistrum* L. (turp otu-hardal), *Sinapis arvensis* L. (hardal otu) and *Capsella bursa-pastoris* (L.) Medik. (çoban çantası-kuş tırnağı) are important species considered as vegetables. *N. officinale* is a semi-aquatic plant and a vegetable of high medicinal importance. This species is cultivated in large areas in many parts of the world. In Türkiye, it spreads especially in regions close to clean water resources. It grows in high altitude plateaus (Girdev plateau etc.) in and around Fethiye. The leaves are consumed raw or cooked. *R. raphanistrum* is widespread in Fethiye and its surroundings, as in many regions of Türkiye. This species is also an invasive species and has the capacity to grow in large areas. *S. arvensis* has been observed on roadsides and damaged areas in this region. It is a type of plant that is consumed by adding young leaves to salads. *C. bursa-pastoris* has hamostatic properties, it is consumed raw or boiled.

Caryophyllaceae

This family is widespread in most of the world and has a large number of species. This family consists of about 700 species found in the northern temperature regions, Africa and South America (Melzheimer, 1988). Popular ornamental plants have an important place in this family. *Dianthus* sp and *Silene* sp genera are popular ornamental plants in this family. *Silene vulgaris* (Moench) Garcke (gıyısın), which has found a distribution area in Fethiye and its surroundings, can be seen in meadows, slopes and bushes. Fresh leaves are added to salads, while mature leaves are boiled or fried. Another wild plant that can be considered as another vegetable belonging to the Caryophyllaceae family in this region is *Stelleria media* (L.) Vill. This plant species can be consumed raw and has a very delicious taste.

Compositae

It is generally herbaceous, with very few shrubs, trees, and woody wrapping plants. Flowers are in head or capitulum states. It is one of the richest families in terms of the number of species in the Flora of Türkiye and there are approximately 1209 species (Özhatay and Kültür, 2006; Doğan, 2007). This family has important species spreading all over the world. Field and garden crops with economic value such as lettuce, sunflower, artichoke belong to this family. In addition, many medicinal plants such as yarrow, chamomile, calendula are members of this family. This family member also includes species that are not cultivated, grow spontaneously in nature and are consumed as vegetables. It has been observed that *Taraxacum* sp. (hindiba) and *Tragopogon* sp. (Tekesakali) are found in Fethiye and its surroundings. The fresh leaves of these plants are consumed by adding them to salads.

Dioscoreaceae

Plants belonging to this family are in climbing and winding formations. There are plants used as food and ornamental in this family. It also includes starchy plant species such as *Dioscoreales rotundata*, whose tubers are edible. There are 350-400 species in the genus *Dioscorea* (Caddick et al., 2002). *Dioscorea communis* (L.) Caddick & Wilkin (acı ot) plants, which are considered as vegetables belonging to this family, were observed in Fethiye and its surroundings. Young shoots of this plant species can be consumed and used in making pastries. The tubers of this plant are known to be poisonous (Yesil and Inal, 2021).

Lamiaceae

It spreads almost all over the world, except for the cold polar regions (Abdelhalima and Hanrahan, 2021). Family members include important medicinal and aromatic plants. Due to the essential oil content of this family members, it is included in the composition of cosmetic products and is used in the preparation of various foods and beverages. Mint, thyme, sage, lavender, rosemary and basil are important species in this family. It has been observed that the *Mentha pulegium* L. (yarpuz-narpız) plant belonging to this family can naturally find a distribution area, especially on the edges of wetlands, in the lands in Fethiye and its surroundings. The leaves and fresh shoots of this plant are used as vegetables and spices.

Malvaceae

It is a family of mostly grasses and rarely shrubs and trees. It is important in terms of vegetable, ornamental and medicinal plant species. Many *Malva* species are used as a vegetable or herbal medicine (Pandy, 2006). Famous plant species such as linden, cotton, cocoa, marshmallow, okra are included in this family. There are plants that are considered to be vegetables that grow naturally in this family, which spreads in most of the world. *Malva nicaeensis* (ilmik otu) and *Malva sylvestris* L. (ebegümeci) are distributed in and around Fethiye. It has been widely observed in the area in fields, devastated lands and roadsides. These plants are collected from nature and their aboveground organs are consumed fresh or cooked.

Papaveraceae

Turkiye is a gene center for *Papaver sp.* species as well as for many plants (Kapoor 1995). There are species with distinctive crown and bowl in the family. The flowers are usually showy and spread throughout much of the world. This family includes many popular ornamental plants (*Dicentra spectabilis*; *Hunnemannia fumariifolia*; *Meconopsis betonicifolia*). *Papaver rhoeas* L (poppy), which is in the family and spreads naturally in Fethiye, is considered as a vegetable. Before blooming in early spring in the region, the above-ground parts are boiled and roasted and consumed as food. *Papaver rhoeas* is used in the form of syrup as cough suppressant, sedative, sugar reducer, pain reliever, expectorant and sweat remover, and its leaves are consumed as salad or roasted (Duke, 1973; Akın, 2011).

Polygonaceae

The family includes climbers, grasses and shrubs distributed throughout the world, especially in temperate regions of the northern hemisphere. The family includes species grown as food (*Fagopyrum esculentum*) and ornamental plants (*Fallopia sachalinensis*). Within this family, there are species used as food (Özudogru et al., 2011) and for traditional medicine (Howes and Perry, 2011). In this family, the number of species consumed as a self-growing vegetable in nature is also high. *Rumex acetosella* L. (kuzukulağı), *Rumex crispus* L., *Rumex patientia* L. (labada) and *Polygonum aviculare* L. (kuş ekmeği) in and around Fethiye are

important plant species in this context. They are consumed raw and cooked, *R. patientia*'s leaves are usually cooked, and *P. aviculare* is consumed by cooking aboveground organs. The leaves of this species contain oxalic acid and can be consumed raw or cooked. It is added to salads because of its sour taste.

Portuguese

It is a family of annual or perennial herbs and shrubs. It is widespread in most of the world. There are plants considered as ornamental plants (*Portulaca grandiflora*) and vegetables (*Portulaca oleracea*) in this family. This is a plant rich in important phytochemicals with medicinal and nutritional properties (Uddin et al., 2014; Zhou et al., 2015). *P. oleracea* (semizotu), which is considered to be an important vegetable in terms of Omega-3, is distributed in Fethiye and its surroundings. It is consumed fresh or roasted in salads.

Urticaceae

Members of the Urticaceae family consist of herbs and shrubs. Plants of this family are widespread in most of the world. One of the most important species of this family is *Urtica dioica* L. (ısrırgan otu). Stinging nettles are easy to digest and highly nutritious. The leaves are rich in iron, vitamins A and C (Allardice, 1993), essential amino acids (West, 2000) and essential fixed fatty acids (Guil-Guerrero et al., 2003). This plant has found a wide distribution area in the geography of Türkiye. It is a plant that can grow in wetlands, destroyed lands and forest borders in and around Fethiye. It is an important plant species that is used as a vegetable for cooking, used in pastries, dried and used as a tea.

In this study, the plants considered as vegetables were determined in 15 families. The families with the highest number of species are Brassicaceae, Polygonaceae and Amaranthaceae. Aksakal and Yusuf (2008) determined that the species used for food purposes mostly belong to the families of Lamiaceae, Rosaceae, Apiaceae and Asteraceae. Korkmaz and Karakurt (2015) stated that Rosaceae, Asteraceae, Apiaceae, Lamiaceae, Chenopodiaceae families ranked in the top five in terms of the number of natural plant taxa used as food by the people living in Kelkit (Gümüşhane) region.

In this study, it was determined that 27 plant species were considered as the most vegetable in Fethiye and its surroundings. Akan et al (2008) determined that 33 of 299 taxa were used as food in their study to determine the ethnobotanical characteristics of Mount Arat and its surroundings (Birecik-Sanlıurfa). Yapıcı et al (2009), ethnobotanical characteristics and local names of some plants identified from Kurtalan (Siirt) district were investigated. They identified 34 ethnobotanical features. Some ethnobotanical studies have been carried out near the region. In the study conducted in Köyceğiz district, 154 plants (Uysal, 2008), in the study conducted in Marmaris district, 95 taxa (Gürdal and Kültür, 2013) and in the study conducted in Ortaca district, 80 plant species were identified (Kazan, 2007). In these studies, it has been detected in medicinal and aromatic plants as well as for use as food. In this study, information about the species used as a vegetable is given. If other field crops used as food are included, the number of these species will increase even more.

Some plant species considered as vegetables determined in Fethiye and its surroundings have also been detected in other parts of Türkiye (Alpaslan, 2004; Akgünlü, 2012). However, the local names of the determined plant species may vary from region to region. While plant species such as *Urtica dioica* are usually given the same local name (nettle), there may be significant local name variation in some other plants. Consumption patterns of plant species

identified in this study may differ from each other. Satil et al. (2007) reported that the plants used for food purposes in and around Madra Mountain are consumed raw as well as cooked. Kadioğlu et al. (2016) reported that wild plant species consumed as vegetables in Erzurum and Erzincan provinces are consumed for a long time by drying, pickling, freezing or preserving as canned, as well as consumed fresh by the local people. Koca et al. (2011) reported in their study in Samsun and its surroundings that some of the wild plants grown are consumed raw or cooked fresh, as well as some of them are consumed by freezing, drying, brine or processing. Wild plant species that are considered as vegetables in Fethiye and its surroundings are mostly consumed raw, but some of them are also consumed by boiling and frying (*A. acutifolius*). Apart from this, some plant species can be consumed for a long time by drying, pickling, freezing or preserving in canned form.

In the Fethiye region, people evaluate some herbaceous plants in every season. The most important form of evaluation is to consume it as a vegetable in various ways. Local people have known these plants for a long time and used them for food and medicinal purposes. These plants are collected and consumed by the public, as well as being sold in the neighborhood markets. Fethiye and its surroundings have been under intense pressure in terms of plant gene resources in recent years due to factors such as agricultural practices, tourism and population growth. However, there is a high interest in plants, which are considered vegetables due to their nutritional regime. However, changes in diet and other factors may cause these plants to be forgotten over time. However, there may be a gradual loss of traditional knowledge about these plants as the intergenerational transmission of knowledge declines. For this reason, it is important to determine the plant varieties that are considered as vegetables and their consumption patterns. In this study, plants that are considered as vegetables, which find a distribution area in Fethiye (Muğla) and its surroundings, were determined. Determining the wild plant diversity adapted to the natural environment will provide important benefits in the studies on plant breeding in the future.

REFERENCES

- Abdelhalim, A., Hanrahan, J. 2021. Chapter 7 - Biologically active compounds from Lamiaceae family: Central nervous system effects, Studies in Natural Products Chemistry, Volume 68, 255-315.
- Akan, H., Korkut, M.M., Balos, M.M. 2008. Arat Dağı ve çevresinde (Birecik, Sanlıurfa) etnobotanik bir araştırma. Fırat Üniv. Fen ve Müh. Bil. Dergisi 20 (1): 67-81.
- Akgünlü, S.B. 2012. Kilis ve Gaziantep yöresinde tüketilen bazı yabancı sebzelerin mineral içerikleri ve mikrobiyolojik analizler. Yüksek Lisans Tezi, Kilis 7 Aralık Üniversitesi Fen Bilimleri Enstitüsü Biyoloji Ana bilim Dalı.
- Akın, B. 2011. *Papaver rhoeas* tohumlarının in vitro ortamda çimlenmesi üzerine farklı uygulamaların etkileri. Dumlupınar Üniversitesi Fen Bilimleri Enstitüsü Dergisi, (026): 17-24.
- Aksakal, Ö., Yusuf, K. 2008. Erzurum ve çevresinde halk tarafından gıda amaçlı olarak kullanılan bitkiler. 1009-1012. Türkiye 10. Gıda Kongresi. 2008 Erzurum.
- Allardice, P. 1993. A-Z of companion planting, Cassell Publishers Ltd, London.

- Alpaslan, D. 2004. Van yöresinde doğal olarak yetişen bazı bitkilerin geleneksel tüketim şekilleri. Yüzüncü Yıl Alparslan, D. 1. Geleneksel Gıdalar Sempozyumunun 23-24 Eylül, Van.
- Caddick, L.R., Wilkin, P., Rudall, P.J., Hedderson, T.A.J., Chase. M.W. 2002. Yams reclassified: A recircumscription of Dioscoreaceae and Dioscoreales. *Taxon* (51)1:103-114
- Casella, S., Leonardi, M., Melai, B., Fratini, F., Pistelli, L. 2013. The role of diallyl sulfides and dipropyl sulfides in the in vitro antimicrobial activity of the essential oil of garlic, *allium sativum* L., and leek, *allium porrum* L. *Phytother. Res.*, 27, 380–383
- Coşkun, O.F. 2022. İnsan gıdası olarak kullanılabilen alternatif sebze adayı: Sumercimeği. *Ziraat, Orman ve Su Ürünleri Alanında Gelişmeler. :Duvar Yayınları, Basım sayısı:1, Sayfa sayısı:157, ISBN:978-625-8109-09-2, Bölüm Sayfaları:79 -92*
- Davis, P.H., Mill, R.R., Tan, K. 1988. *Flora of Turkey and the East Aegean Islands.-X*. Edinburg Univ. Press, Edinburg.
- Dogan, B., Duran, A., Hakki, E.E. 2007. Phylogenetic analysis of *Jurinea* (Asteraceae) species from Turkey based on ISSR amplication. *Annales Botanici Fennici* 44: 353–358.
- Duke, J.A. 1973. Utilization of *Papaver*. *Economic Botany*, 27(4): 390-400
- Fenga C., Costa C., Caruso E., Raffa L., Alibrando C., Gangemi S., Docea A.O., Tsatsakis, A.M. 2016. Current evidence on the protective effect of dietary polyphenols on breast cancer., *Farmacia*, 64(1), 1-12.
- Gelin, Z., Mosyakin, L.S., Clemants, E.S. 2003. *Chenopodiaceae*. *Flora of China*. 5:351-414.
- Guil-Guerrero, J.L., Reboloso-Fuentes, M.M., Isasa, M.E.T. 2003. Fatty acids and carotenoids from Stinging Nettle (*Urtica dioica* L.). *Journal of Food Composition and Analysis*, 16: 111-119.
- Güner, A., Aslan S., Ekim, T., Vural, M. ve Babaç, M.T. 2012. Türkiye bitkileri listesi (damarlı bitkiler). *Nezahat Gökyiğit Botanik ve Flora Araştırmaları Derneği Yayını, İstanbul, 246-299*.
- Güner, A., Özhatay, N., Ekim, T., Başer K.H.C. 2000. *Flora of Turkey and the East Aegean Islands. (Supplement 2)- XI*. Edinburg Univ. Press, Edinburg.
- Gürdal, B., Kültür, Ş. 2013. An Ethnobotanical Study of Medicinal Plants in Marmaris (Muğla, Turkey). *Journal of Ethnopharmacology*, 146: 113-126.
- Howes, M., Perry, E. 2011. The role of phytochemicals in the treatment and prevention of dementia. *Drugs Aging*, 28: 439-68.
- Kadıoğlu, Z., Çukadar, K., Kandemir, A., Aslay, M., Kalkan, N.N., Vurgun, H., Ertürk, N. 2016. Erzincan ve Erzurum illerinde sebze olarak tüketilen yabancı bitki türlerinin tespiti ve kullanım şekilleri. *Uluslararası Erzincan Sempozyumu, 28 Eylül-01 Ekim 2016. Erzincan. s. 855-877*.
- Kapoor, L. 1995. *Opium poppy: botany, chemistry, and pharmacology*. CRC Press.
- Kazan, D. 2007. *Ortaca (Muğla) İlçesinin Etnobotaniği*. Muğla Üniversitesi, Fen Bilimleri Enstitüsü, Biyoloji Anabilim Dalı, Yüksek Lisans Tezi, Muğla.
- Koca, I., Hasbay, I., Bostancı, S. 2011. Samsun ve çevresinde sebze olarak kullanılan bazı yabancı bitkiler ve tüketim şekilleri. *Samsun Sempozyumu. 13-16 Ekim 2011. Samsun*.
- Korkmaz, M., Karakurt, E. 2015. Kelkit (Gümüşhane) ilçesinde doğal gıda bitkilerinin geleneksel kullanımları. *Biyoloji Bilimleri Araştırma Dergisi* 8 (2): 31-39.

- Kumar, S., Brijeshlata, D.S. 2012. Screening of traditional indian spices for inhibitory activity of acetylcholinesterase and butyrylcholinesterase enzymes. *Int. J. Pharma Bio Sci.* 3, 59–65
- Marc, E.B., Nelly, A., Annick, D.D., Frederic, D. 2008. Plants used as remedies antirheumatic and antineuralgic in the traditional medicine of Lebanon. *Journal of Ethnopharmacology*, 120, 315-334.
- Melzheimer, V. 1988 . *Silene L.* In: Rechinger KH (Editor). *Flora Iranica*. Vol. 163, 341-508.
- Özhatay, N., Kültür, F. 2006. Check-List of Additional Taxa to the Supplement Flora of Turkey III, Faculty of Pharmacy, Department of Pharmaceutical Botany, University of Istanbul, Istanbul-TURKEY, *Turk J Bot* 30 (2006) 281-316.
- Özüdoğru, B., Akaydın, G., Erik, S., Yesilada, E. 2011. Inferences from an ethnobotanical field expedition in the selected locations of Sivas and Yozgat provinces (Turkey). *J Ethnopharmacol*, 137: 85-98.
- Pandy, B.P. 2006. A text book of botany Angiosperms. S.Chand & company LTD. Ramngar. Newdelhi.
- Que, F., Hou, X.L., Wang, G.L. et al 2019. Advances in research on the carrot, an important root vegetable in the Apiaceae family. *Hortic Res.*, 6:69.
- Satıl, F., Akçiçek, E., Selvi, S. 2007. Madra dağı (Balıkesir/İzmir) ve çevresinde etnobotanik bir çalışma. *Biyoloji Bilimleri Araştırma Dergisi* 1 (1): 31- 36.
- Uddin, M.K., Juraimi, A.S., Hossain, M.S., Nahar, M.A.U., Ali, M.E., Rahman, M.M. 2014. Purslane weed (*Portulaca oleracea*): a prospective plant source of nutrition, omega-3 fatty acid, and antioxidant attributes. *Sci. World J.* 2014:951019
- Uysal, G. 2008. Köyceğiz (Muğla) İlçesinin Etnobotaniği. Muğla Üniversitesi Fen Bilimleri Enstitüsü, Biyoloji Anabilim Dalı. Yüksek Lisans Tezi. Muğla.
- West, C.E. 2000. Meeting requirements for vitamin A. *Nutrition Reviews* 58, pp. 341–345.
- Yapıcı, I.Ü., Hoşgören, H., Saya, Ö. 2009. Kurtalan (Siirt) ilçesinin etnobotanik özellikleri. *Dicle Üniversitesi Ziya Gökalp Eğitim Fakültesi Dergisi* 12: 191-196.
- Yesil, Y., Inal, I. 2021. Ethnomedicinal Plants of Hasankeyf (Batman-Turkey). *Front. Pharmacol., Sec. Ethnopharmacology*, 11 – 2020.
- Zhou, Y.X., Xin, H.L., Rahman, K., Wang, S.J., Peng, C., Zhang, H. 2015. *Portulaca oleracea* L.: a review of phytochemistry and pharmacological effects. *BioMed Res. Int.* 2015:925631.

RATIONAL USE OF PASTURES USING REMOTE SENSING ON THE LANDS OF NORTHERN KAZAKHSTAN

¹Nogaev Adilbek, ²Serekpaev Nurlan, ³Baytelenova Aliya, ⁴Akhylbekova Balzhan

^{1,2,3}S. Seifullin Kazakh Agro-Technical University, Kazakhstan, 010000 Astana city, Pobeda Avenue 62

²“A.I. Barayev Scientific and production center of grain farming” LLP, Kazakhstan, Akmola region, Shortandy district, 15 Barayev str.

ABSTRACT

Intensive grazing leads to degradation of pastures and, accordingly, to a shortage of pasture feed for animals. With the haphazard use of forage lands, they are trampled and the coefficient of their use decreases, the botanical composition of phytocenoses is depleted and valuable crops fall out of its composition. To maintain pasture productivity, it is necessary to develop a pasture resource management system to control pasture capacity and grazing duration. The article shows the results of studies of corral grazing of beef cattle, using remote sensing of the land in Northern Kazakhstan.

Keywords: pastures, paddock grazing, pasture capacity, pasture turnover.

INTRODUCTION

The potential productivity of the pasture lands of the Republic of Kazakhstan, which make up about 70% of its entire territory, reaches 25 and more million tons of fodder units. The largest areas of pastures are concentrated in the western, central and eastern regions of the country, and the smallest areas of pastures are concentrated in the northern regions due to the plowing of land for agricultural crops.

However, it should be noted that the natural forage lands of the republic and the region are used insufficiently and unevenly. Their unsystematic exploitation has led to the fact that at present the yield of pastures and hayfields has decreased almost everywhere, the area of degraded lands has increased, 48 million hectares of 188 million hectares of natural forage lands are subject to degradation, of which 27 million hectares are downed. As a result, the productivity of hayfields and pastures is significantly lower than the potential. The average productivity of pastures in the steppe and forest-steppe zones does not exceed 5 centners per hectare of pasture mass.

At the same time, only 30% of all pastures in the country are used for grazing, since most of the pastures are not provided with reservoirs. All these factors require new approaches in the use of forage lands. In this regard, the purpose of these studies was the organization of corral grazing for the rational use of pastures using remote sensing of the land in one of the farms of Northern Kazakhstan.

MATERIALS AND METHODS

The study was conducted by LLP "North Kazakhstan Agricultural Experimental Station" (54°12'45.0" N 69°30'50.1"E), located in Akkayyn district of North Kazakhstan region. For the experiment, natural forage lands and beef cattle of the Kazakh white-headed breed in the

amount of up to 60 heads were selected. From the total area of the pastures of the farm, a separate experimental pasture with an area of 70 hectares, with 7 paddocks of an average of 10 hectares, was selected for the organization of grazing by a corral (portion) method (Fig.1). The paddocks were divided into the shape of a petal with a separate single outlet to the watering hole. After the organization of the pasture territory, the animals were grazed alternately in the paddocks during the pasture period.

When selecting and defining the boundaries of the experimental pasture site, the following was carried out:

- 1) collection of information using digital technologies: land and cartographic maps, identification numbers of farm land plots in the AIS GZK system.
- 2) superimposing coordinates on the map and processing satellite images using ArcGIS.
- 3) Fixing the boundaries of pastures and contours using the Garmin Montana 610 GPS navigator using GPS/GLONASS satellite data.
- 4) Calculation of the required area for 60 heads of cattle and the number of paddocks, the number of days for grazing for the entire pasture period.

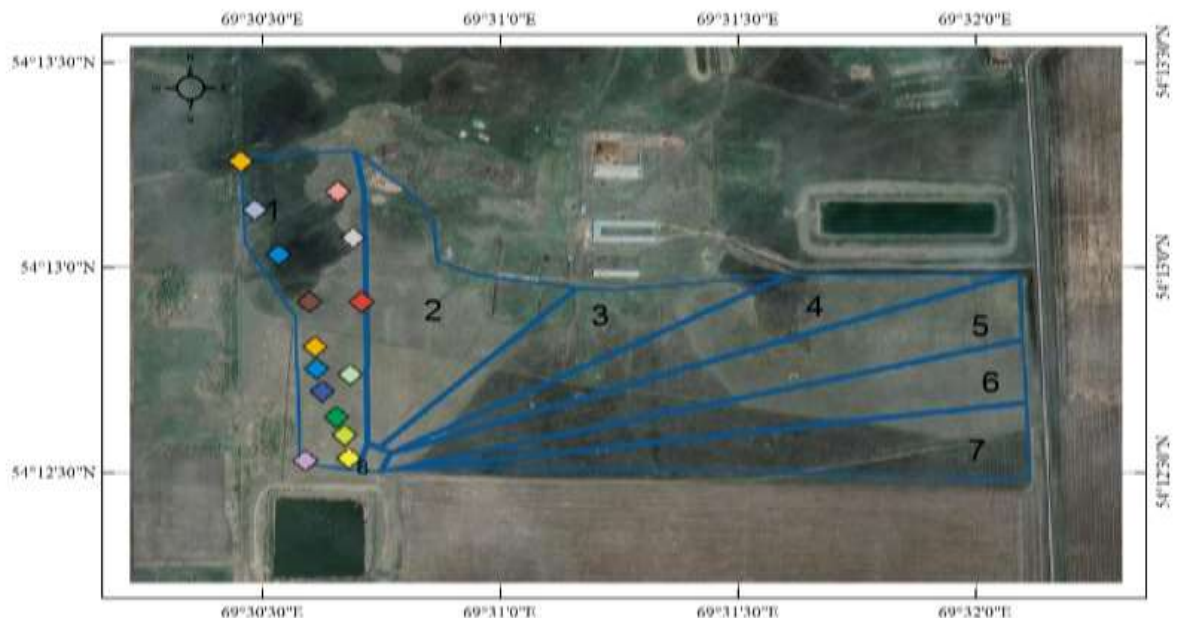

Figure 1. Pasture turnover scheme

The total area and paddocks of the pasture were fenced with electric fences with a battery power system and solar panels.

After the organization of the pasture territories, the animals were grazed alternately in the paddocks during the pasture period. During this period, aboveground records and observations of the dynamics of the botanical composition, the projective cover, plant height, yield, before and after the animals were pitted in the paddocks were carried out.

Analysis of the botanical composition. To determine the botanical composition of the herbage, samples were taken from 1m² of the area. The selected samples were weighed and divided according to the botanical composition. The botanical description of the herbage was carried out according to the determinants [1, 2] and the method of botanical weight analysis of hay and pasture feed samples [3].

Projective coverage (PC) is determined by the Ramensky method, with the help of a mesh superimposed on a plot of 1m², empty spaces are counted, which are measured by cells. Then the number of empty cells (Ec) is divided by the total number of cells (Tc) and multiplied by

100, % of empty cells (n) are obtained: $n = E_c / T_c * 100$, then the projective cover is determined by the following formula:

$$PC=100-n$$

Determination of pasture productivity. Productivity accounting on pastures was carried out by the seasonal sloping method, in each contour on 10 accounting sites with a size of at least 2.5 m² (1x2.5 m) each at a height of 5-6 cm from the ground. An average sample was also taken to determine the absolutely dry substance and then the dry mass yield from 1 ha.

Determination of pasture capacity and load. The actual load for 1 conditional head cattle (A, ha) is the actual pasture area for one head or the need for pasture area, determined by the formula: $A = f/p$; where f is the need of animals for pasture feed during the pasture period; p is the productivity of the pasture during the entire pasture season. The load on 1 ha of pastures (pasture capacity or C, conditional heads) is the number of animals that can be grazed on 1 ha without damage to pasture ecosystems, determined by the formula: $C=Y/(K*D)$; where C is the permissible load on 1 ha of pastures (heads), Y is the yield of green feed or dry mass eaten during the pasture period (kg or feed units), K is the daily need for green feed or dry mass per head of cattle (kg, feed units), D – duration of pasture use (day) [4].

RESEARCH RESULTS AND DISCUSSION

The soil cover of the experimental pasture site is characterized by a low humus content, an average nitrogen content and a low phosphorus content, and in terms of exchange potassium it belongs to a high group, in terms of volumetric weight it belongs to a medium-density group. The degree of acidity of the soil is neutral.

The botanical composition was represented by a typical mixed-grass vegetation with a predominance on individual contours of wormwood (Fig.3), height from 15.7 to 33.3 cm, with a projective coverage from 55.0 to 97.7% and a seasonal yield from 5-6 centners per hectare with a content of 5.58 to 33.59 g of digestible protein in 1 kg of pasture mass, fodder units from 0.20 to 0.55 k units, exchange energy from 2.7 to 6.2 MJ. Thus, according to the soil and botanical characteristics, this site is a typical pasture area of the steppe zone of the northern regions of the republic, the areas of which occupy more than 70% of the total pasture area of the region.

The height of plants varied from 11.5 to 18.6 cm before the first grazing, NDVI indicators were at the level of 0.24-0.39, from 11.7 to 17.6 cm before the second grazing, NDVI from 0.31 to 0.48 (Table 1).

Table 1 – Dynamics of the height of the grass stand and NDVI by the periods of grazing of the paddocks

Paddocks	Projective coverage, %			NDVI		
	1- grazing	2- grazing	+/- between 1-st and 2-nd grazing	1- grazing	2- grazing	+/- between 1-st and 2-nd grazing
1	11,5	17,6	+6,1	0,26	0,32	+0,06
2	14,8	13,7	-1,1	0,38	0,35	-0,03
3	13,6	14	+0,4	0,39	0,36	-0,03
4	18,6	17,6	-1,0	0,24	0,48	+0,24
5	14,5	15,5	+1,0	0,32	0,39	+0,07
6	14,9	11,7	-3,2	0,31	0,35	+0,04
7	14	14,9	+0,9	0,29	0,31	+0,02

The productivity of pastures during the second grazing was higher than during the first. This is due to the rainfall in July, which was 12 mm higher than the annual average and helped the herbage to recover. Whereas at the first grazing in May, the amount of rainfall was 3-4 times lower than the average long-term indicators (Table 3).

Table 3 – Pasture productivity by paddocks

Paddocks	Productivity, t/ha		
	1 – grazing	2 - grazing	+/- between 1-st and 2-nd grazing
1	0,49	1,13	+0,64
2	1,49	1,26	-0,23
3	1,27	1,12	-0,15
4	1,18	2,15	+0,97
5	1,24	1,92	+0,68
6	1,08	0,86	-0,22
7	1	0,6	-0,4
LSD	0,36	0,29	

For example, in paddocks No. 1, 4, 5, pasture productivity increased by 0.64, 0.97, 0.68 t/kg. And also, on the whole, productivity in all pasture paddocks improved on average by 1.29 t/ha.

Subsequently, after data collection, the required area for 60 heads of cattle of the meat direction of the Kazakh White-headed breed was calculated and the number of days for grazing for each paddock for the entire pasture period was determined (Table 4).

Table 4 – Calculation of the load and duration of grazing for each paddock

Paddocks	grazing duration	area	pasture mass yield, t	Actual load, head/ha	Pasture area for one head, ha
1 – grazing					
1	7	9,94	0,49	1,69	0,59
2	8	9,26	1,49	4,50	0,22
3	5	9,57	1,27	6,13	0,16
4	7	9,52	1,18	4,07	0,25
5	6	9,7	1,24	4,99	0,20
6	5	9,68	1,08	5,21	0,19
7	5	9,46	1	4,83	0,21
2– grazing					
1	5	9,94	1,14	5,50	0,18
2	5	9,26	1,27	6,13	0,16
3	5	9,57	1,12	5,41	0,18
4	9	9,52	2,15	5,77	0,17
5	8	9,7	1,92	5,79	0,17
6	5	9,68	0,82	3,96	0,25
7	4	9,46	0,6	3,62	0,28

Thus, during the first grazing, the cattle were grazed on average for about 6 days on each paddock, for a total of 43 days there was completely one cycle for all paddocks. The period of

the first grazing also depended on the type and condition of the pasture herbage. Pasture grass should be inserted during the period of its greatest nutritional tillering, earing-budding, and it is necessary to finish the grazing before the beginning of flowering, when the grasses begin to roughen.

After collecting all the data, a grazing schedule was compiled on the basis of calculations at each paddock (Table 5).

Table 5 - Periods of use of paddocks

Usage periods	Paddocks pastures						
	1	2	3	4	5	6	7
17.05-25.05	B1						
25.05-02.06		B1					
02.06-09.06			B1				
09.06.-15.06				B1			
15.06-23.06					B1		
23.06-1.07						B1	
1.07-11.07							B1
11.07-19.07	B2						
19.07-28.07		B2					
28.07-5.08.			B2				
5.08 -14.08.				B2			
14.08-22.08					B2		
22.08-27.08						B2	
27.08-01.09							B2

*Note: B1, B2...- the sequence of cattle grazing on corral plots

Thus, the livestock, which is consistently drove according to the developed schedule, on average after 6 days of grazing from the previous site to the next, during the first cycle of 43 days, completely passes the entire area of the experimental site allocated for herd grazing, and returns to the initial 1st paddock. The time before re-grazing corresponds to the time for the restoration of the herbage according to agrotechnical standards - 40-50 days. From day 44, the second cycle begins from the 1st paddock. Under favorable weather conditions, the grazing time can be extended.

In our research, with the help of the organization of paddock grazing based on calculations of pasture load, we were able to avoid degradation of pastures without loss of fatness of animals. The organization of cattle grazing for the rational use of pastures is an important factor for preventing the degradation of pastures, since cattle usually spend less time in places far from water, and also do not graze on steep slopes [5].

CONCLUSION

Thus, when organizing paddock grazing for the rational use of pastures in “North Kazakhstan Agricultural Experimental Station” LLP, a typical pasture site was selected by geobotanical surveys, the required area for 60 heads of beef cattle of the Kazakh white-headed breed was calculated. The average grazing area of one head of beef cattle in “North Kazakhstan Agricultural Experimental Station” LLP, which amounted to 0.22 head/ha, as well as the number of consistently used paddocks in the section – 7, with the exception of the possibility of complete grazing, which will allow the farm to reduce costs for this period and increase the use of pasture productivity, is justified.

REFERENCES

1. Fisyunov A.V. Sornye rasteniya. – M.; Kolos, 1984. – p 320.
2. Dmitrieva S.I., Iglovikov V.G., Konyushkov N.S., Ramenskaya V.M. Rasteniya senokosov i pastbishch. – M.: Kolos, 1982. – p.247
3. Konyushkov N.S., Rabotnova T.A., Cacenkina I.A. Metodika opytnyh rabot na senokosah i pastbishchah. – Moskva: SEL'HOZGIZ, 1961. – 287
4. Akhyzbekova, B., Serekpayev, N., Nogayev, A. & Zhumabek, B. (2022). Pasture Productivity Depending on the Method of Pasture use in the Steppe Zone of Northern Kazakhstan. OnLine Journal of Biological Sciences, 22(4), 476-483. <https://doi.org/10.3844/ojbsci.2022.476.483>
5. Hou L, Xin X, Shen B, Qin Q, Altome AIA, Hamed YMZ, Yan R, Serekpaev N., Nogayev A., Akhyzbekova B., et al. Effects of Long-Term Grazing on Feed Intake and Digestibility of Cattle in Meadow Steppe. Agronomy. 2023; 13(7):1760. <https://doi.org/10.3390/agronomy13071760>

THE ROLE OF DNA METHYLATION IN SHEEP' EMBRYONIC DEVELOPMENT

Desislava Abadjieva¹, Vanya Mladenova¹

¹ Institute of Biology and Immunology of Reproduction, Bulgarian Academy of

Sciences, 1113 Sofia, Bulgaria

Corresponding author e-mail: desi_l@abv.bg

ABSTRACT

DNA methylation is one of the epigenetic modifications of the genome, the essence of which is the attachment of a methyl group to nitrogenous bases. They are assumed to CpG islands play an important role in the regulation of gene expression in sheep, coming to regulatory elements of genes.

The interest are processes of methylation and demethylation. The methylation process always depends on the work of enzymatic complexes and is very precisely regulated. The methylation process largely depends on the functioning of enzymes. On other hand, demethylation can be performed not only by enzymatic complexes, but also during DNA replication. So, the maintenance of DNA methylation is more important. Changes in methylation patterns are linked with gene expression and observed during embryonic development.

Keywords: methylation, sheep, gene expression embryogenesis

INTRODUCTION

The crucial DNA modification with significant effects on gene expression is the process methylation. There are the various forms of DNA methylation, but cytosine methylation is the most frequent in eukaryotic cells. It is an epigenetic mechanism in which the methyl group is transferred to the fifth carbon of cytosine and lead to formation a molecule of 5-methylcytosine. It is catalyzed by the DNMT methyltransferase family (Fig. 1), represent a three family groups, numbered in order of their discovery (Lyko, 2018; Bestor, 2000). These enzymes serve the twounic processes of DNA methylation - the establishment of DNA methylation state by de novomethylation and, thereafter, the maintenance of those states by replication (Okano et al., 1999). DNA methyltransferase 1 (DNMT1) is actively involved in the maintenance of DNA methylation patterns. Passive demethylation occurs after each cellular division in the absence of functional DNMT1. DNMT3A and DNMT3B are included in the establishment of de novo DNA methylation. DNA methyltransferase 3L (DNMT3L) interacts and stimulates activity of DNMT3A and DNMT3B. Ten-eleven Translocation dioxygenases enzymes are helping (TET) active demethylation as oxidize 5-methylcytosine (m5C) to 5-hydroxymethylcytosine (hm5C), 5-formylcytosine (f5C) and 5-carboxylcytosine (ca5C), (Lyko, 2018). The structural and functional identities of cells throughout cell division are defined from DNA methylation patterns (Moore et al., 2013).

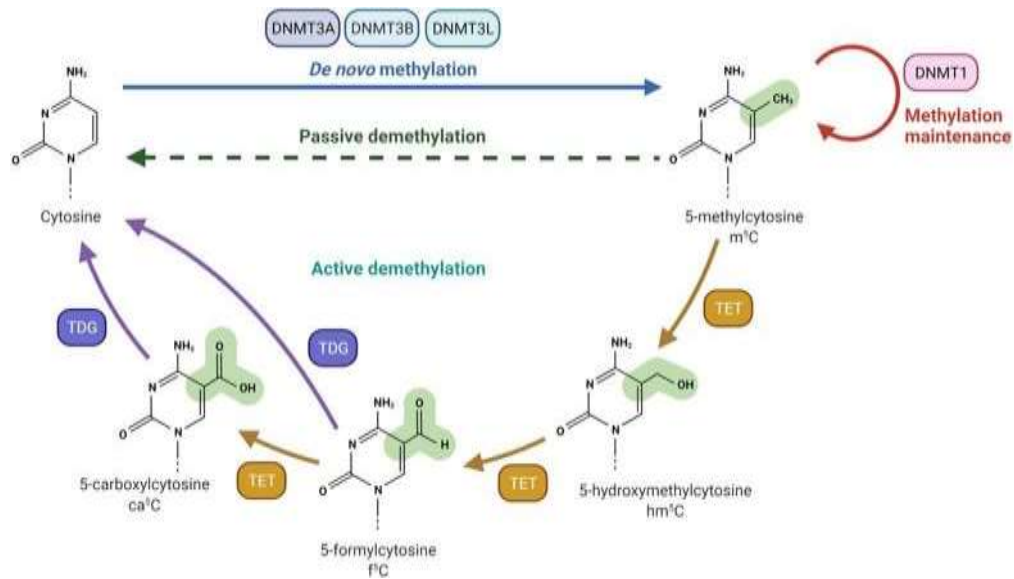

Figure 1. DNA methylation and demethylation machinery

The mammalian genome contains an extremely high burden of sequences. The gene regulation is highly sensitive to the methylation status of these so-called CpG islands. The genome of domestic sheep (*Ovis aries*) contains approximately 28 million CpG dinucleotides, which are unevenly distributed, such each can be in a methylated or unmethylated form. Their diploid number is 54, with 26 pairs of autosomes and two sex chromosomes (Jin, et al., 2011). More than 78% of DNA methylation occurs in cytosines which are located in the CpG dinucleotide in cells. The main of functions of this modification are genomic imprinting, inactivation of X-chromosome, regulation of gene expression, maintenance of epigenetic records or embryonic development (Sun et al., 2021).

During development in mammals, there are two periods of genome-wide DNA methylation reprogramming (Reik & Walter, 2001). The first period is during primordial germ cell differentiation and second period is during preimplantation development. To what extent this important regulatory mechanism operates in early germ cell development and differentiation in specie *Ovis aries* has not yet been clarified. This knowledge will influence the understanding of the DNA methylation process, its impact on the stability of the genome and reproductive biology in particular.

The aim of this report was to review the current understanding of the mechanisms of DNA methylation and demethylation in sheep and the role of methylation in the regulation of gene expression and embryo development.

RESULT AND DISCUSSION

Regulation and functions during Development of gene transcription

Epigenetic regulation of transcription through DNA methylation can occur via two mechanisms. One of this, is based on the steric hindrance of methyl groups to the interaction of transcription factors with DNA. The other mechanism is based on indirect involvement of proteins, which inhibit DNA binding to transcription factors (Loeza-Loeza et al., 2020). It is considered that approximately 40% of the genes encoding proteins contain CpG islands in

the promoter regions. CpG dinucleotides can facilitate the binding of transcription factors to DNA, thereby supporting gene expression (Hartl et al., 2019).

DNA methylation has long been thought to affect gene transcription alone. However, it has been found recently that attachment of the methyl group to cytosine may increase diversity

of mRNAs and their protein products, by modulation of the rate of operation of RNA polymerase II (Shayevitch et al., 2018; Jensen et al., 2023). One of the common features of CpG islands is that they contain fewer nucleosomes than other regions of DNA, and this enhancing gene expression (Moore et al., 2013).

The literature analysis suggests that methylation does not have a suppressive effect on gene expression, as the activity of some genes appears to be independent of methylation. Research has also shown both positive and negative correlations between tissue-specific methylation and gene expression.

DNA methylation during oocyte maturation is essential for viability of the embryos. The development of a mammalian embryo depends on proper epigenetic modifications and resources provided by the oocyte. The ability of oocytes to synthesize and store sufficient quantities of maternal factors, such as Dnmt1, Dnmt3a, and Tet3 mRNA, during maturation, is linked with global methylation and demethylation during oocyte maturation and respectively early embryonic development. Epigenetic mechanisms, specifically DNA methylation dynamics, have been implicated in the capacity of developing oocytes. If DNA methylation defects occur in this phase may occur problems in the pregnancy (Liang et al., 2012).

During germ cell development, erasure of imprinted methylation is followed by temporally asynchronous reacquisition of sex-specific imprints. This restoration of methylation marks requires the activity of de novo MTases. The hypomethylated status of imprinted genes in embryos derived from transplanted Dnmt3a^{-/-} Dnmt3b^{+/-} ovaries suggested a possible role for these MTases in de novo imprint methylation (Hata et al., 2006). Methylation analysis of these embryos revealed severely hypomethylated imprinted genes, suggesting an essential role for Dnmt3a in the establishment of maternal methylation imprints during female germ cell development. The methylation of paternally methylated imprinted gene H19 and minor satellite sequences, appeared normal in these embryos. Likewise, spermatogonia from mutant males also showed hypomethylation of imprinted target sequences. That suggest that Dnmt3a is required by both male and female germ cells for the de novo methylation of imprinted genes during gametogenesis.

The methylation targets of Dnmt3L are identical to those of Dnmt3a, with spermatogenesis was also perturbed in Dnmt3L null males, and germ cells showed impaired de novo methylation of the essential gene H19. Interestingly in this case is that Dnmt3L-deficient spermatocytes display severe meiotic defects (Bourc'his and Bestor, 2004). This reinforces the critical role for maintenance of DNA methylation in chromosomal stability. Dnmt3a and 3b have been shown to be required for maintenance of methylation. About Dnmt1, it remains active following replication, and may achieve this postreplication methylation in only with Dnmt3a and/or Dnmt3b (Liang et al., 2002; Rhee et al., 2002). These results suggest a mutual interrelatedness of the MTases to create and maintain distinctive patterns and levels of DNA methylation.

Dnmt1o is actively transcribed and translated during oocyte growth and maturation. In this period replication no takes place. This suggested a de novo methylase function for Dnmt1o (Mertineit et al., 1998). In the phase MII on oocyte, characterized with distribution of the proteins of oocyte to two- and four-cell stage embryo, included it inherits a vast store of Dnmt1o

protein. However, there is very limited detection of the Dnmt1o transcript after fertilization. It is very specific that the Dnmt1 transcript can be detected throughout this period, with the exception of the fertilized oocyte (Fig. 2), (Ratnam et al., 2002; Ko et al., 2005). Analysis of the Dnmt3 family of proteins and activities has not been completed; however, expression of the de novo methylase Dnmt3a is detected throughout preimplantation. Although Dnmt1s is also present throughout this period, the absence of maintenance methylation and the observation that imprinted methylation remains intact, suggests that Dnmt3a, in its targeting role, acts as a maintenance methylase but only on imprinted target sequences.

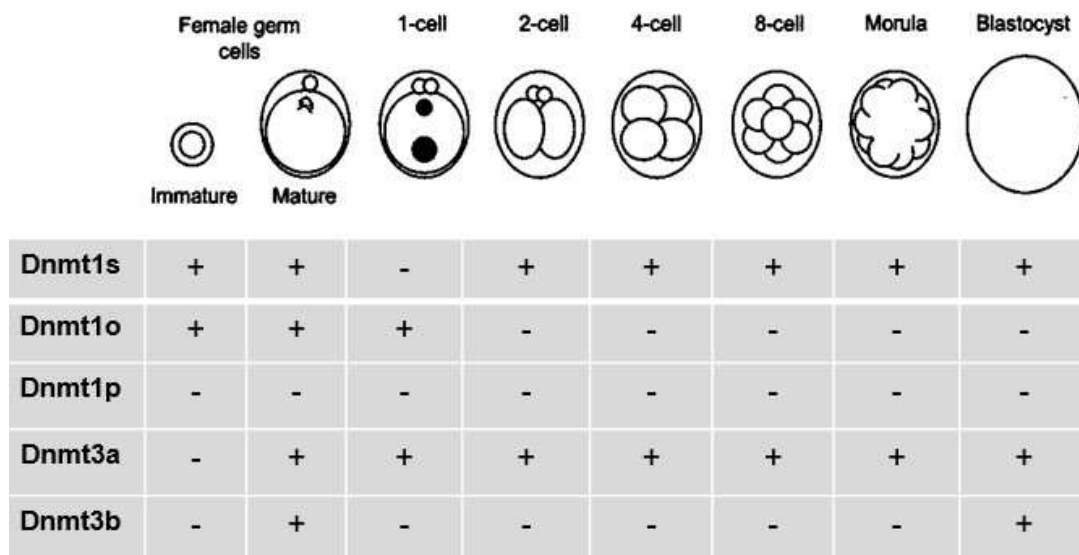

Figure 2. Dynamics of DNA methyltransferase localization during reproductive development: from germ cell to embryo

The epigenome plays a critical role in embryogenesis. The genome undergoes a two-stage reprogramming process during embryogenesis; first - during the formation of primary germ cells. During this early phase of differentiation, PGCs appear to be methylated as measured by indirect immunofluorescence using a highly specific antibody against 5 methyl cytosine (Seki et al., 2005); after that, both male and female gametes are arrested, the female in meiotic prophase and the male in mitosis. The significance of this process is to protect the cell lines of the future embryo from mutations and second, methyltransferases to new methylation patterns de novo (Gopinathan and Diekwisch, 2022).

The genome demethylation occurs during early mammalian embryonic development, a few hours after the formation of the zygote as full complement of appropriately imprinted genes are remodeled to restore a uniform diploid nucleus to the newly formed zygote (Li et al., 2008). At the morula stage, gamete methylation patterns are completely obliterated (Bernstein, 2020). Remethylation occurs at the blastocyst stage when methyltransferases (3a and 3b) create de novo methylation patterns. With embryo implantation, the genome is methylated anew, forming a characteristic pattern, which is then maintained of its cells (Gopinathan and Diekwisch, 2022). Using an antibody approach, Dean et al. (2001) found that active demethylation was conserved among widely divergent mammalian species. Investigations in the sheep suggest that there is a partial reduction of DNA methylation in the zygote. A similar analysis in humans, shown that male pronucleus undergoes demethylation in the zygote (Beaujean et al., 2004).

Experimental manipulation suggest that the partial demethylation of conspecific sperm may be related to the absolute amount, and organization, of genomic DNA methylation in the sheep (Jabbari et al., 1997).

The epigenetic load of the oocyte is essential for its developmental potential. Unfortunately, its remodelling often overlaps with potential interfering events such as exposure to assisted reproduction technologies (Hansen et al., 2005) or environmental changes - nutrition, pathologies or accidental exposition to various contaminants (Cortessis et al., 2012). Accurate knowledge of the methylation and hydroxymethylation status of the growing oocyte and on the molecules involved in their remodelling is fundamental to view an overall picture of the early rearrangements that will originate the embryo epigenome.

CONCLUSIONS

DNA methylation plays an important role in the regulation of sheep embryonic development. Methylation levels change several times during embryogenesis. DNA methylation, as a well-established epigenetic marker, has attracted the efforts of many researchers from diverse fields for decades. Combining new knowledge of DNA with histone modification and non-coding RNAs will provide important insights into the mechanisms of chromatin remodeling and regulation of gene transcription, which is instrumental to comprehensive understanding of developmental reprogramming.

REFERENCES

- Beaujean, N., Taylor, J., Gardner, J., Wilmut, I., Meehan, R., and Young, L. 2004. Effect of limited DNA methylation reprogramming in the normal sheep embryo on somatic cell nuclear transfer. *Biol. Reprod.*, 71: 185–193.
- Bernstein, C. 2022. DNA Methylation and Establishing Memory. *Epigenetics Insights.*,15.
- Bestor, T.H., 2000. The DNA methyltransferases of mammals. *Hum Mol Genet.*, 9(16): 2395-402.
- Bourc'his, D., Bestor, T.H. 2004 Meiotic catastrophe and retrotransposon reactivation in male germ cells lacking Dnmt3L. *Nature*, 431: 96-99.
- Broad, T.E., Hayes, H., Long, S.E. 1997. Cytogenetics: physical chromosome maps. *Geneticsof Sheep*, p. 241–295.
- Cortessis, V.K, Thomas, D.C., Levine, A.J., Breton, C.V., Mack, T.M., Siegmund, K.D., Haile, R.W. & Laird, P.W. 2012. Environmental epigenetics: prospects for studying epigeneticmediation of exposure–response relationships. *Human Genetics*, 131: 1565–1589.
- Dean, W., Santos, F., Stojkovic, M., et al. 2001. Conservation of methylation reprogramming in mammalian development: aberrant reprogramming in cloned embryos. *Proc Natl AcadSci.*, 98: 13734–13738.
- Gopinathan, G., Diekwisch, T.G.H. 2022. Epigenetics and Early Development. *J Dev Biol.*, 16,10(2):26.

- Hansen, M., Bower, C., Milne, E., de Klerk, N., Kurinczuk, J.J. 2005. Assisted reproductive technologies and the risk of birth defects – a systematic review. *Human Reproduction*, 20: 328–338.
- Hartl, D., Krebs, A.R., Grand, R.S., Baubec, T., Isbel, L., Wirbelauer, C., Burger, L., Schübeler, D. 2019. CG dinucleotides enhance promoter activity independent of DNA methylation. *Genome Res.*, 29(4):554-563.
- Hata, K., Kusumi, M., Yokomine, T., Li, E., Sasaki, H. 2006. Meiotic and epigenetic aberrations in Dnmt3L-deficient male germ cells. *Mol Reprod Dev.*, 73(1):116-122.
- Jabbari, K., Caccio, S., Pais de Barros, J.P., et al. 1997. Evolutionary changes in CpG and methylation levels in the genome of vertebrates. *Gene*, 205: 109–118.
- Jensen, D., Chen, J., Turner, J.A., Stephen, J.M., Wang, Y.P., Wilson, T.W., Calhoun, V.D., Liu, J. 2023. Epigenetic associations with adolescent grey matter maturation and cognitive development. *Front Genet.*, 14:1222619.
- Jin, B. Y. Li, K.D. 2011. Robertson DNA methylation: superior or subordinate in the epigenetic hierarchy? *Genes Cancer*, 2 (6): 607-617;
- Ko, Y.G., Nishino, K., Hattori, N., et al. 2005. Stage-by-stage change in DNA methylation status of DNA methyltransferase 1 (Dnmt1) locus during mouse early development. *J Biol Chem.*, 280: 9627–9634.
- Li, X., Ito, M., Zhou, F., Youngson, N., Zuo, X., Leder, P., Ferguson-Smith, A.C. 2008. A maternal-zygotic effect gene, *Zfp57*, maintains both maternal and paternal imprints. *DevCell*, 15: 547–557
- Liang, G., Chan, M.F., Tomigahara, Y. et al. 2002. Cooperativity between DNA methyltransferases in the maintenance methylation of repetitive elements. *Mol Cell Biol.*, 22: 480–491.
- Liang, X., Ma, J., Schatten, H., Sun Q. 2012. Epigenetic changes associated with oocyte aging. *Sci. Chin. Life Sci.*, 55: 670-676
- Loeza-Loeza, J., Beltran, A.S., Hernández-Sotelo, D. 2020. DNMTs and Impact of CpG Content, Transcription Factors, Consensus Motifs, lncRNAs, and Histone Marks on DNAMethylation. *Genes*, 11(11): 1336.
- Lyko, F. 2018. The DNA Methyltransferase Family: a Versatile Toolkit for Epigenetic Regulation. *Nat. Rev. Genet.*, 19: 81–92.
- Mertineit, C., Yoder, J.A., Taketo, T., Laird, D.W., Trasler, J.M., Bestor, T.H. 1998. Sex-specific exons control DNA methyltransferase in mammalian germ cells. *Development*, 125: 889–897.
- Moore, L. D., Le, T., Fan, G. 2013. DNA Methylation and its Basic Function. *Neuropsychopharmacol*, 38, 23–38.
- Okano, M., Bell, D.W., Haber, D.A., Li, E. 1999. DNA methyltransferases Dnmt3a and Dnmt3b are essential for de novo methylation and mammalian development. *Cell.*, 99(3):247-57.

Ratnam, S., Mertineit, C., Ding, F., et al. 2002. Dynamics of Dnmt1 methyltransferase expression and intracellular localization during oogenesis and preimplantation development. *Dev Biol.*, 245: 304–314.

Reik, W., Dean, W., Walter, J. 2001. Epigenetic reprogramming in mammalian development. *Science.*, 293(5532):1089-1093.

Rhee, I., Bachman, K.E., Park, B.H., et al. 2002. DNMT1 and DNMT3b cooperate to silence genes in human cancer cells. *Nature*, 416: 552–556.

Seki, Y., Hayashi, K., Itoh, K., Mizugaki, M., Saitou, M., Matsui, Y. 2005. Extensive and orderly reprogramming of genome-wide chromatin modifications associated with specification and early development of germ cells in mice. *Dev. Biol.*, 278: 440–458.

Shayevitch, R., Askayo, D., Keydar, I., Ast, G. 2018. The importance of DNA methylation of exons on alternative splicing. *RNA.*, 24(10): 1351-1362.

Sun, L., Fu, X., Ma, G., Hutchins, A.P. 2021. Chromatin and Epigenetic Rearrangements in Embryonic Stem Cell Fate Transitions. *Front Cell Dev Biol*, 9:637309.

FUNDING: from the Ministry of Education and Science of the Republic of Bulgaria under the National Scientific Program INTELLIGENT ANIMAL HUSBANDRY, grant agreement no. Д01-62/18.03.2021.

BDELLOVIBRIO BACTERIOVORUS IN BIOFILM AND MICROBIOLOGICALLY INFLUENCED CORROSION INHIBITION

Nahdhoit Ahamada Rachid^{1}, Nihal Doğruöz Güngör²*

¹ *Istanbul University, Institute of Graduate Studies in Sciences, Istanbul, Turkey*

² *Istanbul University, Department of Biology, Faculty of Science, Istanbul, Turkey*

*Corresponding author e-mail: nahdhoit7@gmail.com

ABSTRACT

Metal corrosion is one of the major global economic issues. Consisting of destruction of the metal and metal properties, this electro-chemical process is caused by different factors including microorganisms. Even if some microorganisms can influence the metal corrosion without adhering the surface of the metals, biofilm formation on the metal surface is known as one of the influence factors of microbially influenced corrosion (MIC). In this context, inhibiting the MIC can be processed by inhibiting the biofilm formation on the metal surface. Different methods like using antibiotics and biocides are used to fight this community formations. However, resistances to these substances are still developed in the environment and cause high costs in industrial and health fields. By this fact, it is thought that using predator bacteria which can feed themselves on the biofilm forming bacteria or metal corrosion influencing bacteria can be an environmentally friendly method and reduce the cost damage in the industries. In this review, the Gram-negative bacterium *Bdellovibrio bacteriovorus* is the main focused predator bacteria thought to be used to fight against biofilm formation and MIC. This bacterium isolated from different ecosystems (aquatic and soil), has as hosts both gram negative and Gram-positive bacteria. This study helps to understand in general the MIC, biofilm, MIC inhibition (MICI), and the role that can play the *B. bacteriovorus* in the inhibition of both biofilm formation and MIC.

Keywords: *Bdellovibrio bacteriovorus*, Biofilm, Corrosion, EPS, Microbially Influenced Corrosion.

INTRODUCTION

Metal corrosion is an electro-chemical mechanism resulting in the destruction of metals and their properties (Wadood et al., 2015; Lou et al., 2021). This phenomenon causes industrial economic loss, since it causes destruction of engineering equipment used in different industries like oil recovery, water cooling towers, and other mechanical systems (Li et al., 2015; Li et al., 2022). Environmental conditions including physico-chemical factors and biological factors, especially microorganisms, are known to impact on the metal corrosion process. Microorganisms can be involved in the initiation, acceleration, or facilitation of the corrosion by directly adhering to the metal surface to form biofilm or changing the environmental physico-chemical conditions of the metal (Li et al., 2022; Lou et al., 2021; Qian et al., 2022).

The abundance of microorganisms in water or liquid ecosystems is found to be reduced at the decrease of nutrient in liquids. However, they can adhere to surface of solid materials like metals or silicon that are in contact with the liquids and form the biofilm. Biofilm consists of pure or different microorganisms that adhere a solid surface and remain motionless in which

they secrete organic polymeric matrix known as extracellular polymeric substance (EPS) (AlSalhi et al., 2023; Iroha et al., 2005).

The EPS as well as other chemicals secreted in the biofilm matrix can facilitate the communication between organisms in this microbial community (Quorum Sensing). However, at the same time, this microbial structure can generate a competition between its population which induce physicochemical changes on their microenvironment (Flemming and Wingender, 2010). These changes cause the deterioration of the surface on where the biofilm is formed, thus we talk about corrosion. The output of the corrosion includes organic and inorganic compounds (AlSalhi et al., 2023). These changes don't only impact the metal or the surface from where microorganisms are attached but also cause pollution of the surrounding environments.

The microbial influenced corrosion is estimated at 20% of all corrosion costs (Basera et al., 2019; Kokilaramani et al., 2021). The MIC affects both highly specialised industries as well as our daily living environments like water cooling systems for large air conditioning units, kitchen sink's metal water traps, dental implants, etc... (Kokilaramani et al., 2021; AlSalhi et al., 2023; Fu et al., 2021; Costa et al., 2021). In fact, multiple ways are studied to combat this issue. It consists of chemicals like antibiotics and anti-biofilms developed to inhibit the attachment of the development of cells on the metal surface (Liu et al., 2018; El-Shamy, 2020). However, most of these substances are synthetics and cause significant impacts in the environment or can alter the chemical structure of the metal. In addition, antimicrobial resistance can be developed by the biofilm and the development of new anti-biofilms and antibiotics will still be needed.

In this fact, new strategies to combat the biocorrosion by using microorganisms able to inhibit the biofilm formation are found to be interesting and efficacies. Some microorganisms are feeding on other microorganisms without causing any infections to higher organisms like plants and animals (Lou et al., 2021). Such microorganisms can be used to control the proliferation of undesired microorganisms in different environments. *Bdellovibrio* Like Organisms are group of Gram-negative bacteria living in different ecosystems like water and soil (Negus et al., 2017). They are prey bacteria that can attack both Gram-negative and Gram-positive bacteria in the environments that are present. Study on biocontrol using these bacteria showed their ability to inhibit the development of *E-coli* in meat like food (Ottaviani et al., 2020). Another study showed the ability of these bacteria in reducing the proliferation of sulfate reducing bacteria (SRB) that are known for their capability to induce metal corrosion in anaerobic conditions (Qui et al., 2016). In this fact, it is thought that these bacteria can be effective in the inhibition of biofilm formation on metals and so the inhibition of microbially induced corrosion. Along this current review, general idea on biofilm, microbially induced corrosion (MIC), microbiologically influenced corrosion inhibition (MICI), and the application of *Bdellovibrio bacteriovorus* against biofilm formation and MIC are developed.

BIOFILM

In the environment, microorganisms can be found as planktonic or sessile cells. Sessile cells are attached to the surface of materials and form through different steps the biofilm structure (Rumbaugh and Sauer, 2020, Rather et al., 2021; Sauer et al., 2022). Biofilm can be defined as a surface attached microbial community embedded in a self-produced extracellular matrix composed of the complex extracellular polymeric substances (EPS) (Sauer et al., 2022; Rather et al., 2021). Microorganisms are directed to form the biofilm structure due to environmental stress including starvation, fighting against chemicals and antimicrobials, unfavourable temperature and pH, and continuous water flow (Castiblanco and Sundin, 2016; Rather et al., 2021). The biofilm formation or development is set in four stages which are detailed in different reviews for the mechanisms of each stage.

The first stage consists of the bacterial adherence on the host material surface: 'Adhesion'. In this stage, bacteria as planktonic cells interact with the host surface and form a firmly monolayer (Tuson and Weibel, 2013; Mahamuni- Badiger et al., 2020). At the second stage, we assist in a local proliferation of microorganisms generating the microcolonies. In this stage named 'biofilm formation or growth', a self-secretion of exopolymeric substances (EPS) is starting and a multilayer of microorganisms is orderly structured (Rabin et al., 2015). The third stage is the 'biofilm maturation' which consists of cell adaptation and development to transform the microcolonies into microcolonies. At this stage, the matrixome components including flagella, pili, amino acids, and exopolysaccharides are under regulation and lead to the development of mature biofilm (Liu et al., 2018). The fourth and last stage is the 'dispersion'. This process is due to environmental conditions such as change in temperature, oxygen, and nutrient composition, or caused by some enzymatic reactions from the EPS components, or physical factors like shearing forces by the liquid flow. These factors induce the detachment of cells from the biofilm structure and open the door for new local infestation, thereby a new cycle of biofilm development (Rather et al., 2021; Mahamuni- Badiger et al., 2020; Percival et al., 2015).

Other than the laboratory manipulated environments, the microbial community in a biofilm structure is far to be composed of a single microorganism. These microorganisms can communicate through the quorum sensing mechanism and form different complex matrix (Rather et al., 2021; Karygianni et al., 2020). Depending on the environmental physico-chemical conditions as well as the microbial community, the EPS is composed of biomolecules such as proteins, polysaccharides, lipids, and nucleic acids (Flemming et al., 2016).

On other hand, EPS is thought to afford drug tolerance in biofilms and develop their antimicrobial resistance. By this fact, the biofilm formation ability of microorganisms is recognized to be among their virulence factors (Wall et al., 2019; Gupta et al., 2016). In this context, the use of antimicrobial compounds against biofilms is more than complicated; because every microorganism in such a micro-community can secrete its proper molecules in the biofilm matrix that can have different virulence activities. The EPS form a barrier of ex-situ component like antibiotics by inhibiting them to enter the last layer of biofilms due to the ionic charges of the matrix, by destroying them through exoenzymes secreted by microorganisms in the microcolonies, or by genetic modification of antimicrobial active sites (Wright, 2005; Schroeder et al., 2017). The EPS composition and structure is affected by different factors like the type of microorganisms composed of biofilms, the local stress conditions like shear, and the mono-species or multispecies characteristics of the biofilm (Karygianni et al., 2020).

More of the impacts of the physico-chemical properties of biofilms is the changes of the environmental conditions like pH and oxygen concentration. These changes negatively affect the properties of the materials from which the biofilms are formed. For example, the degradation of microplastics by microorganisms is thought to be more effective with bacteria able to be attached on their surfaces and using these hydrocarbons as carbon sources (Han et al., 2020). In addition, the metal biocorrosion, regardless of its type, can be caused by the cell adherence to the metal surface (biofilm formation) and inducing electrochemical reactions (Yang et al., 2021).

MICROBIALLY INFLUENCED CORROSION (MIC)

MIC consists of deterioration process of metal or other surface caused by the reaction of metabolic reactions on that surface. Biofilm forming on metal induce acceleration of metal corrosion by acting in different ways such as modifying the chemicals transports towards the metal surfaces, removal of the protective films during the biofilm separation stage, causing unequal distribution of oxygen on the metal surface, causing conditions changes on the

oxidation-reduction processes occurred between solution and metal surfaces, and fragilization of the passive layers by changing their inorganic structure and accelerating their decomposition and detachment from the metal surface (Pal and Lavanya, 2022). The type of microorganisms, their metabolic reactions, the environmental conditions including pH, temperature, nutrient availability, metal type, and the addition of new species on the biofilm structure, have important impacts on the metal MIC (Procópio, 2019; Pal and Lavanya, 2022). Different group of bacteria are registered from previous study for their ability to induce metal corrosion.

Gram negative sulphate reducing bacteria (SRB) are known for their metal corrosive property under anaerobic conditions and are one of the most studied bacterial groups in metal corrosion. In mixed biofilm structure on metal, the SRB are found to inhabit the bottom where the oxygen level is lower due to the colonization of the top layers by aerobic and facultative anaerobic bacteria (Jia et al., 2019). They are thought to act in three different mechanisms during their metal corrosion reaction. The steel corrosion induced by SRB is due to the production of hydrogen sulfide (H₂S) in sulfate-containing environments. The sulfide is oxidized on the surface of the steel and produce the thiosulfate which activate the pitting corrosion (Kokilaramani et al., 2021). On the study run by Dou et al. (2018), it is shown that the cause of copper microbially influence corrosion by SRB is their production of sulfide rather than the electron harvesting for their energy production.

As reported by Jia et al. (2019), iron oxidizing bacteria (IOB) are group of bacteria able to oxidize ferrous ions to ferric ions to generate their growth energy and use oxygen as terminal acceptor. This reaction results to the extracellularly iron hydroxides deposit (Jia et al., 2019). IOB are known as corrosion causing agents but together with SRB are known to enhance the microbial corrosion of metals (Liu et al., 2018). It is due to the oxygen-free environment offered by the aerobic and facultative IOB on the biofilm formed on metals (Jia et al., 2019).

Nitrate reducing bacteria (NRB) is another corrosive bacterial group. In the beginning, NRB were used to fight against the development of SRB which are known to have a negative influence on the corrosion of metals. For this purpose, nitrate was injected into the oil and gas industries to promote the multiplication of NRB which use nitrate as a final electron acceptor in a low oxygen environment (Fida et al., 2016; Jia et al., 2019). However, a favourable thermodynamic reaction was reported between the couple formed by this nitrate reduction with iron oxidation. These reactions highlight the role of NRB in the MIC of metals. Other groups like acid producing bacteria, fungi, methanogens are also observed with corrosive role on metals (Kokilaramani et al., 2021; Jia et al., 2019).

MICROBIOLOGICALLY INFLUENCED CORROSION INHIBITION (MICI)

In the previous section, we showed the influence of microorganisms especially bacteria on metal corrosion and destruction. Combatting this industrial issue, traditional methods are applied. Lou et al., (2021) enumerated some protection methods like metal coating with antibacterial materials such as silver, surface treatments, and synthetic corrosion inhibitors. Although these technics are solving most of MIC problems, their negative impacts on the environment and public health, due to the release of toxic materials, limits their uses and incite to an urgent searching for eco-friendly methods to fight against the high loss in industrial and engineering fields (Lou et al., 2021). Previous studies showed some approaches that are thought to be environmentally friends like the use of biocide extracted from the black mustard *Brassia nigra*, using Immunoglobulin A (IgA), and film-forming mixtures of amines, imidazoline and quaternary ammonium compounds (Little et al., 2007; Videla et al., 2004). However, the use of these three approaches is limited on different ways: from the limit to use natural biocide on established biofilm, to the unfavourable use of IgA in medical applications, the toxicity of Alkyl

imidazoline to animals, and the initiation of local corrosion caused by film-forming inhibitors (Little et al., 2007; Videla et al., 2004).

Microorganisms are reported with a dual role in the corrosion process depending to the microorganism types, the environmental conditions, as well as the metal species. When some microorganisms enhance and accelerate the corrosion of metals, others, or the same microorganisms but in different environmental conditions can act oppositely and hindering the MIC (Lou et al., 2021). This process is called microbiologically influenced corrosion inhibition (MICI). Microorganisms act on different mechanisms to inhibit corrosion. Lou et al., (2021) divided the MICI mechanisms into five categories: microbial respiration, competition, secretion corrosion inhibitors, EPS protection, and mineralization. The microbial respiration mechanism consists of both aerobic and facultative anaerobic microorganisms present in metal surface forming biofilm. Facultative anaerobe and aerobic bacteria like *E.coli* and *pseudomonas* have been screened for their ability to inhibit or reduce different metal corrosion processes and the observed results are promised (Jayaraman et al., 1997).

This mechanism is related to the growth conditions of microorganisms, their ability to form biofilm on metal surface, the dissolved oxygen present in the environment, and other environmental conditions like, inorganic nutrient, temperature, and flow velocity (Lou et al., 2021). Wadood et al. (2015) showed the stainless-steel corrosion inhibition role of *Bacillus subtilis* and *Pseudomonas aeruginosa*. This study's results showed through SEM analysis the formation of protective film on the surface of the metal which consist of rod bacterial shape. In addition, authors observed that as long is the incubation time, as high is the decrease of the pH of the medium. This acid production is considered as metabolites production for the bacterial growth. However, an antagonistic reaction has been observed between the two bacteria, since when they are incubated together, the corrosion inhibition is mor important than when they are separately incubated (Wadood et al., 2015).

On other hand, competition between microorganisms can inhibit the microbially induced corrosion of the metals. Some microorganisms can compete other corrosive microorganisms through their metabolic growth systems. They can use the same electron acceptor and reduce the growth of the corrosive microorganisms (Hubert and Voordouw, 2007). Beside this competition, predator microorganisms can use the corrosive microorganisms as host for their growth and inhibit their attachment to the metal surface (biofilm forming inhibition) (Lou et al., 2021). It is the case of *Bdellovibrio* and organisms like (BLO).

APPLICATIONS OF *BDELLOVIBRIO BACTERIOVORUS* FOR BIOFILM INHIBITION AND MICI

Bdellovibrio bacteriovorus is a motile Gram-negative with curved shaped bacterium. This bacterium isolated from different ecosystems such as soil and water, is a predator bacterium known which is feeding from both Gram-negative and Gram-positive bacterial cells (Bratanis et al., 2020; Pantanella et al., 2018). In general, *B. bacteriovorus* attack the prey cells, enter their cytoplasm where they are multiplying. After their multiplication, cells leave the prey cells by causing lysis of their membranes (Bratanis et al., 2020).

Bdellovibrio bacteriovorus and *Bdellovibrio* like organisms are shown in different studies to be with high important uses in the control of pathogen bacteria. In the study conducted by El-Shanshoury et al. (2016), the *Bdellovibrio. sp*, isolated from water shown lytic activity on four antibiotic resistant isolates of *Salmonella sp*. From these results, authors suggest that

the predator bacteria can be used in the treatment of sewage wastewater as antimicrobial agent. In another study, the *Bdellovibrio bacteriovorus* has been revealed with antimicrobial effects against the phytopathogenic strains *Pantoea sp.* and *Xanthomonas campestris* (Odooli et al., 2021). On other hand, experimentations shown that *Bdellovibrio bacteriovorus* could be used during the post-harvest treatment to help the mortality of pathogens like *Esherichia coli* and *Salmonella* which are food borne pathogens (Olanya et al., 2020).

Bdellovibrio species showed effects on both planktonic cells and biofilms. It is reported that the attack to the microorganisms on biofilm structures required high effort than the attack to planktonic cells (Kadouri and O'Toole (2005). However, the reduction of biomass on biofilm formed by different pathogens is observed in previous studies. Kadouri and O'Toole (2005) reported the first anti-biofilm effect of *Bdellovibrio bacteriovorus* on the biofilms of *E. coli* and *Pseudomonas fluorescens* (Kadouri and O'Toole (2005). In addition, *Bdellovibrio bacteriovorus* has significantly reduced the microbial biomass of both pure and multicultures. The mode of action of this predator bacterium on the inhibition or degradation of biofilm formation depends mainly on the prey bacterium. The inhibition of *Staphylococcus aureus*'s biofilm by *Bdellovibrio bacteriovorus* is reported to be the action of extracellular proteases secreted by the predator (Pantarella et al., 2018).

Most of previous studies studying the efficiency of *Bdellovibrio bacteriovorus* and BLO as natural antimicrobial agents, focused on medical importance, biocontrol of plant pathogens and wastewater treatments. Until this date, only one study has investigated the effect of *B. bacteriovorus* on the microbial influenced corrosion caused by SRB. The results of this study show the reduction of corrosion rate of X70 steel from 19.17 to 3.75 mg/dm²/day after 2 months (Qiu et al., 2016). These results promise potential uses of this predator bacterium to escape from industrial damages which cause important economic cost in different sectors. On other hand, the MIC associated bacteria are of different mode of actions as previously illustrated. Some of them are directly attached to the metal surface (biofilm) some of them secret enzymes or other chemical substances which enhance the corrosion of the metal. Since this predator bacterium can attack both planktonic cells and cells in biofilm structure, it is thought to significantly impacted on the MIC. In addition, previous studies investigating the effects of environmental conditions on *B. bacteriovorus* show high range of pH and temperature resistance. Moreover, any oxygen variation impact on this bacterium was not observed (Williams and Chen, 2020). These data reinforce the idea that the *B. bacteriovorus* is a good natural biocontrol agent against MIC and biofilm formed on metal instruments. However, further studies like effects of this bacterium on different metal surface and on different microorganisms are necessary before applied it on the field.

CONCLUSIONS

Metal corrosion is an electro-chemical process resulting to the destruction of metal and metal properties which cause several industrial issues. It is caused by both abiotic and biotic factors including microorganisms. However, some microorganisms have been shown to play an important role in the inhibition of metal corrosion caused by microbial influence (MIC). *Bdellovibrio bacteriovorus* are a Gram-negative vibrio and Rhod- like shape motile bacteria. They are predators of both Gram-negative and some Gram-positive bacteria. Due to their predation and their high enzymatic activities, these bacteria have been studied for their biotechnological and industrial applications. These bacteria may play a significant role in the inhibition of MIC through their predation activity on the biofilm formed on the metal or on the microorganisms responsible for metal corrosion like SRB. Further studies on their predation

mechanisms should highlight the importance of their use in the fight against this industrial issue (corrosion).

REFERENCES

- AlSalhi, M. S., S. Devanesan, A. Rajasekar, S. Kokilaramani. 2023. Characterization of plants and seaweeds based corrosion inhibitors against microbially influenced corrosion in a cooling tower water environment. *Arabian Journal of Chemistry*. 16(3): 104513.
- Basera, P., M. Lavania, B. Lal. 2019. Potential of dynamic bacterial communities in the biocorrosion process: a proof study with surface morphology of metal coupons. *RSC advances*. 9(30): 17040-17050
- Bowen, W. H., R. A. Burne, H. Wu, H. Koo. 2018. Oral biofilms: pathogens, matrix, and polymicrobial interactions in microenvironments. *Trends in microbiology*. 26(3): 229-242.
- Bratanis E., T. Andersson, R. Lood, E. Bukowska-Faniband. 2020. Biotechnological Potential of *Bdellovibrio* and Like Organisms and Their Secreted Enzymes. *Frontiers in Microbiology*. 11 : 662.
- Castiblanco, L.F., G.W. Sundin. 2016. New insights on molecular regulation of biofilm formation in plant-associated bacteria. *Journal of integrative plant biology*. 58: 362-372.
- Costa, R. C., V.L. Abdo, P.H. Mendes, I. Mota-Veloso, M. Bertolini, M.T. Mathew, V.A.R. Barão, J. G. S. Souza. 2021. Microbial corrosion in titanium-based dental implants: how tiny bacteria can create a big problem?. *Journal of Bio-and Tribo-Corrosion*. 7(4):136.
- Dou, W., R. Jia, P. Jin, J. Liu, S. Chen, T. Gu. 2018. Investigation of the mechanism and characteristics of copper corrosion by sulfate reducing bacteria. *Corrosion Science*. 144 : 237-248.
- El-Shanshoury, A. E. R. R., A. E. Abo-Amer, O. M. Alzahrani. 2016. Isolation of *Bdellovibrio* sp. from wastewater and their potential application in control of *Salmonella paratyphi* in water. *Geomicrobiology Journal*. 33(10): 886-893.
- Fida, T.T., C. Chen, G. Okpala, G. Voordouw. 2016. Implications of limited thermophilicity of nitrite reduction for control of sulfide production in oil reservoirs. *Applied environmental microbiology*. 82: 4190–4199.
- Flemming, H. C., J. Wingender, U. Szewzyk, P. Steinberg, S. A. Rice, S. Kjelleberg. 2016. Biofilms: an emergent form of bacterial life. *Nature Reviews Microbiology*. 14(9): 563-575.
- Flemming, HC., J. Wingender. 2010. The biofilm matrix. *Nature Reviews Microbiology*. 8: 623–633
- Fu, Q., J. Xu, B. Wei, Q. Qin, L. Gao, Y. Bai, C. Yu, C. Sun. 2021. The effect of nitrate reducing bacteria on the corrosion behavior of X80 pipeline steel in the soil extract solution of Shenyang. *International Journal of Pressure Vessels and Piping*. 190: 104313.
- Gupta. P., S. Sarkar, B. Das, S. Bhattacharjee, P. Tribedi. 2016. Biofilm, pathogenesis and prevention—a journey to break the wall: a review. *Archives of microbiology*. 198:1–15.
- Han, Y. N., M. Wei, F. Han, C. Fang, D. Wang, Y.J. Zhong, C. L. Guo, X. Y. Shi, Z.K. Xie, F. M. Li. 2020. Greater biofilm formation and increased biodegradation of polyethylene film by a microbial consortium of *Arthrobacter* sp. and *Streptomyces* sp. *Microorganisms*. 8(12): 1979.
- Hubert, C., G. Voordouw. 2007. Oil field souring control by nitrate-reducing *Sulfurospirillum* spp. that outcompete sulfate-reducing bacteria for organic electron donors. *Applied and environmental microbiology*. 73(8): 2644-2652.

- Iroha, N. B., E.E. Oguzie, G. N. Onuoha, A. I. Onuchukwu. 2005. Inhibition of mild steel corrosion in acidic solution by derivatives of diphenyl glyoxal. In 16th International Corrosion Congress, Beijing, China . 2005: 26-131.
- Jayaraman, A., E. T. Cheng, J. C. Earthman, T. K. Wood. 1997. Axenic aerobic biofilms inhibit corrosion of SAE 1018 steel through oxygen depletion. Applied microbiology and biotechnology. 48: 11-17.
- Jia, R., T. Unsal, D. Xu, Y. Lekbach, T. Gu. 2019. Microbiologically influenced corrosion and current mitigation strategies: A state of the art review. International biodeterioration & biodegradation. 137: 42-58.
- Kadouri, D., G. A. O'Toole. 2005. Susceptibility of biofilms to *Bdellovibrio bacteriovorus* attack. Applied and Environmental Microbiology. 71(7): 4044-4051.
- Karygianni, L., Z. Ren, H. Koo, T. Thurnheer. 2020. Biofilm matrixome: extracellular components in structured microbial communities. Trends in microbiology. 28(8): 668-681.
- Kokilaramani, S., M.M. Al-Ansari, A. Rajasekar, F. S. Al-Khattaf, A. Hussain, M. Govarthan. 2021. Microbial influenced corrosion of processing industry by re-circulating waste water and its control measures-A review. Chemosphere. 265 : 129075.
- Li, X., D. Zhang, Z. Liu, Z. Li, C. Dong. 2015 Materials science: Share corrosion data. Nature. 527: 441-442 .
- Li, Z., X. Yuan, M. Sun, Z. Li, D. Zhang, Y. Lei, M. Zhang, Y. Fan, D. Xu, F. Wang. 2022. Rhamnolipid as an eco-friendly corrosion inhibitor for microbiologically influenced corrosion. Corrosion Science. 204: 110390.
- Little, B., J. Lee, R. Ray. 2007. A review of 'green' strategies to prevent or mitigate microbiologically influenced corrosion. Biofouling. 23(2): 87-97.
- Liu, J., Jia, R., Zhou, E., Zhao, Y., Dou, W., Xu, D., k. Yang, T. Gu. 2018. Antimicrobial Cu-bearing 2205 duplex stainless steel against MIC by nitrate reducing *Pseudomonas aeruginosa* biofilm. International Biodeterioration & Biodegradation. 132: 132-138.
- Liu, T., Z. Guo, Z. Zeng, N. Guo, Y. Lei, T. Liu, S. Sun, X. Chang, Y. Yin, X. Wang. 2018. Marine bacteria provide lasting anticorrosion activity for steel via biofilm-induced mineralization. ACS applied materials & interfaces. 10(46): 40317-40327.
- Liu, Y., Q. Qin, T. Defoirdt. 2018. Does quorum sensing interference affect the fitness of bacterial pathogens in the real world?. Environmental microbiology. 20(11): 3918-3926.
- Lou, Y., W.Chang, T. Cui, J. Wang, H. Qian, L. Ma, X. Hao, D. Zhang. 2021. Microbiologically influenced corrosion inhibition mechanisms in corrosion protection: A review. Bioelectrochemistry. 141: 107883.
- Negus. D., C. Moore, M. Baker, D. Raghunathan, J. Tyson, R. E. Sockett. 2017. Predator Versus Pathogen: How Does Predatory *Bdellovibrio bacteriovorus* Interface with the Challenges of Killing Gram-Negative Pathogens in a Host Setting? Annual Review of Microbiology. 71(1) : 441-457
- Odooli, S., R. Roghianian, Y. Ghasemi, M. Mohkam, G. Emtiazi, G. 2021. Predatory and biocontrol potency of *Bdellovibrio bacteriovorus* toward phytopathogenic strains of *Pantoea* sp. and *Xanthomonas campestris* in the presence of exo-biopolymers: in vitro and in vivo assessments. International Microbiology. 24(3): 399-413.
- Olanya, O. M., B. A. Niemira, J. M. Cassidy, G. Boyd, J. Uknalis. 2020. Pathogen reduction by predatory bacteria and survival of *Bdellovibrio bacteriovorus* and *Escherichia coli* on produce and buffer treated with low-dose gamma radiation. LWT. 130: 109630.
- Ottaviani, D., S. Peralisi, G. Angelico, F. Mosca, P. G. Tiscar, E. Rocchegiani, S. Scuota, A. Petruzzelli, S. Fisichella, G. Blasi, E. DiRaimo, F. Leoni, M. Latini, S. Altissimi, N. Haouet. 2020. *Bdellovibrio bacteriovorus* to control *Escherichia coli* on meat matrices. International Journal of Food Science & Technology. 55(3): 988-994.

- Pal, M.K., M. Lavanya. 2022. Microbial Influenced Corrosion: Understanding Bioadhesion and Biofilm Formation. *Journal of Bio-and Tribo-Corrosion*. 8: 76
- Pantarella, F., V. Iebba, F. Mura, L. Dini, V. Totino, B. Neroni, G. Bonfiglio, M. Trancassini, C. Passariello, S. Schippa. 2018. Behaviour of *Bdellovibrio bacteriovorus* in the presence of Gram-positive *Staphylococcus aureus*. *New microbiologica*. 41(2): 145-152.
- Percival, S. L., L. Suleman, C. Vuotto, G. Donelli. 2015. Healthcare-associated infections, medical devices and biofilms: risk, tolerance and control. *Journal of medical microbiology*. 64(4): 323-334.
- Procópio, L. 2019. The role of biofilms in the corrosion of steel in marine environments. *World journal of Microbiology and Biotechnology*. 35(5):1-8.
- Qi, H., Q. Shi, R. Peng, T. Sun, Z. Zhang, L. Li, X. Xie. 2023. Effect of One Sulfate-Reducing Bacterium SRB-Z Isolated from Pearl River on the corrosion Behavior of Q235 Carbon Steel. *Coatings*. 13(2): 478.
- Qian, H. C., W. W. Chang, W.L. Liu, T. Y. Cui, Z. Li, D.W. Guo, D. W., C. T. Kwok, L. M. Tam, D.W. Zhang. 2022. Investigation of microbiologically influenced corrosion inhibition of 304 stainless steel by D-cysteine in the presence of *Pseudomonas aeruginosa*. *Bioelectrochemistry*.143: 107953.
- Qiu, L., Y. Mao, A. Gong, W. Zhang, Y. Cao, L. Tong. 2016. Inhibition effect of *Bdellovibrio bacteriovorus* on the corrosion of X70 pipeline steel induced by sulfate-reducing bacteria. *Anti-Corrosion Methods and Materials*. 63(4): 269-274.
- Rabin N., Y. Zheng, C. Opoku-Temeng, Y. Du, E. Bonsu, H. Sintim. 2015. Biofilm formation mechanisms and targets for developing antibiofilm agents. *Future medicinal chemistry*. 7:493-512.
- Rather, M.A., K. Gupta, M. Mandal. 2021. Microbial biofilm: formation, architecture, antibiotic resistance, and control strategies. *Brazilian journal of microbiology* 52: 1701-1718
- Rumbaugh, K.P., K. Sauer. 2020. Biofilm dispersion. *Nature reviews microbiology*. 18: 571-586.
- Sauer, K., P. Stoodley, D. M. Goeres, L. Hall-Stoodley, M. Burmølle, P. S. Stewart, T. Bjarnsholt. 2022. The biofilm life cycle: Expanding the conceptual model of biofilm formation. *Nature Reviews Microbiology*. 20(10): 608-620.
- Schroeder M., B. D. Brooks, A. E. Brooks. 2017. The complex relationship between virulence and antibiotic resistance. *Genes (Basel)* 8:39.
- Videla, V. A., P. S. Guimet, S. Gómez de Saravia, L. K. Herrera, C. C. Gaylarde. 2004. Environmentally friendly approaches to inhibit biocorrosion – an overview, Houston, TX: NACE International. CORROSION. 04574
- Wadood, H.Z., A. Rajasekar, Y. P. Ting, A. N. Sabari. 2015. Role of *Bacillus subtilis* and *Pseudomonas aeruginosa* on Corrosion Behaviour of Stainless Steel. *Arabian journal for science and engineering*. 4:, 1825-1836
- Wall, G., D. Montelongo-Jauregui, B. V. Bonifacio, J. L. Lopez-Ribot, P. Uppuluri. 2019. *Candida albicans* biofilm growth and dispersal: contributions to pathogenesis. *Current opinion in microbiology*. 52: 1-6.
- Williams H. N., H. Chen, 2020. Environmental Regulation of the Distribution and Ecology of *Bdellovibrio* and Like Organisms. *Frontier in microbiology*. 11:545070.
- Wright, G. D. 2005. Bacterial resistance to antibiotics: enzymatic degradation and modification. *Advanced drug delivery reviews*. 57:1451-1470.
- Yang, Y., M. Masoumeh, E. Zhou, D. Liu, Y. Song, D. Xu, F. Wang, J. A. Smith. 2021. *Streptococcus mutans* biofilms induce metabolite-mediated corrosion of 316 L stainless steel in a simulated oral environment. *Corrosion Science*. 182 : 109286.

Yu, S., Y. Lou, D. Zhang, E. Zhou, Z. Li, C. Du, H. Qian, T. Gu. 2020. Microbiologically influenced corrosion of 304 stainless steel by nitrate reducing *Bacillus cereus* in simulated Beijing soil solution. *Bioelectrochemistry*. 133: 107477.

POTENTIAL APPLICATION OF CANNABIS AND CANNABIS DERIVED COMPOUNDS AGAINST BIOFILM

Nahdhoit Ahamada Rachid^{1}, Nihal Dođruöz Güngör²*

¹ Istanbul University, Institute of Graduate Studies in Sciences, Istanbul, Turkey

² Istanbul University, Department of Biology, Faculty of Science, Istanbul, Turkey

**Corresponding author e-mail: nahdhoit7@gmail.com*

ABSTRACT

Many plants including *Cannabis Sativa* are known for their medicinal uses. Cannabis Sativa is an annual plant known for centuries for its different medicinal benefits including antimicrobial effects. Until 2017, this plant has been reported with more than 500 natural constituents in which 120 of them are cannabinoids. Even if the antimicrobial effects of this plant and its extracts have been shown, studying all its natural constituents in the context of antimicrobial agents is still not enough. In addition, antimicrobial resistance constitutes an important public health problem. Microorganisms still develop this mechanism and cause difficulties in treating many infectious diseases. One of the virulence factors in microorganisms is the ability to form biofilm. Biofilm, as a microbial community in which different substances are secreted, is a highly protective form of the microbial community against antimicrobial agents. This highly protective structure should be studied alone for obtaining alternative antimicrobial agents against a such structure. This review resumes information about the response of biofilm structure to antimicrobial agents, and the use of *Cannabis Sativa* as an alternative anti-biofilm agent to fight infectious diseases caused by biofilm-forming bacteria.

Keywords: Antimicrobial resistance, Antimicrobial agent, Biofilm, *Cannabis Sativa*.

INTRODUCTION

Antimicrobial agents are chemicals that destroy microorganisms or prevent their reproduction. The discovery of antibiotics, one of the most important antimicrobial agents, is one of the greatest achievements of the modern medical world. Since the development of antibiotics, millions of lives have been saved. However, to control the action of these antibiotics, microorganisms develop different ways that are often genetically controlled. One of the most important ways is the development of biofilm-mediated antimicrobial resistance.

Bacterial and fungal resistance to antimicrobial therapy is an important threat to human health and a major concern all over the world. Immunocompromised patients, such as transplant recipients and those undergoing chemotherapy treatment, are particularly vulnerable. Their ability to fight infection depends on the effectiveness of their used antibiotics. Therefore, the spread of multidrug-resistant bacteria/fungi threatens the success and development of these therapies (O'Neill, 2016).

Multiple resistance to antibiotics clearly demonstrates the overuse of existing antibiotic drugs and the inability to develop enough new antibiotics on a global scale. Some antibiotics are currently administrated in combination to combat antibiotic resistance. However, predicting that we will soon run out of these options is not difficult. It is estimated that the number of

deaths caused by antibiotic resistance may reach 10 million by 2050 and the cost of this situation is estimated to be 100 trillion USD globally (O'Neill, 2016).

The major problem is the divestment of most pharmaceutical companies in the research and development of new antibiotics. This is due to the uncertainty of successfully developing new antibiotics from compounds identified in the preclinical period. Furthermore, the profit earned on the investment of developing something is known to be less. In these facts, these companies mostly produce and sell existing antibiotics.

The limited number of new antibiotics that have been developed and approved in recent years to reduce antibiotic resistance obscures the prospects for the use of antimicrobial drugs in the future. It also ensures that the issue of antimicrobial resistance continues to be a priority global health issue. The World Health Organization has identified antimicrobial resistance as one of three major threats to health systems globally (<https://doi.org/10.1086/652237>). Therefore, measures, such as controlling the use of antibiotics, better understanding the genetic mechanisms of drug resistance, and continuing studies to develop new synthetic or natural drugs, should be taken to reduce this problem. The ultimate goal should be to provide the patient with appropriate and effective antimicrobial drugs. Developing new methods to treat antimicrobial resistance is a race against time.

FORMATION OF BIOFILM

Bacteria in the aquatic environment tend to attach to a solid surface and multiply there to form a community known as 'biofilm'. The living conditions in the biofilm are better and safer for microorganisms than their planktonic living environment. While some of the microorganisms leave the surface on which they are attached, others use the nutrients on the surface, multiply and attach irreversibly to the surface by secreting extracellular polymeric substances (EPS). Thus, EPS acts as an adhesive substance and provides the biofilm microorganisms with a "safe life" in which they can grow, reproduce, secrete metabolites, and communicate with other microorganisms. Biofilms protect microorganisms from host immune cells, antibiotics, nutrient shortage, osmolarity, pH, and temperature. Sessile cells can be separated from their biofilms to colonize other regions (Donlan, 2002).

Biofilm formation is an important virulence factor for microorganisms causing chronic infections. Biofilm-forming microorganisms are the main cause of various chronic, hospital-acquired, and medical device-associated infections that are of serious concern or even untreatable nowadays (Wi and Patel, 2018). According to the American National Institutes of Health, approximately 65% of all microbial infections and 80% of all chronic infections are associated with biofilms (Sharma et al., 2019). With the advancement of science, many diseases, disorders, and abnormalities can be effectively managed using various medical devices such as pacemakers, vascular catheters, chronic haemodialysis catheters, prosthetic heart valves and prosthetic joints. However, the effectiveness of these medical devices is severely hampered by the biofilm that forms on them. Due to the complex interactions between microbial cells, host, and biomaterials, treatment of these device-associated infections may be unsuccessful.

INTERACTION BETWEEN BIOFILM AND ANTIMICROBIAL AGENTS

The ability of microorganisms to form biofilms and become resistant to antibiotics causes significant difficulties in disease treatment. In a biofilm under antimicrobial influence, the number of resistant mutants increases, and the resistance genes can spread by horizontal gene transfer to all microorganisms in the biofilm matrix. The main cause of various chronic infections are microorganisms resistant to antibiotics and contagious microorganisms. Most antibacterial agents cannot penetrate biofilms which are the main source of resistant microbial

strains. Consequently, they cannot prevent the proliferation of microorganisms in the biofilm matrix.

The developed antimicrobial agents are mostly tested against free-living planktonic cells. Due to the drug tolerance and the multifactorial nature of biofilm formation, the use of these antimicrobials may be ineffective against pathogenic biofilms. In this fact, combined treatments are needed. The discovery of antibacterial agents that can kill or stop the growth of microorganisms contained in the biofilm and help to prevent infections from the biofilm is urgent.

Plants are one of the most important alternative and effective strategies for reducing resistant microorganisms. Plant-based antibacterial agents have enormous potential to treat a variety of diseases, as they have the power to alleviate infectious diseases and lack adverse side effects, such as hypersensitivity, allergic reaction, and immunosuppression, that are often associated with current antimicrobial agents (Agrawal and Gupta, 2020). Studies have shown that many plant extracts and phytochemicals exhibit antimicrobial properties against pathogens, including clinically resistant bacterial strains (Erdem et al., 2013; Nascimento et al., 2000). Moreover, previous studies confirm the antibacterial activity of plant extracts in animal infection models (Choi et al., 2011; Yunana et al., 2018).

The surfaces of medical devices can be modified with antibiofilm nanoscale biomaterials. Thereby, gold, silver, iron oxide and bimetallic nanoparticles can be made multifunctional either individually or with polymeric substances or drugs. Thus, biofilm formation can be controlled by quorum sensing, cell-to-cell communication, and interruption of multiple drug efflux pumps. The surfaces of medical devices can also be coated with plant extracts. Phytochemicals (including alkaloids, flavonoids), heteroatoms such as N, S, O, and π -electrons in the plant extract contain aromatic rings and are adsorbed on the metal surface through them. The inhibition is mainly attributed to the presence of various organic compounds found in the plant extract (Prabhu and Rao, 2013). *Cannabis sativa L.* is one of these plants which has traditionally been used medicinally for centuries.

CANNABIS PLANT (*Cannabis sativa*)

Cannabis (*Cannabis sativa*), also called Marijuana, is an annual species native to Asia and has been documented as one of the oldest known crops. *Cannabis* has traditionally been widely cultivated in the world. Apart from its use as a recreational drug, it is used for fiber production, human nutrition, and medicinal purposes (House et al., 2010). Due to its variable low lignin content and bast fibers enrichment, the fibers of the hemp plant are suitable to produce textiles, paper, rope, biofuels, biodegradable plastics, and building materials. They are also suitable for use in the automotive industry, insulation, paint, and animal feed (Singh et al., 2018). Due to the versatility of cannabis, valuable essential oils and resins can be extracted from the flowers and leaves, as well as high-quality cellulose can be extracted from the stems and trunk (Baldini et al., 2018). The cannabis seed, which is called “çedene” or “hemp seed” in Anatolia, has an important place in the nutrition of humans and poultry due to its rich oil content. In addition, cannabis has gained a bad reputation due to its widespread use for pleasure and consequently, its versatile benefits have been ignored for many years.

Nowadays, the production of different products has led to an increase in interest of industrial cannabis. Plants of the genus *Cannabis* produce more than 560 known secondary metabolites with 120 of them are cannabinoid compounds (ElSohly et al., 2017). Cannabis phytochemicals include primary metabolites such as amino acids, fatty acids, and steroids, or secondary metabolites such as terpenoids, flavonoids, stilbenoids, lignans, and alkaloids (Flores-Sanchez and Verpoorte, 2008).

CANNABINOIDS

C. sativa is increasingly used for its medical treatments against various diseases such as inflammation, cancer, obesity, osteoporosis, multiple sclerosis, vomiting, epilepsy, pain, glaucoma, and anorexia. Besides, it is applied for the treatment of various neurodegenerative disorders including Tourette syndrome, Huntington's disease, Alzheimer's disease, and Parkinson's disease (Grotenhermen and Müller-Vahl, 2012). Apart from these areas of use, *Cannabis sativa* is a plant that offers many interesting features due to its rich metabolic profile such as anti-biofilm and bactericidal effect. Cannabinoids are *C. sativa* metabolites that are effective in the treatment of contagious bacterial infections diseases.

The production of cannabis has been severely restricted and banned all over the world for many years due to its psychoactive properties. However, because of limited studies, their potential for use in both industrial and health fields could not be ignored any longer. In line with the provisions of the regulation published at September 29, 2016 in the Official Journal, number 29842, the production of cannabis, previously prohibited in Turkey, is allowed in the provinces of Amasya, Antalya, Bartın, Burdur, Çorum, İzmir, Karabük, Kastamonu, Kayseri, Kütahya, Malatya, Ordu, Rize, Samsun, Sinop, Tokat, Uşak, Yozgat, and Zonguldak as well as in all districts of these provinces. In the next years, the regulations supporting the establishment of new companies by utilizing cannabis cultivation and the products obtained from it are expected to be made.

ANTIBIOFILM ACTIVITIES OF CANNABIS

Studies have shown the antimicrobial effects of the cannabis plant, its leaf extracts, essential and seed oils, as well as components isolated from it such as cannabinoids, against pathogenic bacteria and fungi (Frassinetti et al., 2020; Feldman et al., 2021). Alkaloids, flavonoids, peptides, tannins, and phenols also found in the *C. sativa* plant are also known for their antimicrobial properties (Chandra et al., 2017). This suggests that many compounds found in cannabis extracts may additionally or synergistically contribute to the antimicrobial activity (Schofs et al., 2021). Although the antibacterial mechanism of cannabinoids effect remains unclear, some modes of action have been recently proposed (Figure 1).

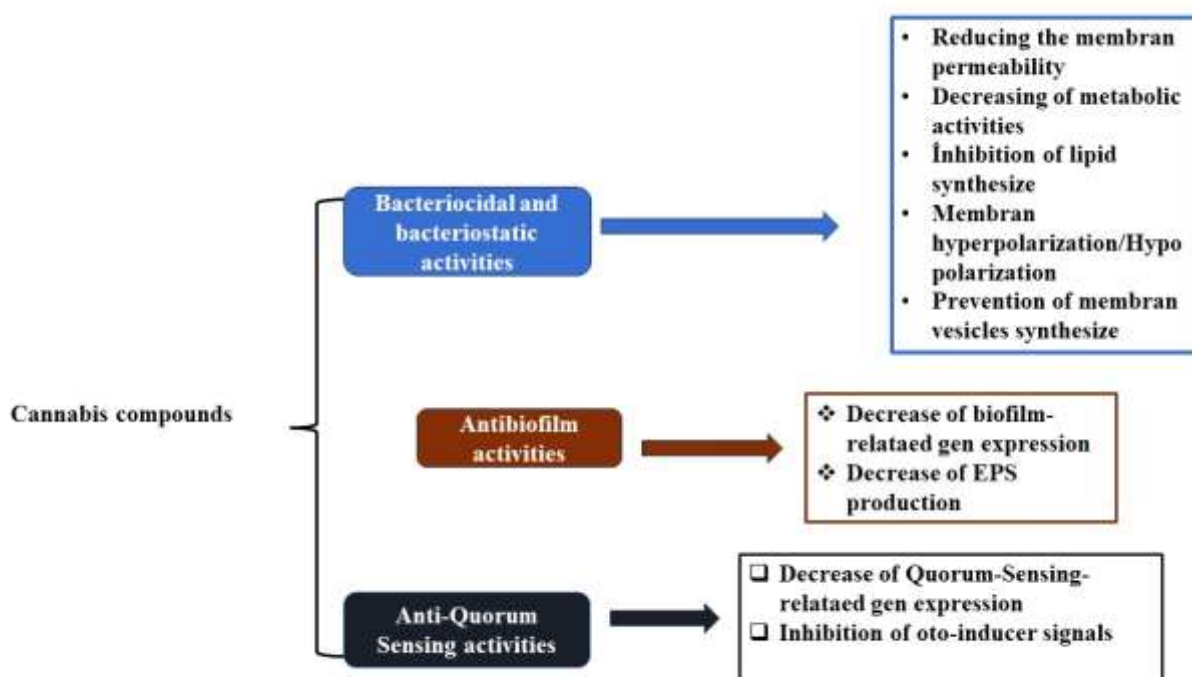

Figure 1: Potential antimicrobial mode of action of cannabis compounds.

One of the modes of action is related to changing the microbial membrane permeability. It was determined that β -caryophyll compounds destroyed the cell integrity and wall structure of *B. cereus* and led to the leakage of intracellular components (Moo et al., 2020).

Another putative mode of action of cannabinoids is the alteration of cell communication through inhibition of membrane vesicles released by bacteria. Cannabidiol that consists of a phyto-cannabinoid obtained from *Cannabis sativa*, was found to be a potent inhibitor of membrane vesicle releasing from *E. coli* VCS257 but the same effect was not detected in *S. aureus* subsp. aureus Rosenbach. In addition, it was determined that cannabidiol used together with selected antibiotics significantly increased the bactericidal effect of several antibiotics in Gram-negative bacteria (Kosgodage et al., 2019). These results suggest that, through different ways including the membrane vesicle inhibition pathway, the cannabidiol can be used with antibiotics selected based on bacterial species to increase antibiotic activity and help to reduce antibiotic resistance.

In one of the limited studies, it was determined that the seeds of *Cannabis sativa* L. showed antimicrobial and antibiofilm activity against *Staphylococcus aureus* (Frassinetti et al., 2020). It was also determined that the biofilm inhibition of *Staphylococcus aureus* by *Cannabis sativa* L. seeds was lower than their minimum inhibition concentrations (MIC) values. Researchers attributed the biofilm inhibition to the high content of phenolic compounds such as caffeoyltyramine and hemp A, B, and C, especially in the cannabis seed extract.

In a study investigating the ability of cannabidiol to inhibit the formation of fungal biofilms, *C. albicans* was exposed to various concentrations of cannabidiol for 24-72 hours and the metabolic activity of biofilms was determined using 3-(4,5-dimethylthiazol-2-yl)-2,5-diphenyl-2H-tetrazolium bromide (MTT) analysis method. The study resulted to the observation of fungal biofilm formation inhibition by cannabidiol depending on time and dose (Feldman et al., 2021).

Other study examining the effect of cannabigerol on *S. mutans* biofilm formation and distribution, shown that cannabigerol inhibited biofilm formation with decreased biofilm biomass, decreased biofilm thickness, less EPS production, decreased DNA content and decreased metabolic activity. It was also determined that cannabigerol changed the roughness profile of the biofilm and provided a smoother biofilm surface. However, when researchers examined the effect of cannabigerol on preformed biofilms, they found that cannabigerol reduced the metabolic activity of *S. mutans* with a transient effect on biomass and suggested that cannabigerol could be a potential drug for the preventive treatment of dental caries (Agawi et al., 2021).

Farha et al. (2020) determined that cannabinoids exhibit antibacterial activity against Methicillin-Resistant *Staphylococcus aureus* (MRSA), inhibit the ability to form biofilms, and destroy preformed biofilms and stationary phase cells that are resistant to antibiotics. They also revealed that the mechanism of action of cannabigerol is to affect the cytoplasmic membrane in Gram-positive bacteria and the inner membrane in Gram-negative bacteria. Researchers have demonstrated that cannabinoids work against multidrug-resistant Gram-negative pathogens (*E. coli*, *Pseudomonas aeruginosa*) in combination with polymyxin B, demonstrating the broad-spectrum therapeutic potential of cannabinoids (Farha et al., 2020).

In a study investigating the potential role of cannabigerol as an anti-biofilm and anti-quorum sensing agent against *Vibrio harveyi*, it was determined that concentrations of cannabigerol that did not affect planktonic bacterial growth reduced the bioluminescence and biofilm formation of *V. harveyi* regulated by quorum sensing. In addition, it was found in the study that cannabigerol decreased the motility of *V. harveyi* in a dose-dependent manner (Agawi et al., 2020).

CONCLUSIONS

Bacterial or fungal biofilm formation is an important virulence factor that inhibits the control of pathogens and the treatment of infections caused by related microorganisms. Much research has been and is still being done to find alternatives to current antibacterial/antifungal treatments. Studies clearly show that *Cannabis sativa* has antimicrobial activity. However, it is not easy to prevent biofilm-based infections. Recently, although limited, studies in which *Cannabis sativa* is effective on biofilm have also been published.

REFERENCES

- Agrawal, A., A. Gupta. 2020. A Review on Exploring the Antibacterial Activity of Cannabinoids with Respect to Biofilm Formation. *Journal of Integrated Health Sciences*. 8: 101-101.
- Aqawi, M., R. Gallily, R. V. Sionov, B. Zaks, M. Friedman, D. Steinberg. 2020. Cannabigerol prevents quorum sensing and biofilm formation of *Vibrio harveyi*. *Frontiers in Microbiology*. 11: 858.
- Aqawi, M., R. V. Sionov, R. Gallily, M. Friedman, D. Steinberg. 2021. Anti-biofilm activity of cannabigerol against *Streptococcus mutans*. *Microorganisms*. 9: 2031.
- Baldini, M., C. Ferfua, B. Piani, A. Sepulcri, G. Dorigo, F. Zuliani, F. Danuso, C. Cattivello. 2018. The performance and potentiality of monoecious hemp (*Cannabis sativa* L.) cultivars as a multipurpose crop. *Agronomy*. 8: 162.
- Chandra, H., P. Bishnoi, A. Yadav, B. Patni, A. P. Mishra, A. R. Nautiyal. 2017. Antimicrobial resistance and the alternative resources with special emphasis on plant-based antimicrobials—a review. *Plants*. 6: 16.
- Choi, J. G., O. H. Kang, Y. S. Lee, H. S. Chae, Y. C. Oh, O. O. Brice, M. S. Kim, D. H. Sohn, H. S. Kim, H. Park, D. W. Shin. 2011. In vitro and in vivo antibacterial activity of *Punica granatum* peel ethanol extract against *Salmonella*. *Evidence-Based Complementary and Alternative Medicine*.
- Donlan, R.M. 2002. Biofilms: microbial life on surfaces. *Emerging infectious diseases*. 8: 881.
- ElSohly, M. A., M. M. Radwan, W. Gul, S. Chandra, A. Galal. 2017. Phytochemistry of *Cannabis sativa* L. *Phytocannabinoids*. 1-36.
- Erdem, A. K., E. Ö. A. Aydoğdu, G. C. Öz, Ç. Erol, M. Yazgan. 2013. Antibacterial and hemolytic activities of different extracts of *Amsonia orientalis* Decne (Apocynaceae). *European Journal of Biology*. 72: 1-8.
- Farha, M.A., O. M. El-Halfawy, R. T. Gale, C. R. MacNai, L. A. Carfrae, X. Zhang, N. G. Jentsch, J. Magolan, E. D Brown. 2020. Uncovering the hidden antibiotic potential of cannabis. *ACS infectious diseases*. 6: 338-346.
- Feldman, M., R. V. Sionov, R. Mechoulam, D. Steinberg. 2021. Anti-biofilm activity of cannabidiol against *Candida albicans*. *Microorganisms*. 9: 441.
- Flores-Sanchez I. J., R. Verpoorte. 2008. Secondary metabolism in cannabis. *Phytochemistry reviews*. 7: 615-639.
- Frassinetti, S., M. Gabriele, E. Moccia, V. Longo, D. Di Gioia D. 2020. Antimicrobial and antibiofilm activity of *Cannabis sativa* L. seeds extract against *Staphylococcus aureus* and growth effects on probiotic *Lactobacillus* spp. 124: 109149.
- Grotenhermen, F., K. Müller-Vahl. 2012. The therapeutic potential of cannabis and cannabinoids. *Deutsches Ärzteblatt International*. 109:495.
- House, J. D., J. Neufeld, G. Leson. 2010. Evaluating the quality of protein from hemp seed (*Cannabis sativa* L.) products through the use of the protein digestibility-corrected amino acid score method. *Journal of agricultural and food chemistry*. 58: 11801-11807.

- Infectious Diseases Society of America. The 10×'20 Initiative: pursuing a global commitment to develop 10 new antibacterial drugs by 2020. *Clinical Infectious Diseases*. 2010; 50: 1081-1083. <https://doi.org/10.1086/652237>
- Kosgodage U. S., P. Matewele, B. Awamaria, I. Kraev, P. Warde, G. Mastroianni, A. V. Nunn, G. W. Guy, J. D. Bell, J. M. Inal, S. Lange. 2019 Cannabidiol is a novel modulator of bacterial membrane vesicles. *Frontiers in cellular and infection microbiology*. 324.
- Moo C. L., S. K. Yang, M. A. Osman, M. H. Yuswan, J. Y. Loh, W. M. Lim, L. I. M. Swee-Hua-Erin, K.S. Lai. 2020. Antibacterial Activity and Mode of Action of β -caryophyllene on. *Polish journal of microbiology*: 69: 49-54.
- Nascimento, G. G., J. Locatelli, P.C. Freitas, G. L. Silva. 2000. Antibacterial activity of plant extracts and phytochemicals on antibiotic-resistant bacteria. *Brazilian journal of microbiology*. 31: 247-256.
- O'Neill J. 2017. Review on antimicrobial resistance: tackling drug-resistant infections globally: final report and recommendations. *Review on antimicrobial resistance: tackling drug-resistant infections globally: final report and recommendations*.
- Prabhu, D., P. Rao. 2013. *Coriandrum sativum* L.—A novel green inhibitor for the corrosion inhibition of aluminium in 1.0 M phosphoric acid solution. *Journal of environmental chemical engineering*. 1: 676-683.
- Schofs, L., M. D. Sparo, S. F. Sanchez Bruni. 2021. The antimicrobial effect behind *Cannabis sativa*. *Pharmacology Research & Perspectives*. 9: e00761.
- Sharma, D., L. Misba, A. U. Khan. 2019. Antibiotics versus biofilm: an emerging battleground in microbial communities. *Antimicrobial Resistance & Infection Control*. 8: 1-10.
- Singh, P., S. Pandit, J. Garnaes, S. Tunjic, V. R. S S. Mokkalpati, A. Sultan, A. Thygesen, A. Mackevica, R. V. Mateiu, A. E. Daugaard, A. Baun, I. Mijakovic. 2018. Green synthesis of gold and silver nanoparticles from *Cannabis sativa* (industrial hemp) and their capacity for biofilm inhibition. *International journal of nanomedicine*. 13: 3571-3591.
- Wi, Y.M., R. Patel. 2018. Understanding biofilms and novel approaches to the diagnosis, prevention, and treatment of medical device-associated infections. *Infectious Disease Clinics*. 32: 915-929.
- Yunana, B. T., J. C. Guiyi, B. B. Bukar. 2018. In vitro and in vivo evaluation of antibacterial activity of *Bridelia ferrugine* extracts on some clinical isolates. *The Journal of Phytopharmacology*. 7: 392-398.

TOMATO RESISTANCE GENES MI AGAINST TO THE ROOT KNOT NEMATODE (*MELOIDOGYNE* SPP.) AND MOLECULAR APPROACHES.

Aslı HÜRRIYET, Seren SARGIN, Selen KARA

A.Hurriyet@enzazaden.com.tr ** Agricultural Engineer, Enza Zaden R&D Department,

S.Sargin@enzazaden.com.tr *** Agricultural Engineer, Enza Zaden R&D Department,

S.Karakaya@enzazaden.com.tr

ABSTRACT

Meloidogyne spp. was first detected in the UK but is now a worldwide problem for tomato and other Solanaceae crop production, threatening production both in open fields and greenhouses. If appropriate control measures are not taken 15- 85 % yield losses can take place. Tolerances of the plants themselves, as well as chemical spraying and biological agents, are of great importance for damage prevention. Understanding and engineering these gene mechanisms is of great importance for development of tolerant varieties against *Meloidogyne* spp. Plant resistance(R) proteins recognize pathogen virulence (Avr) determinants and trigger plant defense mechanism. Then the carefully organized dynamic defense regularly emerges as a Hypersensitive Response (HR) and the defense becomes active. As a result of these changes, new studies identified new components of *Mi-1*-mediated resistance to the nematodes. In this study we review the molecular mechanisms of tolerance against *Meloidogyne* spp. in tomato.

Key words: *Meloidogyne* spp., defense mechanisms, host response, *Solanum lycopersicum*, *Mi-1* genes

INTRODUCTION

Tomato is one of the most important vegetables grown in the world. They also contain high levels of lycopene, an antioxidant that reduces the risks associated with many cancers and neurological diseases. The homeland of the tomato includes Chile, Peru and Ecuador in western South America. In addition, it was determined that there are 2 endemic wild tomato species in Galapagos Island (Darwin et al. 2003). *Solanum peruvianum* L. is the most common and polymorphic wild tomato species. It has been stated that the possible ancestor of the tomato, which is an annual plant, is the wild cherry tomato (*Solanum lycopersicum* var. *cerasiforme*) (Jenkins 1948; Akkurt et al. 2013). It has been reported that in ancient Mexico, the tomato was grown for food and was called “tomati” (Boswell 1937). Tomatoes are used fresh or in various forms such as peeled, chopped, frozen, canned, tomato paste, ketchup, pickles in the food industry (Causse et al. 2016).

After it became widespread in the European Mediterranean countries in the 16th century, it is cultivated in many parts of the world in the 20th century (Yazgan and Fidan 1996). 189.1 million tons of tomatoes were produced around the world in 2021. China ranked first in tomato production and harvested area in 2021. Türkiye ranked 3 rd in world tomato production in 2021.

Tomato production; 8.7 tons in 2021/22. According to the 1st Estimation of Crop Production by TURKSTAT for 2023, tomato production is expected to be 13.5 million tons in 2023. Considering these data, the importance of tomato in the country's agriculture is clearly seen.

There are many pests and diseases that cause yield loss in tomatoes. Root-knot nematodes, which are plant parasitic nematodes that feed as endoparasites, also cause serious damage to tomatoes (Bleve-Zacheo et al. 2007). Root-knot nematodes (*Meloidogyne* spp.) are spread all over the world and have a wide host range (Sasser 1980, Karssen and Moens 2006). The four most important pests worldwide are *Meloidogyne javanica* (Treub) Chitwood, *Meloidogyne*

arenaria (Neal) Chitwood, *Meloidogyne incognita* (Kofoid et White) Chitwood and *Meloidogyne hapla* Chitwood (Netscher and Sikora 1990). Root-knot nematodes are obligate parasites that feed only on the cytoplasm of living plant cells (Williamson and Hussey 1996). They become adults after four larval stages (Luc 1990). It is a second instar larva (J2) that penetrates the root and moves to an area near the vascular tissue to create a permanent feeding site (Williamson and Hussey 1996). After J2 enters the root, it moves between the cells in the vascular cylinder and fixes itself when it determines the feeding area (Abad and Williamson 2010). They cause the formation of giant cells in the area where they feed. The swellings that occur on the root surface as a result of growth in giant cells are called galls or galls (Williamson and Hussey 1996). The resulting galls significantly restrict the nutrient and water uptake of the roots from the soil. Then, they cause yellowing, wilting, stagnation in growth, deterioration in fruit quality and decrease in yield. In addition, they increase the formation of diseases by causing soil-borne pathogens to enter through the wounds they open.

It has been reported that *Meloidogyne* spp. causes an annual loss of 157 billion dollars worldwide (Abad et al. 2008). In addition, disease severity increases as a result of co-infection with soil-borne pathogens (Lambert and Bekal 2002). That's why it's so important to management. Cultural measures, physical control, biological control and chemical control methods are used. Chemical control is the most used method for controlling root-knot nematodes (Gowen et al. 2007). Despite this, the use of nematicides is decreasing in some regions of the world (Nyczepir and Thomas 2009). In addition, the prohibition of widely used fumigant such as methyl bromide (methyl bromide) has increased the search for alternatives in chemicals. Studies are carried out on alternative methods of struggle that will not cause the stated results. One of them is the use of biological organisms. The difficulty of adaptation of these organisms to environmental conditions and the cost of the preparations limit their use. Therefore, the use of resistant varieties comes to the fore (Rotino et al. 2002; Toppino et al. 2008). However, host resistance, which is one of the cultural methods, is known as the most effective and environmentally friendly method against root-knot nematodes (Devran and Söğüt 2014).

Resistant varieties provide ease of application and provide an environmentally friendly solution without the need for special tools and equipment (Lopez-Perez et al. 2006; Cortada et al. 2009; Verdejo-Lucas et al. 2009). Resistance prevents the reproduction or development of the nematode through the resistance genes it carries or keeps it at a very low level (Boerma and Hussey 1992, Roberts 2002). Resistant varieties suppress root-knot nematode and reduce the need for chemical control (Williamson 1999).

1. Resistance to Root Knot Nematodes

Resistance to root-knot nematodes was reported for the first time in a wild tomato species, *Solanum peruvianum* (Bailey, 1941). This resistance gene, called the *Mi-1* gene, was transferred to *S. esculentum*, the cultivar of tomato, by embryo rescue technique (Smith, 1944). Today, commercially developed root-knot nematode resistant cultivars carry this gene (Yaghoobi et al., 2005). Many genes (*Mi-2* to *Mi-9*) have been identified against the root-knot nematode, except the *Mi-1* gene (Capnet al., 1993; Yaghoobi et al., 1995; Veremis & Roberts, 1996a; Veremis & Roberts., 1996b; Milligan et al., 1998; Ammiraju et al., 2003). Knowing the characteristics of resistance genes and their responses to nematodes is important for breeding and control.

Plants have developed different defense mechanisms to protect themselves from diseases and pests. Resistance, which is one of these mechanisms, has been defined as the ability of the plant to prevent, eliminate or reduce the attacks of disease agents and pests (Wingard, 1953).

For entomologists, the "hardy" plant is less affected by the same population of the pest (Painter, 1951). In general, a nematode-resistant plant is one that can inhibit the growth of the nematode compared to a non-resistant one (Cook & Evans, 1987; Trudgill, 1991; Barker, 1993).

Plants first show a passive response consisting of physical barriers to protect themselves from the pathogen. Thickening of the cell wall as a result of lignin accumulation is one of these barriers (Tör, 1998). Important plant hormones such as salicylic acid, jasmonic acid and ethylene play a role in defense (Kunkel & Brooks, 2002). Another defense mechanism is the hypersensitivity reaction (Hypersensitivity Reaction-HR) created by the resistance genes (Williamson & Hussey, 1996).

The emergence of resistance in plants occurs when the resistance gene (R) in the host and the avirulence gene (avr) products of the pathogen match each other (Flor, 1955). Resistant plants prevent the reproduction or development of the nematode through the genes they carry (Roberts, 2002). These plants protect the plant from nematode damage and reduce the nematode population (Lopez-Pérez, 2006). Tolerant plants, on the other hand, cannot suppress the growth of nematodes, but prevent yield loss (Gonzalez, 2009).

Root-knot nematodes cannot form a feeding zone in a resistant plant (Milligan et al., 1998). In order to create a feeding zone, a hypersensitive reaction occurs immediately in the cell to which it inserts its stylet. In the incompatible interaction of the plant with the nematode, O is produced enzymatically outside the cell and is converted to hydrogen peroxide (H₂O₂), a compound that can pass through the cell membrane (Bleve-Zacheo et al., 2007). H₂O₂ begins to accumulate rapidly in the cells, and oxidative combustion occurs along with it. The first symptoms of the hypersensitive reaction resulting from the incompatible relationship appear approximately 12 hours after the nematode inoculation (Dropkin, 1969a; Milligan et al., 1998; Bird & Kaloshian, 2003). As a result, the nematode dies before it can form a feeding place (Verdejo-Lucas et al., 2012). In case of a compatible interaction between the nematode and the plant, H₂O₂ is produced 12 hours after the nematode enters the plant, but after 48 hours H₂O₂ cannot be detected. The reason why H₂O₂ could not be determined is the activity of the genes responsible for the enzymes that prevent oxidative combustion. As a result, structures called giant cells are formed (Apel & Hirt, 2004; BleveZacheo et al., 2007).

Resistance to root-knot nematodes in tomato is provided by the *Mi-1* gene. In tomato, it is a dominant gene called *Mi-1* that provides resistance against *M. incognita*, *M. javanica* and *M. arenaria*. It was named after the nematode species (*M. incognita*) used in tests to determine the resistance status of plants (Gilbert & McGuire, 1956). *Mi* gene was found in *S. peruvianum* (PI128657) and hybrid plant was obtained using embryo rescue technique since it could not be hybridized with culture forms using conventional breeding methods (Smith 1944). The widely used *Mi-1* gene against root-knot nematodes comes from this source (Ammati et al., 1986). *Mi-1* gene is 7 homologous genes (*Mi-1.1*, *Mi-1.2*, *Mi-1.3* and *Mi-1.4*, *Mi-1.5*, *Mi-1.6*, *Mi-1.7* 2 clusters in the 650 kb region of the short arm of the 6th chromosome of tomato) are available as. Of these homologues, *Mi-1.3* and *Mi-1.5* are pseudogenes. As a result of studies carried out in plants to which homologous genes are transferred, it has been determined that resistance is provided by *Mi-1.2* (Milligan et al., 1998) (Table 1). The cytoplasmic protein encoded by *Mi-1.2* consists of 1257 amino acids. This resistance gene motif is called CC-NBS-LRR. The nucleotide binding site of this structural motif is called NBS (Nucleotide Binding Site), the LRR portion with leucine amino acid-rich repeats (Leucine Rich Repeat) and the helical motif at the amino end of these proteins is called CC (Coiled-coil) (Milligan et al., 1998; Hwang & Williamson, 2003).

Mi-1.2 gene was found to be resistant to *Meloidogyne* species as well as some biotypes of potato aphid [*Macrosiphum euphorbiae* (Thomas)] and cotton whitefly [*Bemisia tabaci* (Gennadius)] B and Q biotypes (Nombela et al. 2003).

Table 1: Characteristics of genes providing resistance to root-knot nematode (*Meloidogyne* spp.) in tomato

Gene	Source	Resistant Species	Temperature	Chromosomal Location	Literature
<i>Mi-1 (Mi)</i>	<i>S. peruvianum</i> PI128657	<i>M. incognita</i> <i>M. javanica</i> <i>M. arenaria</i>	<28°C	6	Miligan et al., 1998
<i>Mi-2</i>	<i>S. peruvianum</i> PI270435-2R2	<i>M. incognita</i>	32°C	-	Cap et al., 1993
<i>Mi-3</i>	<i>S. peruvianum</i> PI126443-1MH	<i>M. incognita</i>	32°C	12	Yaghoobi et al., 1995
<i>Mi-4</i>	<i>S. arcanum</i> LA1708-I	<i>M. arenaria</i>	32°C	-	Veremis & Roberts, 1996a
<i>Mi-5</i>	<i>S. peruvianum</i> PI126443-1MH	<i>M. incognita</i>	32°C	12	Veremis & Roberts, 1996b
<i>Mi-6</i>	<i>S. peruvianum</i> PI270435-3MH	<i>M. incognita</i>	32°C	6	Veremis & Roberts, 1996b
<i>Mi-7</i>	<i>S. peruvianum</i> PI270435-3MH	<i>M. incognita</i>	<28°C	6	Veremis & Roberts, 1996b
<i>Mi-8</i>	<i>S. peruvianum</i> PI270435-2R2	<i>M. incognita</i>	<28°C	6	Veremis ve Roberts, 1996b
<i>Mi-9</i>	<i>S. arcanum</i> LA2157	<i>M. incognita</i> <i>M. javanica</i> <i>M. arenaria</i>	32°C	6	Ammiraju et al., 2003

2. Naturally Resistant Resources

Several *Mi*-genes have been detected in some tomato lines, genotypes, and cultivars. These genes confer resistance against root-knot nematodes. Many resources of resistance have been discovered since 1944. Which resistance genes some of these plants contain is still not known. The preferred and safest method for controlling RKNs is in the discovery of new resistant plants. It is important to perform an extensive evaluation of tomato plants whose resistance has not been determined.

2.1. The Mechanism of Natural Resistance

Tomatoes, like all plants, undergo several modes for protection and immunity. The plant has an innate immune system that can recognize pathogen-associated molecular patterns. PAMP-triggered immunity (PTI) is the first defense line of response of the plant to pathogens. The extra cellular receptor proteins, receptor-like kinases (RLK), and receptor-like protein (RLP) are initiation factors and activators of the first defense line. The second defense line is triggered by intracellular proteins that contain a nucleotide-binding site (NBS), a toll-like interleukin receptor (TIR), which is not found in the *Mi-1* gene, and leucine-rich repeats (LRRs). During the second-line defense, there are two modes of pathogen interaction: direct and indirect.

The first pathway depends on a gene-for-gene interaction. In this mode, the receptor protein of tomato directly interacts with the nematode effectors. According to Flor's theory, the inheritance of both resistances in the tomato and the RKN's ability to cause disease are controlled by pairs of matching genes. The first gene, like the *Mi-1* gene, is in the tomato, and the other one is in RKNs and is called a virulence (Avr) gene. One of the responses of this type of defense is localized programmed cell death (PCD), one of the most important responses. This is a type of hypersensitive response (HR) (Figure 3). After the nematode enters the root of the plants; the nematode Avr genes produce effectors that trigger the production and the expression of plant *Mi*-resistant genes in an incompatible interaction. The result, because of this theory, is that no feeding site (giant cell) is formed. The second defense mode is not a direct gene-for-

gene interaction, but an alternative mode called the guard hypothesis. The mechanism in this theory consists of pathogen effectors that trigger the virulence factors/protein of the plant, which finally induces R-gene. In these cases, the virulence factor of nematodes (Avr genes) interacts with tomato accessory protein, resulting in some modification of this accessory protein, which allows for the recognition by plant NBS-LRR proteins that monitor for infection. The last result of this indirect interaction is the prevention of the production and growth of nematodes by the inhibition of the formation of feeding sites.

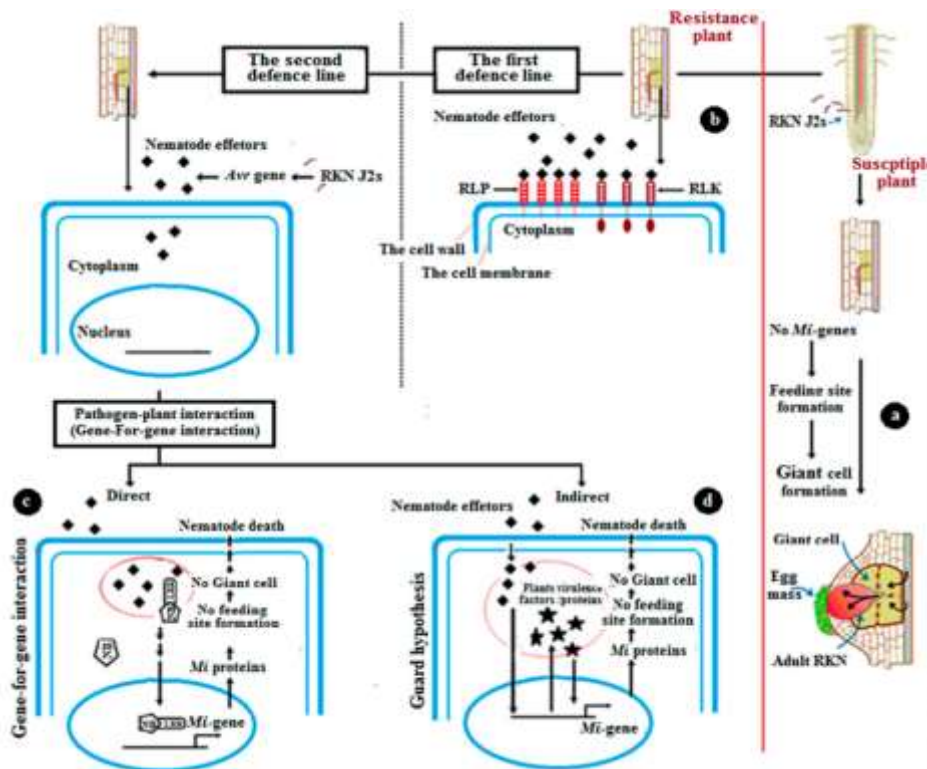

Figure 2. The mechanism of natural resistance against the root-knot nematode (RKN). (a) In susceptible plants, where there are no *Mi*-genes, the nematode completes its life cycle in the root by forming giant feeding cells. (b) In the resistance case, the plant undergoes the first defense line against RKN penetration by the interaction between extracellular receptor proteins, receptor-like kinases (RLK), receptor-like protein (RLP), and nematode effectors. (c) The plant then begins the second defense line, which includes direct gene-for-gene interaction. This theory depends on direct interaction between the receptor protein of tomatoes and nematode effectors, producing *Mi*-proteins, which prevent the nematode from feeding. No giant cell formation is observed. (d) The other second defense line is an indirect pathway, which is referred to as the guard hypothesis. In these cases, the virulence factor of the nematode (*Avr* genes) interacts with tomato accessory protein.

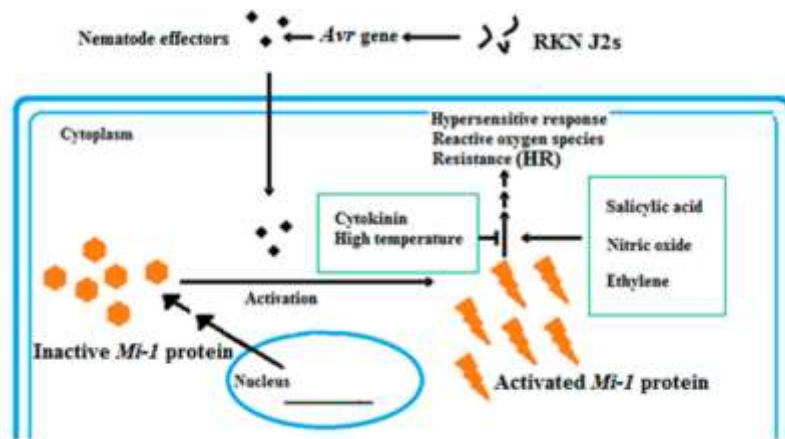

Figure 3. Hypersensitive response of *Mi-1* after nematode infection. The nematode Avr genes trigger the tomato *Mi-1* resistance gene(R-gene) to be active under the salicylic acid pathway with inhibition by both cytokinin and high temperature

3. Different Approaches to Strengthening Natural Resistance

3.1. Marker-Assisted Selection in Breeding Programs

Marker-assisted selection (MAS) means the use of a binding pattern of linked molecular (DNA) markers for indirect selection in the desired plant phenotype. MAS is based on the concept that the presence of a marker that is tightly linked to the gene of interest indicates the presence of that gene. The improvement of new resistance plants has many benefits. The two most important benefits of using molecular breeding are first that it is less harmful to the environment than pesticides, and second that it is less expensive. Tomatoes are considered one of the most optimal plants for using molecular markers in commercial breeding. Moreover, molecular markers linked to the *Mi-1* gene have enabled the rapid screening of resistance alleles, without requiring nematode inoculation. The use of molecular marker technologies in sync with new breeding techniques is promising for the advancement of tomato breeding.

3.1.1 Genetic Engineering in Controlling RKN

Although molecular breeding is the method that is most applied to achieve resistance against root-knot nematodes in tomato plants, genetic engineering is a future aspiration for further increases in resistance

3.1.2 Transfer Resistance Genes

This strategy is based on two foundations. The first is the transfer of a resistance gene from other plants to tomatoes. The second is the transfer of the *Mi* resistance gene from resistant varieties to susceptible one with high production qualities. Several resistance genes from different plants have been successfully transferred to tomatoes. These tomatoes transformed with new genes reduce diseases in transformed plants. Transgenic tomatoes with these genes would be novel sources for resistance against root-knot nematodes. Moreover, cloned *Mi-1* is a good candidate for transfer to susceptible plants. There are more difficulties in understanding the mechanism of R-genes in other plants of the same species or plants of another family. There have been many contradictions in previous studies in the case of other transformed solanaceous

plants with the *Mi-1* gene. Transgenic tomato plants showed reduced chitin content and retardation in embryogenesis in nematode eggs.

3.1.3 Resistance Effectors

Proteinase inhibitors (PIs) are one of the most promising methods for managing nematodes. Proteinase inhibitors are protein molecules secreted by pathogens, which inhibit the function of proteinases. Different types of proteinase have been identified in tomatoes.

CONCLUSIONS

Considerable potential has been developed in recent years for improving rootknot nematode resistance in tomato and other crops. The *Mi* gene of tomato has provided effective resistance to three root-knot nematode species for many years. The availability of a clone of *Mi* will allow introduction of this gene into selected varieties and possibly other crops, further expanding its use. However, *Mi* will not solve all root-knot nematode problems; it is not effective against all species or isolates of this nematode. In addition, the failure of *Mi* at high temperature can be a problem in the field. It is possible that in vitro modifications of the cloned gene will improve the range of nematodes controlled by *Mi*. For example, it may be that the partial resistance against *M. hapla* can be improved or the temperature sensitivity can be reduced by modifications in the structure, expression, or signal transduction of *Mi*. Other resistance genes into cultivated tomato using classical or marker-assisted breeding may also broaden the basis of root-knot nematode resistance. As technology advances, cloning of these genes directly from the wild species may be a faster route than conventional breeding for transferring the gene to elite cultivars or other species. However, even now there are virulent root-knot nematode isolates that can infect all currently identified sources of resistance. Continued searches of germplasm are needed to identify new sources of resistance. Artificially engineered resistance based on antisense technology or expression of anti-nematode proteins may be an additional source of resistance. Strategies to best use *Mi* and other genes to maximize their useful lifespans need to be developed. The gene *Mi*, which confers resistance to several species of root-knot nematode, is present in many modern tomato cultivars. Recent cloning of this gene revealed that it encodes a member of the plant resistance protein family characterized by the presence of a putative nucleotide binding site and a leucine-rich repeat. Although highly effective in many conditions, *Mi* fails to confer resistance at high soil temperature, and *Mi*-virulent nematode isolates have been identified in many areas of the world. These findings have stimulated efforts to identify new sources of root-knot nematode resistance. Resistance genes that differ from *Mi* in properties and genetic position have been identified in *Lycopersicon peruvianum*. These genes, as well as the cloned *Mi* gene, provide a resource for broadening the base of root-knot nematode resistance in tomato and other crops. Is pyramiding several resistance sources in selected elite cultivars the best solution or will it promote the spread of supervirulent nematodes? Getting a better understanding of nematode virulence is an important consideration for developing control strategies. As chemical control is reduced, the need for better understanding and implementation of host resistance and pathogen virulence will continue to increase.

Acknowledgments

The authors would like to thank Enza Zaden Tarım Ar-Ge Taş.ve Tic. A.Ş. for support.

REFERENCES

- Abad, P. vd. 2008. Genome sequence of the metazoan plan-parasitic nematode *Meloidogyne incognita*. *Nature Biotechnology*, 26, 909-915 (2008).
- Abad, P. and Williamson, V.M. 2010. Plant nematode interaction: a sophisticated dialogue. *Advances in Botanical Research*, 53: 147-192.
- Akkurt, H. D., Kaşkavalcı, G. and Peçen, A. 2013. Investigations on the effects of solarization and synergic use of some other treatments against root-knot nematodes (*Meloidogyne* spp.) in organic tomato growing. *Türkiye Entomoloji Dergisi*, 37(1): 81-92.
- Ammati, M., I.J. Thomason & H.E. McKiney, 1986. Retention of resistance to *Meloidogyne incognita* in *Lycopersicon* genotypes at high soil temperature. *Journal of Nematology*, 18: 491 –495.
- Ammiraju, J.S., Veremis, J.C., Huang, X. Roberts, P.A. and Kalshian, I. 2003. The heat-stable root-knot nematode resistance gene *Mi-9* from *Lycopersicon peruvianum* localized on the short arm of chromosome 6. *Theoretical and Applied Genetics*, 106: 478–484.
- Aydınlı, G. and Mennan, S., 2011. Bitkilerde Nematodlara Dayanıklılık. *Türk. Entomol. Bült.*, 2011, 1 (1): 35-47.
- Bailey, D.M. 1941. The seedling method for root-knot nematode resistance. *Proceedings of the American Society for Horticultural Science*, 38: 573-575.
- Barker, K. R., 1993. Resistance/tolerance and related concepts/terminology in plant nematology. *Plant Disease*, 77: 111-113.
- Bleve-Zacheo, T., Melillo, M.T. and Castagnone-Sereno, P. 2007. The contribution of biotechnology to Root-knot Nematode control in tomato plants. *Pest Technology*, 1(1): 1-16.
- Boerma, H.R. and Hussey, R.S. 1992. Breeding plants for resistance to nematodes. *Journal of Nematology*, 24(2), 242.
- Boswell, V.R. 1937. Improvement and genetics of tomatoes, peppers and eggplant. Yearbook of the United States Department of Agriculture, 177-206.
- Causse, M., Giovannoni, J., Bouzayen, M. and Zouine, M. 2016. The Tomato Genome. In: *Compendium of Plant Genomes*, Springer, pp. 259.
- Cap, G.B., P. A. Roberts & I. J. Thomason, 1993. Inheritance of heat-stable resistance to *Meloidogyne incognita* in *Lycopersicon peruvianum* and its relationship to the *Mi* gene. *Theoretical and Applied Genetics*, 85: 777-783.
- Cook, R. & K. Evans, 1987. “Resistance and Tolerance, 179-231”. In: *Principles and Practice of Nematode Control in Crops* (Eds. R. H. Brown & B. R. Kerry). Academic Press, New York, 447 pp.
- Cortada, L., Sorribas, F.J., Ornat, C., Andres, M.F., and Verdejo-Lucas, S. 2009. Response of tomato rootstocks carrying the *Mi*-resistance gene to populations of *Meloidogyne arenaria*, *M. incognita* and *M. Javanica*. *European Journal of Plant Pathology*, 124: 337-343.
- Devran, Z. and Söğüt, M. A. 2014. Response of heat-stable tomato genotypes to *Mi-1* virulent root-knot nematode populations. *Türkiye Entomoloji Dergisi*, 38(3): 229-238.
- Darwin, S.C., Knapp, S. and Peralta, I.E. 2003. Taxonomy of tomatoes in the Galápagos Islands: native and introduced species of *Solanum* section *Lycopersicon* (*Solanaceae*). *Systematics and Biodiversity*, 1 (1): 29-53.

- Dropkin, V. 1969. The necrotic reaction of tomatoes and other hosts resistant to *Meloidogyne*: reversal by temperature. *Phytopathology*, 59: 1632-1637.
- El-Sappah, A. H., MM, I., H. El-awady, H., Yan, S., Qi, S., Liu, J., & Liang, Y. (2019). Tomato natural resistance genes in controlling the root-knot nematode. *Genes*, 10(11), 925.
- Flor, H.H., 1955. Host–parasite interaction in flax rust—Its genetic and other implications. *Phytopathology*, 45: 680–685.
- Gilbert, J.C. & D.C. McGuire, 1956. Inheritance of resistance to severe root-knot from *Meloidogyne incognita* in commercial type tomatoes. *Proceedings of the American Society for Horticultural Sciences*, 68: 437–42.
- González, L.C., 2009. Tomato Rootstocks for the Control of *Meloidogyne* spp: Charaterization and Evaluation of the Resistance Response Conferred by the *Mi-1* Gene in Tomato Rootstocks. Universitat Politècnica de Catalunya, Doktora Tezi, Barcelona, 226 s.
- Gowen, S.R., Javeda, N., Inam-ul-Haqa, M. and Anwar, S.A. 2007. Protective and curative effect of neem (*Azadirachta indica*) formulations on the development of root-knot nematode *Meloidogyne javanica* in roots of tomato plants. *Crop Protection*, 26: 530-534.
- Ho, J. Y., Weide, R., Ma, H. M., van Wordragen, M. F., Lambert, K. N., Koornneef, M., ... & Williamson, V. M. (1992). The root-knot nematode resistance gene (*Mi*) in tomato: construction of a molecular linkage map and identification of dominant cDNA markers in resistant genotypes. *The Plant Journal*, 2(6), 971-982.
- Jenkins, J. A. 1948. The origin of the cultivated tomato. *Economic Botany*, 2(4): 379-392.
- Karssen, G. and Moens, M. 2006. Root-knot nematodes. In: R.N. Perry, M. Moens (Editors), *Plant Nematology*, CABI, pp: 59-90, London.
- Lambert, K. and Bekal, S. 2002. Introduction to plant-parasitic nematodes. *The plant Health instructor*, 10: 1094-1218.
- Lopez-Perez, J. A., Strange, M. L., Kaloshian, I. and Ploeg, A. T. 2006. Differential response of *Mi* gene resistant tomato rootstocks to root-knot nematodes (*Meloidogyne incognita*). *Crop Protection*, 25: 382-388.
- Miilligan, S.B., Bodeau, J., Yaghoobi, J., Kaloshian, I., Zabel, P. and Williamson, V.M. 1998. The root-knot resistance gene *Mi* from tomato is a member of the leucine zipper, nucleotide binding, leucine rich repeat family of plant genes. *Plant Cell*, 10: 1307-1319.
- Netscher, C., and Sikora, R. A. 1990. Nematode parasites of vegetables. In: *Plant parasitic nematodes in subtropical and tropical agriculture*, CABI, pp. 237-283.
- Nombela, G., V. M. Williamson & M. Muniz, 2003. The root-knot nematode resistance gene *Mi.1.2* of tomato irrespensible for resistance against the whitefly *Bemisia tabaci*. *Molecular Plant-Microbe Interactions*, 16:645-649.
- Nyczepir, A.P. and Thomas, S.H. 2009. Current and future management strategies in intensive crop production systems. In: Pery R. N., Moens M., Starr J. L. (Editors), *Root-knot nematodes*, CAB International, pp. 412-443 Wallingford.
- Painter, R. H., 1951. *Insect Resistance in Crop Plants*. The MacMillan Company, New York, 520 pp.
- Rashid, M. H., Al-Mamun, M. H., & Uddin, M. N. (2017). How durable is root knot nematode resistance in tomato?. *Plant breeding and biotechnology*, 5(3), 143-162.

- Roberts, P.A. 2002. Concepts and consequences of resistance. In: Starr, J.L., Cook, R., Bridge, J. (Eds.), *Plant Resistance to Parasitic Nematodes*, CAB International, Oxon, UK., pp. 23-41.
- Sasser J.N. 1980. Root-knot nematodes: a global menace to crop production. *Plant Disease*.64: 36–41.
- Smith, P.G. 1944. Embryo culture of a tomato species hybrid. *Proceedings of the American Society for Horticultural Science*, 44: 413-416.
- Tör, M., 1998. Bitkilerdeki moleküler konukçu-patojen ilişkilerdeki son gelişmeler. *Turkish Journal of Biology*, 22: 271 -278.
- Trudgill, D. L., 1991. Resistance to and tolerance of plant parasitic nematodes in plants. *Annual Review of Phytopathology*, 29: 167-192.
- Veremis, J.C. and Roberts, P.A. 1996a. Differentiation of *Meloidogyne incognita* and *M. arenaria* novel resistance phenotypes in *Lycopersicon peruvianum* and derived bridge-lines. *Theoretical and Applied Genetics*, 93: 960-967.
- Veremis, J.C. and Roberts, P.A. 1996b. Relation ships between *Meloidogyne incognita* resistance genes in *Lycopersicon peruvianum* differentiated by heat sensitivity and nematode virulence. *Theoretical and Applied Genetics*, 93: 950-959.
- Verdejo-Lucas, S., Cortada, L., Sorribas, F. J., and Omat, C. 2009. Selection of virulent populations of *Meloidogyne javanica* by repeated cultivation of *Mi* resistance gene tomato rootstocks under field conditions. *Plant Pathology*, 58(5): 990-998.
- Williamson, V. M., and Hussey, R. S. 1996. Nematode pathogenesis and resistance in plants. *The Plant Cell*, 8(10): 1735.
- Williamson, V. M. (1998). Root-knot nematode resistance genes in tomato and their potential for future use. *Annual review of Phytopathology*, 36(1), 277-293.
- Williamson, V.M. 1999. Plant nematode resistance genes. *Current Opinion in Plant Biology*, 2: 327-331.
- Wingard, S. A., 1953. The nature of resistance to disease. *The Yearbook of Agriculture*. Washington, D.C.: US Department of Agriculture, 165-173.
- Yaghoobi, J., Kaloshian, I., Wen, Y. and V.M. Williamson, 1995. Mapping a new nematode resistance locus in *Lycopersicon peruvianum*. *Theoretical and Applied Genetics*, 91: 457-464.
- Yaghoobi, J., Yates, J.L. and Williamson, V.M. 2005. Finemapping of the nematode resistance gene *Mi-3* in *Solanum peruvianum* and construction of a *S. lycopersicum* DNA contigs panning the locus. *Molecular Genetic Genomics*, 274: 60–69.

EUNIS HABITATS OF HIGH ANTHROPOGENIC IMPACT IN THE WATERSHED OF THE MIDDLE SECTION OF THE DEVOLL RIVER

Marjol Meço^{1*}, Ajola Mesiti², Ermelinda Mahmutaj², Alfred Mullaj²

¹Department of Biology, Faculty of Natural Sciences, University of Tirana, Bulevard Zogu i Parë, no. 25/1, 1001, Tiranë, Albania

²Research Center for Flora and Fauna, Faculty of Natural Sciences, University of Tirana, Tiranë, Albania

*Corresponding author e-mail: mariol.meco@yahoo.com

ABSTRACT

The study aims to describe and map the habitat types of the middle section of Devoll River watershed, where human activity is very high and transformative, using EUNIS classification. Results show that 26.5% of the study area is covered by habitats of high human activity. Among them, semi natural habitats created as result of high and persistent human activity occupy 11% and are represented by E5.3 (*Pteridium aquilinum* fields), G4 (*Mixed deciduous and coniferous woodland*), G1.7C2 (*Carpinus orientalis* woods). Artificial habitats such as agricultural areas and villages occupy 14% of the study area and are represented by J1 (*Buildings of cities, towns and villages*) and X25 (*Domestic gardens of villages and urban peripheries*). The habitat type C1.33 (*Rooted submerged vegetation of eutrophic water bodies*) represents aquatic habitats with rooted macrophytes of artificial ponds and lakes. Hydropower dams constructed in Moglicë village and Banjë turned a huge area of Devoll River flow into permanent lakes with high fluctuation of water level and with few pioneer and ephemeral vegetation in the lake shore. Habitats C1.2 (*Permanent mesotrophic lakes, ponds and pools*) and C3.5 (*Periodically inundated shores with pioneer and ephemeral vegetation*) are present in these man-made permanent lakes. Although human activity is high, the habitat G4 is very rich in plant species. Among them, many species are of conservation interest such as *Anacamptis pyramidalis*, *Juniperus oxycedrus*, *Hypericum perforatum*, *Orchis sp.*, *Ophrys sp.*, etc.

Keywords: EUNIS habitats, human activity, watershed of Devoll River, plant species of conservation interest

INTRODUCTION

The watershed of the middle section of the Devoll River extends in an area of 1,017 km², which makes 3.5% of Albanian territory. It is located in the South-Eastern Albania and it includes territories from Elbasan, Gramsh, Korçë and Skrapar districts (Fig. 1). The area is characterized by a high range of altitudes (from 100 m to 2373 m above the sea level), complex topography, highly variable rock substrates, soil types, and complex hydrological system. The climate conditions are relatively continental and sub-alpine climate prevails but with Mediterranean influences in the lower altitudes (Kabo, 1990; 1991; Norconsult, 2010). These ecological conditions are reflected in a wide floristic diversity, vegetation and habitat types.

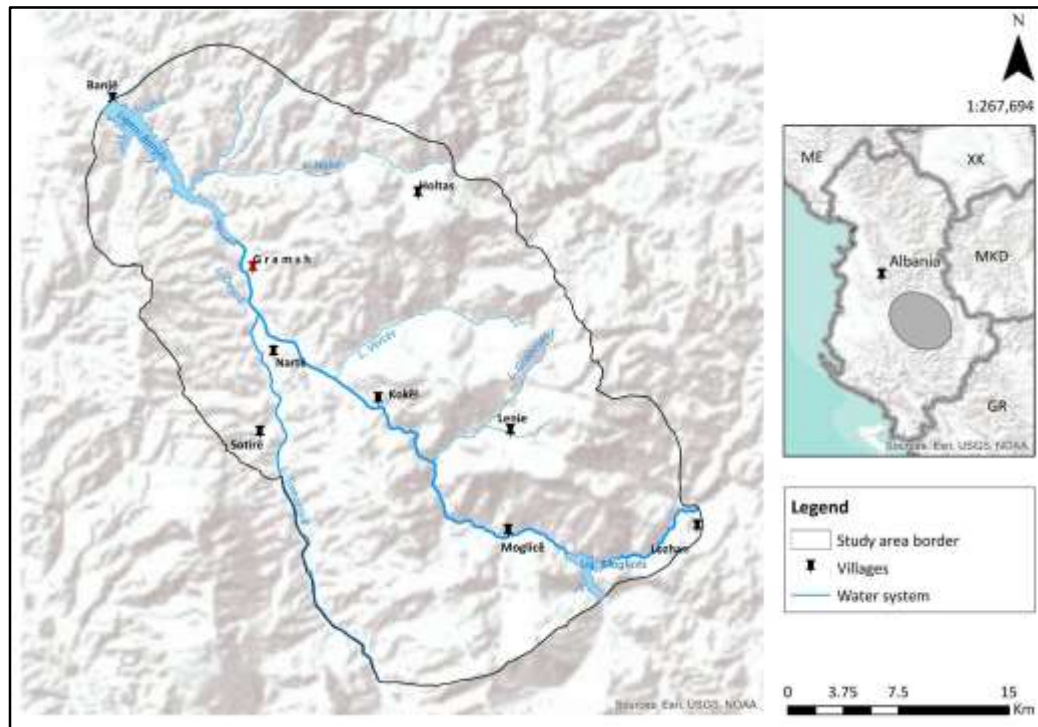

Figure 1. Geographic position of the study area

The first floristic data were published by Markgraf (1927; 1931) and Demiri (1959). Later studies and publications for the area have been mostly sporadic (Paparisto and Qosja, 1976; Gölz and Reinhard, 1984; Vangjeli et al., 2000, a; Barina and Pifkó, 2008; 2011; Shuka and Tan, 2009; Mullaj and Tan, 2010; Meyer, 2011; Mersinllari, 2008; 2014). Studies on the vegetation of this area are even less. Only a few data about the communities of sedge, ash, black pine and alpine pastures in Valamara mountain have been published by Vangjeli (1983), Mersinllari (1988), Hoda (1989), Buzo (1990) and Vangjeli et al. (2000, b). First comprehensive data on habitats according to EUNIS and Annex I of Habitats`Directive classifications were published on period 2016-2019 in the framework of Meço's PhD research thesis (Meço and Mullaj, 2016; Meço et al., 2017, a; et al., 2017, b; et al., 2018, etc).

Flora and vegetation of the area are a precious value for the local community, both as an economic resource and for better life quality. Fire woods, timber, pastures for livestock or medicinal plants are provided by natural resources.

Depending on the type of anthropogenic impact, its intensity and duration, many habitats have lost their naturality completely or partially. Following, new artificial habitats and ecosystems have been created such as agricultural areas, urban areas, industrial areas, infrastructural constructions, artificial lakes etc. Their expansiveness is huge but still they are important for hosting biodiversity values. Therefore, this study is focused on floristic description and mapping of semi-natural and manmade habitats.

MATERIAL AND METHODS

17 field trips were undertaken during 2016 - 2022 as a combination of floristic and phytosociological trips to collect field data. Identification of semi-natural and artificial habitats in the watershed of the middle section of the Devoll River were based on identifying diagnostic species and by comparing the habitat features with habitat description of EUNIS calcification (Davies et. al., 2004). For semi-natural habitats, few phytosociological relevés (Br-BI, 1964) were also carried out mainly in *Carpinus orientalis* formations and mixed deciduous forest.

1000 sampling points were recorded as georeferenced data (GPS Garmin) and all of them were accompanied with ecological data and information on floristic composition and vegetation. The plant identification was done according to Flora Europaea (Tutin et al., 1968; et al., 1980; et al., 1993) and Flora of Albania (Paparisto et al., 1988; Qosja et al., 1992; et al.; et al., 1996; Vangjeli, 2015).

Habitat maps were designed in ArcMap 10.1 in WGS 1984. (Environmental Systems Research Institute, New York, NY, USA). Shapefiles were built by interpreting field data and aerial photographs. The main attribute table was created with data such as: coordinates and the main vegetation communities. It was used as layers for geospatial information the orthophotos, which were taken from ASIG (asig.gov.al/english/index.php) and large scale vegetation maps (Corine Land Cover map) (Devillers et al. 1991).

Since the aerial photos are insufficient to separate and delimit all habitat types, repeated field surveys were undertaken, by making new transects. Subsequent field work missions were undertaken as a quality control measure to verify map information.

RESULTS AND DISCUSSION

The geographical position of watershed of the middle section of the Devoll River, the amplitude and the high relief diversity, the rock substrate, the soil types, the climatic and hydrological conditions, have brought in a very rich flora. The species composition depending on the similar requirements to the environmental conditions form a variety of plant associations and habitat types. The presence of the anthropogenic impact is present almost everywhere, and it is very high in a surface of about 35,976 ha or 26.5% of the study area, changing the natural habitats and creating semi-natural or completely artificial habitats such as wood cutting, overgrazed pastures, mixed deciduous forest and pine plantations, agricultural lands, water bodies and lakes, etc.

8 EUNIS habitats of high human impacts are identified and described:

C1.2-Permanent mesotrophic lakes, ponds and pools

The Devoll River flow is highly impacted by dam construction in this section. Two large dams, Banja and Moglica, were built, which created two lakes, where large areas were flooded. The most affected are the habitats listed in Annex I of the Habitats Directive, such as: 92D0 (124.91ha); 9340 (107.48 ha); 5110 (83.79 ha); 92A0 (81.5 ha); 5210 (79.86 ha); 9250 (71.82 ha); 3270 (43.69 ha); 9530 (14.47 ha); 9540 (9.45 ha); 6210 (2.74 ha); 9280 (0.39 ha); 92C0 (0.18 ha), reported by Meço and Mullaj (2016) and Meço et al. (2018).

The lakes of Banja and Moglicë have flooded many ~~agricultural~~ lands on both sides of the river, as well. There are 438.04 ha of abandoned arable land and 397.07 of regularly or recently cultivated agricultural, horticultural and domestic habitats, to be flooded.

These two water reservoirs represent permanent lakes with high amplitude fluctuation. Generally, water quality of the basin is good but is polluted by urban wastewaters from Gramsh, Maliq, Korçë and Bilisht (Norconsult, 2010). Due to high water fluctuation and the young age of the basin, the riparian vegetation and rooted macrophytes are not installed. Only, some green algae and pioneer plant species live in the shallow water near the lakeshore and on muddy substrate above the water level in summer.

C1.33-Rooted submerged vegetation of eutrophic water bodies

This habitat represents all the artificial water bodies of the study area, with perennial macrophytes rooted in the shallow bottoms of these reservoirs or water basins. The dominant

species belong to the genus *Potamogeton*, alliances Potamion lucentis Vollmar 1947 and Potamion pusilli Wiegleb 1982. Other frequent species are *Myriophyllum spicatum* and *M. verticillatum*. Often, during the summer these aquatic environments dry up completely.

In this habitat type, we have included all the small reservoirs, ponds and artificial fields built by humans, such as Posnovisht Reservoir, Bratila Reservoir and some ponds created to provide water for livestock during the summer period. The total surface of this habitat type in the study area is around 14.7 ha.

C3.5-Periodically inundated shores with pioneer and ephemeral vegetation

This habitat type occurs mostly in shallow waters of Banjë artificial lake, close to Trashovica bridge, where the river flow joins the lake. In summer, lake level drops and the alluvial substrate deposited by Devoll River comes to surface. When these alluvions start to dry up, some annual species start growing such are *Bidens tripartita*, *Persicaria hydropiper*, *P. lapathifolium*, *Rumex conglomeratus*, *Xanthium strumarium*, *Equisetum telmateia*, *Cyperus glomeratus*, *C. fuscus*, *Echinochloa crus-galli*, etc. The plant composition of this habitat type is very similar to habitat 3270 (*Rivers with muddy banks with Chenopodium rubri pp and Bidention pp vegetation*) of annex 1 of Habitats directive, reported by Meço and Mullaj (2016) on the muddy river bank of Devoll River, partly flooded already by the artificial lakes of hydropowers.

E5.3-Pteridium aquilinum fields

The habitat represents the last stage of degradation of forest formations, forming open areas dominated by *Pteridium aquilinum*. The *P. aquilinum* fields appear as a result of massive cutting of trees, followed by burning of the area that clears completely the vegetation from the soil surface and the first heavy rains wash it down from the nutrients. These surfaces, pure in nutrients already, are populated by *P. aquilinum*, which often forms very dense fields, characterized by low floristic diversity. The most common accompanying species are *Fragaria vesca*, *Brachypodium pinnatum*, *B. sylvaticum*, *Viola odorata*, *Dactylis glomerata*, *Scilla autumnalis*, etc.

G1.7C2-Carpinus orientalis woods

This habitat occurs between 400m and 900m above sea level, on different substrate types, exposition and slopes. *Carpinus orientalis* forests and scrub formations extend widely, but mostly in the northwest part of the study area, on hills along both sides of the old Elbasan-Gramsh road to the Kaçivel village and on hills of Sotirë village. The formations with *C. orientalis* represent a degradation stage of mixed broadleaf oak forest dominated by *Quercus cerris*, often with the presence of *Quercus pubescens* and *Quercus frainetto*. The total surface of this habitat is about 10188.36 ha that makes 10% of the study area or 45.8% of the total oak phytoclimatic layer in that area. As result of intensive cutting, grazing and fires 1685 ha of *C. orientalis* formations are very degraded stage.

The hornbeam formations are dominated by *Carpinus orientalis* cover 70%, but with a high presence of: *Acer platanoides*, *Colutea arborescens*, *Cornus mas*, *Coronilla emerus*, *Cotinus coggygia*, *Crataegus monogyna*, *Fraxinus ornus*, *Juniperus oxycedrus*, *Phillyrea angustifolia*, *Quercus pubescens*, *Rubus ulmifolius*, *Acer monspessulanum*, *Paliurus spinachristi*, *Cercis siliquastrum*, *Cornus sanguinea*, *Hedera helix*, *Tamus communis*, *Teucrium polium*, *Buxus sempervirens*, etc. Among the herbaceous plants there are: *Primula vulgaris*, *Anemone apennina*, *Asparagus acutifolius*, *Brachypodium sylvaticum*, *Buglossoides purpureocaerulea*, *Clinopodium vulgare*, *Cnidium silaifolium*, *Cynosurus echinatus*, *Helleborus odoratus*, *Lathyrus niger*, *Luzula forsteri*, *Melica ciliata*, *Potentilla micrantha*, *Prunella vulgare*, *Ruscus aculeatus*, *Satureja montana*, *Symphytum bulbosum*, *Thymus longicaulis*, *Vicia*

grandiflora, etc. In dense formations, the herbaceous layer is often very poor and with a high presence of mosses.

These formations don't have a clear physiognomy and are generally characterized by a low floristic diversity, and high presence of species typical for disturbed areas. They are found almost all over the territory of Albania, often forming dense forests with a height of around 3 m and about 20 years old.

G4-Mixed deciduous and coniferous woodland

Mixed deciduous forests with coniferous (*Pinus nigra*) are found fragmented at altitudes ranging from 350m to 1200m above sea level, from the hills above Bulçarë village close to Dushku lake. The total surface of this habitat is 771.2 ha or 0.7% of the study area. The most important floristic elements of these forests are *Pinus nigra* mixed with *Quercus cerris*, *Q. frainetto*, *Q. pubescens*. Very frequent are also: *Quercus trojana*, *Carpinus orientalis*, *Fraxinus ornus*, *Ostrya carpinifolia*, *Juniperus oxycedrus*, *Acer obtusatum*, *Coronilla emeroides*, *Cotinus coggygria*, *Brachypodium pinnatum*, *B. sylvaticum*, *Aremone agrimonoides*, *Digitalis laevigata*, *Crataegus monogyna*, *Campanula trachelium*, *Clematis vitalba*, *Rubus idaeus*, *Euphorbia spinosa*, *Scrophularia canina*, *Alyssum murale*, *Dictamnus albus*, *Inula spiraeifolia*, *Helleborus odorus*, *Acer monspessulanum*, *Pteridium aquilinum*, *Luzula forsteri*, *Campanula persicifolia*, *Myosotis sylvatica*, *Viola odorata*, *Dactylis glomerata*, *Primula veris*, *Poa bulbosa*, *P. nemoralis*, *Veronica chamaedrys*, *Euphorbia amygdaloides*, etc. Most of these forests have been overexploited as a result of cutting, overgrazing, coppices of new oak branches for livestock, etc.

This habitat type hosts many species with conservation interest. In open woodland or along the forest edge there are found many orchid species such as *Anacamptis pyramidalis*, *Listera ovata*, *Neottia nidus-avis*, *Ophrys apifera*, *O. scolopax*, *O. sphegodes*, *Orchis coriophora*, *O. mascula*, *O. morio*, *O. tridentata*, etc. *Juniperus oxycedrus*, *J. communis* and *Hypericum perforatum* that have conservation status VU according to Albanian Red List (2013) and LC according to IUCN (2016), are also frequent in this habitat type.

J1-Buildings of cities, towns and villages

Rural and urban areas populate the watershed of the middle section of the Devoll River, from the lowest parts along the Devoll River to about 1500m above sea level. The Gramsh town is the largest urban area. The vegetation around these settlements and roads side forms patches dominated by nitrophilous and ruderal species such as: *Urtica dioica*, *U. urens*, *Sambucus ebulus*, *Chenopodium album*, *Cirsium vulgare*, *Sonchus oleraceus*, *Marrubium vulgare*, *M. peregrinum*, *Solanum nigrum*, *Datura stramonium*, *Portulaca oleracea*, *Ballota nigra*, *Parietaria officinalis*, *Heliotropium europaeum*, etc. Often the vegetation of these disturbed area is dominated by invasive alien species such as: *Robinia pseudacacia*, *Dittrichia viscosa*, *Conyza canadensis*, *Aster squamatus*, *Ailanthus altissima*, etc. and frequently medicinal plant species are found such as *Tussilago farfara* and *Hypericum perforatum*.

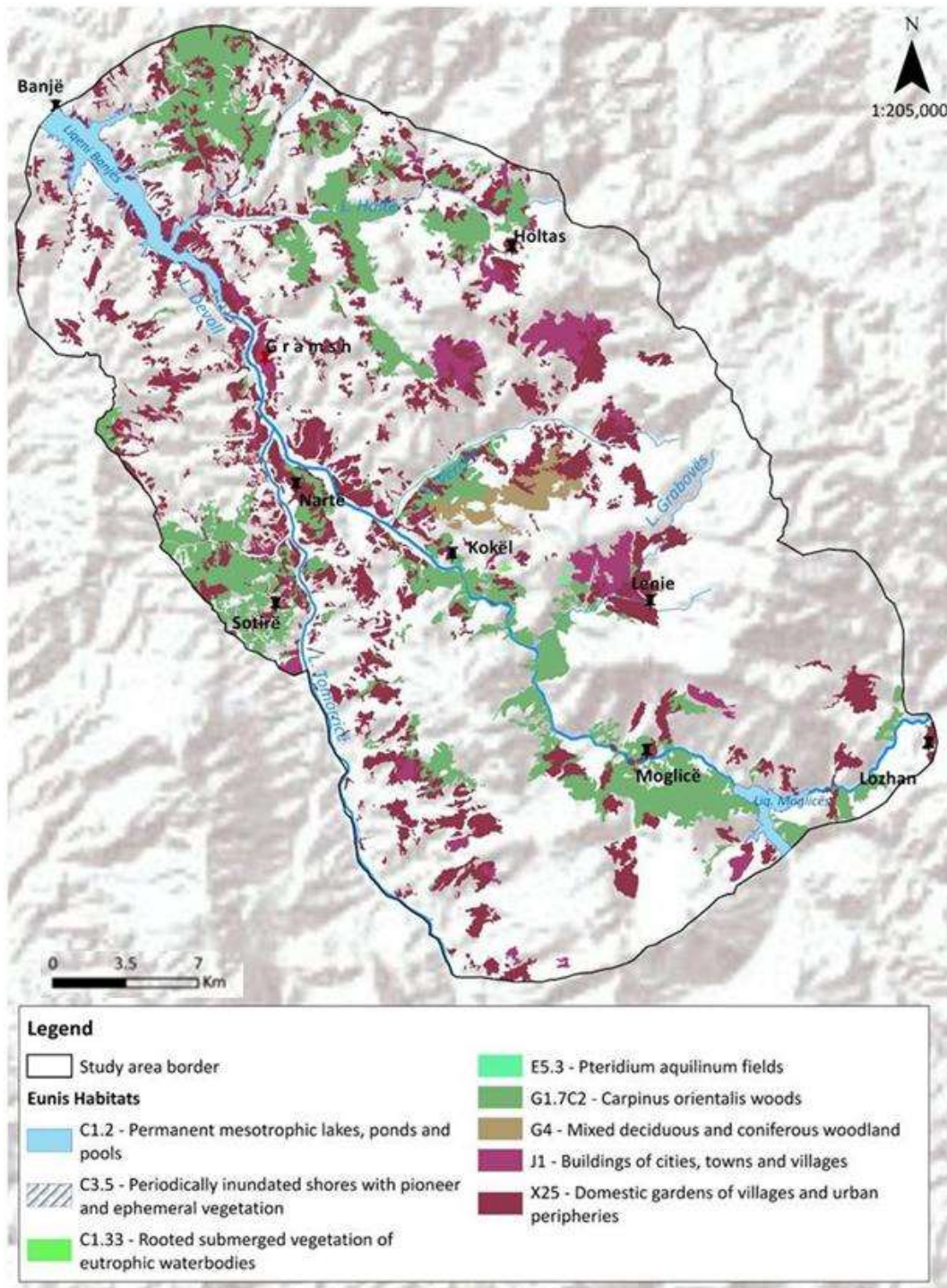

Figure 2. The habitat map of high human impact in the watershed of the middle section of the Devoll River

X25-Domestic gardens of villages and urban peripheries

Agricultural gardens of villages and urban peripheries in the study area are widespread in soils that range from shallow and low calcium content (in the upper part of the watershed) to deep soils with higher nutrient content that are formed by alluvial deposits along the river course. The most important agricultural crops of agricultural gardens are: corn, beans, barley, alfalfa, but also by fruit trees (apples, olives, plums, etc.), vineyards and medicinal plants (lavender, sage, cyan, etc.).

The spontaneous flora of these agricultural lands is represented by weeds such as: *Agrostemma githago*, *Ranunculus arvensis*, *Papaver rhoeas*, *Legousia speculum-veneris*, *Capsella bursa-pastoris*, etc., which are more present in winter crops. Nitrophilous plants such as: *Polygonum aviculare*, *Amaranthus retroflexus*, *Chamomilla recutita* etc. are more present in spring crops. A high presence of invasive alien species such as *Dittrichia viscosa*, *Conyza canadensis* and *Aster squamatus* are often present.

CONCLUSIONS

Due to anthropogenic activities, about 26.5% of the territory of the middle section of Devoll River watershed has lost its naturalness but is still hosting important floristic values in semi-natural and artificial habitats. *Anacamptis pyramidalis*, *Listera ovata*, *Neottia nidus-avis*, *Ophrys apifera*, *O. scolopax*, *O. sphegodes*, *Orchis coriophora*, *O. mascula*, *O. morio*, *O. tridentata*, *Juniperus oxycedrus*, *J. communis*, etc., are some of the species of high conservation interest.

Among the described habitat types, semi natural habitats such as E5.3 (*Pteridium aquilinum* fields), G4 (*Mixed deciduous and coniferous woodland*) and G1.7C2 (*Carpinus orientalis* woods) cover 11% of the study area while, the artificial habitats C1.2 (*Permanent mesotrophic lakes, ponds and pools*), J1 (*Buildings of cities, towns and villages*) and X25 (*Domestic gardens of villages and urban peripheries*) cover 15%.

Recent interventions such as the creation of water reservoirs from operation of Devoll hydropower plant inundated 12 habitats of Annex I of the Habitats Directive of the area reported by Meço and Mullaj (2016) and Meço et al. (2018) with a total surface of 620.3 ha.

The major concern for the area, its naturalness, diversity and conservation is the intense and high human activities resulting in a tendency of future man made landscape and complete loss of biodiversity and habitats. For this not to happen, important information should be published and communicated to decision makers and a wide range of stakeholders to strongly and seriously consider conservation measures, nature restoration and management.

REFERENCES

- Barina, Z., Pifkó, D. 2008. Additions and amendments to the flora of Albania. *Willdenowia*, 38: 455 – 464.
- Barina, Z., Pifkó, D. 2011. Contributions to the flora of Albania, 2. *Willdenowia*, 41(1): 139 – 149.
- Buzo, K. 1990. Rezultate të studimit gjeobotanik për shoqërimet bimore me barimzën kapilar (*Agrostis capillaris* L.) në vendin tonë. *Buletini i Shkencave të Natyrës (BSHN), FSHN, UT.*, 44(2): 64-71
- Davies, E. C., Moss, D., O., Hill, M. 2004. EUNIS habitat classification. Revised 2004, EEA, European Topic Centre on Nature Protection and Biodiversity.
- Demiri, M. 1959. Të dhana botanike mbi florën e kullotave natyrore të Gurit të Topit e Lenijes. *Bul. Univ. Shtetëtor të Tiranës, Ser. Shkencat Natyrore*, 13(3): 81-104
- Devillers, P., Devillers-Terschuren, J., Ledant, J.-P. 1991. CORINE biotopes manual (2). Habitats of the European Community. Office for Official Publications of the European Communities, Luxembourg.

- Gözl, P., Reinhard, H. R. 1984. Die Orchideen Flora Albaniens. Mitt. Bl. Arbeitskr. Heim Orch. Badens-Württ, 16(2): 193-394
- Hoda, P. 1989. Studim gjeobotanik i formacionit të pishës së zezë (*Pinus nigra* Arn) në vendin tonë. Punim Doktorate. Fakulteti i Shkencave Natyrore, Universiteti i Tiranës. Tiranë.
- IUCN, 2016. The IUCN Red List of Threatened Species. Version 2016-3. <http://www.iucnredlist.org> [përditësimi i fundit: 07/12/2017]
- Kabo, M. 1990-1991. Gjeografia Fizike e Shqipërisë, Vol. 1-2. Tiranë.
- Markgraf, F. 1927. An den Grenzen des Mittelmeergebiets. Pflanzengeographie von Mittelalbanien. Repert. Spec. Nov. Regni Veg. Beih., 45: 1-217
- Markgraf, F. 1931. Pflanzen aus Albanien 1928. – Denkschr. Akad. Wiss. Wien, Math. -Nat. Kl., 102: 317-360
- Meço, M., Mullaj, A. 2016. Flora dhe habitatet ripariane (bregore) të rrjedhës së mesme të lumit Devoll. Buletini i Shkencave të Natyrës (BSHN), FSHN, UT., 21: 66-76
- Meço, M., Mullaj, A., Bani, A. 2017,a. Ni-Hyperaccumulator plants in the watershed of the middle flow of Devoll River and their Distribution in Albania. 9th International Conferences on Serpentine Ecology (ICSE), Agriculture University of Tirana, Albania.
- Meço, M., Mullaj, A., Barina, Z. 2018. The vascular flora of the Valamara mountain range (SE Albania), with three new records for the Albanian flora. *Flora Mediterranea*, 28: 5-20. Italy. doi: 10.7320/FlMedit28.005
- Meço, M., Pavlova, D., Mahmutaj, E., Bani, A., Mullaj, A. 2017,b. Conservation status of some rare plant species on the watershed of the middle section of river Devoll (South Central Albania) and their distribution in Albania. *Phyt Balc.*, 23 (2): 199 – 205
- Mersinllari, M. 1988. Vështrim gjeobotanik i ahishteve të vendit tonë. Punim Doktorate. Fakulteti i Shkencave Natyrore, Universiteti i Tiranës. Tiranë.
- Mersinllari, M. 2008. Të dhëna për florën dhe bimësinë e vargut malor Lenije Valamarë. Buletini i Shkencave të Natyrës, Nr. 5 (BSHN), FSHN, UT.
- Mersinllari, M. 2014. Të dhëna për floren dhe bimësinë e faqes jugore te vargut Valamarë Lenije Buletini i Shkencave të Natyrës, Nr. 18. (BSHN), FSHN, UT.
- Meyer, F. K. 2011. Beiträge zur Flora von Albanien. *Hausknechtia Beih*, nr. 15: 1-220. Germany
- Mullaj, A., Tan, K. 2010. *Erica multiflora* (Ericaceae), *Onosma pygmaeum* (Boraginaceae) and *Typha minima* (Typhaceae) in Albania. *Phytol. Balcan.*, 16: 267–269.
- Norconsult, 2010. Devoll Hydropower Project. Development Phase (ESIA Report). Tiranë
- Paparisto, K., Demiri, M., Mitrush, I., Qosja, Xh. 1988. Flora e Shqipërisë vol. 1. Akademia e Shkencave të Shqipërisë. Tiranë.
- Paparisto, K., Qosja, Xh. 1976. Kontribut për florën e R. P. të Shqipërisë. *Bul. Shkencavet Natyrës*, 30(2): 85-98
- Qosja, Xh., Paparisto, K., Demiri, I., Vangjeli, J., Balza, E. 1992. Flora e Shqipërisë, Vol. 2. Tiranë.
- Qosja, Xh., Paparisto, K., Vangjeli, J., Ruci, B., Mullaj, A. 1996. Flora e Shqipërisë, Vol. 3. Tiranë.
- Shuka, L., Tan, K. 2009. On the distribution of *Cerastium smolikanum* (Caryophyllaceae) and *Centaurea vlachorum* (Asteraceae) in Balkan Peninsula. *Phytol. Balcan.*, 15(3): 347–350.
- Tutin, T. G., Burges, N. A., Chater, A. O., Edmondson, J. R., Heywood, V. H., Moore, D. M., Valentine, D. H., Walters, S. M., Webb, D. A. 1993. *Flora Europaea*. Cambridge,
- Tutin, T. G., Heywood, V. H., Burges, N. A., Moore, D. M., Valentine, D. H., Walters, S. M., Webb, D. A. 1968-1980. *Flora Europaea*, Vol. 2-5. Cambridge.
- Vangjeli, J. 1983. Studimi gjeobotanik i rrobullit (*Pinus heldreichii* subsp. *leucodermis*) në Shqipëri. Punim Doktorate. Fakulteti i Shkencave Natyrore, Universiteti i Tiranës. Tiranë.

- Vangjeli, J. 2015. Excursion Flora of Albania. Hardcover, pp. 1-661. Germany.
- Vangjeli, J., Ruci, B., Mullaj, A., Papparisto, K., Qosja, Xh. 2000, a. Flora e Shqipërisë. ASHRSH-Instituti i Kërkimeve Biologjike, Vol. 4, pp. 502. Tiranë
- Vangjeli, J., Ruci, B., Mullaj, A., Xhulaj, M. 2000, b. Flora e vegetazione in Albania. La cooperazione italo-albanese per la valorizzazione della biodiversità Bari: CIHEAM Cahiers Options Méditerranéennes, 53: 51- 66
- VKM, 2013. Miratimi i listës së kuqe të florës dhe faunës së egër http://www.mjedisi.gov.al/files/userfiles/Biodiversiteti/urdhera_dhe_udhezime/2013-Urdher_nr_1280_dt_20.11.2013_Miratimi_Listes_Kuqe_Flores&Faunes_Eger.pdf [përditësimi i fundit: 22.12.2017]

ANTIBIOTIC SUSCEPTIBILITY OF *E. COLI* AGENT ISOLATED FROM CALF DIARRHEA AND MASTITIS CASES IN SOME REGIONS OF TURKEY

Kadir Akar¹, Gökçenur Sanioglu Gölen²

¹ Van Yuzuncu Yil University, Veterinary Faculty, Department of Microbiology, Van, Turkey

² Aksaray University, Veterinary Faculty, Department of Microbiology, Aksaray, Turkey

Corresponding author e-mail: kadirakar@yyu.edu.tr

ABSTRACT

Mastitis affects dairy cattle often and has a significant economic impact. In addition, One of the most prevalent illnesses affecting calves is diarrhea, which costs livestock producers significantly less in terms of economic production. *Escherichia coli* (*E. coli*) is one of the leading infectious agents associated with mastitis and calf diarrhoea. Intimin protein in *E. coli* is encoded by the *eae* gene and is required to disrupt the host cell's cytoskeleton and facilitate bacterial attachment. For this purpose, the causative agent was confirmed in PCR with the intimine gene region primers. The widespread use of antibiotics on dairy farms is still one of the main causes of the development of bacteria that are resistant to antibiotics.

This study aims to determine the antimicrobial resistance patterns of *Escherichia coli* isolates isolated from bovine mastitis and diarrhea in Aksaray and Van provinces between 2018 and 2022 and to determine the prominent antimicrobial resistance among the isolated strains. For this purpose, antimicrobial susceptibility testing against seven antibiotic groups, including Penicillin, Florfenicol, Azithromycin, Novobiocin, Ciprofloxacin, Amoxicillin/Clavulanic acid and Neomycin, was performed using the disc diffusion method. The study used 178 calf faeces with diarrhea and 135 milk with mastitis, and 32 isolates were obtained. These isolates were subjected to antibiogram testing after confirmation with intimin-K99 primers. While the study's results were resistant to Penicillin, Novobicin and Amoxicillin/Clavulanic acid antibiotics for all isolates, Florfenicol and Neomycin are the most sensitive. While some isolates are susceptible to other antibiotics, some are resistant. As a result, both the detection of virulence factors of the agent and antibiotic resistance should be considered in the fight against mastitis and calf diarrhea, and antibiotics should be administered according to the antibiogram results to prevent the development of resistance.

Keywords: Diarrhea, mastitis, antibiotics, disc diffusion

INTRODUCTION

E. coli, a facultative anaerobic, flagellate, rod-shaped bacterium, belongs to the Enterobacteriaceae family. While the causative agent occurs as flora bacteria in the healthy gastrointestinal tract of humans and ruminants, including milk-producing animals, some can cause disease. One of the most prevalent Gram-negative bacteria associated with diarrhea and mastitis is *E. coli*. (Hasson et al. 2022, My et al. 2023). The inflammation of the breast tissues shapes the case of mastitis. This disease can be seen in many mammalian species, such as domestic dairy cattle (Gomes and Henriques 2016). Mastitis is a disease that affects fertile animals in herds and decreases milk yield. The use of serious antibiotics to treat the disease

causes deaths several times a year and thus causes severe economic losses (Zhao and Lacasse 2008, Stevens et al. 2016, My et al. 2023).

E. coli agents use different virulence factors to infect the host. These virulence factors include colicins, hemolysins, proteases, toxins, fimbria-like adhesion and cell surface (Hasson et al. 2022). There is a need to define virulence characteristics in differentiating normal flora bacteria and pathogenic strains (Güler et al. 2008). Intimin protein in *E. coli* is encoded by the *eae* gene and is required to disrupt the host cell's cytoskeleton and facilitate bacterial attachment (Suleiman et al., 2020).

As in many bacteria, the multi-drug resistance (MDR) issue in *E. coli* is very current and accepted as a public health threat worldwide. For the factor, livestock such as cattle are included as known reservoirs (Bandyopadhyay et al. 2021). Proper use of antibiotics requires routine antimicrobial susceptibility tests and screening of emerging MRD strains to determine the dose and preferred antibiotic (Hetta et al. 2021, Kareem et al. 2021). There is limited information on antimicrobial resistance profiles for the pathogen in Turkey.

In this study, antimicrobial resistance patterns of *Escherichia coli* isolates from bovine mastitis and diarrhea in the provinces of Aksaray and Van between 2018 and 2022 were examined, as well as the predominant antimicrobial resistance among the isolated strains.

MATERIAL AND METHOD

Sample collection

Between 2018 and 2022, 178 calf faeces with diarrhea and 135 milk with mastitis were collected from Aksaray and Van provinces, and the samples were transferred to the laboratory at four °C within 3-4 hours.

Bacterial culture and identification

After the milk samples with mastitis and stool samples were delivered to the laboratory, 0.1 mL of the samples were taken for the first isolation and inoculated into 5% sheep blood agar and MacConkey agar. After incubation, the isolates were inoculated into EMB agar as a subculture, and those with a metallic blue-green color were defined as phenotypic. Biochemical tests were performed with Gram stain, catalase, oxidase, and triple sugar iron agar (Momtaz et al. 201A 3). A PCR test was performed to confirm the isolates.

Antimicrobial sensitivity testing

According to previously described techniques, antimicrobial susceptibility testing was carried out using the Kirby Bauer disk diffusion method on Mueller-Hinton agar (Sigma-Aldrich, USA) (Patel et al. 2015). Antimicrobial susceptibility testing against seven antibiotic groups, including tested antimicrobial agents, Penicillin, Florfenicol, Azithromycin, Novobiocin, Ciprofloxacin, Amoxicillin/Clavulanic acid and Neomycin, was performed using the disc diffusion method. After preparation on Mueller-Hilton agar (Sigma-Aldrich, USA) to McFarland 0.5 standard, springs were placed on plates and incubated at 37°C for 24 hours. Sensitivity measurements were determined as sensitive (3), moderate (2), low (1) and resistant (-) according to the diameter of the inhibition zone.

DNA extraction and PCR amplification

Following the manufacturer's recommendations, DNA was extracted from each *E. coli* isolate using the Qiagen DNeasy Blood and Tissue Kit (Life Technologies, USA) and stored at -20°C until further use. For amplification in each PCR tube content, a total of 25 µl of primers were prepared using a total of 1 µM, four µl of Master Mix, 9.8 µl of sterile ultrapure water and five µl of DNA. This mixture was amplified in a heat cycler with a 35-cycle reaction, each cycle consisting of 1 minute at 94°C, 1 minute at 58°C, and 30 seconds at 72°C after 5 minutes of pre-denaturation at 95°C. As a final extension, after the DNAs were kept at 72 °C for 5 minutes, 1.5% agarose gel containing 5 µg/ml ethidium bromide was prepared and subjected to electrophoresis for imaging. By using 100 bp DNA ladder as marker, bands of approximately 424 to 314 bp in size of intimin primers (F 5- ATA TCC GTT TTA ATG GCT ATC T -3 ve R 5- AAT CTT CTG CGT ACT GTG TTC A -3)- K99 (F 5- TAT TAT CTT AGG TGG TAT GG -3 ve R 5- GGT ATC CTT TAG CAG CAG TAT TTC -3), respectively, were evaluated as positive (Güler and Gündüz 2007).

RESULTS AND DISCUSSION

As a result of the study, Thirty-two isolates were isolated from 313 samples, 178 from calf faeces and 1faecesom milk with mastitis. These isolates were verified by PCR according to the primer sequences of the aeg gene region of the intimin protein, and the results are given in **Figure 1** with gel images.



Figure 1. PCR images of 32 *E. coli* isolates isolated from calf diarrhea and mastitis (L: Leader)

To determine the sensitivity of antibiotics from the isolated *E. coli* agent, Antibigram Test was performed on 32 isolates obtained in the study, and the results are given in **Table 1**. There are many studies on the virulence characteristics of *E. coli* from calf samples with mastitis and diarrhea (Bag et al. 2021, Dubreuil et al. 2016). It has been reported that K99 fimbria in calves in Turkey was detected in 30.2%, 35% and 16% of calves, respectively, in previous studies (Erganis, et al., 1988, Uysal et al., 1992, Güler et al. 2008). This study determined it as positive in 11.23% of calf diarrhea. It has been reported that intimin, one of the virulence factors, can be isolated from bovine faeces anfaeceslthy calves (Mainil and Daube, 2005).

Table 1. 32 *E. coli* isolates from calf diarrhea and mastitis were tested for antibiotic susceptibility.

	Isolates	Penicilli n	Florfenico l	Amok/clo u	Azithromyci n	Novobioci n	Ciproflok s	Neomyci n
1	76	---	3	---	---	---	1	1
2	80	---	3	---	---	---	---	1
3	108	---	2	---	1	---	3	1
4	112	---	3	---	1	---	3	2
5	114	---	3	---	---	---	1	2
6	115	---	2	---	---	---	1	1
7	116	---	3	---	---	---	1	1
8	117	---	3	---	---	---	---	2
9	118	---	3	---	1	---	3	2
10	290	---	3	---	---	---	---	2
11	314	---	3	---	---	---	2	1
12	319	---	2	---	---	---	---	1
13	474	---	3	---	1	---	1	1
14	475	---	2	---	---	---	1	2
15	476	---	2	---	1	---	2	1
16	477	---	3	---	1	---	---	1
17	478	---	3	---	1	---	2	2
18	481	---	2	---	1	---	1	1
19	484	---	3	---	---	---	1	1
20	485	---	3	---	1	---	2	2
21	486	---	3	---	1	---	1	1
22	487	---	3	---	---	---	3	1
23	490	---	2	---	---	---	3	1
24	491	---	3	---	---	---	3	1
25	492	---	3	---	---	---	---	2
26	493	---	3	---	---	---	2	1
27	494	---	3	---	1	---	---	1
28	502	---	2	---	---	---	1	1
29	503	---	3	---	1	---	2	2
30	509	---	3	---	---	---	3	2
31	510	---	3	---	1	---	3	2
32	511	---	2	---	---	---	---	1

When the antibiogram results were evaluated, Florfenicol was considered sensitive for all isolates and even the most sensitive for most of them. It can be regarded as sensitive antibiotic preparation, along with neomycin and ciprofloxacin in some isolates. Florfenicol has been used to treat bovine respiratory pathogens in Turkey since 1998. In previous studies, Orden reported the rate of florfenicol resistance in *E. coli* calves as 1%, Hariharan 11%, Werckenthin 35%, White 92%, Güler 9.3% (Güler et al. 2008). In this study, florfenicol resistance was the highest (100%).

In this study, it was determined that it was resistant to amoxicillin-clavulanic acid antibiotics. Previous studies determined amoxicillin-clavulanic acid resistance in 35%

(Werckenthin et al. 2002) and 12% (Güler et al. 2008), respectively. In addition, all isolates were found to be resistant to Penicillin and Novobiocin antibiotic plaques.

It was found that quinolone sensitivity was higher in strains that produced certain virulence factors, such as K99, eae, and necrotoxin, compared to strains that did not produce these factors (Orden et al. 1999). In another study, multidrug-resistant *E. coli* isolates were found to be less virulent compared to susceptible ones (Johnson et al. 2004). A definite relationship between antibiotic resistance and virulence has yet to be determined. Many studies also determined multi-resistance in *E. coli* isolated from healthy animals. This shows that microorganisms are resistant to antibiotics in humans with pathogenic strains and that more antibiotics may be exposed (Madoshi et al. 2016). The relationship between antibiotic resistance and virulence may vary depending on antibiotics and virulence factors, and more research is needed accordingly.

CONCLUSIONS

By using primers for the intimin-K99 virulence genes of *E. coli* isolates recovered from bovine mastitis and calf diarrhea, PCR testing was used to corroborate the study's findings. Later, due to antibiotic susceptibility tests, florfenicol was found to be quite sensitive. The studies examined show multi-antibiotic resistance in *E. coli* isolates from healthy and infected animals. Regarding public health, it is clear that antibiotic susceptibility tests are essential to reduce unessential antibiotic use and for accurate diagnosis. In addition, studies between antimicrobial agents and virulence factors need to be developed and done more.

REFERENCES

- Bandyopadhyay, S., Bhattacharyya, D., Samanta, I., Banerjee, J., Habib, M., Dutta, T., K. 2021. Characterization of multidrug-resistant biofilm-producing *Escherichia coli* and *Klebsiella pneumoniae* in healthy cattle and cattle with diarrhea. *Microb Drug Resist.* 27(11):1457–69.
- Bag, M.,A.,S., Khan, M.,S.,R., Sami, M.,D.,H., Begum, F., Islam, M.,S., Rahman, M.,M., Rahman, M.,T., Hassan, J. 2021. Virulence determinants and antimicrobial resistance of *E. coli* isolated from bovine clinical mastitis in some selected dairy farms of Bangladesh. *Saudi J Biol Sci.* 28(11):6317-6323.
- Dubreuil, J.,D., Isaacson, R.,E., Schifferli, D.,M. 2016. Animal Enterotoxigenic *Escherichia coli*. *EcoSal Plus.* 7(1):10.1128.
- Erganis, O., Ates, M., Corlu, M., Kaya, O., Istanbuluoglu, E. 1988. Ishalli buzağılardan izole edilen *E. coli* suşlarında K99 fimbria'nın varlığı üzerine bir çalışma. *Doğa Vet. Hay. Derg.* 12, 185–190.
- Güler, L., Gündüz, K. 2007. Virulence Properties of *Escherichia coli* Isolated from Clinical Bovine Mastitis. *Turkish Journal of Veterinary & Animal Sciences: Vol. 31: No. 5, Article 12.*
- Güler, L., Gündüz, K., Ok, U. 2008. Virulence factors and antimicrobial susceptibility of *Escherichia coli* isolated from calves in Turkey. *Zoonoses Public Health.* 55(5):249-57.
- Gomes, F. and Henriques, M. 2016. Control of bovine mastitis: Old and recent therapeutic approaches. *Curr. Microbiol.* 72(4): 377–382.
- Hasson, S.O., Judi, H.K., Salih, H.H., Al-Khaykan, A., Akrami, S., Sabahi, S., Saki, M., Al-Rubaie, Z.A. 2022. Intimin (eae) and virulence membrane protein pagC genes are associated with biofilm formation and multidrug resistance in *Escherichia coli* and *Salmonella enterica* isolates from calves with diarrhea. *BMC Res Notes.* 11;15(1):321

- Hetta, H.F., Al-Kadmy, I., Khazaal, S.S., Abbas, S., Suhail, A., El-Mokhtar, M.A. 2021. Antibiofilm and antivirulence potential of silver nanoparticles against multidrug-resistant *Acinetobacter baumannii*. *Sci Rep.* 11(1):10751.
- Kareem, S.M., Al-Kadmy, I.M., Kazaal, S.S., Ali, A.N., Aziz, S.N., Makhirita, R.R. 2021. Detection of *gyrA* and *parC* mutations and prevalence of plasmid-mediated quinolone resistance genes in *Klebsiella pneumoniae*. *Infect Drug Resist.* 14:555–63.
- Madoshi, B., P., Kudirkiene, E., Mtambo, M., M., A., Muhairwa, A., P., Lupindu, A., M., Olsen, J., E. 2016. Characterisation of Commensal *Escherichia coli* Isolated from Apparently Healthy Cattle and Their Attendants in Tanzania. *PLoS ONE* 11(12): e0168160.
- Mainil, J., G. and G. Daube, 2005. Verotoxigenic *Escherichia coli* from animals, humans and foods: who's who? *J. Appl. Microbiol.* 98, 1332–1344.
- Momtaz, H., Dehkordi, F., S., Rahimi, E., Asgarifar, A. 2013. Detection of *Escherichia coli*, *Salmonella* species, and *Vibrio cholerae* in tap water and bottled drinking water in Isfahan, Iran. *BMC Public Health.* 7;13:556.
- My, T.T., Thien, L.V., Manh, V.D., My, B.T.P., Lan, D.T.M., Binh, D.X., Duc, V.M. 2023. Antimicrobial resistance and molecular characterization of *Escherichia coli* isolated from bovine mastitis samples in Nghe An province, Vietnam. *Vet World.* 16(4):743-751.
- Orden, J., A., Ruiz-Santa-Quiteria, J., A., Garcia, S., Cid, D., de la Fuente, R. 1999. In vitro activities of cephalosporins and quinolones against *Escherichia coli* strains isolated from diarrheic dairy calves. *Antimicrob. Agents Chemother.* 43, 510–513.
- Patel, J.B., Cockerill, F., Bradford, P.A., Eliopoulos, G.M. 2015. Performance Standards for Antimicrobial Susceptibility Testing. 25th ed. Informational Supplement, Clinical and Laboratory Standards Institute, Wayne, PA.,
- Suleiman, J.M., Saed, O.-A.S., AL-Kubaisi, S., Hasan, M.S., Owain, M.S., Hussein, M.A. and Jarad, A.S. 2020. Molecular characterization of *Eae* and *Stx*. *Medico-legal update* 20.
- Stevens, M., Piepers, S. and De Vlieghe, S. 2016. Mastitis prevention and control practices and mastitis treatment strategies associated with the consumption of (critically important) antimicrobials on dairy herds in Flanders, Belgium. *J. Dairy Sci.*, 99(4): 2896–2903.
- Uysal, Y., Erdoğan, I., Tavukçuoğlu, F., Gökçen, S., Aslan, N., Türütoğlu, H., Ersoy, Yazıcıoğlu, N., Karagenç, E. 1992. Neonatal buzağı enfeksiyonlarından izole edilen *E. coli*'lerde K99, F41, F(Y) ve 987 P pilusları ile ısıya stabil enterotoksinin aranması ve serotiplendirme çalışmaları. *Pendik Vet. Mikrobiyol.* 23, 119–132.
- Werckenthin, C., Seidl, S., Riedl, J., Kiossis, E., Wolf, G., Stolla, R., Kaaden, O., R. 2002. *Escherichia coli* isolates from young calves in Bavaria: In vitro susceptibilities to 14 antimicrobial agents. *J. Vet. Med. B.* 49, 61–65.
- Zhao, X. and Lacasse, P. 2008. Mammary tissue damage during bovine mastitis: Causes and control. *J. Anim. Sci.*, 86: 57–65.

ANTIMICROBIAL ACTIVITY OF NEW CREAM FORMULATIONS: *Hylocereus polyrhizus* AQUEOUS EXTRACTS AND *Limosilactobacillus fermentum* MA-7

Irem CELIK^{1*}, Meltem ASAN-OZUSAGLAM¹

¹Aksaray University, Faculty of Science and Letters, Molecular Biology and Genetic Department, Aksaray, Turkey.

*Corresponding author e-mail: iremceelkk@gmail.com

ABSTRACT

Knowing the harmful side effects of chemical additives in commercial creams has increased the demand for herbal creams today. Our skin is constantly exposed to physical and chemical threats. *Hylocereus polyrhizus* is known as a tropical fruit with rich bioactive compounds that benefit in many areas. The topical application of probiotics can help protect the skin from a variety of infections. In our study, it was aimed to develop new cream formulations containing *H. polyrhizus* aqueous peel or fruit extracts and probiotic strain *Limosilactobacillus fermentum* MA-7 for topical applications and then to determine the biological activity of these cream formulations. For this purpose, *H. polyrhizus* peel and fruit obtained from Turkey were extracted by sonication method using aqueous solvent. The biological activity of the developed new cream formulations was determined against the test microorganisms by the well diffusion method. The results showed that the cream (control) group did not have a zone of inhibition against all the tested microorganisms. It was determined that the addition of *H. polyrhizus* aqueous extract and *L. fermentum* MA-7 to the cream group increased the antimicrobial activity. The highest inhibition zone diameter of the Cream-Extract-*L. fermentum* MA-7 (CEL) group containing peel extract was determined as 18.68 mm against *S. enteritidis* RSKK 171. The highest inhibition zone diameter of the CEL group containing fruit extract was determined as 17.01 mm against *E. coli* ATCC O157:H7. The results show that the cream formulation containing *H. polyrhizus* aqueous extracts and *L. fermentum* MA-7 can be used as a protective and therapeutic natural agent against some pathogens that cause contamination in our body.

Keywords: Red pitahaya, Cream formulation, Yeast, Bacteria, Pathogens

INTRODUCTION

Antimicrobial substances are synthetic or natural substances that stop the growth or kill unwanted harmful microorganisms (fungus, bacteria, and algae etc.) (Ordu et al., 2018; Ofokansi et al., 2013). Bioactive compounds obtained from plants inhibit the growth of pathogenic microorganisms by mechanisms different from antibiotics and have clinical value in the treatment of diseases resulting from antibiotic-resistant microorganisms (Shankar et al., 2010). Recently, *Hylocereus polyrhizus* is one of the tropical fruit species that has gained popularity and is produced in the Mediterranean Region in Turkey. The popularity of *H. polyrhizus*, which draws attention with its taste and color, is increasing in Turkey (Uğuz and Gezici, 2021; Attar et al., 2022). It is also rich in phyto-albumins, phenolics, betacyanins, and flavonoids, which are extremely valuable for antioxidant potential (Jaafar et al., 2009).

The skin, the largest organ in the human body, acts as a barrier against external factors, including physical, chemical, and bacterial threats (Lolou and Panayiotidis, 2019). Topical applications of probiotic bacteria have the potential to strengthen the skin's natural defense barriers. There is limited information on the efficacy of topically applied probiotics. The

supplements containing probiotics or prebiotics are known to have a positive effect on the skin (Al-Ghazzewi et al., 2014).

The cosmetic products contain organic and inorganic compounds that promote the growth of pathogenic microorganisms that may pose a danger to consumers. Therefore, natural antimicrobial agents are used to increase the durability and safety of cosmetics (Neza and Centini, 2016). Plants and microorganisms provide a wide range of active ingredients acceptable in the cosmetic industry, which can find different applications in the manufacture of cosmetics and personal care products. For example, it can be applied in areas such as the manufacture of creams, protection against UV rays and pollution, production of essence or alleviating the effects of skin aging. (Mahesh et al., 2019; Kentin and Kaarto, 2018; Henkler et al., 2012). The increase in demand for products with natural components in recent years has made consumers aware of the negative effects of using synthetic preservatives (Guzmán and Lucia, 2021).

The purpose of the present study is to investigate alternative uses of cream formulations containing *H. polyrhizus* extract and *Limosilactobacillus fermentum* MA-7 in the pharmaceutical and cosmetic industry.

MATERIAL AND METHOD

Preparation of *Hylocereus Polyrhizus* Peel and Fruit Aqueous Extracts

H. Polyrhizus was purchased in October 2021 from the production greenhouse in Antalya-Turkey. Each fruit supplied weighed ± 200 -300gr. After the samples were washed, their skins were removed from the fruit and dried at room temperature. The powdered samples were extracted separately with aqueous in 2 repetitions of 10 minutes every day (2 days) using a sonication (Hielscher). *H. Polyrhizus* peel and fruit extracts dissolved with Dimethyl sulfoxide (DMSO) were sterilized with sterile filters (0.22 μ m).

Microorganisms Suspensions

Candida albicans ATCC 10231 was cultured at 30°C for 24 hours in Yeast Peptone Dextrose (YPD). *Enterococcus faecalis* ATCC 29212 was cultured at 37°C for 24 hours in Tryptic Soy Broth (TSB). *Escherichia coli* O157:H7, and *Salmonella enteritidis* RSKK 171 were grown in Nutrient Broth (NB) for 24 hours.

Preparation of *Limosilactobacillus fermentum* MA-7 for cream formulation

Limosilactobacillus. fermentum MA-7 microorganism was cultured in Man, Rogosa and Sharpe (MRS) medium at 37°C for 18 hours. The optical density was adjusted to 1.6 at the end of the incubation. Then they were sonication on ice for 15 minutes to use the bacterial lysates.

Antibacterial or Antifungal Activity of Cream Formulation Containing *Hylocereus Polyrhizus* Aqueous Extract and *Limosilactobacillus fermentum* MA-7

The antibacterial or antifungal activity of the cream formulations was determined using the modified method used in our previous study (Asan-Ozusaglam and Celik, 2023). In the prepared antimicrobial cream formulation, a mercantile cream, *H. polyrhizus* peel or fruit aqueous extracts and *L. fermentum* MA-7 isolated from human milk were used. The antibacterial or antifungal activity of the prepared cream groups was determined against the microorganism strains using the well diffusion method. The experiment was performed in triplicate. The culture dishes were incubated under conditions suitable for the test microorganisms.

RESULTS AND DISCUSSION

The biological activity of the cream formulation containing *H. polyrhizus* peel extract is presented in Table 1. The probiotics (Lactic acid bacteria) capable of protecting the skin repair skin damage, UV radiation, prevent age-related skin manifestations, increase skin radiance, and

delay skin aging (Cinque et al., 2011; Htwe et al., 2019). Inhibition zone diameter against test microorganisms was not detected in the control group (C). Inhibition zone diameter was determined against all test microorganisms except *E. faecalis* ATCC 29212 in CE group. The highest Inhibition zone diameter was measured as 18.68 mm in the CEL group against *S. enteritidis* RSKK 171. The inhibition zone diameters of the CEL group against *C. albicans* ATCC 10231 and *E. coli* ATCC O157:H7 were determined as 15.72 mm and 15.66 mm. CEL group (2.17 mm) in *E. faecalis* ATCC 29212 was statistically significant compared to all test groups ($p<0.05$). It was determined that CEL group increased the antimicrobial activity of group C in all microorganisms ($p<0.05$).

Table 1. Antimicrobial activity of *H. polyrhizus* peel aqueous extract cream formulation groups.

Microorganism Strains	Inhibition zone diameter of peel extract (mm±SD)				
	Cream Formulation Groups				F(Sig)
	C	CE	CL	CEL	
<i>C. albicans</i> ATCC 10231	- ^a	4.78±0.43 ^b	6.76±0.60 ^c	15.72±0.60 ^d	562.572(0.000)
<i>E. faecalis</i> ATCC 29212	- ^a	- ^a	- ^a	2.17±0.43 ^b	75.001(0.000)
<i>E. coli</i> ATCC O157:H7	- ^a	3.36±0.45 ^b	6.40±0.24 ^c	15.66±0.42 ^d	1231.351(0.000)
<i>S. enteritidis</i> RSKK 171	- ^a	1.90±0.46 ^b	1.62±0.46 ^b	18.68±0.17 ^c	2042.613(0.000)

C: Cream, CE: Cream-Extracts, CL: Cream-*L. fermentum* MA-7, CEL: Cream-Extract-*L. fermentum* MA-7

The antimicrobial activity of the cream formulation containing *H. polyrhizus* fruit extract is presented in Table 2. The CE group was determined as 1.38 mm and 2.85 mm in *C. albicans* ATCC 10231 and *E. coli* ATCC O157:H. The highest inhibition zone diameter was detected in the CEL group (17.01 mm) against *E. coli* ATCC O157:H. Addition of fruit extract and *L. fermentum* MA-7 increased the antimicrobial activity of the control group. Except for *C. albicans* ATCC 10231, all CEL groups were statistically significant against other test groups ($p<0.05$).

Table 2. Antimicrobial activity of *H. polyrhizus* fruit aqueous extract cream formulation groups.

Microorganism Strains	Inhibition zone diameter of fruit extract (mm±SD)				
	Cream Formulation Groups				F(Sig)
	C	CE	CL	CEL	
<i>C. albicans</i> ATCC 10231	- ^a	1.38±0.44 ^b	6.76±0.60 ^c	6.93±0.08 ^c	271.204(0.000)
<i>E. faecalis</i> ATCC 29212	- ^a	- ^a	- ^a	2.60±0.23 ^b	373.792(0.000)
<i>E. coli</i> ATCC O157:H7	- ^a	2.85±0.42 ^b	6.40±0.24 ^c	17.01±0.58 ^d	1133.072(0.000)
<i>S. enteritidis</i> RSKK 171	- ^a	- ^a	1.62±0.46 ^b	6.98±0.52 ^c	271.844(0.000)

*C: Cream, CE: Cream-Extracts, CL: Cream-*L. fermentum* MA-7, CEL: Cream-Extract-*L. fermentum* MA-7

In our previous study, the biological activity of the cream formulation prepared with *H. undatus* fruit methanol extract and fermentum was determined against *C. albicans* ATCC 10231, *E. faecalis* ATCC 29212, *E. coli* ATCC O157:H7 and *S. enteritidis* RSKK 171 test microorganisms. As a result, it was determined that all CEL groups increased the antimicrobial activity of C groups (Celik and Asan-Ozusaglam, 2023). In a study, cream formulations prepared with *H. undatus* water extracts were used in the treatment of wounds developed in white mice. As a result, the potential of using the prepared cream formulation as an

antimicrobial agent in healing wounds was determined (Mahdi et al., 2018). As the studies with *H. polyrhizus* are limited, more literature studies are needed.

CONCLUSIONS

The antibacterial or antifungal activities of the cream formulation developed to evaluate the potential use of *H. polyrhizus* extracts in the pharmaceutical and cosmetic industry were investigated in vitro. The prepared cream formulations showed high antimicrobial activity against the test microorganisms. As a result, the use of *H. polyrhizus* aqueous extracts can be an alternative solution to the prevention of various skin problems by reducing the use of chemical-containing cosmetic products. The results of the study have the potential to contribute to future in vivo studies.

REFERENCES

- Al-Ghazzewi, F. H., & Tester, R. F. (2014). Impact of prebiotics and probiotics on skin health. *Beneficial microbes*, 5(2), 99-107.
- Asan-Ozusaglam M. & Celik I. 2023. White Pitahaya as a Natural Additive: Potential Usage in Cosmetic Industry, *Foods and Raw Materials*, 11(1), 57-63.
- Attar, Ş. H., Gündeşli, M. A., Urün, I., Kafkas, S., Kafkas, N. E., Ercisli, S., Ge, C., Mlcek, J. and Adamkova, A., 2022. Nutritional analysis of red-purple and white-fleshed pitaya (*Hylocereus*) species, *Molecules*, 27, 3, 808-828.
- Celik, I. & Asan-ozusaglam, M. (2023). Investigation of Antimicrobial and Photoprotective Activity of *Hylocereus undatus* Methanol Extracts. *Eurasian Journal of Food Science and Technology*. 7 (1), 12-22.
- Cinque B, La Torre C, Melchiorre E, Marchesani G, Zoccali G, Palumbo P, Di Marzio L, Masci A, Mosca L, Mastromarino P, Giuliani M, Cifone MG (2011) Use of probiotics for dermal applications. In: Liang MT (ed.) *Probiotics: Biology, Genetics and Health Aspects*, Berlin, Heidelberg, pp. 221–241.
- Guzmán, E., & Lucia, A. (2021). Essential oils and their individual components in cosmetic products. *Cosmetics*, 8(4), 114.
- Henkler, F., Tralau, T., Tentschert, J., Kneuer, C., Haase, A., Platzek, T., ... & Götz, M. E. (2012). Risk assessment of nanomaterials in cosmetics: a European union perspective. *Archives of toxicology*, 86, 1641-1646.
- Htwe, M. M., Teanpaisan, R., Khongkow, P., & Amnuaikit, T. (2019). Liposomes of probiotic's lyophilized cell free supernatant; a potential cosmeceutical product. *Die Pharmazie-An International Journal of Pharmaceutical Sciences*, 74(8), 462-466.
- Jaafar, A. R., Abdul Rahm, A. R. B., Che Mahmud, N. Z. and Vasudevan, R., 2009. Proximate Analysis of Dragon Fruit (*Hylocereus polyrhizus*), *American Journal of Applied Sciences*, 6,7, 1341-1346.
- Kentin, E., & Kaarto, H. (2018). An EU ban on microplastics in cosmetic products and the right to regulate. *Review of European, Comparative & International Environmental Law*, 27(3), 254-266.
- Lolou, V., & Panayiotidis, M. I. (2019). Functional role of probiotics and prebiotics on skin health and disease. *Fermentation*, 5(2), 41.
- Mahdi, M. A., Mohammed, M. T., Jassim, A. M. N., & Mohammed, A. I. (2018). Phytochemical content and anti-oxidant activity of *hylocereus undatus* and study of toxicity and the ability of wound treatment. *Plant Archives*, 18(2), 2672-2680.

Mahesh, S. K., Fathima, J., & Veena, V. G. (2019). Cosmetic potential of natural products: industrial applications. Natural bio-active compounds: volume 2: chemistry, pharmacology and health care practices, 215-250.

Metin, U. Ğ. U. Z., & GEZİCİ, A. (2021). Ejder meyvesinin ozmotik dehidrasyonu ve kuruma özelliklerinin deęerlendirilmesi. Osmaniye Korkut Ata Üniversitesi Fen Bilimleri Enstitüsü Dergisi, 4(2), 149-157.

Neza, E., & Centini, M. (2016). Microbiologically contaminated and over-preserved cosmetic products according Rapex 2008–2014. Cosmetics, 3(1), 3.

Ofokansi, K. C., Attama, A. A., Uzor, P. F., & Ovri, M. O. (2013). Evaluation of the combined antimicrobial activity of the leaf extract of *Phyllanthus muellerianus* with ciprofloxacin. J Pharm Technol Drug Res, 2(1), 16.

Ordu, J. I., Sunday, B. R., & Okafo, S. E. (2018). Evaluation of the activity of *Garcinia kola* seed oil and honey on skin cream formulation. The Pharma Innovation, 7(5, Part J), 675.

Shankar, S. R., Rangarajan, R., Sarada, D. V. L. ve Kumar, C. S., 2010. Evaluation of antibacterial activity and phytochemical screening of *wrightia tinctoria* L, Pharmacognosy Journal, 2, 14, 19-22.

APPLICATION OF LIPOSOMAL ENCAPSULATED ANTIMICROBIAL BIOACTIVE COMPONENTS IN FOOD PRODUCTS AS NATURAL PRESERVATION

Mine ASLAN¹, Nilgün ERTAŞ¹

¹ Department of Food Engineering, Engineering Faculty, Necmettin Erbakan University, Koyceğiz Campus, Konya, 42050, Turkey.

Corresponding author e-mail: mineaslan_90@hotmail.com

ABSTRACT

Encapsulation technology is needed to make more durable and effective of alternative natural preservatives and nutritional components. In recent years, liposomal structures have attracted attention and liposomes ensure the preservation of the encapsulated material until the appropriate place and time thanks to controlled or delayed release capability. Liposomal structures prevent the conversion into harmful components during storage and increase the bioavailability. The liposomal encapsulation process provides to be more stable and more durable bioactive compounds in the food and the digestive system. The slowly release of antimicrobial components during storage against microbiological contaminations can be realized without allowing mold contamination and mycelium formation in food products. In addition, which will be carried out on non-chemical "hurdle" technologies in order to control the development of food-borne microorganisms and increase antioxidant activity in order to respond to consumer expectations, aims to produce product formulations suitable for the concept of 'Clean Label'. In addition, in order to respond to consumer expectations, it is possible to control the development of food-borne microorganisms and to produce product formulations in accordance with the concept of 'Clean Label' with liposomal systems suitable for "hurdle" technologies without chemical content.

Keywords: Liposom, natural preservation, bioactive compounds, Clean Label

INTRODUCTION

Bioactive components have important antioxidant and antimicrobial effects and also effective on human health. Encapsulation procedures have implemented to increase the mechanism of bioactive components' action. Liposome encapsulation is an important application thanks to provide the development of controlled release of bioactive components in food and increased stability. One of the biggest advantages of liposomes is to made from natural components. Liposomes can be included in food formulations without the need for any legal regulation due to natural structure. Liposomes are no usage limit compared to chemical origin substances, and so excessive limits lead to no health problems. This feature removes the obstacles to the use of liposome structures in foods.

Liposomes are used to improve the water dispersibility of hydrophobic components, to increase bioavailability and to protect the encapsulated components from adverse conditions such as light, heat, pH, oxidation, hydrolysis or chemical reactions, to enable the delivery of an encapsulated agent to a specific location, to reduce negative effects and particle toxicity. Liposome systems provide to control the circulation in the body by modulation of their size and regulating the release profiles with surface modifications of the bioactive components (Alavi et al., 2017; Lila and Ishida, 2017). Unlike other encapsulation methods, liposomal structures have no negative effect on product rheology properties thanks to very low phosphorylcholine-based

lecithin concentration. In addition, the encapsulated components are more resistant to processes such as cooking and pasteurization with the controlled release of bioactive substances in the liposomal structure.

ENCAPSULATION TECHNIQUES

Encapsulation is an excellent method for the preservation of bioactive, volatile and readily degradable compounds and additives in food applications. The purpose of encapsulation is to protect active ingredient from external factors, to ensure stable in the digestive system and to release slowly, to increase bioavailability, to mask the negative taste and odor, and to prevent the active ingredient from reacting with other ingredients (Delshadi et al., 2020). In the encapsulation process consists of the active components as the core material and the appropriate wall material. The coating agent plays a key role and an ideal coating material should have low hygroscopicity, high solubility, low viscosity, low cost, ability to produce a stable emulsion and provide high protection (Gomez et al., 2018). Lipids, proteins and carbohydrates are widely used as coating material in encapsulation systems. The coating materials are desirable to be inexpensive, plentiful, non-toxic, and compatible with the food matrix (Jafari et al., 2008; Delshadi et al., 2020).

Lipid-based coating agents have excellent functionality in emulsification, film formation and encapsulation of active compounds. These coating materials are less toxic and have many potential uses in industrial applications (Fathi et al., 2012). The lipid-based coating materials are polar lipids (eg monoglycerides, phospholipids) and non-polar lipids (eg triacylglycerol, cholesterol) (Đorđević et al., 2016). Polar lipids such as phospholipids have some properties as biocompatible, suitable for stabilization, preservation and controlled release of active compounds and good surfactants (Đorđević et al., 2016; Shishir et al., 2018). Encapsulation contains microcapsules, submicron capsules, and nanocapsules sizes. Micro and nano encapsulation techniques include high pressure homogenization (HPH), micro fluidization, ultrasonic technique, spray drying, spray cooling/cooling, freeze drying, spray freeze drying, complex coacervation, emulsification (spontaneous, phase inversion, miscellaneous), anti-solvent precipitation, extrusion, electro-spinning and electro-spraying, layer deposition, solid dispersion, fluid bed coating, molecular inclusion in cyclodextrins. Different forms of micro and nano encapsulation systems are reservoir and matrix, emulsions (multilayer emulsions, nano emulsions), lipid nanoparticles (solid lipid nanoparticles (SLNs), nanostructured lipid carriers (NLCs), lipid vesicular carriers (liposomes, niosomes, phytosomes, bilosomes), hydrogel particles, molecular inclusion complexes, nanofibers, nanotubes, micelles.

LIPOSOMAL ENCAPSULATION

LIPOSOMES

Liposomes are basically amphipathic vesicles in phospholipid structure, similar in structure to the cell membrane, with polar and nonpolar heads and double lipid layer structure. Liposomes are versatile, biocompatible and biodegradable structures that can be used as carrier systems for unstable components due to their amphipathic properties (Subramani and Ganapathyswamy, 2020). Liposomes were first described in 1965 by Bangham et al. (1965) are small intracellular shaped structures consisting of a closed membrane storing or transporting lipid-based substances. Phospholipids are one of the main groups providing liposome formation. Phospholipids are mainly composed of three-carbon alcohol, glycerol or sphingosine. Common alcohol components of glycerol-derived phospholipids are called phosphatidylserine (PS), phosphatidylcholine (PC), phosphatidylethanolamine (PE),

phosphatidylglycerol (PG), and phosphatidylinositol (PI). Phospholipids are formed by esterification of the primary hydroxyl group of glycerol with phosphoric acid. The remaining two hydroxyl groups of the glycerol backbone are esterified to fatty acids (saturated or unsaturated) and form the nonpolar tails of the lipid (Segota and Tezak, 2006). Liposomes consist of two layers of molecules with nonpolar groups. In the liposomal structure, polar head groups are directed outward, while non-polar parts are directed inward. Hydrophobic interactions and Vander Walls bonds that hold long hydrocarbon tails together play an important role in bilayer formation (Bozzuto and Molinari, 2015).

Liposomes are divided into different categories based on their structural properties and composition. Liposomes differ from each other in size and physical morphology, depending on lipid composition and preparation method, and may consist of one or more lipid bilayers. The phospholipid type influences the dimensions and physicochemical properties of the liposomes (Singh et al., 2012). Liposomes according to the composition and mechanism of intracellular delivery as follows: pH sensitive liposomes, conventional liposomes immuno-liposomes, cationic liposomes and long-circulating liposomes (Sharma and Sharma, 1997). Generally, the size change from 20 nm to 5000 nm and consist of one or more lipid bilayers. Liposomes according to lipid composition; preparation method and diameter as follows: multilamellar vesicles-MLV (>500 nm), small unilamellar vesicles-SUV (<50 nm), large unilamellar vesicles-LUV (100-1000 nm), giant unilamellar vesicles-GUV (>1000 nm), Multiple vesicles-MLV (>5000 nm), Oligomellar vesicles-OLV (100–1000 nm) and intermediate unilamellar vesicles-IUV (40-100 nm) (Lasic, 1998; Storm and Crommelin, 1998).

LIPOSOME PRODUCTION METHODS

Bangham method (thin film hydration method); One of the simplest methods for liposome formation in multilamellar vesicles is the thin-film hydration procedure. Thin-film hydration method is the most widely used technique to prepare liposomes (Bangham et al., 1965). The thin-film hydration method consists of sequentially dissolving phospholipids in an organic solvent (mostly chloroform), evaporating the solvent to form a thin film, and then dispersing the dry lipid film in an aqueous phase. In this method, sonication is used to reduce the size of large-sized liposomes (Maja et al., 2020). Apart from this, the methods applied are as follows, solvent (ether or ethanol) injection method, reverse phase evaporation (REV), dialysis, extrusion, spray drying, heating, freeze drying, cross flow injection, microfluidization, membrane contactor, supercritical reverse phase evaporation (SCRPE), improved SCRPE method (ISCRPE), supercritical antisolvent (SAS), depressurization of an expanded liquid organic solution-suspension (DELOS) and ultrasonication method. Each of these methods has different advantages and disadvantages.

LIPOSOMAL ENCAPSULATION METHOD PROPERTIES

Liposomes are preferred in the encapsulation process thanks to biocompatible, biodegradable, no show toxic effects, and high ratio protect of coated material (Laye et al., 2008; Gibis et al., 2012; Chun et al., 2013). One of the most important features of liposomes is that can be obtained from nature components. The natural structure of liposomes enables the usage in food systems without the need for any legal regulation (Taylor et al., 2005). In food science, the liposomal encapsulation method is used to encapsulate antioxidant components, antimicrobial components, enzymes and additives. The liposomal system is used in the encapsulation of many bioactive components, including fatty acids such as gambogenic acid (Tang et al., 2018), resveratrol (Caddeo et al., 2008), tea catechins (Zou et al., 2014) and linolenic acid (Vélez et al., 2019), omega-3 and protein hydrolysates (Li et al., 2015).

Liposomal encapsulation offers a versatile approach in terms of preservation and controlled release of sensitive bioactive ingredients, delaying food spoilage, protecting bioactive ingredients from degradation after consumption, and increasing the bioavailability of ingredients during adsorption (Liu et al., 2020).

Liposome structures improve the solubility of lipophilic compounds in aqueous solutions or hydrophilic compounds in hydrophobic systems. Thanks to high dispersion in water, liposomes can be used to produce low-calorie and fat-reduced products. In addition, liposomes have an important effect in preventing oxidation, removing negative flavors and reducing the energy density of food products (Farrokh et al., 2017). The structural similarity to the cell membrane provides distribution and release some bioactive components to specific areas in the body (Gabizon et al., 2004; Laye et al., 2008). This unique structure allows liposomal nanoparticles to enter the intercellular space in the body. Liposomes have no adverse effects on health and also many health benefits such as liver protection, memory enhancement and inhibition of cholesterol absorption is revealed in studies.

STUDIES ON LIPOSOMAL ENCAPSULATED INGREDIENTS IN FOOD PRODUCTS AS ANTIMICROBIAL AGENTS

The antibacterial activities of clove oil and liposome-encapsulated clove oil were investigated by Cui et al. (2015) and stated that liposome-encapsulated clove oil can be use efficiently as an antimicrobial agent for *S. aureus* in tofu. In a study by Pinilla and Brandelli (2016) determined the antimicrobial activity efficiency of liposome lysine and garlic extract encapsulated with phosphatidylcholine. Nanoliposome-encapsulated nisin-GE has potential as an antimicrobial formulation for food use. According to results, the use of natural antimicrobial nanoliposomes in dairy products is an important alternative way to improve food quality and shelf life. Lopes et al. (2017) carried out the encapsulation of nisin by nanoliposomes obtained using soybean phosphatidylcholine (PC), pectin or polygalacturonic acid. Antimicrobial activities of liposomes were observed against five different strains of *Listeria*, and showed the highest activity against *L. innocua*. In-vitro release studies have indicated that the nisin release rate of PC-pectin and PC-polygalacturonic acid liposomes is lower than that of PC liposomes.

Ghorbanzade et al. (2017) stated that fish oil has important benefits in the daily diet, but applications in food formulations are limited due to strong odor and rapid deterioration. So, fish oil encapsulated with nano-liposomal process and usage in the yogurt formulation. It has been stated that nano-liposome fish oil capsules provide a significant reduction in acidity, syneresis and peroxide values of yogurt. In terms of sensory properties, the addition of nano-encapsulated fish oil in yogurt shows similar properties with the control sample enriched with free fish oil. Pabast et al. (2018) investigated the effects of lamb meat in capsules containing free or chitosan-nano-liposomal encapsulated *Satureja khuzestanica* essential oil on chemical, microbial and sensory properties of lamb at 4°C for 20 days. As a result of the study, the chitosan-liposome encapsulated essential oil of *Satureja khuzestanica* could be a promising active packaging material to extend the shelf life of lamb. Lopes et al. (2019), lysozyme and nisin were liposomal encapsulated with phosphatidylcholine (PC) and pectin or polygalacturonic acid. The co-encapsulation of lysozyme and nisin with liposome has a synergistic antimicrobial effect on *L. monocytogenes* and *S. enteritidis*, but provides greater inhibition against *L. monocytogenes*. The PC-pectin liposomes used in full-fat and skim milk medium reduced the *L. monocytogenes* population by 2 log cfu/ml in whole milk and 5 log cfu/ml in skim milk at 37°C. The *L. monocytogenes* population remained below the detection limit in milk stored for 25 days under refrigeration temperature. This shows that liposomes can be a promising technology to provide controlled release and stability in complex food systems.

Pinilla et al. (2019) used garlic extract encapsulated with liposome process with phosphatidylcholine and oleic acid as an antifungal agent in bread formulation. They reported that bread samples containing encapsulated garlic extract and free garlic extract (0.65ml/100g dough) were more microbiologically stable and showed mold inhibition for five days compared to control samples. As a result of the study oleic acid and liposomal garlic extract can be used as natural antifungal agents to improve the microbiological stability of cooked food products due to their thermal properties. In a study made by Lin et al. (2022), a bio-responsive composite liposome with silk fibroin, L-fucose and *Litsea cubeba* essential oil were designed for chicken preservation as antibacterial agent and as results indicated that 20% (v/v) of the composite liposomes could inactivate 99% *Campylobacter jejuni* (C. jejuni).

CONCLUSION

Food safety is an important issue for people in the food production process and consumption. In this respect, food production is faced with many technological challenges due to the increasing demand for naturally additive foods. The natural preservative components are significantly affected by environmental conditions and therefore components must be protected by encapsulation. In the food industry, liposomes have been investigated to deliver proteins, enzymes, vitamins, antioxidants and flavors. Many studies indicate that the efficacy of antimicrobial components is increased with liposome encapsulation. The great advantage of liposomes over other encapsulation technologies is their high stability. As a result, it has been demonstrated that there is a significant potential for use of liposome-encapsulated antimicrobials to improve the quality and healthiness of a wide variety of food products.

ACKNOWLEDGEMENT

This research was part of the Ph.D. thesis of Mine ASLAN.

REFERENCES

- Alavi, M., Karimi, N., Safaei, M., 2017. Application of various types of liposomes in drug delivery systems. *Advanced Pharmaceutical Bulletin*. 7(1): 3.
- Bangham, A. D., Standish, M. M., Watkins, J. C., 1965. Diffusion of univalent ions across the lamellae of swollen phospholipids. *Journal of Molecular Biology*. 13: 238-252.
- Bozzuto, G., Molinari, A., 2015. Liposomes as nanomedical devices. *International Journal of Nanomedicine*. 10: 975-999.
- Caddeo, C., Teskač, K., Sinico, C., Kristl, J., 2008. Effect of resveratrol incorporated in liposomes on proliferation and UV-B protection of cells. *International Journal of Pharmaceutics*. 363(1-2): 183-191.
- Chun, J. Y., Choi, M. J., Min, S. G., Weiss, J., 2013. Formation and stability of multiple-layered liposomes by layer-by-layer electrostatic deposition of biopolymers. *Food Hydrocolloids*. 30(1): 249-257.
- Cui, H., Zhao, C., Lin, L. 2015. The specific antibacterial activity of liposome-encapsulated Clove oil and its application in tofu. *Food Control*. 56: 128-134.
- Delshadi, R., Bahrami, A., Tafti, A. G., Barba, F. J., Williams, L. L. 2020. Micro and nano-encapsulation of vegetable and essential oils to develop functional food products with improved nutritional profiles. *Trends in Food Science & Technology* 104: 72-83.
- Đorđević, V., Balanč, B., Belščak-Cvitanović, A., Lević, S., Trifković, K., Kalušević, A., Kostić, I., Komes, D., Bugarski, B., Nedović, V., 2015. Trends in encapsulation

- technologies for delivery of food bioactive compounds. *Food Engineering Reviews*. 7(4): 452-490.
- Farrokh, S., Alireze, A., Syed, R., 2017. Generation and characterization of liposomal microcapsules for co-delivery of hydrophilic and lipophilic bioactives in food. *Ag Data Commons*, U.S. Public Domain, New York.
- Fathi, M., Mozafari, M. R., Mohebbi, M., 2012. Nanoencapsulation of food ingredients using lipid based delivery systems. *Trends in Food Science & Technology*. 23: 13-27.
- Gabizon, A., Shmeeda, H., Horowitz, A. T., Zalipsky, S., 2004. Tumor cell targeting of liposome-entrapped drugs with phospholipid-anchored folic acid-PEG conjugates. *Advanced Drug Delivery Reviews*. 56(8): 1177-1192.
- Ghorbanzade, T., Jafari, S. M., Akhavan, S., Hadavi, R., 2017. Nano-encapsulation of fish oil in nano-liposomes and its application in fortification of yogurt. *Food Chemistry*. 216: 146-152.
- Gibis, M., Vogt, E., Weiss, J., 2012. Encapsulation of polyphenolic grape seed extract in polymer-coated liposomes. *Food & Function*. 3(3): 246-254.
- Jafari, S. M., Assadpoor, E., He, Y., Bhandari, B., 2008. Encapsulation efficiency of food flavours and oils during spray drying. *Drying Technology*. 26(7): 816-835.
- Lasic, D. D., 1998. Novel applications of liposomes. *Trends in biotechnology*. 16(7): 307-321.
- Laye, C., McClements, D. J., Weiss, J., 2008. Formation of biopolymer-coated liposomes by electrostatic deposition of chitosan. *Journal of Food Science*. 73(5): 7-15.
- Li, Z., Paulson, A. T., Gill, T. A., 2015. Encapsulation of bioactive salmon protein hydrolysates with chitosan-coated liposomes. *Journal of Functional Foods*. 19: 733-743.
- Lila, A. S. A., Ishida, T., 2017. Liposomal delivery systems: design optimization and current applications. *Biological and Pharmaceutical Bulletin*. 40(1): 1-10.
- Lin, L., Mei, C., Chen, X., Li, C., Hua, Z., Cui, H. (2022). Bio-responsive composite liposomes against *Campylobacter jejuni* in vitro and its application in chicken preservation. *Innovative Food Science & Emerging Technologies*. 103122.
- Liu, W., Hou, Y., Jin, Y., Wang, Y., Xu, X., Han, J., 2020. Research progress on liposomes: Application in food, digestion behavior and absorption mechanism. *Trends in Food Science & Technology*. 104: 177-189.
- Lopes, N. A., Pinilla, C. M. B., Brandelli, A., 2017. Pectin and polygalacturonic acid-coated liposomes as novel delivery system for nisin: preparation, characterization and release behavior. *Food Hydrocolloids*. 70, 1-7.
- Lopes, N. A., Pinilla, C. M. B., Brandelli, A., 2019. Antimicrobial activity of lysozyme-nisin co-encapsulated in liposomes coated with polysaccharides. *Food Hydrocolloids*. 93: 1-9.
- Maja, L., Željko, K., Mateja, P., 2020. Sustainable technologies for liposome preparation. *The Journal of Supercritical Fluids*. 165: 104984.
- Pabast, M., Shariatifar, N., Beikzadeh, S., Jahed, G., 2018. Effects of chitosan coatings incorporating with free or nano-encapsulated Satureja plant essential oil on quality characteristics of lamb meat. *Food Control*. 91: 185-192.
- Pinilla, C. M. B., Thys, R. C. S., Brandelli, A., 2019. Antifungal properties of phosphatidylcholine-oleic acid liposomes encapsulating garlic against environmental fungal in wheat bread. *International Journal of Food Microbiology*. 293: 72-78.
- Pinilla, C. M. B., Thys, R. C. S., and Brandelli, A., 2019. Antifungal properties of phosphatidylcholine-oleic acid liposomes encapsulating garlic against environmental fungal in wheat bread. *International Journal of Food Microbiology*. 293: 72-78.
- Segota, S., Tezak D., 2006. Spontaneous formation of vesicles. *Advances in Colloid and Interface Science*. 121: 51-75.
- Sharma, A., Sharma, U. S., 1997. Liposomes in drug delivery: progress and limitations. *International Journal of Pharmaceutics*. 154(2): 123-140.

- Shishir, M. R. I., Xie, L., Sun, C., Zheng, X., Chen, W., 2018. Advances in micro and nano-encapsulation of bioactive compounds using biopolymer and lipid-based transporters. *Trends in Food Science & Technology*. 78: 34-60.
- Singh, H., Thompson, A., Liu, W., Corredig, M., 2012. Liposomes as food ingredients and nutraceutical delivery systems. In *Encapsulation technologies and delivery systems for food ingredients and nutraceuticals*, Woodhead Publishing. 287-318.
- Storm, G., Crommelin, D. J., 1998. Liposomes: quo vadis?. *Pharmaceutical Science & Technology Today*. 1(1): 19-31.
- Subramani, T., Ganapathyswamy, H., 2020. An overview of liposomal nano-encapsulation techniques and its applications in food and nutraceutical. *Journal of Food Science and Technology*. 57(10): 3545-3555.
- Tang, X., Sun, J., Ge, T., Zhang, K., Gui, Q., Zhang, S., Chen, W., 2018. PEGylated liposomes as delivery systems for Gambogic acid: characterization and in-vitro/in-vivo evaluation. *Colloids and surfaces B: biointerfaces*. 172: 26-36.
- Taylor, T. M., Davidson, P. M., Bruce, B. D., Weiss, J., 2005. Liposomal nanocapsules in food science and agriculture. *Critical Reviews in Food Science and Nutrition*. 45(7-8): 587-605.
- Vélez, M. A., Perotti, M. C., Hynes, E. R., Gennaro, A. M., 2019. Effect of lyophilization on food grade liposomes loaded with conjugated linoleic acid. *Journal of Food Engineering*. 240: 199-206.
- Zou, L. Q., Liu, W., Liu, W. L., Liang, R. H., Li, T., Liu, C. M., Liu, Z., 2014. Characterization and bioavailability of tea polyphenol nanoliposome prepared by combining an ethanol injection method with dynamic high-pressure microfluidization. *Journal of Agricultural and Food Chemistry*. 62(4): 934-941.

IMPACT OF HESPERIDIN AGAINST GENOTOXIC RISKS CAUSED BY SODIUM FLUORIDE IN MICE LEYDIG

Gülşah ARMUT¹, İlayda FAKIOĞLU¹, Yasemin AYDIN¹, Banu ORTA YILMAZ^{1}*

¹ *Istanbul University, Science Faculty, Department of Biology, Istanbul, Turkey*

**Corresponding author e-mail: banu.yilmaz@istanbul.edu.tr*

ABSTRACT

Fluorine is an element with high electronegativity that we encounter in many areas of our daily lives. The element fluorine is found naturally in the air, soil, water, and food. In addition, fluorine is added to toothpastes, mouthwashes, and drinking water to reduce the incidence of dental damage. Although fluorine is among the trace elements necessary for human metabolism, its toxic effects have been determined when exposed to high amounts. The gastrointestinal, endocrine, musculoskeletal, and neurological systems are impacted by excessive fluorine exposure, according to research conducted on both humans and animals. There is also evidence to suggest that fluorine toxicity causes oxidative stress in cells, followed by DNA damage and apoptosis. In recent years, it has been understood that fluorine has toxic effects on the male reproductive system. Fluorine has been found to lower testosterone levels and cause spermatocyte differentiation. For this reason, it is of great importance to evaluate the risk and toxicity of fluorine. The protective effect of hesperidin, a subclass of flavonoid, against the genotoxic potential of sodium fluoride (the most common inorganic form of fluorine) was investigated for the first time in Leydig cells, which are the main cells of the male reproductive system. In this study, sodium fluoride (10 ppm) and hesperidin (20 µM) were applied separately and together for 24 hours to the TM3 Leydig cell line. The genotoxic potential of sodium fluoride was investigated by cell viability, micronucleus, and comet tests in the TM3 Leydig cell. The results indicate that sodium fluoride causes DNA damage by increasing the incidence of micronuclei and comet in Leydig cells. In addition, it has been determined that hesperidin, which has proven natural antioxidant properties, may play a protective role in sodium fluoride-induced genotoxicity.

Keywords: Sodium fluoride, Leydig cells, Hesperidin, Genotoxicity, DNA damage.

INTRODUCTION

Fluorine can be ingested through food, the air, and fluoride-containing dental products, but the main way that fluoride enters the body is through naturally occurring or fluoridated water (WHO, 1994). Fluorine is a highly electronegative element that naturally occurs in salt, which is a compound of sodium, aluminum, and calcium. Fluorine-containing substances are frequently exposed to by both humans and animals. The World Health Organization has determined that the daily exposure dose to fluorine is between 0.7 and 1.2 ppm (Wei et al., 2018). Fresh water sources typically contain 0.01-0.3 ppm fluorine, while sea water includes 1.2–1.5 ppm fluorine. Fluorine can be detected most frequently in black tea (3 ppm), shellfish (2-3 ppm), wine (1-2 ppm), and green tea (2-3 ppm). Fluorine exposure has also increased as a result of the widespread use of fluorine in industry, healthcare, and dentistry (Zhang et al., 2016).

Sodium fluoride (NaF), the most common form of fluorine found in water and food, causes toxic effects when administered in high doses. Studies with different animal models have shown that NaF has harmful effects on the kidneys, lungs, spleen, testis, ovary, brain, and blood (Radovanovic et al., 2021). When studies with most animal models were examined, it was observed that fluoride toxicity also showed toxic effects on the male reproductive system. NaF

can inhibit spermatogenesis and cause spermatocyte differentiation since it can pass the blood-testis barrier (Zhang et al., 2016). NaF is also involved in capacitation, apoptosis, hyperactivation, and chemotaxis in male reproductive cells (Zhang et al., 2017). Additionally, excessive fluorine in the body suppresses zinc levels in the testes and reproductive system, which lowers testosterone levels (Long et al., 2009).

Oxidative stress occurs as a result of an imbalance between free radicals and antioxidants in the cell and causes damage to proteins, lipids, DNA, and other molecules. Living organisms require endogenous antioxidant sources (such as superoxide dismutase, catalase, and glutathione peroxidase) as well as exogenous antioxidants to reduce the effects of oxidative damage (Al-Rikabi et al., 2020). Hesperidin (Hes), known for its exogenous antioxidant effects, is an easily available flavonoid derived from citrus fruits such as oranges, grapefruits, tangerines, limes, and lemons (Pyrzynska, 2022). Hes acts as an antioxidant and has free hydroxyl groups that donate electrons to free radicals. *In vitro* and *in vivo* studies have shown that Hes has antioxidant, anticancer, antimicrobial, anti-inflammatory, and anticarcinogenic activities (Pyrzynska, 2022). In addition, the protective effects of Hes on genotoxicity and cytotoxicity have been confirmed by studies on mice (Shokrzadeh et al., 2015).

Leydig cells were used in this study as a model to clarify the male reproductive system toxicity of NaF, one of the most frequently occurring fluorine compounds in nature. By using comet and micronucleus assays, the genotoxicity of Leydig cells, which are crucial to the male reproductive system and are in charge of testosterone biosynthesis, was examined. Furthermore, the first study in Leydig cells focused on the potential of Hes to protect against NaF-induced genotoxicity.

MATERIALS AND METHODS

Cell culture

The Leydig cells used in the present study were delivered to our laboratory from the Global Bioresource Center of the American Type Culture Collection (ATCC). Cells are cultured in DMEM/F12 culture media with 5% horse serum and 2.5% fetal bovine serum. In our study, NaF and Hes were applied separately and together to the TM3 Leydig cell line. The 10 ppm concentration of NaF, which reduces cell viability to 76%, and the 20 μ M concentration of Hes, which shows antioxidant properties in the literature, were chosen for use in the experiments.

Assessment of cell viability

The effects of NaF and/or Hes treatment to TM3 Leydig cells were evaluated using the 3-(4,5-dimethylthiazol-2-yl)-diphenyl tetrazolium bromide (MTT) test to assess changes in cell viability. Cells were seeded at 5×10^3 cells per 96-well culture dish and incubated for 24 hours in a 37°C CO₂ incubator after being treated with NaF and/or Hes. At the end of the exposure, the kit protocol was applied. The optical densities of the cells were measured with an ELISA device at a wavelength of 540 nm. The viability of the control cells was accepted as 100%, and the viability rates of the experimental cells were calculated relative to the control and expressed as a percentage.

Cytokinesis-Blocked Micronucleus (CBMN) Assay

The method of Fenech (2007) was used in the micronucleus test used to demonstrate genotoxic damage. Micronuclei are formations that occur during the mitosis division of the cell and are not included in the main nucleus, which are indicative of genomic damage. The principle of the test is based on the number of micronuclei in binucleate cells that have completed nuclear division but failed to perform cytoplasmic division by administration of cytochalasin-B. An increased number of micronuclei is associated with genotoxic damage.

TM3 Leydig cells were seeded as 5×10^5 cells in six-well cell culture dishes for both control and experimental groups, and $150 \mu\text{M H}_2\text{O}_2$ was used as a positive control. After the 24 h exposure, cytochalasin-B was applied for 20 h. Following the treatment, the cell pellets were incubated in a potassium chloride hypotonic solution for five min. The cell suspensions were centrifuged after being treated with Cornay fixative (one-unit glacial acetic acid, three-units methanol). The supernatant was removed, the pellet was treated with Cornay fixative again, and the produced cell suspensions were dispersed on the slide. The prepared slides were dyed with a giemsa solution and dried outside. Micronucleus, bud, and cytoplasmic bridge parameters were assessed in at least 1000 cells with mononuclei and binuclei for each group under the microscope. A total of 500 cells with mononuclei, binuclei, trinuclei, and tetranuclei were counted.

Cytokinesis blocked proliferation index (CBPI) was calculated according to the equation given below.

$$CBPI = \frac{(MonoNc) + (2xBiNc) + (3*MultiNc)}{\text{Total Number of cells}}$$

“MonoNc” used in the equation represents mononucleated cell, “BiNc” binucleated cell, and “MultiNc” multinucleated (trinucleated and tetranucleated) cell.

Replicative Index (RI), a measure of cell division kinetics, was calculated according to the equation given below by counting at least 500 cells with one, two or more nuclei.

$$RI = \frac{(((1xBiNc) + (2xMultiNc)) + (Total No. of cells))_{test}}{(((1xBiNc) + (2xMultiNc)) + (Total No. of cells))_{control}} \times 100$$

The percentage of cytostasis (%cytostasis), which provides information about cell kinetics, was calculated according to the equation given below.

$$\% \text{ cytostasis} = 100 - 100 \times \frac{(CBPI_{test} - 1)}{(CBPI_{control} - 1)}$$

In addition, the nuclear division index (NDI) was calculated according to the equation given below by counting at least 500 cells.

$$NDI = \frac{(1xMonoNc) + (2xBiNc) + (3xTriNc) + (4xTetraNc)}{\text{(Total No. of cells)}}$$

“TriNc” used in the equation represents the cell with trinuclei and “TetraNc” represents the cell with tetranuclei.

Single-Cell Gel Electrophoresis (Comet) Assay

The comet test was used to detect single-stranded DNA breaks and evaluate genotoxicity more sensitively by modifying the experimental approach and methodologies used by Singh et al. (1988). TM3 Leydig cells were planted in cell culture dishes as control and experimental groups at 1×10^5 cells per well. Additionally, as a positive control, $150 \mu\text{M H}_2\text{O}_2$ was applied to the cells. The cell pellet obtained at the end of the experimental period was diluted with PBS. The cell suspension in PBS was mixed with 0.05% low-melting-point agarose to form a homogeneous suspension. The resulting cell suspension was spread on slides pre-coated with agar (1.5% normal melting agarose). These prepared slides were kept in a cold lysis solution for one hour at $+4^\circ\text{C}$. After the lysis process was completed, the slides were incubated in alkaline ($\text{pH} > 13$) electrophoresis buffer for 20 minutes to open the double helix structure of the DNA. After the DNA unwinding phase, the slides were placed in the electrophoresis tank and underwent electrophoresis at 300 mA, 25 V, for 30 minutes. After electrophoresis, the slides were washed with distilled water and treated with a neutralization solution three times at 5-minute intervals. Finally, the slides were stained with 4,6-diamidino-2'-phenylindole DNA dye and left to dry. Each slide was photographed randomly under a fluorescent microscope. Parameters such as comet tail length, tail %DNA content, and Olive tail moment were calculated using the comet analysis program.

Statistical Analysis

The Graphpad Prism 9.0 program was used in the statistical evaluation of the data obtained from the cell viability, micronucleus, and comet analysis program on the concentrations of NaF and Hes used alone and in combination. The One-Way ANOVA method and Tukey's test were applied for statistical analysis. Results are expressed as mean \pm standard error, and $p < 0.05$, $p < 0.01$, and $p < 0.001$ values were considered statistically significant.

RESULTS

The effects of NaF and Hes on Leydig cells viability

The TM3 Leydig cells were tested for viability using concentrations of 10 ppm NaF and 20 mM Hes (Figure 1). When the control and NaF groups were compared in terms of MTT values, a significant decrease was observed in the NaF alone group at the end of 24 hours ($p < 0.001$). When only NaF and NaF+Hes groups were compared, a significant increase was observed in the NaF+Hes groups ($p < 0.01$). According to the cell viability data we obtained, it was understood that a 10 ppm NaF concentration had a cytotoxic effect on Leydig cells. However, it has been determined that Hes can be used as an effective antioxidant to improve this negative effect of NaF on Leydig cells.

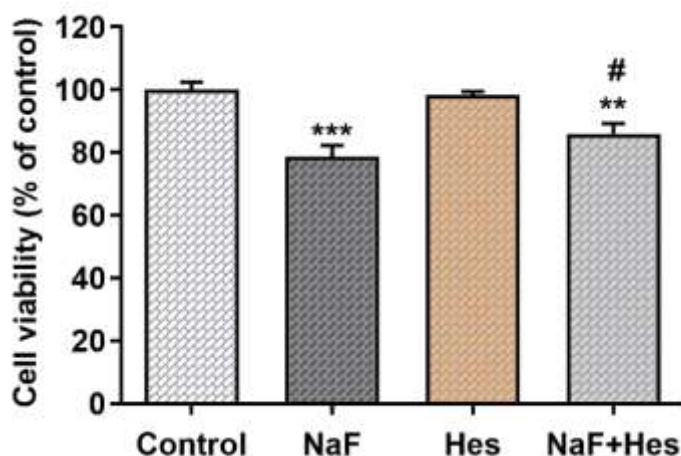

Figure 1. Effects of NaF and Hes on TM3 Leydig cells on cell viability *in vitro*. Each column represents the mean of three independent experiments repeated three times. *in comparison to the control, # in comparison to NaF (* $p < 0.05$, ** $p < 0.01$, *** $p < 0.001$).

The effects of NaF and Hes on the micronucleus assay in Leydig cells

Micronucleus, bud formation, and cytoplasmic bridge appearances caused by NaF and Hes in Leydig cells are presented in Figure 2, and the data obtained as a result of evaluating these parameters by comparing them with the control group are presented in Table 1. When the results were examined, there was a statistical increase in the proportions of binucleated cells and mononucleated cells containing micronuclei in the experimental groups where 10 ppm NaF concentration was applied compared to the control ($p < 0.05$). Furthermore, a significant decrease in the micronucleus rate was seen in the NaF+Hes group compared to the NaF alone group ($p < 0.001$).

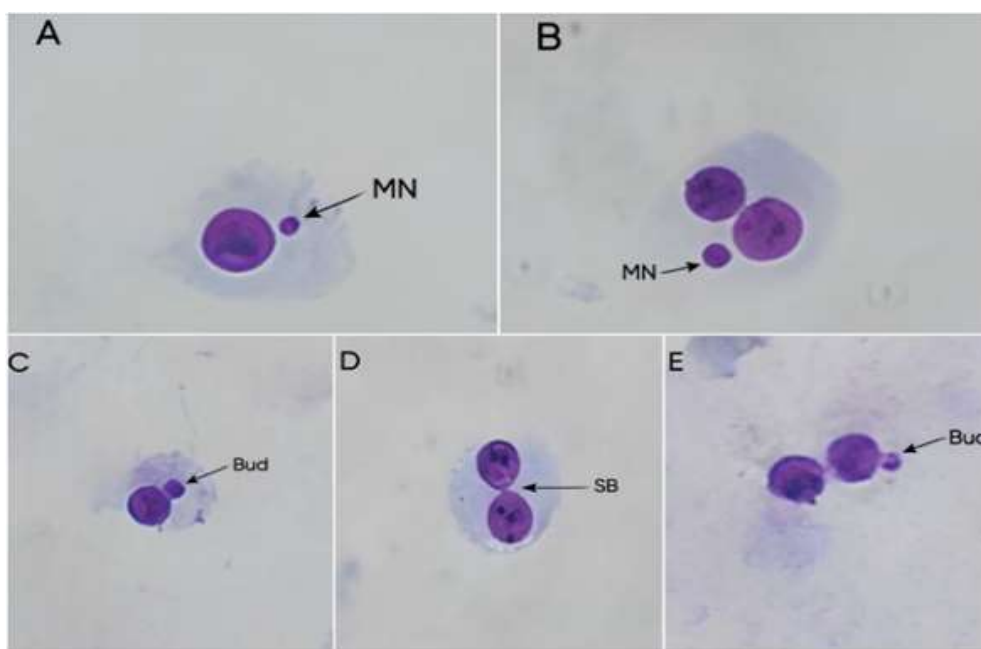

Figure 2. Nuclear abnormalities identified in Leydig cells exposed to NaF and Hes as a consequence of micronucleus testing. A: Micronucleus in a mononucleated cell; B: Micronucleus in a binucleated cell; C: Bud in a mononucleated cell; D: Cytoplasmic bridge in a binucleated cell; E: Bud in a binucleated cell.

Table 1. Micronucleus test results in TM3 Leydig cells treated with NaF and Hes

Groups	Mononucleated cells		Binucleated cells		
	MN	Bud	MN	Bud	Cytoplasmic Bridge
Control	1.61±0.3	1.61±0.1	2.28±0.9	0.98±0.1	0.16±0
NaF	8.02±1.2***	5±1.2***	10.54±1.7***	1.61±0.6*	1.24±0.4*
Hes	1.88±0.7	1.29±0.5	1.11±0.1	0.99±0.0	0.0±0.0
NaF+Hes	2.35±0.3#	2.29±0.5#	1.99±0.1#	1.16±0*#	0.25±0.0
PC (H ₂ O ₂)	43,5±2,4	7±1,3***	48.7 ± 1.9***	12.1 ± 1.3***	43.6 ± 2.1***

Each result represents the average of three independent experiments repeated three times. MN: micronuclei; PC: positive control. *in comparison to the control, # in comparison to NaF (*p<0.05, **p<0.01, ***p<0.001).

There was an important increase in the micronucleus, bud, and cytoplasmic bridge rates in Leydig cells after NaF exposure, and our data suggested that Hes reduced NaF-induced genotoxicity. The effects of NaF and/or Hes on CBPI, RI, NDI, and cytostasis values were calculated using nuclear division types observed in the micronucleus test (Figures 3 and 4). The CBPI value, which is a cytotoxicity indicator, revealed a significant decrease in the NaF-treated group compared to the control (p<0.05) The RI value, which indicates differences in cellular cytotoxicity, decreased significantly in the NaF group when compared to the control (p<0.001). Furthermore, the RI value improved significantly in the NaF+ Hes administered group compared to the NaF alone treated group (p<0.01). While the cytostasis value, which shows cell growth and proliferation inhibition, increased in the NaF-treated group, it lowered

significantly in the NaF+Hes-treated group ($p<0.001$). According to the data analysis results, the NDI value declined significantly in the NaF group ($p<0.01$). Additionally, an improvement was observed in the NaF+Hes group compared to the NaF group.

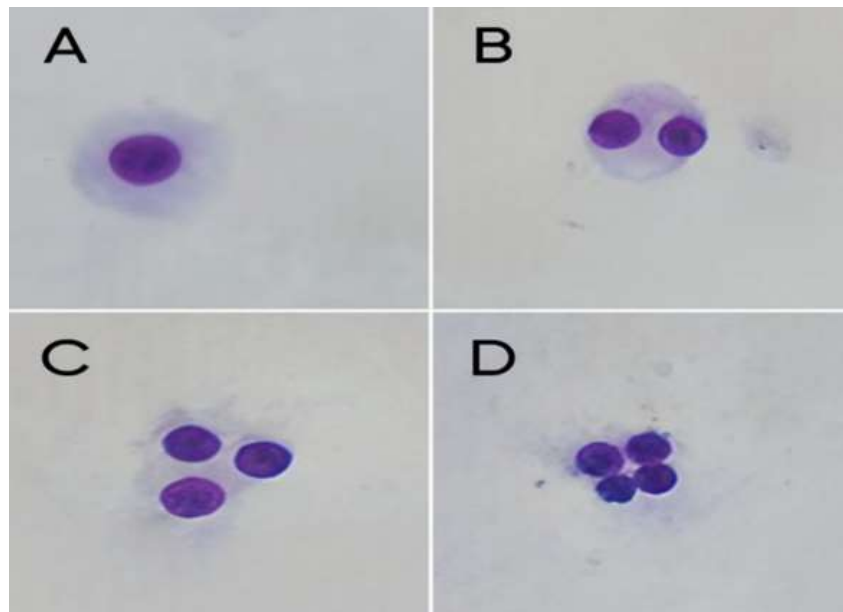

Figure 3. Nuclear division types identified in Leydig cells exposed to NaF and Hes as a result of the micronucleus test. A: mononucleated cell; B: binucleated cell; C: trinucleated cell; D: quadrinucleated cell

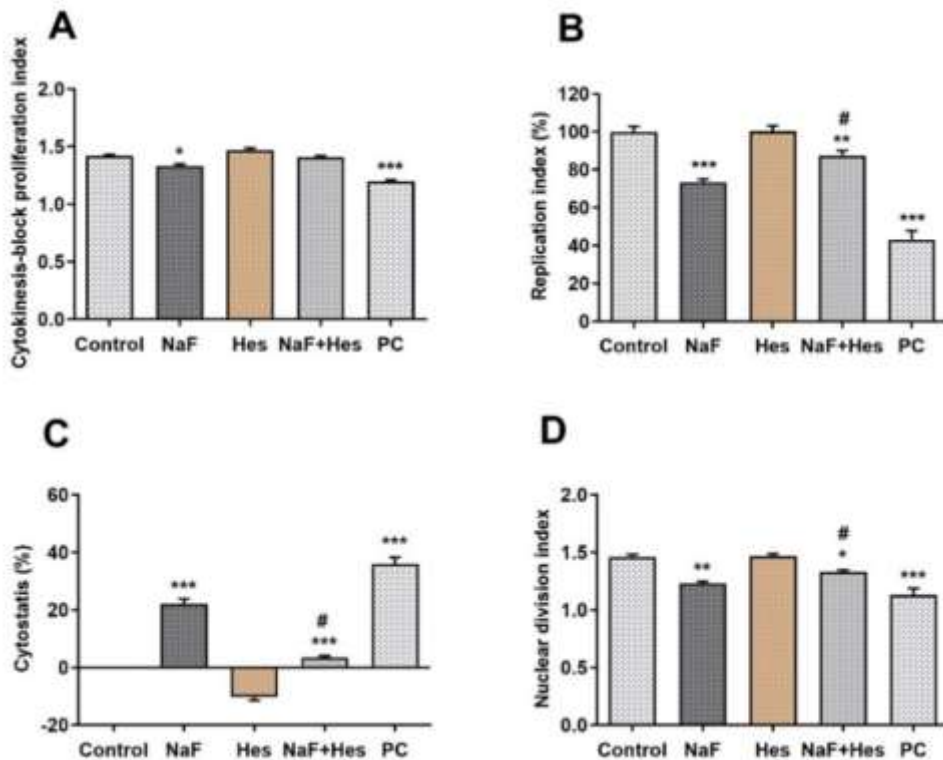

Figure 4. Effects of NaF and/or Hes on (A) cytokinesis-blocked cell proliferation index, (B) replication index, (C) % cytostasis, (D) nuclear division index in TM3 Leydig cells. Each column represents the mean of three independent experiments repeated three times. *in comparison to the control, # in comparison to NaF (* $p<0.05$, ** $p<0.01$, *** $p<0.001$).

The effects of NaF and Hes on the comet assay in Leydig cells

DNA damage after exposure of TM3 Leydig cells to NaF and Hes separately and together was evaluated by the comet test (Table 2, Figure 5). Tail length and tail %DNA amount, which are markers of DNA damage, showed a significant increase in the NaF group ($p < 0.001$). When NaF+Hes was compared with the NaF-treated group, a significant decrease was observed in tail length, tail %DNA and Olive tail moment parameters ($p < 0.05$).

Table 2. Effects of NaF and/or Hes on DNA damage in TM3 Leydig cells.

Groups	Tail Length	Tail % DNA	% Tail Olive Moment
Control	1.13±0.1	8.21±1.4	1.07±0.2
NaF	21.22±2.4***	76.61±11.1***	7.12±2.8**
Hes	0.32±0.1	22.36±4.3	1.49±0.1
NaF+Hes	3.12±0.7*#	29.01±3.7#	3.15±0.4*#
Positive control (H ₂ O ₂)	70.41±1.63***	97.56±1.53***	10.29±1.07***

Each result represents the average of three independent experiments repeated three times. *in comparison to the control, # in comparison to NaF (* $p < 0.05$, ** $p < 0.01$, *** $p < 0.001$).

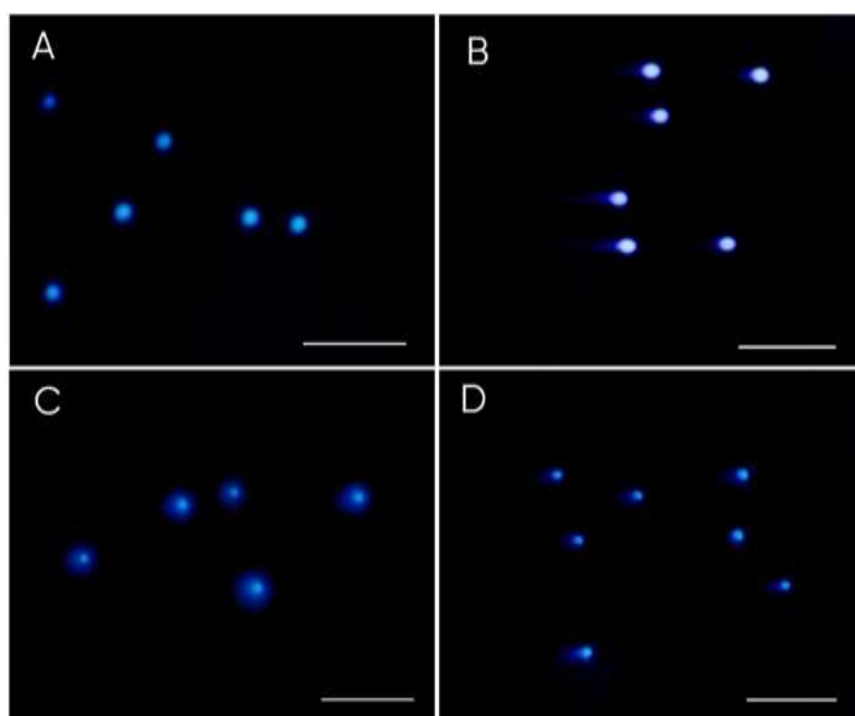

Figure 5. Fluorescence microscope photographs of the alkaline comet assay after applying NaF and Hes to TM3 Leydig cells for 24 h. A: Control; B: NaF; C: Hes; D: NaF+Hes

DISCUSSION

Excess NaF exposure has been proven in studies to have hazardous effects. Studies on the male reproductive system have revealed that NaF has a deleterious impact on reproductive cells, resulting in infertility (Zhang et al., 2006). Understanding and evaluating such effects is critical to defining safe NaF doses and limiting its use. The role of Hes, which has demonstrated

antioxidant characteristics, in mitigating the detrimental impact of NaF in Leydig cells was studied for the first time in this study.

Previous research has demonstrated that NaF decreases cell viability. In the osteoblast cell examination by Xu et al. (2008), NaF significantly decreased MTT cell viability at concentrations of 8, 12, and 20 ppm. Another study found that the quantity of NaF affected the viability of MTT cells in mouse Leydig cells at concentrations of 5, 10, and 20 mg/L (Song et al., 2014). Similar to previous research, our *in vitro* study employing Leydig cells showed that 10 ppm NaF decreased cell viability, while Hes had a protective effect against NaF toxicity by raising cell viability.

Genotoxicity occurs when an agent causes damage to the DNA molecule. Currently, many methods are used to measure the occurrence of DNA strand breaks, DNA insertions, and the induction of DNA damage repair. The micronucleus test, one of these methods, is frequently used in scientific studies to determine genotoxic damage. An *in vitro* investigation with osteosarcoma cells revealed that NaF doses of 0, 20, 100, and 200 ppm increased micronuclei, nucleoplasmic bridges, and nuclear buds (Volobaev et al., 2020). Campos-Pereira et al. (2017) showed that NaF caused genotoxic damage in rat bone marrow cells as a result of the micronucleus test. In another study, it was proven that the diazinon substance caused genotoxic damage in human blood cells as a result of the micronucleus test, and they showed that 50 μ L of Hes significantly reduced the micronucleus frequency (Shokrzadeh et al., 2015). In parallel with this research, our findings revealed that 10 ppm NaF increased micronucleus frequency, while 20 μ L Hes reduced micronucleus damage and therefore potentially improved genotoxic damage.

The comet test is another method for detecting genotoxicity, and it has been demonstrated that NaF induces genotoxicity by causing comet formation in a variety of cells. An *in vivo* study showed that concentrations of 4, 12, and 20 ppm NaF caused an increase in the amount of tail DNA% as a result of the comet test in bone marrow, liver, and kidney cells (Manivannan et al., 2013). Radovanovic et al. (2021) demonstrated that 150 ppm NaF doses caused DNA damage in liver, spleen, and brain cells by increasing the comet DNA tail length and %DNA tail amount. A considerable rise in the percentage of comet tail DNA was discovered in a study using osteosarcoma cells exposed to 20, 100, and 200 ppm NaF (Volobaev et al., 2020). In our study, it was observed that using NaF at lower concentrations increased comet tail length and % tail DNA amount, which is consistent with other findings in the literature. Furthermore, it was discovered that Hes significantly reduced the genotoxicity caused by NaF.

In conclusion, the present study demonstrated that Hes could mitigate Leydig cell damage. Hes considerably increased cell viability and decreased DNA damage. This study revealed that Hes positively modified comet and MN parameters and thereby inhibited cellular damage mediated by NaF.

FUNDINGS

This study was supported by Istanbul University Scientific Research Projects (Project No.39307).

REFERENCES

- Al-Rikabi, R., Al-Shmgani, H., Dewir, Y., El-Hendawy, S. 2020. *In vivo* and *in vitro* evaluation of the protective effects of hesperidin in lipopolysaccharide-induced inflammation and cytotoxicity of cell. *Molecules*, 25(3), 478.
- Campos-Pereria, F.D., Lopes Aguiar, L., Renosto, F.L., Nogueira, G.A.S., Costa, E.F.D., Pulz, R.B., Zacarin, E.C.M.S., et al. 2017. Genotoxic effect and rat hepatocyte death occurred

- after oxidative stress induction and antioxidant gene downregulation caused by long term fluoride exposure. *Chemico-Biological Interactions*, 264: 25-33.
- Fenech, M. 2007. Cytokinesis-block micronucleus cytome assay. [Nature Protocols](#), 2: 1084–1104
- Long, H., Jin, Y., Lin, M., Sun, Y., Zhang, L., & Clinch, C. 2009. Fluoride toxicity in the male reproductive system. *Fluoride*, 42(4), 260-76.
- Manivannan, J., Sinha, S, Ghosh, M., Mukherjee, A. 2013. Evaluation of multi-endpoint assay to detect genotoxicity and oxidative stress in mice exposed to sodium fluoride. *Mutation Research/Genetic Toxicology and Environmental Mutagenesis*, 751(1) 59-65.
- Pyrzyński, K. 2022. Hesperidin: A Review on Extraction Methods, Stability and Biological Activities Multidisciplinary Digital Publishing Institute. *Nutrients*, 14(12): 2387.
- Radovanovic, J., Antonijević, B., Kolarevi, S., et al. 2021. Genotoxicity of fluoride subacute exposure in rats and selenium intervention. *Chemosphere*, 266: 128972.
- Shokrzadeh, M., Ahmadi, A., Ramezani-Jhad, S., Shadboostan, A., 2015. Hesperidin, a Citrus Bioflavonoid, Ameliorates Genotoxicity-induced by Diazinon in Human Blood Lymphocytes. *Drug Research*, 65: 57–60.
- Singh, N. P.; McCoy, M. T.; Tice, R. R.; Schneider, E. L. A. 1988. Simple Technique for Quantitation of Low Levels of DNA Damage in Individual Cells. *Experimental Cell Research*, 175(1):184-91.
- Song, G., Wang, R., Chen, Z., Zhang, B., Wang, H., Liu, M., Gao, J., Yan, X. 2014. Toxic effects of sodium fluoride on cell proliferation and apoptosis of Leydig cells from young mice. *The Journal of Physiology and Biochemistry*, 70:761–768.
- Volobaev, V.P., Serdyukova, E.S., Kalyuzhnaya, E.E., Schetnikova, E.A., Korotkova, A.D., Naik, A.A., Bach, S.N., Prosekov, A.Y., Larionov, A.V. 2020. Investigation of the genotoxic effects of fluoride on a bone tissue model. *Toxicology Research*, 36: 337–342.
- Maurice, T. 1994. Fluorides and oral health Report of a WHO expert committee on oral health status and fluoride use. World Health Organization Technical Report Series. 846: 26-29.
- Wei, Q., Deng, H., Cui, H., Fang, J., Zuo, Z., Deng, J., Li, Y., et al. 2018. A mini review of fluoride-induced apoptotic pathways. *Environmental Science and Pollution Research*, 25: 33926–33935.
- Xu, H., Wang, C., Zhao, Z., Zhang, W., Li, G. 2008. Role of Oxidative Stress in Osteoblasts Exposed to Sodium Fluoride. *Biological Trace Element Research*, 123: 109–115.
- Zhang Y, Sun X, Sun G, Liu S, Wang L 2006. DNA damage induced by fluoride in rat osteoblasts. *Fluoride*, 39 (3): 191-194.
- Zhang, J., Li, Z., Qie, M., Zheng, R., Shetty, J., Wang, J. 2016. Sodium fluoride and sulfur dioxide affected male reproduction by disturbing blood-testis barrier in mice. *Food and Chemical Toxicology*, 94: 103-111.
- Zhang, J., Zhu, Y., Shi, Y., Han, Y., Liang, C., Feng, Z., Zheng, H., Eng, M., Wang, J. 2017. Fluoride induced Autophagy via the regulation of mTOR phosphorylation in mice Leydig cells. *Journal of Agricultural and Food Chemistry*, 65, (40): 8966–8976.

PHYTOSANITARY PRACTICES AND OPERATOR EXPOSURE LEVELS

Loubna BOUDRAA^{1,2}, Hassina Hafida BOUKHALFA^{1,3}

¹ Department of Agronomic Sciences, Université Mohamed Khider-Biskra.

² Ecosystem Diversity and Dynamics of Agricultural Production Systems in Arid Zones

³ Laboratoire Promotion de l'Innovation en Agriculture dans les Régions Arides.

loubna.boudraa@univ-biskra.dz

ABSTRACT

Terrestrial ecosystems are polluted by pesticide residues due to intensive use of phytosanitary products, mainly on cereal crops.

In order to assess the level of exposure of farmers to pesticides and to estimate their potential impact on human health, we carried out a 14-month survey in the wilaya of Khenchela on phytosanitary practices among 368 farmers, including the commune of Remila among 63 farmers (17.11% of farmers). This enabled us to collect data on the phytosanitary practices of farmers in the region through a questionnaire and observations used to estimate risks via the use of mathematical models.

We listed the majority of registered pesticides, and calculated a toxicity risk index for each active ingredient, taking into account both acute and chronic toxicity. Several cases of exceedance of the exposure limits set by legislation reflect the anomalies in the phytosanitary practices of these farmers, most of whom neglect to wear PPE during the preparation of the spray mixture and the application of the treatment.

Key words: Phytosanitary treatment, risk assessment, exposure, active ingredient, Remila.

INTRODUCTION

Cereals are an important part of the food supply for humans and animals (**Karakas, 2011**). Among these cereals, durum wheat (*Triticum durum* Desf) is one of the oldest species and forms a major part of mankind's diet, hence its economic importance. Wheat provides almost all the nutrition of the world's population in the form of grain foods, 95% of which are produced by the main cereal crops (**Greenway et Munns, 1980 ; Bonjean et Picard, 1990**).

The consequences of poor phytosanitary application are numerous, and are not limited solely to problems of treatment efficacy, but can also have harmful repercussions on the environment and operators (**Houmy K., 2001**).

In this context, our study was conducted in the wilaya of Khenchela, among apple growers, to analyze current phytosanitary practices, assess the potential exposure of farmers to pesticides used under usual conditions and perceive their potential impact on human health.

The aim is to demonstrate to farmers the risks associated with the uncontrolled use of pesticides, and the need to respect good phytosanitary practices to protect their health and avoid contamination of the environment (water, soil, air, etc.).

MATERIALS AND METHODS

our study was conducted from 2020 to 2021 (over a period of 14 months) during the main production and processing period for the cereal crop the data collection method is an individual

farmer survey conducted at different sites in the study area, involving 368 producers, including 63 cereal farmers in the commune of Remila Daïra Kais.

The questionnaire included questions on

- ✓ Farm presentation
- ✓ Farmers' knowledge
- ✓ Use of phytosanitary products
- ✓ Storage
- ✓ Personal protective equipment (PPE)



Figure 1 : Realization of the survey with cereal farmers.

The data collected concerns the treatment methods used to control crop diseases and pests, the equipment used for spraying, as well as the various plant protection products used (formulation, dose, frequency, active ingredient, etc.) and protection measures (product-related risk to farmers).

The list of products used was completed by examining empty packaging in the field, agricultural product vendors and packaging stored in the plant.

Observations focused mainly on the preparation of the slurry, since this is a major risk phase for the operator (direct contact with the product).

RESULTS AND DISCUSSIONS

In order to obtain representative results for Khenchela, farms throughout the region were surveyed, including the cereal-growing sectors in Remila.

The study shows that 79% of the 63 farms surveyed have a surface area of [0;10 ha], 5% have a surface area of [10;20 ha] and 11% have a surface area of [20;30 ha], while only 5% have a surface area over [+30 ha].

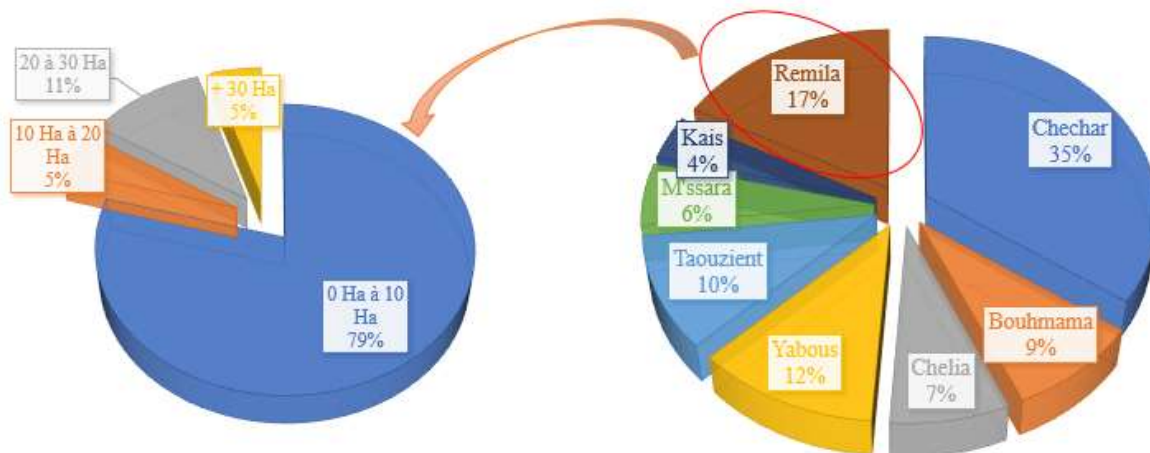

Figure 2 : Surface areas of farms investigated

Application of phytosanitary products

As farm managers are responsible for spraying crop protection products, or for explaining treatment methods (doses to be applied) to applicators, they are the ones most exposed to potential health risks. In order to 62% of farmers wear personal protective equipment (fig. 03).

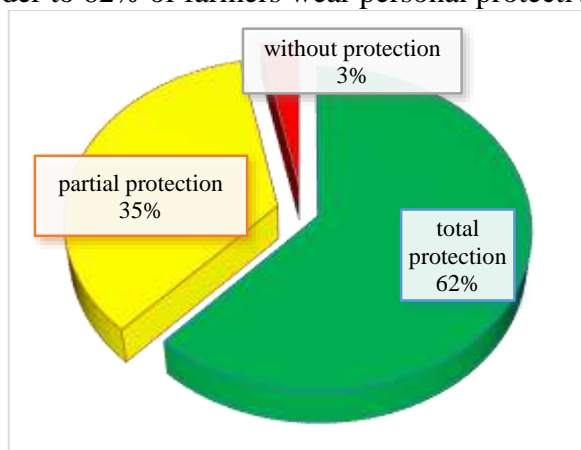

Figure 3 : Personal protection equipment.

The fact that most greenhouse growers in the Ziban region do not use protective equipment is due, on the one hand, to workers' lack of awareness of the real danger posed by pesticides and, on the other, to the lack of such outfits on the market and the unsuitability of those offered by vendors for the working conditions in their greenhouses (high temperatures) (Schiffers and Mar, 2011).

Phytosanitary products for cereal treatments

A total of 63 farms surveyed in the Remila region were found to use commercial specialties, all of them synthetic chemicals. Insecticides and herbicides were the most widely used, accounting for 44% and 29% respectively, or 37% of all plant protection products. Followed by fungicide-based products (19%) (fig. 04).



Figure 4 : Categories of crop protection products used on cereals.

The list of products was completed by examining stored packaging and the sellers of phytosanitary products.

The diagram shows that the most useful products in the study area are: Désormone lourde D by 8 farmers (herbicide), ProAct (6 farmers) and Traxos one by 5 farmers (insecticide) and Amistar xtra (6 farmers) and Actara 25 WG by 5 farmers (fungicide) (fig. 05).

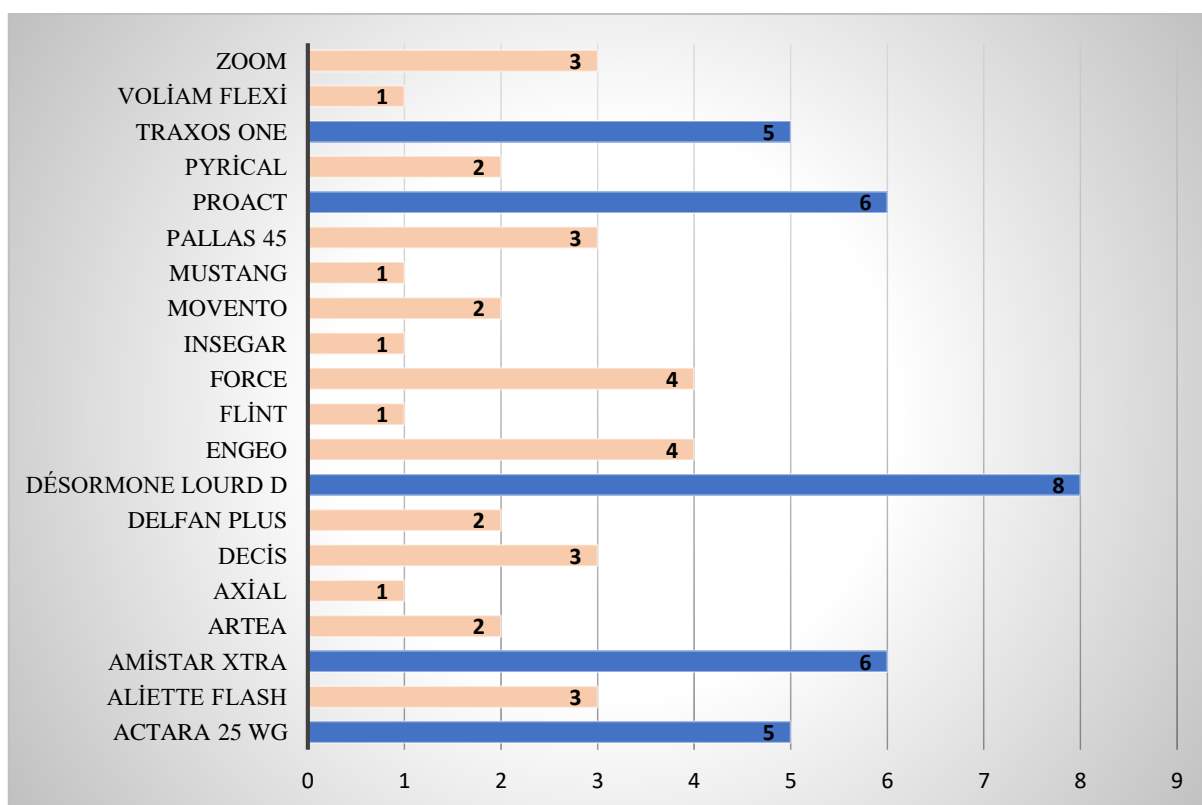

Figure 5 : Phytosanitary products used by farmers of Remila region.

The use of pesticides continues to multiply in many areas, and in large quantities. Approximately 400 phytosanitary products are registered, of which some 40 are widely used by farmers (Bouziani, 2007).

Pesticide use is strongly correlated with crop types and local farming practices. In the United States, where field crops (corn, wheat, soybeans) predominate, herbicides are the main category of pesticides used. In France, fungicides account for around half the tonnages sold (Aubertot et al., 2005).

21 active ingredients were inventoried, with Titrant 872 g/l (13%), Emamectine Benzoate and 200 g/l Azoxystrobine + 80 g/l Cyproconazole with (10%), Thiamethoxam and 30 g/l Pinoxaden+30 g/l Clodinafop-propargyl+7,5 g/l Florasulm+7,5 g/l Cloquitocet-mexyl with (8%) (fig. 06).

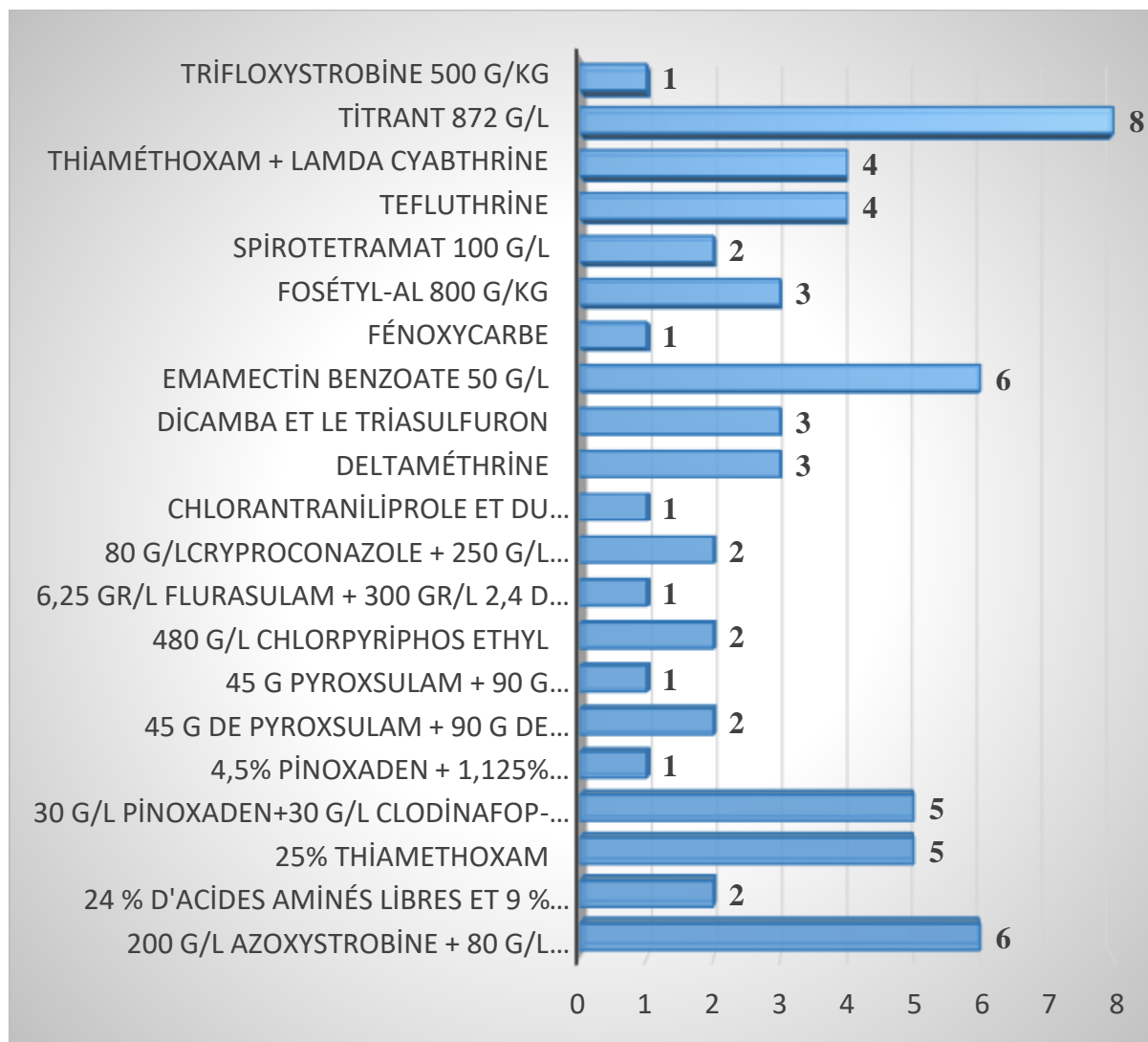

Figure 6 : Distribution of active material handled.

Exposure risk

In the Khenchela region, several noxious or toxic active ingredients have been identified on local markets, on packaging stored at growers' premises or on empty packaging burnt by local farmers after spraying.

Estimation of potential exposure of growers over a working day (mg/kg body weight / day). The following data are integrated: application method, product name, active ingredient, concentration, formulation, PPE, dose and AOEL for each active ingredient. This model enables results to be compared with the AOEL (EU Pesticides database)

1	THE GERMAN MODEL (GEOMETRIC MEAN VALUES)			
2				
3	Application method	Tractor-mounted/trailed broadcast air-assisted sprayer		
4	Product	Bloggo WG	Active substance	bloggo
5	Formulation type	Liquid	a.s. concentration	100 g/l
6	Dermal absorption from product	10 %	Dermal absorption from spray	10 %
7	RPE during mix/loading	None	RPE during application	None
8	PPE during mix/loading	None		
9	PPE during application: Head	None	Hands	None
			Body	None
10	Dose	0,5 l product/ha	Work rate/day	8 ha*
11	AOEL	0,05 mg/kg bw/dag	*nationellt räknas på 30 ha för boom sprayer	
12				

Figure 7 : The GERMAN MODEL of exposure risk.

Estimated operator exposure without wearing protection, expressed as a percentage of the AOEL, represents 1426% (without protection) and 538% (partial protection) of the AOEL for Chlorpyrifos-ethyl, 990 % (without protection) and 372 % (partial protection) of the AOEL for Emamectine Benzoate, 200% (without protection) of the AOEL for Lambda Cyhalothrin and 181 % (without protection) of the AOEL for 2,4-D-ester S/F de Butylglycol (fig. 08).

Based on these results and the toxicological properties of the preparation, the health risk for operators is considered unacceptable, without wearing protection during all phases of preparation and treatment application. The risk decreases when the operator wears PPE.

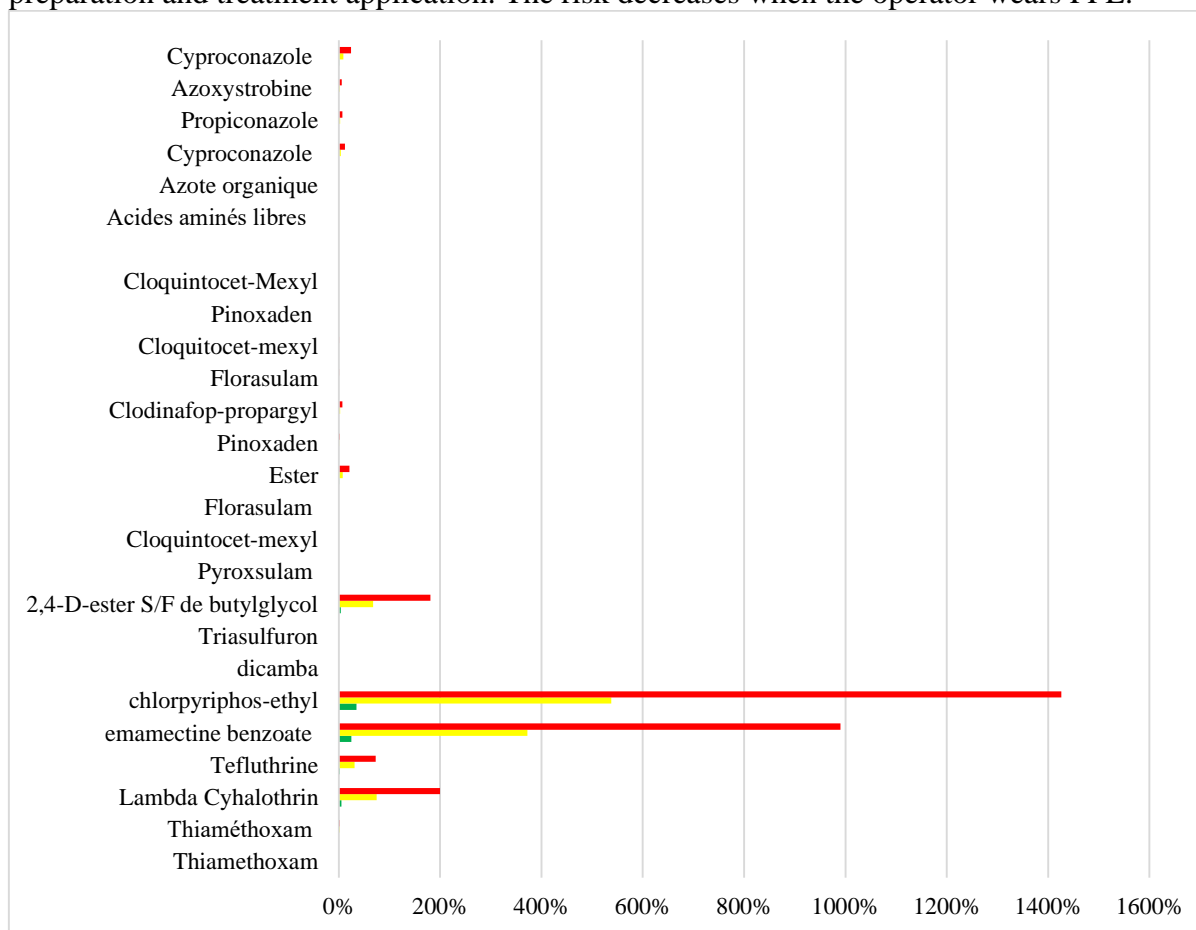

Figure 8 : Operator's exposure level.

CONCLUSION

Cereal growers recognize the risks associated with poor phytosanitary practices: the supply of pesticides from informal channels, the use of toxic phytosanitary products, the total or partial absence of personal protective equipment, and the burning of empty packaging are all practices that expose these operators to danger.

These active ingredients are known to be toxic and could have harmful effects after exposure, especially for farmers who fail to protect themselves when preparing the spray mixture or applying the phytosanitary treatment.

The widespread use of plant protection products, with their adverse effects on human health and the environment, calls for caution and a number of precautions to be taken. To this end, packaging labels include a certain amount of information, including safety information. This information is represented in the form of symbols and colors to better inform users, even the illiterate.

REFERENCE

1. Aubertot J. N., Barbier J. M., Carpentier Z., Gril J. J., Guichard L., Lucas P., Savary S., Voltz M., 2005 : Pesticides, agriculture et environnement. Réduire l'utilisation des pesticides et en limiter les impacts environnementaux. INRA France 119 p.
2. Benzine M., 2006 : les pesticides, toxicities, Résidus et analyse. Les technologies de laboratoires- N°0. P32.
3. Bonjean a., picard e, 1990. Les céréales à paille origine, historique, économie et sélection.
4. Greenway, H. et Munns, R. (1980). Mechanism of salt tolerance in non halophytes. Annu. Rev. Plant Physiol., 31 : 149-190.
5. Houmy K., 2001. Matériels de protection de céréales choix, utilisation et sécurité. Transfert de technologie en Agriculture n°78 Mars 2001, p. 1-4.
6. Karakas, A. (2011). Motivational Attitudes of ELT Students towards Using Computers for Writing and Communication. The Journal of Teaching English with Technology, 11(3), 37-53.(2011).
7. Schiffers B., Mar A , 2011. Sécurité des opérateurs et bonnes pratiques phytosanitaires. Manuel 4. Pip c/o Coleacp. Bruxelles, Belgique, mars.

**EFFECTS OF THE PLANT-GROWTH-PROMOTING RHIZOBACTERIA (PGPRS)
ON EXPRESSION OF SALT STRESS RELATED GENES IN TOMATO PLANTS
UNDER DROUGHT STRESS CONDITIONS**

Yasman Naziri¹, Birsen Çakır Aydemir²

¹ *Ege University, Seed Science and Technology Department, Izmir, Turkey*

² *Ege University, Horticulture Department, Izmir, Turkey*

Corresponding author: Yasaman Naziri, e-mail: nnyasan@gmail.com

ABSTRACT

Climate change, hunger, and food insecurity are among the issues that the agriculture sector is dealing with today. During the critical stages of flowering and seed development, tomato plants are vulnerable to drought stress, and elevated carbon levels also result in yield losses. A decline in tomato productivity, an increase in disease, and a fall in fruit quality will all result from the drought. As a result, emerging biotechnological interventions should focus on enhancing plant yield and stress tolerance. The importance of NAC and NHX genes and the benefits of plant growth-promoting rhizobacteria (PGPR) in improving abiotic stress resistance is widely understood. The potential of a group of SINAC and SINHX genes in the control of drought stress tolerance in the presence of a bacterial strain (113-Bacillus megaterium) in *Solanum lycopersicum* is the subject of the present study. In this study, the expression level of 4 SINAC genes and 4 SINHX genes was assessed using the real-time PCR technique. In general, in studied genes, in leaf tissues, expression increased at different levels and times of drought stress compared to the control sample. Also, the inoculation of *B. megaterium* in the leaf tissue has caused an increase in the relative expression of both genes compared to the control samples and also compared to the samples that were only exposed to drought stress. The results indicated that the transcript accumulation of mentioned genes has been regulated under different levels of drought stress. Once naturally tolerant candidate SINAC and SINHX genes have been discovered and the nature of their correlation with drought stress has been known, transgenic technology can be used to build inherent tolerance in future crops.

Keywords: NAC transcription factor, *NHX* family genes, real-time PCR, gene expression, tomato, drought stress

INTRODUCTION:

According to the latest statistics of FAOSTAT (2022), tomato, as one of the most important garden crops, produced over 13 million tons in Turkey in 2020. Also, this product was produced over 251 million tons throughout the world this year. Important nutrients like phenols, flavones, carotenoids, vitamin C, and vitamin A, powerful antioxidants, and minerals like potassium, phosphorus, calcium, iron, and folic acid are present in tomato. Thus, it is frequently consumed both fresh and processed (Tomas et al., 2017). Turkey, for instance, produces tomatoes with a fourth of its total horticultural production (FAOSTAT 2020). The agriculture industry has progressively suffered as a result of recent global climate change. In this regard, it is crucial to focus on thorough research to counter these changes on a global scale (Mahato, 2014). As immobile organisms, plants are subject to a variety of biotic and abiotic stresses that have a detrimental impact on their growth, development, and yield (Lippmann et al., 2019). Plants have created a variety of defense mechanisms to deal with different challenges, including modifications to gene expression and cell metabolism as well as adjustments to plant growth,

development, and performance (Akula Ramakrishna et al., 2011). Drought stress is one of the most significant and prominent abiotic stresses in the world today (Xu and Zhou, 2005). This type of abiotic stress is effective in the plant when soil moisture hits critical levels and atmospheric factors like air heat and solar radiation are the root of ongoing water loss. All plants have efficient defensive mechanisms to endure drought stress, however, these defense mechanisms function differently in various species (Xu and Zhou, 2005). Broadly speaking, plants have been shown to have five defense mechanisms against drought stress: the unfolded protein response (UPR), heat shock response (HSR), epigenetic controls, ROS homeostasis, and the regulations in which hormones are involved (Zhao et al., 2020). Genetic screening of plants to find stress-resistant species and develop them is one of the best approaches to dealing with all sorts of stress (Ermawati et al., 2021).

One of the most significant plant-specific TF families is the NAC (NAM, ATAF, and CUC) domain protein family. No apical meristem (NAM), ATAF1-2, and cup-shaped cotyledon (CUC) are three proteins that share a DNA-binding domain and from which it initially got its name [Aida et al., 1997; Souer et al., 1996]. Typically, NAC proteins have a varied transcription regulatory region at the C-terminus and a conserved NAM domain at the N-terminus (Ooka et al., 2003). Nearly 160 amino acids (aa) residues make up the N-terminal NAC domain, which was split into different subdomains (Ooka et al., 2003). Some Subdomains were highly diverse and may give NAC TFs functional variety, whereas some others were often largely conserved (Puranik et al., 2012; Ooka et al., 2003). The C-terminal transcription regulatory regions, in contrast, exhibit high levels of divergence and serve as functional domains by regulating a variety of transcriptional activation activities (Puranik et al., 2012; Ooka et al., 2003). Furthermore, several NAC TFs have transmembrane domains at their C-terminal ends that aid in anchoring to the plasma membrane or endoplasmic reticulum (Seo et al., 2008).

Researchers have identified and classified five subdomains for NAC (A to E). Subdomain A is involved in protein dimerization or heterodimerization. E and B subdomains are responsible for diversity in the function of NAC proteins. The presence of D and C subdomains are necessary for DNA interaction (Puranik et al., 2012). The NAC transcription factor family is one of the efficient genes whose function has been established in the tolerance of diverse biotic and abiotic stressors in plants (Shao et al., 2015). Additionally, studies have shown that this large gene family plays an important role in controlling the synthesis of the secondary cell wall (Zhong et al. 2010), the formation of the stem apical meristem (Aida et al. 1997), embryo development (Duval et al. 2002), and flower growth (Sablowski and Meyerowitz 1998) over the years. The study of this gene family in the past years has attracted the attention of researchers due to the significant role they play in the life of plants and their location so far in many plants such as *Arabidopsis* (Ooka et al., 2003), rice (Nuruzzaman et al., 2010), pear (Ahmad et al., 2018), tomato Li et al. (2022, etc.) has been identified. Also, the effective role of the large NAC family against plants with a variety of biotic and abiotic stresses has been investigated in many research, for example, the role of NAC in tomato in drought stress (Jian et al., 2021), aluminum, salinity (Wang et al., 2017) and pathogen attack (Du et al., 2022) have been investigated.

Na⁺/H⁺ antiporters, also known as NHXs, which serve as secondary ion transporters for H⁺ exchange and Na⁺ or K⁺ transport across the plant membrane during stressors, are among other genes that have a substantial impact on how the plant reacts to various stresses. Tian). SOS1-like NHX, which is found on the cell membrane, and the second category, known as IC-NHE/NHX, which contains a multitude of isoforms, are the two primary groups into which NHXs have so far been classified by scientists. According to research by Rodriguez-Rosales et al. (2009) and Leidi et al. (2010), NHXs are involved in the regulation of internal pH and cell development. Different NHX isoforms have so far been shown to have a favorable impact on plants that have experienced a variety of abiotic challenges, such as salinity stress, ionic stress, and nutrient shortage stress (Brini and Masmoudi, 2012).

Beet researchers Kloepper and Schroth discovered in 1981 that rhizobacteria in the soil accelerate beet development by altering the roots and also making the plant more resistant to plant diseases. After further research, these helpful rhizobacteria were termed plant growth-promoting rhizobacteria (PGPR) a few years later, in 1981. Based on where each PGPR acts on the plant cell, Martinez-Viveros proposed classifying PGPRs in 2010. This gives them the names Epgpr and iPGPR, respectively, depending on whether they have an extracellular or intracellular action. Numerous researchers have so far looked into how PGPR affects various plants in various environments. The impact of PGPR, for instance, has been researched so far on tomato production growth, fruit quality, resistance to water stress (Tahiri et al., 2022), salinity stress (Nseri et al., 2022), drought stress (Calvo-Polanco et al., 2016), and *Verticillium dahliae* stress (Bhattacharyya and Jha., 2012). Cakmakci et al. have also conducted other experiments on the impact of PGPRs on potato, wheat, corn, peas, corn, and cucumber (2006). They can be regarded as biological control agents in biotic and abiotic challenges, effective in enhancing production efficiency, and as biofertilizers in sustainable agriculture due to the great strengths that have been demonstrated in PGPR thus far (Freitas et al. 2007; Yildirim et al. 2011).

This study examines the potential role of a collection of *SINAC* and *SINHX* genes in the regulation of drought stress tolerance when a bacterial strain (113-*Bacillus megaterium*) is present in *Solanum lycopersicum*.

MATERIALS AND METHODS

Plant Selection and Inoculation: The study used *Solanum lycopersicum* MSC-50 variety. A selected group of these plants were inoculated with *Bacillus megaterium*, a type of PGPR. The objective of this step was to observe how the plant responds to the PGPR treatment.

Induction of Drought Stress: After the inoculation, drought stress conditions were created. This was done by applying three different concentrations of Polyethylene Glycol (PEG), a commonly used substance to mimic drought stress in lab settings. The PEG treatment was administered at two distinct time points: 2 hours and 12 hours after the PGPR inoculation. The doses of PEG and their effects on the plants were detailed in Tables 2 and 3.

Sampling and Tissue Collection: The plants were systematically sampled by collecting both leaves. To maintain the cellular integrity of the samples, they were pulverized using liquid nitrogen. This step was crucial for accurate subsequent analysis.

Sample Preservation: The pulverized samples were stored in Falcon tubes at a temperature of -80 degrees Celsius. This temperature control was essential to ensure the preservation of the biological and biochemical characteristics of the samples.

3.1. Leaf Samples & Treatments

Table 1. Leaf Sample Treatments

Applied Dose of PEG	Samples
<p>(0.25 mM PEG)</p> <p>31 g of PEG per liter – 1116 g of PEG was used for 36 liters. (36 pots - 1 liter per pot)</p>	MC: Control group of MSC-50 tomato variety with no application
	MP1-2h: PEG-treated samples (2 hours)
	MP1-12h: PEG-treated samples (12 hours)
	MBC: Untreated control sample of MSC-50 variety inoculated with 113- <i>B. megatrium</i>
	MP1B-2h: PEG-treated samples (2 hours) included with 113- <i>B. megatrium</i>
	MP1B-12h: PEG-treated samples (12 hours) included with 113- <i>B. megatrium</i>
<p>(0.50mM PEG)</p> <p>50 g of PEG per liter – 1500 g of PEG was used for 30 liters. (30 pots - 1 liter per pot)</p>	MP2-2h: PEG-treated samples (2 hours)
	MP2-12h: PEG-treated samples (12 hours)
	MP2B-2h: PEG-treated samples (2 hours) included with 113- <i>B. megatrium</i>
	MP2B-12h: PEG-treated samples (12 hours) included with 113- <i>B. megatrium</i>
<p>(0.75mM PEG)</p> <p>65.5 g of PEG per liter – 1179 g of PEG was used for 18 liters. (24 pots - 750 ml per pot)</p>	MP3-2h: PEG-treated samples (2 hours)
	MP3-12h: PEG-treated samples (12 hours)
	MP3B-2h: PEG-treated samples (2 hours) included with 113- <i>B. megatrium</i>
	MP3B-12h: PEG-treated samples (12 hours) included with 113- <i>B. megatrium</i>

RNA Isolation

RNA isolation was accomplished following a modified version of Bray's (1988) method. About 300 mg of the sample was weighed and placed in Eppendorf tubes, followed by the addition of an extraction solution comprising 50 mM Tris (pH 9), 150 mM LiCl, 5 mM EDTA, and 5% SDS. After vortexing and centrifugation, the upper phase was combined with a phenol chloroform isoamyl alcohol mixture. Subsequent centrifugation separated the supernatant, half of which was treated with 10M LiCl and incubated at +4°C. After centrifugation, the upper phase was discarded, and the remaining supernatant was treated with ethanol, centrifuged, and dried. The pellet was then dissolved in DEPC-treated water.

Purification of RNAs from DNA

RNA purification involved the use of DNase I RNase Free (Thermo) to eliminate genomic DNA from total RNA following the manufacturer's guidelines. The procedure included treating 1 µg

of RNA with DNase I and specific reagents, incubating at 37°C for 30 minutes, and subsequently at 65°C for 10 minutes. The quality of the RNA was assessed through 1% agarose gel electrophoresis. The resulting DNase-treated RNAs were stored at -20 degrees Celsius for subsequent steps.

cDNA Synthesis

The cDNA synthesis process utilized a Thermo Fisher cDNA kit according to the manufacturer's instructions. Sample analysis employed BiO1D software, using 500 ng of RNA based on observed mRNA bands from gel electrophoresis. A 12 µL solution containing 500 ng RNA, 1 µg oligo(dT)18, and dH₂O was heated at 65°C for 5 minutes, followed by rapid cooling on ice. In a separate Eppendorf tube, a mixture of 5X reaction buffer, RiboLock RNase Inhibitor, dNTPs, and RevertAid Reverse Transcriptase RNA was prepared. Then, 8 µL of this mixture was added to each sample. Incubation occurred at 42°C for 1 hour, followed by a 5-minute step at 70°C and cooling on ice. The generated cDNAs were partitioned into separate Eppendorf tubes and stored at -20°C to maintain stability.

Gene Sequence Identification

The nucleotide sequences of the genes whose expression will be analyzed were obtained via the Solgenomics database (<https://solgenomics.net/organism/Solanum%20lycopersicum/view>) and similar genes were searched using the NCBI and its Blast tool. The Gene ID of the genes studied in this research can be found in Appendix 1.

Designing Specific Primers for *NAC* and *NHX* Genes

The sequences of *SINAC* and *SINHX* genes of Arabidopsis was extracted from the TAIR database and in order to find the similar sequences of tomato, using the blast tool on the solgenomics database and the prepared sequences were re-checked for certainty in NCBI and the specific primers were designed in the Eurofins genomics database (<https://eurofinsgenomics.eu/en/ecom/tools/pcr-primer-design/>). Appendix 2 contains the primer sequences list used in this study. Each primer was evaluated for effectiveness with cDNA produced using standard PCR equipment, and the results were verified on a 1% agarose gel.

Real-Time PCR Test

The Real-Time PCR analysis was performed using a LightCycler 480 II machine from Roche. The RealQ Plus 2x Master Mix Green qPCR Master Kit was utilized with the actin gene as the reference. Peak profiles were established for each gene in the samples, and Ct (Cycle Threshold) values were generated from these profiles. The 2- $\Delta\Delta$ CT method was employed to calculate relative expression values based on Ct values.

RESULTS

Expression Profiles of *SINAC* Genes in Tomato Leaves

The relative expression profile revealed that the *SINAC37* gene was significantly upregulated following PEG treatment across all concentrations tested. Notably, after 12 hours of exposure to MP1, the upregulation was evident in comparison to the control group. The application of PGPR strain 113-Bacillus megaterium further augmented the expression of *SINAC37*. In

conditions of MP2, the gene exhibited a transient downregulation at the 2-hour mark, followed by an upregulation after 12 hours. Meanwhile, under MP3 conditions, a moderate upregulation was recorded both at 2 and 12 hours post-treatment (Fig. A2). *SINAC40* gene expression saw an upsurge post-PEG treatment, with both 2-hour and 12-hour intervals showing increased transcript abundance relative to the control. Moreover, the presence of PGPR strain 113-Bacillus megaterium was found to positively regulate *SINAC40* gene expression in tomato leaves (Fig. A3). For both the *SINAC43* and *SINAC45* genes, PEG treatment resulted in a marked increase in transcript abundance at 2 and 12-hour intervals when juxtaposed with the control sample. The introduction of PGPR strain 113-Bacillus megaterium further modulated the gene expressions, underscoring the combined effects of PEG-induced drought stress and PGPR treatment on the genes' activity in tomato leaves (Fig. A4 & Fig. A5 respectively).

Expression Profiles of *SINHX* Genes in Tomato Leaves

The *SINHX1* gene displayed an upregulation in its transcript levels both at 2 and 12-hour marks, in comparison to the control sample. Furthermore, the presence of PGPR strain 113-Bacillus megaterium distinctly influenced the *SINHX1* gene's expression patterns (Fig. A6). Similar to *SINHX1*, *SINHX2* gene also manifested an elevated expression profile at both the 2-hour and 12-hour intervals following PEG treatment. The influence of PGPR strain 113-Bacillus megaterium on the gene was evident, bolstering its expression in the tomato leaves (Fig. A7). The *SINHX3* gene showcased an upregulation in its transcripts at the 2 and 12-hour post-PEG treatment intervals. The inclusion of PGPR strain 113-Bacillus megaterium further amplified the gene's expression, signifying the synergistic effects of drought stress and PGPR treatment (Fig. A8). Observations for echoed the patterns seen in other *SINHX* genes, with the transcript *SINHX4* abundance escalating at both intervals after PEG treatment. The addition of PGPR strain 113-Bacillus megaterium further augmented the gene's expression, emphasizing the role of both drought stress and PGPR in modulating its activity (Fig. A9).

DISCUSSION

Tomato cultivars responded to water restriction with a significant proportional fall in yield in semi-arid climate circumstances such as Turkey, also Water stress made plants more vulnerable to pathogenic diseases such as viruses, bacteria, and fungi (Celebi 2014). It is now widely known that several genes, including transcription factors (TFs) that help plants endure adverse conditions, regulate drought tolerance. These genes continue to be prospective genomic candidates for widespread crop breeding (Joshi et al., 2016). Also, globally, drought stress has an impact on plant development and productivity, and *NHX* genes, are well known for increasing drought tolerance in transgenic plants. Several plants have well-defined; nevertheless, nothing is known about *NHXs* in tomato plant (*S. lycopersicum*).

Expression Profile of *SINAC* Genes

In the current study, the expression profile of the tomato NAC gene family was systemically examined. Numerous researches have shown that NAC Transcription factors are present in a wide variety of plant species. and their ability to play a role in controlling plant growth, development, and stress responses (Puranik et al., 2012). Up until this point, this family appeared to be one of the biggest TFs. It was reported that Arabidopsis, rice, grape, apple, maize, chickpea, cassava, sesame, pears, and buckwheat have 117, 151, 79, 180, 152, 71, 96, 87, 185, and 80 NAC genes (Ooka et al., 2003; Nuruzzaman et al., 2010; Wang et al., 2013; Shiriga et al., 2014; Ha et al., 2014; Hu et al., 2015; Zhang et al., 2018; Ahmad et al., 2018; Liu et al., 2019).

According to previous studies in the Solanaceae family, a considerable number of NAC genes were overexpressed under drought stress in *S. lycopersicum* (Al-Abdallat et al., 2015), *S. tuberosum* (Singh et al., 2013), *S. muricatum* (Yang et al., 2021), and sweet potato (Yan et al., 2021), and under other abiotic stresses such as *S. lycopersicum* under Aluminum stress (Jin et al., 2020) or in the development process in *S. melongena* (Wan et al., 2021). This trend was consistent with the result of the present study where overexpression of a huge number of NAC genes under drought stress and PGPR inoculation has been approved.

Gene expression patterns can typically offer crucial clues for gene activity. Consequently, the expression levels of the 4 SINAC genes in the leaf of *S. lycopersicum* were determined using qRT-PCR data. A higher or lower expression level of the studied SINACs under different conditions (drought stress and PGPR treatment) in the leaf tissue, compared to the control samples was found. These SINACs demonstrated tissue- and stress-specific expression patterns. These genes may play significant roles in tomato stress tolerance. NAC genes in leaf samples including SINAC37, SINAC40, SINAC43, and SINAC47 were highly expressed in all doses of drought stress treated samples, indicating that they may be involved in particular drought tolerance system in *S. lycopersicum*. The specific roles of the tomato SINAC genes will require further investigation in the future.

4.2. Expression Profile of *SINHX* Genes

For many plants, including *A. thaliana* (Yokoi et al., 2002), rice (Basu et al., 2014), wheat (Yarra, 2019), sweet beet (Wu et al., 2019), cotton (Ma et al., 2020), and other plants, the importance of NHX gene families under drought and salt stresses have previously been discovered. However, the functionality of NHX genes in *S. lycopersicum* under drought stress using PGPR has not been studied yet. In this investigation, the genomic expression of four NHX genes in *S. lycopersicum* was examined. According to the research papers that have been mentioned earlier, the expression level of NHX genes changed significantly in drought and salt-stress-treated samples. Those results are completely consistent with the results of the *SINHX* gene expression profile in the present study.

Sodium-proton antiporters in tomato plants (*S. lycopersicum*) facilitate Na^+/H^+ and K^+/H^+ exchanges. This contributes to stress tolerance as well as K^+ nutrition. NHXs have also been found to increase salinity tolerance in leaves (Zhang and Blumwald, 2001). There was another research which was done by Rodríguez-Rosales et al. (2008) in this regard with the same approach. The *SINHX*s may also be a part of the responses to drought, according to the expression pattern for different genes and tissues. The tissues' diverse expression patterns suggested that the NHX gene family offers options to breed this plant and overcome the functional restriction imposed by the original gene under drought stress. According to previous studies, it is known that there are many NHX protein isoforms present in tomato plants. Based on a study carried out by Rodríguez-Rosales et al. (2009) the majority of the NHX genes were activated by salt stress in the leaves of tomato (*lycopersicon esculentum*). It shows that NHX genes play a crucial role and have different functions in the defense system of *S. lycopersicum* in different tissues.

Regarding the effect of different durations of exposure to drought stress, it is reported that the expression level at different durations of PEG treatment was highly variable in leaf and root tissues of tea (*Camellia sinensis*) (Paul et al., 2021). This fold change variation was exactly what was observed in this study.

4.3. Plant growth-promoting rhizobacteria

The influence of plant growth-promoting rhizobacteria (PGPR) in bolstering host resilience during abiotic stress periods is well-documented, yet the molecular impact on tomato plants (*S.*

lycopersicum), which frequently face drought conditions in Turkey, remains largely underexplored. *Bacillus megaterium* was found to stimulate tomato growth under both normal and salt-stressed environments. Regardless of the conditions, *B. megaterium* notably boosted the development of tomato plants, leading to more robust roots, shoots, and leaves (Nascimento et al., 2020). This study revealed that the inoculation of tomato seedlings with *B. megaterium* under normal conditions significantly increased the root and shoot dry weight, resulting in a pronounced augmentation in the overall dry biomass of the tomato plant. Similar observations were recorded under stress conditions, where *B. megaterium*-inoculated tomato seedlings displayed a substantially higher root and shoot dry weight, leading to an increase in total dry biomass compared to non-inoculated plants. These findings were complemented by the observed elevated NAC and NHX expression levels in PGPR-treated samples exposed to PEG, underpinning the beneficial role of PGPR in supporting tomato plants during drought stress.

While *B. megaterium* boosted expression levels of specific genes involved in the repair of damaged photosynthetic equipment and the preservation of redox equilibrium, it lowered the production of ROS and ethylene. Additionally, *B. megaterium* dramatically changed the metabolic profile to fix salinity-induced physiological disturbances in tomato (*L. esculentum*) (Akram et al., 2019). An observed increase in drought tolerance in this study is completely consistent with the higher level of expression in NAC and NHX genes in the leaf samples treated with X bacteria in this study.

Yang et al., (2022) also reported that *B. megaterium* could efficiently increase the tolerance of tomato (*S. lycopersicum*) under biotic stresses by affecting a number of functional resistance genes. In addition, Samaras et al. (2021) provided the same result in the transcription pattern of defense-related genes when this genus of rhizobacteria was inoculated into this plant. This rhizobacterium had the same impact as these two previous studies on NAC and NHX genes in this study.

CONCLUSION

The data obtained from this study will provide essential information for the functional characterization of these genes in tomato under drought stress. In general, we can see that Differential gene expression in NAC and NHX genes were considerable in leaf samples. Also a notable increase in the expression of almost all of investigated SINAC genes has been seen in the leaf specially in 12 hour . This increase in expression at the highest level of PEG has been more considerable than other doses. Also, PGPR inoculation had a positive effect on increasing the expression of the mentioned genes, especially in the second and third doses of PEG. In relation to four SINHX genes, an increase in expression has been seen due to exposure to drought. This increase in expression in samples inoculated with PGPR has increased more in the second and third doses and time has a considerable effect on level of expression .

REFERENCES

- Ahmad, M., Yan, X., Li, J., Yang, Q., Jamil, W., Teng, Y. and Bai, S., 2018. Genome wide identification and predicted functional analyses of NAC transcription factors in Asian pears. *BMC plant biology*, 18(1), pp.1-15.
- Aida, M., Ishida, T., Fukaki, H., Fujisawa, H. and Tasaka, M., 1997. Genes involved in organ separation in Arabidopsis: an analysis of the cup-shaped cotyledon mutant. *The plant cell*, 9(6), pp.841-857.
- Akram, W., Aslam, H., Ahmad, S.R., Anjum, T., Yasin, N.A., Khan, W.U., Ahmad, A., Guo, J., Wu, T., Luo, W. and Li, G., 2019. *Bacillus megaterium* strain A12 ameliorates salinity stress in tomato plants through multiple mechanisms. *Journal of Plant Interactions*, 14(1), pp.506-518.

- Al-Abdallat, A.M., Ali-Sheikh-Omar, M.A. and Alnemer, L.M., 2015. Overexpression of two ATNAC3-related genes improves drought and salt tolerance in tomato (*Solanum lycopersicum* L.). *Plant Cell, Tissue and Organ Culture (PCTOC)*, 120(3), pp.989-1001.
- Aroca, R., 2012. Plant responses to drought stress. *From morphological to molecular features*, pp.1-5.
- Basu, S. and Roychoudhury, A., 2014. Expression profiling of abiotic stress-inducible genes in response to multiple stresses in rice (*Oryza sativa* L.) varieties with contrasting level of stress tolerance. *BioMed research international*, 2014.
- BhattacharyyaPN, J., 2012. Plantgrowth-promotingrhizobacteria (PGPR): Emergencein agriculture. *World J. Microbiol. Biotechnol*, 28, pp.1327-1350.
- Blum, A., 2005. Drought resistance, water-use efficiency, and yield potential—are they compatible, dissonant, or mutually exclusive?. *Australian Journal of Agricultural Research*, 56(11), pp.1159-1168.
- Bray, E.A., 1988. Drought-and ABA-induced changes in polypeptide and mRNA accumulation in tomato leaves. *Plant Physiology*, 88(4), pp.1210-1214.
- Brini, F. and Masmoudi, K., 2012. Ion transporters and abiotic stress tolerance in plants. *International Scholarly Research Notices*, 2012.
- Calvo-Polanco, M., Sánchez-Romera, B., Aroca, R., Asins, M.J., Declerck, S., Dodd, I.C., Martínez-Andújar, C., Albacete, A. and Ruiz-Lozano, J.M., 2016. Exploring the use of recombinant inbred lines in combination with beneficial microbial inoculants (AM fungus and PGPR) to improve drought stress tolerance in tomato. *Environmental and Experimental Botany*, 131, pp.47-57.
- Celebi, M., 2014. The effect of water stress on tomato under different emitter discharges and semi-arid climate condition. *Bulgarian Journal of Agricultural Science*, 20(5), pp.1151-1157.
- Chaves, M.M., Flexas, J. and Pinheiro, C., 2009. Photosynthesis under drought and salt stress: regulation mechanisms from whole plant to cell. *Annals of botany*, 103(4), pp.551-560.
- Cruz de Carvalho, M.H., 2008. Drought stress and reactive oxygen species: production, scavenging and signaling. *Plant signaling & behavior*, 3(3), pp.156-165.
- Du, M., Zhai, Q., Deng, L., Li, S., Li, H., Yan, L., Huang, Z., Wang, B., Jiang, H., Huang, T. and Li, C.B., 2014. Closely related NAC transcription factors of tomato differentially regulate stomatal closure and reopening during pathogen attack. *The Plant Cell*, 26(7), pp.3167-3184.
- Duval, M., Hsieh, T.F., Kim, S.Y. and Thomas, T.L., 2002. Molecular characterization of AtNAM: a member of the Arabidopsis NAC domain superfamily. *Plant molecular biology*, 50(2), pp.237-248.
- Ermawati, N., Hong, J.C., Son, D. and Cha, J.Y., 2021. Isolation of Multi-Abiotic Stress Response Genes to Generate Global Warming Defense Forage Crops. *Journal of The Korean Society of Grassland and Forage Science*, 41(4), pp.242-249.
- FAO (2020) Food and Agriculture Organization of the United Nations. FAO, Rome
- Garretón, V., Carpinelli, J., Jordana, X. and Holuigue, L., 2002. The as-1 promoter element is an oxidative stress-responsive element and salicylic acid activates it via oxidative species. *Plant physiology*, 130(3), pp.1516-1526.
- Ha, C.V., Nasr Esfahani, M., Watanabe, Y., Tran, U.T., Sulieman, S., Mochida, K., Van Nguyen, D. and Tran, L.S.P., 2014. Genome-wide identification and expression analysis of the CaNAC family members in chickpea during development, dehydration and ABA treatments. *PLoS One*, 9(12), p.e114107.
- Hu, W., Wei, Y., Xia, Z., Yan, Y., Hou, X., Zou, M., Lu, C., Wang, W. and Peng, M., 2015. Genome-wide identification and expression analysis of the NAC transcription factor family in cassava. *PLoS One*, 10(8), p.e0136993.

- Jian, W., Zheng, Y., Yu, T., Cao, H., Chen, Y., Cui, Q., Xu, C. and Li, Z., 2021. SINAC6, A NAC transcription factor, is involved in drought stress response and reproductive process in tomato. *Journal of Plant Physiology*, 264, p.153483.
- Jin, J.F., Wang, Z.Q., He, Q.Y., Wang, J.Y., Li, P.F., Xu, J.M., Zheng, S.J., Fan, W. and Yang, J.L., 2020. Genome-wide identification and expression analysis of the NAC transcription factor family in tomato (*Solanum lycopersicum*) during aluminum stress. *BMC genomics*, 21(1), pp.1-14.
- Joshi, R., Wani, S.H., Singh, B., Bohra, A., Dar, Z.A., Lone, A.A., Pareek, A. and Singla-Pareek, S.L., 2016. Transcription factors and plants response to drought stress: current understanding and future directions. *Frontiers in Plant Science*, 7, p.1029.
- Leidi, E.O., Barragán, V., Rubio, L., El-Hamdaoui, A., Ruiz, M.T., Cubero, B., Fernández, J.A., Bressan, R.A., Hasegawa, P.M., Quintero, F.J. and Pardo, J.M., 2010. The AtNHX1 exchanger mediates potassium compartmentation in vacuoles of transgenic tomato. *The Plant Journal*, 61(3), pp.495-506.
- Li, H., Ding, X., Wang, C., Ke, H., Wu, Z., WANG, Y., Liu, H. and Guo, J., 2016. Control of tomato yellow leaf curl virus disease by *Enterobacter asburiae*BQ9 as a result of priming plant resistance in tomatoes. *Turkish Journal of Biology*, 40(1), pp.150-159.
- Li, M., Li, Y., Li, H. and Wu, G., 2011. Overexpression of AtNHX5 improves tolerance to both salt and drought stress in *Broussonetia papyrifera* (L.) Vent. *Tree physiology*, 31(3), pp.349-357.
- Lippmann, R., Babben, S., Menger, A., Delker, C. and Quint, M., 2019. Development of wild and cultivated plants under global warming conditions. *Current Biology*, 29(24), pp.R1326-R1338.
- Liu, M., Ma, Z., Sun, W., Huang, L., Wu, Q., Tang, Z., Bu, T., Li, C. and Chen, H., 2019. Genome-wide analysis of the NAC transcription factor family in Tartary buckwheat (*Fagopyrum tataricum*). *BMC genomics*, 20(1), pp.1-16.
- Ma, W., Ren, Z., Zhou, Y., Zhao, J., Zhang, F., Feng, J., Liu, W. and Ma, X., 2020. Genome-wide identification of the *Gossypium hirsutum* NHX genes reveals that the endosomal-type GhNHX4A is critical for the salt tolerance of cotton. *International journal of molecular sciences*, 21(20), p.7712.
- Mahato, A., 2014. Climate change and its impact on agriculture. *International Journal of Scientific and Research Publications*, 4(4), pp.1-6.
- Nascimento, F.X., Hernández, A.G., Glick, B.R. and Rossi, M.J., 2020. Plant growth-promoting activities and genomic analysis of the stress-resistant *Bacillus megaterium* STB1, a bacterium of agricultural and biotechnological interest. *Biotechnology reports*, 25, p.e00406.
- Nuruzzaman, M., Manimekalai, R., Sharoni, A.M., Satoh, K., Kondoh, H., Ooka, H. and Kikuchi, S., 2010. Genome-wide analysis of NAC transcription factor family in rice. *Gene*, 465(1-2), pp.30-44.
- Ooka, H., Satoh, K., Doi, K., Nagata, T., Otomo, Y., Murakami, K., Matsubara, K., Osato, N., Kawai, J., Carninci, P. and Hayashizaki, Y., 2003. Comprehensive analysis of NAC family genes in *Oryza sativa* and *Arabidopsis thaliana*. *DNA research*, 10(6), pp.239-247.
- Osakabe, Y., Osakabe, K., Shinozaki, K. and Tran, L.S.P., 2014. Response of plants to water stress. *Frontiers in plant science*, 5, p.86.
- Paul, A., Chatterjee, A., Subrahmanya, S., Shen, G. and Mishra, N., 2021. NHX Gene Family in *Camellia sinensis*: In-silico Genome-Wide Identification, Expression Profiles, and Regulatory Network Analysis. *Frontiers in plant science*, 12..
- Pinheiro, C. and Chaves, M.M., 2011. Photosynthesis and drought: can we make metabolic connections from available data?. *Journal of experimental botany*, 62(3), pp.869-882.

- Plant, Á.L., Cohen, A., Moses, M.S. and Bray, E.A., 1991. Nucleotide sequence and spatial expression pattern of a drought-and abscisic acid-induced gene of tomato. *Plant Physiology*, 97(3), pp.900-906.
- Puranik, S., Sahu, P.P., Srivastava, P.S. and Prasad, M., 2012. NAC proteins: regulation and role in stress tolerance. *Trends in plant science*, 17(6), pp.369-381.
- Puranik, S., Sahu, P.P., Srivastava, P.S. and Prasad, M., 2012. NAC proteins: regulation and role in stress tolerance. *Trends in plant science*, 17(6), pp.369-381.
- Puranik, S., Sahu, P.P., Srivastava, P.S. and Prasad, M., 2012. NAC proteins: regulation and role in stress tolerance. *Trends in plant science*, 17(6), pp.369-381.
- Rodríguez-Rosales, M.P., Gálvez, F.J., Huertas, R., Aranda, M.N., Baghour, M., Cagnac, O. and Venema, K., 2009. Plant NHX cation/proton antiporters. *Plant signaling & behavior*, 4(4), pp.265-276.
- Sablowski, R.W. and Meyerowitz, E.M., 1998. A homolog of NO APICAL MERISTEM is an immediate target of the floral homeotic genes APETALA3/PISTILLATA. *Cell*, 92(1), pp.93-103.
- Samaras, A., Roumeliotis, E., Ntasiou, P. and Karaoglanidis, G., 2021. *Bacillus subtilis* MBI600 promotes growth of tomato plants and induces systemic resistance contributing to the control of soilborne pathogens. *Plants*, 10(6), p.1113.
- Seo, P.J., Kim, S.G. and Park, C.M., 2008. Membrane-bound transcription factors in plants. *Trends in plant science*, 13(10), pp.550-556.
- Shao, H., Wang, H. and Tang, X., 2015. NAC transcription factors in plant multiple abiotic stress responses: progress and prospects. *Frontiers in plant science*, 6, p.902.
- Shi, H. and Zhu, J.K., 2002. Regulation of expression of the vacuolar Na⁺/H⁺ antiporter gene AtNHX1 by salt stress and abscisic acid. *Plant molecular biology*, 50(3), pp.543-550.
- Shiriga, K., Sharma, R., Kumar, K., Yadav, S.K., Hossain, F. and Thirunavukkarasu, N., 2014. Genome-wide identification and expression pattern of drought-responsive members of the NAC family in maize. *Meta gene*, 2, pp.407-417.
- Singh, A.K., Sharma, V., Pal, A.K., Acharya, V. and Ahuja, P.S., 2013. Genome-wide organization and expression profiling of the NAC transcription factor family in potato (*Solanum tuberosum* L.). *DNA research*, 20(4), pp.403-423.
- Souer, E., van Houwelingen, A., Kloos, D., Mol, J. and Koes, R., 1996. The no apical meristem gene of *Petunia* is required for pattern formation in embryos and flowers and is expressed at meristem and primordia boundaries. *Cell*, 85(2), pp.159-170.
- Tahiri, A.I., Meddich, A., Raklami, A., Alahmad, A., Bechtaoui, N., Anli, M., Göttfert, M., Heulin, T., Achouak, W. and Oufdou, K., 2022. Assessing the potential role of compost, PGPR, and AMF in improving tomato plant growth, yield, fruit quality, and water stress tolerance. *Journal of Soil Science and Plant Nutrition*, 22(1), pp.743-764.
- Tian, F., Chang, E., Li, Y., Sun, P., Hu, J. and Zhang, J., 2017. Expression and integrated network analyses revealed functional divergence of NHX-type Na⁺/H⁺ exchanger genes in poplar. *Scientific reports*, 7(1), pp.1-17.
- Tomas, M., Beekwilder, J., Hall, R.D., Sagdic, O., Boyacioglu, D. and Capanoglu, E., 2017. Industrial processing versus home processing of tomato sauce: Effects on phenolics, flavonoids and in vitro bioaccessibility of antioxidants. *Food Chemistry*, 220, pp.51-58.
- Wan, F.X., Gao, J., Wang, G.L., Niu, Y., Wang, L.Z., Zhang, X.G., Wang, Y.Q. and Pan, Y., 2021. Genome-wide identification of NAC transcription factor family and expression analysis of ATAF subfamily members under abiotic stress in eggplant. *Scientia Horticulturae*, 289, p.110424.
- Wang, D.C., Jiang, C.H., Zhang, L.N., Chen, L., Zhang, X.Y. and Guo, J.H., 2019. Biofilms positively contribute to *Bacillus amyloliquefaciens* 54-induced drought tolerance in tomato plants. *International journal of molecular sciences*, 20(24), p.6271.

- Wang, N., Zheng, Y., Xin, H., Fang, L. and Li, S., 2013. Comprehensive analysis of NAC domain transcription factor gene family in *Vitis vinifera*. *Plant cell reports*, 32(1), pp.61-75.
- Wu, G.Q., Wang, J.L. and Li, S.J., 2019. Genome-wide identification of Na⁺/H⁺ antiporter (NHX) genes in sugar beet (*Beta vulgaris* L.) and their regulated expression under salt stress. *Genes*, 10(5), p.401.
- Xu, Y., Jin, Z., Xu, B., Li, J., Li, Y., Wang, X., Wang, A., Hu, W., Huang, D., Wei, Q. and Xu, Z., 2020. Identification of transcription factors interacting with a 1274 bp promoter of MaPIP1; 1 which confers high-level gene expression and drought stress Inducibility in transgenic *Arabidopsis thaliana*. *BMC Plant Biology*, 20(1), pp.1-14.
- Xu, Z.Z. and Zhou, G.S., 2005. Effects of water stress and nocturnal temperature on carbon allocation in the perennial grass, *Leymus chinensis*. *Physiologia Plantarum*, 123(3), pp.272-280.
- Yan, H., Ma, G., Teixeira da Silva, J.A., Qiu, L., Xu, J., Zhou, H., Wei, M., Xiong, J., Li, M., Zhou, S. and Wu, J., 2021. Genome-wide identification and analysis of NAC transcription factor family in two diploid wild relatives of cultivated sweet potato uncovers potential NAC genes related to drought tolerance. *Frontiers in genetics*, p.2378.
- Yang, S., Zhu, H., Huang, L., Zhang, G., Wang, L., Jiang, X. and Zhong, Q., 2021. Transcriptome-wide and expression analysis of the NAC gene family in pepino (*Solanum muricatum*) during drought stress. *PeerJ*, 9, p.e10966.
- Yang, W., Zhao, Y., Yang, Y., Zhang, M., Mao, X., Guo, Y., Li, X., Tao, B., Qi, Y., Ma, L. and Liu, W., 2022. A Genomic Analysis of *Bacillus megaterium* HT517 Reveals the Genetic Basis of Its Abilities to Promote Growth and Control Disease in Greenhouse Tomato. *International Journal of Genomics*, 2022.
- Yarra, R., 2019. The wheat NHX gene family: potential role in improving salinity stress tolerance of plants. *Plant Gene*, 18, p.100178.
- Yarra, R., He, S.J., Abbagani, S., Ma, B., Bulle, M. and Zhang, W.K., 2012. Overexpression of a wheat Na⁺/H⁺ antiporter gene (TaNHX2) enhances tolerance to salt stress in transgenic tomato plants (*Solanum lycopersicum* L.). *Plant Cell, Tissue and Organ Culture (PCTOC)*, 111(1), pp.49-57.
- Yildirim, E., Karlidag, H., Turan, M., Dursun, A. and Goktepe, F., 2011. Growth, nutrient uptake, and yield promotion of broccoli by plant growth promoting rhizobacteria with manure. *HortScience*, 46(6), pp.932-936.
- Yokoi, S., Quintero, F.J., Cubero, B., Ruiz, M.T., Bressan, R.A., Hasegawa, P.M. and Pardo, J.M., 2002. Differential expression and function of *Arabidopsis thaliana* NHX Na⁺/H⁺ antiporters in the salt stress response. *The Plant Journal*, 30(5), pp.529-539.
- Yu, T., Cen, Q., Kang, L., Mou, W., Zhang, X., Fang, Y., Zhang, X., Tian, Q. and Xue, D., 2022. Identification and expression pattern analysis of the OsSnRK2 gene family in rice. *Frontiers in Plant Science*, 13.
- Zhang, H., Kang, H., Su, C., Qi, Y., Liu, X. and Pu, J., 2018. Genome-wide identification and expression profile analysis of the NAC transcription factor family during abiotic and biotic stress in woodland strawberry. *PLoS One*, 13(6), p.e0197892.
- Zhao, J., Lu, Z., Wang, L. and Jin, B., 2020. Plant responses to heat stress: physiology, transcription, noncoding RNAs, and epigenetics. *International journal of molecular sciences*, 22(1), p.117.
- Zheng, X.Y., Spivey, N.W., Zeng, W., Liu, P.P., Fu, Z.Q., Klessig, D.F., He, S.Y. and Dong, X., 2012. Coronatine promotes *Pseudomonas syringae* virulence in plants by activating a signaling cascade that inhibits salicylic acid accumulation. *Cell host & microbe*, 11(6), pp.587-596.

Appendix 1:

Table 2. Gene IDs

Gene Name	Ensembl Gene ID
<i>SINAC37</i>	Solyc04g079940
<i>SINAC40</i>	Solyc05g009840
<i>SINAC43</i>	Solyc05g055470
<i>SINAC45</i>	Solyc06g008360
<i>SINHX1</i>	Solyc06g008820.2
<i>SINHX2</i>	Solyc04g056600.2
<i>SINHX3</i>	Solyc01g067710.2
<i>SINHX4</i>	Solyc01g098190.2

Appendix 2:

Table 3. Primer Sequences

Primer	Sequence
<i>LeActinF</i>	GCCGGGCGTGATCTTACTGA
<i>LeActinR</i>	AGCTACTCCTGGCGGTCTCC
<i>SINAC37F</i>	AATGGTGGGACAGCGAGTCA
<i>SINAC37R</i>	CGGGTCCTAAACGCGCATAA
<i>SINAC40F</i>	TGTTGGGCGGTATTCTTGCT
<i>SINAC40R</i>	AACCCGTCCATCCCATTGCT
<i>SINAC43F</i>	TGTAGCTGCACCTCCTGGTT
<i>SINAC43R</i>	TGGAGCACTCGCCAATCAGT
<i>SINAC45F</i>	TGACCCATGGGACCTTCCAG
<i>SINAC45R</i>	TGTCTTTCCCTGTGGCTTTCCA
<i>SINHX1F</i>	GCGTCGAGCACCATCTTAGG
<i>SINHX1R</i>	TCACGGTCAGTAGAGTGCCT
<i>SINHX2F</i>	CTCCTGCTCCTCGTTCTCCA
<i>SINHX2R</i>	AAGGACCTGGGTGAAGCTGT
<i>SINHX3F</i>	GCGAGGGCTGCTAATGTGTT
<i>SINHX3R</i>	TGACTGCAAAGCAAGGGCAA
<i>SINHX4F</i>	TGGTGGGCTGGTTTAATGCG
<i>SINHX4R</i>	TTGGGTGTGGCCAAATCTCG

Appendix 3: Results:

Expression Profile of *SINAC* Genes in leaves of tomato plants

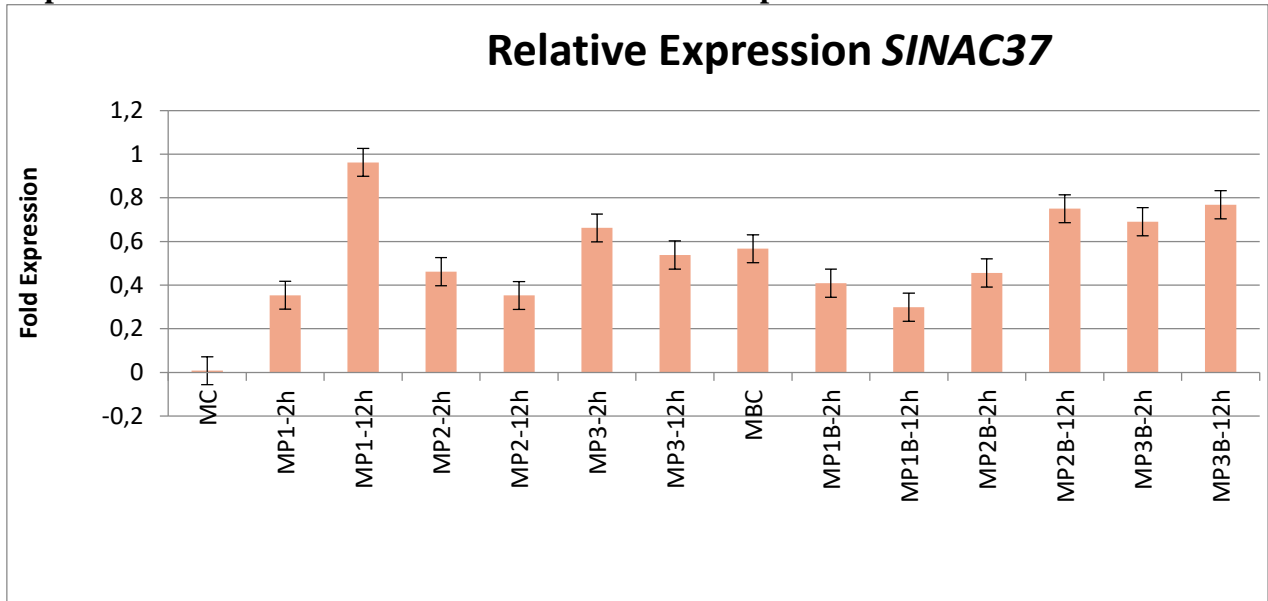

Figure 1. The Relative expression profile of *SINAC37* in leaves

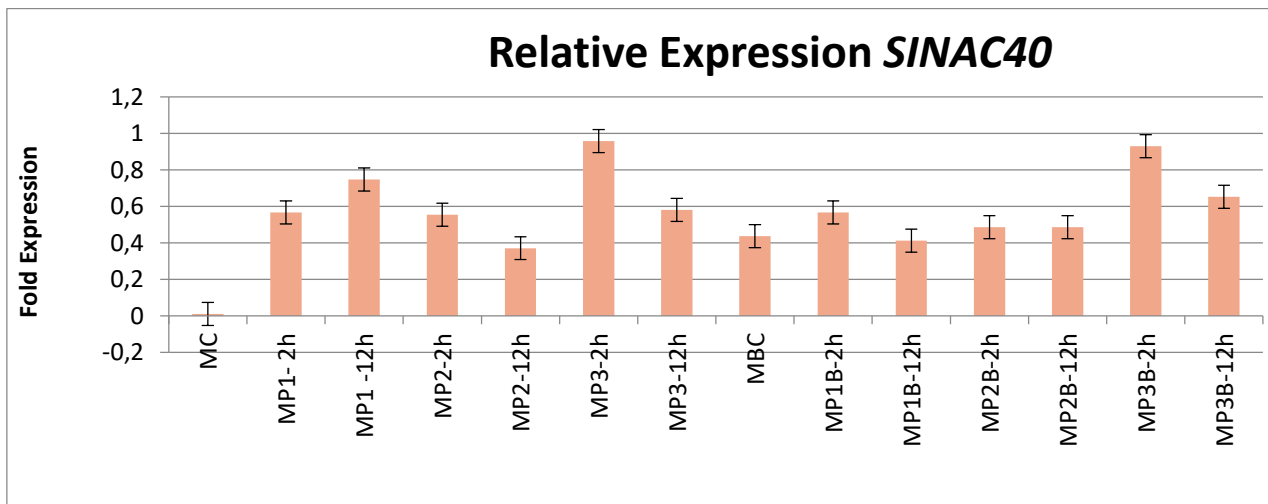

Figure 2. The Relative expression profile of *SINAC40* in leaves

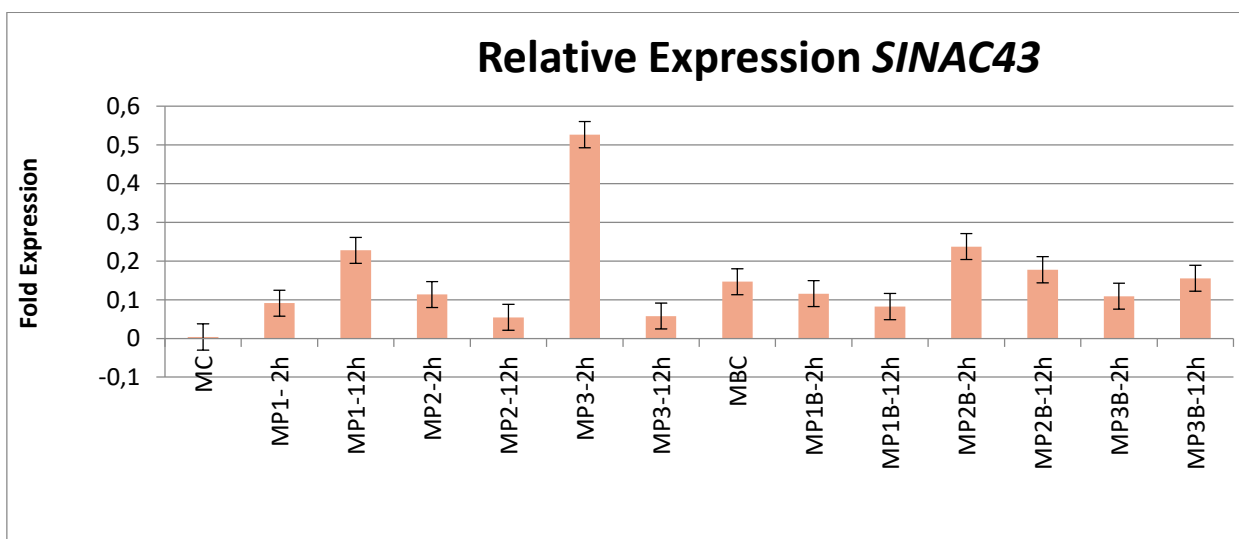

Figure 3. The Relative expression profile of *SINAC43* in leaves

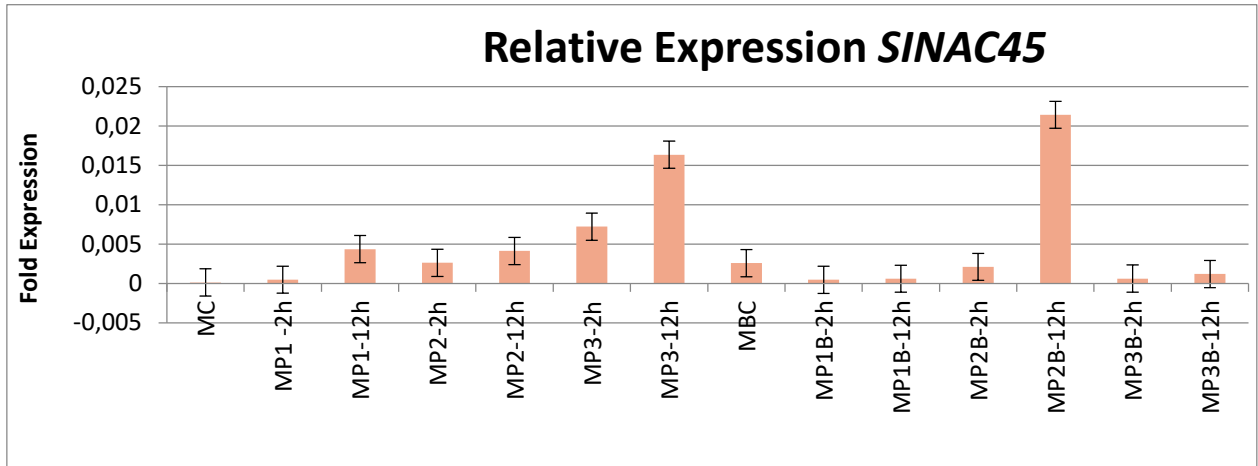

Figure 4. The Relative expression profile of *SINAC45* in leaves

Expression Profile of *SINHX* Genes in leaves of tomato plants

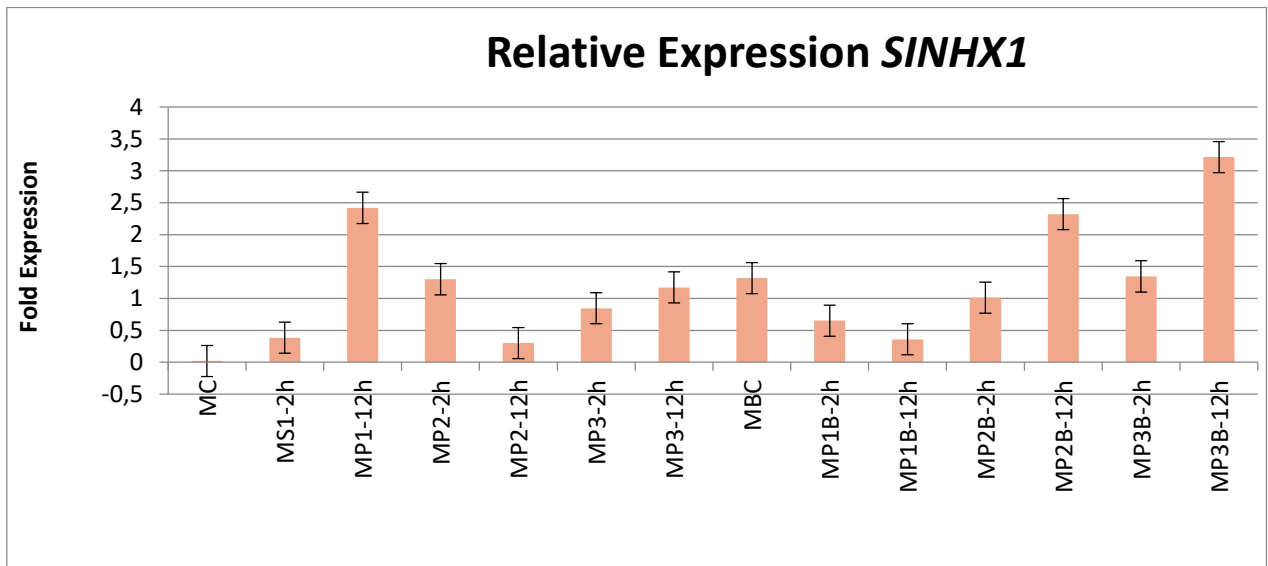

Figure 5. The Relative expression profile of *SINHX1* in leaves

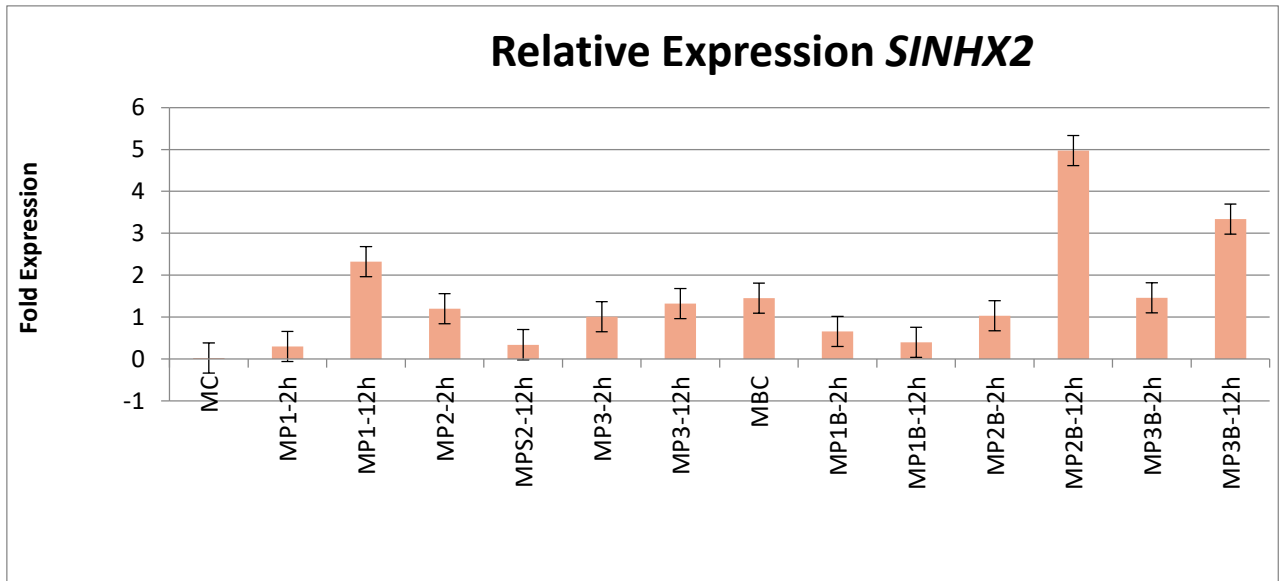

Figure 6. The Relative expression profile of *SINHX2* in leaves

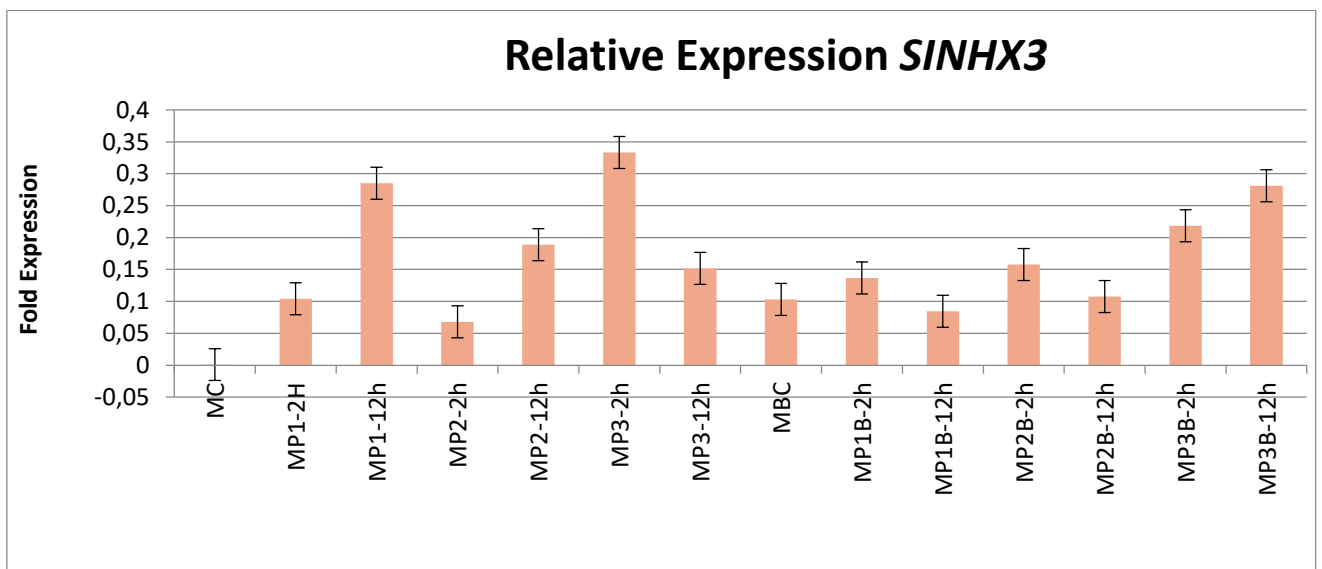

Figure 7. Relative expression profile of *SINHX3* in leaves

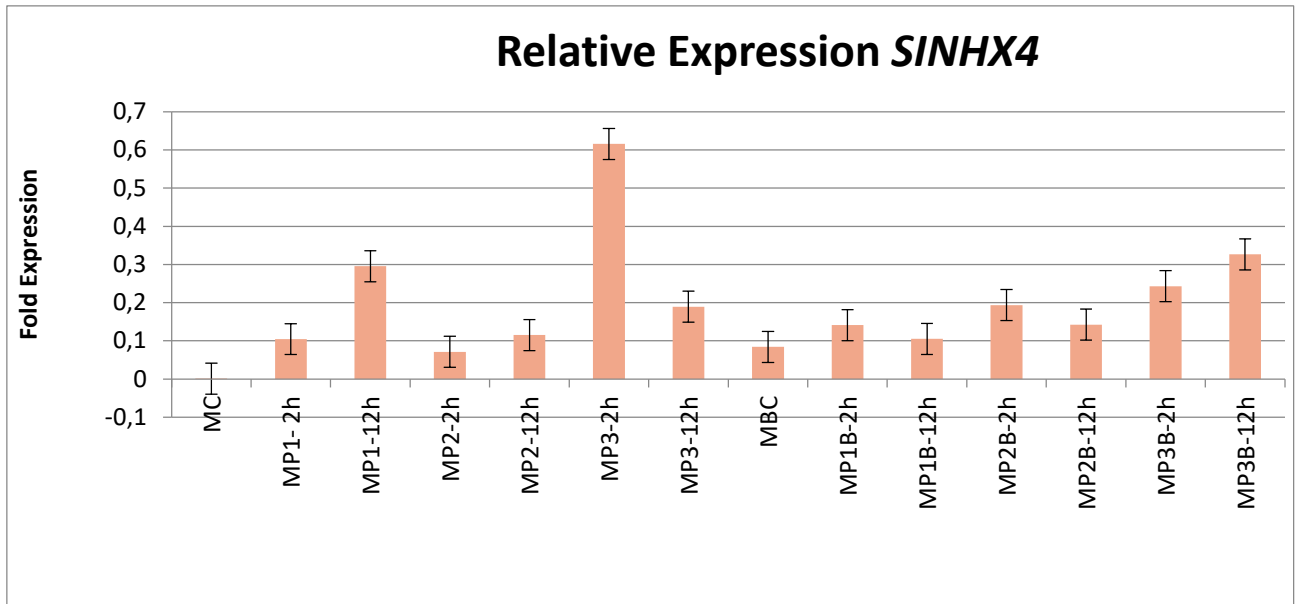

Figure 8. The Relative expression profile of *SINHX4* in leaves

ASSESSING THE IMPACT OF IRRIGATION WATER SALINITY ON MINERAL COMPOSITION IN DIFFERENT PART OF TOMATO

Gülçin Ece ASLAN¹ Cihan KARACA² Ahmet KURUNÇ¹ Dursun BÜYÜKTAŞ¹ Ruhi BAŞTUĞ¹
Alejandra NAVARRO³

¹ Department of Agricultural Structures and Irrigation, Faculty of Agriculture, Akdeniz
University, Antalya, Türkiye

² Greenhouse Production Program, Kumluca Vocational School, Akdeniz University Antalya,
Türkiye

³ Research Centre for Vegetable and Ornamental Crops, Council for Agricultural Research
and Economics (CREA), Pontecagnano, SA, Italy

Corresponding author e-mail: ecebacalan@akdeniz.edu.tr OrcID: 0000-0002-5187-7588

ABSTRACT

This study aimed to determine the effects of different irrigation water salinity on the mineral contents (nitrogen (N), phosphorus (P), potassium (K), calcium (Ca), magnesium (Mg), and sulfur (S)) in the leaves, stems, fruits, and roots of tomato plants at the end of the growing period. The research was conducted in two growing seasons between March 2021 - July 2021 and September 2021 - February 2022 under greenhouse conditions. In this study, a randomized block experimental design was used to examine the effects of three different levels of saline irrigation water (EC=0.7-control, 2.5, and 5.0 dS m⁻¹). The result showed that the effects of saline irrigation water differed in both growing seasons. The different salinity levels of irrigation water significantly affected the mineral content of leaves, particularly N (p<0.01), K (p<0.05), Mg (p<0.05), and S (p<0.05); the roots, particularly K (p<0.05) and Ca (p<0.05); and stems, particularly N (p<0.05), K (p<0.01), and Mg (p<0.01), during the fall season. On the other hand, there were no significant differences in the fruit during the fall season. In the spring season, different salinity treatments resulted in significant variations in leaf P (p<0.05), K (p<0.01), Mg (p<0.05), and S (p<0.001) contents, fruit N (p<0.01), Ca (p<0.001), and Mg (p<0.05) contents, root Ca (p<0.001), and stem S (p<0.01) contents. When both growing periods were considered, the differences in mineral content of tomato plants with an increase in salt concentration were in the form of a decrease in N, K, Ca, and P content and an increase in Mg and S content.

Keywords: Abiotic stress, EC_i, greenhouse, salinity stress

INTRODUCTION

Irrigation plays an important role for sustainable agricultural production in many parts of the world, particularly in arid and semi-arid regions like the Mediterranean basin (Oron, 2003). However, existing good-quality water resources are insufficient to sustain irrigated agricultural production in arid and semi-arid regions. For the sustainability of water resources, it is critical to enhance water consumption efficiency in irrigated agriculture, which consumes more than 70% of the world's freshwater on a global scale (Singh, 2015). In this scope, it's essential to assess the utilization of low-quality wastewater and saline water resources in agricultural production. However saline water can negatively affect crop quality and yield. Therefore, to

minimize the adverse effects of salinity, it is necessary to understand the salinity tolerance mechanisms of plants. To comprehend these mechanisms, studies have been conducted on the accumulation and transport of ions such as Na, Cl, K, and Mg, and the balance of these ions (e.g., K/Na and Ca/Na) in plant organs when plants are exposed salinity stress (Aziz and Khan, 2001; Parida and Das, 2005; Akay Rastgeldi, 2010; Dođru and Canavar, 2020;). High salt concentrations increase the amounts of Na⁺ and Cl⁻ in the tissues of many plant species, while reducing the levels of K⁺, Ca⁺², Mg⁺², and P (Noshadi et al., 2013; Dođru and Canavar, 2020). Tomato (*Solanum lycopersicum* L.), a rich food source known for its high carotenoid, lycopene, flavonoid, and potassium content (Erba et al., 2013), is one of the most widely cultivated vegetables worldwide, with a production of approximately 189 million tons in 2021, according to FAO (2023) data. The tomato plants, with a salinity threshold value of 2.5 dS/m, is a vegetable that is moderately sensitive to salinity (Maas and Hoffman, 1977). Numerous studies in the literature have extensively investigated the effects of salinity on the growth, yield, and quality parameters of tomato plants (Del Amor et al., 2001; Singh et al., 2012; Tanveer et al., 2020; Karaca et al., 2023;). Nevertheless, it is noteworthy that the effect of salinity varies among different tomato varieties (Alian et al., 2000). Hence, the diverse body of research on this subject is of paramount significance for elucidating the distinct responses of tomato plants to salinity. The objective of this study was to investigate the effects of salinity on the mineral content (N, P, K, Ca, Mg, S) of various organs of tomato plants.

MATERIALS AND METHODS

The research was conducted in two growing seasons between March 2021 - July 2021 and September 2021 - February 2022 under Mediterranean-type greenhouse with a lysimeter system of the Akdeniz University's Agricultural Research Area in Antalya, Turkey (36°53'15" N, 30°38'53" E, 31 m altitude above sea level). The greenhouse had dimensions of 9.6 × 25 m and was oriented in a north-south direction, featuring a gothic-style roof. It had natural ventilation through both its sides and roof and was covered with a 200 μm polyethylene film, which incorporated UV, IR, EVA, and AD additives.

The physical properties of the soil are presented in Table 1, and its chemical properties are given in Table 2.

Table 1. The physical properties of soil used in the experiment

Soil particles (%)			Field Capacity	Permanent Wilting Point	Bulk Density
Sand	Silt	Clay	(cm ³ cm ⁻³)	(cm ³ cm ⁻³)	(gr cm ⁻³)
21	51	28	0.31	0.14	1.38

Table 2. The chemical properties of soil used in the experiment

pH	Lime (%)	Electrical conductivity (EC _e , dS m ⁻¹)	Organic matter	N (%)	P (ppm)	K (ppm)	Ca (ppm)	Mg (ppm)
8.1	31.4	0.137	0.9	0.192	3	91	3284	454

Tensiometers were used to monitor soil water content. Irrigation was carried out when the tensiometer readings reached 20 cb, equivalent to approximately 20% of the available water depletion at a depth of 0.6 meters within the profile, achieved by elevating the available water content to the field capacity (Karaca et al., 2023) (Equation 1).

$$I = \frac{P_{V(FC)} - P_{V(AW)}}{100} \times D_s \times A \times P_a \quad (1)$$

where I is the amount of irrigation water (L), $P_{V(FC)}$ is the field capacity of the soil ($\text{cm}^3 \text{cm}^{-3}$), $P_{V(AW)}$ is the available water content in the soil ($\text{cm}^3 \text{cm}^{-3}$), D_s is the soil depth (mm), A is the lysimeter area (m^2), and P_a is the wetted area percentage (%).

In the experiment, the chosen plant material was the OZKAN F1 tomato variety, which is widely cultivated in the Antalya province and is suitable for both spring and autumn planting. The tomato seedlings were transplanted into the plots at intervals of 0.6×0.5 meters.

Irrigation was performed using dripper laterals that supplied water at a rate of 2 L h^{-1} under a pressure of 0.1 MPa to the lysimeter plots, with a spacing of 0.5 m between lines and 0.2 m between drippers. Tomato plants were cultivated using a single-stem approach and provided support through strings. Emerging side shoots were pruned at regular intervals. Following the eighth cluster, apical tips were removed from the plant.

A randomized complete block design was used to evaluate the effects of three levels of irrigation water salinity (S) on the N, P, K, Ca, Mg, and S content of different plant parts (leaves, fruits, roots, and stems) of six plants from each treatment group. The electrical conductivity of the irrigation water was $S_0 = 0.7 \text{ dS m}^{-1}$ (control), $S_1 = 2.5 \text{ dS m}^{-1}$, and $S_2 = 5.0 \text{ dS m}^{-1}$ (Maas and Hoffman, 1977). At the end of each growing period, the leaves, fruits, roots, and stems of the plants were sampled and analyzed for their mineral content. The total N content in the leaves, stems, fruits, and roots of the plant was determined using the Kjeldahl method (Kjeldahl, 1883). The P, K, Ca, Mg, and S contents of plant organs were determined by using an Inductively Coupled Plasma (ICP) spectrometer.

In this study, differences between various treatments were assessed using the ANOVA test conducted with the SPSS Statistics Base v23 (SPSS Inc., Chicago, IL, USA) for overall variations, followed by the LSD test for pairwise mean differences at a significance level of $p < 0.05$. In addition, the degree of correlations between the parameters was assessed by considering the r value as suggested by Peck and Devore (2012); strong ($r \geq 0.8$), moderate ($0.5 < r < 0.8$) and weak ($r \leq 0.5$).

RESULTS AND DISCUSSION

Statistical evaluations regarding to the effects of different salinity levels on the mineral content in the organs of tomato plants during both spring and fall periods are presented in Table 3 and 4, respectively.

While the changes in leaf K ($p < 0.01$; $p < 0.05$), Mg ($p < 0.05$; $p < 0.05$), and S ($p < 0.001$; $p < 0.05$) contents due to salinity were statistically significant in the spring and fall growing seasons, the changes in Ca content were not significant. In both growing seasons, leaf K content showed a decrease with increasing salinity (Table 3,4). In the spring growing season, this decrease was 15% and 26% for salinity levels of 2.5 dS m^{-1} and 5 dS m^{-1} , respectively, relative to the control treatment. In the fall growing season, the decrease was 23% and 31%, respectively. In contrast to K, leaf Mg and S contents increased with salinity treatments. Leaf Mg content increased by 121% and 71% in the spring, and by 23% and 31% in the fall, respectively compared to the control. In the spring, leaf S content increased by 35% and 22% in the 2.5 dS m^{-1} and 5.0 dS m^{-1} treatments, respectively, compared to the control. In the fall, there was a 13% increase in leaf sulfur content in the 5.0 dS m^{-1} application, while the 2.5 dS m^{-1} application did not show a statistically significant difference from the control. Under saline conditions, several factors such as reduced root permeability, reduced microbial activity, high chloride levels in the root zone, and low soil nitrogen concentrations result in reduced plant N uptake (Noshadi et al., 2013). Assessing the effect of saline irrigation water applications on leaf N content, it was found that leaf N content was 6% lower in the fall at 5.0 dS m^{-1} compared to the control treatment.

However, in the spring, the differences between the irrigation water salinity treatments were not statistically significant.

Table 3. Effect of irrigation water salinity on mineral content in the spring growing period

	Salinity (dS m ⁻¹)	N	P	K	Ca	Mg	S
Leaf	0.7	2.63 [†]	0.31 a	1.84 a	5.44	0.48 b	1.29 c
	2.5	2.60	0.30 a	1.57 b	5.49	1.06 a	1.74 a
	5.0	2.30	0.19b	1.37 b	5.19	0.82 ab	1.58 b
	Significant level	ns	*	**	ns	*	***
Fruit	0.7	2.16 b	0.22	2.63	0.39 a	0.09 a	0.12
	2.5	2.55 a	0.22	3.07	0.32 b	0.10 a	0.16
	5.0	2.07 b	0.21	2.95	0.25 c	0.06 b	0.16
	Significant level	**	ns	ns	***	*	ns
Stem	0.7	1.26	0.14	2.93	2.35	0.28	0.23 b
	2.5	1.37	0.15	4.10	2.08	0.62	0.35 a
	5.0	1.26	0.14	3.73	2.14	0.50	0.33 a
	Significant level	ns	ns	ns	ns	ns	**
Root	0.7	1.23	0.10	1.73	3.58 a	0.14	0.16
	2.5	1.34	0.09	1.16	1.82 b	0.11	0.13
	5.0	1.29	0.08	0.90	1.94 b	0.12	0.13
	Significant level	ns	ns	ns	***	ns	ns

[†]Each value is the average of measurements from six different plants

*, **, *** and ns, significant at the p < 0.05, p < 0.01, p < 0.001 level, and not significant, respectively

Table 4. Effect of irrigation water salinity on mineral content in the fall growing period

	Salinity (dS m ⁻¹)	N	P	K	Ca	Mg	S
Leaf	0.7	3.26 [†] a	0.26	2.26 a	6.83	0.47 b	2.05 b
	2.5	3.34 a	0.21	1.75 b	9.15	0.68 a	1.98 b
	5.0	3.07 b	0.26	1.57 b	8.05	0.69 a	2.32 a
	Significant level	**	ns	*	ns	*	*
Fruit	0.7	2.06	0.23	3.78	0.37	0.15	0.27
	2.5	1.92	0.26	3.60	0.42	0.17	0.27
	5.0	2.20	0.26	3.78	0.34	0.16	0.24
	Significant level	ns	ns	ns	ns	ns	ns
Stem	0.7	1.47 a	0.12	3.81 b	2.97	0.56 b	0.40
	2.5	1.30 b	0.11	3.28 b	1.97	0.73 a	0.38
	5.0	1.41 a	0.12	4.71 a	2.56	0.50 b	0.46
	Significant level	*	ns	**	ns	**	ns
Root	0.7	1.67	0.10	2.68 a	2.81 a	0.32	0.25
	2.5	1.44	0.11	1.99 b	3.51 a	0.33	0.25
	5.0	1.58	0.11	2.18 b	1.96 b	0.35	0.26
	Significant level	ns	ns	*	*	ns	ns

[†]Each value is the average of measurements from six different plants

*, **, *** and ns, significant at the p < 0.05, p < 0.01, p < 0.001 level, and not significant, respectively

Under saline conditions, many factors such as decreased permeability of plant roots, decreased microbial activity and consequent loss of mineralization of organic compounds in the soil, high chloride concentration in the root zone and decreased soil N concentration are effective in reducing nitrogen uptake by plants (Noshadi et al., 2013). The differences in leaf P content were

statistically significant only in spring ($p < 0.05$). At 5.0 dS m^{-1} , leaf P content was 39% lower than in the control.

The most significant difference in the mineral content of the fruit, according to the saline irrigation water treatment was the Ca content in the spring growing season. Due to the increase in salinity, there was a decrease of 18% and 36% in the 2.5 and 5.0 dS m^{-1} treatments, respectively, compared to the control. Calcium, which plays a fundamental role in plant growth and development (Hepler, 2005), has a positive effect by regulating Na ions that compete for the same membrane binding sites in the plant, thus protecting the cell membrane from the toxic effects of salt (Tuteja and Mahajan, 2007). In the spring growing season, while the highest fruit N and Mg contents were found in the 2.5 dS m^{-1} treatment, the control treatment was not statistically different from this treatment in Mg content. However, there was 33% decrease in fruit Mg content in the 5.0 dS m^{-1} treatment compared to the control. In the fall period, the differences in the mineral content of the fruit were not statistically significant.

There was a statistical difference in the mineral content of the stem for S ($p < 0.01$) in the spring and for N ($p < 0.05$), K ($p < 0.01$), and Mg ($p < 0.01$) in the fall. In the spring, the S content increased in the salinity treatment compared to the control (52 and 43% in 2.5 and 5.0 dS m^{-1} , respectively), as well as in the leaves. During the fall growing season, 5 dS m^{-1} treatment differed from the control only in the potassium content of the stem, which showed a significant increase of 24%. Nitrogen and phosphorus contents of the stem varied according to the control with a salinity of 2.5 dS m^{-1} . In the 5.0 dS m^{-1} treatment, there was a 12% decrease in stem N content and a 30% increase in Mg content compared to the control.

The change in mineral content in the root of the tomato plant in response to salinity stress is particularly noteworthy in the case of Ca during the spring season. It was observed that the Ca content in the roots increased significantly by 49% and 46% in response to treatments of 2.5 and 5 dS m^{-1} salinity treatments, respectively, compared to the control treatment (Table 3). The differences in mineral content in the root zone of the plants in the fall period were in the minerals Ca and K. Both mineral contents decreased at high salinity compared to the control (Table 4).

In this study, we also investigated the correlation between mineral content in different organs of tomato plants under saline conditions (Figure 1). The correlation test shows that various minerals in different plant organs have significant positive and negative correlations under saline conditions. In particular, strong positive correlations were observed, between leaf N content and fruit Mg ($r=0.94^{***}$) and S ($r=0.87^{***}$); root K ($r=0.83^{***}$), Mg ($r=0.91^{***}$), and S ($r=0.85^{***}$) contents; fruit Mg and S ($r=0.88^{***}$), as well as root Mg ($r=0.93^{***}$) and S ($r=0.90$) contents; fruit S content and leaf and root S ($r=0.81$, 0.82 respectively) contents; root S content and fruit K ($r=0.83^{***}$), root Mg ($r=0.92^{***}$), and K ($r=0.87^{***}$) content; and root Mg and leaf Ca ($r=0.83^{***}$), S ($r=0.81^{***}$), fruit K ($r=0.82^{***}$), and S content ($r=0.89^{***}$). In addition, there was a strong positive correlation observed between leaf S and stem S content ($r=0.91^{***}$) (Figure 1). On the other hand, weak positive correlations were observed between leaf Ca and stem S contents ($r=0.48^*$); leaf Mg and root S contents ($r=0.47^*$); leaf S and stem N and K contents ($r=0.49^*$). In addition, there was a weak correlation between root Mg, Ca and S contents and fruit Ca ($r=0.48^*$), root P ($r=0.49^*$) and stem N contents ($r=0.48^*$), respectively.

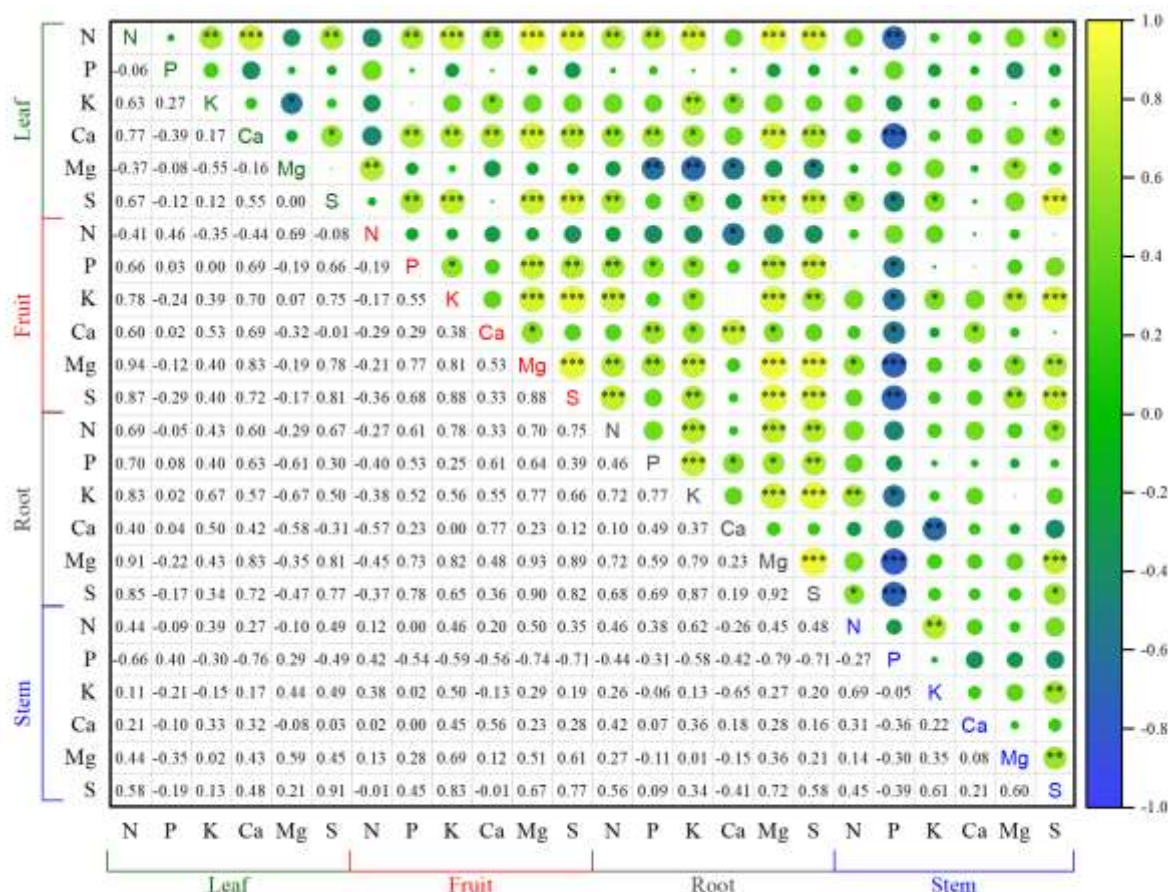

Figure 1. The correlations of mineral substances within different part of tomato plants under saline conditions

CONCLUSIONS

In this study, we aimed to investigate the physiological changes in tomato plants cultivated with varying concentrations of saline irrigation water. In this context we examined alterations in mineral content across the leaves, stems, fruits, and roots of the plants. The results revealed that the impact of salinity on mineral content within tomato plant organs varied depending on the growth period. Salinity stress led to decreases in N, P, K, and Ca content, while magnesium Mg and sulfur S levels increased. Furthermore, it was concluded that there were positive and negative correlations between the minerals in the plant organs. The strongest positive correlation was observed between leaf N content and fruit Mg content ($r = 0.94^{***}$). In contrast, the weakest correlations were identified between stem N and root S content ($r = 0.48^*$), as well as between leaf Ca and stem S content ($r = 0.48^*$). The strongest negative correlation was between root Mg and stem P content ($r = -0.79^{***}$), while the weakest negative correlation was between leaf Mg content and root S content ($r = -0.47^*$). Salt compounds entering the plant are harmful to the plant when they exceed a certain concentration depending on their type and amount. Salinity is known to be toxic to plants by disrupting nutrition and metabolism (Ekmekçi et al., 2005). Since the differences in the mineral content of tomato plants due to salinity have a direct effect on yield and quality, plant nutrition should be given special attention when growing under saline conditions.

REFERENCES

- Akay Rastgeldi, Z.H., 2010. Biberde Farklı Tuz Konsantrasyonlarının Bazı Fizyolojik Parametreler ile Mineral Madde İçeriği Üzerine Etkisi. Harran Üniversitesi.
- Alian, A., Altman, A., Heuer, B., 2000. Genotypic difference in salinity and water stress tolerance of fresh market tomato cultivars. *Plant Sci.* 152, 59–65. [https://doi.org/10.1016/S0168-9452\(99\)00220-4](https://doi.org/10.1016/S0168-9452(99)00220-4)
- Aziz, I., Khan, M.A., 2001. Experimental assessment of salinity tolerance of *Ceriops tagal* seedlings and saplings from the Indus delta, Pakistan. *Aquat. Bot.* 70, 259–268. [https://doi.org/10.1016/S0304-3770\(01\)00160-7](https://doi.org/10.1016/S0304-3770(01)00160-7)
- Del Amor, F.M., Martinez, V., Cerdá, A., 2001. Salt tolerance of tomato plants as affected by stage of plant development. *HortScience* 36, 1260–1263. <https://doi.org/10.21273/hortsci.36.7.1260>
- Doğru, A., Canavar, S., 2020. Bitkilerde Tuz Toleransının Fizyolojik ve Biyokimyasal Bileşenleri. *Acad. Platf. J. Eng. Sci.* 155–174. <https://doi.org/10.21541/apjes.541620>
- Ekmekçi, E., Apan, M., Kara, T., 2005. Tuzluluğun Bitki Gelişimine Etkisi. *OMÜ Zir. Fak. Derg.* 20, 118–125.
- Erba, D., Casiraghi, M.C., Ribas-Agustí, A., Cáceres, R., Marfà, O., Castellari, M., 2013. Nutritional value of tomatoes (*Solanum lycopersicum* L.) grown in greenhouse by different agronomic techniques. *J. Food Compos. Anal.* 31, 245–251. <https://doi.org/10.1016/j.jfca.2013.05.014>
- FAO, 2023. FAOSTAT-Crops and livestock products [WWW Document]. <https://www.fao.org/faostat/en/#data/QCL/visualize>. URL
- Hepler, P.K., 2005. Calcium: A central regulator of plant growth and development. *Plant Cell.* <https://doi.org/10.1105/tpc.105.032508>
- Karaca, C., Aslan, G.E., Buyuktas, D., Kurunc, A., Bastug, R., Navarro, A., 2023. Effects of Salinity Stress on Drip-Irrigated Tomatoes Grown under Mediterranean-Type Greenhouse Conditions. *Agronomy* 13, 36. <https://doi.org/10.3390/agronomy13010036>
- Kjeldahl, J., 1883. Neue Methode zur Bestimmung des Stickstoffs in organischen Körpern. *Zeitschrift für Anal. Chemie* 22, 366–382. <https://doi.org/10.1007/BF01338151>
- Maas, E.V., Hoffman, G.J., 1977. Crop Salt Tolerance—Current Assessment. *J. Irrig. Drain. Div.* 103, 115–134. <https://doi.org/10.1061/JRCEA4.0001137>
- Noshadi, M., Fahandej, S., Sepaskhah, A.R., 2013. Effects of salinity and irrigation water management on soil and tomato in drip irrigation. *Int. J. Plant Prod.* 7, 295–312.
- Oron, G., 2003. Agriculture, water and the environment: future challenges, in: *Water Science and Technology: Water Supply*. IWA Publishing, pp. 51–57.
- Parida, A.K., Das, A.B., 2005. Salt tolerance and salinity effects on plants: A review. *Ecotoxicol. Environ. Saf.* 60, 324–349. <https://doi.org/10.1016/j.ecoenv.2004.06.010>
- Peck, R., Devore, J.L., 2012. *Statistics: The Exploration and Analysis of Data*, 7th Editio. ed. Brooks / Cole.
- Singh, A., 2015. Poor quality water utilization for agricultural production: An environmental perspective. *Land use policy* 43, 259–262.
- Singh, J., Sastry, E.V.D., Singh, V., 2012. Effect of salinity on tomato (*Lycopersicon esculentum* Mill.) during seed germination stage. *Physiol. Mol. Biol. Plants* 18, 45–50. <https://doi.org/10.1007/s12298-011-0097-z>
- Tanveer, K., Gilani, S., Hussain, Z., Ishaq, R., Adeel, M., Ilyas, N., 2020. Effect of salt stress on tomato plant and the role of calcium. *J. Plant Nutr.* 43, 28–35. <https://doi.org/10.1080/01904167.2019.1659324>
- Tuteja, N., Mahajan, S., 2007. Calcium signaling network in plants: An overview. *Plant Signal. Behav.* <https://doi.org/10.4161/psb.2.2.4176>

INVESTIGATION OF THE EFFECT OF PHAGE APPLICATION ON ANTIBIOTIC RESISTANCE LEVELS OF MULTIDRUG-RESISTANT ESCHERICHIA COLI ISOLATES

Ayçe Fadime DÜZENLİ¹, Gizem ÇUFAOĞLU¹

¹Kırıkkale University, Faculty of Veterinary Medicine, Department of Food Hygiene and Technology, Kırıkkale, Türkiye

Corresponding author e-mail: gizemcufaoglu@kku.edu.tr

ABSTRACT

Bacteriophages are defined as viruses that infect bacteria. Phages have started to gain importance again because of the increase in antibiotic-resistant bacteria due to the widespread and misuse of antibiotics. These natural killers of bacteria are used in many areas, and the use of phages in combination with antibiotics is an application that has come to the fore in recent years to achieve synergy. This study aimed to investigate the effect of phage application on antibiotic resistance levels of multidrug-resistant *Escherichia coli* isolates. Five antibiotics (ampicillin, fosfomycin, nitrofurantoin, tobramycin, and chloramphenicol) belonging to different antibiotic groups, three lytic phages (M8A, M11A, and M12A) isolated from previous studies, and multi-antibiotic resistant *E. coli* and *E. coli* O157 strains isolated from cattle and chicken were used. Three experimental groups were formed; the *control group*, which was not treated with the phage cocktail; the *phage group*, in which the phage cocktail and bacteria were treated simultaneously; and the *phage mutant group*, which consisted of survivors after treatment with the phage cocktail. Minimal inhibition concentration (MIC) values of the isolates after treatments were determined using the broth microdilution method. According to the results, all *E. coli* O157 isolates were sensitized in the fosfomycin phage group and also in the chloramphenicol phage and phage mutant groups. All strains resistant to nitrofurantoin in the phage group became sensitized in generic *E. coli* isolates. However, MIC values were significantly increased in the phage group in all ampicillin-resistant strains. For tobramycin, MIC values were increased in all isolates in the phage group, while sensitization was detected in the phage mutant group. As a result, it was determined that the combinations of phages and antibiotics caused sensitization in phenotypic antibiotic resistance in multidrug-resistant *E. coli*, but the synergistic effect of phage and antibiotics showed great variability according to the strain and antibiotic. Further molecular studies are needed to elucidate the mechanisms of phage-antibiotic synergism clearly.

Keywords: Bacteriophage, antibiotic resistance, minimal inhibition concentration

INTRODUCTION

Bacteriophages were first discovered by d'Herelle in the early 1900s and successfully used for treatment in a child with dysentery (Roy and Yusuf, 2013; Keen, 2015). With the discovery of antibiotics in the 1930s, the interest in bacteriophages decreased, but the increase in antibiotic-resistant bacteria due to the widespread and misuse of antibiotics caused it to become one of today's biggest problems. The emergence of antibiotic-resistant modified pathogens such as *Mycobacterium tuberculosis*, *Enterococcus faecalis*, *Acinetobacter baumannii*, *Pseudomonas aeruginosa*, colistin-resistant *Escherichia coli*, and methicillin-resistant *S. aureus* creates major problems in the treatment of patients in hospitals (Coelho et al., 2004; Hanlon, 2007; Burrowes et al., 2011). It has become necessary to find alternatives to

antibiotics due to several factors. These include the decrease in the effectiveness of antibiotics, the emergence of resistance mechanisms in bacteria, the limited discovery and production of new antibiotics, and inadequate studies to prevent resistance. In this context, bacteriophages have gained importance again in recent years (Tagliaferri, Jansen and Horz, 2019). These natural killers of bacteria are used in many areas, such as biological control of foodborne pathogens, phage therapy, bio-sanitation (Endersen and Coffey, 2020). The use of phages in combination with antibiotics is an application that has come to the fore in recent years and has been applied in various case studies (Abedon, 2019). Specifically, studies on the sensitization of antibiotic-resistant bacteria by creating a synergistic effect of the combination of antibiotics and bacteriophages are increasing (Abhilash, Vidya, Jagadevi, 2008; Torres-Barceló, 2018). In this study, it was aimed to investigate the effect of phage application on antibiotic resistance levels (ampicillin, fosfomycin, nitrofurantoin, tobramycin, and chloramphenicol) of multidrug-resistant *Escherichia coli* isolates by using the microdilution method.

MATERIAL AND METHOD

Bacterial strains and bacteriophages

In the study, P21x, P67b, P91, and P106 generic *E. coli* isolates isolated from chicken neck skin (Cufaoglu et al., 2022) and 120GA, 180KD, 19RA and 10KoKC *E. coli* O157 isolates isolated from cattle carcass swabs (Ayaz et al., 2015) were used as the test microorganisms. The resistance profiles of the isolates were previously reported by Cufaoglu et al. (2022). In addition, three bacteriophages (M8A, M11A, and M12A) with lytic activity against *E. coli*, previously isolated from slaughterhouse wastewater were used (Gencay et al., 2016).

Determination of phage activities

Before starting the Minimal Inhibition Concentration (MIC) study, the lytic effect of bacteriophages on the test *E. coli* strains selected for use in the study was checked using the spot test method on double-layer LB agar (Figure 1) (Gencay et al., 2016).

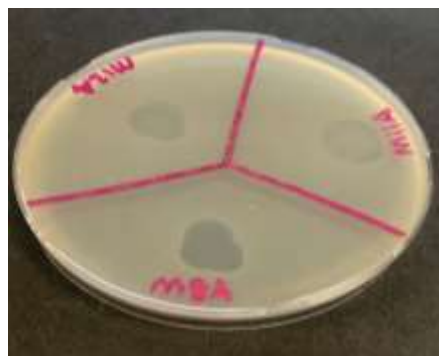

Figure 1. **Plaque image of M8A, M11A, and M12A phages in the *E. coli* ATCC 43895 reference strain.**

Minimal Inhibition Concentration (MIC) Test

Ampicillin, tobramycin, fosfomycin, chloramphenicol, and nitrofurantoin antibiotics, which belonged to five different antibiotic classes, were used. MIC values of antibiotics according to EUCAST (European Committee on Antimicrobial Susceptibility Testing) (2022) standards are given in Table 1.

Table 1. MIC values ($\mu\text{g/ml}$) of antibiotics specified for *Enterobacterales* according to EUCAST (2022) standards.

Group	Antibiotic	MIC values	
		S \leq	R $>$
Penicillin	Ampicillin	8	8
Phosphonic	Fosfomycin	8	8
Aminoglycoside	Tobramycin	2	2
Nitrofurantoin	Nitrofurantoin	64	64
Phenicol	Chloramphenicol	8	8

S: susceptible, R: resistant

In order to determine the effect of the bacteriophage cocktail on the antibiotic resistance of *E. coli* strains, the MIC values of the isolates were determined using the broth microdilution method specified in the international standards of CLSI (Clinical and Laboratory Standards Institute) (2018). In the study, three groups were formed: the *control group*, which was not treated with phage, the *phage group* in which the phage and bacteria were treated simultaneously, and the *phage mutant group*, which was formed by the survivors after treatment with phage. For the phage group, a phage cocktail was obtained by mixing equal volumes of three phages (M8A, M11A, and M12A) (10^{10} pob/ml), and their appropriate dilutions were made. Instead of 100 μl bacteria, 50 μl bacteria (10^5 cfu/ml) and 50 μl phage cocktail (10^7 pob/ml) were added to the wells (MOI 100). In the phage mutant group, phage-resistant bacterial cells that could survive after treatment with phage were used. For this purpose, after the active test bacteria (10^2 cfu/ml) phage cocktail (10^{10} pob/ml) was incubated overnight at 37°C , phage mutant bacteria were separated from the medium by centrifugation. Subsequently, the obtained bacteria were used in the MIC test. The test was performed in three parallel repetitions.

RESULTS AND DISCUSSION

According to the results, it was determined that all *E. coli* O157 isolates were sensitized in the fosfomycin *phage group* and in the *phage mutant group* with chloramphenicol. It was determined that all the strains resistant to nitrofurantoin in the *phage group* became sensitized in generic *E. coli* isolates. However, MIC values were significantly increased in the *phage group* in all ampicillin-resistant strains. For tobramycin, an increase in MIC values was observed in all isolates in the *phage group*, while sensitization was detected in the *phage mutant group*. The MIC values and resistance profiles of the isolates after phage cocktail administration are shown in Table 2.

Table 2. MIC values and resistance profiles of *E. coli* isolates.

	Control Group (µg/ml)					Phage Group (µg/ml)					Phage Mutant Group (µg/ml)				
	AMP	FM	N	TOB	CPL	AMP	FM	N	TOB	CPL	AMP	FM	N	TOB	CPL
P21x	2048	32	128	128	512	>8192	16	256	>256	>1024	256	128	64	32	512
P91	4096	16	128	128	256	>8192	32	128	>256	512	512	64	64	32	512
P67b	4096	128	32	256	512	>8192	2	16	256	8	8	64	32	8	8
P106	1024	16	256	2	512	>8192	64	128	32	64	32	32	64	2	128
120GA	8	64	64	1	16	8	2	32	8	1	8	256	64	1	8
19KA	2048	16	64	4	32	>8192	2	64	2	1	128	64	64	4	8
180KD	4096	128	64	256	512	>8192	1	16	256	1	8	128	64	8	8
10Ko	4096	16	64	4	16	>8192	2	64	8	1	256	64	64	2	8

	Control Group					Phage Group					Phage Mutant Group				
	AMP	FM	N	TOB	CPL	AMP	FM	N	TOB	CPL	AMP	FM	N	TOB	CPL
P21x	R	R	R	R	R	R	R	R	R	R	R	R	S	R	R
P91	R	R	R	R	R	R	R	R	R	R	R	R	S	R	R
P67b	R	R	S	R	R	R	S	S	R	S	S	R	S	R	S
P106	R	R	R	S	R	R	R	R	R	R	R	R	S	S	R
120GA	S	R	S	S	R	S	S	S	R	S	S	R	S	S	S
19KA	R	R	S	R	R	R	S	S	S	S	R	R	S	R	S
180KD	R	R	S	R	R	R	S	S	R	S	S	R	S	R	S
10Ko	R	R	S	R	R	R	S	S	R	S	R	R	S	S	S

AMP: ampicillin; FM: fosfomycin; N: nitrofurantoin; TOB: tobramycin; CLP: chloramphenicol

The results of the study revealed that the combinations of phage and antibiotics varied according to the strain and the antibiotic. Other researchers have reported similar results. For example, in an *in-vitro* study conducted by Lin et al. (2018), the interaction of *Pseudomonas aeruginosa* between phage and antibiotics was investigated, and it was determined that the synergy was dependent on both the strain and the antibiotic. In the study, a lytic phage and ciprofloxacin, amikacin, and colistin were used separately and in combination against the clinical strain of *P. aeruginosa* and a synergistic effect was observed. However, complete inhibition of bacterial growth occurred only when the phage was combined with ciprofloxacin. In contrast, in another clinical *P. aeruginosa* strain, no synergistic effect was observed when the same phage was combined with amikacin, aztreonam, ciprofloxacin, colistin, or tobramycin (Lin et al., 2018). In another study, Jansen et al. (2018) reported that a T4-like phage (KARL-1) infecting the multidrug-resistant *Acinetobacter baumannii* strain showed significant synergy with meropenem but more moderate synergy with ciprofloxacin or colistin. In this thesis study, the most significant increase in MIC value was observed in ampicillin and tobramycin in groups where phage and antibiotic were administered simultaneously. The opposite sensitization was observed in the phage mutant groups of these antibiotics. Ampicillin inhibits cell wall synthesis by causing a blockade of the transpeptidase enzyme (Bereda, 2022). Conversely, tobramycin causes inhibition of protein biosynthesis by irreversible binding of aminoglycoside to the 30S subunit of the bacterial ribosome. Obtaining similar results, regardless of strain, against two antibiotics that act in different mechanisms in the study can indicate that phage-antibiotic combinations are antibiotic-dependent.

In this study, it was observed that the effect of phage and antibiotics also varied depending on the strain. For example, it was observed that the MIC values of the generic *E. coli* strains in the phage mutant group in nitrofurantoin decreased, and they went from resistant to sensitized.

It was determined that the MIC values of *E. coli* O157 strains of the same group did not change. Nitrofurantoin acts on bacteria by inhibiting various enzymes, damaging protein synthesis and genetic material (McOsker, 1994). The fact that phage mutant *E. coli* O157 strains are more pathogenic than generic strains and are more capable of surviving phage treatment may influence the profile of resistance to nitrofurantoin. However, simultaneous treatment of phage and antibiotic for fosfomycin caused sensitization in *E. coli* O157 isolates, while an increased MIC value was noted in *E. coli* O157 in the phage mutant group. Considering that fosfomycin inhibits cell wall synthesis by inhibiting peptidoglycan synthesis (Falagas et al., 2016), it may be possible that the simultaneous presence of phage and antibiotic may cause bacterial sensitization due to cell wall synthesis blockade. In phage mutant bacteria, on the other hand, resistance was slightly increased in those that survived due to the selective stress brought by the phage. It was observed that the sensitivity of *E. coli* O157 strains increased, and MIC values decreased in chloramphenicol. However, unlike fosfomycin, sensitization was observed in both phage and phage mutant groups in chloramphenicol. Although the decrease in MIC values in the phage group was higher than in the phage mutant group, the increased sensitivity in both groups suggests that chloramphenicol is related to the inhibition of protein synthesis of the cell by blocking the peptidyl transferase enzyme (Oong et al., 2022).

Many studies have been carried out in recent years to determine the synergistic effect of various phages and antibiotics. These studies show that the use of phages with antibiotics increases the effect of antibiotics and is effective in preventing bacterial resistance. Engeman et al. (2021) used a combination of ceftazidime, ciprofloxacin, gentamicin, and meropenem to determine whether a cocktail consisting of five phages showing lytic effects against *P. aeruginosa* increases antibiotic activity. The investigators found that *in-vitro* combination therapy caused a significant increase in the susceptibility of multi-resistant strains to antibiotics and reported that treatment with ceftazidime, meropenem, gentamicin, or ciprofloxacin in the presence of phages increased the number of *P. aeruginosa* susceptible to these antibiotics in 63%, 56%, 31%, and 81%, respectively. In addition, in a mouse dorsal wound model, seven out of eight mice treated with a combination of ceftazidime and phage cocktail for three days had no detectable bacteria in their wounds at day 4, whereas it was detected that all mice treated with ceftazidime alone or a phage cocktail had $\sim 10^7$ cfu bacteria at the wound site. The researchers also tested *P. aeruginosa* bacteria isolated from post-treatment mouse wounds in a waxworm model and observed reduced virulence. Treatment with a phage cocktail in combination with antibiotics has been reported to result in both resensitization of *P. aeruginosa* to antibiotics *in-vitro* and a synergistic reduction in bacterial load *in-vivo*.

There are various mechanisms behind the phage-antibiotic synergy (Segall et al., 2019). In a study by Tkhilaishvili et al. (2018) on the synergy between phage therapy (SB-1) and antibiotics against vegetative and biofilm forms of methicillin-resistant *Staphylococcus aureus* (MRSA), it was reported that antibiotics are effective in killing the vegetative form but ineffective in killing the cells in the biofilm. However, combinations of phages with certain antibiotics markedly reduced bacterial growth within biofilms. The study reported that the simultaneous use of phage SB-1 with rifampin or daptomycin resulted in the synergistic killing of cells within biofilms. It was concluded that pretreatment of planktonic or biofilm-forming cells with phage SB-1 followed by a combination with any of the five antibiotics tested (rifampin, daptomycin, fosfomycin, ciprofloxacin or vancomycin) was more effective than co-treatment in synergistically inhibiting bacterial growth. Researchers have also reported that phage SB-1 not only disrupts the exopolysaccharide component of the MRSA strain biofilm but also reduces the titer of metabolically inactive cells such as stationary phase cells or persisters (Tkhilaishvili et al., 2018). These results are of particular interest, as some phages lyse only actively growing bacterial cells.

CONCLUSIONS

In this study, it was determined that combinations of phages and antibiotics caused sensitization in phenotypic antibiotic resistance in strains with multi-antibiotic resistance, but the synergistic effect of phage and antibiotics showed great variability according to the strain and antibiotic. However, further molecular studies are required to elucidate the mechanisms of phage-antibiotic synergism clearly. Along with antibiotics, phages can potentially prolong the effective life of antibiotics in our 'pharmaceutical arsenal', broaden the spectrum of these drugs, and greatly reduce the burden of last-resort drugs and preserve them for future use. By exploiting the synergistic effect of phages and antibiotics, it is envisaged not only to increase clinical efficacy against multi-antibiotic-resistant bacteria but also to slow or reverse the incidence of antibiotic-resistant bacterial pathogens potentially.

ACKNOWLEDGEMENT

This article contains the findings of Ayçe Fadime DÜZENLİ's Master thesis at Kırıkkale University Institute of Health Sciences, Department of Food Hygiene and Technology.

REFERENCES

- Abedon ST. 2019. Phage-antibiotic combination treatments: antagonistic impacts of antibiotics on the pharmaco- dynamics of phage therapy?. *Antibiotics (Basel)*. 8(4): 182.
- Abhilash M, Vidya Ag, Jagadevi T. 2008. Bacteriophage Therapy: A War Against Antibiotic Resistant Bacteria. *The Internet Journal of Alternative Medicine*, 7: 1-5.
- Ayaz ND., Gencay YE., Erol I. 2015. Phenotypic and genotypic antibiotic resistance profiles of *Escherichia coli* O157 from cattle and slaughterhouse wastewater isolates. *Annals of Microbiology*, 65(2), 1137–1144.
- Bereda G. 2022. Clinical Pharmacology of Ampicillin. *Journal of Pharmaceutical Research & Reports*. SRC/JPRSR-141.
- Burrowes B., Harper DR., Anderson J., McConville M., Enright MC. 2011. Bacteriophage therapy: potential uses in the control of antibiotic-resistant pathogens. *Expert review of anti-infective therapy*, 9(9), 775-785.
- Coelho J, Woodford N, Turton J, Livermore DM. 2004. Multiresistant *Acinetobacter* in the UK, pp. how big a threat? *Journal of Hospital Infection* 58: 167–169.
- Cufaoglu G., Cengiz G., Onaran B., Yesilkaya B., Ayaz ND., Levent G., Goncuoglu M. 2022. Antibiotic, heavy metal and disinfectant resistance in chicken, cattle, sheep *E. coli* isolates and whole-genome sequencing of a multidrug resistant *E. coli* O100:H25 strain. *Journal of Food Safety*, 42(5): e12995.
- Endersen L. 2020. Coffey A. The use of bacteriophages for food safety, *Curr Opin Food Sci*. 36: 1-8.
- Engeman E, Freyberger HR, Corey BW, Ward AM, O Y, Nikolich MP, Filippov AA, Tyner SD, Jacops AC. 2021. Synergistic killing and re-sensitization of *Pseudomonas aeruginosa* to antibiotics by phage-antibiotic combination treatment. *Pharmaceuticals*. 14(3): 184
- Falagas ME, Vouloumanou EK, Samonis G, Vardakas KZ. 2016. Fosfomycin. *Clin Microbiol Rev*. Apr;29(2):321-47.
- Gencay YE., Ayaz ND., Copuroglu G., Erol I. 2016. Biocontrol of Shiga Toxigenic *Escherichia coli* O157: H7 in Turkish Raw Meatball by Bacteriophage. *Journal of Food Safety*, 36(1), 120-131.
- Hanlon GW. 2007. "Bacteriophages: an appraisal of their role in the treatment of bacterial infections". *International Journal of Antimicrobial Agents* 30(2), 118-128,
- Jansen M., Wahida A., Latz, S., Krüttgen, A., Häfner, H., Buhl, EM., Horz, HP. 2018. Enhanced antibacterial effect of the novel T4-like bacteriophage KARL-1 in combination with

- antibiotics against multi-drug resistant *Acinetobacter baumannii*. *Scientific reports*, 8(1), 14140.
- Keen EC. 2015. A century of phage research: bacteriophages and the shaping of modern biology. *Bioessays*. 37(1) 6–9.
- Lin Y., Chang RYK., Britton WJ., Morales S., Kutter E., Chan, HK. 2018. Synergy of nebulized phage PEV20 and ciprofloxacin combination against *Pseudomonas aeruginosa*. *International journal of pharmaceutics*, 551(1-2), 158-165.
- McOsker CC. 1994. Fitzpatrick PM. Nitrofurantoin: mechanism of action and implications for resistance development in common uropathogens, *J Antimicrob Chemother.* vol. 33 Suppl A(pg. 23-30)
- Oong GC, Tadi P. 2023. Chloramphenicol. [Updated 2022 Jul 4]. In: *StatPearls* [Internet]. Treasure Island (FL): StatPearls Publishing.
- Roy S, Yusuf MA. 2013. Bacteriophage therapy: issues and controversies. *Bangladesh J Med Microbiol* 7(1) 25–8.
- Segall AM., Roach DR., Strathdee SA. 2019. Stronger together? Perspectives on phage-antibiotic synergy in clinical applications of phage therapy. *Current Opinion in Microbiology*. 51: 46-50
- Tagliaferri TL., Jansen M., Horz HP. 2019. “Fighting Pathogenic Bacteria on Two Fronts: Phages and Antibiotics as Combined Strategy.” *Frontiers in cellular and infection microbiology* vol. 9 22.
- Tkhilaishvili T., Lombardi L., Klatt AB., Trampuz A., Di Luca M. 2018. Bacteriophage Sb-1 enhances antibiotic activity against biofilm, degrades exopolysaccharide matrix and targets persisters of *Staphylococcus aureus*. *International journal of antimicrobial agents*, 52(6), 842-853.
- Torres-Barcelo C, Gurney J, Gougat-Barbera C, Vasse M, Hochberg ME. 2018. Transient negative effects of antibiotics on phages do not jeopardise the advantages of combination therapies. *FEMS Microbiol Ecol*;94(8).

A PRELIMINARY STUDY ON THE EFFECTS OF MANURE AND ADDITIONAL PHOSPHORUS FERTILIZER IN DIFFERENT RATIO ON FOUR-WINGED SALTBUSH

Nur Koç Koyun¹, Ayşegül Korkmaz²

¹ Selçuk University, Agriculture Faculty, Department of Field Crops, Konya, Türkiye

² Selçuk University, Agriculture Faculty, Department of Soil Science and Plant Nutrition, Konya, Türkiye

Corresponding author e-mail: nurkoc@selcuk.edu.tr

ABSTRACT

Pasture improvement is carried out worldwide by using shrub species in regions with marginal climate and soil structure, such as drought and salinity. The four-winged saltbush (*Atriplex canescens* (Pursh) Nutt.) belonging to the *Chenopodiaceae* family is one of the shrub species used in the world, especially in the improvement of pastures in arid regions, as it provides quality feed to animals by remaining green during the dry feed period. It is also used to reclamation saline soils by absorbing the salt in the ground. Various researchers have reported that phosphorus deficiency is observed in plants because agricultural soils of Türkiye generally contain high reaction and lime, low organic matter and especially in the pastures of Central Anatolia region because of the arid climate and low temperature, the diffusion coefficient in the soil decreases, and the plants cannot take phosphorus sufficiently. For this reason, in this study, which was established in three replications according to the randomized complete block design, manure and additional phosphorus fertilizer at different rates (Control, Manure (M), M + 40% P, M + 60% P, and M + 100% P) were applied to four-winged salt bushes. The study examined morphological characteristics such as plant height, canopy diameter, new shoot stem diameter, leaf length, and leaf width in the vegetative and generative stages of the four-winged saltbush. In addition, in this preliminary study, the N, P, and K contents of plants in the generative phase and the root contents of these elements at the end of the growing season were examined. In general terms, it can be stated that the morphological characteristics of plants grow more in the generative period than in the vegetative period. In addition, the highest plant height of 115 cm and the tallest plant diameter of 156.25 cm were obtained only from manure (M) applications in the generative period. As a result of the nutrient analysis of the samples taken from the young shoots of the plant during the generative period, the highest protein and N contents were obtained from M+60%P treatment with 18.63% and 2.98%, respectively, and the highest P content was obtained from manure (M) treatment with 0.31%. In the samples taken from the roots at the end of the growing season, the highest N content was obtained from M+60%P treatment with 2.49%, while the highest P content was obtained from manure (M) treatment with 0.357%. This situation can be explained by the fact that plants send the nutrients they produce at the end of the growing season to their reserve nutrient stores in the root zones. As a result of this study, which is a preliminary study for four-winged saltbush fertilization studies, it can be stated that only manure (M) application is sufficient to increase plant growth in phosphorus-deficient soils considering sustainability.

Keywords: Four-winged saltbush, Fertilizer, Manure, Pasture improvement, Phosphorus, Sustainability,

INTRODUCTION

The utilization of fodder plants in rangelands by mowing and grazing causes the nutrients taken by the plants to be depleted in the soil, and the continuation of this situation for many years causes nutrient deficiencies in the soil. This issue is among the factors that reduce pasture productivity (Çınar et al., 2018). For these reasons, Türkiye's pasture yield is approximately 70 kg da⁻¹, one-third of the world's pasture yield (Babalık and Fakir, 2017). In our country, herbaceous plants are primarily used in pasture improvement studies to increase pasture yield. However, the development of herbaceous species takes a long time, and it takes longer and more costly to achieve success in breeding. For this reason, pasture improvement is carried out by using shrub species in regions with marginal climate and soil structure, such as drought and salinity (Acar et al., 2013).

The four-winged saltbush (*Atriplex canescens* (Pursh) Nutt.) belonging to the *Chenopodiaceae* family is a C4 forage shrub. It is dioecious, and male and female flowers can be on different plants, or male and female organs can be found in the same flower (Tilley et al., 2012). The plant is a polymorphic species, evergreen in warm climates and deciduous in cold climates (Tan and Temel, 2012). *Atriplex* sp. species provide green fodder to animals during the dry feed period because they are green in the summer months in places where the Mediterranean climate is dominant. *A. canescens*, which grows well in arid and semi-arid areas, grows naturally in the arid regions of North America, from Mexico to Canada. In addition to these regions, it also grows in Australia and areas with a climate similar to the Mediterranean. Saltbush species are also widely cultivated in the Middle East (Erdoğan et al., 2013). In our country, in recent years, this plant has been included in pasture improvement in the Central Anatolia region, especially in Aksaray and Karaman. In addition, the four-winged saltbush shows salt resistance by accumulating sodium in its specialized salt sacs and thus can grow in saline and sodic soils (Yuan et al., 2016). With this feature, it can also be used in the reclamation of soils in marginal areas' rangelands with saline and boron toxicity.

Manure, which has an essential place in the fertilization of pastures due to its organic origin, is a widely applied pasture improvement method because it increases the organic matter content of the soil and ensures water retention in the soil (Bakır, 1985; Gregorich et al., 1994). In general, manure has high nitrogen content and low phosphorus content. Therefore, manure should be given to pasture areas with phosphorus (Bakır, 1985). Eyüpoğlu (1999) reported that phosphorus deficiency was observed in 58% of the soils of Türkiye. Therefore, it is crucial to supplement phosphorus by fertilization in agricultural production areas in our country. Phosphorus fertilizers increase the roughage rate of plants grown in the pasture (de Groot et al., 2003; Çomaklı et al., 2005). In addition, phosphorus fertilizers also affect the quality of the product and contribute to increasing the tolerance of plants to winter conditions and drought (Kantarıcı, 2000; McCauley et al., 2009; Kacar, 2020). When the effect of phosphorus fertilizers on soil was examined, it was found that phosphorus fertilizers that were not taken into the plant structure accumulated in the production areas and plants benefit from this phosphorus accumulated in the soil in the following production period (Moschler et al., 1957). For this reason, as a preliminary study, which is the first of its kind in the region, this study was carried out to determine the effects of manure and different rates of phosphorus fertilizers added to manure on the botanical characteristics and nutrient content of the plant, and the organic matter and available phosphorus in the soil at the end of the growing season on four-winged saltbush grown under Konya conditions.

MATERIAL AND METHOD

Four-winged saltbush seedlings obtained from Konya Forest Nursery Directorate without tubes were grown with tubes in the greenhouse on February 5, 2020 (Figure 1). The plants were planted in S.U. Faculty of Agriculture Prof. Dr. Abdülkadir AKÇİN experimental field (Selçuklu- Konya) on November 15, 2020, with a row spacing of 3 m and a row spacing of 3 m (Erdoğan et al. 2013). Parcel spacing was adjusted to be 1 m. Our study was planned as a preliminary study to determine the responses of four-winged saltbush plants to fertilizer, and each parcel contained one plant due to the limited supply of the plant (Karimi et al., 2021). In this experiment, which was established with three replications according to the Randomized Complete Block Design (RCBD), fertilization was carried out on December 29, 2020, during the period of rainfall by following the meteorological data due to changing climatic conditions (Acar et al., 2020). According to the long-term climate average (1990-2019), total precipitation is 330 mm; 290 mm was recorded in the planting year (2020), and 360 mm in 2021. However, the long-term climate mean of monthly average temperatures is at 11,8 °C, in the planting year (2020) was reported at 13,1 °C, and 12,5 °C is in the harvest year (2021).



Figure 1. Images of plants grown in the greenhouse, planted in the field, and after fertilization.

In the research, a mixture of sheep and cattle manure was used as manure with a moisture content of 5.27%. The chemical content of the barnyard manure used in the research is given in Table 1, and the soil analysis results are shown in Table 2.

Table 1. The result of fertilizer analysis used in the experiment.

Parameters	Value	Parameters	Value
pH	7.09	EC(mS cm ⁻¹)	7.90
Organic Matter (%)	6.41	Total N (%)	8.53
Water Soluble Ca	1427	Total Ca	76832
Water Soluble K	29413	Total K	30460
Water Soluble Mg	444	Total Mg	6677
Water Soluble P	2127	Total P	5047
Water Soluble B	43	Total B	53
Water Soluble Cu	5	Total Cu	25
Water Soluble Fe	45	Total Fe	4912
Water Soluble Zn	6.00	Total Zn	86

Table 2. Soil analysis results of the trial area

Parameters	Values	Parameters	Values
Texture class	Clay Loam	Available K (mg kg ⁻¹)	144
pH	7.54	Extractable Na mg kg ⁻¹	36
EC (μS cm ⁻¹)	290	Extractable Mg (mg kg ⁻¹)	239
Lime (%)	43	Extractable Ca (mg kg ⁻¹)	4229
Organic Matter (%)	1.43	Available Zn (mg kg ⁻¹)	1.39
Inorg. N (NH ₄ + NO ₃ -N) (mg kg ⁻¹)	17.40	Available Fe (mg kg ⁻¹)	4.39
Available P (mg kg ⁻¹)	6.30	Available Mn (mg kg ⁻¹)	15.41
Available B (mg kg ⁻¹)	0.90	Available Cu (mg kg ⁻¹)	1.38

The preliminary study applied six treatments (control, manure (M), M + 40%, M + 60% P, M + 80%, and M + 100% P). Since Bakır (1985) recommended 1.0 t da⁻¹ of manure for pastures, this amount was applied to the crown projections of four-winged saltbushes according to the application subjects. In addition, 5 kg P₂O₅ da⁻¹ phosphorus application for four-winged saltbush was used with TSP (Triple superphosphate) at 100% phosphorus level, and the rates of other levels were adjusted and applied according to this value. In the study, irrigation was done once in July 2021, and hoeing was done twice during spring.

After awakening in spring, some morphological characteristics were examined during the vegetative period (June 2021) and the flowering and transition to the generative period (August 2021). In addition, to determine the nutrient content of the plants during the generative period, plant leaves that had just completed their development during the transition to the generative period just below the main branches or trunk and in full sunlight were taken as representative samples and subjected to certain pre-treatments (washing, drying, and grinding) to be used in the analyzes (Kacar, 2014). In addition, at the end of the growing season in November, root and soil samples were taken from the plant's rhizosphere at a depth of 30 cm to determine the nutrient content (Figure 2).

Morphological properties measurements carried out in the study are given below.

Plant height (PH) (cm): Without disturbing the natural state of the plant, the distance from the soil surface to the very tip of the stems was measured and recorded in cm.

Canopy diameter (CD) (cm): The longest and shortest diameters were measured without disturbing the plant's natural state, and the average value was determined as canopy diameter in cm.

New shoot stem diameter (NSSD) (mm): The stem thickness of the branch of 5 new shoots was measured with calipers and recorded in mm (Aygün and Olgun, 2018).

Leaf length (LL) (mm): The length of 5 leaves of the plant that had completed their development was measured and recorded in mm.

Leaf width (LW) (mm): The thickness of the widest part of the five leaves of the plant that had completed their development was measured with calipers and recorded in mm (Özköse, 2012).

Hay Yield (HY) (kg da⁻¹): Plant samples were taken based on 10-14% benefit of livestock from each plant, and the samples were kept in an oven at 58°C until they reached constant weight and their dry weights were found and calculated in kg da⁻¹ (Tamkoç, 1992; Mellado et al., 2012).

Chemical analysis in plants carried out in the study is given below.

Crude Protein Ratio (%): N content was determined in the LECO C/N analyzer according to Dumas Combustion Method given in AACC (2000). The crude protein ratio was recorded as % using the data obtained (N x 6.25) (Merrill and Watt, 1955).

Nutrients [P, K (%)]: 0.2 g of dried sample was weighed, 5 ml of HNO₃ and 2 ml of H₂O₂ were added and dissolved in the microwave. One NIST SRM 1573a leaf sample was added to the

40-cell microwave set as a witness and reference material to ensure the reliability of the analysis. The dissolved samples were made up to 20 ml with distilled water, and the samples were filtered through blue banded filter paper and the total P, K amounts in the filtrate were determined by ICP-OES (Kacar and Inal, 2010).

The soil analysis carried out in the study is given below.

Organic matter (%): After determining the organic carbon by the Walkey-Black method, it was multiplied by a coefficient of 1.724 (Tüzüner, 1990).

Available P ($mg\ kg^{-1}$): Determined by Olsen's $NaHCO_3$ method (Bayraklı, 1987).



Figure 2. Plant responses to fertilization in September 2021 (30.09.2021)

The data on morphological traits were analyzed in RCBD with two factors (Treatment and Period). The other characteristics were analyzed in RCBD with one factor (Treatment) in the JMP 7 package program, and the Tukey HSD test was performed for each significant trait (Sall et al.,2017).

RESULTS AND DISCUSSION

Results of Morphological Characteristics

The summary of the analysis of variance for the measurements taken within the scope of morphological traits of the research is given in Table 3, and the mean values of the interactions are presented in Figures 3-8. According to the results of the analysis of variance shown in Table 3, it was determined that the period factor was significant at a 1% level in all traits except leaf width. In addition, canopy diameter and leaf length were found to be statistically significant at 5% level, and other characteristics were found to be insignificant in terms of treatment factor. Treatment x period interaction was effective only in leaf length at 5% level, while this value was statistically negligible in other traits.

Table 3. The Summary of variance analysis (F value)***

Source of Variation	DF	PH	CD	NSSD	LL	LW	HY
Total	35						
Replication	2	0.68	0.26	2.38	2.19	0.04	1.31
Treatment (T)	5	2.12	2.98*	2.39	3.49*	2.30	1.99
Period (P)	1	48.75**	78.77**	20.44**	13.18**	0.75	44.91**
T*P	5	0.90	0.99	0.42	2.62*	0.07	0.65
Error	22						
CV (%)		13,43	23.51	18.86	21.59	30.20	31.56

*p<0.05; **p<0.01; ***PH: Plant Height, CD: Canopy Diameter, NSSD: New Shoot Stem Diameter, LH: Leaf Length, LW: Leaf Width, HY: Hay Yield

When the effects of manure and additional phosphorus ratios applied to four-winged saltbush on morphological characteristics were examined, it can be stated in general terms that the treatments increased the growth of plants in the generative period. The most extended plant height of 115.00 cm was obtained from manure (M) application in the generative period (Figure 3). Similarly, in terms of canopy diameter, the largest diameter was obtained from M treatment with 156.25 cm (Figure 4). When the averages of the treatments in terms of canopy diameter were analyzed, it can be stated that M was in group a with 115.63 and control was in group b with 69.38 cm (LSD: 42.81).

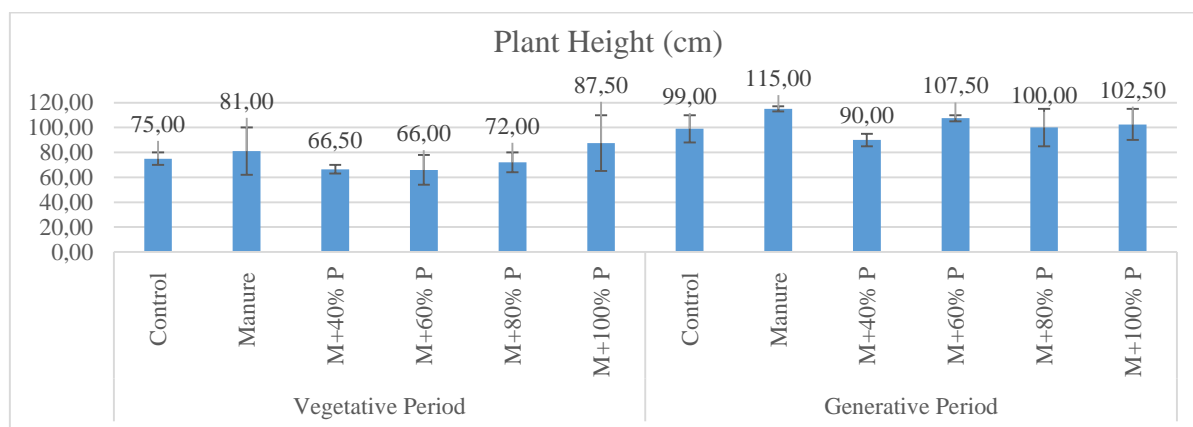

Figure 3. Plant height averages obtained in fertilizer applications to four-winged saltbush.

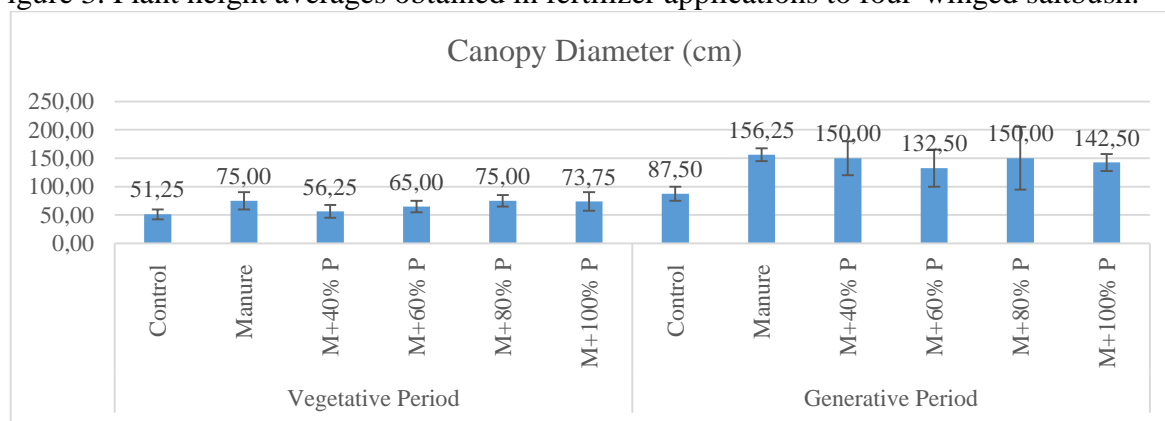

Figure 4. Canopy diameter averages obtained in fertilizer applications to four-winged saltbush

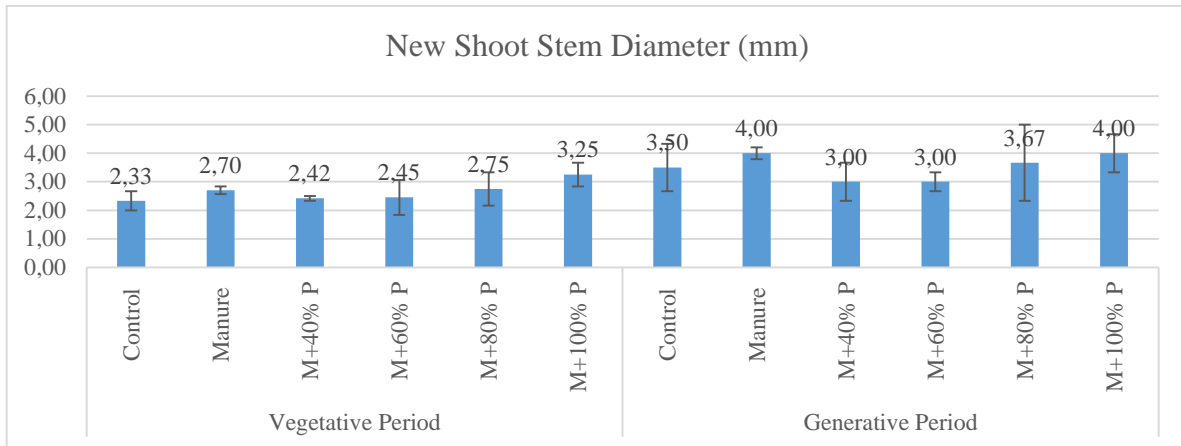

Figure 5. New shoot stem diameter averages obtained in fertilizer applications to four-winged saltbush.

When the effects of manure and additive phosphorus rates on the new shoot stem diameter of the four-winged saltbush were examined, it can be stated that M and M+100%P treatments had the largest diameter width of 4.00 mm in the generative period (Figure 5).

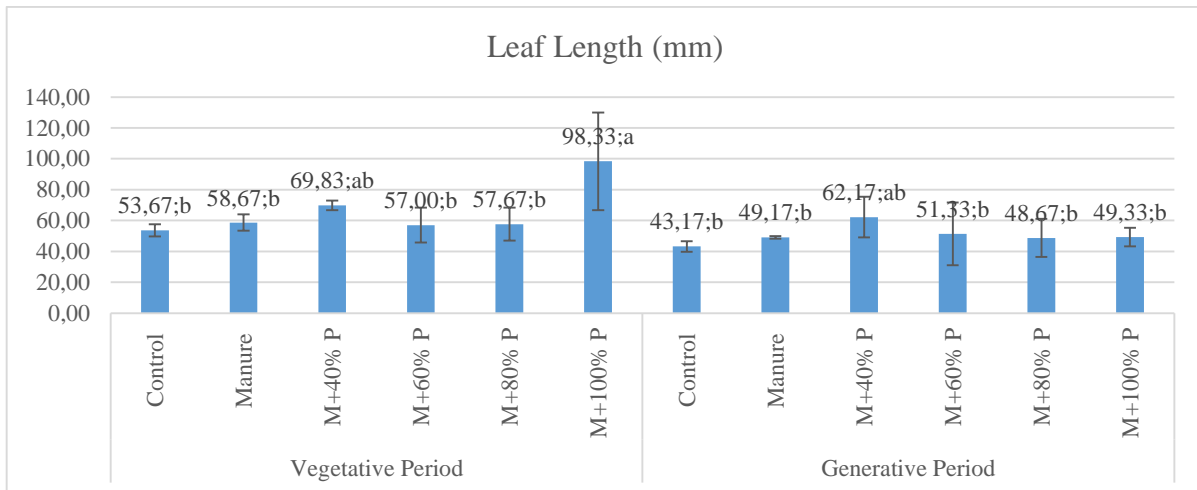

Figure 6. Leaf length averages obtained in fertilizer applications to four-winged saltbush (LDS: 37.36)

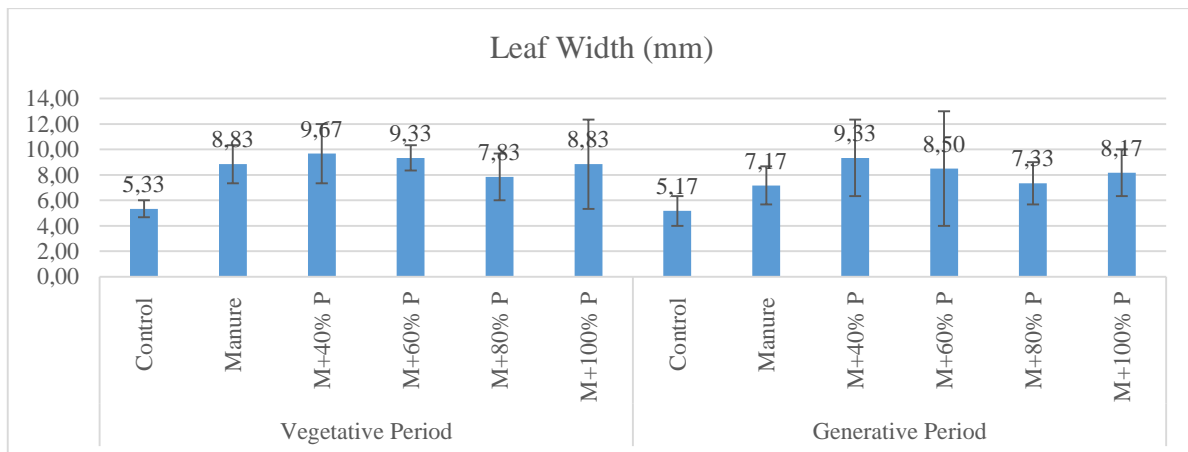

Figure 7. Leaf width averages obtained in fertilizer applications to four-winged saltbush.

According to Figure 6, in contrast to the other traits, the most extended value in leaf length (98.33 mm) was obtained from M+ 100% P treatments during the vegetative period (group a). In addition, the mean values of the treatments were statistically at a 5% significance level divided into two groups, and M+ 100% P application was in group a with 73.83 mm while the control group (48.42 mm) was in group b (LSD: 22.62). The highest value in leaf width was obtained in the vegetative period, and it was 9.67 mm in the M+40% P treatment (Figure 7).

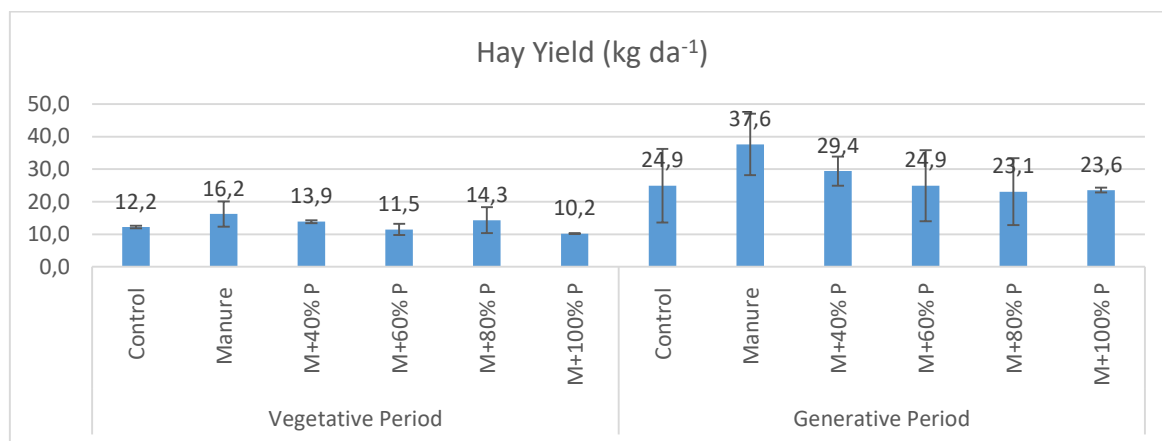

Figure 8. Hay yield averages obtained in fertilizer applications to four-winged saltbush.

The highest value of 37.6 kg da⁻¹ was obtained from M treatments in the generative period regarding hay yield. The fact that these yield values were obtained in August is of particular importance due to the limitation of plant species that can remain green and have high yields in that period.

Results of Nutrient Content in the Generative Period

According to the analysis of variance results of crude protein, N, P, and K contents investigated in the generative period in Table 4, except for K content, the other traits were found to be significant at a 1% level. When the mean values and groupings given in Table 5 are analyzed, it can be stated that M, M+60%P, M+80%P, and M+100%P treatments are in group A regarding crude protein and N content. Numerically, the highest value was obtained from M+60%P treatment with 18.63% crude protein and 2.98 mg kg⁻¹ N. However, the highest value in terms of phosphorus content was obtained from the M application with 0.31 mg kg⁻¹ (group A). The highest value in terms of potassium content was recorded from the M+40%P treatment.

Table 4. Analysis of variance’s summary of nutrient element contents analyzed in the generative period (F value)

Source of Variation	DF	Crude Protein	N	P	K
Total	17				
Replication	2	0.60	0.61	2.28	1.78
Treatment	5	17.34**	17.41**	9.99**	2.73
Error	10				
CV (%)		7.12	7.09	9.74	7.84

*:p<0.05; **p<0.01

Table 5. Mean values, standard error (SE), and groupings of nutrient element contents analyzed during the generative period.

	Crude Protein (%)	N (mg kg ⁻¹)	P (mg kg ⁻¹)	K (mg kg ⁻¹)
Control	11.62 ^B	1.86 ^B	0.18 ^C	4.05
M	18.27 ^A	2.92 ^A	0.31 ^A	3.80
M+40% P	14.45 ^{AB}	2.31 ^{AB}	0.22 ^{BC}	4.06
M+60% P	18.63 ^A	2.98 ^A	0.27 ^{AB}	3.70
M+80% P	17.99 ^A	2.88 ^A	0.25 ^{A-C}	3.38
M+100% P	17.82 ^A	2.85 ^A	0.26 ^{A-C}	3.50
SE	0.676	0.108	0.014	0.17
LSD	4.35	0.69	0.09	-

Results of Nutrient Content in Root at the End of the Growing Season

When the summary of the analysis of the variance table of N, P, and K contents in roots was analyzed, all traits were found to be statistically significant at a 1% level. At the end of the growing season, the highest value was obtained from M+60%P treatment with 2.49 mg kg⁻¹ in terms of nitrogen content in the root, while 0.36 mg kg⁻¹ P and 1.64 mg kg⁻¹ K content was determined from M treatment in terms of phosphorus and potassium content.

Table 6. Summary of analysis of variance for nutrient content in root at the end of the growing season (F value)

Source of Variation	DF	N	P	K
Total	17			
Replication	2	0.00	0.00	0.38
Treatment	5	2409.55**	137.48**	42.86**
Error	10			
CV (%)		1.68	4.93	14.21

*:p<0.05; **:p<0.01

Table 7. Mean values, standard error (SE), and groupings of nutrient contents in root at the end of the growing season

	N (mg kg ⁻¹)	P (mg kg ⁻¹)	K (mg kg ⁻¹)
Control	0.59 ^F	0.12 ^C	0.66 ^{CD}
M	1.64 ^D	0.36 ^A	1.64 ^A
M+40% P	1.81 ^C	0.23 ^B	1.36 ^{AB}
M+60% P	2.49 ^A	0.23 ^B	0.85 ^C
M+80% P	2.08 ^B	0.20 ^B	1.02 ^{BC}
M+100% P	0.78 ^E	0.24 ^B	0.19 ^D
SE	0.015	0.01	0.08
LSD	0.098	0.042	0.503

Soil Analysis Results at the End of the Growing Season

According to the soil analysis results given in Table 8, at the end of the growing season, the figures for soil organic matter and soil available P content were statistically significant at 1% level.

Table 8. Analysis of variance’s summary of soil analysis results at the end of the growing season (F value)

Source of Variation	DF	Organic Matter	Available P
Total	17		
Replication	2	0.21	0.58
Treatment	5	43.93**	25.14**
Error	10		
CV (%)		7.02	30.88

*:p<0.05; **p<0.01

When the organic matter remaining in the soil at the end of the growing season was analyzed, it can be interpreted that there may be an increase in the amount of soil organic matter after M + 80%P application with 2.75% (Figure 9).

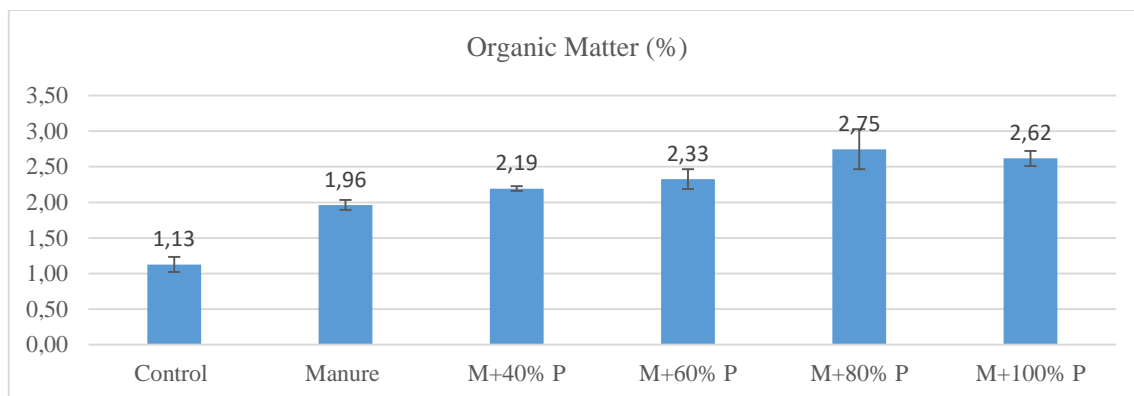

Figure 9. Means of soil organic matter at the end of the growing season (LSD: 0.564)

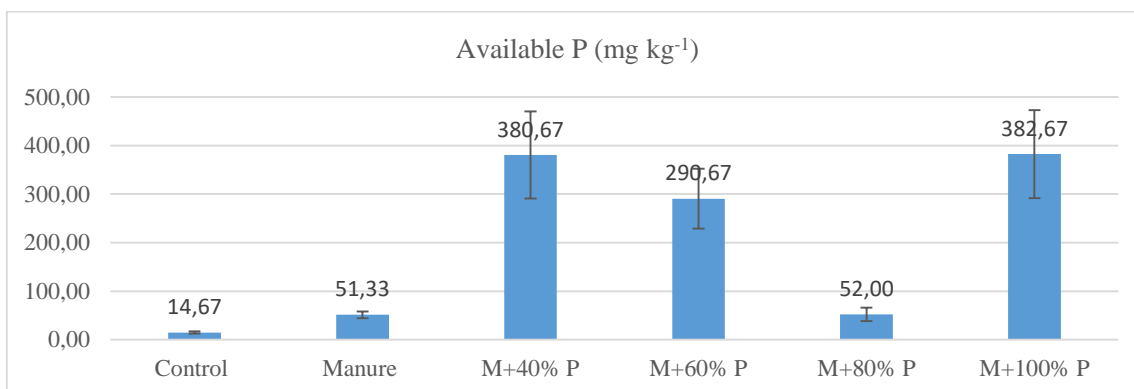

Figure 10. Means of available P in the soil at the end of the growing season (LSD: 223.86)

In terms of soil available P content, M + 100%P application ($382.67 \text{ mg kg}^{-1}$) had the highest value, but since the aim of this study was to target the utilization of the additional phosphorus by the plant, M with 51.33 mg kg^{-1} and M + 80%P with 52.00 mg kg^{-1} , which have lower values, stand out (Figure 10).

DISCUSSIONS

The four-winged saltbush has different levels of ploidy; the tetraploid ($2n=36$) and hexaploid ($2n=54$) species are short shrubs with a height between 60 and 150 cm and a leaf width between 5-10 mm, while the diploid ($2n=18$) species are between 100 cm and 300 cm tall and have a narrow leaf width (2-5 mm) (Le Hou rou, 2000). In addition, as the plant ages, the area covered by the plant on the soil increases. With this feature, it is one of the prominent plant groups in preventing erosion (Tan and Temel, 2012). The plant height ranging from 66.00 cm to 115.00 cm and leaf width ranging from 5.17 mm to 9.67 mm, which we obtained in our study, is close to the short shrub feature.

In northern Mexico, goats were grazed on control pastures and pastures where four-winged saltbush was predominant, and it was reported that there was a change in the diet of goats according to the seasons (spring, summer, fall) in 2007. In the study, in the pasture where saltbush was dominant, goats had an average of 58% four-winged saltbush in their diet, while this rate was 14% in the control parcel (Mellado et al., 2012). For this reason, while calculating the yield of four-winged saltbushes in our study, it was estimated by considering the utilization of the livestock between 10-15%. While 13.04 kg da^{-1} yield was obtained in the vegetative period, this value was recorded as 27.24 kg da^{-1} in the generative period (group A). In Montana, USA 1975, 535 kg ha^{-1} biomass was obtained in the greenhouse with nitrogen ($37 \text{ kg pure N ha}^{-1}$), phosphorus ($94 \text{ kg pure P ha}^{-1}$) fertilizers, and 67 kg ha^{-1} biomass was obtained with fertilization under field conditions. In the same study, 280 kg ha^{-1} biomass was obtained in the greenhouse, and 56 kg ha^{-1} biomass was obtained under field conditions in plots where fertilizer was not applied (Holechek, 1982). Four-winged saltbushes, which are not native plants of T rkiye, were grown from seeds brought from the USA in 2005 by the Ministry of Food, Agriculture and Livestock. Cuttings from these plants were planted at different planting distances (2 m and 3 m) in Eski ehir (Hamidiye) and Konya (Center and Karapınar) locations in our country in 2011. In the study, a dry leaf weight of 200 g plant^{-1} (22 kg da^{-1}) was obtained at a 3 m planting distance, and it was stated that a 3.0 m planting distance came to the fore in terms of yield. Regarding quality, the highest values were obtained at a 2.0 m planting distance with 18.8% crude protein (Erdođdu et al., 2013).

Ko  et al. (2020) examined the nutrient content of four winged saltbushes planted in 2013 in soil with low organic matter and insufficient P in Konya, T rkiye, 2017, during the dry feed period. The study stated that it contained 10.09% crude protein, 1.76% K, and 0.15% P.

Karimi et al. (2021), who studied the effect of nitrogen and phosphorous fertilizers on four-wing saltbush under saline conditions, stated that applying nitrogen at a rate of 25 and 50 kg ha^{-1} increased shoot fresh weight. However, the phosphorous application had no meaningful impact on the four-wing saltbush performance irrigated with saline waters. Nowadays, microbial fertilizers are gaining importance rather than chemical fertilizers. Noshad et al. (2022), who studied arbuscular mycorrhizal fungi on four-wing saltbush, reported that the application of AMF (*Funneliformis phosphorus*, *F. mosseae*) increased the plant growth variables such as stem diameter, root length, shoot dry weights, and shoot to root ratio as well as nitrogen and phosphorus uptakes in the root. The application of both AMF types was practical as compared to the control. However, *F. mosseae* indicated better performance, especially regarding the effect on plant growth variables.

In the samples taken from the roots at the end of the growing season, the highest N content was obtained from the M+60%P treatment with 2.49%, while the highest P content was obtained from the M treatment with 0.357%. This situation can be explained by the fact that plants send the nutrients they produce at the end of the growing season to the root zones, their reserve nutrient stores (Altın et al., 2011).

Due to the utilization of additional phosphorus by the plant in soil applications, low amounts of phosphorus were detected in the M application (51.33 mg kg⁻¹) and M+ 80% P application (52.00 mg kg⁻¹). In similar studies (Jat and Ahlawat, 2006; Alam et al., 2007; Makinde et al., 2011), it was stated that the phosphorus uptake from the soil increased with the effect of chemical fertilizers and organic fertilizers. It has been determined that applying chemical fertilizers and manure or only manure application is more effective because the manure mixed into the soil transforms the soil phosphorus and the phosphorus applied to the soil into a more useful form for the plants (Richardson, 2001). In another study that supports our findings, it was determined that organic fertilizer applications were more effective than chemical fertilizer applications, and it was stated that the presence of organic compounds may be due to the reduction or inhibition of phosphorus binding in the soil (Gatiboni et al., 2003).

CONCLUSIONS

In this study, manure and additional phosphorus fertilizer at different rates were applied to four-winged saltbush; it was determined that M and M+60% P treatments were prominent in terms of morphological characteristics and nutrient content. In contrast, the effect of M+80% P was significant in terms of organic matter in the soil at the end of the growing season. Still, the impacts of M and M+80%P treatments were substantial regarding available phosphorus. As a result of this study, which is a preliminary study for four-winged saltbush fertilization studies, it can be stated that only manure (M) application is sufficient to increase plant growth in phosphorus-deficient soils, considering sustainability. Considering the data obtained in the study, with the increase in organic compounds, they can be used together with chemical fertilizers, or they can be an alternative to chemical fertilizers. At the same time, they can cause a decrease in using chemical fertilizers.

According to the results of this preliminary study, in this and similar studies, because of the different responses of male and female plants to fertilizer, there should be male and female plants in each parcel, and the research should be perennial. In addition, we opinion that for combusting climate change, quality and especially the cold resistance of plants with phosphorus fertilizers is one of the research topics that should be studied in the future regarding sustainability.

REFERENCES

- AACC, I., 2000. Approved Methods of the AACC, Association of Cereal Chemists, St. Paul
- Acar, R., Dursun, S., Özkose A. 2013. Usage of Shrubby Trees to Provide as Bait Plant and Improvement Activities in the Arid and Desert Areas, Proceeding Book of Int. Conference of Ecosystems (ICE 2013), May 31- June 5, 2013.
- Acar, R., Koç Koyun, N., Erbaş, O., Şimşekli, N., Bağcı, M., Akınerdem, F. 2020. The Effect on Yield, Yield Component and Protein Ratio of Tall Wheatgrass [*Agropyron elongatum* (Host) P. Beauv.] of Applied Ammonium Sulfate at Different Dosage. Journal of Bahri Dagdas Crop Research 9(2), 220-228. (In Turkish).
- Alam, S. 2003. Wheat yield and P fertilizer efficiency as influenced by rate and integrated use of chemical and organic fertilizers. Pakistan J. of Soil Sci. 22: 72-76.

- Altın, M., Gökkuş, A., Koç, A. 2011. Pasture Rangeland Management. Volume I (General Principles). T.C. Tarım ve Köyişleri Bakanlığı, Tarımsal Üretim ve Geliştirme Genel Müdürlüğü, Ankara (In Turkish).
- Aygün, C., Olgun M. 2018. The observation criteria belonging to shrub and bushy plants. Gıda, Tarım ve Hayvancılık Bakanlığı ISBN: 978-605-68346-0-8, Eskişehir (In Turkish).
- Babalık, A. A., Fakir, H. 2017. Comparison of vegetation properties on the protected and grazed rangeland areas: The case of Kocapınar Rangeland. Turkish Journal of Forestry, 18(3), 207-211 (In Turkish).
- Bakır, Ö. 1985. Pasture Rangeland Improvement, Principles and Practices. Ankara University. Faculty of Agriculture Publications 947, Textbook: 272, Ankara (In Turkish)
- Bayraklı, F., 1987. Soil and plant analysis. Ondokuz Mayıs University Publications No: 17, s: 7 (In Turkish).
- Çınar, S., Hatipoğlu, R., Avcı, M., İnal, İ., Yücel, C. 2018. A Research on The Determination of Botanical Composition Of Pastures İn District Tufanbeyli, Adana. Turkish Journal of Nature and Science, 7(2), 21-29 (In Turkish).
- Çomaklı, B., Güven, M., Koç, A., Menteşe, Ö., Bakoğlu, A., Bilgili, A. 2005. The Effects of Nitrogen, Phosphorus and Sulphur on Hay Production and Botanical Composition of Rangelands Of Ardahan Province. Türkiye VI. Tarla Bitkileri Kongresi (6th Turkish Field Crops Congress), 5-9 Eylül 2005 Antalya, Volume II, 757-761 (In Turkish).
- Erdoğan, İ., Sever, A. L., Atalay, A. K., Aygün, C., Akkaya, S., Işık, Ş., Kırtiş, F. 2013. Effect of Different Planting Spaces on Some Yield and Forage Quality Characteristics of Four Wing Saltbush (*Atriplex canescens* Pursh Nutt.) at Three Locations in Eskişehir and Konya. Journal of Agricultural Faculty of Uludağ University Uludağ, 27(1), 55-63 (In Turkish).
- Eyüpoğlu, F. 1999. Productivity Status of Turkey's Soils (Türkiye Topraklarının Verimlilik Durumu). Soil and Fertilizer Research Institute Publications, General Publication No: 220, Technic Pub. No: T-67, Ankara, P:122 (In Turkish).
- Gatiboni, L., Kaminski, J., Rheinheimer, D., Brunetto, G. 2003, Superphosphate and Rock Phosphates as Phosphorus Sources for Grass-Clover Pasture on a Limed Acid Soil in Southern Brazil, Communications in soil science and plant analysis, 34 (17-18), 2503-2514.
- Gregorich, E.G., Carter, M.R., Angers, D.A., Monreal, C.M., Ellert, B.H. 1994. Towards a minimum data set to assess soil organic matter quality in agricultural soils. Can. J. Soil Sci. 74: 367–385.
- Holechek, J. L. 1982. Fertilizer Effects on Above- and Below-ground Biomass of Four Species. Journal Of Range Management 35(1), 39-42.
- Jat R, Ahlawat I, 2006. Direct and residual effect of vermicompost, biofertilizers and phosphorus on soil nutrient dynamics and productivity of chickpea-fodder maize sequence. J. Sustai. Agric. 28: 41-54.
- Kacar, B., İnal, A. 2010. Plant analysis. Nobel Publications, Ankara (In Turkish)
- Kacar, B. 2014. Plant, soil, and fertilizer analysis 2, Easy applicable plant analysis, Nobel Academic Publishing, p. 1-404, Ankara (In Turkish).
- Kacar, B. 2020. Phosphorus in human and animal in sustainable agriculture, Nobel Academic Publishing, p. 86-87, Ankara (In Turkish).
- Kantarıcı, M.D. 2000. Soil Science. IU Department of Soil Science and Ecology, IU Publication No. 4261, Faculty of Forestry Publication No. 462, 420 s. 23. İstanbul (In Turkish).
- Karimi, M., Banakar, M. H., Yazdani Bouki, R. 2021. Effect of nitrogen and phosphorous fertilizers on forage production of saltbush (*Atriplex canescens*) under saline conditions. Crop Science Research in Arid Regions, 2(2), 141-154.

- Koç, N., Korkmaz, A., Gülcan, K., Santos, P. A. 2020. The Comparison of Chemical Content in Leave and Stem of *Atriplex canescens* and *Kochia prostrata*. Ulusal Çevre Bilimleri Araştırma Dergisi, 3(2), 74-82. (In Turkish).
- Noshad, M. H., Chavoshi, E., Mosaddeghi, M. R., Dorostkar, V., Hosseini, F. 2022. Growth and nutrient uptake of haloxylon and atriplex as affected by mycorrhizal symbiosis under combined drought and salinity stresses. Canadian Journal of Soil Science, 103(2), 305-317.
- Le Houérou, H.N. 2000. Utilization of fodder trees and shrubs in the arid and semiarid zones of West Asia and North Africa. Arid Soil Research and Rehabilitation, 14(2), 101-135.
- Makinde, E., Ayeni, L., Ojeniyi, S., 2011. Effects of organic, organo-mineral and NPK fertilizer treatments on the nutrient uptake of *Amaranthus cruentus* (L) on Two Soil Types in Lagos. Nigeria J. Cent. Euro. Agric. 12: 114-123.
- McCauley, A., Jones, C., Jacobsen, J. 2009. Nutrient Management. Nutrient management module 9 Montana State University Extension Service. Publication, 4449-9, p.1-16.
- Mellado, M., Rodríguez, A., Lozano, E. A., Dueñez, J., Aguilar, C. N., Arévalo, J.R. 2012. The food habits of goats on rangelands with different amounts of fourwing saltbush (*Atriplex canescens*) cover. Journal of Arid Environments, 84, 91-96.
- Merrill, A. L. and Watt, B. K. 1955. Energy value of foods: basis and derivation (No. 74). Human Nutrition Research.
- Moschler, W. W., Krebs, R. D., Obenshain, S. S. 1957. Availability of Residual Phosphorus from Long-Time Rock Phosphate and Superphosphate Applications to Groseclose Silt Loam. Soil Science Society of America Journal, 21(3), 293-295.
- Özkose, A. 2012. Determination of some morphological and agronomic characteristics of perennial ryegrass (*Lolium perenne* L.) genotypes collected from the natural flora of Ankara, Dissertation, Selcuk University, Konya (In Turkish).
- Richardson, A.E. 2001. Prospects for using soil microorganisms to improve the acquisition of phosphorus by plants. Functional Plant Biology, 28, 9, 897-906.
- Sall, J., Stephens, M.L., Lehman, A., Loring, S. 2017. JMP Start Statistics: A Guide to Statistics and Data Analysis Using JMP. Sas Institute.
- Tamkoç, A. 1992. The Comparison of Elçi Clones Selected from Kayseri Alfalfa and Other Varieties in Konya Condition, Dissertation, Selcuk University, Konya (In Turkish)
- Tan, M., Temel, S. 2012. Alternative Forage Crops. Atatürk University Faculty of Agriculture Course Publications No: 246, Erzurum (In Turkish).
- Tüzüner, A. 1990. Soil and Water Analysis Handbook. Köy Hizmetleri Genel Müdürlüğü, Ankara (In Turkish).
- Tilley, D. and L. St. John, L., Tilley, D. 2012. Plant Fact Sheet for fourwing saltbush (*Atriplex canescens*). USDA-Natural Resources Conservation Service, Aberdeen, ID Plant Materials Center. 83210-0296.
- Yuan, F., Leng, B., Wang, B. 2016. Progress in Studying Salt Secretion from The Salt Glands in Recreteohalophytes: How Do Plants Secrete Salt?, Frontiers in Plant Science, 7, 977.

AGRONOMIC PROPERTIES AND L-DOPA CONTENT OF BROAD BEAN (*Vicia faba* L.) GROWN IN DIFFERENT WEED DENSITY

Zeynep AYBEY¹, Hatice BOZOĞLU²

¹ Ondokuz Mayıs University, Graduate School of Education, Samsun, TURKIYE

² Ondokuz Mayıs University, Agriculture Faculty, Field Crops Department, Samsun, TURKIYE,

Corresponding author e-mail: zeynepaybey4@gmail.com

ABSTRACT

Due to plants not relocating, they adopt allelopathy as a survival strategy when environmental conditions are unfavourable. This situation consists of releasing chemical compounds into the environment that can positively or negatively affect the growth and development of neighbouring plants. One of these chemicals is L-Dopa (L-3,4-dihydroxyphenylalanine), which is not an amino acid and is mostly in velvet bean (*Mucuna pruriens*) and broad bean (*Vicia faba*) plants. Weeds are an important problem in regions like Samsun, where winters and springs are rainy and warm. However, the broad bean has less weed density than other plants. This study was planned to determine the relationship of this situation with the L-Dopa production feature of broad beans. In the experiment, Lara variety, 5 different treatments (weed-free control, weedy control, 1-time hand hoeing, 2-time hoeing, 3-time hoeing) were used in a randomized block design with three replications. Sowing was done on November 3, 2022, with 50 cm row spacing. One week after the last hoeing (April 4, 2023), samples were taken from the roots and stem parts of the plants for L-Dopa analysis. Both fresh pod and dry seed components were made in the plots. In the features, weeds belonging to other families (*Veronica* sp, *Scandix pecten-veneris*, *Lupinus* sp, *Cirsium arvense*, *Fumaria officinalis*, etc.) were more common than wheatgrass. It has been determined that the plant height of the broad bean is 99-131 cm, and it is the longest in weed control. The fresh pod yield was between 5186-7504 kg per decare, and the highest was obtained from the weed-free control; the dry seed yield was between 375.9-481.5 kg, and the highest in hoeing three times. L-Dopa analyses are not yet complete.

Key Word: Broad bean, weed density, L-Dopa

INTRODUCTION

The concept of allelopathy was defined by Hans Molisch (1937) as the mutual suffering of organisms, which was formed by combining the Greek words "Allelo" and "Pathos" (Yılmaz et al., 2021). Conversely, plants use allelopathy as a survival strategy under unfavourable environmental conditions. Allelopathy is the chemicals secreted by plants from different secretory organs, such as roots, leaves, fruits and stems, which positively or negatively affect other plants' germination (İkincikarakaya, 2022). Plants with known allelopathic properties constitute an essential resource for sustainable agriculture. The allelopathic effects of some cultivated plants have an important role in alternation systems and yield increase and in the control of weeds, diseases and pests as a natural method of struggle (Yılmaz et al., 2021).

The high adaptability of the broad beans has allowed it to be cultivated in many countries (Köse et al., 2021). The broad beans have a cultivation area of 2.72 million ha worldwide. The country with the highest cultivation is China, with 804.3 thousand ha. In

Turkey, broad beans have a cultivation area of about 2.6 thousand ha (FAO, 2021). Although it is commonly cultivated in the Aegean, Marmara and Mediterranean regions, it is one of the indispensable products in small-family agriculture, especially in the Black Sea coastal region. The studies we have carried out in Samsun for many years have shown that the broad bean is very suitable for the ecology of the region, that winter plantings are highly yielding, have nitrogen fixation ability and soil healing effects and produce L-Dopa (Bozoğlu and Topal, 2011; Karyel et al., 2016; Topal et al., 2020; Bozoğlu and Bezmen, 2021; Oğuz and Bozoğlu, 2022).

One of the chemicals with an allelopathic effect is L-Dopa (L-3,4-dihydroxyphenylalanine). L-Dopa is a non-protein amino acid secreted within the plant (Soares et al., 2014). It is primarily found in *Mucuna pruriens* (velvet bean) and *Vicia faba* (broad bean) plants and is used in treating Parkinson's disease. The broad bean is one of the few plant species known to produce L-Dopa and has the potential to be developed as a functional food product for Parkinson's disease (Hu et al., 2015). In addition, some studies show that L-Dopa may be effective as a herbicide and insecticide (Soares et al., 2014).

In the study conducted to determine the L-Dopa content of the leaves, flowers and fruits of broad beans genotypes in Samsun, 22 genotypes were used. The difference between genotypes in terms of the amount of L-Dopa in the flowers and fresh fruits of the broad bean was found to be important. This study determined that the amount of L-Dopa in flowers was higher than in leaves and pods (Topal and Bozoğlu, 2016).

In a study to determine the effect of L-Dopa on herbicides, wheat and barley were used as control crops. *Sinapis arvensis*, *Cirsium arvense*, *Papaver rhoeas* and *Lamium amplexicaule* weeds have been found. According to the study results, concentrations of L-Dopa of 1500-3000 mg/L showed a suppressive herbicide effect on the weeds studied without significantly affecting the development of wheat and barley. The most affected species was found to be the *Papaver rhoeas*. In general, it was concluded that the decrease in root elongation was more significant than the trunk elongation (Topal and Kocaçalışkan, 2006).

Etemadia et al. (2018) similarly reported in their study that the highest L-Dopa content was in seedlings, leaves, flowers, young pods, grown pods, roots, and stems, respectively, and increased with drought stress.

In a study examining L-Dopa, vicin and convisin at different stages (seedling, vegetative cycle, flowering and maturity) of broad beans grown under greenhouse conditions, the highest L-Dopa was found in young flower buds. They reported that root and stem are similar and rich in L-Dopa production (Duan et al., 2021).

It is necessary to use environmentally friendly and harmless practices in all cultivation techniques, from seedbed preparation to harvesting and threshing in plant production. Weeds are an important problem in regions such as Samsun, where winters and springs are rainy and hot. Especially when it comes to good agricultural practices and struggle without using herbicides in organic agriculture, activating the cultural struggle and the natural struggle abilities of the grown plants is crucial. Broad beans are a plant of this nature. In our observations, there is less weed density in the broad bean areas than in many other plants in the plant-growing areas. This situation, and very few studies in the literature, have given us the idea of investigating the relationship between the broad bean's L-Dopa-producing property and weed density. This study was planned to determine the effect of different weed densities on the agronomic characteristics of the pod and the affect on L-Dopa production.

MATERIAL AND METHOD

In this study, Lara broad beans variety developed for fresh consumption was used. The experiment was carried out under the conditions of the university's campus on Samsun grounds. The trial soils were clayey, pH neutral, very little lime, and medium in organic matter.

The experiment was set up in a randomized block design with 3 replications. In the experiment, 5 different weed densities (Y_1 :weed-free control, Y_2 :weedy control, Y_3 : 1-time hand hoeing, Y_4 :2-time hand hoeing, Y_5 :3-time hoeing) were done. The effects of these processes on the agronomic characteristics of the broad beans and the L-Dopa content of the root stems were investigated. Sowing was done by hand on November 3, 2022, in 3 m long rows consisting of 5 rows, 50 cm between rows and 10 cm above rows. Weed removal operations were carried out from mid-December to mid-March. Samples for L-Dopa analyses were received on April 4, 2023, when weed removal was complete. After the dry weights of the samples were determined, they were ground and stored. As of the second half of April, the plants marked on the plots were harvested four times. The ratio of each harvest to the total fresh fruit yield is defined separately. Dry seed harvests were carried out in June, and properties of dry seed were made during this period.

RESULTS AND DISCUSSION

The broad bean is a plant that can be grown in our region for the winter without irrigation. The production of broad beans for both vegetable and dry seeds allows another summer product to develop after harvest (Bozoğlu, 2005). The studies conducted in the region determined that winter sowings were higher yielding than early spring sowings (Bozoğlu and Gülümser, 1994). The growing period of the plant is from November to June. This period is when precipitation and weed density are the highest in Samsun conditions. It is a region where many kinds of weeds are seen every period due to the temperate climate and the high precipitation in autumn and spring. In this study, only species observations were taken from weeds, and their density per unit area was not defined. Weeds started to appear about 1.5 months after the broad beans emerged, and it is time to fight weeds with the high temperatures in January and February. *Veronica sp*, *Scandix pecten-veneris*, *Lupinus sp*, *Cirsium arvense*, *Fumaria officinalis* and *Lamium sp*. were the most common weeds in our plots.

According to our observations and literature in the region for many years (Frenda et al., 2017), it has a higher competition with broad bean weeds than other winter plants. Because the broad bean is a vigorous growing plant. In addition to the shading effect of the broad beans, the literature suggests that L-Dopa production also suppresses weeds (Soares et al., 2014). In this study, the change in the agronomic characteristics of the broad beans in different weed densities and the L-Dopa content in the root and stem were tried to be determined. In the trial where weedy, weed-free and three different hand-hoeing applications were used, both harvests in the fresh and dry seed periods were done. The results of the variance analysis are given in Table 1, and the means of properties in Table 2.

According to the variance analysis results, it was seen that the block variance was statistically significant in some properties. Using the randomized blocks experiment design shows that these variances correctly minimize the error by subtracting them from the general. Different people sowed each block by hand while the experiment was being set up. This emphasizes that sowing depths are effective in the development of the plant and that the subject should be investigated because we believe that the land soil structure is uniform in the experiment area.

Lara is a variety developed for green purposes. Therefore, fresh harvest observations were taken. The total yield of fresh pods and the ratio of the first harvest to this yield were found to be statistically significant. Yıldız (2018) conducted a study at the same location with 15 genotypes and three control varieties and reported that the fresh harvest was done seven times, and the earliest fresh harvest was in April. The weather was warm during the trial from January to February 2023, and the broad beans bloomed early in February. However, although the flowering was early, the cool weather that came later brought the pod binding period to April again. In this study, only four times fresh harvests were made. It was observed that different weed densities statistically affected the pod yield in the first and fourth harvests (Table 1).

The highest yield was obtained in the application where weeds were taken as soon as they emerged (Y₁: weed-free). Weeds were not intervened at all (Y₂), and two-time hoeing (Y₄) were included in the same statistical group. The exciting thing is that a higher yield is obtained in one hoeing. In our opinion, the reason for this is that the growth period of the plant and the surrounding weeds is more important when hoeing together with the number of hoes made 2 or 1 times.

It was determined that the plant height and the weed density on the number of pods, which are the most important features affecting the yield of the broad beans, have a statistical effect. Plant height was the longest in the control application, where no weed was removed. Kavurmacı et al. (2010). In their study in Hatay, plant height, number of pods per plant, number of seeds per pod and 1000-seed weight were significantly decreased due to weeds. In our study, it was seen that the plant increased in height to suppress them depending on the weed density, and the plant height was the longest in the weeded parcel (Table 2). The number of twigs varied between 3.6 and 4.0 pieces and did not show statistical differences. This indicates that the variety used in the trial is stable in terms of the number of branches. Karayel et al. (2016) reported that the branch number was not different in the frequency trial they conducted under Samsun conditions and that seed yield was positively related to the number of pods, trunk diameter, pod length and hundred seed weights.

Table 1. Variance analysis results of some characteristics of broad bean grown at different weed densities.

VS	DF	Total fresh pod weight	First harvest	Second harvest	Third harvest	Dry matter of root	Dry matter of stem	Fourth harvest	Height	Branch	Pod number	Biological yield	Fresh pod yield	Dry seed yield	100 seed weight
Treat.	4	12646.7	67.2 *	137.4	94.3	1.4	30.5	508.3	464.9 **	0.12	55.2 *	615468.6	9089.0	4730.6	273.1
Block	2	35950.0 **	179.8 **	127.1	341.0	6.9	1.3	627.7	956.2 **	1.59	222.3 **	63553.6	25966.1	2010.3	167.1
Error	8	4165.2	16.1	102.1	170.8	2.6	32.4	283.1	50.4	0.48	18.3	382615.2	7075.6	3463.8	202.5

Table 2. Mean of some characteristics of broad bean grown at different weed densities.

Treatment	in the fresh pod harvest							in the dry harvest time					
	Fresh pod yield (kg/da)	First harvest (%)	Second harvest	Third harvest (%)	Fourth harvest (%)	Dry matter of root (%)	Dry matter of stem (%)	Height (cm)	Branch	Pod number	Biological yield (kg/da)	Dry seed yield (kg/da)	100 seed weight (g)
Weedy	5186 b	8.1 b	10.9	9.8	73.0 a	15.1	29.9	131.1 a	3.6	23.9 ab	1979.3	399.9	125.4
Weed-free	7470 a	15.1 ab	5.2	22.4	48.7 ab	15.0	23.3	115.3 b	3.7	26.3 a	2844.0	481.5	141.8
1 hoe	5908 ab	18.2 a	22.7	19.5	37.7 b	16.4	27.0	108.3 bc	3.6	23.0 ab	2193.3	404.2	149.8
2 hoe	3912 b	16.4 a	9.2	23.3	50.3 ab	14.6	26.5	99.7 c	4.0	17.1 b	2218.0	375.9	145.9
3 hoe	5674 ab	20.7 a	7.9	22.5	47.8 ab	15.3	31.5	103.0 bc	3.9	27.7 a	1597.9	410.7	135.9

The number of pods varied between 17.7 and 27.7 pieces. A significant ($P < 0.05$) difference was detected between the procedures. It gave the process of hoeing twice the lowest number of pods, which entered the same statistical group as the weedy parcel. In order to eliminate weeds, hoeing was carried out, taking into account the density of weeds. These operations were carried out in December, the last month of 2022, and in the middle of February, depending on the weed density in the hot weather. The broad beans were about 35-40 cm tall during this period but began to bloom with the temperature. Frenda et al. (2017) determined the critical period of weed control as 428 days after emergence for the broad bean. This period is mentioned when the row space is completely closed, and there is flowering. The reason why three hoes were better in our study may have been made during March when the rainfall and the growth of both the broad bean and the weeds accelerated. Removing weeds from 25 to 75 days after crop sowing led to significantly larger yields than on plots that were not weeded. Maximum yield was obtained in both years when weeds were removed thrice at 25, 50 and 75 days after crop sowing (Tawaha and Turk 2001).

Dry seeds yield varied between 375.9 and 481.4 kg per decare, but no statistical difference was determined. The highest yield was obtained in the weed-free parcel, while the application of 2 hoes showed a decrease of about 21% while giving the lowest value. However, this difference from the height of the variance between the parcels was not found to be significant in the experiment. Kavurmacı et al. reported that in 2010, seed yield losses due to uncontrolled weed growth throughout the broad beans crop cycle were 46%.

Frenda et al. (2017) also stated in their study on chickpeas and broad beans that yield losses in broad beans were less than in chickpeas due to weeds. This could be attributable to more vigorous early growth and the plant's greater height, which is related to a more extraordinary shading ability and, consequently, to a better ability to suppress weeds. In addition, we believe it is very important to investigate the L-Dopa content that the broad beans secrete, especially from the roots, due to weed stress.

CONCLUSIONS

Broad beans are not very widely grown in our country. However, its ecological demands and the vital development feature of the plant are remarkable in terms of being an alternative plant. One of the essential ways to ensure the spread of the plant can be realized by accessing new data that will reveal the diversity of use, health and agricultural importance. One of the aims of this study is to determine the change in the agronomic characteristics of the plant by weed pressure in the broad beans under the conditions of our region with high spring rainfall. The broad bean is a plant that shows an absolute need for hoeing because it is a plant capable of nitrogen fixation. However, it also can suppress weeds with its strong development and ability, such as shading.

In the studies we have carried out in recent years, we have shown that broad bean is important for human health due to their L-Dopa content. L-Dopa is a seconder metabolite that is important for the health of the plant and human health. Another goal of this study was to observe whether the broad beans used L-Dopa against weeds. However, this aim could not be achieved because L-Dopa analyses could not be completed until this article was prepared.

The data we obtained showed that although higher data were obtained in weed-free applications in our weed control conditions in terms of the agronomic characteristics of the broad beans, very successful results could not be accepted. The most important situation we have identified is the need to examine precisely in which period the hoe should be made rather

than the number of hoes in the cultural struggle with weeds. In order to obtain healthier data, it will be helpful to repeat the experiments by adding the mentioned situations. We believe that to maintain biological stability and maintain soil and water health, the ability of plants to cope with stress should be better examined, and the broad bean is a plant of this nature.

REFERENCES

- Bozođlu H. ve Glmser A. 1994. Samsun Ekolojik Őartlarında Farklı Zamanlarda Ekilen Bazı Bakla eřitlerinin eliŐme Durumları ve Verimlerinin Tespiti zerine Bir AraŐtırma. Tarla Bitkileri Kongresi 25-29 Nisan, İzmir, Cilt:1, Agronomi Bildirileri, 247-249, 1994
- Bozođlu H. 2005. Baklada (*Vicia faba* L.) ieklenme Ve Meyve Bađlama Durumlarının Tespiti Ve Tane Verimi ile İliŐkileri. Trkiye VI. Tarla Bitkileri Kongresi, 5-9 Eylül 2005, Antalya (AraŐtırma Sunusu Cilt II, Sayfa 637-642)
- Bozođlu H. ve Bezmen M. 2021. Determination of the L-DOPA (L-3, 4-Dihydroxyphenylalanine) Content in Faba Bean (*Vicia faba* L.) Flowers and Faba Bean Flower Tea. Turkish Journal of Agriculture - Food Science and Technology, 9(4): 733-739, 2021
- Duan S, Kwon S J, Lim Y J 1, Gil C S, Jin C and Eom S H. 2021. L-3,4-dihydroxyphenylalanine Accumulation in Faba Bean (*Vicia faba* L.) Tissues during Different Growth Stages. Agronomy 2021, 11, 502.
- Etemadia F, Hashemia M, Randhirb R, Vakilia O Z, Ebadi A. 2018. Accumulation of L-DOPA in various organs of faba bean and influence of drought, nitrogen stress, and processing methods on L-DOPA yield. The Crop Journal 6 (2018) 426 – 434
- [Frenda A S](#), [Ruisi P](#), [Saia S](#), [Frangipane B](#), [Di Miceli G](#), [Amato G](#) and [Giambalvo D](#). 2017. The Critical Period of Weed Control in Faba Bean and Chickpea in Mediterranean Areas. 2017. Weed Science Vol 61 Issue 3.
- FAO, 2021. Dnya Bakla Ekim Alanları, www.fao.org. (EriŐim Tarihi:18.05.2023)
- Hu J G, Kwon S J, Park J J, Landry E, Mattinson D S, Gang D R. 2015. LC-MS determination of L-DOPA concentration in the leaf and flower tissues of six Faba Bean (*Vicia faba* L.) lines with common and rare flower colors. Functional Foods in Health and Disease, Volume5, Issue 7, Pages 243-250.
- İkincikarakaya, S.. 2022. ZTB448 - Ekim Nbeti Sistemleri Dersi, Ders Notları, Ankara niversitesi Ziraat Fakltesi Tarla Bitkileri Blm.
- Karayel R., Topal N., Bozođlu H. 2016. Bakla (*Vicia faba* L.)’da Farklı Ekim Sıklıklarının Yaprak Alanı ve Verim Unsurlarına Etkisi. Tarla Bitkileri Merkez AraŐtırma Enstits Dergisi, 2016, 25 (zel sayı-1):213-219
- Kavurmacı Z, Karadavut U, Kkten K., Bakođlu A. 2010. Determining Critical Period of Weed-crop Competition in Faba Bean (*Vicia faba*) International Journal Of Agriculture & Biology ISSN Print: 1560–8530; ISSN Online: 1814–9596 09–424/MFA/2010/12–2–318–320
- Kse, M., KardeŐ, Y. M. (2021). Baklanın (*Vicia faba* L.) Besinsel ieriđi ve tıbbi aıdan yararları. Journal of the Institute of Science and Technology, 11(3), 2371-2379.
- Ođuz Z G and Bozođlu H. 2022. The Effect of Some Treatments on Seed and Plant on The Agricultural Characteristics of Faba Bean (*Vicia faba* L.) and The LDOPA (L-3, 4-Dihydroxyphenylalanine) Content. International Journal of Innovative Approaches in Agricultural Research 2022, Vol. 6 (4), 426-438
- Soares A R, Rita de Cssia M R., Soares S., Lima R B., Santos W D., and Ferrarese-Filho O. 2014. The role of L-DOPA in plants. Plant Signaling & Behavior 9, e28275; March; © 2014 Landes Bioscience.

- Tawaha A M. and Turk M A. 2001. Crop-Weed Competition Studies In Faba Bean (*Vicia Faba L.*) Under Rainfed Conditions. *Acta Agronomica Hungarica* Volume/Issue: Volume 49: Issue 3
- Topal, N. ve Bozođlu, H. 2006. Tepe ve Dal Almanın Baklanın (*Vicia faba L.*) ieklenme ve Bakla Bađlama Durumuna Etkisi. *OMÜ Ziraat Fakóltesi Dergisi*, 21 (3):296-302, 2006.
- Topal N., Bozođlu H. 2016. Determination of L-Dopa (L-3, 4-dihydroxyphenylalanine) Content of Some Faba Bean (*Vicia faba L.*) Genotypes. *Journal Of Agricultural Sciences* 22 (2016) 145-151
- Topal S, Kocaalıřkan I. (2006). Allelopathic effects of DOPA against four weed species. *DPÜ Fen Bilimleri Enstitüsü*; 11:27-32
- Topal N., Bulduk İ., Mut Z., Bozođlu H., Tosun Y K. (2020). Flowers, Pollen and Honey for Use in the Treatment of Parkinson's Disease. *Rev. Chim.*, 71 (9), 2020, 308-319 308.
- Yıldız, K. 2018. Yerel bakla (*Vicia faba L.*) genotiplerinin taze ve kuru tane amaçlı kullanıma uygunluđunun belirlenmesi. Yüksek Lisans Tezi. Ondokuz Mayıs Üniversitesi Fen Bilimleri Enstitüsü Tarla Bitkileri Ana Bilim Dalı, 110, Samsun.
- Yılmaz M., Köse, M. 2021. Kültürü Yapılan Bazı Tarla Bitkilerinde Allelopatik Etkinin Deđerlendirilmesi. *Journal of Agricultural Biotechnology (JOINABT)* 2(2), 97-104

BIOLOGICAL AND PHYSICOCHEMICAL INVESTIGATION OF CERTAIN STATIONS OF TUNCA RIVER

Nurcan Ozkan¹

¹ *Trakya University, Education Faculty, Mathematics and Sciences Education Department, Edirne, Turkey*

Corresponding author e-mail: nurcanozkan@hotmail.com

ABSTRACT

This study was carried out in order to determine some water analysis, substrate and environmental data of 3 stations determined in Tunca River in Edirne province in 2012. The first station on the river was determined as Suakacagi Village, which is close to the border where the river enters Turkey, the second station as Degirmenyeni Village, and the third station as Trakya University Tunca Barracks garden. Field studies carried out between June and October 2012 were carried out as monthly periods. During the study, water samples were taken from each station and brought to the biology department laboratory for some analysis (temperature, pH, dissolved oxygen, total hardness, conductivity, suspended solids). In addition, notes were taken by observing the water in the river and the surrounding environments, and as a result, the stations were compared from various perspectives. Months and stations were evaluated physicochemical according to the Bray-Curtis similarity index. The months of September and October and September and August show the most similarity; In terms of stations, the 3rd and 2nd stations were found to be similar at most. In addition, the results of other studies conducted on the river were compared.

Keywords: Tunca River, Physicochemical analysis, Ecology

INTRODUCTION

Freshwater pollution has become a known limiting issue almost all over the world. Lotic ecosystems are among the most vulnerable freshwater bodies to pollution due to their role in municipal wastewater, runoff from agricultural fields, and industrial transport (Kose et al., 2014; Tokatli, 2014; Tokatli, 2015).

It is a necessity to attach great importance to fresh water resources in terms of quality and pollution of surface waters (Cicek et al., 2013; Ustaoglu et al., 2017; Ustaoglu and Tepe, 2019). Monitoring, management and evaluation of water quality in surface waters, especially rivers, is a vital sustainability issue for humans (Boyd, 2015; Wu et al., 2018). Pollution of these unique resources by many anthropogenic, chemical and polluting substances not only degrades ecosystems, but also threatens public health (Tepe and Cebi, 2017; Ustaoglu et al., 2017).

One of the important carbon sources of streams is the leaves that fall from the trees and reach the water. Dried leaves are an indispensable source of carbon, especially for mountain streams. The polymers in the leaf are a source of energy for many benthic organisms. With the deterioration of the leaf, the chemicals it contains, lignin, phenolic compounds, tannin and the nutrient in its carbon affect the nutrient dynamics in the water (Hunter et al., 2003; Welsh, 2007). It has been proven that the activity of certain benthic invertebrates increases with the amount of decaying leaves. Leaf decomposition chemistry and leaf decomposition activities of macroinvertebrates are interdependent. Because the composition of the leaf litter is the most important factor in colony formation of macroinvertebrates. Decomposed plant litter is thought

to be important in the distribution of benthic invertebrates (Hunter et al., 2003). In addition, it can be effective in both leaf rot and colony formation in environmental conditions (Costa and Melo, 2008).

The richness and diversity of the habitat as nutrients and substrate are among the factors that naturally increase biodiversity. However, another factor that should not be forgotten is the flow rate and physicochemical factors. The decay of plants in water is carried out by bacteria and as a result of the intensity of this activity, it is defined by the formation of some toxic gases such as CH₄ and H₂S and the lack of oxygen. A range of environmental factors limit the benthic habitat and change the species composition of the macrozoobenthic invertebrate community (Cupsa et al., 2005).

This study was carried out to evaluate macroinvertebrates from a biological point of view by comparing some water analysis parameters, substrate and environmental data at 3 stations in Tunca River.

MATERIAL AND METHOD

Description of the Work Area

Tunca River originates in the Montenegro Region of Bulgaria and enters Turkey from the Suakacagi location of Lalapasa district of Edirne province. The drainage basin area is 7 884 km² and a short distance (12 km) forms the Turkish-Bulgarian border (URL 1) and mixes with the Meric River in Edirne province. It is one of the main tributaries of the Meric River. Its length is 350 km (URL 2). There are two large dams in Bulgaria, Koprinka and Zhrebchevo Dams, on the Tunca River. The average flow value of the Tunca River was determined as an average of 32.09 m³/sec, according to data from a measuring station in Bulgaria. During the observation period, the highest flow value was 69.36 m³/sec and the lowest flow value was 18.81 m³/sec (Orsam, 2011; Tombul, 2014).

Fish such as pike, catfish, mullet, crustacean, barbell, pearl fish, carp, and crucian fish live in the Tunca River. People living in Edirne center and the villages around the river in Turkey use almost every area of the river as fishing and recreation areas. There are many agricultural areas (basic rice crops) around.

Field Study and Sampling

The study was carried out in a 5-month period between June and October 2012. Three stations were identified that characterize the river. The first of the stations is Suakacagi Village, which is close to the border where the river enters Turkey, the second is Degirmenyeni Village, and the third is Trakya University Tunca Barracks (Figure 1). Features of the stations:

– Station 1: Suakacagi Village – This is the area where Tunca enters the Bulgarian border for approximately 300 m. There are many willow and poplar trees around the river. The edges of the water in the river are reeds. There are plant remains as organic material on the ground. The base is sandy and in some areas mud covers the top of the sand. The water level is 50-60 cm around (Figure 2).

– Station 2: Degirmenyeni Village – It is the region that is popularly known as Egribuk. The bottom of the river is muddy and rich in vegetation. The back part of the sampling area consists of a large amount of reeds. It is surrounded by paddy fields and is used as a recreation area. The water level is approximately 75 cm and is the deepest station (Figures 3 and 4).

– Station 3: Edirne Central Tunca Barracks – It is the region where the Tunca River enters the city of Edirne. The water level in the river is approximately 60 cm, the bottom structure consists of mud, but the bottom part is sand. There are small grasses on the shore in its immediate vicinity and it is an open area. Further back, there are trees that are not dense. The opposite shore is wooded (Figure 5).



Figure 1. Tunca River sampling stations: 1. Suakacagi Village (465409.00 D, 4632519.00 K, 47m); 2. Degirmeniyeni Village (461067.00 D, 4623425.00 K, 40 m); 3. Trakya University Tunca Barracks (Edirne) (462965.63 D, 4619414.88 K, 37m)

For water analysis in Tunca River, air and water temperature, pH, dissolved oxygen, total hardness, conductivity, suspended solids parameters were selected for measurement. While the samples were being taken, the air and water temperatures were measured on-site with a thermometer at the stations. Water samples which were taken by a Ruttner water sampler were carried to laboratory. pH, dissolved oxygen, total hardness, conductivity, and suspended solids values were measured in the laboratory with the Hach Lange Brand HQ40D Model Multiparameter device.

Samples taken with a hand mud scoop for macroinvertebrates were diagnosed under the microscope in the laboratory and separated into groups. Different sources were used in the identification process of the groups.

RESULTS

Before the first fieldwork, the weather was quite rainy. In the following week, these precipitations caused the water level to rise by 30-40 cm. However, after 3 weeks, the water level decreased to the normal level due to both the water withdrawal and the very hot weather for the paddy fields, which are abundant in the surrounding area.

In July, when the 2nd fieldwork was carried out, the water levels decreased at all stations, especially at the 2nd station, due to the above-mentioned reasons. This decrease is particularly there were quite a few at the station.

The third fieldwork was carried out in August. The water level decreased considerably due to the hottest months of the year when the 3rd field study was carried out. The water level has receded on the coasts and has decreased considerably, especially at stations 1 and 3. Although the water in the river is less compared to the winter months as usual, there is a current. Islets were formed in the water due to the decrease in the water level from time to time.



Figure 2. Station 1



Figure 3. Station 2



Figure 4. Station 2



Figure 5. Station 3

During the 4th fieldwork in September, the water level continued to decrease, albeit slightly, in the areas outside the second station. The water in the river flows normally at all stations. At station 1, the water colour is yellowish green and has decreased considerably. The ground is sandy and contains invertebrates such as annelids. On the shores, the presence of frogs has been observed. At station 2, the water has a muddy appearance and a cloudy colour. The bottom of the river is mud. In the 3rd station, the soil, sand and plant mixture, the water level decreased slightly compared to the previous month.

The 5th field work was carried out in October and the field work was completed. Since there was no precipitation in this period, the water level did not change much compared to the previous month. The ground and water feature in the river are the same as in September.

Water samples were taken from each station for 5 months and some analysis were done in the biology department laboratory (pH, dissolved oxygen, total hardness, conductivity, suspended solids). In addition, air and water temperatures were measured in situ while taking samples. The results of the physicochemical analysis carried out in the Tunca River was given in Table 1 below.

Table 1. Some physicochemical parameter values in Tunca River

Parameters	June			July			August			September			October		
	1	2	3	1	2	3	1	2	3	1	2	3	1	2	3
Water Temperature (°C)	27	27	28	28	29	29	29	28	28	27	26	26	23	23	22
pH	7,61	7,53	7,85	8,67	8,17	8,17	8,22	8,17	8,27	8,67	8,17	8,17	7,73	7,77	8,08
Electrical conductivity (µS/cm)	583	622	621	616	709	666	596	690	646	626	685	693	677	710	716
Dissolved Oxygen (mg/l)	11,31	10,15	10,31	4,8	2,5	3,8	3,8	2,9	3,7	4,86	3,97	4,89	7,12	8,01	6,4
Total hardness (FS ⁰)	24,4	25	25,4	24,4	25	25,4	24,4	25	25,4	24,4	25	25,4	24,4	25	25,4
Suspended solid (mg/l)	3,2	3,3	3	269	215	303	75	63	86	29	28	33	13	20	18

(1, 2 and 3 stations)

In Figure 6 and 7, the months and stations were compared according to the Bray-Curtis similarity index according to the results of the river water analysis.

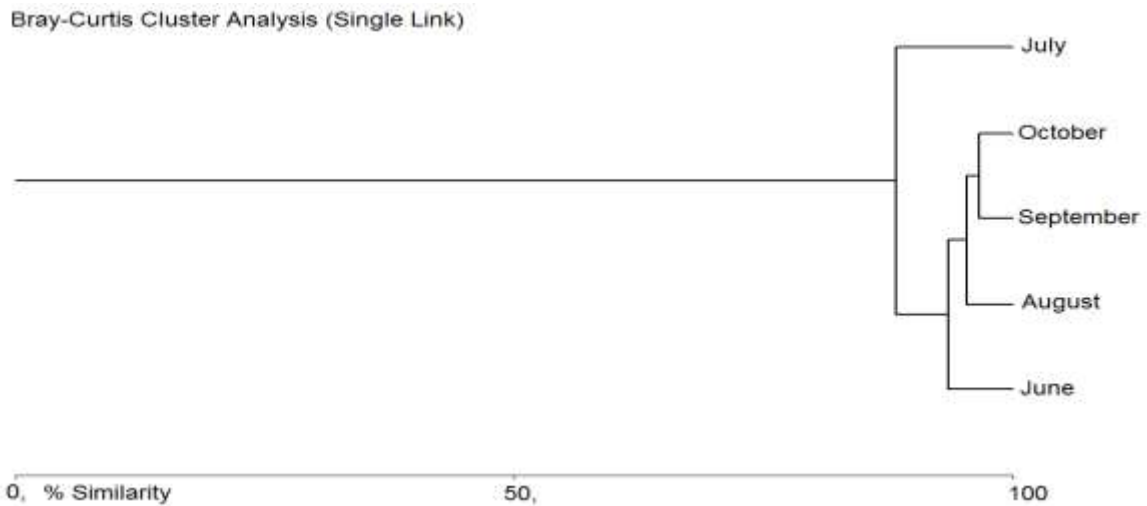

Figure 6. Dendrogram of similarity of months in Tunca River in terms of some physicochemical values (single linkage, Bray-Curtis, log base 10)

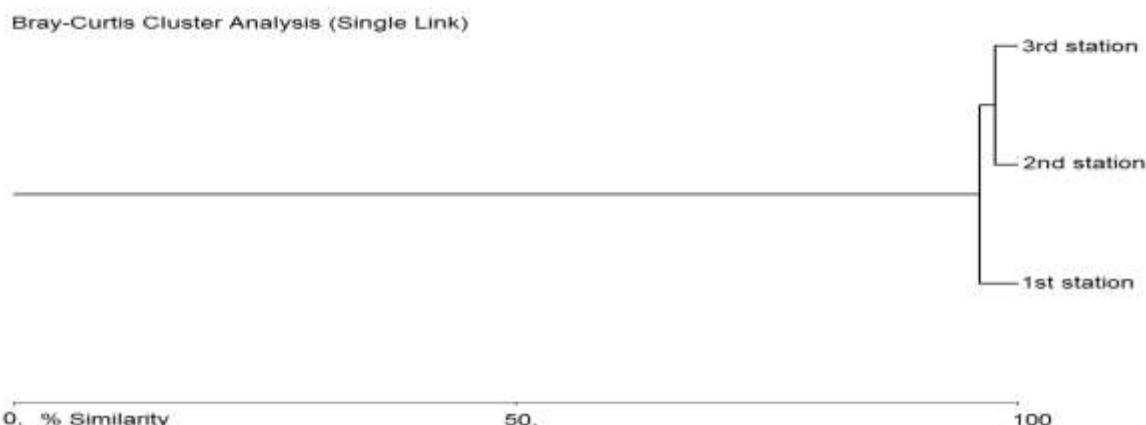

Figure 7. Dendrogram of similarity of stations in Tunca River in terms of some physicochemical values (single linkage, Bray-Curtis, log base 10)

When the Bray-Curtis similarity index is examined; When some physicochemical values of Tunca River are compared as months, September and October (96%), September and August (95%) show the most similarity. The months with the least similarity are June and July (80%) (Figure 6). But the similarity rate is quite high. When the stations are considered in terms of similarity, the most similar stations are 3 and 2, then 1 and 3, and finally 1 and 2 (Figure 7).

Different types of taxa were obtained by sampling soil types with different characteristics with the help of hand scoops at the stations. The individual numbers of these taxa, which are distributed according to stations and months, are presented in Tables 2 and 3.

Table 2. Individual numbers of taxa showing distribution by stations

Taxa	1. station	2. station	3. station
Chironomidae	1549	830	873
Oligochaeta	371	1205	1194
Odonata	27	23	74
Trichoptera	2	185	7
Ephemeroptera	8	96	10
Isopoda	5	24	31
Gastropoda	3	2	54
Other*	19	10	5
Total	1984	2375	2248

Other* = Crustacea, Hirudinae, Plecoptera, Tabanidae, Culicidae

Table 3. The number of individuals in taxa according to months

Taxa	June	July	August	September	October
Chironomidae	558	604	1428	350	499
Oligochaeta	1404	287	211	348	285
Odonata	14	29	45	24	12
Trichoptera	10	7	65	77	35
Ephemeroptera	5	2	35	6	66
Isopoda	4	7	14	19	18
Gastropoda	42	4	10	11	11
Other	5	12	9	12	23
Total	2042	952	1817	847	949

When examined according to the stations, the highest number of individuals is found at the second station. When the distribution by months is analysed, June has the highest number of individuals.

DISCUSSION AND CONCLUSIONS

Monoculture agricultural practices in the region impoverish the soil in terms of many minerals. In order to eliminate this deficiency, inorganic and phosphate fertilizers are used intensively in almost all basin soils. According to the surface water data obtained as a result of the study; It has been determined that many agricultural lands, especially paddy, located around the basin and which are of great importance for our country, create very important pressures on the ecosystem. The data obtained from the statistical analyzes clearly reveal the negative effects on the agricultural system. River waters should be given importance to increase the quality of this most important river basin of the Thrace region, to reduce the stress and pressure on aquatic organisms and to protect the health of the local people.

Since the study generally coincided with the summer period and the temperatures were high due to the dry weather, the dissolved oxygen level was generally low except in June. In July, the suspended solids ratio was high due to the excessive decrease in water. This situation can be explained by the high precipitation and flooding in the spring months in 2012 and the rapid decrease in water in the river due to excessive water withdrawal for agricultural purposes, especially paddy fields, in a short time. These results are consistent with the results of Fritz and Feminelle (2011).

In the study conducted by Camur-Elipek et al. (2006), hydromorphological structures, habitat and physicochemical characteristics of the stations are generally similar. The months that are most similar to each other in terms of seasonal changes are April and May, and the most different from each other are August and January. In the study conducted in Tunca, water temperature, electrical conductivity, chloride, salinity, sulphate, phosphate were found at normal levels. Dissolved oxygen was generally found in abundance and oversaturated due to aquatic vegetation. Total hardness was found at hard water quality level (except winter and October). Nitrate was generally found at the second quality level (only found at the second quality level in September). Nitrite is usually found in the fourth quality level. COD was found at the second quality level (third quality level only in September), while BOD was found at the first or second quality level (third quality level in October only). Regarding the Pearson correlation index, the relationship between the mean number of benthic macroinvertebrates and physicochemical properties and pH ($r = +0.57$, $P < 0.05$) was directly proportional, while the relationship between the number of macroinvertebrates and Nitrate ($r = -0.99$, $P < 0.05$) was inversely proportional. It can be said that these data are consistent with the study in general.

In the research conducted by Tokatli (2015) in the following years, it was observed that the water quality in Tunca downstream was Class III and the river was becoming more and more polluted. According to Cluster analysis results, the river was moderately contaminated. As similar to reported data by DSI, nitrite, ammonia, and phosphate concentrations waters of the Meric, Tuna, and Ergene Rivers were detected at very high levels and they have Class III-IV (highly-very highly contaminated) water quality in terms of these parameters (SKKY, 2004; Uslu and Turkman, 1987). The high nitrite, ammonia and phosphate concentrations in river water are thought to be due to runoff in agricultural areas. According to detected data, the pressure of the Tunca was clearly presented and the pollution levels of the investigated rivers were recorded as Ergene > Tunca > Meric.

Also, in studies on benthos, which were performed in the Bulgarian part of Tunca, Uzunov (1980) recorded 32 and Uzunov and Kapustina (1993) recorded 47 Oligochaeta species

in the river. According to Kovachev and Uzunov (1981), the Tundzha River is a relatively polluted river (at the limit between α - and β -mesosaprobity). According to Camur-Elipek et al. (2006) and Tokatli (2014) also show compatibility with the studies. The chemical fertilizers used in paddy farming areas around the river and the use of all areas by humans have led to the pollution of the river water. It also explains the abundance of Oligochaeta taxon. Kavaz (1997) studied especially benthic macroinvertebrates and physicochemical parameters in her master's thesis, but did not deal with the relationships between them. These results show that the water quality of the river has gradually decreased over time.

Chironomidae and Oligochaeta taxa have a large number of individuals, as was the case in the study conducted by Camur-Elipek et al. (2006) in the Tunca River. In both studies, the total number of individuals was found to be the highest in the second station, which corresponds to approximately the same region, and shows similarity. In addition, Nematoda, Amphipoda and Hemiptera were not found in this study.

According to Fritz and Feminelle (2011), the density and abundance of invertebrates were found to be less in dry months such as June - August than in all rainy months such as September - October. These results are consistent with other taxa except Oligochaeta in the study.

In Tunca River, aquatic fauna is richly found on the bottom of the river. This may be attributed to the fact that the river bottom has different substrate structures, its physicochemical structure, the fact that the river water is in a continuous flow position and the water is rich in vegetation due to its shallowness.

As a result, irrigation, sewage system, variable flow rate, temperature etc. affects the quality of water. The structure of the benthic macrofauna in the Tunca River changes under the influence of environmental variables. In addition, similar studies should be repeated periodically in the Tunca River to determine the future of the river.

ACKNOWLEDGEMENTS

This study is supported by Trakya University Scientific Research Project TUBAP 2011/130.

REFERENCES

- Boyd, C. E. 2015. Water Quality: An Introduction. <http://dx.doi.org/10.1007/978-3-319-17446-4>.
- Camur-Elipek, B., N. Arslan, T. Kirgiz, B. Oterler. 2006. Benthic Macrofauna in Tunca River (Turkey) and Their Relationships with Environmental Variables. *Acta Hydrochimica et Hydrobiologica*, 34: 360 – 366.
- Cicek, A., R. Bakis, A. Ugurluoglu, E. Kose, C. Tokatli. 2013. The Effects of Large Borate Deposits on Groundwater Quality. *Polish Journal Environmental Studies*, 22(4):1031-1037.
- Costa, S. S., A. S. Melo. 2008. Beta Diversity in Stream Macro Invertebrate Assemblages: among-Site and among-Microhabitat Components. *Hydrobiologia*, 598:131–138.
- Cupsa, D., I. Sas, I. Telcean, S. D. Covaciu-Marcov. 2005. Studies on the Dynamics of the Macrozoobenthic Invertebrate Groups in the Thermal Lake Ochiul Mare Natural Reserve (Bihar County, Romania). *Analele Universității din Oradea, Fascicula Biologie, Tom. XII*, 11-20.
- Fritz, K. M., J. W. Feminella. 2011. Invertebrate Colonization of Leaves and Roots within Sediments of Intermittent Coastal Plain Streams across Hydrologic Phases. *Aquatic Science*, 73: 459–469.
- Hunter, M. D., S. Adi, C. M. Pringle, D. C. Coleman. 2003. Relative Effects of Macroinvertebrates and Habitat on the Chemistry of Litter during Decomposition. *Pedobiologia*, 47: 101-115.

- Kavaz, E. 1997. Tunca Nehri Bentik Makroomurgasız Faunası (Fauna of Benthic Macroinvertebrates in Tunca River). MSc Thesis, Trakya University, Graduate School. Edirne (Turkey).
- Kovachev, S., Y. Uzunov. 1981. The Mutual Effects of the Tundja River and the Zhrebchevo Dam Lake on the Development of the Macrozoobenthic Communities. *Hydrobiology (Sofia)* 15: 43 – 48.
- Kose, E., C. Tokatli, A. Cicek. 2014. Monitoring Stream Water Quality: A Statistical Evaluation. *Polish Journal Environmental Studies*, 23(5): 1637, 2014.
- ORSAM. 2014. Meriç Havzası'nda Uluslararası Su Yönetimi (International Water Management in the Meric Basin). Su Araştırmaları Programı Rapor No: 2, 34.
- SKKY (Su Kirliliği Kontrol Yönetmeliği). 2004. Water Pollution Control Regulations. Official Journal of the publication, Date 31.12.2004, No. 25687.
- Tepe, Y., A. Cebi. 2017. Acrylamide in Environmental Water: A Review on Sources, Exposure, and Public Health Risks. *Exposure and Health*. [http://dx.doi.org/ 10.1007/s12403-017-0261-y](http://dx.doi.org/10.1007/s12403-017-0261-y).
- Tombul, F. 2014. Uluslararası Antlaşmalar Çerçevesinde Meriç Havzasında Su Yönetimi (Water Management in the Meriç Basin within the Framework of International Treaties). *Anadolu Üniversitesi Bilim ve Teknoloji Dergisi A-Uygulamalı Bilimler ve Mühendislik*, 15(2): 147-155.
- Tokatli, C. 2014. Drinking Water Quality of a Rice Land in Turkey by a Statistical and GIS Perspective: Ipsala District. *Polish Journal Environmental Studies*, 23(6): 22-47.
- Tokatli, C. 2015. Assessment of Water Quality in the Meriç River as an Ecosystem Element in Turkey's Thrace Region. *Polish Journal Environmental Studies*, 24(5): 2205-2211, doi: 10.15244/pjoes/58780
- URL 1. Tunca. <https://tr.wikipedia.org/wiki/Tunca>
- URL 2. Tunca Nehri Nerede? Nereden Doğar Ve Nereye Dökülür? (Where is Tunca River? Where Does It Originate And Where Does It Discharge?). <https://www.milliyet.com.tr/egitim/tunca-nehri-nerede-nereden-dogar-ve-nereye-dokulur-6681521>
- Uslu, O., A. Turkman. 1987. Water Pollution Control. Turkey Prime Ministry Directorate General for Environment Publications, Education Series I, Ankara.
- Ustaoglu, F., Y. Tepe, H. Aydın, A. Akbas. 2017. Investigation of Water Quality and Pollution Level of Lower Melet River, Ordu, Turkey. *Alinteri Zirai Bilimler Dergisi*. 32(1): 69-79.
- Ustaoglu, F., Y. Tepe. 2019. Water Quality and Sediment Contamination Assessment of Pazarsuyu Stream, Turkey Using Multivariate Statistical Methods and Pollution Indicators. *International Soil Water Conservation Research*, 7(1): 47-56. doi:10.1016/j.iswcr.2018.09.001
- Uzunov, Y. 1980. Water Oligochaets (Oligochaeta Limicola) from some Bulgarian Rivers; Frequency and Domination. *Hydrobiology (Sofia)*, 12: 79 – 89.
- Uzunov, Y., L. Kapustina. 1993. Current Review on Oligochaeta from Macrozoobenthic Communities of the Bulgarian Rivers. *Lauterbornia*, 13: 73 – 83.
- Welsh, J. H. 2007. The Effects of Suspended Sediment on Aquatic Community Structure and Detritus Processing. Presented to the Faculty of Humboldt State University in Partial Fulfillment of the Requirements for the Degree Masters of Arts, 1-37.
- Wu, Z., X. Wang, Y. Chen, Y. Cai, J. Deng. 2018. Assessing River Water Quality Using Water Quality Index in Lake Taihu Basin, China. *Science of the Total Environment*, 612: 914–922. <http://dx.doi.org/10.1016/j.scitotenv.2017.08.293>.

REGRESSION ANALYSIS BETWEEN AGRICULTURAL PRODUCTS AND ATMOSPHERIC CONDITIONS

Cenk ATLIG¹

¹ *Trakya University, Computer Technology Department, Edirne, Turkey*

Corresponding author e-mail: cenk.atlig@gmail.com

ABSTRACT

Number of factors effects agricultural products. Controlling some of them can be relatively easy for instance irrigation is possible if water available or you can improve the quality of soil by supplying appropriate minerals and/or fertilizers. On the other hand, farming threatened by several uncontrollable issues. Atmospheric conditions are one of these tough issues that consists of many parameters such as temperature, wind and air content. In this paper, outcomes of atmospheric issues studied to understand effects to farming. Satellite-based observations utilized in evaluations. Paper presents regression between agriculture and different parameters of atmosphere. Analysis utilizes Copernicus Atmosphere Monitoring Service, Climate Change Service and EUMETSAT.

Keywords: Threatening issues of agriculture, Satellite-based atmospheric analysis, Climate change.

1. INTRODUCTION

Agriculture is an essential part of food supply for mankind. It has evolved as time goes by in the history. Current technology and skills make possible to cultivate wide variety of yields such as wheat, maize and sunflower. Different elements made it simpler to produce different types of agricultural products as well as the amount of harvest. In order to name two types of agricultural facilitators, using different manure strategies or utilizing advanced and/or hybrid seeding, considerable improve farming. On the other hand, life is not always so easy, and humankind may not control every aspect in life and agriculture is not an exception. Atmospheric conditions are one of these threatening factors in farming. Efforts to minimize the influence of atmospheric conditions in agriculture becomes deficient frequently.

Number of previous efforts to analyze atmospheric effects to agriculture includes in situ data collection such as temperature [1], precipitation [2] and wind speed [3]. On the other hand, recent advances made possible to observe them from the space. These modern technologies could be used for diverse elements of atmospheric elements. Moreover, temporal and spatial detection is more flexible based on space-based applications. More than 14.000 satellites have sent, 10.290 currently in orbit and around 7.800 of them are operational as of 01.April.2023, according to [4] (numbers does not include space garbage).

In this study, effects of atmospheric issues analyzed in agriculture. Advanced space technology allows miscellaneous pre and post farming observations and reactions. Paper presents sample space-based agricultural technics. Copernicus Atmosphere Monitoring Service, Climate Change Service and EUMETSAT are example centers to utilize space technologies selected to discuss in this work.

The rest of the paper is organized as follows. In Section 2, atmospheric effects to farming are discussed. In Section 3, various atmospheric related space technologies presented. Section 4 provides samples using these space technologies in agriculture. Section 5 conclude the paper, and it also includes selected future works.

2. ATMOSPHERIC EVENTS AND FARMING

Atmosphere consists of many elements and keeps on fluctuating. This is one of the reasons that it is becoming difficult to plan and react well in advance. Not only the atmospheric seasonal characteristics may repeat inconsistent, but also in and out seasonal variance can be significantly high. To give two examples; summer in Mediterranean coast may be much more rainy than usual. Another example a desert without any snow in fifty or one hundred years may have a huge snow accumulation suddenly. Table 1 shows some atmospheric parameters that can be used in observations and research.

Table 1 Some elements of atmospheric observations

Type	Description	Unit
Temperature	Quantity of hot or coldness.	Kelvin (K), Celsius (°C), Fahrenheit (°F).
Humidity	Atmospheric moisture.	Units of grams of water vapor per cubic meter air (g.m ⁻³).
Precipitation	Types of water drops (i.e. rain, snow, hail, etc.) on to the ground.	millimeters (mm) or inch of liquid water within the preceding duration.
Air pressure	Barometric pressure applied by air.	millimeters (mm) or inches of mercury ("Hg), pounds per square inch (psi), dynes per square centimeter, millibars (mb), standard atmospheres (atm), kilo Pascals (kPa).
Wind speed	Flow of air speed from high to low pressure.	meters/second (m/s), miles per hour (mph), (knots), feet per second (ft/s), kilometers per hour (km/h).
Wind direction	Direction of air flowing.	Cardinal or compass direction, 0° to 360° can be used.
Gas content	Concentration of atmospheric gases.	Parts per million (ppm).
Air quality Index (AQI)	Ground level ozone	Scale between 0–500

Some of the elements of atmospheric observations listed in Table 1. The relation of farming and these atmospheric elements is given with the following examples. Very high or very low temperatures directly affects farming since it can burn/sear crops. Moreover, appropriate temperature for the seeding, growing and maturity period are important for successful farming. Humidity is another important factor such as suitable growing and adequate amount for the harvesting season. Precipitation sounds one of the crucial factors of farming, however, lots of rain or snow might be harmful. Additionally, if precipitation turns into sleet or hail it can turn into a serious problem. Air pressure is another factor in farming, it can change the quality of products as well as types of yields as pressure varies. Wind speed can be a significant threat to yields as strong winds can easily break or incline plants. Wind direction is important for instance some winds are originating from mild directions whereas others are deriving from stringent regions. For instance, wind from the northern regions for the northern hemisphere may be very tough in winter. Whereas same region has opposite threat from

southern regions in summer. Gas content affects number of farming factors and one of them is the quality and health of the yield.

All the discussed atmospheric elements in this Section can be observed and analyzed by spaced-based systems. The following section discuss some of these space-based observations about atmosphere.

3. ATMOSPHERE AND SPACE TECHNOLOGIES

Although most of the atmospheric events have critical effects to human life in general and farming in particular, limited data and forecast could be utilized until the emergence of space technology. Currently we have many satellites in space, which operate different types of services [4]. At this section, we present some of the important institutions and organizations, which study on atmosphere monitoring using technical advantages of space equipment.

Copernicus Atmosphere Monitoring Service (CAMS) [5] is a service provided by European Centre for Medium-Range Weather Forecasts (ECMWF) wide range of atmospheric data, analysis as well as projects provided through this service.

Climate Change Service (C3S) [6] is one of the services provided by Copernicus Programme of European Union (EU). Service provides climate bulletins, heatwaves, drought reports, etc.

European Organisation for the Exploitation of Meteorological Satellites (EUMETSAT) [7] operates Meteosat GEO satellites over Europe, Africa and Indian Ocean. In addition to these, this organization has different satellite agreements for other geographical regions about meteorologic research.

National Aeronautics and Space Administration (NASA) [8] is one of the oldest and largest organization study in space sector. It has number of projects and diverse instruments. One of the latest space instruments of NASA is TEMPO. It starts operation in the late 2023.

Table 2 shows some of the systems and satellites operated and/or used by these four organizations.

4. ATMOSPHERIC SPACE TECH IN AGRICULTURE

As discussed in the previous section, there are different space-based services available for atmospheric observations and forecasts. Here are some examples with their use. Copernicus Atmosphere Monitoring Service (CAMS) provides number of post and future gas content data. Many of them provided in the printed and some are available in the animated form. For instance, if a certain region is intended to be analyzed for a particular gas content, it is possible to obtain post data. Furthermore, still image maps and even animated maps are available for some cases. For example, ensemble data can be provided for certain area within a period. Thus, it is possible to analyze number of parameters. For instance, it is possible to compare the quality of harvested yields based on these data.

Table 2 Selected space atmospheric observation systems

Owner or partner	Name of the space system	Description	Name of sample satellites
CAMS	JAXA	Methane (CH ₄) observation with TANSO instrument	GOSAT
CAMS	EUMETSAT	Cloud info. with SEVIRI instrument	MSG
C3S	Copernicus program	Flooding, ice, agriculture, etc.	Sentinel 1, 2, 3 and 6
C3S	EUMETSAT	Gas compositions such as CH ₄	Sentinel 4 and 5
EUMETSAT	Meteosat GEO	Geostationary satellites (GEO) over Europe, Africa and Indian ocean	Meteosat 9, 10, 11
EUMETSAT	Metop	Low Earth Orbit (LEO) satellites for polar monitoring	Metop B, C
EUMETSAT	Jason 3 and Jason CS/Sentinel 6	Low Earth Orbit (LEO) satellites for sea level monitoring for Europe and US	Jason 3 and Sentinel 6
NASA	TEMPO	Geostationary satellite (GEO) for monitoring air pollution of Northern America	TEMPO

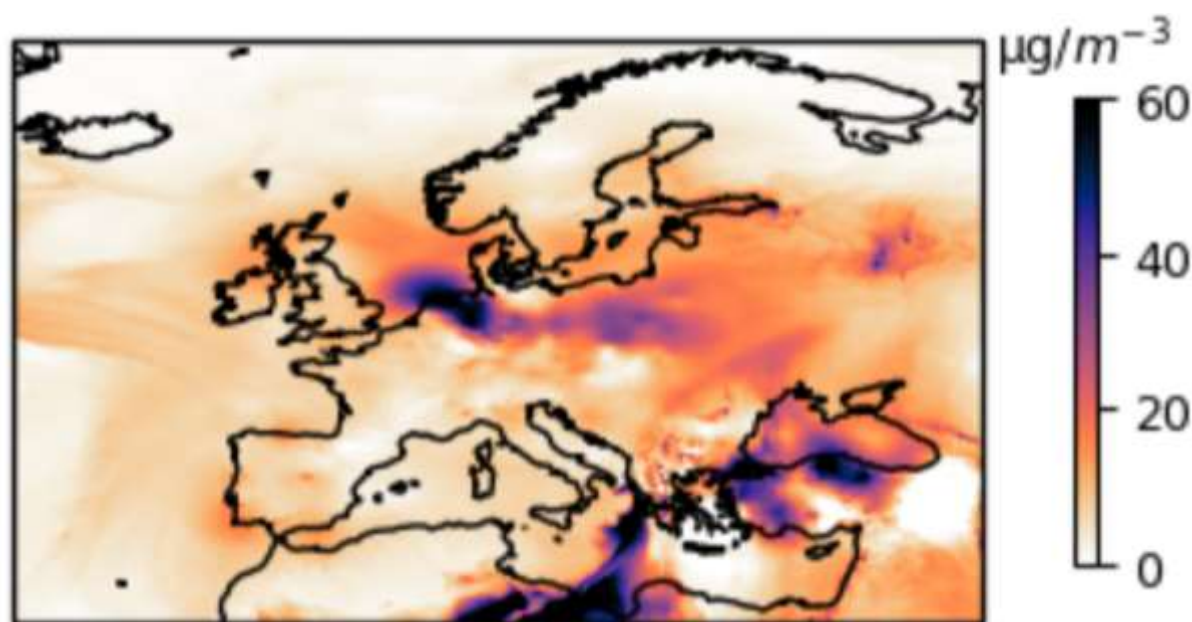

Figure 1 CAMS air quality ensemble of nine air quality data of European region for 01.April.2018.

Figure 1 demonstrates quality of air in European region for 01.April.2018 collected from the datasets of CAMS system. In that specific period, relatively high values of air quality index available in some parts of Turkey including most of the western regions.

Climate Change Service (C3S) works on enormous data sets to provide past, current and future predictions about climate change. It gathers data from different space instruments as well as with in situ equipment. Agricultural predictions, flooding, heavy snow expectations are just to name a few past, current and future forecasts.

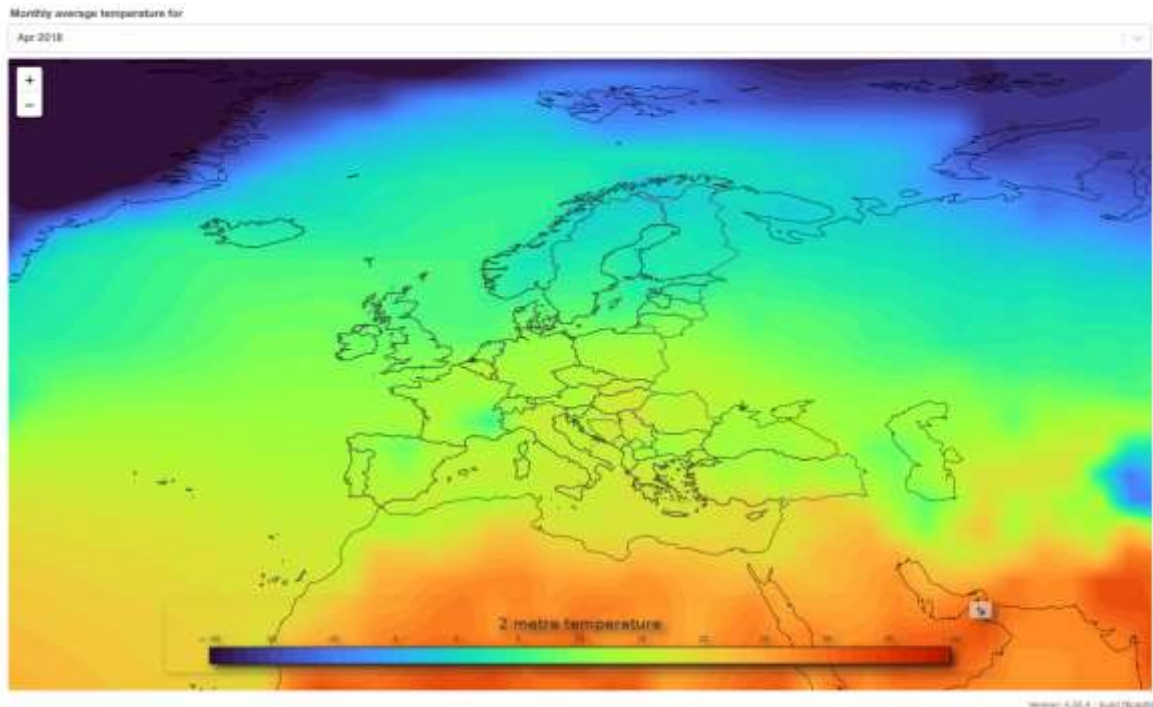

Figure 2 Monthly mean surface air temperature for 2018.April prepared by data and services of Climate Change Service (C3S).

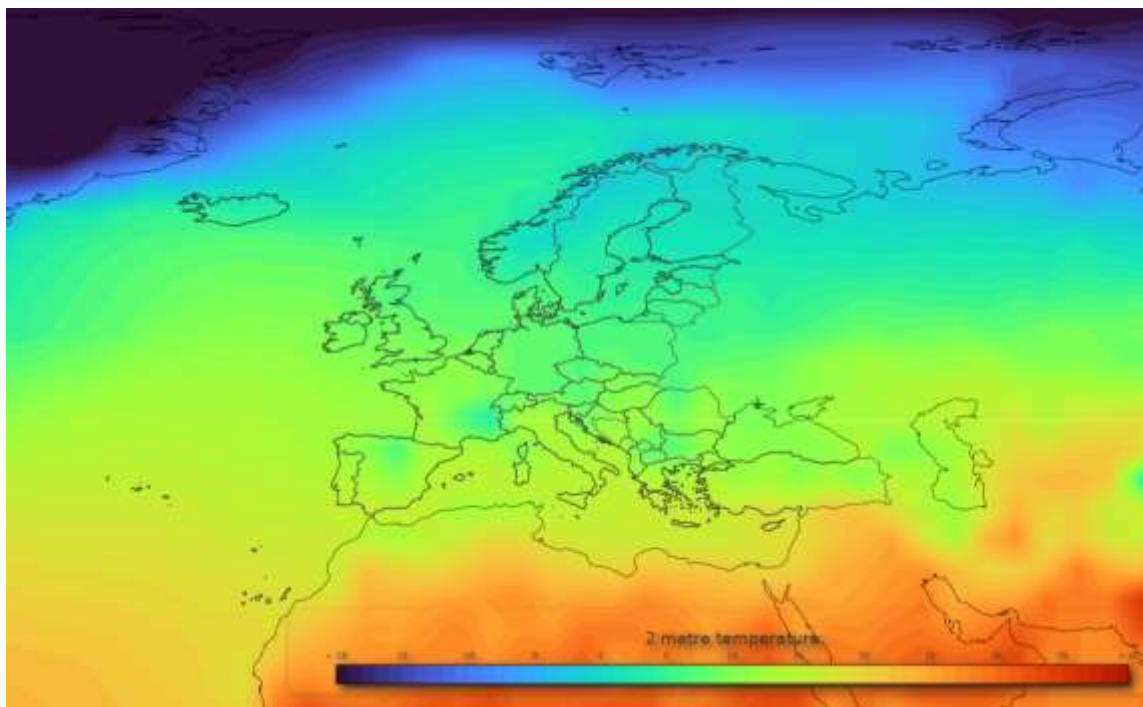

Figure 3 Monthly mean surface air temperature for 2022.April prepared by data and services of Climate Change Service (C3S).

Figure 2 and Figure 3 depict monthly mean surface air temperature for 2018.April and 2022.April respectively. The two figures appear to be identical to each other as an initial impression, but they are not. One of the reasons for their similarities is that the data comes from monthly average temperature values. Although it is an average value, there is a difference in the figures. While it was slightly colder in April 2022 in regions such as France and Spain, the temperature averages increased in the northern African region. Dissimilarities between two figures are also available in other regions.

Since precipitation is important factor in agriculture, Figure 4 depicts one of the precipitation type, snow, in a particular day as an example. In the selected date 2018.April.01, snow type of precipitation was not occurred, but it was available in some parts of Siberia, Baltic Sea, Northern America, etc. This analysis can be applied to other dates and or to make analysis for the extended period instead of a day.

Large scale precipitation water equivalent m

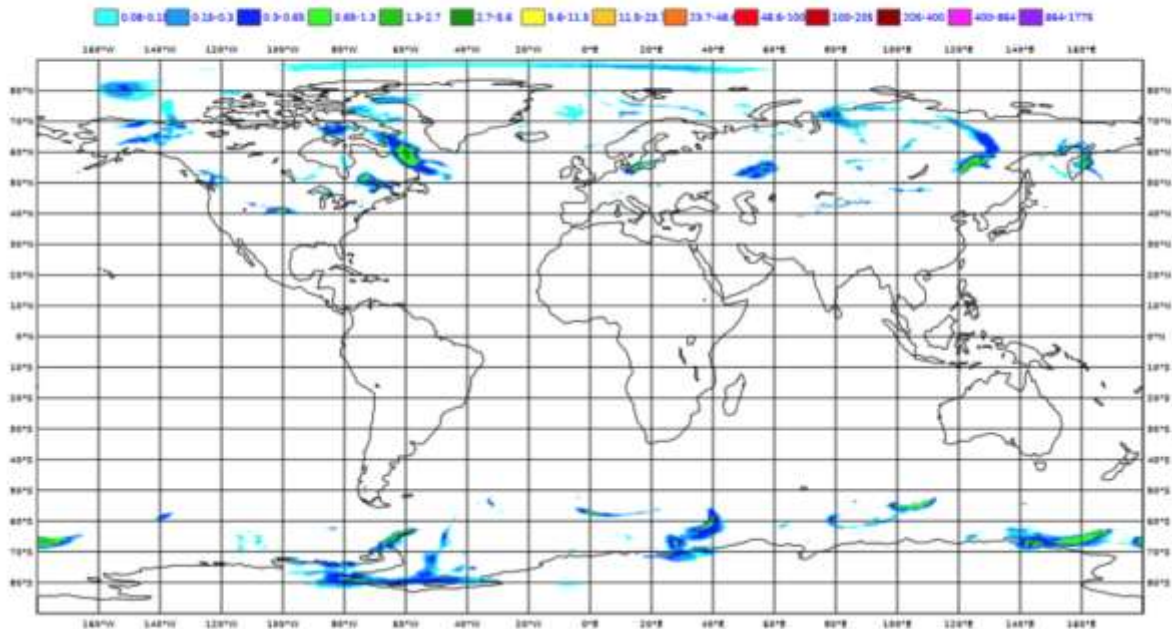

Figure 4 Large scale snow precipitation water equivalent for 2018.April.01 prepared by data and services of Climate Change Service (C3S).

Table 3 shows oil sunflower production in city of Edirne region for 2018 [9] and 2022 [10]. Table 3 indicates area of sunflower production increased from 2018 to 2022 as well as product obtained per unit area.

Figure 1, Figure 2, Figure 3 as well as Figure 4 suitable for agricultural analysis of a region as well as for a specific agricultural product. Moreover, similar observations can be utilized to further extend the research in other fields.

Table 3 Oil sunflower production in Edirne region in 2018 and 2022 years.

Year	Area (Decare)	Quantity (Ton)	Yield (kg/decare)
2018	954.502	237.136	248.4
2022	1.260.318	325.812	258.5

Many implications can be drawn such as; Northern part of Edirne region has better air quality index compared to the rest of the Trakya region. This is because of the fact that less polluter industry available in the region and earth's rotation direction. Considering that air temperatures are increasing, product diversity will probably increase, especially in years with suitable rainfall or in regions with irrigation facilities. On the other hand, air temperatures may also have adverse effect to agriculture that may even burnout the yield. Different sectors can make use of these valuable observations for appropriate predictions. For instance, insurance sector can forecast potential risk of hail for the next season. Since, similar post or future hail map can be generated from these system data sources.

5. CONCLUSION

As discussed in this paper, various satellite equipment and organizations available in the market. Some of them provides free products and services and others requires different amount of money and/or subscriptions. As indicated in this work, their data can be used and/or enhanced for past and future agricultural estimates. These estimates have a positive effect on many areas such as product increase, ideal amount of seed use and appropriate and reasonable fertilizer selection.

As for future works, we are working on these systems for forecasting future scenarios of wheat and sunflower production in Balkan region in general and in Edirne region in particular. Moreover, we conduct our previous work [11] to extend in agriculture field. This prospective study will also an area in the healthy food production and consumption.

REFERENCES

- [1] Kamlesh S. P., Vishvesh P., Riya S., Yash A., Vinay S. P., "Temperature compensated and soil density calibrated soil moisture profiling sensor with multi-sensing point for in-situ agriculture application," *Measurement*, Vol.201, 2022.
- [2] Singh, D.N, Singh, B.P, Verma, V.K., *Agronomic Measures for In-situ Rain Water Harvesting and Moisture Conservation*, Innovative Approach of Integrated Resource Management, New Delhi Publishers, pp.175-186, 2018.
- [3] Han, S., Tang, Q., Zhang, X., Xu., D., Kou, L., "Surface wind observations affected by agricultural development over Northwest China," *Environmental Research Letters*, Vol.11, No.5, 2016.
- [4] *UNOOSA 2022 Annual Report*, United Nations Office for Outer Space Affairs (UNOOSA), June 2023.
- [5] Copernicus Atmosphere Monitoring Service (CAMS), <https://atmosphere.copernicus.eu> .
- [6] Climate Change Service (C3S), <https://climate.copernicus.eu> .

- [7] European Organisation for the Exploitation of Meteorological Satellites (EUMETSAT), <https://www.eumetsat.int> .
- [8] National Aeronautics and Space Administration (NASA), <https://www.nasa.gov> .
- [9] *2018 yılı Ayçiçeği Raporu*, T.C. Ticaret Bakanlığı, Esnaf, Sanatkârlar ve Kooperatifçilik Genel Müdürlüğü, April.2019.
- [10] *Bozer, P., Durum ve Tahmin Ayçiçeği 2022*, Tarımsal Ekonomi ve Politika Geliştirme Enstitüsü Müdürlüğü, May.2023.
- [11] *Atlig, C., Satellite-Based Remote Sensing of Tropospheric Methane in Trakya Region*, 4th International Hydrogen Technologies Congress, pp.520-523, 20-23.June.2019.

THE EFFECTS OF LUTEOLIN ON ACRYLAMIDE INDUCED OXIDATIVE DAMAGE IN 3T3 EMBRYONIC FIBROBLAST CELLS

EMİNE ÇAKIR¹, Banu ORTA YILMAZ², Yasemin AYDIN^{2,}*

¹ *Department of Biology, Institute of Graduate Studies in Sciences, Istanbul University, Istanbul, Turkey*

² *Istanbul University, Science Faculty, Department of Biology, Istanbul, Turkey*

**Corresponding author e-mail: yastun@istanbul.edu.tr*

ABSTRACT

Acrylamide, which is used in various fields of industry (paint, textile, cosmetics), is a water-soluble white, odorless and crystal compound. Studies have indicated that high amounts of acrylamide are found in foods such as potatoes, bread, coffee and cereal products. Many studies have been conducted to investigate possible human health risks from acrylamide exposure, along with the determination of daily dietary intake. Previously studies have demonstrated that acrylamide has cytotoxic, neurotoxic, genotoxic and carcinogenic effects. In order to reduce the toxic effects of heat-treated food contaminants, foods with antioxidant properties should be consumed. Luteolin is an antioxidant compound found in significant concentrations in vegetables, fruits, and spices. Luteolin exerts its antioxidant effects by scavenging free radicals responsible for oxidative damage, inhibiting some enzymes that catalyze oxidation, and strengthening endogenous antioxidants. The purpose of this study was to examine the effects of acrylamide on the viability of 3T3 embryonic fibroblast cells, lipid peroxidation, and antioxidant enzyme levels (superoxide dismutase, catalase, and glutathione peroxidase), as well as to show how luteolin protects against acrylamide toxicity. For 24 hours, 2 mM concentrations of acrylamide and/or 10 μ M concentrations of luteolin were applied to 3T3 embryonic fibroblast cells. The findings indicate that acrylamide significantly reduces cell viability and antioxidant enzyme activities and increases lipid peroxidation. As a result of the treatment of 3T3 embryonic fibroblast cells exposed to acrylamide with luteolin, it was found that cell viability and enzymatic antioxidant activities increased, and lipid peroxidation significantly decreased. This has led to the discovery that luteolin possesses potent antioxidant properties that protect embryonic fibroblast cells from the cytotoxicity and oxidative damage caused by acrylamide.

Keywords: Acrylamide, Luteolin, embryonic fibroblast cells, oxidative damage, antioxidant system.

INTRODUCTION

Acrylamide is a water-soluble white, odorless and crystalline chemical compound that is widely used in the manufacture of industrial products in the world (Kusnin et al., 2015; Paleologos and Kontominas, 2005; Khezerlou et al., 2018). Acrylamide has been discovered to be produced during the heat processing of food products, in addition to its industrial usage (Lineback et al., 2012). In a 2002 report, the Swedish National Food Administration (SNFA) and Stockholm University first mentioned the occurrence of acrylamide in food products (Keramat et al., 2011). Acrylamide is mainly produced through the Maillard reaction that occurs after cooking foods at temperatures above 120°C. Heat-treated fried potatoes, coffee, bread, breakfast cereals, and biscuits are among the food products containing high amounts of acrylamide (Yaylayan and Stadler, 2005; Michalak et al., 2019; Lineback et al., 2012). Studies indicate that exposure to acrylamide negatively affects human health and causes toxicity (Raffan et al., 2019). The International Agency for Research on Cancer (IARC) has classified acrylamide as a potential human carcinogen as a result of these studies, including it in the

"Group 2A carcinogen class" (IARC, 1994). Although there are various *in vitro* and *in vivo* studies on acrylamide in the literature, there are few studies investigating the toxicity of acrylamide in embryonic fibroblast cells (Hamdy et al., 2022; Hong et al., 2021; Evazalipour et al., 2021; Mahdizade et al., 2021).

Acrylamide exposure occurs by three different routes: oral, inhalation or skin contact (Rifai and Saleh, 2020). Once in the body, acrylamide is rapidly and intensively absorbed from the gastrointestinal tract and enters various organs, including the liver, brain, and kidney (Belhadj Benziane et al., 2019; Yan et al., 2023). Studies have shown that acrylamide increases the production of reactive oxygen species (ROS) and decreases the amount of various antioxidant enzymes involved in their detoxification, leading to disruption of oxidative balance (Zamani et al., 2017; Friedman, 2003). In order to minimize the toxic effects of acrylamide, foods or food supplements with antioxidant properties should be consumed in sufficient amounts in the daily diet (Aslani and Ghobadi, 2016). Flavonoids are a different group of antioxidants that humans receive through food. Flavonoids, commonly referred to as secondary plant metabolites, are compounds with antioxidant characteristics (Zenebe et al., 2001). Luteolin, a flavonoid derivative, is found naturally in the structures of various plant species and is widely included in the daily diet. Luteolin is known to have protective effects against oxidative stress, which causes cell and tissue damage. It acts as an antioxidant by scavenging free radicals responsible for oxidative damage, inhibiting some enzymes that catalyze oxidation, or enhancing endogenous antioxidants (Malacaria et al., 2023; Lin et al., 2008; Mahdiani et al., 2022).

The goal of this study was to determine the potential protective role of luteolin, which has antioxidant capabilities, against the toxicity that acrylamide may induce in 3T3 embryonic fibroblast cells by assessing cell viability, lipid peroxidation, and antioxidant enzyme levels.

MATERIAL AND METHODS

Cell culture and experimental design

The 3T3 embryonic fibroblast cell line used in this study, is a non-tumorigenic cell line derived from 14-17 days pregnant Balb/c mice. This cell line was brought to our laboratory by obtaining from American Type Culture Collection (ATTC): The Global Bioresource Center and is grown by passage regularly once or twice a week under *in vitro* conditions. Cells were maintained in DMEM culture medium with 10% calf serum, 4.5 g/L glucose, L-glutamine, sodium pyruvate, and penicillin-streptomycin solution at 37°C in a humid environment containing 5% CO₂ and 95% air. For acrylamide, the concentration that reduces cell viability to 75% was chosen, while the 10 µM concentration of luteolin used in previous *in vitro* studies was preferred in our study (Li et al., 2019). The experimental groups selected to be applied on the cells were acrylamide, luteolin, and acrylamide + luteolin. 3T3 embryonic fibroblast cells were exposed to the experimental groups for 24 hours.

Cell viability evaluation

The viability of embryonic fibroblast cells after acrylamide and luteolin administration was assessed by measuring formazan development from 3-(4,5-dimethylthiazol-2-yl)-2,5-diphenyl tetrazolium bromide (MTT). Leydig cells were seeded in 96-well plates at 5x10³ cells/well in 100 µL experiment medium. The MTT I solution was added to each well after the incubation period, and the plates were then incubated in a CO₂ incubator at 37°C for 4 hours. Each well was then filled with 100 µL of MTT II solution (SDS) and left to incubate in a CO₂ incubator for an additional day. The absorbance was measured at 540 nm using an ELISA reader. The viability ratios of the acrylamide and luteolin-administered groups were represented as percentages based on control, with the viability ratios of the control cells being considered to be 100%.

Biochemical experiments

In this study, 3T3 embryonic fibroblast cells were seeded in six-well culture plates at 5×10^5 cells per well to perform biochemical experiments. The cells were then treated with acrylamide and/or luteolin concentrations and incubated for 24 hours. After the exposure time was completed, the cells were transferred to ice-cold tris buffer (Tris-HCl, pH:7.2) and the membranes of the cells were disrupted by the ultrasonicator. The cell suspension of lysed cells was centrifuged at in a refrigerated centrifuge. The supernatants were collected and stored at -86°C for analysis of total protein, lipid peroxidation, catalase (CAT), superoxide dismutase (SOD), and glutathione peroxidase (GPx) activity.

Determination of membrane lipid peroxidation

Lipid peroxidation was determined according to the method of Heath and Packer (1968). The principle of the method is based on measuring the amount of the pink-red colored compound formed as a result of the reaction of malondialdehyde (MDA), the product of polyunsaturated fatty acid peroxidation in cells, with thiobarbituric acid (TBA) at pH, in a spectrophotometer at a wavelength of 532 nm.

Measurement of total protein

The smart BCA protein assay kit was used to determine the samples total protein amounts. The principle of this method is that the amount of protein is determined by colorimetrically measuring the purple-colored reaction product formed as a result of the binding of a copper ion to two BCA molecules. The purple-colored reaction product formed within the scope of the method shows linear absorbance with increasing protein amount at 562 nm.

Determination of antioxidant enzyme activities

The Marklund and Marklund (1974) method was used to evaluate the SOD enzyme activity. The principle of the method is based on the inhibition of pyrogallol autoxidation by the SOD enzyme at an alkaline pH. After the experimental steps were performed, the varying absorbance of the test solution was read in the spectrophotometer at 420 nm at 30-second intervals for three minutes.

The Sinha (1972) method was used to evaluate the activity of the catalase enzyme, an important antioxidant. The principle of this method is that the dark blue-black color of chromate acetic acid formed by H_2O_2 turns into light green by heat. The mixtures were then examined in the spectrophotometer at 570 nm against a blank.

The method of Hafeman et al. (1974) was used for the analysis of GPx enzyme activity. In the presence of reduced glutathione, the GPx enzyme catalyzes the breakdown of H_2O_2 to generate oxidized glutathione and water. The principle of the experiment is based on the use of reduced glutathione's 5,5'-Dithio-bis(2-nitrobenzoic acid) reagent to produce a quantified compound at a wavelength of 412 nm.

Statistical Analysis

3T3 embryonic fibroblast cells were assessed by the GraphPad Prism 9.0 program (GraphPad PRISM Software, San Diego, California, USA) to statistically evaluate total protein, malondialdehyde, catalase enzyme, superoxide dismutase, and glutathione peroxide enzymes. The obtained data were statistically analyzed using Tukey's multiple comparison test and a one-way ANOVA test and expressed as mean \pm standard deviation. The results were evaluated according to the significance levels of $p < 0.001$, $p < 0.01$, $p < 0.05$.

RESULTS

Cell viability

3T3 embryonic fibroblast cells were administered separately and together with 2 mM acrylamide and 10 μM luteolin concentrations for 24 hours and the resulting viability rates (%) are presented in Figure 1. MTT results revealed a substantial decrease in cell viability in the acrylamide-administered experimental group compared to the control group ($p < 0.001$). When

the Acr+Lut group was compared to the acrylamide alone group, there was a significant rise in cell viability ($p < 0.01$).

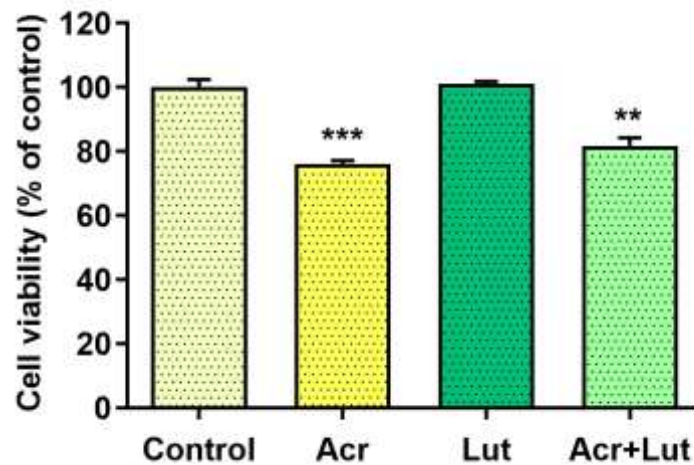

Figure 1. Effects of acrylamide and/or luteolin on cell viability in 3T3 embryonic fibroblast cells. The columns indicate the average (\pm SEM) from three independent experiments. (** $p < 0.01$; *** $p < 0.001$: compared with control)

Total protein amount

The total amount of protein obtained in 3T3 embryonic fibroblast cells is shown in Figure 2. Acrylamide and luteolin and their combined groups were applied to cells for 24 hours alone and there was no significant difference.

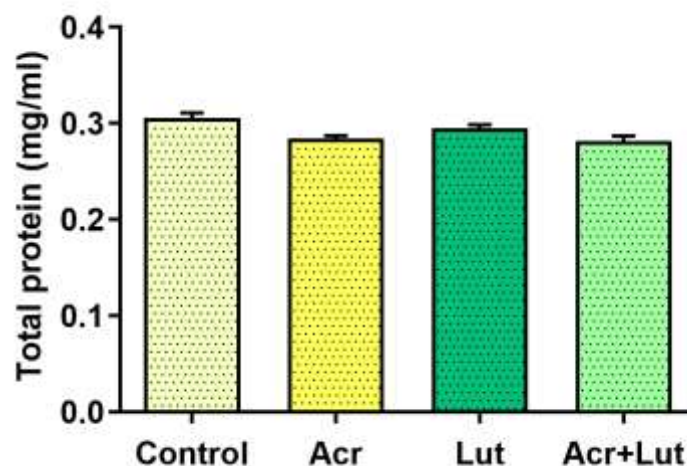

Figure 2. Effects of acrylamide and luteolin on total protein amount on 3T3 embryonic fibroblast cells

Lipid peroxidation

The amount of MDA after 3T3 embryonic fibroblast cells were exposed to acrylamide, luteolin, and their combination for 24 hours is shown in Figure 3. When compared to the control group, the amount of MDA was significantly increased in the group that received acrylamide alone ($p < 0.001$). MDA levels significantly decreased ($p < 0.05$) when the group treated with acrylamide+luteolin was compared to the group exposed only to acrylamide ($p < 0.05$). According to the lipid peroxidation data, it was determined that the use of luteolin was effective in improving acrylamide-induced lipid peroxidation in 3T3 embryonic fibroblast cells.

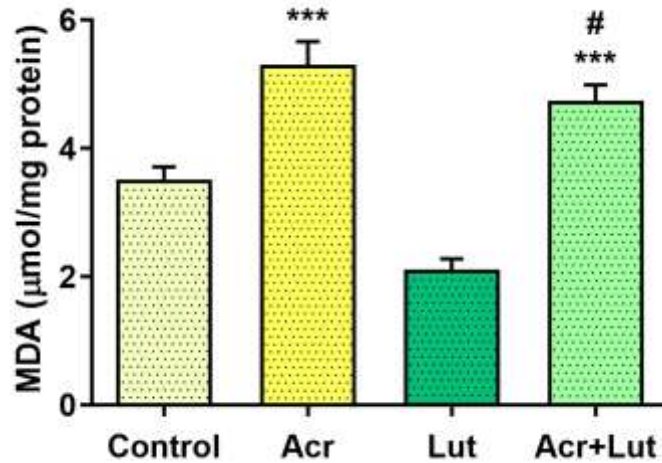

Figure 3. Effects of acrylamide and luteolin on lipid peroxidation in 3T3 embryonic fibroblast cells (*: $p < 0,05$, ***: $p < 0,001$ *: compared with control, #: compared with acrylamide)

SOD Activity

The amount of SOD enzyme activity after 3T3 embryonic fibroblast cells were exposed to acrylamide, luteolin, and their combination for 24 hours is shown in Figure 4. The amount of SOD enzyme in the acrylamide-treated group was significantly decreased compared to the control group ($p < 0.001$). When the amounts of SOD enzyme in the acrylamide group and the groups treated with luteolin in addition to acrylamide were examined, it showed that the enzyme activity increased significantly ($p < 0.05$).

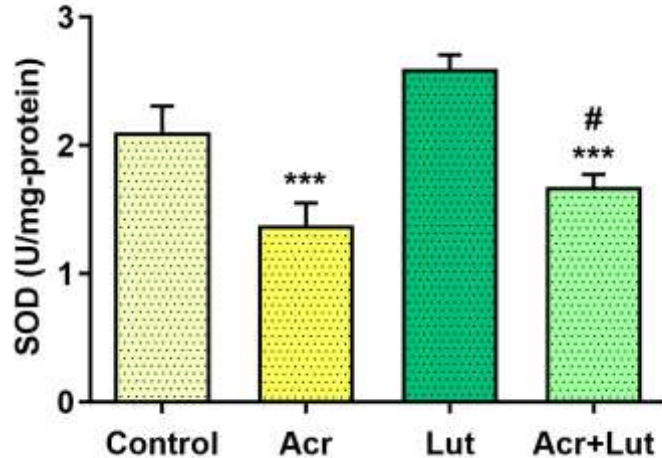

Figure 4. Effects of acrylamide and luteolin on SOD activities in 3T3 embryonic fibroblast cells (*: $p < 0,05$, ***: $p < 0,001$ *: compared with control, #: compared with acrylamide)

CAT activity

Figure 5 displays the findings of CAT enzyme activity after treating 3T3 embryonic fibroblast cells with Acr, Lut, and Acr+Lut for 24 hours. When acrylamide was administered, the CAT enzyme activity considerably decreased compared to the control group ($p < 0.01$). The acrylamide + luteolin group revealed a noticeably higher level of CAT enzyme than the acrylamide group alone ($p < 0.05$).

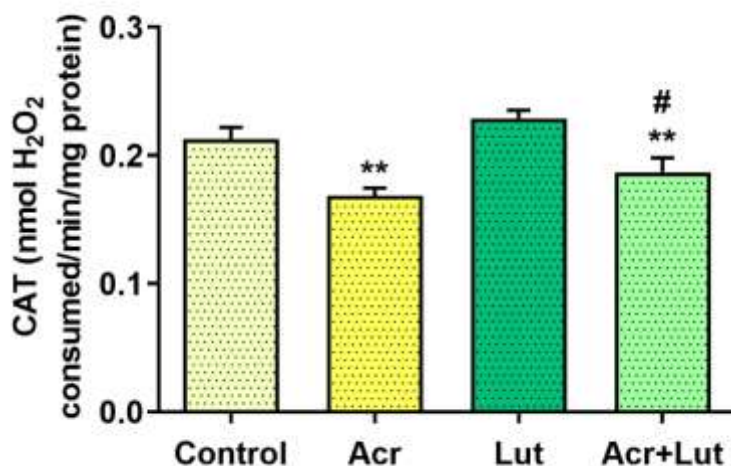

Figure 5. Effects of acrylamide and luteolin on CAT activities in 3T3 embryonic fibroblast cells (* $p < 0,05$; ** $p < 0,01$; #: compared with acrylamide)

GPx activity

Figure 6 indicates the amount of GPx enzymes measured by the quantity of glutathione consumed in 3T3 embryonic fibroblast cells after a 24-hour acrylamide and/or luteolin treatment. According to the results obtained, it was determined that the amount of GPx enzyme decreased only in the acrylamide group compared to the control group ($p < 0.001$). In addition, when the groups treated with acrylamide and acrylamide + luteolin were compared in terms of GPx enzyme amount, it was concluded that the enzyme activity increased significantly in the acrylamide + luteolin group ($p < 0.05$).

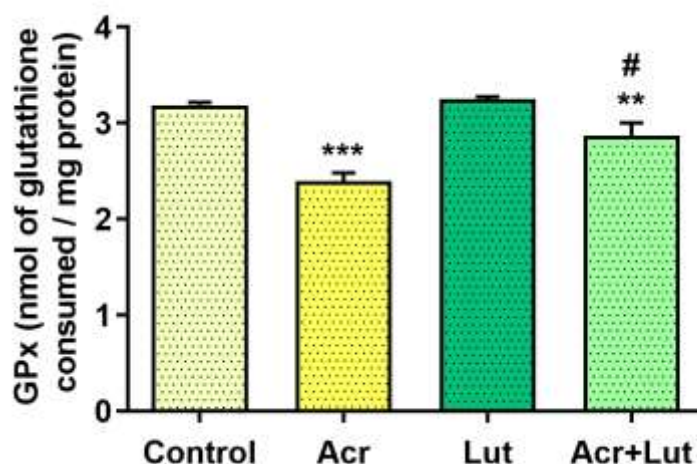

Figure 6. Effects of acrylamide and luteolin on GPx activities in 3T3 embryonic fibroblast cells (* $p < 0,05$; ** $p < 0,01$; *** $p < 0,001$; #: compared with acrylamide)

DISCUSSION

Studies indicate that acrylamide, which has become a considerable problem in terms of food safety, has negative effects on biological systems. Antioxidant compounds have been used in many studies employing different cell types to reduce acrylamide-induced toxicity (Chen et al., 2014; Cao et al., 2008). However, there are limited studies on cell viability in 3T3 embryonic fibroblast cells (Evazalipour et al., 2021; Mahdizade et al., 2021). Cell viability was dramatically decreased in groups exposed to acrylamide at doses of 25, 50, and 100 μM in a

study using human lymphocyte cells. According to this study, supplementing with 10, 25, and 50 μM concentrations of chrysin in addition to 50 μM acrylamide decreased the detrimental effects of acrylamide on cell viability (Salimi et al., 2021). In a different investigation, cultured embryonic fibroblast cells were exposed to acrylamide at concentrations of 1, 2, and 5 mM. It was showed that 5 mM acrylamide significantly reduced cell viability. In the present study, it was discovered that 10 μM luteolin greatly increased cell viability, while 2 mM acrylamide significantly decreased cell viability in 3T3 embryonic fibroblast cells.

An excessive increase in the quantity of ROS produced at particular levels during the regular metabolic processes of cells disrupts the oxidative balance. Biological substances including lipids, proteins, and DNA are damaged by elevated quantities of ROS, resulting in cellular damage (Kohen and Nyska, 2002). Acrylamide can induce oxidative damage by causing excessive production of ROS in cells (Hong et al., 2021; Salimi et al., 2021). According to a study with HepG2 cells, exposure to 10 mmol/L acrylamide significantly increased the MDA level, a lipid peroxidation product. In the same study, anthocyanin extracts (AEP) isolated from blueberries at concentrations of 5, 10, 20 $\mu\text{g}/\text{mL}$ were administered to the cells together with acrylamide, and as a result, it was revealed that the amount of MDA decreased (Li et al., 2018). In a 2019 study by Orta-Yilmaz, it was demonstrated that administration to 3T3 embryonic fibroblast cells for 24 hours resulted in significantly higher lipid peroxidation levels at 10, 100, and 1000 mol/L acrylamide concentrations, and that the same study also demonstrated that curcumin treatment combine with acrylamide resulted in significantly lower lipid peroxidation levels (Orta-Yilmaz, 2019). Similar to the above studies, acrylamide has been found to significantly increase lipid peroxidation in 3T3 embryonic fibroblast cells. In groups in which acrylamide and luteolin were co-administered to 3T3 embryonic fibroblast cells, lipid peroxidation levels were significantly reduced. Based on the healing effects of antioxidant compounds such as vitamin C, curcumin and blueberry extract against acrylamide toxicity, the study concluded that luteolin has a healing effect on lipid peroxidation.

Antioxidant enzymes are responsible for the detoxification of ROS, and the changing activities of these enzymes are an important indicator of oxidative damage levels (Adwas et al., 2019). Various chemicals and food pollutants cause the oxidative balance to be disrupted by reducing the levels of antioxidant enzymes in organisms. Earlier studies have shown that acrylamide affects the level of antioxidant enzymes (Orta-Yilmaz 2019; Albalawi et al., 2017). A study with the ARPE-19 cell line found that 0.7 and 1 mM of acrylamide significantly reduced the activity of SOD and CAT enzymes, while 10 μM of carnolic acid significantly increased activity when administrated to cells as a pre-treatment before acrylamide (Albalawi et al., 2017). In a study with 3T3 embryonic fibroblast cells, 100 and 1000 $\mu\text{mol}/\text{L}$ acrylamide decreased the activity of the SOD, CAT, and GPx enzymes at the end of the 24 h period, while the enzyme activity of SOD and CAT and GPx increased significantly when supplemented with vitamin C or curcumin (Orta-Yilmaz 2019). In this study, the reduction in enzyme activity resulting from the administration of acrylamide to 3T3 embryonic fibroblast cells was parallel to the above *in vitro* studies. In our study, 2 mM acrylamide decreased the activity of the enzymes SOD, CAT and GPx in fibroblast cells, while 10 μM luteolin significantly increased the activities of these enzymes, playing a protective role in acrylamide toxicity.

CONCLUSIONS

Consequently, our research shown that 2 mM acrylamide decreases cell viability and elevates lipid peroxidation. In 3T3 embryonic fibroblast cells, the study revealed that exposure to acrylamide decreases the activity of the CAT, SOD, and GPx enzymes, which are involved in the intracellular antioxidant defense system. Luteolin has been discovered to be a useful antioxidant molecule against acrylamide toxicity.

REFERENCES

- Adwas, A. A., A. Elsayed, A. E. Azab, F. A. Quwaydir. 2019. Oxidative stress and antioxidant mechanisms in human body. *J. Appl. Biotechnol. Bioeng*, 6(1): 43-47.
- Albalawi, A., R. H. A. Alhasani, L. Biswas, J. Reilly, X. Shu. 2017. Protective effect of carnosic acid against acrylamide-induced toxicity in RPE cells. *Food and Chemical Toxicology*, 108, 543-553.
- Aslani, B. A., S. Ghobadi. 2016. Studies on oxidants and antioxidants with a brief glance at their relevance to the immune system. *Life sciences*, 146, 163-173.
- Belhadj Benziane, A., A. Dilmi Bouras, A. Mezaini, A. Belhadri, M. Benali. 2019. Effect of oral exposure to acrylamide on biochemical and hematologic parameters in Wistar rats. *Drug and chemical toxicology*, 42(2): 157-166.
- Cao, J., Y. Liu, L. Jia, L. P. Jiang, C. Y. Geng, X. F. Yao, Y. Kong, B. F. Jiang, L. F. Zhong. 2008. Curcumin attenuates acrylamide-induced cytotoxicity and genotoxicity in HepG2 cells by ROS scavenging. *Journal of agricultural and food chemistry*, 56(24): 12059-12063.
- Chen, W., Y. Shen, H. Su, X. Zheng. 2014. Hispidin derived from *Phellinus linteus* affords protection against acrylamide-induced oxidative stress in Caco-2 cells. *Chemico-Biological Interactions*, 219, 83-89.
- Evazalipour, M., P. S. Kozani, P. S. Kozani, S. Shabani, B. R. Soufi, E. Zamani. 2021. Acrylamide induced oxidative cellular senescence in embryonic fibroblast cell line (NIH 3T3): a protection by carvacrol. *Jundishapur Journal of Natural Pharmaceutical Products*, 16(4).
- Friedman, M. 2003. Chemistry, biochemistry, and safety of acrylamide. A review. *Journal of agricultural and food chemistry*, 51(16): 4504-4526.
- Hamdy, S. M., Z. El-Khayat, A. R. Farrag, O. N. Sayed, M. M. El-Sayed, D. Massoud. 2022. Hepatoprotective effect of Raspberry ketone and white tea against acrylamide-induced toxicity in rats. *Drug and Chemical Toxicology*, 45(2): 722-730
- Hafeman, D. G., R.A. Sunde, W.G. Hoekstra. 1974. Effect of dietary selenium on erythrocyte and liver glutathione peroxidase in the rat, *The journal of nutrition*, 104 (5): 580-587.
- Heath, R. L., and L. Packer. 1968. Photoperoxidation in isolated chloroplasts: I. kinetics and stoichiometry of fatty acid peroxidation, *Archives of biochemistry and biophysics*, 125 (1): 189-198
- Hong, Z., W. Minghua, N. Bo, Y. Chaoyue, Y. Haiyang, Y. Haiqing, X. Chunyu, Z. Yan, Y. Yuan. 2021. Rosmarinic acid attenuates acrylamide induced apoptosis of BRL-3A cells by inhibiting oxidative stress and endoplasmic reticulum stress. *Food and Chemical Toxicology*, 151, 112156.
- IARC. 1994. Acrylamide in some industrial/chemicals; IARC monographs on the evaluation of carcinogenic risks to humans; International Agency for research on cancer: Lyon, France, 60:389-433.
- Keramat, J., A. LeBail. C. Prost, N. Soltanizadeh. 2011. Acrylamide in foods: chemistry and analysis. A review. *Food and bioprocess technology*, 4, 340-363
- Khezerlou, A., M. Alizadeh-Sani, N. Z. Firouzsalar, A. Ehsani. 2018. Formation, properties, and reduction methods of acrylamide in foods: A review study. *Journal of Nutrition, Fasting and Health*, 6(1 (Special issue on Food Safety), 52-59.
- Kohen, R., A. Nyska. 2002. Invited review: oxidation of biological systems: oxidative stress phenomena, antioxidants, redox reactions, and methods for their quantification. *Toxicologic pathology*, 30(6), 620-650.
- Kusnin, N., M. A. Syed, S. A. Ahmad. 2015. Toxicity, pollution and biodegradation of acrylamide: A mini review. *Journal of biochemistry, microbiology and biotechnology*, 3(2): 6-12.
- Li, X., H. Liu, L. Lv, H. Yan, Y. Yuan. 2018. Antioxidant activity of blueberry anthocyanin extracts and their protective effects against acrylamide-induced toxicity in HepG2 cells. *International Journal of Food Science & Technology*, 53(1): 147-155.
- Li, L., Luo, W., Qian, Y., Zhu, W., Qian, J., Li, J., Jin, Y., Xu, X., Liang, G., 2019. Luteolin protects against diabetic cardiomyopathy by inhibiting NF- κ B-mediated inflammation and activating the Nrf2-mediated antioxidant responses. *Phytomedicine*, 59: p.152774.

- Lin, Y., R. Shi, X. Wang, H. M. Shen. 2008. Luteolin, a flavonoid with potential for cancer prevention and therapy. *Current cancer drug targets*, 8(7): 634-646.
- Lineback, D. R., J. R. Coughlin. R. H. Stadler. 2012. Acrylamide in foods: a review of the science and future considerations. *Annual review of food science and technology*, 3, 15-35.
- Mahdiani, S., N. Omidkhoda, S. Heidari, A. W. Hayes, G. Karimi. 2022. Protective effect of luteolin against chemical and natural toxicants by targeting NF- κ B pathway. *Biofactors*, 48(4): 744-762.
- Mahdizade, E., M. Baeri, M. Hodjat, M. Rahimifard, M. Navaei-Nigjeh, H. Haghi-Aminjan, S. Moeini-Nodeh, S. Hassani, G. Dehghan, M. A. Hosseinpour-Feizi, M. Abdollahi. 2021. Impact of acrylamide on cellular senescence response and cell cycle distribution via an in-vitro study. *Iranian Journal of Pharmaceutical Research: IJPR*, 20(4): 165.
- Malacaria, L., J. Bijlsma, R. Hilgers, W. J. de Bruijn, J. P. Vincken, E. Furia. 2023. Insights into the complexation and oxidation of quercetin and luteolin in aqueous solutions in presence of selected metal cations. *Journal of Molecular Liquids*, 369, 120840.
- Marklund, S., G. Marklund. 1974. Involvement of the superoxide anion radical in the autoxidation of pyrogallol and a convenient assay for superoxide dismutase, *European journal of biochemistry*, 47 (3): 469-474.
- Michalak, J., M. Czarnowska-Kujawska, E. Gujska. 2019. Acrylamide and thermal-processing indexes in market-purchased food. *International Journal of Environmental Research and Public Health*, 16(23): 4724.
- Orta-Yilmaz, B., 2019. Protective effects of vitamin C and curcumin against acrylamide toxicity in embryonic fibroblast cells. *Toxicological & Environmental Chemistry*, 101(7-8): 389-403.
- Paleologos, E. K., M. G. Kontominas. 2005. Determination of acrylamide and methacrylamide by normal phase high performance liquid chromatography and UV detection. *Journal of Chromatography A*, 1077(2): 128-135.
- Raffan, S., N. G. Halford. 2019. Acrylamide in food: Progress in and prospects for genetic and agronomic solutions. *Annals of Applied Biology*, 175(3): 259-281.
- Rifai, L., F. A. Saleh. 2020. A review on acrylamide in food: occurrence, toxicity, and mitigation strategies. *International Journal of Toxicology*, 39(2): 93-102.
- Salimi, A., N. Hashemidanesh, E. Seydi, E. Baghal, F. Khodaparast, H. Ghobadi. 2021. Restoration and stabilization of acrylamide-induced DNA, mitochondrial damages and oxidative stress by chrysin in human lymphocyte. *Expert Opinion on Drug Metabolism and Toxicology*, 17(7): 857-865.
- Sinha, A. K., 1972. Colorimetric assay of catalase, *Analytical biochemistry*, 47 (2): 389-394.
- Yan, F., L. Wang, L. Zhao, C. Wang, Q. Lu, R. Liu. 2023. Acrylamide in food: Occurrence, metabolism, molecular toxicity mechanism and detoxification by phytochemicals. *Food and Chemical Toxicology*, 113696.
- Yaylayan, V. A., R. H. Stadler. 2005. Acrylamide formation in food: a mechanistic perspective. *Journal of AOAC International*, 88(1): 262-267.
- Zamani, E., M. Shokrzadeh, M. Fallah, F. Shaki. 2017. A review of acrylamide toxicity and its mechanism. *Pharmaceutical and biomedical research*, 3(1): 1-7.
- Zenebe, W., O. Pechánová, I. Bernátová. 2001. Protective effects of red wine polyphenolic compounds on the cardiovascular system. *Experimental and Clinical Cardiology*, 6(3): 153.

COMPARATIVE METHODS FOR DETECTION OF SUBCLINICAL MASTITIS AT DAIRY COWS IN ORDER TO IMPROVE MILK QUALITY

Biljana TRAJKOVSKA¹, Blagoja RISTESKI¹, Vesna KARAPETKOVSKA-HRISTOVA¹

¹ *University st. Kliment Ohridski, Faculty of Biotechnical Sciences, Bitola, North Macedonia
Corresponding author e-mail: biljana.trajkovska@uklo.edu.mk*

ABSTRACT

The control of the health status of the udder is a significant element for obtaining a hygienically and safety milk. The aim of our research was to make a comparative analysis of the methods for determining subclinical mastitis, such as CMT and somatic cell count (SCC/mL) in comparison with electrical conductivity (EC) and lactose as an indirect method for detection of subclinical mastitis. It was determined that by increasing the number of somatic cells in milk (SCC/mL), the percentage of lactose in milk decreases from 4.80% to 4.13%, and the electrical conductivity increases from 4.21 mS/cm to 4.95 mS/cm. The number of somatic cells obtained using the MKC EN ISO 13366-2:2010 method was taken as a standard method for determining the somatic cells in milk, and based on these results, the sensitivity of the other methods was further determined. The results indicate that the California mastitis test (CMT) has 57% sensitivity and 88% specificity, while measuring the electrical conductivity (EC) has a sensitivity of 82% and a specificity of 50%. Whereas the sensitivity of the lactose is 79%, and the specificity is 60%. The sensitivity of the test, the so-called true positive rate, or probability of detection, expresses the percentage of correctly identified infected quarters. According to this with determination of EC and the percentage of lactose, more reliable results are obtained compared to the CMT test. On the other hand the specificity of the test, the ability to detect all negative samples, i.e. healthy cows, better results were obtained with the CMT test.

Keywords: mastitis, California mastitis test (CMT), electrical conductivity (EC), lactose.

INTRODUCTION

Mastitis is still one of the most significant problems in the dairy industry and one of the most expensive diseases affecting dairy cows. The losses that occur are the result of milk reduction, veterinary costs, deterioration of milk quality, and increase in the risk of subsequent mastitis (Lightner, J.K., et al., 1988). These losses are mostly caused by subclinical mastitis, while clinical mastitis can easily be determinate by the farmer (Kaşıkçı, G., et al., 2012).

Diagnosing subclinical mastitis can be problematic because the milk still looks normal, but the number of somatic cells is increased (Forsback et al., 2010). These changes can be determined indirectly using several diagnostic methods such as California mastitis test (CMT), pH, chlorides, catalase test, modified White Side test (MWT) (Reddy, B. S. S., et al., 2014) as well as electrical conductivity. These tests are preferred to be used as screening tests for subclinical mastitis and can be easily used and satisfactory and repeatable results can be obtained (Leslie et al., 2002). The diagnosis of mastitis according to the International Dairy Federation (IDF) should be made based on the number of somatic cells (SCC) and the microbiological status of the quarter, i.e. bacteriological cultures of milk samples are the standard method for determining mastitis, which is financially more expensive and therefore not widely used.

For these reasons, the goal was to determine the compliance of several methods with standard protocols for diagnosing subclinical mastitis as somatic cell count. Because, in recent times, the awareness of consumers who expect quality and safety products obtained from healthy animals is increasing more and more. Precisely because of this, it is necessary to control the quality of milk on the farm itself in order to meet the demands of consumers.

MATERIAL AND METHOD

The milk samples (N=69) were taken from a farm in the Pelagonian region, with a tied cow housing system. First, the milk was milked on a black pad in order to determine if there was clinical mastitis or inflammation of the teat canal, then the milk was milked on California mastitis test (CMT) plates in order to determine if there was subclinical mastitis. Two milk samples per quarter were taken, for determination of somatic cell count (SCC/mL) and for determination of conductivity and physicochemical parameters of the milk. The samples taken were transported to the laboratory at a temperature of 5-8°C in a hand-held refrigerator, and the tests were performed within 24 hours.

The obtained results were grouped into four categories depending on the number of somatic cells. At the same time, the first category referred to normal milk, where the number of somatic cells was $\leq 200,000$ cells/ml, while the second, third and fourth categories referred to the number of somatic cells from 200,001 to 400,000 cells/ml; 400,001 to 600,000 cells/ml; and $\geq 601,000$ cells/ml, respectively.

California mastitis test (CMT). The test is based on the action of surfactants (alkylaryl sulfonate) on DNA polymer from leukocytes, during which DNA is separated, and the protein part spontaneously turns into a gel. Interpretation of the results was done as previously described by Galfi A., (2016).

The electrical conductivity (EC) was examined using a HANNA HI 98192 EC/TDS/NaCl/Resistivity conductometer, which has a measurement range of 0-400 mS/cm. The samples were analyzed after milking. During the measurement, the temperature of the samples was 20-25 °C. About 50 ml of milk was taken for analysis.

The number of somatic cells was determined using a fluoro-opto-electronic method, BENTLEY SOMACOUNT CC 150, according to standard MKC EN ISO 13366-2:2010: Milk - Somatic cell counting - Part 2: Instructions for use with fluoro-opto- electronic counter ISO 13366-2:2006. Samples intended for determining the number of somatic cells were previously preserved with bronopol and heated to a temperature of 40 °C in a water bath before analysis in the apparatus.

Physicochemical parameters in milk (fat, protein, lactose, dry matter (SNF), density, casein, pH) were analyzed using LactoScope FTIR Advanced.

The examination of the sensitivity and specificity of indirect tests was done as previously described by Sharma et al., (2010).

Statistical significance between the studied categories was analyzed at a significance level of 5% ($p < 0.05$) and 1% ($p < 0.01$) using the Student's t-test. The data are presented in tables and graphs. The results were processed using Microsoft Office Excel and SPSS 20 statistical software.

RESULTS AND DISCUSSION

Monitoring the health status of dairy cows is necessary in order to obtain quality and hygienic milk (Boboš et al., 2012). The somatic cells of the milk are an indicator of the health status of the udder as well as the hygienic quality of the milk. A large number of factors which interact with each other affect the number of somatic cells in milk, such as the lactation period,

the number of lactations, i.e. the age of the animals, milk yield, improper milking, stress, chronic diseases as well as mechanical injury to the udder tissue (Laevens et al., 1997; Pyörälä, 2003; Boboš and Vidić, 2005).

The increased number of somatic cells is usually accompanied by changes in the physicochemical composition in raw milk. The results shown in table 1 refer to the changes that occur in the milk composition, as a result of the increased number of somatic cells. Additionally, electrical conductivity in milk gradually increases with the increase in the number of somatic cells (Graph 1).

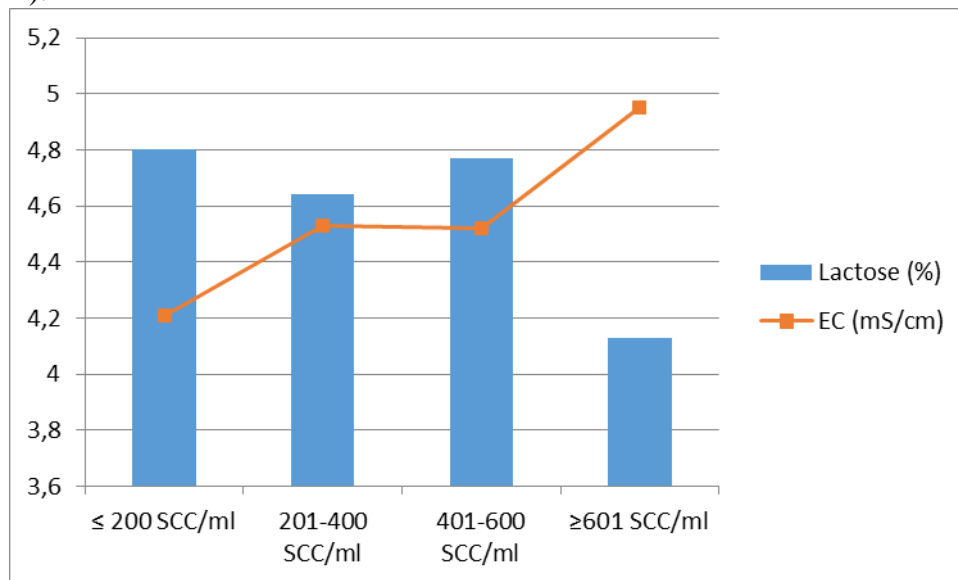

Graph 1 Changes in EC and lactose depending on the categories according to the number of somatic cells

Significant differences were determined only between the group where the number of somatic cells was over 600,000 cells/ml compared to the rest of the groups ($p < 0.05$) (table 1). In addition, although we have an increase in milk conductivity when the number of somatic cells is above 200,000 cells/ml (4.53 mS/cm (201-400 x 10^3 SCC/ml) and 4.52 mS/cm (401-600 x 10^3 SCC/ml), however, no significant differences were observed, which we believe is due to the small number of samples in these two groups (N=8 and N=9, respectively). Additionally EC can have significant variations even in the absence of mastitis which can be due to a number of factors such as stage of lactation, age of cows, milking intervals as well as cow condition (Biggadike et al. 2000). Factors such as milk temperature, pH, and milk fat percentage can have an effect on EC measurement (Qayyum et al. 2016).

Table 1 Changes in the physicochemical composition of milk by category according to the number of somatic cells (N=69)

Categories according to the number of somatic cell count SCC/ml (N=69)	Milk parameters $\bar{x} \pm SD$							
	SCC/ml $\times 10^3$	Fat (%)	Proteins (%)	Lactose (%)	SNF (%)	pH (%)	Casein (%)	EC (mS/cm)
$\leq 200 \times 10^3$ (N=25)	77,92 \pm 56,34	2,06 \pm 1,78	3,32 \pm 0,24	4,80 \pm 0,19 ^a	9,07 \pm 0,25	6,74 \pm 0,06	2,79 \pm 0,20	4,21 \pm 0,68 ^a
201-400 $\times 10^3$ (N=8)	322,83 \pm 231,00	2,23 \pm 0,54	3,48 \pm 0,49	4,64 \pm 0,31 ^a	9,04 \pm 0,52	6,77 \pm 0,07	2,92 \pm 0,38	4,53 \pm 2,42 ^a
401-600 $\times 10^3$ (N=9)	466,03 \pm 45,46	2,51 \pm 0,69	3,65 \pm 0,25	4,77 \pm 0,20 ^a	8,87 \pm 0,31	6,73 \pm 0,10	3,13 \pm 0,20	4,52 \pm 0,64 ^a
$\geq 601 \times 10^3$ (N=27)	1.415,65 \pm 726,00	2,21 \pm 0,64	3,64 \pm 0,34	4,13 \pm 0,57 ^b	8,61 \pm 0,68	6,87 \pm 0,11	3,04 \pm 0,25	4,95 \pm 1,15 ^b

*** Differences in values with different superscripts in the same column are statistically significant at the level: a:b p<0.05**

The CMT test is accepted as a quick, simple and reliable method for identifying cows with altered secretion and subclinical mastitis. At the same time, based on the results of CMT, the number of somatic cells can be indirectly determined in individual milk samples (Galfi A., 2016). Table 2 shows the results obtained using CMT, where the number of somatic cells is taken as a standard. 4% of the examined samples are false positives, while false negatives are 28%. In comparison with the studies of Galfi A., (2016), that value is 13.33% for false positive in the period before the drying of the cows, where bacteriological tests are taken as a standard. Sharma et al., (2010) states that the false positive reaction of CMT is 23.79%, while the false negative is 25.72%. Additionally, according to Varatanović et al., (2010), CMT test was positive at 11 samples, which were determinate previously as bacteriologically negative, on the other hand CMT give a negative reaction in 10 samples, previously determinate as bacteriologically positive.

The sensitivity of CMT in our research was 57%, and in the research of Galfi A., (2016) in dry cows the sensitivity of the test is 75%, while in the early lactation period the sensitivity is 87.5%. Sharma et al., (2010) found a higher sensitivity of the test (86.07%), while Langer et al., (2014) found a lower sensitivity of 60.1% compared to our research. The specificity of the test is 88% in our research, while in the research of Galfi A., (2016) that specificity of the test in the period before the drying of the cows is 86.67%, and in the period of early lactation it is 87.5%. According to the research of Dingwell et al., (2004) the sensitivity of CMT four days after parturition is 82.4%, and the specificity is 80.6%, which indicates that this method can be applied with success in determining udder secretion disorders and subclinical mastitis during the early lactation period. The validity of the test according to the studies of Langer et al., (2014) is 61.56%, Reddy et al., (2014) 73.33%, while according to the results of Sharma et al., (2010) the validity of the CMT is 75.52%.

Table 2. Results obtained with the California mastitis test (CMT) and using SCC/ml as a standard

Test	CMT	
	N	%
TP	25	36
FP	3	4
TN	22	32
FN	19	28
Total number of analyzed samples	69	
Sensitivity (%)	57	
Specificity (%)	88	
Validity (%)	68	
PPV (%)	89	
NPV (%)	54	

TP - true positive, FR - false positive, TN - true negative, FN - false negative, PPV - positive predictive value, NPV - negative predictive value

The sensitivity of the test with EC in our research is 82% (table 3). Similar results were obtained by Mansell and Seguya (2003) where they observed a sensitivity of 51%, while Langer et al., (2014) determined significantly low values of sensitivity compared to other authors and it was 12.5%. Galfi A., (2016) states that the sensitivity of the test in the drying period is 74.32%, while during early lactation it was significantly low at 2.86%, and for the specificity of the test, it is 50%. According to research by Mansell and Seguya (2003), the specificity of the test was 71%, while Nielen et al., (1992) observed a high specificity of 94%. In addition, Langer et al., (2014) considers that the possibility of determining the subclinical form of mastitis measured by the Draminski mastitis detector is relatively low 7.6%. While the validity in our research is 55%. According to the obtained results of Galfi A., (2016) when measuring the electrical conductivity with the Draminsky test, it was determined that the validity of the test in the drying period is 52%, while in the early lactation period it is 48.65%. While Langer et al., (2014) determined validity with the Draminski test of 59.05%.

From the results (table 3), it can be noted that the percentage of false positives is high (38%). The validity of manual instruments for measuring electrical conductivity has been investigated by many authors. Musser et al., (1998) indicated that 71% of test positive samples were bacteriologically negative and minor mastitis pathogens were isolated in 11% of negative milk samples. According to Galfi A., (2016) the stage of lactation, type of pathogenic microorganism's plays a significant influence on EC values. Additionally, Seguya and Mansell (2000) observed the lowest electrical conductivity in milk samples infected with major mastitis pathogens. Additionally, during mastitis the electrical conductivity is not always increased (Norberg et al., 2004). Also, Woolford et al., (1998) stated that the difficulties in the interpretation of electrical conductivity measurement results arising from large variations in EC values in uninfected udder quarters between cows, between udder quarters of same cow, as well as between different milking periods in the same udder quarters. Large deviations in the electrical conductivity of milk during the drying period and early lactation are thought to be the result of a physiological increase in chloride concentration in milk (Linzell and Peaker, 1975). Langer et al., (2014) explained that the reduced electrical conductivity of milk in infected udder quarters occurs as a result of increased capillary permeability during intramammary infection

and the transport of sodium, potassium and chlorine ions into the alveolar lumen resulting in to increase their concentration in milk.

IDF experts Hamann J., and Zecconi A., (1998) published a meta-analysis on electrical conductivity (EC) in which they concluded that EC does not provide satisfactory results for the detection of subclinical and clinical mastitis. According to their research the ability of EC to predict clinical mastitis can be considered in two ways. Moreover, if the clinical signs of the animal are taken as a criterion for diagnosis, in that case the sensitivity is 68%, specificity 82%, PPV 58%, NPV 82%. While if the number of somatic cells is taken as a criterion, the sensitivity remains at the same level of 68%, the specificity increases to 88%, the percentage of PPV and NPV is 72% and 85%, respectively. In subclinical mastitis, when intra mammary infection is taken as a criterion, sensitivity is 61%, specificity 66%, PPV 55% and NPV 70%.

Table 3. Results obtained by measuring electrical conductivity (EC) and using SCC/ml as a standard

Test	EC	
	N	%
TP	19	33
FP	22	38
TN	13	22
FN	4	7
Total number of analyzed samples	58	
Sensitivity (%)	82	
Specificity (%)	50	
Validity (%)	55	
PPV (%)	46	
NPV (%)	76	

TP - true positive, FR - false positive, TN - true negative, FN - false negative, PPV - positive predictive value, NPV - negative predictive value

As a result of tissue damage during the occurrence of mastitis and the reduction of the synthetic ability of the enzyme system of the secretory cells, there is also a reduction in the biosynthesis of lactose (Pyörälä, S. 2003). According to Pyörälä, S. (2003), lactose can be used as an indicator of mastitis, as it decreases during inflammation. According to the results obtained in our research, the sensitivity is 79%, while the specificity is 60% (table 4). The ability of lactose to determine intramammary infection according to the predicted limits of 4.7% whose value applies when the number of somatic cells is up to 100,000 cells/ml is 60.8% for sensitivity, and 80.6% for specificity (Pyörälä, S. 2003).

Table 4 Results obtained by measuring lactose and using SCC/ml as standard

Test	Lactose	
	N	%
TP	19	30
FP	16	25
TN	24	37
FN	5	8
Total number of analyzed samples	64	
Sensitivity (%)	79	
Specificity (%)	60	
Validity (%)	67	
PPV (%)	54	
NPV (%)	83	

TP - true positive, FR - false positive, TN - true negative, FN - false negative, PPV - positive predictive value, NPV - negative predictive value

CONCLUSIONS

Based on our research there is a positive correlation between somatic cells count and electrical conductivity. The highest values were observed in the fourth defined category according to the number of somatic cells ($\geq 600,000$ cells/ml) of 4.95 (mS/cm), compared to the normal milk group ($\leq 200,000$ cells/ml) 4.21 (mS/cm). Additionally, with the increase in the number of somatic cells in the milk, there is also a decrease in the percentage of lactose. The lowest values were observed in the fourth defined category according to the number of somatic cells ($\geq 600,000$ cells/ml) of 4.13%, compared to the normal milk group ($\leq 200,000$ cells/ml) 4.80%. The best results in terms of the sensitivity of the test were obtained with EC (82%), then with lactose (79%) and finally with CMT (57%), from the total number of analyzed samples. The best results in terms of specificity were obtained using CMT (88%), lactose (60%) and EC (50%), from the total number of analyzed samples. Sensitivity of the test represents the ability of the test to detect all positive, infected individuals, the application of EC and the percentage of lactose gives more reliable results, compared to the CMT test. In terms of the specificity of the test, where its ability to detect all negative, i.e. healthy cows, better results were obtained with the CMT test, which is just another proof that the person performing the test needs training for correct interpretation of the obtained results

REFERENCES

- Biggadike H, Ohnstad I, Hillerton E. 2000. A practical evaluation of milk conductivity measurements. Proceeding of British Mastitis Conference Shepton Mallet, Institute for Animal Health/Milk Development Council. p. 56-61.
- Boboš S., Vidić B. 2005. Mlečna žlezda preživara. Morfologija – patologija – terapija. Novi Sad.
- Dingwell R., Leslie K., Timms L. L, Schukken Y., Sargent J. 2004. Evaluation of the California mastitis test to determine udder health status of early lactation dairy cows. Animal Industry Report. AS 650, ASL R1913.. http://lib.dr.iastate.edu/ans_air/vol650/iss1/72

- Galfi A., 2016. Klinički i ultrazvučni pregled vimena krava nakon primene laktoferina u periodu involucije. Doktorska disertacija. Univerzitet U Novom Sadu Poljoprivredni Fakultet Departman Za Veterinarsku Medicinu, Novi Sad
- Hamann J., Zecconi A., 1998. Evaluation of the electrical conductivity of milk as a mastitis indicator, in: IDF bulletin 334, International Dairy Federation, Brussels, Belgium.
- KAŞIKÇI, G., ÇETİN, Ö., BİNGÖL, E. B., & GÜNDÜZ, M. C. 2012. Relations between electrical conductivity, somatic cell count, California mastitis test and some quality parameters in the diagnosis of subclinical mastitis in dairy cows. *Turkish Journal of Veterinary and Animal Sciences*, 36(1), 49-55.
- Laevens H., Deluyker H., Schukken Y. H., De Meulemeester L., Vandermeersch R., De Mue Lenaere E., De Kruif A. 1997. Influence of parity and stage of lactation on the somatic cell count in bacteriologically negative dairy cows. *J. of Dairy Sci.* 80(12): 3219-26.
- Langer A., Sharma S., Sharma N. K., Nauriyal D. S. 2014. Comparative efficacy of different mastitis markers for diagnosis of subclinical mastitis in cows. *International Journal of Applied Science and Biotechnology*. 2(2): 121-5.
- Leslie, K. E., Jansen, J. T., & Lim, G. H. 2002. Opportunities and implications for improved on-farm cow-side diagnostics. In *Proc. De Laval Hygiene Symp (Vol. 147)*.
- Lightner, J. K., Miller, G. Y., Hueston, W. D., & Dorn, C. R. 1988. Estimation of the costs of mastitis, using National Animal Health Monitoring System and milk somatic cell count data. *Journal of the American Veterinary Medical Association*, 192(10), 1410-1413.
- Mansell P.D., Seguya A. 2003. The use of a hand-held conductivity meter for the diagnosis of subclinical mastitis in dairy cows during late lactation. *New Zealand Vet. J.* 51(1): 21-5.
- Musser J. M. B., Anderson K. L., Caballero M., Amaya D., Maroto-Puga J. 1998. Evaluation of a hand-held electrical conductivity meter for detection of subclinical mastitis in cattle. *American Journal of Veterinary Research*. 59(9): 1087-91.
- Nielen M., Deluyker H., Schukken Y., Brand A. 1992. Electrical conductivity of milk: measurement, modifiers, and meta-analysis of mastitis detection performance. *Journal of Dairy Science*. 75(2): 606-14.
- Norberg E., Hogeveen H., Korsgaard I. R., Friggens N. C., Sloth K. H. M. N., Løvendahl P. 2004. Electrical conductivity of milk: Ability to predict mastitis status. *Journal of Dairy Science*. 87(4): 1099-107.
- Pyörälä S. 2003. Indicators of inflammation in the diagnosis of mastitis. *Veterinary Research*. 34(5): 565-78.
- Qayyum A, Ali-Khan J, Hussain R, Avais M, Ahmad N, Sarwar-Khan M. 2016. Investigation of milk and blood serum biochemical profile as an indicator of sub-clinical mastitis in Cholistani cattle. *Pak Vet J.* 36:275-279.
- Reddy, B. S. S., Kumari, K. N., Reddy, Y. R., Reddy, M. V. B., & Reddy, B. S. 2014. Comparison of different diagnostic tests in subclinical mastitis in dairy cattle. *International Journal of Veterinary Science*, 3(4), 224-228.
- Sharma N., Pandey V., Sudan N. A. 2010. Comparison of some indirect screening tests for detection of subclinical mastitis in dairy cows. *Bulgarian Journal of Veterinary Medicine*. 13(2): 98-103.
- Varatanović N., Podžo M., Mutevelić T., Podžo K., Čengić B., Hodžić A., Hodžić E. 2010. Use of California mastitis test, somatic cells count and bacteriological findings in diagnostics of subclinical mastitis. *Biotechnology of Animal Husbandry*. 26(1-2): 65-74.
- Woolford M. W., Williamson J. H., Henderson H. V. 1998. Changes in electrical conductivity and somatic cell count between milk fractions from quarters subclinically infected with particular mastitis pathogens. *Journal of Dairy Research*. 65(2): 187-98.

CURRENT BIOTECHNOLOGICAL BREEDING METHODS AND APPLICATIONS IN HEMP (*Cannabis sativa* L.)

Mert ARSLANBAYRAK¹, Ali Kemal AYAN¹, Büşra TİK¹, Hossein HAJIABAEI¹

*¹Ondokuz Mayıs University, Faculty of Agriculture, Department of Field Crops, Samsun,
Turkey*

Corresponding author e-mail: Mert.arslanbayrak@hotmail.com

ABSTRACT

Cannabis (Cannabis sativa) is an industrial plant with a long history and extensive application areas. Thanks to biotechnology, the synthesis and extraction of active chemicals from hemp has been developed, providing a wide variety of treatment opportunities in the field of health. In addition, hemp is utilized in about 60 different industries, including cosmetics, textiles, food, paper, bioenergy and biocomposites. Using these methods, purposes such as micropropagation, optimization, material conservation, production, and breeding are served in hemp. In this study, biotechnological research conducted with hemp in recent years has been examined from a broad perspective.

Keywords: Hemp, Genotype, In vitro culture, Biotechnological methods

INTRODUCTION

Hemp is a versatile industrial plant that has numerous applications. Its secondary metabolites, known as hemp cannabinoids, including THC (Δ^9 -tetrahydrocannabinol) and CBD (Cannabidiol), are utilized in the medical and pharmaceutical industries. Moreover, hemp is utilized in around 60 different industries, including cosmetics, textiles, food, paper, bioenergy, bio-composites, and biodegradable product manufacturing, as well as the automotive and construction sectors where petroleum and petro-chemistry are used.

Hemp synthesizes chemical compounds in terpenophenolic structures called cannabinoids. When hemp is mentioned, the perception it creates in people is usually related to the narcotic part. THC (Δ^9 -tetrahydrocannabinol) in the content of hemp is the only psychoactive compound. In this sense, hemp has been used as an arbitrary plant (addictive). For this reason, cultivation of the plant has recently been banned. For many years, hemp cultivation has not been done globally, and the industry, which developed based on hemp, had to change its production direction and techniques. Later, scientists carried out breeding studies and developed hemp varieties with low THC content by using cultural and biotechnological methods. In this way, it has been made possible to make hemp farming worldwide again with permission. Over time, industrial hemp varieties with low THC ratios have begun to be developed in many countries. For Turkey, two hemp varieties were registered by Samsun Ondokuz Mayıs University Faculty of Agriculture and Samsun Karadeniz Agricultural Research Institute in 2021. These varieties are essential for being Turkey's first and local varieties (Aytaç., 2022), and protecting genetically created varieties and using them as breeding material is vital. It may be inevitable that cross-pollinated plants such as hemp show genetic

expansion. For this reason, it is crucial to use biotechnological methods to ensure the continuity of the obtained varieties.

Botanical Characteristics of Hemp

hemp (*Cannabis sativa*) is a one-year cultivar with $2n=20$ chromosomes belonging to the Cannabinaceae family. The homeland of hemp is known as Asia. Since cannabis is a foreign pollinated plant, it creates a difficult situation for the breeder to collect the desired genes in a plant in breeding studies. For this reason, clonal studies are important especially in dioecious plants such as hemp. In this sense, effective results can be obtained by applying biotechnological methods and principles (Yaman., 2020).

Biotechnological Methods

Tissue culture applications are a method that allows micro-propagation in an aseptic environment and in cultures specially prepared for the plant, and in which plant growth and regulators are used in the prepared environment, the desired material is the same or plants with different gene structures according as the technique used (Kodym et al., 2019). This method is free from diseases, allows rapid reproduction, and is used to protect rootstock plants and in gene transfer. Although it has been reported recently that the success rate of these techniques on hemp is low, significant progress has been made now thanks to optimization studies.

Hemp is a traditionally grown crop and is propagated from its seed. Nevertheless, reproduction is usually done using clonal methods in hemp produced for medical purposes. In this way, the desired product level can be produced without expanding the population. Hemp can be grown under diode-led lamps in clonal propagation, culture vessels, and culture rooms. In this way, many plantlets can be grown in a small area. In this way, in plants grown in these environments, Insect, pathogen, or virus-free plants can be obtained (Monthony et al., 2021).

B5 vitamins and MS salts have been developed to support the culture of hemp, callus induction, and suspension (Mandolino and Ranalli, 1999). Researchers have reported that hemp responds positively to the MS environment and B5 vitamins (Braemer and Paris., 1987).

In a study, the effects of different combinations of plant growth regulators on plant regeneration were investigated. For this purpose, three different monoic hemp cultivars (Bialobrzieskie, Beniko, Silesia) were studied. Cotyledon, stem, and root parts were used as explant sources. Sterilized for 10 seconds in 70% ethanol and 20 minutes in 1% sodium hypochlorite. Prepared explants were kept in the dark for 4 to 7 days at 24°C innocent of plant growth regulators in Knopp medium “(KNO₃ 200 mg/L, Ca(NO₃)₂ 4H₂O 500 mg/L, MgSO₄ 7H₂O 200 mg/L)”. The cotyledon, stem, and root explants (1 mg/L kinetin and 0.05 Naphthalene Acetic Acid (NAA) mg/l) were transferred to the medium with plant growth regulators. It was incubated in a 24–26°C growth chamber under a 16-hour photoperiod. Three weeks later, the explants were supplemented with plant growth regulators 0.2 mg/L BAP and 0.03 mg/L NAA for callus development. Explants were moved to a medium containing 2.0 mg/L Indole-3-acetic acid (IAA) for root formation. It has been reported that the calluses formed are of the same efficiency in the three cultivars, but there are some characteristic differences. It was reported that differences were observed in terms of water content and callus color, and the best callus induction was obtained from stem explants. Researchers have reported that the root explanatory callus color is white and brown and unsuitable for morphogenesis. In addition, it has been reported that they differ in regeneration. It was reported that the highest regeneration was

observed in the cotyledon parts of the Beniko variety (Wielgus., 2008). For this reason, the genotypes studied on success have a direct relationship with the protocol applied.

Anther and pollen culture is an essential protocol for obtaining haploid plants. It is also a vital breeding method applied in breeding studies. In this context, in a study conducted in 2009, anthers collected from seven hemp cultivars (Finola, Jermakowskie, Silistrenskie, W1, Juso11, Bialobrzieskie, Zenit) were cultured for callus induction from anthers grown in vitro to determine the optimal condition in hemp anther culture. Plant regeneration has been studied. It is embedded in the Medium PYL (Medium Pylon Protocol) environment. MS medium modifiers: Plantlet growth was supported with 6-Benzylaminopurine (BAP) (1 mg/L) and NAA (0.5 mg/L), and after culturing, they were placed in a dark environment for two weeks. The cultures were then kept in a photoperiod of 23°C, 16/8 hours light. While the Jermakowskie cultivar showed the maximum (42%) callus induction rate, it was reported that no callus production was observed in Finola, Juso11, and Silistrenskie cultivars (Luwanska and Wielgus., 2009).

Seed germination, which is the initial physiological stage of plant life, is significant in examining the factors affecting growth conditions and obtaining juvenile tissue as a potency explant for various in vitro procedures. In other words, in vitro seed germination is a variable biological stage that can be affected by environmental and genetic factors (media composition and environmental conditions). In in vitro production, the success rate may decrease due to contaminations. For this purpose, hydrogen peroxide (H₂O₂) applications have been frequently used in tissue environments in recent years. At the same time, since hydrogen peroxide allows the cells in the tissue environment to develop faster, the cells in the medium provide callus formation in a much shorter time. A study conducted in 2022 was carried out to stabilize production, and infrastructure was created with algorithms and artificial neural network technology. The study was designed to explore possible responses to hydrogen peroxide ratios. Five different algorithms were used to predict germination and morphological characteristics of cannabis grown in vitro. These algorithms; Gaussian Process (GP), Extreme Gradient Boosting (XGBoost), Vector Classifier (SVC), Random Forest (RF) models and Multilayer Perceptron (MLP) system. In this study, the Narlısaray hemp variety was studied. The development of seeds in vitro was estimated using five different algorithms. In the study, for the sterilization of plant seeds, they were subjected to surface sterilization with 70% ethanol for 3 minutes, followed by 0.10% HgCl₂ (Civachloride) for 10 minutes, then washed three times with distilled water for 5-7 minutes. Seeds were treated with different concentrations of hydrogen peroxide (0.5%, 1.0%, 2.0% and 3.0% v/v) for 24 hours and transferred to MS medium. The medium for in vitro germination was prepared using 0.44% MS, 3.0% sucrose. The medium was gelled with 0.65% agar. The pH of the medium was adjusted to 5.8 with HCl (hydrogen chloride) and NaOH (sodium hydroxide). The medium was autoclaved at 121 °C and a pressure of 1.5 atm for 15 minutes. In addition, 200 mg/L “Sulcid” antibiotic was added to the medium to prevent bacterial formation. All culture media were grown in the growth chamber at 24 °C under white light diode lamps and 16/8 h illumination. Established in eight replicates with ten seeds per replicate. Fresh and dry weight measurements were taken from the plantlets formed after 21 days. Morphological characteristics (seedling fresh weight, seedling dry weight, shoot length and root length) along with germination (%) and plantlet (%) were recorded and the algorithm (RF) giving these values was reported to be the Random Forest model. The most realistic result in estimation. When the seeds were exposed to different concentrations of hydrogen peroxide compared to the control seeds, it was reported that high hydrogen peroxide concentration had positive effects on average germination as well like over germination, shoot length, fresh weight and dry weight (Aasim et al., 2022).

In another study, plantlets were obtained from seed and treated in different concentrations of hydrogen peroxide solutions (0, 1, 3, 5, and 10%) for one day. Surface sterilization was performed with 70% ethanol for 3 minutes and 6% sodium hypochlorite for 5 minutes. The sterilized seeds were then washed with distilled water. For hydrogen peroxide applications, the seeds were directly treated with the indicated concentrations of the solutions. Hydrogen peroxide solution gave the fastest and most successful germination results for hemp seeds, while at higher concentrations, the germination rate decreased, and contamination was observed (Ahsan et al., 2022).

In a study conducted in 2022, a study was conducted on the evaluation of genetic transformation in in vitro reproductions. In this study, cultivars with high cannabinoid (CBD) and cannabigerol (CBG) levels were studied. Simple Sequence Repeat (SSR) technology was used to evaluate genetic stability. Callus was obtained by culturing in MS basal medium with various concentrations of 6-benzyl adenine (BA) or tiazuron (TDZ) for shoot regeneration. Then, 1-Naphthaleneacetic acid (NAA) was supplemented with 2,4-Dichlorophenoxyacetic acid (2,4-D) or kinetin (KIN), and stem explants were used. For rooting of the formed plantlets, they were transferred to a semi-strong MS medium supplemented with Indole-3-butyric acid (IBA), and rooting was achieved. No somacloning variation was observed in clones propagated by SSR technology. It has been reported that genetic homogeneity is achieved in clones in this culture production. It has been shown that culture protocols developed for in vitro propagation are suitable and applicable for clonal mass dissemination (Ioannidis et al., 2022). The absence of somacloning variation for hemp provides an opportunity for mass production and quickly obtaining a homogeneous population.

An alternative in vitro method has been developed for medicinal hemp production from plant nodes. This method made it possible to obtain new plantlets. The study used ground Stagnum Peat Moss containing sponges in semi-strength MS medium in different hemp varieties. Supplemented with indole-3-butyric acid (IBA) (0, 4.92, 2.46, and 9.84 μm) as growth hormones, Explantations were sterilized with 0.05% Tween-20 and 1% NaOCl, 70% ethanol for 12 minutes. It was then rinsed three times with deionized water. Two culture forms were created with and without aeration. The most effective result was obtained in the IBA (2.46 μm) solution, where the highest rooting was achieved in the environment without aeration, while the maximum growth was obtained in IBA (4.92 μm) in the ventilated containers. It was determined that the presence of IBA and reducing MS to half strength were more effective regarding rooting properties. This result supports the claim of Lata et al., (2010) that it is the most effective hormone in the development of hemp cultures under IBA. In addition, it has been reported by researchers that there is a significant correlation between genotype, culture vessel, and IBA (Ioannidis et al., 2022).

A study in 2021 was conducted on optimizing the in vitro seed germination of cannabis of the Finola cannabis cultivar. To sterilize the hemp seeds, they were treated with 70% ethanol for 60 seconds and rinsed under tap water for 15 minutes and washed with deionized water for 5 minutes in a laminar air flow cabinet. Seeds were sterilized using 12% (v/v) commercial bleach for 12 minutes, then rinsed with deionized water for 3-5 minutes. Then, different concentrations of DKW (Driver and Kuniyuki, 1984) medium (tenth, half and whole), glucose (5% and 2%) were added to the seeds. The pH was adjusted to 5.8 and 30 ml of GA7 (Gibberic Acid) was added for each treatment. As a result of the study, the best root length (8.68 cm) and number of leaves (6.67) were obtained as DKW+5% sucrose, DKW+2% sucrose and 1/2, respectively. Maximum seedling fresh weight (0.37 g) and shoot length (13.99 cm) were

observed in semi-strength mMS medium containing 5% glucose. In general, seedling fresh weight and shoot length decreased in full power environments (DKW and mMS). According to the results of the correlation coefficient, all morphological features were significantly related; The highest correlation was between plant weight and shoot length, and the lowest correlation was between root length and number of leaves (Hesami et al., 2021).

Another study was conducted on developing hemp varieties containing high CBD and CBG *in vitro*. Plant particles containing axillary buds were taken from the plant and transferred to an MS medium after sterilization. The shoots of the resulting plant were then subcultured in complete and semi-strength MS medium supplemented with various concentrations of 6-benzyl-amino-purine BA (4.0, 8.0 μM) or tidiazuron TDZ (2.0, 4.0 μM). The researchers reported that the highest average shoot number and length were obtained and rooted in adding 4.0 μM BA hormone in complete and half-strength MS mediums. In the same study, after enrichment with different concentrations of IBA (indole-3-butyric acid) 2.0 or 4.0 μM or NAA (α -Naphthalene Acetic Acid) 4.0 μM , it resulted in optimum rooting rates, Average root number and length yield per shoot, 4.0 μM IBA (indole-3-butyric acid) and NAA (Naphthalene Acetic Acid) in the culture medium, which successfully formed approximately 92% of the plant hormone Naphthalene Acetic Acid It has been reported that it is adapted to the conditions (Ioannidis et al., 2020).

In another study on the evaluation of the efficacy of growth regulators, a study was conducted in 2020 to obtain plantlets from hemp shoot tip and node segment tissues under *in vitro* conditions. This study investigated callus development in environments containing different growth regulators by utilizing cytokinin activities. The cultivar used in the study is the CBD-rich monoecious Eplison68 cultivar. For the sterilization process of the seed, it was kept in 75% ethanol for 1 minute and then in 5% active sodium chloride for 15 minutes. Then it was rinsed five times with deionized water and transferred to an MS medium. It was kept dark ($25 \pm 1^\circ\text{C}$) for seven days. Explants were taken from shoot tip and node segment tissues obtained from the seed, while plantlets were *in vitro*. Explants were cultured on complete and half-strength MS medium. Daylight was maintained with fluorescents for a photoperiod of 16 hours at $25 \pm 1^\circ\text{C}$ under a photosynthetic photon flux density of 120 μmol . It was then transferred to a semi-strength MS medium containing 2% sucrose supplemented with 0.5 mg/L indole-3-acetic acid (IAA). Measurements were taken after 21-28 days. Shoots were examined in 3 different parameters: well-growing, weak-growing, and non-growing. Visual observations determined the shooting status, and IAA and IBA (0.5 mg/L concentration in $\frac{1}{2}$ MS medium) were tested in the rooting status of explants. However, no statistical difference was observed between the two hormones regarding rooting. Different concentrations of tidiazuron (TDZ 0.1–0.5 mg/L), 6-Benzylaminopurine (BAP 0.5–2.0 mg/L), and meta-topolin (mT 0.1–1 mg/L) were used in the MS medium. The explants obtained from plants grown in this medium were compared regarding their ability to form new shoots. The regeneration rate decreased proportionally regarding shoot formation features in subcultured plants. The most effective hormone in MS basal medium for shoot induction has been reported as TDZ (0.5 mg/L). Success has been achieved in obtaining plants from shoots compared to nodal segments (Wróbel et al., 2022).

In a 2021 study to evaluate the regenerative ability on the Yumna7 hemp cultivar, hemp was cultured in MS medium to investigate the effects on embryo, cotyledon hypocotyl and leaf regeneration. Calli formed 10 days, 15 days, 20 days and 25 days after callus formation were collected and transferred to a callus induction medium. During the 4-week incubation, the highest callus yield was observed in explant specimens transplanted after 15 days. Induction

frequencies of 5.97% in leaves, 7.65% in cotyledons, and 5.31% in hypocotyls were observed. The tissues grown here were transferred a regeneration medium at 26°C and uninterrupted light for five weeks. About 6.12% produced shoots, and less than 3% of calli-developed shoots proliferating from the other three explants were reported by investigators. In addition, the study was repeated on 1000 different hemp varieties, and as a result, it was reported that the most effective explant sample was from cotyledons. In addition, it was reported that the success rate of the variety used was statistically significant. The most productive regeneration is reported to be a hemp hybrid, DMG278, with the F2 strain obtained from crossing Red Cherry Berry and Yunma7. This line gave the highest cotyledon regeneration rate at 7.09% (Zhang et al., 2021).

CONCLUSION

Hemp is an industrial plant that can be used in many areas with its history and agriculture dating back to ancient times. On 12/06/1933, hemp farming was banned in Turkey due to its illegal use. It is banned not only in Türkiye but also in many countries. World scientists have reduced the effectiveness of cannabinoids that cause neuropathic effects, such as THC, which is one of the most important reasons for the ban on hemp, allowing its agriculture to continue in a permitted way. In this process, this success has been achieved by using biotechnological methods and principles. It can be difficult to provide genetic stability with cultural methods, especially when working in a plant that is usually dioecious, such as hemp. It may be necessary to use the possibilities of biotechnology in a plant such as hemp. This is important in saving both work and time. In recent years, the scientific world has come a long way in the functionality and usefulness of biotechnological methods in studies with hemp and has achieved successful results. For this purpose, they discovered protocols that serve different purposes by using different media, different plant growth hormones and doses, different sugars and different sterilization methods. As a result of all studies, it was stated that different theories and unique methods should be developed for each genotype, and it was determined that the most important difference in success was due to the genotype.

REFERENCES

- Aytaç , S., Kenevir; çiftçi eğitimleri söyleşi. Samsun Vezirköprü. (2022).
- Aasim, M., Katırcı, R., Akgur, O., Yildirim, B., Mustafa, Z., Nadeem, M. A., ... & Yılmaz, G. (2022). Machine learning (ML) algorithms and artificial neural network for optimizing in vitro germination and growth indices of industrial hemp (*Cannabis sativa* L.). *Industrial Crops and Products*, 181, 114801.
- Ahsan, S. M., Shin, J. H., & Choi, H. W. (2022). Availability of Hydrogen Peroxide Solutions as a Germination Liquid Medium for Contamination-free in vitro Seedling Development of *Cannabis sativa*. *Horticultural Science and Technology*, 40(6), 605-613.
- Braemer, R., & Paris, M. (1987). Biotransformation of cannabinoids by a cell suspension culture of *Cannabis sativa* L. *Plant cell reports*, 6(2), 150-152.
- Classic Murashige, T., & Skoog, F. (1962). A revised medium for rapid growth and bioassays with tobacco tissue cultures. *Physiol Plant*, 15, 473-497.
- Driver, J. A., & Kuniyuki, A. H. (1984). In vitro propagation of Paradox walnut rootstock. *HortScience*, 19(4), 507-509.
- Hesami, M., Pepe, M., Monthony, A. S., Baiton, A., & Jones, A. M. P. (2021). Modeling and optimizing in vitro seed germination of industrial hemp (*Cannabis sativa* L.). *Industrial Crops and Products*, 170, 113753.

- Kodym, A., & Leeb, C. J. (2019). Back to the roots: protocol for the photoautotrophic micropropagation of medicinal Cannabis. *Plant Cell, Tissue and Organ Culture (PCTOC)*, 138, 399-402.
- Lata, H., Chandra, S., Khan, I. A., & ElSohly, M. A. (2010). High frequency plant regeneration from leaf derived callus of high Δ^9 -tetrahydrocannabinol yielding Cannabis sativa L. *Planta medica*, 76(14), 1629-1633.
- Ioannidis, K., Dadiotis, E., Mitsis, V., Melliou, E., & Magiatis, P. (2020). Biotechnological approaches on two high CBD and CBG Cannabis sativa L.(Cannabaceae) varieties: In vitro regeneration and phytochemical consistency evaluation of micropropagated plants using quantitative $^1\text{H-NMR}$. *Molecules*, 25(24), 5928.
- Ioannidis, K., Tomprou, I., Mitsis, V., & Koropouli, P. (2022). Genetic evaluation of in vitro micropropagated and regenerated plants of Cannabis sativa L. using SSR molecular markers. *Plants*, 11(19), 2569.
- Mandolino, G., & Ranalli, P. (1999). Advances in Biotechnological Approaches for Hemp Breeding. *Advances in hemp research*, 185.
- Luwanska, A., & Wielgus, K. (2009). Anther culture and callus induction in Cannabis sativa L. *New Biotechnology*, 25, S302.
- Monthony, A. S., Page, S. R., Hesami, M., & Jones, A. M. P. (2021). The past, present and future of Cannabis
- YAMAN, C. (2020). Cannabis Sativa L.(Kenevir)'de İn Vitro Mikroçoğaltım. Sürdürülebilir Mühendislik Uygulamaları ve Teknolojik Gelişmeler Dergisi, 3(2), 54-62.
- Richez-Dumanois, C., Braut-Boucher, F., Cosson, L., & Paris, M. (1986). Multiplication végétative in vitro du chanvre (Cannabis sativa L.). Application à la conservation des clones sélectionnés. *Agronomie*, 6(5), 487-495.
- Wielgus, K., Luwanska, A., Lassocinski, W., & Kaczmarek, Z. (2008). Estimation of Cannabis sativa L. tissue culture conditions essential for callus induction and plant regeneration. *Journal of Natural Fibers*, 5(3), 199-207.
- Wróbel, T., Dreger, M., Wielgus, K., & Słomski, R. (2022). Modified nodal cuttings and shoot tips protocol for rapid regeneration of Cannabis sativa L. *Journal of Natural Fibers*, 19(2), 536-545.
- Zhang, X., Xu, G., Cheng, C., Lei, L., Sun, J., Xu, Y., ... & Su, J. (2021). Establishment of an Agrobacterium-mediated genetic transformation and CRISPR/Cas9-mediated targeted mutagenesis in Hemp (Cannabis Sativa L.). *Plant biotechnology journal*, 19(10), 1979-1987.

DETERMINATION OF ANTIMICROBIAL ACTIVITY OF TOPICAL CREAM DEVELOPED WITH PLANT EXTRACT AND PROBIOTIC

Ali SAGLAM^{1*}, Meltem ASAN-OZUSAGLAM¹

¹Department of Molecular Biology and Genetic, Faculty of Science and Letters, Aksaray University, Aksaray, TURKEY

*Corresponding author: saglamali801@gmail.com

ABSTRACT

Plants have been used for therapeutic purposes in many diseases from past to present. China rose is known to be used in skin diseases with its antibacterial and antifungal effects. The aim of this study is to evaluate the biological activity of water extract from China rose (*Hibiscus rosa-sinensis*) flowers on some pathogens. Disc diffusion and micro-dilution methods were used to evaluate the biological activity of China rose extract. In addition, an antimicrobial cream was formulated with China rose extract and the probiotic candidate strain *Limosilactobacillus fermentum* MA-7 originated from breast milk. The antibacterial and antifungal activities of the developed topical cream against the test microorganisms were determined by the well diffusion method. In conclusion, the China rose extract showed good biological activity on the test microorganisms. The highest activity was determined against *Staphylococcus aureus* ATCC 25923 with an inhibition zone diameter of 9.36 mm. The MIC and MBC or MFC values of the extract was determined as 12.5-50 µg/µL and 25-50 µg/µL. The developed cream formulations showed variable antimicrobial activity against the test microorganisms. The cream group prepared with Cream-Extract-Probiotic showed the highest inhibition zone (10.46 mm) against *Escherichia coli* O157:H7. The results of the current research show that China rose flower is a suitable candidate for the medical and pharmacological industries. The developed cream formulation containing China rose water extract and probiotic strain may be an alternative in the prevention and treatment of some infections.

Keywords: Cream formulation, *Hibiscus rosa-sinensis*, *Limosilactobacillus fermentum*, Natural additive, Skin

INTRODUCTION

Since medicinal and aromatic plants have the potential to provide benefits in the fields of medicine, cosmetics and pharmacology, the supplement has been attracting attention since ancient times (Abate and Belay, 2022). China rose (*Hibiscus rosa-sinensis*)(Malvaceae), is widely cultivated in subtropics and tropical regions due to its ornamental and medicinal properties (Izquierdo-Vega et al., 2020; Silva et al., 2019). China rose contains bioactive substances with therapeutic benefits such as flavonoids, terpenoids, tannins, alkaloids and saponins (Pawbake et al., 2023). With high medicinal values, China rose has many curative activities, including antibacterial, antifungal and antiviral activities (Abate and Belay, 2022; Hema et al., 2022; Sidhu et al., 2023). It is also effective against skin infections, menstrual cramps, hyperlipidemia, hypertension, obesity, anemia and inflammation in folk medicine (Riaz and Chopra, 2018; Shen et al., 2017; Silva et al., 2019).

Skin infections are caused by microbial invasion of the skin layers and can cause life-threatening conditions (Esposito et al., 2016). The skin infections are quite high among hospital infections in recent years (Kaye et al., 2019). Soft tissue and most skin infections can result in surgery, bacteremia and sometimes death (Miller et al., 2015). In recent years, gram negative, gram positive and fungal pathogens have become important causes of acute skin infections (Altuntaş, 2019; Sönmez et al., 2020; Altun et al., 2023).

Live microorganisms that help protect human health when taken in appropriate amounts are called probiotics (Merenstein et al., 2023). Faced with the external environment of the human body, the skin has a large microbiota and functions as a physical barrier to protect the body against pathogens (Habeebuddin et al., 2022). The probiotics have many healing effects on the skin such as moisturizing, whitening, anti-aging, removing body odor and preventing wrinkles (Yu et al., 2022). The probiotics and their lysates can inhibit pathogenic microorganisms that cause skin infections and are used for skin health (Habeebuddin et al., 2022; Joshi et al., 2023).

In the study, the potential uses of cream formulations developed with China rose flower extract and *L. fermentum* MA-7 lysate for pharmaceutical and cosmetic industries were investigated. First, the biological activity of water extract from Chinese rose flower against pathogenic test microorganisms was determined to reveal its potential as a natural antimicrobial agent as an alternative to synthetic antimicrobials. Then, antimicrobial activity of cream formulations containing China rose extract and/or *L. fermentum* MA-7 were determined against clinical test microorganisms.

MATERIAL AND METHOD

Preparation Flower Extract from China Rose

The flower samples of China rose were collected from Alata Horticultural Research Institute (Turkey). After the plant material was washed with distilled water, it was dried in an airy environment. The dried samples were pulverized with a waring blender. The extract was obtained using distilled water in a hot water bath for 2 days (6 hours per day). After extraction, the residue was filtered and the solvent was evaporated. The China rose flower water extract was dissolved in Dimethyl-Sulfoxide (DMSO) and filter sterilized (0.45 µm). The extract was stored at 4°C for the duration of the study.

Test Microorganisms

The antibacterial and antifungal activities of the extract from the China rose flower was tested against four microorganisms. *Escherichia coli* O157:H7 and *Staphylococcus aureus* ATCC 25923 were cultured in Nutrient-Broth (NB) medium at 37°C. *Candida albicans* ATCC 10231 and *Candida glabrata* RSKK 04019 were grown in Yeast-Peptone-Dextrose (YPD) medium at 30°C.

Disc Diffusion Assay

The biological activity of China rose extract against pathogens was determined using the disc diffusion assay. The pathogens prepared at a McFarland concentration of 0.5 were spread on agar medium by dropping (100 µL). 20 µl (2 mg/disc) sample from China rose flower extract was impregnated onto sterile filter discs (Whatman No: 3; Diameter: 6 mm). The discs were placed on agar medium in triplicate. The petri dishes were incubated under conditions suitable for the test microorganisms. At the end of the incubation, the inhibition zone diameter was measured using Vernier calipers. Fluconazole (FCA; 25 µg/disc) and Kanamycin (K; 30 µg/disc) were used as positive controls.

Micro-dilution Method

Minimum inhibitory concentration (MIC) and minimum bactericidal (MBC) or fungicidal (MFC) concentration values of China rose flower extract were determined by the micro-dilution method against test pathogens. The extract was added to each tube containing broth to obtain final concentrations (100-3.12 µg/µL). The microbial suspension at 0.5 McFarland density was added to the tubes. The tubes were incubated under the conditions necessary for the microorganism. At the end of the incubation, the lowest extract concentration that inhibited the growth of the microorganism was determined as MIC. Subsequently, the sample taken from the tubes was inoculated into agar medium and the lowest concentration without growth was

determined as MBC or MFC. If the MBC/MIC or MFC/MIC ratio is ≤ 4 , it was determined as bactericidal, and if the MBC/MIC or MFC/MIC ratio was >4 , it was determined as bacteriostatic effect (Al-Shammari et al., 2022; Baj et al., 2020).

Biological Activity of New Cream Formulations

The biological activity of new creams developed China rose flower extract and/or probiotic candidate strain *L. fermentum* MA-7 (Asan-Ozusaglam and Gunyakti, 2019) isolated from breast milk was determined by modifying our previous study (Saglam and Asan-Ozusaglam, 2023). The antimicrobial activity of commercial cream (C) as a control, Cream - Extract (CE) mixture, Cream - Probiotic (CP) mixture and Cream - Extract - Probiotic (CEP) mixture against test microorganisms was determined using the well diffusion method. The pathogens prepared at a McFarland density of 0.5 were dropped (100 μL) onto agar and spread. Cream formulations were added to each well (6 mm) in 3 replicates. After incubation, the diameter of the inhibition zone was measured using Vernier calipers.

RESULTS AND DISCUSSION

Since ancient times, plants have been a source for therapeutic agents. Plants have become leading natural resources in the manufacture of many contemporary medicines and as a result of traditional practices (Alexander et al., 2023). In the present study, the water extract was obtained from China rose flowers to determine its biological activity. The results of the disc diffusion assay of China rose flower extract on the test microorganisms are presented in Table 1. The extract formed zones of inhibition between 6.07 mm and 9.36 mm on the test microorganisms. Among the tested bacteria and yeasts, the most sensitive (9.36 mm) strain to China rose extract was found as *S. aureus* ATCC 25923.

Table 1. Disc Diffusion Test Results of China Rose Extract

Test Microorganisms	Inhibition Zone Diameter (mm \pm SD)		
	China Rose Extract	Kanamycin	Fluconazole
<i>C. albicans</i> ATCC 10231	6.12 \pm 0.12 ^a	16.34 \pm 0.84 ^a	14.48 \pm 0.57 ^a
<i>C. glabrata</i> ATCC 04019	6.58 \pm 0.12 ^b	11.68 \pm 1.54 ^b	NA ^b
<i>E. coli</i> O157:H7	6.07 \pm 0.06 ^a	17.82 \pm 0.42 ^a	NA ^b
<i>S. aureus</i> ATCC 25923	9.36 \pm 0.25 ^c	16.37 \pm 1.74 ^a	NA ^b
F(Sig)	296.742(0.000)	13.558(0.002)	1890.058(0.000)

*No Activity

*Different letters in the column indicate significant difference at $p < 0.05$ between samples.

In a study, the antimicrobial activity of water, ethanol and methanol extracts obtained from *H. rosa-sinensis* flowers was determined against test microorganisms (*Listeria monocytogenes* MTCC 657, *Bacillus cereus* MTCC 430, *S. aureus* MTCC 87, *Clostridium perfringens* MTCC 450). The inhibition zone was obtained as 10 mm to 13 mm for water extract, 5 mm to 18 mm for ethanol extract and 5 mm to 15 mm for methanol extract (Karnwal, 2022).

MIC is the minimum concentration of antimicrobial agent that visibly inhibits microorganism growth. MBC or MFC is the concentration at which microorganism growth is completely inhibited (Kowalska and Dudek, 2021). MIC values of China rose extract vary between 12.5 $\mu\text{g}/\mu\text{L}$ and 50 $\mu\text{g}/\mu\text{L}$. The lowest MIC value was obtained on *C. glabrata* ATCC 04019 (12.5 $\mu\text{g}/\mu\text{L}$). *C. glabrata* ATCC 04019 has an MFC value of 25 $\mu\text{g}/\mu\text{L}$ as the most sensitive yeast to the extract. Other test microorganisms have an MBC or MFC value of 50

µg/µL. Since MBC/MIC or MFC/MIC values were ≤4, the extract showed a cidal effect on the test microorganisms.

Table 2. MIC and MBC or MFC Values of China Rose Extract

Test Microorganisms	MIC (µg/µL)	MBC or MFC (µg/µL)	MBC/MIC or MFC/MIC
<i>C. albicans</i> ATCC 10231	25	50	2
<i>C. glabrata</i> ATCC 04019	12.5	25	2
<i>E. coli</i> O157:H7	50	50	1
<i>S. aureus</i> ATCC 25923	25	50	2

Ngan et al., (2021) determined the MIC and MBC values of the water extract obtained from *H. rosa-sinensis* flowers on *Helicobacter pylori* ATCC 43504 and ATCC 51932. The results indicated that MIC values were 5 mg/mL and 10 mg/mL and MBC values were 7.5 mg/mL and 12.5 mg/mL, respectively.

The biological activity analyzes of the cream formulations developed with China rose water extract and/or *L. fermentum* MA-7 are presented in Table 3. The control group (C) created a 2.08 mm zone of inhibition on *C. albicans* ATCC 10231, but did not have activity on the other pathogens. While the CE group (2.39 mm) containing the extract did not significantly increase the activity of *C. albicans* ATCC 10231, the CP group with probiotic added significantly increased it with 4.01 mm and the CEP group with 4.60 mm (p<0.05). The highest inhibition zone of CE with 6.76 mm was determined on *S. aureus* ATCC 25923. The highest inhibition zone of the CP group was determined with 4.01 mm on *C. albicans* ATCC 10231. Among the cream formulations, the highest zones of inhibition against the test microorganisms was belong to the CEP group. The highest inhibition zone was determined as 10.46 mm against *E. coli* O157:H7 and was significant compared to the other groups (p<0.05). The synergistic effect of China rose extract and *L. fermentum* MA-7 inhibited the growth of the test pathogens. This effect will lead to a new alternative for the cosmetic industry.

Table 3. Antimicrobial Activity Results of Cream Formulations

Test Microorganisms	Inhibition Zone Diameter (mm±SD)				
	C	CE	CP	CEP	F(Sig)
<i>C. albicans</i> ATCC 10231	2.08±0.11 ^a	2.39±0.28 ^a	4.01±0.68 ^b	4.60±0.72 ^b	16.529(0.001)
<i>C. glabrata</i> ATCC 04019	- ^a	1.37±0.42 ^b	2.21±0.12 ^c	2.40±0.25 ^c	56.444(0.000)
<i>E. coli</i> O157:H7	- ^a	3.28±0.70 ^b	1.25±0.10 ^c	10.46±0.53 ^d	331.477(0.000)
<i>S. aureus</i> ATCC 25923	- ^a	6.76±0.59 ^b	- ^a	8.53±0.21 ^d	605.635(0.000)

*C: Cream, CE: Cream - Extract, CP: Cream - Probiotic, CEP: Cream – Extract - Probiotic, NA: No Activity

*Different letters in the line indicate significant difference at p<0.05 between samples.

In a study, the wound healing potential of a cream prepared with an extract obtained from *H. rosa-sinensis* flower extracted with 95% ethanol was determined. It was determined that the wound formed in rats healed 93.52% faster than the control in 20 days (Mustaffa et al., 2020)

CONCLUSION

In this study, the antibacterial and antifungal activities of water extract obtained from China rose flower on test microorganisms shows that it has a high potential for use as an

antimicrobial agent in creams to be obtained for topical uses. In vitro antimicrobial activity of topical cream formulations prepared with China rose extract and probiotic candidate strain *L. fermentum* MA-7 were found to be effective on pathogens.

REFERENCES

- Abate, T.A., & Belay, A.N. (2022). Assessment of antibacterial and antioxidant activity of aqueous crude flower, leaf, and bark extracts of Ethiopian *Hibiscus rosa-sinensis* Linn: geographical effects and Co2Res2/Glassy carbon electrode. *International Journal of Food Properties*, 25(1), 1875-1889.
- Alexander, P.S., Ramachandran, B., & Chandrasekar, N. (2023). Green synthesis of cerium nanoparticles using *Hibiscus rosasinesis* extract and evaluation of their antimicrobial activity and photocatalytic activity. *Materials Today: Proceedings*.
- Al-Shammari, K.I., Batkowska, J., Gryzińska, M., Wlazło, Ł., Ossowski, M., & Nowakowicz-Dębek, B. (2022). The use of selected herbal preparations for the disinfection of Japanese quail hatching eggs, *Poultry Science*, 101(10), 102066.
- Altun, G., Akbaş, T., & Yekenkurul, D. (2023). İnvazif Kandida Enfeksiyonu. *Sağlık Bilimlerinde Değer*, 13(1), 156-164.
- Altuntaş, M. (2019). Deri ve Yumuşak Doku Enfeksiyonları. *Klinik Tıp Aile Hekimliği*, 11(1).
- Asan-Ozusaglam, M., & Gunyakti, A. (2019). *Lactobacillus fermentum* strains from human breast milk with probiotic properties and cholesterol-lowering effects. *Food Science and Biotechnology*, 28, 501-509.
- Baj, T., Biernasiuk, A., Wróbel, R., & Malm, A. (2020). Chemical composition and in vitro activity of *Origanum vulgare* L., *Satureja hortensis* L., *Thymus serpyllum* L. and *Thymus vulgaris* L. essential oils towards oral isolates of *Candida albicans* and *Candida glabrata*. *Open Chemistry*, 18(1), 108-118.
- Esposito, S., Noviello, S., & Leone, S. (2016). Epidemiology and microbiology of skin and soft tissue infections. *Current Opinion in Infectious Diseases*, 29(2), 109-115.
- Habeebuddin, M., Karnati, R.K., Shiroorkar, P.N., Nagaraja, S., Asdaq, S.M.B., Khalid Anwer, M., & Fattepur, S. (2022). Topical probiotics: more than a skin deep. *Pharmaceutics*, 14(3), 557.
- Hema, K., Vasthi Ganana Rani, S., & Praveen Kumar, G. (2022). In vitro Anti-inflammatory Studies of Flavonoids from *Hibiscus rosa-sinensis* Linn. *Oriental Journal Of Chemistry*, 38(1).
- Izquierdo-Vega, J.A., Arteaga-Badillo, D.A., Sánchez-Gutiérrez, M., Morales-González, J.A., Vargas-Mendoza, N., Gómez-Aldapa, C.A., ... & Madrigal-Santillán, E. (2020). Organic acids from Roselle (*Hibiscus sabdariffa* L.)—A brief review of its pharmacological effects. *Biomedicines*, 8(5), 100.
- Joshi, C., Suthar, R., Patel, A., Patel, F., & Makwana, D. (2023). Probiotics for Skin Health. In *Probiotics, Prebiotics, Synbiotics, and Postbiotics: Human Microbiome and Human Health* (pp. 329-346). Singapore: Springer Nature Singapore.
- Karnwal, A. (2022). In vitro antibacterial activity of *Hibiscus rosa sinensis*, *Chrysanthemum indicum*, and *Calendula officinalis* flower extracts against Gram negative and Gram positive food poisoning bacteria. *Advances in Traditional Medicine*, 22(3), 607-619.
- Kaye, K.S., Petty, L.A., Shorr, A.F., & Zilberberg, M.D. (2019). Current epidemiology, etiology, and burden of acute skin infections in the United States. *Clinical Infectious Diseases*, 68(Supplement_3), S193-S199.
- Kowalska-Krochmal, B., & Dudek-Wicher, R. (2021). The minimum inhibitory concentration of antibiotics: Methods, interpretation, clinical relevance. *Pathogens*, 10(2), 165.

- Merenstein, D., Pot, B., Leyer, G., Ouwehand, A.C., Preidis, G.A., Elkins, C.A., ... & Sanders, M.E. (2023). Emerging issues in probiotic safety: 2023 perspectives. *Gut Microbes*, 15(1), 2185034.
- Miller, L.G., Eisenberg, D.F., Liu, H., Chang, C.L., Wang, Y., Luthra, R., ... & Suaya, J.A. (2015). Incidence of skin and soft tissue infections in ambulatory and inpatient settings, 2005–2010. *BMC Infectious Diseases*, 15, 1-8.
- Mustaffa, F., Parasuraman, S., & Sahgal, G. (2020). Wound Healing Activity of Herbal Ointment Containing the Extracts of *Hibiscus rosa-sinensis* Flowers and *Curcuma longa* Rhizomes. *Free Radicals and Antioxidants*, 10(2), 86-88.
- Ngan, L.T.M., Tan, M.T., Hoang, N.V.M., Thanh, D.T., Linh, N.T.T., Hoa, T.T.H., ... & Hieu, T.T. (2021). Antibacterial activity of *Hibiscus rosa-sinensis* L. red flower against antibiotic-resistant strains of *Helicobacter pylori* and identification of the flower constituents. *Brazilian Journal of Medical and Biological Research*, 54, e10889.
- Pawbake, O.R., Phatangare, P.S., Mhaske, M.P., & Phalke, M.P.L. (2023). Review on *Hibiscus rosa-sinensis* Flowers. *International Journal of Pharmaceutical Research and Applications*. 8(3), 3305-3310.
- Riaz, G., & Chopra, R. (2018). A review on phytochemistry and therapeutic uses of *Hibiscus sabdariffa* L. *Biomedicine & Pharmacotherapy*, 102, 575-586.
- Saglam, A., & Asan-Ozusaglam, M. (2023). A Natural Additive Alternative to the Cosmetics Industry: Hazelnut and Its Waste Products. *Journal of Skin and Stem Cell*, 10(2).
- Shen, H.M., Chen, C., Jiang, J.Y., Zheng, Y.L., Cai, W.F., Wang, B., ... & Shi, G.G. (2017). The N-butyl alcohol extract from *Hibiscus rosa-sinensis* L. flowers enhances healing potential on rat excisional wounds. *Journal of Ethnopharmacology*, 198, 291-301.
- Sidhu, R., Kaushal, S., Kaur, V., & Sharma, P. (2023). Chemical Composition, Synergistic Antimicrobial and Antioxidant Potential of *Hibiscus rosa-sinensis* L. Leaves Essential Oil and Its Major Compound. *Journal of Essential Oil Bearing Plants*, 26(2), 469-485.
- Silva, N.L., Viana, F.C., Alves, L.F., Santos, E.C.S., de Andrade, L.R., Morais, M.G., ... & Amaro, S.H. (2019). Avaliação da atividade antioxidante e antibacteriana do extrato da flor de *Hibiscus sabdariffa* e *Hibiscus rosa-sinensis*. *Conexão Ciência* (online), 14(1), 14-20.
- Sönmez, U., Atalay, S., Ersan, G., Şamlıoğlu, P., & Köse, Ş. (2020). Pürülan Olmayan Deri ve Yumuşak Doku Enfeksiyonlarında Tigesiklinin Etkinliğinin Değerlendirilmesi. *Journal of Tepecik Education & Research Hospital/İzmir Tepecik Eğitim ve Araştırma Hastanesi Dergisi*, 30(2).
- Yu, J., Ma, X., Wang, X., Cui, X., Ding, K., Wang, S., & Han, C. (2022). Application and mechanism of probiotics in skin care: A review. *Journal of Cosmetic Dermatology*, 21(3), 886-894.

**DETERMINING THE APPROACH AND EXPECTATIONS ACCORDING TO THE
PROFILE OF ENTERPRISERS IN RURAL DEVELOPMENT SUPPORT: THE
EXAMPLE OF THE WEST MEDITERRANEAN**

Yavuz TAŞCIOĞLU¹, Cengiz SAYIN¹

*¹ Akdeniz University, Agriculture Faculty, Agricultural Economic Department, Antalya,
Turkey*

Corresponding author e-mail: ytascioglu@akdeniz.edu.tr

ABSTRACT

The phenomenon of development is the common goal of both developed and developing countries and can be defined as the advancement of human life in the economic and social field and the increase of welfare by changing the economic, social, and political structures of the countries. The phenomenon of development should be achieved through social cohesion. While the development initiatives, which started with industrialization, manifested themselves in urban areas, rural areas were ignored. However, rural areas should not be excluded from the development initiative. This situation, which is seen as social development, has been prevented by industrialization. However, rural development initiatives that started in the 1960s are steps towards the integration of rural areas with urban areas and their inclusion in social development. Rural development initiatives that started in these years found their reflection in Turkey as well as in other countries of the world. The support given to rural areas has been the main basis for this. These supports to the rural areas were primarily applied on a regional basis, but they did not receive sufficient response due to the differences between the regions and the practices were not suitable for the local area. One of the most important supports to rural development initiatives implemented in Turkey is the Rural Development Investments Support Program (RDISP). Within the scope of this program, it is aimed to increase the income level in rural areas, to improve infrastructure, to ensure the integration of agricultural production and agro-industry, to strengthen food security, to create alternative income sources in rural areas, to increase the effectiveness of rural development activities, to increase the level of basic public services, to increase access to services and to create a certain capacity in rural society, taking into account the protection of natural resources. Although these applications are province-based, they were also applied in the provinces of Antalya, Burdur and Isparta, which are the Western Mediterranean Region. In this study, it is aimed to divide the enterprises benefiting from RDISP in the Western Mediterranean Region into groups, to reveal the profile of each group and to examine the benefits of support elements according to the characteristics of these groups.

Keywords: Rural area, Rural Development, Support, Western Mediterranean

INTRODUCTION

Countries attach importance to development to progress in economic and social fields and to ensure social welfare. Development is recognized as a process that involves increasing the level of social welfare and raising living standards. This process includes economic, social, and cultural dimensions. In these dimensions, economic development includes increasing the production power and raising per capita income, social development includes improving education, health and social services, and cultural development includes protecting and developing the society's own cultural values and heritage. However, development is the growth and development of a country by enabling it to become stronger economically, socially, and

culturally. For the country to grow and develop, it is desirable for the society to reach the desired level in economic, social, and political fields. In addition, development is the reduction of human deficiencies emerging in countries by integrating them with ecological balance.

Development is the building of the future of a country. Therefore, in order for development to be balanced, it requires the participation of all dynamics of the country. The human structure, natural resources, economic activities, technological developments, social and cultural structures of the country are these dynamics. Ensuring harmony between these dynamics and developing planning and policies for this is an important factor for development. Countries develop various policies to ensure that there is no discrimination between communities and regions to achieve the desired goals in development. However, the impact of industrialization, the inability to create alternative sources of income in rural areas, the dominance of the agricultural sector in rural areas and the dependence of the sector on nature have caused rural areas to remain in the background. In this framework, rural development policies have started to be seen as a special policy area for individuals living in rural areas to reach humane living conditions, to increase their income levels and to provide them with the opportunities of individuals living in urban areas.

Rural development is defined as "the process of improving the quality of life and economic welfare of people living in rural areas" (Moseley 2003). Rural development is defined differently. According to the Croatian rural development network; "the integral and multi-sectoral and sustainable development of the rural (non-urban) area", according to Atkinson "efforts that are economic and social in nature, aimed at promoting the concepts of retention, growth and expansion in non-urban areas, including improving the quality of life for rural residents" and according to another source; it is explained as "a method of improving the quality of life and financial well-being of individuals living in particularly populated and remote areas" (Anonymous 2023a, Atkinson 2017, Anonymous, 2023b). To define rural development in more detail, it is "the process of increasing people's access to humane living conditions, improving income distribution, increasing income level, ensuring localized developments in social and cultural areas, protecting and utilizing natural resources and reflecting the wealth to the lives of individuals" (SPO 2006).

Rural development policies are policies designed to reveal the efforts made throughout the country to improve the economic, social, social, and cultural opportunities of the communities living in rural areas, to increase the living standards of these communities and to support them to participate in national development (SPO 2000).

Today, both developed and developing countries have increased the importance they attach to rural development. Rural development activities vary from country to country. Even in the USA, there are differences in the rural development program of each state (Gürlük 2001a). In the EU, the basis of rural development activities is to ensure the continuity of production in agriculture, protection of the environment and transparency during the conduct of different economic activities in rural areas (Can 2007). In the Agriculture and Rural Development Report published by the European Union in 2022, it is stated that the European Commission supports rural development through a series of programs and initiatives despite the difficulties encountered, that it is determined to make agriculture and rural development sustainable, and that priorities for the future are set out. The same report calls for continued co-operation between the European Commission, Member States, and stakeholders. In addition, about the rural development activities of the report, it is stated that the Union has helped to improve the quality of life in rural areas and progress has been made in making rural development more sustainable (EC, 2023).

In Turkey, the developments in technology and knowledge level, the increase in the use of machinery in agricultural production have caused the rural labor force to leave agricultural production and employment deficit in rural areas. In addition, the high rate of population growth and limited job

opportunities accelerated migration from rural areas to urban areas and Turkey entered a rapid process of distorted urbanization after the 1950s. Migration and rapid urbanization caused by the development differences between rural and urban areas have created problems both in rural and urban areas. With the planned period, national development plans and programs were envisaged within rural development studies.

In this context, rural development projects have started to be implemented throughout Turkey. Rural development projects cover areas such as development of agriculture and animal husbandry, irrigation, improvement of wetlands, construction of village and forest roads, construction of drinking water ponds, provision of drinking water, increasing agricultural and animal production, afforestation activities.

In addition to general and regional activities for rural development in Turkey, various development-oriented programs are also carried out. One of these is the "Program for Supporting Rural Development Investments (RDISP)"(Taşcıoğlu, 2011).

The program aims to determine the procedures and principles for raising the income level in rural areas, improving infrastructure, ensuring integration of agricultural production and agro-industry, strengthening food security, creating alternative income sources in rural areas, increasing the efficiency of the rural development activities being carried out, increasing the level of basic public services, increasing access to services and creating a certain capacity in rural society, taking into account the protection of natural resources (OJ, 2006).

In this study, it was aimed to divide the enterprises benefiting from the program, which aims to create alternative sources of income in rural areas by evaluating the on-site processing of agricultural products to make rural development activities more effective, to reveal the profile and general structure of each group and to determine the opinions of these enterprises on the program.

MATERIAL AND METHOD

The research is supported by secondary data based on the literature but largely based on original data obtained through a survey based on face-to-face interviews with enterprisers of enterprises benefiting from the Rural Development Investments Support Program in the Western Mediterranean Region. A significant number of these enterprisers (e.g. those who benefit from irrigation investments or process their own produce) are also engaged in agricultural production.

The study was conducted in the Western Mediterranean Region. The Western Mediterranean Region is the region called TR61 in the Classification of Statistical Regional Units (IBBS) Level 2, which covers the provinces of Antalya, Burdur and Isparta in the west of the Mediterranean Region. The region has been home to various civilizations since the early ages due to its geographical location, fertile soils, and rich water resources.

In the study, a survey was conducted with the owner/manager (enterpriser) of 47 enterprises in Antalya province, 26 enterprises in Burdur province and 23 enterprises in Isparta province benefiting from the Rural Development Investments Support Program. Face-to-face interviews were conducted with a total of 96 enterprisers benefiting from the support program in the region in question.

In the analysis of the data, simple descriptive statistics and Cluster Analysis were used to divide the enterprisers into groups according to their level of utilization of the program and to reveal the profile of each subgroup and to develop appropriate policy recommendations for the target groups.

Cluster analysis is one of the multivariate statistical analyses that divides units and objects into classes by arranging them in general. Kaufman and Rousseuw (1990) define cluster analysis as a method that enables to classify the units examined in research by gathering them in certain groups according to their similarities, to reveal the common characteristics of the

units and to make general definitions about these classes. Hair and Black (2000), after stating that the primary reason for using cluster analysis is to find similar (homogeneous) groups of individuals in any data set, define cluster analysis as a collection of objective methods that quantify the structural characteristics of units in observation clusters.

The aim of the analysis is to reveal the similarities of the units according to certain characteristics and to classify the units on the basis of these similarities and to group the units in such a way that they are like each other.

Although cluster analysis is an analysis based on classification theory, it differs in some respects. The most important of these is that the classification technique is used to divide observations into different subgroups, whereas in clustering, sub-clusters are tried to be formed based on p variables (Kendall 1975).

In this study, clustering analysis was conducted to reveal the preferences of enterprisers in determining the type of support in rural development and to classify enterprisers into groups in terms of their characteristics. The main reason for making this distinction is to reveal which support instruments are preferred by the groups to be formed according to the characteristics of the enterprisers. The aim here is to examine the opinions of the groups to be formed among the enterprisers with the same characteristics about the program and to determine the expectations of the enterprises in such supports to be applied in the future. The results obtained from the clustering analysis will be presented in detail in the findings and discussion section.

RESULTS AND DISCUSSION

In the study, the field research was examined in two stages: general descriptive information about the enterprises benefiting from the program and the results of the analysis. Firstly, information about the enterprises benefiting from the program is given in Table 1.

In the Western Mediterranean Region, the highest number of enterprises benefiting from the program is in Antalya province. Although the region is located in the same geography, it shows differences in terms of climate conditions and soil fertility. While Antalya province has the typical climate conditions of the Mediterranean Region, Burdur and Isparta provinces show the common characteristics of the Mediterranean and continental climate zone. This situation also affects the agricultural sector and agriculture-based industry. In addition, due to the entrepreneurial characteristics of Antalya province and the fact that individuals are in closer relations with agricultural organizations, they have more information about such supports.

Table 1. General characteristics of enterprises benefiting from RDISP in the Western Mediterranean Region

		Rate (%)
Distribution of enterprises by province	Antalya	49.0
	Burdur	27.0
	Isparta	24.0
Legal structure of businesses	Company	56.3
	Cooperative, Union	21.9
	VSPU	18.8
	Sole proprietorship	3.1
Status of interviewees in enterprises benefiting from the program	Business manager	52.0
	Business owner	24.0
	Cooperative, Union President	18.0
	Operating partner	6.0
Education level of the interviewees	Primary School	6.0
	Middle School	12.0
	High School	28.0
	Associate degree	20.0
	University (Undergraduate)	32.0
	Postgraduate	2.0

When the enterprises benefiting from the support in the region are classified according to their legal structures, it is seen that the highest number of investments are made by limited, joint stock and collective companies. It is observed that companies utilize more than half of the total economic investment (56%). After the companies, development and irrigation cooperatives and unions (22%) and Village Service Provision Unions (VSPU) operating under district governorships (19%) made the most investments. Individuals or bilateral partnerships were the least beneficiary enterprises (3%). 56% of the enterprises benefiting from the program are in company status and 80.9% of the total beneficiary enterprises in Antalya province and 52.2% of the enterprises benefiting from the support in Isparta province are in company status in terms of their legal structures. On the other hand, in Burdur province, due to the effective work of the provincial governorship and the fact that they see the program as an opportunity, Village Service Provision Unions (approximately 60%) were the enterprises that benefited the most from the program.

Within the scope of the survey, most interviews were conducted with people who were in managerial positions such as business managers, accountants, etc. and who were actively working in the application to the program. At the company level, interviews were mostly conducted with company managers or company owners, chairmen or partners in cooperatives and unions, chairmen or managers in VSPU, and partners in sole proprietorships.

It was observed that the education level of the interviewees was generally high. This feature is directly related to the beneficiary status of the program. Because there is a one-to-one relationship between having information about the program and the education level of the people. This situation emerged from the general structure of the interviewees during the observations made during the survey period.

Within the scope of the program, many projects have been supported throughout Turkey. Information on the provinces and fields of activity of the enterprises receiving grant support in the Western Mediterranean Region is given in Table 2.

Table 2. Fields of activity of enterprises benefiting from RDISP by provinces distribution

Activity	Antalya		Burdur		Isparta		Total	
	Quantity	Rate (%)	Quantity	Rate (%)	Quantity	Rate (%)	Quantity	Rate (%)
Processing, packaging, storage	31	66.0	12	46.2	16	69.6	59	61.5
Drip irrigation	9	19.1	11	42.3	4	17.4	24	25.0
Capacity expansion	7	14.9	-	-	3	13.0	10	10.4
Sewerage, road	-	-	3	11.5	-	-	3	3.1
Total	47	100.0	26	100.0	23	100.0	96	100.0

Within the scope of the program, enterprises in the region that determined their own field of activity benefited from grant support for processing, packaging, and storage (61.5%). This situation is valid for all three provinces in the region. Agricultural production is intensive in the region due to the fact that the climate and soil fertility is suitable for fruit and vegetable production compared to other regions of Turkey in general. Intensive agricultural production increases the desire to meet post-production services from within the region. In this context, the program has been an opportunity for the enterprises in the region, and the need for processing and packaging of the products produced has been met to a certain extent. In addition, the need for storage of agricultural products produced in the region has been met through the support program. In this respect, it has been observed that the support program has benefited the rural areas of the Western Mediterranean Region.

The analyses of the enterprises benefiting from RDISP supports were summarized and divided into two clusters according to the non-hierarchical K-means clustering method. Individuals in cluster 1 constitute 54% of the total population and those in cluster 2 constitute 43% of the total population. Information about the clusters obtained is given in Table 3.

Table 3. Group and characteristics of enterprises benefiting from RDISP according to cluster analysis.

Criteria	1st group	2nd group
Field of activity of enterprises	Activity related to processing, packaging, and storage	Irrigation activity
Project subject of the enterprises	Animal and herbal products	Irrigation activity
Legal structure of businesses	Company	Cooperative and Village Service Union
Interviewees	company owners/managers	president
Education level of interviewees	Elementary and high school	Associate degree and undergraduate
Other sources of income the business	Have additional income	No additional income

Table 3. continued

Criteria	1st group	2nd group
Membership status of the operator to the agricultural producer organization	no membership	has a membership
How the courses to be organized in the region should be	Practical courses with a subject expert	Meeting, seminar etc.
Reason for businesses to do the project	Being an enterprise that the region needs, Support is an opportunity to establish an economic enterprise, Processing its own product,	Protecting water resources Saving natural resources and energy
Type of investment of enterprises in the project	establishing new businesses and upgrading technology	Increase capacity
Those working on project implementation and reporting	Business managers and private consultant	Personnel working in the company
Businesses' source of information about the program	Meetings organized by the provincial directorates of the Ministry and friends	Provincial Chamber of Commerce and Industry, governorship units
Whether the enterprises have other applications for support	Businesses with more than one application	Businesses with a single applicant
Difficulties encountered by enterprises during project application	Businesses facing difficulties in applying	
Businesses' intention to make other investments in the region in the future	They will make other investments	They will not make any other investments
Investments that enterprises intend to make in the future	Cotton processing, animal husbandry, milking unit, greenhouse cultivation, cold storage, and packaging facility	
Benefits of the program to the region	Collective decision-making and social solidarity	
Problems with the program according to enterprises	Excessive demand for equity capital, long investment period and the necessity of private consultancy	The evaluation period is long, the number of documents required is high, the support rules are strict, and the Ministry staff do not have sufficient knowledge
The idea of businesses to develop environmentally friendly projects and ensure environmental protection	Businesses that do not harm the environment and pay special attention to environmental protection	
Increased job opportunities in rural areas		Businesses arguing that their investments in rural areas will increase job opportunities for people living in rural areas
The situation of using the knowledge and experience of the company owners/managers	Businesses that think that their own knowledge and experience are important in business management	
Experts make business decisions		Businesses that advocate that the final decision on management and other issues in businesses should be taken by specialists
Adequacy of the amount of support		Businesses that agree that the amount of support is sufficient

Table 3. continued

Criteria	1st group	2nd group
Reasons for businesses to choose project topics	Thinking it will bring good income.	Reasons for businesses to choose project topics
Goals that businesses want to achieve with the project	Evaluating products To evaluate the existing resources of the region Increase capacity. The need of the business Contributing to the development of the region Technology innovation Exporting	To utilize the resources of the region The need of the region Protecting water resources Contributing to the development of the region Increasing efficiency Meeting the needs of the producer
Businesses' expectations from the government regarding the overall program	Increasing the monetary amount of support Expansion of area of activity Providing support separately according to sectors Giving to people who will produce. Separate grant for building construction	Expanding the scope of support Benefiting from the same support subject for a second time
Reasons for the continuation of the program according to the company owners/managers	Investment opportunity for businesses Providing financial contributions to businesses Increasing employment	Contribution to the region Making investments that cannot be made in the region. Protection of natural resources Ensuring effective use of resources Saving time and labor
Problems with the program according to the company owners/managers	Taxes within the support amount Lack of financial support Too many documents requested. Long evaluation period after application	No problem
Aspects of PSRDI that need improvement according to company owners/managers	The amount of money in support should be increased. Support should be tax-free. The number of required documents should be reduced. Should be given differently according to the sector. Support should be given to projects to encourage production. Facilitate the application process	No need to improve. Support for cooperatives should be diversified and prioritized

CONCLUSIONS

Development is the reflection of the changes to be made in social, economic, and cultural structure on human life, reaching the desired living conditions of people, increasing their income levels economically. In order to realize this, it is necessary to use the natural and human resources and technological structure of the country. For this purpose, the creation of policies should be done in a planned manner.

To realize the development initiative, it should be carried out without regional distinctions. Since the focus of development is seen as urban areas, more importance should be given to rural areas where agriculture and food products are produced, nutrition needs are met, and alternative income opportunities are limited. For this purpose, rural development policies have been implemented.

Rural development activities vary from country to country. Along with the developments in rural development in countries, various policies are developed and implemented for the development of rural areas in the world.

In Turkey, rural development activities and policies have been increasing in parallel with development initiatives in recent years. The "Rural Development Investments Support Program", which was established according to the principles specified in the National Rural Development Strategy (NRDS) issued for this purpose, is one of the most important ones.

The main purpose of this study is to categorize the enterprises benefiting from the RDISP in the Western Mediterranean Region into groups and to reveal the profile of each group. According to the results obtained in line with this main objective, it is examined how the supports for rural development should be on the basis of enterprises, and what kind of priorities and expectations the enterprises prefer in future such programs and/or supports.

According to the clustering analysis applied in the study, enterprises are divided into two groups.

The first group of enterprises benefiting from the support element are enterprises with company status that apply to the program for the processing of agricultural products, which is the next stage after the production of both plant and animal products, or for technology renewal in the existing enterprise. The second group of enterprises are agricultural producer organizations such as cooperatives and unions that support the producers to carry out the irrigation activities necessary for agricultural production.

The first group of enterprises benefited from the program to purchase equipment for processing.

While interviews were conducted with managers and company owners in the first group enterprises, interviews were conducted with the heads of agricultural producer organizations in the second group enterprises.

While the education level of the interviewees in the first group enterprises was primary school and high school, the education level of the interviewees in the second group enterprises was associate degree and bachelor's degree.

In the first group of enterprises, it is seen that the enterprises have different income-generating sources other than the program application, while in the second group, there are no income sources because they are agricultural producer organizations, and they are non-profit organizations in line with the objectives and principles of producer organizations.

It was observed that the first group enterprises were not members of agricultural producer organizations because they were engaged in commercial activities.

While the first group of enterprises wanted the courses for rural areas to be in the form of applications, the second group of enterprises preferred more general applications such as meetings and seminars.

While the first group of enterprises think that the main reasons for doing the project are that there is an enterprise that the region needs, the grant support received is an opportunity to establish an enterprise in the economic sense, and to process their own products, the second group of enterprises are to protect water and natural resources and to save energy.

The first group of enterprises benefited from the support program to establish new enterprises and renew their technologies. The second group of enterprises applied to the program to make use of the water resources of the region, to make the existing irrigation systems work more efficiently and to open more areas for irrigation.

While the first group of enterprises worked with enterprise managers and private consultants in the preparation and reporting of the project in the application to the support program, the personnel of the producer organizations worked in the second group of enterprises. The first group of enterprises encountered various difficulties during the application due to the fact that they made the preparation and reporting of the project through managers, private consultants, and technical staff.

The information sources of the first group enterprises about the support program are the meetings held by the Ministry of Agriculture and Forestry. The second group of enterprises

received information about the program from both public institutions and chambers of commerce and industry.

The first group of enterprises applied to benefit from the support program by making more than one application. The second group of enterprises did not have a second application.

The opinions of the two groups of enterprises about the functioning of the support program are as follows.

The first group of enterprises think that they will establish facilities for processing, packaging, and storing agricultural products in the future, thus more people and enterprises will benefit from the support program and alternative income and employment opportunities will be provided to the rural areas. This situation, which is important for rural development studies, is thought that the incomes of individuals living in rural areas will increase and rural development studies and supports will provide the desired effect in rural areas. In addition, this group of enterprises stated that with the increase in the support program, they will transfer other economic investments to the region in the coming years. On the other hand, since the second group of enterprises received support from the program only for irrigation-based projects, they do not have any thoughts about investing in the region in the future.

The first group enterprises add that with such support elements, besides the economic benefit that the enterprises will provide to the region, there will be elements that support social solidarity and collective decision-making.

When the problems encountered within the scope of the support program are examined, it is seen that the most important problems are the high demand for the amount of equity of individuals or companies, the long investment period and the necessity of a special consultancy system, while the second group of enterprises consider the long evaluation period, the excessive amount of required documents and the strictness of the support rules as the most important problems.

The opinions on the development of environmentally friendly projects are considered important for the first group enterprises in terms of developing projects that do not harm the environment and thus creating projects that respect the environment and protect nature in rural development studies.

Within the scope of the opinion on increasing job opportunities in rural areas, especially the enterprises with agricultural producer organizations, which are the second group of enterprises, are in the position of enterprises that advocate that investments to be made in rural areas will provide new job opportunities for the rural community.

When the reasons for the enterprises to choose the project subjects within the scope of the support program are analyzed, the first group of enterprises are of the opinion that such supports will bring alternative and good income to the region and the rural community, the products produced in the region will be evaluated with the establishment of an enterprise that the region needs, the needs of the enterprise will be met with financial support for new technology and modernization, the support will be seen as an opportunity for those who want to establish an enterprise in the region, the enterprises producing in the region will process their own products and increase regional and local production. In the second group of enterprises, the determination of the project subjects came to the forefront due to the fact that an enterprise that is needed in the region will be established by providing services to the rural area, the sustainability of natural resources will be ensured by protecting water resources, water saving will be ensured with irrigation systems and there is a support element within the field of activity of the enterprise.

The objectives that the enterprises want to realize with the project are to evaluate the products of the first group enterprises, to evaluate the existing resources of the region, to improve the business capacity of the region, to reach the elements needed by the enterprise, to contribute to the development of the region, to renew the technology and to export, which will

contribute to the development of production and the region in general. In the second group of enterprises, the evaluation of the existing resources of the region, especially the evaluation of water resources, meeting the irrigation needs of the region, protecting water resources and transferring them to future generations, contributing to the development of the region, increasing the yield of agricultural products with irrigation and meeting an important need of the enterpriser has been determined as the target to be achieved in the project.

Enterprises have various expectations in the support program. The first group of enterprises expect that the monetary amount of the support should be increased, the fields of activity should be extended to the whole rural area, the support should be given in different qualities and quantities according to the sectors, the support should be given to the people who will produce, and a separate grant support should be established for the construction of buildings. The second group of enterprises demanded that the scope of the grant capacity should be expanded and that they should be able to benefit from the existing support program for the second time.

When the reasons for the continuation of the program according to the enterprises are examined, the first group of enterprises are the enterprises that argue that the program is an investment opportunity for the enterprises, provides financial contribution to the enterprises and increases the employment opportunities of the region. The second group of enterprises, on the other hand, want the program to continue for reasons such as the protection of natural resources related to the natural structure, efficient use of resources, saving time and labor, contributing to the rural development activities of the region, and making investments that cannot be made in the region.

As for the problems related to the program, the first group enterprises consider the reduction in the amount of support due to the fact that the value added tax rate is included in the grant program, the fact that the amount of support is not sufficient financially for enterprise establishment, capacity increase and modernization, the excessive amount of documents required before the application and at the time of implementation of the project, and the long evaluation process of the application as the most important problems of the program. The second group enterprises argue that there are no problems with the program.

In this study, the expectations of groups with similar characteristics from rural development policies were investigated. Rural development studies have differences from other policy implementations. In rural development policies, the characteristics of the rural area, its potential, the social, economic, and social structure of the rural community, etc. need to be analyzed. It is expected that the analysis of the rural area and the society and the support elements to be made according to the social structure of the social structure, the groups showing similar characteristics in the face of situations and events are classified and the implementation of rural development policies for these groups can increase the effectiveness of existing policies.

ACKNOWLEDGMENT

We would like to thank Akdeniz University Scientific Research Projects Coordination Unit for their financial support.

REFERENCES

Anonymous 2023a Croatian network for rural development <https://hmrr.hr/en/what-is-rural-development/>.

Anonymous 2023b <https://byjus.com/commerce/meaning-of-rural-development/>

- Atkinson, C.L. 2017. Rural Development. In: Farazmand, A. (eds) Global Encyclopedia of Public Administration, Public Policy, and Governance. Springer, Cham. https://doi.org/10.1007/978-3-319-31816-5_1014-1.
- Can, M. 2007. Investigation of European Union Rural Development Programs in Terms of Turkey's Rural Development: SAPARD and IPARD Case, Agricultural Economic Research Institute Publications, Ankara, 152 ss.
- SPO. 2000. Rural Development Specialization Commission Reports, Republic of Turkey Prime Ministry State Planning Organization, VIII. Development Plan, Ankara, 73 ss.
- SPO. 2006. National Rural Development Strategy, Republic of Turkey Prime Ministry State Planning Organization, Ankara. <http://sgb.tarim.gov.tr/mevzuat/YPK/20060204-9-2.pdf>
- EC, 2023 European Commission Annual activity report 2022 - Agriculture and Rural Development (europa.eu) https://commission.europa.eu/publications/annual-activity-report-2022-agriculture-and-rural-development_en
- Gürlük, S. 2001a. Evaluation of Rural Development Projects According to Macro-Economic Criteria: Example of Cumalıkızık, Uludağ University, Graduate School of Sciences, Department of Agricultural Economics, Master's Thesis, Bursa, Türkiye. 123 pages.
- Hair J., W. Black, 2000. Cluster Analysis, L.G Grimm and P.R. Yarnold (Ed.), Reading and Understanding More Multivariate Statistics, American Psychological Association, Washington, 147 pages.
- Kaufman, L., P.J. Rousseeuw. 1990. Finding Groups in Data: An Introduction to Cluster Analysis, John Wiley and Sons. Ltd, Chichester, New York, Weinheim.
- Kendall, M.G. 1975. Multivariate Analysis, Charles Griffin b. Co Ltd., London.
- Moseley, Malcolm J. 2003. Rural development: principles and practice (1. publ. ed.). Londra, SAGE. ISBN 978-0-7619-4766-0
- Taşcıoğlu, Y. 2011. Social and Economic Evaluation of the Rural Development Investments Support Program: The Example of the Western Mediterranean Region, Akdeniz University, Institute of Science, PhD Thesis, Antalya, Türkiye. 208 pages.

DETERMINATION OF SUPPORT PREFERENCES OF ENTREPRENEURS UTILIZING SUPPORTS POLICIES FOR RURAL DEVELOPMENT BY CONJOINT ANALYSIS

Yavuz TAŞCIOĞLU¹, Cengiz SAYIN¹

*¹ Akdeniz University, Agriculture Faculty, Agricultural Economic Department, Antalya,
Turkey*

Corresponding author e-mail: ytascioglu@akdeniz.edu.tr

ABSTRACT

Countries attach importance to development for the continuity and sustainability of societies. Economic, social, political, etc. of development It is expected that it will change in areas, and this will be reflected in society. Development starts with economic indicators and can be achieved with improvement in social indicators. Changes in economic indicators around the world have gained rapid momentum mainly in industry and service sectors. The change in the industrial sector, which started especially in the urban area, caused the rural area to remain in the background. Elimination of the separation of urban and rural areas, which is necessary for social development, has begun to be achieved by supporting rural development studies. Different models have also been used in rural development studies, and they have changed due to the general characteristics of the rural area. Various studies have been made and are being carried out for the development of rural areas in Turkey. In recent years, various programs have been implemented to support rural development studies. The main purpose of these programs is to increase the income level in rural areas, to improve the infrastructure, to ensure the integration of agricultural production and agro-industry, to strengthen food security, to create alternative income sources in rural areas, and to increase the effectiveness of the rural development studies, considering the protection of natural resources. The most important of these programs is the Rural Development Investment Support Program (RDISP). In the program, which includes the support given on a provincial basis, it is aimed to process and evaluate agricultural products, and to ensure the integration of agriculture and industry in rural areas. However, within the scope of the support, the preferences of the business owners/ manager (enterprisers) in rural development supports were not considered. Support preferences of entrepreneurs are important in terms of entrepreneurial activity. Support elements and types are a situation that encourages entrepreneurs to start businesses.

This study, it is aimed to determine the support preferences of the enterprisers benefiting from Rural Development Investment Support Program in the Western Mediterranean Region, which includes the provinces of Antalya, Burdur, and Isparta, by using conjoint analysis. Thus, it is aimed to determine the degree of influence of the policy set that maximizes the utility of the business owners/ manager and the characteristics of the manufacturer in this policy preference.

Keyword: Rural development, Support policies, Conjoint analysis

INTRODUCTION

Development is the common goal of developed and developing countries. Development can be defined as the change in the economic, social, and political structures of countries and the progress and welfare of human life in the economic and social fields. Harris (1992) defines development as the growth of the economy, change in its structure, improvement of income distribution and improvements in the political and cultural spheres. In the Special Specialization Commission (SPC) Report of the State Planning Organization (SPO) for the 9th Development

Plan, development is defined as "the process of increasing people's access to decent living conditions, improving income distribution, raising income levels, ensuring locally appropriate developments in social and cultural areas, protecting and using natural resources, and reflecting wealth on the lives of individuals" (SPO, 2006a). Within the framework of the human dimension, development is the mobilization of the existing power to reduce the human deficiencies that arise in countries to a great extent and to increase the welfare of people in material terms. In the light of comprehensive definitions, development is not only the increase in the income of individuals in economic terms, but also social and cultural developments and the phenomenon of living in greater social welfare.

For development to be balanced, it is necessary to ensure harmony between elements such as population dynamics, natural resources, economic activities, technology level, social and cultural structures of the country. As a result of the analysis of these factors, planning and policy formulation and development processes have an important role in the success of development. To achieve the expected goals in development, improving the qualifications of the society in terms of education, health, and manpower, raising the standard of living, eliminating the differences between regions and settlements should be one of the most important goals (Anonymous, 2002).

The economic dimension of development started especially with the industrial revolution. This change in the industrial sector has led to the development of the economic structure and its reflection on human life and the concentration of the population in urban areas where the industrial sector is intense. The inability to create alternative sources of income other than the agricultural sector in rural areas has caused this change to bring urban areas to the forefront and rural areas to be ignored.

The first foundations of rural development were started to be established with the traditional rural development approach, which started in the 1960s, with the increase in ideas about the lack of distinction between urban and rural areas for social development. Today, different models and methods of rural development approaches have been applied, rural development policies have been harmonized with sustainable development policies and changes in rural structure have been tried to be achieved.

The change in the industrial sector in the world has also been experienced in our country, especially with migration and rapid urbanization, which has led to the emergence of various problems in both rural and urban areas and the development at the national scale has not reached the desired dimensions.

With the Planned Period, various strategies were developed and put into practice in order to increase infrastructure and public services for rural areas and to accelerate rural development (SPO, 2006b). In addition to the basic legal regulations on rural areas, issues such as rural development, village problems and village development have been mentioned in all national development plans, and the priority targets for rural areas have been determined in these plans and programs.

The main purpose of rural development policies is to improve the economic, social, and cultural opportunities of the communities living in rural areas, to bring these communities to the national level of living, and to ensure their full participation in national development (SPO, 2000). A significant portion of the world's population lives in rural areas, and these communities provide their development in economic and socio-cultural areas, especially in the agricultural sector, with their own means or through external support (Taşcıoğlu, 2011).

With the planned period in Turkey, approaches to rural areas and rural development were generally different from the previous period. In addition to the basic laws enacted in the previous period, industrialization, modernization in agriculture and urbanization were considered in rural development and it was emphasized that rural development was a part of national development and should be handled together (Çağlar, 1986). In addition, regional development projects were implemented during this period and continue to be implemented.

In addition to general and regional activities for rural development in Turkey, various development-oriented programs are also carried out. One of these is the "Program for Supporting Rural Development Investments (RDISP)", which was established according to the principles set out in the National Rural Development Strategy (NRDS) published in 2003 and put into practice after being published in the Official Gazette dated 06.04.2006 and numbered 26131. The Program aims to determine the procedures and principles for raising the income level in rural areas, improving infrastructure, integrating agricultural production and agro-industry, strengthening food security, creating alternative sources of income in rural areas, increasing the efficiency of ongoing rural development activities, increasing the level of basic public services, increasing access to services and creating a certain capacity in rural society, taking into account the protection of natural resources (OJ, 2006).

The scope of the program is determined as the issues related to what needs to be done in order to encourage and support the economic activity investments of real and legal persons for the processing, evaluation, and marketing of agricultural products and the investments of organizations for the rehabilitation of existing infrastructure facilities in order to ensure economic and social development in rural areas within the provinces determined for the projected investments based on equity capital to be made individually and/or collectively by agricultural enterprisers (business owners/managers) in rural areas within the framework of development plans and programs and the National Agricultural Strategy.

Within the scope of RDISP, projects for village-based Irrigation facilities that ensure participation with a bottom-up approach, develop local capacity and organization, have the potential to create employment, increase and diversify entrepreneur incomes, encourage the increase in the level of education and entrepreneurship of the female population, and are based on the development and expansion of small and medium-sized industries based on agriculture are supported.

This study, it is aimed to determine the support preferences of the enterprisers benefiting from Rural Development Investment Support Program in the Western Mediterranean Region, which includes the provinces of Antalya, Burdur, and Isparta, by using conjoint analysis. Thus, it is aimed to determine the degree of influence of the policy set that maximizes the utility of the enterprisers and the characteristics of the entrepreneurs in this policy preference.

MATERIAL AND METHOD

The research was carried out with original data, supported by secondary data based on the literature, but largely obtained through a survey based on face-to-face interviews with enterprises benefiting from the Rural Development Investments Support Program in the Western Mediterranean Region.

The study was conducted in the Western Mediterranean Region. The Western Mediterranean Region is the region called TR61 in the Classification of Statistical Regional Units (IBBS) Level 2, which covers the provinces of Antalya, Burdur and Isparta in the west of the Mediterranean Region, with Muğla and Denizli in the west, Afyon and Konya in the north, Karaman and Mersin in the east, and the Mediterranean Sea in the south. The region has been home to various civilizations since ancient times due to its geographical location, fertile soils, and rich water resources.

A "field survey" covering the enterprises benefiting from the Rural Development Investments Support Program was conducted in the area called TR61 according to the Statistical Regional Units Classification (IBBS) Level 2, which includes the provinces in the Western Mediterranean Region (Antalya, Budur and Isparta). Information on these enterprises was obtained from the Support Branches of the Provincial Directorates of Agriculture.

In the study, 47 enterprises in Antalya province, 26 enterprises in Burdur province and 23 enterprises in Isparta province benefiting from the Rural Development Investments Support

Program were surveyed. Face-to-face interviews were conducted with a total of 96 enterprises benefiting from the support program in the region in question.

Conjoint Analysis methods, one of the multivariate analysis techniques, were used to analyze the data. Conjoint, as a word, means collective participation. The word Conjoint was formed by combining the words consider and joint (Churchill and Lacoubicci, 2002). If a Turkish equivalent is desired, it can be called "Analysis of Relationships", "Association Analysis" or "Composite Analysis" (Yiğit, 2008). With conjoint analysis, it is possible to define the service as combinations of quality levels and to determine the quality levels and the detailed judgments of individuals towards that service (Gill and Sanchez, 1997). Conjoint analysis is a multivariate analysis technique used to analyze individuals' preferences for different combinations of measured and unmeasured attributes. According to another definition, Conjoint analysis is defined as a method of systematically evaluating and estimating a decision maker's choice of a limited number of alternatives (Joel, 2002). This analysis is a method that tries to determine which features a newly developed or already existing product or service should have, to reveal the preference behavior of individuals who benefit from this service and to determine the most desirable features of the service.

In this analysis, it is assumed that the value people place on a service corresponds to the sum of the benefits they derive from all its identified attributes, and that they will then use that service in proportion to the benefits they derive from it. Utility is a highly subjective phenomenon that varies from person to person. It would therefore be difficult to know without the help of Conjoint analysis. The analysis is widely used in a wide range of fields and can be used in new service planning to determine the impact of innovations and in efforts to improve existing achievements.

The starting point of Conjoint analysis is based on "Total Benefit Theory". In the partial benefit contribution model, the partial benefits of each attribute level of the product are independent of each other and the sum of the partial benefits of these attribute levels constitutes the total benefit.

In Conjoint analysis, two different calculation methods are used to determine the importance levels of policy-related features. The first one is to determine the difference between the partial utility values of each attribute. The other way is to calculate the relative importance levels of the combinations. The difference between the partial utility values of the attributes is the difference between the two attribute levels with the highest and the lowest partial utility value. This value shows the relative importance of each level of each combination in the combination. In measuring the relative importance between combinations, the partial benefit change values calculated for each combination are proportioned to the total partial benefit change value.

When applying Conjoint analysis, it is important to determine the variables and measurement methods at the beginning. The stages start with defining the problem and determining the research purpose, and end with determining the variables and levels and collecting and evaluating the data accordingly.

The purpose of Conjoint analysis is to determine the priorities and options that affect the outcome in the decision phase (Schweickl, 1985). The first step in the analysis is the selection of the preference function that will determine the effect of the factor characteristics that have an impact on the preferences of the people participating in the analysis on the decision. This function is the basis for determining the partial values of the factor attributes that affect the preferences of the participants in the analysis (Gutsche, 1995; Green and Srinivasan, 1978). The most used models are the ideal vector model, the ideal point model and the partial benefit model (Gustafsson, 2003).

As in all statistical studies, the first step in conjoint analysis is to determine the decision mechanism and objectives of the research problem. The point to be considered at this stage is

that the research problem can be solved by defining preferences between variables and variable levels.

Within the scope of the Conjoint study, the selection of the factors and their levels to be included in the cards to be shown to the interviewee is a critical step. For this reason, the researcher should pay attention to the following points while determining the characteristics and levels of the product or service:

- Factors should be determinative in a way that they could influence individuals' choice. Any factor that is not related to choose should not be included in the study. However, the inclusion of factors that are important but do not create differences between preferences will make it difficult for the respondent to decide (Hair et al. 1995).

- Factors should provide complete and meaningful information about the service and be realistic.

- Factors should be practical and represent a single concept. The use of factors that include more than one dimension such as quality should be avoided.

- Factors should be easily communicated by the interviewee to enable a realistic assessment.

- The number of factors included in the analysis directly affects the reliability and statistical validity of the results. In addition, when the number of factors and factor levels is increased, the increased number of parameters will either lead to the presentation of more cards or to a decrease in the validity of the parameters.

In addition, many factors may cause respondents to be reluctant to participate in the research, as it would take too much time.

In this study, conjoint analysis was used to determine the support preferences of the enterprisers benefiting from RDISP in agricultural policy and rural development policy. Thus, the policy set that maximizes the benefit of the enterprisers and the degree of influence of the characteristics on this policy preference of the enterprisers were determined. At this stage, first of all, 5 factors required for the policy were determined and these are support type, support amount, support area, investment period and tax exemption. While determining the factors and factor levels, the factors and factor levels previously given in the supports for this field and given within the scope of this program were used. Factor levels according to these factors are given in Table 1.

Table 1. Factors and Factor Levels Used in Conjoint Analysis

Factors	Factor Levels			
	1	2	3	4
Support area	Animal husbandry	Greenhouse cultivation	Irrigation	Manufacturing industry
Type of support	Cash payment	Building construction	Machinery purchase	-
Support amount (rate)	25%	50%	75%	-
Investment period (months)	9	12	15	-
Tax exemption	None	2 years	3 years	-

The combinations to be used in the analysis according to factors and factor levels were determined as 16 in the SPSS package program. Accordingly, the combinations were formed as shown in Table 2.

Table 2. Conjoint Analysis Combinations

Card No	Type of support	Support amount (rate)	Support area	Investment period (months)	Tax exemption
1	Machinery purchase	50%	Greenhouse cultivation	12	None
2	Machinery purchase	50%	Animal husbandry	9	3 years
3	Cash payment	50%	Animal husbandry	9	2 years
4	Building construction	75%	Animal husbandry	15	None
5	Cash payment	25%	Irrigation	9	None
6	Cash payment	25%	Greenhouse cultivation	15	None
7	Building construction	25%	Greenhouse cultivation	9	3 years
8	Cash payment	75%	Manufacturing industry	12	3 years
9	Cash payment	75%	Greenhouse cultivation	9	2 years
10	Machinery purchase	75%	Irrigation	9	None
11	Building construction	25%	Irrigation	15	None
12	Machinery purchase	25%	Manufacturing industry	15	2 years
13	Cash payment	25%	Animal husbandry	12	None
14	Building construction	50%	Manufacturing industry	9	None
15	Cash payment	25%	Manufacturing industry	9	None
16	Cash payment	50%	Irrigation	15	3 years

RESULTS AND DISCUSSION

The study was examined in two stages: general descriptive information about the enterprises benefiting from the program and the results of the analysis. First, information about the enterprises benefiting from the program is given below.

In the Western Mediterranean Region, the highest number of enterprises benefiting from the program was in Antalya province. In Burdur and Isparta provinces, the need for agriculture-based industry differs from Antalya due to the nature of the investments made, and this is also reflected in the program.

When the enterprises benefiting from the support in the region are classified according to their legal structures, it is seen that most investments are made by limited, joint stock and collective companies. More than half of the support program (56%) was used by companies. After companies, development and Irrigation cooperatives and unions (22%) and Village Service Provision Unions (VSPU) operating under district governorships (19%) made the most investments. Individuals or bilateral partnerships benefited the least from the program (3%) (Table 3). In Antalya and Isparta provinces, companies benefited the most from the program, while in Burdur province, Village Service Provision Unions (approximately 60%) benefited the most from the program due to the effective work of the provincial governorship and the fact that they saw the program as an opportunity (Table 3).

Table 3. Distribution of legal structure of program enterprises by province

Legal Structure of Support Beneficiaries	Antalya		Burdur		Isparta		Total	
	Quantity (person)	Rate (%)	Quantity (person)	Rate (%)	Quantity (person)	Rate (%)	Quantity (person)	Rate (%)
Company	38	80.9	4	15.4	12	52.2	54	56.3
Cooperative, Union	7	14.9	5	19.2	9	39.1	21	21.9
VSPU	1	2.1	15	57.7	2	8.7	18	18.8
Sole proprietorships	1	2.1	2	7.7	-	-	3	3.1
Total	47	100.0	26	100.0	23	100.0	96	100.0

The survey was conducted with the people who are in the managerial positions such as business manager, accountant, etc. in the enterprises benefiting from the program and who are actively working in the application to the program. This also shows that the results are directly proportional to the legal structure of the enterprises. At the company level, interviews were

mostly conducted with company managers or company owners, chairmen or partners in cooperatives and unions, chairmen or managers in VSPU, and partners in sole proprietorships.

The education level of the interviewees was generally high. This feature is directly related to the beneficiary status of the program. Because there is a one-to-one relationship between having information about the program and the education level of the people. This situation emerged from the general structure of the people interviewed during the observations made during the survey period.

Within the scope of the program, enterprises that determined their own field of activity in the region benefited from grant support for processing, packaging, and storage (61.5%). Agricultural production is intensively carried out in the region since the climate and soil fertility is suitable for fruit and vegetable production compared to other regions of Turkey. Intensive agricultural production increases the desire to meet post-production services from within the region. In this context, the program has been an opportunity for the enterprises in the region, and the need for processing and packaging of the products produced has been met to a certain extent. In addition, the need for storage of agricultural products produced in the region has been met through the support program. In this respect, it has been observed that the support program has benefited the rural areas of the Western Mediterranean Region.

Within the scope of the program, other supports other than processing, packaging and storage grants were also benefited from. While 25% of the enterprises benefited from the support for drip Irrigation, 10.4% received grants for capacity increase and 3.1% received grants for infrastructure works such as sewerage and road construction.

Accordingly, the evaluations of the surveyed individuals about each alternative were taken and the evaluation of the individuals on the subject was made on a 10-point scale. In the scoring system, 1 point was accepted as the highest score for the alternative preferred by the individuals.

Individuals who benefited from the support were asked to rank the cards obtained as a result of the orthogonal design according to their preferences. Everyone's ranking was subjected to the Bretton-Clark Conjoint Designer process and the partial utility coefficient, the degree of importance calculated for each factor and the preference ranking of everyone were calculated.

When the results of the analysis are evaluated, it is revealed that the most important factor in the support preference of individuals is the "support area". The degree of influence of the support area on the decision of individuals to benefit from support was calculated as 38.23%. After the support area, the second most important factor in the decision of individuals to benefit from support is "investment period". The degree of influence of the investment period on the decision of individuals to benefit from support was calculated as 16.25%. The third most important factor in the decision of individuals to benefit from support is "type of support". The degree of influence of the type of support on the decision of individuals to benefit from support was calculated as 15.57%. "Tax exemption" is the fourth most important factor in individuals' decisions to benefit from support. The degree of influence of tax exemption on individuals' decision to benefit from support was calculated as 15.42%. Finally, the fifth and last factor in individuals' decisions to benefit from support is the "amount of support". The degree of influence of the investment period on the decision of individuals to benefit from support was calculated as 14.53% (Table 4).

Table 4. Results of Conjoint Analysis

Factors	Factors levels	Partial utility (Part worth value)	Significance levels (%)
Support area (SA)	Animal husbandry (SA1)	0.925	38.232
	Greenhouse cultivation (SA2)	0.917	
	Manufacturing industry (SA3)	-0.291	
	Irrigation (SA4)	-1.551	
Investment period (months) (IP)	9 (IP1)	0.331	16.246
	12 (IP2)	-0.081	
	15 (IP3)	-0.250	
Type of support (TS)	Machinery purchase (TS1)	0.666	15.572
	Cash payment (TS2)	-0.265	
	Building construction (TS3)	-0.401	
Tax exemption (TE)	3 years (TE1)	0.102	15.418
	2 years (TE2)	0.086	
	None (TE3)	-0.188	
Support amount (rate)(SAR)	50% (SAR1)	0.419	14.532
	75% (SAR2)	0.023	
	25% (SAR3)	-0.442	
Total			100.000
Pearson's R Value = 0.983		Significance = 0.0000	
Kendall's tau Value = 0.833		Significance = 0.0000	

Within the framework of the findings obtained in the research region, it can be said that the most important feature in the optimum policy choice that gives the highest total benefit in the support decision of the enterprisers benefiting from RDISP in the Western Mediterranean Region is the "area of support" to be provided to the region. It is seen that enterprisers and administrators primarily pay attention to the area of support in the investments to be made in their regions. This situation shows that the bottom-up implementation in the EU in recent years, especially in rural development studies, is also suitable for the region in question. As a matter of fact, in relation to the investments to be made in a region, cooperation with local stakeholders or non-governmental organizations of that region is requested first. This is based on the fact that local stakeholders have knowledge about the shortcomings and potential of the region. It is seen that the individuals who will benefit from the support first pay attention to the area to be supported and prefer to benefit from the support accordingly.

The partial utility values of each factor level show the effect of those levels on individuals' preferences. The factor level with the highest partial utility value is the most preferred option by individuals. Accordingly, the factor level with the highest partial utility score in the support area factor is "animal husbandry" with 0.925. Animal husbandry is followed by "greenhouse farming" with a benefit score of 0.917, "manufacturing industry" with a factor score of -0.291 and finally "Irrigation" with a benefit score of -1.551. These data show that in the selection of the support area, the livestock breeding activity of the enterprisers benefiting from the program in the region is the factor level with the highest partial benefit for the region.

In the investment duration factor, the factor level with the highest partial benefit score is "9 months" with 0.331. This factor level is followed by "12 months" with a benefit score of -0.081 and "15 months" with -0.250. In the selection of the investment period given in the supports, enterprisers who benefit from RDISP in the region prefer a period of 9 months.

Table 5. Total Utility Values of combinations in Conjoint Analysis

No	TS	Partial utility	SAR	Partial utility	SA	Partial utility	IP	Partial utility	TE	Partial utility	Total utility
2	TS1	0.666	SAR1	0.419	SA1	0.925	IP1	0.331	TE1	0.102	2.443
1	TS1	0.666	SAR1	0.419	SA2	0.917	IP2	-0.081	TE3	-0.188	1.733
3	TS2	-0.265	SAR1	0.419	SA1	0.925	IP1	0.331	TE2	0.086	1.496
9	TS2	-0.265	SAR2	0.023	SA2	0.917	IP1	0.331	TE2	0.086	1.092
7	TS3	-0.401	SAR3	-0.442	SA2	0.917	IP1	0.331	TE1	0.102	0.507
4	TS3	-0.401	SAR2	0.023	SA1	0.925	IP3	-0.250	TE3	-0.188	0.109
13	TS2	-0.265	SAR3	-0.442	SA1	0.925	IP2	-0.081	TE3	-0.188	-0.051
14	TS3	-0.401	SAR1	0.419	SA3	-0.291	IP1	0.331	TE3	-0.188	-0.130
6	TS2	-0.265	SAR3	-0.442	SA2	0.917	IP3	-0.250	TE3	-0.188	-0.228
12	TS1	0.666	SAR3	-0.442	SA3	-0.291	IP3	-0.250	TE2	0.086	-0.231
8	TS2	-0.265	SAR2	0.023	SA3	-0.291	IP2	-0.081	TE1	0.102	-0.512
10	TS1	0.666	SAR2	0.023	SA4	-1.551	IP1	0.331	TE3	-0.188	-0.719
15	TS2	-0.265	SAR3	-0.442	SA3	-0.291	IP1	0.331	TE3	-0.188	-0.855
16	TS2	-0.265	SAR1	0.419	SA4	-1.551	IP3	-0.250	TE1	0.102	-1.545
5	TS2	-0.265	SAR3	-0.442	SA4	-1.551	IP1	0.331	TE3	-0.188	-2.115
11	TS3	-0.401	SAR3	-0.442	SA4	-1.551	IP3	-0.250	TE3	-0.188	-2.832

In the form of support factor, the factor level with the highest partial benefit score is "machinery purchase" with 0.666. Machinery purchase is followed by "cash" with a benefit score of -0.265 and "building" with -0.401. In the choice of the type of support, enterprisers who benefit from RDISP in the region prefer to receive machinery directly.

In the tax exemption factor, the factor level with the highest partial benefit score is "3 years" with 0.102. This factor level is followed by "2 years" with a benefit score of 0.086 and "none" with -0.188. In the choice of taxation in the supports provided, enterprisers who benefit from RDISP in the region prefer that the business they will establish be exempt from tax for 3 years.

Finally, the factor level with the highest partial utility score in the support amount factor is "50% grant" with 0.419. This factor level is followed by "75% grant" with a benefit score of 0.023 and "25% grant" with -0.442. According to the enterprisers benefiting from the program in the region, the factor level with the highest partial benefit when choosing the support amount is the support amount with "50% grant" rate (Table 5).

The average and total utility values of the combinations (question cards) presented to the enterprisers within the scope of Conjoint analysis and the priority order of individuals in policy choice are given in Table 5. The total utility value is the sum of the factor level scores and the combination with the highest total utility value is defined as the policy set that provides optimum utility for individuals. The combination with the lowest total utility value provides minimum benefit to the enterprisers.

According to the enterprisers, the optimum policy pattern that provides the maximum utility is card or combination number 2 with a total utility value of 2.443. The second most preferred combination by the enterprisers is card number 1. As can be seen from the above, machinery and cash grants are the most preferred forms of support for the owner, manager, shareholders, or heads of cooperatives/unions. As for support, 50% and 75% grants are preferred by the enterprisers. Animal husbandry and greenhouse cultivation are the most preferred sectors in the region. However, keeping the investment period short is seen as a preferred practice by individuals. The policy support set that provides the minimum (least)

benefit to individuals is determined as combination number 11 with a total benefit score of -2.832. This result shows that individuals do not prefer building construction, 25% support rate and irrigation investments (Table 5).

CONCLUSIONS

Development is the process of increasing people's access to humane living conditions, improving income distribution, increasing the level of income, ensuring localized developments in social and cultural areas, protecting, and utilizing natural resources and reflecting the wealth to the lives of individuals. Development is a target that countries want to reach and a series of developing movements.

Developments and development initiatives in countries have been to the detriment of rural areas and in favor of urban areas. For centuries, it has been accepted that urban areas are the focal points of development and progress. However, in recent years, this idea has started to change in many countries, especially with the demonstration that no distinction can be made between urban and rural areas for social development.

Policies have been established to make rural development efforts more efficient. These policies are the policies that reveal the efforts made on a national basis to improve the economic, social, and cultural opportunities of the communities living in rural areas, to increase the living standards of these communities, and to support them to participate in national development. However, these efforts have ceased to be the domestic policy of countries and have become an international issue in the world. Rural development activities vary from country to country. With the developments in rural development in countries, various policies are developed and implemented for the development of rural areas in the world. In Turkey, rural development activities started in the early years of the Republic and rural development policies were implemented with various regulations in the following years. One of these practices is the "Rural Development Investments Support Program". The program aims to create a certain capacity in rural society.

In this study, a "field research" covering the enterprises benefiting from the Rural Development Investments Support Program in the provinces in the Western Mediterranean Region was conducted. A survey based on face-to-face interviews was conducted with a total of 96 enterprises benefiting from the support program in the said region. According to this

When the results of the Conjoint analysis were evaluated, it was revealed that the most important factor in the support preference of individuals was the "support area". The degree of influence of the support area on the decision of individuals to benefit from support was calculated as 38.23%. After the support area, the second most important factor in the decision of individuals to benefit from support is "investment period". The degree of influence of the investment period on the decision of individuals to benefit from support was calculated as 16.25%. The third most important factor in the decision of individuals to benefit from support is "type of support". The degree of influence of the type of support on the decision of individuals to benefit from support was calculated as 15.57%. "Tax exemption" is the fourth most important factor in individuals' decisions to benefit from support. The degree of influence of tax exemption on individuals' decision to benefit from support was calculated as 15.42%. Finally, the fifth and the most important factor in the decision of individuals to benefit from support is the "amount of support". The degree of influence of investment duration on the decision of individuals to benefit from support is calculated as 14.53%. According to these results, the enterprises benefiting from the support in the region preferred the support combination of machinery in the form of support, 50% in the support amount (rate), livestock breeding in the support area, 9 months in the investment period and 3 years in tax exemption. In addition, according to the enterprisers, this combination is accepted as the policy pattern that maximizes their total benefits.

Conjoint analysis reveals the results obtained in the field of agricultural policy and the opinions of the people who benefit from the support. The study has created an entrepreneur-oriented approach that reveals the thoughts of the enterprisers on how the support for rural areas should be and can answer the question of how the support should be. As a result of this approach, the study is an important resource for policy makers.

In line with the results obtained from the study, the objectives of the support program, scope, support area, investment period, form of support, amount of support, what kind of support they benefit from the support program due to what kind of features of the support, according to which features the enterprises benefit from the support to operate in rural areas and which support combination the enterprises prefer were carried out through the example of enterprises benefiting from RDISP in the Western Mediterranean Region. With the findings obtained, the creation of support units according to the wishes, expectations, and potential of local knowledge in support policies for rural development will ensure that rural development efforts will achieve the desired success.

ACKNOWLEDGMENT

We would like to thank Akdeniz University Scientific Research Projects Coordination Unit for their financial support.

REFERENCES

- Churchill, G.A., D. Iacobucci, 2002. Marketing Research Methodological Foundation, Eight Edition, Southwestern, , California, USA. 48 pages.
- Çağlar, Y. 1986. Village, Peasantry and The Problem of Village Development In Turkey, Turkish Agriculturalists' Association Publications, Ankara.
- SPO. 2000. Rural Development Special Expertise Commission Reports, Republic of Turkey Prime Ministry State Planning Organization, VIII. Development Plan, Ankara, Türkiye, 73 pages.
- SPO. 2006a. National Rural Development Strategy, Republic of Turkey, Prime Ministry State Planning Organization, Ankara, Türkiye. <http://sgb.tarim.gov.tr/mevzuat/ypk/20060204-9-2.pdf>
- SPO. 2006b. IX. Development Plan Rural Development Specialized Sub-Commission Report, Prime Ministry State Planning Organization, Ankara.
- Gill, J. M., M. Sanches, 1997. Consumer Preferences for Wine Attributes: A Conjoint Approach, British Food Journal, 99 (1): 4-5.
- Green, P.E., V. Srinivasan, 1978. Conjoint Analysis in Consumer Research: Issues and Outlook, Journal of Consumer Research, 5: 103-123, UK.
- Gustafsson, A., A. Herrmann, F. Huber, 2003. Conjoint Measurement: Methods and Applications, Springer-Verlag.
- Gutsche, J. 1995. Produkt Präferenz Analyse: Ein Modell Theoretisches Und Methodisches Konzept Zur Marktsimulation Mittels Präferenz Erfassungsmodellen, Berlin.
- Harris, J. 1992. Rural Development, Routledge, pp. 15-37, London,
- Hair, J.F., R.E. Anderson, R.L. Tahtam, W.C. Block, 1995. Multivariate Data Analysis with Reading, Macmillan Book Company, London, UK. 74 pages.
- Joel, W.H. 2002. Conjoint Analysis in Pharmaceutical Research, JMCP, 8 (3): 206-208, <http://www.amcp.org/workarea/downloadasset.aspx?id=6571>
- OJ. 2006. Republic of Turkey 06.04.2006 dated and 26131 numbered Official Journal, Ankara.
- Schweikl, H. 1985. Computergestützte Präferenz an Analyse Mit Individuell Wichtigen Produktmerkmalen, Berlin, Germany.

- Yiğit, A.M. 2008. Conjoint Analysis and an Application on The Preferences of Office Furniture Consumers, Gaziosmanpaşa University Institute of Social Sciences, Master's Thesis, Tokat. 105 pages.
- Taşcıoğlu, Y. 2011. Social and Economic Evaluation of the Rural Development Investments Support Program: The Example of the Western Mediterranean Region, Akdeniz University, Institute of Science, PhD Thesis, Antalya, Türkiye. 208 pages.

ASSESSMENT OF PHENOLIC CONTENTS IN BASIL GROWN INDOORS AND OUTDOOR CONDITIONS

Dursun KISA¹

¹Bartın University, Faculty of Science, Department of Molecular Biology and Genetics,
74100 Bartın, Türkiye

Corresponding author e-mail: drsn57@hotmail.com

ABSTRACT

The accumulation of plant phenolic compounds varies according to the conditions of the environment in which plants are grown. The lighting conditions the plant is exposed to are among the most important factors for plant production and metabolite content. This study aimed to assess the quantity of phenolic substances with HPLC equipment in basil (*Ocimum basilicum*) grown in two different conditions. In each light condition, the phenolic contents of basil plants significantly changed depending on the natural daylight and grow cabinet lighting conditions. The results showed that the quantity of rosmarinic acid, rutin, eugenol, chicoric acid, benzoic acid, methyl chavicol, chlorogenic acid, vanillic acid, caffeic acid, and TPC significantly increased under natural daylight. However, the level of cinnamic acid, quercetin, and TFC did not alter under both conditions. Overall, natural daylight condition is the most suitable lighting strategy to increase the phenolic content of sweet basil.

Keywords: *Ocimum basilicum*, Phenolic compound, Rosmarinic acid, Light exposure

INTRODUCTION

Environmental factors such as light spectrum, watering, temperature, and nutrients in agriculture are important ingredients for plant development and growth (Sutulienė et al., 2022). Light is one of the major elements that regulate plant behavior depending on light quality, quantity, duration, and direction (Dou et al., 2018). Photosynthetic characteristics are physiological traits indicating plant responses to environmental stress. Synthesis of primary molecules, sugars, is directly related to photosynthesis, and the accumulation of secondary metabolites through various biosynthetic pathways via intermediate molecules is also affected by environmental factors (Chutimanukul et al., 2022a).

Plant growth conditions play a crucial role in the yield and secondary substance accumulation in herbs. Among abiotic factors, light is a key abiotic factor that drives photosynthetic production and regulates physiological responses in plants. The primary and secondary responses of plants are triggered by changes in photoperiodic and photosynthetic light conditions (Chutimanukul et al., 2022b). Light quality has a profound effect, influencing complicated responses in plant morphology, physiology, biochemistry, and gene expression to regulate plant growth, morphogenesis, chloroplast, and secondary metabolite accumulations (Xu et al., 2020). Light situations influence the synthesis of phenolic compounds as a secondary metabolite in the growing conditions of the plants. Accumulation of the metabolites is also varied according to plant tissues at different developmental stages of herbs (Maurya and Sangwan, 2020; Chutimanukul et al., 2022b).

Basil is raised as a traditional and medicinal herb in Türkiye, and the phytochemical content of the plant varies depending on the growth and development conditions. The study was aimed to compare the effect of indoor and outdoor plant growth conditions on phenolic compound content in green sweet basil (*Ocimum basilicum* L.)

MATERIAL AND METHOD

Basil growth conditions

The sterilized basil seeds were seeded in a seedling tray containing garden soil, perlite, and vermiculite (2:1:1). After the approximately four weeks, the seedlings having four true leaves were transferred to plastic pots, then plant growth conditions were carried out in two different environments. For the indoor conditions, a controlled growth chamber was used to continue the experiment at 25 °C under 500 $\mu\text{mol m}^{-2} \text{s}^{-1}$ white fluorescence 14:10 h light/dark cycles. For the outdoor conditions in the periods of April to August, the plants were grown in pots under open air conditions covered with a transparent plastic sheet to protect them from rain. The basil plants were watered with tap water, and sweet basil leaves were sampled in liquid nitrogen from approximately 4-month-old plants. For phenolic compound analysis with HPLC, the samples were kept at - 80 °C.

Analysis of phenolic compounds with HPLC

The samples were powdered in liquid nitrogen and extraction was done in methanol-chloroform solution (4:1). The mixture was sonicated for 45 min at 37 °C and then centrifuged at ambient temperature. The upper solvent phase was filtered to analyze total phenolic, flavonoid, and individual components.

The quantitative analysis of basil extract was performed HPLC (Shimadzu, Japan) by transferring to vials with an automatic injection of the samples (20 μL). Methanol and acidified water (2% acetic acid, v/v) was used as mobile phases by executing in reverse-phase C18 analytical column (250 mm \times 4.6 mm, 5 μm , GL Sciences) at 25 °C. The flow rate was 1 mL min^{-1} and elution gradient was as follows: 0–2 min, 13% methanol; 2–7 min, 22% methanol; 7–30 min, 40% methanol; 30–50 min, 75% methanol and 50–59 min, 90% methanol; 59–67 min 95% methanol. The detection of basil phenolic compounds was determined by comparing the standard compound's chromatographic profiles (Elmastaş et al., 2017).

Determination of total phenolic and flavonoid contents

The contents of the total phenolic and flavonoid of basil extract were briefly analyzed according to earlier methods (Peşkal and Pyrzyńska, 2014; Genç et al., 2019). For TPC, folin-ciocalteu reagent, basil extract, and 2% NaHCO_3 were mixed, and after two hours of incubation, the absorbance was read at 765 nm. For TFC analysis, basil extract, CH_3COONa , and AlCl_3 were pipetted to tubes, and following 30 min incubation, the absorbance was measured at 425 nm.

RESULTS AND DISCUSSION

Based on the phenolic compound study results, rosmarinic acid, rutin and eugenol were major metabolites both for basil leaves grown indoors and outdoors conditions. On the other hand, it was determined that the content of all three metabolites in plants grown under external conditions was approximately 17, 4.7, and 4.4 times higher, respectively (Fig. 1). Based on study results at the pot study; the level of methyl chavicol, chlorogenic acid, vanillic acid, and caffeic acid were significantly higher in basil cultivated outdoor environment. However, cinnamic acid and quercetin contents did not significantly change in both conditions (Fig. 2). Also, it was calculated that chicoric acid and benzoic acid had 5-fold more content in basil grown in outdoor conditions. Total phenolic content of basil leaves was changed from 9.12 to 42.47 mg g^{-1} in the plants cultivated in indoors and outdoors environment, respectively. However, total flavonoid content did not show any significant change according to the growing conditions of the plants (Fig. 3).

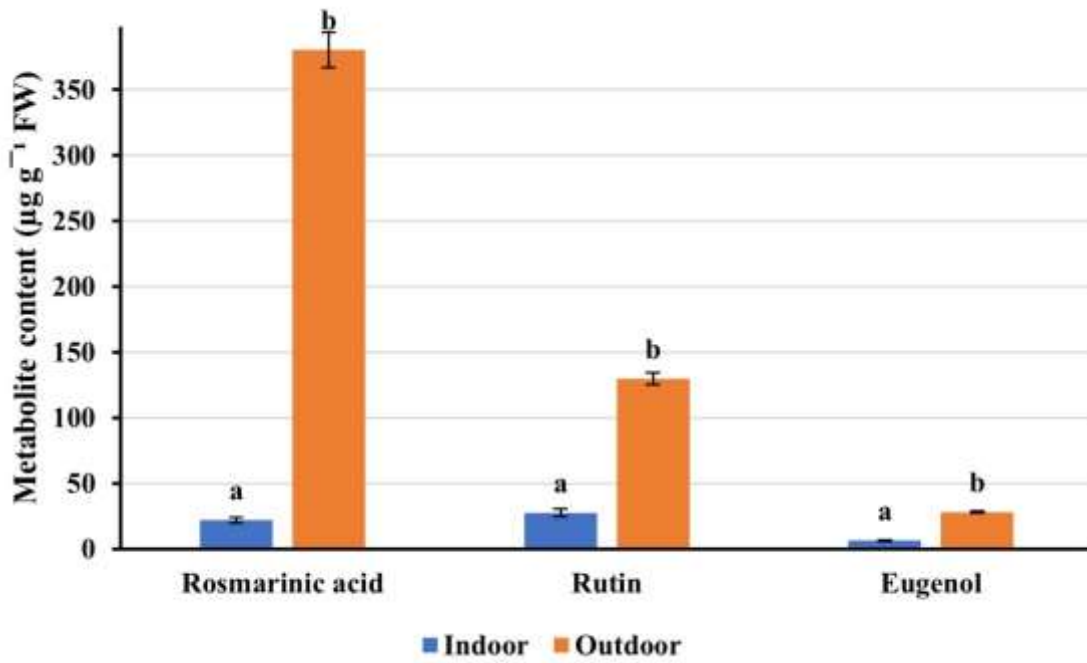

Figure 1. The major metabolites of basil leaves at the pot study

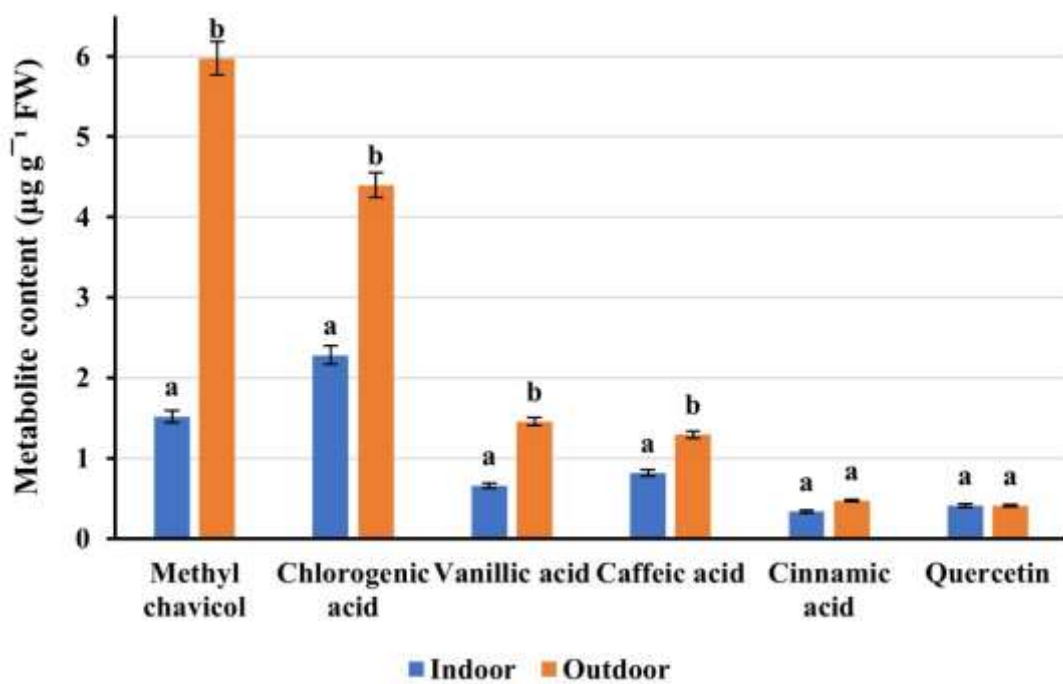

Figure 2. Six metabolites detected in basil leaves at the pot study

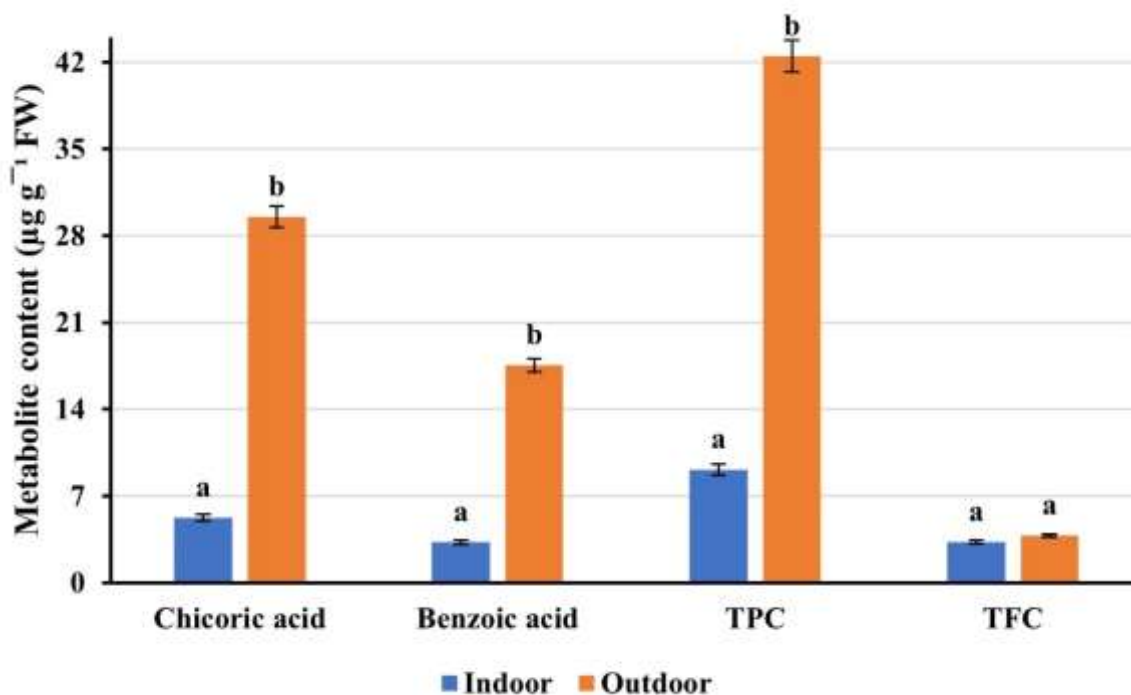

Figure 3. Chicoric acid, benzoic acid, TPC and TFC contents in basil leaves at the pot study (Concentration for TPC and TFC is mg g⁻¹).

The results of the study showed that the phenolic content of the basil mainly increased in the outdoor condition compared to the plant growth chamber conditions. The previous study on the effect of different shading treatments on the phenolic profile of basil declared that the highest phenolic contents for chlorogenic acid, caffeic acid, and rosmarinic acid were detected in unshaded plants compared to the various shading treatments (Castronuovo et al., 2019). Chutimanukul et al (2022) reported that TPC content in basil cultivars notable highest in the plants under the lights treatments treated with % 25 red and % 75 blue spectrum (Chutimanukul et al., 2022b). It may be said that the current study results are consistent with the different light application results mentioned.

CONCLUSIONS

Based on the study, the phenolic profiles of the basil exhibited different accumulations under cultivated in indoor and outdoor conditions. The increase of some phenolic substances in plants grown outdoors may be associated with different wavelengths of light to which plants in the open environment are exposed, while indoor plants are exposed only to white-fluorescent light. However, in the future, more detailed studies can be carried out on the change of plant phenolic profile by growing plants grown outdoors under more controlled conditions.

REFERENCES

- Castronuovo, D., D. Russo, R. Libonati, I. Faraone, V. Candido, P. Picuno, P. Andrade, P. Valentao, L. Milella. 2019. Influence of shading treatment on yield, morphological traits and phenolic profile of sweet basil (*Ocimum basilicum* L.). *Sci Hort (Amsterdam)*, 254:91–98. doi: 10.1016/j.scienta.2019.04.077
- Chutimanukul, P., H. Jindamol, A. Thongtip, S. Korinsak, K. Romyanon, T. Toojinda, C.T. Darwell, P. Wanichananan, A. Panya, W. Kaewsri, A. Auvuchanon, K. Mosaleeyanon, P. Chutimanukul. 2022a. Physiological responses and variation in secondary metabolite content among Thai holy basil cultivars (*Ocimum tenuiflorum* L.) grown under controlled environmental conditions in a plant factory. *Front Plant Sci*, 13:1–19. doi:

10.3389/fpls.2022.1008917

- Chutimanukul, P., P. Wanichananan, S. Janta, T. Toojinda, C.T. Darwell, K. Mosaleeyanon. 2022b. The influence of different light spectra on physiological responses, antioxidant capacity and chemical compositions in two holy basil cultivars. *Sci Rep*, 12:1–17. doi: 10.1038/s41598-021-04577-x
- Dou, H., G. Niu, M. Gu, J.G. Masabni. (2018). Responses of sweet basil to different daily light integrals in photosynthesis, morphology, yield, and nutritional quality. *HortScience*, 53:496–503 . doi: 10.21273/HORTSCI12785-17
- Elmastaş, M., A. Demir, N. Genç, Ü. Dölek, M. Güneş. 2017. Changes in flavonoid and phenolic acid contents in some Rosa species during ripening. *Food Chem*, 235:154–159 . doi: 10.1016/j.foodchem.2017.05.004
- Genç, N., İ. Yıldız, T. Karan, Ö. Eminağaoğlu, R. Erenler. 2019. Antioxidant activity and total phenolic contents of *Galanthus woronowii* (Amaryllidaceae). *Turkish J Biodivers*, 2:1–5 . doi: 10.38059/biodiversity.515111
- Maurya S., N.S. Sangwan. 2020. Profiling of Essential Oil Constituents in Ocimum Species. *Proc Natl Acad Sci India Sect B - Biol Sci*, 90:577–583 . doi: 10.1007/s40011-019-01123-8
- Pękal, A., K. Pyrzynska. 2014. Evaluation of Aluminium Complexation Reaction for Flavonoid Content Assay. *Food Anal Methods*, 7:1776–1782 . doi: 10.1007/s12161-014-9814-x
- Sutulienė, R., K. Laužikė, T. Pukas, G. Samuolienė. 2022. Effect of Light Intensity on the Growth and Antioxidant Activity of Sweet Basil and Lettuce. *Plants* 11, 1709. doi: 10.3390/plants11131709
- Xu, Y., M. Yang, F. Cheng, S. Liu, Y. Liang. 2020. Effects of LED photoperiods and light qualities on in vitro growth and chlorophyll fluorescence of *Cunninghamia lanceolata*. *BMC Plant Biol*, 20:1–12 . doi: 10.1186/s12870-020-02480-7

EVALUATING THE IMPACT OF STRAW MULCH ON LOW-INPUT ULTIVATION OF TWO PARSLEY VARIETIES (*PETROSELINUM CRISPUM* (Mill.) Fuss)

Slavica DUDAŠ¹, Tamara KRESINA², Marin TOMIČIĆ¹, Martina PERŠIĆ¹, Melita
ZEC VOJINOVIĆ¹

¹ Polytechnic of Rijeka, Rijeka, Croatia, ² Student of the Polytechnic of Rijeka
Corresponding author e-mail: sdudas@veleri.hr

ABSTRACT

Leafy parsley (*Petroselinum crispum* (Mill.) Fuss) is an aromatic herb from the Apiaceae family, widely used in culinary, cosmetic, and pharmaceutical applications. It is distributed across all continents and is one of the oldest herbs used as a spice in food, with its leaves commonly utilized in fresh, frozen, or dried forms. Organic mulch is applied in the ecological cultivation of parsley to protect, maintain, and improve soil quality, as well as to reduce weed growth and erosion. The study was conducted on two parsley varieties, 'Domaći lišćar' as flat-leaf parsley and 'Moos curled', as curly parsley. The field experiment was carried out in the region of Pamići in Istria, on red soil with shallow to moderately deep depth and low to moderate rockiness. Organic mulch, in the form of straw, was applied in a 10 cm thick layer between the rows of parsley plants. The research investigated the effects of straw mulching on yield components and leaf quality, including vitamin C, chlorophyll, carotenoids, and the content of essential oil in the leaves of both parsley varieties. Initially, straw mulching slowed down the growth of parsley, but ultimately resulted in increased fresh herb yield. It was observed that straw mulching affected leaf quality, as the parsley leaves contained more water compared to those from the non-mulched control plots. There was a tendency of reduced vitamin C and pigment content, while the content of essential oil remained unchanged.

Keywords: leafy parsley, ecological cultivation, straw mulch, yield, quality

INTRODUCTION

Petroselinum crispum (Mill.) Fuss., better known as leafy parsley, is an aromatic plant from the Apiaceae family (Umbelliferae). The name of the genus *Petroselinum* was derived from the Greek word "petra" (πέτρα) for rock or stone and the Latin word "selinum" for plants growing on rocky and stony soil. The name of the species "crispum" comes from the Latin word "crispus," meaning curled (Mathe, 2020).

Parsley is primarily used in the kitchen as a condiment, for garnishing, or for flavoring food (Chenard et al., 2005). The advantage of this vegetable and spice is that it is used in various forms, such as fresh, frozen, or dried. It also finds applications in cosmetics for perfume, soap, and cream production, as well as in pharmaceuticals (Sidra et al., 2014).

Leafy parsley is recognized as a rich source of vitamin C, carotenoids, flavonoids, and essential oils (Buchter-Wisbrodt, 2005). The vitamin C content in parsley leaves ranges from 150 to 180 mg per 100g of fresh leaves, and the carotenoid content is on average up to 5 mg per 100g of fresh leaves (Kišgeci and Adamović, 1994). It is also a good source of mineral salts, primarily calcium, potassium, magnesium, and phosphorus (Pokluda, 2003), as well as iron, vitamins A, B, C, and bioactive compounds from the group of carotenoids, particularly lutein-zeaxanthin and beta-carotene (Chenard et al., 2005).

As an aromatic plant, parsley contains from 3% to 7% of essential oil in mature fruits, the root contains about 0,1%, while in dried leaves essential oil content vary between 0,8% and 1,0% (Kišgeci and Adamović, 1994). The fresh leaves contain from 0,041 to 0,121 ml essential oil per 100 g of fresh weight (Gruszecki and Walasek-Janusz, 2022). Essential oil of parsley is yellow to yellow-green in color, with a pleasant aromatic smell and taste. The dominant components of the essential oil are apiol and myristicin, which vary depending on the chemotype and variety. The aroma of parsley is determined by four components: 1,3,8-p-menthatriene (Chenard et al., 2005), apiol, β -phellandrene, and myristicin (Petropoulos et al., 2010). The characteristic taste of parsley comes from 1,3,8-p-menthatriene (Chenard et al., 2005).

Due to its favorable phytonutrient content, parsley leaves are used for medicinal purposes in the treatment of skin diseases, hypertension, hyperlipidemia, urinary tract infections, and as a diuretic (Chauhan and Aishwarya, 2018). Parsley leaves also contain furanocoumarins, averaging up to 0,2% (Mathe, 2020), which are phototoxic substances that, in combination with UV radiation, can cause a phototoxic reaction on the skin, resulting in phototoxic dermatitis (Agyare et al., 2017), an acute skin inflammation characterized by redness and blisters. The use of parsley as a natural deodorant is linked to its high chlorophyll content (Agyare, 2017).

Parsley's origin is in the Mediterranean region, where it has been cultivated since ancient times, and throughout history, parsley's popularity led to its spread to various parts of the world, to all continents. It is believed that the first wild parsley populations from Sardinia were transferred to England, where it was first cultivated in 1548 (Agyare et al., 2017). Leafy parsley is cultivated in most Mediterranean countries, Europe, America, and also in tropical regions, including East and West Africa. In tropical regions, such as Southeast Asia, leafy parsley is grown on a smaller scale (Agyare et al., 2017). In Turkey, parsley is widely distributed and grown in gardens and fields (Yanardağ et al., 2003), with an annual production of approximately 108.604 tons (Coskun et al., 2023 according to TUIK, 2021).

Within the European Union, the cultivation of leafy parsley is estimated at an average of 5.000 hectare. Significant areas of leafy parsley production are in Germany, France, the United Kingdom, Poland, the Netherlands, and Belgium. Apart from open fields, parsley is cultivated as well as fresh potted herbs. The production of potted parsley is intensive in the Netherlands, Germany, Belgium, France, Great Britain, and Poland (Mathe, 2020). According to the same author, basil (*Ocimum basilicum* L.) dominates the production of fresh potted herbs in Germany, making up 47% of the total, followed by parsley ranking second with a share of 19%.

The European Union's common variety list includes 215 varieties of leafy parsley. Notably, the list includes local races and land races, which are of special interest (European Commission, Plant Variety Database, 2023, available at <https://ec.europa.eu/food/plant-variety-portal/index.xhtml>, accessed on July 31, 2023). In the Republic of Croatia's variety list, there is a single registered variety of leafy parsley, "Domaći lišćar." This variety is preserved, and its seeds are recognized as "standard seeds." The preservation and maintenance of this variety are carried out by Podravka d.d. from Koprivnica (Republic of Croatia Variety List, 2023, available at <https://www.hapih.hr/wp-content/uploads/2023/08/Sortna-lista-Republike-Hrvatske-01082023.pdf>, accessed on July 31, 2023).

In cultivation, parsley is usually grown as a biennial species, but it is often cultivated as an annual crop. It is recommended to plant parsley as the second crop in a crop rotation, after crops fertilized with fresh manure. Fertilization and supplementation should be done using permitted organic fertilizers, fully mineralized organic fertilizers, or mineral fertilizers. Monoculture cultivation of parsley is not recommended, and a rotation period of 5 to 7 years on the same plot is advisable (Mathe, 2020).

Parsley is cultivated by direct sowing in rows. The germination process is slow at soil temperatures of 3-4°C and can take two to three weeks or even up to a month, depending on soil moisture availability. The first harvest of parsley leaves occurs when the plants develop 10-15 leaves, approximately 10 to 12 weeks after sowing. Harvesting is done by cutting the leaves at least 2 cm above the vegetative apex to promote regeneration. Throughout the year, multiple harvests can be done every 21 to 30 or more days, depending on the growing conditions.

During the prolonged germination period and after seed germination, weeds thrive vigorously, presenting a significant challenge in organic farming. The limited opportunity for inter-row cultivation before row formation and visibility intensifies the issue.

Organic mulching is used to slow down, hinder, and prevent weed growth. However, mulching also brings several additional benefits to cultivation, such as retaining soil moisture, protecting the soil surface from crust formation, and shielding it from overheating. As a result, mulching positively influences the plant's growth. The observed climate changes significantly modify production conditions and risks in agriculture. Mulching, as a soil protection measure and weed growth reducer, can contribute to mitigating the negative effects of climate change. This research was conducted to investigate the impact of straw mulching on morphometric characteristics and the quality of leafy parsley.

MATERIAL AND METHOD

The field experiment was conducted at an altitude of 340 m in Pamići, Istria, with geographical coordinates 45°09'36"N 13°52'41"E. Two standard varieties of leafy parsley were tested in the experiment: the mid-early variety "Domaći lišćar" (Bio Valentin) and the early variety "Moos curled" (Marcon). Parsley was cultivated with and without the use of mulch. (Figure 1). The "Domaći lišćar" variety has a declared vegetation period of 80 days, while the "Moos curled" variety ranges from 70 to 85 days.

Parsley was sown in the 16th week, on April 20, with an average monthly air temperature of 12°C. The average soil temperature at a depth of 10 cm was 8,8°C, and the total rainfall in April amounted to 37,4 mm. The annual precipitation sum was 1.309,8 mm (Croatian Meteorological and Hydrological Service,

https://meteo.hr/klima.php?section=klima_podaci¶m=k2_1 accessed on July 29, 2023).

The parsley was sown densely in rows with a row spacing of 25 cm. The cultivation of parsley was done on a red soil, shallow to moderately deep, low to moderately rocky, in cartographic unit 12/13 of the Istrian pedological map (Figure 2).

The soil was poor in physiologically active phosphorus, with 1,35 mg100 g⁻¹, well supplied with physiologically active potassium, with 15,6 mg100g⁻¹, and had a heavier mechanical composition with an average clay content of 30%. The soil pH value was 6,55. Before sowing, organic fertilization was carried out with 0,35 kgm⁻² of fully mineralized manure, which was incorporated to a depth of 15-20 cm. Parsley was grown passively, under stress conditions, without irrigation and additional fertilization, initially with the addition of mineralized organic fertilizer and after germination with the addition of organic mulch.

The field experiment had a randomized design with four replications, covering a total area of 80 m², with each individual plot measuring 5 m² (Figure 3). The germination period was 17 days. After germination, a 10 cm thick layer of straw mulch was applied. In this experiment, various parameters were monitored, including plant height, leaf number, fresh and dry parsley leaf yield. Additionally, qualitative parameters such as vitamin C content, pigments, and essential oil were analyzed in fresh leaf samples.



Figure 1. Leafy parsley, varieties “Domaći lišćar” and “Moos curled” with straw and in control variant

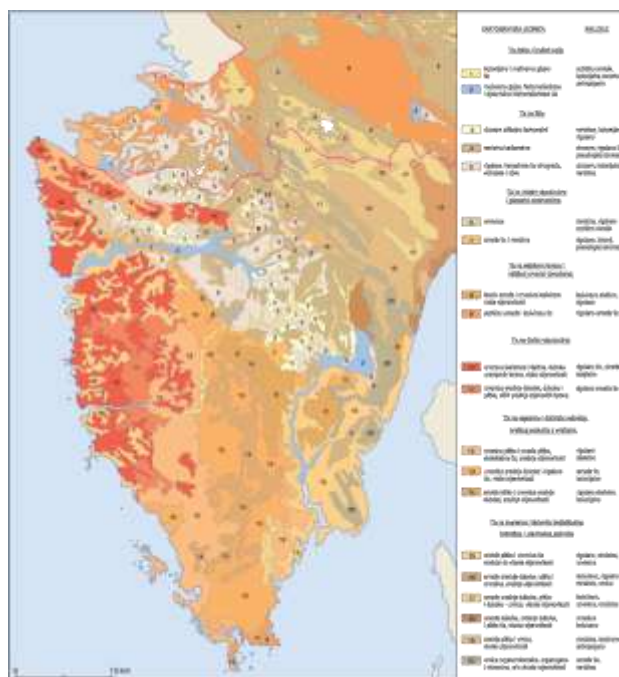

Figure 2. Pedological map of Istria (Bertoša i Matijašić ed., 2005)

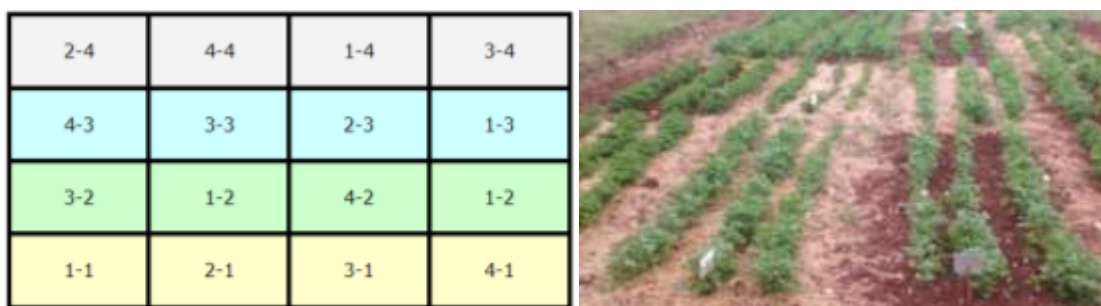

Figure 3. Field experiment with parsley

The vitamin C content ($\text{mg}100 \text{ g}^{-1} \text{ FW}$) was determined by titration with 2,6-dichlorindophenol according to the AOAC standard method (2002). Fresh parsley leaves (10 g

±0,01) were homogenized with 100 ml of 2% oxalic acid and filtered. Then, 10 ml of the filtrate was titrated with 2,6-dichlorindophenol until a pink color appeared in the solution.

Pigment content, chlorophyll a, chlorophyll b, and total carotenoids were determined in a 96% ethanol extract of 0,5 g of fresh parsley leaves. The plant material was homogenized with quartz sand and MgCO₃, and then 10 ml of ethyl alcohol was added. Filtration was carried out using a water pump. The filtrate was quantitatively transferred to a 25 ml measuring flask and topped up with ethyl alcohol. Pigment concentration was determined spectrophotometrically, according to the method described in Pompelli et al. (2012).

The essential oil was obtained by hydrodistillation using an adapted Neo Clavenger apparatus according to ISO standard 6571-2008, in dry material, with a duration of 3 hours.

Statistical analysis was performed using IBM SPSS Statistics, version 23, applying Two-way ANOVA and Post-hoc Tukey's test with $p \leq 0,05$ and $0,01$. In case of a significant interaction between the tested factors, One-way ANOVA and post-hoc Tukey's test were conducted with $p \leq 0,05$ and $0,01$.

RESULTS AND DISCUSSION

The aim of the research was to determine the impact of mulching on quantitative and qualitative parameters in the cultivation of two varieties of flat-leaf parsley. The harvests were conducted three times, at 84, 135, and 190 days after sowing. The observed quantitative and qualitative parameters were influenced by different factors with varying intensity: variety, mulching, harvest time, and their interactions. The results of the statistical analysis on the influence of each individual factor and their interactions are presented in Table 1.

Table 1. Effects of main factors and their interactions on morphometric parameters and quality in leafy parsley (Two way ANOVA, $p \leq 0,01$)

Parameter <i>Factor</i>	Plant height	Leaf number	Yield fresh leaves	Yield dried leaves	Vit C content	Essential oil content	Chl. A	Chl. B	Chl. AB	Carotenoids content
<i>A -variety</i>	+	-	+	+	+	+	-	-	-	-
<i>B- mulching</i>	+	+	+	-	+	-	-	-	-	-
<i>C- harvest</i>	+	+	+	+	+	+	+	+	+	+
<i>AxB</i>	-	-	-	-	-	-	-	-	-	-
<i>AxC</i>	+	-	+	+	+	+	-	-	-	-
<i>BxC</i>	-	+	+	-	+	-	-	-	-	-
<i>AxBxC</i>	-	-	-	-	+	+	-	-	-	-

Plant height, leaf number, fresh leaf yield, and vitamin C content were affected by the variety, mulching, harvest time, and interactions between these factors. Dry leaf yield and essential oil content depended on the characteristics of the variety and harvest time, as well as the interaction between these factors. Regarding pigment content, only influence of the harvest time on pigment concentration was statistically confirmed. A detailed overview of the impact of these factors is presented below in graphs 5 to 10 and in Table 2.

The height of leafy parsley just before harvest ranged from 13,5 to 23,5 cm, with variations depending on variety and treatment. According to Mathe (2020), parsley's plant height at the time of harvesting typically falls between 8,0 and 25,0 cm, and curly-leaf parsley

generally has a noticeably lower plant height compared to flat-leaf parsley. For commercial harvesting of flat-leaf parsley, the recommended plant height is usually in the range of 20 to 25 cm (Prez et al., 2021).

Mulching with straw had a significant impact on the plant height of the "Domaći lišćar" variety during the third measurement, as shown in Figure 5.

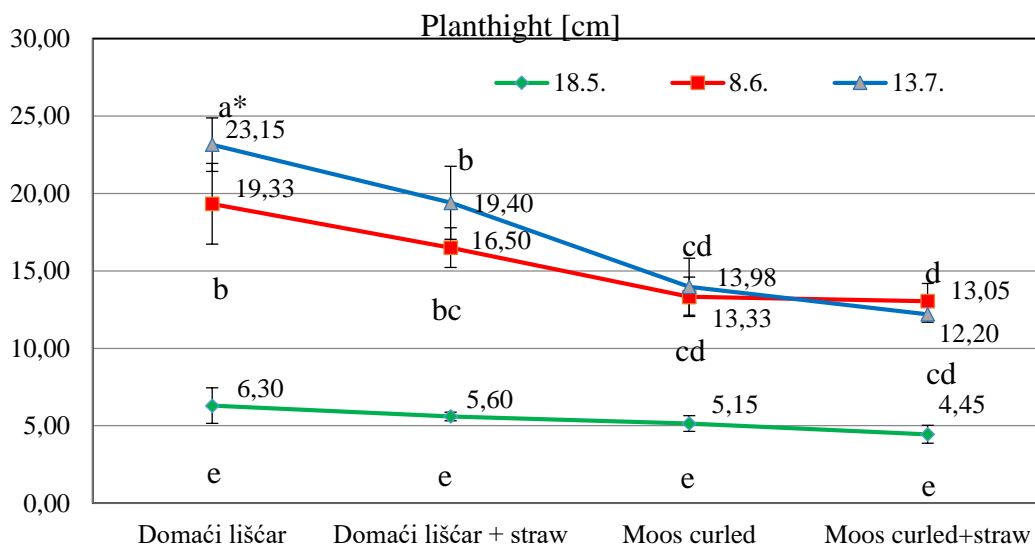

*different letters indicate significant differences

Figure 5. Hight of the parsley plants [cm] 28, 49 and 84 days after sowing

In the mulched variants of the "Domaći lišćar" variety, the plants were noticeably shorter compared to those grown without mulch. The differences in height just before harvest were statistically confirmed, as well as the differences between the varieties (in non-mulched variants). The dry straw layer in mulched variants between the parsley rows led to the absorption of moisture from the soil, resulting in reduced moisture availability for the plants during their initial development compared to the control plants. Additionally, organic material undergoes microbial degradation, and it is expected that a portion of the available nitrogen for the plants was also utilized by microorganisms. The results of the study by Crossman et al. (1997) support this finding; mulching with silver and white plastic film significantly contributed to reducing the height of parsley. However, in the same study, straw mulch did not have a significant impact on plant height compared to the control.

Before the parsley was collected for harvesting, careful attention was given to observing and counting the number of leaves within its rosette. The average number of leaves before the first harvest ranged from 13 to 15, in the second harvest from 15 to 20, and in the third harvest from 17 to 20 (Figure 6).

Based on the statistical analysis, there is no statistically significant difference in the number of leaves among different varieties of parsley. However, the number of leaves is significantly affected by the harvest. The number of leaves per plant increased from one harvest to another. A significant increase in the number of leaves was found in the "Domaći lišćar" variety in the mulched variant between the first and third harvests, and in the "Moos curled" variety in the mulched variant of the first harvest to second and third harvest terms (Figure 6).

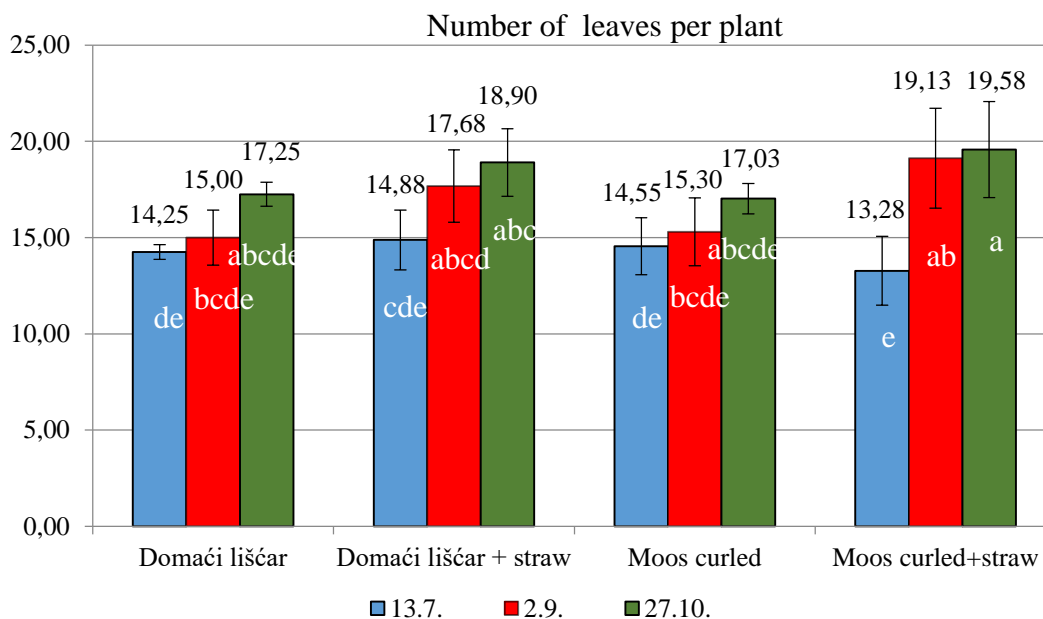

*different letters indicate significant differences

Figure 6. Number of leaves per plant 84, 135 and 190 days after sowing

The yield of fresh parsley leaves varied between harvests and treatments significantly, the highest yield of fresh parsley leaves (Figure 7) was determined in the "Domaći liščár" variety with straw mulch in the second harvest, and the yields of the first and third harvest did not differ significantly.

Hoda et al. (2022) confirmed significant differences in parsley leaf yield between the first, second, and third harvests in the same growing season, with the highest yield achieved in the second harvest. The total yields of fresh parsley leaves were 2.275 kg ha^{-1} in the first, 2.356 kg ha^{-1} in the second, and 1.835 kg ha^{-1} in the third harvest. The notable reduction in yields can be attributed to the chosen planting density and the quantity of plants within each designated area. In the context of this study, parsley was sown using a notably broader row spacing of 60 cm, accompanied by a 5 cm interval between individual plants within the row. Similar findings were reported in a study by Osińska et al. (2012), where the yield of parsley leaves per 1 m^2 varied between 0,55 and $3,57 \text{ kg}$. The highest yield was observed during the second out of three harvests for all the investigated varieties.

In the study conducted by Kołota and Adamczewska-Sowińska (2012) on parsley cultivation using black mulch film, fleece, and plastic tunnel cultivation, significantly higher yields were observed on fleece with $17,6 \text{ tha}^{-1}$ and black film with $15,9 \text{ tha}^{-1}$, compared to the control variant. However, the yield of parsley grown in the plastic tunnel with $15,0 \text{ tha}^{-1}$ did not show a significant difference from the control variant, which yielded $13,7 \text{ tha}^{-1}$.

Fresh harvested parsley leaves were dried at room temperature in a well-ventilated room. The average mass loss during drying ranged between 74,3% and 85,5%. The moisture content after drying varied between 9% and 11%. The total mass loss of fresh parsley leaves from the first harvest was on average 74,3%, 88,5% in the second harvest, and 85,5% in the third harvest.

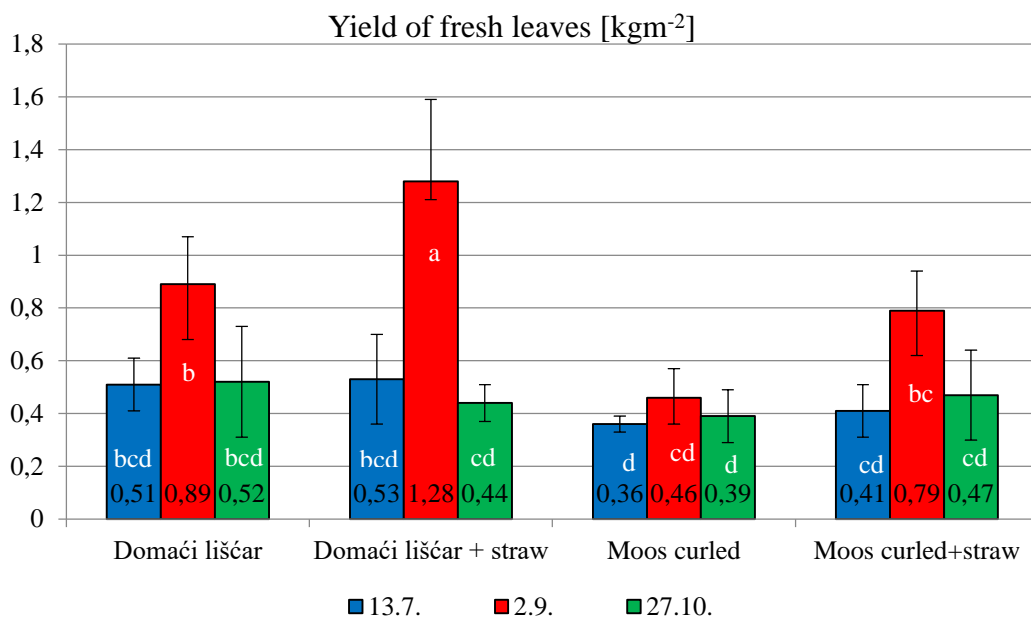

Figure 7. Yield of fresh leaves [kg m⁻²] 84, 135 and 190 days after sowing

The average mass loss over the three harvests for the "Domaći lišćar" variety without mulching was 78,9%, and with mulching was 84,9%. For the "Moos curled" variety, the mass loss during drying was 82,23% and 83,36%. Fresh parsley leaves from the mulched variants contained more water than leaves from the non-mulched variants, as evident from the yield of dried leaves (Figure 8).

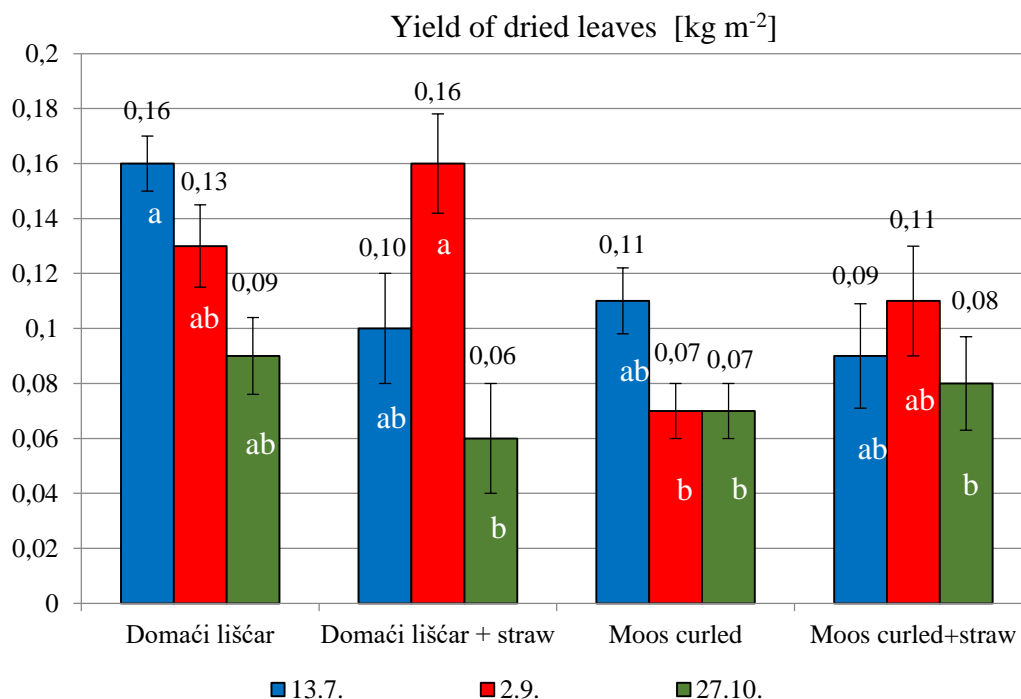

Figure 8. Yield of dried leaves [kg m⁻²] 84, 135 and 190 days after sowing

The study confirmed significant differences in the yield of dried parsley leaves of „Domaći lišćar“ in mulched variant between second and third harvest term.

In the study conducted by Carrillo-Lopez et al. (2010), it was determined that fresh parsley leaves, on average, contain 87,42% water. Mathe (2020) reported that hermetically packaged dried spices, including parsley leaves, typically retain residual moisture ranging between 4% and 6%. As a result, the ratio of fresh to dry parsley leaves varies between 10:1 and 7:1, depending on the final moisture content achieved during the drying process.

The findings from the research conducted by Crossman et al. (1997) suggest that although mulching with straw and white and silver films may result in higher yields of fresh parsley leaves, it does not necessarily lead to higher yields of dried parsley leaves. In other words, the increase in fresh leaf yield due to mulching does not directly lead to a proportional increase in the yield of dried parsley leaves.

The vitamin C content in fresh parsley leaves ranged between 147,54 and 253,23 mg100g⁻¹ (Figure 9). These results align with generally reported range of 150 to 180 mg vitamin C100g⁻¹ by Kišgeci and Adamović (1994). The results are consistent as well with the findings from Osińska et al. (2012), with 98,88 to 312,7 mg100g⁻¹ vitamin C in fresh leaves, where the vitamin C content varied depending on the specific parsley variety.

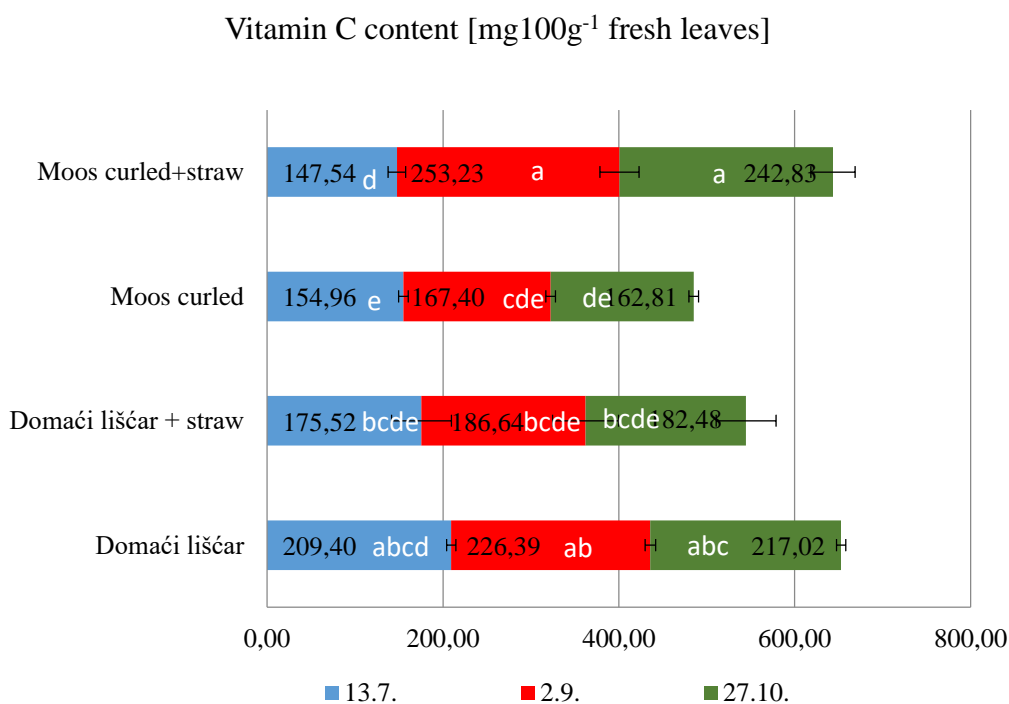

*different letters indicate significant differences

Figure 9. Vitamin C content [mg100g⁻¹ fresh leaves] 84, 135 and 190 days after sowing

Furthermore, the study revealed significant variations in vitamin C content among different parsley varieties and also differences between terms of harvest. Mulching with straw had no impact on vitamin C content in the "Domaći lišćar" variety, while in the "Moos curled" variety in mulched variant showed a significantly higher vitamin C content. In the second harvest parsley leaves contained the highest vitamin C level, while the leaves from the first harvest had the lowest content. These findings are consistent with Osińska et al.'s (2012) research, which compared three parsley varieties across three terms of the harvest.

The research conducted by Kołota and Adamczewska-Sowińska (2012) on six distinct parsley varieties, using synthetic mulches, highlighted notable differences between different

harvest periods. This indicates that the timing of the harvest can have a substantial influence on the quality of parsley. Moreover, the type of mulching material used also played a role, with fleece being the most beneficial mulching material. However, mulching with black plastic film did not affect the vitamin C content in fresh parsley leaves, indicating that its impact on parsley quality might be limited.

As shown in the research conducted by Prez et al. (2021), the vitamin C content in fresh parsley leaves significantly varies depending on the growing conditions. Parsley cultivated in open fields exhibited 2,6 times higher vitamin C content compared to parsley grown under controlled conditions, such as in a chamber. Furthermore, the difference was even more pronounced, with 5,4 times higher vitamin C content, for parsley grown in a greenhouse, for instance, potted parsley.

The analysis of essential oil content in parsley leaves revealed a significant variation, ranging from 0,63 to 1,25 ml100g⁻¹ of dry weight (Figure 10). These range in essential oil content generally aligns with the results of a study examining six different parsley varieties, which reported essential oil content ranging from 0,38 ml100g⁻¹ in the "Hamburger Schnitt" variety to the highest content of 1,18 ml100g⁻¹ of dry weight in the "Mooskrause" variety (Franz and Glasl, 1976).

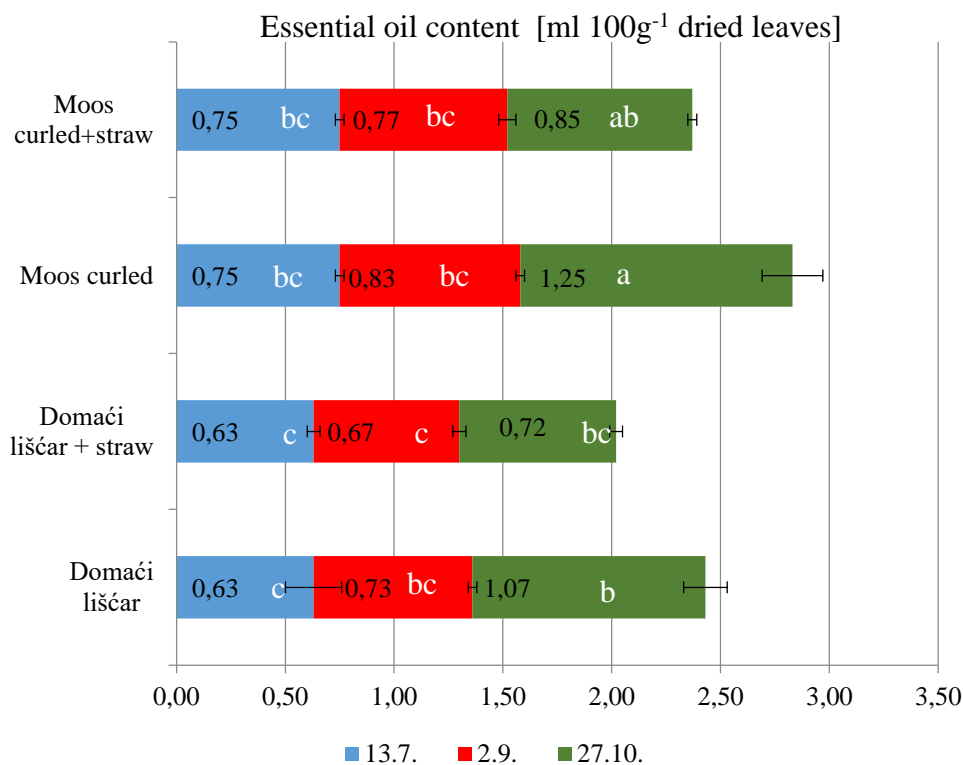

*different letters indicate significant differences

Figure 10. Essential oil content [ml 100g⁻¹ dried leaves] 84, 135 and 190 days after sowing

The literature on parsley and other herbs has consistently emphasized the significant influence of various factors on the content of essential oil, including the specific variety, growth period, and cultivation conditions (Proz et al., 2021; Dudaš et al., 2016; Petropoulos et al., 2009; Gruszecki et al., 2009; Petropoulos et al., 2004).

The current study's results are in line with the existing literature, as it also demonstrated significant variations in the essential oil content among different parsley varieties. Additionally, the influence of harvest timing on essential oil content was statistically confirmed for both

varieties in the non-mulched variant, particularly between the first and third harvests. These findings further underscore the importance of considering multiple factors when assessing and optimizing the essential oil content in parsley.

Earlier studies on various herbs, such as basil (*Ocimum basilicum* L.), have statistically confirmed effects of mulching on essential oil content. Specifically, the utilization of white plastic mulch resulted in significantly increased essential oil content across two distinct basil varieties. This increase was as well influenced by both the variety of basil and the timing of harvest, as demonstrated by research conducted by Dudaš et al. (2009). Similar findings were also observed by Gruszecki and Walasek-Janusz (2022) in their study on root parsley, where the essential oil content was analyzed in both the root and leaves. In the leaves, the yield of essential oil varied significantly among the tested varieties. However, the oil yield per growth season differed between the root and leaves. The content of essential oil in the root did not vary significantly depending on the growth season, while in the leaves, it exhibited greater variability and was higher during the second growth season, characterized by higher temperatures and dry periods.

The content of *chlorophyll a* in parsley leaves varied between 1,08 to 1,23 mg100g⁻¹ of fresh weight (Table 2). For *chlorophyll b*, the measured values ranged from 0,16 to 0,95 mg100g⁻¹ and finally, total *chlorophyll a+b* ranged from 1,21 to 2,18 mgg⁻¹ of fresh weight. The determined chlorophyll content are within the range reported by Papista et al. (2002) and Chenard et al. (2005), who stated chlorophyll a content as 75,89 to 159,19 mg100g⁻¹ and chlorophyll b as 16,37 to 36,14 mg100g⁻¹ in fresh parsley leaves.

Variations in chlorophyll content in parsley leaves, according to Chenard et al. (2005), are influenced by fertilization rates. Abd El-Hameed et al. (2018), in their research on the influence of harvest terms on four parsley varieties (Local, Peione, Gigante, Bravour) in Egypt, found that the average total chlorophyll content (mean of four varieties) decreased in the third harvest to 2,14 mgg⁻¹ compared to the content in the first (2,52 mgg⁻¹ of fresh weight) and second harvests (2,67 mgg⁻¹).

Total chlorophyll content in *Trigonella foenum graecum* L. leaves fell within a comparable range, with significant differences based on the harvest term. In the non-mulched variant, the content of total chlorophyll was 23,55 mg100g⁻¹ of fresh weight. However, in the mulched variant with straw, the content increased to 32,89 mg100g⁻¹ of fresh weight after 60 days of cultivation and further to 35,32 mg100g⁻¹ of fresh weight after 90 days (Nabil et al., 2019).

The content of total carotenoids in "Domaći lišćar" parsley leaves varied between 0,03 and 0,05 mgg⁻¹ (Table 2). The carotenoid content in parsley leaves of both "Domaći lišćar" and "Moos curled" varieties is comparable to the values reported in the literature, with 5 and 8 mg100g⁻¹ in fresh parsley leaves (Lešić et al., 2004; Kišgeci and Adamović, 1994).

As stated by Kamel (2013), the carotenoid content within fresh parsley leaves varies between 29,02 and 40,0 mgkg⁻¹. There is an observed trend of decreasing carotenoid content as a result of microwave drying, with the decline being influenced by the duration of the drying process.

Higher values of total carotenoid content were determined in the study by Dobričević et al. (2019) for different parsley varieties from a partially newer assortment. The determined carotenoid concentration averaged 0,8 mgg⁻¹ for the "Petra" variety and 0,16 mgg⁻¹ in the fresh leaves of the "Mooskrause" variety.

Table 2. Chlorophyll and total carotenoids content in leafy parsley [mgg⁻¹ fresh leaves]*

Harvest**	I		II		III	
Chlorophyll a content \pm Standard deviation (SD)						
Domaći lišćar	1,21ab	0,04	1,12abc	0,08	1,17abc	0,02
Domaći lišćar + straw	1,19abc	0,06	1,10abc	0,07	1,23a	0,01
Moos curled	1,23a	0,02	1,08bc	0,07	1,22ab	0,03
Moos curled+straw	1,23a	0,01	1,06c	0,06	1,22a	0,02
Chlorophyll b content \pm Standard deviation (SD)						
Domaći lišćar	0,66a	0,03	0,23b	0,01	0,17b	0,01
Domaći lišćar + straw	0,81a	0,02	0,22b	0,03	0,16b	0,05
Moos curled	0,95a	0,07	0,24b	0,02	0,17b	0,01
Moos curled+straw	0,84a	0,05	0,22b	0,03	0,16b	0,01
Total Chlorophyll content (a+b) \pm Standard deviation (SD)						
Domaći lišćar	1,87a	0,26	1,34b	0,07	1,34b	0,04
Domaći lišćar + straw	2,00a	0,29	1,31b	0,05	1,38b	0,03
Moos curled	2,18a	0,11	1,31b	0,06	1,37b	0,09
Moos curled+straw	2,06a	0,16	1,21b	0,07	1,38b	0,03
Total carotenoids \pm Standard deviation (SD)						
Domaći lišćar	0,038bc	0,004	0,054a	0,001	0,040ab	0,002
Domaći lišćar + straw	0,032bc	0,001	0,049a	0,002	0,042ab	0,001
Moos curled	0,036bc	0,002	0,049a	0,003	0,040abc	0,002
Moos curled+straw	0,036bc	0,003	0,048a	0,001	0,041abc	0,002

* significant differences in content of pigments only between harvesting period, ANOVA, Tukey's post-hoc test, $p \leq 0,01$

**first harvest 84 days (13.7.), second 135 days (2.9.) and third 190 days after sowing (27.10.)

Lower carotenoid content values in parsley leaves were found in the study by Proz et al. (2021), with $112,91 \mu\text{gg}^{-1}$ of fresh weight for parsley grown in open-field conditions and 22 to

30% higher values for parsley grown in controlled conditions with additional white LED lighting (460-560 nm), providing a greater supply of green and blue light.

In summary, the main finding of this study is that straw mulching does not have a significant effect on the carotenoid content in parsley leaves. Additionally, there were no significant differences in pigment content between the "Domaći lišćar" and "Moos curled" varieties. The study did reveal significant variations in pigment content depending on the different harvest terms for multiple parsley harvests. These results emphasize the importance of considering the harvest timing when assessing the pigment content in parsley leaves.

The study on garlic demonstrated that mulching with straw and plastic mulch film had no significant effect on the carotenoid content. The carotenoid quantities in garlic leaf samples from both the straw-mulched variant (3,98 mg100g⁻¹) and the plastic film variant (3,91 mg100g⁻¹) were not significantly different from the control (3,98 mg100g⁻¹) (Anwar et al., 2020). However, the study was unable to determine a significant impact of harvest terms within the same year due to the single garlic harvest, and differences in carotenoid content between two consecutive garlic growing seasons with mulch were not determined.

The study conducted by Osińska et al. (2012) revealed significant variations in the total carotenoid content of parsley leaves across different harvest periods, involving multiple harvests and various parsley varieties. The carotenoid content in the 'Amphia' variety was 3,57 mg100g⁻¹ in the first harvest, 1,64 mg100g⁻¹ in the second harvest, and 2,61 mg100g⁻¹ in the third harvest. For the 'Festival' variety, the respective values were 1,57 mg100g⁻¹, 1,66 mg100g⁻¹, and 1,61 mg100g⁻¹, while for the 'Verta' variety, they were 1,65 mg100g⁻¹, 1,43 mg100g⁻¹, and 1,54 mg100g⁻¹ of fresh parsley leaves in the third harvest. These findings underscore the impact of harvest timing on the carotenoid content in parsley leaves among different varieties.

CONCLUSIONS

Based on the research results, we conclude that mulching significantly affects plant height, number of leaves, fresh mass yield, and vitamin C content in parsley leaves. However, mulching did not have significant impact on the yield of dried leaves, the content of essential oil, and pigment content. The yield of dried leaves and the content of essential oil varied depending on the variety and harvest time, while the pigment content was statistically influenced only by the harvest time.

Further research on a larger number of varieties and other mulching materials, as well as expanding the analysis to include mineral content, nitrate accumulation, and specific components of essential oil, could provide additional and more precise information on the impact of these factors on quantitative and qualitative parameters in parsley cultivation.

REFERENCES

- Abd El-Hameed S.M., Serag El-Din W.M., Saleh M.A. 2018. Yield, Quality and Postharvest Studies on Some Parsley Cultivars. *Journal of Horticultural Science & Ornamental Plants* 10(3): 197-211.
- Agyare C., Appiach T., Boakye Y.D., Apenteng J.A. 2017. *Petroselinum crispum*. Medicinal Spices and Vegetables from Africa. Academic Press, 527-547.
- Anwar, R.S.E., Awad E.M., Mohamed R.A. 2020. Effect of Mulching Materials and Foliar Spray with Compost Tea on Growth, Yield and Bulb Quality of Garlic Plants under Sandy Soil Conditions. *Journal of Plant Production, Mansoura University*, 11(12): 1657 – 1662.
- AOAC 2002. Official methods of analysis. 17th edition. Washington: Association of Official Analytical Chemists.

- Bertoša, M., Matijašić, R., ur. 2005. Pedološka karta Istre, Istarska enciklopedija. Leksikografski zavod Miroslav Krleža, Zagreb.
- Buchter-Wisbrodt H. 2005. Vegetables- utilization and health: parsley. *Gemuse* 5, 10,
- Carrillo-Lopez A., Yahia E.M., Ramirez-Padilla G.K. 2010. Bioconversion of Carotenoids in Five Fruits and Vegetables to Vitamin A Measured by Retinol Accumulation in Rat Livers *American Journal of Agricultural and Biological Sciences* 5(2): 215-221
- Chauhan E.S., Aishwarya J. 2018. Nutraceuticals Potential of *Petroselinum crispum*: A Review. *Journal of Complementary Medicine and Alternative Healthcare*, 7(2): 555707.
- Chenard C.H., Kopsell D.A., Kopsell D.E. Nitrogen Concentration Affects Nutrient and Carotenoid Accumulation in Parsley. 2005. *Journal of Plant Nutrition*, 28(2): 285-297.
- Coşkun, O.F., Gündüz, Y.F., Toprak, S., Mavi, K. 2023. Molecular characterization of some parsley (*Petroselinum crispum* Mill.) genotypes. *Mustafa Kemal Üniversitesi Tarım Bilimleri Dergisi*, 28(1): 236-244.
- Croatian Meteorological and Hidrological Service
https://meteo.hr/klima.php?section=klima_podaci¶m=k2_1 accessed 29.7.2023.
- Crossman, S.M.A., Palada, M.C., Kowalski, J.A. 1997. Comparison of mulch type effects on yield of parsley in the Virgin Islands. *Proceedings of the Caribbean Food Crops Society*. 33: 216-220.
- Dobričević N., Šic Žlabur J., Voća S., Pliestić S., Galić, A., Delić A., Fabek Uher, S. 2019. Bioactive compounds content and nutritional potential of different parsley parts (*Petroselinum crispum* Mill.). *Journal of Central European Agriculture*, 20(3): 900-910.
- Dudaš, S., Jurica, B. 2009. Use and effect of mulch on yield and drug quality of basil *Ocimum basilicum* L. // *Proceedings & ABSTRACTs*, 2nd international scientific /professional conference, Agriculture in nature and environment protection, June 4-6 2009/ Vukovar, Croatia, 71-78.
- Dudaš, S., Poljuha, D., Šola, I., Šegula, S., Varga, S., Sladonja, B. 2016. Effects of biodynamic production on growth and essential oil content in basil *Acta botanica Croatica*, 75(2): 260-265.
- European Commission (2023) Plant variety catalogue for parsley (*Petroselinum crispum*). Plant variety database – European Commission, <https://ec.europa.eu/food/plant-variety-portal/index.xhtml>, accessed 31.7.2023.
- Franz, C., Glasl, H. 1976. Zur Kenntnis der Ätherischen öle von Petersilie II. Vergleichende Untersuchung des Frucht-, Blatt- und Wurzelöles Einiger Petersiliensorten. *Plant Foods for Human Nutrition* 25: 253–262.
- Gruszecki, R. 2009. The effect of growth stage on essentials oil composition of Hamburg parsley. *Acta Horticulturae*, 826: 391–395.
- Gruszecki R., Walasek-Janusz M. 2022. Essential Oil Diversity of Turnip-Rooted Parsley Cultivars. *Agronomy*, 12, 1949: 1-12.
- Hoda S., Hussein S.A., Tessema A. 2022. Essential oil content, yield, and components from the herb, leaf, and stem of curly-leafed parsley at three harvest days. *Journal of Centaral Europaeen Agriculture*, 23(1): 54-61.
- IBM Corp. Released 2015. IBM SPSS Statistics for Windows, Version 23.0. Armonk, NY: IBM Corp.
- ISO 6571:2008(en) Spices, condiments and herbs — Determination of volatile oil content (hydrodistillation method).
- Kamel, S.H. 2013. Effect of microwave treatments on some bioactive compounds of parsley (*Petroselinum crispum*) and dill (*Anethum graveolens*) leaves. *Journal of Food Processing Technology*, 4(6): 233-239
- Kišgeci, J., Adamović, D. 1994. Gajenje lekovitog bilja, Nolit, Beograd.
- Kołota E, Adamczewska-Sowińska K. 2012. The Effects of Genetic and Agronomic Factors

- on Quantity and Quality of Leafy Parsley Yield. Polish Journal of Environmental Studies, 21(4): 937-942.
- Lešić R., Borošić J., Buturac I., Herak Čustić M., Poljak M., Romić D. 2004. Povrčarstvo. Zrinski, Čakovec.
- Marthe F. 2020. *Petroselinum crispum* (Mill.) Nyman (Parsley). Medicinal, Aromatic and Stimulant Plants, 435-466.
- Nabil L.R., Alkoorenee J. T., Gatea Alshammary A.A., Rodrigo-Comino J.R. 2019. Effect of Wheat Straw as a Cover Crop on the Chlorophyll, Seed, and Oilseed Yield of *Trigonella foenum graecum* L under Water Deficiency and Weed Competition. Plants, 8: 503.
- Osińska E, Rosłon W., Drzewiecka M. 2012. The Evaluation Of Quality Of Selected Cultivars Of Parsley (*Petroselinum sativum* L. ssp. *crispum*). Acta Scientiarum Polonorum, Hortorum Cultus 11(4): 47-57
- Papista E., Acs E., Böddi B. 2002. Chlorophyll-a determination with ethanol - A critical test. Hydrobiologia, 485: 191-198.
- Petropoulos, S.A., Daferera, D.; Akoumianakis, C.A.; Passam, H.C.; Polissiou, M.G. 2004. The effect of sowing date and growth stage on the essential oil composition of three types of parsley (*Petroselinum crispum*). Journal of the Science of Food and Agriculture, 84: 1606–1610.
- Petropoulos, S.A., Daferera, D., Polissiou, M.G., Passam, H.C. 2009. Effect of salinity on the growth, yield and essential oils of turnip-rooted and leaf parsley cultivated within the Mediterranean region. Journal of the Science of Food and Agriculture, 89: 1534–1542.
- Petropoulos, S.A., Daferera, D., Polissiou, M.G., Passam, H.C. 2010. Effect of freezing, drying and the duration of storage on the composition of essential oils of plain-leafed parsley [*Petroselinum crispum* (Mill.) Nym. ssp. *neapolitanum* Danert] and turnip-rooted parsley [*Petroselinum crispum* (Mill.) Nym. ssp. *tuberosum* (Bernh.) Crov.]. Flavour Fragrance Journal, 25: 28–34.
- Pokluda R. 2003. Comparison of selected characteristics of root parsley [*Petroselinum crispum* conv. *radicosum* (Alef.) Danert] cultivars. Horticultural Science (Prague), 30(2): 67–72.
- Pompelli M.F., Suéle C.F., Carvalho Tigre R., Teixeira de Oliveira M., Sacilot M., Pereira E.C. Spectrophotometric determinations of chloroplastidic pigments in acetone, ethanol and dimethylsulphoxide. Brazilian journal of biosciences. 11(1): 52-58.
- Proz MLÁ, da Silva MAS, Rodrigues E, Bender RJ, Rios AO. 2021. Effects of indoor, greenhouse, and field cultivation on bioactive compounds from parsley and basil. Journal of Science in Food and Agriculture, 101(15): 6320-6330
- Sidra M., Shahzad H. Farnaz M. 2014. Critique of medicinal conspicuousness of Parsley (*Petroselinum crispum*): a culinary herb of Mediterranean region. Pakistan Journal of pharmaceutical sciences, 27(1): 193-202.
- Sortna lista RH, 2023, <https://www.hapih.hr/wp-content/uploads/2023/06/SORTNA-LISTA-REPUBLIKE-HRVATSKE-23.06.2023.pdf>, pristupljeno 31.7.2023.
- Yanardağ, R., Bolkent, S., Tabakoglu-Oguz, A., Ozsoy-Sacan, O., 2003. Effects of *Petroselinum crispum* extract on pancreatic B cells and blood glucose of streptozotocin-induced diabetic rats. Biological and Pharmaceutical Bulletin 26(8): 1206–1210.
- TUIK, 2021. www.tuik.gov.tr in Coşkun, O.F., Gündüz, Y.F., Toprak, S., Mavi, K. 2023. Molecular characterization of some parsley (*Petroselinum crispum* Mill.) genotypes. Mustafa Kemal Üniversitesi Tarım Bilimleri Dergisi, 28(1): 236-244.

PHENOTYPIC AND GENOTYPIC RESISTANCE OF MERCURY AMONG *Escherichia coli* ISOLATES FROM VEGETABLES

Seza Arslan¹, Fatma Özdemir¹, Şerife Topçuoğlu¹

¹ Bolu Abant İzzet Baysal University, Faculty of Arts and Sciences, Department of Biology,
14030 Gölköy / Bolu, Turkey

Corresponding author e-mail: serifetop7@gmail.com

ABSTRACT

Vegetables are an important part of a healthy and balanced diet and are commonly consumed raw or undercooked by humans. Vegetables have been implicated in many foodborne outbreaks of *Escherichia coli* infections. The presence of *E. coli* in vegetables can indicate that fecal contamination has occurred. Heavy metals from polluted soils and environmental wastes enter via the roots of plants and accumulate in variable concentrations in the roots, leaves, and fruits of vegetables. The existence of heavy metal-resistant pathogens in vegetables contaminated with highly toxic heavy metals such as mercury poses a serious risk to human and environmental health. This study aimed to determine the resistance to mercury (Hg) phenotypically by the broth microdilution method and genotypically by PCR for the presence of the mercury reductase encoded by the *merA* gene. Out of the *E. coli* isolates from vegetables, five isolates (45.5%) were resistant to Hg. Furthermore, only one of these Hg-resistant isolates carried the *merA* gene, which is associated with mercury resistance. Consequently, it may be critical to evaluate the presence of mercury-resistant pathogens found in vegetables because they pose a human health risk.

Keywords: *Escherichia coli*, mercury resistance, *merA* gene, vegetables, broth microdilution method, PCR

INTRODUCTION

Fresh fruits and vegetables are an excellent source of nutrients, minerals, and vitamins for humans, as well as an important basic raw material for the food industry (Carlin, 2007). Vegetables as an essential component of a healthy and balanced diet are commonly consumed raw or undercooked by people. They are extensively exposed to microbial contamination through contact with contaminated water used to irrigate, animal or human feces used as fertilizer, contaminated seeds, untreated manure, food handlers, production facilities, insect vectors, and slicing tool (Bhunia, 2008; Carlin, 2007). As a result, these conditions may lead to spoilage and a loss of quality. Microbial contamination of vegetables is a significant human health concern. In addition to bacteria, molds and yeasts that cause spoilage in vegetables, pathogenic microorganisms also cause various foodborne disease outbreaks associated with the consumption of raw fruits and vegetables (Carlin, 2007; Luna-Guevara et al., 2019; Pintor-Cora et al., 2021).

Escherichia coli, an *Enterobacteriaceae* family member, is prevalent in humans and animal intestinal microflora. They are usually released into the environment, where they may contaminate water and soil, and hence fruits and vegetables, particularly if untreated manures are used as fertilizers (Bhunia, 2008). Vegetables as a common source of *E. coli* contamination have been documented in many studies (Holvoet et al., 2013; Freitag et al., 2018; Luna-Guevara et al., 2019). Pathogenic *E. coli* strains can cause a variety of illnesses including septicemia, neonatal meningitis, pneumonia, gastroenteritis, hemolytic uremic syndrome, dysentery, and urinary tract infection (Bhunia, 2008). In recent years, it has been a major concern that an

increasing number of *E. coli* outbreaks have been associated with the consumption of contaminated vegetables, including sprouts, spinach, lettuce, coleslaw, and salad, in developing countries (WHO, 2018).

Heavy metals are widespread in the environment. Heavy metals from polluted soils and environmental wastes enter plants through the roots and accumulate in variable concentrations in the roots, leaves, and fruits of vegetables (Bhunia, 2008). Therefore, in their natural environments, bacteria are continuously exposed to various metals, which leads to the survival of metal-tolerant cells due to mutations. Extrinsic resistance determinants in pathogens have been to the development of heavy metal resistance (Vats et al., 2022). Heavy metal resistance in various pathogenic bacteria has been shown in previous studies (Wickramanayake et al., 2020; Cufaoglu et al., 2022; Ejaz et al., 2022; Dahanayake et al., 2019). In addition to antimicrobial agents, heavy metals are frequently used in animal husbandry, aquaculture, and human and animal health, which can promote the dissemination of antimicrobial resistance through co-selection (Seiler and Berendonk, 2012). Some researchers found that heavy metals enhance resistance to antimicrobials in bacterial isolates (Yazdankhah et al., 2014; Ejaz et al., 2022; Vats et al., 2022; Anedda et al., 2023). Due to its toxicity, persistence in the environment, and bioaccumulative nature, heavy metal contamination is a major hazard to human health and ecological environment safety (Seiler and Berendonk, 2012).

The presence of heavy metal-resistant pathogens in vegetables contaminated with highly toxic heavy metals such as mercury, which is an extremely hazardous heavy metal, poses a significant risk to both human health and the global environment. Therefore, this study aimed to determine the resistance to mercury (Hg) phenotypically by the broth microdilution method and genotypically by PCR for the presence of the mercury reductase encoded by the *merA* gene.

MATERIALS AND METHODS

Bacterial isolates

In the present study, a total of 11 *E. coli* isolates obtained from various vegetable samples, including 3 spinach, 3 lettuce, 2 arugula, 2 black cabbage, and 1 lamb's lettuce, were examined. Fresh vegetables, not pre-cooked or frozen, were collected from various supermarkets and public bazaars. The *E. coli* isolates were previously identified using traditional biochemical tests and a PCR for the *uspA* gene (*E. coli*-specific universal stress protein A) (Chen and Griffiths, 1998; Scheutz and Strockbine, 2005). All *E. coli* isolates were cultured overnight at 37 °C in Brain Heart Infusion broth (BHI) (Merck, Germany). Isolation of genomic DNA from the *E. coli* isolates was performed using the cetyl trimethyl ammonium bromide (CTAB) method for PCR detection of the heavy metal mercury resistance gene, according to Ausubel et al. (1991). The DNA was stored at -20°C after being dissolved in Tris-EDTA (TE) buffer.

Detection of MIC of heavy metal mercury

The heavy metal mercury (HgCl₂) used in this study was obtained from Sigma-Aldrich (Sinopharm Chemical Reagent Co., Shanghai, China). The broth microdilution method was used to quantitatively determine the minimum inhibitory concentrations (MICs) of heavy metal mercury (CLSI, 2012; He et al., 2016; Dahanayake et al., 2019). Mercury (Hg) concentration ranged from 400 to 0.78 µg/mL. For MIC determinations, a 96-well U-bottom sterile polystyrene microplate (LP Italiana) was used. MICs were defined as the lowest heavy metal concentration that completely inhibited organism development after 18-20 hours of incubation at 37 °C. The tests were carried out in triplicates. *Escherichia coli* K-12 strain was used as a quality control in the heavy metal resistance test (Dahanayake et al., 2019).

Detection of heavy metal mercury resistance gene by PCR

Detection of mercury resistance gene

Resistance to Hg was also evaluated genotypically using PCR for the presence of the mercury reductase encoded by the *merA* gene. The *merA* primers were merA-F: 5'-GAGATCTAAAGCACGCTAAGGC-3' and merA-R: 5'-GGAATCTTGACTGTGATCGGG-3', which were predicted to yield a 1011 bp product (Misra et al., 1984). All PCR experiments were performed in a DNA thermal cycler (Bio-Rad T100). The PCR reaction mix (50 μ L) contained 5 μ L of 10X PCR buffer (100 mM Tris-HCl pH 8.8, 500 mM KCl, 0.8% [v/v] Nonidet P40) (Thermo Fisher Scientific), 2 mM MgCl₂ (Thermo Fisher Scientific), 200 μ M dNTP mix (Thermo Fisher Scientific), 0.4 μ M primer (Oligomer Biotechnology), 1.5 U Taq DNA polymerase (Thermo Fisher Scientific), 4 μ L (50 ng) isolated DNA and 31.7 μ L molecular grade water (AppliChem). The PCR cycling conditions were carried out with the following setup: 94°C for 3 min and 30 cycles of denaturation (30 sec, 94°C), annealing (30 sec, 57°C), extension (1 min, 72 °C), and final extension (5 min, 72°C). The amplified *merA* products were analyzed by electrophoresis (BioRad) on a 1% agarose gel containing ethidium bromide in 1X Tris borate EDTA (TBE) buffer with a 100 bp Plus DNA ladder (Vivantis, Malaysia). The gels were visualized using UV transillumination (DNR Minilumi Bioimaging Systems, Israel).

RESULTS AND DISCUSSION

This study investigated the resistance of *E. coli* isolates obtained from various vegetables to heavy metal mercury phenotypically and genotypically. Table 1 shows the phenotypic and genotypic results for mercury (Hg) resistance using the broth microdilution method and PCR for the presence of the mercury reductase encoded by the *merA* gene. Five *E. coli* isolates (45.5%) exhibited resistance to Hg at a MIC value of 12.5 μ g/mL. Furthermore, only one of these Hg-resistant isolates carried the *merA* gene, which is associated with mercury resistance.

Table 1. Phenotypic and genotypic resistance to mercury (Hg) heavy metal among the *E. coli* isolates from vegetables

No	Isolate	Origin	Phenotypic resistance to mercury heavy metal MIC (μ g/mL)	Genotypic resistance to the mercury resistance gene <i>merA</i>
1	V13	Spinach	12.5	-
2	V14	Spinach	12.5	-
3	V15	Spinach	6.25	-
4	V17	Lettuce	12.5	+
5	V22	Lettuce	6.25	-
6	V23	Lettuce	6.25	-
7	V30	Arugula	6.25	-
8	V35	Arugula	12.5	-
9	V38	Black cabbage	12.5	-
10	V39	Black cabbage	1.56	-
11	V40	Lamb's lettuce	6.25	-
	<i>E. coli</i> K-12 strain		6.25	-

According to phenotypic heavy metal mercury (Hg) results, the MICs were found to range between 1.56-12.5 $\mu\text{g/mL}$ (Table 1). Yang et al. (2020) reported that the MICs of Hg for *E. coli* and *Salmonella* strains from chicken farms and retail meat ranged from 12.5 to 25 mg/mL . In contrast to our results, the higher MIC values of Hg for *E. coli* isolates from chicken, cattle, and sheep carcasses, slaughterhouse wastewater ranged from 3.12 to 50 $\mu\text{g/mL}$, as previously documented by Cufaoglu et al. (2022). The MIC concentration for Hg in *E. coli* isolates from Mediterranean mussels and sea snails in the Southeastern Black Sea varied from 100 to 400 $\mu\text{g/mL}$ (Terzi and Civelek, 2021). Contrary to these results, Sipahi et al. (2019) found that all *E. coli* isolates from cattle stool samples were phenotypically sensitive to Hg.

Several studies have demonstrated that various bacterial species other than *E. coli* develop resistance to Hg and other heavy metals (Seiler and Berendonk, 2012; Yazdankhah et al., 2014). A study published in China by He et al. (2016) found Hg MIC values for *Vibrio parahaemolyticus* isolated from fresh shrimp in Shanghai fish markets ranged from 50 to 6.25 $\mu\text{g/mL}$. In Korea, the mercury-resistant phenotype was not found in any of the *Aeromonas* spp. isolates from Pacific abalone obtained from retail and wholesale markets (Wickramanayake et al., 2020). In a reported study on Gram-positive bacteria, all *Bacillus* isolates exhibited high resistance to Hg, with MICs ranging from 125 to 180 $\mu\text{g/mL}$ (Singh et al., 2013).

The presence of the *merA* resistance gene was identified in the *E. coli* isolates examined, and the products of PCR were visualized using agarose gel electrophoresis, as demonstrated in Figure 1.



Figure 1. Agarose gel electrophoresis of the PCR product of the *merA* (1011 bp) gene in *E. coli* isolates from vegetables. Lane M: 100 bp DNA ladder (Vivantis, Malaysia). Lane 4: The *merA* positive *E. coli* isolate recovered from lettuce in this study. Lanes 1, 2, 3, 5, 6, 7, 8, 9, 10, and 11: Negative results for the *merA* gene in the *E. coli* isolates.

Based on the results of genotypic mercury (Hg) resistance encoded by the *merA* gene, a low frequency of the *merA* gene was observed in *E. coli* isolates (2.5%) and *Salmonella* isolates (11.4%) from chicken broiler farms and retail meat (Yang et al., 2020), similar to our results (9.1%). Similarly, resistance to Hg, indicated by *merA*, was less prevalent (11%) in European honey bees (*Apis mellifera*) (Fry et al., 2023). On the other hand, Cufaoglu et al. (2022) revealed that the *merA* gene was present at a greater frequency in the chicken, cattle, and sheep origin *E. coli* isolates (50%). Resistance to the heavy metal mercury is common in *E. coli* strains of veterinary significance. The mercury resistance gene, *merA*, was found in 79% of the clinical avian *E. coli* isolates (Bass et al., 1999). In a study reported by Çelik et al. (2023), the presence of the *merA* gene was detected in 11 *E. coli* isolates, of which 5 (27.8%) were mussels and 6 (37.5%) were shrimp. Dahanayake et al. (2019) also observed the *merA* gene in 17 (47%) *Aeromonas* spp. strains from the Manila Clam (*Ruditapes philippinarum*) in Korea. Similarly, Wickramanayake et al. (2020) found that the *merA* gene was positive at a rate of 41% in *Aeromonas* spp. isolates from Pacific abalone.

CONCLUSIONS

This study demonstrated the phenotypic and genotypic resistance profiles of *E. coli* from vegetables against the heavy metal mercury. Consequently, it may be critical to evaluate the presence of mercury-resistant pathogens found in vegetables because they pose a human health risk.

REFERENCES

- Anedda, E., Farrell, M. L., Morris, D., Burgess, C.M. 2023. Evaluating the impact of heavy metals on antimicrobial resistance in the primary food production environment: A scoping review. *Environmental Pollution*. 320: 121035.
- Ausubel, F.M., Kingston, R.E., Brent, R., Moore, D.D., Seidman, J., Smith, J.A., Struhl, K. 1991. *Current protocols in molecular biology*. Greene Publishing Associates & Wiley Interscience. New York.
- Bass, L., Cynthia, A., Liebert, C. A., Lee, M.D., Summers, A.O., White, D.G., Thayer, S.G., Maurer, J.J. 1999. Incidence and Characterization of Integrons, Genetic Elements Mediating Multiple-Drug Resistance, in Avian *Escherichia coli*. *Antimicrobial Agents and Chemotherapy*. 43(12): 2925-2929.
- Bhunia, A.K. (2008). *Foodborne Microbial Pathogens: Mechanisms and Pathogenesis*. New York: Springer.
- Carlin, F. 2007. Fruits and Vegetables. In: *Food Microbiology: Fundamentals and Frontiers*. Editors: Doyle, M.P., Beuchat, L.R. 3rd ed. ASM Press: Washington, DC, USA, 157-170.
- Çelik, B., Sipahi, N., Kekeç, A.I., Halac, B. 2023. Investigation of Some Heavy Metal Resistance Genes in *E.coli* Isolated from Shrimp and Mussels. *Journal of the Hellenic Veterinary Medical Society*. 74 (2): 5637-5644.
- Chen, J., Griffiths, M.W. 1998. PCR differentiation of *Escherichia coli* from other Gram negative bacteria using primers derived from the nucleotide sequences flanking the gene encoding the universal stress protein. *Letters in Applied Microbiology*. 27: 369-371.
- Clinical and Laboratory Standards Institute (CLSI). 2012. "Methods for dilution antimicrobial susceptibility tests for bacteria that grow aerobically-Ninth Edition, Approved standard," M7-A9. Wayne, PA, USA.,
- Cufaoglu, G., Cengiz, G., Acar, B.O., Yesilkaya, B., Ayaz, N.D., Levent, G., Goncuoglu, M. 2022. Antibiotic, heavy metal, and disinfectant resistance in chicken, cattle, and sheep

- origin *E. coli* and whole-genome sequencing analysis of a multidrug-resistant *E. coli* O100:H25 strain. *Journal of Food Safety*. 42: e12995.
- Dahanayake, P.S., Hossain, S., Wickramanayake, M.V.K.S., Heo, G-J. 2019. Antibiotic and heavy metal resistance genes in *Aeromonas* spp. isolated from marketed Manila Clam (*Ruditapes philippinarum*) in Korea. *Journal of Applied Microbiology* 127: 941-952.
- Ejaz, H., Junaid, K., Yasmeen, H., Naseer, A., Alam, H., Younas, S., Qamar, M.U., Abdalla, A.E., Abosalif, K.O.A., Ahmad, N., Bukhari, S.N.A. 2022. Multiple Antimicrobial Resistance and Heavy metal tolerance of biofilm-producing bacteria isolated from dairy and non-dairy food products. *Foods*. 11: 2728.
- Freitag, C., Michael, G.B., Lid, J., Kadlec, K., Wang, Y., Hassel, M., Schwarz, S., 2018. Occurrence and characterisation of ESBL-encoding plasmids among *Escherichia coli* isolates from fresh vegetables. *Veterinary Microbiology*. 219: 63-69.
- Fry, K.L., McPherson, V.J., Gillings, M.R., Taylor, M.P. 2023. Tracing the Sources and Prevalence of Class 1 Integrons, Antimicrobial Resistance, and Trace Elements Using European. *Environmental Science Technology*. 57: 10582-10590.
- He, Y., Jin, L., Sun, F., Hu, Q., Chen, L. 2016. Antibiotic and heavy-metal resistance of *Vibrio parahaemolyticus* isolated from fresh shrimps in Shanghai fish markets, China. *Environmental Science and Pollution Research*. 23: 15033-15040.
- Holvoet, K., Sampers, I., Callens, B., Dewulf, J., Uyttendaele, M. 2013. Moderate Prevalence of Antimicrobial Resistance in *Escherichia coli* Isolates from Lettuce, Irrigation Water, and Soil. *Applied and Environmental Microbiology*. 79(21): 6677-6683.
- Luna-Guevara, J.J., Arenas-Hernandez, M.M.P., Martinez de la Pena, C., Silva, J.L., Luna-Guevara, M.L. 2019. The Role of Pathogenic *E. coli* in Fresh Vegetables: Behavior, Contamination Factors, and Preventive Measures. *International Journal of Microbiology*. 2894328.
- Misra, T. K., Brown, N. L., Fritzing, D. C., Pridmore, R. D., Barnes, W. M., Haberstroh, L., Silver, S. 1984. Mercuric ion-resistance operons of plasmid R100 and transposon Tn501: The beginning of the operon including the regulatory region and the first two structural genes. *Proceedings of the National Academy of Sciences*, 81(19): 5975-5979.
- Pintor-Cora, A., Alvaro-Llorente, L., Otero, A., Rodriguez-Calleja, J.M., Santos, J.A. 2021. Extended-Spectrum Beta-Lactamase-Producing *Enterobacteriaceae* in Fresh Produce. *Foods*. 10: 2609.
- Scheutz, F., Strockbine, N. A. 2005. Genus I *Escherichia*. In: Garrity, GM, Brenner DJ, Krieg NR, Staley JT. (Eds.), *Bergey's manual of systematic bacteriology 2 (Part B)*. Springer, New York, pp. 607- 623.
- Seiler, C., Berendonk, T. U. 2012. Heavy metal driven co-selection of antibiotic resistance in soil and water bodies impacted by agriculture and aquaculture. *Frontiers in Microbiology*. 3: 399.
- Singh, Y., Ramteke, P.W., Tripathy, A., Shukla, P.K. 2013. Isolation and Characterization of *Bacillus* resistant to multiple heavy metals. *International Journal of Current Microbiology and Applied Sciences*. 2(11): 525-530.
- Sipahi, N., Karakaya, E., İköz, S. 2019. Phenotypic and genotypic investigation of the heavy metal resistance in *Escherichia coli* isolates recovered from cattle stool samples. *Turkish Journal of Veterinary and Animal Sciences*. 43: 684-691.
- Terzi, E., Civelek, F. 2021. Cu, Cd, As and Hg resistance levels in *Escherichia coli* isolated from Mediterranean mussel and sea snail in the Southeastern Black Sea. *Marine Science and Technology Bulletin*. 10 (1): 36-41.
- Vats, P., Kaur, U.J., Rishi, P. 2022. Heavy metal-induced selection and proliferation of antibiotic resistance: A review. *Journal of Applied Microbiology*. 132:4058-4076.

- Wickramanayake, M.V.K.S., Dahanayake, P.S., Hossain, S., De Zoysa, M., Heo, G-J. 2020. *Aeromonas* spp. Isolated from Pacific Abalone (*Haliotis discus hannai*) Marketed in Korea: Antimicrobial and Heavy-Metal Resistance Properties. *Current Microbiology*. 77: 1707-1715.
- World Health Organization (WHO) 2018. *E. coli*. <https://www.who.int/news-room/fact-sheets/detail/e-coli#>
- Yang, S., Denga, W., Liub, S., Yua, X., Mustafaa, G.R., Chen, S., He, L., Aob, X., Yang, Y., Zhou, K., Li, B., Hand, X., Xue, X., Zou, L. 2020. Presence of heavy metal resistance genes in *Escherichia coli* and *Salmonella* isolates and analysis of resistance gene structure in *E. coli* E308. *Journal of Global Antimicrobial Resistance*. 21: 420-426.
- Yazdankhah, S., Rudi, K., Bernhoft, A. 2014. Zinc and copper in animal feed-development of resistance and co-resistance to antimicrobial agents in bacteria of animal origin. *Microbial Ecology in Health & Disease*. 25: 25862.

EFFECT OF USING PROBIOTICS SUPPLEMENTED WHEAT INSTEAD OF CORN IN THE DIET ON PERFORMANCE AND SLAUGHTERING CHARACTERISTICS OF BROILERS

Esra Tuğçe Gül,¹ Osman Olgun¹, Yusuf Cufadar¹, Seyit Ahmet Gökmen¹, Behlül Sevim²

¹*Department of Animal Science, Agriculture Faculty, Selcuk University, 42130, Konya, Türkiye.*

²*Department of Food Processing, Aksaray Technical Sciences Vocational School, Aksaray University, 68100, Aksaray, Türkiye.*

Corresponding author e-mail: esra.gul@selcuk.edu.tr

ABSTRACT

The aim of this study was to determine the effects of diets using 1 g/kg probiotics supplemented 50 and 100% wheat instead of corn on the performance, carcass characteristics and visceral weight of broilers. In the study, a total of 120 male Ross 308 broiler chicks at the day-old were randomly allocated to 3 treatment groups with 4 replicates of 10 chicks each. Treatment groups were formed from diets using corn as a grain source (Wheat0), wheat with 1 g/kg probiotics added at the rate of 50% of maize (Wheat50), and wheat with 1 g/kg probiotics added at 100% of maize (Wheat100). Performance parameters were determined on the 10th, 25th and 42nd days, and carcass and visceral weights were determined at the end of the study (42nd day). Effect of using probiotics supplemented wheat in the diet on body weight, body weight gain, and feed intake of broilers was statistically insignificant ($P>0.05$). Compared the control group (Wheat0), 11-25th days for Wheat50 and Wheat100 groups, as cumulative for Wheat100 feed efficiency improved ($P<0.05$). Relative carcass decreased in Wheat50 group and relative abdominal fat decreased in Wheat100 ($P<0.05$). According to the results of this study, it was determined that the addition of probiotics and the use of wheat instead of whole corn (100%) in male broiler diets improved feed efficiency and reduced fattening.

Keywords: wheat, probiotics, broiler, performance, carcass

INTRODUCTION

Breeding studies in poultry and the high level of applicability of hybrid production have maximized the productivity of these animals for today. However, to obtain maximum production from animals, improvement of genetic structure and environmental demands is not sufficient alone, and they should be fed with diets based on products such as corn and soybean meal that are highly digestible and do not contain anti-nutritional factors. This situation creates concerns in terms of sustainability for our country and some other countries where corn and soybean cultivation is not sufficient. In these countries, corn and soybean are supplied by importation and increase foreign dependency with high foreign exchange loss. The use of cereals, such as wheat, which is more suitable for the ecological structure of our country and has more production, instead of corn in the nutrition of broilers, maintains its currency. However, the anti-nutritional factors and biased directions in these products have limited the use of these products.

Wheat is the grain with the most energy after corn due to low cellulose and high starch content. However, the non-starch polysaccharides (arabinoxylan, beta-glucan) it contains cause problems such as doughing and wet litter, and therefore yield loss. The energy content of wheat

is approximately 90% of corn. In addition, the protein content is almost twice that of corn. While wheat can be used up to 25% in broiler diets, this amount can be up to 50% with the addition of enzymes. This amount means that it can be used instead of almost all of the corn.

In many studies conducted since the 1970s with the aim of using probiotics as growth factors in poultry, positive or negative results have been obtained regarding animal performance (Jernigan et al., 1985). In laying hens given *Lactobacillus* cultures, egg production increased by 3.03%, feed efficiency by 7.41%, while fertility and hatching rates were not affected (Krueger et al., 1977). At the end of the 21-day trial in the first of two separate studies conducted by adding *L. acidophilus* to chick diets, Watkins et al. (1983) stated that the body weight gain and feed efficiency were negatively affected by 0.4% and 3.3%, respectively. In the second, they reported that despite the increase in body weight gain by 2.31% as a result of the 49-day trial, feed efficiency was not affected. In contrast, Alp et al. (1993) noted that the supplementation of Lactiferm-L5 (*Streptococcus faecium*) alone and together with some antibiotics to broiler diets did not have a significant effect on performance, abdominal fat weight, and serum cholesterol. In a different study conducted by the same researchers, the effect of probiotics added to oxidized broiler diets on fattening performance, ascites formation, blood oxidation and antioxidant status was investigated, but no statistically positive results were found (Alp et al. 1999).

The aim of this study was to determine the effect of using wheat with probiotics supplement instead of 50% and 100% corn on performance and slaughtering characteristics in broilers.

MATERIAL AND METHODS

The experiment was carried out to randomized arrangement design with three dietary treatments. A total of 120 1-day-old Ross 308 male broiler chicks were randomly distributed among three trial groups. In each experimental group, there were four subgroups, each with 10 chicks. The animal and feed raw materials were obtained from commercial companies and the diets were prepared in the Feed Unit in the Selcuk University Faculty of Agriculture Prof. Dr. Orhan Düzgüneş Animal Husbandry Research and Application Facility. In the study, diets containing wheat with probiotics supplement were used instead of 0% (control, Wheat0), 50% (Wheat50), and 100% (Wheat100) corn (Table 1). In the study, the probiotics strain *Bacillus velezensis* (10^{11} CFU/g) obtained from a commercial company was used. The birds were raised in environmentally controlled house and pens were 150 × 150 cm. During the trial, ahemeral lighting (23 hours/day) was applied, water and feed were given ad-libitum.

During the experiment, body weight and feed intake were determined as g/chick by group weighings at the hatching, 10th day, 24th day, and final (42th day) of the trial. Body weight gain was also found from these measurements. Feed conversion ratio was calculated as g feed/g gain with *feed intake / body weight gain* formula.

Table 1. Treatment diets using different levels of wheat instead of corn and nutrient contents of diets

Ingredients	Treatment Diets								
	Wheat0			Wheat50			Wheat100		
	Starter (0-10. days)	Grower (11-25. days)	Finisher (26-42. days)	Starter (0-10. days)	Grower (11-25. days)	Finisher (26-42. days)	Starter (0-10. days)	Grower (11-25. days)	Finisher (26-42. days)
Corn	48.14	51.28	56.40	26.69	26.65	28.90	---	---	---
Wheat	---	---	---	25.00	26.10	28.90	53.00	54.04	59.38
Soybean meal	42.70	39.00	33.80	35.40	37.00	31.80	33.44	35.00	29.50
Corn gluten	---	---	---	4.00	---	---	4.00	---	---
Soybean oil	5.40	6.30	6.80	5.00	6.80	7.40	5.65	7.50	8.10
Limestone	0.70	0.60	0.60	0.85	0.65	0.60	0.85	0.73	0.65
Dicalcium phosphate	2.20	2.00	1.75	2.08	1.95	1.75	2.05	1.85	1.68
Salt	0.25	0.25	0.25	0.25	0.25	0.25	0.25	0.25	0.25
Premix	0.10	0.10	0.10	0.10	0.10	0.10	0.10	0.10	0.10
L-lysine	0.17	0.26	0.12	0.30	0.28	0.12	0.33	0.31	0.16
DL-methionine	0.34	0.21	0.18	0.33	0.22	0.18	0.33	0.22	0.18
Calculated nutrient contents									
Metabolizable energy, kcal/kg	3003	3105	3203	3007	3101	3200	3008	3105	3203
Crude protein, %	23.012	21.530	19.496	23.052	21.496	19.541	23.082	21.504	19.508
Calcium, %	0.973	0.872	0.794	0.976	0.873	0.789	0.964	0.873	0.785
Available phosphorus, %	0.489	0.445	0.396	0.480	0.448	0.409	0.486	0.441	0.409
Lysine, %	1.288	1.291	1.063	1.288	1.283	1.042	1.291	1.284	1.046
Methionine, %	0.675	0.521	0.467	0.679	0.528	0.466	0.678	0.526	0.463
Methionine+cystine	0.974	0.899	0.815	1.057	0.915	0.823	1.065	0.922	0.829

¹Premix provided the following (per kg of diet): manganese 80 mg; iron 60 mg; copper 5 mg; iodine 1 mg; selenium 0.15 mg; vitamin A 8800 IU; vitamin D₃ 2200 IU; vitamin E 11 mg; nicotinic acid 44 mg; Cal-D-Pan 8.8 mg; vitamin B₂ 4.4 mg; vitamin B₁ 2.5 mg; vitamin B₁₂ 6.6 mg; folic acid 1 mg; biotin 0.11 mg; choline 220 mg.

***Wheat0**: Group using 100% corn as grain source, **Wheat50**: Group in which 1 g/kg probiotics added wheat is used instead of 50% of the corn, **Wheat100**: The group in which 1 g/kg probiotics added wheat is used instead of 100% of the corn.

Determination of relative carcass and visceral organ weights

At the end of the experiment, two broilers at six weeks of age from each subgroup were euthanized by cervical dislocation. Carcass, thigh+drumstick, breast, abdominal fat, liver, gizzard, pancreas, and were weighed with a 0.01 g precision scale, and then their relative weights were determined. Relative weights of carcasses and some organs were calculated as percentage of body weight. On the other hand, relative weights of thigh+drumstick and breast were determined as a percentage of the carcass.

Data were analysed in the SPSS 18.0 software package (SPSS Inc., Chicago, IL, USA) with a model of one-way ANOVA, using the group mean as an experimental unit. Differences among the group means were determined by Duncan's range tests. A probability value of $P < 0.05$ was considered statistically significant.

RESULTS AND DISCUSSION

The effect of using at the levels of 50% and 100% wheat with probiotics supplement instead of corn in broiler diets on performance is demonstrated in Table 2.

Table 2. The effect of using probiotics (1 g/kg) supplemented wheat instead of corn (50 or 100%) in the diet on the performance of broilers

Parameters	Treatments*			Standard error	P value
	Wheat0	Wheat50	Wheat100		
Body weight, g/broiler					
Hatching	41.38	42.07	40.63	0.267	0.076
10. days	247.0	251.3	257.8	2.23	0.136
25. days	1175.0	1198.3	1218.5	14.13	0.497
42. days	3213.8	3260.0	3306.1	36.33	0.629
Body weight gain, g/broiler					
0-10. days	205.6	209.3	217.2	2.33	0.110
11-25. days	928.0	947.0	960.7	13.22	0.642
26-42. days	2038.8	2061.7	2087.6	27.06	0.796
0-42. days	3172.4	3217.9	3265.5	36.29	0.623
Feed intake, g/broiler					
0-10. days	270.9	275.5	273.4	1.19	0.322
11-25. days	1258.5	1249.9	1218.0	12.88	0.441
26-42. days	3385.2	3359.5	3311.3	27.89	0.593
0-42. days	4914.7	4884.8	4802.8	39.96	0.542
Feed conversion ratio					
0-10. days	1.318	1.316	1.262	0.0131	0.133
11-25. days	1.356 ^a	1.322 ^b	1.268 ^b	0.0140	0.013
26-42. days	1.662	1.632	1.587	0.0136	0.057
0-42. days	1.550 ^a	1.519 ^a	1.471 ^b	0.0115	0.003

***Wheat0**: Group using 100% corn as grain source, **Wheat50**: Group in which 1 g/kg probiotics added wheat is used instead of 50% of the corn, **Wheat100**: The group in which 1 g/kg probiotics added wheat is used instead of 100% of the corn.

^{a,b}: Within a row, values not sharing a common superscript are statistically different; $P \leq 0.05$.

The use of 50% and 100% wheat with 1 g/kg probiotics added instead of corn in the diet did not affect the body weight of broilers statistically ($P > 0.05$). The body weights of the broilers were 40.63-42.07 g in the hatching, 247.0-257.8 g on the 10. day, 1175.0-1218.5 g on the 25. day and 3213.8-3306.1 g on the 42. day. In the study, the body weight gain was 205.6-217.2 g on the 0-10. days, 11-25. days 928.0-960.7 g, 26-42. days 2038.8-2087.6 g and 0-42. days 3172.4-3265.5 g, but the body weight gain was not affected by the treatments considerably ($P > 0.05$). Feed intake was not affected by the use of probiotics supplemented wheat instead of corn in the diet ($P > 0.05$). Feed intake according to periods as follows: 0-10. days 270.9-275.5 g, 11-25. days 1218.0-1258.5 g, 26-42. days 3311.3-3385.2 g, and 0-42. days was 4802.8-4914.7 g. The use of 50% and 100% wheat with 1 g/kg probiotics supplement instead of corn in the diet of broilers at 0-10. days (1.262-1.318) and 26-42. days (1.587-1.662) did not affect the feed efficiency statistically ($P > 0.05$). In the second period (11-25. days) of the study, feed efficiency in Wheat50 (1.322) and Wheat100 (1.268) groups was significantly improved ($P < 0.05$), compared to the control group (Wheat0) (1.356). In the 0-42. days, feed efficiency of Wheat100 group (1.471) improved considerably compared to Wheat0 (1.550) and Wheat50 (1.519) groups ($P < 0.05$). In most cases, improved growth has been associated with increased feed intake in broilers fed a diet containing probiotics (Abdel-Raheem et al., 2012; Landy and Kavyani, 2013; Lei et al., 2015). Kirkpınar et al. (2018) reported that the addition of probiotics to wheat-based broiler diets improved body weight but did not affect other performance parameters. Afsharmanesh and Sadaghi (2014), Mookiah et al. (2014), Zhang and Kim (2014), Lei et al. (2015) stated that dietary supplementation of probiotics improved broiler growth rates.

However, these results are not compatible with the current study. Mountzouris et al. (2010), Hung et al. (2012), Fajardo et al. (2012), Shim et al. (2012), and Zhang and Kim (2014) demonstrated that the use of probiotics in broiler diets improved the feed efficiency. However, feed intake and feed conversion ratio were not affected by the treatments in current study. These outcomes are similar to the feed efficiency results in the current research. Differences between studies may be due to differences in the dosage and composition of the administered probiotics, diet components, and variations in the physiological status of animals.

The effect of using at the levels of 50% and 100% wheat with probiotics supplement instead of corn in broiler diets on slaughtering characteristics is given in Table 3.

Table 3. The effect of using probiotics (1 g/kg) supplemented wheat instead of corn (50 or 100%) in the diet on the slaughtering parameters of broilers

Parameters	Treatments*			Standard error	P value
	Wheat0	Wheat50	Wheat100		
Carcass ¹	76.17 ^a	74.09 ^b	76.31 ^a	0.428	0.041
Thigh+drumstick ²	27.23	27.74	26.85	0.289	0.497
Breast ²	36.31	36.50	39.33	0.662	0.103
Abdominal fat ¹	1.13 ^a	0.80 ^{ab}	0.59 ^b	0.0899	0.026

***Wheat0:** Group using 100% corn as grain source, **Wheat50:** Group in which 1 g/kg probiotics added wheat is used instead of 50% of the corn, **Wheat100:** The group in which 1 g/kg probiotics added wheat is used instead of 100% of the corn.

¹% of body weight, ²% of carcass.

^{a,b}: Within a row, values not sharing a common superscript are statistically different; $P \leq 0.05$.

The use of 50% and 100% wheat with probiotics added instead of corn in the diet did not statistically affect the relative thigh+drumstick (26.85%-27.74%) and breast (36.31%-39.33%) weights of broilers ($P > 0.05$). However, the relative carcass and abdominal fat were affected by treatments ($P < 0.05$), and the carcass ratio in the Wheat50 (74.09%) group was considerably lower than the Wheat0 (76.17%) and Wheat100 (76.31%) groups. In the research, the relative abdominal fat weight was statistically decrease in the Wheat100 group (0.59%) compared to the control (Wheat0) group (1.13%).

The effect of using at the levels of 50% and 100% wheat with probiotics supplement instead of corn in broiler diets on performance is shown in Table 4.

Table 4. The effect of using probiotics (1 g/kg) supplemented wheat instead of corn (50 or 100%) in the diet on the visceral weights of broilers

Parameters ¹	Treatments*			Standard error	P value
	Wheat0	Wheat50	Wheat100		
Liver	1.57	1.90	1.68	0.069	0.123
Gizzard	1.34	1.48	1.29	0.050	0.287
Pancreas	0.217	0.205	0.193	0.0104	0.680

***Wheat0:** Group using 100% corn as grain source, **Wheat50:** Group in which 1 g/kg probiotics added wheat is used instead of 50% of the corn, **Wheat100:** The group in which 1 g/kg probiotics enzyme added wheat is used instead of 100% of the corn.

¹% of body weight

^{a,b}: Within a row, values not sharing a common superscript are statistically different; $P \leq 0.05$.

The use of 50% and 100% wheat with probiotics added in the diet instead of corn did not statistically affect the relative liver (1.57-1.90%), gizzard (1.29-1.48%), and pancreas (0.193-0.217) weights of broilers ($P>0.05$). Kırkpınar et al. (2018) reported that the addition of probiotics to wheat-based broiler diets had no effect on slaughtering characteristics. Similar results were found by Mountzouris et al. (2010), Hung et al. (2012), Fajardo et al. (2012), Shim et al. (2012), and Zhang and Kim (2014), these results are partially similar to the present study.

In the current study, body weight, feed intake, carcass yield, and slaughtering characteristics were not affected by the treatment diets, except for abdominal fat. In addition, while the feed efficiency improved in the Wheat100 group, the carcass yield decreased in the Wheat50 group. According to these results, it was observed that feed efficiency improved, and fat accumulation decreased with the use of probiotics supplemented wheat instead of whole corn in the feeding of broilers.

REFERENCES

- Abdel-Raheem, S. M., Abd-Allah, S. M., Hassanein, K. M. 2012. The Effects of Prebiotic, Probiotic and Synbiotic Supplementation on Intestinal Microbial Ecology and Histomorphology of Broiler Chickens. *International Journal for Agro Veterinary and Medical Sciences*, 6(4): 277-289.
- Afsharmanesh, M., Sadaghi, B. 2014. Effects of Dietary Alternatives (Probiotic, Green Tea Powder, and Kombucha Tea) As Antimicrobial Growth Promoters on Growth, Ileal Nutrient Digestibility, Blood Parameters, and Immune Response of Broiler Chickens. *Comparative Clinical Pathology*, 23: 717-724.
- Alp, M., Kahraman, R., Kocabağlı, N., Eren, M., Şenel, H. S. 1993. Lactiferm-L5 ve Bazı Antibiyotiklerin Broiler Performansı, Abdominal Yağ ve İnce Bağırsak Ağırlığı ile Kan Kolesterolüne Etkileri. *İstanbul Üniversitesi Veteriner Fakültesi Dergisi*, 19: 145-157.
- Fajardo, P., Pastrana, L., Mendez, J., Rodriguez, I., Fucinos, C., Guerra, N. P. 2012. Effects of Feeding of Two Potentially Probiotic Preparations From Lactic Acid Bacteria on the Performance and Faecal Microflora of Broiler Chickens. *Scientific World Journal*, Art. No. 562635.
- Hung, A. T., Lin, S. Y., Yang, T. Y., Chou, C. K., Liu, H. C., Lu, J. J., Wang, B., Chen, S. Y., Lien, T. F. 2012. Effects of *Bacillus Coagulans* ATCC 7050 on Growth Performance, Intestinal Morphology, and Microflora Composition in Broiler Chickens. *Animal Production Science*, 52(9): 874-879.
- Jernigan, M. A., Miles, R. D., Arafa, A. S. 1985. Probiotics in Poultry Nutrition-A Review1. *World's Poultry Science Journal*, 41(2): 99-107.
- Kırkpınar, F., Açıkgöz, Z., Selim, M., Özgün, I. 2018. Effects of Dietary Probiotic, Prebiotic and Enzyme Mixture Supplementation on Performance, Carcase, Organs, Ileal pH and Viscosity of Broilers. *Hayvansal Üretim*, 59(2): 1-9.
- Krueger, W. F., Bradley, J. W., Patterson, R. H. 1977. Interaction of Gentian Violet and *Lactobacillus* Organisms in Diet of Leghorn Hens. In *Poultry Science* (Vol. 56, No. 5, Pp. 1729-1729). 1111 North Dunlap Ave, Savoy, IL 61874: Poultry Science Assoc Inc.
- Landy, N., Kavyani, A. 2013. Effects of Using a Multi-Strain Probiotic on Performance, Immune Responses and Cecal Microflora Composition in Broiler Chickens Reared Under Cyclic Heat Stress Condition. *Iranian Journal of Applied Animal Science* 3(4): 703-708.
- Lei, X., Piao, X., Ru, Y., Zhang, H., Péron, A., Zhang, H. 2015. Effect of *Bacillus Amyloliquefaciens*-Based Direct-Fed Microbial on Performance, Nutrient Utilization, Intestinal Morphology and Cecal Microflora in Broiler Chickens. *Asian-Australasian Journal of Animal Sciences*, 28(2): 239.

- Mookiah, S., Sieo, C. C., Ramasamy, K., Abdullah, N., Ho, Y. W. 2014. Effects of Dietary Prebiotics, Probiotic and Synbiotics on Performance, Caecal Bacterial Populations and Caecal Fermentation Concentrations of Broiler Chickens. *Journal of the Science of Food and Agriculture*, 94(2): 341-348.
- Mountzouris, K. C., Tsitsrikos, P., Palamidi, I., Arvaniti, A., Mohnl, M., Schatzmayr, G., Fegeros, K. 2010. Effects of Probiotic Inclusion Levels in Broiler Nutrition on Growth Performance, Nutrient Digestibility, Plasma Immunoglobulins, And Cecal Microflora Composition. *Poultry Science*, 89(1): 58-67.
- Shim, Y. H., Ingale, S. L., Kim, J. S., Kim, K. H., Seo, D. K., Lee, S. C., Chae, B. J., Kwon, I. K. 2012. A Multi-Microbe Probiotic Formulation Processed at Low and High Drying Temperatures: Effects on Growth Performance, Nutrient Retention and Caecal Microbiology of Broilers. *British Poultry Science*, 53(4): 482-490.
- Watkins, B. A., Miller, B. F. 1983. Competitive Gut Exclusion of Avian Pathogens by *Lactobacillus Acidophilus* in Gnotobiotic Chicks. *Poultry Science*, 62(9): 1772-1779.
- Zhang, Z. F., Kim, I. H. 2014. Effects of Multistrain Probiotics on Growth Performance, Apparent Ileal Nutrient Digestibility, Blood Characteristics, Cecal Microbial Shedding, and Excreta Odor Contents in Broilers. *Poultry Science*, 93(2): 364-370.

DETERMINATION OF THE HARVEST TIME OF SILAGE CORN IN HIGH ALTITUDE REGIONS

Erdal Güney¹, Mustafa Tan²

¹Ministry of Agriculture and Forestry East Anatolian Agricultural Research Institute, Erzurum-Türkiye

²Trakya University Havsa Vocational School Department of Park and Horticulture, Edirne-Türkiye

Corresponding author e-mail: mustafatan@trakya.edu.tr

ABSTRACT

Animal feeding with silage has become an indispensable technique all over the world. However, the cultivation of maize, which is the most important crop of silage in high altitude regions, is risky. For this reason, it is necessary to determine the varieties to be grown according to the altitude and their harvest times. This research is about the harvesting of corn varieties (SZE TC-513, Prestige and OSSK-644) with 3 different maturation periods on 3 different dates (1 September, 10 September and 20 September) in Erzurum, which has an altitude of 1860 m. The research was carried out in the experimental area of Atatürk University Plant Production and Research Center in 2012 and 2103. The field trial was set up as 3 replications according to randomized complete blocks experimental design, and the mean scores found to be significant were lettered according to the 5% probability level with the LSD multiple comparison test. Silage yield, some plant characteristics and silage quality characteristics were investigated during two years. According to the two-year average results; under current ecological conditions, Prestige and OSSK-644 varieties have higher silage yields (78.6 and 75.6 t/ha respectively). Between the harvest dates, September 20 (81.2 t/ha) was determined to give higher yields. According to the results of the research, it can be recommended to use mid-early varieties in high altitude regions and similar ecologies and to harvest them at the end of September.

Keywords: Silage maize, high altitude, variety, harvest time

INTRODUCTION

Corn (*Zea mays* L.) is the plant most used in making silage all over the world, due to its high yield, rich in soluble carbohydrates and dry matter, and easy cultivation. However, maize is a tropical grass, and it is productive in warm climates with a long development period and sufficient rainfall or irrigation. A frost-free growing period of at least 3 months is needed to grow corn safely. For this reason, the last frosts of spring and the first frosts of autumn in high altitude regions shorten the corn growing season and put corn agriculture at risk. For this reason, it is important to choose the appropriate variety and determine the harvest time for corn cultivation in high altitude regions.

For the silage corn harvest, the plants must form the cob, set the grain and reach the milk-dough stage. In the sources related to silage, it is reported that 50% of the total silage yield and 70% of the feeding value come from the cob (Açıkgöz, 2002). For this reason, varieties that do not form sufficient cobs are deficient in terms of both yield and quality. It is also a known fact that the yields of very early varieties are low (Güney *et al.*, 2010). For this reason, it should be

determined which corn varieties with which growing period are suitable in a region. Güney *et al.* (2010) found that among the corn varieties they examined under Erzurum conditions, those with an FAO value between 400 and 500 reached silage maturity early, but their yield was low. They found that those with an FAO value between 500 and 600 are more suitable for this region, while those with an FAO value above 600 give good results for some years, and for some years they cannot reach the desired maturity.

Adjusting the harvest time in silage corn is important for both the yield of the plant and the quality of the silage. When the plants are harvested early, they are rich in water and low in carbohydrates; when it is harvested late, a very hard grained and dried forage is obtained. If the grains become too hard, their evaluation by animals becomes difficult, and the silage gains a straw appearance (Kılıç, 1986). If the water content of the plant is high, the risk of leakage increases. In the appropriate harvest period, the cobs should be mature enough. Demarguilly (1973) stated that if the corn to be ensiled is harvested earlier than the dough formation period, the amount of dry matter produced per hectare decreases and the nutrient losses increase by leaching during ensiling. Kılıç and Gül (2007) determined that the most suitable harvest time for obtaining high dry matter and silage quality in Diyarbakır is the hard dough stage. However, this maturation takes place as warm weather permits. As a matter of fact, in studies conducted at high altitudes in the Eastern Anatolia Region, there are reports that silage corn is damaged by cold in the first week of September in some years (Güney, 2005). This shows that it will not be advantageous to wait longer in similar ecologies. For this reason, it is also necessary to determine the harvest dates in high altitude regions.

This study deals with the harvest dates of corn varieties with different developmental periods at different times in high altitude regions, which are risky for silage maize cultivation. In the study, it was tried to determine the appropriate ripening value and harvest dates for maize in a region with a high altitude and continental climate.

MATERIALS AND METHODS

The research was carried out in the irrigated trial area of Atatürk University Faculty of Agriculture in 2012 and 2013. In the study, 3 different varieties of corn (*Zea mays* L.) (SZE TC-513, Prestige and OSSK-644) and 3 different harvest dates (1 September, 10 September and 20 September) were used. The varieties used were selected from materials with different FAO values (early-FAO: 500, mid-early-FAO: 550 and mid-late-FAO: 640). The research was established in the randomized complete blocks experimental design with 3 blocks according to the factorial arrangement.

Sowing was done in a pre-prepared seed bed with 70 cm row spacing and 15 cm row spacing. There were 4 rows in the parcels, the width of the parcel was 2,8 m, the length of the parcel was 3 m and the area was 8,4 m². As fertilizer, 150 kg N ha⁻¹ and 50 kg P₂O₅ ha⁻¹ were applied. All of the phosphorus fertilizer was mixed by sprinkling on the plots during the seed bed preparation, and the nitrogen fertilizer was divided into two parts, half of which was applied during planting and the other half when the plants were 40-50 cm tall. After the planted plants completed the emergence, the first weed control was carried out in the form of hoeing at a height of approximately 20-25 cm. In this hoeing, the plants were diluted to be 15 cm above the row. The second hoe was made in the form of throat filling when the plants were about half a meter tall. The second part of the nitrogen fertilizer was given before this application. Taking into account the rainfall and the morphological structures of the plants, flood irrigation was done according to the need (Tan, 2018).

In the research, plant height and ear ratio were determined by cutting 5 plants from the root collar of the middle rows during harvest. In the harvests, one row at the edges of the parcel and 0,5 m from the heads were discarded as the edge effect, and the remaining area (2,8 m²) was harvested. After the harvested plants were weighed as wet, they were first dried in the open air for a week and then dried in a drying oven set at 60 °C for 48 hours, and dry matter ratio and dry matter yield were determined. The methods followed by Güney (2005) and Geren *et al.* (2003) were used to determine the morphological and agricultural characteristics. Crude protein ratios were determined by Mikro Kjeldahl method (Kacar, 1984), ADF (Acid Detergent Fiber) and NDF (Neutral Detergent Fiber) ratios were determined with the help of ANKOM Fiber Analyzer according to the principles stated by Van Soest (1963). The relative feed value (RFV) is Rohweder *et al.* (1978), dry matter digestion and dry matter consumption were determined by calculation.

The two-year data obtained in the research were subjected to variance analysis according to the randomized complete blocks experimental design. Analyzes were made with the help of MSTAT-C package program. The differences between the means were compared and grouped at the 5% probability level according to the LSD Multiple Comparison Test.

Erzurum province, where the research was conducted, has an altitude of 1869 m and is located on 39° 51' north latitude and 41° 61 ' east longitude. The continental climate prevails in the province, with cold and snowy winters and cool and dry summers. Autumn and spring, which are the transitional seasons, are short, and the winter period is long. Some climate data of Erzurum province for the years 2012 and 2013 and the long-term average are shown in Table 1. In the first year of the experiment (2012), the total precipitation amount (313,4 mm) was below the long-term average, the monthly average temperature (5,6 °C) was at the same level as the long-term average. In the second year of the experiment (2013), precipitation values were lower than both 2012 and the long-term average. However, the monthly average temperatures in the second year of the experiment are close to both 2012 and long-term averages. In May-August, when plants are actively growing, temperatures were close to each other in both years, except for June 2012, it was more rainy.

Table 1. Some climatic data of Erzurum province for 2012, 2013 and the long-term average (LTA)¹

Months	Total Precipitation (mm)			Mean Temperature (°C)		
	2012	2013	LTA	2012	2013	LTA
January	6,7	28,7	19,6	-8,8	-9,5	-9,3
February	22,2	28,5	23,1	-14,6	-7,4	-7,9
March	8,4	30,9	32,0	-6,7	-0,8	-2,3
April	37,2	36,3	51,5	7,2	7,2	5,5
May	73,0	32,3	70,3	11,0	11,5	10,6
June	7,0	25,1	46,7	15,7	15,0	14,9
July	19,8	7,8	25,8	19,0	19,4	19,3
August	22,8	5,2	16,5	22,0	19,5	19,4
September	11,0	11,5	22,5	15,0	13,6	14,6
October	41,7	17,2	46,8	9,4	6,0	8,0
November	34,2	19,6	30,7	3,8	2,3	0,7
December	29,4	8,3	20,5	-5,9	-13,4	-6,1
Total/Mean	313,4	251,4	406,0	5,6	5,3	5,6

¹ It was taken from the data of Erzurum Meteorology Regional Directorate.

The texture class of the soils of the study is clay-loam. According to the EC and % salt values of the soil, it is seen that there is no salinity problem and it is in the salt-free class. It has a pH value of 7,56 and is slightly alkaline, with a lime rate of 1,14% and a slightly calcareous structure. P₂O₅ and K₂O values suitable for plants in the soil are 44.1 kg ha⁻¹ and 1710 kg ha⁻¹, respectively, phosphorus amount is low and potassium amount is sufficient. The organic matter content in the soil is insufficient (1,01%; Anonymous, 2019).

RESULTS AND DISCUSSIONS

In the second year of the study, silage maize plants were found to be taller, cob ratios and dry matter were higher. Accordingly, their silage yields are higher (Table 2). Differences in climatic characteristics between years can lead to significant differences in characteristics such as plant height (Öztürk *et al.*, 2008). This may be due to the fact that precipitation was higher in 2013, especially in the months in which the experiment was conducted.

In the study, variety selection significantly affected plant height, cob ratio, dry matter ratio and silage yield of silage mass. Sorting, cob ratio and dry matter content are genetic characteristics of plants and emerge when environmental conditions allow. In this study, the earliest cultivar, TC-513, was shorter (179,0 cm), while the cultivar with the highest ear rate (42,13%) and dry matter rate (24,83%). Later maturing varieties have longer plant heights, but lower ear and dry matter ratios. Many researchers working with different corn varieties pointed to similar results (Kim *et al.*, 2001; Kılıç and Gül, 2007; Güney *et al.*, 2010; Kaya and Kuşaksız 2012; Guyader *et al.*, 2018).

Since harvesting at different dates affected the development times of the plants, it led to an increase in length, an increase in the cob and dry matter ratio, and an increase in silage yield (Table 2). The lowest yield was determined at the harvest on September 1 with 68,9 t ha⁻¹, while the highest yield was obtained from the last harvest date with 81,2 t ha⁻¹. With the delay of the harvest date; Kaya and Kuşaksız (2012) reported that plant height, Rabelo *et al.* (2015) determined that the ear rate and Çağrı (2020) determined silage yield increased.

Table 2. Silage yield and some characteristics of corn varieties harvested on different dates*

Applications	Plant Height (cm)	Ear Ratio (%)	Dry Matter Ratio (%)	Silage Yield (t ha ⁻¹)
Variety				
SZE TC-513	179,0 C	42,13 A	24,83 A	70,0 B
Prestige	195,7 B	31,91 B	24,53 AB	78,6 A
OSSK-644	211,0 A	30,05 C	24,04 B	75,6 A
Harvest Date				
1 September	186,9 B	30,19 C	21,69 C	68,9 C
10 September	194,2 B	35,12 B	24,77 B	74,0 B
20 September	204,6 A	38,77 A	26,94 A	81,2 A
Year				
2012	182,5 B	31,74 B	22,78 B	73,7
2013	207,9 A	37,66 A	26,16 A	75,8
Mean	195,2	34,70	24,47	74,7
Variety x H. Date	ns	0.05	ns	0.05

*Means marked with the same letter are statistically similar. Statistically significant at the 5% level, ns: non-significant

In the study, harvest dates had the greatest effect on the quality parameters of silage maize, and the effect of cultivars was found to be insignificant (Table 3). In 2012, the first year of the study, crude protein ratio and RFV value were found to be higher than the other year. This may be related to the lower content of ADF and NDF in silage material in 2012.

The effects of cultivars used in the study on silage quality parameters were not found significant. Depending on the cultivars, crude protein ratio was 9,58-9,83%, NDF ratio was 39,83-40,24%, ADF ratio was 34,00-34,21% and RFV value showed insignificant changes between 144,4-145,9%.

Delayed harvest dates significantly affected feed quality in silage maize. As the harvest time was delayed, crude protein ratio decreased, irregular changes were observed in ADF and NDF ratios, and RFV value increased. These irregular changes may have occurred due to the increase in the cob ratio in the forage, although the structural materials increased with over time. Horst *et al.* (2021) also determined that crude protein ratio decreases with maturation.

Table 3. Some nutritional value characteristics of silage maize varieties harvested on different dates*

Applications	Crude Protein (%)	NDF (%)	ADF (%)	RFV
Variety				
SZE TC-513	9,58	39,83	34,11	145,9
Prestige	9,83	40,24	34,21	144,4
OSSK-644	9,63	40,24	34,00	144,7
Harvest Date				
1 September	9,98 A	40,40 A	34,45 A	143,3 B
10 September	9,82 A	40,83 A	33,72 B	142,9 B
20 September	9,23 B	39,07 B	34,16 AB	148,7 A
Year				
2012	10,08 A	39,89	33,48 B	146,9 A
2013	9,29 B	40,32	34,73 A	143,0 B
Mean	9,68	40,10	34,30	145,0
Variety x H. Date	ns	ns	ns	ns

*Means marked with the same letter are statistically similar. Statistically significant at the 5% level, ns: non-significant

CONCLUSION

It has been revealed in many studies that the variety and harvest time have an effect on the yield and feed quality of silage maize. This research focused on the determination of the corn varieties to be grown for silage and the harvesting times in high altitude regions such as Erzurum. According to the results of the research, harvesting at a later date resulted in a higher yield as it provided a longer development period for the plants. It also led to an increase in the cob ratio and dry matter ratio, which are of great importance for silage. Filya (2002) states that the dry matter ratio in silage corn should be more than 20%, and even around 35% gives better results. Harvests done at the wrong time cause high losses with leakages after silage, or decrease silage quality (Hunt *et al.*, 1989). In this study, since the low temperature that causes freezing did not occur in September in the years in which the research was carried out, it was revealed that September 20 was more suitable for harvesting. Prestige and OSSK-644 varieties with longer growth times were found to be more productive because an early autumn low temperature did not occur.

ACKNOWLEDGMENTS

This article was produced from Erdal GÜNEY's PhD Thesis. The project of the thesis study was supported by the Atatürk University Scientific Research Projects Fund (BAP-2012/216).

REFERENCES

- Açıkgöz, E., 2002. Silaj Yapımında Kullanılan Diğer Bitkilerin Tarımı. Silaj Bitkileri Yetiştirme ve Silaj Yapımı (E. Açıkgöz, İ. Filya ve İ. Turgut ed.) Hasad Yayıncılık, Türkiye, s: 35-57.
- Anonim, 2019. Toprak ve Arazi Sınıflaması Standartları Teknik Talimatı https://www.tarimorman.gov.tr/Belgeler/Mevzuat/Talimatlar/ToprakAraziSiniflamasiStandartlariTeknikTalimativeIlgiliMevzuat_yeni.pdf. Erişim Tarihi: 6 Ocak 2019.
- Çağır, S., 2020. Farklı Olum Dönemlerinde Hasat Edilen Silajlık Mısır Çeşitlerinin Verim ve Kalite Özelliklerinin Belirlenmesi. Adnan Menderes Üniversitesi Fen Bilimleri Enstitüsü Tarla Bitkileri Anabilim Dalı, Y.L. Tezi, Aydın.
- Demarguilly, C., 1973. Principes de Base de 14 Ensilage. Extrait de la Reuve de Four- Rages. No: 26.
- Filya, İ., 2002. Silaj Yapımı. Silaj Bitkileri Yetiştirme ve Silaj Yapımı (E. Açıkgöz, İ. Filya ve İ. Turgut ed.) Hasad Yayıncılık, Türkiye, s: 59-86.
- Geren, H., Avcıoğlu, R., Kır, B., Demiroğlu, G., 2003. İkinci ürün olarak yetiştirilen bazı mısır (*Zea mays* L.) çeşitlerinde ekim zamanlarının silaj özelliklerine etkisi. Türkiye 5. Tarla Bitkileri Kongresi, 13-17 Ekim 2003, s: 74-78, Diyarbakır.
- Guyader, J., Baron, V.S., Beauchemin, K.A., 2018. Corn forage yield and quality for silage in short growing season areas of the Canadian prairies. *Agronomy*, 8(9): 2-25.
- Güney, E., Tan, M., Gül, Z. D., Gül, İ., 2010. Erzurum şartlarında bazı silajlık mısır çeşitlerinin verim ve silaj kalitelerinin belirlenmesi. Atatürk Üniversitesi Ziraat Fakültesi Dergisi, 41(2): 105-111.
- Güney, E. (2005). Erzurum Şartlarında Silajlık Amacıyla Yetiştirilen Bazı Bitkilerin Verim, Bitkisel Özellikler ve Silaj Kalitesi Yönünden Değerlendirilmesi Üzerine Bir Araştırma. Yüksek Lisans Tezi, Atatürk Üniversitesi Fen Bilimleri Enstitüsü, Erzurum.
- Horst, E.H.; Bumbieris Junior, V.H.; Neumann, M.; López, S.2021. Effects of the Harvest Stage of Maize Hybrids on the Chemical Composition of Plant Fractions: An Analysis of the Different Types of Silage. *Agriculture* 2021, 11, 786.
- Hunt, C.W., Kezar, W., Vinande, R., 1989. Yield, Chemical composition and ruminal fermentability of corn whole plant, Ear, and Stover as Affected by Maturity. *Journal of Production Agriculture* 2: 357-361.
- Kacar, B., 1984. Bitki ve Toprağın Kimyasal Analizleri: II. Bitki Analizleri. Ankara Üniversitesi Ziraat Fakültesi Yayınları No: 453, 464 s, Ankara.
- Kaya, Ç., Kuşaksız, T., 2012. Farklı ekim zamanlarında yetiştirilen mısır (*Zea mays* L.) çeşitlerinde verim ve verimle ilgili bazı özelliklerin belirlenmesi. *Anadolu*, 22(2): 48-58.
- Kılıç, A. 1986. Silo Yemi. Bilgehan Basımevi, 327 sayfa, Bornova-İzmir.
- Kılıç, H., Gül, İ., 2007. Hasat zamanının Diyarbakır şartlarında ikinci ürün olarak yetiştirilen mısır çeşitlerinde verim ve bazı tarımsal karakterler ile silaj kalitesine etkileri üzerine bir araştırma. Harran Üniversitesi Ziraat Fakültesi Dergisi, 11(3/4): 43-52.
- Kim, J. D., Kwonand, C.H., Kim, A., 2001. Yield and quality of silage corn as affected by hybrid maturity, planting date and harvest stage. *Asian-Australian Journal Animal Science*, 104(12): 1705-1711.
- Öztürk, A., Bulut, S., Boran, E., 2008. Bitki Sıklığının silajlık mısırdaki verim ve bazı agronomik karakterlere etkisi. Atatürk Üniversitesi Ziraat Fakültesi Dergisi, 39(2): 217-224.
- Rabelo, C.H.S, Rezende, A.V., Rabelo, F.H S., Basso, F.C., Härter, C., Reis, R.A., 2015. Chemical composition, digestibility and aerobic stability of corn silages harvested at different maturity stages. *Revista Caatinga*, 28(2): 107-116.
- Rohweder, D.A., Barnes, R.F., Jorgensen, N., 1978. Proposed hay grading standards based on laboratory analyses for evaluating quality. *Journal Animal Science*, 47: 747-759.

- Tan, M.. 2018. Baklagil ve Buğdaygil Yem Bitkileri. Atatürk Üniversitesi Ziraat Fakültesi Ders Yayınları No: 256, Erzurum, 356 s.
- Van Soest, P.J., 1963. Use of Detergents in the analysis of fibrous feeds. II. A rapid method for the determination of fiber and lignin. Journal of Assoc. Official Agronomy Chemical, 46: 829-835.

EVOLUTION OF AMPELOGRAPHIC TECHNIQUES FOR CHARACTERIZATION BETWEEN VINE GRAPE VARIETIES

HBYAJ $k^{1,2}$, El OUALKADI A², HMOUNI D¹

1: Natural resources and sustainable development, faculty of sciences, Ibn Tofail University of Kenitra.

2: CRRA Regional Agricultural Research Center of Tangier.

Corresponding author e-mail: karima.hbyaj@uit.ac.ma

ABSTRACT

Viticulture has a long history. The species, *Vitis vinifera* includes thousands of varieties with similarities, hence the birth of a discipline called ampelography whose objective is to distinguish and identify the different grape varieties. The characterization of vine varieties by ampelography was based on description using morphological characters called descriptors concerning the organs of the plant (vegetative, floral, and fruit), each parameter is codified for a single universal language established by the International Vine Office OIV. The application of this visual and subjective method on many individuals is quite difficult and takes years. The morphological description was supplemented by ampelometric studies by carrying out measurements of interest mainly to the adult leaf, these measurements are combined with advanced statistics for differentiation between varieties. The influence of environmental factors severely limited these methods, forcing laboratory studies with biochemical internal markers, such as isoenzymes, polyphenols, flavonoids, proteins, and carbohydrates. To use the most precise tools, genome sequencing projects become the techniques of choice; especially with high-multiplication technologies; for the search for relationships between varieties. However, the application of these techniques had the disadvantage of expensive cost, the dependence on laboratory techniques and products. Despite the high precision of these biochemical and molecular methods, ampelographers have subsequently used technological means such as electronic imaging, artificial intelligence, and machine learning due to the large amount of data that these tools can contain and the large number of samples that can be studied. This makes it possible to structure the information in the form of ampelographic data banks that lead to the construction of computerized identification systems and to use them in an updated way. An ampelographer will obviously be able to couple several methods, to highlight the discrimination between similar varieties.

Key words: ampelography, similarity, vine varieties, identification.

INTRODUCTION:

The grape ; the fruit of the vine; belongs to the Vitaceae family. It is among the oldest cultures. There are three groups of cultivated vines: Asian vines, American vines and Euro-Asian vines which include only one species, *Vitis vinifera*, including the cultivated archetype, *Vitis vinifera sativa*, giving rise to thousands of varieties , or grape varieties (HUGLIN and SCHNEIDER, 1998).

According to the Food and Agriculture Organization (FAO, 2018) the total viticulture area is 7.15 million hectares with an annual production of 79.12 million Ton (MT) across the

world(Zheng et al., 2020). This fruit is appreciated thanks to its nutritional value due to the presence of different compounds such as oses (fructose and glucose), pectins, organic acids, minerals, vitamins, proteins and amino acids, fibers and its richness in polyphenols and resveratrol (Conde et al., 2007).

Ampelography (from the Greek ampélos = vine and graphy = description) is a discipline which began in the second half of the 19th century with GOETHE (1878) who was the first to think about the study of leaf morphology for recognition and classification of vine stocks (BOURSIQUOT et al. (1989).

It therefore aims to distinguish and identify the different grape varieties based on morphological or internal characters revealed by biochemical and molecular markers. She is also interested in the classification and requirements of vines as well as their evolution and therefore she also studies the botanical and agronomic side (REYNIER, 2003).

AMPELOGRAPHIC METHODS.

1/- Descriptive methods

Since the 19th century the methods used were essentially descriptive, using qualitative and quantitative morphological characters, the grape varieties are collected and grouped to be described. The description concerns each organ of the vine: buds, leaves, branches, clusters, these morphological characters are subsequently classified and codified (fig 01). To achieve the practical recognition of grape varieties and rootstocks, observations must be repeated several times (SWANEPOEL and DE VILLIERS, 1987; SCHNEIDER, 1996; SOTES et al., 1996 and REYNIER, 2003). However, such studies based on visual description necessarily have shortcomings, even if they are interesting (GALET, 1998).(FERNANDES et al., 2019).

These descriptive parameters are described by codes established by the OIV (Figure 01) representing the degree of expression for each parameter.

les paramètres ampélographique, agronomiques et biochimiques O. Boumab, Z. Laiadi / South African Journal of Botany 124 (2019) 71–79

les organes	les parametres ampélographiques	les parametres agronomiques	les parametres biochimiques
Woody shoot	OIV101, OIV102, OIV103, OIV105, OIV 106	OIV305	
Shoot	OIV353, OIV006, OIV007, OIV008, OIV014, OIV009, OIV010, OIV013, OIV354,	OIV351	
Bud		OIV301	
Inflorescences	OIV153, OIV151	OIV501, OIV302	
Seed	OIV243, OIV242, OIV241		
Bunch	OIV203, OIV202, OIV209, OIV207, OIV208, OIV204, OIV206	OIV502, OIV303, OIV504, OIV304,	
Berry	OIV220, OIV221, OIV238, OIV222, OIV223, OIV225, OIV226, OIV231, OIV232, OIV240, OIV235	OIV503	OIV233, OIV505, OIV508, OIV506
Tip	OIV003, OIV002, OIV005, OIV004		
Young leaf	OIV056, OIV055, OIV054, OIV053, OIV051		
Mature leaf	OIV306, OIV94, OIV83-2, OIV,83-1, OIV82, OIV80, OIV79, OIV93, OIV72, OIV71, OIV70, OIV69, OIV67, OIV76, OIV75, OIV74, OIV73, OIV88, OIV89, OIV84, OIV85, OIV86, OIV87, OIV90, OIV91, OIV92, OIV610, OIV607, OIV608, OIV609, OIV617, OIV616, OIV618, OIV615, OIV614, OIV77, OIV601, OIV602, OIV613, OIV612, OIV611, OIV603, OIV604, OIV605, OIV606, OIV78, OIV065		
Tendrils	OIV017		
Total	94	10	04

region with repetitions of 10 clusters for each variety. The samples are collected during the fruiting period and the description is made according to the descriptors of the OIV 2001.

The results were analyzed by the principal component analysis technique using the SPSS Version 10 software, they showed a very large variability between the samples and even with the principal component analysis the results were not structured (Figure 02).

The author was able to notice that none of the characteristics studied makes it possible to distinguish one variety from the others, at least from the data obtained from these samples despite the discriminatory power of the parameters used (El OUALKADI 2019).

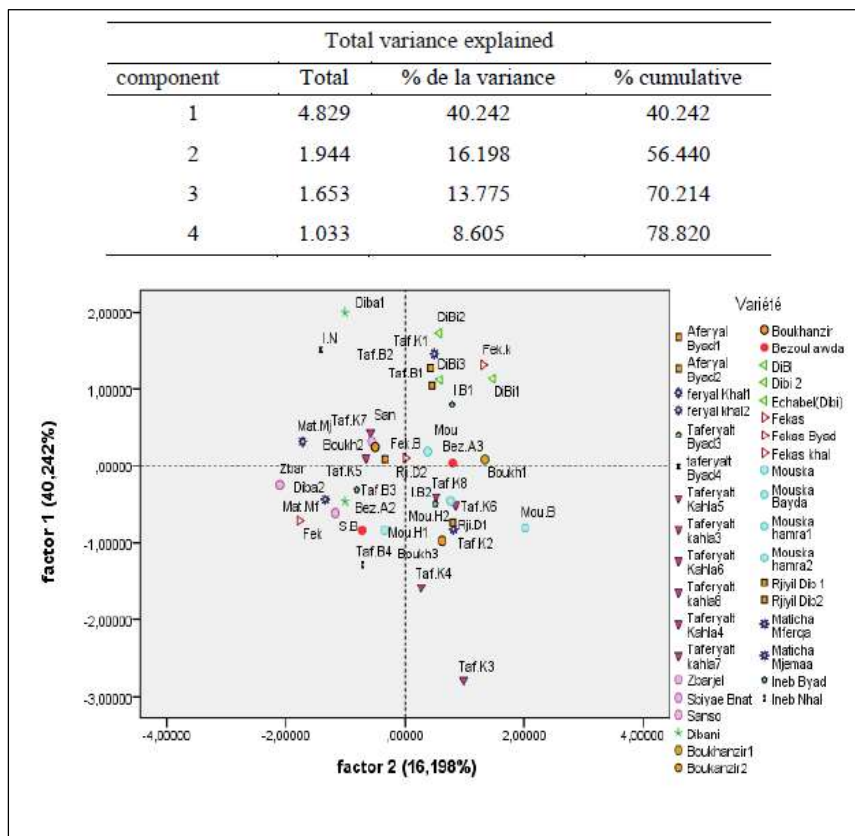

Figure 02: The association of variances with the axes of the PCA of the characteristics of the clusters. (EL OUALKADI, 2019).

Other disadvantages of this classic descriptive method are the impact of environmental factors, for example "the differences that the clusters can present between them lack constant" RAVAZ in 1902. The glitch although it is important for the distinction but does not allow us to characterize the varieties making up the species *Vitis vinifera* (BALMELLE et al., 2001). The serration of the adult leaf (rectilinear, ogival, concave, hooked) which is a very good visual ampelographic character, but very difficult to be coded because on the same sheet we find teeth of different shapes and unequal depths (GALET, 1998). This method is based on visual description which must be carried out by a well-trained expert (DIAGO MP et al, 2013).

2/ Ampelometric methods

The descriptive study is complemented by a quantitative study based on measurements called ampelometry or phyllometry. These measurements focus on the lengths of the main veins and the angles that these veins make between them, the values are also coded, which brings an interesting element to the characterization of the grape varieties (GALET, 1998 and TOMAŽIČ

and KOROŠEC-KORUZA, 2003) . The bases and principles of the codifications of ampelometry were launched in 1902 by RAVAZ and it was GALET who continued this path by completing it and making improvements (BOURSIQUOT, 1989).

Ampelometry is illustrated by computerized analytical and electronic imaging techniques which facilitate the realization of measurements as well as the processing of results. This method is also subject to environmental factors, such as the dimensions of the leaf which depend on many factors such as soil fertility, the vigor of the strain, the training method and the latitude (LAKHRIF z., 2011).

3/ Biochemical and physiological methods

The importance of biochemical characterization was proven for the identification of grape varieties by the work of SATISHA et al. (2007) and RUSJAN and KOROŠEC-KORUZA (2007). The parameters studied are polyphenols, flavonoids, proteins and carbohydrates (LAKHRIF z., 2011).

These methods are also influenced by climatic conditions and therefore environmental factors. For example: Disruption of the immediate cyanogenic response in tissues will likely be linked to interactions with invading microorganisms (FRANKS TK et al, 2005).

The phenolic compounds contained in grape berries are of great importance as ampelographic and taxonomic characteristics for the classification of cultivars. But their concentration in red vines depends on several environmental factors and cultivation practices (LETAIEF H. et al, 2007).

The use of isoenzymes and biochemical techniques in general can only be applied by specialized personnel, require time and are dependent on laboratories and do not allow the identification of a high number of varieties in a rapid manner (DIAGO MP and al, 2013).

The separation of the isoenzymes (Figure 03) is carried out by vertical electrophoresis on polyacrylamide gel. These enzymes are: catechol oxidase (CO), peroxidase (PER), glutamate-oxalacetate transaminase (GOT) and acid phosphatase (AcP) as described by Royo et al. (1997). After electrophoresis, gels were stained for AcP, GOT, and PER with staining solutions as described by Arulsekar and Parfitt (1986); or for CO as described by Sa'nchehez-Ye'lamo (1992). Isoenzyme models were assessed visually(JAHNKE et al., 2009).

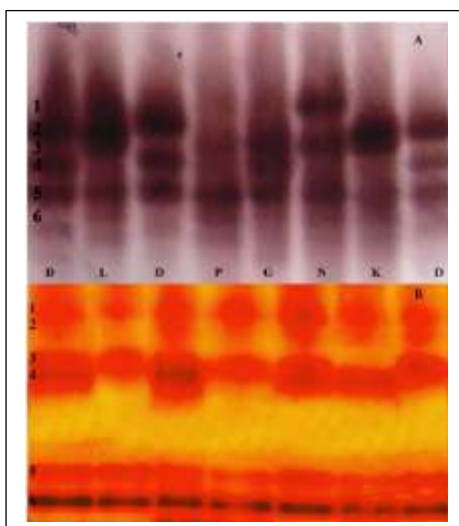

Figure 03: photo of the gel of the isoenzymes (a) CO and (b) AcP, the numbers represent the number of bands and the capital letters express the types of zymo gram in the figure(JAHNKE et al., 2009)

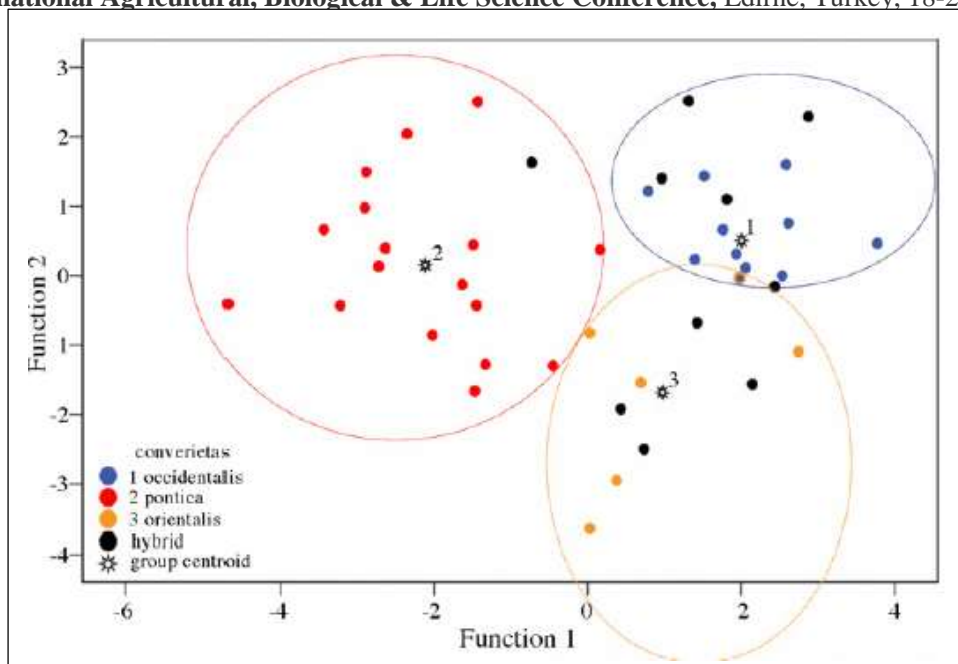

Figure 04: separation of varieties of *Vitis vinifera* L. according to their origin and the origin of their zymogram of isoenzymes (JAHNKE et al., 2009)

The separation between these varieties (Figure 04) is based on isozyme band patterns, for catechol oxidase, glutamate-oxaloacetate transaminase, acid phosphatase and peroxidase the results are reproducible, and the varieties are characterized and sorted. More than 40 varieties among the 48 which were the subject of this investigation were identified, they are classified into three groups according to their origin. This analysis attempts to investigate whether there are established links between phenotypic characteristics and patterns obtained by isozyme analysis. The enzyme that showed high polymorphism was CO while GOT had the lowest rate of polymorphism, but these enzymes are influenced by the environment (JAHNKE et al., 2009)

4 / Molecular methods

In order to seek more precise and more efficient methods independently of the impact of the environment, researchers are moving towards molecular techniques and isoenzymatic analysis which provide complementarity of ampelographic information both for characterization and identification only to reveal the relationships between grape varieties (MEREDITH and BOWERS, 1996; DE MICHELI et al., 1997; GOLINO, 2000; COSTACURTA et al., 2001; MEREDITH, 2001; REYNIER, 2003; COBAN, 2004; MOSS et al., 2005; THIS et al., 2006; ALMADANIM et al., 2007; LE CUNFF et al., 2008; SPRING et al., 2008; IŞÇI et al., 2009; LAIADI et al., 2009, SABIR et al., 2009 and ZINELABIDINE et al., 2010).

The molecular testing. are enable to determine the genetic structure, gene flow, and spatial structuring of genetic content in table grape populations (Kajkolah 2023). AND molecular markers are introduced in recent years for genetic studies, characterization of cultivars and their identification, RFLP analysis is used for the identification of 16 commercialized rootstock cultivars (Bourquin et al., 1992) and RAPD analysis was applied to reveal genetic relationships (JAHNKE G. et al 2009). The first SSR marker for grapevine was published by Thomas and Scott (1993) and after a few primary SSR sequences were described (Di Gaspero et al., 2000; Scott et al., 2000; Lefort et al., 2002; Arroyo- Garcia and Martinez-Zapater, 2004).

Molecular techniques use many DNA markers called microsatellite markers such as Simple Sequence Repeats (SSR), also called Sequence-tagged Microsatellite Site (STMS) used to identify collections of cultivars, they are suitable for the genotype of grape varieties

(SÁNCHEZ-ESCRIBANO et al., 1999). In addition, these microsatellite markers have enabled the acquisition of more in-depth knowledge on naming problems such as synonymies and homonyms as well as the origin of grape varieties (RIAHI et al., 2010).

Several methods have shown their effectiveness such as the Random Amplification Polymorphism of DNA by PCR (RAPD) method for the identification and molecular analysis of grape varieties (BINIARI and STAVRAKAKIS, 1999; TESSIER et al., 1999; VIDAL et al., 1999; HERRERA et al., 2002; ARAS et al., 2005; KOCSIS et al., 2005; GÖKBAYRAK et al., 2006; IŞÇI et al., 2009 and BUTIUC-KEUL et al., 2010), Amplified Fragment Length Polymorphism (AFLP) has been used to identify genetic relationships within grapevine accessions and to detect these intervarietal variations (CERVERA et al., 1998; CERVERA et al., 2001; LABRA et al., 2001; IMAZIO et al., 2002; VIGNANI et al., 2002; SIRET et al., 2002; MARTINEZ et al., 2003; ERGÜL et al., 2006; MONCADA and HINRICHSSEN, 2007 and IŞÇI et al., 2009).

These methods are slow and expensive, which prevents their widespread use.(FERNANDES et al., 2019), require time, intensively dependent on the laboratory and the intervention of expert technicians(ÁLVAREZ et al., 2020).

Other types of molecular markers such as RAPD (ZOGHLAMI et al. 2003), nuclear SSR (ZOGHLAMI et al. 2009; RIAHI et al. 2010, 2012) and chloroplast SSR (RIAHI et al. 2011) were used to estimate the genetic diversity and characterization of indigenous Tunisian grape varieties, and more recently single nucleotide polymorphism SNPs have become the most popular genetic marker for plants(Riahi et al., 2013).

SSR markers are used as genetic markers to reveal genetic diversity, relationships among cultivars among them, relationships, thus constructing genetic maps.

ZOGHLAMI et al used these markers to study 61 Tunisian indigenous varieties (Figure 05), this analysis allowed the identification of 5 possible parents and that the Tunisian vine derives from an Out crossing between these 5 possible parents. The combination between the alleles is treated and analyzed (Figure 06) by the method (UPGMA), the DNA is extracted according to the Mini Kit protocol from plants by Qiagen DNeasy and Quantified by visual comparison by Lambda DNA: molecular marker on ethidium (brand stained) on agarose gel, 10 SSR loci are selected and quantification is done by PCR using TaQ polymerase(ZOGHLAMI et al., 2009)

Locus	Allele number	Genotype patterns	He	Ho	PI	Q	r
VVMD28	11	17	0.778	0.96	0.142	0.578	-0.106
VVMD27	6	12	0.668	0.803	0.285	0.411	-0.08
VVMD21	6	11	0.742	0.885	0.179	0.522	-0.082
VVIP60	7	10	0.621	0.819	0.365	0.347	-0.122
VVMD5	7	18	0.829	0.95	0.096	0.659	-0.066
VVIP31	10	21	0.833	0.901	0.09	0.669	-0.037
VVMD32	11	15	0.773	0.885	0.135	0.58	-0.062
VVMD24	8	18	0.778	0.786	0.137	0.581	-0.004
VVS2	10	19	0.855	0.918	0.07	0.71	-0.003
VVMD7	8	19	0.791	0.688	0.112	0.614	0.057
Overall	84	160	0.766	0.859	3.39×10^{-9}	0.9999	-0.05

Figure 05: Genetic polymorphism parameters obtained with 10 marked SSRs of 61 indigenous Tunisian cultivars He: Expected heterozygosity, Ho: Observed heterozygosity, PI: probability of identity, Q: exclusion of paternity, r: zero allele frequency(ZOGHLAMI et al., 2009).

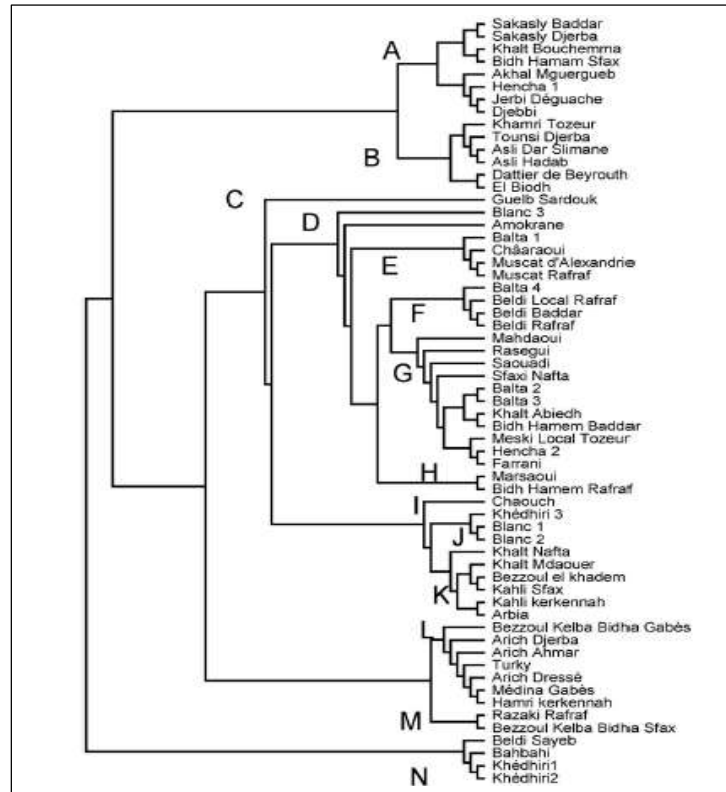

Figure 06: UPGMA dendrogram obtained from microsatellite data from 61 Tunisian indigenous clusters.(Zoghalmi et al., 2009)

The abundance of SNPs in genome sequencing projects and the wide choice of high multiplication technologies make them a marker of choice for research (FAN et al. 2006). In addition, the evolution of the natural conservation of SNPs reduces their exposure to homoplasmy problems (BRUMFIELD et al. 2003).

With the aim of investigating the variation of alleles and the occurrence of the effects of domestication on the keys to genes controlling adaptation to the environment (RIAHI, 2013). Molecular methods are generally combined with biochemical separation and identification techniques such as PCR and electrophoresis for better processing of results. Riahi et al attempted to study the genetic diversity and differentiation of cluster samples from the North African region using nuclear microsatellites, DNA is extracted from young leaves or cambium following the DNeasy protocol Plant Mini Kit (Qiagen, Hilden, Germany) then amplified by PCR and separated by electrophoresis.

The use of microsatellites as a complement to descriptors and variety protection became important after the acceptance of allelic SSR by the USDA Plant Variety Protection Office (DIWAN, 1997).

5-Methods based on IT resources

With the development of information technology, new tools are available to the ampelographer to help him, facilitate processing, analyze the results obtained, save effort and time in studies and structure the data in the form of ampelographic databases thus using them in an updated way (BOURSIQUOT et al., 1987). Researchers have made it possible to obtain the coordinates of specific points on the leaves and image analysis (REYNIER, 2003). By comparing data according to variety, we can determine whether a new variety introduced into the collection is not already there under another name (BOURSIQUOT et al., 1987). The statistical analysis of

a computerized ampelographic file also made it possible to propose groupings of grape varieties which share some particularities (BOURSIQUOT et al., 1987). A factorial correspondence analysis (CFA) will highlight the most important ampelographic characters and obtain an image of the *Vitis vinifera* population (LAKHRIF Z.2011). However,

With the aim of creating simple methods, in recent years the spectroscopy method has been combined with “machine learning” (Gutiérrez et al., 2015a; Gutiérrez et al., 2016; Gutiérrez et al., 2015b; Cao et al., 2010; Arana et al., 2005; Diago et al., 2013; Yang et al., 2012). The need for the use of these combinations comes from the large quantity of data that this software can contain, the large number of samples that can be studied, which leads to the construction of computerized systems for identifying vine varieties and which can be marketed (FERNANDES et al., 2019) such as classification systems like Support Vector Machines (SVM) and Convolutional Neural Networks (CNN) which is applied for the first time for the identification of vine varieties (Qiu et al., 2018).

New methods such as: attenuated total reflectance (ATR) and Fourier Transform Infrared spectroscopy (FTIR) combined with advanced statistics for differentiation of genotypes of vines are easier and lower priced, faster with computerized data acquisition except that they are non-destructive, these methods measure the absorption of radiation from the surfaces of the samples to obtain an IR spectrum (ÁLVAREZ et al., 2020), the vibrations of this spectrum are considered a fingerprint of any biological or botanical sample (DA Luz, 2006; Milosevic, 2004; Schmidtke, Smith, Müller, & Holzapfel, 2012; Shah, Cynkar, Smith, & Cozzolino, 2010).

The reproducibility of this method must be evaluated on samples of leaves of the same genotypes (variety and clone) obtained in different environments and with different management and trellis systems such as samples which have different physiological conditions, different health conditions and different development stages with the aim of determining its total confidentiality, technical strengths and weaknesses (ÁLVAREZ et al., 2020)

CONCLUSION

The characterization of the high number of vine varieties by ampelography was based first on the description using morphological characters. Applying this visual and subjective method to many individuals is quite difficult and takes years. The morphological description was then completed by ampelometric studies. The influence of environmental factors has strongly limited these methods, which has imposed studies in laboratories with internal biochemical and molecular markers.

Despite the high precision of these biochemical and molecular methods, the dependence on laboratory techniques and products subsequently imposed the use of technological means of artificial intelligence and machine learning. An ampelographer will obviously have to combine several methods, with the aim of highlighting discrimination between similar varieties. However, the classic ampelographic description remains an essential tool in grape variety identification and characterization studies. All other means are therefore complementary.

REFERENCES

- ALMADANIM MC, BALEIRAS-COUTO MM, PEREIRA HS, CARNEIRO LC, FEVEREIRO P., EIRAS-DIAS JE, MORAIS-CACILIO L., VIEGAS W. and VELOSO MM, 2007. Genetic diversity of the grapevine (*Vitis vinifera* L.) cultivars most utilized for wine production in Portugal. *Vitis*, 46, 116-119.
- ÁLVAREZ, Á., Yáñez, J., Neira, Y., Castillo-Felices, R., Hinrichsen, P., 2020. Simple distinction of grapevine (*Vitis vinifera* L.) genotypes by direct ATR-FTIR. *Food Chem.* 328, 127164. <https://doi.org/10.1016/j.foodchem.2020.127164>

- ARANA, I., JAREN, C., ARAZURI, S., 2005. Maturity, variety and origin determination in white grapes (*Vitis vinifera* L.) using near infrared reflectance technology. *J. Infrared Spectrosc.* 13, 349–357.
- ARAS S., BURGIN-POLAT J., CANSERVAN D. and SÖYLEMEZOĞLU G., 2005. RAPD analysis of genetic relationships between Rüzgülü grape cultivars *Vitis vinifera* L. grown in different parts of Turkey. *ACTA Biologica Cracoviensia Serie Botanica*, 47, 77-82.
- ARROYO-GARCÍA, R., MARTÍNEZ-ZAPATER, JM, 2004. Development and characterization of new microsatellite markers for grape. *Vitis* 43, 175–178.
- Bourquin, JC, Tournier, P., Otten, L., Walter, B., 1992. Identification of sixteen grapevine rootstocks by RFLP and RFLP analysis of nuclear DNA extracted from the wood. *Vitis* 31, 157–162.
- ARULSEKAR, S., PARFITT, DE, 1986. Isozyme analysis procedures for stone fruits, almond, grape, pistachio, and fig. *HortScience* 21, 928–933.
- BACHMANN, O., BLAICH, R., 1988. Isoelectric focusing of grapevine peroxidases as a tool for ampelography. *Vitis* 27, 147–155.
- BALMELLE C., BARRAND D., BRUN JP DUPRAT P., GAILLARD H., JAQUES P., MAURIN L., PETIT-AUPERT C., RIGAL D., ROBEN K., ROUDIE P., SILLIERES P. and VERNOU C., 2001. Ancient viticulture in Aquitaine. *Gallia*, 58, 1-26.
- BINIARI K. and STAVRAKAKIS MN (page consulted on 03/05/2010). Genetic study of 46 Greek grape cultivars by Random Amplified Polymorphic DNA markers (RAPD-PCR), 1999.
- BOURSIQUOT J. M, VIGNAU L. and BOULET JC, 1989. Ricerche sull'utilizzazione dell'ampelometria. *Riv. Vitic. Enol.*, 1, 37-52.
- BRUMFIELD RT, BEERLI P, NICKERSON DA, EDWARDS SV (2003) The utility of single nucleotide polymorphisms in inferences of population history. *Trends Ecol Evol* 18:249–256
- BUTIUKEUL AL, CRĂCIUNAȘC., COSTA A. and FARAGO M., 2010. Discrimination and genetic polymorphism in several cultivars of grapevine by RAPD markers Romanian. *Biotechnological letters*, 15, 110-115.
- CAO, F., WU, D., HE, Y., 2010. Soluble solids content and pH prediction and varieties discrimination of grapes based on visible–near infrared spectroscopy. *Comput. Electron. Agric.* 71, S15–S18.
- CERVERA, MT, CABEZAS JA, SANCHA JC, MARTINEZ DE TODA F., and MARTINEZ-ZAPATER JM, 1998. Application of AFLPs to the characterization of grapevine *Vitis vinifera* L. genetic resources. A case study with accessions from Rioja (Spain). *Theor. Appl. Broom.* 97, 51-59.
- CERVERA MT, RODRIGUEZ JA, CABEZAS JA, CHAVEZ J., MARTINEZ-ZAPATER JM and CABELLO F., 2001. Morphological and molecular characterization of grapevine accessions known as Albillo. *Am. J. Enol. Vitic.*, 52, 127-135.
- COBAN H., 2004. Application of an artificial Neural Network (ANN) for the identification of grapevine (*Vitis vinifera* L.) genotypes Asian. *J. plant Sci.*, 3, 340-343.
- CONDE, C., SILVA, P., FONTES, N., DIAS, ACP, TAVARES, RM, SOUSA, MJ, AGASSE, A., DELROT, S., GEROS, H., 2007. Biochemical changes throughout grape berry development and fruit and wine quality. *Food*. 1, 1–22.
- COSTACURTA A., CALO A., CRESPIAN M., MILANI M., CARRARO R., AGGIO L., FLAMINI R. and AJMONE-MARSAN P., 2001. Morphological, aromatic and molecular characterization of Moscato grape varieties and research on their phylogenetic relationships. *OIV Bulletin* 2001, 841-842, 133-150.

- CRESPAN, M., MILANI, N., 2001. The Muscats: a molecular analysis of synonyms, homonyms and genetic relationship within a large family of grapevine cultivars. *Vitis* 40, 23–30.
- DA Luz, R.B. (2006). Attenuated total reflectance spectroscopy of plant leaves: A tool for ecological and botanical studies. *New Phytologist*, 172, 305–318. <https://doi.org/10.1111/j.1469-8137.2006.01823.x>.
- DE MICHELI L., MAINES F., LACONO F. and COMPOSTRINI F., 1997. Analisi Ampelographica in vite: La tecnica fillometrica quale ausilio per la caratterizzazione e il riconoscimento. *Riv. Vitic. Enol.*, 3, 37-53.
- Di Gaspero, G., Peterlunger, E., Testolin, R., Edwards, KJ, Cipriani, G., 2000. Conservation of microsatellite loci within the genus *Vitis*. *Theor. Appl. Genet.* 101, 301–308.
- Diwan, N., Cregan, PB, 1997. Automated sizing of fluorescent-labeled simple sequence repeat (SSR) markers to assay genetic variation in soybean. *Theor. Appl. Broom.* 95, 723–733.
- EL OUALKADI A., HAJOUJI B., 2019. Application of ampelographic parameters to differentiate native *Vitis vinifera* L. cultivars. *Int. J. About. Agric. Biotechnology.* 4, 1654–1658. <https://doi.org/10.22161/ijeab.46.3>.
- FAN JB, Chee MS, Gunderson KL (2006) Highly parallel genomic assays. *Nat Rev Genet* 7(8):632–644
- FERNANDES, AM, Utkin, AB, Eiras-Dias, J., Cunha, J., Silvestre, J., Melo-Pinto, P., 2019. Grapevine variety identification using “Big Data” collected with miniaturized spectrometer combined with support vector machines and convolutional neural networks. *Comput. Electron. Agric.* 163, 104855. <https://doi.org/10.1016/j.compag.2019.104855>
- JAHNKE, G., Májer, J., Lakatos, A., Molnár, JG, Deák, E., Stefanovits-Bányai, É., Varga, P., 2009. Isoenzyme and microsatellite analysis of *Vitis vinifera* L. varieties from the Hungarian grape germplasm. *Sci. Hortic.* 120, 213–221. <https://doi.org/10.1016/j.scienta.2008.11.021>
- GALET P., 1967. Research on methods of identification and classification of Vitaceae in temperate zones. Montpellier, 526 p
- GALET P., 1988. Viticulture summary. Déhan Parc Euromédecine, Montpellier
- GALET P., 1998. Summary of practical ampelography. JF impression, Montpellier
- GÓKBAYRAK Z., ÖZER C. and SÖYLEMEZOĞLU G., 2006. Preliminary results on genome mapping of an Italian x Mercan grapevine population. *Turk. J. Agri. For.*, 30, 273-280
- GOLINO DA, 2000. Trade in grapevine plant materials: Local, national and worldwide perspectives. Proceeding of the ASEV 50th anniversary meeting, Seattle, Washington, 216-221
- GUTIÉRREZ, S., TARDAGUILA, J., FERNÁNDEZ-NOVALES, J., DIAGO, MP, 2015b. Data mining and non-invasive proximal sensing for precision viticulture. In: Proceedings of the 2nd Int. Electron. Conf. Sense. Appl
- GUTIÉRREZ, S., TARDAGUILA, J., FERNÁNDEZ-NOVALES, J., DIAGO, MP, 2015a. Support vector machine and artificial neural network models for the classification of grapevine varieties using a portable NIR spectrophotometer. *PloS One* 10, e0143197
- GUTIERREZ, S., TARDAGUILA, J., FERNANDEZ-NOVALES, J., DIAGO, MP, 2016. Data mining and NIR spectroscopy in viticulture: applications for plant phenotyping under field conditions. *Sensors* 16, 236
- HERRERA R., CARES V., WILKINSON MJ and CALIGARI PDS, 2002. Characterization of genetic variation between *Vitis vinifera* cultivars from central Chile using RAPD and Inter Simple Sequence Repeat marker. *Euphytica*, 124, 139-145
- HUGLIN, P., SCHNEIDER, C., 1998. Biology and ecology of the vine, 2nd edition. ed. Tec & doc-Lavoisier, Paris.

- IMAZIO S., LABRA M., GRASSI F., WINFIELD M., BARDINI M. and SCIENZA A., 2002. Molecular tools for clone identification: The case of grapevine cultivar Traminer. *Plant Breeding*, 121, 531-535
- IŞÇI B., KALKAN-YILDIRIM H. and ALTINDIŞLI A., 2009. A review of the authentication of the wine origin by molecular markers. *J. Inst. Brew.*, 115, 259-264.
- KAJKOLAH M., SHEIDAI M, KOOHDAR F (2023) Population and landscape genetic studies of indigenous table grapes (*Vitis vinifera* subsp. *vinifera* Hegi). *Genet Resour Crop Evol.* <https://doi.org/10.1007/s10722-023-01582-z>
- KOCSIS M., JÀROMI L., PUTNOKY P., KOZMA P. and BORHIDI A., 2005. Genetic diversity among twelve grape cultivars indigenous to the Carpathian basin revealed by RAPD markers. *Vitis*, 44, 1-5.
- LABRA M., WINFIELD M., GHIANI A., GRASSI F., SALO F., SCIEBZA A. and FAILLA O., 2001. Genetic studies on Trebbiano and morphologically related varieties by SSR and AFLP markers. *Vitis*, 40, 187-190.
- LACAR, FM, LEWIS, MM, GRIERSON, IT, 2001b. Use of hyperspectral reflectance for discrimination between grape varieties. *Geoscience and Remote Sensing Symposium, 2001-IGARSS '01.*
- LAIADI Z., BENTCHIKOU MM, BRAVO G., CABELLO F. and MARTINEZ-ZAPATER J., 2009. Molecular identification and genetic relationships of Algerian grapevine cultivars maintained at the germplasm collection of Skikda (Algeria). *Vitis*, 48, 25-32
- LAKHRIF z., 2011. (Magister's thesis: University of Constantine) Contribution to the characterization of the varietal diversity of local vines by the development of a bioinformatics and statistical model based on ampelographic data (Data OIV), 9- 18.
- LE CUNFF L., FOURNIER-LEVEL A., LAUCON V., VEZZULI S., LACOMBE T., ADAM-BLONDON AF, BOURSQUOT JM and THIS P., 2008. Construction of the nested genetic core collection to optimize the exploitation of natural diversity in *Vitis vinifera* subsp. *Sativa*. *BMC Plant Biology*, 8, 1-12.
- LEFORT, F., KYVELOU, CJ, ZERVOU, M., EDWARDS, KJ, ROUBELAKIS-ANGELAKIS, KA, 2002. Characterization of new microsatellite loci from *Vitis vinifera* and their conservation in some *Vitis* species and hybrids. *Mol. School. Notes* 2, 20–21.
- LETAIEF H., L. ROLLE, G. ZEPPA, I. ORRIOLS1 and V. GERBI*PHENOLIC CHARACTERIZATION OF GRAPEVINE, 2007. Cultivars from Galicia (SPAIN): Brancellao, Mere nza and Mencia (*Vitis vinifera* L.) *Ital. J. Food Sci. not.* 1, vol. 19.
- MONCADA X. and HINRICHSEN P., 2007. Limited genetic diversity among clones of red wine cultivars Carmenere as revealed by microsatellite and AFLP markers. *Vitis*, 46, 174-180.
- MARTINEZ L., CAVAGNARO P., MASUELLI R. and RODRIGUEZ J., 2003. Evaluation of diversity among Argentine grapevine *Vitis vinifera* L. varieties using morphological data and AFLP markers. *Elec. J. of Biotech.*, 6, 241-250.
- MEREDITH CP and BOWERS JE, 1996. Genetic similarities among wine grape cultivars revealed by restriction Fragment-length Polymorphism AFLP analysis. *J. Amer. Soc. Hort. Sci.*, 121, 620-624.
- MEREDITH CP, 2001. Grapevine Genetics: Probing the past and fictionalizing the future. *Agriculturae Conspectus Scientificus*, 66, 21-25.
- MILOSEVIC, M. (2004). Internal reflection and ATR spectroscopy. *Applied Spectroscopy Reviews*, 39(3), 365–384. <https://doi.org/10.1081/ASR-200030195>.
- MOSS. S., JELASKA S. and PONGOR S., 2005. *Essays in bioinformatics*. NATO Public Diplomacy Division, 251 p.
- OIV (2001) *The code of descriptive characters of varieties and species of Vitis*. OIV (Off. Int. Vigne Vin), Paris.

- PARFITT, DE, ARULSEKAR, S., 1989. Inheritance and isozyme diversity for GPI and PGM among grape cultivars. *J. Am. Soc. Hortic. Sci.* 114, 486–491.
- Qiu, Z., Chen, J., Zhao, Y., et al., 2018. Variety identification of single rice seeds using hyperspectral imaging combined with convolutional neural network. *Appl. Sci.* 8, 212. <https://doi.org/10.3390/app8020212>.
- REYNIER A., 2003. *Viticulture manual*. Tech. And Doc. Lavoisier, 549 p.
- RIBEREAU-GAYON J. and PEYNAUD E., 1971. *Vine sciences and techniques*. Dunod, Paris, 540 p.
- RIAHI, L., Zoghlami, N., El-Heit, K., Laucou, V., Le Cunff, L., Boursiquot, JM, Lacombe, T., Mliki, A., Ghorbel, A., This, P., 2010. Genetic structure and differentiation among grapevines (*Vitis vinifera*) accessions from Maghreb region. *Broom. Resour. Crop Evol.* 57, 255–272. <https://doi.org/10.1007/s10722-009-9467-6>
- RIAHI L, Zoghlami N, Laucou V, Mliki A, This P (2011) Use of chloroplast microsatellite markers as a tool to elucidate polymorphism, classification and origin of Tunisian grapevines. *Sci Hort* 130:781–786
- RIAHI, L., Laucou, V., Le Cunff, L., Zoghlami, N., Boursiquot, J.-M., Lacombe, T., El-Heit, K., Mliki, A., This, P., 2012. Highly polymorphic nSSR markers: A useful tool to assess origin of North African cultivars and to provide additional proofs of secondary grapevine domestication events. *Sci. Hortic.* 141, 53–60. <https://doi.org/10.1016/j.scienta.2012.04.023>
- RIAHI, L., Zoghlami, N., Fournier-Level, A., Dereeper, A., Le Cunff, L., Laucou, V., Mliki, A., This, P., 2013. Characterization of single nucleotide polymorphism in Tunisian grapevine genome and their potential for population genetics and evolutionary studies. *Broom. Resour. Crop Evol.* 60, 1139–1151. <https://doi.org/10.1007/s10722-012-9910-y>
- SABIR A., TANGOLAR S., BUYUKALACA S. and KAFKAS S., 2009. Ampelographic and molecular diversity among grapevine (*Vitis vinifera* L.) cultivars Czech. *J. Genet. Plant Brres.*, 45, 160-168.
- SA'NCHEHEZ-YE'LAMO, MD, 1992. Isoenzyme electrophoretic studies among some species of genus *Eucastrum* and *Hirscheldia incana* (Cruciferae: Brassicaceae) with reference to their chemotaxonomic relationships. *Biochem. Syst. School.* 20.631–637.
- SÁNCHEZ-ESCRIBANO EM, MARTIN JP, CARREÑO J. and CENIS JL, 1999. Use of Sequence Tagged Microsatellites Site markers for characterizing table grape cultivars. *Genome*, 42, 87-93.
- SCHMIDTKE, LM, Smith, JP, Müller, MC, & Holzappel, BP (2012). Rapid monitoring of grapevine reserves using ATR-FT-IR and chemometrics. *Analytica Chimica Acta*, 732, 16–25. <https://doi.org/10.1016/j.aca.2011.10.055>.
- SCHNEIDER A., 1996. Grape variety identification by means of ampelographic and biometric descriptors. *Riv. Vitic. Enol.*, 1, 11-16.
- SCHWENNESEN, J., Mielke, EA, Wolfe, WH, 1982. Identification of seedless table grape cultivars and a bud sport with berry isozymes. *HortScience* 17, 366–368.
- SCIENZA, A., VILLA, P., TEDESCO, G., PARINI, L., ETTORT, C., MAGENES, S., GIANAZZA, E., 1994. A chemotaxonomical investigation on *Vitis vinifera*. II. Comparison among ssp. *Sativa* traditional cultivars and wild biotypes of ssp. *silvestris* from various Italian regions. *Vitis* 33, 217–224.
- SCOTT, KD, LEE, LS, DOW, T., HENRY, RJ, 2000. Isolation and characterization of new grape microsatellites. *Acta Hortic.* 528, 199–200
- SHAH, N., CYNKAR, W., SMITH, P., & COZZOLINO, D. (2010). Use of attenuated total reflectance midinfrared for rapid and real-time analysis of compositional parameters in

- commercial white grape juice. *Journal of Agricultural and Food Chemistry*, 58, 3279–3283. <https://doi.org/10.1021/jf100420z>
- SIRET R., MERLES MH, BLAISE A., CABANIS JC and THIS P., 2002. New molecular techniques: Application to the characterization of grape varieties in wines. *OIV Bulletin* 2002 (Janv/Ferv), 851-852, 21-27.
- SOLDAVINI, C., STEFANINI, M., DALLASERRA, M., POLICARPO, M., SCHNEIDER, A., 2009. Superampelo, A software for ampelometric and ampelographic descriptions in *Vitis*. *Acta Hort.* 827, 253–258.
- SOTES V., GOMEZ DEL CAMPO M. and RUIZ C., 1996. Use of ampelographic methods for the differentiation of two cultivars of *Vitis vinifera* L. *Riv. Vitic. Enol.*, 1, 5-10.
- SPRING JL, GUGERLI P. and BRUGGER JJ, 2008. Muscats in Valais. *Swiss magazine Vitic. Arboric. Hortic.*, 40, 257-261.
- SWANEPOEL JJ and DE VILLIERS CE, 1987. A numerical taxonomic classification of *Vitis* spp. And cultivars based on leaf characteristic. *S. Afr. J. Enol.*, 8, 31-35.
- TESSIER C., DAVID J., THIS P., BOURSQUOT JM and CHARRIER A., 1999. Optimization of the choice of molecular markers for varietal identification in *Vitis vinifera* L. *Theor. Appl. Broom.* 98, 171-177.
- THOMAS, MR, SCOTT, NS, 1993. Microsatellite repeats in grapevine reveal DNA polymorphism when analyzed as sequence tagged sites (STSs). *Theor. Appl. Broom.* 86, 895–990.
- TOMAŽIČ I. and KOROŠEC-KORUZA Z. 2003. Validity of phyllometric parameters used to differentiate local *Vitis vinifera* L. cultivars. *Broom. Resour. Crop Evol.*, 50, 773-778.
- VIDAL JR, COARER M. and DEFONTAINE A., 1999. Genetic relationships among grapevine varieties grown in different French and Spanish based on RAPD markers. *Euphytica*, 109, 161-172.
- VIGNANI R., SCALI M., MASI E. and CRESTI M., 2002. Genomic variability in *Vitis vinifera* L. Sangiovese assessed by microsatellite and non-radioactive AFLP test *EJB. Elec. J. of Biotech.*, 5, 1-11.
- ZHENG, T., HAIDER, MS, ZHANG, K., Jia, H., FANG, J., 2020. Biological and functional properties of xylem sap extracted from grapevine (cv. Rosario Bianco). *Sci. Hortic.* 272, 109563. <https://doi.org/10.1016/j.scienta.2020.109563>.
- ZINELABIDINE LH, HADDIOUI A., BRAVO G. and MARTINEZ-ZAPATER J., 2010. Genetic Origins of cultivated and wild grapevine from Morocco. *Am. J. Enol. Vitic.*, 61, 83-90.
- ZOGLAMI N, Mliki A, Ghorbel A (2003) Occurrence and discrimination of spontaneous grapes native to Tunisia by RAPD markers. *Acta Hort* 603:157–165.
- ZOGLAMI N, RIAHI L, Laucou V, Lacombe T, Mliki A, Ghorbel A, This P (2009) Origin and genetic diversity of Tunisian grapes as revealed by microsatellite markers. *Sci Hort* 120:479–486
- YANG, HQ, Luo, WQ, Wang, WJ, 2012. Nondestructive discrimination of grape seed varieties using UV-VIS-NIR spectroscopy and chemometrics. *Appl. Mech. Mater. Trans. Tech. Publ.* 89–94.

DETERMINATION OF YIELD PROTEIN CHARACTERISTICS IN DIFFERENT BEAN CULTIVARS

Feride ÖNCAN SÜMER

*Aydın Adnan Menderes University Faculty of Agriculture, Department of Field Crops, Aydın, Turkey
e-mail: fsumer@adu.edu.tr*

ABSTRACT

The experiment was conducted in the 2021-2022 growing season under the conditions of Aydın Province. The study aimed to determine the performance of three different bean varieties (Dermason-Efsane-Maş). The experiment was carried out in the producer field of Köşk district of Aydın province with three replications according to the coincidence blocks experimental design. Grain yield and protein ratios of the varieties were analyzed. It was determined that grain yield values varied between 150-200 kg/da and grain protein ratios varied between 22-25%. As a result of the study, it was determined that genotype factor was effective on the studied traits.

Keywords: Bean, grain yield, grain protein ratio.,

INTRODUCTION

Bean (*Phaseolus vulgaris*) is widely used for direct human consumption, especially in tropical and subtropical countries of America, Europe, Africa and Asia (He et al., 2018). It is cultivated in 126 countries in the world (Mızrak, 2020). Dried beans, which are grown in the temperate climate zone, have a wide adaptation area and can be produced in areas close to sea level in America and Europe and in areas higher than 3000 meters in South America (Sözen and Karadavut, 2020). Although dry bean ranks first in the world among edible grain legumes with a cultivation area of 34,495,662 ha and a production of 30,434,280 tons, it ranks second after chickpea in our country with a cultivation area of 84,786 ha and a production of 220,000 tons. While the average yield in the world countries growing dry beans is 88 kg per decare, this value is around 259 kg in our country (Anonymous, 2018).

Beans are widely consumed in the world and in our country as fresh, canned, fresh grain and dried grain due to their high protein content and delicious taste. Typically, most dried beans contain 15% to 25% protein on a dry weight basis. Water-soluble albumins and salt-soluble globulins account for 10% to 30% and 45% to 70% of total proteins, respectively Globulin in dry beans is salt-soluble and accounts for 50 to 55% of total proteins in dry beans (Sathe, 2002). Its dry grains contain 23-34% protein, 60% carbohydrate, 5% crude cellulose, 1.7% fat and 3.6% ash (Abacı and Kaya, 2018). According to Gepts (2001), beans contain 22-27% protein and 39-47% carbohydrates, making them a valuable foodstuff for more than half a billion people. The digestibility of dry bean proteins ranges from 71-94% (Barampama and Simard, 1994). The main functional components of beans are carbohydrates, vitamins, phytate, lectins, soluble fiber and phenolic. Phenolic, which include phenolic acids, flavonoids and proanthocyanidins, are particularly noteworthy due to their strong antioxidant properties (García-Lafuente et al., 2014). Beans are also rich in proteins that complement the amino acid profile of cereals.

Low yields in beans are associated with both biotic and abiotic stresses. Biotic stresses include diseases, insects and weeds, and the low nitrogen (N) fixing capacity of bean plants. Abiotic stresses include drought, acidic and infertile soils, and reduced use of chemical

fertilizers, especially in developing countries. Plant parameters such as shoot dry weight, pods per plant or per unit area, 100-grain weight, grain harvest index, N harvest index and leaf area index affect bean yield (Fageria and Santos, 2008). In addition, due to increasing global warming in recent years, drought yield losses are generally reported to be between 30% and 90%; (Hussain et al., 2019).

Dry beans have many varieties including black beans, bush beans, pea beans, pink beans, kidney beans, etc. and village varieties. In this study, grain yield and protein values of some bean varieties were determined.

MATERIAL and METHOD

The experiment was conducted in the growing season of 2022 under the conditions of Köşk District of Aydın Province. Grain yield and some yield components of three different bean cultivars (Dermason-Efsane-Local cultivars) were analyzed. The experiment was sown on 2.08.2022 with three replications. After sowing and maintenance operations were carried out during the growing season, the harvest was realized on 29.11.2022. Hoeing was done when the plants reached 15 cm in height.

Figure 1. Meteorological data for the trial area

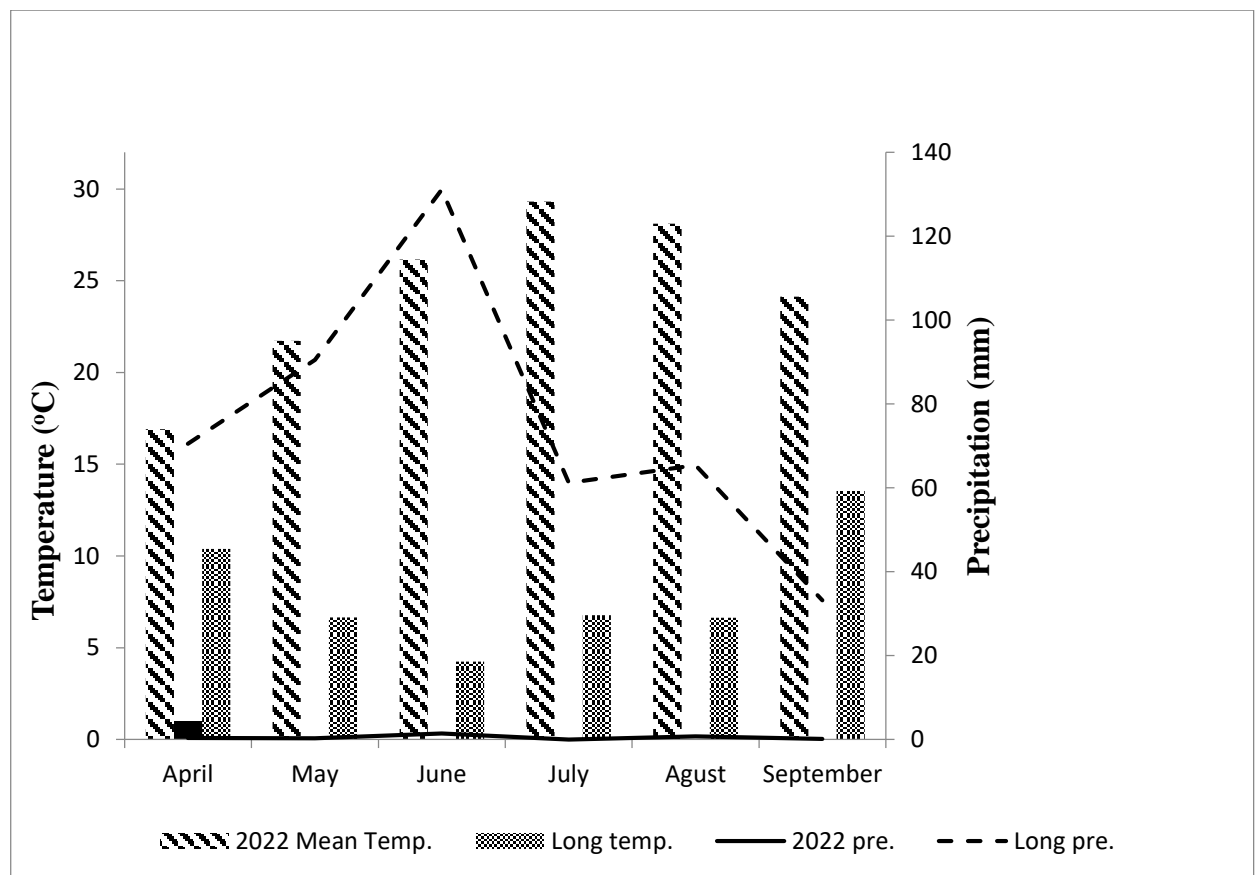

Climatic data are presented in Table 1. According to these data, it is observed that the average air temperatures during the bean growing period are higher than the long-term average and the total rainfall is lower than the long-term average.

RESULTS and DISCUSSION

Table 1 shows the results of ANOVA with the data obtained from the experiment. According to the results, the effect of cultivars on the traits other than pod number was found significant.

Table 1. Analysis of variance for the traits examined in the experiment

Cultivars	Plant Height	First Pod Height	Branch Number	Pod Number	Pod Length	Seed per Pod	100 Seed Weight	Seed Yield	Protein
Blocks	10,05	1,09	0,058	0,671	0,041	0,008	3,821	4,941	0,724
Cultivars	63,41*	118,62*	1,361*	0,618	13,541*	0,383*	57,858*	227,68**	6,168*
General	6,69	1,508	0,091	1,404	0,720	0,0513	2,770	8,971	0,564

*Significant at $P < 0.05$ level, ** Significant at $P < 0.01$ level

Mean values of the traits are presented in Table 2. The average plant height values of the varieties varied between 31.5-40.5 cm. The highest plant height was obtained from Dermason variety with 40.5 cm. Elkoca and Cinar (2015) observed plant height ranging between 37.7-50.5 cm.

Table 2. Averages of the data obtained from the trial

Cultivars	Plant Height (cm)	First Pod Height (cm)	Branch Number	Pod Number	Pod Length (cm)	Seed per Pod	100 Seed Weight (gr)	Seed Yield (kg/da)	Protein (%)
Dermason	40,5 a	17,2 b	3,8 a	8,1	8,0 a	3,4 a	34,0 a	64,5 a	25,0 a
Efsane	34,3 b	14,5 b	3,3 a	6,3	10,9 b	2,7 b	28,1 b	56,6 b	22,5 b
Local	31,5 b	26,5 a	2,4 b	6,7	6,8 b	3,0 ab	23,2 c	47,1 c	22,5 b
Mean	35,4	19,4	3,2	7,0	8,6	3,0	28,4	56,1	23,3
LSD _{cultivar}	5,84	2,78	0,67	ns	0,19	0,49	3,74	6,76	1,68

ns:non significant

The mean values of the first pod height varied between 14.5-26.5 cm. The highest first pod height was obtained from Local (26,5 cm). The varieties were ranked as local>dermason>efsane.

Varieties were found to be significant in terms of the number of lateral branches. mean values varied between 2.4-3.8. the highest number of branches was obtained from dermason (3.8). The number of side branches is one of the factors affecting yield. In previous studies, İyigün and Kayan (2019) measured 6.3-10.2 and Elkoca and Çınar (2015) measured 2.1-3.6 branches per plant.

The difference between the varieties in terms of the number of pods was not found to be significant. However, in average values, dermason variety (8.1 pieces) had a higher number of

Pods per plant compared to other varieties. However, Güneş (2015) reported that the effect of genotypes on the number of pods in bean was significant and the mean values varied between 14.9-46.1. Bozoğlu and Gülümser (2000) and Babagil et al. (2011) reported that the number of pods per plant varies depending on genotype and environmental conditions.

The difference between the varieties in terms of the number of grains in pods was found to be significant. The highest number of grains was obtained from dermason (3,4). This was followed by local>efsane. Yılmaz (2008) measured the number of grains in pods as 2.50-3.87 and Babagil et al. (2011) measured 8.63 grains. Akçin (1974) reported that yield components in beans differ according to growing conditions and genetic structure. Some other researchers reported that there may be significant differences in the number of grains in pods, which is a character with high heritability, according to varieties (Ülker and Ceyhan, 2008; Güneş, 2011).

The difference between the varieties in terms of hundred grain weight was found to be significant. dermason variety (34.0 g) had the highest hundred grain weight followed by efsane>local. In previous studies, Kahraman and Önder (2009) measured face grain weights between 23.98 - 41.62 g, Bozoğlu and Gülümser (2000) measured face grain weights between 15.96-52.09 g.

The effect of varieties on grain yield was found to be significant. The variety with the highest grain yield was dermason (64,5 kg/da). This was followed by efsane (56,6 kg/da)>local (47,1 kg/da). Düzdemir (1998) and Pekşen and Gülümser (2005) reported that many factors affect the productivity of bean varieties and genetic structure is one of the most important traits affecting yield. In previous studies, Bozoğlu and Gülümser (2000) reported that grain yield varied between 162.7 and 237.7 kg/ha, Elkoca and Çınar (2015) reported that grain yield varied between 92.0 kg/ha and 195.4 kg/ha.

The effect of varieties on grain protein values was found to be significant. The highest protein content was measured in dermason (25%), while the protein contents of legend and local were the same. In some of the studies, the grain protein content of the genotypes was lower than our results (17.96-22.07%) (Shimelis and Rakshit, 2005,) in some of the studies it was similar to our results (22.03-24.86%) (Barros and Prudencio, 2016) and in some of the studies it was higher than our results (21.0-30.0%) (Pinheiro et al., 2010). It is reported that genotypes differ in terms of protein content and this difference is influenced by genetic structure and environmental conditions (Vural et al., 1986; Santalla, et al., 1995).

CONCLUSIONS

According to the results of the study, dermason variety was high yielding among the varieties. While the number of pods was not found to be effective on the varieties, the difference between the varieties in terms of plant height, first pod height, number of branches, pod length, number of grains in pods, grain yield and protein ratio was found to be significant.

REFERENCES

- Abacı E, Kaya M (2018) Farklı Termal Suların Fasulye (*Phaseolus vulgaris* L.)’de Çimlenme ve Bazı Fide Gelişim Özelliklerine Etkileri. Süleyman Demirel Üniversitesi Ziraat Fakültesi Dergisi, 13(2) :1-6.
- Babagil G.E. , Tozlu E., Dizikısa T., 2011. Erzincan ve Hınıs ekolojik koşullarında yetiştirilen bazı kuru fasulye genotiplerinin verim ve verim unsurlarının belirlenmesi. Atatürk Üniv. Ziraat Fak. Derg., 42 (1): 11-17
- Barros, M., Prudencio, S.H., 2016. Physical and chemical characteristics of common bean varieties. Semina: Ciências Agrárias, 37(2): 751-762. doi:10.5433/1679-0359.2016v37n2p751

- Bozođlu, H. ve Gölümser, A., 2000. Kuru fasulyede bazı tarımsal özelliklerin genotip çevre interaksiyonları ve stabilitelelerinin belirlenmesi üzerine bir araştırma. Turk J Agric For 24: 211–220.
- Düzdemir, O., 1998. Kuru Fasulye (*Phaseolus vulgaris* L.) Genotiplerinde Verim ve Diğer Bazı Özellikler Üzerine Bir Araştırma. Gaziosmanpaşa Üniversitesi Fen Bilimleri Enstitüsü (Basılmamış), Yüksek Lisans Tezi, Tokat, 64 s.
- Elkoca, E., Çınar, T., 2015. Bazı kuru fasulye (*Phaseolus vulgaris* L.) çeşit ve hatlarının Erzurum ekolojik koşullarına adaptasyonu, tarımsal ve kalite özellikleri. Anadolu Tarım Bilimleri Dergisi, 30:141-153.
- Fageria, N. K., & Santos, A. D. (2008). Yield physiology of dry bean. Journal of plant nutrition, 31(6), 983-1004.
- García-Lafuente, A., Moro, C., Manchón, N., Gonzalo-Ruiz, A., Villares, A., Guillamón, E., ... & Mateo-Vivaracho, L. (2014). In vitro anti-inflammatory activity of phenolic rich extracts from white and red common beans. Food Chemistry, 161, 216-223.
- Gepts, P. (2001). *Phaseolus vulgaris* (Beans). In: Encyclopedia of Genetics, pp. 1444–1445. Brenner S., and Miller J. H., Ed., Academic Press, Los Angeles.
- Güneş, Z., 2011. Van-Gevaş’da Ümitvar Bulunan Fasulye (*Phaseolus vulgaris* L.) Hatlarında Verim ve Bazı Verim Öğelerinin Belirlenmesi. Yüzüncü Yıl Üniversitesi Fen Bilimleri Enstitüsü, Yüksek lisans Tezi, Van, 34 s
- He, S., Simpson, B. K., Sun, H., Ngadi, M. O., Ma, Y., & Huang, T. (2018). *Phaseolus vulgaris* lectins: A systematic review of characteristics and health implications. Critical reviews in food science and nutrition, 58(1), 70-83.
- Hussain, S., Hussain, S., Qadir, T., Khaliq, A., Ashraf, U., Parveen, A., ... & Rafiq, M. (2019). Drought stress in plants: An overview on implications, tolerance mechanisms and agronomic mitigation strategies. Plant science today, 6(4), 389-402.
- İyigün, T. & Kayan, N. (2019). Bazı fasulye genotiplerinin Eskişehir koşullarına uyum yetenekleri . Akademik Ziraat Dergisi , 8 (2) , 291-300 . DOI: 10.29278/azd.597086
- Kahraman, A., Önder, M. 2009. Genetic diversity in the dwarf dry bean populations grown in Konya. 1st International Symposium on Sustainable Devel, 3(8-10), 13-19.
- Mızrak, G. (2020). FASULYE YETİŞTİRİCİLİĞİ. Gürbüz Mızrak.
- Pekşen, E., Gölümser, A., 2005. Bazı fasulye (*Phaseolus vulgaris* L.) genotiplerinde verim ve verim unsurları arasındaki ilişkiler ve path analizi. Ondokuz Mayıs Üniversitesi Ziraat Fakültesi Dergisi, 20 (3): 82-87.
- Pinheiro, C., Beata, J.P., Pereira, A.M., Domingues, H., Ricardo, C.P., 2010. Diversity of seed mineral composition of *Phaseolus vulgaris* L. germplasm. Journal of Food Composition and Analysis, 23: 319-325. doi.org/10.1016/j.jfca.2010.01.005.
- Santalla, M., Ron, A, M., Casquero, P. A., 1995. Nutritional and culinary quality of bush bean populations inter cropped with maize. Euphytica 84:57-65.
- Sathe, S. K. (2002). Dry bean protein functionality. Critical reviews in biotechnology, 22(2), 175-223.
- Shimelis, E.A., Rakshit, S.K., 2005. Proximate composition and physico-chemical properties of improved dry bean (*Phaseolus vulgaris* L.) varieties grown in Ethiopia. Food Science and Technology, 38: 331-338. doi.org/10.1016/j.lwt.2004.07.002
- Sözen, Ö., & Karadavut, U. (2020). Farklı lokasyonlarda yetiştirilen kuru fasulye genotiplerinin (*Phaseolus vulgaris* L.) bazı kalite özelliklerinin belirlenmesi üzerine bir araştırma. Türk Tarım ve Doğa Bilimleri Dergisi, 7(4), 1205-1217.
- Wilker, J., Navabi, A., Rajcan, I., Marsolais, F., Hill, B., Torkamaneh, D., & Pauls, K. P. (2019). Agronomic performance and nitrogen fixation of heirloom and conventional dry bean varieties under low-nitrogen field conditions. Frontiers in plant science, 10, 952

- Ülker, M., Ceyhan, E., 2008. Orta Anadolu ekolojik şartlarında yetiştirilen fasulye (*Phaseolus vulgaris* L.) genotiplerinin bazı tarımsal özelliklerinin belirlenmesi. Selçuk Üniversitesi Ziraat Fakültesi Dergisi, 22 (46): 77-89
- Vural, H., Şalk, A., Özzambak, E., Eşiyok, D., 1986 Bazı önemli yerli kuru fasulye çeşitlerinin Bornova koşullarında yetiştirilmeye uygunlukları üzerine araştırmalar. Ege Üniversitesi Ziraat Fakültesi Dergisi. 23(1):15-23. İZMİR.
- Yılmaz, S., 2008. Erzincan koğullarında kuru fasulye yetiştiriciliği için uygun ekim zamanı ve çeşitlerin belirlenmesi. Erzincan Bahçe Kültürleri Araştırma Merkezi ile TAGEM ortak projesi

THE IMPORTANCE OF LENTIL GRAIN QUALITY IN HUMAN NUTRITION

Feride ÖNCAN SÜMER

*Aydın Adnan Menderes University Faculty of Agriculture, Department of Field Crops, Aydın,
Turkey*

e-mail: fsumer@adu.edu.tr

ABSTRACT

The lentil is one of the edible grain legume plants that have been cultivated and used in nutrition from ancient times to the present day. In our country, the cultivation of commercial lentils is second only to chickpea among edible legume crops. The lentil production, which has an important position in the agriculture of our country, consists of 87.8% red lentils and 12.2% green lentils. Besides having an important place in human nutrition due to its high protein content, lentils also have an important effect on animal nutrition. Its dry grains contain 25% protein. In addition, it also contains important amino acids such as isoleucine and lysine. When compared to cereals, it is an important legume plant in terms of nutritional value with its high amount of protein and rich amino acid content. In human nutrition, lentils are preferred more than other edible grain legumes due to its low amount of anti-nutritional factors, high protein content and short cooking time compared to other legumes. The lentil is a legume that provides additional income to both the producer and the national economy by entering the cultivation shift in arid regions.

Key words: Lentil, grain protein content, quality, amino acid,

INTRODUCTION

Lentils are an important nutritious crop grown around the world due to their high macro and micronutrient content, including all minerals. Canada and India account for 58% of total production in the world. It can replace animal proteins, especially in countries where poor people live. In developed countries, it takes its place as a part of vegetarian diets (Sharma et al., 2022).

Lentil protein and its amino acid composition maintain amino acid balance for physiological functions. It can positively affect human health by preventing protein-energy malnutrition and non-communicable diseases. Therefore, studies aim to improve the protein quality of lentils (Salaria et al., 2022). Factors affecting protein quality include protein content, amino acid composition and protein digestibility. Although lentil has a protein content of 23.22-31.7%, it contains higher protein than cereals and this protein content can be affected by variety and environmental factors (Lee et al., 2007; Zeidan, 2007; Niri et al., 2010; Nosworthy et al., 2018; Amirnia et al., 2019; Öktem 2019; Köse et al., 2019; Küçükay et al., 2019; Subedi et al., 2021)

Influence of Some Factors on Lentil Grain Quality

Harvest Date

Lentil grain quality also depends on harvest time. Choosing the right harvest time helps to harvest the best quality grains. Lentil plants are usually sown in the fall and green and red lentils are harvested with moisture contents around 16-18% and 14-16%, respectively (Chelladurai and Erkinbaev 2020). It is recommended to harvest lentils at higher moisture levels (16-20% weight) in order to reduce grain losses during harvest and reduce post-harvest drying

losses to 13-14% to extend shelf life. This can also increase susceptibility to damage and breakage during transportation, storage and post-harvest handling (Opoku et al., 2009).

Seed Size

The size and shape of lentil grains also affect grain quality. More regular and homogeneous grains are generally considered to be of higher quality. In terms of market preference, cooking time and hull separation are greatly influenced by seed size and shape. Moreover, seed size and seed number determine the overall seed yield of any crop; this trait is determined at early seed development stages (Dutta et al., 2022). Large grain varieties favor higher emergence and lower mortality, increased seedling, root: and shoot rates (Sing et al., 2019). Among various quality traits, seed size is an important trait that defines overall lentil quality. Lentil cultivars with round seed shape have reduced damage during processing compared to thin, sharp-edged cultivars (Singh et al., 2022). In a study conducted on neither lentils nor chickpeas, it was found that the effect of seed size on yield and yield components was not significant (Biçer, 2009) Lentils generally cook faster than other legumes due to their seed size and thin seed coat (Choukri, et al., 2023).

Grain Density

The density of lentil grains has an impact on their commercial and processing value. Higher grain density is considered to be higher quality lentil grains. Lentils contain high amounts of dietary fiber. Dietary fiber is widely recognized in plants to comprise mainly the plant cell wall, complex substances of indigestible polysaccharides (e.g. cellulose, hemicellulose, oligosaccharides, pectins, gums), waxes and lignin, In addition, pulse fibers can be used to improve or modify the texture of food products through fat or water retention Important health benefits associated with dietary fiber intake include reduced risk of heart disease, diabetes, obesity, and some types of cancer (Tosh and Yada 2010)

Grain Color

Lentil grains can be of different colors. Color is a factor affecting grain quality. Seed coat color is an important visual trait that significantly affects the market value of pulse grains (Mishili et al., 2009). There are different colored lentil species in the market such as red, green, yellow and black. It is noteworthy that the color of lentil grain is an important quality parameter (Shahin and Symons, 2001). The color of lentil seeds can range from light to brown or darker brown; (Jackson et al., 2021) Red and green lentil species are the most widely consumed varieties of these edible legumes (Oduro-Yeboah et al., 2023) The color of lentils has been reported to vary from black, brown, green, orange, red or yellow depending on the variety and the composition of the cotyledons and seed coats. The cotyledon color, which can be red or yellow, is the main factor determining the color of the groats, while the color of the seeds can be black, brown, green, gray or tan depending on the color of the seed coat. (Mokrani, 2023)

Factors Important for Human Nutrition in Lentil Grain

Proteins and Amino acids

Lentil proteins consist of storage proteins classified according to their solubility properties, including globulins (salt soluble), glutelins (dilute acid/base soluble) and prolamins (alcohol soluble). The protein content consists of 16% albumin, 70% globulins, 11% glutelins and 3% prolamins (Boye et al., 2010; Joehnke et al. 2021). Lentil proteins are stored in protein bodies called 'storage proteins' in cotyledon cells (Duranti and Gius, 1997). These seed proteins provide carbon (C), nitrogen (N) and sulfur (S) and account for 80% of the total protein available for plant growth and disease resistance after germination (Khazaei et al., 2019). Furthermore, lentils can be an alternative to animal and soybean proteins in food processing industries due to their broad functional properties (Khazaei et al., 2019). As functional properties of proteins in foods; solubility, water retention and fat binding capacities, foaming properties are of great importance in determining the quality of the protein (Boye et al., 2010).

Lentils are a source of high quality protein. High protein content is an important factor in terms of nutritional value.

The synthesis of sufficient protein in cells for the body to remain healthy requires a good balance of amino acids. Of the 20 amino acids needed to synthesize protein, nine are essential for adults and must be ingested through food (Bonke et al., 2020). The most abundant amino acid in lentils is glutamic acid, followed by aspartic acid, arginine, leucine and lysine, while cystine, tryptophan and methionine are at the bottom of the list according to their content. Therefore, methionine and tryptophan are the first and second limiting amino acids, respectively. Lentil proteins contain both essential and non-essential amino acids, but the sulfur-containing amino acids methionine (Met) and cysteine amino acids are less abundant (Salaria et al., 2022).

Table 1. Amino acid content of lentil grain

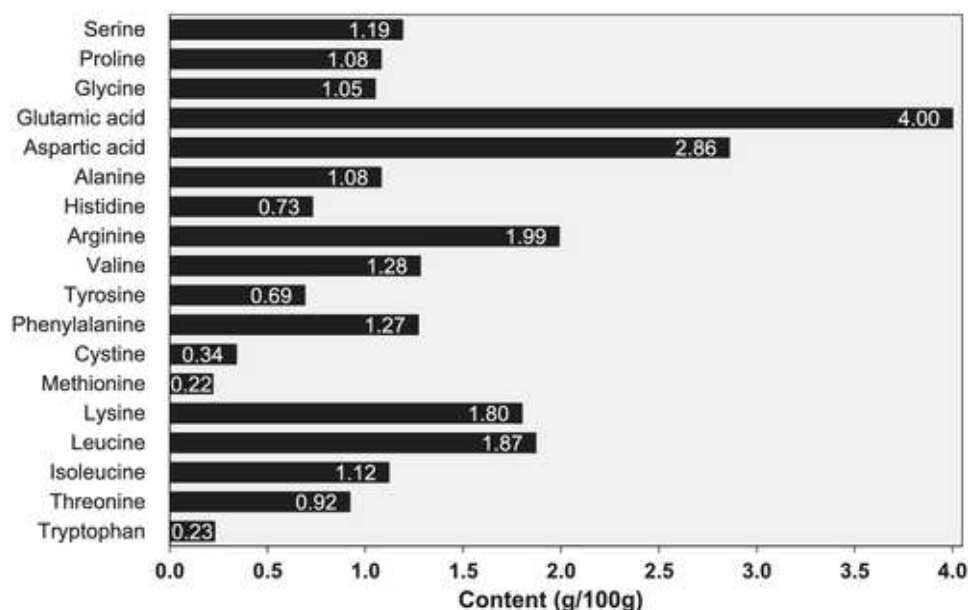

Source: (Dhull et al., 2023)

Lentils contain all essential amino acids (table 1). When assessing grain quality, the amino acid profile of lentil grains should also be considered. Especially the content of important amino acids such as lysine and methionine is important. It is also rich in leucine, arginine, aspartic and glutamic amino acids. It contains limited amounts of sulfur-containing amino acids (methionine and cysteine) and tryptophan (Monnet et al., 2019). Due to the high content of amino acids such as lysine and arginine, lentils complement cereal proteins (Paucean et al., 2018). Amino acid amounts in lentil varieties were examined. They measured that Arginine, one of the essential amino acids, was the most abundant amino acid in most of the lentil genotypes and ranged from 6.6 to 10 g/kg. It was followed by leucine, valine, lysine, phenylalanine, threonine, histidine and isoleucine amino acids. In a study, tryptophan and methionine were found to be the limiting amino acids and ranged from 0.61 to 0.92 and 0.96 to 2.1 g/kg, respectively (Alghamdi et al., 2013).

Vitamin and Mineral Content

In studies conducted in the USA, Canada and Egypt, the mineral content of raw, dehulled and cooked grains varies. This content may vary according to the chemical composition of the grain and the type of soil in which the lentil is grown.

Table 2. Lentil mineral composition

	Ca	K	P	Mg	S	Fe	Zn	Cu	Mn	Na	I	B	Se	Mo
g/kg	mg/kg													
Raw														
Whole seed	0.20-1.60	5.4-14.4	0.72-6.30	0.70-2.98	1.2-2.56	54-505	181.8-330	2.0-18.0	8.4-20.0	13-1100	0	1.5	2.3-6.0	0.15-1.60
Kernel	0.47-0.88	7.80-80.62	2.86-5.22	0.91	-	40-101	31.5	8.9	14.2	25-840	-	-	0.56	-
Cooked														
Whole seed	0.16-4.0	0.2-2.0	1.15-4.68	0.5-0.90	1.0-1.2	22-24	29-33	8.0-28.0	17-8.0	60-200	-	-	-	0.16-1.82
kernel	0.18-0.84	3.92-8.11	1.86-3.17	0.3	-	39.8-370		2.5-9.0	2.5-9.0	21.1	-	-	-	-

Source: Sharma et al., 2022.

Lentils are richer in calcium than cereals (table 2). It is found in equal amounts in the husk and seed. It has the lowest calcium content among legumes. Phosphorus is accumulated in the grain. 40.5-42.9 % of the phosphorus in lentil grain is found in phytic acid. The level of phytic acid phosphorus in kabuki and grain may decrease during cooking. The sodium content is in a wide range of 13-849 mg/kg in whole grain and 25-840 mg/kg in grain.

In general, legumes are rich in B group vitamins and generally low in A, C and E group vitamins. While cooking causes a loss of vitamins in legumes, peeling the skins may increase the vitamin content (Pekşen and Artık, 2005).

Other Nutrients

Lentils also contain other nutrients such as fiber, vitamins, minerals and antioxidants. These nutrients also affect grain quality. Lentils are a nutritionally high-quality legume with high protein content, slowly digestible starch and carbohydrate with lower crude fiber content, essential minerals, vitamins and high energy value. Moreover, lentils also contain significant amounts of bioactive phytochemicals such as antioxidants and phytoestrogens (Kaale et al., 2023). Bioactive compounds found in lentils include polyphenols (flavonols, tannins, phenolic compounds), phytate, phytosterols, minerals, vitamins, oligosaccharides, resistant starch, proteins, bioactive peptides and saponins and have beneficial health effects. Scientific research explains that consumption of lentils has beneficial effects on cardiovascular diseases, diabetes, and various types of cancer (Zhang et al., 2014). Lentils have the highest total phenolic content compared to six other legumes such as green peas, chickpeas, cowpeas, yellow peas, mung beans and peanuts

CONCLUSIONS

Studies have partially revealed the nutritional content of lentil grain. Lentils are frequently used in meals because they are easy to eat and have high digestibility. It is a preferred food with low calories and high protein content.

REFERENCES

- Alghamdi, S. S., Khan, A. M., Ammar, M. H., El-Harty, E. H., Migdadi, H. M., Abd El-Khalik, S. M., ... & Al-Faifi, S. A. (2013). Phenological, nutritional and molecular diversity assessment among 35 introduced lentil (*Lens culinaris* Medik.) genotypes grown in Saudi Arabia. *International journal of molecular sciences*, 15(1), 277-295.
- Amirnia, R., Ghiyasi, M., Siavash Moghaddam, S., Rahimi, A., Damalas, C. A., & Heydarzadeh, S. (2019). Nitrogen-fixing soil bacteria plus mycorrhizal fungi improve seed yield and quality traits of lentil (*Lens culinaris* Medik). *Journal of Soil Science and Plant Nutrition*, 19, 592-602.
- Asif, M., Rooney, L. W., Ali, R., & Riaz, M. N. (2013). Application and opportunities of pulses in food system: a review. *Critical reviews in food science and nutrition*, 53(11), 1168-1179.
- Bhatty, R. S., Slinkard, A. E., & Sosulski, F. W. (1976). Chemical composition and protein characteristics of lentils. *Canadian Journal of Plant Science*, 56(4), 787-794.
- Biçer, B. T. (2009). The effect of seed size on yield and yield components of chickpea and lentil. *African Journal of Biotechnology*, 8(8).
- Bonke, A., Sieuwerts, S., & Petersen, I. L. (2020). Amino acid composition of novel plant drinks from oat, lentil and pea. *Foods*, 9(4), 429.
- Boye, J., Zare, F. & Pletch, A. (2010). Pulse proteins: processing, characterization, functional properties and applications in food and feed. *Food Research International*, 43, 414-431.
- Boye, J. I., Aksay, S., Roufik, S., Ribéreau, S., Mondor, M., Farnworth, E., & Rajamohamed, S. H. (2010). Comparison of the functional properties of pea, chickpea and lentil protein concentrates processed using ultrafiltration and isoelectric precipitation techniques. *Food Research International*, 43(2), 537-546.
- Chelladurai, V., & Erkinbaev, C. (2020). Lentils. *Pulses: Processing and product development*, 129-143.
- Choukri, H., El Haddad, N., Aloui, K., Hejjaoui, K., El-Baouchi, A., Smouni, A., ... & Kumar, S. (2022). Effect of high temperature stress during the reproductive stage on grain yield and nutritional quality of lentil (*Lens culinaris* Medikus). *Frontiers in Nutrition*, 9, 857469.
- Dhull, S. B., Kinabo, J., & Uebersax, M. A. (2023). Nutrient profile and effect of processing methods on the composition and functional properties of lentils (*Lens culinaris* Medik): A review. *Legume Science*, 5(1), e156.
- Duranti, M., & Gius, C. (1997). Legume seeds: protein content and nutritional value. *Field Crops Research*, 53(1-3), 31-45.
- Dutta, H., Mishra, G. P., Aski, M. S., Bosamia, T. C., Mishra, D. C., Bhati, J., ... & Dikshit, H. K. (2022). Comparative transcriptome analysis, unfolding the pathways regulating the seed-size trait in cultivated lentil (*Lens culinaris* Medik.). *Frontiers in Genetics*, 13, 942079.
- Kaale, L. D., Siddiq, M., & Hooper, S. (2023). Lentil (*Lens culinaris* Medik) as nutrient-rich and versatile food legume: A review. *Legume Science*, 5(2), e169.
- Khazaei, H., Subedi, M., Nickerson, M., Martínez-Villaluenga, C., Frias, J., & Vandenberg, A. (2019). Seed protein of lentils: Current status, progress, and food applications. *Foods*, 8(9), 391.
- Köse, Ö. D. E., Bozoğlu, H., & Zeki, M. U. T. Mercimek Genotiplerinin Kimyasal, Fizikokimyasal Özellikleri ile Mineral Madde İçeriklerinin Değerlendirilmesi. *Journal of Agricultural Faculty of Gaziosmanpaşa University (JAFAG)*, 36(1), 23-29.

- Küçükay, A. B., Şener, A., & Kaya, M. (2019). Determination of Yield and Yield Components of Red Lentil Varieties in Isparta Conditions. *Turkish Journal of Agriculture-Food Science and Technology*, 7(Special Issue 2), 97-102.
- Jackson, N., Noble, S. D., & Vandenberg, A. (2021). Evaluating the effect of light exposure and seed coat on lentil cotyledon color by computer vision. *Legume Science*, 3, e98.
- Laskar, R. A., Laskar, A. A., Raina, A., Khan, S., & Younus, H. (2018). Induced mutation analysis with biochemical and molecular characterization of high yielding lentil mutant lines. *International journal of biological macromolecules*, 109, 167-179.
- Lee, H. C., Htoon, A. K., & Paterson, J. L. (2007). Alkaline extraction of starch from Australian lentil cultivars Matilda and Digger optimised for starch yield and starch and protein quality. *Food Chemistry*, 102(3), 551-559.
- Joehnke, M. S., Jeske, S., Ispiryani, L., Zannini, E., Arendt, E. K., Bez, J., ... & Petersen, I. L. (2021). Nutritional and anti-nutritional properties of lentil (*Lens culinaris*) protein isolates prepared by pilot-scale processing. *Food chemistry: X*, 9, 100112.
- Mishili, F.J.; Fulton, J.; Shehu, M.; Kushwaha, S.; Marfo, K.; Jamal, M.; Kergna, A.; Lowenberg-DeBoer, J. Consumer preferences for quality characteristics along the cowpea value chain in Nigeria, Ghana, and Mali. *Agribusiness* 2009, 25, 16–35.
- Mokrani, A. (2023). In vitro assessment of antioxidant capacity and phenolic contents of some lentil (*Lens culinaris* L.) cultivars commonly consumed in Algeria. *Chemical Papers*, 1-12.
- Monnet, A. F., Laleg, K., Michon, C., & Micard, V. (2019). Legume enriched cereal products: A generic approach derived from material science to predict their structuring by the process and their final properties. *Trends in Food Science & Technology*, 86, 131-143.
- Niri, H. H., Tobeh, A., Gholipouri, A., Zakaria, R. A., Mostafaei, H., & Jamaati-e-Somarin, S. (2010). Effect of nitrogen and phosphorous on yield and protein content of lentil in dryland condition. *Am Eurasian J Agric Environ Sci*, 8(2), 185-188.
- Nosworthy, M. G., Medina, G., Franczyk, A. J., Neufeld, J., Appah, P., Utioh, A., ... & House, J. D. (2018). Effect of processing on the in vitro and in vivo protein quality of beans (*Phaseolus vulgaris* and *Vicia Faba*). *Nutrients*, 10(6), 671.
- Oduro-Yeboah, C., Sulaiman, R., Uebersax, M. A., & Dolan, K. D. (2023). A review of lentil (*Lens culinaris* Medik) value chain: Postharvest handling, processing, and processed products. *Legume Science*, 5(2), e171.
- Opoku, A., Tabil, L., & Meda, V. (2009). Effect of microwave drying and storage on the color, breakage, dehulling and cooking quality of two red lentil varieties. The Canadian Society for Engineering in Agricultural, Food, Environmental, and Biological Systems (CBSE). Paper presented at the CSBE/SCGAB 2009 Annual Conference, Georgetown, PEI, Canada (Paper No. CSBE09-304).
- Öktem, A. G. (2019). Effects of different zinc levels on grain yield and some phenological characteristics of red lentil (*Lens culinaris* Medic.) under arid conditions. *Turkish Journal of Agriculture and Forestry*, 43(3), 360-367.
- Papandreou, C., Becerra-Tomás, N., Bulló, M., Martínez-González, M. Á., Corella, D., Estruch, R., ... & Salas-Salvadó, J. (2019). Legume consumption and risk of all-cause, cardiovascular, and cancer mortality in the PREDIMED study. *Clinical Nutrition*, 38(1), 348-356.
- Paucean, A., Moldovan, O. P., Mureşan, V., Socaci, S. A., Dulf, F. V., Alexa, E., ... & Muste, S. (2018). Folic acid, minerals, amino-acids, fatty acids and volatile compounds of green and red lentils. Folic acid content optimization in wheat-lentils composite flours. *Chemistry Central Journal*, 12, 1-9.

- Salaria, S., Boatwright, J. L., Thavarajah, P., Kumar, S., & Thavarajah, D. (2022). Protein biofortification in lentils (*Lens culinaris medik.*) toward human health. *Frontiers in Plant Science*, 13, 869713.
- Shahin, M. A., & Symons, S. J. (2001). A machine vision system for grading lentils. *Canadian Biosystems Engineering*, 43, 7-7.
- Siddiq, M., Oduro-Yeboah, C., & Abong, G. O. (2023). Value-Added Processing of Lentils and Emerging Research Trends. *Lentils: Production, Processing Technologies, Products, and Nutritional Profile*, 63-85.
- Singh, A., Dikshit, H. K., Mishra, G. P., Aski, M., & Kumar, S. (2019). Association mapping for grain diameter and weight in lentil using SSR markers. *Plant Gene*, 20, 100204.
- Singh, A., Dikshit, H. K., Mishra, G. P., Aski, M., Kumar, S., Sarker, A. (2022). Breeding for abiotic stress tolerance in lentil in genomic era. In *Genomic designing for abiotic stress resistant pulse crops*
- Subedi, M., Khazaei, H., Arganosa, G., Etukudo, E., & Vandenberg, A. (2021). Genetic stability and genotype \times environment interaction analysis for seed protein content and protein yield of lentil. *Crop Science*, 61(1), 342-356.
- Tosh, S. M., & Yada, S. (2010). Dietary fibres in pulse seeds and fractions: Characterization, functional attributes, and applications. *Food research international*, 43(2), 450-460.
- Wang, N., & Daun, J. K. (2006). Effects of variety and crude protein content on nutrients and anti-nutrients in lentils (*Lens culinaris*). *Food chemistry*, 95(3), 493-502.
- Zeidan, M. S. (2007). Effect of organic manure and phosphorus fertilizers on growth, yield and quality of lentil plants in sandy soil. *Res. J. Agric. Biol. Sci*, 3(6), 748-752.
- Zhang B, Deng Z, Tang Y, Chen P, Liu R, Ramdath DD et al (2014) Fatty acid, carotenoid and tocopherol compositions of 20 Canadian lentil cultivars and synergistic contribution to antioxidant activities. *Food Chem* 161(Supplement C):296–304
- Zia-Ul-Haq, M., Ahmad, S., Shad, M. A., Iqbal, S., Qayum, M., Ahmad, A., ... & Amarowicz, R. (2011). Compositional studies of lentil (*Lens culinaris Medik.*) cultivars commonly grown in Pakistan. *Pak. J. Bot*, 43(3), 1563-1567.

THE EVALUATION OF SOME DROUGHT INDICES IN SUNFLOWER HYBRIDS IN DRY CONDITIONS

Fatmagül KAVUT¹, Ali Kemal AYAN¹, Selim AYTAÇ²

¹ *Ondokuz Mayıs University, Agriculture Faculty, Field Crops Department, Samsun, Turkey*

² *Ondokuz Mayıs University, Hemp Search Institute Samsun, Turkey*

Corresponding author e-mail: sekenay@gmail.com

ABSTRACT

The biodynamic farming system was built in 1924 by Rudolf Steiner (philosopher) and E. Pfeiffer (agronomist) and an anthropological theory based on the concept of human-nature-universe. Biodynamic farming is familiar to organic farming. Fundamentally, both stem from opposing perspectives on the use of chemical inputs (fertilizers, pesticides, herbicides, hormones, etc.). The basic ecological principle of biodynamic agriculture is that it considers the farm as an organism and a self-sufficient entity. Organic agriculture, home-made products, safe and traceable foods and ancient teachings (old knowledge) have come to the fore in societies that have turned inward with the effect of the Covid 19 pandemic. It was prepared to compile the teachings.

Keywords: Biodynamic Agriculture, Plant Life, Demeter

INTRODUCTION

With the existence of humanity, nutrition has taken the first place among basic needs. From the research carried out in different geographies of the world, where the first findings of people living together were made, to the ruins of Göbeklitepe in our country, to today's modern age, the existence of agriculture cannot be ignored. Production of plant and animal products, improving their quality and efficiency, preserving, processing, evaluating and marketing these products under appropriate conditions are the basic issues of today's agriculture. Proof of the negative effects of pesticides used in the past years on human health and the fact that the damage to the environment constitutes the most important input cost in production has enabled the development and dissemination of production models such as GAP, Organic Agriculture and EKUY. With the 1990s, "ORGANIC AGRICULTURE" came to the fore. Organic agriculture includes plant rotation, green manure, compost, "biological pest control" and relies on mechanical processing to ensure soil productivity; It is a method of agriculture that rejects or limits the use of synthetic fertilizers, pesticides, hormones, animal feed additives and genetically modified organisms (Anonim., 2023).

Biodynamic agriculture is; Increasing popularity with the industrial revolution in the 18th century and global warming caused people to realize the ecological degradation on the world, and accordingly, saving ecology and the world became one of the main topics of current affairs. The biodynamic farming system was built in 1924 by Rudolf Steiner (philosopher) and E. Pfeiffer (agronomist) and an anthropological theory based on the concept of human-nature-universe. Biodynamic farming is familiar to organic farming. Fundamentally, both stem from opposing perspectives on the use of chemical inputs (fertilizers, pesticides, herbicides, hormones, etc.) (Anonim., 2023a) The basic ecological principle of biodynamic agriculture is that it considers the farm as an organism and a self-sufficient entity. It is accepted that each farm has its own characteristics, that is, an individuality. The aim is to recycle everything produced on the farm land, sustainability of the soil, and the healthy continuity of the crops and

sheltered animals. Farmers are also a part of this whole. As a result of the farmer acting by taking into account the interactions in his ecosystem, the environmental, social and financial aspects of the farm are highlighted and a holistic management is implemented. The farmer produces with minimal external inputs and uses materials from his own farm whenever possible. With this feature, biodynamic agriculture is the most economical production and processing method for farmers.

Biodynamic agriculture came to life with the ancient knowledge that Rudolf Steiner, a philosopher, scientist, educator, artist and founder of the school of anthroposophy, born in Austria in the second half of the 19th century, gathered under the title 'Agricultural Lessons' in Koberwitz in 1924 and conveyed it to farmers in eight separate seminars (Anonim., 2023b).

Biodynamic agriculture is a spiritual, ecological and holistic organic living system. The aim is to heal the soil.

In biodynamic agriculture, defined as nature-friendly agriculture, celestial dynamism and agriculture are used together. In biodynamic agriculture, environmental pollution is minimized by preserving soil and water. In this agricultural method based on integrated pest management, the aim is not to eliminate the pest completely, but the basic principles are to protect soil and water resources by preserving biodiversity, collecting rainwater and ensuring that the organic matter and water retention capacity in the soil is at the desired

level. In biodynamic agriculture;

- Minimal cultivation of the soil
- Minimizing chemical entry
- Protecting biodiversity
- Ensuring that the soil is covered with products
- It is based on the basic principles of adaptation to the local environment.

In biodynamic agriculture, it is known that in plant production, as the moon grows, the ones growing upwards are decreasing while they shrink downwards, that is, the plants with rhizomes and tubercles are affected by planting, harvesting or collecting ripe fruits in these periods, and that the plants are exposed to insect attacks during this period because the amount of liquid that attracts insects increases in the plant at the new moon. . The water in the soil rises with the gravity of the moon. Therefore, capillarity in the soil also increases during the full moon. Planting is completed a few days before the full moon. It is known that logs left on the new moon (when the moon is waxing) attract insects, while logs left on the old moon (when the moon is waning) do not harm insects.

Completing work and operations according to the moon movements is a part of farming. While all biodynamic agricultural products are organic, not every organic product is a biodynamic product.



Figure 9. Effect of moon phases on agriculture

All technical, economic and legal measures taken to protect agricultural products from diseases and damages, to treat them or to minimize the damage that may arise from them are called plant protection (plant health) (Anonim 2023₁). Plant protection activities are quite comprehensive and form the basis of agricultural activities. It should not be forgotten that growing the plant healthy is much more economically and environmentally important than saving it after it becomes sick / damaged.

The distinguishing feature of biodynamic agriculture is the use of nine biodynamic preparations defined by Steiner to improve soil quality and stimulate plant life. They consist of mineral, plant or animal manure extracts, usually fermented and administered in small proportions to compost, fertilizers, soil or directly to plants, after dilution and mixing procedures called dynamisation. Original biodynamic (BD) preparations are identified by numbers to distinguish each plant. BD 500 preparation (horn manure), also known as land preparation (spray preparation), is made from cow manure (obtained by fermenting cow manure by burying it in the ground for six months during autumn and winter) and is sprayed into the soil to stimulate solid root development and humus formation. . BD 501 preparation (horn silica) is obtained by filling powdered quartz into cow horn and burying it in the ground for six months during spring and summer. It is applied as a foliar spray to stimulate growth, regulate and enhance flavour. The next six preparations, BD 502-507, are used in preparing Compost. Finally, there is the BD preparation 508, which is prepared from the silica-rich horsetail plant (*Equisetum arvense*) and used as a foliar spray to suppress fungal diseases in plants. (1).

Medicinal plants used in biodynamic agriculture: Biodynamic compost, together with biodynamic preparations, are the cornerstones of this practice. It is an effective way to transform animal manure and organic waste on the farm, keep the nitrogen level in balance, increase humus production and ensure the healthy sustainability of the soil. BD Compost and its preparations prepared with BD preparations are listed below:

- No. 502 Yarrow flowers (*Achillea millefolium*)
- No. 503 Chamomile flower (*Chamomilla officinalis*)
- No. 504 Nettle (*Urtica dioca*)
- No. 505 Oak bark (*Quercus robur*)
- No. 506 Dandelion flowers (*Taraxacum offtcinale*)
- No. 507 Valerian (*Valeriana officinalis*)

Biodynamic preparations are thought to help to improve and strengthen life on the farm (etheric), as well as to moderate and regulate biological processes. Preparations are used in homeopathic amounts, that is, they produce an effect in extremely dilute amounts. (Anonim., 2023c).

Medicinal plants used in biodynamic agriculture:

- 1- Yarrow flowers (*Achillea millefolium*):
- 2- Daisy flower (*Chamomilla officinalis*)
- 3- Nettle (in full bloom on the whole plant) (*Urtica dioica*)
- 4- Oak bark (*Quercus robur*)
- 5- Dandelion flowers (*Taraxacum officinale*)
- 6- Valerian (*Valeriana officinalis*)

Characteristics of medicinal plants used in biodynamic agriculture:

Yarrow flowers (*Achillea millefolium*): Yarrow is also known as the Kandil flower and the thousand-leaf herb, which grows spontaneously in our country. It has been known and used since ancient times for its different therapeutic properties. According to legend, in ancient Greece, Achilles used yarrow to heal the wounds of his friends during the siege of Troy (Anonim., 2021). *Achillea* is a mythological plant, belonging to the Asteraceae family, growing especially in the northern hemisphere, with more than 100 species in the world and a total of 52 taxa in our country, 30 of which are endemic. *Achillea* species are used in folk medicine to reduce fever, relieve colds, relieve digestive complaints and heal wounds (Anonim., 2023l). As a medicinal plant, yarrow has a plant height of 25-95 cm, depending on the ecological conditions in which it is found. In general, yarrow can show its growth and development ability up to an average altitude of 2500 meters (Anonim 2023m). In biodynamic agriculture, the preparation prepared in the deer bladder increases the adaptation of the plant used to its location and regulates the potassium metabolism, nitrogen, carbon, sulfur and potassium processes in the plant.



Figure1. Yarrow and Deer Bladder (Anonim 2023r).

Chamomile flower (*Chamomilla officinalis*) *Matricaria chamomilla* (Medical Chamomile, May daisy) is from the Asteraceae (Compositae) family, and most of the plants of this family are herbaceous, a few of them are shrubs or trees. The family is the richest family of flowering plants, with nearly 1000 genera and nearly 20,000 species. (Anonim.,2023d). Chamomile has been used in herbal medicine for thousands of years and is known in ancient Egypt, Greece and Rome. Anglo-Saxons believe that this plant is one of the 9 sacred plants given to humans by God. Chamomile medicine is included in the pharmacopoeia of 26 countries. As a medicine for flatulence, colic, hysteria and intermittent fever. The flowers of *chamomilla* contain between 0.2% and 1.9% blue essential oil. Chamomile is used mainly as an anti-inflammatory and antiseptic, but also as an antispasmodic and mild diaphoretic. True daisy is an annual plant with thin spindle-shaped roots that penetrate only straight into the soil. The flower heads with long

and narrow leaves are individually located, 10-30 mm in diameter, stalked and heterogamous. The 5-toothed golden-yellow tubular flowers are 1.5-2.5 mm long and always end in a glandular tube. The chamber is 6–8 mm wide, initially flat, later conical, cone-shaped, hollow (the latter being a very important distinguishing feature of *Matricaria*) and paleaeless (Anonim., 2023n). In biodynamic agriculture, this sulfur-containing preparation prepared in the cow intestine reacts with calcium and regulates the health of the soil.

Nettle (in full flower on the whole plant) (*Urtica dioica*) is a large group within the Urticales order of the Nettle family (Urticaceae), widespread in tropical and subtropical areas of both hemispheres. He listed 48 genera and 1050 species in the Nettle family. Cronquist (1981) described the nettle family as having features such as stinging hairs, individual seeds, most of them lacking milky pulp, simple leaves and showing foreign pollination (Anonim., 2023e).

The rhizomes of the nettle plant spread more than 150 cm underground, and the fringe roots develop by exiting along the underground rhizomes. It is covered with burning pointed soft hairs on a thin and branchless stem that can grow up to 90-300 cm high. Since the flowers are separate sexual, male and female clusters are found on the same plant but in different leaf axils, or there may be completely male or female flowers on different plants. Its state is longer than the female flower state. The plant has many uses in medicine, as a fiber, in cosmetics, as a dye, pollen source, animal food, energy plant, insecticide, herbicide and fertilizer (Ayan et al., 2020). In biodynamic agriculture, it is used to improve the soil structure.

Oak bark (*Quercus robur*) has a wide distribution in Europe, Turkey and the Caucasus. Its general distribution in portions is in Thrace, the Black Sea Region and Eastern Anatolia. It is a multidimensional forest tree that can live 400-500 years, sometimes 1,000 years. It is found in small groups or singly in forests, on foothills of mountains, on plains with high water table, and in streams. It can spread up to altitudes of 100-2,300 meters. It is quietly sensitive to mild autumn and winter frosts. It is resistant to cold climate conditions. It thrives more in a temperate and humid climate (Anonim., 2023f). Oak is a large deciduous tree. The diameter of its body can reach up to 4-12 meters. The oak is 7–14 centimeters (2.8–5.5 in) tall, with lobes and very short stems. It flowers in mid-spring and its acorns ripen in mid-autumn. Mature trees are flood resistant. It is long lasting. Ensuring the transformation of trees with large branches like a wide crown. Although they can live for several centuries in nature, the longest-lived ones are those pruned by humans. (19)In biodynamic agriculture, animal

(such as cows, goats, horses, sheep) The preparation prepared in its pages promotes calcium processes and protects fungi from infecting and pests. Configure exactly that data wherever the plant is likely to be

Dandelion (*Taraxacum officinale*) is a common plant species from the Asteraceae family. Even though its flowers are yellow and its leaves are green, the name of the plant is called "dandelion". This plant, known as "katagan" by the Egyptian and Kipchak Turks and "saçratku" by the Chagatai Turks, has survived to this day as "dandelion". Chicory is a word of Arabic origin. It is claimed that the eye disease it is used to treat is caused by trachoma. Although it is known as "acıgıçcı", "acıgünek", "güneyik", "çıtlık", "cırtlık" and "arlandışi" in Anatolia, its most commonly used name is "radika". Dandelion grows in meadows and roadsides all over the field in April and May. is a perennial herbaceous plant with yellow flowers. The long taproot, filled with a bitter milk called "kengel", bears deeply toothed leaves gathered at the base in rosettes and flower stalks that are longer than the leaves (Anonim., 2023g). In biodynamic agriculture, the preparation prepared from cow shirt fat (Cow intestinal hanger) promotes calcium processes and protects the fungus from diseases and pests. It strengthens the exact area of the plant where there is a possibility of disease.

Catnip:(*Valeriana officinalis*,) is a perennial herbaceous plant with fragrant leaves, stems, flowers and roots. The plant, which grows up to 30-150 cm, has deeply lobed basal leaves and white to pale pink flowers in a paniculate flower state. Its roots have a strong scent that cats love. The used parts, such as the rhizome, root and stolon, are harvested in September and must be carefully dried at temperatures below 40°C. The plants, which usually grow naturally on roadsides and fields, are native to Europe and Western Asia. The plant grows naturally in Europe, Asia, Northeast America and Turkey. *Valeriana* genus is represented by 12 species including this species in our country. The genus name comes from the medieval name derived from the Latin word “valere” meaning “to be wholesome,” possibly in reference to the plant's medicinal uses in nervousness and hysteria (Anonim., 2023h). In biodynamic treatment, it increases the processes of phosphorus and is used to regulate the relationship between temperature, soil, fertilizer and plants.



Figure 3. (Anonim 2023s).



Figure 4. (Anonim 2023t).

Biodynamic compost, together with biodynamic preparations, are the cornerstones of this practice. It is an effective way to transform animal manure and organic waste on the farm, keep the nitrogen level in balance, increase humus production and ensure the healthy sustainability of the soil. Biodynamic preparations are thought to help to improve and strengthen life on the

farm (etheric), as well as to moderate and regulate biological processes. Preparations are used in homeopathic amounts, meaning that they produce an effect in extremely dilute amounts. For example, just one teaspoon of each preparation is added to a seven to ten-ton compost pile (Anonim 2023k).

Table 1. Table 1. Preparation and usage of MAP used in Biodynamic Agriculture (Anonim., 2023j).

PLANT OF
PREPARATIONS
(502-507)

of the preparation Its number	name	what what it is prepared in or filled with	effect
502P	Yarrow flowers (Achillea millefolium)	Deer in his bladder	It increases the adaptation of the plant to its location and regulates potassium metabolism, nitrogen, carbon, sulfur and potassium processes in the plant.
503P	Daisy blossom (Chamomilla officinalis)	Cow in your gut	This prp. containing sulfur reacts with calcium and regulates the health of the soil.
504P	Urtica (Urtica dioca)		Improves the structure of the soil
505P	Oak peel (Quercus robur)	Animal (such as cow, goat, horse, sheep) to the skull	It promotes calcium processes and protects the fungus from diseases and pests. It strengthens the exact area of the plant where there is a possibility of disease.
506P	Dandelion flowers (Taraxacum officinale)	Cow shirt oil (Cow intestine hanger)	It promotes potassium and silicate processes, increases the plant's adaptation to external conditions and its ability to absorb nutrients.
507P	Valerian (Valeriana officinalis)	—	It increases phosphorus processes and regulates the relationship between temperature, soil, fertilizer and plants.

CONCLUSION and RECOMMENDATIONS

As a result, in response to the increasing world population, in order to increase plant and animal production at the same pace, to keep it at a certain standard and efficiency, to ensure sustainability in agriculture by causing the least harm to the environment, soil, water and other living things, people have engaged in agricultural activities in different ways and methods from the Industrial Revolution to the present day.

With Biodynamic Agriculture;

1. By harvesting rain water, existing water resources will be protected and water will not be wasted. Noting that our water resources are rapidly decreasing and we are among the water poor countries, it is important to protect water resources in Biodynamic agriculture.

2. Considering the negative effects of the pesticides used on soil, water, air and other living things, the global and national costs are very high.

3. BD 502 yarrow contains potassium and sulfur BD 503 medicinal chamomile stabilizes nitrogen in biodynamic compost piles. It activates the soil and revitalizes the plant. BD 504 provides the nitrogen, iron, potassium and calcium that the plant needs and revitalizes the soil. BD 505 is used against oak bark fungal diseases. BD 506 strengthens the relationship between dandelion flowers silicylic acid and potassium. Silica attracts cosmic power to the soil. BD 507 valerian flowers stimulate photosynthesis. It increases flowering and fruit set. BD 508 horsetail prevents fungal diseases (Pakkener.,2023)

4. In the application time and repetition of the above-mentioned compost and preparations, the plant used should be used in accordance with the "Biodynamic Agricultural Calendar", taking into account the element of water, air, fire or earth, and the state of the planets and the moon.

5. Biodynamic agriculture is ahead of organic agriculture in ensuring sustainability in agriculture by protecting soil, water, the environment and other living things.

6. They often decide when to plant and harvest crops, when to prune fruit trees, when insects will infest the crops, when to trim the wool of animals, and when to make bulgur, tomato paste, pickles, cheese and bread by looking at the moon in the sky at night.

7. Considering the current state of the agricultural areas used by the Egyptians, who practiced irrigated agriculture by taking advantage of the tides in the Nile River hundreds of years ago, the reuse of ancient teachings, the transfer of the wisdom of the ancestors from generation to generation, BIODYNAMIC agriculture, which is an environmentally friendly agriculture model compatible with celestial and earth movements, should be implemented in suitable locations. and should be an example to the new generation and the world by opening up to ecotourism.

8. The basis of the biodynamic philosophy is based on the DEMETER certificate. Demeter takes its name from Demeter, the goddess of agriculture, fertility, seasons and maternal love in Greek mythology. It symbolizes crops, especially wheat. Biodynamic agriculture;

- The farmer must first have his business certified by a control and certification body (KSK) in accordance with the relevant regulations of the European Union (EU): 834/2007 and 889/2008.

- The farmer starts bio-dynamic agriculture by working with a consultant accredited for Turkey by "Demeter".

- The transition of the producer certified according to the EU to biological dynamic agriculture is made by the consultant according to the "Demeter" regulation.

- The agricultural enterprise is controlled by a KSK approved by Demeter and its report is sent to Demeter. Certification is done by Demeter based on the report.

The yield trials were conducted in Edirne and Tekirdag location in 2017 to determine yield performances of candidate sunflower hybrids. There were 23 hybrids including 4 controls from commercial hybrids (ITALICA, SY GIBRALTAR, P 64 LL 62, LG 5582) in the market. The experimental design was a Randomized Complete Block Design with four replicates. The four rows plots were 7,50-m long with the 70 x 35 cm plant spacing. Total plot area at planting was 7,5*2,8 as 21 m². The middle two rows were harvested and the border rows were discarded, and plot size was 9.66 m² at harvest. The compose fertilizers (20-20-0, Zn) were applied 200 kg/ha dose at planting. Statistical analysis was performed with JMP statistical program.

Tekirdag location was conducted in Beyazkoy village fields, Saray County and the trials were planted by hand in 15 April 2017. Emergence date of sunflower plants was in 22 April 2017 and left only one plant each as mentioned plant density above. The trials were harvested by hand in 25 August 2017 as middle two rows except one plant at the beginning of the middle rows. Edirne location was conducted in Sarayakpinar village fields and the trials were planted by hand in 28 April 2017. Emergence date of sunflower plants was in 5 May 2017 and the trials were harvested by hand in 5 September 2017. The plant height and head diameter of hybrids were measured from 3 plants at mid rows of the plots in each replication at PM stage. Oil content of the hybrids were determined utilizing Nuclear Magnetic Resonance (NMR) analysis.

Some sunflower hybrids both from classical and IMI types were planted in the pots to measure responses to drought conditions with measuring of dry and wet root weight as well as total chlorophyll content as the most known drought indices in sunflower drought tests (Figure 1, 2 and 3). The ratio of Chlorophyll content of sunflower hybrids was recorded by Portable Florescence Device (HandyPEA, Hansatech Ltd.) at R5-1 vegetative stages (Figure 4). Furthermore, plant height, plant number per area, leaf number per plant, leaf area, anthocyanin existence, head inclination, hairiness at stem, total chlorophyll content, leaf width and leaf length were measured at the yield trials conducted in the field to determine their responses to drought stress.

REFERENCES

- Anonim2023;https://tr.wikipedia.org/wiki/Organik_tar%C4%B1m (erişim tarihi :18.07.2023 saat 22:00).
- Anonim., 2023a <http://agrifoodscience.org/index.php/TURJAF/article/view/1648> (erişim tarihi :18.07.2023 saat 22:15).
- Anonim., 2023b <https://demeter-turkey.com/biyodinamik-organik-tarim-nedir> (erişim tarihi :18.07.2023 saat 22:20).
- Anonim., 2023c <https://demeter-turkey.com/biyodinamik-preparatlar-hangileridir-islevleri-nelerdir> (erişim tarihi :18.07.2023 saat 22:10) .
- Anonim.,2023d chrome-extension://efaidnbmnnnibpcajpcgclefindmkaj/https://www.researchgate.net/profile/Reza-Amirnia/publication/316621915_The_influence_of_altitude_on_the_morphology_of_achilla_millefolium_in_iran_azerbaijan/links/590856a2aca272116d3dfaf2/The-influence-of-altitude-on-the-morphology-of-achilla-millefolium-in-iran-azerbaijan.pdf (erişim tarihi :16.09.2023 saat 22:26).
- Anonim 2021 <https://dogal-tarim.org/index.php/2021/01/21/civanpercemi-achillea-millefolium/> (erişim tarihi :18.07.2023 saat 22:30).
- Anonim., 2021 <chrome-extension://efaidnbmnnnibpcajpcgclefindmkaj/http://libratez.cu.edu.tr/tezler/11572.pdf> (erişim tarihi :18.07.2023 saat 22:45)

Anonim 2023e chrome-extension://efaidnbmnnnibpcajpcglclefindmkaj/https://dergipark.org.tr/tr/download/article-file/187642 (erişim tarihi :18.07.2023 saat 22:00).

Anonim 2023f https://www.ogm.gov.tr/tr/yararli-bilgiler/haftanin-agaci/sapli-mese (erişim tarihi :18.07.2023 saat 22:50).

Anonim., 2023g https://tr.wikipedia.org/wiki/Karahindiba (erişim tarihi :18.07.2023 saat 22:55).

Anonim 2023h https://tibuad.istanbul.edu.tr/tr/content/blog/valeriana-officinalis-(kediotu) (erişim tarihi :18.07.2023 saat 23:20)

Anonim 2023i https://books.google.com.tr/books?hl=tr&lr=&id=lhjfljKGM0sC&oi=fnd&pg=PA1&dq=bitki+koruma+nedir&ots=44ZV6jJBls&sig=hZ-9xdK5l3Apt2iKE3Arg0SemSE&redir_esc=y#v=onepage&q=bitki%20koruma%20nedir&f=false erişim tarihi :13.09.2023 saat 23:20).

Anonim 2023j https://demeter-turkey.com/biyodinamik-preparatlar-hangileridir-islevleri-nelerdir (erişim tarihi :16.09.2023 saat 20:18).

Anonim 2023k https://demeter-turkey.com/rudolf-steiner (erişim tarihi :15.09.2023 saat 20:31).

Anonim 2023l https://teav.ankara.edu.tr/xmlui/handle/20.500.12575/85263 erişim tarihi :16.09.2023 saat 22:20).

Anonim 2023m chrome-extension://efaidnbmnnnibpcajpcglclefindmkaj/https://www.researchgate.net/profile/Reza-Amirnia/publication/316621915_The_influence_of_altitude_on_the_morphology_of_achilla_millefolium_in_iran_azerbaijan/links/590856a2aca272116d3dfaf2/The-influence-of-altitude-on-the-morphology-of-achilla-millefolium-in-iran-azerbaijan.pdf (erişim tarihi :16.09.2023 saat 22:26).

Anonim 2023n https://www.ncbi.nlm.nih.gov/pmc/articles/PMC3210003/ (erişim tarihi :16.09.2023 saat 22:38).

Isırgan (Ayan AK, Aytaç S, Paslı R.Isırgan 2020 DOKAP yayınları)
https://tr.wikipedia.org/wiki/Saplı%20me%20Fe (erişim tarihi :16.09.2023 saat 23:06).

20. Zir.Müh.Mine PAKKENER (Antalya Tarım Online Ders Notları).

Fotograf 1 :

Anonim 2021a images.search.yahoo.com/search/images;_ylt=AwrigyrlAQZIBOMEJhOJzbfK;_ylu=c2xrA3RleHQEaXQDQWxzbl1RyeV9OBHNIYwNyZWwEcG9zAzc-?p=Yarrow+Varieties&fr2=p%3As%2Cv%3Ai%2Cm%3Ars-top%2Cct%3Abing%2Crgn%3Atop%2Cpos%3A7&fr=yfp-t#id=27&iurl=https%3A%2F%2Fwww.petalrepublic.com%2Fwp-content%2Fuploads%2F2021%2F05%2FPopular-Yarrow-Types-Species-and-Cultivars.jpeg&action=click erişim tarihi :16.09.2023 saat 22:40).

Fotograf 2-3:

Anonim2023r https://images.search.yahoo.com/search/images;_ylt=AwrFG099AwZl3CMd0h1XNyoA;_ylu=Y29sbwNiZjEEcG9zAzEEdnRpZANBRFRFU1RTQ18xBHNIYwNwaXZz?p=Chamomilla+officinalis&fr2=piv-web&fr=yfp-t.#id=54&iurl=https%3A%2F%2Fwww.naturamediterraneo.com%2FPublic%2Fdata%2Ffistrice%2F20045113919_camo.jpg&action=click erişim tarihi :16.09.2023 saat 22:35)

https://eunis.eea.europa.eu/species/185149 (erişim tarihi :16.09.2023 saat 22:15)

Anonim 2023s Fotograf 4-9: <https://www.harsitvadisi.com/mese-agaci-pelit-nedir.html>
erişim tarihi :16.09.2023 saat 22:00).

<https://www.exotic-seeds.store/tr/home/common-dandelion-seeds-medical-herb-taraxacum-officinale.html> (erişim tarihi :16.09.2023 saat 22:10).

<https://pixabay.com/tr/photos/kediotu-bah%C3%A7e-kediotu-848672/> erişim tarihi :16.09.2023 saat 10:00).

Tablo 1: Bayturan N.(<https://zehirsizsofralar.org/biyodinamik-tarim-nedir/>) erişim tarihi :17.09.2023 saat 20:00).

FEASIBILITY OF SAFFRON (*Crocus sativus* L.) CULTIVATION IN AEGEAN REGION, TÜRKİYE

Mehmet Uğur Yıldırım^{1*}, Hossein Kazemi², Ercüment Osman SARIHAN¹, Tuba ARJUMEND³

¹ Uşak University, Faculty of Agriculture, Department of Field Crops, Uşak, Türkiye

² Gorgan University of Agricultural Sciences and Natural Resources (GUASNR), Faculty of Plant Production, Department of Agronomy, Gorgan, Iran.

³ Department of Plant Protection, Faculty of Agriculture, Uşak University, Türkiye.
Corresponding author e-mail: hkazemi@gau.ac.ir

ABSTRACT

In the past few years, an increasing interest in saffron (*Crocus sativus* L.) cultivation has been observed due to its high economic value and low requirements to agronomical inputs. Based on this, a study was done to investigate the climatic parameters in Aegean region (Türkiye) for the development of saffron cultivation using spatial analysis of geographic information system (GIS). Some climatic parameters including annual rainfall, annual average temperature, minimum temperature, maximum temperature, relative humidity and number of frost days were chosen for saffron-land suitability analysis in Aegean region. This climatic data was obtained from metrological stations located within the study area. The total data was averaged from 1991 to 2020. In this research, the climatic requirements of saffron were determined and classified based on scientific sources and the opinions of local experts. The final land suitability map indicated that the most suitable areas for growing saffron were located in the south, central and western Aegean region. Also, in the viewpoint of the number of frost days, the north of this region was located in non-suitable (NS) zone especially Kütahya. The results highlighted that in the areas with limited saffron production potential across the region, the main limiting features were number of frost days and minimum temperature. In general, development of saffron cultivation is possible in the southern part of Aegean region especially İzmir and Denizli. In addition, Aydın, Manisa, Uşak and Muğla provinces were classified as moderately suitable (S2) zone. These results can be useful as a planning support tool for decision makers and farmers to determine feasibility of saffron cultivation in Aegean region.

Keywords: Aegean, Climatic parameters, GIS, Saffron

INTRODUCTION

Saffron (*Crocus sativus* L.) is the most expensive plant in the world. Although other types of saffron are also used as ornamental plants due to having beautiful flowers, but its cultivated species has a special place economically. The distinctive characteristics of saffron is the appearance of flowers before the vegetative organs, the beginning of vegetative growth in the autumn, end of growth in the spring, the lack of fertile seed production, and harvesting flowers in the morning (Kafi, 2001).

Saffron (*C. sativus* L.) is an economically important species of the *Crocus* genus within the Iridaceae family. It is known that there are approximately 85 species of crocus (*Crocus*) in the world. Approximately 70 species of these grow naturally in Asia Minor and Mediterranean countries (Vurdu, 2004; Yıldırım et al., 2016; Yıldırım and Hatipoğlu, 2020). It is stated that a total of 72 taxa, including 36 species and 36 subspecies, grow naturally in Turkey, and 19 of

these species and 21 of the subspecies, a total of 40 taxa, are endemic in Turkey (Yıldırım et al., 2016; 2017; Yıldırım and Hatipoğlu, 2020).

Climatic parameters and their effects on plants are one of the most important effective factors in increasing yield and agricultural production. With agro-climatological evaluation, it is possible to determine the current facilities of different regions in terms of growing different plants and make maximum use of these facilities. In this regard, Rashid Sorkhabadi et al., (2014) determined the suitable area for saffron cultivation based on climatic and soil variables using the hierarchical analysis method in Torbet-Haidarieh city (east of Iran). The climatic capability of saffron cultivation in Kermanshah (west of Iran) was investigated by Mojarad and Ghaforizadeh (2014). The results of the research showed that nearly 30.48% of region had the moderate capacity for saffron cultivation. In other study, Maleki et al. (2017) developed a land use suitability model for saffron cultivation by multi-criteria evaluation and spatial analysis in northeast of Iran (Azadshahr township). The results demonstrated that climate and soil conditions play major role in potential saffron cultivation.

In the last few years, an increasing interest in saffron expansion has been observed due to the high economical value and low requirements to agronomical inputs. The present study was therefore carried out with the objective land suitability analysis for feasibility saffron cropping using geographical information system (GIS), and evaluation of climatic variables in Aegean region, Türkiye.

MATERIAL AND METHOD

Study area

The study carried out in Aegean region, Türkiye, during 2023. The Aegean region is one of the 7 geographical regions of Türkiye (Figure 1). This region covers approximately 11% of Türkiye's territory, with a surface area of around 85,000 km². It is neighbor on the Marmara Region in the north, Central Anatolia Region in the east, and the Mediterranean Region in the southeast and surrounded by the Aegean Sea in the west. The provinces in the Aegean Region are Kütahya, Uşak, Aydın, Manisa, Denizli, Muğla, İzmir, and Afyonkarahisar. The climate type in the Aegean region is the Mediterranean climate. Summers are hot and dry in the region, while winters are rainy and warm. The Mediterranean climate is more common on the coast than inland. Cold weather is seen in the northern parts of the region. January is the coldest month, and July is the hottest. The amount of precipitation can vary between 500 and 999 mm (Anonymous, 2021).



Figure 1. Location of the study area in Aegean region, Türkiye

Climatic data

In this study, some climatic parameters include annual rainfall, annual average temperature, minimum temperature, maximum temperature, relative humidity and number of frost days are chosen for saffron-land suitability analysis and thematic maps are developed for each of the parameters. These climatic data are obtained from 8 meteorological stations located within the study region. The data are averaged from 1991 to 2022. In this research, the spatial distribution of climatic variables is evaluated using interpolation methods.

Land suitability analysis

In GIS environment, all the spatial data convert into raster layers and georeferenced to UTM coordinate system. In order to assess the land suitability of Aegean region, are used to match the climatic requirements of saffron and the land characteristics. Schematic diagram of land suitability is shown in Figure 2. The first step in delineating suitable areas is to identify the relevant climatic variables. In this research, the climatic requirements are identified from scientific resources and local expert's opinion then classified (Table 1) and thematic maps are provided by ArcGIS 10.3 software. Then land suitability model carried out based on matching between land qualities/characteristics and crop requirements by weighted overlay technique (WOT) in GIS media. In final, the land suitability map for this crop is generated in 3 classes including: suitable (S1), moderately suitable (S2), and non-suitable (NS). Thus, S1 class represents that the land unit is suitable to saffron production with no limitations, S2 class represents that the land unit is moderately suitable with some limitations; and non-suitable(NS) land was assumed to have limitations (Zhang et al., 2015; Nasrollahi et al., 2017).

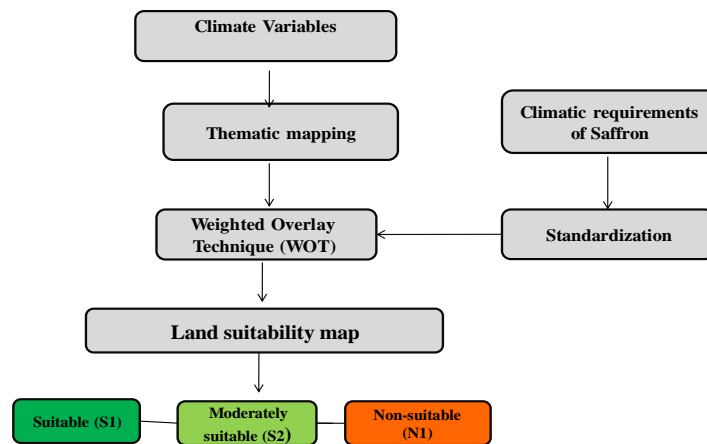

Figure 2. Schematic diagram of land use suitability for saffron in Aegean region, Türkiye.

Table 1. Criteria for delineating land suitability of saffron

Climatic factors	Suitable (S1)	Moderately suitable (S2)	Non-suitable (NS)
Annual rainfall (mm)	300-400	180-300 >400	<180
Rainfall of reproductive period (mm)	17-20	17-25	>25
Rainfall of growth period (mm)	>58	37-58	<37
Annual average temperature (°c)	>14.5	9.5-14.5	>9.5
Maximum temperature of reproductive period (°c)	>23	14.5-23	<14.5
Maximum temperature of growth period (°c)	23	15-23	<15
Minimum temperature of reproductive period (°c)	>9	5-9	<5
Minimum temperature of growth period (°c)	>(-14)	(-14)-(-22)	<(-22)
Number of frost days	<20	20-40	>40
Relative humidity (%)	40-50	50-70	>70

RESULTS AND DISCUSSION

The final land suitability map indicated that the most suitable area for growing saffron were located in the south, central and western of Aegean region (Figure 3). Also, in the viewpoint of the number of frost days, the north of this region was located in non-suitable (NS) zone particularly Kütahya. The low number of frost days especially during flowering, is an advantage for growing saffron (Arsalani et al, 2015). Basically, the occurrence of autumn frosts during the flowering time of saffron has a very harmful effect on crop (Nokandi, 1999). Mojarad and Ghaforzadeh (2014) concluded that the average number of frost days in the reproductive growth period for saffron to be 16.5 days or less. Also, our results highlighted that the main limiting features in non-suitable class were number of frost days, minimum temperature, high relative humidity, and high annual rainfall.

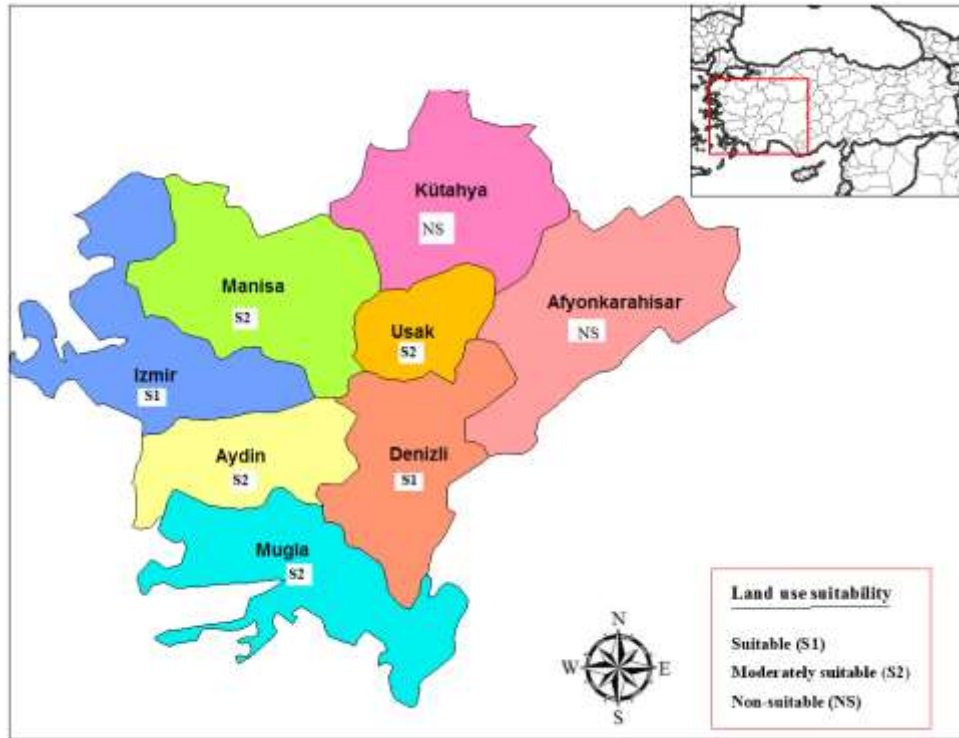

Figure 3. Land suitability map for saffron cultivation in Aegean region Türkiye.

Results showed that development of saffron cultivation is possible (S1 class) in the south part of Aegean region, especially İzmir and Denizli (Figure 3). In addition, Aydın, Manisa, Uşak and Muğla provinces were classified in moderately suitable (S2) zone. Maleki et al. (2017) demonstrate that climate and soil conditions play major role in potential saffron expansion in northeast of Iran (Azadshahr). Their results highlighted that the main limiting features in these region were high rainfall in reproductive stage of saffron (25-30 mm), slope 12% <, high relative humidity, low annual rainfall and high elevation in north (2700 m <). In general, these results can be useful for decision markers and farmers to determine feasibility of saffron cultivation in Aegean region, as a planning support tool.

REFERENCES

- Anonymous. 2021. Geographical Regions of Turkey: Aegean Region. <https://www.tremglobal.com/articles/geographical-regions-of-turkey-aegean>
- Arsalani, F., Rasouli, J., Asgharzadeh, A. 2015. Climatic variables effects (rainfall, temperature, relative humidity, number of frost days and sunshine hours) on saffron yield (*Crocus sativus* L.) in Kashmar and Ghaenat. J. Saffron Crop. Technol. 3(1):66-75. (In Persian with English Summary).
- Kafi, M. 2001. Saffron, technology, production, process. Zaban and Adab Press. Mashhad, 276pp. (In Persian).
- Maleki, F., Kazemi, H., Siahmarguee, A., Kamkar, B, 2017. Development of a land use suitability model for saffron (*Crocus sativus* L.) cultivation by multi-criteria evaluation and spatial analysis. Ecol. Eng. 106:140-153.
- Mojarad, F., Ghaforizadeh, M. 2014. Climatic capability of saffron cropping in Kermanshah and Kurdistan provinces. Geograph. Res. 2:87-102. (In Persian with English Summary)

- Nasrollahi, N., Kazemi, H., Kamkar, B. 2017. Feasibility of ley-farming system performance in a semi-arid region using spatial analysis. *Ecol. Ind.* 72:239-248.
- Nokandy, A.K. 1999. Climatic variables effects on saffron cultivation in south of Khorasan. M.Sc. Thesis, Geography and Planning College, Esfahan University, 125pp. (In Persian with English ABSTRACT)
- Rashid Sorkhabadi, M., Shahidi, A., Khashei Sioki, A. 2014. Determine suitable regions for saffron cultivation based on water and soil parameters by analytical hierarchy process (Case study: Torbat Heidariyeh township). *Saffron Res. J.* 1:58-72. (In Persian with English Summary).
- Vurdu, H. 2004. Room Table: Agronomical and biotechnological approaches for saffron improvement. *Proceedings of the First on Saffron Biology and Biotechnology Acta Horticultura*, Number 650: 285-290.
- Yıldırım, M.U., Asil, H., Hajyzadeh, M., Sarihan, E.O. and Khawar, K.M. 2017. Effect of changes in planting depths of saffron (*Crocus sativus* L.) corms and determining their agronomic characteristics under warm and temperate (Csa) climatic conditions of Turkish province of Hatay. *Acta horticulturae.* 47-54. Doi: 10.17660/ActaHortic.2017.1184.7.
- Yıldırım, M.U., Hatipoğlu (Bayram), H. 2020. Farklı Büyüme Ortamı ve Hümik Asit Uygulamalarının Safran (*Crocus sativus* L.) Kormlarının Gelişimine Etkisi . *Ziraat Fakültesi Dergisi* , Türkiye 13. Ulusal, I. Uluslararası Tarla Bitkileri Kongresi Özel Sayısı , 143-151 . Retrieved from <https://dergipark.org.tr/en/pub/sduzfd/issue/52563/650502>
- Yıldırım, M.U., Özdemir, F.A. ve Kahriz, P.P. 2016. Safran (*Crocus sativus* L.) Bitkisinde Farklı Hormon Ön Muamele ve Sürelerinin Korm Çoğaltımı Üzerine Etkileri. *Tarla Bitkileri Merkez Araştırma Dergisi*, 2016, 25(özel sayı-2): 301-305.
- Zhang, J., Su, Y., Wu, J., Liang, H. 2015. GIS based land suitability assessment for tobacco production using AHP and fuzzy set in Shandong province of China. *Comput. Electron. Agric.* 114:202-211.

HEAVY METAL RESISTANCE OF *Staphylococcus aureus* ISOLATES FROM SEAWATER FISH

Fatma Özdemir¹, Seza Arslan¹

¹ Bolu Abant İzzet Baysal University, Faculty of Arts and Sciences, Department of Biology, 14030 Gölköy / Bolu, Turkey

Corresponding author e-mail: ozkardes_f@ibu.edu.tr

ABSTRACT

Staphylococcus aureus is an important foodborne pathogen present in the aquatic environment. Seafoods, including fish and fish products, are frequently contaminated with this pathogen due to its high tolerance to salt stress. Heavy metals are widespread environmental pollutants. Heavy metal pollution in seawater fish has become a major global concern. Therefore, resistance to various heavy metals was investigated in the *S. aureus* isolates of seawater fish origin in this study. The heavy metals used in the present research included mercury (HgCl₂), copper (CuCl₂), zinc (ZnCl₂), lead (Pb (NO₃)₂), chromium (Cr (NO₃)₂ 9H₂O), and cadmium (Cd (NO₃)₂ 4H₂O). The minimum inhibitory concentration (MIC) of the tested heavy metals against the isolates was determined quantitatively using a broth microdilution test. Among the seawater fish isolates, the highest resistances to copper (Cu) (91.7%) at a MIC value of 1600 µg/ mL, chromium (Cr) (58.3%) at a MIC value of 3200 µg/ mL were found, followed by mercury (Hg) (25%) at a MIC value of 12.5 µg/ mL. However, none of the isolates were resistant to lead (Pb), cadmium (Cd), and zinc (Zn). This study documented the presence of resistance to heavy metals in some *S. aureus* isolates from seawater fish. As a result, it is important to monitor heavy metal resistance, which poses a significant risk to ecosystems and human health.

Keywords: *Staphylococcus aureus*, heavy metal resistance, seawater fish, minimum inhibitory concentration (MIC)

INTRODUCTION

Staphylococcus aureus is a Gram-positive bacterium that is the most common pathogen in the genus *Staphylococcus*. It is normally a commensal member of the human microbiota but can also become an opportunistic pathogen. It is one of the main pathogens and causes various diseases, including skin infections, respiratory infections, soft tissue infections, wound infections, urinary tract infections, osteomyelitis, septicemia, endocarditis, and food poisoning (Bhunja, 2008; Götz et al., 2006). It can grow in the presence of high salt concentrations, such as 10% NaCl, and at temperatures ranging from 18 to 40 °C (Schleifer and Bell, 2009). *S. aureus* has been isolated from a wide range of foods, including meats, fish, shellfish, poultry and egg products, milk and dairy products, and natural environments such as sea water, fresh water, soil, and plant surfaces (Bhunja, 2008; Schleifer and Bell, 2009).

Fish as a food is considered a nutritionally valuable part of the human diet due to its excellent protein source, vitamins (vitamin A, vitamin B2, vitamin B6), omega-3 fatty acids, minerals (calcium, potassium, iron, and other minerals), carbohydrates, and other nutrients. It has health benefits, especially for cardiovascular disease, high blood pressure, age-related vision loss, and a lower risk of cancer of the prostate and dementia (Abraha et al., 2018).

Bacteria, enzymes, and oxygen are the primary causes of a variety of physiological and microbiological deteriorations in fish and seafood products. *S. aureus* does not belong to the

natural flora of fish or related marine products. These bacteria, however, can be isolated from fish (Bhunia, 2008; Abraha et al., 2018). Seafood contamination can occur at any point along the chain, from production or harvesting to processing and transportation, due to several factors, such as improper handling and processing or storage of food, inadequate cooking temperatures, poor hygiene, and cross-contamination by workers (Bhunia, 2008; Kukulowicz, 2021). Many studies have reported contamination of fish and fish products with foodborne pathogens, including *S. aureus* (Vazquez-Sanchez et al., 2012, Arslan and Özdemir, 2017; Kukulowicz, 2021; Külahcı and Gündoğan 2021, Mumbo et al., 2023).

Foods can act as vehicles of transmission for pathogenic bacteria, such as antimicrobial resistant *S. aureus* to humans (Bhunia, 2008). Previous studies indicated that *S. aureus* isolated from fish and fishery products could be resistant to various antimicrobial agents (Vazquez-Sanchez et al., 2012; Sergelidis et al., 2014; Arslan and Özdemir, 2017; Mumbo et al., 2023). Fish is considered a potential source for the emergence and spread of antimicrobial-resistant pathogens, posing a threat to human health and safety (Kukulowicz, 2021). Antimicrobial resistance is affected not just by the presence of antimicrobials; it has also been demonstrated that environmental factors, such as heavy metals, can promote the development of antimicrobial-resistant bacteria (Seiler and Berendonk, 2012; Yazdankhah et al., 2018). Particularly, heavy metals can increase resistance to antimicrobials through cross-resistance or co-resistance (Vats et al., 2022; Anedda et al., 2023). The link between antimicrobial resistance and heavy metals has been reported in many studies (Seiler and Berendonk, 2012; He et al., 2017; Hu et al., 2017; Duan et al., 2019; Hao et al., 2021).

Heavy metals naturally occur in the environment. Heavy metal contamination is widespread in aquaculture as well as agriculture. Furthermore, heavy metals are used as nutritional additives in animal and fish feed to enhance animal health and growth. For instance, higher concentrations of copper (Cu) and zinc (Zn) are normally used in animal feed for the prevention of various bacterial infections, such as diarrheal illnesses, and as an alternative to on-feed antimicrobials for promoting growth (Yazdankhah et al., 2018; Vats et al., 2022; Anedda et al., 2023).

Heavy metals are among the most dangerous environmental pollutants of anthropogenic origin due to their toxic effects, persistence in the environment and bioaccumulative nature (Anedda et al., 2023). Heavy metal contamination of fish and seafood leads to serious problems to human health and ecological integrity. Therefore, resistance to various toxic heavy metals, including mercury (Hg), copper (Cu), cadmium (Cd), lead (Pb), zinc (Zn), and chromium (Cr) was investigated in the *S. aureus* isolates of seawater fish origin in this study.

MATERIALS AND METHODS

Bacterial isolates

Twelve *S. aureus* isolates from seawater fish samples were examined in the current study. Of them, 11 were gilthead sea bream (*Sparus aurata*) and 1 was European sea bass (*Dicentrarchus labrax*). Seawater fish samples were purchased from several public bazaars and supermarkets in Bolu, Turkey's northwest region. The biochemical tests and PCR for the thermonuclease gene (*nucA*) and species-specific fragment (Sa442) were previously used to identify the *S. aureus* isolates (Brakstad et al., 1992; Martineau et al., 1998; Götz et al., 2006; Becker and von Eiff, 2011). All *S. aureus* isolates from seawater fish were grown overnight at 37°C in Brain Heart Infusion broth (BHI) (Merck, Germany).

Determination of MIC by broth microdilution

The heavy metal resistance of *S. aureus* isolates from seawater fish samples was investigated using six heavy metals, including chromium (Cr (NO₃)₂), copper (CuCl₂), cadmium (Cd (NO₃)₂), mercury (HgCl₂), lead (Pb (NO₃)₂), and zinc (ZnCl₂). All heavy metals were purchased from Sigma-Aldrich (Sinopharm Chemical Reagent Co., Shanghai, China). The minimum inhibitory concentrations (MICs) of heavy metals against the isolates were quantified in 96-well microplates using the broth microdilution method (CLSI, 2012; He et al., 2016; Dahanayake et al., 2019). Heavy metal concentrations ranged from 3200 to 62.5 µg/mL for Cr, Cu, Cd, Pb, and Zn, whereas Hg concentration ranged from 400 to 0.78 µg/mL. MICs were determined as the lowest concentration of heavy metal that completely inhibited the growth of the organism after 18-20 hours of incubation at 37 °C. The tests were carried out in triplicates. *Escherichia coli* K-12 was used as a quality control strain in heavy metal resistance test (Dahanayake et al., 2019).

RESULTS AND DISCUSSION

Resistance of the *S. aureus* isolates seawater fish to toxic heavy metals, such as mercury (Hg), copper (Cu), lead (Pb), chromium (Cr), zinc (Zn), and cadmium (Cd) was investigated in the current study. As presented in Table 1, a maximum MIC of 3200 µg/mL for Cr, 1600 µg/mL for Cu, and 12.5 µg/mL for Hg were detected as compared to the *E. coli* K-12 control strain (Dahanayake et al., 2019).

Table 1. Heavy metal resistance of the *S. aureus* isolates from seawater fish

Seawater isolates	MICs for heavy metals in µg/mL					
	Hg	Cd	Pb	Cu	Cr	Zn
S1	12.5	100	200	800	1600	200
S2	12.5	400	400	1600	1600	200
S3	6.25	100	400	1600	1600	800
S4	6.25	400	400	1600	3200	800
S5	6.25	200	200	1600	3200	200
S6	6.25	100	800	1600	3200	800
S7	12.5	100	400	1600	3200	800
S8	1.56	200	200	1600	3200	50
S9	1.56	100	200	1600	3200	50
S10	1.56	100	200	1600	3200	800
S11	1.56	50	400	1600	1600	800
S12	6.25	100	400	1600	1600	800
<i>Escherichia coli</i> K-12 strain	6.25	400	800	800	1600	800

MIC, Minimum inhibitory concentration

Among the seawater fish isolates, the highest resistances to copper (Cu) (91.7%) at a MIC value of 3200 $\mu\text{g}/\text{mL}$ were found, followed by chromium (Cr) (58.3%) at a MIC value of 3200 $\mu\text{g}/\text{mL}$ and mercury (Hg) (25%) at a MIC value of 12.5 $\mu\text{g}/\text{mL}$. However, none of the isolates were resistant to lead (Pb), cadmium (Cd), and zinc (Zn) (Table 1 and Figure 1).

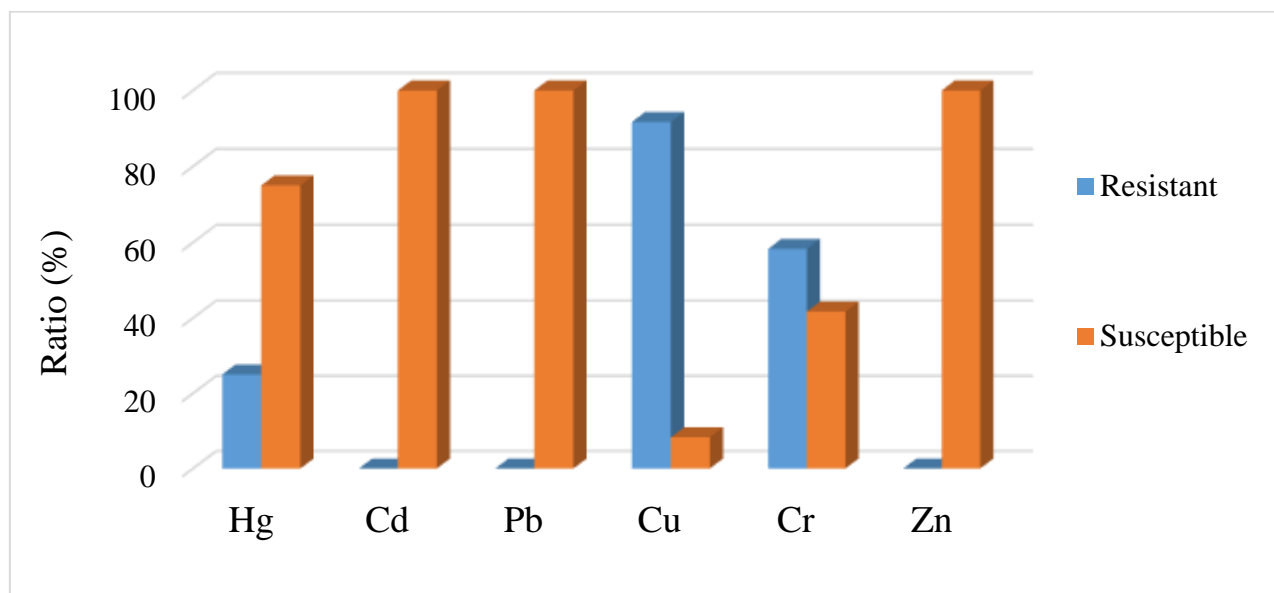

Figure 1. Prevalence of resistance to heavy metals in the *S. aureus* isolates from seawater fish

Heavy metal resistance has been documented in several studies related to fresh shrimp (He et al., 2016), crustaceans and shellfish (Hu and Chen, 2016), seafood (Dahanayake et al., 2019), and Nile tilapia fish (Gufe et al., 2022). He et al. (2016) reported the majority of *Vibrio parahaemolyticus* isolated from fresh shrimps in Shanghai fish markets displayed resistance to Cu (93.3%), similar to our results. High resistances to Cu (89.4%), Pb (80.3%), and Cd (80.3%) were also found in *V. parahaemolyticus* isolated from crustaceans and shellfish (Hu and Chen, 2016). In contrast to our findings, Gufe et al. (2022) were reported that lead (Pb) resistance ranging from 30.8-69.2% among the various bacterial species including *S. aureus* isolated from fish samples in anthropogenically polluted Lake Chivero, Zimbabwe.

In this study, *S. aureus* isolates originated from seawater fish indicated five different heavy metal resistance profiles (Figure 2). Among the detected resistance phenotypes, “Cr, Cu” was the most predominant (50%). In the current study, only one isolate (8.3%) exhibited the “Cr, Cu, Hg”, resistance phenotype, against three heavy metals. Moreover, only three of the isolates (25%) showed resistance to a single metal “Cu”. In this research, 75% of the isolates had resistance two or more heavy metals, might be pose a potential threat to human health.

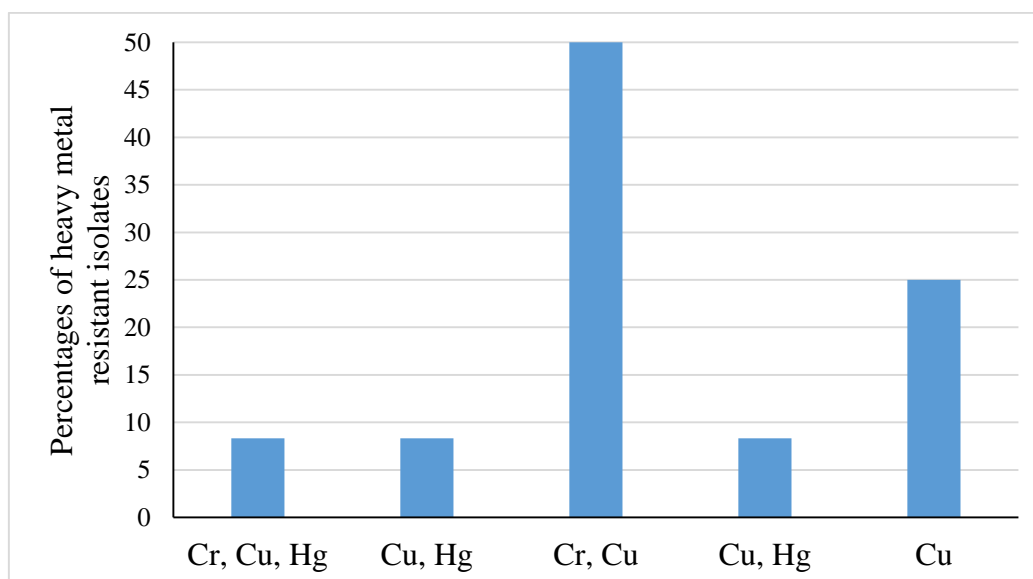

Figure 2. Incidences of heavy metal-resistant phenotypes among the *S. aureus* isolates from seawater fish

CONCLUSIONS

This study documented the presence of resistance to toxic heavy metals such as mercury, copper, and chromium, which are commonly associated with poisoning in humans, in some *S. aureus* isolates from seawater fish. As a result, it is important to monitor heavy metal resistance, which poses a significant risk to ecosystems and human health.

REFERENCES

- Abraha, B., Admassu, H., Mahmud, A., Tsighe, N., Sui, X.W., Fang, Y. 2018. Effect of processing methods on nutritional and physico-chemical composition of fish: a review. *MOJ Food Processing & Technology*. 6(4): 376-382.
- Anedda, E., Farrell, M. L., Morris, D., Burgess, C.M. 2023. Evaluating the impact of heavy metals on antimicrobial resistance in the primary food production environment: A scoping review. *Environmental Pollution*. 320: 121035.
- Arslan, S., Özdemir, F. 2017. Molecular characterization and detection of enterotoxins, methicillin resistance genes and antimicrobial resistance of *Staphylococcus aureus* from fish and ground beef. *Polish Journal of Veterinary Sciences*. 20: 85-94.
- Becker, K., von, Eiff C. 2011. *Staphylococcus, Micrococcus*, and other catalase-positive cocci. In: *Manual of Clinical Microbiology*. Editors: J. Versalovic, K.C. Carroll, g. Funke, J.H. Jorgensen, M.L. Landry, D.W. Warnock. ASM Press, USA. 308-330.
- Bhunia, A.K. 2008. *Foodborne Microbial Pathogens: Mechanisms and Pathogenesis*. New York: Springer.
- Brakstad, O.G., Aasbakk, K., Maeland, J.A. 1992. Detection of *Staphylococcus aureus* by polymerase chain reaction amplification of the *nuc* gene. *Journal of Clinical Microbiology*. 30: 1654-1660.
- Clinical and Laboratory Standards Institute (CLSI). 2012. "Methods for dilution antimicrobial susceptibility tests for bacteria that grow aerobically-Ninth Edition, Approved standard," M7-A9. Wayne, PA, USA.
- Dahanayake, P.S., Hossain, S., Wickramanayake, M.V.K.S., Heo, G-J. 2019. Antibiotic and heavy metal resistance genes in *Aeromonas* spp. isolated from marketed Manila Clam (*Ruditapes philippinarum*) in Korea. *Journal of Applied Microbiology* 127: 941-952.

- Duan, M., Gu, J., Wang, X., Li, Y., Zhang, R., Hu, T., Zhou, B. 2019. Factors that affect the occurrence and distribution of antibiotic resistance genes in soils from livestock and poultry farms. *Ecotoxicology and Environmental Safety*. 180: 114-122.
- Götz, F., Bannerman, T., Schleifer, K.H. 2006. The genera *Staphylococcus* and *Micrococcus*. In: *The Prokaryotes*. Editors: M. Dworkin, S. Falkow, E. Rosenberg, K.H. Schleifer, E. Stackebrandt, Springer: USA, 5-75.
- Gufe, C., Karembera, B., Marumurei J., Makuvara, Z. 2022. Lead, silver nitrate and antibiotic resistance in bacteria isolated from Nile tilapia (*Oreochromis niloticus*) in anthropogenically polluted Lake Chivero, Zimbabwe *Cogent Food and Agriculture*. 8: 2082040.
- Hao, Y.-L., Li, G., Xiao, Z.-F., Liu, N., Azeem, M., Zhao, Y., Xu, Y.-Y., Yu, X.-W. 2021. Distribution and influence on the microbial ecological relationship of antibiotic resistance genes in soil at a watershed scale. *Sustainability*. 13: 9748.
- He, X., Xu, Y., Chen, J., Ling, J., Li, Y., Huang, L., Zhou, X., Zheng, L., Xie, G. 2017. Evolution of corresponding resistance genes in the water of fish tanks with multiple stresses of antibiotics and heavy metals. *Water Research*. 124: 39-48.
- He, Y., Jin, L., Sun, F., Hu, Q., Chen, L. 2016. Antibiotic and heavy-metal resistance of *Vibrio parahaemolyticus* isolated from fresh shrimps in Shanghai fish markets, China. *Environmental Science and Pollution Research*. 23:15033-15040.
- Hu, H.W., Wang, J.T., Li, J., Shi, X.Z., Ma, Y.B., Chen, D., He, J-Z. 2017. Long-term nickel contamination increases the occurrence of antibiotic resistance genes in agricultural soils. *Environmental Science and Technology*. 51: 790-800.
- Hu, Q., Chen, L. 2016. Virulence and Antibiotic and Heavy Metal Resistance of *Vibrio parahaemolyticus* isolated from crustaceans and shellfish in Shanghai, China. *Journal of Food Protection*, 79 (8): 1371-1377.
- Kukulowicz, A. 2021. Presence of antibiotic-resistant *Staphylococcus aureus* in fish and seafood originating from points of sale in the Tri-City Area (Poland). *Journal of Food Protection*, 84 (11): 1911-1914.
- Külahcı, M.B., Gündoğan, N. 2021. Occurrence and characteristics of staphylococci and enterococci in retail fish used for human consumption in Turkey. *European Journal of Science and Technology*. 28: 911-916.
- Martineau, F., Picard, F.J., Roy, P.H., Quелlette, M., Bergeron, M.G. 1998. Species-specific and ubiquitous-DNA-based assays for rapid identification of *Staphylococcus aureus*. *Journal of Clinical Microbiology*. 36: 618-623.
- Mumbo, M.T., Nyaboga, E.N., Kinyua, J., Muge, E.K., Mathenge, S.G.K., Muriira, G., Rotich, H., Njiraini, B., Njiru, J.M. 2023. Prevalence and antimicrobial resistance profile of bacterial foodborne pathogens in Nile tilapia fish (*Oreochromis niloticus*) at points of retail sale in Nairobi, Kenya. *Frontiers in Antibiotics*. 2:1156258.
- Schleifer, K.H., Bell, J.A. 2009. Family VIII. Staphylococcaceae fam. nov. In: P. De Vos, G.M. Garrity, D. Jones, N.R. Krieg, W. Ludwig, F.A. Rainey, K.H. Schleifer, and W.B. Whitman (eds): *Bergey's Manual of Systematic Bacteriology*, second edition, vol. 3 (The Firmicutes), Springer, Dordrecht, Heidelberg, London, New York, 392-421.
- Seiler, C., Berendonk, T. U. 2012. Heavy metal driven co-selection of antibiotic resistance in soil and water bodies impacted by agriculture and aquaculture. *Frontiers in Microbiology*. 3:399.
- Sergelidis, D., Abraham, A., Papadopoulos, T., Soultos, N., Martziou, E., Koulourida, V., Govaris, A., Pexara, A., Zdragas, A., Papa, A. 2014. Isolation of methicillin-resistant *Staphylococcus* spp. from ready-to-eat fish products. *Letters in Applied Microbiology*. 59: 500-506.

- Vats, P., Kaur, U.J., Rishi, P. 2022. Heavy metal-induced selection and proliferation of antibiotic resistance: A review. *Journal of Applied Microbiology*. 132:4058-4076.
- Vazquez-Sanchez, D., Lopez-Cabo, M. 2012. Saa-Ibusquiza, P.; Rodriguez-Herrera, J.J. Incidence and characterization of *Staphylococcus aureus* in fishery products marketed in Galicia (Northwest Spain). *International Journal of Food Microbiology*. 157: 286-296.
- Yazdankhah, S., Rudi, K., Bernhoft, A. 2014. Zinc and copper in animal feed-development of resistance and co-resistance to antimicrobial agents in bacteria of animal origin. *Microbial Ecology in Health & Disease*. 25: 25862.

THE FLORISTIC VALUES OF 'NARTË - PISHË PORO' PROPOSED NATURA 2000 SITE IN ALBANIA

Marjol Meço^{1*}, Ermelinda Mahmutaj², Ajola Mesiti², Petrit Hoda², Lefter Kashta², Alfred Mullaj²

¹Department of Biology, Faculty of Natural Sciences, University of Tirana, Boulevard Zogu I Parë, no. 25/1, 1001, Tiranë, Albania

²Research Center for Flora and Fauna, Faculty of Natural Sciences, University of Tirana, Tiranë, Albania

*Corresponding author e-mail: mariol.meco@yahoo.com

ABSTRACT

The Nartë-Pishë Poro is proposed as a Natura 2000 site in Albania with a surface of 235.4 km², situated along the Adriatic Sea shore, on both sides of Vjosa River and its delta. Two existing national protected areas are included in the site, namely the 'Vjosë-Nartë Protected Landscape' and the "Pishë Poro Managed Nature Reserve" (Category V and IV according to IUCN criteria). In this study we aim to describe its floristic richness, important species distribution, and the existing pressures and threats with mapping display of their normalized values. Thus values will testify of the site's uniqueness which fulfills the scientific requirement for sites of interest of the European Community. As result, 770 species were identified of which 757 species phanerogams, 6 species ferns and 6 species algae. 120 species of this floristic richness have a conservation status according Albanian Red List and/or IUCN. Specifically, 41 species are part of the Albanian Red List, 99 species of IUCN, and 20 species have a conservation status according to the Albanian Red List and IUCN. There are reported 4 species of annex II, IV and V of Habitats Directive and two species of annex I of Berne Convention. *Galatella albanica*, *Achillea baldaccii* and *Silene cephalenia* are three subendemic species found in the area; *Halopeplis amplexicaulis*, *Isoetes histrix*, *Arthrocnemum perenne*, *Chamaemelum fuscatum*, *Euphorbia pinea*, *Glycyrrhiza glabra*, *Sphenopus divaricatus*, *Ononis variegata* and *Thymelaea hirsuta* occur only in this site in the whole country. The estimated floristic richness of conservation interest species are given numerical values to carry out statistical processing which are reflected in maps of normalized species values, according to the request and instructions of Article 17 of the Habitats Directive. Also, it was estimated 4 main pressures and threats for floristic values of the study area, which are: intensive public maintenance parks/cleaning of beaches, forestry clearance, actively burning down existing vegetation and invasive non-native species. The maps of normalized threats values were designed.

Keywords: Nartë-Pishë Poro, Natura 2000, floristic values, species of conservation interest, normalized maps

INTRODUCTION

Nartë-Pishë Poro study area extends approximately 40 km along the Albanian Riviera with a surface of 235.4 km². It borders with Hoxhara channel in the north, Vjosa River in north-east, Panaja-Mifol hills chain in the east, Soda forest in the south and the Adriatic sea coastline in the west (Fig.1).



Figure 1. The map of the study area.

The boundaries of the study area are defined following ecological criteria and mainly natural boundaries such as: vegetation community, water bodies, coastlines, hill slopes, etc., determined by satellite images of the area.

Two protected areas, Vjosë-Nartë Protected Landscape (Category V according to IUCN criteria) and the Pishë Poro Managed Nature Reserve (Category IV according to IUCN criteria) are included in the proposed site, as well as many important and well-preserved habitats, but at the same time many areas under high pressure and threats which affect the long-term preservation of its natural values.

There are more than 20 villages with a population of more than 24,000 inhabitants in the proposed site. The nearest city is Vlora, one of the largest cities in Albania with a population of 106,000 (Anonymous, 2019). The life of these inhabitants is closely related to nature and their activities are livestock, agriculture, fishing, coastal tourism, collection of medicinal plants, beekeeping, orchards, etc.

The Nartë-Pishë Poro is widely reported for its biodiversity values. Among the most important ecosystems are wetlands, agricultural areas and forests. Wetlands cover 37% of the surface, agricultural areas 33% and forests 6%. The rest is occupied by urbanized areas or other forms of land use (PPNEA, 2013). The high floristic diversity of this territory has attracted researchers' attention and several papers and reports are published already (Buzo, 2000; Xhulaj and Mullaj, 2002; Pano and Frashëri, 2007; Imeri et al., 2018, etc.).

Based on the existing reported data and new updated field data, this paper aims to estimate the floristic richness of the area, by analyzing and mapping floristic values of species with conservation concern, their threats, and presentation of these values and threats on normalized maps according to the request and instructions of Article 17 of the Habitats Directive for Natura 2000 sites.

MATERIAL AND METHOD

Field data collection was carried out through 18 botanical expeditions during the period May 2020 – May 2021, mostly during flowering seasons, in spring and autumn. Plant species were collected as living material and were dried in electric presses. After the final determination they were deposited in the National Herbarium (TIR), in the Museum of Natural Sciences, Faculty of Natural Sciences, University of Tirana. For the full list of flora, data from the literature of previous publications, the register of TIR, and unpublished data were used as well (Buzo, 2000; Anonymous, 2005; Pano and Frashëri, 2007; PPNEA, 2013; Barina et al., 2017; Imeri et al., 2018). The location of important species found in the field was georeferenced with GPS Gramin.

All identified and confirmed plant species were entered into a Microsoft Excel 2010 database. Plant identification was carried out mainly based on the Flora of Albania, Vol. 1- 4 (Paparisto et al., 1988; Qosja et al., 1992; et al., 1996; Vangjeli et al., 2000), Flora Europaea, Vol. 1-5 (Tutin et al., 1964; et al., 1968; et al., 1972; et al., 1976; et al., 1980) and the flora of neighboring countries such as the Flora of Italy (Pignatti 1982). For the national and European conservation status, were consulted the Albanian Red List of vascular plants (VKM, 2013), the IUCN Red List of Threatened Species (IUCN, 2016), Habitats Directive (Appendix II, IV), Bern Convention and Appendix II of CITES.

The important species for the genofond and for conservation at the national, European and global level, accompanied by ecological data, were uploaded into the BIONNA format (Pacifici et al., 2018), the unified database for important species for the genofond at national, European and global level. In this database, the species is uploaded as many times as it has been encountered in the field, accompanied by other data such as: location, coordinates, habitat, plant community, threats and pressures, date of data collection, altitude above the sea level, slope, presence in the conservation lists, etc. From here, data processing and statistical analyzes are carried out. Species distribution maps were designed by downloading the georeferenced BIONNA data into ArcMap 10.7.

For each species of conservation interest, 'values' and normalized values have been estimated. 'Value' is called the integration of all the elements that determine the balance of biodiversity, the importance and uniqueness that appears (Viola et al., 2002). The 'value' in this method is not a theoretical determination but a quantitative one. The values of the species are calculated from the sum of their quantitative affiliations in the important national and international lists, according to the numerical system in the table below (Tab. 1).

Table 1. Quantitative values of species of conservation interest according to Viola et al., 2002.

Values category	Values
Annex II of the Habitats Directive	10
Annex IV of the Habitats Directive	5
Endemic	8
Steno – Endemic	10
IUCN conservation status (Global)	
<i>Cr</i>	10
<i>En</i>	8
<i>VU</i>	6
<i>NT</i>	4
<i>LC</i>	2
Albanian Red List conservation status	
<i>Cr</i>	10
<i>En</i>	8
<i>VU</i>	6
<i>NT</i>	4
<i>LR</i>	2

For map designation in the GIS, the evaluated values have been reclassified to achieve a quantitative and qualitative homogeneity, between values and species of conservation interests. According to the most accurate method the values were normalized from 0 to 1 (or from 1 to 100), through the formula: $z_i = (x_i - \min(x)) / (\max(x) - \min(x))$ (Costantini, 2005).

The existing and potential pressures and threats were assessed according to the European list of threats, defined in Article 17 of the Habitats Directive (<https://cdr.eionet.europa.eu/help/natura2000>). From this list, the experts identified 10 biggest risks and threats in the area. The vulnerability was determined for each important species and vegetation group. It was estimated by the combination of threats, relative value and vulnerability. For each species with conservation interest of the BIONNA database and for plant communities, 4 of the threats and pressures were estimated that affect directly. The threat levels were determined according to the scale from 0-3, where 0- no threats, 1- low intensity threats, 2- medium intensity threats and 3- high intensity threats. The scaling of vulnerability provided by Prosser and Sitzia (2001) are: 0 - no damage, 1 - low vulnerability, 2 - medium vulnerability and 3 - high vulnerability. It means the overall possibility for a species to suffer degradation or loss of relevant values as a result of external pressures.

RESULTS AND DISCUSSION

1) Floristic richness

The results showed a great floristic diversity in the Nartë-Pishë Poro. A total of 764 species (20.9% of the Albanian Flora) belonging to 450 genera (46.3% of the genera of Albanian Flora) and 110 families (62.2% of the families of Albania Flora) were identified. Analyzed according to taxonomic divisions results that 98% (757 species) of this flora is represented by phanerogams, 1% (6 species) of ferns and 1% (6 species) of algae.

20 plant species were reported for the first time in the area from the data collected during may 2021 - may 2022 (Appendix, Tab.1), while the rest of the floristic richness has been reported before by different authors (Buzo, 2000; Anonymous, 2005; Pano & Frashëri, 2007; PPNEA, 2013; Barina et al., 2017; Imeri et al., 2018;) and listed in unpublished data.

Human activity is almost everywhere in the area and isolated natural habitats are very rare, but still there are some rare plant species for the country. *Galatella albanica*, a sub endemic species to Albania was recorded and reported for the first time. In Barina et. al, 2017,

two other sub endemic species such as *Achillea baldaccii* and *Silene cephalenia* are reported as well.

The area is also very important for sheltering plant species which don't have any conservation status or have in general a wide areal but in Albania according to Barina et. al, 2017, these species occur only in this proposed Natura 2000 site which makes it very important for national biodiversity conservation. Such species are: *Halopeplis amplexicaulis*, *Isoetes histrix*, *Arthrocnemum perenne*, *Chamaemelum fuscatum*, *Euphorbia pinea*, *Glycyrrhiza glabra*, *Sphenopus divaricatus*, *Ononis variegata*, *Thymelaea hirsuta*.

The study contributed with accurate data for the distribution of the aquatic phanerogam *Althenia filiformis* and the green algae *Lamrothamium papulosum*, two rare aquatic macrophytes found only in the study area and Divjakë-Karavasta National Park. Temporary coastal wetlands with semi-salty water bodies are the main habitats for these species. The damage of these habitats or intervention to turn them into lagoons for fishing purposes, such has happened with Kallanga, could seriously endanger the extinction of these species.

2) Flora of conservation interest

In Nartë-Pishë Poro were identified 120 species with a conservation status (Appendix, Tab.2) according to the Albanian Red List (VKM, 2013) and/or IUCN (2016). Of these 120 species, 41 are included in the Albanian Red List, 99 species have a conservation status according to the IUCN, and 20 have conservation status according to the Albanian Red List and the IUCN.

Among the 41 species of the Albanian Red List, *Petrosimonia oppositifolia*, listed for the area from unpublished data, has the status 'critically endangered' (CR), 9 species have the status 'endangered' (EN), 30 species have the status 'vulnerable' (VU), 2 species have the status 'low risk' (LR). Almost all species with a IUCN conservation status belong to 'low risk' (LC) or 'data deficient' (DD) such as *Gladiolus palustris*, *Luzula forsteri*, *Daucus carota*, *D. guttatus* and *Malus sylvestris*. *Platanus orientalis* and *Marsilea quadrifolia* have the conservation status 'vulnerable' (VU) (Appendix, Tab.2).

4 plant species are part of the annexes of the Habitats Directive and 2 species are part of the Bern Convention. Specifically, *Anacamptis pyramidalis* is part of Annex II of the Habitats Directive, *Marsilea quadrifolia* is part of Annexes II and IV, *Gladiolus palustris* is part of Annex IV and *Ruscus aculeatus* is included in Annex V. Aquatic phanerogams *Cymodocea nodosa* and *Zostera noltii* are part of the Bern Convention. About 15 species of orchids are part of the CITES Convention (Appendix, Tab.2).

For each species with conservation interests, their quantitative value was calculated and the results are presented in the value map of figure 2, which also shows the distribution of species with conservation interests. The size of the circles on this map is proportional to the natural values that the species have. The larger the circle drawn at the location of a species of conservation interest, the greater the sum of the values of this species, which means that it can be an endemic/sub endemic species and at the same time has a high national conservation status and/or international (see methodology).

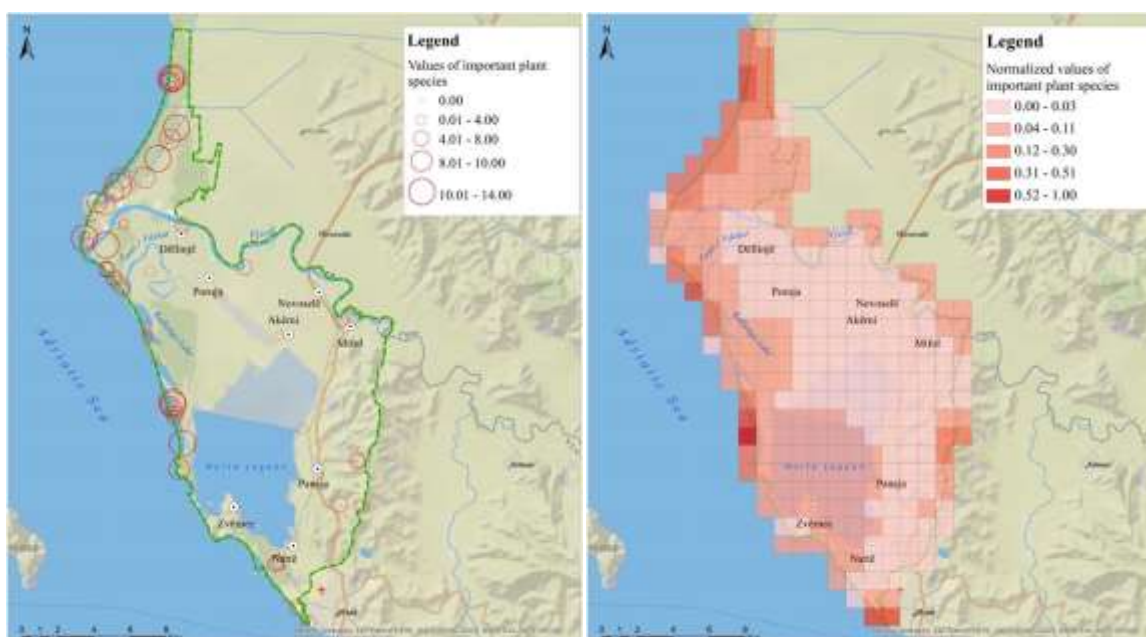

Figure 2. The values map (left) and normalized map of values (right) of the species with conservation interests.

From the administration and management point of view of a Natura 2000 site, as we proposed the Nartë-Pishë Poro, it is important that all values of the species are identified, monitored and preserved together with the area where they are located and not only as individual species. For this purpose, the normalized map of values (Fig. 2) shows the geographical areas with the highest values of the study, presented in a 1 x 1 km system as required by Article 17 of the Habitats Directive. The stronger the color of these squares, the greater is the sum of the values that this 1 km² area shelters.

We clarify that according to this methodology: 1) if a squared area (1 km²) has values (species with conservation interests) even a small part of it, the entire square of 1 km² receives a value that is visually indicated by color on the map; 2) if a quadrat due to spatial/dimensional reasons extends to two or more habitats/environments (e.g. in coastal sands and part of it includes marine water surfaces) its value is determined by that area of the quadrat that has species with conservation value (e.g. coastal dunes with *Pancratium maritimum*, *Ammophila arenaria*, etc., and not the water surface).

Following the map of normalized values, the most critical areas, which host 1 or several important species, are the most natural ones, such as the sandy seacoast area, the pine forest and the area along the Vjosa River. In these areas there are individuals or populations of species with national and/or international conservation interest. *Pancratium maritimum* (sea lily) is one of the species of conservation interests that is found in almost every 1 km² of the fens and old pine wooded dunes. The sea lily is often found close (within a 1 km² quadrat) to *Ammophila arenaria*, *Galatella albainca* or other species of conservation interest causing some quadrat areas to take on an intense color as the sum of the values is high. Along the Vjosa River, the most common species of conservation interest that gives value and colors the map squares is *Populus alba*. The squared areas of the Narta lagoon and small coastal marshes receive values (between 0.03 and 0.1) because in these habitats there are present some macrophytes species of conservation interest such as *Ruppia cirrhosa*, found almost everywhere. Although with a limited area, the Mediterranean shrubs on the hilly area have medium to high values for housing plant species of conservation interest.

On the map of figure 2 it is obvious that even the areas of intensive agriculture or the villages have values, although lower compared to natural ones. The squared areas of these semi-

natural or artificial habitats gain value as a result of the reeds that are found almost everywhere in the drainage channels of agricultural lands. These reeds are dominated by *Phragmites australis* and *Typha angustifolia*, both with conservation status LC according to the IUCN. Also, along the banks of the drainage and irrigation canals there are belts of *Tamarix hampeana*, which has also a conservation status (LC) according to the IUCN. In these canals or abandoned agricultural land there are several other plant species with conservation status LC according to the IUCN (*Lemna minor*, *Lolium perenne*, *Lotus corniculatus*, *Lythrum salicaria*, *Ranunculus baudotii*, *Trifolium repens*, etc.) which give color to almost each square 1 km² of the map of normalized values.

3) Threats and pressures of floristic values

4 main pressures and threats for floristic values were prioritized in the area as expert judgment, consultation with stakeholders and communication with inhabitants: Intensive maintenance of public parks/cleaning of beaches:

1. Intensive maintenance of public parks/cleaning of beaches:

The sandy coastline of the proposed site is used for sunbathing and beach activities. Wrong practices such as flattening or plowing dunes to clear or open new beaches are a major extinction risk for species of conservation interest there. In the map of figure 3 (left), squares with intense color show those areas where the risk is high because in those areas there are species of conservation interest that are directly threatened by this factor. This pressure is more intense and serious in the recently opened beaches because the sandline which is used for years for sunbathing unfortunately is not any more affected because species of conservation interest have already gone extinct. This important species extinction in the old beach areas is clear evidence of how the long-term of this human activity is a serious threatening factor.

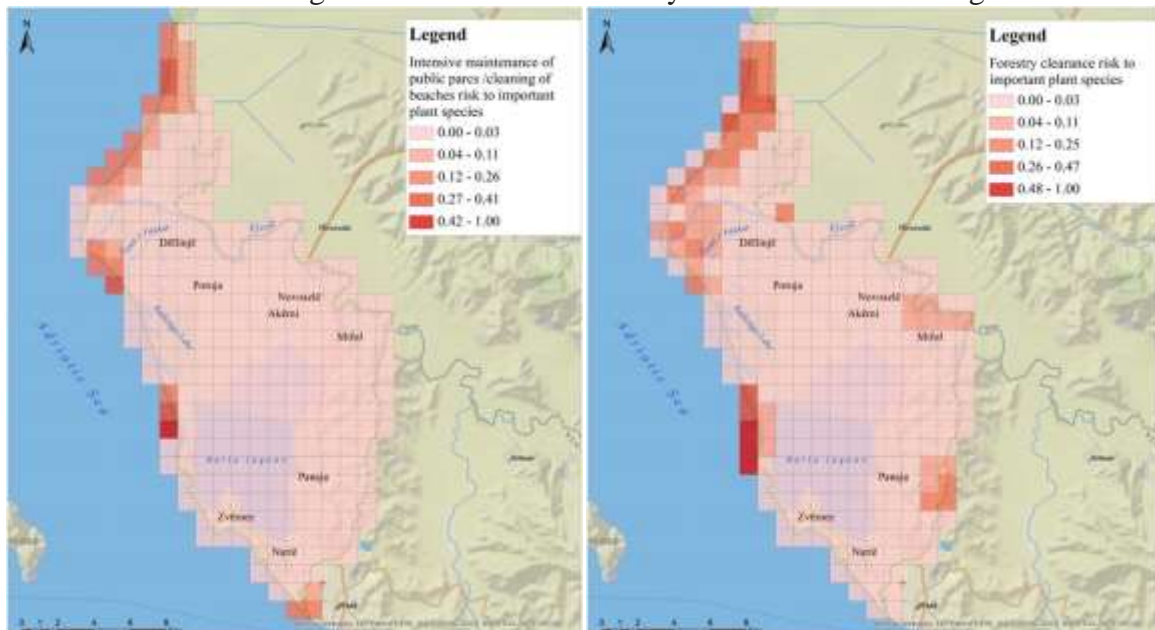

Figure 3. Normalized map of risk level assessment ‘Intensive maintenance of public parks/cleaning of beaches’ (left) and normalized map of risk level assessment ‘actively burning down existing vegetation’ (right) on plant species of conservation interests.

2. Forestry clearance:

The wood cuttings and deforestation are a direct threat factor for wood species with conservation interests such as *Populus alba*, *Ulmus minor*, *Tamarix hampeana*, etc., and for other herbaceous species of the forest layers: *Galatella albanica*, *Orchis sp.*, *Ophrys sp.*, etc.

Along Vjosa River the threat is more moderate and it is attributed to the cutting of *P. alba* and *U. minor*, species with national and international conservation status.

The squared areas of 1 km² with intense color on the map show those areas where forestry clearance risks the population of the species with conservation interests which represent higher natural values than the sparse individuals of the species. This is why the squares that cover the area of *T. hampeana* galleries along the Limpua lagoon have intense color (the belt between the sea and Narta lagoon, Fig.3, right).

3. Actively burning down existing vegetation:

The forest and scrublands of the study area are under the risk of fires. Species of conservation interest such as *Tamarix hampeana*, *Populus alba*, *Juniperus oxycedrus subsp. macrocarpa*, *Ulmus minor*, etc., are under the direct pressure of this risk. When fires threaten plant formations formed by species of conservation interest the damage caused is higher and serious. Exactly these areas of the Nart-Pishë Poro are strongly colored on the 'actively burning down existing vegetation' map of figures 4 (left).

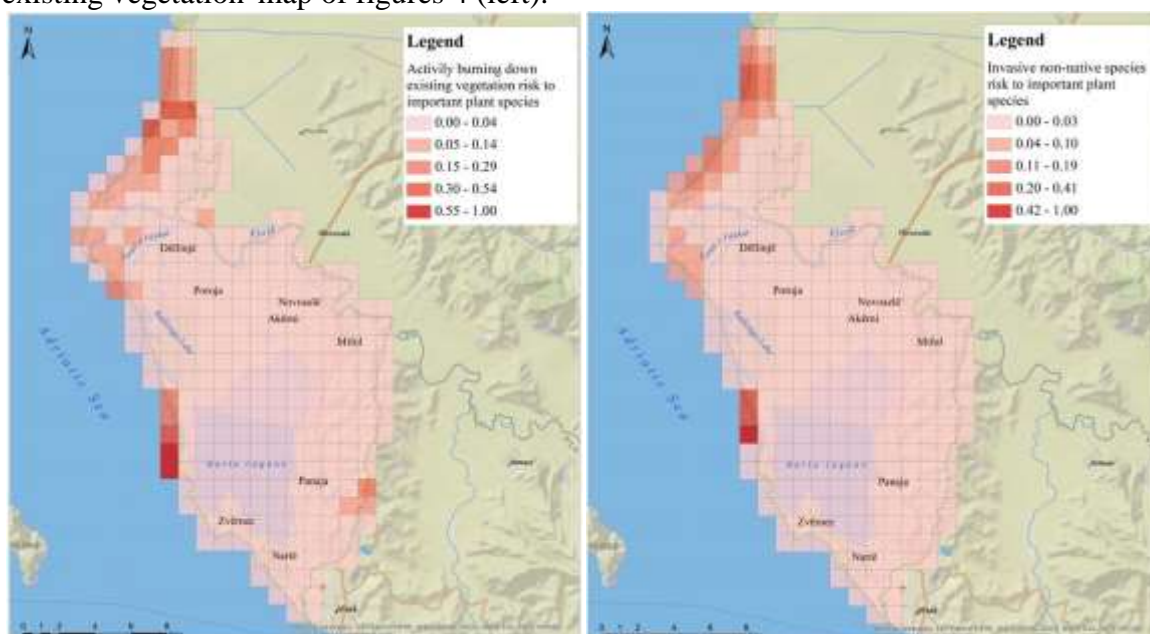

Figure 4. Normalized map of the risk level assessment 'actively burning down existing vegetation' (left) and normalized map of the risk level assessment of 'invasive non-native species' (right) on plant species of conservation interests.

4. Invasive non-native species.

5.8% of the plant species in the study area are alien species (45) (Appendix, Tab.3). The majority of alien species (27.5%) originate from North America and East Asia (12.5%). The species *Carpobrotus edulis* and *Robinia pseudacacia* are part of the list of the 100 most dangerous invasive species in Europe (Nentwig et al., 2018), but in Nartë-Pishë Poro it is *Acacia saligna* which is the most dangerous. This species, originally from Australia, was planted in the area before the 1990s. Today it is one of the most aggressive invasive plant species that is putting directly in pressure the *Juniperus oxycedrus subsp. macrocarpa* which has national and international conservation status and forms the annex one priority habitat 2250*: Coastal dunes with *Juniperus* spp.. *Oenothera parodianaee*, is a newly reported invasive species in the area, as a direct result of this study. Previously it was known only for the Velipoja area (Rakaj and Rostanski, 2009).

The map of figure 4 (right) shows the squared areas where the invasive plants directly threaten native species with conservation interests. In general, it is obvious that sandy coastal areas are most threatened by the invasion of alien species. The information of this map is very

valuable even from the conservation and management point of view. It should be taken into consideration even by any activity or management plan for invasive species and for the native species preservation, among them many of conservation interest.

CONCLUSIONS

Nartë-Pishë Poro is characterized by a high floristic richness. This area represents less than 1% of Albanian territory but there are found 764 plant species or 20.9% of the Albanian floristic richness. Among the identified species, 757 species of this flora are represented by phanerogams, 6 ferns species and 6 algae species .

20 species are reported for the first time in the area. *Galatella albanica*, a sub endemic species to Albanian i reported for first time in this area and together with *Achillea baldaccii* and *Silene cephalenia*, reported previously from this area, increase the total number of sub endemic species in the area in three.

9 species such are *Halopeplis amplexicaulis*, *Isoetes histrix*, *Arthrocnemum perenne*, *Chamaemelum fuscatum*, *Euphorbia pinea*, *Glycyrrhiza glabra*, *Sphenopus divaricatus*, *Ononis variegata* and *Thymelaea hirsuta* are found only in Narte Pise Poro, in the whole Albanian territory, making it an important site for plant species genofond. *Althenia filiformis* and *Lamrothamium papulosum* are two rare aquatic macrophytes found only in the study area and Divjakë-Karavasta National Park.

The Nartë-Pishë Poro has many species with conservation status: 41 species are included in the Albanian Red List, 99 species have a conservation status according to the IUCN, and 20 have a conservation status according to the Albanian Red List and the IUCN.

Among the species with conservation interest of the Albanian Red List (VKM, 2013), *Petrosimonia oppositifolia* has conservation status 'critically endangered' (CR), 9 species 'endangered' (EN), 30 species 'vulnerable' (VU) , 2 species 'low risk' (LR). The most of the species with a conservation status according to the IUCN belong to the lowest category 'low risk' (LC) or 'data deficient' (DD). *Platanus orientalis* and *Marsilea quadrifolia* are two threatened species according to IUCN with conservation status 'vulnerable' (VU).

Among the species with international conservation interest *Anacamptis pyramidalis* is part of Annex II of the Habitats Directive, *Marsilea quadrifolia* part of Annexes II and IV, *Gladiolus palustris* part of Annex IV and *Ruscus aculeatus* is included in Annex V. Aquatic phanerogams *Cymodocea nodosa* and *Zostera noltii* are part of the Bern Convention an about 15 species of Orchids are part of the CITES Convention.

Based on the normalized map values, the most natural areas which host the species of national and global conservation interest are the sandy seacoast, the pine forest and the area along the Vjosa River.

Four main pressures and threats to the floristic values are prioritized following the definition at the Article 17 of the Habitats Directive:: intensive maintenance of public parks/cleaning of beaches forestry clearance, actively burning down existing vegetation and invasive non-native species. These directly or indirectly affect the floristic values. Their most negative impact is when they affect the population of species with conservation interests, shown in the maps of normalized threats values with squares colored more intensely.

ACKNOWLEDGMENTS

The authors are thankful to Protection and Preservation of Natural Environment in Albania (PPNEA) that through implementation of project 'Paving the way towards a sustainable Natura2000 network in Albania; the case of Nartë-Pishë Poro complex site' supported this study.

REFERENCES

- Anonymous, 2005. Management Plan Vjose-Narta Landscape Protected Area. 1-148.
- Anonymous, 2019. Peisazhi i Mbrojtur "Vjosë-Nartë". Ministria e Infrastrukturës dhe Energjisë. Tiranë: 1-47.
- Barina, Z., Mullaj, A., Pifkó, D., Somogyi, G., Meço, M., Rakaj, M. 2017. Distribution atlas of vascular plants in Albania. Hungarian Natural History Museum.
- Buzo, K. 2000. Dati sulla flora e la vegetazione al delta del Vjosa. In : Marchiori S. (ed.), De Castro F. (ed.), Myrta A. (ed.). La cooperazione italo-albanese per la valorizzazione della biodiversità. Bari : CIHEAM, 2000. p. 85-98. (Cahiers Options Méditerranéennes; n. 53). Seminario: La Cooperazione Italo-Albanese per la Valorizzazione della Biodiversità, 2000/02/24-26, Lecce (Italy). <http://om.ciheam.org/om/pdf/c53/01002029.pdf>
- CITES, 2011. Convention on International Trade in Endangered Species of Wild Fauna and Flora. <http://www.cites.org>
- COSTANTINI. P. 2005. Studio per la descrizione della biodiversità del Monte Bondone. Museo Tridentino di Scienze Naturali e Comune di Trento, manoscritto depositato presso il Comune di Trento.
- Council Directive 92/43/EEC, 1992. On the conservation of natural habitats and of wild fauna and flora.
- Council of Europe, 1979. Convention on the Conservation of European Wildlife and Natural Heritage. Bern, Switzerland.
- Imeri, A., Koci, R., Mullaj, A. 2018. The assesment of Floristic Diversity in Narta (Albania). Albanian j. Agric. Sci. 364-370.
- IUCN, 2016. The IUCN Red List of Threatened Species. [Last Updated: 07/12/2017]
- Nentwig, W., Bacher, S., Kumschick, Pyšek, P., Vilà, M. 2018. "100 worst" alien species in Europe. Biol Invasions 20, 1611–1621. <https://doi.org/10.1007/s10530-017-1651-6>
- Pacifici, M., Attorre, F., Martellos, S., Bego, F., De Sanctis, M., Hoda, P., Meço, M., Rondinini, C., Saçdanaku, E., Salihaj, E., Scepti, E., Shuka, L., Ghiurghi, A. 2018. BioNNA: the Biodiversity National Network of Albania. Nature Conservation 25: 77–88. <https://doi.org/10.3897/natureconservation.25.22387>.
- Pano, N., Frashëri, A. 2007. Principal aspects of the ecosystem Vlora Bay- Narta Lagoon- Vjosa River Mouth. Tirana: 1-32.
- Paparisto, K., Demiri, M., Mitrushi, I., Qosja, Xh. 1988. Flora e Shqipërisë vol. 1. Akademia e Shkencave të Shqipërisë. Tiranë.
- Pignatti, S. 1982. Flora d'Italia. Bologna, vol. 1-3
- PPNEA, 2013. Preliminary Report for Key Biodiversity Area of Narta Lagoon. 1-39.
- Prosser F., Sitzia T., 2001. La vegetazione della Riserva Integrale Tre Cime Monte Bondone, manoscritto depositato presso il Servizio Parchi e Conservazione della Natura, Trento
- Qosja, Xh., Paparisto, K., Demiri, I., Vangjeli, J., Balza, E. 1992. Flora e Shqipërisë, Vol. 2. Tiranë.
- Qosja, Xh., Paparisto, K., Vangjeli, J., Ruci, B., Mullaj, A. 1996. Flora e Shqipërisë, Vol. 3. Tiranë.
- Rakaj M., Rostanski K. (2009): New species of the genus *Oenothera* L. from the coast of the Albania and Montenegro

- Tutin, T. G., Burges, N. A., Chater, A. O., Edmondson, J. R., Heywood, V. H., Moore, D. M., Valentine, D. H., Walters, S. M., Webb, D. A. 1993. Flora Europaea. Cambridge,
- Tutin, T. G., Heywood, V. H., Burges, N. A., Moore, D. M., Valentine, D. H., Walters, S. M., Webb, D. A. 1968-1980. Flora Europaea, Vol. 2-5. Cambridge.
- Vangjeli, J., Ruci, B., Mullaj, A., Papparisto, K., Qosja, Xh. 2000, a. Flora e Shqipërisë. ASHRSH-Instituti i Kërkimeve Biologjike, Vol. 4, pp. 502. Tiranë
- Vangjeli, J., Ruci, B., Mullaj, A., Xhulaj, M. 2000, b. Flora e vegetazione in Albania. La cooperazione italo-albanese per la valorizzazione della biodiversità Bari: CIHEAM Cahiers Options Méditerranéennes, 53: 51- 66
- Viola. F., Ferrari, C., Semenzato, P., Sitzia, T. 2002. La ricerca nei parchi e la ricerca per i parchi. EM Linea Ecologica 34 (4): 10-19, ISSN:1721-9450
- VKM, 2013. Miratimi i listës së kuqe të florës dhe faunës së egër http://www.mjedisi.gov.al/files/userfiles/Biodiversiteti/urdhera_dhe_udhezime/2013-Urdher_nr_1280_dt_20.11.2013_Miratimi_Listes_Kuqe_Flores&Faunes_Eger.pdf [Last Updated: 22.12.2017]
- Xhulaj, M., Mullaj, A. 2002. Conservation of Wetlands and Coastal Ecosystems of Mediterranean Region, Diagnosis Report on the Narta Area, Flora and Vegetation, PHARE Programme Albania, Strategy for Albanian Lagoon Management (Final report).

APPENDIX

No.	Species name	Family
1.	<i>Silene velutina</i> Loisel.	Caryophyllaceae
2.	<i>Crepis foetida</i> L. subsp. <i>foetida</i>	Compositae
3.	<i>Eleocharis ovata</i> (Roth) Roem. & Schult.	Cyperaceae
4.	<i>Melilotus neapolitanus</i> Ten.	Fabaceae
5.	<i>Bellardia trixago</i> (L.) All.	Lamiaceae
6.	<i>Linum trigynum</i> L.	Linaceae
7.	<i>Oenothera parodiana</i> Munz subsp. <i>parodiana</i>	Onagraceae
8.	<i>Ranunculus peltatus</i> Schrank	Ranunculaceae
9.	<i>Kochia prostrata</i> (L.) Schrader	Chenopodiaceae
10.	<i>Chamaemelum mixtum</i> (L.) All.	Compositae
11.	<i>Symphotrichum squamatum</i> (Spreng.) G. L. Nesom	Compositae
12.	<i>Juniperus phoenicea</i> subsp. <i>turbinata</i> (Guss.) Nyman	Cupresaceae
13.	<i>Carex cuprina</i> (Heuff.) A. Kern.	Cyperaceae
14.	<i>Trifolium echinatum</i> M. Bieb.	Fabaceae
15.	<i>Micromeria cristata</i> (Hampe) Griseb.	Lamiaceae
16.	<i>Aegilops neglecta</i> Req. ex Bertol.	Poaceae
17.	<i>Bromus arvensis</i> L.	Poaceae
18.	<i>Aremonia agrimonoides</i> (L.) DC.	Rosaceae
19.	<i>Populus</i> × <i>canescens</i> (Aiton) Sm.	Salicaceae
20.	<i>Sixalix atropurpurea</i> (L.) Greuter & Burdet	Caprifoliaceae

Table 2. The species with conservation interests according to Albanian Red List (2013) and IUCN (2016).					
Species name	Al. Red List	IUCN	Species name	Al. Red List	IUCN
<i>Ruscus aculeatus</i>	-	LC	<i>Lythrum salicaria</i>	-	LC
<i>Arundo donax</i>	-	LC	<i>Agrimonia eupatoria</i>	-	LR
<i>Eriophorum angustifolia</i>	-	LC	<i>Urtica dioica</i>	-	LC
<i>Equisetum arvense</i>	-	LC	<i>Butomus umbellatus</i>	VU A1b	-
<i>Equisetum palustre</i>	-	LC	<i>Nymphoides peltata</i>	VU A1b	-
<i>Equisetum telmateia</i>	-	LC	<i>Sparganium erectum</i>	-	LC
<i>Juncus articulatus</i>	-	LC	<i>Zostera marina</i>	VU A2d	-
<i>Typha angustifolia</i>	-	LC	<i>Posidonia oceanica</i>	VU A2d	-
<i>Iris pseudacorus</i>	VU A2b	LC	<i>Alisma lanceolatum</i>	-	LC
<i>Orchis albanica</i>	EN A1b	-	<i>Alisma plantago-aquatica</i>	-	LC
<i>Orchis x paparisti</i>	Vu A1b	-	<i>Lemna minor</i>	-	LC
<i>Nymphaea alba</i>	VU A1b	LC	<i>Potamogeton crispus</i>	-	LC
<i>Orchis morio</i>	VU A1b	LC	<i>Potamogeton natans</i>	-	LC
<i>Orchis coriophora</i>	VU A1b	LC	<i>Spyrodela polyrhiza</i>	-	LC
<i>Anacamptis laxiflora</i>	VU A1b	LC	<i>Vitis sylvestris</i>	-	LC
<i>Anacamptis pyramidalis</i>	VU A1b	LC	<i>Salix amplexicaulis</i>	-	LC
<i>Ophrys apifera</i>	VU A1b	LC	<i>Tamarix hampeana</i>	VU A2b	-
<i>Ophrys scolopax</i>	VU A1b	LC	<i>Alnus incana</i>	-	LC
<i>Ophrys sphegodes</i>	VU A1b	LC	<i>Capparis spinosa</i>	VU A1b	-
<i>Serapias vomeracea</i>	-	LC	<i>Juniperus oxycedrus ssp. macrocarpa</i>	-	LC
<i>Ammophila arenaria</i>	EN A1b	-	<i>Quercus robur</i>	VU A1b	-
<i>Asphodelus macrocarpus</i>	-	LC	<i>Malus sylvestris</i>	-	DD
<i>Gladiolus palustris</i>	LR nt	DD	<i>Prunus spinosa</i>	-	LC
<i>Juncus effusus</i>	-	LC	<i>Ulmus glabra</i>	VU A1c	-
<i>Typha latifolia</i>	-	LC	<i>Ulmus campestris</i>	VU A2b	-
<i>Asparagus acutifolius</i>	-	LC	<i>Sambucus nigra</i>	VU A1b	-
<i>Allium roseum</i>	-	LC	<i>Quercus coccifera</i>	-	LR
<i>Pancreatium maritimum</i>	EN A1b	LC	<i>Tamarix parviflora</i>	-	LC
<i>Ophrys bertolonii</i>	VU A1b	LC	<i>Quercus ilex</i>	EN A1b	-
<i>Ophrys fusca</i>	VU A1b	LC	<i>Laurus nobilis</i>	EN A1b	-
<i>Ophrys bombyliflora</i>	VU A1b	LC	<i>Populus alba</i>	VU A2b	-
<i>Ophrys lutea</i>	VU A1b	LC	<i>Populus nigra</i>	-	LC
<i>Ophrys speculum</i>	VU A1b	LC	<i>Salix alba</i>	-	LC
<i>Ophrys umbilicata</i>	VU A1b	LC	<i>Platanus orientalis</i>	VU A2b	LC
<i>Serapias parviflora</i>	-	LC	<i>Bidens tripartita</i>	-	LC
<i>Arundo plinii</i>	-	LC	<i>Avena fatua</i>	-	LC
<i>Cyperus longus</i>	-	LC	<i>Trifolium nigrescens</i>	-	LC
<i>Adiantum capillus-veneris</i>	-	LC	<i>Medicago minima</i>	-	LC
<i>Ophrys ferrum-equinum</i>	VU A1b	LC	<i>Aegilops triuncialis</i>	-	LC
<i>Eleocharis palustris</i>	-	LC	<i>Vulpia ciliata</i>	-	LC
<i>Phragmites australis</i>	-	LC	<i>Trifolium angustifolium</i>	-	LC
<i>Cephalanthera rubra</i>	-	LC	<i>Vicia bithynica</i>	-	LC

<i>Agrostis stolonifera</i>	-	LC	<i>Vicia lutea</i>	-	LC
<i>Holcus lanatus</i>	-	LC	<i>Lepidium ruderae</i>	-	LC
<i>Poa pratensis</i>	-	LC	<i>Petrosimonia oppositifolia</i>	CR A1c	-
<i>Melilotus officinalis</i>	-	LC	<i>Trifolium patens</i>	-	LC
<i>Origanum vulgare</i>	EN A1b	-	<i>Juncus bufonius</i>	-	LC
<i>Trifolium repens</i>	-	LC	<i>Daucus guttatus</i>	-	DD
<i>Veronica beccabunga</i>	-	LC	<i>Desmazeria marina</i>	VU A1b	-
<i>Carex distans</i>	-	LC	<i>Vicia sativa</i>	-	LC
<i>Luzula forsteri</i>	-	DD	<i>Cyperus fuscus</i>	-	LC
<i>Mentha pulegium</i>	-	LC	<i>Centaurium erythraea</i>	-	LC
<i>Teucrium scordium</i>	-	LC	<i>Centaurium pulchellum</i>	-	LC
<i>Nasturtium officinale</i>	-	LC	<i>Cyperus flavescens</i>	-	LC
<i>Cichorium intybus</i>	-	LC	<i>Daucus carota</i>	-	DD
<i>Veronica anagallis-aquatica</i>	-	LC	<i>Digitalis lanata</i>	LR cd	LR
<i>Lotus cytisoides</i>	EN A1b	-	<i>Silene vulgaris</i>	-	LC
<i>Hordeum bulbosum</i>	-	LC	<i>Mentha aquatica</i>	-	LC
<i>Apium graveolens</i>	-	LC	<i>Lycopus europaeus</i>	-	LC
<i>Hypericum perforatum</i>	EN A1b	-	<i>Medicago lupulina</i>	-	LC

Table 3. Alien species of the study area.			
No.	Species name	Family	Corology
1	<i>Carpobrotus edulis</i>	Aizoaceae	S Africa
2	<i>Amaranthus hybridus</i>	Amaranthaceae	America Trop.
3	<i>Amaranthus retroflexus</i>	Amaranthaceae	N America
4	<i>Amaranthus albus</i>	Amaranthaceae	S America
5	<i>Agave Americana</i>	Asparagaceae	N America
6	<i>Heliotropium supinum</i>	Boraginaceae	Paleosubtropic
7	<i>Heliotropium curassavicum</i>	Boraginaceae	Neotropic.
8	<i>Coronopus didymus</i>	Brassicaceae	S America
9	<i>Chenopodium ambrosioides</i>	Chenopodiaceae	Cosmopolit.
10	<i>Conyza bonariensis</i>	Compositae	America Trop.
11	<i>Conyza canadensis</i>	Compositae	N America
12	<i>Xanthium strumarium</i>	Compositae	Cosmopolit.
13	<i>Cuscuta campestris</i>	Convolvulaceae	N America
14	<i>Cupressus sempervirens</i>	Cupressaceae	E Asia
15	<i>Lemna minuta</i>	Lemnaceae	N America
16	<i>Euphorbia maculate</i>	Euphorbiaceae	N America
17	<i>Amorpha fruticosa</i>	Fabaceae	N America
18	<i>Robinia pseudacacia</i>	Fabaceae	N America
19	<i>Sisyrinchium angustifolium</i>	Iridaceae	America
20	<i>Linum usitatissimum</i>	Linaceae	Euromedit.
21	<i>Punica granatum</i>	Lythraceae	Euromedit -Asia
22	<i>Ficus carica</i>	Moraceae	E Asia
23	<i>Alcea rosea</i>	Malvaceae	Asia
24	<i>Morus alba</i>	Moraceae	E Asia
25	<i>Oenothera parodiana</i>	Onagraceae	N America
26	<i>Oenothera biennis</i>	Onagraceae	America
27	<i>Oxalis pes-caprae</i>	Oxalidaceae	S America
28	<i>Arundo donax</i>	Poaceae	Asia
29	<i>Paspalum paspalodes</i>	Poaceae	Sub-Cosmopolit.
30	<i>Sorghum halepense</i>	Poaceae	Cosmopolit.
31	<i>Cydonia oblonga</i>	Rosaceae	E Asia
32	<i>Cydonia oblonga</i>	Rosaceae	E Asia
33	<i>Acer negundo</i>	Sapindaceae	N America
34	<i>Ailanthus altissima</i>	Simaroubaceae	E Asia
35	<i>Portulaca oleracea</i>	Portulacaceae	Tropic.
36	<i>Capsicum annum</i>	Solanaceae	S America
37	<i>Physalis angulata</i>	Solanaceae	America Trop.
38	<i>Datura stramonium</i>	Solanaceae	Cosmopolit.
39	<i>Allium sativum</i>	Amaryllidaceae	Asia
40	<i>Symphyotrichum squamatum</i>	Compositae	N America
41	<i>Xanthium spinosum</i>	Compositae	S America
42	<i>Pinus pinaster</i>	Pinaceae	Steno Mesdit.
43	<i>Acacia saligna</i>	Fabaceae	W Australia
44	<i>Ficus carica</i>	Moraceae	E Asia
45	<i>Zizifus jujuba</i>	Rhamnaceae	EuroAsia

BIODIVERSITY AND TROPHIC STRUCTURE OF INVERTEBRATE ASSEMBLAGES ASSOCIATED WITH RED ALGAE *TITANODERMA TROCHANTER* AND *ELLISOLANDIA ELONGATA* BEDS

Ina NASTO^{1*}, Denada SOTA¹, Brunilda VASHAJ¹, Anxhela KAMBERAJ¹,
Kristiana LUSHNJARI¹, Megi MALAJ¹

¹Department of Biology, Faculty of Technical and Natural Sciences,
University Ismail Qemali Vlore

* Corresponding author e-mail.: ina.nasto@yahoo.com

ABSTRACT

The modern biodiversity crisis, referred to as the "seventh extinction," sets itself apart from previous mass extinctions due to its primary cause - human activities. Human actions, such as deforestation, pollution, overexploitation, and climate change, are central factors driving this crisis, with marine ecosystems bearing the brunt of the consequences. Despite the importance of marine species and ecosystems, the conservation efforts of organizations like the IUCN Red List often tend to prioritize terrestrial species, possibly due to the dominance of terrestrial-focused groups within these organizations.

Addressing the neglect of marine species' conservation needs is crucial. Ensuring comprehensive protection for both terrestrial and marine ecosystems is vital, as both play essential roles in maintaining global biodiversity and ecological balance. Bridging the gap between terrestrial and marine conservation efforts requires increased awareness, international cooperation, and more inclusive policies to effectively combat the ongoing biodiversity crisis.

This research aims to evaluate the importance of biodiversity, shelter, and reproduction habitats of two significant species of bioconstructors in the marine intertidal area. The study focuses on two red algae species, *Titanoderma trochanter* and *Ellisolandia elongata*, which are included in Annex II ('endangered and threatened species') of the Barcelona Convention's Mediterranean Action Plan by the United Nations. These calcareous rhodophytes' structures enhance substrate complexity, support diverse assemblages, and play a crucial role in CO₂ sequestration. Additionally, they host many endemic species of the Mediterranean Sea, making their evident structures rare in the Basin.

The research examines the associated fauna of these two calcareous rhodophytes through sampling in 20 x 20 cm squares in four areas of the Karaburun peninsula, within the Karaburun Sazani Marine Protected Area. The sampling was conducted during March, April, September, and October of 2021 and 2022.

In the spring season, a total of 67 invertebrate species were identified among 126 sampled invertebrates in *Ellisolandia elongata*. On the other hand, *Titanoderma trochanter* revealed 59 identified species out of 136 sampled invertebrates. During the autumn season, a total of 75 invertebrate species were identified in *Ellisolandia elongata*, while *Titanoderma trochanter* hosted 72 species.

Both species showed a dominance of the phylum Polychaeta, especially in *Ellisolandia elongata*, which had the highest number of present families. The researchers conducted spatiotemporal and comparative analyses to determine the diversity of the associated fauna of these two calcareous rhodophytes.

Keywords: *Ellisolandia elongata*, *Titanoderma trochanter*, macrozoobenthos, marine invertebrates, polychaeta, Karaburun peninsula

INTRODUCTION

The Mediterranean Sea, comprising only 0.82% of the world's ocean surface area and 0.32% of its volume (Bianchi and Morri, 2000), stands as a renowned hotspot for marine biodiversity, boasting a documented species count exceeding 20,000 (Pascual et al., 2017; Rindi et al., 2019). Within coastal ecosystems, macroalgal beds are widely acknowledged for their pivotal roles in biodiversity maintenance and carbon fluxes (Dayton 1985). However, the coastal marine environments of the Mediterranean have been subjected to continuous exploitation for millennia (Rindi et al., 2019), resulting in pervasive transformations. Presently, these changes have given rise to urbanized, heavily polluted, and densely populated coastlines. These anthropogenic activities exert a disproportionately greater influence on the Mediterranean compared to other global seas (Coll et al., 2010; Rindi et al., 2019). The primary drivers of these changes include habitat loss, degradation, pollution, overexploitation of marine resources, and the introduction of invasive species. Moreover, these drivers are expected to intersect and interact with climate-induced changes in the coming decades. Consequently, understanding the biology of Mediterranean coastal habitats has emerged as a pressing priority in recent years. Coralline algae, which have thrived in the Mediterranean for approximately 140 million years (Chatalov et al., 2015), continue to be widely distributed in the region (Chatalov et al., 2015). Certain species of coralline algae form communities and habitats that are recognized in the 2000 habitat list.

This research aims to elucidate the significance of two coralline algae species as habitat builders while providing insights into the associated invertebrate fauna's biodiversity and trophic structure. Notably, *Ellisolandia elongata* and *Titanoderma trochanter* are both designated as 'endangered and threatened species' within Annex II of the Barcelona Convention's Mediterranean Action Plan, as designated by the United Nations (Verlaque et al., 2019). These two species often play a crucial role as ecosystem engineers. They modify the substrate through their three-dimensional structure consisting of calcareous thalli and trapped sediment (Bressan et al., 2009; Ingrosso et al., 2018; Rindi et al., 2019). These calcareous algae bioconstructions are recognized as biodiversity hotspots of the Mediterranean sea (Ballesteros, 2006).

Recent efforts to quantify energy flows within Mediterranean algal forests and coralligenous outcrops have highlighted their significant contribution to the energy balance of coastal ecosystems (Buonocore et al., 2020; De la Fuente et al., 2019). However, despite their importance, there remains a lack of comprehensive and precise assessment regarding the ecosystem services offered by rocky reefs throughout the Mediterranean Sea. Such an evaluation would be of utmost significance for policymakers and environmental practitioners, aiding in the development of suitable conservation and management strategies (Bevilacqua et al., 2021).

MATERIAL AND METHOD

The study area

The Karaburuni Peninsula, spanning 62 km² in Vlora Bay, separates the Albanian coast along the Adriatic and Ionian Seas. It connects to Sazani Island via the Mezokanali channel. Geologically, it's primarily Cretaceous limestone with terrigenous deposits in the northwest (Kashta et al., 2011). The terrain has hills, with peaks like Maja e Ilqes (733 m), Maja e Flamurit (826 m), and Çadëri (839 m). The peninsula's coastline is rugged with cliffs, especially on the western side, making access to some areas challenging without a boat. In contrast, the eastern coast is less fragmented. The northwestern tip is Cape Gjuhezes, Albania's westernmost point. Vegetation is sparse, except for some maquis and grass, and there are no freshwater sources. The peninsula encloses bays like Raguza, St. Jan, Bristan, and Dafina (Kashta et al., 2011). Peninsula was declared a natural reserve in 1966 and in April 2010, the coastal and marine area of Sazani Island and the Karaburuni Peninsula were raised to the status of Marine Protected Area (MPA), which is the first MPA in Albania (Kashta et al., 2011).

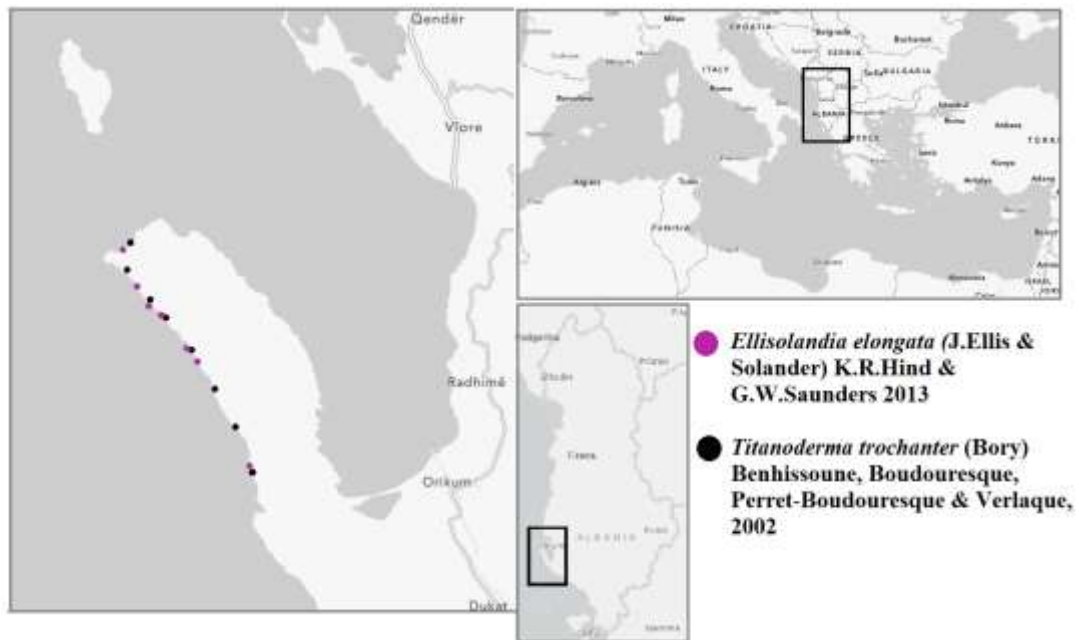

Figure 10. Location of the study area: a) and b) Karaburuni peninsula part of Sazan Karaburuni MPA.

In the months of May, June, September, and October 2021, we carried out benthic sampling on hard bottoms, adhering to established protocols outlined by Cattaneo et al. (1978), Drago et al. (1980), and Salomidi (2003). Our primary objective for this sampling endeavor was to conduct a quantitative assessment of benthic populations within diverse algal assemblages and to assess the variety of benthic fauna associated with each specific assemblage. For every algal grouping, we collected three random samples, each covering a 20 cm x 20 cm area. In total, we sampled 15 distinct algal associations, which are itemized in the table provided. Our sampling location was the Karaburun Peninsula, chosen based on guidance from the distribution and vitality map of *Lithophyllum byssoides* rims, as documented by Blanfuné et al. in (2016) (Figure 1).

Our rationale for selecting the 20x20 cm sample size was twofold; it allowed us to focus on the dominant species that constituted over 90% of the algal composition in each sample, and it helped minimize any potential impact on the habitat resulting from the sampling process. We conducted the collection by carefully scraping the substrate using metallic tools and subsequently preserved the collected material in a solution of 4% formaldehyde. These samples were then transported to the laboratory for identification, employing appropriate instruments such as stereomicroscopes and determination keys.

Data analyses

The analysis of epifaunal community data aimed to compare community structure and diversity across two host algal species, and sites. To assess differences in assemblages hosted by different macroalgal samples in terms of morphologies and spatiotemporal variations, we utilized the Bray–Curtis dissimilarity index (Bray & Curtis, 1957) and visualized these dissimilarities through non-metric multidimensional scaling (NMDS). Additionally, we employed Analysis of Similarities (ANOSIM) to test for variations in community structure among different algal species. These analyses were conducted using the PERMANOVA statistical method (Anderson 2001).

To investigate the influence of algal morphology and algal species on the diversity of epifauna associated with macroalgae, we employed a multiple linear regression model. We quantified diversity using the Shannon–Wiener diversity index for each epifaunal community within a macroalgal sample, which served as the response variable. Furthermore, we conducted an

analysis to identify the trophic structure of each algal species. A comprehensive model encompassing the mentioned effects and their potential interactions was fitted for these analyses (Gan et al., 2019).

RESULTS AND DISCUSSION

Biodiversity and trophic structure of *Titanoderma trochanter* beds

In the samples of *Titanoderma trochanter* collected during both Spring and Autumn, we identified a total of 109 taxa across the two seasons. During the Summer season, the dominant phylum, in terms of species numbers, is Polychaeta (31 taxa), followed by Mollusca (11 taxa) and Arthropoda (9 taxa). Concerning the abundance of invertebrates during this season, Polychaeta stands out, constituting an average of 32.59% of the invertebrates in the analyzed samples. Mollusca accounts for 24.75%, and Arthropoda for 20.1% (refer to Figure 2).

The proportions of different phyla in terms of both the number of identified taxa and the number of individuals in the samples change notably in the Autumn season. Polychaeta still exhibits the highest species diversity with 24 taxa, followed by Arthropoda (20 taxa) and Mollusca (18 taxa). However, when considering the average number of individuals present in the samples, Mollusca becomes more abundant, making up an average of 55.84% of the counted invertebrates. Arthropoda follows as the second most abundant phylum at 24.83% (figure 2).

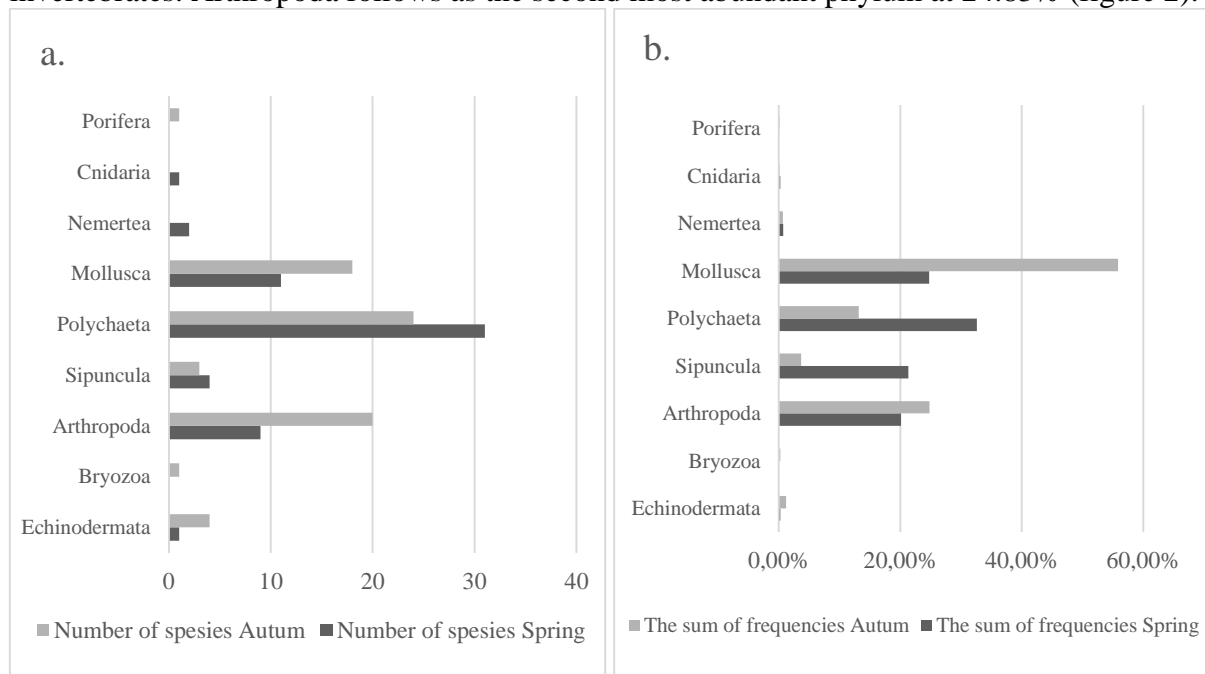

Figure 11. (%DQ - a) Number of taxa present in *Titanoderma trochanter* algal beds. (%DI - b) Percentages of cumulative abundance of each phylum.

Trophic Analysis and Marine Biotic Index AMBI ecological group analysis

The trophic analysis of the fauna associated with *Titanoderma trochanter* algae has classified them into eight feeding type groups, as outlined in the literature. In instances where data was lacking, some groups were denoted as "NE" (Figure 3, Table 1).

The most populous trophic group is the Predators, encompassing 48 identified species, with a significant representation of polychaetes. Regarding the abundance of individuals within the analyzed samples, the Filter Feeders constitute 27.36% of the invertebrates during the spring season and 52.52% during the autumn season. This is primarily attributed to the substantial presence of *Mytilus galloprovincialis* and various sedentary polychaetes. Consequently, there is a notable density of sessile fauna, including barnacles, sedentary polychaetes, and bivalves, which attach themselves to the calcareous structures of these algae thalli.

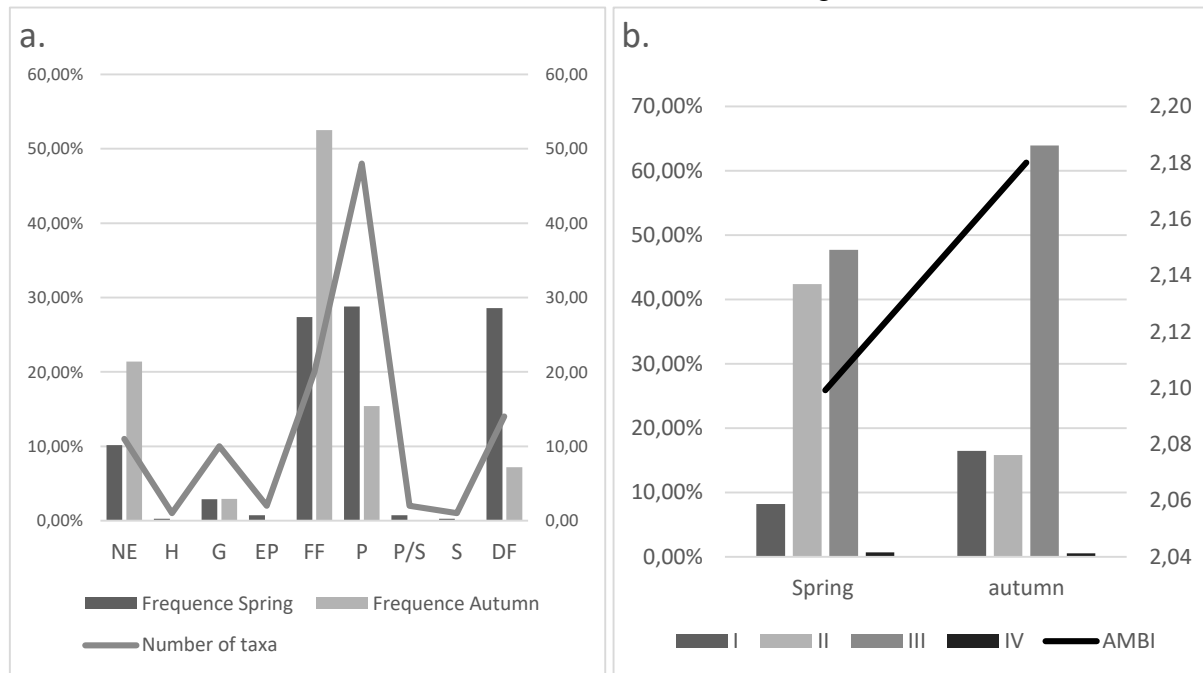

Figure 12. Trophic analysis of *Titanoderma trochanter* algal beds (a). Percentages of abundance (%DI) according to the feeding guilds feeding guilds (Filter feeder-FF; Predator- P; Grazer-G; Deposit feeder-DF; Not Evaluated-NE; Predator/Scavenger-P/S; Scavenger-S; Ectoparasitic-EP; Herbivore-H) and b. AMBI values at each season and cumulative frequencies of AMBI ecological group ((I)- very sensitive to disturbance; (II)- indifferent to disturbance; (III)- tolerant to disturbance; (IV)- second-order opportunistic; Not Evaluated-NE).

To assess the ecological conditions of the sampled waters, we utilized the Marine Biotic Index AMBI and conducted an ecological group analysis. Table 1 presents the AMBI ecological groups, and Figure 3 displays the analysis results. Threshold values for AMBI classification were determined based on recommendations from Muxika et al. (2005) and Borja & Tunberg (2011): 'high quality' <1.2; 'Poor quality' 1.2-3.3; 'Moderate quality' 3.3-4.3; 'Poor quality' 4.3-5.5; 'Bad quality' >5.5.

According to Muxika et al.'s (2005) classification, the Marine Biotic Index AMBI value ranges from 2.10 in spring to 2.18 in autumn. Both of these values fall within the 'Good quality' category for the marine waters where *Titanoderma trochanter* substrates were sampled.

Table 1. Taxonomic list of species, occurring in *Titanoderma trochanter* beds in 2 seasons (Spr- Spring; Aut-Autumn), with their abundance (N), feeding guilds (Filter feeder-FF; Predator- P; Grazer-G; Deposit feeder-DF; Not Evaluated-NE; Predator/Scavenger-P/S; Scavenger-S; Ectoparasitic-EP; Herbivore-H) and AMBI ecological group ((I)- very sensitive to disturbance; (II)-indifferent to disturbance; (III)- tolerant to disturbance; (IV)- second-order opportunistic; Not Evaluated-NE).

<i>Titanoderma trochanter</i>	Trophic group	AMBI group	Spring		Autumn	
			Abundance	Frequency	Abundance	Frequency
Species						
Porifera						
<i>Scalarispongia scalaris</i> (Schmidt, 1862)	FF	(II)	0.00	0.00%	0.33	0.13%
Cnidaria						
<i>Bunodactis verrucosa</i> (Pennant, 1777)	P	(I)	0.33	0.24%	0.00	0.00%
Nemertea						
<i>Leucocephalonemertes aurantiaca</i> (Grube, 1855)	P/S	(II)	0.33	0.24%	0.00	0.00%
<i>Notospermus geniculatus</i> (Delle Chiaje, 1822)	P/S	(II)	0.67	0.48%	0.00	0.00%
Mollusca						
<i>Rhyssoplax corallina</i> (Risso, 1826)	G	NE	0.67	0.48%	4.00	1.60%
<i>Rhyssoplax olivacea</i> (Spengler, 1797)	G	(II)	1.33	0.97%	0.00	0.00%
<i>Acanthochitona crinita</i> (Pennant, 1777)	G	(I)	0.33	0.24%	0.00	0.00%
<i>Acanthochitona fascicularis</i> (Linnaeus, 1767)	G	(I)	1.33	0.97%	0.67	0.27%
<i>Diodora italica</i> (DeFrance, 1820)	P	(I)	0.00	0.00%	0.67	0.27%
<i>Tritia unifasciata</i> (Kiener, 1834)	S	(I)	0.33	0.24%	0.00	0.00%
<i>Pisania striata</i> (Gmelin, 1791)	P	NE	0.33	0.24%	0.00	0.00%
<i>Trophonopsis muricata</i> (Montagu, 1803)	P	(I)	0.33	0.24%	0.00	0.00%
<i>Pyrghostylus striatulus</i> (Linnaeus, 1758)	EP	(I)	0.67	0.48%	0.00	0.00%
<i>Bittium reticulatum</i> (da Costa, 1778)	G	(I)	0.00	0.00%	0.33	0.13%
<i>Cerithium vulgatum russoi</i> T. Cossignani, 2021	P	(II)	0.00	0.00%	0.67	0.27%
<i>Rissoa variabilis</i> (Megerle von Mühlfeld, 1824)	G	(I)	0.00	0.00%	0.33	0.13%
<i>Pisania striata</i> (Gmelin, 1791)	P	(IV)	0.00	0.00%	0.67	0.27%
<i>Ocenebra edwardsii</i> (Payraudeau, 1826)	P	(II)	0.00	0.00%	0.33	0.13%
<i>Patella ulyssiponensis</i> Gmelin, 1791	G	(I)	0.00	0.00%	0.33	0.13%
<i>Gibbula turbinoides</i> (Deshayes, 1835)	DF	(I)	0.00	0.00%	2.67	1.06%
<i>Azorinus chamasolen</i> (da Costa, 1778)	DF	(I)	0.00	0.00%	0.33	0.13%
<i>Scaphopoda</i>	DF	(II)	1.33	0.97%	0.33	0.13%
<i>Kellia suborbicularis</i> (Montagu, 1803)	FF	(I)	2.00	1.45%	0.00	0.00%
<i>Striarca lactea</i> (Linnaeus, 1758)	FF	(I)	0.67	0.48%	0.00	0.00%
<i>Musculus costulatus</i> (Risso, 1826)	FF	(I)	0.00	0.00%	9.00	3.59%
<i>Mytilus galloprovincialis</i> Lamarck, 1819	FF	(III)	25.67	18.64%	113.00	45.08%
<i>Pinctada radiata</i> (Leach, 1814)	FF	(II)	0.00	0.00%	5.67	2.26%
Annelida						
<i>Lumbrineris</i> sp Blainville, 1828	P	(III)	0.33	0.24%	0.00	0.00%
<i>Aphrodita perarmata</i> Roule, 1898	P	(III)	0.33	0.24%	0.00	0.00%
<i>Pontogenia chrysocoma</i> (Baird, 1865)	P	(III)	0.33	0.24%	1.00	0.40%
<i>Eunoe hubrechtii</i> (McIntosh, 1900)	P	(III)	0.00	0.00%	0.33	0.13%
<i>Lepidonotus clava</i> (Montagu, 1808)	P	(III)	10.67	7.75%	10.33	4.12%
<i>Ceratonereis (Compositia) costae</i> (Grube, 1840)	P	(II)	3.67	2.66%	0.00	0.00%
<i>Hediste diversicolor</i> (O.F. Müller, 1776)	P	(III)	1.00	0.73%	0.00	0.00%
<i>Alitta succinea</i> (Leuckart, 1847)	P	(III)	0.00	0.00%	1.33	0.53%
<i>Neanthes fucata</i> (Savigny, 1822)	P	(III)	1.33	0.97%	0.00	0.00%
<i>Neanthes nubila</i> (Savigny, 1822)	P	(III)	0.33	0.24%	0.00	0.00%
<i>Neanthes acuminata</i> (Ehlers, 1868)	P	(III)	0.00	0.00%	2.33	0.93%
<i>Nereis</i> sp. Linnaeus, 1758	P	(III)	0.00	0.00%	0.33	0.13%
<i>Nereis pelagica</i> Linnaeus, 1758	P	(III)	1.00	0.73%	4.67	1.86%
<i>Hesionella splendida</i> Lamarck, 1818	P	(II)	0.67	0.48%	0.00	0.00%
<i>Nereis persica</i> Fauvel, 1913	P	(III)	8.67	6.30%	2.00	0.80%
<i>Perinereis</i> Kinberg, 1865	P	(III)	0.33	0.24%	0.00	0.00%
<i>Perinereis macropus</i> (Claparède, 1870)	P	(III)	0.33	0.24%	0.00	0.00%
<i>Perinereis olivireae</i> (Horst, 1889)	P	(III)	0.00	0.00%	0.67	0.27%
<i>Platynereis coccinea</i> (Delle Chiaje, 1822)	P	(III)	0.33	0.24%	0.00	0.00%
Syllidae Grube, 1850	P	(III)	0.33	0.24%	0.67	0.27%

V. International Agricultural, Biological & Life Science Conference, Edirne, Turkey, 18-20 September 2023

<i>Odontosyllis</i> Claparède, 1863	P	(III)	0.67	0.48%	0.00	0.00%
<i>Syllis amicornis</i> Simon, San Martín & Robinson, 2014	P	(II)	0.00	0.00%	1.00	0.40%
<i>Syllis hyalina</i> Grube, 1863	P	(II)	1.67	1.21%	0.00	0.00%
<i>Syllis krohnii</i> Ehlers, 1864	P	(II)	3.00	2.18%	2.33	0.93%
<i>Syllis prolifera</i> Krohn, 1852	P	(II)	1.00	0.73%	0.00	0.00%
<i>Syllis variegata</i> Grube, 1860	P	(II)	0.33	0.24%	0.67	0.27%
<i>Syllis vittata</i> Grube, 1840	P	(II)	0.33	0.24%	0.00	0.00%
<i>Syllis gracilis</i> Grube, 1840	P	(II)	0.00	0.00%	0.33	0.13%
<i>Trypanosyllis zebra</i> (Grube, 1860)	P	(II)	0.67	0.48%	0.00	0.00%
<i>Nephtys</i> Cuvier, 1817	P	(II)	0.33	0.24%	0.00	0.00%
<i>Syllis variegata</i> Grube, 1860	P	(II)	0.00	0.00%	0.67	0.27%
<i>Nereiphylla rubiginosa</i> (de Saint-Joseph, 1888)	P	(II)	0.00	0.00%	0.67	0.27%
<i>Phyllodoce laminosa</i> Savigny in Lamarck, 1818	P	(II)	0.00	0.00%	0.33	0.13%
<i>Phyllodoce schmardaei</i> Day, 1963	P	(II)	0.00	0.00%	0.33	0.13%
Sabellidae Latreille, 1825	P	(II)	0.00	0.00%	1.33	0.53%
<i>Eulalia pusilla</i> Ørsted, 1843	P	(II)	0.67	0.48%	0.00	0.00%
<i>Bathypermia langerhansii</i> (Fauvel, 1909)	FF	(II)	1.33	0.97%	0.00	0.00%
<i>Filograna</i> sp. Berkeley, 1835	FF	(II)	0.33	0.24%	0.00	0.00%
<i>Serpula</i> Linnaeus, 1758	FF	(II)	1.33	0.97%	0.00	0.00%
<i>Serpula vermicularis</i> Linnaeus, 1767	FF	(II)	1.33	0.97%	0.33	0.13%
<i>Spirobranchus</i> Blainville, 1818	FF	(II)	0.33	0.24%	0.00	0.00%
<i>Vermiliopsis</i> Saint-Joseph, 1894	FF	(II)	0.00	0.00%	0.33	0.13%
<i>Vermiliopsis infundibulum</i> (Philippi, 1844)	FF	(II)	0.00	0.00%	1.00	0.40%
<i>Dodecaceria concharum</i> Ørsted, 1843	FF	(IV)	0.00	0.00%	0.33	0.13%
<i>Polycirrus</i> Grube, 1850	FF	(IV)	0.00	0.00%	0.33	0.13%
<i>Janua heterostropha</i> (Montagu, 1803)	FF	(II)	0.33	0.24%	0.00	0.00%
<i>Spirorbis</i> sp. Daudin, 1800	FF	(IV)	1.00	0.73%	0.00	0.00%
Sipuncula						
<i>Aspidosiphon muelleri</i> Diesing, 1851	DF	(I)	1.00	0.73%	0.67	0.27%
<i>Phascolosoma granulatum</i> Leuckart, 1828	DF	(II)	24.00	17.43%	6.00	2.39%
<i>Golfingia vulgaris</i> (de Blainville, 1827)	DF	(I)	1.33	0.97%	0.00	0.00%
<i>Phascolion strombus</i> (Montagu, 1804)	DF	(II)	2.67	1.94%	2.67	1.06%
Crustacea						
<i>Megabalanus tintinnabulum</i> (Linnaeus, 1758)	FF	(II)	3.33	2.42%	0.00	0.00%
<i>Achelgia echinata</i> Hodge, 1864	EP	(I)	0.33	0.24%	0.00	0.00%
<i>Nototropis massiliensis</i> (Bellan-Santini, 1975)	P	(I)	0.33	0.24%	0.00	0.00%
Caprellidae Leach, 1814	H	(I)	0.33	0.24%	0.00	0.00%
<i>Autonoe spiniventris</i> Della Valle, 1893	DF	(I)	0.33	0.24%	0.00	0.00%
<i>Unciolella lunata</i> Chevreux, 1911	DF	(I)	1.33	0.97%	0.00	0.00%
<i>Amphithopsis depressa</i> Schiecke, 1976	NE	(I)	0.00	0.00%	0.33	0.13%
<i>Elasmopus brasiliensis</i> (Dana, 1853)	NE	(III)	14.00	10.17%	18.67	7.45%
<i>Elasmopus pecteniscrus</i> (Spence Bate, 1862)	NE	(III)	0.00	0.00%	3.00	1.20%
<i>Stenothoe marina</i> (Spence Bate, 1857)	NE	(II)	0.00	0.00%	0.33	0.13%
<i>Ampelisca anophthalma</i> Bellan-Santini, Kaim-Malka, 1977	NE	(II)	0.00	0.00%	1.00	0.40%
<i>Microprotopus maculatus</i> Norman, 1867	NE	(I)	0.00	0.00%	1.33	0.53%
<i>Apothysa crassipes</i> (Heller, 1866)	NE	(II)	0.00	0.00%	3.67	1.46%
<i>Ptilohyale eburnea</i> (Krapp-Schickel, 1974)	NE	(I)	0.00	0.00%	22.00	8.78%
<i>Joeropsis brevicornis brevicornis</i> Koehler, 1885	NE	(II)	0.00	0.00%	1.33	0.53%
<i>Joeropsis</i> sp. Koehler, 1885	NE	NE	0.00	0.00%	1.33	0.53%
<i>Anthura gracilis</i> (Montagu, 1808)	NE	(I)	0.00	0.00%	0.67	0.27%
<i>Gnathia phallonajopsis</i> Monod, 1925	DF	NE	0.00	0.00%	0.33	0.13%
<i>Microdeutopus</i> Costa, 1853	DF	(II)	0.00	0.00%	0.33	0.13%
<i>Dynamene edwardsi</i> (Lucas, 1849)	DF	(II)	2.00	1.45%	0.67	0.27%
<i>Dynamenella sheareri</i> (Hatch, 1947)	DF	(II)	5.33	3.87%	1.67	0.66%
<i>Paracerceis</i> sp. Hansen, 1905	DF	(II)	0.00	0.00%	2.33	0.93%
<i>Eriphia verrucosa</i> (Forskål, 1775)	P	(III)	0.00	0.00%	2.00	0.80%
<i>Thia scutellata</i> (JC Fabricius, 1793)	P	(II)	0.00	0.00%	0.33	0.13%
<i>Pachygrapsus marmoratus</i> (J.C. Fabricius, 1787)	P	(II)	0.00	0.00%	1.33	0.53%
Bryozoa						
<i>Patinella radiata</i> (Audouin, 1826)	FF	(II)	0.00	0.00%	0.67	0.27%
<i>Perforatus perforatus</i> (Bruguière, 1789)	FF	(II)	0.00	0.00%	0.67	0.27%
Echinodermata						
<i>Echinoidea</i>	G	NE	0.00	0.00%	1.00	0.40%

<i>Arbaciella elegans</i> Mortensen, 1910	G	(I)	0.33	0.24%	0.00	0.00%
<i>Psammechinus microtuberculatus</i> (Blainville, 1825)	G	(I)	0.00	0.00%	0.67	0.27%
<i>Amphipholis squamata</i> (Delle Chiaje, 1828)	P	(I)	0.00	0.00%	1.33	0.53%

Biodiversity and trophic structure of *Ellisolandia elongata* beds

The analysis of substrate samples containing *Ellisolandia elongata* beds revealed a total of 110 taxa, with 67 taxa identified during the spring season and 76 taxa during the autumn season. Polychaetas exhibited the highest diversity in terms of the number of species, with 32 species present during spring and 37 species during autumn. In contrast, the diversity of Mollusca and Arthropoda associated with this algae was relatively low, comprising only 12 species for each phylum. However, it's worth noting that the number of Echinodermata species increased significantly, with 7 species identified in this habitat (Table 2; Figure 4).

These findings underscore the seasonal variations in species diversity within *Ellisolandia elongata* beds, with Polychaetas dominating and Echinodermata showing an uptick in species richness. The contrast in diversity levels among different phyla highlights the complex ecological dynamics at play in this particular substrate environment across different seasons.

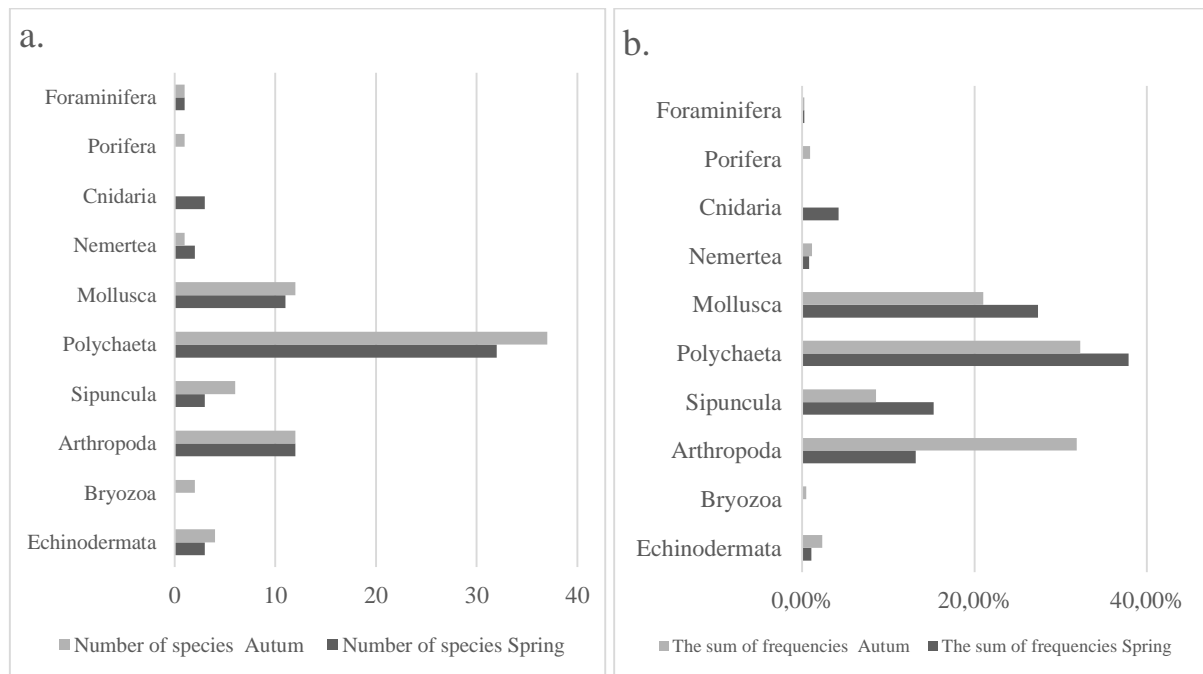

Figure 13. (%DQ - a) Number of taxa present in *Ellisolandia elongata* algal beds. (%DI - b) Percentages of cumulative abundance of each phylum.

The analysis of the average frequency of invertebrates present in the samples of *Ellisolandia elongata* reveals intriguing seasonal variations in the composition. During the spring season, approximately 38% of the invertebrates comprise polychaeta, whereas in the autumn season, this percentage decreases slightly to around 33%. This shift is primarily attributed to the notable abundance of species belonging to the Nereididae and Syllidae families, both of which exhibit the highest number of individuals within the examined samples.

Moving on to Mollusca, their abundance makes up about 27% of the samples during the summer season, and this percentage decreases to 21% in the autumn season. This fluctuation can be attributed to the high-density presence of two bivalve mollusks, namely *Musculus costulatus* and *Mytilus galloprovincialis*, which contribute significantly to the overall composition.

Crustaceans, on the other hand, show an interesting pattern. Their average abundance experiences a peak of approximately 31%, driven primarily by the substantial presence of two

amphipoda species, *Elasmopus rapax* and *Apohyale crassipes*, during the periods under consideration.

These findings illustrate the dynamic nature of the *Ellisolandia elongata* habitat, with distinct invertebrate groups exhibiting varying degrees of abundance and dominance across different seasons. This highlights the intricate interplay between ecological factors and the community structure of this substrate environment throughout the year.

Trophic Analysis and Marine Biotic Index AMBI ecological group analysis

The trophic analysis of *Ellisolandia elongata* unveils a noteworthy dominance of Predators (41.35% in spring and 30.72% in autumn) in terms of both species diversity and average abundance during the sampled seasons (Figure 5). This prevalence is attributed to the rich diversity of polychaetes and echinoderms present in the examined epiphytic fauna. Following Predators, the Filter Feeders group (30.26% in spring and 21.02% in autumn) takes center stage, primarily composed of sedentary bivalves, barnacles, and polychaetes. Additionally, there is a notable abundance of Deposit Feeders, mainly consisting of mollusks and arthropods.

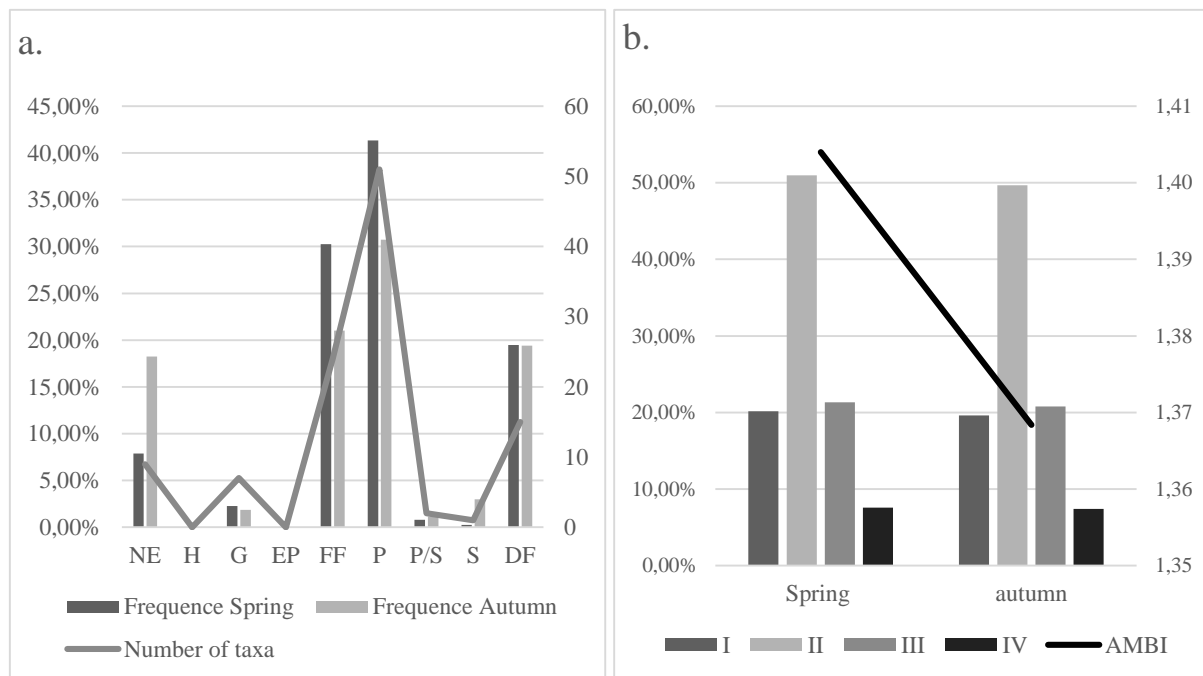

Figure 14. Trophic analysis of *Ellisolandia elongata* algal beds (a). Percentages of abundance (%DI) according to the feeding guilds feeding guilds (Filter feeder-FF; Predator- P; Grazer-G; Deposit feeder-DF; Not Evaluated-NE; Predator/Scavenger-P/S; Scavenger-S; Ectoparasitic-EP; Herbivore-H) and b. AMBI values at each season and cumulative frequencies of AMBI ecological group (I)- very sensitive to disturbance; (II)-indifferent to disturbance; (III)- tolerant to disturbance; (IV)- second-order opportunistic; Not Evaluated-NE).

In evaluating the ecological conditions of the sampled waters, we employed the Marine Biotic Index AMBI and conducted an analysis of ecological groups. Table 1 provides an overview of the AMBI ecological groups, while Figure 3 visually represents the analysis results. The cumulative frequency of AMBI ecological groups highlights the dominance of group II, often categorized as "indifferent to disturbance." This predominance is a consequence of the high density of polychaetes, sipunculids, and mollusks within the composition.

According to the classification proposed by Muxika et al. (2005), the Marine Biotic Index AMBI ranges from 1.40 in spring to 1.36 in autumn. Notably, both of these values fall within

the 'Good quality' category for the marine waters where *Ellisolandia elongata* substrates were sampled. These findings indicate a favorable ecological state in the studied marine environment during the seasons under investigation.

Table 2. Taxonomic list of species, occurring in *Ellisolandia elongata* beds in 2 seasons (Spr-Spring; Aut-Autumn), with their abundance (N), feeding guilds (Filter feeder-FF; Predator- P; Grazer-G; Deposit feeder-DF; Not Evaluated-NE; Predator/Scavenger-P/S; Scavenger-S; Ectoparasitic-EP; Herbivore-H) and AMBI ecological group ((I)- very sensitive to disturbance; (II)-indifferent to disturbance; (III)- tolerant to disturbance; (IV)- second-order opportunistic; Not Evaluated-NE).

Ellisolandia elongata	Species	Trophic group	AMBI group	Spring		Autumn	
				Abundance	Frequency	Abundance	Frequency
Foraminifera							
	<i>Miniacina minicea</i> (Pallas, 1766)	FF	(I)	0.33	0.26%	0.33	0.23%
Porifera							
	<i>Scalariispongia scalaris</i> (Schmidt, 1862)	FF	(II)	0.00	0.00%	1.33	0.92%
Cnidaria							
	<i>Actinia equina</i> (Linnaeus, 1758)	FF	(I)	0.33	0.26%	0.00	0.00%
	<i>Bunodactis verrucosa</i> (Pennant, 1777)	P	(I)	0.33	0.26%	0.00	0.00%
	<i>Exaiptasia diaphana</i> (Rapp, 1829)	FF	(II)	4.67	3.68%	0.00	0.00%
Nemertea							
	<i>Nemertea</i>	P/S	(II)	0.33	0.26%	1.67	1.15%
	<i>Tubulanus annulatus</i> (Montagu, 1804)	P/S	(II)	0.67	0.53%	0.00	0.00%
Mollusca							
	<i>Acanthochitona fascicularis</i> (Linnaeus, 1767)	G	(I)	0.33	0.26%	0.00	0.00%
	<i>Rhyssoplax olivacea</i> (Spengler, 1797)	G	(II)	0.67	0.53%	0.00	0.00%
	<i>Cymbula safiana</i> (Lamarck, 1819)	G	(I)	0.33	0.26%	0.00	0.00%
	<i>Bittium reticulatum</i> (da Costa, 1778)	G	(I)	0.67	0.53%	0.33	0.23%
	<i>Alvania lineata</i> Risso, 1826	DF	(I)	0.00	0.00%	2.00	1.39%
	<i>Pseudofusus margaritae</i> (Buzzurro & Russo, 2007)	P	(I)	0.00	0.00%	7.33	5.08%
	<i>Tritia louisii</i> (Pallary, 1912)	S	NE	0.33	0.26%	4.33	3.00%
	<i>Pisania striata</i> (Gmelin, 1791)	P	(IV)	1.33	1.05%	0.00	0.00%
	<i>Muricopsis cristata</i> (Brocchi, 1814)	P	(I)	0.00	0.00%	0.33	0.23%
	<i>Pusia granum</i> (Forbes, 1844)	P	(I)	0.00	0.00%	0.33	0.23%
	<i>Patella ulyssiponensis</i> Gmelin, 1791	G	(I)	0.00	0.00%	0.33	0.23%
	<i>Steromphala rarilineata</i> (Michaud, 1829)	G	(I)	0.00	0.00%	2.00	1.39%
	<i>Ocenebrina edwardsii</i> (Payraudeau, 1826)	P	(II)	0.67	0.53%	0.00	0.00%
	<i>Scaphopoda</i>	DF	(II)	1.33	1.05%	0.00	0.00%
	<i>Parvicardium trapezium</i> Cecalupo & Quadri, 1996	FF	NE	0.00	0.00%	0.33	0.23%
	<i>Parvicardium scriptum</i> (Bucquoy & Dollfus, 1892)	FF	(I)	1.33	1.05%	0.00	0.00%
	<i>Musculus costulatus</i> (Risso, 1826)	FF	(I)	18.67	14.74%	0.33	0.23%
	<i>Mytilus galloprovincialis</i> Lamarck, 1819	FF	(III)	9.00	7.11%	12.33	8.55%
Polycheta							
	<i>Polychaeta</i>	P	(III)	0.67	0.53%	0.00	0.00%
	<i>Pontogenia chrysocoma</i> (Baird, 1865)	P	(III)	0.00	0.00%	0.33	0.23%
	<i>Lepidonotus clava</i> (Montagu, 1808)	P	(III)	8.33	6.58%	0.33	0.23%
	<i>Lepidonotus squamatus</i> (Linnaeus, 1758)	P	(III)	0.33	0.26%	0.00	0.00%
	<i>Harmothoe Kinberg, 1856</i>	P	(II)	0.00	0.00%	0.33	0.23%
	<i>Harmothoe impar</i> (Johnston, 1839)	P	(II)	0.00	0.00%	0.33	0.23%
	<i>Dorvillea Parfitt, 1866</i>	P	(II)	1.00	0.79%	0.00	0.00%
	<i>Dorvillea rubrovittata</i> (Grube, 1855)	P	(II)	0.33	0.26%	0.00	0.00%
	<i>Lysidice ninetta</i> Audouin & H Milne Edwards, 1833	P	(II)	0.67	0.53%	2.33	1.62%
	<i>Glycera tridactyla</i> Schmarda, 1861	P	(II)	0.00	0.00%	0.33	0.23%
	<i>Hesionidae</i> Grube, 1850	P	(II)	0.00	0.00%	0.67	0.46%
	<i>Lumbrineris</i> Blainville, 1828	P	(III)	0.67	0.53%	0.00	0.00%
	<i>Arabella iricolor</i> (Montagu, 1804)	P	(I)	0.33	0.26%	0.00	0.00%
	<i>Nereididae</i> Blainville, 1818	P	(III)	0.33	0.26%	5.67	3.93%
	<i>Ceratonereis</i> (Compositia) <i>costae</i> (Grube, 1840)	P	(III)	0.33	0.26%	0.33	0.23%
	<i>Hediste diversicolor</i> (O.F. Müller, 1776)	P	(III)	1.00	0.79%	0.00	0.00%
	<i>Neanthes acuminata</i> (Ehlers, 1868)	P	(III)	0.67	0.53%	0.67	0.46%
	<i>Neanthes nubila</i> (Savigny, 1822)	P	(III)	3.00	2.37%	0.33	0.23%
	<i>Nereis</i> Linnaeus, 1758	P	(III)	1.67	1.32%	0.00	0.00%
	<i>Nereis pelagica</i> Linnaeus, 1758	P	(III)	4.00	3.16%	0.33	0.23%

<i>Nereis splendida</i> Grube, 1840	P	(III)	0.33	0.26%	0.33	0.23%
<i>Nereis zonata persica</i> Fauvel, 1913	P	(III)	5.33	4.21%	3.33	2.31%
<i>Perinereis marionii</i> (Audouin & Milne Edwards, 1833)	P	(III)	1.67	1.32%	4.00	2.77%
<i>Streptosyllis Webster & Benedict, 1884</i>	P	(III)	0.00	0.00%	0.33	0.23%
<i>Odontosyllis cucullata</i> (McIntosh, 1908)	P	(III)	0.00	0.00%	1.33	0.92%
<i>Haplosyllis spongicola</i> (Grube, 1855)	P	(III)	1.67	1.32%	0.00	0.00%
<i>Salvatoria limbata</i> (Claparède, 1868)	P	(II)	0.00	0.00%	7.00	4.85%
<i>Syllis Lamarck, 1818</i>	P	(II)	0.33	0.26%	0.00	0.00%
<i>Syllis amicarmillaris</i> Simon, San Martín, Robinson, 2014	P	(II)	0.33	0.26%	0.33	0.23%
<i>Syllis gracilis</i> Grube, 1840	P	(II)	2.00	1.58%	0.33	0.23%
<i>Syllis krohnii</i> Ehlers, 1864	P	(II)	3.67	2.89%	0.33	0.23%
<i>Syllis prolifera</i> Krohn, 1852	P	(II)	2.00	1.58%	0.33	0.23%
<i>Syllis variegata</i> Grube, 1860	P	(II)	2.33	1.84%	0.67	0.46%
<i>Naiades cantrainii</i> Delle Chiaje, 1830	P	(II)	0.67	0.53%	0.67	0.46%
<i>Eulalia viridis</i> (Linnaeus, 1767)	P	(II)	1.00	0.79%	0.00	0.00%
<i>Myxicola infundibulum</i> (Montagu, 1808)	FF	(II)	0.00	0.00%	0.67	0.46%
<i>Protula anomala</i> Day, 1955	FF	(II)	0.00	0.00%	1.33	0.92%
<i>Phyllodoce Lamarck, 1818</i>	P	(II)	0.67	0.53%	0.33	0.23%
<i>Phyllodoce laminosa</i> Savigny in Lamarck, 1818	P	(II)	0.00	0.00%	0.33	0.23%
<i>Janua heterostropha</i> (Montagu, 1803)	FF	(II)	0.33	0.26%	0.00	0.00%
<i>Maldanidae</i> Malmgren, 1867	FF	(II)	0.67	0.53%	0.00	0.00%
<i>Polyophthalmus pictus</i> (Dujardin, 1839)	DF	(II)	1.33	1.05%	0.67	0.46%
<i>Fam. Scalibregmatidae</i> Malmgren, 1867	DF	(I)	0.33	0.26%	0.00	0.00%
<i>Serpula vermicularis</i> Linnaeus, 1767	FF	(II)	0.00	0.00%	0.33	0.23%
<i>Janua heterostropha</i> (Montagu, 1803)	FF	(II)	0.00	0.00%	0.33	0.23%
<i>Cirriformia tentaculata</i> (Montagu, 1808)	FF	(II)	0.00	0.00%	0.33	0.23%
<i>Flabelligera affinis</i> M. Sars, 1829	FF	(II)	0.00	0.00%	0.33	0.23%
<i>Ampharete</i> Malmgren, 1866	FF	(II)	0.00	0.00%	0.33	0.23%
<i>Anobothrus gracilis</i> (Malmgren, 1866)	FF	(II)	0.00	0.00%	10.00	6.93%
<i>Polycirrus</i> Grube, 1850	FF	(II)	0.00	0.00%	1.00	0.69%
<i>Capitellidae</i> Grube, 1862			0.00	0.00%	1.00	0.69%
Sipuncula						
<i>Phascolosoma granulatatum</i> Leuckart, 1828	DF	(II)	17.67	13.95%	0.67	0.46%
<i>Golfingia elongata</i> (Keferstein, 1862)	DF	(I)	0.00	0.00%	2.33	1.62%
<i>Golfingia vulgaris</i> (de Blainville, 1827)	DF	(I)	0.00	0.00%	1.00	0.69%
<i>Phascolion strombus</i> (Montagu, 1804)	DF	(II)	1.67	1.32%	2.67	1.85%
<i>Sipunculus nudus</i> Linnaeus, 1766	DF	(I)	0.00	0.00%	5.33	3.70%
<i>Aspidosiphon muelleri</i> Diesing, 1851	DF	(I)	0.00	0.00%	0.33	0.23%
Arthropoda						
<i>Perforatus perforatus</i> (Bruguère, 1789)	FF	NE	0.67	0.53%	0.00	0.00%
<i>Adna anglica</i> Sowerby, 1823	FF	NE	1.00	0.79%	0.00	0.00%
<i>Leucothoe incisa</i> Robertson, 1892	FF	(I)	1.33	1.05%	0.00	0.00%
<i>Gammaropsis crenulata</i> Krapp-Schickel & Myers, 1979	NE	NE	1.33	1.05%	0.67	0.46%
<i>Autonoe spiniventris</i> Della Valle, 1893	DF	(I)	2.00	1.58%	0.00	0.00%
<i>Monomia</i> sp. Gistel, 1848	NE	NE	0.00	0.00%	0.67	0.46%
<i>Gammarus</i> sp. Fabricius, 1775	NE	NE	3.67	2.89%	2.33	1.62%
<i>Pasiphaea multidentata</i> Esmark, 1866	NE	NE	0.00	0.00%	2.33	1.62%
<i>Apohyale crassipes</i> (Heller, 1866)	NE	(II)	4.33	3.42%	21.67	15.01%
<i>Anthura gracilis</i> (Montagu, 1808)	NE	(I)	0.33	0.26%	0.00	0.00%
<i>Anthuroidea</i> Leach, 1814	NE	(I)	0.00	0.00%	0.33	0.23%
<i>Cymodoce truncata</i> Leach, 1814	NE	(I)	0.00	0.00%	0.33	0.23%
<i>Dynamene curalii</i> Holdich & Harrison, 1980	NE	(I)	0.33	0.26%	0.00	0.00%
<i>Dynamene sheareri</i> (Hatch, 1947)	DF	(II)	0.33	0.26%	0.00	0.00%
<i>Dynamene edwardsi</i> (Lucas, 1849)	DF	(II)	0.00	0.00%	0.67	0.46%
<i>Elasmopus pecteniscrus</i> (Spence Bate, 1862)	DF	(II)	0.00	0.00%	3.33	2.31%
<i>Elasmopus rapax</i> Costa, 1853	DF	(II)	0.00	0.00%	9.00	6.24%
<i>Acanthonyx lunulatus</i> (Risso, 1816)	P	(I)	1.00	0.79%	4.33	3.00%
<i>Eriphia verrucosa</i> (Forskål, 1775)	P	(III)	0.33	0.26%	0.33	0.23%
Bryozoa						
<i>Cellepora</i> sp. Linnaeus, 1767	FF	(II)	0.00	0.00%	0.33	0.23%
<i>Patinella radiata</i> (Audouin, 1826)	FF	(II)	0.00	0.00%	0.67	0.46%
Echinodermata						
<i>Asterina gibbosa</i> (Pennant, 1777)	P	(I)	0.33	0.26%	0.00	0.00%
<i>Amphiura</i> sp. Forbes, 1843	P	(I)	0.33	0.26%	0.00	0.00%
<i>Amphiura chiajei</i> Forbes, 1843	P	(II)	0.67	0.53%	0.00	0.00%
<i>Amphipholis squamata</i> (Delle Chiaje, 1828)	P	(I)	0.67	0.46%	0.00	0.00%
<i>Amphiura filiformis</i> (O.F. Müller, 1776)	P	(I)	0.67	0.46%	0.00	0.00%
<i>Ophiura ophiura</i> (Linnaeus, 1758)	P	(II)	1.00	0.69%	0.00	0.00%
<i>Psammechinus microtuberculatus</i> (Blainville, 1825)	G	(I)	1.00	0.69%	0.00	0.00%

Comparative analysis

In our comprehensive study, we meticulously assessed the Shannon–Wiener index for the two host algae across each of the distinct seasons. The Shannon index exhibited a noteworthy range, spanning from 3.31 to 3.81, which signifies a high biodiversity value. Intriguingly, the values at the upper end of this range were consistently associated with *Titanoderma trochanter* in both seasons, as depicted in Figure 6. This underscores the prominent role of *Titanoderma trochanter* in hosting a diverse array of species, contributing to the overall biodiversity of the ecosystem.

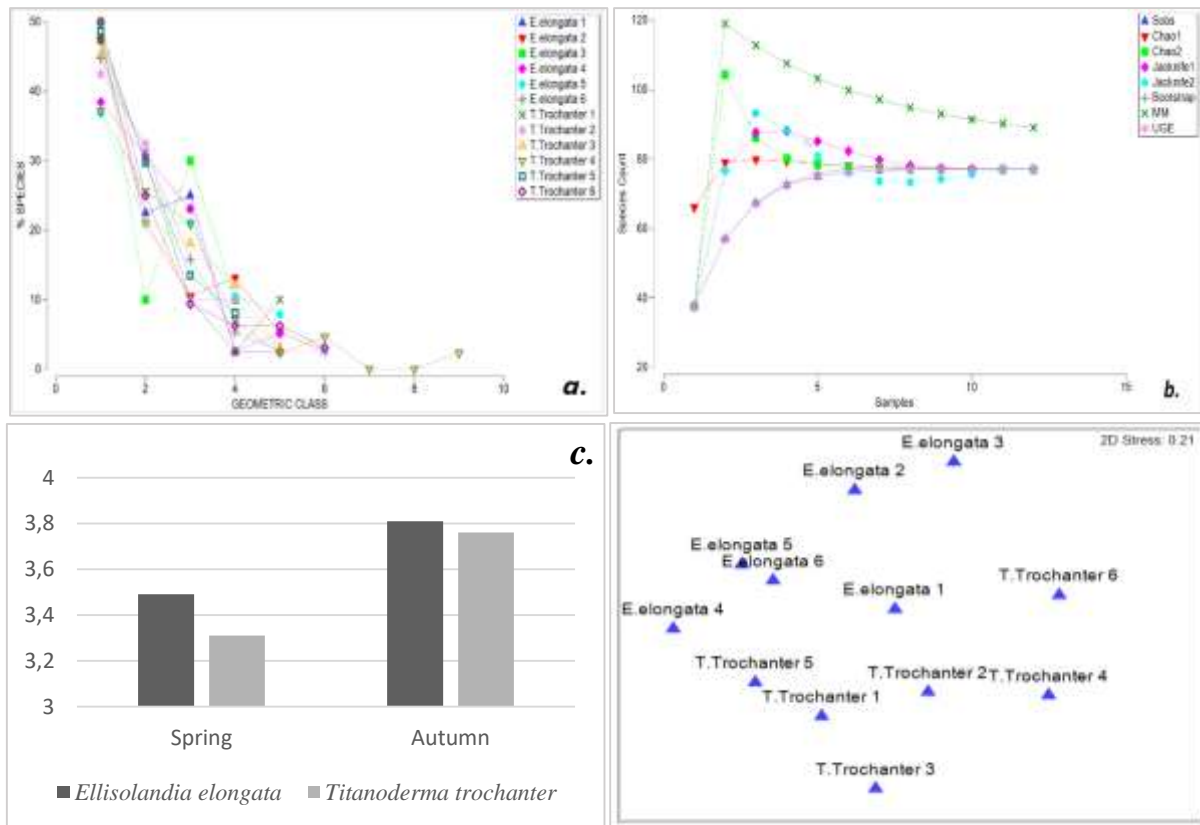

Figure 15. Comparative analysis between *Ellisolandia elongata* e *Titanoderma trochanter*: a. Geometric class plot; b. Species accumulation plot; c. Shannon–Wiener index; d. Bray-Curtis similarity analysis.

Furthermore, the results obtained from the Bray-Curtis similarity analysis shed light on the specific composition of the associated fauna within the two host algae species. It is evident that the similarity between these compositions remains relatively low. Interestingly, when comparing samples collected in close geographical proximity, a greater degree of similarity is observed in the associated fauna, whereas samples from locations with distinct geographical proximity display a lower level of similarity. This intriguing pattern suggests that geographical proximity plays a pivotal role in shaping the composition of the associated fauna.

Moreover, our analysis employed both the geometric class plot and species accumulation plot to gain deeper insights into the composition of species and the abundance ratios among them. These analyses revealed striking differences in species composition and abundance ratios, further underscoring the complex dynamics and unique ecological characteristics of the studied substrate environments. These findings emphasize the importance of considering not only the diversity of species but also their relative abundance and distribution patterns in the assessment of ecological conditions and habitat quality.

CONCLUSIONS

This research represents a pioneering effort, as it stands among the initial endeavors to comprehensively investigate both the composition of macroalgae-associated assemblages and their trophic structure by leveraging macrozoobenthic fauna assemblages. The amalgamation of these two distinct but interconnected approaches has provided us with a profound understanding of the intricate dynamics governing invertebrate communities associated with each seaweed species.

Remarkably, both *Titanoderma trochanter* and *Ellisollandia elongata*, despite their classification as calcareous algae with relatively modest nutritional profiles, have proven to be thriving hosts for a diverse array of invertebrates. Within these assemblages, annelids and mollusks dominate, contributing significantly to the richness of the associated fauna. This intriguing similarity in the composition of associated assemblages challenges conventional expectations, suggesting that a substantial portion of the associated fauna may not necessarily depend on the host algae for sustenance. Instead, it underscores the pivotal role played by sediment, which becomes trapped within the intricate three-dimensional structures of these algae, serving as a foundational component of the local food web.

Given the paramount influence of nutritional factors in structuring macroalgae-associated assemblages, as noted in prior studies (Norderhaug et al. 2003; Schaal et al. 2010), we advocate for the continued development of integrated approaches, similar to the one employed in this study, to further unravel the ecological intricacies of these ecosystems. Rocky shores, as recognized, are extraordinarily dynamic environments where an array of processes unfolds at varying spatial and temporal scales (Burrows et al. 2008; Benedetti-Cecchi & Trussell 2014; Gauthier et al., 2016). While this study has unveiled statistically significant findings, signifying differences among understory algae-associated invertebrate assemblages at the micro-scale, it's worth acknowledging that our sampling was limited to just three replicates, providing a somewhat confined spatial perspective.

Consequently, there remains an intriguing avenue for future research to explore the multifaceted interplay of factors acting at diverse spatial scales, encompassing hydrodynamics, substrate orientation, temperature, and more (Gauthier et al., 2016). Such investigations will inevitably shed light on the nuanced structure and functioning of these assemblages, ultimately influencing biodiversity patterns within rocky shore ecosystems. The complexity and variability inherent to these coastal habitats beckon for continued exploration and understanding, promising new insights into the intricate relationships that define them.

REFERENCES

- Ballesteros, E. (2006). Mediterranean coralligenous assemblages: a synthesis of present knowledge. *Oceanography. Mar. Biol. Ann. Rev.* 44, 123–195. doi: 10.1201/9781420006391.ch4
- Benedetti-Cecchi L, Trussell G. 2014. Rocky intertidal communities. In: Bertness MD, Bruno JF, Silliman BR, Stachowicz JJ, editors. *Marine Community Ecology and Conservation*. Sunderland, MA: Sinauer Press, p 203–25.
- Bevilacqua, S., Airoidi, L., Ballesteros, E., Benedetti-Cecchi, L., Boero, F., Bulleri, F., ... & Terlizzi, A. (2021). Mediterranean rocky reefs in the Anthropocene: Present status and future concerns. *Advances in Marine Biology*, 89, 1-51.
- Bianchi, C. N., and Morri, C. (2000). Marine biodiversity of the Mediterranean Sea: situation, problems and prospects for future research. *Mar. Poll. Bull.* 40, 367–376. doi: 10.1016/S0025-326X(00)00027-8

- Blanfuné, A., Boudouresque, C. F., Verlaque, M., Beqiraj, S., Kashta, L., Nasto, I., ... & Thibaut, T. (2016). Response of rocky shore communities to anthropogenic pressures in Albania (Mediterranean Sea): ecological status assessment through the CARLIT method. *Marine pollution bulletin*, 109(1), 409-418.
- Borja, A., & Tunberg, B. G. (2011). Assessing benthic health in stressed subtropical estuaries, eastern Florida, USA using AMBI and M-AMBI. *Ecological indicators*, 11(2), 295-303.
- Bray JR and Curtis JT (1957) An ordination of the upland forest communities of southern Wisconsin. *Ecological Monographs* 27, 325–349.
- Bressan, G., Chemello, R., Gravina, M. F., Gambi, M. C., Peirano, A., Cocito, S., et al. (2009). “Other types of bioconcretions” in Italian habitats - Marine bioconstructions, eds A. Cosentino, A. La Posta, C. Morandini, and G. Muscio (Udine: Museo Friulano di Storia Naturale), 89–150.
- Buonocore, E., Appolloni, L., Russo, G. F., & Franzese, P. P. (2020). Assessing natural capital value in marine ecosystems through an environmental accounting model: A case study in Southern Italy. *Ecological Modelling*, 419, 108958.
- Burrows MT, Harvey R, Robb L. 2008. Wave exposure indices from digital coastlines and the prediction of rocky shore community structure. *Marine Ecology Progress Series* 353:1–12. doi:10.3354/meps07284
- Chatalov, A., Boney, N., and Ivanova, D. (2015). Depositional characteristics and constraints on the mid-Valanginian demise of a carbonate platform in the intra-Tethyan domain, Circum-Rhodope Belt, northern Greece. *Cret. Res.* 55, 84–115. doi: 10.1016/j.cretres.2015.02.001
- Coll, M., Piroddi, C., Steenbek, J., Kaschner, K., Lasram, F. B. R., Aguzzi, J., et al. (2010). The biodiversity of the Mediterranean Sea: estimates, patterns and threats. *PLoS ONE* 5:e11842. doi: 10.1371/journal.pone.0011842
- Dayton PK. 1985. Ecology of kelp communities. *Annual Review of Ecology and Systematics* 16:215–45. doi:10.1146/annurev.es.16.110185.001243
- De La Fuente, G., Asnaghi, V., Chiantore, M., Thrush, S., Povero, P., Vassallo, P., ... & Paoli, C. (2019). The effect of *Cystoseira* canopy on the value of midlittoral habitats in NW Mediterranean, an emergy assessment. *Ecological Modelling*, 404, 1-11.
- Gan, S. X., Tay, Y. C., & Huang, D. (2019). Effects of macroalgal morphology on marine epifaunal diversity. *Journal of the Marine Biological Association of the United Kingdom*, 99(8), 1697-1707.
- Gauthier Schaal, Jean-Charles Leclerc, Gabin Droual, Cedric Leroux & Pascal Riera (2016): Biodiversity and trophic structure of invertebrate assemblages associated with understory red algae in a *Laminaria digitata* bed, *Marine Biology Research*, DOI: 10.1080/17451000.2016.1164318
- Ingresso, G., Abbiati, M., Badalamenti, F., Bavestrello, G., Belmonte, G., Cannas, R., et al. (2018). Mediterranean bioconstructions along the Italian coast. *Adv. Mar. Biol.* 79, 61–136. doi: 10.1016/bs.amb.2018.05.001
- Muxika, I., Borja, A., Bonne, W., 2005. The suitability of the marine biotic index (AMBI) to new impact sources along European coasts. *Ecological Indicators* 5 (1), 19–31.

- Norderhaug KM, Fredriksen S, Nygaard K. 2003. Trophic importance of *Laminaria hyperborea* to kelp forest consumers and the importance of bacterial degradation to food quality. *Marine Ecology Progress Series* 255:135–44. doi:10.3354/meps255135
- Pascual, M., Rives, B., Schunter, C., and Macpherson, E. (2017). Impact of life history traits on gene flow: a multispecies systematic review across oceanographic barriers in the Mediterranean Sea. *PLoS ONE* 12:e0176419. doi: 10.1371/journal.pone.0176419
- Rindi, F., Braga, J. C., Martin, S., Peña, V., Le Gall, L., Caragnano, A., & Aguirre, J. (2019). Coralline algae in a changing Mediterranean Sea: how can we predict their future, if we do not know their present?. *Frontiers in Marine Science*, 6, 723.
- Schaal G, Riera P, Leroux C. 2010. Trophic ecology in a Northern Brittany (Batz Island, France) kelp (*Laminaria digitata*) forest, as investigated through stable isotopes and chemical assays. *Journal of Sea Research* 63:24–35. doi:10.1016/j.seares.2009.09.002
- Verlaque, M., Boudouresque, C. F., & Perret-Boudouresque, M. (2019). Mediterranean seaweeds listed as threatened under the Barcelona Convention: A critical analysis. *Sci. Rep. Port-Cros Natl. Park*, 33, 179-214.

**PRELIMINARY STUDY ON HEALTH INDICATORS OF UNWEANED CALVES
FED WITH A PREBIOTIC BASED ON SACCHAROMYCES CEREVISIAE
(AVIATOR®)**

*Amel Najjar*¹, *Emna Bouabdallah*¹, *Kais Oueslati*², *Zied Maalaoui*³

¹ *Laboratory of Animal Genetic and Feed Resources, National Institute of Agronomy of Tunisia, University of Carthage, Tunisia.*

² *Ben Chiboub farm.*

³ *Arm & Hammer Animal and Food production, 469N.Harrison Street /Princeton NJ 08540, United States of America.*

*Corresponding author: Amel Najjar,
e-mails: amel.najarbenmaatoug@inat.ucar.tn*

ABSTRACT

The objective of this study was to investigate the effect of supplementation with a prebiotic *saccharomyces cerevisiae* yeast culture (Aviator®) on the health indicators of unweaned calves. The study involved 24 unweaned Holstein calves (average age = 15 days) over a period of 8 weeks (W1 to W8). The calves were assigned into three homogeneous groups. Each group was composed of 8 calves (4 males and 4 females). The first control group (C) received the conventional feed (milk without prebiotic). The second group (T1) received milk supplemented with 7g/calf/day of Aviator®, and the third group (T2) received milk supplemented with 14g/calf/day Aviator®. The Health parameters of the calves were noted such as coat condition, presence or absence of diarrhea and bronchitis. Calf feces were collected for bacteriological analysis. The results showed that 21% of the calves had an abnormal coat, while 46% had a coat soiled by feces. The rates of diarrhea and bronchitis were noted in 15% of and 17% of the calves, respectively. Besides, the rate of diarrhea occurrence in all calves decreased from W1 to W3 (8% vs 4%) and it was lower in the T1 and T2 groups compared to the C group (1.5% and 3% vs 8%, $p < 0.05$). However, the rate of bronchitis cases ranged from 4.5% to 37% over the period of the trial. It was lower in the C group compared to the treated groups T1 and T2 (6.5% vs 12.5% and 31.5%). Bacteriological analysis of the calves' feces showed that the number of bacterial colonies was lower in the T2 group compared to the T1 and C groups ($p < 0.01$). The number of bacterial colonies varied according to the weeks of the trial ($p < 0.01$). Nevertheless, health parameters did not varied between male and female ($p > 0.05$). The preliminary results of the study suggest that the supplementation with the prebiotic Aviator® improved some health parameters in unweaned calves, especially the diarrhea rate and the number of bacterial colonies in feces.

Key-words: *Saccharomyces cerevisiae*, unweaned calves, diarrhea, bronchitis, bacteriological analysis.

INTRODUCTION

Improved management and nutrition can promote better feed efficiency and health in young calves (Heinrichs and Heinrichs, 2011). Feed additives are usually used in intensive system to enhance the well-being and performance of young calves before weaning (Alugongo et al., 2017). On the other hand, when research has shown that the use of antibiotics in livestock farming has harmful effects on animal and human health, in addition to antibiotic resistance (Langford et al., 2003), probiotics and prebiotics have been seen as the best alternative to antibiotic use in livestock (Signorini et al., 2012).

Yeast of *Saccharomyces cerevisiae* has been incorporated into domestic animal diets, particularly ruminant animals and their young ones. The use of *Saccharomyces cerevisiae* has improved the immune system by stimulating the antioxidative system of young and adult animals (Jensen et al., 2008 ; Zaworski et al., 2014).

The objective of this study was to investigate the effect of supplementation with a prebiotic *saccharomyces cerevisiae* yeast culture (Aviator®) on the health indicators of unweaned calves.

MATERIAL AND METHODS

Study location

The study took place in the BEN CHIBOUB FARM, situated in the north of Tunisia and 48km from the capital Tunis. The region belongs to the sub humid bioclimatic stage. The region has a temperate Mediterranean climate with hot and dry summers according to the Köppen-Geiger classification. Over the year, the average temperature is 18.6°C and rainfall averages is 473.9mm. The farm is known for its Holstein dairy cattle.

Experiment

The trial involved Twenty four (24) unweaned Holstein calves. The average age at the starting of the trial was 15 days. The calves were assigned into three homogeneous groups. Each group was composed of 8 calves (4 males and 4 females). The first control group (C) received the conventional feed (milk without prebiotic). The second group (T1) received milk supplemented with 7g/calf/day of Aviator®, and the third group (T2) received milk supplemented with 14g/calf/day of Aviator®. The groups were fed during 8 weeks (W1 to W8).

Aviator® is a heat-stable feed additive consisting of a preparation of refined functional carbohydrates, namely Mannan-oligosaccharides (MOS), D-mannose and β -glucan, derived from the cell wall of the yeast *Saccharomyces cerevisiae*. It's a blend of hydrolyzed yeast, yeast culture and yeast extracts.

Health indicators

The Health parameters of the calves were noted in the three groups once a week.

- Coat condition: the coat is noted whether it is damaged, altered or dehydrated, abnormally colored or textured or heavily soiled with feces, mud or other soiling, and either whether it has parasites (OIE, 2019).
- Diarrhea: the tail and hindquarters were controlled whether are soiled with liquid stools. The stools give indications of the origin of the disease, either an infection or a feeding error, based on color (yellow, bloody, dark), quantity and consistency (watery, pasty).
- Bronchitis: the animal was monitored whether it displays signs such as accelerated respiratory rate, panting and coughing.
- Bacteriological analysis: In the treated groups, fecal samples of calves were taken from the rectums every week during the trial period (total number of samples/group= 56). For the control group, a single sample was taken during the first week of the trial (n= 8). From each sample, 0.5 g of faecal material was diluted and vortexed. 100 μ L of the dilution suspensions were spread on VRBL (or TBX) medium and incubated overnight at 37°C (VRBL agar selective and differential medium used for the detection and enumeration of enterobacteria). After incubation, plates were examined and presumptive colony counts were performed. Colonies of *E. coli* were selected and subcultured on VRBL medium to obtain pure cultures.

The antibiotic sensitivity of the strains identified was studied using 8 antibiotics: amoxicillin, amoxicillin+clavulanic acid, ceftazidime, cefotaxime, tetracycline, gentamicin, tobramycin, clavulanic acid, trimethoprim/sulfamethoxazole, tobramycin.

Statistical analysis

Statistical analysis were carried out using SAS software (SAS Institute, Inc). The General Linear model (GLM) procedure was used to study the effects of the group, sex and week on calves' health parameters. The level of signification was fixed at $p < 0.05$.

RESULTS AND DISCUSSION

The general condition of the calves' coats showed that 21% had abnormal coats, while 46% had coats soiled with faeces. Diarrhea was noted in 15% of calves, due to digestive problems. Bronchitis was detected in 17% of calves, indicating respiratory problems. Respiratory problems were mainly observed in calves housed in group stalls and in humid areas (Hr = 54%) with draughts.

Besides, the rate of diarrhea occurrence in all calves decreased from W1 to W3 (8% vs 4%, Figure 1) and it was lower in the T1 and T2 groups compared to the C group (1.5% and 3% vs 8%, $p < 0.05$, Figure 2).

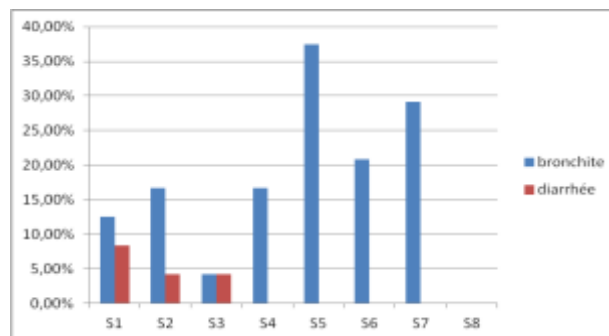

Figure 1. Variation of the percentages of diarrhea and Bronchitis during the experiment.

However, the rate of bronchitis cases ranged from 4.5% to 37% over the period of the trial (Figure 1). It was lower in the C group compared to the treated groups T1 and T2 (6.5% vs 12.5% and 31.5%, Figure 2).

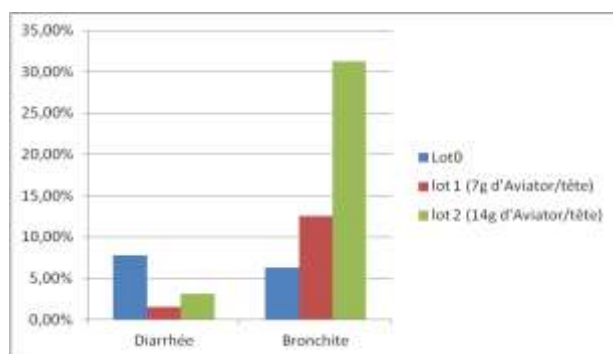

Figure 2. Variation of the percentages of diarrhea and Bronchitis according to the groups.

ANOVA (Table 1) showed that bacteriological flora varied according to groups and weeks of the trial. Nevertheless, health parameters did not varied between male and female ($p > 0.05$).

Table 1. Results of the ANOVA.

	ddl	Number of bacterial colonies
group	2	**
Sex	1	ns
Week	6	***
R²		0,26

ns : not significant; ** : $p < 0,05$; *** : $p < 0,01$

ddl= degree of freedom ; R²= model coefficient of determination

Bacteriological analysis of the calves' feces showed that the number of bacterial colonies was lower in the T2 group compared to the T1 and C groups ($p < 0.01$). The number of bacterial colonies varied according to the weeks of the trial ($p < 0.01$, Table 2).

Table 2. Variation of the number of bacterial colonies according to the groups during the experiment (UFC/g).

	W1	W2	W3	W4	W5	W6	W7
C	0.2±0,1	-	-	-	-	-	-
T1 (7g/head)	0.12±0.07	41.74±16.99	111.12±77.64	774.56±462.82	65.80±57.85	61.68±60.15	170.96±102.50
T2 (14g/head)	0.04±0.02	1.29±1.26	15.89±10.84	700.23±611.41	47.15±43.15	80.69±44.03	395.15±373.38

Our results are in agreement with those found by Askri et al. (2018) who reported a significant decrease in the numbers of pathogenic bacteria: in groups receiving prebiotic in diet. The decrease of *E. coli* could be explained by the competition between mannan-oligosaccharides (mos), components of the yeast wall, and the antigenic determinants of certain pathogens containing mannan residues which limits the possibility of pathogen attachment to the intestinal wall and therefore their development (Castro et al. 1994; De ruiter et al. 1994). On the other hand, Askri et al. (2018) found that the number of lactobacilli in chickens receiving the prebiotic was higher than in the control group on days 10, 30 and 42. A study by Baurhoo et al. (2007)

showed that MOS intake (0.2%) in chickens led to an increase in Lactobacilli and Bifidobacteria in their caecal contents, compared with to the control diet. Another study showed that mannan-oligosaccharides are able to improve gastrointestinal health by increasing beneficial bacteria such as lactobacilli in the gut (Patterson and Burkholder 2003). Generally, administration of the Aviator® prebiotic could selectively improve lactobacillus populations and reduce pathogenic bacteria.

The results in table 3 showed that only 7 antibiotic-resistant to *E.coli* strains were present in the group C. While in T1, the total number of antibiotic-resistant *E.coli* colonies was around 38, with the highest proportion 34/38 for the Amx antibiotic. Similarly, for T2, the total number of antibiotic-resistant to *E.coli* was around 37, with the highest proportion 30/38 for the Amx antibiotic.

Table 3. Variation of the number of antibiotic-resistant *E. coli* strains in batches of treated calves.

	Amx	Amc	Caz	Tet	An	Gen	Tob	Ctx
T1	34/38	22/38	10 /38	31/38	3/38	5/38	6/38	4/38
T2	30/37	18/37	8/37	29/37	2/37	11/37	5/37	2/37

Amx: amoxicillin, amc: amxicillin+clavulanic acid, caz: ceftazidime, ctx: cefotaxime, tet: tetracycline, gen: gentamicin, tob: tobramycin, An: clavulanic acid, sxt: trimethoprim/sulfamethoxazole, tob: tobramycin

CONCLUSIONS

The preliminary results of this study suggest that the supplementation with the prebiotic Aviator® improved some health parameters in unweaned calves, especially the diarrhea rate and the number of bacterial colonies in feces.

REFERENCES

- Alugongo G.M., J. Xiao, Z. Wu, S. Li, Y. Wang, Z. Cao 2017. Review: Utilization of yeast of *Saccharomyces cerevisiae* origin in artificially raised calves. *J. Anim. Sci. Biotechnol.*, 1;8:34.
- Askri A., N. Fitouhi, A. Raach-Moujehed, M.S. Abbassi, Z. Maalaoui, H. Debbabi 2018. Effet d'un prébiotique commercial «AVIATOR®» sur les performances zootechniques, la composition de la microflore caecale et la qualité de la viande des poulets de chair. *Journal of New Sciences*, 8(2):136-168.
- Baurhoo B., Letellier A., X. Zhao, C.A. Ruiz-Feria 2007. Caecal populations of Lactobacilli and Bifidobacteria and *Escherichia coli* after in vivo *Escherichia coli* challenge in birds fed diets with purified lignin or mannanoligo-saccharides. *J. Poultry Sci.*, 86:2509–2516.
- Castro M., N.V. Ralston, T.I. Morgenthaler, M.S. Rohrbach, A.H. Limper 1994. *Candida albicans* stimulates arachidonic acid liberation from alveolar macrophages through alpha-mannan and beta-glucan cell wall components. *Infect. Immun.*, 62(8): 3138-3145.
- De Ruiter GA., A.W. Van Bruggen-Van der Lugt, P. Mischnick, P. Smid, J.H. Van Boom, S.H. Notermans, F.M. Rombouts 1994. 2-O-methyl-D-mannose residues are immunodominant in extracellular polysaccharides of *Mucor racemosus* and related molds. *J. Biol. Chem.*, 269(6): 4299-4306.

- Heinrichs A.J., B.S. Heinrichs 2011. A prospective study of calf factors affecting first-lactation and lifetime milk production and age of cows when removed from the herd. *J. Dairy Sci.*, 94:336–41.
- Jensen G.S., K.M. Patterson, I. Yoon 2008. Yeast culture has anti-inflammatory effects and specifically activates NK cells *Comp. Immunol. Microbiol. Infect. Dis.*, 31: 487-500
- Langford F.M., D.M. Weary, L. Fisher 2003. Antibiotic resistance in gut bacteria from dairy calves: a dose response to the level of antibiotics fed in milk. *J Dairy Sci.*, 86:3963–6.
- OIE. 2019. Bien-être animal dans les systems de production de bovins à viande. Code sanitaire pour les animaux terrestres.
- Signorini M.L., L.P. Soto, M.V. Zbrun, G.J. Sequeira, M.R. Rosmini, L.S. Frizzo 2012. Impact of probiotic administration on the health and fecal microbiota of young calves: a meta-analysis of randomized controlled trials of lactic acid bacteria. *Res Vet Sci.*, 93:250–8.
- Patterson JA., K.M. Burkholder 2003. Application of prebiotics and probiotics in poultry production. *J. Poultry Sci.*, 82: 627–631.
- Zaworski E.M., C.M. Shriver-Munsch, N.A. Fadden, W.K. Sanchez, I. Yoon, G. Bobe 2014. Effects of feeding various dosages of *Saccharomyces cerevisiae* fermentation product in transition dairy cows. *J. Dairy Sci.*, 97, 3081-3098.

INFLUENCE OF DIETARY SUPPLEMENTATION OF SACCHAROMYCES CEREVISIAE (A-Max Ultra®) ON GROWTH AND DIGESTIBILITY OF WEANED CALVES

Amel Najjar¹, Emna Bouabdallah¹, Kais Oueslati², Zied Maalaoui³

¹ Laboratory of Animal Genetic and Feed Resources, National Institute of Agronomy of Tunisia, University of Carthage, Tunisia.

² Ben Chiboub farm.

³ Arm & Hammer Animal and Food production, 469N.Harrison Street /Princeton NJ 08540, United States of America.

Corresponding author: Amel Najjar,
e-mails: amel.najarbenmaatoug@inat.ucar.tn

ABSTRACT

The study aimed to determinate the effect of dietary supplementation with prebiotic *Saccharomyces cerevisiae* (A-MAX Ultra®) on Holstein calves growth parameters. Twenty three weaned calves aged 3 months were assigned into 3 groups : the control group (C, n=8) was fed with the conventional diet, and the 2 treated group (T1, n=8 and T2, n=7) with the conventional diet supplemented with 7g and 14g per calf and per day of *Saccharomyces cerevisiae* respectively, during 8 weeks. The height at withers (HT), chest circumference (CC) and the weight (W) were determined once a week using a tape. Then, the average daily gain (ADG) was determined in each group. The digestibility (D) was studied at the end of the experiment at the week 8. ANOVA was carried out using the SAS software. The results showed that the ADG did not varied between groups. However, the HT, CC and W were higher in T1 compared to C and T2 groups ($p<0.01$). Moreover, the D was higher in T1 and T2 groups compared to C group ($p<0.05$). The findings suggest that the dietary supplementation with 7g of *Saccharomyces cerevisiae* (A-MAX Ultra®) improved growth and digestibility in Holstein weaned calves.

Key-words : *Saccharomyces cerevisiae*, weaned calves, growth parameters, digestibility.

INTRODUCTION

Most of dairy calves performances depend on rumen environment and conditions. Feed additives have therefore been applied to stimulate rumen activity and improve digestibility efficiency that could increase feed intake and growth (Newbold et al., 1996). The yeast culture *Saccharomyces cerevisiae* is one of the alternatives that has been applied to the feed of growing calves. The results of its application have been positive according to some authors (Stefańska et al., 2018) and negative (Mitchell and Heinrichs, 2020) or even no significant variation according to others (Saldana et al., 2019). These differences could be attributed to the livestock conditions in which the animals are reared, the method of administration of the yeast and the animal itself.

The study aimed to determinate the effect of dietary supplementation with prebiotic *Saccharomyces cerevisiae* (A-MAX Ultra®) on Holstein calves growth parameters and digestibility.

MATERIAL AND METHODS

Twenty three weaned calves aged three months were assigned into 3 groups : the control group (C, n=8) was fed with the conventional diet, and the 2 treated group (T1, n=8 and T2, n=7) with the conventional diet supplemented with 7g and 14g per calf and per day of *Saccharomyces cerevisiae* (A-MAX Ultra®) respectively, during 8 weeks.

The weaned calves receive 3kg of concentrate per calf and unlimited straw. The concentrate is based on soya, barley, maize, crushed declassified dates, mineral elements and CMV. The drinking water used is well water, which is permanently and automatically available to the animals. The recommended doses of A-MAX Ultra® for the treated groups were mixed with the concentrate and were distributed every day at 8 am.

The different groups of calves were housed in collective boxes (density : 8). The boxes are located in the open air. The boxes are arranged side by side, with a metal roof and a cemented floor covered with straw bedding.

The height at withers (HT), chest circumference (CC) and the weight (W) were determined once a week using a tape. Then, the average daily gain (ADG) was determined in each group.

The digestibility (D) was studied at the end of the experiment at the week 8, and was measured *in vivo* for each group using two sieves placed one on top of the other. The first with a diameter of 5 mm and the second with a diameter of 2 mm. The method consisted in collecting 250g of faeces from each group separately, then pouring them into the upper sieve, and washing them with water until all the particles with a diameter of less than 5 mm pass to the second sieve, which has a diameter equal to 2 mm. Finally, the particles recovered from the 2nd sieve were weighed. It represented the undigested particles of the group.

The digested portion was calculated (Carjot, 2013): $dX = (X_i - X_f) / X_i$

(X: proportion of component; X_i: proportion of initial component: faeces; X_f: proportion of final component: undigested part).

ANOVA was carried out using the SAS software (SAS Institute Inc®). The General Linear model (GLM) procedure was used to study the effects of the group, sex and week on calves' growth and digestibility. The level of signification was fixed at p<0.05.

RESULTS AND DISCUSSION

The results of the ANOVA were presented in table 1. The ADG did not varied between groups. No effect of sex on all the studied parameters was shown.

Table 1. Results of the ANOVA.

	ddl	ADG	ddl	HT	CC	W
Group	2	ns	2	***	***	***
sex	1	ns	1	ns	ns	ns
week	6	***	7	***	***	***
R ²		0,18		0,35	0,39	0,39

ns : not significant ; *** : p<0,01

The HT, CC and W were higher in T1 compared to C and T2 groups (p<0.01, Table 2). Hiss and Sauerwein (2003) and Rozeboom et al. (2005) reported that dietary supplementation with

Saccharomyces cerevisiae improved weight in farm animals. Zhang et al. (2005) showed that supplementation with yeast wall extracts gave the best growth results.

Table 2. Variation of the height at withers (HT), chest circumference (CC) and weight (W) according to the groups.

	C	T1	T2
HT (cm)	104±1.3 ^a	106±1.1 ^b	101±2.7 ^c
CC (cm)	145±3.5 ^a	147±3.5 ^b	135±5.2 ^c
W (Kg)	208±6.7 ^a	212±6.7 ^b	189±9.7 ^c

Digestibility (D) was higher in T1 and T2 groups compared to C group ($p < 0.05$, table 3). Fomenky et al, (2019) showed that adding probiotics to calves' rations increased beneficial bacteria populations and disadvantaged other harmful populations in their digestive systems.

Table 3. Variation of digestibility (D) according to the groups.

	C	T1 (7g/head)	T2 (14g/head)
Digestibility (D)	0,76 ^a	0,83 ^b	0,82 ^b

C : conventional feed ; *T1* : conventionnal feed supplemented with 7g A-max Ultra /head ; *T2* : conventionnal feed supplemented with 14g A-max Ultra /head

CONCLUSIONS

The findings suggest that the dietary supplementation with 7g of *Saccharomyces cerevisiae* (A-MAX Ultra®) improved growth and digestibility in Holstein weaned calves.

REFERENCES

- Carjot A.C., 2013. Etude de la corrélation entre l'efficacité alimentaire et l'analyse des résidus de bouses chez les vaches laitières nourries avec une ration totale mélangée. Mémoire de thèse Vétérinaire. Université Claude-Bernard, Lyon I, 114p.
- Fomenky B., N. Bissonnette, E. Ibeagha-Awemu 2019. Des probiotiques pour la santé et la croissance des veaux. Centre de recherche et de développement de Sherbrooke.
- Hiss S, H. Sauerwein 2003. Influence of dietary β -glucan on growth performance, lymphocyte proliferation, specific immune response and haptoglobin plasma concentrations in pigs. *J Anim Physiol Anim Nutr (Berl)*, 87(1-2):2-11.
- Rozeboom D.W., D.T. Shaw, R.J. Tempelman, J.C. Miguel, J.E. Pettigrew, A. Connolly 2005. Effects of mannan oligosaccharide and an antimicrobial product in nursery diets on performance of pigs reared on three different farms. *J Anim Sci.*, 83(11):2637-44.
- Zhang A.W., B.D. Lee, S.K. Lee, K.W. Lee, G.H. An, K.B. Song, C.H. Lee 2005. Effects of yeast (*Saccharomyces cerevisiae*) cell components on growth performance, meat quality, and ileal mucosa development of broiler chicks. *Poult Sci.*, 84(7):1015-21.

- Newbold C.J., R.J. Wallace, F.M. McIntosh 1996. Mode of action of the yeast *Saccharomyces cerevisiae* as a feed additive for ruminants. *Br. J. Nutr.*, 76(2):249-61.
- L.K. Mitchell, A.J. Heinrichs 2020. Feeding various forages and live yeast culture on weaned dairy calf intake, growth, nutrient digestibility, and ruminal fermentation. *J. Dairy Sci.*, 103 : 8880-8897.
- B. Stefańska, J. Komisarek, D. Stanisławski, M. Gąsiorek, M. Kasprowicz-Potocka, A. Frankiewicz, W. Nowak 2018. The effect of *Yarrowia lipolytica* culture on growth performance, ruminal fermentation and blood parameters of dairy calves. *Anim. Feed Sci. Technol.*, 243 : 72-79.
- D.J. Saldana, C.M. Jones, A.M. Gehman, A.J. Heinrichs 2019. Effects of once- versus twice-a-day feeding of pasteurized milk supplemented with yeast-derived feed additives on growth and health in female dairy calves. *J. Dairy Sci.*, 102 : 3654-3660.

**DIVERSITY OF BENTHIC MACROMOLLUSCAN COMMUNITIES ON
THE ROCKY SHORES OF EASTERN KARABURUNI PENINSULA, VLORE,
ALBANIA**

Denada SOTA¹, Ina NASTO^{1}, Brunilda VASHAJ¹, Anxhela KAMBERAJ¹,
Kristiana LUSHNJARI¹, Klevisa KARROQAJ¹, Lorela PASHAJ¹*

¹ *Department of Biology, Faculty of Technical and Natural Sciences, University Ismail
Qemali Vlore, Albania*

** Corresponding author e-mail: ina.nasto@yahoo.com*

ABSTRACT

Variations in species richness within ecosystems are influenced by natural processes and can be further affected by both natural and human activities. Our research focuses on the Karaburuni Peninsula, situated in the southern part of the Albanian coast. This peninsula features a diverse rocky coastline interspersed with small pebble beaches and gulfs, such as the gulf of Raguzë, Shën Vasil, and Shën Jan. The outer region of the peninsula is encompassed within the Karaburun Sazani Marine Protected Area. For our study, we specifically investigate the eastern part of the Karaburuni peninsula, which was divided into three study stations: Raguzë, Shën Vasil, and Shën Jan. These stations comprise rocky coasts that serve as our primary areas of interest for the research. The main objective of this research was to investigate these variations. The study focused on rocky intertidal mollusks and aimed to achieve three specific goals: 1) to determine the species richness of these mollusks; 2) to track their geographical distribution at the State level; and 3) to understand how species richness changes in response to aquaculture activities. To accomplish these objectives, data were collected at different time points throughout two seasons: May, July and October of 2020. The sampling area comprised three transects for each site, and within each transect, three samples were taken. The sampling area was delimited using a PVC rectangle frame measuring 50 x 50 cm per side. During the sampling process, all mollusks present within these designated units were meticulously collected, identified, and counted. The analysis of species distribution in the study was based on different sites seasonal species richness and biodiversity composition. Overall, the research identified 45 mollusk species between 1396 individuals. Their richness was found to be associated with factors such as substrate stability, wave intensity at each site, and trophic level. Among the mollusk classes, Gastropods exhibited the highest species richness. When examining the sites distribution, the researchers observed a consistent pattern of species richness in areas with marine vegetation. The dominance of gastropods in species composition and density could be attributed to their broad food range, which includes carnivorous, necrophagous, phytophagous, and detritophagous species. Notably, certain species like *Phorcus sp* and *Patella rustica* contributed to the high ecological value and thus, the dominance of these species across all stations. Surprisingly, the overall species richness in the rocky intertidal zone was significantly increased by aquaculture activities in the Ragusa area. However, upon closer analysis, the malacofauna exhibited changes in species richness influenced by the constant expansion of marine barens and the retreat of marine forests of *Cystoseira sensu lato*. These changes in habitat appear to have a direct impact on the diversity of mollusk species in the region.

Keywords: Karaburuni, macrozoobenthos, gastropod, malacofauna, Bivalvia, Vlora Bay

INTRODUCTION

The coastal ecosystems, especially the hard-bottomed ones of Albania, are rich in habitat types, communities and animal and plant species important for the natural heritage of the country and the Mediterranean region (Kashta et al., 2011). In the last twenty years, Albania has undergone profound changes, including huge investments along the coast. The effects of these investments have become visible on coastal ecosystems in terms of changes in natural habitat fragmentation, eutrophication, increase in sea urchin barriers (Fraschetti et al., 2011; Maiorano et al., 2011). The waters of the gulf of Vlora, in particular, has been subject in the last few progressive natural and anthropic impacts (Maiorano et al., 2011). Regular studies of the structure and composition of species in the coastal marine communities of this gulf represent a register of important data for the assessment of the environmental impact that these activities have on the ecosystem of the gulf.

The existing data on the macrozoobenthos of the rocky areas of the Albanian Adriatic coast of Vlora are relatively recent and often concentrated on the malacofauna (Kasemi et al., 2008; Kasemi & Haxhiraj, 2009; Kasemi et al., 2008; Ruci et al., 2013; Nasto et al., 2022 a, b). Studies focused on the macrozoobenthos of these areas aim to evaluate the species composition, abundance, environmental status of macrozoobenthic populations and their seasonal comparisons are limited. The most recent studies on the macrozoobenthos of the rocky coasts of the Gulf of Vlora date back to 2008 (Kasemi et al. 2008; Selmani et al., 2015; Nasto et al., 2022b). The studies in question cover the eastern part of the gulf of Vlora and the island of Sazani.

The southwestern area of the gulf of Vlora includes a large portion of the gulf coast. The area is characterized by the presence of rocky coasts mainly made by limestone; a defining characteristic of this marine basin often interrupted by small pebble beaches. The area has some bays such as Raguza 1 and Raguza 2, Shen Vasil, Shen Jan. Being on the border of the first Marine Protected Area in Albania, Karaburun Sazani MPA, the area of our research has an importance for the assessment of anthropogenic environmental impact on ecosystems. In the research area lies an intense marine aquaculture activity at Raguza 1 and 2 bays (Bakiu et al., 2018). The primary aim of this research was to explore these ecological situations of this study area. The investigation centered around mollusks inhabiting rocky intertidal zones, with the intention of accomplishing three distinct objectives: 1) ascertaining the diversity of species among these mollusks; 2) mapping out their geographic prevalence within the State boundaries; and 3) comprehending the fluctuations in species diversity in reaction to aquaculture undertakings. This study attempts to expand the current knowledge on the rocky infralittoral zone of the Vlora gulf by providing occurrence data of molluscan species from three different stations of infralittoral zone.

MATERIAL AND METHOD

The study area

Stretching across the western expanse of Vlora Bay, the Karaburuni Peninsula spans an area of 62 km², effectively acting as a separator between the Albanian coastline along the Adriatic Sea and the Ionian Sea. This landmass is connected to Sazani Island by a slender sea channel, referred to as Mezokanali, meaning "middle channel" in English. Geologically speaking, Karaburuni is predominantly comprised of Cretaceous carbonic limestone, with the northern-western portion around the Bay of St. Jani being characterized by terrigenous deposits (Kashta et al., 2011).

The terrain consists of a series of hills, reaching elevations of up to 800 meters. Among the highest peaks stand Maja e Ilqes (733 m), Maja e Flamurit (826 m), and Çadëri (839 m). The peninsula's perimeter meets the sea through sheer and unapproachable cliffs. On the western shore, the terrain rises steeply, marked by numerous crevices, caverns, openings, and small shores. Gaining access to several coastal regions and beaches, particularly on the western flank, proves to be quite challenging and at times impossible without a boat due to the coastal cliffs (Kashta et al., 2011).

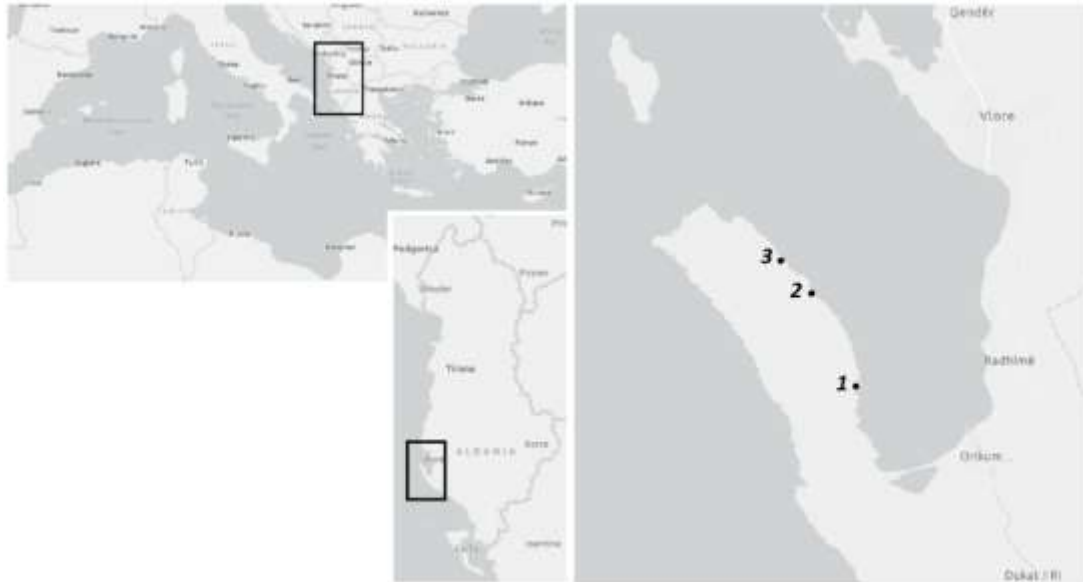

Figure 16. Map of the study stations: 1) Ragusa Station, 2) St. Vasil Station. 3) St. Jan Station.

In contrast, the eastern coast exhibits less fragmentation. The northwestern tip of the peninsula is marked by Cape Gjuhezes (Kepi i Gjuhezes), positioning itself as the westernmost point of Albania. Woody vegetation is notably scarce throughout the area, except for pockets of sparse maquis and untamed grasses, and freshwater sources are absent. Within the embrace of the Karaburun Peninsula lie several diminutive bays, including the Bay of Ragusa, the Bay of St. Jan, the Bay of Bristan, the Bay of Dafina, and more (Kashta et al., 2011). The stations where benthic macroinvertebrates have been collected include the rocky shores of the Adriatic Sea, from Ragusa II to Saint Jan on the border with Cape Gjuheza, specifically 3 stations: Ragusa II, Saint Vasil, Saint Jan (Figure 1). For the collection of material, field expeditions were carried out during 3 months of 2020, more precisely during the months of May, July, and at the beginning of October 2020. Sampling was carried out in three seasons: spring, summer and autumn to verify the variations spatiotemporal of the malacofauna.

Sampling method

Sampling was conducted in accordance with established protocols for benthic data collection on solid substrates (as outlined by Cattaneo et al. 1978, Revkov et al. 1999). The objective was to quantitatively assess benthic populations during the spring, summer, and autumn seasons in supralittoral and medio-littoral zones. Due to challenges in precisely distinguishing between medio-littoral and infralittoral areas, upper infralittoral regions were also included in the sampling.

The collection procedure targeted both surface-dwelling macroinvertebrates on rocks and those sheltered within algae. Consequently, samples were taken from prominent algal cover types to provide a more comprehensive understanding of the biocenoses. Within each station, three

transects were sampled, maintaining a linear separation of 50 meters. Within each transect, six samples were collected: three from the supralittoral and three from the medio-littoral and upper infralittoral zones. This resulted in a total of 18 samples per station per period, amounting to 54 samples for all three stations in each sampling period, or a grand total of 162 samples over all sampling sessions.

Quantitative data acquisition involved using a 50 cm x 50 cm test quadrat for capturing and evaluating macrobenthos. This quadrat was further divided into 16 smaller quadrats to facilitate detailed quantitative assessments of the macrobenthos. Within these smaller sections, counts of individuals or percentage assessments of algal coverage, along with small colonial organisms like *Chthamalus*, *Mytilaster*, *Serpula*, etc., were conducted. The collection process was carried out manually. Following sample collection, the material was preserved in 75% ethanol and transported to the laboratory for subsequent identification and analysis.

Data analysis

Species-area curves were generated for each habitat to assess the effectiveness of the sampling process. The analysis of molluscan communities involved the utilization of sin ecological indices, including species richness (SR), the count of individuals (N) per 2 dm³, Pielou's Evenness (J), and the Shannon-Weaver diversity index (H'). Additionally, both quantitative (DI, representing the percentage of individuals of a specific species relative to the total individuals) and qualitative (DQ, denoting the percentage of species within a given taxon relative to the total species) indices were computed.

Comparative analyses of habitats were expanded using sample-based and individual-based interpolation (rarefaction) and extrapolation curves, as outlined by Colwell et al. (2012) and Chao and Jost (2012). To discern variations across habitats, a permutational analysis of variance (PERMANOVA) was performed. This analysis was based on Euclidean distance and carried out as a univariate approach (Anderson, 2012), employing a one-way model with habitat as a fixed factor.

Employing the same design, a PERMANOVA analysis based on Bray-Curtis similarity was conducted to assess distinctions in molluscan communities among the five habitats, each with four replicates. Further investigation was facilitated through pairwise tests, elucidating disparities among the habitats. For visualization, a non-metric multidimensional scaling (n-MDS) ordination (Bray & Curtis, 1957) was employed. To unveil the species that chiefly contributed to habitat similarities and those that distinctly characterized each habitat, a similarity percentage–species contribution analysis (SIMPER) was executed (Clarke, 2014).

RESULTS AND DISCUSSION

Within the scope of this study, the three designated sampling stations revealed a collective tally of 45 distinct species. Among the identified mollusks, they are classified into three primary classes: Polyplacophora, Gastropoda, and Bivalvia. In the Polyplacophora class, a total of 3 families were discerned, namely Leptochitonidae (comprising 2 distinct types), Chitonidae (consisting of 1 type), and Ischnochitonidae (encompassing 1 type). Within the gastropod class, there exists a comprehensive assembly of 32 species, distributed across 11 distinct families: Cerithiidae (inclusive of 2 species), Triphoridae (comprising 1 species), Rissoidae (with 1 species), Columbellidae (consisting of 1 species), Fascioliariidae (comprising 2 species), Conidae (including 1 species), Rissoinidae (with 1 species), Muricidae (encompassing 3 species), Patelidae (comprising 5 species), Tudicidae (1 species), Pisaniidae (1 species), and Trochidae (encompassing a diverse count of 13 species) (Table 1). The Bivalvia class, on the other hand, encompasses four distinctive families: Mytilidae (accounting for 5 species),

Anomiidae (comprising 1 species), Arcidae (inclusive of 2 species), and Carditidae (with 1 species) (Figure 1a).

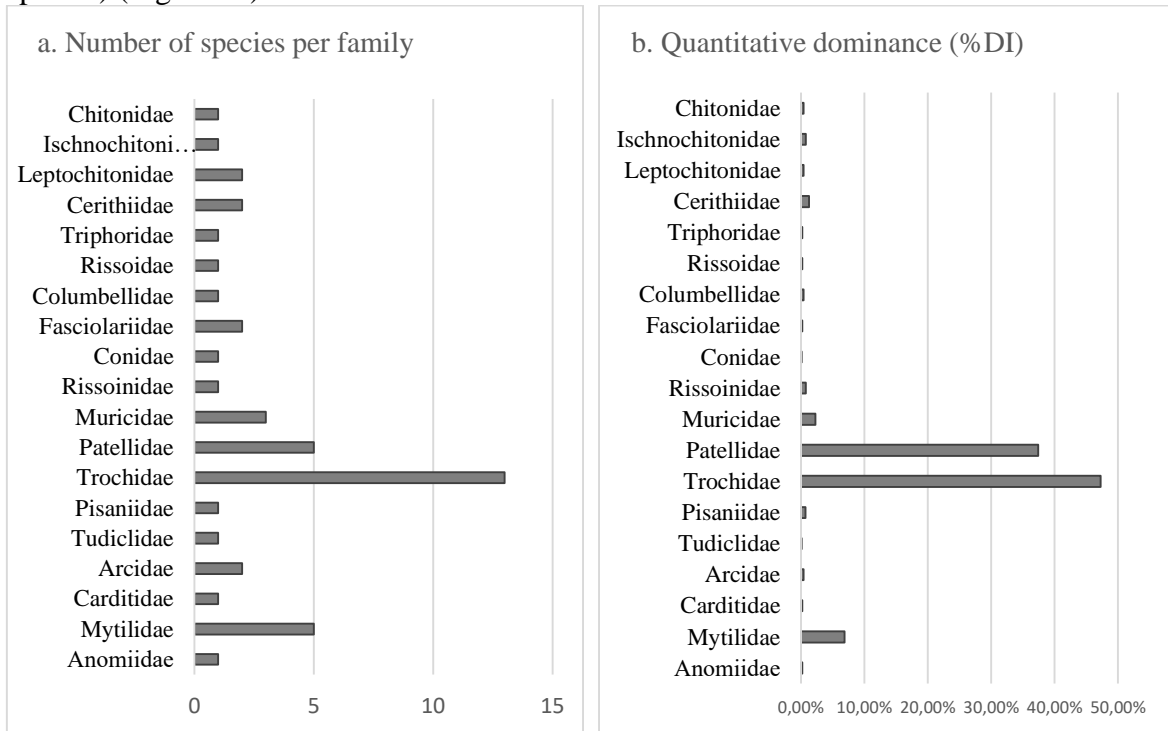

Figure 17. Percentages of abundance (%DI - a) and species richness (%DQ - b) of of the families present in the study.

Both in percentages of abundance and species richness, the family Trochidae dominates with an average of 47.26% of all samples (figure 2b). Another family equally represented is the Patellidae family which, despite having 5 species present, constitutes 37.39% of the collected samples. The ones with the highest frequency values are *Patella rustica* 15.25%, *Patella caerulea* 14.56%, *Steromphala divaricata* 16.35%, *Phorcus turbinatus* 11.17%.

Table 1. Taxonomic list of species, occurring in each sampling station in 3 seasons (Spr-Spring; Su-Summer; Aut-Autumn), with their abundance (N), feeding guilds (G-Grazer; SF-Suspension feeders; DF/G-Deposit feeder /Grazer; DF -Deposit feeder; P-Predators; H-Herbivores; SF-Suspension feeders) and AMBI ecological group ((I)- very sensitive to disturbance; (II)-indifferent to disturbance; (III)- tolerant to disturbance).

FG	AMBI EcoGroup	Scientific Name	Raguza II			St. Vasil			St. Jan		
			Spr	Su	Aut	Spr	Su	Aut	Spr	Su	Aut
Polyplacophora											
G	(II)	<i>Rhysoplax olivacea</i> (Spengler, 1797)	-	1	-	1	1	-	1	-	-
G	(II)	<i>Ischnochiton rissoi</i> (Payraudeau, 1826)	-	-	-	-	1	-	1	6	-
G	(I)	<i>Leptochiton algesirensis</i> (Capellini, 1859)	-	-	-	-	-	-	-	1	-
G	(I)	<i>Leptochiton scabridus</i> (Jeffreys, 1880)	-	-	-	-	1	-	1	1	-
Gastropoda											
P	(II)	<i>Cerithium vulgatum</i> Bruguière, 1792	2	1	2	-	4	-	-	1	-
P	(II)	<i>Cerithium caeruleum</i> G. B. Sowerby II, 1855	-	1	-	-	-	1	-	-	1
P	(I)	<i>Monophorus perversus</i> (Linnaeus, 1758)	-	-	-	-	1	1	-	-	-
G	(I)	<i>Alvania cimex</i> (Linnaeus, 1758)	-	1	-	-	-	-	-	1	4
P	(II)	<i>Pisania striata</i> (Gmelin, 1791)	-	-	2	1	1	-	2	1	-
H	(I)	<i>Columbella rustica</i> (Linnaeus, 1758)	-	-	-	-	1	-	2	1	-
P	(I)	<i>Euthria cornea</i> (Linnaeus, 1758)	-	1	-	-	-	-	-	-	-
P	(I)	<i>Pseudofusus rolani</i> (Buzzurro & Ovalis, 2005)	-	1	-	-	-	-	-	-	-
P	(I)	<i>Tarantinaea lignaria</i> (Linnaeus, 1758)	-	-	-	-	-	-	-	-	1
P	(I)	<i>Conus ventricosus</i> Gmelin, 1791	-	-	-	1	-	-	-	-	-
G	(II)	<i>Rissoina bruguieri</i> (Payraudeau, 1826)	1	-	-	-	-	-	-	1	-
P	(I)	<i>Hexaplex trunculus</i> (Linnaeus, 1758)	-	3	3	-	-	-	-	-	1
P	(II)	<i>Ocenebrina aciculata</i> (Lamarck, 1822)	-	1	-	-	-	6	-	-	6
P	(II)	<i>Muricopsis cristata</i> (Brocchi, 1814)	-	2	-	-	1	-	-	-	-
G	(III)	<i>Patella caerulea</i> Linnaeus, 1758	4	-	3	3	-	53	28	9	46
G	(I)	<i>Patella depressa</i> Pennant, 1777	1	-	-	-	-	-	1	-	-
G	(III)	<i>Patella rustica</i> Linnaeus, 1758	2	1	12	18	64	4	8	44	-
G	(I)	<i>Patella ulyssiponensis</i> Gmelin, 1791	1	-	-	-	-	1	-	-	-
G	(II)	<i>Cymbula safiana</i> (Lamarck, 1819)	1	2	7	27	3	-	22	8	4
DF	(I)	<i>Steromphala adriatica</i> (R. A. Philippi, 1844)	57	14	3	4	-	-	-	-	-
DF/G	(I)	<i>Steromphala divaricata</i> (Linnaeus, 1758)	3	72	32	46	1	2	-	6	2
DF/G	(I)	<i>Steromphala leucophaea</i> (R. A. Philippi, 1836)	-	-	1	1	-	-	-	-	-
DF/G	(I)	<i>Steromphala pennanti</i> (R. A. Philippi, 1846)	1	7	7	1	-	-	-	-	1
DF/G	(II)	<i>Steromphala ricketti</i> (Payraudeau, 1826)	1	-	1	-	-	1	-	-	-
DF/G	(I)	<i>Steromphala umbilicalis</i> (da Costa, 1778)	-	-	-	1	-	-	-	-	-
DF/G	(I)	<i>Steromphala varia</i> (Linnaeus, 1758)	-	-	-	-	-	21	-	-	6
DF/G	(II)	<i>Gibbula philberti</i> (Récluz, 1843)	-	1	-	-	-	-	-	-	1-
DF/G	(II)	<i>Gibbula vimontiae</i> Monterosato, 1884	-	1	-	-	-	-	-	-	-
DF/G	(III)	<i>Phorcus articulatus</i> (Lamarck, 1822)	-	24	25	-	2	-	-	14	1
DF/G	(II)	<i>Phorcus lineatus</i> (da Costa, 1778)	-	-	1	-	1	27	-	-	22
DF/G	(I)	<i>Phorcus richardi</i> (Payraudeau, 1826)	-	2	7	-	-	-	-	-	-
DF/G	(III)	<i>Phorcus turbinatus</i> (Born, 1778)	23	2	4	38	2	-	59	6	1
Bivalvia											
SF	(I)	<i>Cardita calyculata</i> (Linnaeus, 1758)	-	1	-	-	1	-	-	-	-
SF	(I)	<i>Arca noae</i> Linnaeus, 1758	-	1	1	-	-	-	-	1	-
SF	(I)	<i>Barbatia barbata</i> (Linnaeus, 1758)	-	-	-	-	1	-	-	-	-
SF	(I)	<i>Lithophaga lithophaga</i> (Linnaeus, 1758)	6	-	-	-	-	-	-	-	-
SF	(I)	<i>Modiolus barbatus</i> (Linnaeus, 1758)	-	1	-	-	-	-	-	2	-
SF	(I)	<i>Mytilaster minimus</i> (Poli, 1795)	-	-	-	5	21	-	-	4	-
SF	(III)	<i>Mytilus galloprovincialis</i> Lamarck, 1819	-	4	-	3	11	-	-	1	-
SF	(I)	<i>Musculus costulatus</i> (Risso, 1826)	-	-	-	-	5	-	4	1	1
SF	(I)	<i>Anomia ephippium</i> Linnaeus, 1758	-	1	-	-	-	-	1	-	-

Trophic Analysis

As for trophic analysis, five feeding guilds were identified in the three sampling stations (Figure 3). Considering the ecological conditions at the three research stations, we opted to conduct a trophic analysis to assess whether the presence of aquaculture activity at the Ragusa station impacts the local ecosystem. In our study, these three stations exhibit variations in terms of vegetation, substrate composition, and suspended organic matter levels.

At the Ragusa II station, the notable feature is the accumulation of suspended organic materials, primarily attributable to the presence of aquaculture cages. Here, the substrate lacks significant algae growth, with only a few species sporadically covered by a thin layer of mud and organic substances.

In contrast, the St. Vasil station stands out for its notable presence of *Posidonia oceanica* meadows, brown algae from the *Cystoseira* genus, and *Corallina* algae.

Lastly, the St. Jan's station encompasses an entire coastline characterized by extensive sea barrens, prominently inhabited by sea urchins and gastropods belonging to the *Patellidae* family.

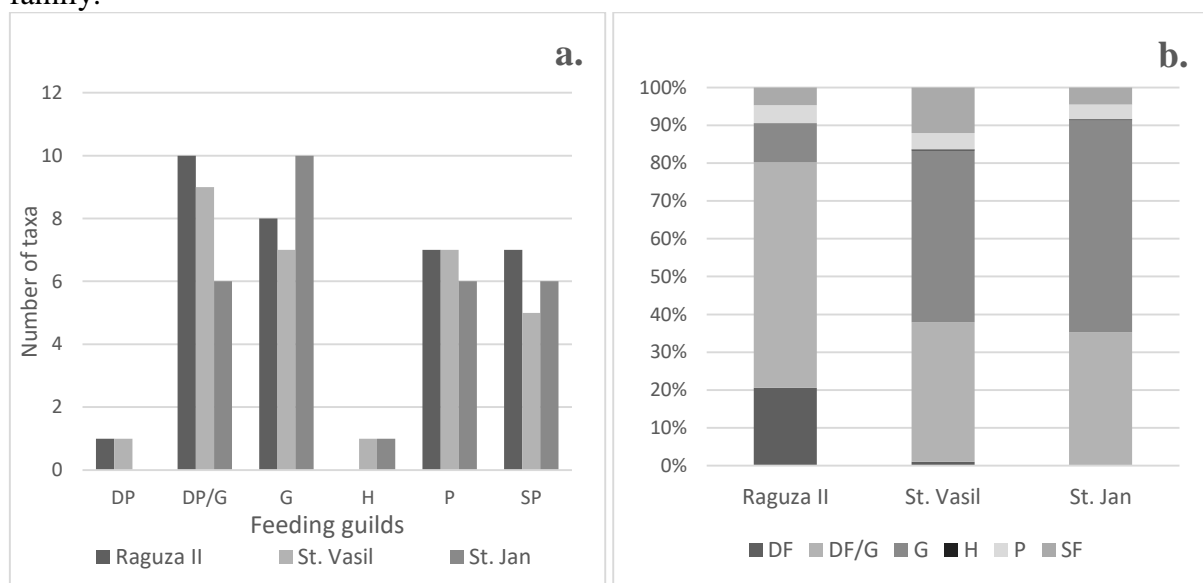

Figure 18. (a). Species richness (Number of taxa) and (b). Percentages of abundance (%DI) according to the feeding guilds feeding guilds (G-Grazer; SF-Suspension feeders; DF/G-Deposit feeder /Grazer; DF -Deposit feeder; P-Predators; H-Herbivores; SF-Suspension feeders).

As depicted in Figure 3, Deposit feeders and Deposit feeders/Grazers are the dominant groups in terms of both species diversity and the frequency of individuals observed at the Ragusa II station (DF - 20.6% and DF/G - 59.7%). However, the number of species and the frequency of Deposit feeders/Grazers show a decrease in the other two stations, specifically at St. Vasil (DF - 36.9%) and St. Jan (DF - 35.33%). In terms of species diversity, G-Grazers between these two stations exhibit relatively stable numbers, with 7 species at the St. Vasil station and 10 species at the St. Jan station. Nevertheless, the cumulative frequency of G-Grazers appears to increase as we move away from the aquaculture cages. Notably, in the case of the St. Jan station, which is dominated by sea urchin barrens, G-Grazers are particularly abundant throughout the habitat. Regarding SF-Suspension feeders, the number of species is higher at the Ragusa II station. Even though, the frequency of individuals is notably greater at the St. Vasil station due to the presence of two species from the *Mytilidae* family, namely *Mytilaster minimus* and *Mytilus galloprovincialis*.

Marine Biotic Index AMBI ecological group analysis

The AMBI (AZTI's Marine Biotic Index) was specifically developed to evaluate how macrobenthic assemblages in European coastal waters respond to shifts in environmental quality, as documented by Borja et al. in 2000 and Warwick et al., 2010. It categorizes species into five ecological groups based on their sensitivity to environmental stressors, and the index relies on the relative abundance of species within each group. This index has emerged as a cornerstone for evaluating ecological conditions in accordance with the European Water Framework Directive, as highlighted by Blanchet et al. in 2008. Moreover, this index's effectiveness has been demonstrated by comparing its results across the three sampling stations to identify potential environmental disturbances in one of them.

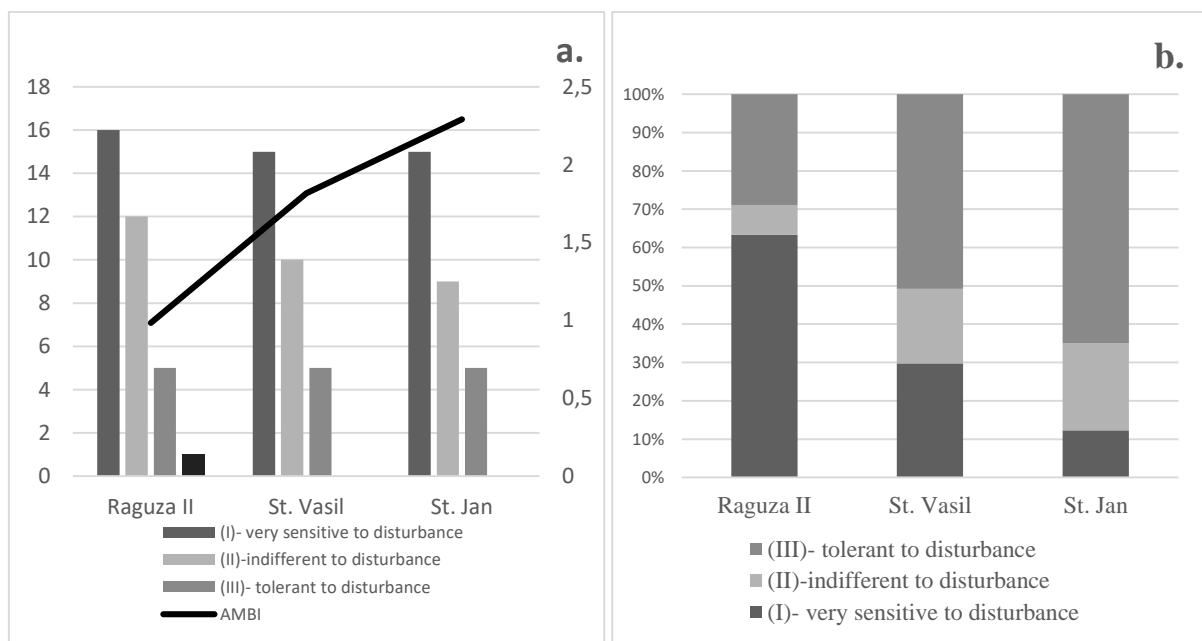

Figure 19. a. Number of species per each ecological group and AMBI values at each one of the three sampling locations, b. Cumulative frequencies of ecological groups (I, II, III)

As reported by Muxika et al. in 2003 and as indicated by the findings depicted in Figure 4, the Marine Biotic Index AMBI exhibits a range of values, ranging from 0.98 at the Raguza station to 2.29 at the St. Jan station. Notably, all three stations fall within the category of slightly polluted values according to the AMBI Index.

Inter-Habitat Comparison of the Molluscan Assemblages

According to Figure 5, three distinct and statistically significant clusters have emerged. Cluster 1 pertains to the Raguza sampling site, situated in proximity to the aquaculture farm. Cluster 2 encompasses the St. Vasil sampling sites, which are located near the Raguza II station. Cluster 3, representing St. Jan, situated to the north of the study area, appears to have experienced less impact from the Fish Farm.

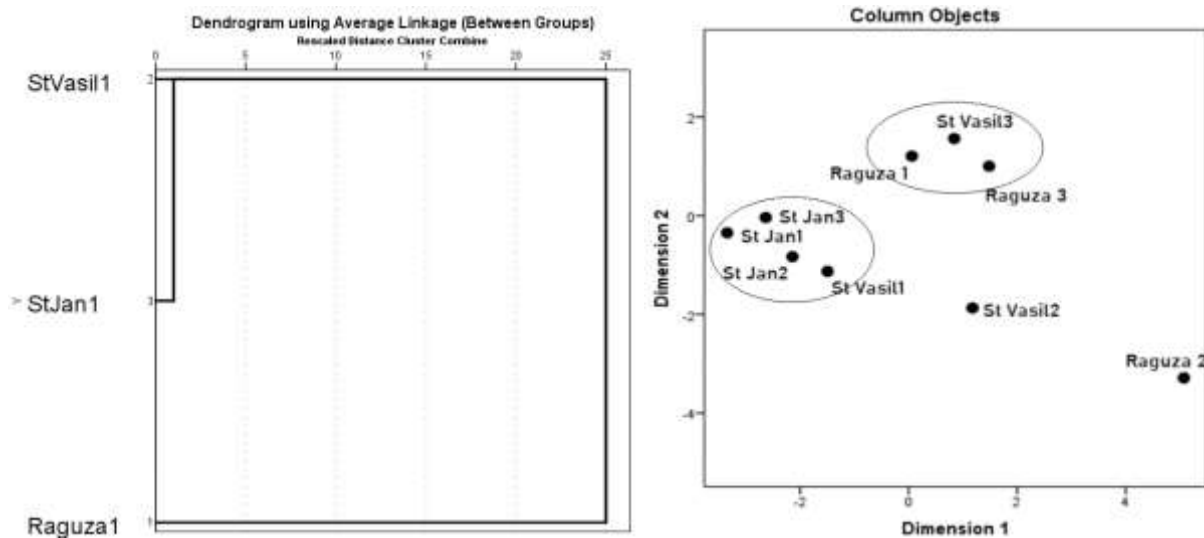

Figure 20. Cluster analysis of sampling stations based on species composition (mean values) during study period.

The dendrogram provides clarity regarding the differences at the Raguza II sampling station, which forms Cluster 1. This cluster appears to receive effluents from various sources, including both point and non-point sources—namely, from the fish farm activities and potentially from urban waters originating from the city of Orikum.

In contrast, the sampling sites at St. Jan and St. Vasil exhibit a lower influence from these polluting activities, resulting in a higher degree of similarity in species composition between these two stations.

CONCLUSIONS

This research has furnished a comprehensive dataset regarding the mollusc fauna inhabiting the study area, coupled with an analysis of the ecological conditions observed during the monitoring period. In summary, our findings unequivocally underscore the pivotal role of food availability and the heightened habitat complexity facilitated by biological structures on substrates in shaping mollusc assemblages. This holds true across the infralittoral to the circalittoral zones of the Mediterranean Sea. Notably, the prevalence of algae and their epiphytes on photophilic hard substrates emerges as a critical factor influencing gastropod-dominated assemblages, predominantly characterized by both micro- and macro-grazers with high mobility.

Looking ahead, the introduction of aquaculture production in these regions may potentially exert adverse impacts on benthic communities. However, it is imperative to conduct further assessments to comprehensively evaluate the potentially deleterious effects of aquaculture practices on the surrounding areas.

REFERENCES

- L. Kashta, S. Beqiraj, V. Tilot, V. Zuna, E. Dodbiba (2011) The first MPA in Albania , Sazani Island – Karaburun peninsula, as a regional priority conservation area for marine biodiversity. VARSTVO NARAVE, Supl. 1
- Anderson, M. J. (2001). A new method for non-parametric multivariate analysis of variance. *Austral ecology*, 26(1), 32-46.
- Bakiu, R., Hala, E., & Demiri, A. (2018). Development Trends of Albanian Marine Aquaculture of Gilthead Seabream and European Seabass. *World Aquaculture*, 49(4), 64-68.

- Blanchet, H., Lavesque, N., Ruellet, T., Dauvin, J.C., Sauriau, P.G., Desroy, N., Desclaux, C., Leconte, M., Bachelet, G., Janson, A.L., Bessineton, C., Duhamel, S., Jourde, J., Mayot, S., Simon, S., de Montaudouin, X., 2008. Use of biotic indices in semienclosed coastal ecosystems and transitional waters habitats – implications for the implementation of the European Water Framework Directive. *Ecological Indicators* 8, 360–372.
- Borja, Á., Franco, J., Pérez, V., 2000. A marine biotic index to establish the ecological quality of soft bottom benthos within European estuarine and coastal environments. *Marine Pollution Bulletin* 40, 1100–1114.
- Bray, J. R., & Curtis, J. T. (1957). An ordination of the upland forest communities of southern Wisconsin. *Ecological monographs*, 27(4), 326-349.
- Cattaneo, M., Albertelli, G., Drago, N. 1978. Macroenthos dei fondi dell' Isola di Capraia. *Atti del 2° Congresso dell' Associazione Italiana di Oceanologia e Limnologia*: 145 – 149.
- Chao, A., & Jost, L. (2012). Coverage-based rarefaction and extrapolation: standardizing samples by completeness rather than size. *Ecology*, 93(12), 2533-2547.
- Clarke, K. R., Gorley, R. N., Somerfield, P. J., & Warwick, R. M. (2014). *Change in marine communities: an approach to statistical analysis and interpretation*.
- Colwell, R. K., Chao, A., Gotelli, N. J., Lin, S. Y., Mao, C. X., Chazdon, R. L., & Longino, J. T. (2012). Models and estimators linking individual-based and sample-based rarefaction, extrapolation and comparison of assemblages. *Journal of plant ecology*, 5(1), 3-21.
- Fraschetti, S., Terlizzi, A., Guarnieri, G., Pizzolante, F., D'ambrosio, P., Maiorano, P., Beqiraj, S. and Boero, F. (2011). Effects of unplanned development on marine biodiversity: a lesson from Albania (central Mediterranean Sea). *Journal of coastal research*, (58), 106-115.
- Kasemi, D., Beqiraj, S., & Ruci, S. (2008). Macrozoobenthos on the rocky coasts of Vlora, Albania. *Natura Montenegrina*, 7(2), 133-145.
- KASEMI, D., RUCI, S., & BEQIRAJ, S. (2014). Comparative study on macrozoobenthos between Jonufra and Radhima coasts (Vlora Bay, Albania). *International Journal of Research in Applied, Natural and Social Sciences.(IMPACT: IJRANSS)*, 2(2), 177-186.
- Kasemi, V., & Haxhiraj, A. (2009). Experimental Analyses of the Influence on Corrosive Environment in Seawater of Vlore Bay to the Centre on Fatigue of Steel A-3. *Materials and Manufacturing Processes*, 24(7-8), 847-849.
- Maiorano, P., Mastrototaro, F., Beqiraj, S., Costantino, G., Kashta, L., Gherardi, M., Sion, L., D'ambrosio, P., Carlucci, R., D'onghia, G. and Tursi, A., (2011). Bioecological study of the benthic communities on the soft bottom of the Vlora Gulf (Albania). *Journal of Coastal Research*, (58), pp.95-105.
- Muxika, I., Borja, A., & Franco, J. (2003). The use of a biotic index (AMBI) to identify spatial and temporal impact gradients on benthic communities in an estuarine area. *ICES CM2003/Session J-01, Tallinn (Estonia)*, 24-28.
- Nasto, I., Sota, D., Haskoçelaj, P., Ismailaj, M., Kicaj H., (2022); Bioecological Assessment of Cage Farming on the Soft Bottom Benthic Communities of the Vlora Gulf (Albania); IRC 2022 XVI. International research conference proceedings; Conference: Marine Ecology and Research, November 2022 in Rome, Italy international scholarly and scientific research & innovation. online issn: 1307-6892., Pg. 142-156

- Nasto, I., Sota, D., Sacaj, K., Veshaj, B., Kicaj, H., (2022), Assessment of Marine Diversity on Rocky Shores of Triporti, Vlore, Albania; XVI. International research conference proceedings, Conference: Oceanography, Marine Biology and Aquaculture, December 2022, Amsterdam Netherlands international scholarly and scientific research & innovation; ISSN: 1307-6892; open science index 16 2022. Pg. 99-110.
- Revkov, N. K., Zenetos, A., Konsulova, T., Sergeeva, N. G., Simboura, N., Todorova, V., & Zaika, V. E. (1999). Coastal benthic diversity in the Black and Aegean seas. In *Oceanography of the Eastern Mediterranean and Black Sea. Similarities and differences of two interconnected basins* (pp. 263-263).
- Ruci, S., Kasemi, D., & Beqiraj, S. (2013) Seasonal comparative study of macrozoobenthos of the rocky areas of the Adriatic Sea in Albania. In *17th International Symposium on Environmental Pollution and its Impact on Life in the Mediterranean Region* (p. 67).
- Selmani, J., Ruci, S., Kasemi, D., Beqiraj, S., & Kashta, L. (2015). Preliminary data on the Posidonia meadows and associated macrozoobenthic community of Sazani island (Albania). *PeerJ PrePrints*.
- Warwick, R. M., Clarke, K. R., & Somerfield, P. J. (2010). Exploring the marine biotic index (AMBI): variations on a theme by Ángel Borja. *Marine Pollution Bulletin*, 60(4), 554-559.

DETERMINATION OF INDICATOR BENTHIC MACROINVERTEBRATES IN LÜLEBURGAZ STREAM (KIRKLARELİ, TÜRKİYE)

Kübra İŞÇİ¹, Belgin ÇAMUR-ELİPEK¹, Gazel Burcu AYDIN¹

¹ Trakya University, Faculty of Science, Biology Department, Edirne, Turkey
Corresponding author e-mail: gburcuaydin@trakya.edu.tr

ABSTRACT

In the present study, the benthic macroinvertebrate fauna of the Lüleburgaz Stream located in Kırklareli Province (Turkish Thrace) was examined. Sediment samples were taken from the selected four sampling stations at seasonal intervals in 2022 and 2023 years. The obtained benthic macroinvertebrates were evaluated according to their ecological tolerances. In addition, some environmental variables (dissolved oxygen, calcium, magnesium, total hardness, salinity, nitrite nitrogen, nitrate nitrogen, phosphate, sulfate, pH, temperature, conductivity, and total dissolved matter) were measured in water samples taken from the sampling stations in autumn and spring seasons to support the indicators' ecological tolerance conditions. A total of ten benthic macroinvertebrate taxa (*Limnodrilus hoffmeisteri* Claparède, 1862 and *Tubifex* sp. belonging Oligochaeta; *Chironomus riparius* (Meigen, 1803), *Chironomus plumosus* (Linnaeus, 1758), *Polypedilum nubifer* (Skuse, 1889) belonging Diptera; *Physella acuta* (Draparnaud, 1805) belonging Gastropoda, *Gammarus* sp. belonging Amphipoda, *Asellus aquaticus* (Linnaeus, 1758) belonging Isopoda and the individuals belonging Bivalvia and Hirudinae) were identified. While the ecological tolerances of the taxa were presented in this study, the measured environmental variables that may be effective in the distribution of the detected organisms were also evaluated. As a result, it was determined that some physicochemical properties measured in the Lüleburgaz Stream showed seasonal fluctuations and that the stream was exposed to pollution load, while it was determined that the benthic macroinvertebrate species obtained also supported these results.

Keywords: Water Quality, Indicator Organisms, Physicochemical Variables, Stream

INTRODUCTION

Water is vital for humans and all ecosystems. So, the importance of aquatic ecosystems in the world for humans and ecosystems is clear (Kazancı, 2008). Aquatic ecosystems are most affected by climate changes caused by global warming (Yanık and Aslan, 2018). In addition, due to the agricultural and industrial pollution that develops due to the increase in population, the control and protection of these ecosystems has gained importance (Tokatlı, 2019). Limnological studies are necessary to protect water resources and aquatic ecosystems. Because aquatic ecosystems can maintain continuity as long as they contain biodiversity (Kazancı, 2008).

Aquatic ecosystems have a dynamic structure with their living diversity and water quality (Protasov et al., 2019). Especially those living at the bottom of water bodies, benthic macroinvertebrates, are a group of organisms that are effectively used in biological monitoring studies because they are a heterogeneous group, respond differently to environmental pollution, have a longer life cycle than other organism groups, are easy to identify and collect, and are found in water bodies at all times of the year (Akay et al., 2018). These organisms have been used in various monitoring studies to determine biological water quality in our country in recent years. (Akay et al., 2018).

The use of benthic macroinvertebrates as indicators of contamination in waters provides an early warning mechanism for short-term changes that may be missed in chemical analysis. While some of these organisms such as Tubificidae and Chironomidae larvae show high tolerance to pollution, some groups such as Ephemeroptera and Tricoptera are quite sensitive. (Hawkes, 1979; Metcalfe-Smith, 1994).

Lüleburgaz Stream is a stream located in the Thrace Region, flowing into the Ergene River after it rises from the Aktepe foothill in the north of the Poyralı district. (<http://docs.neu.edu.tr/library/6298108714.pdf>). Lüleburgaz stream flows for 58 km through residential areas and then flows into the Ergene River and it is also exposed to anthropogenic effects.

Among the previous studies on Lüleburgaz Stream, the causes of pollution of the stream were mentioned in the Kırklareli Environmental Status Report 2019 (Çevre, T.K.V., & Müdürlüğü, Ş.İ. 2020). In addition, the ecological status of Lüleburgaz Stream and the status and quality of water were evaluated in the Meriç-Ergene River Basin Management Plan. As a result, it has been stated that the amount and quality of Lüleburgaz Stream groundwater is in poor condition. (<https://www.tarimorman.gov.tr/SYGM/Belgeler/NHYP%20DEN%C4%B0Z/MER%C4%B0%C3%87-ERGENE%20NEH%C4%B0R%20HAVZASI%20Y%C3%96NET%C4%B0M%20PLANI.pdf>). Although there are taxonomic studies that include the study area, no field-specific study has been found to date, evaluating the Lüleburgaz Stream benthic macroinvertebrates and their relationships with environmental factors.

In this study, it was aimed to evaluate the indicator benthic macroinvertebrates detected from Lüleburgaz Stream together with environmental parameters that may be effective in their distribution.

MATERIAL AND METHOD

The study area, the Lüleburgaz Stream, is located within the borders of Kırklareli Province of the Thrace Region in Turkey and is located at the coordinates 41° 20' 48" North and 27° 19' 4" East (Figure 1). A total of two stations were determined over the stream, one in the city center (station 1, St. 1) and the other approximately 500 meters before it flows into the Ergene River (station 2, St. 2) (Figure 1).

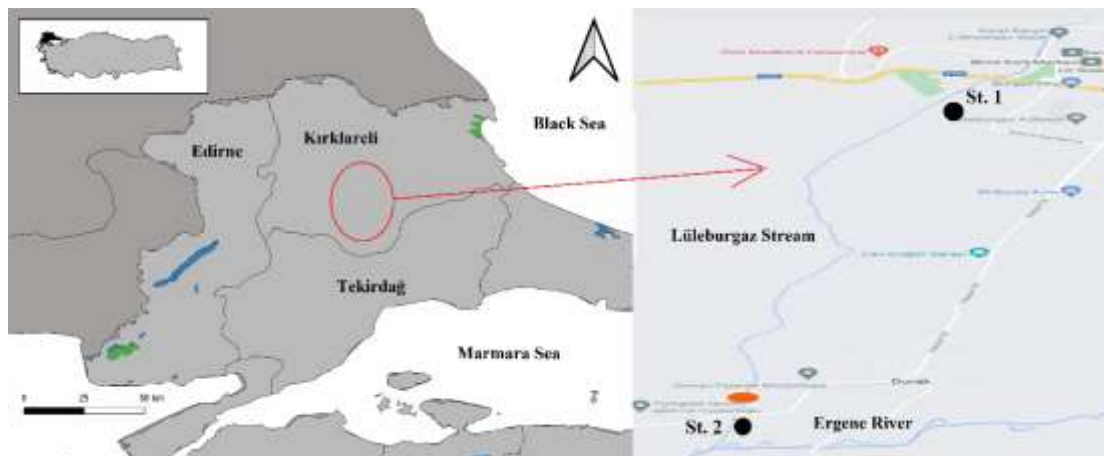

Figure 1. The study area and the sampling stations

The sediment samples taken from the selected sampling stations at seasonal intervals (In 2022, on dates corresponding to the summer and autumn seasons, and in 2023, on dates corresponding to the winter and spring seasons) The ordinary drift nets were used to take

sediment sampling. The sediment samples were washed through a 100-µm sieve and the obtained material was transferred to 250 cc bottle containing 70% ethanol. At the laboratory, samples were determined using a stereomicroscope and specimens identified to the possible taxonomical category. The following literature was used in identification; Brinkhurst (1971), Karaman and Pinkster (1977), Cranston (1982), and Schmelz and Collado (2010).

For the evaluating physicochemical variables, in autumn 2022 and spring 2023, the water samples taken from the water surface were placed in dark glass bottles (1 L). The water temperature, salinity, pH, conductivity, and total dissolved matter were measured using a Consort™ multi-parameter analyzer C5020 were measured in the stations when the field studies. The other parameters (dissolved oxygen, calcium, magnesium, total hardness, nitrite nitrogen, nitrate nitrogen, phosphate, sulfate) were measured in the laboratory by using classical titrimetric and spectrophotometric methods (Egemen, Sunlu 1996).

RESULTS AND DISCUSSION

The obtained data belonging to benthic macroinvertebrates were given in Table 1 and Table 2. The species *Limnodrilus hoffmeisteri* and *Tubifex* sp. belonging Oligochaeta group; *Chironomus riparius*, *Chironomus plumosus*, and *Polypedilum nubifer* belonging Diptera group; *Physella acuta* belonging Gastropoda group; *Gammarus* sp. Belonging Amphipoda group; *Asellus aquaticus* belonging Isopoda group, and individuals belonging to Bivalvia and Hirudinea groups were detected.

When the ecological preferences of the benthic macroinvertebrate taxa detected in the Lüleburgaz Stream were examined, it was determined that especially those identified at the species level were individuals with wide ecological tolerance and were also shown in studies as pollution indicators. The species *L. hoffmeisteri* is ecologically known as an indicator species that shows organic pollution and low oxygen in the waters, and is also frequently used in studies to determine the toxicity and bioaccumulation of pollutants in sediment (Shang et al., 2014). The species *C. riparius*, *C. plumosus*, *P. nubifer* belonging to Chironomidae survive in places with very low oxygen values and high organic pollution (Epler, 2001). The species *A. aquaticus* and *P. acuta* have a fairly cosmopolitan distribution, they feed on dead organic material in the sediment and can survive under temporary harsh conditions (extreme temperatures and water pollution) (Semenchenko et al., 2008).

Table 1. The benthic macroinvertebrates of the Lüleburgaz Stream obtained from station 1

Taxa/Seasons ↓	Spring	Summer	Autumn	Winter
Oligochaeta	Tubificidae <i>L. hoffmeisteri</i>	Oligochaeta (immature) <i>L. hoffmeisteri</i>	-	Oligochaeta (immature) <i>Tubifex</i> sp. <i>L. hoffmeisteri</i>
Diptera	-	<i>C. plumosus</i> <i>C. riparius</i>	<i>C. riparius</i>	<i>C. riparius</i>
Gastropoda	Gastropoda	<i>Physella acuta</i>	<i>Physella acuta</i>	<i>Physella acuta</i>
Bivalvia	Bivalvia	Bivalvia	Bivalvia	-
Amphipoda	Amphipoda	-	<i>Gammarus</i> sp.	Amphipoda
Hirudinea	-	-	-	-
Isopoda	Isopoda	-	<i>Asellus aquaticus</i>	-

Table 2. The benthic macroinvertebrates of the Lüleburgaz Stream obtained from station 2

Taxa/Seasons ↓	Spring	Summer	Autumn	Winter
Oligochaeta	Oligochaeta (immature) Tubificidae <i>L. hoffmeisteri</i>	Oligochaeta (immature) <i>L. hoffmeisteri</i>	Oligochaeta (immature) <i>Tubifex</i> sp.	Oligochaeta <i>L. hoffmeisteri</i>
Diptera	-	<i>C. plumosus</i> <i>P. nubifer</i>	<i>C. riparius</i> <i>C. plumosus</i> <i>P. nubifer</i>	-
Gastropoda	Gastropoda	Gastropoda <i>Physella acuta</i>	-	<i>Physella acuta</i>
Bivalvia	Bivalvia	Bivalvia	Bivalvia	-
Amphipoda	Amphipoda	Gammarus sp.	-	Amphipoda
Hirudinea	Hirudinea	Hirudinea	Hirudinea	Hirudinea
Isopoda	-	-	<i>Asellus aquaticus</i>	-

The values of physicochemical variables belonging to spring and autumn season were given in Table 3. When physicochemical data are examined according to the Surface Water Resources Control Regulation (YSKKY, 2016):

It was observed that while dissolved oxygen values showed second-class water quality values in the autumn, they approached first-class quality in the spring. pH values varied between minimum 7.4 and maximum 7.7 in both periods, and it was determined that the water was close to slightly basic. While it was observed that the stream showed freshwater character in the spring in terms of conductivity values (678-762 $\mu\text{S}/\text{cm}$), it was observed that the conductivity increased very much in the autumn period, especially in the city center (St.1) (1330 $\mu\text{S}/\text{cm}$), and this increase continued at the next station (1100 $\mu\text{S}/\text{cm}$). The temperature values of the stream, which shows freshwater character in terms of salinity values (0.3-0.6 ‰), were measured low (1.5-1.8 °C) during the sampling periods. It was determined that the stream, which was soft water in the autumn in terms of total hardness, increased to medium/hard water (in the city center) in the spring and the increasing magnesium and calcium ions were effective in this increase. The medium/hard feature of water in terms of pH value was parallel to the medium hard water feature determined by total hardness. While nitrite nitrogen was not found in the stream in the autumn period, it was determined that this value increased and decreased to the fourth class water quality at both sampling stations in the spring period. While an increase was observed in terms of nitrate nitrogen in the spring period, it was determined that the measured values did not exceed first class water quality (0.250-4.72 mg/L). The values measured in terms of sulfate ion increased in the spring compared to the autumn period and the values were of first class water quality. In terms of total phosphate measurements, it was determined that the station near the Ergene River (St. 2) had a second-class water quality in both autumn and spring, while the city center station (St.1) had a third-class water quality in the spring. It was determined that the values measured in the spring period in terms of total dissolved matter doubled in the autumn period, but still did not show a significant deviation from the first class water quality of 0.5 g/L.

Table 3. Physicochemical analysis results of the Lüleburgaz Stream sampling stations for the spring and autumn seasons

Physicochemical Variables	SPRING SEASON		AUTUMN SEASON	
	St. 1	St. 2	St. 1	St. 2
Dissolved Oxygen (mg/L)	7.03	6.79	5	6
pH	7.71	7.45	7.4	7.6
Conductivity (μ S/cm)	678.7	762.5	1330	1100
Temperature ($^{\circ}$ C)	1.5	1.5	1.8	1.8
Salinity (‰)	0.380	0.422	0.6	0.5
TDS (g/L)	0.333	0.374	0.66	0.59
Calcium (mg/L)	24.04	16.32	14.2	12.3
Magnesium (mg/L)	14.52	9.6	1.9	1.8
Total Hardness (FS ⁰)	25.04	19.2	3.8	3.6
Nitrite nitrogen (mg/L)	0.09	0.08	*	*
Nitrate nitrogen (mg/L)	4.13	4.172	*	0.25
Phosphate (mg/L)	1.385	1.298	0.717	1.014
Sulfate (mg/L)	0.42	0.08	*	0.156

* Below measurable value

In terms of measured physicochemical variables, especially low oxygen values (indicating second-class water quality) and seasonally increasing nutrient salts, as well as seasonal increase in conductivity, indicate that organic and inorganic pollutants have entered the stream.

In addition, some of the benthic macroinvertebrate species detected in the study (such as *C. plumosus*, *C. riparius*, *P. nubifer*) belong to Chironomids, which are indicators of organic pollution, and Oligochaetes, which are also highly tolerant to pollution (such as *L. hoffmeisteri* and *Tubifex* sp.), apart from *P. acuta*. The fact that they contain Gastropod species, which can live in polluted waters, and Hirudinae individuals, which are pollution indicators, supports our determination that the Lüleburgaz Stream is exposed to polluting elements.

CONCLUSIONS

As a result, it was determined that the Lüleburgaz Stream, which was determined as the study area, was occasionally exposed to pollutants and therefore pollution indicator species settled more in the stream. Considering that the physicochemical variables fluctuate seasonally in the study, it is recommended to carry out periodic studies in the stream in question and prevent the entry of pollutants that will deteriorate the water quality into the stream.

REFERENCES

- Akay, E., Dalkıran N., Dere Ş. 2019. The Use of Benthic Macro Invertebrates in Determining Biological Water Quality of Rivers. İklim Değişikliği ve Çevre, 3(1): 60-67.
- Brinkhurst, O.R. 1971. British Aquatic Oligochaeta. Univ. Toronto Press, Toronto. 53 p.
- Çevre, T. K. V., & Müdürlüğü, Ş. İ. 2020. Kırklareli İli 2019 Yılı Çevre Durum Raporu.
- Cranston, P.S. 1982. A key to the larvae of the British Orthocladinae (Chironomidae). Freshwater Biological Association Scientific Publication, 45 p.
- Egemen, Ö., & Sunlu, U. (1996). Water Quality Textbook (3rd ed.).

- Epler, J.H. 2001. Identification Manual for the Larval Chironomidae (Diptera) North and South Carolina. North Carolina Department of Environment and Natural Resources Division of Water Quality.
- Hawkes, A. 1979. Invertebrates as Indicators of River Water Quality (In the Biological of Water Quality, Edited by A. James and L. Evison), Wiley-Interscience Publication, Great Britain.
- <http://docs.neu.edu.tr/library/6298108714.pdf>
- <https://www.tarimorman.gov.tr/SYGM/Belgeler/NHYP%20DEN%C4%B0Z/MER%C4%B0%C3%87ERGENE%20NEH%C4%B0R%20HAVZASI%20Y%C3%96NET%C4%B0M%20PLANI.pdf>
- Karaman, G.S., Pinkster, S. 1977. Freshwater Gammarus Species from Europe, North Africa and Adjacent Regions of Asia (Crustacea-Amphipoda), Part I. Gammarus pulex-group and Related Species. *Bijdr Dierkd*, 47(1): 1-97.
- Kazancı, N. 2008. The developments in Limnology. *Ege University Journal of Fisheries & Aquatic Sciences*, 25(4): 365-369.
- Metcalf-Smith, J.L. 1994. Biological water-quality assessment of rivers: use of macroinvertebrate communities. *The rivers handbook: hydrological and ecological principles*, 144-170.
- Protasov, A., Barinova, S., Novoselova, T., Sylaieva, A. 2019. The Aquatic Organisms Diversity, Community Structure, and Environmental Conditions. *Diversity*, 11, 190.
- Schmelz, R.M., and Collado, R. 2010. A guide to European Terrestrial and Freshwater Species of Enchytraeidae (Oligochaeta). *Soil Organisms*, 82(1): 1-176.
- Semenchenko, V., Graczyk, T.K., Laenko, T., Razlutskiy, V. 2008. A new record of the North American gastropod *Physella acuta* (Draparnaud 1805) from the Neman River Basin, Belarus. *Aquatic Invasions*, 3(3): 359-360.
- Shang, J., Liao, Q., Zhang, L., Fan, C. 2014. The Influence of Different Benthic Fauna on Inorganic Nitrogen Flux and Denitrification in a Large Shallow Hyper-eutrophic Lake. *Fundamental Applied Limnology*, 184(2): 101-108.
- Tokatlı, C. 2019. Sediment Quality of Ergene River Basin: Bio-ecological Risk Assessment of Toxic Metals. *Environmental Monitoring and Assessment*, 191: 706.
- Yanık, T., Aslan, İ. 20018. Impact of Global Warming on Aquatic Animals. *Pakistan Journal of Zoology*, 50(1): 353-363.

PRELIMINARY CHARACTERIZATION OF *METSCHNIKOWIA PULCHERRIMA* STRAINS FOR FUTURE APPLICATIONS IN WINE BIOTECHNOLOGY

*Mamica Ruci*¹, *Renata Kongoli*², *Massimo Iorizzo*³, *Bruno Testa*³, *Francesco letizia*³,
*Gianluca Albanese*³, *Julian Karauli*¹, *Fatbardha Lamçe*¹, *Onejda Kyçyk*¹

¹ *Faculty of Biotechnology and Food, Food Research Center, Agricultural University of Tirana, Albania*

² *Faculty of Biotechnology and Food, Department of Agro-food Technology, Agricultural University of Tirana, Albania*

³ *Department of Agriculture, Environmental and Food Sciences, University of Molise, 86100 Campobasso, Italy*

Corresponding author e-mail:mruci@ubt.edu.al

ABSTRACT

In recent years, in the oenological sector there has been a re-evaluation of non-*Saccharomyces* oenological yeasts, considered in the past as unwanted or deteriorating yeasts, for a positive contribution they can make in improving the analytical composition and aromatic profile of the wine. Therefore, the selection and use of non-*Saccharomyces* yeasts with peculiar technological and enzymatic characteristics could represent a key point for the production of wines with good and distinctive chemical and organoleptic characteristics. The main objective of this work was to evaluate a possible use of *Metschnikowia pulcherrima* as starters in the production of wines obtained from native grape varieties of Albania. Therefore, three *M. pulcherrima* strains (ASB3R, AS3C1, 14AS), isolated from grape must, have been tested for their antimicrobial and enzymatic activities, biogenic amine production and some fermentative properties. The results showed an antimicrobial activity of these yeasts that suggests their possible use as biocontrol agents in winemaking. In addition, their β -glucosidase activity was detected, which could contribute to the release of varietal aromas from aromatic precursors present in grapes. Furthermore, these strains were safe for health because they did not produce biogenic amines. These results, although preliminary, open the way to further investigations aimed at a possible use of these yeasts as a starter in the alcoholic fermentation of grape juice and the contribution they can give in the definition of the physical-chemical and organoleptic characteristics of regional wines

Keywords: *Winemaking, non-Saccharomyces, Metschnikowia pulcherrima, Biocontrol, β -glucosidase activity*

INTRODUCTION

The increasing interest in natural wines has spurred researchers to investigate strategies that promote sustainability, environmental impact reduction, and wine quality enhancement. Recent scientific studies have focused on the oenological properties, enzymatic activity and antimicrobial capacity of non-*Saccharomyces* yeasts, aiming to utilize their winemaking potential in improving aromatic complexity and the stability of wine (Bruno Testa, 2021). To be considered as 'suitable', selected non-*Saccharomyces* yeasts should show desirable enological characteristics, including good fermentation rates, ethanol tolerance and complete consumption of reducing sugars, resistance to SO₂, absence of H₂S or off-flavors, as well as

killer character or resistance to toxin activity. Among these yeasts, preference should be given to those that enrich the wines with superior sensorial attributes.

Wine yeasts play a crucial role in converting grape sugars into ethanol, carbon dioxide and various secondary compounds. In this context, the use of mixed and multi starters in fermentation process, involving both *Saccharomyces* and non-*Saccharomyces* wine yeasts, is proposed as a new strategy for winemakers to enhance the chemical composition and sensorial characteristics of wine (Ciani, 2009). Extensive research is conducted on non-*Saccharomyces* yeasts, such as *Torulaspota delbrueckii*, *Lachancea thermotolerans*, *Metschnikowia pulcherrima*, *Hanseniaspora uvarum*, *Schizosaccharomyces pombe*, and *Pichia kluyveri*, commonly founded on grape skins. The utilization of these non-*Saccharomyces* yeasts is associated with significant contributions to the metabolic impact and aroma complexity of the final wine product (Benito, 2019; Bruno Testa, 2021; Maurizio Ciani, 2009). Non-*Saccharomyces* yeasts exhibit higher enzyme production compared to *Saccharomyces* species, including β -glucosidase, proteases, lipases, esterase, among others, which play a pivotal role in the production of aroma-active compounds in wine (Charoenchai C, 2009). For instance, β -glucosidase enzymes hydrolyze β -D-glycosidic bonds, leading to the volatile compound formation, such as terpenes, aliphatic alcohols, and esters. Additionally, certain non-*Saccharomyces* yeasts can produce proteolytic and pectinase enzymes that aid in reducing protein haze and extracting polyphenols from grape skins (Ubeda-Iranzo JF, 1998; Charoenchai C, 2009; Javier Vicente, 2020). Non-*Saccharomyces* yeasts dominate the early stage of alcoholic fermentation; notably, *M. pulcherrima* exhibits high β -glucosidase activity and its presence in mixed cultures can lead to wine improvements, such as reduced volatile acidity, increased production of medium-chain fatty acids, higher alcohol content, enhanced esters and terpenoids, and elevated glycerol levels (García, 2016; María Eugenia Rodríguez, 2007).

Furthermore, non-*Saccharomyces* yeasts possessing antimicrobial activity can contribute to the preservation of must and wine by protecting them from spoilage bacteria and yeasts. As such, these yeasts can be utilized as bio protective agents at different stages of winemaking. The protective mechanisms employed by these yeasts include competition for nutrients and the production of killer toxins or inhibitory compounds (Morata A. , 2021; Simonin, 2020). For instance, certain species of non-*Saccharomyces*, such as *M. pulcherrima*, can produce pulcherrimin acid, a red-brown pigment that exhibits antimicrobial effects. The union of pulcherrimin acid with Fe^{3+} ions results in inhibition of other microorganisms that require high levels of Fe ions for their cellular processes. Nutrient competition represents another widespread mechanism through which one microorganism affects the growth of another. Additionally, the secretion of extracellular lytic enzymes, such as chitinase and glucanase, by non-*Saccharomyces* yeasts can inhibit the growth of other microorganisms by damaging their cell walls or other components (Sipiczki, 2020; Javier Vicente, 2020). Moreover, studies have demonstrated that non-*Saccharomyces* yeasts exhibit good adaptability when combined with *Saccharomyces cerevisiae* yeast for completing alcoholic fermentation. Sequential inoculation of non-*Saccharomyces* and *Saccharomyces* yeasts has been identified as an optimal approach for producing wines with distinctive aromatic profiles and increased complexity (Maëlys Puyo, 2023; Kai Chen, 2018). Importantly, scientific research indicates that non-*Saccharomyces* yeasts do not produce toxic compounds such as biogenic amines, thereby ensuring their safe use in winemaking.

The focus of this study is to characterize a specific strain of *M. pulcherrima* in terms of its oenological properties and enzymatic activities relevant to winemaking. By examining these characteristics, we aim to evaluate the strain's potential as a valuable mean in enhancing wine quality, improving sensorial attributes and mitigating microbial risks during fermentation and aging process.

To accomplish this, the chosen strain will be subjected to comprehensive analyses, including assessments of its fermentation performance, sensory impact on wines, enzymatic activities and antimicrobial properties. By understanding the specific traits and capabilities of this strain, we can ascertain its suitability for integration into winemaking practices and identify potential avenues for optimizing wine production.

In conclusion, the strains exploration and characterization present a promising opportunity to enhance winemaking toward sustainable wine production practices. This study aims to contribute to the existing knowledge by evaluating the oenological properties and enzymatic activities of a specific strain, shedding light on its potential application in the pursuit of high-quality, environmentally conscious wines.

MATERIAL AND METHODS

2.1 Yeast Strains

This study aimed to characterize three strains of *M pulcherrima* and assess their suitability for the production of high-quality wine. The strains, namely *AS3C1*, *14AS*, and *ASB3R*, were isolated, identified from grape must and preserved in the culture collection of the DiAAA (Department of Agricultural, Environmental and Food Sciences, University of Molise). The experiments were conducted at the Microbiological Laboratory of the University of Molise.

The selected strains were subject of various tests to assess their enzymatic activity, antimicrobial activity and oenological properties. These tests included evaluating their β -glucosidase β -lyases, and proteases activities and antimicrobial activity as well. Also are examined their oenological properties such as production of acetic acid, alcohol, reducing sugar in fermentation on synthetic must.

To conduct the experiments, strains were refreshed in YPD medium (consisting of 1% yeast extract, 2% peptone, and 2% dextrose) under aerobic conditions at a temperature of 30°C. The cultivation period lasted for 48 hours.

2.2 Antimicrobial activity

The antimicrobial activity of the strains was tested in accordance with the (Massimo Iorizzo, 2022) refreshed in YPD medium (1% w/v yeast extract, 2% w/v peptone and 2% w/v dextrose) at 30°C under aerobic condition for 48h. The antimicrobial activity of yeast strains assessment followed these steps:

Prepare the YPD Agar medium with the following components for 100ml: Peptone: 2g, Glucose: 2g, Agar: 2g, Yeast extract: 1g, sterilized in an autoclave at 121°C for 15 minutes. If the concentration of the refreshed wild yeast culture is higher than 10^5 cells/ml, perform dilutions. Vortex all the wild yeast samples to ensure homogeneity. Prepare the plates by adding 2ml of the diluted yeast culture and 18ml of YPD Agar medium, totaling 20ml. When the medium has solidified, create wells and pipette 50-70 μ L of yeast strains sample into each well. The plates incubate at 28°C for 24 hours. After incubation, examine the plates and record the results to evaluate the antimicrobial activity of each yeast strains, measuring the diameter (mm) of the clear zone of inhibition (ZOI) around the inoculated wells.

V2.3 Enzymatic activity

β -glucosidase activity

In the characterization of β -glucosidase activity in yeast of oenological origin, a screening method was prepared to assess the activity of this enzyme. The following components were used to prepare a 100ml nutrient agar medium: (Nutrient agar: 2.8g, Arbutin: 0.5g, Ammonium ferric citrate $[(\text{NH}_4)_3[\text{Fe}(\text{C}_6\text{H}_4\text{O}_7)_2]]$: 1g (1% w/v), Distilled water: 100ml, Final pH: 5.0).

The Ammonium ferric citrate was weighed before and sterilized in an Eppendorf pipette at 121°C for 15 minutes. After sterilization, it was added to the medium in sterile condition under. The yeast strains of interests, which were refreshed in YPD agar broth the day before, were then streaked onto the surface of the prepared plates using a sterile pipette, with 10 μ L of the yeast strains culture in each plate. The plates were incubated at 28°C for 48 hours and after are observed the results. Yeast with β -glucosidase activity grow on the medium and are surrounded by a dark color, the darker the color, the stronger the enzymatic activity of the strains.

β -lyases activity

In the characterization of β -lyases activity, a medium was prepared to assess the activity of this enzyme. The following components were used to prepare a 100ml medium: (Carbon yeast base: 1.1g, Methionine: 0.1g, Pyridoxal 5' phosphatase (LP) (Vitamin B6): 0.02g, Final pH: 3.50). To prepare the medium, 80ml of water was added to the above components. Separately, 2g of bacteriological agar was mixed with 20ml of water, and after adjusting the pH of the agar solution, it was added to the medium. The entire mixture was then autoclaved for sterilization. Once the medium was sterilized, it was poured into separate plates. Each yeast strain was then plated onto the surface of the medium using sterile pipette 10 μ L of the yeast strains culture. The plates were incubated at 28°C for 48 hours. After the incubation period, the results of the β -lyases activity analysis were obtained. The yeasts that have β -lyase activity grow in the medium and form a white halo around them, whereas those that lack the activity of this enzyme do not grow.

Protease activity

To assess protease activity in yeast, the following medium can be prepared:

Components for 100ml: (YPD Peptone: 2g, Agar: 2g, Glucose: 2g, Yeast extract: 1g are dissolved in 50ml of water, and the mixture is sterilized and additionally, 2g of skimmed milk is mixed with 50ml of water and pasteurized at 75°C for 15 minutes).

After both the YPD medium and the pasteurized skimmed milk are prepared, they are combined under sterile conditions. The mixture is then poured into plates, and in each solidified plate, 10 μ L of yeast culture is dropped.

The plates are then incubated under appropriate conditions suitable for the yeast being tested. This medium allows the assessment of protease activity in yeast by observing the degradation or clearing of the skimmed milk protein caused by the protease enzymes produced by the yeast strains and the formation of halos surround them, the results express by measure the diameter of halo.

2.4 Fermentation ability

The fermentation ability of strains was evaluated using standard fermentation assays. A synthetic must grape is prepared with a composition for g/L (Tartaric acid 5g, Citric acid 0.3g, DL-Malic acid 5g, Fructose 100g, Yeast extract 1g, Glucose / dextrose 100g, Sodium chloride NaCl 0.2g, Dipotassium hydrogen phosphate trihydrate $\text{KH}_2\text{PO}_4 \cdot 3\text{H}_2\text{O}$ 5g, $(\text{NH}_4)\text{SO}_4$ 2g, Magnesium sulfate heptahydrate ($\text{MgSO}_4 \cdot 7\text{H}_2\text{O}$) 0.4g, Manganese sulfate (MnSO_4) 0.05g, and the final Ph 3.50), is placed in the 100ml flask, capped with cotton and sterilized. In each of the flasks was inoculated a strain of yeast and fermentation was allowed to proceed under controlled

conditions. Parameters such as sugar consumption, alcohol production and pH changes, were monitored at regular intervals to assess the fermentation performance of the strains.

2.5 Statistical Analysis

The data are express as mean of standard deviation (n=3) using analysis of variance (ANOVA). Statistical significance was attributed to values of $p \leq 0.05$.

3. RESULTS AND DISCUSSION

The characterization of the strains (ASB3R, AS3C1, 14AS) in terms of their oenological properties and enzymatic activities revealed several remarkable findings.

3.1. Antimicrobial Activity

The results of the antagonistic activity of the strains toward the wild yeast indicator are presented in **Figure 1** as the mean diameter (mm) of the zone of inhibition (ZOI), with water as the control. The strains inhibited the growth of the wild yeast indicator by producing a ZOI between 2 and 4 mm. The strain *AS3C1* has the ability to inhibit all indicator wild yeasts with different power expression as ZOI. The *14AS* strain was not able to inhibit the growth of the *S. Ludwigi* indicator wild yeast. While the strain *ASB3R* was only able to partially inhibit the development of *S. Pompea*.

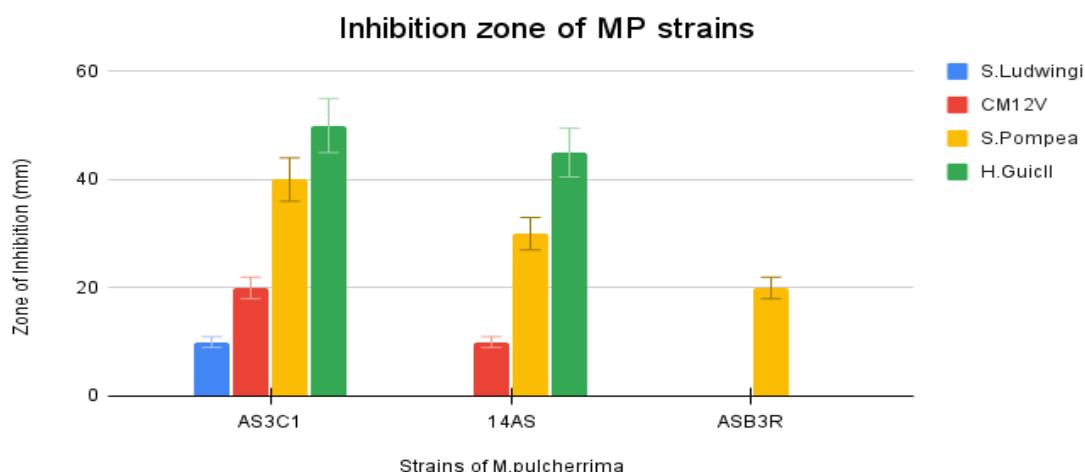

Figure 1 the mean diameter (mm) of the growth inhibition zone (ZOI)

3.2 Enzymatic Activity:

Significant β -glucosidase activity was observed in the strains. This enzymatic activity is essential for the release of varietal aromas and contributes to the improved sensory profile of wines. Good protease activity was observed in strain ASB3R. While the β -lyase activity was better expressed by the strain AS3C1 than two other strains, the results are shown in Table1.

Yeast strains MP	B-Glucosidase	B-Lyases	Protease activity (halo mm)
ASB3R	++	w	8mm
AS3C1	+++	++	4mm
14AS	+++	w	3mm

Table 1 The results of the enzymatic activity of the strains express – (negative), +(positive).w(weak), mm (diameter of halo).

3.3 Fermentation Ability:

The strains are refreshed in YPD broth for 48 hours. The synthetic grape must is prepared, separated in 200 ml elutriators and sterilized at 121°C for 15 minutes. Before inoculation, the strains are centrifuged at 8000 rpm after washing with physiological water (0.9%). Fermentation is carried out under control temperature and is monitored until constant weight is reached. At the end of fermentation a physico-chemical analysis is carried out on three of the strains. The data obtained show a good fermentation capacity for both strains. The changes in pH were significantly for AS3C1 as were the pH and volatile acidity (0.12g/l acid acetic). The consumed sugar is efficiently and produced desirable levels of alcohol during the fermentation process. In Table 2, the data are expressed as means with standard deviations. The analysis is performed in triplicate and results correspond to the average; the letter (a) indicates significant with 95% confidence differences.

Strains of MP	pH	Total acidity (g/l)	Vol. Acidity(g/l)	Alcohol %(v/v)	Reducing sugar Brix
14AS	3.08±0.02	7.15±0.03	0.15±0.02	3.1±0.10	12.07±0.12
ASB3R	3.07±0.06	7.25±0.02	0.18±0.01	3.37±0.06	11.13±0.15
AS3C1	3.1±0.01 ^a	7.34±0.02	0.12±0.01 ^a	4.6±0.20	9.77±0.21

Table 2 Data are expressed as mean values ± standard deviations (n = 3) with ($p \leq 0.05$);

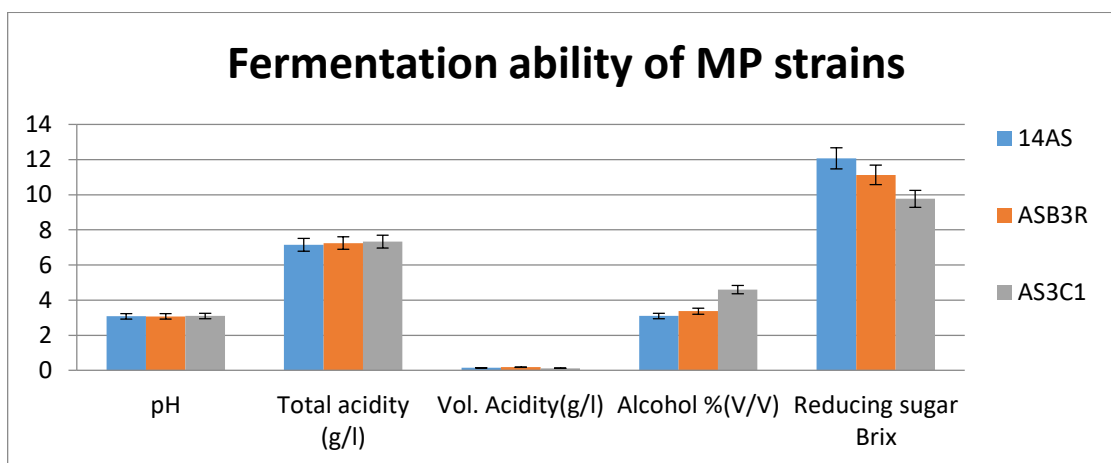

Figure 2, Fermentation ability of *M pulcherrima* strains in synthetic grape must

CONCLUSION

In conclusion, the characterization of the strains (*ASB3R*, *AS3C1*, *14AS*) for their oenological properties and enzymatic activities has provided valuable insights into their potential applications in winemaking. The results demonstrate that the AS3C1 possesses strong antimicrobial activity against wild yeasts, highlighting their effectiveness in microbial control during fermentation.

The significant β -glycosidase activity observed in the strains indicates the ability to release grape varietal flavors, contributing to enhanced sensorics profiles and the development of complex aromas and flavors in wines.

Furthermore, the fermentation ability displayed by the strain AS3C1, with efficient pH, volatile acidity, sugar consumption and alcohol production, support the suitability for winemaking processes.

Overall, these findings suggest that the strains (*ASB3R*, *AS3C1*, *14AS*) have great potential as beneficial components in winemaking, offering improved microbial control, enhanced sensorial characteristics promising the production of high-quality wines.

Further research and application trials are warranted to explore the full potential of these strains and to optimize their integration into winemaking practices. With continued investigation, *M pulcherrima* strains could contribute to the advancement of sustainable and quality-focused winemaking techniques.

REFERENCES

- Benito, Á. (2019). The Influence of Non-Saccharomyces Species on Wine.
- Bordet, F., Joran, A., Klein, G., Roullier-Gall, C., & Alexandre, H. (2020). east-Yeast Interactions: Mechanisms, Methodologies and Impact on Composition. 8.
- Bruno Testa, F. C. (2021). Influence of *Hanseniaspora uvarum* AS27 on Chemical. *Processes*, 326.
- Charoenchai C, F. G. (2009). Screening of non-Saccharomyces wine yeasts for the presence of extracellular hydrolytic enzymes. 3(1).
- Ciani1, M. (2009). Controlled mixed culture fermentation: a new perspective on the. 10.
- Domizio, P. (2006). Spontaneous and inoculated yeast populations dynamics and their effect on. 115.
- García, M. (2016). *Non-Saccharomyces Yeasts: Biotechnological Role for*. Grape and wine Biotechnology.
- Javier Vicente, J. R. (2020). The Genus *Metschnikowia* in Enology. 7.
- Kai Chen, C. E. (2018). Use of non-Saccharomyces yeasts and oenological tannin in red winemaking: Influence on colour, aroma and sensorial properties of young wines. 69.
- Lin, M., Boss, P., Walker, M., Sumbly, K., Grbin, P., & Jiranek, V. (2020). Evaluation of indigenous non-Saccharomyces yeasts isolated from a South Australian vineyard for their potential as wine starter cultures. 312.
- Maëlys Puyo, S. S. (2023). Use of Oenological Tannins to Protect the Colour of Rosé Wine in a Bioprotection Strategy with *Metschnikowia pulcherrima*. 4.
- María Eugenia Rodríguez, C. L. (2007). Selection and preliminary characterization of β -glycosidases producer Patagonian wild yeasts. 41(6-7).
- Massimo Di Renzo, F. L. (April 2023). Natural Fiano Wines Fermented in Stainless Steel Tanks, Oak Barrels, and Earthenware Amphora. *Processes*, 1273.
- Massimo Iorizzo, G. A. (2022). Probiotic Potentiality from Versatile *Lactiplantibacillus plantarum* Strains as Resource to Enhance Freshwater Fish Health. *Microrganisms*, 463.
- Maurizio Ciani, F. C. (2009). Controlled mixed culture fermentation: a new perspective on the use of non-Saccharomyces yeast in winemaking. *FEMS Yeast*, 10, 123-133.
- Morata. (2019). Applications of *Metschnikowia pulcherrima* in Wine Biotechnology. *Fermentation*, 63.
- Morata, A. (2021). Non- Saccharomyces as Biotools to Control the Production of Off-Flavors in Wines. 15.

- Parafati. (2015). Biocontrol ability and action mechanism of food-isolated yeast strains against *Botrytis cinerea* causing post-harvest bunch rot of table grape. *Food microbiology*, 47, 85-92.
- Rodríguez, M. E. (2010). Influence of *Candida pulcherrima* Patagonian strain on alcoholic fermentation. 138(19-25).
- Simonin, S. (2020). Bio-Protection as an Alternative to Sulphites: Impact on Chemical and Microbial Characteristics of Red Wines. 11-1308(105.).
- Sipiczki, M. (2020). *Metschnikowia pulcherrima* and Related. *Microorganisms*, 1029.
- Spano, G., & Torriani, S. E. (2016). Microbiota of Grapes: Positive and Negative Role on Wine Quality. 7.
- Ubeda-Iranzo JF, B.-P. A.-C. (1998). Study of the oenological characteristics and enzymatic activities of wine yeasts. *food Microbiology*, 399-406.
- Wang. (2018). Biological control of *botrytis cinerea*: interactions with native vineyard yeasts from Washington State. *Phytopathology*, 108(6), 691-701.

THE IMPORTANCE OF BIODEGRADABILITY OF PLASTICS USED IN AGRICULTURE

Gizem MOĞOL¹, Sibel ÖZDEMİR¹

*¹ Doktor Tarsa Tarım Industry and Trade Inc., R&D Department, Antalya, Turkey
Corresponding author e-mail: gizem.mogol@drt.com.tr*

ABSTRACT

Plastic products find use in the agricultural sector as well as in many areas. Covering films successfully perform essential tasks such as maintaining moisture and soil temperature and preventing weeds. Granular fertilizer coating films supplies slow or controlled release of fertilizers by preventing the environment from the residues and provides sustainability. Biodegradability is a sought-after feature in agricultural applications, especially starch-based biodegradable plastics are the most widely used ones. In agriculture, biodegradable polymers are also used as planting tapes, which contain plant seeds and fertilizer together. After harvesting, these films are destroyed by the degradation process. Biodegradable plastics break down spontaneously as a result of microbiological and chemical processes and remain in the environment as microplastics. Biodegradable plastics, on the other hand, are destroyed in the environment by turning into products such as carbon dioxide, water and methane as a result of the process called mineralization. In this study, the ASTM D 5988-03 test method and the equivalent ISO 17556:2019 test method, which allows determining the degree of aerobic biodegradation of plastic materials by using soil or soil-compost mixture under laboratory conditions, were followed. The measurements of CO₂ formed in the presence of microorganisms after a period of exposure of the plastic material to the soil are provided the evaluation of the degree of biodegradability. Biodegradability tests are not carried out in our country, and very few laboratories around the world perform this test and issue a biodegradability certificate. This method has been validated in our laboratory and biodegradability tests have been analyzed on some polymer materials, which are used in agriculture. With the results obtained, it was checked whether the European Union met the criteria set forth or not.

Keywords: Biodegradability, Sustainability, Agriculture, Test method

INTRODUCTION

With the advancement of technology and the increase in the world population, plastic materials have found wide application areas in all areas of life and industry. Most conventional plastics such as polyethylene, polypropylene, polystyrene, poly(vinyl chloride) and poly(ethylene terephthalate) are not biodegradable, and their increasing accumulation in the environment poses a threat to the planet. Bioplastics consist of either biodegradable plastics (i.e. plastics produced from fossil materials) or bio-based plastics (i.e. plastics synthesized from biomass or renewable resources). Polyhydroxybutyrate (PHB), polylactide (PLA) and starch mixtures are produced from biomass or renewable resources and are therefore biodegradable. Although Polyethylene (PE) and Nylon 11 (NY11) can be produced from biomass or renewable resources, they are not biodegradable. Environmentally friendly biodegradable plastics reduce greenhouse gas emissions because they are obtained from renewable raw materials. For example, polyhydroxyalkanoates (PHA) and lactic acid (raw materials of PLA) can be produced by fermentative biotechnological processes using agricultural products and microorganisms [1–

3]. It offers many benefits, including increased soil fertility, reduced accumulation of bulky plastic materials in the environment (minimizing animal injury) and reduced waste management costs. Additionally, biodegradable plastics can be converted into useful metabolites (monomers and oligomers) by microorganisms and enzymes. It should be evaluated in terms of biodegradability, microbial (enzyme) properties and plastic properties. Microbial (enzyme) properties refer to the distribution and types of microorganisms, as well as growth conditions (pH, temperature, moisture content, oxygen, nutrients, etc.) and enzyme types (intracellular and extracellular enzyme, exo- or endo-cleavage types). The chemical structure of polymers is important for the biodegradability of water-soluble polymeric materials. When evaluating the biodegradability of solid polymers, attention should be paid to their physical properties as polymer aggregates as well as their chemical properties. In addition, the surface conditions of plastics (surface area, hydrophilic, hydrophobic properties) generally affect the biodegradation mechanism of plastics [2].

The biological diversity and formation of microorganisms vary depending on environmental factors such as soil, sea, compost and activated sludge. In general, adhesion of microorganisms to the plastic surface and subsequent colonization of the exposed surface are the main mechanisms involved in microbial degradation of plastics. Enzymatic degradation of plastics by hydrolysis is a two-step process: first the enzyme binds to the polymer substrate, then catalyzes a hydrolytic cleavage. Polymers are broken down into low molecular weight oligomers, dimers and monomers and finally mineralized to CO₂ and H₂O [4-5]. Two standard test methods were followed to determine the degree and rate of aerobic biodegradation of plastic materials in contact with soil relative to the reference material under laboratory conditions. These test methods are designed to be applicable to all plastic materials that do not inhibit bacteria and fungi found in soil.

Soil medium (natural soil or laboratory mixture of natural soils collected from selected locations or “natural soil/mature compost mixtures for standard soil”), shape of the test sample (large film samples or fragmented or pulverized film), soil pH (natural or adjusted), C/N ratio (natural or adjusted to 10:1-20:1 in the sample or with added organic C or the sample adjusted to at least 40:1 for the ratio of organic C to soil N) parameters must be set [6-7-9]. When performed by different laboratories, such permissible variations in the application of the test method may lead to poor reproducibility of results. Reproducibility is one of the most important issues in biodegradation standard testing methods [10-11]. Many factors such as soil type, soil biodiversity, testing conditions (temperature, water content, nutrients) and measurement method can affect the repeatability of results. Eliminating some of these sources of uncertainty and assessing the range of validity of test methods are important issues for establishing robust and reliable biodegradation test methods [8].

MATERIAL AND METHOD

By following the ISO 17556 test method and its equivalent ASTM 5988 test method, biodegradability test trials were carried out by taking some plastic samples with different carbon contents used in agriculture to determine the amount of carbon dioxide produced by microorganisms. The test setup is an environment where soil and test material are mixed at the bottom of the desiccator, and there is barium hydroxide (Ba(OH)₂) solution in one beaker and water in the other beaker on a perforated plate. Samples were sent to the METU University Central Laboratory to determine the initial %C content of each test sample. The test was carried out in a dark environment in an air-conditioning cabinet and the ambient temperature was kept between 20°C and 28°C. Then, to start the first series of biodegradability trials, a soil sample was taken from the forest and analyzed. Care was taken to ensure that the soil pH value was between 6 and 8. By studying 21 test samples that were different from each other in terms of

content, 3 parallel experiments were started from each of them to see the repeatability. A total of 72 tests were started simultaneously. Cellulose was used as the reference material, and 3 parallel tests were started for blank and technical trials. The water in the environment was changed at certain time intervals and the amount of CO₂ produced by microorganisms was calculated by back titrating the unreacted barium hydroxide solution (Ba(OH)₂) with hydrochloric acid solution. The values are compared with the theoretically expected amount of CO₂. Then, for the 2nd series of biodegradability trials, standard soil was used, unlike the 1st series. This standard soil contains 700g/kg industrial quartz sand, 100g/kg clay, 160g/kg natural soil and 40g/kg mature compost. To standard soil, Potassium dihydrogen phosphate (0.2 g/kg soil), Magnesium sulfate (0.1 g/kg soil), Sodium nitrate (0.4 g/kg soil), Urea (0.2 g/kg soil) and Ammonium chloride (0.4 g/kg soil) salts were added dissolved in water. After the standard soil was prepared, it was analyzed to know its initial values such as %C content, lime, pH and EC. Samples with different contents from the first series were added and an applicator was used to keep the film thickness constant. The samples were passed through a grinder and turned into powder. To see their repeatability, 3 parallel tests were started. Cellulose was used as the reference material, and tests were started for blank and technical trials. The water in the environment was changed at certain time intervals and the amount of mg CO₂ produced by microorganisms was calculated by back titrating the unreacted barium hydroxide solution with HCl. Percentage biodegradability values were calculated by proportioning the amount of CO₂ released as a result of the measurement with the amount of CO₂ theoretically required to be found.



Figure 1. Applicator used to adjust film thickness



Figure 2. Adjusting the thickness of various film samples using an applicator



Figure 3. Film sample pulverized by cryogenic crusher



Figure 4. Experimental set up

RESULTS AND DISCUSSION

Deviations in the 1st series biodegradability studies (Example 1, Example 2, Example 7, Example 8 and Blank samples in Graph 1.) were eliminated by conducting the 2nd series studies. Unlike the 2nd series, standard soil (as seen in Table 1, organic matter content was reduced from 10.64% to 2.43%) was used and the amount of soil and sample was increased. The chemical and physical structure of the soil (mineral, lime amount, organic matter, C/N ratio, pH, etc.) is one of the most important parameter. The pH value should be between 6-8. When pH is above 8.0, the soil retains more CO₂ developed by microorganisms than a neutral soil. A soil with a pH below 6.0 has the potential to contain an atypical microbial population. As seen in Table 1, the pH of the soil used in the 1st series is 7.8 (slightly alkaline) and the pH of the soil used in the 2nd series is 7.75. Viability, number of microorganisms, diversity of microorganisms, inhomogeneity of film thickness and bubbles on the film surface affect the result of the test. An applicator was used to keep the film thickness constant, and the test materials were pulverized with a cryogenic crusher. One of the most important reasons for the deviation in the 1st trial is that the blank trial (no sample, only soil) constantly produces CO₂ due to its high organic matter content (as seen in Table 1).

ANALYSIS RESULTS				
Test	Unit	Test method	Serie-1	Serie-2
Body (Sand)	%	Hydrometer	15	51
Body (Clay)	%	Hyrometer	47	5
Body (Silt)	%	Hydrometer	38	44
pH (25°C)		1:2,5	7,8	7,75
EC	mS/cm	1:2,5	0,24	1,68
Limestone	%	Calcimetric	21,3	11,8
Organic Matter	%	Walkey-Black	10,64	2,43
Nitrogen (N)	%	Theoretical	0,59	0,12
Phosphor (P)	ppm	Spectrofotometric	77,4	64,85
Potassium (K)	ppm	A.A/ICP-OES	1,088	623
Calcium (Ca)	ppm	A.A/ICP-OES	5,868	3,378
Magnesium (Mg)	ppm	A.A/ICP-OES	301	181
Sodium (Na)	ppm	A.A/ICP-OES	59,1	279
Change Na	%	Theoretical		5,71
Iron (Fe)	ppm	DTPA/ICP-OES	38,84	11,5
Manganese (Mn)	ppm	DTPA/ICP-OES	10,9	10,48
Zinc (Zn)	ppm	DTPA/ICP-OES	6,64	3,34
Copper (Cu)	ppm	DTPA/ICP-OES	1,37	0,72

Table 1. Analysis results of soil samples used in the 1st series and 2st series biodegradability trials

According to the standard method the validation criterias are given below;

- a) the degree of biodegradation of the reference material is more than 60 % at the plateau phase or at the end of the test;
- b) amount of carbon dioxide evolved from, the three blanks are within 20 % of the mean at the plateau phase or at the end of the test.

As seen in Table 3, the deviation value of the three blank trials at the end of the test was within 20% of the average.

	1. measurement %deg	2. measurement %deg	3. measurement %deg	Average %	Range %
Blank	11,23	10,29	13,89	11,8	9,44-14,16

Table 3. Deviation values of three repeated blank experiments

Even in the 2nd series trial, most of the estimated reason of the errors seen in the 1st series were eliminated, the biodegradability value of cellulose remained at 53,56% and there are many factors that may cause this. The purpose of this trial is to see whether the measures taken against the problems in the 1st series worked in the 2nd series.

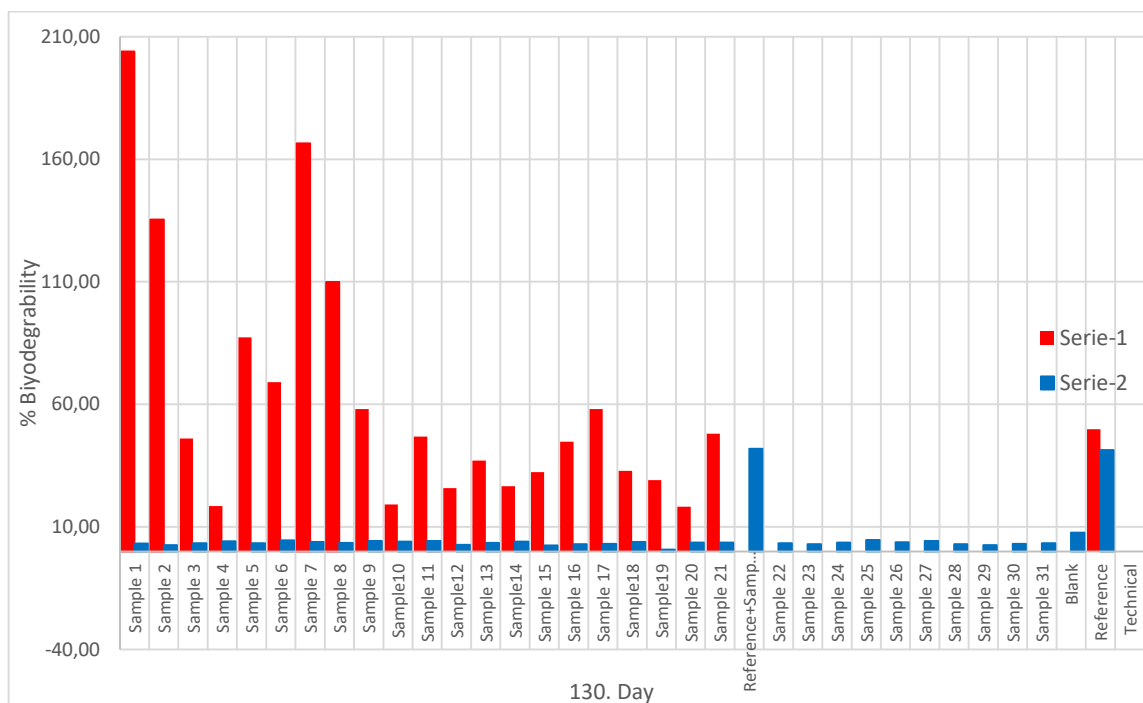

Graph 1. Biodegradability values of the samples in the 1st and 2.st series at the end of 130 days

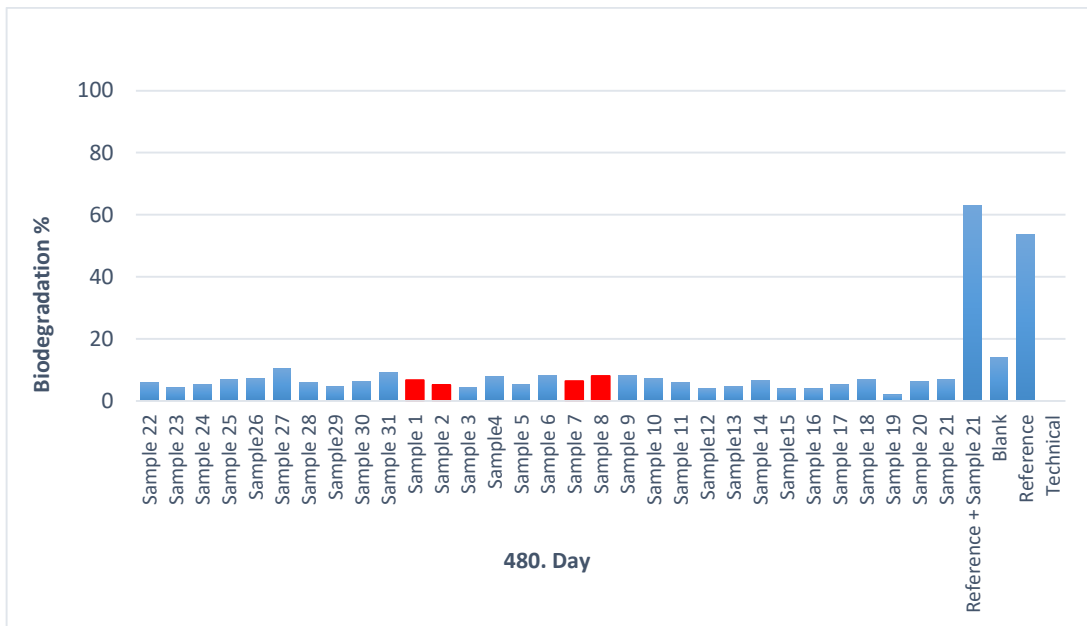

Graph 2. Biodegradability values of the samples in the 2st series at the end of 480 days

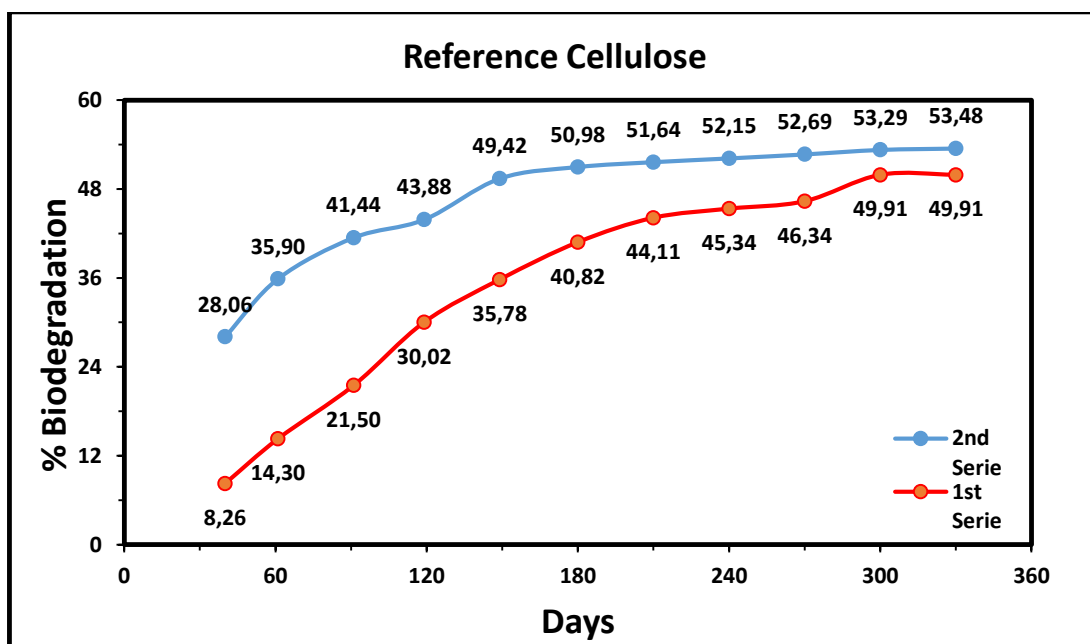

Graph 3. Decomposition trend of the same substance at different times

CONCLUSIONS

In this study, biodegradability values were determined by applying standard test methods. However, parameters such as viability, number and diversity of microorganisms, soil properties, soil amount, %C content of the sample, sample amount, temperature and humidity affect the course of the test. Errors observed in the 1. Series were eliminated by changing these parameters. The 1st and 2nd series trials require a lot of experience, and the studies shed light on the next steps.

REFERENCES

- Wang F, Lee SJ. Poly(3-hydroxybutyrate) production with high productivity and high polymer content by a fed-batch culture of *Alcaligenes latus* under nitrogen limitation. *Appl. Environ. Microbiol.* 1997;63:3703–3706.
- Tokiwa, Y., Calabia, B. P., Ugwu, C. U., & Aiba, S. (2009). Biodegradability of plastics. *International journal of molecular sciences*, 10(9), 3722-3742.
- Tokiwa Y, Calabia BP. Biological production of functional chemicals from renewable resources. *Can. J. Chem.* 2008;86:548–555.
- Tokiwa Y, Ando T, Suzuki T. Degradation of polycaprolactone by a fungus. *J. Ferm. Technol.* 1976;54:603–608.
- Tokiwa Y, Suzuki T. Hydrolysis of polyesters by lipases. *Nature.* 1977b;270:76–78.
- ISO17556, S. (2019). *Plastics—Determination of the Ultimate Aerobic Biodegradability of Plastic Materials in Soil by Measuring the Oxygen Demand in a Respirometer or the Amount of Carbon Dioxide Evolved.* ISO/TC, 61.
- ASTM. (2018). *Standard Test Method for Determining Aerobic Biodegradation of Plastic Materials in Soil.* PA: ASTM.
- Briassoulis, D., Mistriotis, A., Mortier, N. ve Tosin, M. (2020). A horizontal test method for biodegradation in soil of bio-based and conventional plastics and lubricants. *Journal of Cleaner Production*, 242 , 118392.
- Briassoulis, D., Degli Innocenti, F. Chapter 6: standards for soil biodegradable plastics Mario Malinconico (Ed.), *Soil Degradable Bioplastics for a Sustainable Modern Agriculture*, 978-3-662 54128-9, Springer-Verlag GmbH Germany (2017), pp. 139-16. Series Title: *Green Chemistry and Sustainable Tecchnology.*
- Briassoulis, D., Mistriotis, A. Key parameters in testing biodegradation of bio-based materials in soil *Chemosphere*, 207 (2018), pp. 18-26.
- Rücker, C., Mahmoud, W.M.M., Schwartz, D., Kümmerer, K. Biodegradation tests of mercaptocarboxylic acids, their esters, related divalent sulfur compounds and mercaptans. *Environ. Sci. Pollut. Control Ser.*, 25 (2018), pp. 18393-18411.

NOVEL APPLICATION OF POMEGRANATE PEELS-CHITOSAN AS A PRETREATMENT FLOCCULANT FOR ENHANCED SAND FILTRATION AND EFFICIENT REMOVAL OF HEAVY METALS FROM WASTEWATER

Rana KHANKISHIYEVA^{1,2}, Leyla MAHARRAMOVA³, Aydan MUSAYEVA³

¹Azerbaijan Research Institute of Crop Husbandry, Ministry of Agriculture of the Republic of Azerbaijan, Baku, Azerbaijan

²Scientific-research institute Geotechnological Problems of oil, gas and chemistry, Baku, Azerbaijan

³Landau School, Ministry of Science and Education, Baku, Azerbaijan

Corresponding author e-mail: renanamazova0@gmail.com

ABSTRACT

This work explores the potential of using pomegranate peels and chitosan as a natural flocculant for pre-treating wastewater to enhance sand filtration and remove heavy metals (Ni^{2+} , Cu^{2+} and Zn^{2+}) effectively. Active compounds like tannin are extracted and purified from the pomegranate peels, then chitosan and tannin are modified to create a novel flocculant. The results of this project provide a safe, easy, eco-friendly and cheap method of wastewater treatment. The parameters investigated include flocculant dosage, contact time, pH, and heavy metal concentration. To ensure the effective execution of this research, a series of flocculation jar tests were performed under varying conditions. The natural compounds exhibit synergistic effects, combining the adsorption capabilities of extract product of pomegranate peels - tannin and the coagulation properties of chitosan. The findings of this study contribute to the development of sustainable and cost-effective solutions for heavy metal removal from water. The utilization of natural compounds offers an eco-friendly approach, reducing the reliance on synthetic flocculants and minimizing the environmental impact associated with heavy metal contamination. The flocculation-sand filtration system offers a viable solution for treating wastewater with dissolved metal ions, operating at low pressures, and enabling environmentally safe discharge.

Keywords: Wastewater treatment, Natural flocculant, Chitosan, Pomegranate peels, Eco-friendly

INTRODUCTION

Water is a vital resource that is essential for sustaining life and supporting various industrial processes. However, the rapid growth of industrialization and urbanization has led to a significant increase in the volume of wastewater, which is often contaminated with harmful pollutants, including heavy metals. Heavy metal pollution resulting from industrial activities in ferrous and nonferrous metallurgy and chemical industries poses a significant threat to the environment. The presence of heavy metals such as nickel (Ni^{2+}), copper (Cu^{2+}), and zinc (Zn^{2+}) in wastewater poses a serious threat to the environment, affecting ecosystems and human health [Verma A.K., et al., 2012]. To mitigate these challenges and promote sustainable water management, there is an urgent need for innovative and environmentally friendly wastewater treatment methods. Traditional treatment approaches often rely on chemical flocculants, which can be expensive and pose additional environmental problems [Freitas T.K.F.S, et al., 2018].

Heavy metals such as chromium, copper, iron and lead are ubiquitous pollutants that, even in low concentrations, can cause serious damage to living organisms. Traditional methods of wastewater treatment often use inorganic and synthetic polymer flocculants, which can contain toxic and harmful chemical compounds that have a negative impact on the environment.

The use of iron and aluminum salts as inorganic coagulants in water and wastewater treatment has been widespread due to their effectiveness in pollutant removal, ease of mixing, user-friendly handling and storage, and cost-effectiveness [Chai W.S., et al., 2021]. However, despite their advantages, the usage of these coagulants is not without drawbacks, leading to certain concerns in water treatment processes. One of the main drawbacks associated with the use of iron and aluminum salts is the generation of a substantial volume of sludge during the treatment process. This sludge can pose challenges for disposal and can contribute to environmental concerns if not managed properly. Furthermore, the application of these coagulants often requires the addition of alkalinity and pH adjustment to achieve optimal treatment results. This additional step can increase the complexity of the treatment process and may result in increased operational costs. Another significant concern is the potential high concentration of residual metals, particularly aluminum, in the treated water or sludge. High levels of aluminum in water sources can have adverse effects on human health and the environment. Studies have raised concerns about the potential link between the neurotoxicity of aluminum found in wastewater sludge and the pathogenesis of Alzheimer's disease [Beyene H.D., et al., 2016]. While the direct cause-effect relationship between aluminum exposure and Alzheimer's disease remains a subject of ongoing research, the potential risk underscores the need for careful consideration and monitoring of metal concentrations in treated water and sludge.

Plant-based coagulants have garnered significant attention in the field of water and wastewater treatment and have been the subject of frequent research. Some of the plant-based coagulants that have been extensively studied include *Moringa oleifera* (*M. oleifera*), *Strychnos potatorum* (*nirmali*), tannin, and cactus [Sellami M., et al., 2014], [Hameed Y.T., et al. 2018].

The use of natural flocculants such as chitosan and tannin offer an environmentally friendly alternative to wastewater treatment. Recent research has shown the potential of cationic tannins as effective coagulants or flocculants for wastewater treatment. However, previous studies mainly focused on the removal of colloidal substances and the influence of heavy metals on hardness has not yet been fully studied. The structure of tannin is presented schematically in Figure 1.

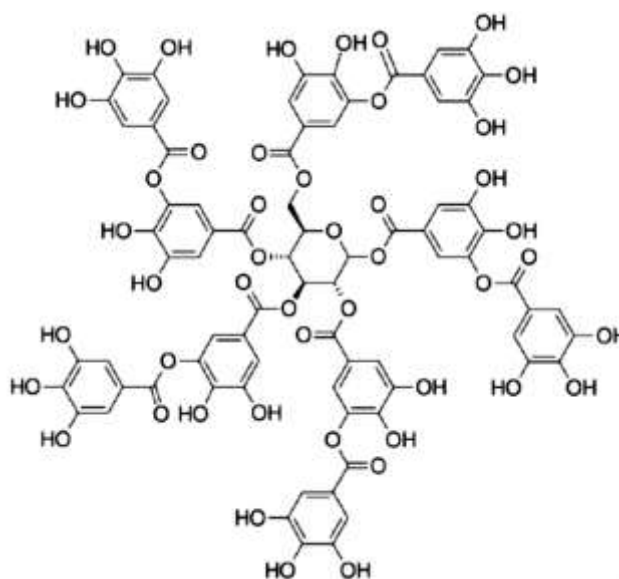

Figure 1. Structure of Tannin

Tannin extracted from various sources, such as valonia oak and *Schinopsis balansae*, has been applied in wastewater treatment for turbidity removal [Simón U.-F., et al., 2021], [Saad H., et al., 2012].

This project investigates the potential of using natural resources, namely pomegranate peel and chitosan, as a novel and environmentally friendly flocculant for the pre-treatment of wastewater. Pomegranate peel, an abundant agricultural waste, has been found to contain active compounds such as tannin known for their flocculating properties [Li X., et al., 2019]. By extracting and purifying these compounds, we can harness their potential for wastewater treatment. For over 4000 years, pomegranate (*Punica granatum* L.) has been cultivated by humans due to its medicinal and nutritional properties. This fruit holds significant cultural importance in ancient Mediterranean civilizations. In 2018 alone, California produced approximately 218,000 tons of pomegranates, making roughly 118,000 tons of pomegranate rind and seed waste. On a global scale, there are three-million tons of total pomegranate production, resulting in approximately 1.62 million tons of waste [Pantoja-Castro M. A., 2019]. The sheer amount of waste that is produced for each edible percentage of pomegranate makes it important to look for proper methods of optimizing the nutritional and bioactive components of pomegranate waste and then convert this waste into value-added products to save energy, sustain resources, and protect the environment.

Chitosan, a biopolymer derived from chitin, complements the natural flocculating properties of pomegranate peel. Through modification, chitosan can be enhanced to further enhance its effectiveness as a flocculant, making it an ideal candidate for combination with tannin.

Chitosan, a non-toxic polysaccharide composed of repeating N-acetyl-D-glucosamine (GlcNAc) and D-glucosamine (GlcN) monomers, is widely used as a cationic coagulant pretreatment to assist in the removal of microbial and heavy metal contamination from drinking water. The structure of chitosan is presented schematically in Figure 2.

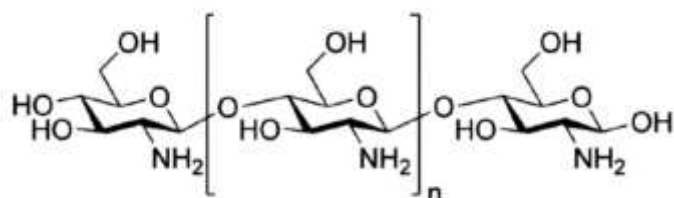

Figure 2. Structure of chitosan

Chitosan can neutralize the negative charges and also bridge the aggregate of destabilized particles. Chitosan can be produced locally as it is derived from the chitin found in the shells of shrimp and crustaceans, which are abundant in many resource-limited settings. This local production of chitosan presents a viable business opportunity for entrepreneurs in those regions. Presently, commercial production of chitin and chitosan is primarily conducted in several countries, including Japan, the United States, India, Poland, Australia, and Norway. Additionally, to a lesser extent, these materials are produced in Canada, Italy, Chile, and Brazil. The cost of chitosan manufacturing will vary depending on the specific region and the availability of feedstocks. According to Roberts, G., the average manufacturing cost of chitosan is estimated to be around \$11.5/kg [Lipps W.C., et al., 2011].

Indeed, the urgent need to address the challenge of heavy metal removal from wastewater calls for the development of an efficient flocculant that can effectively treat such pollutants before conventional sand filtration. While natural coagulants have been extensively studied for water and wastewater treatment, the potential of chitosan modified with tannin as a

natural coagulant remains unexplored. This presents a valuable opportunity for researchers to investigate the effectiveness and applicability of this novel coagulant in environmental remediation and sustainable water treatment practices. The study of chitosan-modified tannin as a new flocculant holds great promise and may lead to significant advancements in wastewater treatment methodologies.

MATERIAL AND METHOD

Chitosan was supplied by Merck (Sigma-Aldrich, USA CAS Number: 9012-76-4). Tannin extract from pomegranate peels is obtained using the Soxhlet extraction method.

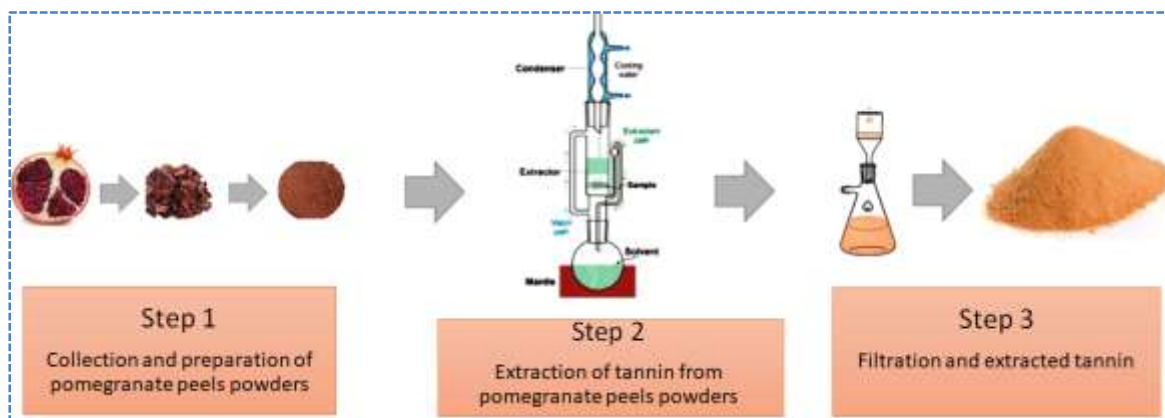

Figure 3. Soxhlet extraction of tannin

The Soxhlet extraction is a technique that involves continuously cycling a solvent (such as ethanol or water) through a sample material to extract desired compounds (Figure 3.). In this case, pomegranate peels are placed in a thimble and subjected to repeated solvent extraction and condensation cycles. This process allows for the efficient extraction of tannins from the peels, which can then be used as a coagulant in combination with chitosan for the pretreatment of wastewater and removal of heavy metals.

To extract tannin from pomegranate peels, the cleaned peels were first cut into pieces, thoroughly washed with distilled water, and then dried in an oven for a duration of 4 hours. Once dried, the peels were ground into a fine powder using a grinder. Subsequently, the powdered samples were sieved through a 40-mesh sieve to achieve a uniform particle size. To maximize tannin extraction, the process was carried out at elevated temperatures. This involved four rounds of extraction using a water-ethanol mixture (1:1) in a Soxhlet apparatus, following a known method [Lipps W.C., et al.,]. The tannin extract obtained from the extraction process was collected in a ceramic bowl and further dried in a thermostat until its weight reached a stable state. To verify the presence of tannin in the pomegranate peel extract, a test was conducted. A mixture of 5 ml of the extract, 5 ml of distilled water, and 3-4 drops of 0.1% ferric chloride was prepared in a test tube. If tannin was present, a color change to blue would be observed in the reaction mixture, indicating the presence of tannin.

To analyze the chemical structure of the extracted tannin, was using the Fourier Transform Infrared (FTIR) spectroscopy (Shimadzu® Japan) within the wave range of 4000-500 cm^{-1} in ± 60 seconds. This spectroscopic analysis allowed for the identification and characterization of the chemical bonds present in the obtained tannin, providing valuable insights into its molecular structure and properties.

Figure 4. shows that the spectrum of tannic acid where it can find a strong absorption around 3402 cm^{-1} . This band is assigned to the hydroxyl groups (-OH) H-bonded broad. At 1521-1517 a band due to the C-C aromatic compounds are observed. A weak signal at 1611

cm^{-1} is related to carbonyl groups. Peaks determining during $1600\text{-}1400\text{ cm}^{-1}$ are characteristics of aromatic compounds.

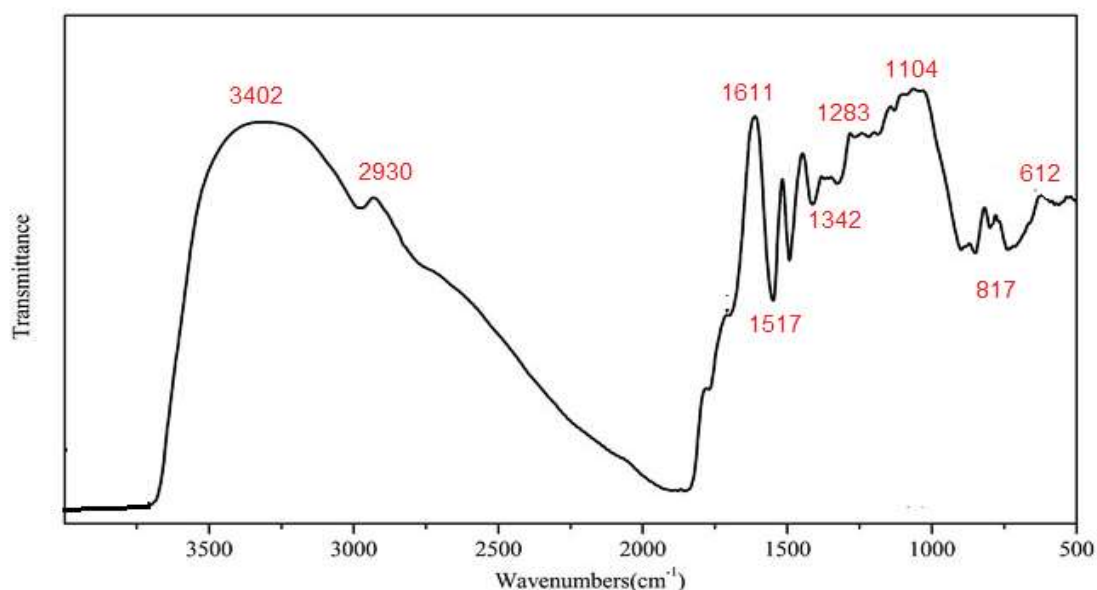

Figure 4. IR Fourier spectrum of tannin compound extracted from pomegranate peel

The composite utilized in the study incorporates a 25% glutaraldehyde or 1,5-pentanodial ($\text{OHC}-(\text{CH}_2)_3\text{-COH}$) compound, which is locally produced in Russia and serves as a binding agent in the composition. This compound is cost-effective and plays a significant role in altering the properties of the polymer through cross-linking via amino groups present in chitosan. By utilizing 25% glutaraldehyde or 1,5-pentanodial in the composite, the researchers can create strong bonds between the chitosan molecules, enhancing the overall structural integrity and stability of the material. This cross-linking process results in improved properties such as increased mechanical strength, enhanced chemical resistance, and better tolerance to environmental conditions. The low cost and advantageous properties of this binding agent make it a suitable choice for the synthesis of the composite, further supporting the development of a cost-effective and efficient flocculant for water and wastewater treatment applications.

1.1. Modification and blending of tannin and chitosan.

In the experimental procedure, 4 g of chitosan was introduced into a 500 mL 2-neck round-bottom flask containing 1% acetic acid. The mixture was then stirred at a rate of 100 rpm using a magnetic stirrer for 1 hour. Concurrently, 4 g of tannin was added to 25 ml of distilled water and mixed thoroughly. The two aqueous solutions were then combined and stirred together at a temperature of 25°C for a duration of 6 hours. Subsequently, 1 mL of glutaraldehyde (25%) was introduced into the suspended mixture. The stirring process continued initially at 25°C for 4 hours and then at an elevated temperature of 40°C for another 4 hours. Throughout the experiment, the pH of the medium was maintained at 2 by the addition of hydrochloric acid. The resulting product was a pale yellow material, which was then filtered, washed with distilled water, and dried in an oven at 40°C for 20 hours. Once dried, this modified tannin-chitosan composite was applied as a pretreatment coagulant in wastewater treatment. By combining tannin and chitosan with the modification process, a synergistic coagulant mixture is created, offering improved capabilities for the efficient removal of heavy metals from wastewater. This innovative approach has the potential to significantly enhance the overall efficiency and effectiveness of wastewater treatment procedures, contributing to a more sustainable and environmentally friendly water management system.

1.2. Collection of wastewater samples and analysis methods

Surface water was collected from Vilash river in the South of Azerbaijan on February 22, 2023 and was artificially contaminated with various metal solutions. The purpose of this approach was to examine the issue from a realistic perspective. The river water was treated immediately after collection. Metal concentration analysis was carried out by a spectrophotometric method. The characteristics of the raw water sample were analyzed following the APHA standard methods to assess both water and wastewater properties [Lipps W.C., et al., 2023].

The treatment process involved the following steps: 1 liter of the turbid surface water was placed in a beaker. Approximately 20 ppm of metal was added, and the pH of the experiment was adjusted using a 1 M HCl solution and a saturated NaOH solution. The JAR-test procedure was performed using a VELP-Scientifica JLT4 apparatus. Subsequently, a specific dose of flocculant was added, the pH was readjusted, and the jar test procedure was repeated in the same manner. After 1 hour of settling, the loss in metal concentration was determined. Flocculation process at laboratory shown in Figure 5.

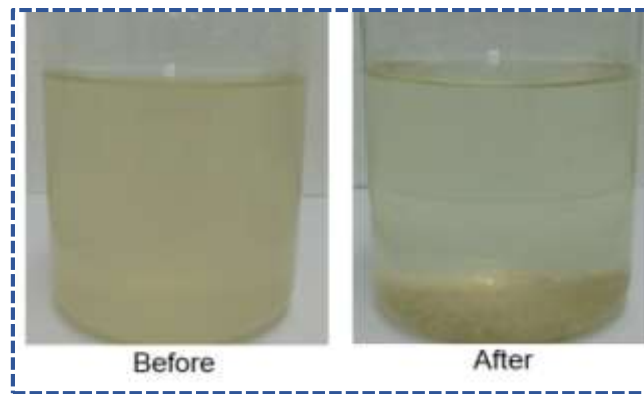

Figure 5. Flocculation process at laboratory

1.3. Chemical treatment and sand filtration

The schematic diagram of our proposed flocculation and sand filtration system consists of various components arranged in a sequential flow to purify water.

Firstly, coagulant adds to the wastewater. Coagulants help destabilize and aggregate small suspended particles in the water. Then the water with added coagulant enters the rapid mix tank. In this tank, high-speed mechanical mixing agitation is employed to promote the rapid and uniform mixing of the coagulant with the water. The detailed setup of the offer treatment filter system is shown in *Figure 6*.

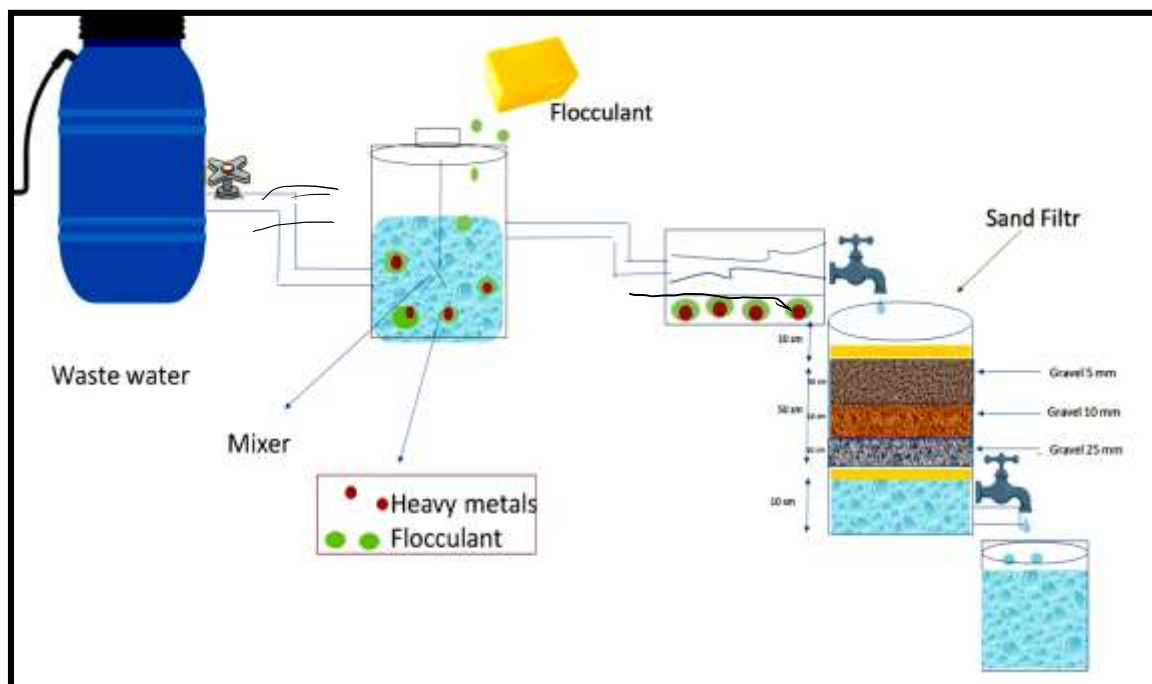

Figure 6. Schematic diagram of water treatment filtration system

As it clearly seen the water from the flocculation tank moves into the clarifier, which facilitates the settling of the larger floc particles. The clarifier is designed to provide a quiescent zone where the floc particles can settle under the force of gravity. The settled particles form a sludge layer at the bottom, while the clarified water moves on to the next stage. The clarified water then enters the sand filter, which consists of a bed of granular media. The sand acts as a physical barrier, trapping remaining suspended particles as well as some dissolved substances. The water percolates through the sand bed, allowing the clean water to pass through while retaining the contaminants.

RESULTS AND DISCUSSIONS

During the electroplating process, the wastewater generated can contain complex heavy metals, including Cu^{2+} , Zn^{2+} and Ni^{2+} . These heavy metals pose significant risks to human health and the ecological environment if discharged without proper treatment [Asrafuzzaman M., et al., 2011]. The utilization of pomegranate peel extract and chitosan as a novel flocculant for wastewater pretreatment shows great potential in enhancing sand filtration and effectively removing heavy metals.

The combination of pomegranate peel extract tannin and chitosan as a flocculant offers several advantages, including being natural and eco-friendly. Application of this flocculant has successfully demonstrated the removal of heavy metals such as Cu^{2+} , Zn^{2+} , and Ni^{2+} from wastewater, achieving significant reductions in metal concentrations, with Cu^{2+} reduced by up to 90%, Zn^{2+} by up to 75%, and Ni^{2+} by up to 70%.

Figure 7 shows the removal of Cu^{2+} , Zn^{2+} , and Ni^{2+} ions from water, depending on the dosage of the flocculant and the pH of the water.

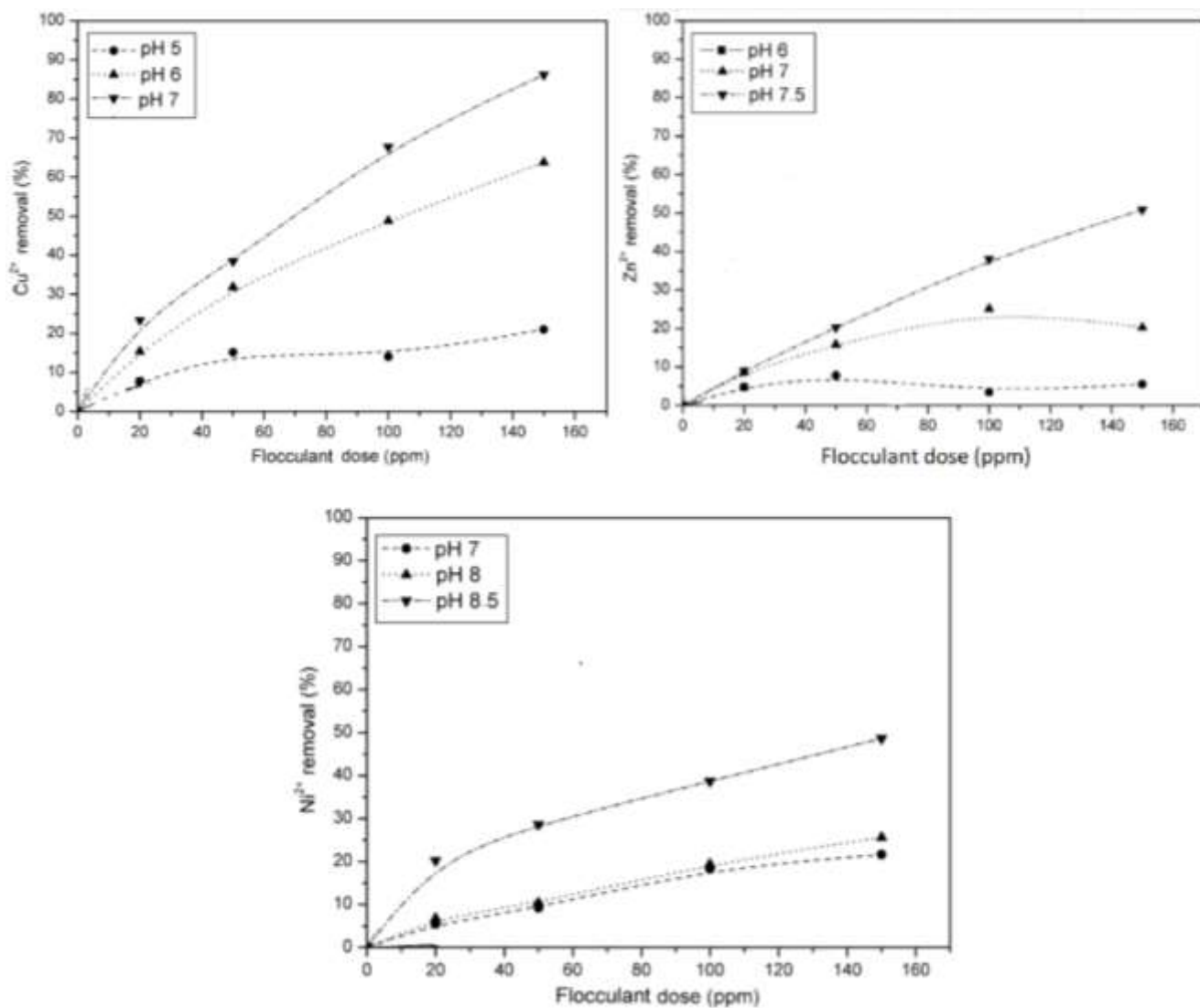

Figure 7. Removal of Cu^{2+} , Zn^{2+} , and Ni^{2+} ions from water depending on the dosage of the flocculant and the pH of the water

The addition of the flocculant, along with proper pH adjustment, has improved the efficiency of the metal removal processes. pH was identified as a critical variable, with specific optimum values determined for different metals. Compared to traditional methods such as chemical precipitation and conventional coagulation-flocculation processes, the pomegranate peel-chitosan flocculant offers advantages due to its natural origin, ease of production, and simplified pH adjustment requirements. Further investigations are warranted to explore the efficacy of the pomegranate peel-chitosan flocculant with other challenging-to-remove metals using conventional methods.

CONCLUSION

The implemented wastewater treatment system, comprising of flocculation and sand filtration processes, effectively treated metal-ion-containing wastewater from a chemistry research laboratory, meeting the recommended discharge standards. The novel bioflocculant process significantly improved various water characterization parameters, including pH and turbidity. The application of bioflocculant successfully removed heavy metals such as Cu^{2+} ,

Zn²⁺, and Ni²⁺ from the wastewater, achieving substantial reductions in their concentrations, with Cu²⁺ reduced by up to 90%, Zn²⁺ by up to 75%, and Ni²⁺ by up to 70%. The flocculation-sand filtration system offers a viable solution for treating wastewater with dissolved metal ions, operating at low pressures, and enabling environmentally safe discharge.

REFERENCES

- Verma A.K., et al., "A review on chemical coagulation/flocculation technologies for removal of colour from textile wastewaters," *Journal of Environmental Management*. vol. 93, pp. 154–168, 2012.
- Freitas T.K.F.S., et al., "Review of utilization plant-based coagulants as alternatives to textile wastewater treatment", *Detox Fashion: Waste Water Treatment*, Springer Singapore, Singapore, 2018.
- Chai W.S., et al., "A review on conventional and novel materials towards heavy metal adsorption in wastewater treatment application," *Journal of Cleaner Production*, vol. 296, pp. 126589, 2021.
- Beyene H.D., et al., "Investigation of coagulation activity of cactus powder in water treatment," *Journal of Applied Chemistry*, vol. 2016, pp.1-9, 2016.
- Sellami M., et al., "Cactus juice as bioflocculant in the coagulation-flocculation process for industrial wastewater treatment: a comparative study with polyacrylamide", *Water Science Technology*, vol. 70, 1175–1181, 2014.
- Hameed Y.T., et al., "A tannin-based agent for coagulation and flocculation of municipal wastewater as a pretreatment for biofilm process," *Journal of Cleaner Production* vol. 182, pp. 198-205, 2018.
- Simón U.-F., et al., "Evaluation of Seeds *Moringa oleifera* Lam. Present in Urban Forests as a Coagulant-Flocculant for Water Treatment" *Biology and Life Sciences Forum* 4, Vol. 1, pp. 1. 2021.
- Saad H., et al., "Characterization of pomegranate peels tannin extractives," *Industrial Crops and Products*, vol. 40, pp. 239–246, 2012.
- Li X., et al., "Chitosan modification persimmon tannin bioadsorbent for highly efficient removal of Pb(II) from aqueous environment: the adsorption equilibrium, kinetics and thermodynamics," *Environmental technology*, vol. 40(1), pp.112–124, 2019.
- Bacardit A.D., Olle L.O., Sorolla S.C., Casas C.S., "Process for obtaining a tannin extract isolated from grapes, tannin extract obtained and uses thereof," *C. Patent* 109952110, 2019.
- Pantoja-Castro M. A. and González-Rodríguez H., "Study by infrared spectroscopy and thermogravimetric analysis of tannins and tannic acid," *Revista Latinoamericana de Quimica*, vol.39, pp.107–112, 2011.
- Lipps W.C., et al., "Standard Methods for the Examination of Water and Wastewater". 24th ed. Washington DC: APHA Press; 2023.
- Asrafuzzaman M., et al., "Reduction of turbidity of water using locally available natural coagulants", *ISRN Microbiol.* 2011 1–6 (2011)

SEROLOGICAL ANALYSES OF VIRUSES PRESENCE ON TOMATO COLLECTION FROM THE GENE BANK OF THE REPUBLIC OF SRPSKA

Biljana Lolić¹, Sonja Umićević¹, Tatjana Milaković¹, Stefani Tepić¹, Marina Antić¹

¹ *Institute of Genetic Resources, University of Banja Luka, Genetic Resources, Bosnia and Herzegovina*

Corresponding author e-mail: sonja.raseta@igr.unibl.org

ABSTRACT

Testing for virus presence on tomato (*Solanum lycopersicum* L.) collection from the Gene Bank of the Republic of Srpska was conducted during 2023 in greenhouse of the Institute of Genetic Resources. Thirty samples were taken and preliminary tested for presence of 3 viruses: TSWV (Tomato spotted wilt virus, Tospovirus), TBRV (Tomato black ring virus, Nepovirus), ToBRFV (Tomato brown rugose fruit virus, Tobamoviruses) with ELISA (Bioreba) test. Fourteen samples were positive for TSWV presence and negative for other two viruses. The previous investigations have been conducted on the presence of TSWV on conventional tomato varieties in the open field and in the greenhouse, but never on the tomato accessions from the Gene Bank that represent domesticated germplasm.

Keywords: TSWV, TBRV, ToBRFV, tomato, Gene Bank

INTRODUCTION

Tomato spotted wilt virus (TSWV) is one of the most widespread plant viruses and also have the largest host-range. The current list of TSWV hosts consists of 1090 plants species (Parrella, et al. 2003) both monocotyledonous and dicotyledonous plants (Moyer, 1999) and weed species. Tomato spotted wilt virus (TSWV) belongs to the genus Tospovirus of the family Bunyaviridae. TSWV is transmitted by thrips in a circulative and propagative manner (Pappu, 2008). This virus is one of the most destructive virus, responsible for numerous epidemics in different regions of the world, and cause heavy economic losses (Parrella et al., 2003). In Republic of Srpska (district of Bosnia and Herzegovina), until now TSWV was detected in pepper plants from greenhouses and tobacco plants from open field (Delić et al., 2017) and also confirmed the presence of western flower thrips (WFT), *Frankliniella occidentalis* (Pergande) and tobacco thrips, *Thrips tabaci* (Linderman) in greenhouses in Herzegovina region (Trkulja et al., 2013; Kohnić et al., 2006). The highly polyphagous nature, the efficiency of virus transmission and the biological activity of its vectors, the rapidity with which new variants arise,

and difficulties in the control of the vectors, make TSWV one of the most feared plant viruses by growers of agricultural crops. Preventive and integrated cultural practices such as the eradication of weed hosts able to serve as virus reservoirs, combined with vector management strategies, play a crucial role in the control of the virus.

Tomato black ring virus (TBRV) belong to the Nepoviruses group (nematode-transmitted virus) that infect many plant families: annual, perennial and woody plants, economically important crop species like: grapevine, cherry, apricot, peach, berry-fruits, different ornamental plants and weeds, and solanaceous species like: potato, pepper, tobacco and tomato (Brunt et al., 1997; Edwardson, Christie, 1997). They cause of economic importance diseases in a wide range of cultivated, and concerned as quarantine worldwide (Šneideris et al., 2012). Their wide host range combined with ability to be transmitted by nematodes, seed and/or pollen makes them severe problem, hard to eradicate and control (Murant, 1981; Card et al., 2007). TBRV is transmitted both through seeds and by free-living nematodes *Longidorus elongatus* and *Longidorus attenuatus* (Harrison et al., 1961; Brown et al., 1989) by feeding on roots. The virus has been reported in Europe, North and South America, India and Japan (Brunt et al., 1997; Harper et al., 2011), Australia, New Zealand (Šneideris et al., 2012). Known until now, Tomato black ring virus (TBRV) was previously detected on potato and grapevine in some parts of Yugoslavia. Isolates from sugarbeet, pepper and tobacco were found in North Bosnia, the second tobacco isolate in Herzegovina, and the potato isolate in West Bosnia (Buturović et al., 1979).

Tomato brown rugose fruit virus (ToBRFV) belong to the genus *Tobamovirus*, and has been identified from tomato plants (Luria et al., 2017; Salem et al., 2016). ToBRFV was discovered in greenhouse tomato plants grown in Jordan and its first outbreak was in Israel (Salem et al., 2016). To date, the virus has been reported in at least 35 countries across four continents in the world. ToBRFV infects tomato as the primary host and considered the most serious threat to tomato production in the world. Recently, virus has caused devastating disease outbreaks in tomato production areas in many countries, resulting in a severe reduction in yield (Avni et al., 2021; EPPO, 2020; Jones, 2021; Oladokun et al., 2019). ToBRV is transmitted by mechanical contact, propagation material, plant debris, contaminated soil, growing media, circular water, workers farming activities and tools (Oladokun et al., 2019). Italy is the nearest country to Bosnia and Herzegovina that is identified the presence of this virus (Panno et al., 2019a). EPPO Working Party on Phytosanitary Regulations and Council agreed that ToBRFV should be added to the A2 List of pest recommended for regulation as quarantine pests in 2020.

MATERIALS and METHODS

Plant material

The research was conducted on 30 tomato accessions from the Gene Bank of Republic of Srpska: GB00415, GB00498, GB00545, GB00548, GB00874, GB00875, GB01092, GB01106, GB01107, GB01108, GB01109, GB01110, GB01122, GB01123, GB01124, GB01125, GB01126, GB01128, GB01129, GB01132, GB01238, GB01239, GB01240, GB01323, GB01324, GB01325, GB01345, GB01353, GB01414 and GB01421.

Containerized tomato seedlings were produced according to standard agricultural technology in the unheated glass greenhouse at the Faculty of Agriculture, University of Banja Luka. Total of 60 plants (2 plants per accession) were planted in pots in a tunnel-type polypropylene greenhouse at Institute of Genetic Resources (158 m altitude, 44.774971 latitude and 17.211463 longitude) with total area of 115 m². Fertilization was applied before planting and during vegetation. Plants were maintained using standard horticultural practices such as trellising and pinching. Insecticide was sprayed twice on the plants after transplanting in greenhouse to exterminate any thrips vector.

Leaf samples were collected on 105th day of vegetation when fruits on the 1st truss were ripe. All samples were collected in duplicate. All plants were tested for the presence of all 3 viruses, no matter if leaf symptoms were present.

Sample preparation

Fresh leaf samples were homogenized using Bioreba extraction bags. Prepared samples were stored at 4°C over night.

Serological analysis

Prepared samples were analyzed by double-antibody sandwich enzyme-linked immunosorbent assay (DAS-ELISA) using commercial diagnostic kits (Bioreba AG, Reinach, Switzerland) against: TSWV (Tomato spotted wilt virus, Tospovirus), TBRV (Tomato black ring virus, Nepovirus) and ToBRFV (Tomato brown rugose fruit virus, Tobamoviruses) according to manufacturer's instructions. Commercial positive and negative controls were included in each assay. ELISA reactions were read for absorbance at 405 nm using a HiPo MPP-96 Microplate Reader (BioSan, Lithuania). Also, yellow colour development was assessed visually after 30 and 60 minutes.

Statistical analysis

All obtained results were analyzed by standard descriptive statistical methods. Samples with absorbance values twice higher than in healthy uninfected negative controls were considered positive for virus infection.

RESULTS and DISCUSSION

A total of 30 domesticated germplasm of tomato samples were collected in greenhouse. The main aim of this work is to check the presence of those 3 viruses in tomato accessions that are multiplied for seed collection in the Gene Bank. Several leaf samples of each plant were collected from all accessions, symptomatic and asymptomatic plants. Mild symptoms like leaf chlorosis and leaf nerve yellowing were visible during sample collection and other symptoms were not noticed.

DAS-ELISA positive tests resulted in 46.67% (14/30) of TSWV infected plants, most of them asymptomatic plants. These results showed a high infection on TSWV which presence is already detected in Bosnia and Herzegovina. Also, the presence of *F. occidentalis*, vector of TSWV, raises possibilities for rapid dissemination of this virus in greenhouse.

Other two viruses TBRV and ToBRFV were negative in DAS-ELISA test for selected 30 tomato accession. This paper represents preliminary work and first results of virus presence in domesticated germplasm in Gene Bank.

CONCLUSION

During multiplication for seeds collection, plants must be checked in quality and health status before storage in the Gene Bank. However, this pilot study represents background for a wider survey of TSWV, TBRV and ToBRFV presence and thrips species as potential insect-vectors in BiH.

REFERENCES

- Avni B. Gelbart, D., Sufrin-Ringwald, T, Zinger, A, Chen, L., Machbash, Z. (2021). Tomato genetic resistance to tobamoviruses is compromised, *Acta Horticulturae*, Vol. 1316, pp. 89-98.
- Buturović, D., Grbelja, J., Jelić, Ž. (1979). On the geographical distribution of tomato black ring virus in Yugoslavia, *Acta Botanica Croatica*, Vol. 38, No. 1., pp. 9-12.

- Brown D. F., Murant A. F., Trudgill D. L. (1989). Differences between isolates of the English serotype of tomato black ring virus in their transmissibility by an English population of *Longidorus attenuatus* (Nematoda: Dorylaimoidea), *Revue Nematologie*, Vol. 12, pp. 51–56.
- Card S. D., Pearson M. N., Clover G. R. G. (2007). Plant pathogens transmitted by pollen, *Australasian Plant Pathology*, Vol. 36, pp. 455–461.
- Delić, D., Balech, B., Radulović, M., Đurić, Z., Lolić, B., Santamaria, M., Đurić, G. (2017). Molecular identification of Tomato spotted wilt virus on pepper and tobacco in Republic of Srpska (Bosnia and Herzegovina), *European Journal of Plant Pathology*, Vol. 134, No. 3.
- Edwardson J. R., Christie R. G. (1997). Viruses infecting peppers and other Solanaceous crops. Gainesville, USA, Vol. 2, pp. 337–390.
- EPPO (2020). Tomato bron rugose fruit virus, *EPPO Bulletin*, Vol. 50, pp. 529-534.
- Harper S. J., Delmiglio C., Ward L. I., Clover G. R. G. (2011). Detection of Tomato black ring virus by realtime one-step RT-PCR. *Journal of Virological Methods*, Vol. 171, No.1, pp. 190–194.
- Harrison B. D., Mowat P., Taylor C. E. (1961). Transmission of a strain of tomato black ring virus by *Longidorus elongatus* (Nematoda). *Virology*, Vol. 4, No. 4, pp. 480–485.
- Jones, R.A.C. (2021). Global plant viruses disease pandemic and epidemic, *Plants*, Vol. 10, pp. 233.
- Moyer, J.W. (1999). *Encyclopedia of virology*, Second edition, pp. 1803-1807.
- Murant A. F. (1981). Nepoviruses, *Handbook of plant virus infections/Comparative Diagnosis* – Amsterdam, Netherlands, pp. 197–238.
- Oladokun, J.O., Halabi, M.H., Barua, P., Nath, P.D. (2019). Tomato brown rugose fruit disease: current distribution. Knowledge and future prospects, *Plant Pathology*, Vol. 8, pp. 1579-1586.
- Panno, S., Caruso, A.G., Davino, S. (2019a). First report of tomato brown rugose fruit virus on tomato crops in Italy, *Plant Disease*, Vol. 103, pp. 1443.
- Pappu, H.R. (2008). Tomato Spotted Wilt Virus, *Encyclopedia of Virology (Third Edition)*, pp. 133-138.

- Parrella, G., Gognalons, P., Gebre-Selassie, K., Vovlas C. and Marchoux G. (2003). An update of the host range of Tomato Spotted Wilt Virus, *Journal of Plant Pathology*, [Vol. 85, No. 4](#), pp. 227-264.
- Roselló, S., Díez, M.J., Nuez, F. (1996). Viral diseases causing the greatest economic losses to the tomato crop. I. The Tomato spotted wilt virus, *Scientia Horticulturae*, Vol. 67, Issues 3-4, pp.117-150.
- Salem, N., Mansour, A., Ciuffo, M., Falk, B.W, Turina, M. (2016). A new tobamovirus infecting tomato crops in Jordan, *Archives of Virology*, Vol. 161, pp.503-506.
- Trkulja, V., Mihić Salapura, J., Čurković, B., Stanković, I., Bulajić, A., Vučurović, A., Krstić, B. (2013). First report of tomato spotted wilt virus on gloxinia in Bosnia and Herzegovina, *Plant Disease*, Vol. 97, pp. 429.
- Šneideris, D., Zitikaitė, I., Žižytė, M., Grigaliūnaitė, B., Staniulis, J. (2012). Identification of nepoviruses in tomato (*Lycopersicon esculentum* Mill.), *Agriculture*, Vol. 99, No. 2, pp. 173-178.

APPLICATION OF LIPOSOMAL ENCAPSULATED ANTIMICROBIAL BIOACTIVE COMPONENTS IN FOOD PRODUCTS AS NATURAL PRESERVATION

Mine ASLAN¹, Nilgün ERTAŞ¹

¹ Department of Food Engineering, Engineering Faculty, Necmettin Erbakan University, Koyceğiz Campus, Konya, 42050, Turkey.

Corresponding author e-mail: mineaslan_90@hotmail.com

ABSTRACT

Encapsulation technology is needed to make more durable and effective of alternative natural preservatives and nutritional components. In recent years, liposomal structures have attracted attention and liposomes ensure the preservation of the encapsulated material until the appropriate place and time thanks to controlled or delayed release capability. Liposomal structures prevent the conversion into harmful components during storage and increase the bioavailability. The liposomal encapsulation process provides to be more stable and more durable bioactive compounds in the food and the digestive system. The slowly release of antimicrobial components during storage against microbiological contaminations can be realized without allowing mold contamination and mycelium formation in food products. In addition, which will be carried out on non-chemical "hurdle" technologies in order to control the development of food-borne microorganisms and increase antioxidant activity in order to respond to consumer expectations, aims to produce product formulations suitable for the concept of 'Clean Label'. In addition, in order to respond to consumer expectations, it is possible to control the development of food-borne microorganisms and to produce product formulations in accordance with the concept of 'Clean Label' with liposomal systems suitable for "hurdle" technologies without chemical content.

Keywords: Liposom, natural preservation, bioactive compounds, Clean Label

INTRODUCTION

Bioactive components have important antioxidant and antimicrobial effects and also effective on human health. Encapsulation procedures have implemented to increase the mechanism of bioactive components' action. Liposome encapsulation is an important application thanks to provide the development of controlled release of bioactive components in food and increased stability. One of the biggest advantages of liposomes is to made from natural components. Liposomes can be included in food formulations without the need for any legal regulation due to natural structure. Liposomes are no usage limit compared to chemical origin substances, and so excessive limits lead to no health problems. This feature removes the obstacles to the use of liposome structures in foods.

Liposomes are used to improve the water dispersibility of hydrophobic components, to increase bioavailability and to protect the encapsulated components from adverse conditions such as light, heat, pH, oxidation, hydrolysis or chemical reactions, to enable the delivery of an encapsulated agent to a specific location, to reduce negative effects and particle toxicity. Liposome systems provide to control the circulation in the body by modulation of their size and regulating the release profiles with surface modifications of the bioactive components (Alavi et al., 2017; Lila and Ishida, 2017). Unlike other encapsulation methods, liposomal structures have no negative effect on product rheology properties thanks to very low phosphorylcholine-based

lecithin concentration. In addition, the encapsulated components are more resistant to processes such as cooking and pasteurization with the controlled release of bioactive substances in the liposomal structure.

ENCAPSULATION TECHNIQUES

Encapsulation is an excellent method for the preservation of bioactive, volatile and readily degradable compounds and additives in food applications. The purpose of encapsulation is to protect active ingredient from external factors, to ensure stable in the digestive system and to release slowly, to increase bioavailability, to mask the negative taste and odor, and to prevent the active ingredient from reacting with other ingredients (Delshadi et al., 2020). In the encapsulation process consists of the active components as the core material and the appropriate wall material. The coating agent plays a key role and an ideal coating material should have low hygroscopicity, high solubility, low viscosity, low cost, ability to produce a stable emulsion and provide high protection (Gomez et al., 2018). Lipids, proteins and carbohydrates are widely used as coating material in encapsulation systems. The coating materials are desirable to be inexpensive, plentiful, non-toxic, and compatible with the food matrix (Jafari et al., 2008; Delshadi et al., 2020).

Lipid-based coating agents have excellent functionality in emulsification, film formation and encapsulation of active compounds. These coating materials are less toxic and have many potential uses in industrial applications (Fathi et al., 2012). The lipid-based coating materials are polar lipids (eg monoglycerides, phospholipids) and non-polar lipids (eg triacylglycerol, cholesterol) (Đorđević et al., 2016). Polar lipids such as phospholipids have some properties as biocompatible, suitable for stabilization, preservation and controlled release of active compounds and good surfactants (Đorđević et al., 2016; Shishir et al., 2018). Encapsulation contains microcapsules, submicron capsules, and nanocapsules sizes. Micro and nano encapsulation techniques include high pressure homogenization (HPH), micro fluidization, ultrasonic technique, spray drying, spray cooling/cooling, freeze drying, spray freeze drying, complex coacervation, emulsification (spontaneous, phase inversion, miscellaneous), anti-solvent precipitation, extrusion, electro-spinning and electro-spraying, layer deposition, solid dispersion, fluid bed coating, molecular inclusion in cyclodextrins. Different forms of micro and nano encapsulation systems are reservoir and matrix, emulsions (multilayer emulsions, nano emulsions), lipid nanoparticles (solid lipid nanoparticles (SLNs), nanostructured lipid carriers (NLCs), lipid vesicular carriers (liposomes, niosomes, phytosomes, bilosomes), hydrogel particles, molecular inclusion complexes, nanofibers, nanotubes, micelles.

LIPOSOMAL ENCAPSULATION LIPOSOMES

Liposomes are basically amphipathic vesicles in phospholipid structure, similar in structure to the cell membrane, with polar and nonpolar heads and double lipid layer structure. Liposomes are versatile, biocompatible and biodegradable structures that can be used as carrier systems for unstable components due to their amphipathic properties (Subramani and Ganapathyswamy, 2020). Liposomes were first described in 1965 by Bangham et al. (1965) are small intracellular shaped structures consisting of a closed membrane storing or transporting lipid-based substances. Phospholipids are one of the main groups providing liposome formation. Phospholipids are mainly composed of three-carbon alcohol, glycerol or sphingosine. Common alcohol components of glycerol-derived phospholipids are called phosphatidylserine (PS), phosphatidylcholine (PC), phosphatidylethanolamine (PE), phosphatidylglycerol (PG), and phosphatidylinositol (PI). Phospholipids are formed by

esterification of the primary hydroxyl group of glycerol with phosphoric acid. The remaining two hydroxyl groups of the glycerol backbone are esterified to fatty acids (saturated or unsaturated) and form the nonpolar tails of the lipid (Segota and Tezak, 2006). Liposomes consist of two layers of molecules with nonpolar groups. In the liposomal structure, polar head groups are directed outward, while non-polar parts are directed inward. Hydrophobic interactions and Vander Walls bonds that hold long hydrocarbon tails together play an important role in bilayer formation (Bozzuto and Molinari, 2015).

Liposomes are divided into different categories based on their structural properties and composition. Liposomes differ from each other in size and physical morphology, depending on lipid composition and preparation method, and may consist of one or more lipid bilayers. The phospholipid type influences the dimensions and physicochemical properties of the liposomes (Singh et al., 2012). Liposomes according to the composition and mechanism of intracellular delivery as follows: pH sensitive liposomes, conventional liposomes immuno-liposomes, cationic liposomes and long-circulating liposomes (Sharma and Sharma, 1997). Generally, the size change from 20 nm to 5000 nm and consist of one or more lipid bilayers. Liposomes according to lipid composition; preparation method and diameter as follows: multilamellar vesicles-MLV (>500 nm), small unilamellar vesicles-SUV (<50 nm), large unilamellar vesicles-LUV (100-1000 nm), giant unilamellar vesicles-GUV (>1000 nm), Multiple vesicles-MLV (>5000 nm), Oligomellar vesicles-OLV (100–1000 nm) and intermediate unilamellar vesicles-IUV (40-100 nm) (Lasic, 1998; Storm and Crommelin, 1998).

LIPOSOME PRODUCTION METHODS

Bangham method (thin film hydration method); One of the simplest methods for liposome formation in multilamellar vesicles is the thin-film hydration procedure. Thin-film hydration method is the most widely used technique to prepare liposomes (Bangham et al., 1965). The thin-film hydration method consists of sequentially dissolving phospholipids in an organic solvent (mostly chloroform), evaporating the solvent to form a thin film, and then dispersing the dry lipid film in an aqueous phase. In this method, sonication is used to reduce the size of large-sized liposomes (Maja et al., 2020). Apart from this, the methods applied are as follows, solvent (ether or ethanol) injection method, reverse phase evaporation (REV), dialysis, extrusion, spray drying, heating, freeze drying, cross flow injection, microfluidization, membrane contactor, supercritical reverse phase evaporation (SCRPE), improved SCRPE method (ISCRPE), supercritical antisolvent (SAS), depressurization of an expanded liquid organic solution-suspension (DELOS) and ultrasonication method. Each of these methods has different advantages and disadvantages.

LIPOSOMAL ENCAPSULATION METHOD PROPERTIES

Liposomes are preferred in the encapsulation process thanks to biocompatible, biodegradable, no show toxic effects, and high ratio protect of coated material (Laye et al., 2008; Gibis et al., 2012; Chun et al., 2013). One of the most important features of liposomes is that can be obtained from nature components. The natural structure of liposomes enables the usage in food systems without the need for any legal regulation (Taylor et al., 2005). In food science, the liposomal encapsulation method is used to encapsulate antioxidant components, antimicrobial components, enzymes and additives. The liposomal system is used in the encapsulation of many bioactive components, including fatty acids such as gambogenic acid (Tang et al., 2018), resveratrol (Caddeo et al., 2008), tea catechins (Zou et al., 2014) and linolenic acid (Vélez et al., 2019), omega-3 and protein hydrolysates (Li et al., 2015). Liposomal encapsulation offers a versatile approach in terms of preservation and controlled

release of sensitive bioactive ingredients, delaying food spoilage, protecting bioactive ingredients from degradation after consumption, and increasing the bioavailability of ingredients during adsorption (Liu et al., 2020).

Liposome structures improve the solubility of lipophilic compounds in aqueous solutions or hydrophilic compounds in hydrophobic systems. Thanks to high dispersion in water, liposomes can be used to produce low-calorie and fat-reduced products. In addition, liposomes have an important effect in preventing oxidation, removing negative flavors and reducing the energy density of food products (Farrokh et al., 2017). The structural similarity to the cell membrane provides distribution and release some bioactive components to specific areas in the body (Gabizon et al., 2004; Laye et al., 2008). This unique structure allows liposomal nanoparticles to enter the intercellular space in the body. Liposomes have no adverse effects on health and also many health benefits such as liver protection, memory enhancement and inhibition of cholesterol absorption is revealed in studies.

STUDIES ON LIPOSOMAL ENCAPSULATED INGREDIENTS IN FOOD PRODUCTS AS ANTIMICROBIAL AGENTS

The antibacterial activities of clove oil and liposome-encapsulated clove oil were investigated by Cui et al. (2015) and stated that liposome-encapsulated clove oil can be use efficiently as an antimicrobial agent for *S. aureus* in tofu. In a study by Pinilla and Brandelli (2016) determined the antimicrobial activity efficiency of liposome lysine and garlic extract encapsulated with phosphatidylcholine. Nanoliposome-encapsulated nisin-GE has potential as an antimicrobial formulation for food use. According to results, the use of natural antimicrobial nanoliposomes in dairy products is an important alternative way to improve food quality and shelf life. Lopes et al. (2017) carried out the encapsulation of nisin by nanoliposomes obtained using soybean phosphatidylcholine (PC), pectin or polygalacturonic acid. Antimicrobial activities of liposomes were observed against five different strains of *Listeria*, and showed the highest activity against *L. innocua*. In-vitro release studies have indicated that the nisin release rate of PC-pectin and PC-polygalacturonic acid liposomes is lower than that of PC liposomes.

Ghorbanzade et al. (2017) stated that fish oil has important benefits in the daily diet, but applications in food formulations are limited due to strong odor and rapid deterioration. So, fish oil encapsulated with nano-liposomal process and usage in the yogurt formulation. It has been stated that nano-liposome fish oil capsules provide a significant reduction in acidity, syneresis and peroxide values of yogurt. In terms of sensory properties, the addition of nano-encapsulated fish oil in yogurt shows similar properties with the control sample enriched with free fish oil. Pabast et al. (2018) investigated the effects of lamb meat in capsules containing free or chitosan-nano-liposomal encapsulated *Satureja khuzestanica* essential oil on chemical, microbial and sensory properties of lamb at 4°C for 20 days. As a result of the study, the chitosan-liposome encapsulated essential oil of *Satureja khuzestanica* could be a promising active packaging material to extend the shelf life of lamb. Lopes et al. (2019), lysozyme and nisin were liposomal encapsulated with phosphatidylcholine (PC) and pectin or polygalacturonic acid. The co-encapsulation of lysozyme and nisin with liposome has a synergistic antimicrobial effect on *L. monocytogenes* and *S. enteritidis*, but provides greater inhibition against *L. monocytogenes*. The PC-pectin liposomes used in full-fat and skim milk medium reduced the *L. monocytogenes* population by 2 log cfu/ml in whole milk and 5 log cfu/ml in skim milk at 37°C. The *L. monocytogenes* population remained below the detection limit in milk stored for 25 days under refrigeration temperature. This shows that liposomes can be a promising technology to provide controlled release and stability in complex food systems.

Pinilla et al. (2019) used garlic extract encapsulated with liposome process with phosphatidylcholine and oleic acid as an antifungal agent in bread formulation. They reported

that bread samples containing encapsulated garlic extract and free garlic extract (0.65ml/100g dough) were more microbiologically stable and showed mold inhibition for five days compared to control samples. As a result of the study oleic acid and liposomal garlic extract can be used as natural antifungal agents to improve the microbiological stability of cooked food products due to their thermal properties. In a study made by Lin et al. (2022), a bio-responsive composite liposome with silk fibroin, L-fucose and *Litsea cubeba* essential oil were designed for chicken preservation as antibacterial agent and as results indicated that 20% (v/v) of the composite liposomes could inactivate 99% *Campylobacter jejuni* (C. jejuni).

CONCLUSION

Food safety is an important issue for people in the food production process and consumption. In this respect, food production is faced with many technological challenges due to the increasing demand for naturally additive foods. The natural preservative components are significantly affected by environmental conditions and therefore components must be protected by encapsulation. In the food industry, liposomes have been investigated to deliver proteins, enzymes, vitamins, antioxidants and flavors. Many studies indicate that the efficacy of antimicrobial components is increased with liposome encapsulation. The great advantage of liposomes over other encapsulation technologies is their high stability. As a result, it has been demonstrated that there is a significant potential for use of liposome-encapsulated antimicrobials to improve the quality and healthiness of a wide variety of food products.

ACKNOWLEDGEMENT

This research was part of the Ph.D. thesis of Mine ASLAN.

REFERENCES

- Alavi, M., Karimi, N., Safaei, M., 2017. Application of various types of liposomes in drug delivery systems. *Advanced Pharmaceutical Bulletin*. 7(1): 3.
- Bangham, A. D., Standish, M. M., Watkins, J. C., 1965. Diffusion of univalent ions across the lamellae of swollen phospholipids. *Journal of Molecular Biology*. 13: 238-252.
- Bozzuto, G., Molinari, A., 2015. Liposomes as nanomedical devices. *International Journal of Nanomedicine*. 10: 975-999.
- Caddeo, C., Teskač, K., Sinico, C., Kristl, J., 2008. Effect of resveratrol incorporated in liposomes on proliferation and UV-B protection of cells. *International Journal of Pharmaceutics*. 363(1-2): 183-191.
- Chun, J. Y., Choi, M. J., Min, S. G., Weiss, J., 2013. Formation and stability of multiple-layered liposomes by layer-by-layer electrostatic deposition of biopolymers. *Food Hydrocolloids*. 30(1): 249-257.
- Cui, H., Zhao, C., Lin, L. 2015. The specific antibacterial activity of liposome-encapsulated Clove oil and its application in tofu. *Food Control*. 56: 128-134.
- Delshadi, R., Bahrami, A., Tafti, A. G., Barba, F. J., Williams, L. L. 2020. Micro and nano-encapsulation of vegetable and essential oils to develop functional food products with improved nutritional profiles. *Trends in Food Science & Technology* 104: 72-83.
- Đorđević, V., Balanč, B., Belščak-Cvitanović, A., Lević, S., Trifković, K., Kalušević, A., Kostić, I., Komes, D., Bugarski, B., Nedović, V., 2015. Trends in encapsulation technologies for delivery of food bioactive compounds. *Food Engineering Reviews*. 7(4): 452-490.

- Farrokh, S., Alireze, A., Syed, R., 2017. Generation and characterization of liposomal microcapsules for co-delivery of hydrophilic and lipophilic bioactives in food. Ag Data Commons, U.S. Public Domain, New York.
- Fathi, M., Mozafari, M. R., Mohebbi, M., 2012. Nanoencapsulation of food ingredients using lipid based delivery systems. Trends in Food Science & Technology. 23: 13-27.
- Gabizon, A., Shmeeda, H., Horowitz, A. T., Zalipsky, S., 2004, Tumor cell targeting of liposome-entrapped drugs with phospholipid-anchored folic acid-PEG conjugates. Advanced Drug Delivery Reviews. 56(8): 1177-1192.
- Ghorbanzade, T., Jafari, S. M., Akhavan, S., Hadavi, R., 2017. Nano-encapsulation of fish oil in nano-liposomes and its application in fortification of yogurt. Food Chemistry. 216: 146-152.
- Gibis, M., Vogt, E., Weiss, J., 2012. Encapsulation of polyphenolic grape seed extract in polymer-coated liposomes. Food & Function. 3(3): 246-254.
- Jafari, S. M., Assadpoor, E., He, Y., Bhandari, B., 2008, Encapsulation efficiency of food flavours and oils during spray drying. Drying Technology. 26(7): 816-835.
- Lasic, D. D., 1998. Novel applications of liposomes. Trends in biotechnology. 16(7): 307-321.
- Laye, C., McClements, D. J., Weiss, J., 2008. Formation of biopolymer-coated liposomes by electrostatic deposition of chitosan. Journal of Food Science. 73(5): 7-15.
- Li, Z., Paulson, A. T., Gill, T. A., 2015. Encapsulation of bioactive salmon protein hydrolysates with chitosan-coated liposomes. Journal of Functional Foods. 19: 733-743.
- Lila, A. S. A., Ishida, T., 2017. Liposomal delivery systems: design optimization and current applications. Biological and Pharmaceutical Bulletin. 40(1): 1-10.
- Lin, L., Mei, C., Chen, X., Li, C., Hua, Z., Cui, H. (2022). Bio-responsive composite liposomes against *Campylobacter jejuni* in vitro and its application in chicken preservation. Innovative Food Science & Emerging Technologies. 103122.
- Liu, W., Hou, Y., Jin, Y., Wang, Y., Xu, X., Han, J., 2020. Research progress on liposomes: Application in food, digestion behavior and absorption mechanism. Trends in Food Science & Technology. 104: 177-189.
- Lopes, N. A., Pinilla, C. M. B., Brandelli, A., 2017. Pectin and polygalacturonic acid-coated liposomes as novel delivery system for nisin: preparation, characterization and release behavior. Food Hydrocolloids. 70, 1-7.
- Lopes, N. A., Pinilla, C. M. B., Brandelli, A., 2019. Antimicrobial activity of lysozyme-nisin co-encapsulated in liposomes coated with polysaccharides. Food Hydrocolloids. 93: 1-9.
- Maja, L., Željko, K., Mateja, P., 2020. Sustainable technologies for liposome preparation. The Journal of Supercritical Fluids. 165: 104984.
- Pabast, M., Shariatifar, N., Beikzadeh, S., Jahed, G., 2018. Effects of chitosan coatings incorporating with free or nano-encapsulated Satureja plant essential oil on quality characteristics of lamb meat. Food Control. 91: 185-192.
- Pinilla, C. M. B., Thys, R. C. S., Brandelli, A., 2019. Antifungal properties of phosphatidylcholine-oleic acid liposomes encapsulating garlic against environmental fungal in wheat bread. International Journal of Food Microbiology. 293: 72-78.
- Pinilla, C. M. B., Thys, R. C. S., and Brandelli, A., 2019. Antifungal properties of phosphatidylcholine-oleic acid liposomes encapsulating garlic against environmental fungal in wheat bread. International Journal of Food Microbiology. 293: 72-78.
- Segota, S., Tezak D., 2006. Spontaneous formation of vesicles. Advances in Colloid and Interface Science. 121: 51-75.
- Sharma, A., Sharma, U. S., 1997. Liposomes in drug delivery: progress and limitations. International Journal of Pharmaceutics. 154(2): 123-140.

- Shishir, M. R. I., Xie, L., Sun, C., Zheng, X., Chen, W., 2018. Advances in micro and nano-encapsulation of bioactive compounds using biopolymer and lipid-based transporters. *Trends in Food Science & Technology*. 78: 34-60.
- Singh, H., Thompson, A., Liu, W., Corredig, M., 2012. Liposomes as food ingredients and nutraceutical delivery systems. In *Encapsulation technologies and delivery systems for food ingredients and nutraceuticals*, Woodhead Publishing. 287-318.
- Storm, G., Crommelin, D. J., 1998. Liposomes: quo vadis?. *Pharmaceutical Science & Technology Today*. 1(1): 19-31.
- Subramani, T., Ganapathyswamy, H., 2020. An overview of liposomal nano-encapsulation techniques and its applications in food and nutraceutical. *Journal of Food Science and Technology*. 57(10): 3545-3555.
- Tang, X., Sun, J., Ge, T., Zhang, K., Gui, Q., Zhang, S., Chen, W., 2018. PEGylated liposomes as delivery systems for Gambogic acid: characterization and in-vitro/in-vivo evaluation. *Colloids and surfaces B: biointerfaces*. 172: 26-36.
- Taylor, T. M., Davidson, P. M., Bruce, B. D., Weiss, J., 2005. Liposomal nanocapsules in food science and agriculture. *Critical Reviews in Food Science and Nutrition*. 45(7-8): 587-605.
- Vélez, M. A., Perotti, M. C., Hynes, E. R., Gennaro, A. M., 2019. Effect of lyophilization on food grade liposomes loaded with conjugated linoleic acid. *Journal of Food Engineering*. 240: 199-206.
- Zou, L. Q., Liu, W., Liu, W. L., Liang, R. H., Li, T., Liu, C. M., Liu, Z., 2014. Characterization and bioavailability of tea polyphenol nanoliposome prepared by combining an ethanol injection method with dynamic high-pressure microfluidization. *Journal of Agricultural and Food Chemistry*. 62(4): 934-941.

EFFECTS OF AQUAFABA AS ALTERNATIVE PLANT ADDITIVE ON PHYSICAL, TEXTURAL AND SENSORY CHARACTERISTICS OF EGGLESS TURKISH PASTA (ERİŞTE)

Mine ASLAN¹, Nilgün ERTAŞ¹, Esma Nur BULUT²

¹ Department of Food Engineering, Engineering Faculty, Necmettin Erbakan University, Koyceğiz Campus, Konya, 42050, Turkey.

² Department of Food Technology, Food Agriculture and Livestock Vocational School, Bingöl University, Bingöl, Turkey

Corresponding author e-mail: mineaslan_90@hotmail.com

ABSTRACT

Consumers experience health problems with egg consumption and also preference of vegan and vegetarian nutrition leads to the search for alternative egg substitutes in new product development. This research determined the quality and acceptability of Turkish noodle (Erişte) substituted with 25%, 50%, 75% and 100% chickpea aquafaba instead of egg. Erişte were analyzed for physical, textural, and sensory properties compared with sample containing egg. An increase in substitution led to a rise of 12.76% in water uptake, 12.94% in volume increase and 40.19% in the cooking loss. The addition of up to 75% aquafaba increased the firmness of .erişte significantly compared to the control sample. Erişte sample containing 100% aquafaba showed significantly $p < 0.05$ higher values in L^* (75.11) and hue angle (94.85), while lower values in a^* (-2.13), b^* (24.30) and saturation index (24.39). The odor (7.00), taste (7.00), appearance (7.00), chewiness (7.00) and overall acceptability (6.88) of samples containing aquafaba were found more acceptable than control sample (4.00, 5.50, 5.90, 5.95 and 5.47, respectively). Based on our results, possible to produce erişte with acceptable sensory properties, and good physical quality product by adding up to 50% aquafaba.

Keywords: Aquafaba, egg-less noodle, physical properties, textural properties

INTRODUCTION

Turkish pasta (Erişte) is one of the traditional Turkish foods was generally produced from wheat flour, salt and egg. Milk, whey powder and some other additives can also be added in different regions of Turkey (Özkaya et al., 2004). The high rate of egg component used in pasta products can reduce production and consumption due to both the cost of the product and various reasons. So, many issues such as changing consumer preferences, increasing allergens, improving food safety, improving nutritional balance, reducing price variability and supporting environmental sustainability have increased the interest in researching egg substitutes and alternatives (Grizio and Specht, 2018).

Plant-based proteins are one of the most important food components to use as egg substitution in product development. Recently, the viscous liquid obtained from cooked chickpeas or other legumes and pulses called 'aquafaba' according to the Latin origin of water (aqua) and beans (faba) has been recently used as eggs replacement in many foods (Erem et al., 2021). Some studies in the literature revealed that aquafaba has many functional properties such as water and oil holding capacity, emulsion stabilizer, foaming, gelling and thickening in various formulations (Mustafa and Reaney 2020) and can be used as an egg substitute in vegan products (Raikos et al., 2020).

Aquafaba has used in meringue (Stantiall et al. 2018), sponge cake (Mustafa et al. 2018) and vegan mayonnaise (Raikos et al., 2020) as an emulsifier instead of egg. To our knowledge, no studies have been conducted on the inclusion of aquafaba in the formulation of egg-less Turkish pasta (Erişte). The objective of this study was to investigate egg substitutes for Turkish pasta using aquafaba. The effects of aquafaba on physical, textural and sensory properties of eggless pasta were evaluated.

MATERIAL AND METHOD

Materials

Commercial chickpea, wheat flour, whole egg and salt were purchased from local markets in Konya, Turkey.

Methods

Production of Aquafaba

Aquafaba was prepared according to the method described by Baik and Han (2012) with some modifications. Firstly, chickpeas were washed and were cleared from dirt, dust and foreign matter. Aquafaba was obtained by cooking 100 g chickpea in 500 mL water (1:5 chickpea/water ratio) for 30 min in boiling water at 98 °C. After the cooking, water and cooked chickpeas waited for 12 hr in a refrigerator at 4 °C. Finally, aquafaba was obtained by removing cooked chickpeas.

Production of Turkish noodle (Erişte)

For production of control Turkish pasta sample, firstly wheat flour (100 g), whole egg (40 g), salt (1 g) and water were mixed and kneaded in a laboratory-type mixer (Hobart N50, Offenburg, Germany) for 8 min. The kneaded dough rested for 20 min and 2 mm thickness/5 mm wide long strips were obtained (1 time in section 6 and 7) by a pasta machine (Shule Pasta Machine; Jiangsu, China). Then, strip-shaped dough were cut to a length of 4 cm. The drying of samples took place in a laboratory-type oven (Nüve KD 200, Ankara, Turkey) at 50 °C for 18 h. In the other samples, aquafaba were replaced at levels of 25, 50, 75 and 100% on the basis of whole egg. The samples were preserved in sealed polyethylene bags at 4 °C.

Cooking properties

Volume increase, weight increase and cooking loss values of pasta were determined according to Bilgiçli et. al. (2011). The weight increase and volume increase were found by differences of dry and cooked erişte samples weights and by the volume difference of water overflow, respectively. For cooking loss determination, cooking water was evaporated to constant weight in an oven and the weight of total solids expressed as a percentage (AACC, 2000).

Texture analysis

The firmness values of erişte samples were measured by TAXT Plus Texture Analyser (Stable Microsystems, Surrey, UK) and A/LKB-F was used as a probe (AACC, 1990). Firstly, 10 g samples were cooked in 200 mL distilled water for optimum cooking time and drained. Then, three strips of erişte sample were placed onto the stand and analyzed.

Color analysis

Color measurement was made by measuring L* value [(0) black- (100) white], a* value [(+) red- (-) green] and b* value [(+) yellow - (-) blue] using the Hunter Lab Color Quest II Minolta CR-400 (Konica Minolta Sensing, Inc., Osaka, Japan) (Francis, 1998). Three measurements were taken on each sample. The hue angle and the saturation index value were determined with $\arctan(b^*/a^*)$ and $(a^{*2}+b^{*2})^{1/2}$ equations, respectively.

Sensory analysis

Sensory analysis was carried out for cooked Turkish pasta samples. Turkish pasta samples were evaluated in terms of color, odor, taste, appearance, chewiness and general acceptability properties by 12 panelists (aged 20–50). Sensory properties of samples were scored using a 7-point hedonic scale in which a score of 7 = like extremely, 1 = dislike extremely.

Statistical analysis

The results were expressed as mean \pm standard deviation and were analyzed using the Statistical software JMP 5.0.1 (SAS Institute). The averages of the main variation sources were compared at $p < .05$ level. All measurements were performed in duplicate for each sample.

RESULTS AND DISCUSSION

The data on the effect of different levels of aquafaba on the cooking quality and firmness properties are shown in Table 1. The water uptake values of Turkish pasta samples increased with the use of more than 50%. Compared to control, addition of aquafaba increased volume increase value of Turkish pasta samples from 219.69 to 248.11%. Similar behavior in terms of cooking loss properties was observed Turkish pasta samples produced with different aquafaba. While Turkish pasta prepared with 50-100% legume flour revealed the highest cooking loss, the addition of 25% aquafaba showed similar cooking loss with control sample. The findings of this study demonstrated that the addition of aquafaba increased 1.82-fold with 100% aquafaba the firmness values of pasta samples compared to the control sample (Table 1).

Table 1. Physical properties of Turkish pasta¹

	Water uptake (%)	Volume increase (%)	Cooking loss (%)	Firmness (g)
Control	215.59 \pm 1.89b	219.69 \pm 6.03b	4.23 \pm 0.11b	642.12 \pm 23.35c
25% Aquafaba	220.06 \pm 3.44b	229.72 \pm 4.81ab	4.75 \pm 0.25b	698.98 \pm 61.62c
50% Aquafaba	236.70 \pm 3.03a	244.86 \pm 6.52a	5.43 \pm 0.10a	809.39 \pm 90.10bc
75% Aquafaba	238.14 \pm 1.25a	245.15 \pm 5.82a	5.74 \pm 0.16a	988.47 \pm 35.67ab
100% Aquafaba	243.12 \pm 3.16a	248.11 \pm 3.95a	5.93 \pm 0.13a	1166.62 \pm 92.43a

¹Means followed by the different letters within a column are significantly ($P < 0.05$) different.

Color values of Turkish pasta samples are demonstrated in Table 2. Color L*, a*, and b* results of Turkish pasta samples varied in the range of 65.24-75.11, 0.26-(-2.13), and 24.30-30.56, respectively. Compared to the control sample, the addition of aquafaba into the formulation of Turkish pasta significantly ($p < .05$) increased L*, but decreased a* and b* values. The findings are associated with the natural color properties of eggs. The reason of this result was lower lightness and higher yellowness values of egg compared with aquafaba. The SI value of Turkish pasta sample incorporated with 100% aquafaba were lower than the control and other samples. The hue angle values demonstrated an increase with high aquafaba usage ratio.

Table 2. Color properties of Turkish pasta¹

	L*	a*	b*	Saturation Index	Hue angle
Control	65.24±1.58c	0.26±0.07a	30.56±0.83a	30.56±0.77a	89.51±0.58b
25% Aquafaba	67.72±1.98bc	-	29.94±0.69a	29.94±0.10a	90.71±0.99b
Aquafaba		0.37±0.10b			
50% Aquafaba	70.52±1.37abc	-	29.73±0.59a	29.74±0.84a	91.77±1.02ab
Aquafaba		0.92±0.14c			
75% Aquafaba	73.12±1.87ab	-	28.50±1.92ab	28.58±0.68a	94.27±0.35a
Aquafaba		2.06±0.03d			
100% Aquafaba	75.11±0.66a	-	24.30±1.00b	24.39±0.52b	94.85±0.91a
Aquafaba		2.13±0.04d			

¹Means followed by the different letters within a column are significantly ($P < 0.05$) different

Sensory properties of Turkish pasta samples are presented in Figure 1. According to the results; color score shown no any change with incorporation of aquafaba in pasta formulation. When compared with the control sample, the odor, taste, appearance, chewiness and overall acceptability scores of the Turkish pasta samples were found higher with high aquafaba addition levels, statistically. As a result, 50% and more aquafaba usage improved the sensory properties and overall acceptability of Turkish pasta. Mustafa et al. (2018) prepared sponge cake with egg white and aquafaba. The color and texture of sponge cake made with egg white or aquafaba was similar and acceptable, but cakes made with aquafaba were less pliable and less sticky than cakes made with egg whites.

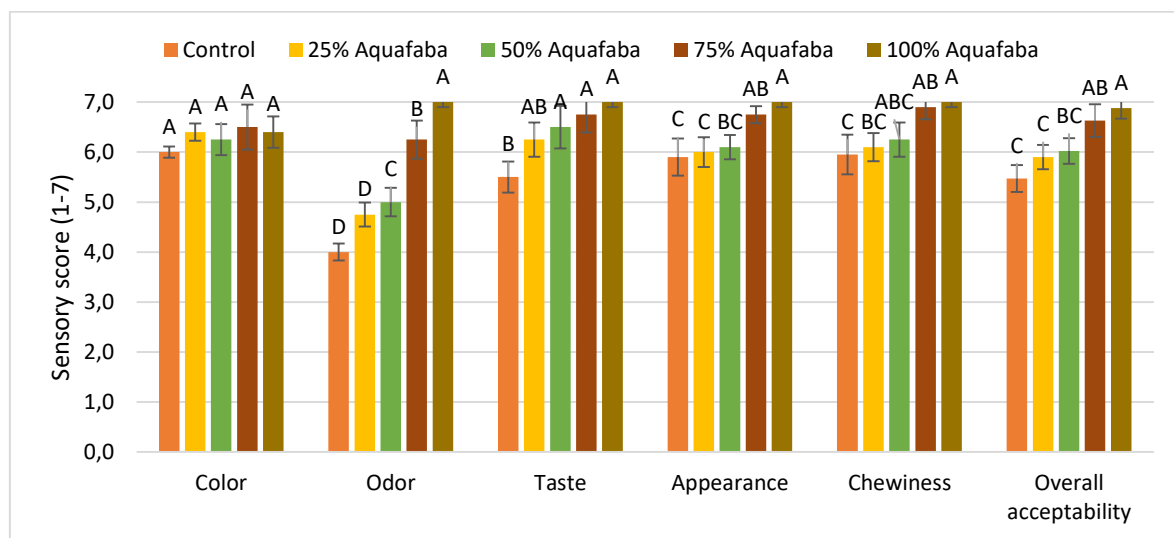

Figure 1. Sensory properties of Turkish pasta

Aslan and Ertas (2020) used aquafaba as an egg substitute in the cake formulation. According to the results of sensory evaluation, they reported that samples containing 25% aquafaba were preferred more by the panelists.

CONCLUSIONS

In this study, the usability of aquafaba as egg substitute in Turkish pasta (Erişte) production was investigated. According to results, the use of aquafaba as an egg substitute was concluded with an increase in the water uptake, volume increase and cooking loss of pasta

samples and so, in terms of cooking quality properties considerably not caused a negative effect up to 50% ratio. Also, the use of aquafaba increased the firmness values compared to the control samples. The incorporation of aquafaba in the pasta samples positively affected the sensory profile in terms of all sensory scores except to color scores.

REFERENCES

- AACC, 1990. Approved methods of the American Association of Cereal Chemists. 8th ed. St Paul, MN: AACC Press.
- AACC, 2000. Approved Methods of the American Association of Cereal Chemists. St Paul, MN: American Association of Cereal Chemists.
- Aslan, M., Ertas., N. 2020. Possibility of using “chickpea aquafaba” as egg replacer in traditional cake formulation. *Harran Journal of Agricultural and Food Science*. 24(1): 1-8.
- Baik, B. K., Han, I. H. 2012. Cooking, roasting, and fermentation of chickpeas, lentils, peas, and soybeans for fortification of leavened bread. *Cereal Chemistry*. 89(6): 269-275.
- Bilgiçli, N., Demir, M. K., Ertaş, N., Herken, E. N. 2011. Effects of gluten and emulsifier on some properties of erişte prepared with legume flours. *International Journal of Food Sciences and Nutrition*. 62(1): 63-70.
- Erem, E., Icyer, N. C., Tatlısu, N. B., Kilicli, M., Kaderoglu, G. H., Toker, Ö. S. 2021. A new trend among plant-based food ingredients in food processing technology: Aquafaba. *Critical Reviews in Food Science and Nutrition*. 1-18.
- Francis, F. J. 1998. Colour analysis. *Food analysis*.
- Grizio, M., Specht, L. 2018. Plant-based egg alternatives: Optimizing for functional properties and applications. The Good Food Institute. Recuperado de <https://www.gfi.org>.
- Mustafa, R., Reaney, M. J. 2020. Aquafaba, from food waste to a value-added product. *Food Wastes and By-products: Nutraceutical and Health Potential*. 93-126.
- Mustafa, R., He, Y., Shim, Y. Y., Reaney, M. J. 2018. Aquafaba, wastewater from chickpea canning, functions as an egg replacer in sponge cake. *International Journal of Food Science & Technology*. 53(10): 2247-2255.
- Özkaya B, Özkaya H, Bayrak H., Gökpınar F. 2004. The effect of drying process on the quality of erişte. In: *Proceedings of the Traditional Foods Symposium Van, Yüzüncü Yıl University, Turkey*, 60-66.
- Raikos, V., H. Hayes, H. Ni. 2020. Aquafaba from commercially canned chickpeas as potential egg replacer for the development of vegan mayonnaise: Recipe optimisation and storage stability. *International Journal of Food Science & Technology*. 55(5):1935-42.
- Stantiall, S. E., K. J. Dale, F. S. Calizo, L. Serventi. 2018. Application of pulses cooking water as functional ingredients: The foaming and gelling abilities. *European Food Research and Technology*. 244(1):97-104.

BIBLIOMETRIC ANALYSIS OF POLLEN CONTAMINATION DETERMINATION IN SEED ORCHARDS WITH MOLECULAR MARKERS

Behiye Banu BİLGEN¹, Nuray KAYA²

¹*Tekirdağ Namık Kemal University, Faculty of Agriculture, Agricultural Biotechnology
Department, Tekirdağ, Turkey*

²*Akdeniz University, Faculty of Science, Biology Department, Antalya, Turkey*
Corresponding author e-mail: bbilgen@nku.edu.tr

ABSTRACT

Seed orchards are special plantations established to produce genetically superior seeds/seedlings from genetically superior candidate parents. Pollen contamination is one of the most important factors affecting the yield, adaptation, and genetic quality of seeds produced from seed orchards in forest tree breeding programs. Potential pollen from the forests surrounding the seed orchard is a concern in tree breeding studies, as it causes the loss of genetic gains expected from seed orchards. It has been determined that different molecular marker techniques are used in the determination of pollen contamination. These molecular markers have advantages and disadvantages over each other. In this study, bibliometric analysis was performed to quantitatively and qualitatively evaluate the published articles on the determination of seed orchards and pollen contamination with molecular markers. Searching the Web of Science (WOS) by "seed orchard", "pollen contamination", and "marker" criteria revealed that 67 articles were published. Japan, Canada, Sweden, China, and France were the countries that contributed the most to pollen contamination studies in the seed orchards of forest trees, respectively. According to the data obtained, it has been shown that the pollen contamination level of forest tree species in seed orchards is generally between 5% and 90%. In Turkey, three studies on this subject were found. It was concluded that studies on pollen contamination were carried out in only two *Pinus brutia* orchards in Turkey, which has 189 seed orchards, most of which are coniferous, and that similar studies should be planned in other seed orchards.

Keywords: Bibliometric analysis, Isoenzymes, Pollen contamination, RAPD, Seed Orchards, SSRs

INTRODUCTION

Biodiversity is necessary and very important for the continuity of all life on Earth. In order to have a healthy ecosystem, we need various animals, plants and microorganisms. Plant biodiversity of a country has very significant role agriculture, forestry, medicine, pharmacy, and industry, both economically and in terms of use. However, the biological diversity is rapidly depleting due to many reasons like rapid population growth, urbanization, industrialization, forest fires, air pollution, agricultural land acquisition, global warming, erosion, and misuse of our natural resources. For conservation programs, the protection of forest ecosystems with rich biodiversity has primary importance in terms of ecological, aesthetic, and economic aspects, and also preventing the extinction of endangered species. In Türkiye, forest ecosystems exist in the mountainous regions and the climate, soil, and biological environmental factors change over short distances and more frequently in these areas. Gene pools and gene combinations are different due to different environmental factors and selection pressures in neighboring

populations of the same species. Because of this, races having different fitness values may occur in short distances. The existence of different races or sub-races has been demonstrated by the studies (Bradshaw, 1972; Hamann et al., 1998; Işık, 1999a, b; Ohsawa & Ide 2008).

The estimation of genetic diversity is vital for sustainability. Sustainable management of forests is possible with studies from the gene level to the ecosystem level. To increase productivity in forest trees, it is necessary to determine and improve the genotypes that are fast-growing and resistant to biotic and abiotic factors. Genetic diversity is the main resource for establishing genetic breeding programs (Sütcü et al., 2022). Natural forest populations, seed stands, seed plantations, or seed orchards, whose genetic diversity has been determined, based on morphological data or at the molecular level, are used for the establishment of new forests. The main purpose of this study is bibliometric analysis of pollen contamination determination in seed orchards with molecular markers from Web of Science (WOS) and to compare them with the studies conducted in our country.

CONIFER SEED ORCHARDS AND POLLEN CONTAMINATION

Conifer seed orchards are specialized forest plantations to obtain genetically superior seeds and seedlings from selected genetically superior candidate parents for use in forestry studies (Buiteveld et al., 2001; Zhuowen, 2002; Funda & El-Kassaby, 2012; Bilgen & Kaya 2014, 2016). The pollen flow from outside the orchard is reduced or destroyed in conifer seed orchards and they are specially operated to produce easy and abundant forest tree seeds (Kang et al., 2001a, 2004). Seed source is very significant for afforestation. The genetic gain expected from the forests to be established should be high by ensuring the superior genetic characteristics of the seeds. To obtain the superior species and breeds required for use in forestry and afforestation studies, selecting and bringing together genetically superior individuals for the establishment of seed orchards is major target. The seed orchards are isolated from other pollen sources, and vital for obtaining frequent, abundant, easy, high genetic and physiological value seeds, and are subjected to special care and management (El-Kassaby et al., 1989; Di-Giovanni & Kevan, 1991; Kang et al., 2004). There are mainly two types of seed orchards, i.e. the vegetative or clonal seed orchard, and the seedling seed orchard (Tunçtaner, 2007).

The first clonal seed orchard was established on the island of Java/Netherlands in 1880 for the *Cinchona ledgeriana* species (Feilberg & Soegaard, 1975; Ertekin, 2012). In Türkiye, the first seed orchards were established in 1964 in Istanbul-Belgrad Forest with *Pinus nigra* and *P. sylvestris* species by the Istanbul University Faculty of Forestry Department of Silviculture and Afforestation (Tunçtaner, 2007). Until 2023, 189 seed orchards (*P. brutia*, *P. nigra*, *P. sylvestris*, *P. pinea*, *P. halepensis*, *P. pinaster*, *Picea orientalis*, *Cedrus libani*, *Juniperus phoenicea*, *Sorbus torminalis*, *Liquidambar orientalis*, and *Ziziphus jujuba*) were established in different regions of Türkiye by the Republic of Türkiye, Ministry of Agriculture and Forestry (OATIAM, 2023).

There are potentially two important problems with pollination in seed orchards. First one is the pollen contamination from individuals outside the seed orchard, and second is self-pollination (Adams & Birkes, 1989). Correct determination of pollen contamination is of great importance for determining genetic gain in the orchard, developing seed orchard management strategies to reduce pollen contamination, and evaluating the effectiveness of seed orchards (Torimaru et al., 2009).

BIBLIOMETRIC ANALYSIS OF POLLEN CONTAMINATION STUDIES

In this study, bibliometric analysis was performed to assess the published articles related to the determination of pollen contamination with molecular markers in seed orchards.

Searching the Web of Science Core Collection (WOS) by "seed orchard", "pollen contamination", and "marker" criteria revealed that 67 articles were published (Figure 1). It has been observed that these articles belong to 12 different WOS categories and the article can be indexed in more than one category (Figure 2). The WOS results of which academic journals published the publications on pollen contamination in seed orchards are shown in Table 1. When the journals in which 67 publications were published from 1986 to 2022 were examined, it was observed that the majority of them were published in specific journals on forestry (Table 1). Tree Genetics Genomes, Scandinavian Journal of Forest Research, and Silvae Genetica take the first three ranks in these journals.

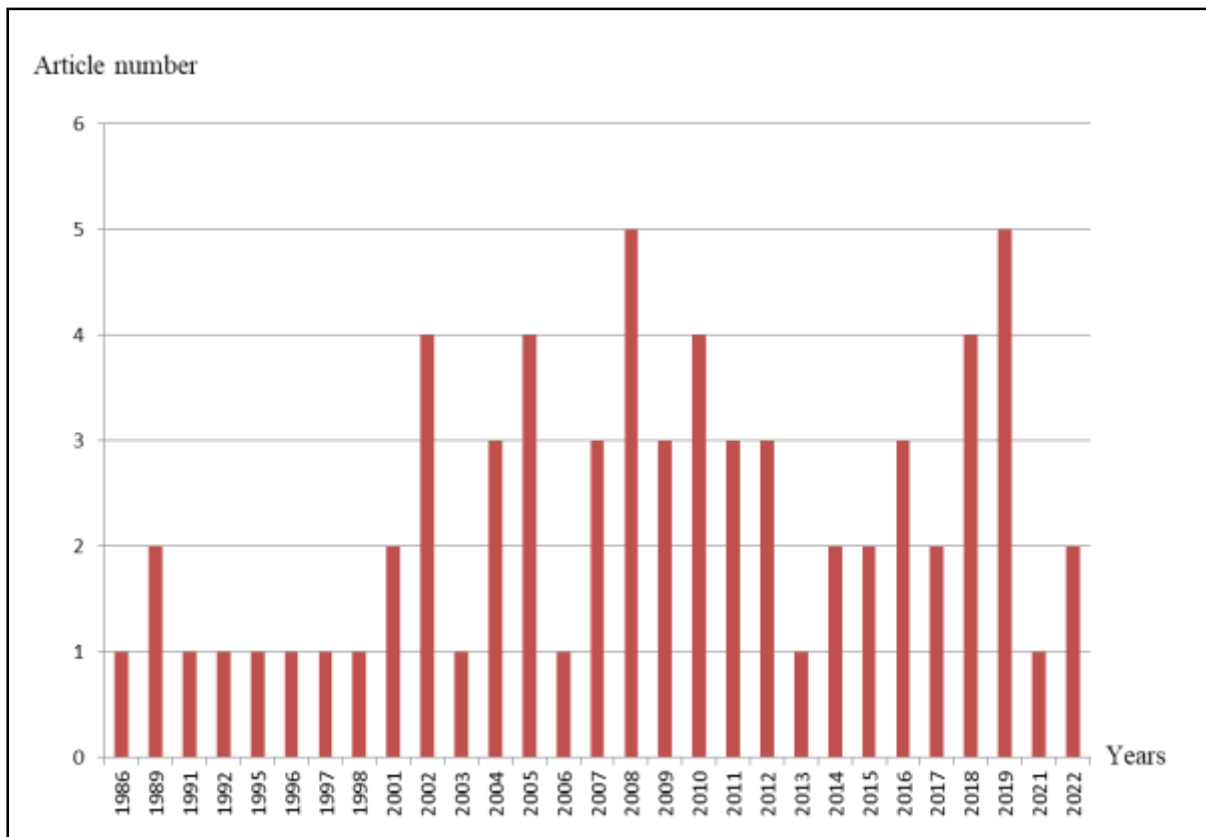

Figure 1. Search results of Web of Science Core Collection (WOS) by "seed orchard", "pollen contamination", and "marker" criteria



Figure 2. Web of Science Categories of 67 published articles during 1986-2022

Table 1. Search results of WOS Publication Titles of published 67 articles

Publication Titles	Number of Articles
Tree Genetics Genomes	7
Scandinavian Journal of Forest Research	6
Silvae Genetica	6
Annals Of Forest Science	4
Canadian Journal of Forest Research	4
Canadian Journal of Forest Research Revue Canadienne De Recherche Forestiere	4
Theoretical and Applied Genetics	4
Forest Ecology and Management	3
Plos One	3
Allgemeine Forst Und Jagdzeitung	2
Heredity	2
Journal of Tropical Forest Science	2
New Forests	2
Turkish Journal of Agriculture and Forestry	2
Acta Botanica Sinica	1
Breeding Science	1
Dendrobiology	1
Ecological Modelling	1
European Journal of Forest Research	1
Forestry Chronicle	1
Forestry Sciences	1
Fresenius Environmental Bulletin	1
Frontiers In Plant Science	1
Iforest Biogeosciences and Forestry	1
Journal of Horticultural Science Biotechnology	1
Molecular Breeding	1
Population Genetics of Forest Trees	1
Science China Life Sciences	1
Scientific Reports	1
Silva Fennica	1
Tree Physiology	1
Total	67

Japan, Canada, Sweden, China, and France were the countries that contributed the most to pollen contamination studies in the seed orchards of forest trees during 1986-2022, respectively (Figure 3).

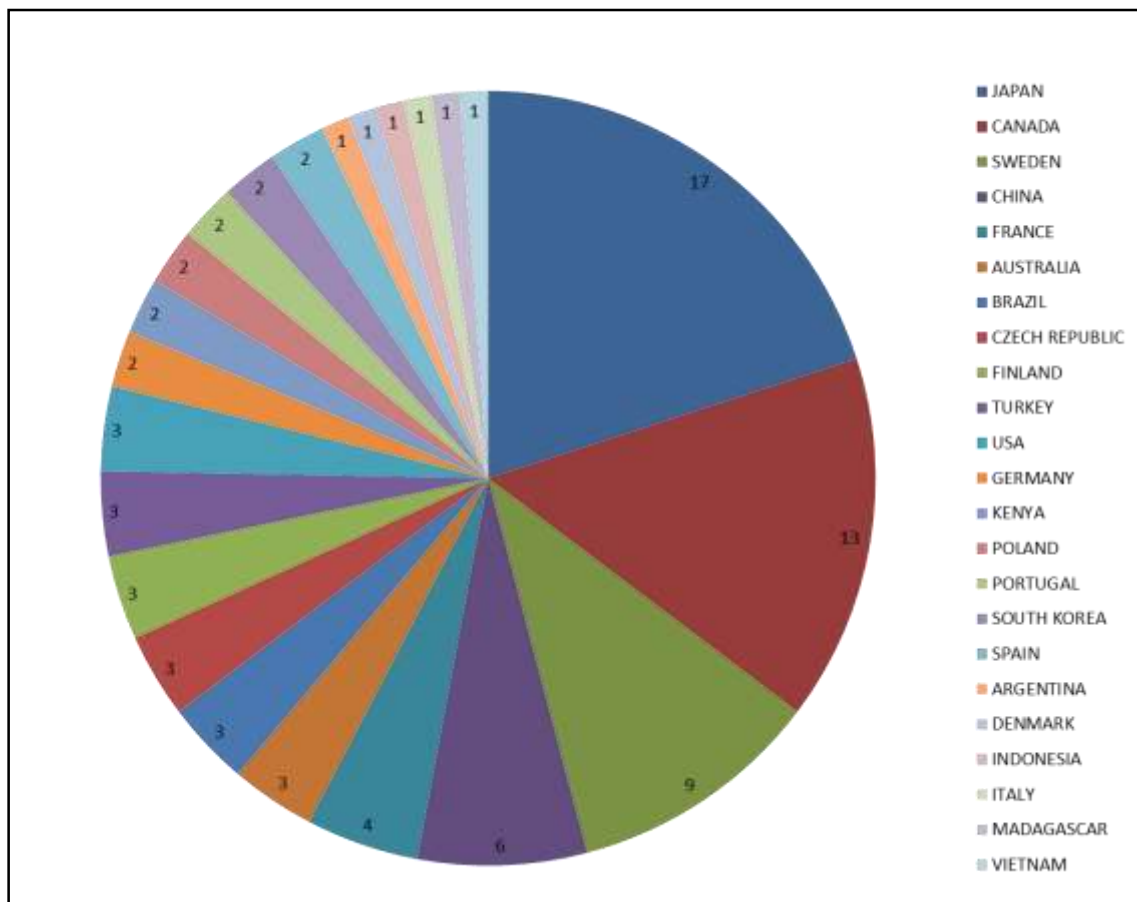

Figure 3. Countries/regions that contributed to publications on pollen contamination in seed orchards

According to the data obtained, it has been shown that the pollen contamination level of forest tree species in seed orchards is approximately between 5% and 90% (Table 2). When we look at pollen contamination studies in the past years, the use of isoenzyme markers is observed. El-Kassaby et al., (1989), reported 36% pollen contamination rate by 21 isoenzyme loci in *P. sylvestris* seed orchard. Kaya et al., (2006) estimated pollen contamination rate as 85% with isozyme analysis (14 loci) in Antalya-Asar *P. brutia* seed orchard and this was the first study in Türkiye. Over time, biochemical markers have been replaced by DNA markers. In *P. thunbergii* seed orchard, pollen contamination rate was estimated by 28 RAPD loci (Goto et al., 2002). In two *P. pinaster* seed orchards, pollen contamination rates were determined as 36% and 52.4% with 6 and 3 SSR loci, respectively (Plomion et al., 2001; Fernandes et al., 2008). Sonstebo et al., 2018 determined pollen contamination rate 20% in *Picea abies* by 11 SSR loci. The second study in Türkiye is performed by Bilgen and Kaya (2014) with the use of cpSSR markers in Antalya *P. brutia* seed orchard and the pollen contamination rate was calculated as %39.3. Bilgen and Kaya (2016) studied clonal identity and genetic structure of *P. brutia* clonal seed orchard via nSSR markers (Table 2).

Table 2. Estimates of pollen contamination rate (m) in different tree seed orchards by molecular markers

Species name	Molecular marker used (locus number)	m (%)	Reference
<i>Pinus sylvestris</i>	Isoenzyme (21)	36; 21	El-Kassaby et al., 1989
<i>Pinus sylvestris</i>	Isoenzyme (21)	24-40	Yazdani and Lindgren 1991
<i>Pseudotsuga menziesii</i>	Isoenzyme (11)	49	Adams et al., 1997
<i>Picea abies</i>	Isoenzyme (11)	70	Pakkanen et al., 2000
<i>Pinus brutia</i>	Isoenzyme (14)	85.7	Kaya et al., 2006
<i>Pinus thunbergii</i>	RAPD (28)	2.4	Goto et al., 2002
<i>Pinus pinaster</i>	SSR (6)	36	Plomion et al., 2001
<i>Quercus robur</i>	SSR (6)	70	Buiteveld et al., 2001
<i>Pinus contorta</i>	SSR (6)	5.5	Stoehr & Newton, 2002
<i>Pseudotsuga menziesii</i>	SSR (9)	35.3	Slavov et al., 2005
<i>Pinus pinaster</i>	SSR (3)	52.4	Fernandes et al., 2008
<i>Pinus sylvestris</i>	SSR (9)	52	Torimaru et al., 2009
<i>Pinus koraiensis</i>	SSR (13)	25	Feng et al., 2010
<i>Pinus brutia</i>	SSR (6)	39.3	Bilgen & Kaya, 2014
<i>Pseudotsuga menziesii</i>	SSR (6)	18.4	Kess & El-Kassaby, 2015
<i>Eucalyptus camaldulensis</i>	SSR (11)	14.7	Gonzaga et al., 2016
<i>Schima superba</i>	SSR (13)	7.01	Yang et al., 2017
<i>Picea abies</i>	SSR (11)	20	Sonstebo et al., 2018
<i>Larix kaempferi</i>	SSR (17)	6.3	Chen et al., 2018
<i>Prosopis alba</i>	SSR (10)	28-37	D'Amico et al., 2019
<i>Eucalyptus urophylla</i>	SSR (12)	11.9	Pupin et al., 2019

CONCLUSION

The size of the seed orchard, the distance between the seed orchard and populations with genetically undesirable traits, the amount of pollen produced by ramets in the seed orchard, and the overlapping of flowering times in the surrounding populations are some of the factors that influence pollen contamination rate. Different techniques (such as pollen traps and emasculation, biochemical markers) used to determine the rate of pollen contamination in the seed orchards have now been replaced by the use of DNA markers. DNA markers have been used more widely in recent years to determine the degree of pollen migration and genetic pollution due to their advantages (Fernandes et al., 2008, Torimaru et al., 2009, Feng et al., 2010; Bilgen and Kaya, 2014; Kess and El-Kassaby, 2015; Gonzaga et al., 2016; Yang et al., 2017; Chen et al., 2018; Sonstebo et al., 2018; D'Amico et al., 2019; Pupin et al., 2019).

In the WOS analysis, 67 publications were determined when the studies on pollen contamination from 1986 to the present were examined. Only three of these publications were made in two seed orchards of our country. It was concluded that studies on pollen contamination were carried out in only two *Pinus brutia* orchards in Turkey, which has 189 seed orchards, most of which are coniferous, and that similar studies should be planned in other seed orchards.

REFERENCES

- Adams, W.T., & Birkes, D.S. (1989). Mating patterns in seed orchards. In: Proceedings of 20th Southern Forest tree Improvement Conference, June 26-30, 1989, Charleston, South Carolina.
- Adams, W.T., Hipkins, V.D., Burczyk, J. & Randall, W.K. (1997). Pollen contamination trends in a maturing Douglas-fir seed orchard. *Canadian Journal of Forest Research*, 27: 131-134.
- Bilgen, B.B., & Kaya, N. (2014). Chloroplast DNA variation and pollen contamination in a *Pinus brutia* Ten. clonal seed orchard: implication for progeny performance in plantations. *Turkish Journal of Agriculture and Forestry*, 38: 540-549.
- Bilgen, B.B., & Kaya, N. (2016). Use of nSSR markers for determination of clonal identity and genetic structure in a *Pinus brutia* Ten. clonal seed orchard. *Fresenius Environmental Bulletin*, 25(9): 3687-3693.
- Bradshaw, A.D. (1972). Some of the evolutionary consequences of being a Plant. In: M. Dobzhansky K. Hecht and W.C. Stere (Eds.). *Evolutionary Biology*. Appl. Century Crofts, 25-47, New York.
- Buiteveld, J., Bakker, E.G., Bovenschen, J., & de Vries, S.M.G. (2001). Paternity analysis in a seed orchard of *Quercus robur* L. and estimation of the amount of background pollination using microsatellite markers. *Forest Genetics*, 8 (4): 331-337.
- Chen, X., Sun, X., Dong, L., & Zhang, S. (2018). Mating patterns and pollen dispersal in a Japanese larch (*Larix kaempferi*) clonal seed orchard: a case study. *Sci. China Life Sci.* 61: 1011-1023. <https://doi.org/10.1007/s11427-018-9305-7>
- D'Amico, I., Juan, C.V., Beatriz, O.S., Ewens, M., & Bessega, C. (2019). Pollen contamination and mating patterns in a *Prosopis alba* clonal orchard: impact on seed orchards establishment. *iForest*, 12: 330-337. <https://doi.org/10.3832/ifor2936-012>
- Di-Giovanni, F., & Kevan, P.G. (1991). Factors affecting pollen dynamics and its importance to pollen contamination: a review. *Canadian Journal of Forest Research*, 21: 1155-1170.

- El-Kassaby, Y.A., Rudin, D., & Yazdani, R. (1989). Levels of outcrossing and contamination in two *Pinus sylvestris* L. seed orchards in Northern Sweden. *Scandinavian Journal of Forest Research*, 4: 41-49.
- Ertekin, M. (2012). Genetic diversity of seed orchard crops, The molecular basis of plant genetic diversity, Prof. Mahmut Caliskan (Ed.), ISBN: 978-953-51-0157-4, InTech, <http://www.intechopen.com/books/the-molecular-basis-of-plant-genetic-diversity/genetic-diversity-of-seedorchard-crops>.
- Feng, F.J., Sui, X., Chen, M.M., Zhao, D., Han, S.J., & Li, M.H. (2010). Mode of pollen spread in clonal seed orchard of *Pinus koraiensis*. *Journal of Biophysical Chemistry*, 1(1): 33-39.
- Feilberg, L., & Soegaard, B. (1975). Historical review of seed orchards, in. Seed orchards, Forestry Commission Bulletin, No.54, pp. 1-8, London, England.
- Fernandes, L., Rocheta, M., Cordeiro, J., Pereira, S., Gerber, S., Oliveira, M.M., & Ribeiro, M.M. (2008). Genetic variation, mating patterns and gene flow in a *Pinus pinaster* Aiton clonal seed orchard. *Annals of Forest Science*, 65: 706p1-10.
- Funda, T., & El-Kassaby, Y.A. (2012). Seed orchard genetics. *CAB Reviews*, 7: 13.
- Gonzaga, J.M.S., Manoel, R.O., Sousa, A.C.B., Souza, A.P., Moraes, M.L.T., Freitas, M.L.M., & Sebbenn, A.M. (2016). Pollen contamination and nonrandom mating in a *Eucalyptus camaldulensis* Dehnh seedling seed orchard. *Silvae Genetica*, 65: 1-11.
- Goto, S., Miyahara, F., & Ide, Y. (2002). Identification of the male parents of half-sib progeny from Japanese black pine (*Pinus thunbergii* Parl.) clonal seed orchard using RAPD markers. *Breeding Science*, 52: 71-77.
- Hamann, A., El-Kassaby, Y.A., Koshy, M.P., & Namkoong, G. (1998). Multivariate analysis of allozymic and quantitative trait variation in *Alnus rubra*: geographic patterns and evolutionary implications. *Canadian Journal of Forest Research*, 28: 1557-1565.
- Işık, K. (1999a). Orman ağacı türlerimizde lokal ırkların önemi ve genetik kirlenme sorunları. *Çevre Sorunları, Biyolojik Çeşitlilik ve Orman Gen Kaynaklarımız*, TEMA Vakfı, İstanbul. 25: 137-150.
- Işık, K. (1999b). Bitki gen kaynaklarımız niçin korunmalı ve planlanmalıdır? *Çevre Sorunları, Biyolojik Çeşitlilik ve Orman Gen Kaynaklarımız*, TEMA Vakfı, İstanbul. 25: 151-160.
- Kang, K.S., Lindgren, D., & Mullin, T.J. (2001a). Prediction of genetic gain and gene diversity in seed orchard crops under alternative management strategies. *Theoretical and Applied Genetics*, 103: 1099-1107.
- Kang, K.S., Harju, A.M., Lindgren, D., Nikkanen, T., Almqvist, C., & Suh, G.U. (2001b). Variation in effective number of clones in seed orchards. *New Forests*, 21: 17-33.
- Kang, K.S., Lindgren, D., & Mullin, T.J. (2004). Fertility variation, genetic relatedness, and their impacts on gene diversity of seeds from a seed orchard of *Pinus thunbergii*. *Silvae Genetica*, 53(5-6): 202-206.
- Kaya, N., Isik, K., & Adams, W.T. (2006). Mating system and pollen contamination in a *Pinus brutia* seed orchard. *New For* 31: 409-416.
- Kess, T., & El-Kassaby, Y.A. (2015). Estimates of pollen contamination and selfing in a coastal Douglas-fir seed orchard. *Scandinavian Journal of Forest Research*, 30(4): 266-275. <https://doi.org/10.1080/02827581.2015.1012112>
- Lowe, W.J., & Wheeler, N.C. (1993). Pollen contamination in seed orchards. In: D.L. Bramlett, G.R. Askew, T.D. Blush, F.E. Bridgwater and J.B. Jett (eds). *Advances in Pollen Management*. pp.49-54. USDA Agric. Handb. 698. Washington, DC.

- OATIAM. (2023). General Directorate of Forestry. Forest Tree Seeds and Tree Breeding Research Directorate. <http://www.ortohum.gov.tr/>
- Ohsawa, T., & Ide, Y. (2008). Global patterns of genetic variation in plant species along vertical and horizontal gradients on mountains. *Global Ecology and Biogeography*, 17: 152-163.
- Pakkanen, A., Nikkanen, T., & Pulkkinen, P. (2000). Annual Variation in Pollen Contamination and Outcrossing in a *Picea abies* Seed Orchard. *Scandinavian Journal of Forest Research*, 15: 399-404.
- Plomion, C., Leprovost, G., Pot, D., Vendramin, G., Gerber, S., Decroocq, S., Brach, J., Raffin, A., & Pastuszka, P. (2001). Pollen contamination in a maritime pine polycross seed orchard and certification of improved seeds using chloroplast microsatellites. *Canadian Journal of Forest Research*, 31: 1816-1825.
- Pupin, S., Sebbenn, A.M., Cambuim, J., da Silva, A.M., Zaruma, D.U.G., Silva, P.H.M., Rosse, L.N., Souza, I.C.G., Marino, C.L., & Moraes, M.L.T. (2019). Effects of pollen contamination and non-random mating on inbreeding and outbreeding depression in a seedling seed orchard of *Eucalyptus urophylla*. *Forest Ecology and Management*, 437: 272-281. <https://doi.org/10.1016/j.foreco.2019.01.050>.
- Slavov, G.T., Howe, G.T., & Adams, W.T. (2005). Pollen contamination and mating patterns in a Douglas-fir seed orchard as measured by simple sequence repeat markers. *Canadian Journal of Forest Research*, 35(7): 1592-1603.
- Sonstebo, J.H., Tollefsrud, M.M., Myking, T., Steffenrem, A., Nilsen, A.E., Edvardsen, O.M., Johnskas, O.R., & El-Kassaby, Y.A. (2018). Genetic diversity of Norway spruce (*Picea abies* (L.) Karst.) seed orchard crops: Effects of number of parents, seed year, and pollen contamination. *Forest Ecology and Management*, 411: 132-141. <https://doi.org/10.1016/j.foreco.2018.01.009>.
- Stoehr, M.U., & Newton, C.H. (2002). Evaluation of mating dynamics in a lodgepole pine seed orchard using chloroplast DNA markers. *Canadian Journal of Forest Research*, 32: 469-476.
- Sütçü, T., Bilgen, B.B., & Tuna, M. (2022). Analysis of genetic diversity among *Onobrychis* accessions with high agronomic performance by simple sequence repeat (SSR) markers. *Molecular Biology Reports*, 49: 5659-5668. <https://doi.org/10.1007/s11033-022-07584-x>
- Torimaru, T., Wang, X.R., Fries, A., Andersson, B., & Lindgren, D. (2009). Evaluation of pollen contamination in an advanced scots pine seed orchard. *Silvae Genetica*, 58(5-6): 262-269.
- Tunçtaner, K. (2007). Orman genetiği ve ağaç ıslahı, Türkiye Ormancılar Derneği, Eğitim Dizisi: 4, 364 s.
- Yang, H., Zhang, R., & Zhou, Z. (2017). Pollen dispersal, mating patterns and pollen contamination in an insect-pollinated seed orchard of *Schima superba* Gardn. et Champ. *New Forests*, 48: 431-444. <https://doi.org/10.1007/s11056-017-9568-6>
- Yazdani, R. & Lindgren, D. (1991). Variation of pollen contamination in a Scots pine seed orchard. *Silvae Genetica*, 40(5-6): 243-245.
- Zhuowen, Z. (2002). Pollen dispersal and its spatial distribution in seed orchards of *Cunninghamia lanceolata* (LAMB.) Hook. *Silvae Genetica*, 51(5-6): 237-241.

HARD SEED FRUIT GENE RESOURCES OF TÜRKİYE AND MOLECULAR CHARACTERIZATION STUDIES

Ödül Efsane AYÇİÇEK¹, Behiye Banu BİLGİN², Hayat TOPÇU²

¹Tekirdağ Namık Kemal University, Graduate School of Natural and Applied Sciences, Agricultural Biotechnology Department, Tekirdağ, Turkey

²Tekirdağ Namık Kemal University, Faculty of Agriculture, Agricultural Biotechnology Department, Tekirdağ, Turkey

Corresponding author e-mail: bbilgen@nku.edu.tr

ABSTRACT

Türkiye has rich soils that offer suitable habitat for many plants. Our country, which is rich in gene resources, is the gene center of many plants. Fruits, which can be classified according to their different characteristics, are examined in seven groups when classified according to fruit characteristics. The most important stone fruits grown in our country are peach (*Prunus persica* L.), nectarine (*Prunus persica* var. *nectarina*), apricot (*Prunus armeniaca* L.), cherry (*Prunus avium* L.), sour cherry (*Prunus cerasus* L.), and plum (*Prunus domestica* L.). Many varieties of these fruits, which are widely consumed in the world, have been obtained by using both traditional and modern breeding methods. While applying modern breeding methods, it is very significant to use and protect natural populations in factors such as expanding the gene pools of this group, which have a lot of wild ones in our country, and resistance to biotic and abiotic stress. Molecular markers are the most efficient and reliable methods used in the genetic characterization and identification of wild varieties. RAPD, SSR, ISSR, AFLP, and SRAP markers, which are used for many purposes, such as the characterization of wild and cultivated fruits and advanced breeding programs, are just some of them. This review examines the molecular characterization studies of stone fruits carried out in Turkey via molecular markers.

Keywords: Breeding, Drupe fruits, Gene resources, Molecular characterization

INTRODUCTION

More than one fruit variety can be grown in Turkey due to the favorable climate condition and soil types. There are different types of classifications of fruits. When classified according to fruit characteristics (pomologically); Mediterranean fruits are divided into seven groups as hard-skinned, soft-core, drupe, berry, citrus, and pleasure fruits. Cherry, sour cherry, apricot, peach, nectarine, and plum fruits are the leading stone fruits produced in our country. Apart from these, even though the production amount is less, the fruits of buckthorn, cranberry, and jujube, which are included in the production of our country, are also included in the class of stone fruits. Our country is the leader in all of these fruits, each of which grows in different conditions (Duru et al., 2022). Stone fruits are biologically classified as Rosales team, Rosaceae family. It is in the Prunoideae subfamily and comes from the genus *Prunus*. Traded *Prunus* species were first seen between Eastern Europe and Western China, and are suitable for cultivation between 30°-40° latitudes, in climates with long and dry seasons (Duru et al., 2022).

Although wild varieties are plants that can adapt to various conditions, they are endangered day by day due to some reasons such as pollution and the destruction of their habitats. Plants can be lost due to such factors, and gene resources that will be significant to use in important studies such as breeding in the future are lost. Studies are carried out to ensure that

gene resources are not lost. Chemical and *in vitro* techniques, cryo-storage, slow-growth techniques, artificial seed storage, and DNA storage methods are used to preserve gene resources. These protected wild varieties are important to use in molecular studies in the development of new varieties in breeding studies (Bilir, 2016; Balkaya and Yanmaz, 2001).

Identification of plant genetic resources is as important as diversity and protection. Thanks to the development of biotechnology and plant genetics in recent years, many DNA-based techniques have been developed for breeding and variety development. Some of these are RAPD, PCR-RFLP, AFLP, ISSR, and SSR. With these techniques, progress has been made in many varieties of development and molecular studies (Kose, 2013). This review aimed to examine the molecular characterization studies of stone fruits carried out in Turkey via molecular markers.

HARD SEEDS AND GENETIC RESOURCES

Turkey has significant and very rich plant biodiversity. The most obvious example of this is that approximately 3500 of 9500 plant species are endemic to our country. These endemic species can be found in most parts of the country. Moreover, it is mostly seen in the mountainous parts of Southern and Southeastern Anatolia. These plants are also found in the Thrace region. The Iran-Turan Region and Mediterranean Region of our country contain the largest number of endemic species (Tan, 2010). Gene resources and rich genetic diversity are important for plant breeding studies. Breeders use local varieties, especially in the development of new varieties. Most of our proprietary varieties originate from Turkey's plant genetic resources collections (Tan, 2010).

The genetic diversity of fruits is quite high. They are sources of various antioxidants, rich in vitamins and minerals. Therefore, fruit gene resources should be protected at least as much as other plants. With the selection and characterization studies pioneered by Ministries, Research Institutions, and universities, it has been ensured that the fruit gene source in most of the regions was determined and defined, protected, and used in breeding studies. In addition to various gene banks established as a result of these research and development studies, name-specific Research Institutes were established in fruit species such as Hazelnut, Pistachio, Viticulture, Fig, Apricot, Nuts (Almond), and Olive, which have an important place in the Turkish economy (Kuden and Dasgan, 2021; Bozhuyuk, 2020). When the TUIK data are examined, it has been seen that stone fruit types have an important place in Turkey's fresh fruit production and export. According to TUIK data, peach and nectarine are the most produced stone fruits in Turkey whereas the least produced were jujube in 2022 (Table 1).

MOLECULAR MARKERS AND THEIR USES IN CHARACTERIZATION

In breeding studies, classical breeding methods are used for most species for the development of new varieties, but in the classical breeding method, the process is long, it requires a lot of effort, and it is not sufficient alone for the food needed with increased resistance to disease and pests. Morphological and phenotypic measurements are not considered sufficient in today's studies to determine the kinship relations between selected species and resistant varieties. As a result of developments in the field of biotechnology, molecular markers have been developed (Ehliz et al., 2021). Today, using molecular markers to define the correctness of the names of the varieties in a short time has an important place in fruit growing (Aksu, 2015). Molecular markers are not affected by environmental conditions, they are used in every period of plant development without waiting for maturation, they show wide variation and provide advantages compared to other markers and are used more widely (Sönmezoğlu et al., 2010).

Table 1. Production amount of hard seed fruits in Turkey in 2022 (tonnes) (TUIK, 2022)

Hard Seed Fruits	Production Amount in Turkey Tonnes
Peaches and Nectarine	1.008.185
Plums	348.750
Apricots	803.000
Wild apricots	20.832
Cherries	656.041
Sour Cherries	176.770
Cranberry	13.750
Silverberry	3.903
Jujube	2.248

Molecular markers have many advantages over morphological and biochemical markers with features such as high polymorphism, frequent and uniform distribution in the genome, being dominant and codominant, identifying more than one region, being easy, fast, and reproducible, but not all of these features are present in all molecular markers. While selecting the marker that is suitable for our purpose in the study, it is desired that some of these features be together (Shidfar, 2014). Molecular markers are categorized as dominant markers and codominant markers according to their scoreability and heredity in terms of heterozygosity and homozygosity (Devran, 2003). Molecular markers can also be used in analysis such as selection with the help of markers (MAS), characterization studies of gene sources, phylogenetic analyses, determination of varieties, and genetic relatedness (Shidfar, 2014). Markers such as SSR, AFLP, and ISSR which can give more precise results due to the low reproducibility level of the DNA-based RAPD technique, have been started to be used by many researchers (Ehliz et al., 2021).

GENETIC CHARACTERIZATION OF PEACH AND NECTARINE WITH MOLECULAR MARKERS

The latin name is *Prunus persica* L., was thought to be native to Iran and the Caucasus. In 1883, however, De'candolle proved that East Asia and China were the origin of the peach. The name peach has been found in Chinese literature dating back to 2000 BC. Due to its adaptability to different climates, peach has spread throughout the world (Ercan and Özkarakas, 2003). The most important fruit type in Europe after apple is the peach, and it is also the most important species of the genus *Prunus*. Peach is a diploid species ($2n = 16$) (Dirlewanger et al., 2006). Contrary to popular belief, nectarine is not different from peach. It is in the sub-variety of peach, *Prunus persica* var *nectarina*, named as nectarina (Erbil and Erenoğlu, 2006).

If we examine the molecular studies on peach, Gür and Şeker (2012) examined the genetic relationships of white nectarine cultivars with other *Prunus* (peach, nectarine, cherry, almond, apricot, and plum) in their study. The *Prunus* species included in their study were taken from the Çanakkale Onsekiz Mart University fruit plots and producer gardens in 2011. The AFLP marker was chosen to determine the genetic relationship between fruits. As a result of the analysis, 182 of the 282 AFLP fragments from 6 primer pairs were observed as polymorphic. As a result of the study, it was seen that the white nectarine has different genetic characteristics

from other *Prunus*. White nectarines were defined as closest to each other, and the most distant related ratio was observed in cherry cultivars.

Demirel et al., (2023), using 32 ISSR markers, the genetic characterization study of a total of 54 peach genotypes, 52 local and 2 commercial varieties, obtained from the province of Iğdır, was carried out. A total of 213 alleles, 154 of which were polymorphic, were obtained in the study and 54 genotypes were grouped into four groups according to the UPGMA dendrogram. According to the results they obtained, they reported that 54 peach genotypes were different in terms of genetic similarity; ISSR markers used in the study could benefit breeding programs in selecting individuals as parents. In another study conducted by Demirel (2018), it was desired to determine the genetic differences between two local varieties of Iğdır province, Zeferan and Ağşeftali. ISSR marker was chosen for the study. 54 peach varieties were studied. Of the 57 primers, 42 were optimized and 32 were selected as polymorphic. 7 ISSR primers with the highest rate of polymorphism (100%) used in the study were determined. It was decided that the characterization of peach genotypes could be made with these 7 primers. As a result of the study, Zaferan6 and Ağşeftali18 genotypes were determined to be far from each other and other genotypes in the study. Ağşeftali6 and Ağşeftali16 genotypes were almost very similar to each other, so it was decided that Ağşeftali6 and Ağşeftali16 genotypes could not be selected as parents in the breeding study. Distant genotypes were found suitable for selection as parents in breeding.

In a study conducted in Spain, Bouhadida et al., (2007) worked with local varieties unique to Spain. In their study, by using the SSR marker, the similarity to the known local varieties was evaluated by having information about the genetic diversity of 19 varieties of Miraflores, whose pedigree is unknown. High polymorphic 20 SSR markers developed for peach were used. As a result of the analysis, 46 scoreable alleles were obtained. While 14 of the SSRs used in the study were found to be polymorphic, 16 of the 30 cultivars studied were clearly distinguishable.

GENETIC CHARACTERIZATION OF APRICOT AND WITH MOLECULAR MARKERS

The origin of the cultivated apricot (*Prunus armeniaca* L.) was stated by Vavilov's China and Central Asia (Vavilov, 1951). Near Eastern centers extending from Northeast Iran to the Caucasus and Central Anatolia are also defined as the second origin. The *P. armeniaca* species was divided into 4 major eco-geographical groups and 13 regional subgroups by Kostina and added our country to the Iran-Caucasus eco-geographic group (Bakır et al., 2018). All apricot species contain 8 pairs of chromosomes ($2n = 16$) (Asma and Ozturk 2005).

Phylogenetic analysis of genotypes collected from Malatya, RAPD-PCR, ISSR-PCR, and DNA sequence analysis methods were used in the study conducted by Sevindik et al., (2020) examining some Turkish *P. armeniaca* L. cultivars. 11 RAPD primers and 15 ISSR primers were used to determine the molecular characterization of apricot genotypes. As a result of the analysis, RAPD gave 46 bands, while ISSR gave 95 bands. Sequence analysis results vary between 398-403 nucleotides. As a result, they observed that the use of markers is more polymorphic than DNA sequencing. Sheikh et al., (2021), using 4 ISSR markers, performed the genetic characterization study of the differentiation of 50 varieties of apricots collected from various geographical regions of Jammu and Kashmir from native germplasm from exotic germplasm. While the similarity ratio between 0.48 and 0.94 was obtained by using Jaccard's similarity coefficient of the 50 genotypes used in the study, it was observed that two main groups were formed in the UPGMA clustering analysis. They concluded that the four ISSR markers were able to distinctly distinguish native germplasm from exotic germplasm. However, more ISSR markers should be scanned in order to better understand the distribution of diversity

in the region. The genetic difference between native genotypes and exotic genotypes has been reported to be useful in apricot breeding studies. Another study was carried out in our country, Bakır et al. (2018) with 44 wild apricots collected from Cappadocia. These wild varieties were compared with 5 locally known varieties suitable for trade and market in terms of their characteristics. Thirteen of the 16 SSR primers worked successfully and a total of 107 alleles were detected. It has been reported that the similarity rates of wild apricots vary from 12% to 96%, and high genetic diversity was estimated.

In another study, Ehliz et al., (2021) investigated the differences between 7 apricot cultivars collected from farmers' orchards in Mersin Mut Collecta Village, using the SSR marker. As a result of the analysis, apricot cultivars were divided into two main groups. The similarity coefficients of these groups varied between 0.677 and 0.938. While the lowest similarity value was seen between A1 and Italian buckle, the highest similarity value was seen in Septik and Iğdır Şalâğı varieties. SSR findings of apricot cultivars grown in Turkey can be an important guide for the selection of parents for breeding studies carried out in the country, and for determining factors such as differences in fruit quality parameters or resistance to some specific diseases. It can also be used to determine the distribution areas of apricot cultivars, to compare genetic collections, and to characterize apricot cultivars.

GENETIC CHARACTERIZATION OF CHERRY AND SOUR CHERRY WITH MOLECULAR MARKERS

Cherry (*Prunus avium* L.) is seen to be included in the Rosaceae family, Prunoideae subfamily, *Prunus* genus when the taxonomy is examined. The region between the South Caucasus, the Caspian Sea, and Northeast Anatolia is the region of cherry (*P. avium* L.) is known as the origin. From the area of origin, it spread to the east and west of the world and gained a large production area. As with most fruits, one of the ancient cultural areas of cherries is Anatolia. Therefore, Anatolia is one of the origin centers of cherries. There are about 1500 varieties in the world (Çelik and Sarıaltın, 2019). Especially the species produced are sweet cherry and sour cherry. Sweet cherry (*P. avium* L.) is diploid ($2n = 16$), and sour cherry (*P. cerasus* L.) is a tetraploid species ($2n = 32$). It is thought that sour cherry emerged as a result of the natural hybridization of *P. avium* and *P. fruticosa* L. species (Khadivi et al., 2019). Gülen et al., (2010) used 6 SSR and 4 AFLP molecular markers to detect genetic diversity in 78 local sweet cherry cultivars. The similarity rate was found to be more than 42%. In the study, it was concluded that these two marker systems are unique in all 78 genotypes, genetic diversity is high among genotypes and this genetic variation can be used in breeding programs in the future. Patzak et al., (2019), 20 SSR markers and 5 EST-SSR markers were used for the molecular characterization of 123 old and local varieties obtained from the genetic resources of the Pomology Research and Breeding Institute in Holovousy. 115 polymorphic bands were obtained. In the dendrogram, 3 main clusters and 16 subcluster were observed. As a result of the study, they concluded that the SSR marker would be beneficial in maintaining genetic diversity and providing information while creating genetic resource collections.

In a study by Pınar et al., (2018) in cherry, it is aimed to determine genetic relatedness by using the RAPD marker. 16 RAPD primers were used for 20 different cherry genotypes and 109 bands were obtained, 92 of which were polymorphic. The average polymorphism rate was determined as 84.40%. In another study, Uzan Eken et al., (2022) in order to prevent the loss of diversity in the wild cherry (*P. avium* L, syn. *Cerasus avium* L. Moench.) tree, which is ecologically widespread but whose genetic diversity was endangered and shed light on breeding studies and gene resources, molecular studies was carried out to protect. 440 genotypes from 22 different populations in our country were analyzed with 10 SSR markers. While the intra-population genetic diversity rate was found to be 88.5%, the inter-population genetic diversity rate was found to be 9.8%. Veliköy and Kemerköprü populations grown at high altitudes,

Macara population closest to European varieties, and Tota sample taken from the Mediterranean Region population showed genetic differences compared to other populations. For this reason, as a result of the study, Kemerköprü, Macara, Veliköy, and Tota populations have suggested *in situ* protection. The data they obtained for the protection of wild cherry gene resources of our country were interpreted as useful.

GENETIC CHARACTERIZATION OF PLUM WITH MOLECULAR MARKERS

Prunus genus and *Prunophora* subgenus is an important stone fruit species that has spread over a wide area in the world. It is reported that there are about 200 plum species belonging to the genus *Prunus* in the world (Yaşar et al., 2022). The European plum (*Prunus domestica* L.) is a hexaploid ($2n = 48$) species and its biological origin remains controversial and unclear. According to archaeological findings, the use of plums by humans dates back to the 6,000s. It is also known that it was grown a lot in Roman times. A long history of adaptation has resulted in diversity. Çakal plum (*P. spinosa* L.) belonging to the *Prunus* genus in the Prunoideae subfamily of Rosaceae is a tetraploid ($2n = 32$) species thought to be native to Southern Europe, Turkey, and Armenia, and the cherry plum is known as diploid ($2n = 16$) (Erturk et al., 2009).

Erturk et al., (2009) with *P. spinosa*, Çakal plum, wild populations were collected from the Coruh Valley in Northeast Turkey. 16 distinct genotypes were analyzed using RAPD. Fifteen of the 51 primers yielded reproducible patterns. These 15 primers produced 226 bands, 65% of which were polymorphic. As a result of the study, they decided that RAPD could be used to measure the genetic difference of the Çakal plum. In another study, Çakır et al., (2021) investigated 66 genotypes in the Turkish National *P. cerasifera* collection in their study with *P. cerasifera* Ehrh, a highly preferred variety in our country. These 66 varieties were taken from Denizli, Balıkesir, İzmir, Aydın, Manisa, and Muğla, and our important local varieties, Can and Papaz plum, were used. Analyzes of the samples were performed with the SRAP marker. Of the 495 bands showing polymorphism, 98 percent were identified as polymorphic. The dice coefficient was used to determine the mean of diversity. After the Dice coefficient was determined as 0.39, it was decided that this study had similar results to the studies conducted in Belarus, France, and Iran, but higher results than the studies conducted in China. In addition, in this study, it was determined that although Can and Papaz plums were different from each other morphologically, they were molecularly the same. Qiao et al., (2006) studied a total of 56 genotypes using 54 Japanese plums and 2 European plums. 10 ISSR, 21 SSR, and 24 RAPD markers were used in the study. As a result of the study, 86 ISSR bands, 102 SSR alleles, and 21 RAPD bands were obtained. When the similarities of the Japanese plums to the European plums are examined, it has been observed that the two varieties have different distributions. Within-group similarity rates of Japanese plums varied between 0.286 and 0.730.

In another study, Antanyiene et al., (2023) evaluated genetic diversity with SSR markers using European plum (*P. domestica*) and its hybrids from Lithuania. A total of 107 *P. domestica* L. genotype with SSR markers, 68 European and 39 hybrids, were studied from the genetic resource collection of the Horticulture Institute of the Lithuanian Agriculture and Forestry Research Center. The number of alleles in each primer ranged from 18 to 30 with an average of 24.33. The result of the study was the characterization and identification of Lithuanian plum genotypes. The uniqueness of the analyzed varieties is emphasized. European plum varieties originating in Lithuania have been interpreted as having several unique alleles required for plant breeding under exceptional northern climatic conditions.

CONCLUSION

Our country is important habitat for many plant varieties with its wide genetic diversity and endemic species. There will always be a need for our wild endemic varieties for the breeding studies of our country and the development of new varieties. Fruit genetic resources

should also be protected and a lot of work should be done on our unstudied gene resources. Stone fruits have a very important place, especially in trade and market. It is very important to make more varieties known by conducting molecular studies on stone fruits such as peach, nectarine, apricot, cherry, sour cherry, and plum. Many marker systems such as RAPD, SSR, ISSR, and AFLP can be used in such studies. This information sheds light on breeders in selecting varieties to be used in breeding. Our wild varieties are plants that are of great value in order to deliver new, more durable plants that are of great importance in the protection of gene resources for future generations. It is very important to protect the genetic resources of these varieties. Wild varieties, which are resistant to most diseases compared to local varieties, may be the only solution for us to overcome a possible plant disease that we may encounter in the future. We need to increase our knowledge of these plants and identify their genetic variation so that we can use these more resistant wild varieties in the future. For this reason, wild varieties of stone fruits, which have an important place in the market, should be researched and determined, multiplied, studies should be done by making collection gardens and these studies should be supported by molecular analysis in order to be used in further breeding studies in the future.

REFERENCES

- Aksu, M. (2015). Uses of molecular markers in fruit breeding. *Fruit Science*, 2 (1), 49-59. <https://dergipark.org.tr/en/pub/fruit/issue/19544/208089>
- Antanyniene, R., Šikšnianiene, J.B., Stanys, V., Frercks, B. (2023). Fingerprinting of plum (*Prunus domestica*) genotypes in Lithuania using SSR markers. *Plant*, 12, 1538.
- Asma, B.M., Ozturk, K. (2005). Analysis of morphological, pomological and yield characteristics of some apricot germplasm in Turkey. *Genetic Resources and Crop Evolution*, 52, 305-313.
- Bakır, M., Dumanoğlu, H., Erdoğan, V., Ernim, C., Macit, T. (2018). Characterization of wild apricot (*Prunus armeniaca* L.) genotypes selected from Cappadocia region (Nevşehir-Turkey) by SSR markers. *Journal of Agricultural Sciences*, 25, 298-507.
- Balkaya, A., Yanmaz, R. (2001). Conservation possibilities of plant genetic resources and working systems of seed gene banks. *Ecology Environment Journal*, 10(39): 25-30.
- Bilir, Ö. (2016). Biotechnology in terms of conservation of plant genetic resources. *Turkish Journal of Scientific Reviews*. 9 (2), 29-33.
- Bouhadida, M., Casas, A.M., Moreno, M.A., Gogorcena, Y. (2007). Molecular characterization of Miraflores peach variety and relatives using SSRs. *Scientia Horticulturae*, 111, 140-145.
- Bozhuyuk, M.R. (2020). Morphological and biochemical characterization of wild sour cherry (*Prunus cerasus* L.) germplasm. *Erwerbs-Obstbau*, 64, 357-363.
- Çakır, G., Taşcıoğlu, T., Çavdar, A., Doğanlar, S., Frary, A., Frary, A. (2021). Molecular genetic characterization of the Turkish national green plum (*Prunus cerasifera* Ehrh.) collection. *Anadolu, J. of AARI*, 31(1), 61-73.
- Çelik, Y., Sarıaltın, H.K. (2019). Structural analysis of cherry production in Turkey. *Turkish Journal of Agricultural and Natural Science*, 6(4), 596-607.
- Demirel, S. (2018). Determination of genetic diversity of local peach genotypes grown in Iğdır (Master Thesis), Iğdır University of Science Institute, Iğdır.
- Demirel, S., Pehlivan, M., Aslantaş, R. (2023). Evaluation of genetic diversity and population structure of peach (*Prunus persica* L.) genotypes using inter-simple sequence repeat (ISSR) markers. *Genetic Resources and Crop Evolution*, 1-12.
- Devran, Z. (2003). Moleküler işaretleyicilerin (markörlerin) dayanıklılık ıslahında kullanılması. *Derim* 20:1-6.

- Dirlewanger, E., Cosson, P., Boudehri, K., Renaud, C., Capdeville, G., Tauzin, Y., Laigret, F., Moing, A. (2006). Development of a second-generation genetic linkage map for peach [*Prunus persica* (L.) Batsch] and characterization of morphology traits affecting flower and fruit. *Tree Genetics & Genomes*, 3, 1-13.
- Duru, S., Fan, S., Gul, A. (2022). Production of stone fruits in Turkey and evaluation of competitiveness in export. *Garden*, 51 (1), 29-36.
- Ehliz, F., Karakurt, Y., Çelik, C. (2021). Molecular characterization of apricot (*Prunus armeniaca* L.) cultivars with SSR markers. *Journal of the Faculty of Agriculture*, 16 (1), 78-85.
- Erbil, Y., Erenoğlu, B. (2006). Peach breeding illness and pests. Ankara: Farmer Education Series 22
- Ercan, N., Ozkarakas, I. (2003). Aegean to the region suitable some peach and nectarine varieties. *Anadolu, J. of AARI*, 13(2), 17-31.
- Erturk, Y., Ercisli, S., Maghradze, D., Orhan, E., Agar, G. (2009). An assessment of genetics variability and relationships among wild-grown blackthorn (*Prunus spinosa* L.) plants based on RAPD markers. *Genetics and molecular research*, 8 (4), 1238-1244.
- Gülen, H., Ipek, A., Ergin, S., Akcay, E., Eris, A. (2010). Assessment of genetic relationships among 29 introduced and 49 local sweet cherry accessions in Turkey using AFLP and SSR markers. *The Journal of Horticultural Science and Biotechnology*, 85 (5), 427-431.
- Gür, E., Şeker, M. (2012). Comparison of the AFLP molecular marker polymorphism of white nectarine types with important species in the genus *Prunus*. *Journal of Agricultural Faculty of Uludag University*, 26(2), 29-36.
- Khadivi, A., Mohammadi, M., Asgari, K. (2019). morphological and pomological characterizations of sweet cherry (*Prunus avium* L.), sour cherry (*Prunus cerasus* L.) and duke cherry (*Prunus × gondouinii* Rehd.) to choose the promising selections. *Scientia horticulturae*, 257, 108719.
- Kose, O. (2013). Genetic characterization of some plum and cherry genotypes based on SSRs (Simple Sequence Repeats) (Master's Thesis). Ankara University, Science Institute, Ankara.
- Kuden, A.B., Dasgan, H.Y. (2021). Fruit and vegetable cultivation in Turkey. 3rd International Congress on Agriculture and Food Ethics. Congress Book of Proceedings, 105.
- Patzak, J., Henychová, A., Paprštejn, F., Sedlák, J. (2019). Evaluation of genetic variability within sweet cherry (*Prunus avium* L.) genetic resources by molecular SSR markers. *Acta Scientiarum Polonorum Hortorum Cultus*, 18(3), 157-165.
- Pınar, H., Yaman, M., Sarisu, H.C., Uzun, A., Yigit, M.A. (2018). Determination of genetic related relationships of some cherry rootstocks by RAPD molecular marker method. *Harran Journal of Agricultural and Food Sciences*, 22 (3), 326-334.
- Qiao, Y.S., Fang, J.G., Cong, Y., Zhou, J., Zhang, Z. (2006). Analysis of genetic diversity of Japanese plum cultivars based on RAPD, ISSR and SSR markers. *Acta Hort.* 763, 177-184. DOI: 10.17660/ActaHortic.2007.763.23
- Sarikamis, G. (2014). Molecular approaches in vegetable breeding. *Turkish Journal of Scientific Reviews*, (2), 80-83.
- Sevindik, E., Murathan Z.T., Sevindik, M. (2020). Molecular Genetic Diversity of *Prunus armeniaca* L. (Rosaceae) Genotypes by RAPD, ISSR-PCR, and Chloroplast DNA (cpDNA) trnL-F Sequences. *International Journal of Fruit Science*, 20 (3);1652–S1661. <https://doi.org/10.1080/15538362.2020.1828223>.
- Sheikh, Z.N., Sharma, V., Shah, R.A., Sharma, N., Summuna, B., Al-Misned, F.A., El-Serehy, H.A., Mir, J.I. (2021). Genetic diversity analysis and population structure in apricot (*Prunus armeniaca* L.) grown under north-western Himalayas using ISSR markers. *Saudi Journal of Biological Sciences*, 28 (10), 5986-5992.

- Shidfar, M. (2014). Use of molecular markers for developing new cultivars tolerant to *Plasmopara viticola* and (erysiphe- uncinula necator) diseases based on marker assisted selection-(mas) on vitis vinifera (PhD Thesis), Ankara University, Institute of Science and Technology, Ankara.
- Sönmezoğlu, O.A., Yıldırım, A., Eserkaya Güleç, T., Kandemir, N. (2010). Use of marker assisted selection in wheat breeding. GOU Journal of the Faculty of Agriculture, 27 (1), 105-112.
- Tan, A. (2010). Turkey plant genetic resources and enclosure. Anadolu, J. of AARI. 20 (1), 9-37.
- TUIK (2022). Bitkisel üretim istatistikleri (Crop Production Statistics). <http://www.tuik.gov.tr>
- Uzan Eken, B., Kırdök, E., Veliöglu, E., Özden Çiftçi, Y. (2022). Assessment of genetics variation of natural population of wild cherry (*Prunus avium* L.) via SSR markers. Turkish Journal of Botany, 46, 14-25.
- Vavilov, N.I. (1951). The Origin, variation, immunity and breeding of cultivated plants (translated by S. K. Chestitee). Chronica Botonica, 13, 1-366.
- Yaşar, Ö., Gülsoy, E., Aslantaş, R., Şimşek, M. (2022). Determination of phenological and pomological characteristics of local black plum (*Prunus domestica* L.) genotypes grown in Iğdır. Journal of Agriculture, 5 (1), 31-38.

MORPHOLOGICAL CHARACTERISTICS OF GIANT STINGING NETTLE (*Girardinia Diversifolia*) IN GIRESUN ECOLOGICAL CONDITIONS

Büşra TİK¹ *, Ali Kemal AYAN¹ ,Selim AYTAÇ² ,Özbay DEDE³ , Mert ARSLANBAYRAK¹
Ondokuz Mayıs University, Agriculture Faculty, Field Crops Department, SAMSUN, Turkey
Ondokuz Mayıs University,Hemp Research Institü, , SAMSUN, Turkey
Ordu University, Agriculture Faculty, Field Crops Department ORDU, Turkey
Corresponding author e-mail: btik952@gmail.com

ABSTRACT

Girardinia diversifolia is a perennial plant belonging to the Urticaceae family, reaching a height of 1.5 to 3 meters. *Girardinia diversifolia* is commonly known as the Giant Nettle. It is naturally abundant in forested areas, along riverbanks, and moist habitats in the Himalayas, India, Sri Lanka, and China. The plant grows in clusters, with multiple stems in each cluster. Its stems are upright, pentagonal, and branch out from the base. The stems are also covered with stinging, pointed, and soft hairs. *Girardinia diversifolia* is known for its bast (bark) fibers, which are long, strong, smooth, and shiny. The fibers of the Giant Nettle are used in the production of various textiles, ropes, mats, sacks, and various other household items. It is a crucial fiber source that can be cultivated to generate income in rural areas. Considering its ecological requirements and growth conditions, it has been experimented to evaluate its potential for fiber production in the rural areas of the Black Sea region. This study aims to determine the morphological characteristics of *Girardinia diversifolia* cultivated under the ecological conditions of Giresun province.

Keywords: Bast fiber, Giant stinging nettle, *Girardinia diversifolia*, Giresun, Morphological characteristics

INTRODUCTION

Fiber plants are the raw materials for the textile industry and a source of cellulose. In our country, cotton production is the main source of fiber. Cotton fiber production in our country cannot meet the consumption demand. The textile sector meets its raw material needs through imports (Mert and Çopur, 2010). In some areas where cotton cultivation is not possible, bast fiber plants (hemp, flax, nettle) are cultivated to supply raw materials to the textile industry. The Giant Nettle (*G. diversifolia*), which naturally grows in the Black Sea region with its ecological adaptability, is thought to have the potential to become an alternative fiber source for the textile industry due to its long, high-quality, and durable fibers.



Figure 1. The general appearance of the *Girardinia diversifolia* plant and flower.

Girardinia diversifolia L. is a perennial plant from the Urticaceae family, which can reach a height of 1.5-3.5 meters. It has more pronounced stinging hairs on its stem compared to common nettles. Its leaves are 5-lobed and serrated. The stem is covered with fine thorns. The width of the leaf averages 24-26 cm. Its flowers bloom from July to September, and the seeds mature around November (Sethmann, 2004). *G. diversifolia* grows in shaded areas at altitudes ranging from sea level to 3000 meters and requires a high moisture content, frost resistance, and a fertile environment (Subedee, 2018). The bark of *Girardinia diversifolia* contains fibers that possess unique qualities, including strength, smoothness, lightness, and a silk-like shine when processed correctly (Lanzilao et al., 2016). These fibers have a wide range of applications, including weaving, medicine, papermaking, biofuel, cosmetics, and the automotive industry. In the Himalayas, its leaves are cooked as a vegetable and consumed as food, as well as used in traditional medicine for treating headaches, fevers, and swollen joints (Gurung et al., 2012; Rokaya et al., 2010). Its flowers are also commonly cooked and consumed as a vegetable along with its leaves. Long, strong, smooth, and shiny high-quality fibers can be obtained from its stems. Woody stem parts can be used in papermaking, biofuel, and biocomposite production (Gurung et al., 2012).

MATERIAL AND METHOD

This study was conducted in the village of Balıklısu, Keşap district, Giresun province, within the scope of the "Dissemination of Nettle Farming and Technology" project supported by DOKAP in 2021. The nettle seedlings required for a total area of 1000 m² were grown in pots at Ondokuz Mayıs University, Faculty of Agriculture. Planting was carried out on June 11, 2021, with a spacing of 50x50 cm. Observations and measurements for morphological characteristics were made in the next year (2022) to determine the morphological characteristics. The soil structure of the experimental area was medium-textured and had an acidic reaction, with an elevation of 300 meters above sea level. To increase the organic matter content in the soil, manure (450 kg per hectare) was applied for soil correction. The climate data for the Keşap district of Giresun province in 2022, where the trial was conducted,

especially during the flowering and maturation period, provided suitable conditions for the development of Giant Nettle (Table 1).

Table 1. Climate data for the Keşap district of Giresun province (January 2022-December 2022).

<i>Months</i>	<i>Relative Humidity (%)</i>	<i>Temperature (°C)</i>	<i>Precipitation (mm)</i>
January	68,5	3,5	224,7
February	66	6,1	96,1
March	79,3	1,6	436
April	58,8	12,6	63,9
May	69,4	12,9	138,1
June	86,3	17,2	69,4
July	87,1	18	119,2
August	89,7	21,1	138,6
September	77,8	18,2	196
October	84,8	12,7	236,4
November	76,5	11,4	107,4
December	72,6	8,8	151
Average	76,4	12,0	164,0

The research was conducted on 10 randomly selected plants from the Giant Nettle trial established in an area of 1000 m². Measurements of plant height, technical stem length, stem diameter, and the number of lateral branches were made to determine morphological characteristics. These measurements were made according to UPOV criteria.

Results

As a result of the research, data related to plant height, technical stem length, stem diameter, and the number of lateral branches, etc., are given in Table 2.

Table 2. Average data for some of the examined characteristics of Giant Nettle cultivated under ecological conditions.

Replication	Plant Height(m)	Technical Stem Length (m)	Stem Diameter (mm)	Lateral Branches(max-min) avg
1	2,18	0,53	11,94	(0-4) 2,00
2	1,80	1,25	11,00	(0-5)1,25
3	3,35	1,26	15,22	(0-5)1,71
4	2,41	2,18	11,39	(0-5)0,20
5	2,24	1,98	10,97	(0-2)0,40
6	2,36	2,13	9,24	(0-1)0,20
7	2,43	2,21	9,25	(0-2)0,40
8	2,47	2,47	9,86	(0)0,00
9	2,23	1,91	10,10	(0-1)0,20
10	2,06	2,06	8,40	(0)0,00
Avarage	2,35	1,80	10,74	0,64

Upon examination of Table 2, it is determined that the plant height varies between 1.80 m and 3.35 m, with an average plant height of 2.35 m. Technical stem length (m) ranged from 0.53 m to 2.21 m, with an average technical stem length of 1.80 m. Stem diameter (mm) varied from 8.40 mm to 16.06 mm, with an average stem diameter of 10.82 mm. The average number of lateral branches on the plant ranged from 0 to 2.00, with an average of 0.65.

In addition to genetic factors, breeding techniques and environmental factors play a limiting role in the emergence of yield and yield elements in production. Considering the quality and yield factors, the multifaceted effects of these factors should be considered in determining the varieties or genotypes that can adapt to the ecological conditions of a region.

RESULTS AND DISCUSSION

With the data obtained in this study, the effect of *Girardinia diversifolia* plant on its morphological features on the adaptation quality and yield elements of Giresun province Keşap district Balıklısu village was investigated. Within these compatible parameters, plant heights between 1.80 and 3.35 were obtained. Since the first 2 years of this plant were the establishment years, it was expected that the yield would be low. In this study, although we made the measurements in the 2nd year, the efficiency was higher than our expectations.

The distance (meters) from the root of the plants to the extreme point was measured as plant height. Based on literature studies of giant nettle, it has been stated that the plant height is 1.5 m to 3.5 m. In this study, plant height varied between 1.80 m and 3.35 m. Although it is the second year of this study, these results have emerged. Since it is a perennial plant, its economic harvest life is 8-10 years (Ayan et al., 2020). Giresun's ecological conditions have also been achieved in this second year.

The technical stem is defined as the length of the technical stem up to the point where the generative part or branching begins (Kara, 2013). It is emphasized that technical stem length can be affected by climatic conditions as well as a variety features (Aksoy and Aytaç, 2021). Although our genotypes were different, they showed non-type characteristics. When the general population was looked at, some plants showed different developmental patterns. There were both upright and spreading plants in the same parcel.

In giant nettle, stem diameter was measured in the middle part of the stem with the help of calipers. Stem thickness is affected by environmental conditions and genotypic characteristics. The stem thickness of the nettle (*Urtica dioica* L.), which grows naturally in our country, is thinner than the giant nettle. This difference is because the plant height of the giant nettle plant is longer than the nettle. The advantage of having more stalk thickness provides higher fiber yield.

Generally, parameters such as side branches are not taken into consideration in fiber plants. However, since this plant is an unknown plant in our country, different parameters are included to know the morphological characteristics of the plant by including wider parameters.

CONCLUSION AND RECOMMENDATIONS

Girardinia diversifolia started to bloom in October in Giresun conditions. The plant was harvested in January and morphological observations were taken. As a result of this study, it was determined that the average plant height was 2.35 m and the average technical stem length was 1.80 m. The shank diameter (mm) and the average shank diameter were

determined to be 10.82 mm. It was determined that the number of side branches (max-min) in the plant varied between 0 and 2.00, the average was 0.65.

As a recommendation, it is important to conduct further studies to determine its chemical and physical properties. Although the giant nettle (*G. diversifolia*) is from the same family as the nettle (*Urtica spp.*) that grows naturally in our country, *G. diversifolia* is in a more primitive form, but in terms of plant height and technical stem. is superior. Considering these features, it carries raw material potential to the textile industry. The plant grows fast and has the potential to be an important energy plant in terms of being a perennial. This study was carried out to determine the morphological characteristics of the plant. It is envisaged that studies should be carried out to recognize the plant and understand its content by using wider parameters.

REFERENCES

- Aksoy, D., & Aytaç, S. (2021). *Samsun ekolojik koşullarında Narlısaray popülasyonu ile yabancı orijinli kenevir çeşitlerinin verim ve bazı kalite özelliklerinin araştırılması* [Ondokuz Mayıs Üniversitesi, Lisansüstü Eğitim Enstitüsü].
- Ayan, A. K., Aytaç, S., & Paslı, R. (2020). Isırgan. In: Samsun: DOKAP. doi: <https://www.researchgate.net/publication/346529135>.
- Gurung, A., Flanigan, H., Ghimeray, A. K., Bista, R., & Gunrung, O. P. (2012). Traditional knowledge of processing and use of the Himalayan giant nettle (*Girardinia diversifolia* (Link) Friis) among the Gurungs of Sikles, Nepal. *Ethnobotany Research and Applications*, 10, 167-174.
- Kara, K. (2013). *Lif bitkileri yetiştiriciliği ve ıslahı* (Vol. 239). Atatürk Üniversitesi Ziraat Fakültesi.
- Lanzilao, G., Goswami, P., & Blackburn, R. S. (2016). Study of the morphological characteristics and physical properties of Himalayan giant nettle (*Girardinia diversifolia* L.) fiber in comparison with European nettle (*Urtica dioica* L.) fibre. *Materials Letters*, 181, 200-203.
- Mert, M., & Çopur, O. (2010). Lif bitkileri üretiminin artırılması olanakları. *Türkiye Ziraat Mühendisliği VII. Teknik Kongresi*, 1, 397-421.
- Rokaya, M. B., Münzbergová, Z., & Timsina, B. (2010). Ethnobotanical study of medicinal plants from the Humla district of western Nepal. *Journal of Ethnopharmacology*, 130(3), 485-504.
- Sethmann, A. (2004). *Girardinia diversifolia (LINK) FRIIS (Urticaceae)-eine neue Faserpflanze-Untersuchungen zu den morphologischen und mechanischen Fasercharakteristika* Staats-und Universitätsbibliothek Hamburg Carl von Ossietzky].
- Subedee, B. R. C., Ram Prasad Uprety, Yadav Dorji, Tashi. (2018). Socio-ecological perspectives of himalayan giant nettle (*Girardinia diversifolia* (link) Friis) in Nepal. *Journal of natural fibers*.

EFFECT OF BASAL MEDIA ON GROWTH AND EXOPOLYSACCHARIDES PRODUCTION BY ARONIA MELANOCARPA (MICHX.) ELLIOTT CELL SUSPENSION CULTURE

Gergana KRASTEVA¹, Tsvetanka TENEVA-ANGELOVA¹, Ilian BADJAKOV¹, Ivayla DINCHEVA¹, Atanas PAVLOV¹, Vasil GEORGIEV¹

¹ Laboratory of Cell Biosystems, Institute of Microbiology, Bulgarian Academy of Sciences, Plovdiv, Bulgaria

¹ AgroBioInstitute, Agricultural Academy, Sofia, Bulgaria

¹ Department of Analytical Chemistry and Physical Chemistry, Technological Faculty, University of Food Technologies, Plovdiv, Bulgaria
Corresponding author e-mail: vasgeorgiev@gmail.com

ABSTRACT

Aronia melanocarpa (Michx.) Elliott (black chokeberry) is well known plant among the consumers and its berries are widely used for production of jam, wines, juices and food colorants. Nowadays, with the stunning advance in cellular agriculture, different in vitro systems from many edible plants are considered as perspective renewable sources of valuable phytochemicals. In this study, the effect of basal medium composition on biomass accumulation and exopolysaccharides production by *Aronia melanocarpa* cell suspension culture was investigated. The results showed that maximal amount of accumulated biomass (ADB=10.37±0.52 g/L; GI=2.13±0.05) and exopolysaccharide content (3.44±0.20 g/L) were achieved when the culture was cultivated on Gamborg B5 medium, whereas, when grown on Murashige and Skoog medium the biomass was significantly lower (ADB=0.21±0.11 g/L; GI=0.06±0.03). It worth noting, that there was no significant difference in total phenolic content between the cells grown on B5, WP and MS media. The reported results are the base for further development of black chokeberry cell suspension culture as alternative platform for sustainable production of valuable food additives.

Keywords: Cellular agriculture, Sustainable production, Black chokeberry, Exopolysaccharides, Nutrient media,

INTRODUCTION

Black chokeberry (*Aronia melanocarpa* [Michx.] Elliot) is a shrub that produces edible black colored berries. The plant belongs to the Rosaceae family and originates from North America and East Canada. Nowadays is widely cultivated in Europe, Russia and China (Kulling and Rawel, 2008). The fruits of *Aronia* are among the richest source of antioxidants and colorants among all berries (Sidor and Gramza-Michałowska, 2019). Moreover, the fruits contains high amount of dietary fibers and polysaccharides with interesting medicinal properties (Kulling and Rawel, 2008, Zhao et al., 2021, Oziembłowski et al., 2022, Zhao et al., 2022, Wen et al., 2023).

Cellular agriculture, an technology for controlled and sustainable manufacture of agricultural products by using single cells and tissues without involving plants or animals, is attracting lot of attention over the past decade (Eibl et al., 2021). Large scale cultivation of plant cells, tissues and organs was proved to be highly efficient eco-friendly technology for production of active ingredients for cosmetics, pharmacy and foods (Georgiev et al., 2018). The fast advance in the field now allows plant cells from different species to be used for commercial

production of biomass, phytochemicals and plant-derived technical goods (Krasteva et al., 2021). However, the optimal composition of nutrient medium is one of the key factors, responsible for productivity and economical effectiveness of the process (Ananga et al., 2013). Among many commercially available formulations, there are three widely used basal media for cultivation of plant cells - Murashige and Skoog (MS), WP (Woody Plant) or Gamborg B5 (B5) media. The basic differences between them is the amount of nitrogen and the ratio between ammonia and nitrate sources, as well as the amount of calcium and vitamin composition (Ananga et al., 2013, Krasteva, 2022). The optimal composition of basal medium varies for different plant species and has to be determined experimentally.

This study was conducted to determine the effect of basal nutrient medium on biomass, exopolysaccharide production and phenolic antioxidants accumulation by cell suspension of *Aronia melanocarpa* (Michx.) Elliott (black chokeberry).

MATERIAL AND METHOD

Plant material

Aronia melanocarpa (Michx.) Elliott cell suspension culture was initiated from callus as described elsewhere (Krasteva et al., 2023). The cell suspension was cultivated on Woody Plant medium, supplemented with 30 g/L sucrose, 0.5 mg/L kinetin and 2.0 mg/L picloram, on orbital shaker at 110 rpm, on darkness. The cells were sub-cultured every 7 days. For the experiments, 7 days old cell suspension was centrifuged at 4000 rpm for 10 min in sterile 50 ml tubes and the cells were separated from the culture liquids. 20 grams of fresh cells were inoculated in 100 ml sterile Murashige and Skoog (MS), WP (Woody Plant) or Gamborg B5 (B5) media and cultivated for 7 days under the described conditions. The cell growth was evaluated on the base on Accumulated Dry Biomass (ADB, g/L) and Growth Index (GI).

Evaluation of exopolysaccharide production

The exopolysaccharides, secreted into the culture media, were determined by weight after precipitation with ethanol. The culture liquids, after the cells removal, were treated with 4 volumes of cooled ethanol (4°C) and kept in the fridge for 12 hours. The precipitated exopolysaccharides were filtrated under vacuum and dried at 50°C until reach constant weight.

Total phenolic content and antioxidant activity assays

Dry *Aronia* cell biomass was extracted in triplicate with 70% methanol under ultrasound (1:10 w/v). The combined methanol extracts were evaporated at 40°C under vacuum for methanol removal and the volume was adjusted to 10 ml with dH₂O. For purification of phenolic fraction, 5 ml of extracts were subject to solid phase extraction (C18 Strata, Phenomenex) following the manufacturer instructions. The phenolic fraction was eluted with 2 ml HPLC grade methanol and used for future analyses. The evaluation of total phenolic content was done by using Folin–Ciocalteu assay, whereas the evaluation of antioxidant activity was performed by using DPPH radical scavenging, TEAC (Trolox equivalent antioxidant capacity), FRAP (Ferric reducing antioxidant power), and CUPRAC (Cupric ion reducing antioxidant capacity) assays as described elsewhere (Krasteva et al., 2022). The results were expressed as mg gallic acid equivalents (GAE) per gram of dry biomass for total phenolics, and as μM Trolox equivalents (TE) per gram of dry biomass for antioxidant activity assays.

HPLC profiling and quantification of phenolic compounds

Methanol extracts from dry *Aronia* cell biomass were analyzed by High-performance liquid chromatography (HPLC) as described previously (Krasteva et al., 2022). The HPLC system consisted of a Waters 1525 Binary Pump, equipped with a Waters 2484 dual λ Absorbance Detector and Supelco Discovery HS C18 column (5 μm, 25 cm × 4.6 mm).

Statistical analyses

All data is presented as mean with standard deviations (\pm SD) of three independent biological experiments ($n = 3$). All spectrophotometric experiments were carried out in 8 technical repeats. The means were statistically compared using one-way ANOVA, with Tukey post hoc test. The differences between the means were considered significant for values of $p \leq 0.01$.

RESULTS AND DISCUSSION

Plant cell suspension of *A. melanocarpa* is homogenous and grow in high dens culture with maximum of biomass accumulation after 7 days of cultivation (Krasteva et al., 2023). When the basal medium was changed, the cells showed significantly different growth with visible changes in culture density (Figure 1).

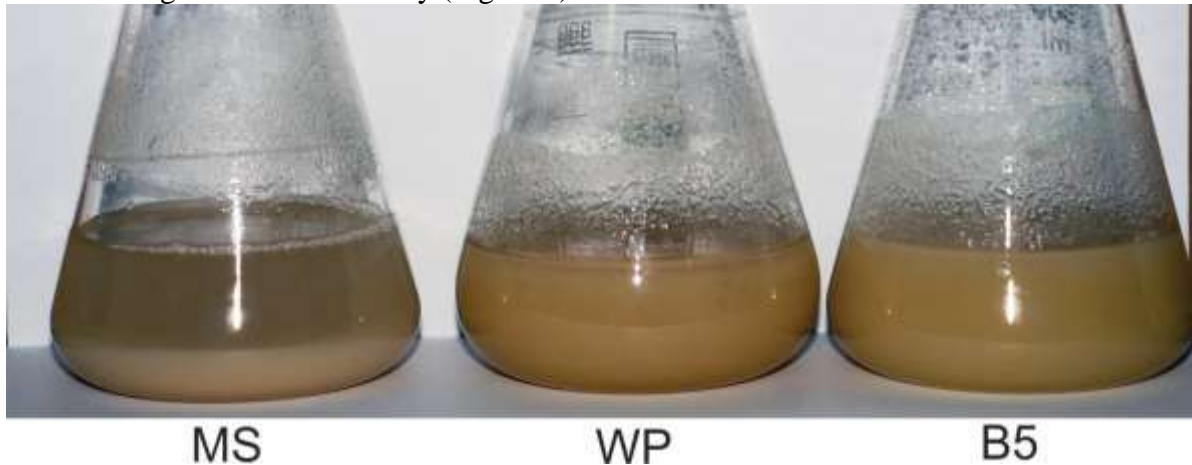

Figure 1. *Aronia* cell suspension culture, grown on Murashige and Skoog (MS), WP (Woody Plant) or Gamborg B5 (B5) media for 7 days

The *Aronia* cells growth was significantly decreased in MS medium ($ADB=0.21\pm 0.11$ g/L) when compared to WP and B5 media ($ADB=9.19\pm 1.43$ g/L and $ADB=10.37\pm 0.52$ g/L, respectively) (Figure 2A).

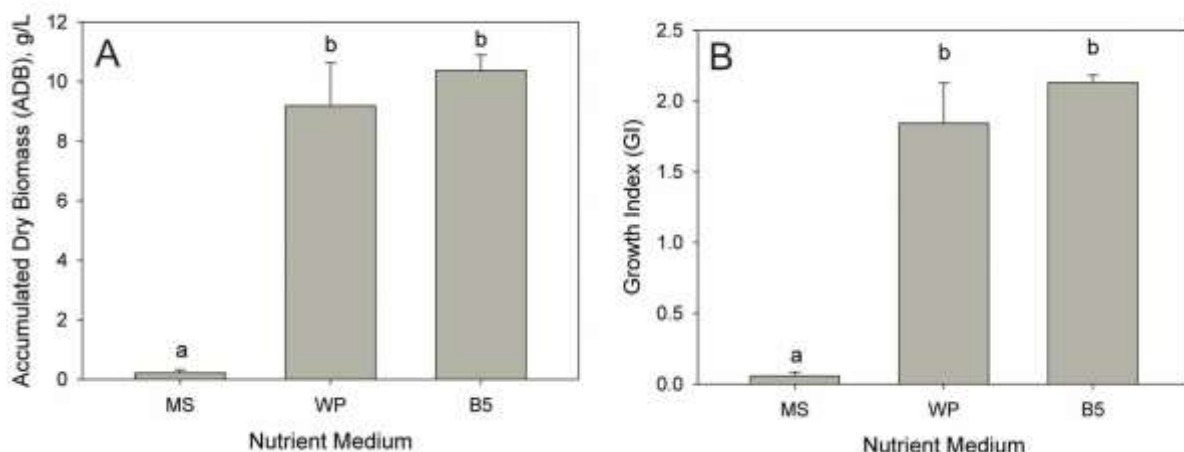

Figure 2. Accumulated Dry Biomass (A) and Growth Index (B) of *Aronia* cell suspension culture, grown on Murashige and Skoog (MS), WP (Woody Plant) or Gamborg B5 (B5) media for 7 days. The mean that do not share a letter were significantly different at $p \leq 0.01$ (one-way ANOVA with Tukey post hoc test, $n=3$).

The changes in growth index follows the changes in accumulated dry biomass ($GI=0.06\pm 0.03$, $GI=1.84\pm 0.28$ and $GI=2.13\pm 0.05$, for cells cultivated on MS, WP and B5

media) (Figure 2B). Study of cell morphology showed significant changes in cell shape and size, depending on the medium, used for they growth (Figure 3).

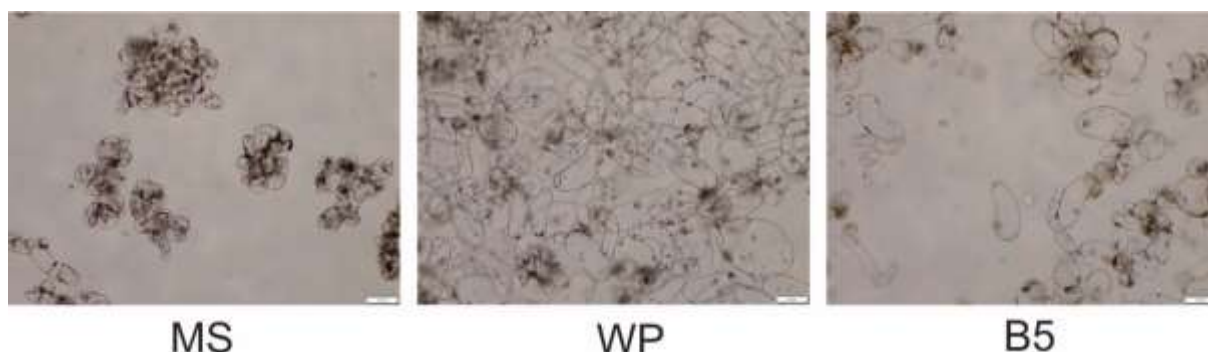

Figure 3. Light microscopy (Olympus CX23, 40x) of *Aronia* cell suspension culture, grown on Murashige and Skoog (MS), WP (Woody Plant) or Gamborg B5 (B5) media for 7 days

It is well known, that the ammonia/nitrate ratio, concentration of phosphates and calcium ions could have dramatic effect on biomass accumulation, cell morphology and secondary metabolite production of plant cells (Ananga et al., 2013). The results confirm that statement for *Aronia* cell suspension culture as well.

The composition of basal medium also affects the production of exopolysaccharides from cultured cells (Figure 4). The maximal amount of secreted polysaccharides was achieved when the cells were grown on B5 (3.44 ± 0.20 g/L) and WP (3.37 ± 0.04 g/L), whereas the amount was significantly lower (1.13 ± 0.03 g/L) when MS medium was used. It worth noting, that there is no significant differences in growth and exopolysaccharides production between *Aronia* cells grown on B5 and WP media in short term cultivation, but our future experiments showed that prolonged cultivation on B5 medium (more than 10 sub-culturing cycles) lead to cell arrest and block biomass accumulation, whereas on WP such negative effect was not observed.

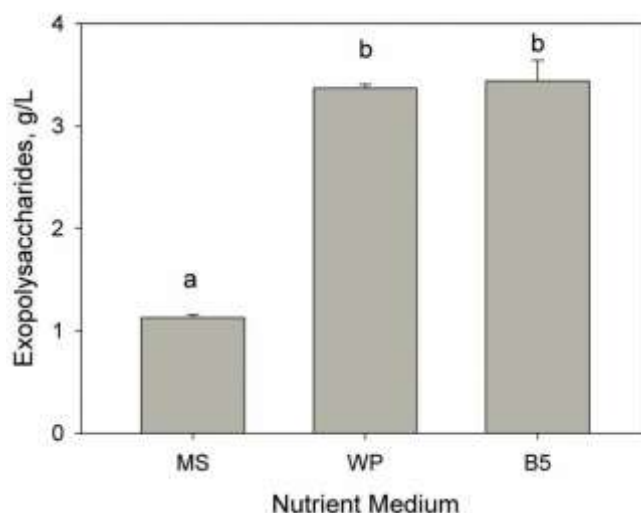

Figure 4. Accumulation of exopolysaccharides in culture medium by *Aronia* cell suspension culture, grown on Murashige and Skoog (MS), WP (Woody Plant) or Gamborg B5 (B5) media for 7 days. The mean that do not share a letter were significantly different at $p \leq 0.01$ (one-way ANOVA with Tukey post hoc test, $n=3$).

The HPLC fingerprint (Figure 5), showed dramatic differences in HPLC profiles of *Aronia* cells biomasses when cultured on different media.

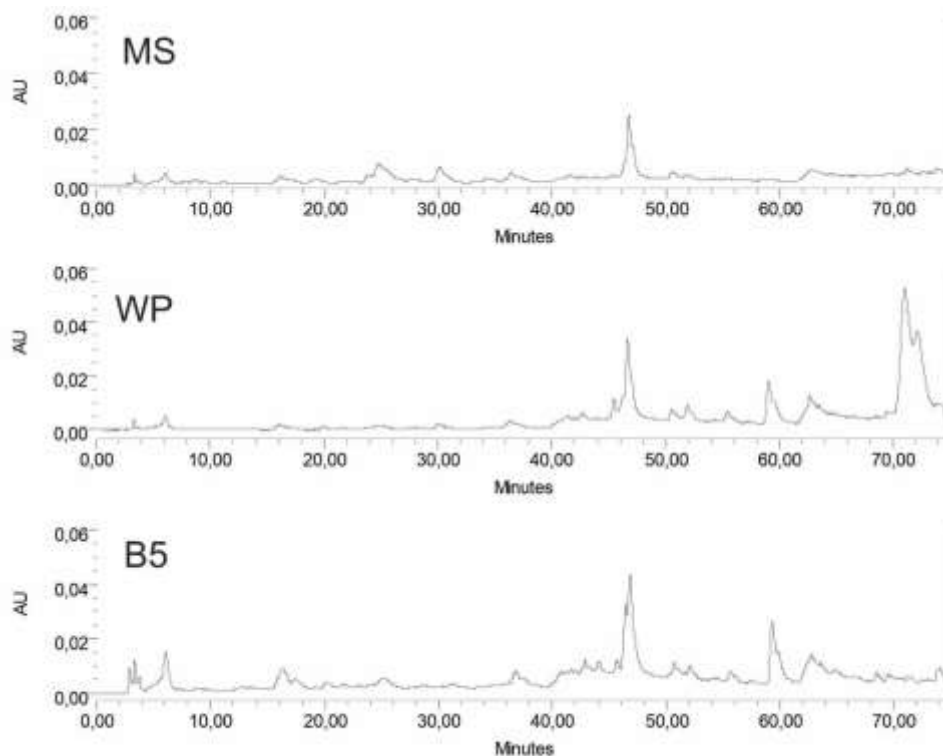

Figure 5. HPLC fingerprint (280 nm) of *Aronia* cell suspension culture, grown on Murashige and Skoog (MS), WP (Woody Plant) or Gamborg B5 (B5) media for 7 days

The quantitative analyses showed that *Aronia* cells accumulate highest amounts of chlorogenic acid, caffeic acid and (-)-epicatechin when cultivated on MS medium (Table 1). This could be explained with the fact that secondary metabolite production in plants is stimulated by the stress and the results showed that in MS medium the *Aronia* cells are exposed to higher stress and showed the slowest growth and highest morphological changes (Figure 1, 2 and 3).

Table 1. HPLC analyses of phenolics found in biomass of *Aronia* cell suspension culture, grown on Murashige and Skoog (MS), WP (Woody Plant) or Gamborg B5 (B5) media for 7 days. The mean that do not share a letter in columns were significantly different at $p \leq 0.01$ (one-way ANOVA with Tukey post hoc test, $n=3$).

Nutrient Medium	(+)-Catechin, $\mu\text{g/g DW}$	Chlorogenic acid, $\mu\text{g/g DW}$	Caffeic acid, $\mu\text{g/g DW}$	(-)-Epicatechin, $\mu\text{g/g DW}$	Salicylic acid, $\mu\text{g/g DW}$
MS	ND	49.41 ^a ±1.64	40.51 ^a ±5.82	65.26 ^a ±0.61	19.17 ^a ±0.69
WP	ND	ND	9.63 ^b ±1.43	28.27 ^b ±0.69	19.59 ^a ±10.01
B5	16.08 ^a ±0.87	9.87 ^b ±1.39	ND	25.83 ^b ±1.46	29.76 ^a ±3.07

Analyses of total phenolic content and antioxidant activities follow the tendency, observed with HPLC assay (Table 2). However, even some there is no significant differences between total phenolic content and antioxidant activities of extracts from *Aronia* cells when grown in different media. An exception are the CUPRAC and TEAC assays where is significant changes in activities. These methods are based on electron exchange and evaluate the potential of antioxidants to reduce cupric and ferric ions (Krasteva et al., 2022). The observed differences could be explained with possible differences in phenolic composition of investigated extracts

(supported by chromatograms, presented in Figure 5), rather than by the observed differences in phenolic concentrations.

Table 2. Total phenolic content and antioxidant activities of extracts from biomass of *Aronia* cell suspension culture, grown on Murashige and Skoog (MS), WP (Woody Plant) or Gamborg B5 (B5) media for 7 days. The mean that do not share a letter in columns were significantly different at $p \leq 0.01$ (one-way ANOVA with Tukey post hoc test, $n=3$).

Nutrient Medium	Total Phenolic, mg GAE/g DW	CUPRAC, $\mu\text{M TE/g DW}$	FRAP, $\mu\text{M TE/g DW}$	DPPH, $\mu\text{M TE/g DW}$	TEAC, $\mu\text{M TE/g DW}$
MS	0.95 ^a ±0.33	9.87 ^a ±0.90	2.54 ^a ±0.19	2.34 ^a ±0.14	0.15 ^c ±0.05
WP	0.84 ^a ±0.09	9.15 ^{ab} ±0.98	2.21 ^a ±0.27	2.12 ^a ±0.37	0.30 ^a ±0.04
B5	0.75 ^a ±0.10	8.24 ^b ±0.74	2.25 ^a ±0.20	2.17 ^a ±0.22	0.22 ^b ±0.03

CONCLUSIONS

Composition of basal media has strong effect on biomass accumulation, exopolysaccharide production and accumulation of phenolic and antioxidant compounds in *Aronia* cell suspension culture. The Murashige and Skoog (MS) suppress the culture growth and exopolysaccharide production but stimulate the accumulation of phenolic compounds, probably in response to stress. B5 medium provide maximal biomass production, but there is no significant differences compared to WP medium in short term cultivation. However, prolonged cultivation on B5 medium (more than 10 sub-culturing cycles) inhibited cells growth, whereas such negative effect was not observed on WP medium. The reported results are the base for further development of black chokeberry cell suspension culture as alternative platform for sustainable production of valuable food additives.

ACKNOWLEDGEMENTS

This work was supported by the Bulgarian National Science Fund, Bulgarian Ministry of Education and Science, under the contract KP-06-H66/14; BG-175467353-2022-04-0214-C01.

REFERENCES

- ANANGA, A., GEORGIEV, V., OCHIENG, J., PHILLS, B. & TSOLOVA, V. 2013. Production of Anthocyanins in Grape Cell Cultures: A Potential Source of Raw Material for Pharmaceutical, Food, and Cosmetic Industries. *In: DANIJELA, P. & BARBARA, S. (eds.) The Mediterranean Genetic Code*. Rijeka: IntechOpen.
- EIBL, R., SENN, Y., GUBSER, G., JOSSEN, V., BOS, C. V. D. & EIBL, D. 2021. Cellular Agriculture: Opportunities and Challenges. *Annual Review of Food Science and Technology*, 12, 51-73.
- GEORGIEV, V., SLAVOV, A., VASILEVA, I. & PAVLOV, A. 2018. Plant cell culture as emerging technology for production of active cosmetic ingredients. *Engineering in Life Sciences*, 18, 779-798.
- KRASTEVA, G. Effect of basal medium on growth and polyphenols accumulation by *Gardenia jasminoides* Ellis cell suspension. BIO Web of Conferences, 2022. EDP Sciences, 02006.

- KRASTEVA, G., BERKOV, S., PAVLOV, A. & GEORGIEV, V. 2022. Metabolite Profiling of *Gardenia jasminoides* Ellis In Vitro Cultures with Different Levels of Differentiation. *Molecules*, 27, 8906.
- KRASTEVA, G., GEORGIEV, V. & PAVLOV, A. 2021. Recent applications of plant cell culture technology in cosmetics and foods. *Engineering in Life Sciences*, 21, 68-76.
- KRASTEVA, G., TENEVA-ANGELOVA, T., BADJAKOV, I., DINCHEVA, I., PAVLOV, A. & GEORGIEV, V. Plant cell culture technology as potential environmentally-safe alternative for sustainable production of food supplements. Biotechnology for a circular bioeconomy. European Federation of Biotechnology and Asian Federation of Biotechnology Virtual Conference, 28-29 March 2023 2023 on-line.
- KULLING, S. E. & RAWEL, H. M. 2008. Chokeberry (*Aronia melanocarpa*)– A Review on the Characteristic Components and Potential Health Effects. *Planta Med*, 74, 1625-1634.
- OZIEMBŁOWSKI, M., TRENKA, M., CZAPLICKA, M., MAKSIMOWSKI, D. & NAWIRSKA-OLSZAŃSKA, A. 2022. Selected Properties of Juices from Black Chokeberry (*Aronia melanocarpa* L.) Fruits Preserved Using the PEF Method. *Applied Sciences*, 12, 7008.
- SIDOR, A. & GRAMZA-MICHAŁOWSKA, A. 2019. Black Chokeberry *Aronia melanocarpa* L.—A Qualitative Composition, Phenolic Profile and Antioxidant Potential. *Molecules*, 24, 3710.
- WEN, X., QIN, X., HAN, Z., ZHAO, X., ABUDUAINI, G., CHENG, Z. & YU, H. 2023. Effects of Extraction Methods on the Structural Characteristics and Functional Properties of Insoluble Dietary Fiber Extracted from *Aronia melanocarpa*. *ACS Food Science & Technology*, 3, 666-674.
- ZHAO, Y., LIU, X., DING, C., ZHENG, Y., ZHU, H., CHENG, Z., ZHAO, C. & LIU, W. 2022. *Aronia melanocarpa* polysaccharide ameliorates liver fibrosis through TGF- β 1-mediated the activation of PI3K/AKT pathway and modulating gut microbiota. *Journal of Pharmacological Sciences*, 150, 289-300.
- ZHAO, Y., LIU, X., ZHENG, Y., LIU, W. & DING, C. 2021. *Aronia melanocarpa* polysaccharide ameliorates inflammation and aging in mice by modulating the AMPK/SIRT1/NF- κ B signaling pathway and gut microbiota. *Scientific Reports*, 11, 20558.

SOME TECHNOLOGICAL PROPERTIES AND BIOACTIVE COMPONENTS OF LEAVENED AND UNLEAVENED FLATBREADS SUBSTITUTED WITH GERMINATED MILLET FLOUR

Hilal ASLAN BAYRAKCI¹ Tekmile CANKURTARAN KÖMÜRÇÜ² Nermin BİLGİÇLİ²

¹Selçuk University, Karapınar Aydoğanlar Vocational School, Konya, Turkey

²Necmettin Erbakan University, Engineering Faculty, Food Engineering Department, Konya, Turkey

Corresponding author e-mail: hilalbayrakci@gmail.com

ABSTRACT

In this study, millet (*Panicum miliaceum* L.) was germinated for three days to improve bioactive components. Flour obtained from germinated millet was used at different ratios (0-20%) in the production of leavened and unleavened flatbread with replacing wheat flour. Control leavened and unleavened flatbreads were produced from wheat flour. Color, diameter, thickness, spread ratio, antioxidant activity (DPPH, FRAP and CUPRAC) and phenolic (free, bound and total) contents of all breads were determined. The use of high ratios of germinated millet flour (GMF) increased the diameter, and surface a* and b* color values of both. The bound, free and total phenolic content of leavened flatbread increased up to 2522.22 mg GAE/kg, 5250.83 mg GAE/kg and 7773.04 mg GAE/kg, respectively with 20% GMF usage. As the GMF ratio increased, antioxidant activity values (DPPH, FRAP and CUPRAC) of leavened and unleavened flatbreads were also increased. The highest phenolic contents and antioxidant activity values were achieved especially at the 20% GMF addition ratio.

Keywords: Germination, millet, leavened bread, unleavened bread, flatbread.

INTRODUCTION

Proso millet (*Panicum miliaceum* L.) is one of the oldest cereals. The caryopsis of millet is rich in carbohydrates, protein, mineral substances, and vitamins and its nutritive parameters are comparable or better than common cereals. Millet was richer in essential amino acids (leucine, isoleucine, methionine) than wheat. Functional components found in millet such as phenolic, antioxidant, beta-glucan and dietary fibers have positive effects on health and nutrition. On the other hand, some antinutritional factors such as phytic acid, oxalate, and tannins decrease the nutritional value of millet (Kalinova and Moudry, 2006; Kalinova, 2007). Germination is an economical and effective bioprocessing technique that increases digestibility and bioavailability of nutrients by reducing antinutritional factors. Germination results in the biosynthesis and accumulation of various secondary metabolites such as vitamin C, tocopherols, flavonoids, tocotrienols, γ -aminobutyric acid and phenolic compounds. Germinated grains have beneficial effects on health and free radical scavenging abilities (Koehler et al., 2007; Azeke et al., 2011; Kaur and Gill, 2020; Dhillon et al., 2020; Ceccaroni et al., 2020). There have been conducted many studies in the literature on the use of germinated cereals, legumes and pseudocereals in the preparation of cereal products (Torres et al., 2007; Tok, 2017; Zhu et al., 2017; Demir and Bilgiçli, 2020). In these studies, significant improvement in the nutritional and functional properties of end products has been determined with the use of germinated grains.

Bread is a cereal product that has an important place in meeting daily energy requirements. In recent years, interest in leavened and unleavened traditional flatbreads has increased. Various studies have been carried out to improve the nutritional and functional properties of these breads, which are commonly produced from refined wheat flour (Başman and Köksel, 1999, 2001; Coşkuner and Karababa, 2005; Levent et al., 2012; Levent and Bilgiçli, 2012a; Levent and Bilgiçli, 2012b; Madenci et al., 2012; Yıldız and Bilgiçli, 2012). In this study, the effect of GMF on some technological and functional properties of leavened and unleavened flatbreads was investigated.

MATERIAL AND METHOD

Materials

Millet was purchased from Taşan Ticaret, Konya, Turkey. Wheat flour, salt, baker's yeast and sugar were procured from a local market in Konya.

Germination of millet

The millet germination process was performed according to Parameswaran and Sadasivam (1994) and Li et al., (2017) with some modifications. The surfaces of the samples were sterilized by soaking in a solution of 1.0% aqueous sodium hypochlorite for 15 minutes at room temperature and then rinsed with distilled water. Before germination, the grains were soaked overnight in distilled water (at room temperature) and germinated in the dark for 4 days at room temperature. The germinated grain was dried in an oven at 45 °C for 12 h and milled (< 500 µm) on a laboratory grinder with a 100% extraction ratio.

Leavened and unleavened breadmaking

Leavened flatbread samples were prepared according to the method given by Akbaş (2000). Wheat flour (200 g), salt (3 g), sugar (2 g), fresh yeast (5 g) and water were used to control leavened flatbread production. Unleavened flatbread was prepared according to Başman and Köksel (2001). To control unleavened flatbread production, wheat flour (200 g), salt (3 g) and water were used. In other leavened and unleavened flatbread formulations, wheat flour was replaced with GMF at 5, 10, 15 and 20% ratios.

Color measurement

The color measurements of flatbreads were performed using a chromometer Minolta CR-400 (Minolta Camera, Co., Ltd., Osaka, Japan). Parameters L*, a* and b* determine a three-dimensional color space, in which L* indicates lightness (100 = white; 0 = black), a* values determine the redness (+) and greenness (-), and b* values determine yellowness (+) and blueness (-). Hue angle ($\arctan(b^*/a^*)$) and SI value ($((a^{*2}+b^{*2})^{1/2})$) was calculated.

Technologic properties

The diameter and thickness of leavened flatbread and unleavened flatbread samples were determined according to Yıldız and Bilgiçli (2012). The spread ratio values of samples were found by dividing the diameter to the thickness value of flatbreads.

Antioxidant activity and phenolic content

The antioxidant activity of leavened flatbread and unleavened flatbread samples was determined using 2,2-diphenyl-1-picrylhydrazyl (DPPH) radical scavenging assay (Gyamfi et al., 1999; Beta et al., 2005), ferric reducing antioxidant power assay (FRAP) (Yılmaz, 2019) and cupric ion reducing antioxidant activity assay (CUPRAC) (Apak et al., 2008). The free and bound phenolic content was determined based on the Folin-Ciocalteu colorimetric method as described by Naczki and Shahidi (2004). Total phenolic content was calculated as the sum of free and bound phenolic content. Phenolic content was expressed as gallic acid equivalents (mg of GAE/100 kg).

Statistical analysis

Leavened and unleavened flatbread results were analyzed separately. SPSS statistical program version 22.0 (SAS Institute Inc., Cary, NC, USA) was used for statistical data analysis. Mean values were compared with Duncan's multiple range test.

RESULTS AND DISCUSSION**Color values of leavened and unleavened flatbreads**

Color values of leavened and unleavened flatbread containing different ratios of GMF are shown in Table 1. Increasing usage ratios of GMF decreased the L* value of both bread types. For leavened flatbread, a* value increased in all GMF usage ratios, but for unleavened flatbreads, 10% or more GMF usage increased a* value. The reason for the decrease in lightness of the flatbread surface is probably due to the Maillard reaction. Increasing amylase and protease enzyme activity with germination causes the Maillard reaction by increasing the amount of free sugar and amino acids (Goesaert et al., 2009).

Table 1. Color values of leavened and unleavened flatbread containing different ratios of GMF

Leavened flatbread					
GMF (%)	L*	a*	b*	SI	Hue
0	79.01±0.31a	-4.95±0.05e	19.10±0.59c	104.52±0.29a	19.73±0.58c
5	74.19±0.12b	-4.22±0.13d	21.91±0.69b	100.92±0.65b	22.31±0.65b
10	72.99±0.99bc	-3.35±0.00c	22.45±0.38b	98.48±0.13c	22.70±0.37b
15	71.82±0.13c	-3.06±0.10b	24.57±0.80a	97.15±1.41cd	24.76±0.17a
20	69.37±0.43d	-2.77±0.17a	24.97±0.86a	96.31±0.24d	25.13±1.02a
Unleavened flatbread					
GMF (%)	L*	a*	b*	SI	Hue
0	77.89±0.24a	-4.41±0.20d	21.05±0.12c	101.88±0.51a	21.51±0.17c
5	75.76±0.05b	-3.84±0.28cd	23.84±0.12b	99.14±0.63b	24.15±0.16b
10	70.44±0.75c	-3.25±0.57bc	24.07±0.01b	97.70±1.31bc	24.30±0.07b
15	67.29±0.55d	-2.40±0.63b	24.78±1.37ab	95.51±1.11c	24.90±1.42ab
20	65.86±0.16e	-1.20±0.24a	26.41±1.17a	92.57±0.44d	26.46±1.16a

Means followed by the different letters within a column are significantly ($p < 0.05$) different. GMF: Germinated millet flour.

Marti et al. (2017) reported that the use of germinated wheat flour increased the crumb a*, crust a* and b* values but decreased the bread crumb and crust L* values. The use of GMF in both bread formulations increased the yellowness value and the highest values were reached with the use of 15-20% GMF. The high carotenoid pigment content of millet affected the b* value of flatbreads. While the SI values of the bread decreased with the use of GMF, the Hue values increased.

Technologic properties of leavened and unleavened flatbreads

The diameter, thickness and spread ratio values of leavened and unleavened flatbread containing different ratios of GMF are given in Table 2. The diameter of the leavened flatbreads ranged from 17.32 to 18.28 cm and there was a slight increase in the diameter value with the use of GMF. The diameter value of bread using only 20% GMF was significantly ($p < 0.05$) higher than the control bread. In unleavened flatbreads, the diameter value increased with the use of 10% or more GMF. The use of 15-20% GMF in leavened flatbreads decreased the

thickness value; on the other hand, all usage ratios of GMF decreased the thickness of unleavened flatbreads compared to control. High GMF usage ratios increased the spread ratio in leavened flatbreads and all GMF usage ratios in unleavened breads. Diluting gluten content with GMF addition may cause a decrease in thickness. There are numerous studies in the literature about decreasing the volume or thickness of breads with the substitution of non-gluten flours or bran (Sidhu et al., 2001; Gómez et al., 2012; Levent and Bilgiçli 2012a; Levent and Bilgiçli 2012b).

Table 2. Technologic properties of leavened and unleavened flatbread containing different ratios of GMF

Leavened flatbread			
GMF (%)	Diameter (cm)	Thickness (cm)	Spread ratio
0	17.32±0.16b	1.63±0.65a	10.63±0.05c
5	17.64±0.34ab	1.47±0.71ab	12.00±0.08bc
10	17.82±0.11ab	1.46±1.24ab	12.21±0.09bc
15	18.00±0.57ab	1.27±1.24bc	14.17±0.10ab
20	18.28±.11a	1.18±1.33c	15.49±0.18a
Unleavened flatbread			
GMF (%)	Diameter (cm)	Thickness (cm)	Spread ratio
0	24.48±0.45c	0.16±0.17a	154.94±2.12e
5	26.34±0.48c	0.12±0.20b	227.07±1.52d
10	30.28±0.68b	0.10±0.03bc	296.86±0.11c
15	31.62±0.31b	0.08±0.03c	405.38±1.94b
20	34.92±2.15a	0.07±0.06c	471.89±0.39a

Means followed by the different letters within a column are significantly ($p < 0.05$) different. GMF: Germinated millet flour.

Antioxidant activities of leavened and unleavened flatbreads

Antioxidant activities leavened and unleavened bread containing different ratios of GMF are presented in Table 5. DPPH, FRAP and CUPRAC antioxidant activity values for leavened bread ranged between 181.77-344.93 mg TE/kg, 0.54-1.39 $\mu\text{mol TE/g}$ and 3.61-8.34 $\mu\text{mol TE/g}$, and for unleavened bread changed between 152.89-300.91 mg TE/kg, 0.33-1.35 $\mu\text{mol TE/g}$ and 2.91-6.73 $\mu\text{mol TE/g}$, respectively. With the increasing use of GMF in leavened flatbreads, DPPH, FRAP and CUPRAC antioxidant activity values increased. In unleavened flatbreads, DPPH and CURAC values increased with increasing GMF ratio, while FRAP value increased with 10% or more GMF use. The highest antioxidant activity values were achieved with the use of 20% GMF in both bread types.

Table 5. Antioxidant activities leavened and unleavened flatbread containing different ratios of GMF

Leavened flatbread			
GMF (%)	DPHH (mg TE/kg)	FRAP (μmol TE/g)	CUPRAC (μmol TE/g)
0	181.77 \pm 1.39e	0.54 \pm 0.05e	3.61 \pm 0.05e
5	204.21 \pm 1.29d	0.67 \pm 0.02d	4.10 \pm 0.04d
10	232.13 \pm 0.00c	0.88 \pm 0.01c	5.20 \pm 0.14c
15	292.33 \pm 2.97b	1.02 \pm 0.02b	6.56 \pm 0.002b
20	344.93 \pm 1.40a	1.39 \pm 0.04a	8.34 \pm 0.27a
Unleavened flatbread			
GMF (%)	DPHH (mg TE/kg)	FRAP (μmol TE/g)	CUPRAC (μmol TE/g)
0	152.89 \pm 0.87e	0.33 \pm 0.08d	2.91 \pm 0.05e
5	187.20 \pm 1.45d	0.42 \pm 0.01d	3.74 \pm 0.05d
10	224.87 \pm 1.52c	0.84 \pm 0.05c	4.15 \pm 0.06c
15	240.18 \pm 1.38b	0.96 \pm 0.02b	5.03 \pm 0.02b
20	300.91 \pm 0.48a	1.35 \pm 0.01a	6.73 \pm 0.12a

Means followed by the different letters within a column are significantly ($p < 0.05$) different. DPPH: 2,2-diphenyl-1-picrylhydrazyl radical scavenging (TE: Trolox equivalent). FRAP: Ferric reducing antioxidant power CUPRAC: Cupric ion reducing antioxidant capacity.

Phenolic contents of leavened and unleavened flatbreads

Phenolic contents of leavened and unleavened bread containing different ratios of GMF are given in Table 4. Bound, free and total phenolic content of leavened flatbread increased up to 2522.22 mg GAE/kg, 5250.83 mg GAE/kg and 7773.04 mg GAE/kg with GMF usage. All addition levels of GMF increased the bound, free and total phenolic content of leavened flatbread. Bound, free and total phenolic content of unleavened flatbreads increased with the use of GMF as in leavened flatbreads, and the highest values were reached with the use of 20% GMF.

There are many studies reporting an increase in antioxidant activity and phenolic content in cereals and legumes with germination (Demir and Bilgiçli, 2021; Alvarez-Jubete et al., 2010; Žilić et al., 2014; Swieca and Dziki, 2015; Cankurtaran-Kömürcü, 2021). Sharma et al. (2015) determined that the total phenolic content (free/bound) increased significantly with the germination of foxtail millet. Cankurtaran-Kömürcü, (2021) used germinated modern and primitive wheat in different ratios to produce bread (0, 5, 10, 15 and 20%) and noodles (0, 15, 30, 45 and 60%). It has been reported that germinated wheat significantly increased the antioxidant activity and phenolic content of bread and noodles. Demir and Bilgiçli (2021) used germinated quinoa flour at the rates of 0, 10, 20 and 30% in gluten-free pasta production and found that the antioxidant activity and phenolic content increased with increasing germinated quinoa flour.

Table 5. Phenolic contents of leavened and unleavened flatbread containing different ratios of GMF

Leavened flatbread			
GMF (%)	BPC (mg GAE/kg)	FPC (mg GAE/kg)	TPC (mg GAE/kg)
0	2095.60±20.86d	4167.68±16.22d	6263.28±37.08e
5	2264.83±12.87c	4523.44±26.27c	6788.27±13.40d
10	2336.61±6.52bc	4683.43±83.63c	7020.04±77.16c
15	2404.78±31.23b	4912.21±29.15b	7316.48±2.08b
20	2522.22±13.99a	5250.83±16.33a	7773.04±30.32a
Unleavened bread			
GMF (%)	BPC (mg GAE/kg)	FPC (mg GAE/kg)	TPC (mg GAE/kg)
0	2042.01±6.85e	4078.20±35.99d	6120.20±42.84e
5	2194.54±10.59d	4486.62±12.35c	6681.15±1.76d
10	2280.36±7.15c	4698.82±37.56b	6979.17±30.40c
15	2357.65±13.49b	4758.87±7.87b	7116.52±5.62b
20	2425.90±10.99a	5159.43±4.27a	7585.33±15.26a

Means followed by the different letters within a column are significantly ($p < 0.05$) different. BFC: Bound phenolic content, FPC: Free phenolic content TPC: Total phenolic content (GAE, gallic acid equivalent).

CONCLUSIONS

In this study, the effects of GMF on the technological properties and bioactive components of leavened and unleavened flatbreads were examined. The findings were evaluated separately for leavened and unleavened flat breads. While the increase in the use of GMF decreased the L* and SI values of the bread, it increased the a*, b* and Hue values. While higher a* and b* color values were determined in unleavened bread samples compared to leavened breads, lower L* values were generally measured. Especially high utilization ratios of GMF increased the spread ratio values of the both breads. As predicted, unleavened flatbreads were determined as breads with higher diameter and spread ratio than leavened flatbreads. The use of GMF in flatbread production significantly ($p < 0.05$) increased DPPH, FRAP and CUPRAC antioxidant activity values. The highest antioxidant activity values were obtained with the use of 20% GMF. In addition, it was determined that the amount of free, bound and total phenolic content increased in both bread types with the use of GMF, and these values reached the highest amounts at the highest use of GMF. Utilization of 20% GMF resulted in the greatest redness, yellowness, diameter, spread ratio value and bioactive components of the breads.

REFERENCES

- Akbaş, B.E. 2000. Mısır ekmeğinin bazı özellikleri ve yapım yöntemlerinin fitik asit miktarı üzerine etkileri. MSc thesis, Ankara University, Ankara, Turkey, 63 pp.
- Alvarez-Jubete, L., Wijngaard, H., Arendt, E. K., Gallagher, E. 2010. Polyphenol composition and in vitro antioxidant activity of amaranth, quinoa buckwheat and wheat as affected by sprouting and baking. *Food Chemistry*. 119 (2), 770-778.
- Apak, R., Güclü, K., Özyürek, M., Celik, S. E. 2008. Mechanism of antioxidant capacity assays and the CUPRAC (cupric ion reducing antioxidant capacity) assay. *Microchimica Acta*. 160 (4), 413-419. DOI 10.1007/s00604-007-0777-0.
- Azeke, M. A., Egielewa, S. J., Eigbogbo, M. U., Ihimire, I. G. 2011. Effect of germination on the phytase activity, phytate and total phosphorus contents of rice (*Oryza sativa*), maize (*Zea mays*), millet (*Panicum miliaceum*), sorghum (*Sorghum bicolor*) and wheat (*Triticum aestivum*). *Journal of Food Science and Technology*. 48 (6), 724-729.

- Başman, A., Köksel, H. 1999. Properties and composition of Turkish flatbread (bazlama) supplemented with barley flour and wheat bran. *Cereal Chemistry*. 76: 506-511.
- Başman, A., Köksel, H. 2001. Effects of barley flour and wheat bran supplementation on the properties and Turkish flatbread, yufka. *European Food Research and Technology*. 212: 198-202.
- Beta, T., Nam, S., Dexter, J. E., Sapirstein, H. D. 2005. Phenolic content and antioxidant activity of pearled wheat and roller-milled fractions. *Cereal Chemistry*. 82 (4), 390-393. <https://doi.org/10.1094/CC-82-0390>.
- Cankurtaran-Kömürcü, T. 2021. Çimlendirilmiş bazı ilkel buğdayların fonksiyonel özellikleri ile erişte ve ekmek üretiminde kullanılabilirliklerinin araştırılması. Necmettin Erbakan Üniversitesi Fen Bilimleri Enstitüsü, Dr. Tezi, Konya
- Ceccaroni, D., Alfeo, V., Bravi, E., Sileoni, V., Perretti, G. Marconi, O. 2020. Effect of the time and temperature of germination on the phenolic compounds of *Triticum aestivum*, L. and *Panicum miliaceum*, L. *LWT - Food Science and Technology*. 127, 109396.
- Coşkun, Y., Karababa, E. 2005. Studies on the quality of Turkish flatbreads based on blends of triticale and wheat flour. *International Journal of Food Science and Technology*. 40: 469-479.
- Demir, B., Bilgiçli, N. 2020. Changes in chemical and anti-nutritional properties of pasta enriched with raw and germinated quinoa (*Chenopodium quinoa* Willd.) flours. *Journal of Food Science and Technology*. 57 (10), 3884-3892.
- Demir, B., Bilgiçli, N. 2021. Utilization of quinoa flour (*Chenopodium quinoa* Willd.) in gluten-free pasta formulation: effects on nutritional and sensory properties. *Food Science and Technology International*. 27 (3), 242-250.
- Dhillon, B., Choudhary, G., Sodhi, N. S. 2020. A study on physicochemical, antioxidant and microbial properties of germinated wheat flour and its utilization in breads. *Journal of Food Science and Technology*. 57 (8), 2800-2808. <https://doi.org/10.1007/s13197-020-04311-x>.
- Goesaert, H., Slade, L., Levine, H., Delcour, J. A. 2009. Amylases and bread firming—an integrated view. *Journal of Cereal Science*. 50(3), 345–352.
- Gómez, M., González, J., Oliete, B. 2012. Effect of extruded wheat germ on dough rheology and bread quality. *Food Bioprocess Technology*. 5: 2409-2418.
- Gyamfi, M. A., Yonamine, M., Aniya, Y. 1999. Free radical scavenging action of medical herbs from ghane: *Thonningia sanguinea* on experimentally-induced liver injuries. *General Pharma*. 32 (6), 661-667. [https://doi.org/10.1016/S0306-3623\(98\)00238-9](https://doi.org/10.1016/S0306-3623(98)00238-9).
- Kalinova, J. 2007. Nutritionally important components of Proso millet (*Panicum miliaceum* L.). *Food*. 1(1)94-100
- Kalinova, J., Moudry, J. 2006. Content and Quality of Protein in Proso Millet (*Panicum miliaceum* L.) Varieties. *Plant Foods for Human Nutrition*. 61, 43–47
- Kaur, H. A., Gill, B. S. 2020. Comparative evaluation of physicochemical, nutritional and molecular interactions of flours from different cereals as affected by germination duration. *Journal of Food Measurement and Characterization*. 14 (3), 1147-1157. <https://doi.org/10.1007/s11694-019-00364-5>.
- Koehler, P., Hartmann, G., Wieser, H., Rychlik, M. 2007. Changes of folates, dietary fiber, and proteins in wheat as affected by germination. *Journal of Agricultural and Food Chemistry*. 55(12), 4678–4683. <https://doi.org/10.1021/jf0633037>
- Levent, H., Bilgiçli, N. 2012a. Bazı baklagil unlarının geleneksel düz ekmeğin fiziksel, kimyasal ve duyusal özelliklerine etkisi. In: Proceedings of the 11th Gıda Kongresi, 10-12 October 2012, Hatay, Turkey, pp. 484.

- Levent, H., Bilgiçli, N. 2012a. Bazı baklagil unlarının geleneksel düz ekmeğin fiziksel, kimyasal ve duyuşsal özelliklerine etkisi. In: Proceedings of the 11th Gıda Kongresi, 10-12 October 2012, Hatay, Turkey, pp. 484.
- Levent, H., Bilgiçli, N. 2012b. Evaluation of physical, chemical and sensory properties of turkish flatbreads (bazlama and yufka) supplemented with lupin, buckwheat and oat flours. *International Journal of Food Science and Nutrition Engineering*. 2: 89-95.
- Levent, H., Bilgiçli, N. 2012b. Evaluation of physical, chemical and sensory properties of turkish flatbreads (bazlama and yufka) supplemented with lupin, buckwheat and oat flours. *International Journal of Food Science and Nutrition Engineering*. 2: 89-95.
- Levent, H., Bilgiçli, N., Madenci, B. 2012. The usage of resistant starch in traditional flatbreads, bazlama, lavash and yufka. In: Proceedings of III. Geleneksel Gıdalar Sempozyumu, 10-12 May 2012, Konya, Turkey, pp. 303-306.
- Li, C., Oh, S. G., Lee, D. H., Baik, H. W., & Chung, H. J. 2017. Effect of germination on the structures and physicochemical properties of starches from brown rice, oat, sorghum, and millet. *International journal of biological macromolecules*. 105, 931-939.
- Madenci, B., Türker, S., Bilgiçli, N. 2012. Effect of some dairy by-product on physical, chemical and sensory properties of lavash bread. In: Proceedings of III. Geleneksel Gıdalar Sempozyumu, 10-12 May 2012, Konya, Turkey, pp. 309-312
- Marti, A., Cardone, G., Nicolodi, A., Quaglia, L., Pagani, M. A. 2017. Sprouted wheat as an alternative to conventional flour improvers in bread-making. *LWT-Food Science and Technology*. 80, 230–236.
- Naczki, M., Shahidi, F. 2004. Extraction and analysis of phenolics in food. *Journal of Chromatography A*. 1054(1-2), 95–111.
- Parameswaran, K. P., Sadasivam, S. 1994. Changes in the carbohydrates and nitrogenous components during germination of proso millet, *Panicum miliaceum*. *Plant foods for human nutrition*. 45, 97-102.
- Sharma, S., Saxena, D. C., Riar, C. S. 2015. Antioxidant activity, total phenolics, flavonoids and antinutritional characteristics of germinated foxtail millet (*Setaria italica*). *Cogent Food & Agriculture*, 1(1), 1081728.
- Sidhu, J.S., Al-Hooti, S.N., Al-Saqer, J.M., Al-Othman, A. 2001. Studies on the development of pan bread using raw wheat germ. *Journal of Food Quality*. 24: 235-247.
- Świeca, M., Dziki, D. 2015. Improvement in sprouted wheat flour functionality: Effect of time, temperature and elicitation. *International Journal of Food Sci & Tech.* 50(9), 2135-2142.
- Tok, H. 2017. Bazı tahıl ve baklagil çimlerinin ekmek ve bisküvi üretiminde kullanım olanakları, Yüksek Lisans Tezi, Necmettin Erbakan Üniversitesi Fen Bi.i Enst, Konya
- Torres, A., Frias, J., Granito, M., Vidal-Valverde, C. 2007. Germinated *Cajanus cajan* seeds as ingredients in pasta products: Chemical, biological and sensory evaluation. *Food Chemistry*. 101 (1), 202-211.
- Yıldız, G., Bilgiçli, N. 2012. Effects of whole buckwheat flour on physical, chemical, and sensory properties of flatbread, lavaş. *Czech Journal of Food Science*. 30: 534-540.
- Yılmaz, V. A. 2019. Effects of different cooking and drying methods on phenolic acids, carotenoids, and antioxidant activity of emmer (*Triticum turgidum* ssp. dicoccum) bulgur. *Cereal Chemistry*. 96(6), 1093-1102. <https://doi.org/10.1002/cche.10219>
- Zhu, L., Adedeji, A. A., Alavi, S. 2017. Effect of germination and extrusion on physicochemical properties and nutritional qualities of extrudates and tortilla from wheat. *Journal of Food Science*. 82 (8), 1867-1875.
- Žilić, S., Basić, Z., Hadži-Tašković Šukalović, V., Maksimović, V., Janković, M., Filipović, M. 2014. Can the sprouting process applied to wheat improve the contents of vitamins and phenolic compounds and antioxidant capacity of the flour? *International Journal of Food Science & Technology*. 49 (4), 1040-1047.

INVESTIGATION OF MORPHOMETRIC VARIATIONS ON *PTEROCHLOROIDES PERSICAE* (CHOLODKOVSKY, 1898) (HEMIPTERA: APHIDIDAE) DEPENDS ON HOST PLANT PREFERENCES

Gizem BAŞER¹, Gazi GÖRÜR¹, Özhan ŞENOL¹

¹ Niğde Omer Halisdemir University, Arts and Sciences Faculty, Biotechnology Department, Niğde, Türkiye

Corresponding author e-mail: gizem_baser@outlook.com

ABSTRACT

The brown peach aphid *Pterochloroides persicae* distributes in Southern Europe, North Africa, Southwest and Central Asia, Indonesia, Türkiye, India, and Pakistan. This aphid species cause serious damage to *Prunus* members (*Prunus persica*, *P. dulcis*, *P. domestica*, *P. armeniaca*, *P. salicina*). Although they show both holocyclic and anholocyclic life cycles, this species shows monoecious holocyclic life cycles in cooler climates. In recent years, it gradually widened its geographic distribution and prompted more financial destruction, becoming an important threat to peach and almond trees. So far, there is no study has been conducted in Türkiye with *P. persicae* related to its host plant preference or agricultural importance. The speciation process of *P. persicae* populations might occur based on their host plant preferences. In this context, this study aimed to find out morphometric variations of *P. persicae* depending on host plant usage. The study was conducted in Adıyaman, Malatya, Şanlıurfa, Afyonkarahisar, Kütahya, Uşak, Antalya, Muğla, Karaman, Erzurum, and Niğde provinces, and the samples collected from *Prunus* spp. The 25 morphometric characters were evaluated for statistical analyses from 228 aptera individuals of *P. persicae*. As a result of the study, 23 morphometric characters. It was determined that host plant preference plays an important role in morphological variations observed in *Pterochloroides persicae* populations.

Keywords: Morphological variation, *Prunus* spp, *Pterochloroides persicae*, Türkiye

INTRODUCTION

Aphids are obligate phytophagous insects that feed on plant sap. They have economic importance in terms of direct damage to the plant and indirectly as carriers of various plant viruses. Therefore, aphids are closely related to the host plant (Blackman and Eastop, 2023). Aphids show a great deal of phenotypic plasticity. Phenotypic plasticity has been shown to be very important for aphids to adapt to new host plants, to bring about new reproductive strategies and especially in the speciation of aphids (Görür, 2005). In aphids, the state of physiological and morphological characteristics of the host species, its locality, the effects of biotic and abiotic conditions may cause morphological differences in the same species. Studies have shown that aphids can show differences in morphological characters to adapt to environmental conditions (Hales et al., 2010; Siddiqui et al. 2019; Nibouche et al., 2021).

Brown peach aphid *Pterochloroides persicae* is a pest of *Prunus* spp. Although they show both holocyclic and anholocyclic life cycles depending on environmental conditions, this species shows monoecious holocyclic life cycles in colder climates (Talhouk, 1977; Blackman and Eastop, 2023). It is distributed in southern Europe, North Africa, south-west and central Asia, India, Pakistan and Indonesia and has recently increased its distribution and has become a significant threat to peach and almond trees in Romania and Tunisia (Blackman and Eastop, 2023). *P. persicae* has caused weakening of young fruit trees, drying of branches, reduction in

yield and mould formation due to honeydew (Cross and Poswal, 1996; Moya, 2014; Mdellel, 2015). In addition, biotic and abiotic factors have caused changes in the growth and development period of *P. persicae* (Müller et al. 2001; Mdellel et al. 2011). The effect of host plant on the morphology of *P. persicae* has been reported in studies (Mdellel and Kamel, 2015; Mdellel et al, 2011).

In this study, it was aimed to reveal possible morphological differences due to different host preferences of *Pterochloroides persicae* feeding on *Prunus* spp. (*P. persica*, *P. dulcis*, *P. domestica*, *P. armeniaca*, *P. salicina*).

MATERIAL AND METHOD

Samples of *Pterochloroides persicae* preferring *Prunus persica*, *P. dulcis*, *P. domestica*, *P. armeniaca* and *P. salicina* host plants distributed in Adıyaman, Malatya, Şanlıurfa, Afyonkarahisar, Kütahya, Uşak, Antalya, Muğla, Karaman, Erzurum and Niğde provinces were performed. The samples were taken in eppendorf tubes containing 96 % ethyl alcohol and then prepared according to Martin (1983). After, the identification of the specimens was made according to the identification keys offered by Blackman and Eastop, 2023. Morphometric measurements of 3-4 wingless adult individuals suitable for morphometric analysis from each of the colonies in 5 different host plants were made under OLYMPUS BX51 brand microscope. Measurements of 25 morphological characters belonging to a total of 228 individuals were carried out. Measured characters are;

Body Length (BL), Body Width (BW), Total Antenna Length (AL), Antenna 1st segment length (A1L), Antenna 2 st segment length (A2L), Antenna 3 st segment length (A3L), Antenna 4 st segment length (A4L), Antenna 5 st segment length (A5L), Length of the 6 st Antenna Segment Processus Terminalis (A6PT), Length of the 6 st Antennal Segment Base (A6BASE), Length of segments IV and V of the rostrum (URSL), Rostrum segment IV width (URSW), Cauda length (CL), Caud Width (CW), Diameter of Siphunculi (SIP BD), Hind tarsus I. segment length (HTI), Hind tarsus II. segment length (HTII), Hind Femur Length (HFL), Hind Femur Width (HFW), Fore Femur Length (FFL), Fore Femur Width (FFW), Hind Tibia Length (HTL), Longest hair length of antennal 3 st segment (A3HL), Antenna 5 primary rhinaria width (A5RW), Antenna 6 primary rhinaria width (A6RW)

Canonical Analysis of Variance (CVA) was performed to determine the principal components of variation in morphological data. One-way Analysis of Variance (ANOVA) and Multiple Comparison Analysis (Tukey-HSD Test) were evaluated to determine the possible effects of the host plant on the morphological characteristics of *Pterochloroides persicae* members. SPSS ver 26.0 package programme was used for statistical analyses.

RESULTS AND DISCUSSION

Measurements of 25 morphological characters of 228 individuals of *Pterochloroides persicae* collected from 5 different host plants (*Prunus persica*, *P. dulcis*, *P. domestica*, *P. armeniaca*, *P. salicina*) were carried out.

Morphometric variations depending on the host plant

As a result of the evaluation of the obtained morphological characters, it was determined that the measured characters of the population sampled in the *Prunus armeniaca* host were shorter than other populations characters. These variations among *P. persicae* populations were tested by applying One-Way Analysis of Variance (ANOVA). In 22 of the 25 characters

measured, it was observed that the host plant caused statistically significant differences on *P. persicae* populations (Table 1).

Table 1. Differences among morphological characters (ANOVA) of *Pterochloroides persicae* populations collected on different host plants, *Prunus* spp. (P < 0.05)

	Sum of Squares		F	P
	Between groups	Within groups		
BL	5,958	59,887	5,547	,000
BW	1,689	34,936	2,696	,032
AL	,436	3,191	6,998	,000
A1L	,002	,031	2,665	,033
A2L	,001	,007	4,947	,001
A3L	,067	1,163	3,030	,019
A4L	,015	,133	6,035	,000
A5L	,021	,087	12,008	,000
A6BASE	,002	,033	3,252	,013
URSL	,002	,034	2,849	,025
CL	,004	,074	2,955	,021
SIPBD	,372	1,839	11,133	,000
HTI	,001	,008	6,203	,000
HTII	,012	,059	10,759	,000
FFL	,262	2,448	5,709	,000
FFW	,015	,097	8,149	,000
HFL	1,064	7,753	7,202	,000
HFW	,019	,094	10,632	,000
HTL	4,616	28,115	8,538	,000
A3HL	,000	,005	3,621	,007
A5RW	,001	,007	3,713	,006
A6RW	,001	,005	7,054	,000

Following the differences detected by applying ANOVA, Multiple Comparison Analysis (Tukey-HSD test) was performed. Especially, morphological features of the *Pterochloroides persicae* population collected on *Prunus armeniaca* differed from other populations. In addition to the overall differences in BL, there are also differences between *P. armeniaca* and *P. dulcis* (Tukey HSD[37.72]=-0.34, P=0.010), differences in BW between *P. armeniaca* and *P. domestica* populations (Tukey HSD[37.72]=-0.25, P=0.023), differences in AL between *P. armeniaca* and *P. salicina* (Tukey HSD[35.91]=-0,11, P=0.008) respectively. Moreover, there are differences in HTI between *P. armeniaca* and *P. dulcis* populations (Tukey HSD[34.63]=-0,00, P=0.001) and differences in HFL between *P. armeniaca* and *P. persica* (Tukey HSD[35.67]=-0,14, P=0.007). Furthermore, Canonical Vector obtained according to Wilk's lambda analysis is significant with P=0.00 and P=0.11 values and Function 1 (CV1) accounts for 39.5% of the variances; Function 2 (CV2) explains 35% of variances indicating strong host plant effects on morphological features of the *P. persicae* populations. Standardised Canonical Analysis of Variance (CVA) was also performed to determine the relative

significance of the characters used to separate the populations related with host plant usage. According to Canonical Vector 1 (CV1), the highest values belong to HFL (1,381), FFL (0,988), HFW (0,842); according to Canonical Vector 2 (CV2), the highest values belong to AL (1,058), A3L (0,604) and A5L (0,689).

The host plant influences on the morphometric characters was given graphically by discriminant function analysis. It was observed that *P. persicae* populations differed in morphometric characters depending on host plant preference, especially *P. armeniaca* clearly separated from others (Figure 1).

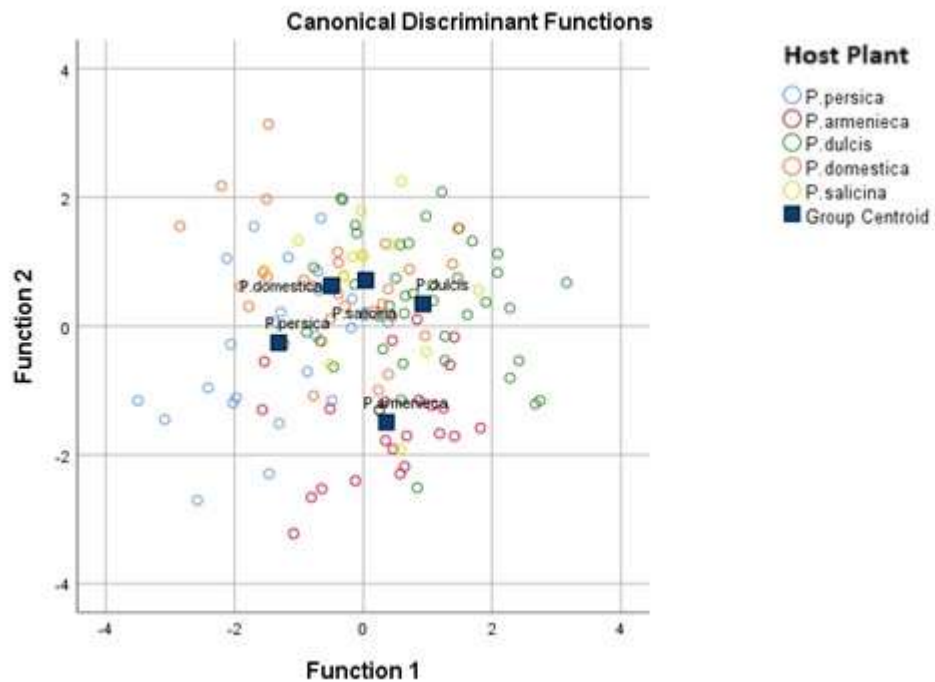

Figure 1. Classification of *Pterochloroides persicae* populations according to canonical discriminant function depending on host plant

CONCLUSIONS

In this study, *Pterochloroides persicae* populations feeding on 5 different host plants (*P. persica*, *P. armeniaca*, *P. dulcis*, *P. domestica*, *P. salicina*) were evaluated to reveal morphometric variations related with the host plant utilization. According to the results of ANOVA analyses, there are significant differences in 23 morphometric characters of the *P. persicae* populations sampled from 5 different host plants, *Prunus* spp. Hind femur length, total antenna length, fore femur length, hind femur width, antenna 3 and 5 length were the most differentiated characters in the differentiation of *P. persicae* populations on *Prunus* spp. Among 23 measured characters, 9 of the morphometric characters were incorporated for the first time when comparing *P. persicae* populations collected from different host plants. Findings of the presented study shown similar host plant effects with the previous studies. Adouani et al. (2021) measured 16 morphometric characters and among these characters, body length, body width, total antennal length, hind femur length showed a significant difference. Mdellel and Kamel (2015), 13 morphological characters were determined by ANOVA. Among them, there were significant differences in the length of antenna segments I, IV and V, body length and siphunculi diameter. Mdellel and Kamel (2015a), measured 12 morphometric characters and showed differences in 1 antennal segment, body length and cauda length. The host plant appears

to play an effective role in the morphology of the *P. persicae* population. This study is the first morphometric study on *P. persicae* populations, which is one of the important agricultural pests in Türkiye.

ACKNOWLEDGMENT

Authors thank to TUBITAK (Project number:115Z325, 119Z250) for partial support of the study.

REFERENCES

- Adouani, R. B., Mdellel, L., Kamel, M. B. H., Martinez, D. T. 2021. Morphology, genetics and biology of *Pterochloroides persicae* Cholodkovsky (Hemiptera: Lachninae) and their effect on *Pauesia antennata* Mukerji (Hymenoptera: Aphidinae) behaviour. *African Entomology*, 29(1), 59-68.
- Blackman, R. L., Eastop, V. F. 2023. Aphids of the world's plants. An online identification and information guide, <http://www.aphidsonworldsplants.info>.
- Cross, A. E., Poswal, M. A. 1996. Dossier on *Pauesia antennata* Mukerji. Biological Control Agent for the Brown Peach Aphid, *Pterochloroides persicae* in Yemen, International Institute of Biological Control.
- Görür, G. 2005. The importance of phenotypic plasticity in herbivorous insect speciation. In *Insect Phenotypic Plasticity*, 153-180. CRC Press.
- Hales, D., Footitt, R. G., Maw, E. 2010. Morphometric studies of the genus *Sitobion* Mordvilko 1914 in Australia (Hemiptera: Aphididae), *Australian Journal of Entomology*, 49(4), 341-353.
- Martin, J.H. 1983. The identification of common aphid pests of tropical agriculture, *Tropical Pest Management*, 29, 395-411.
- Mdellel, L., Kamel, M. B. H., Da Silva, J. A. T. 2011. Effect of Host Plant and Temperature on Biology and Population Growth of *Pterochloroides persicae* Cholodv (Hemiptera: Lachninae). *Pest technology*, 5(1), 74-78.
- Mdellel, L., Kamel, M. B. H. 2015. Effect of host plant on morphology of *Pterochloroides persicae* Cholodkovsky 1899 (Hemiptera, Aphididae), *J. Entomol. Zool. Stud.*, 3, 324-327.
- Mdellel, L., Kamel, M. B. H. 2015a. Morphometry and biological parameters of different instars of the giant brown peach aphid: *Pterochloroides persicae* Cholodkovsky 1899 (Hemiptera: Aphididae) in Tunisia. In *Annales de la Société entomologique de France* (NS), Taylor & Francis, 51(1), 4-9.
- Moya, L. 2014. *Pterochloroides Persicae*, Una plaga de reciente aparición, pulgón negro de las ramas.
- Müller, C. B., Williams, I. S., Hardie, J. 2001. The role of nutrition, crowding and interspecific interactions in the development of winged aphids, *Ecological Entomology*, 26(3), 330-340.
- Nibouche, S., Costet, L., Medina, R.F., Holt, J.R., Sadeyen, J., Zoogones, A-S., Brown, P., Blackman, R.L. 2021. Morphometric and molecular discrimination of the sugarcane aphid, *Melanaphis sacchari*, (Zehntner, 1897) and the sorghum aphid *Melanaphis sorghi* (Theobald, 1904), *PLoS ONE*, 16(3).
- Siddiqui, J.A., Zou, X., Liu, Q., Zhang, H., Lin, X., Huang, X. 2019. Functional Morphology and Defensive Behavior in a Social Aphid, *Insects*, 10(6), 163.
- Talhok, A. S. 1977. Contribution to the knowledge of almond pests in East Mediterranean countries. VI. The sap sucking pest, *Zeitschrift für Angewandte Entomologie* 83, 248–25.

EFFECT OF CAULIFLOWER POWDER ON THE CHEMICAL AND FUNCTIONAL PROPERTIES OF GLUTEN-FREE SNACK PRODUCT

Tekmile CANKURTARAN KÖMÜRÇÜ¹

¹*Necmettin Erbakan University, Engineering Faculty, Food Engineering Department, Konya, Turkey*

Corresponding author e-mail: tekmilecankurtaran@gmail.com

ABSTRACT

Cauliflower (*Brassica oleracea*) is one of the most important winter vegetables grown throughout the world and is widely used in food formulations due to its high nutritional quality. In this study, cauliflower powder (0-15%) was used in gluten-free gluten-free cracker formulations. Moisture, ash, protein, fat, antioxidant activity (DPPH, FRAP and CUPRAC) and phenolic (free, bound and total) contents of the cracker samples were determined. The use of cauliflower powder in the gluten-free cracker formulation increased the ash, fat, protein, antioxidant activity and phenolic content compared to the control gluten-free crackers. DPPH, FRAP and CUPRAC antioxidant activity values of control gluten-free crackers were found as 79.87 mg TE/kg, 1.47 $\mu\text{mol TE/kg}$ and 251.62 $\mu\text{mol TE/kg}$, respectively. Those antioxidant activity values were 477.21 mg/kg, 7.38 $\mu\text{mol TE/kg}$ and 478.48 $\mu\text{mol TE/kg}$ for gluten-free crackers containing 20% cauliflower powder. The total phenolic content of the control was determined as 2889.58 mg GAE/kg. In comparison, the same value was 5175.15 mg GAE/kg in containing 20% cauliflower powder gluten-free cracker samples. It was concluded that the use of cauliflower powder contributed to the improvement of the nutritional and functional properties of gluten-free crackers.

Keywords: Gluten-free cracker, vegetable powder, cauliflower, antioxidant activity, bioactive component.

INTRODUCTION

Vegetables have an important place in our daily diet due to their high dietary fiber, mineral matter, phenolic substances and antioxidant contents. The bioactive components of vegetables have an important role in the prevention of many diseases. Cauliflower (*Brassica oleracea* var. *botrytis* L.) is a vegetable of the cabbage group. Antioxidants (E, C and β -carotene), flavonoids, flavones and phenolic compounds of cauliflower have a protective effect against cancer (Sadik, 1962; Lin and Chang, 2005). Vegetables can be used for a long time by drying in seasons when their production is high. The obtained vegetable powders can be added to meals or evaluated in functional food formulations.

Cracker is a snack product with low nutritional and functional properties that is produced from refined flour. There are various studies in the literature on fortifying crackers and cookies with vegetables. In these studies, cabbage, broccoli, carrot, and tomatoes have been added into cracker or cookie formulation (Gül et al., 2013; Ahmad et al., 2016; Lafarga et al., 2019). There are limited studies on the use of cauliflower powder in cereal products. Cauliflower powder and other parts of cauliflower (stalk and leaves) were used in the production of wheat/rice crackers, cookies, bread and bakery products (El Sheikh et al., 2021; Ribeiro et al., 2015; Saleh, 2022) In this study, the effects of cauliflower powder on nutritional and functional properties of gluten-free crackers were investigated.

MATERIAL AND METHOD

Materials

Gluten-free cracker ingredients (rice flour, corn flour, shortening, salt, sugar, baking powder baker's yeast) and fresh cauliflower were obtained from local markets in Konya. Protease enzyme was procured from Vatan Enzyme (İstanbul, Turkey).

Preparation cauliflower powder

Fresh cauliflower was washed under running tap water, then cut into small pieces and dried in a dryer at 60 ± 2 °C for 12 hours. After drying, cauliflower samples were ground and passed through a 500 μ m sieve to obtain cauliflower powder.

Preparation of gluten-free crackers

The formulation of control gluten-free control cracker was 50 g rice flour, 50 g corn flour, 20 g shortening, 1.6 g salt, 1.5 g sugar, 1.5 g baking powder and 0.2 g baker's yeast. In other gluten-free crackers, formulations replace rice flour: corn flour (50:50) with 5, 10, 15 and 20% levels of cauliflower powders. Gluten-free cracker samples were prepared according to Davidson (2016) with small modifications. After baking, the gluten-free crackers were cooled and ground and then stored in polyethylene packaging until laboratory analysis.

Proximate composition, antioxidant activity and phenolic content

Moisture, ash, protein and fat content of the gluten-free cracker samples were determined according to AACC methods (AACC, 2000). The antioxidant activity of gluten-free cracker samples was determined using 2,2-diphenyl-1-picrylhydrazyl (DPPH) radical scavenging assay (Gyamfi, et al., 1999; Beta et al., 2005), ferric reducing antioxidant power assay (FRAP) (Yılmaz, 2019) and cupric ion reducing antioxidant activity assay (CUPRAC) (Apak et al., 2008). The free and bound phenolic content was determined based on Folin-Ciocalteu colorimetric method as described by Naczki and Shahidi (2004). Total phenolic content was calculated as the sum of free and bound phenolic content. Phenolic content was expressed as gallic acid equivalents (mg of GAE/100 kg).

Statistical analysis

All analyses were performed in duplicate. For statistical analysis, the JMP statistical program, version 10.0 (SAS Institute Inc., Cary, NC, USA) was used.

RESULTS AND DISCUSSION

Proximate compositions of gluten-free cracker samples are given in Table 1. The moisture content of the gluten-free cracker samples prepared in different amounts of cauliflower powder ranged between 4.02 and 6.48%. Cauliflower powder addition increased the moisture content of the gluten-free crackers and the highest value was obtained with 20% cauliflower powder addition. Increasing the amount of cauliflower powder ratio in gluten-free crackers significantly ($p < 0.05$) increased the ash content. Gluten-free crackers containing 20% cauliflower powder had 2.2 times higher ash content than control gluten-free crackers. The use of 10% or more cauliflower powder increased the fat content of gluten-free crackers. Increasing amount of cauliflower powder ratio also increased the protein content of gluten-free crackers up to 8.19% from 6.23%. El Sheikh et al. (2021) found ash protein and fat content of wheat crackers containing 25% cauliflower powder as 2.68, 14.82 and 2.94%, respectively. The same values were 0.79, 12.49 and 2.63% in the control cracker respectively. It has been reported that crackers containing 25% cauliflower powder provide a significant increase in the amount of ash and protein content compared to the control. Gül et al. (2013) used different ratios (%0-7.5) of white cabbage powder in cookie production and found that ash, fat and protein content between 1.06-1.50%, 19.68-20.30% and 4.35-4.93, respectively. In the present study, the chemical

properties of cauliflower powder, which is used as a raw material, are reflected in the final product.

Table 1. Proximate composition of gluten-free cracker samples

Cauliflower powder ratio (%)	Moisture (%)	Ash (%)	Fat (%)	Protein (%)
0	4.02±0.15c	1.14±0.02e	13.99±0.17c	6.23±0.14e
5	5.16±0.22b	1.44±0.02d	14.23±0.16c	6.70±0.03d
10	5.74±0.19ab	1.85±0.04c	14.74±0.11b	7.20±0.03c
15	6.13±0.18ab	2.11±0.02b	14.82±0.12ab	7.62±0.08b
20	6.48±0.71a	2.51±0.04a	15.09±0.15a	8.19±0.11a

Means with the same letter within a column are not significantly different ($p > 0.05$). Results are dry matter basis.

Antioxidant activities and phenolic contents of gluten-free cracker samples are presented in Table 2 and Table 3. The antioxidant activity values measured by all methods increased with the addition of cauliflower powder. DPPH, FRAP and CUPRAC antioxidant activity values of control gluten-free crackers were found as 79.87 mg TE/kg, 1.47 $\mu\text{mol TE/kg}$ and 251.62 $\mu\text{mol TE/kg}$, respectively. Those antioxidant activity values were 477.21 mg/TEkg, 7.38 $\mu\text{mol TE/kg}$ and 478.48 $\mu\text{mol TE/kg}$ for gluten-free crackers containing 20% cauliflower powder. The amount of antioxidant activity determined by the DPPH method of the cracker with 20% cauliflower powder increased 6 times compared to the control gluten-free cracker. DPPH, FRAP and CUPRAC antioxidant activity values of wheat flour and cauliflower powder which were used as raw material in cracker formulation were 115.81 mg TE/kg, 0.22 $\mu\text{mol TE/kg}$ and 4.71 $\mu\text{mol TE/kg}$; 2009.35 mg TE/kg, 14.53 $\mu\text{mol TE/kg}$ and 603.17 $\mu\text{mol TE/kg}$, respectively (data not shown). The higher antioxidant activity of cauliflower powder compared to wheat flour may have been effective in increasing antioxidant activity in cracker samples. Similarly, El Sheikh et al., (2021) reported that the amount of antioxidant activity in crackers increased with increasing use of cauliflower powder. Lafarga et al. (2019) found that the incorporation of broccoli co-products (12.5 and 15%) into crackers significantly increased the total phenolic content and antioxidant capacity.

Free, bound and total phenolic content of gluten-free crackers changed between 1722.46-2690.71 mg GAE/kg, 1425.06-2484.44 mg GAE/kg and 2889.58-5175.15 mg GAE/kg, respectively. Cauliflower powder addition was found significant ($p < 0.05$) on free, bound and total phenolic content of gluten-free crackers. As expected, the highest free, bound, and total phenolic content was found in the samples with 20% cauliflower powder. In a study, the total phenolic content of crackers produced with 0, 25, 50 and 75% cauliflower powder were reported as 0.75, 2.68, 3.62 and 5.75 Gallic acid g^{-1} , respectively (El Sheikh et al., 2021). With increasing cauliflower powder amount in the cracker, the amount of total phenolic content also increased significantly ($p < 0.05$). Free, bound and total phenolic content of wheat flour and cauliflower powder were found as 2393.86, 3351.41 and 5745.27 mg GAE/kg; 5759.30, 3164.83 and 8924.13 mg GAE/kg, respectively (data not shown). It is known that vegetables and fruits have high antioxidant activity and phenolic content. Since the cauliflower powder used in this study has high antioxidant activity and phenolic content, high increases were observed in the antioxidant activities and total phenolic content of crackers, especially with the high use ratios of cauliflower powder.

Table 2. Antioxidant activities of gluten-free cracker samples

Cauliflower powder ratio (%)	DPPH (mg TE/kg)	FRAP ($\mu\text{mol TE/g}$)	CUPRAC ($\mu\text{mol TE/g}$)
0	79.87 \pm 1.53d	1.47 \pm 0.10d	251.62 \pm 1.10e
5	117.13 \pm 9.41cd	5.16 \pm 0.14c	301.05 \pm 0.00d
10	153.83 \pm 21.82bc	4.83 \pm 0.47bc	345.30 \pm 1.49c
15	189.37 \pm 26.23b	6.32 \pm 0.86ab	400.66 \pm 2.59b
20	477.21 \pm 15.64a	7.38 \pm 0.11a	478.48 \pm 3.00a

Means with the same letter within a column are not significantly different ($p > 0.05$). DPPH: 2,2-diphenyl-1-picrylhydrazyl radical scavenging (TE: Trolox equivalent). FRAP: Ferric reducing antioxidant power CUPRAC: Cupric ion reducing antioxidant capacity.

Table 3. Phenolic contents of gluten-free cracker samples

Cauliflower powder ratio (%)	FPC (mg GAE/kg)	BPC (mg GAE/kg)	TPC (mg GAE/kg)
0	1722.46 \pm 27.72d	1425.06 \pm c13.48e	2889.58 \pm 23.58d
5	2138.40 \pm 14.69c	1543.05 \pm 25.70c	3681.45 \pm 11.02c
10	2274.16 \pm 15.77b	1981.02 \pm 21.47b	4359.14 \pm 26.78b
15	2366.00 \pm 62.81b	2055.62 \pm 16.63b	4421.63 \pm 16.96b
20	2690.71 \pm 14.68a	2484.44 \pm 8.57a	5175.15 \pm 23.25a

Means with the same letter within a column are not significantly different ($p > 0.05$). BFC: Bound phenolic content, FPC: Free phenolic content TPC: Total phenolic content (GAE, gallic acid equivalent). Results are dry matter basis.

CONCLUSIONS

In this study, the effects of cauliflower powder on some chemical and functional properties of gluten-free crackers were investigated. It was determined that the addition of cauliflower powder increased the amount of ash, fat and protein in gluten-free crackers, and the increase in ash content according to control was quite high. Antioxidant activity values of gluten-free cracker samples measured by different methods were significantly ($p < 0.05$) affected by the addition of cauliflower powder. The highest antioxidant activity values were obtained with the use of 20% cauliflower powder. As the cauliflower powder ratio increased in the gluten-free cracker formulation, there were significant ($p < 0.05$) increases in the amounts of free, bound and total phenolic contents. It has been determined that all usage ratios of cauliflower powder are effective in improving the nutritional and functional properties of gluten-free crackers, and there is a much greater increase in functional properties, especially at high usage ratios.

REFERENCES

- AACC, 2000. American Association of Cereal Chemists, Approved Methods of the AACC, 10th ed., St. Paul, MN, USA.
- Naczki, M., Shahidi, F. 2004. Extraction and analysis of phenolics in food. *Journal of Chromatography A*. 1054(1-2), 95–111.
- Apak, R., Güçlü, K., Özyürek, M., Celik, S. E. 2008. Mechanism of antioxidant capacity assays and the CUPRAC (cupric ion reducing antioxidant capacity) assay. *Microchimica Acta*. 160 (4), 413-419. DOI 10.1007/s00604-007-0777-0.
- Beta, T., Nam, S., Dexter, J. E., Sapirstein, H. D. 2005. Phenolic content and antioxidant activity of pearled wheat and roller-milled fractions. *Cereal Chemistry*. 82 (4), 390-393. <https://doi.org/10.1094/CC-82-0390>.

- Gyamfi, M. A., Yonamine, M., Aniya, Y. 1999. Free radical scavenging action of medical herbs from ghane: *Thonningia sanguinea* on experimentally-induced liver injuries. *General Pharma.* 32 (6), 661-667. [https://doi.org/10.1016/S0306-3623\(98\)00238-9](https://doi.org/10.1016/S0306-3623(98)00238-9).
- Yilmaz, V. A. 2019. Effects of different cooking and drying methods on phenolic acids, carotenoids, and antioxidant activity of emmer (*Triticum turgidum* ssp. *dicoccum*) bulgur. *Cereal Chemistry.* 96(6), 1093-1102. <https://doi.org/10.1002/cche.10219>
- Davidson, I. (2023). *Biscuit baking technology: processing and engineering manual*. Elsevier.
- Sadik, S. (1962). Morphology of the curd of cauliflower. *American Journal of Botany.* 49(3),290-297.
- Lin, C. H., Chang, C. Y. (2005). Textural change and antioxidant properties of broccoli under different cooking treatments. *Food chemistry.* 90(1-2), 9-15.
- Gül, H., Yanik, A., Acun, S. (2013). Effects of white cabbage powder on cookie quality. *Journal of Food, Agriculture & Environment.* 11(1), 68-72.
- Lafarga, T., Gallagher, E., Bademunt, A., Bobo, G., Echeverria, G., Viñas, I., Aguiló-Aguayo, I. (2019). Physiochemical and nutritional characteristics, bioaccessibility and sensory acceptance of baked crackers containing broccoli co-products. *International Journal of Food Science & Technology.* 54(3), 634-640.
- Ahmad, M., Wani, T. A., Wani, S. M., Masoodi, F. A., Gani, A. 2016. Incorporation of carrot pomace powder in wheat flour: effect on flour, dough and cookie characteristics. *Journal of Food Science and Technology.* 53, 3715-3724.
- Saleh, S. (2022). Quality Attributes of Shamy Bread Supplemented With Cauliflower Wastes. *Egyptian Journal of Food Science,* 50(1), 73-82.
- El Sheikh, D. M., Helal, M. S., Barakat, H. A. 2021. Improving the nutritional values of wheat and rice crackers by using cauliflowers. *Food and Nutrition Sciences.* 12(6), 643-658.
- Ribeiro, T. D. C., Abreu, J. P., Freitas, M. C. J., Pumar, M., Teodoro, A. J. 2015. Substitution of wheat flour with cauliflower flour in bakery products: effects on chemical, physical, antioxidant properties and sensory analyses. *International Food Research Journal.* 22(2), 532.

DETERMINATION OF MOLECULAR MARKER FOR SEEDLING EMERGENCE IN WATERMELON

Ömer Faruk COŞKUN^{1*}, Osman GÜLŞEN

Hatay Mustafa Kemal University, Faculty of Agriculture, Department of Horticulture, Hatay,
Türkiye

*Corresponding author's e-mail: omerfaruk.coskun@mku.edu.tr (Coskun, O.F.).

ABSTRACT

DNA markers associated with phenotype can be determined by establishing a connection between phenotype and genotype with the association mapping technique that emerged with the development of molecular techniques. In this study, DNA markers related to seedling emergence rate and time in watermelon were determined by using association mapping technique using 96 watermelon genotypes. According to the Q-Q plot graph, the best agreement between the expected and observed values was determined by the GLM (Q) method. In the GLM (Q) analyzes, 11 markers were found to be correlated at the $p < 0.01$ level. The model formed as a result of the back regression analysis included 3 markers (iPBS-2392.460, iPBS-2243.420 and iPBS-2081.500). The rate of explaining the seedling emergence of the model depending on these markers is 70.9%. Obtained marker information can be used in marker assisted selection studies.

Keywords: Watermelon, *Citrullus lanatus*, association mapping, seedling emergence

INTRODUCTION

Watermelon [*Citrullus lanatus* (Thunb.) Matsum. and Nakai] is one of the most important members of the Cucurbitaceae family. *C. lanatus* has spread around the world thanks to its delicious fruit flesh and has become one of the most consumed vegetable products. In terms of fresh vegetable production, watermelon production is among the top 5 in the world (Guo et al., 2013). For this reason, improvement studies are carried out continuously with the breeding method in watermelon.

One of the basic conditions to achieve early and high yield in vegetable production is to provide a uniform and fast seedling emergence. Generally, the period from planting to seedling emergence is critical for vegetable species grown from seed. Seedling emergence rate and seedling emergence time are important parameters in watermelon cultivation. Delays in seedling emergence can cause yield losses and significant disruptions in production. Even under optimum conditions, seedling emergence problems may occur in some genotypes and cultivars. Therefore, determining the genetic mechanism of seedling emergence is important for breeding.

Marker-assisted selection method shortens the breeding period and enables this process to be completed with less labor. Genetic markers are the most important factor that helps breeding studies in plants. Molecular markers are the most widely used techniques for genetic

characterization because of their advantages. Preliminary information has been obtained for breeding studies by using many marker techniques on plant genotypes and varieties (Karaman et al., 2018; Kıracı et al., 2022; Coşkun, 2022; Coşkun, 2023).

Marker development studies on important fruit and plant characters in watermelon are insufficient. In molecular breeding studies, it is aimed to identify genomic regions associated with phenotypic traits (Zhu et al., 2008). Quantitative trait locus (QTL) can be determined by detecting DNA markers associated with genes controlling important characters. Genetic mapping studies are carried out in plants to determine these regions. With the increase in genetic techniques, the association mapping method has been developed as an alternative to genetic link maps. With this method, phenotype-related markers can be determined using natural populations without the need for a long-time mapping population (Rafalski, 2010). In addition, with this method, more alleles can be obtained and map resolution increases (Yu and Buckler, 2006). As a result of evolutionary recombination and natural genetic diversity in relational mapping, high resolution maps can be obtained (Zhu et al., 2008). The aim of this study is to determine molecular markers associated to seedling emergence rate and time in watermelon, which is an important vegetable species.

MATERIAL AND METHODS

In the study, 96 genotypes were used. 94 of the genotypes have *C. lanatus* var. *lanatus*, 1 of them is *C. lanatus* var. *citroides* and 1 of them belong to the *P. fistulosus* species. The study was carried out in the greenhouse, molecular biology laboratories and trial field of Erciyes University, Faculty of Agriculture, Department of Horticulture. Morphological measurements were made in 3 replications and 7 times in each replication. For seedling emergence rates and time: Seed emergence rates and the number of days with the highest emergence rate were recorded in viols under controlled greenhouse conditions.

Seeds were sown in 2:1 peat perlite medium, and leaf samples were collected when the seedlings reached the stage with 2 true leaves. CTAP method was used for DNA isolation. PCR study was performed using ISSR, SSR and iPBS primers giving reliable bands. SPSS.22, Structure Harvester, Structure and Tassel 5.2 programs were used for the bioinformatic analysis of the obtained locus data. The LD level between loci, the combined marker data were obtained in the Tassel 5.2 program. Analyzes were performed after removing loci with low number of alleles ($f < 0.10$). In the association mapping study, the results obtained using the model containing three different statistical approaches were compared. By using different models, false positive results were eliminated and probability (P) probability values were determined for each marker associated with the feature of interest. The significance level between the marker and phenotypic traits was determined by the Tassel 5.2 program (Bradbury et al., 2007) based on the P values and the F test. The model with the best results was determined by obtaining the QQ (quantile quantile plot) graphs. Quantile Quantile Plot and Manhattan plots were obtained using Tassel 5.2. Regression analyzes were performed with the associated markers obtained by 3 different statistical methods with the Tassel 5.2 program. For this purpose, backward and forward regression models were used in SPSS.22 program.

RESULTS AND DISCUSSION

As a vegetative observation, seedling emergence rate and seedling emergence time parameters were examined. When all genotypes were examined, the average seedling emergence rate was determined as $92.98 \pm 1.42\%$. The smallest value was measured in genotype 224 (23%). When all genotypes were examined, the average number of days when seedling emergence was completed was determined as 9.19 ± 0.3 . The lowest value was measured in genotypes 68, 77, 161, 171 and 213 (6 days), while the highest value was measured in genotypes 59, 62, 234 and 354 (18 days). On the 6th day, seedling emergence was observed in viols in 85 genotypes except 11 genotypes (13, 58, 59, 62, 168, 192, 224, 225, 331, 342 and 354). In addition, on the 6th day, the emergence rate reached 100% in 5 genotypes (68, 77, 161, 171 and 213). On the 6th day, 5 genotypes reached the highest emergence rate. At the end of 22 days, the emergence rate of 50 genotypes was determined as 100%. Seedling emergence rates were determined between 90-100% in 30 genotypes, between 70-90% in 11 genotypes, between 50-70% in 2 genotypes and between 0-40% in 3 genotypes. The lowest seedling emergence was recorded in genotypes 224 (23%), 342 (33%), 62 (40%), 23 (57%) and 206 (57%). Except for genotype 58, seedling emergence could not reach 100% in genotypes that started to germinate in more than 6 days. In the correlation analysis, the seedling emergence rate shows a correlation of -45% with the number of seedling emergence days.

Table 1. Seedling emergence rate (SER) information of genotypes

No	SER (%)	No	SER (%)	No	SER (%)	No	SER (%)
3	100	53	93	122	100	203	100
5	80	56	93	125	100	206	57
6	93	58	100	136	100	213	100
9	86	59	73	137	100	223	100
11	100	62	40	138	97	224	23
13	77	63	100	141	90	225	93
18	100	68	100	147	100	229	97
22	100	70	93	149	100	234	100
23	57	71	93	151	100	241	97
28	100	75	100	152	93	244	100
35	100	77	100	161	100	247	100
36	90	78	100	165	100	252	100
37	100	80	90	168	93	260	100
38	97	85	100	171	100	285	100
40	97	86	80	174	97	298	87
41	100	89	87	183	97	303	100
42	100	90	93	184	93	305	100
44	83	91	100	187	93	331	97
45	100	96	100	190	77	341	100
46	97	111	100	192	80	342	33
47	100	112	97	194	93	347	100
48	97	114	100	195	100	350	90
50	93	117	97	199	90	354	83
52	100	119	100	200	100	356	100

Table 2. Seedling emergence time (SET) information of genotypes

No	SET	No	SET	No	SET	No	SET
3	7	53	7	122	8	203	7
5	8	56	7	125	7	206	9
6	8	58	11	136	11	213	6
9	8	59	18	137	7	223	8
11	9	62	18	138	8	224	15
13	9	63	10	141	10	225	9
18	10	68	6	147	7	229	10
22	7	70	15	149	7	234	18
23	9	71	8	151	7	241	7
28	7	75	9	152	7	244	10
35	8	77	6	161	6	247	11
36	8	78	7	165	8	252	9
37	7	80	15	168	15	260	8
38	9	85	7	171	6	285	7
40	7	86	7	174	10	298	10
41	7	89	10	183	11	303	7
42	9	90	9	184	9	305	10
44	12	91	7	187	8	331	15
45	12	96	8	190	12	341	7
46	12	111	7	192	15	342	11
47	7	112	8	194	10	347	7
48	7	114	10	195	7	350	12
50	7	117	7	199	12	354	18
52	8	119	7	200	10	356	7

The relationship between seedling emergence rate and 583 markers was investigated. In the GLM (Q) analyzes, it was determined that 29 markers were related at the $p<0.05$ level and 11 markers at the $p<0.01$ level. In MLM (K) analyzes, it was determined that 54 markers were correlated at $p<0.05$ level and 12 markers at $p<0.01$ level. In MLM (K+Q) analyzes, it was determined that 28 markers were related at the $p<0.05$ level and 9 markers at the $p<0.01$ level. When the Q-Q plot graphics are examined, it is understood that the agreement between the expected and observed values is best determined by the GLM (Q) method. According to this model, 14 of the related markers belong to iPBS, 3 to ISSR and 12 to SSR primers. The level of correlation (R) ranged from 4.91% to 18.67%. The most highly correlated markers are ISSRGACA4400, SSRCMTp174450, and ISSRCAC6200.

When the seedling emergence values were examined, the average seedling emergence rate was determined as $92.98\pm 1.42\%$ in all genotypes. On the sixth day, seedling emergence from viols was observed in 85 genotypes except 11 genotypes (13, 58, 59, 62, 168, 192, 224, 225, 331, 342 and 354). The lowest seedling emergence was recorded in genotypes 224 (23%), 342 (33%), 62 (40%), 23 (57%) and 206 (57%). Seedling emergence rates showed a 22% correlation with ovary height. The number of seedling emergence days showed a negative

correlation (-45%) with the seedling emergence rate. As the number of seedling emergence days increased, seedling emergence rates decreased moderately. In some studies, germination percentage was determined in watermelon genotypes. Maggs-Kölling et al. (2000) determined the germination percentage as 61.76% in some watermelon genotypes. In this study, seedling emergence rates in watermelon were determined at high rates.

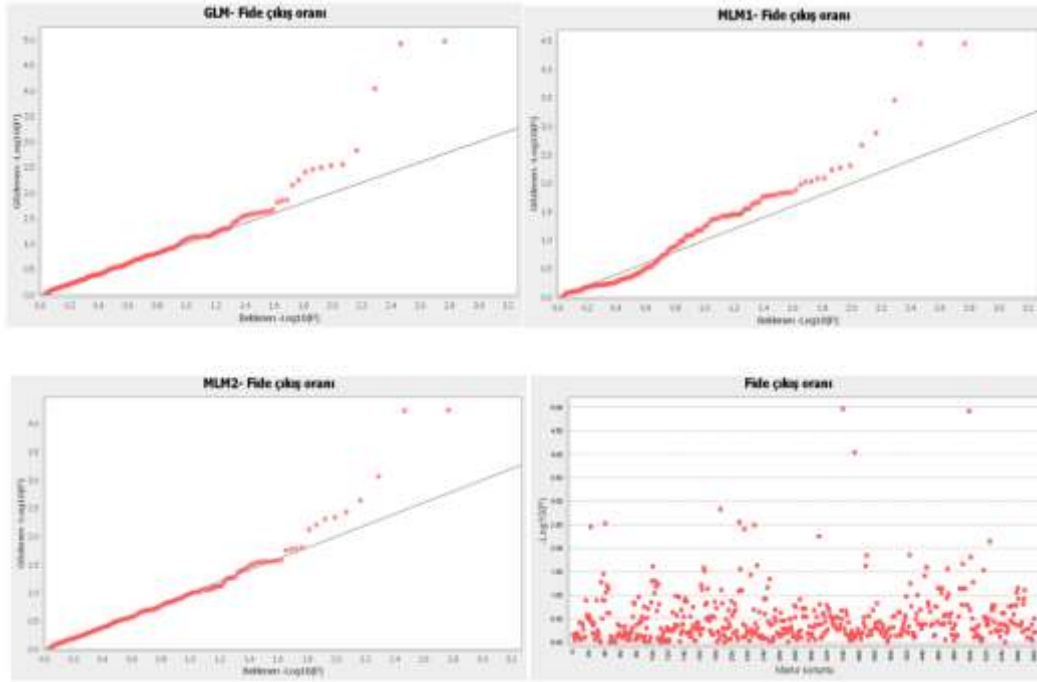

Figure 1. Q-Q and Manhattan graph for seedling emergence rate.

Table 3. Association mapping results obtained for seedling emergence rate using the GLM model ($p<0.05$ and $p<0.01$)

GLM (Q)					
Marker	p	R	Marker	p	R
ISSR.GACA4.400	0.0001	0.1867	iPBS-2081.500	0.0234	0.0542
SSR.CMTp174.450	0.0001	0.1866	SSR.CSTCC813.200	0.0238	0.0531
ISSR.CAC6.200	0.0001	0.157	iPBS-2392.460	0.0244	0.0526
iPBS-2243.420	0.0015	0.1053	SSR.CI.2-23.330	0.0256	0.0523
iPBS-2249.420	0.0028	0.0939	SSR.CI.2-23.1300	0.0256	0.0523
iPBS-2376.650	0.003	0.0989	iPBS-2230.590	0.0261	0.0526
iPBS-2080.660	0.0032	0.0889	SSR.CMTp201.750	0.0276	0.0576
iPBS-2077.590	0.0035	0.0871	iPBS-2249.590	0.0277	0.0521
iPBS-2249.1600	0.0039	0.0894	SSR.CMTmC14.250	0.0296	0.0551
ISSR.HVHTCC7.400	0.0057	0.0785	iPBS-2230.620	0.0307	0.0497
SSR.CMTp182.150	0.0072	0.0756	iPBS-2376.550	0.0353	0.051
SSR.CSJCT 720.450	0.014	0.0732	iPBS-2252.270	0.037	0.0454
SSR.CSTCC813.600	0.0143	0.0627	SSR.ASUW13.800	0.0391	0.0449
SSR.CMTp174.1500	0.0155	0.0612	iPBS-2095.1200	0.0453	0.0491
SSR.CMTp46.850	0.0217	0.0606			

Regression analysis was performed between the dependent variable of the seedling emergence rate and 29 independent variables (markers) by using the important markers that emerged as a result of the GLM (Q) analysis. In the back regression analysis, 12 significant models were formed. In the 12th model, there were 3 independent variables at the $p<0.05$ level (iPBS-2392.460, iPBS-2243.420 and iPBS-2081.500). There is no high level of correlation between these markers. In the model, the 'Intercept' value was 22.121 and the 'B' value was 23.939, 10.939 and 39.939, respectively. The rate of explaining the seedling emergence of the model depending on these markers is 70.9%.

The relationship between seedling emergence days and 583 markers was examined. In GLM (Q) analyzes, it was determined that 146 markers were correlated at $p<0.05$ level and 75 markers were correlated at $p<0.01$ level. In MLM (K) analyzes, it was determined that 95 markers were correlated at $p<0.05$ level and 26 markers were correlated at $p<0.01$ level. In MLM (K+Q) analysis, it was determined that 54 markers were related at the $p<0.05$ level and 21 markers at the $p<0.01$ level. When the Q-Q plot graphs are examined, it is understood that the agreement between the expected and observed values is best determined by the MLM (K) and MLM (K+Q) methods. According to the MLM (K) model, 20 of the relevant markers belong to iPBS, 17 to ISSR and 58 to SSR primers. The level of correlation (R) varied between 4.21% and 18.14%. The highest associated markers were iPBS-2226.1450, iPBS-2272.680 and SSR.CI.2-23.330. According to the MLM (K+Q) model, 8 of the related markers belong to iPBS, 5 to ISSR and 41 to SSR primers. The level of correlation (R) ranged from 5.77% to 14.3%. The most highly correlated markers are SSR.CI.2-23.330, SSR.CI.2-23.1300 and iPBS-2272.680.

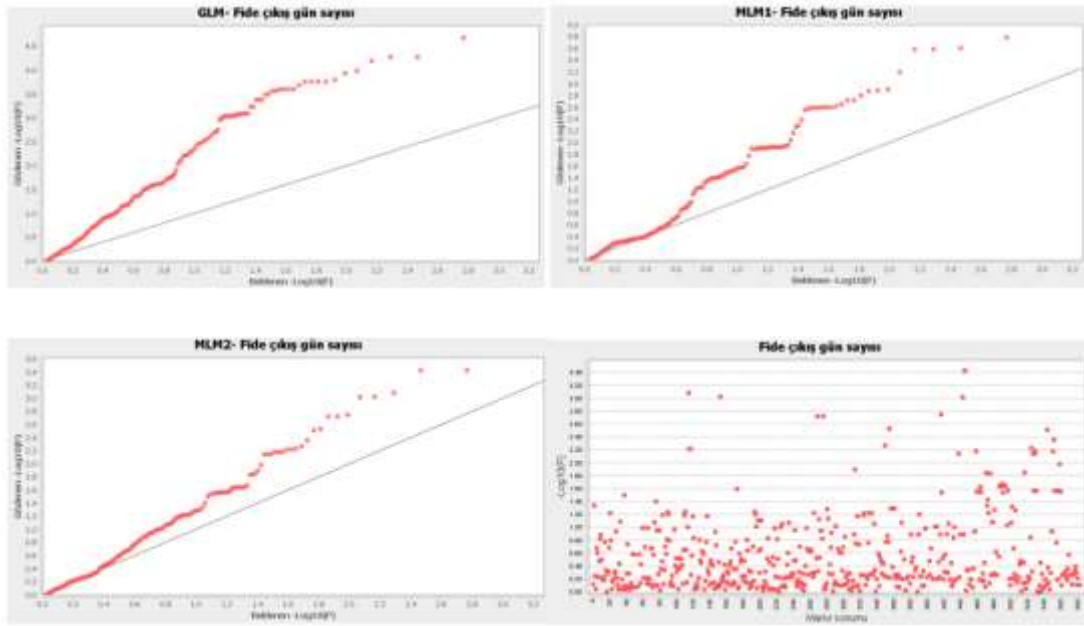

Figure 2. Q-Q and Manhattan graph for number of seedling emergence time.

Table 4. Association mapping results obtained for seedling emergence time using MLM (K) and MLM (K+Q) models

MLM (K)			MLM (K+Q)		
Marker	p	R	Marker	p	R
iPBS-2226.1450	0.0002	0.1814	SSR.CI.2-23.330	0.0004	0.143
iPBS-2272.680	0.0002	0.1675	SSR.CI.2-23.1300	0.0004	0.143
SSR.CI.2-23.330	0.0003	0.1522	iPBS-2272.680	0.0008	0.1366
SSR.CI.2-23.1300	0.0003	0.1522	iPBS-2226.1450	0.001	0.1366
SSR.ASUW13.800	0.0006	0.1318	SSR.ASUW13.800	0.001	0.1219
SSR.CSJCT 315.100	0.0013	0.1165	SSR.CSJCT 315.100	0.0018	0.1082
ISSR.CT8TG.720	0.0013	0.1176	ISSR.CT8TG.720	0.0019	0.1086
ISSR.TAA8.880	0.0013	0.1157	ISSR.TAA8.880	0.0019	0.1075
SSR.CMTm111.380	0.0016	0.1257	ISSR.CAC6.200	0.003	0.1124
iPBS-2272.870	0.0019	0.1173	SSR.CMTm111.380	0.0031	0.109
iPBS-2272.950	0.0019	0.1173	SSR.CMTmC34.700	0.0044	0.1006
ISSR.CAC6.200	0.0022	0.1196	ISSR.VHVG7.900	0.0054	0.0854
SSR.CMTmC34.700	0.0024	0.1155	SSR.CMTp182.150	0.0059	0.0936
SSR.CSJCT746.255	0.0025	0.1143	iPBS-2272.870	0.0061	0.09
SSR.CMTp182.300	0.0025	0.1143	iPBS-2272.950	0.0061	0.09
SSR.CMTp182.490	0.0025	0.1143	SSR.CMTp193.380	0.0067	0.091
SSR.CMTp193.380	0.0026	0.1138	SSR.CMTp182.830	0.0067	0.091
SSR.CMTp182.830	0.0026	0.1138	SSR.CMTmC34.580	0.0067	0.091
SSR.CMTmC34.580	0.0026	0.1138	SSR.CSJCT746.255	0.0072	0.0891
ISSR.VHVG7.900	0.0027	0.1005	SSR.CMTp182.300	0.0072	0.0891
SSR.CMTp182.150	0.0028	0.1117	SSR.CMTp182.490	0.0072	0.0891
SSR.CMTp125.405	0.0041	0.1029			
SSR.CMTp201.600	0.005	0.1065			
SSR.CMTp201.1200	0.0055	0.1044			
iPBS-2376.530	0.0069	0.0939			
ISSR.HVHTCC7.1090	0.0091	0.0746			

Regression analysis was performed between the dependent variable of the number of days of seedling emergence and 26 independent variables (markers) by using the important markers that emerged as a result of MLM (K) analyzes. In the back regression analysis, 8 significant models were formed. In the 8th model, there were 3 independent variables at the $p < 0.05$ level (iPBS-2226.1450, ISSR.CAC6.200 and 552). There is no high level of correlation between these markers. In the model, the 'Intercept' value was 21,688 and the 'B' value was -2.854, -6.833 and -3.688, respectively. The rate of explaining the number of seedling emergence days of the model depending on these markers is 35.2%. Regression analysis was performed between the dependent variable of the number of seedling emergence days and 21 independent variables (markers) by using the important markers that emerged as a result of MLM (K+Q) analyzes. In the back regression analysis, 7 significant models were formed. In the 7th model,

there were 3 independent variables at the $p < 0.05$ level (iPBS-2226.1450, ISSR.CAC6.200 and SSR.CMTmC34.700). In the model, the 'Intercept' value was 20.725 and the 'B' value was -2.17, -7.389 and -2.725. The rate of explaining the number of seedling emergence days of the model depending on this marker is 28.8%.

High yield and high fruit quality are the main goals of today's watermelon growers. Within the scope of this study, DNA markers related to seedling emergence characteristics were tried to be determined by association mapping analysis by using different marker techniques in watermelon. Association mapping method is a powerful method that reveals gene-marker relationships. This study brings together different mapping models and provides information on the suitability of watermelon genotypes for association mapping analyses. The data obtained as a result of the study will contribute to future genetic and breeding studies.

ACKNOWLEDGEMENT

This research was supported by the Erciyes University, Scientific Research Projects Unit (FDK-7724).

REFERENCES

- Coşkun, O.F. 2023. Molecular Characterization, Population Structure Analysis, and Association Mapping of Turkish Parsley Genotypes Using iPBS Markers. *Horticulturae*, 9, 336.
- Coskun, O.F. 2023. Determination of genetic diversity in some pumpkin genotypes using SSR marker technique. *Erzincan Univ. J. Sci. Tech.*, 15, 942–952.
- Guo, S.G., Zhang, J.G., Sun, H.H., Salse, J., Lucas, W.J., Zhang, H.Y., Zheng, Y., Mao, L.Y., Ren, Y., Wang, Z.W., Min, J.M., Guo, X.S., Murat, F., Ham, B.K., Zhang, Z.L., Gao, S., Huang, M.Y., Xu, Y.M., Zhong, S.L., Bombarely, A., Mueller, L.A., Zhao, H., He, H.J., Zhang, Y., Zhang, Z.H., Huang, S.W., Tan, T., Pang, E.L., Lin, K., Hu, Q., Kuang, H.H., Ni, P.X., Wang, B., Liu, J.A., Kou, Q.H., Hou, W.J., Zou, X.H., Jiang, J., Gong, G.Y., Klee, K., Schoof, H., Huang, Y., Hu, X.S., Dong, S.S., Liang, D.Q., Wang, J., Wu, K., Xia, Y., Zhao, X., Zheng, Z.Q., Xing, M., Liang, X.M., Huang, B.Q., Lv, T., Wang, J.Y., Yin, Y., Yi, H.P., Li, R.Q., Wu, M.Z., Levi, A., Zhang, X.P., Giovannoni, J.J., Wang, J., Li, Y.F., Fei, Z.J., Xu, Y., 2013. The draft genome of watermelon (*Citrullus lanatus*) and resequencing of 20 diverse accessions. *Nature Genetics*, 45 (1):51-58.
- Karaman, K., Dalda–Sekerci, A., Yetisir, H., Gulsen, O., Coskun, O.F. 2008. Molecular, morphological and biochemical characterization of some turkish bitter melon (*Momordica charantia* L.) genotypes. *Ind. Crops Prod.*, 123, 93–99.
- Kirac, H., Dalda–Sekerci, A., Coskun, O.F., Gulsen, O. 2022. Morphological and molecular characterization of garlic (*Allium sativum* L.) genotypes sampled from Turkey. *Gen. Res. Crop Evol.*, 69, 1833–1841.
- Maggs-Kölling, G.L., Madsen, S., Christiansen, J.L. 2000. A phenetic analysis of morphological variation in *Citrullus lanatus* in Namibia. *Genetic Resources and Crop Evolution*, 47: 385.

- Rafalski, J. 2010. Association genetics in crop improvement. *Current Opinion in Plant Biology*, 13 (2): 174-180.
- Yu, J., Buckler, E.S. 2006. Genetic association mapping and genome organization of maize. *Current Opinion in Biotechnology*, 17 (2): 155-160.
- Zhu, C., Gore, M., Buckler, E.S., Yu, J. 2008. Status and prospects of association mapping in plants. *The Plant Genome*, 1(1): 5-20.

HERBAL TEA PRODUCTION TECHNOLOGY AND CURRENT APPROACHES

Sıddıka Yusra ÖZKILIÇ¹, Derya ARSLAN¹

¹ Necmettin Erbakan University, Engineering Faculty, Food Engineering Department, Konya, Türkiye

Corresponding author e-mail: yusraydn@gmail.com

ABSTRACT

Herbal tea is produced as fresh or dried mixtures of botanical elements other than *Camellia sinensis* species. It has different advantages such as ease of use, consumer preferences, nutraceutical ingredients blended in small bags, and being profitable for both consumers and producers. The type of raw material used in the preparation of herbal teas, the diffusion rate of the tea bags, the extraction efficiency, the phytochemical potential, the loading size of the bag and the safety aspects are the most important factors affecting the success of the tea bags in the market. In this study, the information in the literature has been compiled from a current perspective regarding the production, preparation methods and packaging materials of herbal tea. In addition, the case of adulteration and the plants used in the treatment of some diseases are included. The production, risks, technological features and abaca fiber (Manila hemp), which is a completely natural source used in production, are mentioned. The prior consideration includes important parameters such as the type of materials used, its pore size, shape, loading capacity, infusion rate, holding time, temperature and so forth. As a result, herbal teas are products that are frequently consumed, which have distinctive sensory qualities as they contain various volatile fractions.

Keywords: Herbal tea, Production, Packaging materials

INTRODUCTION

There is a lot of archaeological evidence that people used plants for medicinal purposes in prehistoric times (Varlı et al., 2020). Before black tea and coffee, which we frequently consume today, people used plants as tea in every region of the world. They benefited from the therapeutic properties of plants and preferred herbal teas because of their pleasant taste. Reasons such as the fact that herbs support healthy life, consumers' awareness and caution against artificial substances, and the increasing interest in ethnic products have led to the re-popularization of herbal teas and enabled them to capture a large market share all over the world (Akgül and Ünver, 2001).

Türkiye has very diverse and endemic plant species in terms of its geographical location. There are approximately 11000 plant taxa and about 500 of them are used for alternative medicine. Lavender, poppy, St. John's wort, mint, cassia, cumin, fennel, chamomile, thyme, sage, black cumin are among the commercially cultivated plants. Exported plants are mainly laurel, thyme, poppy, aniseed, while imported plants are mainly black pepper. Plants are consumed as tea as well as spices and are frequently used in kitchens, medicine, pharmacy and cosmetics (Göktaş and Gıdık, 2019; Varlı et al., 2020).

People have benefited from medicinal and aromatic plants for therapeutic purposes for ages. Phytotherapy, the method of treatment with plants, is as old as human history. Medicinal and aromatic plants have played a role in the use of plants in diseases since the past. Today, these plants are utilized in many sectors including food, cosmetics, pharmacy, medicine, chemistry and pesticides. Herbal teas, one of the areas of use of medicinal and aromatic plants,

are gaining importance day by day and have become a frequently consumed product due to their benefits proven by studies (Toker et al., 2012).

Herbal medicines are of great importance for human health, mostly in developing countries. Approximately 80% of the world's population uses medicinal plant products in the first stage of preventive and post-illness treatment. Plants contain bioactive secondary metabolites such as flavonoids, phenolic compounds, steroids, tannins, saponins and alkaloids. These metabolites have many properties such as inhibiting fungal and yeast growth, lowering blood sugar, preventing allergies, antioxidant, preventing cancer formation, lowering high blood pressure, reducing inflammation, reducing intestinal parasites, protecting cardiovascular health, pain relief and antispasmodic (Varlı et al., 2020). Although herbal teas are beneficial for health, they also have some disadvantages. These can be listed as containing heavy metals, pesticide residues, being contaminated with pathogenic microorganisms and mycotoxins (Can and Duraklı Veliöğlu, 2018).

Among nutraceutical beverages, herbal teas produced from medicinal and aromatic plants and their alternative beverages have an important place (Suna, 2014). Recently, the demand for herbal tea bags is increasing day by day due to the increasing interest in healthy living, the fact that herbs have been consumed as tea since time immemorial and their practicality. These tea bags, which look like filter paper, contain 1-2 grams of product and are commonly offered to the market in boxes containing 20 bags.

Parts of plants such as leaves, roots, bark, seeds, fruits, stems and flowers can be consumed as tea (Sarwar and Lockwood, 2010). Factors affecting the use of a plant as tea are the culture of the region or country and the plant diversity of the region. Herbal teas are an easy way to get bioactive and antioxidant substances into the body without using much sugar and energy. Herbal teas are defined in the European Pharmacopoeia as: "They are orally used aqueous preparations prepared by maceration, decoction and infusion of one or more droplets; they are prepared before use" (Kabakçı, 2016). Herbal teas do not contain caffeine compared to *Camellia sinensis* species and are easy to drink (Ravikumar, 2014). In our country, sage, linden, thyme, chamomile, chamomile, mint, laurel, rosemary, clove, cinnamon, rosehip, anise, dill, fennel, tarragon, ginger, basil, hibiscus and lavender are some of the herbs used as tea (Akgül and Ünver, 2001; Etheridge and Derbyshire, 2020).

In this study, production of herbal teas, points to be considered in production, microbiological examination of herbal teas, adulteration issue and preparation methods were explained. The effect of harvest time, brewing time and temperature on the amount of active ingredient was explained with the studies conducted, and the plants used in the treatment of some diseases were also included. The raw materials used in the production of tea bags, which have recently increased in popularity, and the properties and risks that they should have are stated.

HERBAL TEA PROCESSING TECHNOLOGY

A wide variety of materials can be used in herbal tea making. Among the factors affecting plant diversity are geographical location and climate diversity (Akgül and Ünver, 2001). The number of medicinal and aromatic plants used only in the food sector is more than 10,000 (Varlı et al., 2020). Although the consumption of wild-growing plants as tea has decreased today, there are still countries that resort to this method. Using these plants, which are abundant in nature, can be preferred because it reduces the cost, but there are some risks it poses. These include inconvenient raw material procurement and quality differences. In addition, the inability to distinguish plants with excessive amounts of some toxic compounds may harm health. Teas that can be dangerous to consume frequently should be prepared and used by experts. As in developed countries, tea production should be realized by cultivating plants with proven health benefits and botanical identification (Akgül and Ünver, 2001).

Harvesting and collection of plants

The first step in herbal tea processing is to harvest and collect the plant at the right time. Because the active ingredient content of the plant depends on its age and stage of development. The cultivation and harvesting of the plant should be carried out by trained people under hygienic conditions. Foreign matter contamination of the material during harvesting should be avoided as much as possible. The main factor affecting the quality is harvesting according to the plant organ to be used. Subsoil organs such as ginger, galangal and licorice should be harvested towards the end of vegetation. The above-ground parts of herbaceous plants, on the other hand, usually contain a large amount of effective compounds at the beginning of flowering. Plants with flowers such as lavender, linden and chamomile should be harvested when the flowers are in full bloom; plants with leaves such as sage, rosemary, laurel, mint and senna should be harvested just before flowering; and plants with bark such as cinnamon and buckthorn should be harvested before drying. Plants whose fruits such as rose hips, lemon, bergamot and seeds such as cumin, coriander, anise, fennel should be picked after ripening. The harvested products may be damaged by mechanical action or overfilling. As a result of the activity of enzymes and microorganisms, loss of active ingredients, decay and reduction in the amount of product may occur. Harvested products should be brought to the processing plant as soon as possible under good ventilation conditions, in clean baskets or sacks, avoiding excessive stacking. Harvested plant parts (leaves, flowers, roots, etc.) should not be mixed with other parts and should be transported in separate containers. Harvesting can be done by machine for some plants. The machines used should always be kept clean to prevent contamination, and care should be taken not to contaminate the products with the oils used in the lubrication of machine equipment (Akgül and Ünver, 2001; Douglas et al., 2005; Pandey, 2017).

Separation and cleaning of the material

The second stage in the processing of herbal teas is to clean the collected product from all foreign materials and to separate the plant organ to be used from other parts. The subsoil organs to be used may need to be washed and peeled. In small-scale enterprises, cleaning operations can be done manually. For large-scale enterprises, some methods applied to cereals according to the type of material can be adapted for plants and machines can be used (Akgül and Ünver, 2001). The material should also be made microbiologically safe. Non-thermal decontamination methods for plants are divided into two as physical and chemical. Physical methods are irradiation, pulsed electric field (PEF), cold plasma and pulsed light. Chemical methods include ozonation, ethylene dioxide fumigation and high pressure CO₂ gas application combined with ultrasound.

Gamma rays, X-rays and electron beams are permitted for food irradiation. The smaller a microorganism is, the more resistant it is to irradiation, thus requiring high doses of irradiation. Viruses are more resistant than bacteria, bacteria than molds and yeasts, molds and yeasts than insect larvae and insects. Irradiation prolongs the shelf life of the product and increases its safety. At a certain dose, the nutritional value and sensory quality of the product are at the desired level, but when irradiation is applied at high doses, losses may occur in these criteria. PEF application is a non-thermal decontamination method and is mostly used in the sterilization of liquid foods such as milk, liquid eggs, fruit juice. There are studies on the decontamination of herbs and spices with PEF, but it is a subject that needs research and development.

Plasma is the fourth state of matter and is an ionized gas that contains sufficient energy. Cold plasma is the ionization of gases such as helium, nitrogen, argon, hydrogen, nitrogen and/or a mixture of these gases under ambient conditions without heating. It has been proven by studies that cold plasma applied to plants does not cause loss of volatile oil and content, color and phenolic compounds of the products. It can be successful in preserving ingredients in the use of sensitive products that are not resistant to heat treatment. Pulsed light

technology is based on the principle of breaking down and inactivating the DNA and RNA of microorganisms using short wavelength ultraviolet rays. It is frequently used for disinfection of food contact surfaces and decontamination of liquid foods. With second applications, microorganisms can be inactivated in a short time. On solid surfaces, it can be difficult for the rays to penetrate, so the thickness of the material is important for an effective process.

Although there are few studies on the effectiveness of pulsed light in plant decontamination, effective results have been obtained. Therefore, it is useful to conduct research on its use in plant decontamination. Ozonation, one of the non-thermal chemical methods, is based on the principle of disinfection by utilizing the properties of ozone gas with three oxygen atoms as a strong oxidant and reactive. It has been observed that it significantly reduces the microbiological load when used. It was observed that the microbial load decreased with the application of ozone gas to plants, but high concentration and maximum time (120 min) caused appearance defects and phenolic substance losses. In addition, different microorganisms have different sensitivities to ozone. Its use in plants needs more research.

Fumigation with ethylene dioxide is an inefficient method of destroying microorganisms. In some countries it is used to decontaminate medicinal herbs and spices, but some countries have banned it because it can cause the formation of carcinogens. Ultrasound (US) is used in the food industry for pasteurization, extraction, freezing, drying, enzyme inactivation, filtration, de-foaming, gelling, etc. While high pressure CO₂ (HPCD) is a supercritical fluid, it can diffuse into solids like a gas and dissolve substances like a liquid. Research has shown that HPCD+US is not sufficient for decontamination, although efficient results have been achieved. Non-thermal decontamination processes for crops have advantages and disadvantages, but require less energy and cause less damage to the crop compared to traditional thermal methods. Non-thermal decontamination methods for crops should be further investigated and the appropriate one should be preferred (Perussello, 2020).

Drying process

Depending on the nature of the product to be used, several different drying processes can be applied. For delicate and precious materials, hot air drying in the shade is preferred. Durable products can be dried in the sun. The name of the drying process applied due to the economic structure of the facility, the amount and type of raw material may be drying tunnel, room or cabinet (Akgül and Ünver, 2001).

Studies have shown that drying methods and temperature applied to herbal teas significantly affect the active ingredient content. In a study, different drying methods and temperatures were applied to rosemary, basil, thyme, mint and stevia plants and antioxidant activity and phenolic matter values were investigated. The plants were dried in drying tunnel (30, 40 and 50°C), microwave oven (450, 600, 700 and 800 W), sun, shade and refrigerator. The highest phenolic content was found in rosemary and basil dried in microwave oven at 800 W power level, in thyme dried in drying tunnel at 30 °C, in mint dried in sun, stevia and shade. The highest antioxidant activity value was observed in rosemary and basil at 700 W and 800 W power levels in microwave oven, in thyme at 30 °C in drying tunnel, in mint at 600 W, 700 W, 800 W power levels in microwave oven and in sun, in stevia in sun and shade dried samples (Güler, 2019).

Aydın et al. (2019) examined the essential oil content and oil components of Anatolian sage (*Salvia fruticosa* Mill. = *Salvia triloba* L.) at different drying temperatures and determined that the applied temperature affected the amount of essential oil and its components.

Grinding

The next stage after drying is grinding. The material supplied to the market in cup/beverage bags or in bulk needs to be ground to a certain size or reduced to particles. It is important that the grinding is not too fine because of the problem of cloudy brew and dust. It is reasonable for products packaged in bulk or in kraft bags in higher quantities to be coarser than

bagged products. According to the capacity of the enterprise and the physical structure of the product, grinder or mill methods can be applied for the grinding process (Akgül and Ünver, 2001).

Blending/additive

If blending and addition are required based on the product type, they are typically carried out post milling. Blending is the mixing of products containing more than one plant. In some herbal teas, additives such as naturally identical flavors, vitamins, minerals and sweeteners can be added. Granulated/powdered products impregnated with essential oils or extracts in carrier solids are not classified as herbal tea (Akgül and Ünver, 2001).

Bagging/packaging

The packaging material used must be clean and dry, and the packaging must be protected from damage by biological pests. The packaged product should be stored in a clean place away from moisture, heat and odor. Regardless of the bagging method, if the plant used contains substances that may cause side effects, it should be reported on the package and the amount should be specified. For example, tea bags containing senna may have an excessive laxative effect when consumed more than two times a day (Akgül & Ünver, 2001; Pandey, 2017).

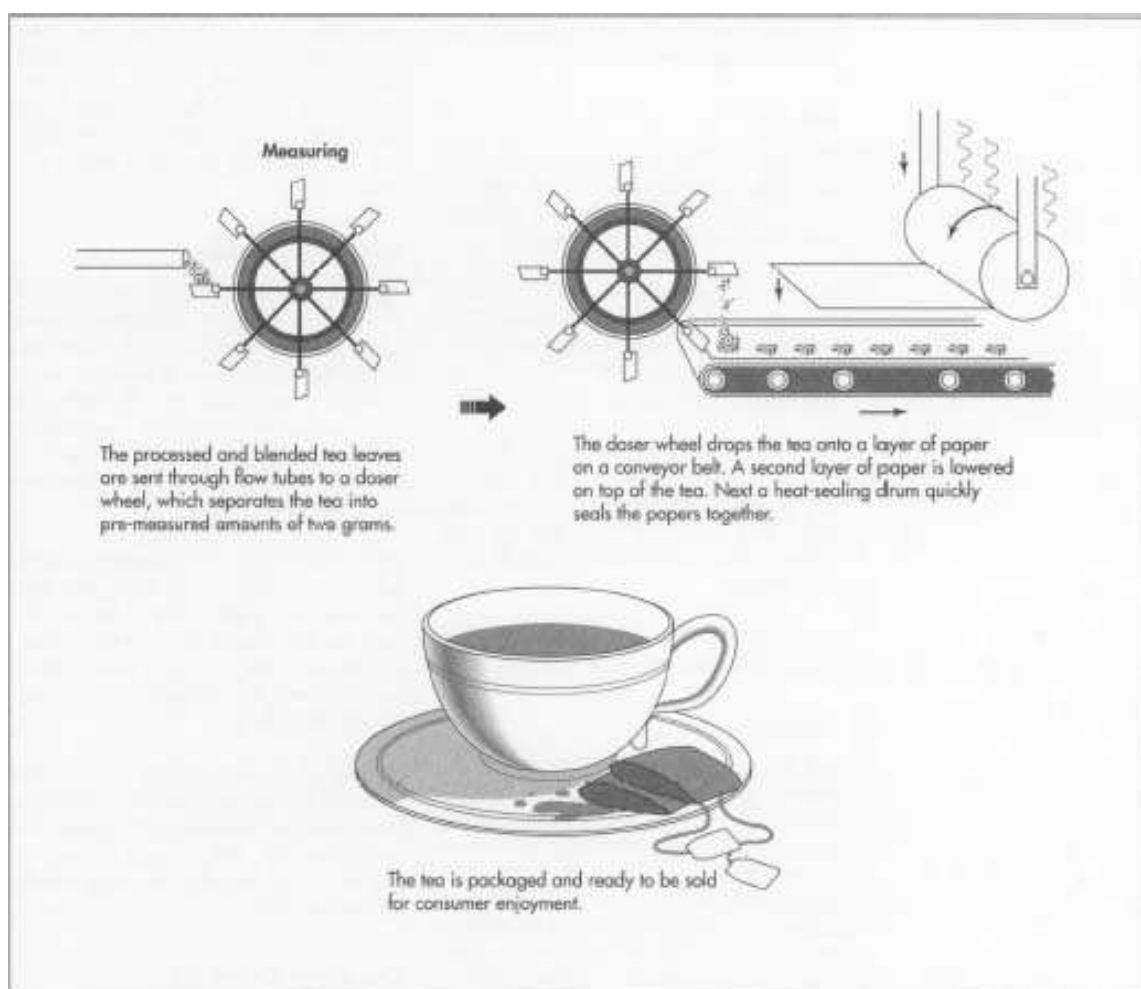

Figure 1. Bagging of blended teas (Anonymous, 2022)

Herbal Teas and Quality Control

There may be a need to determine the quality criteria of herbal teas at more than one stage: raw material, ground product and brew. Chemical analyses such as moisture, ash, extract, volatile oil, fiber and oil content determination, physical analyses such as defective parts and

foreign matter, microbiological analyses such as mold contamination, mycotoxins, pathogenic bacteria should be performed. In addition, qualitative and quantitative analysis of effective compounds that vary according to the plant, determination of all contaminants (such as pesticides, microplastics and heavy metal residues) and additives, if used, are other criteria. In addition, the degree of grinding, the amount of herbs used, and the sensory profile of the material can be determined by experts and panelists (Akgül and Ünver, 2001).

Another issue in quality control criteria is adulteration. Since herbal teas can be sold in bulk, they are open to adulteration. Unfortunately, there are people who add different plants to valuable products, disregarding human health, in order to make more money from valuable and/or expensive plants. Studies have also shown that herbal teas and/or mixtures use products other than the plants specified on the package. In a study conducted by Şaşkara et al. (2010), organic and inorganic pollution elements, foreign plant parts, insect residues, moldy plant parts, organic and inorganic pollution elements, foreign plant parts, insect residues, moldy plant parts were found in open and sacked samples taken from herbalists to examine the lemon balm leaf droplet (used plant part) (*Melissae folium*) obtained from *Melissa officinalis* (Melissa, lemon balm) plant. According to the study, the presence of other plant parts and inorganic contaminants in the herbalist samples is an indication that the herbal was collected and sold by unconscious people. Another sample was taken as a swordwort, but the amount of swordwort in the bag was very small and other drugs and stone fragments were observed. In addition, in the three samples examined, it was determined that the label attached to the box after the purchase stated that it was melissa, but it was a species of mountain tea (*Sideritis* sp.), another genus belonging to the *Lamiaceae* family, and not *M. officinalis*.

In another study, Kabakçı (2016) microscopically and macroscopically examined 153 kinds of packaged herbal teas containing 65 plant species belonging to 5 different brands (A, B, C, D, E) sold only through pharmacies and the internet, and also performed active ingredient controls of 5% infusions with preliminary trials. As a result of his studies, he found that there was a lack of information about the plant names on the packages and that the packaging information of B, C, D, E brands was insufficient. Regarding the samples he examined macroscopically, he found that brand B had lemon balm leaves and *Aloysia triphylla* (L'Hérit.) Britton leaves instead of *Melissa officinalis* L. species stated on the package. In the 5% infusions he made, in line with the literature information, he did not detect the presence of saponin in 14 tea samples, anthracene in 6 tea samples, flavones in 110 tea samples, alkaloids in 17 tea samples and tannins in 28 tea samples.

Microbiological risks in herbal teas

Herbal teas, which are most commonly consumed in diseases requiring mild treatment, carry some risks as well as benefits. These plants growing in nature are of course open to contamination with some microorganisms and their metabolites. However, it is inevitable that plants collected and stored by unconscious people carry microbiological risks. The causes of these microorganism-induced contaminations include pre-harvest, harvesting, drying, grading, grinding, processing, packaging and storage stages through soil, water, fertilizer, sewage, animal wastes and residues (Can and Duraklı Veliöğlu, 2018).

Mycotoxins, which enter the body through various routes, can cause impaired liver and kidney function and have neurotoxic effects. Some mycotoxins can interfere with protein synthesis and cause various disorders ranging from skin sensitivity and necrosis to extreme immunodeficiency. Some mycotoxins can be teratogenic (substances that cause permanent deformity and dysfunction in the baby during pregnancy) and/or carcinogenic. Studies show that herbal teas can contain high levels of total bacteria and molds, and are contaminated with coliform group bacteria, *Bacillus cereus*, *Clostridium perfringens* and their spores, *Salmonella* spp. Although there are not enough studies on the microbiological comparison of plants

collected from nature and cultivated plants, it is thought that post-harvest processes cause contamination in cultivated plants (Can and Duraklı Velioğlu, 2018).

Halt (1998) conducted a study with 73 samples to determine the presence of toxigenic molds in herbal teas and found that the most dominant molds were *Penicillium* spp. found in 54.58% of the samples and *Aspergillus* spp. found in 19.80% of the samples, and *Aspergillus flavus*, one of the most important aflatoxin producers, was found in 16% of the samples. Arslan (2013) investigated the aflatoxin B1 levels and microbiological quality of some organic spices and herbal teas produced in Türkiye and found that 30 (82%) of 37 herbal tea samples had yeast-mold, 33 (89.19%) had *Staphylococcus aureus*, 36 (97.29%) had *Enterobacteriaceae* and 25 (67.56%) had coliform bacteria. Among the herbal teas analyzed, the lowest bacterial contamination was found in fennel. In 32 organic herbal tea samples, aflatoxin B1 was found. The organic herbal tea with the highest aflatoxin B1 (52.50 µg/kg) was rosehip samples.

Studies on herbal products and teas show large differences in contamination rates. The reasons for this situation include the type of plant examined, the number of samples, geographical region, processing, storage and sales conditions and packaging status (Vural et al., 2020). In order to eliminate the microbiological risks of plant material, the processing steps should be applied carefully. In addition, the presence of aflatoxins and other mycotoxins in the final product should be detected. Otherwise, people who use plants for therapeutic purposes may develop different ailments instead of showing signs of improvement (Halt, 1998).

Research results show that it is very important to ensure microbiological stability in plant materials. The most important production steps to be considered for this purpose are drying and storage. The drying stage, which is carried out by taking into account factors such as the protection of the active components of the organ in which the plant will be used and the moisture level, triggers the development of microorganisms in the material when it is carried out at low temperatures, and when it is carried out at high temperatures, the total number of mesophilic aerobic bacteria decreases. Improving storage conditions (ventilation, humidity level, temperature, etc.) will significantly reduce the development of mold and toxins in the material and safe products that do not carry health risks can be produced (Can and Duraklı Velioğlu, 2018).

Herbal Tea Preparation Methods

The nutritional value of herbal teas increases with their antioxidant substances. These substances provide inactivation of free radicals in the body. Natural plant sources of antioxidant substances are phenolic compounds. Flavonoids constitute the largest part of phenolic compounds and play an important role in antioxidant activity. Herbal tea preparation methods are important on the amount of flavonoids in water (Cavlak and Yağmur, 2016). With the high number of plant varieties and organs to be used for herbal tea, different methods are applied to prepare tea. It is the organs of the plant that determine the method to be used. There are three different methods of preparation: brewing (infusion), boiling (decoction) and keeping at room temperature (maceration) (Üstü and Uğurlu, 2018).

Brewing (infusion)

If the soft organs of the plant such as leaves and flowers (for example, sage and mint leaves, chamomile and linden flowers) are to be used, the brewing method should be applied. This technique should also be preferred for valuable plants containing essential oils. It should be prepared fresh each time to prevent bacterial contamination. Generally, 2% of the herb is used. Approximately one tablespoon (approximately 2 grams) of the herb is added to a glass (approximately 150 ml) of boiled water and left to infuse for 5-10 minutes with the lid closed. After straining, it is consumed (Üstü and Uğurlu, 2018). Strained tea bags are added into the cup or teapot, boiled water is added and the brewing time written on the package is applied. At the end of the time, the filter bag is removed and consumed (Akgül & Ünver, 2001).

Boiling (decoction)

This is the method used to use the hard tissues of the plant such as seeds, bark and roots (e.g. turmeric, cinnamon, ginger, anise). The active ingredients in these parts of the plant are difficult to pass into water and therefore need to be boiled. It should be prepared fresh each time to prevent bacterial contamination. Usually 2% of the plant is used. Approximately one tablespoon (approximately 2 grams) of the herb is added to a glass (approximately 150 ml) of cold water and left to boil. After boiling, lower the heat, boil for 5-10 minutes, then strain and consume (Üstü and Uğurlu, 2018).

Maceration

Room temperature maceration is used for plants containing mucilage (e.g. flaxseed, marshmallow root) and heat-sensitive substances. The plant parts are cut into small pieces, water at room temperature is added and left overnight. It is consumed by straining. It should be prepared in an amount to be drunk daily (Göktaş and Gıdık, 2019; Üstü and Uğurlu, 2018).

Herbal tea can be prepared from a single herb or it is possible to use more than one herb. It should not be forgotten that plants can be harmful as well as beneficial and should be consumed with attention to the toxic compounds they contain. In order to fully utilize the effective compounds contained in plants, attention should be paid to brewing, boiling and maceration (Göktaş and Gıdık, 2019).

Herbal teas can be prepared from both a single plant and a mixture of several plants. When preparing herbal teas, attention should be paid to the preparation times, the effects of the plants, the dose, and care should be taken not to use plants that cannot be adjusted without turning them into medicine.

USE AND EFFECT OF HERBAL TEA

Today, herbal teas, which are used for ailments requiring mild treatment, can be prepared from thousands of different plants. The chemical content of the teas depends on the herbs and/or combinations used. The therapeutic properties of herbal tea are due to the active ingredients of the plants. Flavor is the sum of hot water soluble compounds. The compounds that give herbal teas this characteristic feature are mainly essential oils, resins, heterosides, alkaloids, pigments, tannins, vitamins, minerals, organic acids and polysaccharides. Among the factors affecting the type and amount of these effective compounds of herbal teas are the harvest time of the plant, the organ used, the processes applied to the material and storage (Akgül and Ünver, 2001).

Herbal Teas and Health Benefits

Herbal teas, which have been used in the treatment of various diseases since ancient times, have been proven in today's medicine to cure many diseases with continuous and long-term use. It is necessary to consume the herb and the amount to be used for the disease to be treated in consultation with experts in the field. Otherwise, it may have bad consequences. In addition, the dose used in disease treatment may be higher than normal drinking. Because it may be necessary to take more of the active substance into the body (Akgül & Ünver, 2001; Aslan, 2019). However, poorly produced products may not only be a source of healing but may also cause harm. This is because the products contain harmful contamination elements such as pesticides, heavy metals, aflatoxin, insect larvae. It is beneficial to use products with controlled production and it will be healthier to realize production in high standard facilities to protect against these damages (Poswal et al., 2019).

Other considerations

The fact that disposable tea bags provide convenience in our daily lives, as well as the fact that they are seen quite frequently in the supermarket aisles, clearly shows that teabags are frequently used in our society. In addition to the advantages of tea bags, microplastic (MP) content, which is the subject of studies, is a striking issue. Microplastics have been found to be solid, insoluble, polymeric substances, usually produced directly to a size below 5 mm (primary

microplastics) or formed by fragmentation from large plastics (<5 mm, secondary). Microplastics are plastic materials of micro and sub-micro sizes formed from the breakdown of plastics (Kuriş, 2022).

In the study conducted by Kuriş (2022), the release potential was observed in tea bags using polymer materials such as polyethylene, polypropylene and polyester as well as cellulose material used in non-woven fabrics by separation with different methods. In this study on microplastic contamination in food, the release of microplastics from non-woven tea bags used in the market and their transfer to the beverage through brewing was investigated. The main purpose of the study is to evaluate the release of microplastic fibers from tea bags with different separation methods and to draw attention to microplastic pollution in terms of food safety. Since tea bags produced from nonwoven tissues are disposable and brewed at high temperature, microfibers in the bag tissue have the potential to pass directly into the drinking liquid. Unfortunately, there is no information on the packaging that these bags contain plastic. Studies and patents in the literature confirm that in addition to cellulose (paper), different polymers (polypropylene, polyethylene, polyester, etc.) are used in tea bags to ensure durability and to ensure that the bag is easily adhered with heat in the sealing process. According to the results of the study, a minimum of 4,000 MP and a maximum of 43,000 MP debris can pass into tea from a teabag. It was stated that these materials, which are considered suitable for contact with food, can cause a high release of MP, especially with the effect of temperature, and that this is transferred to the beverage.

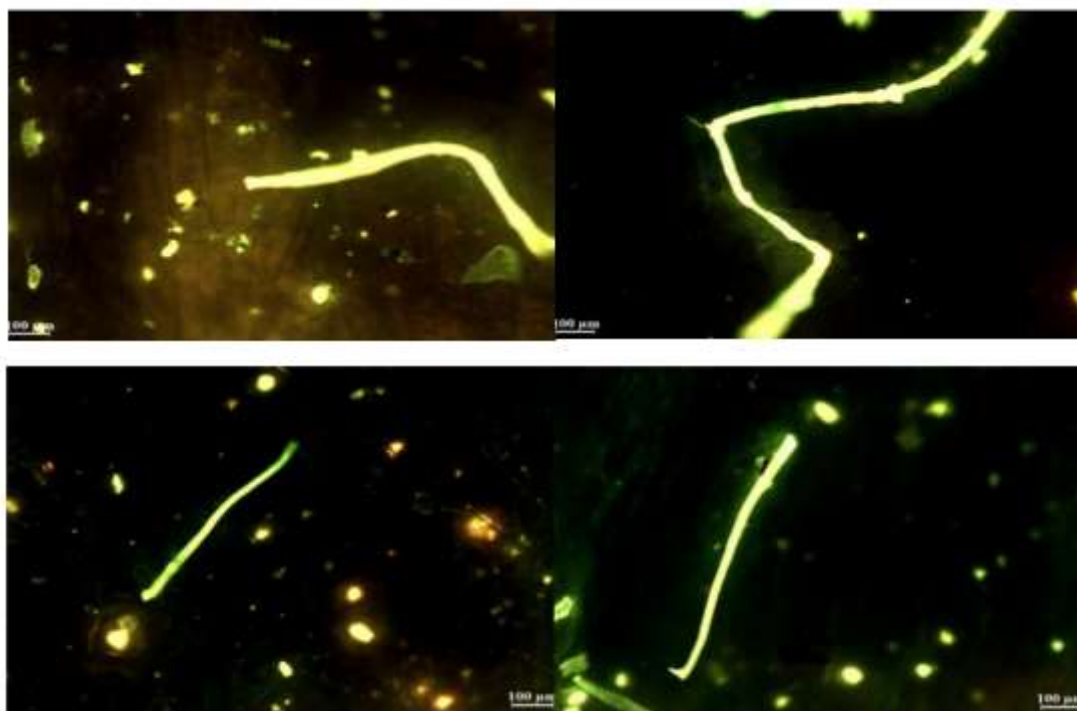

Figure 2. Blue-emitting microplasmacytes released from tea bag samples under BAB fluorescence microscopy (Kuriş, 2022)

Dried herbs (roots, bark, seeds, leaves, flowers, etc.) to be used as herbal tea usually retain their therapeutic properties for 1 year. For this reason, herbs that have been collected more than 1 year after the collection date should not be used for therapeutic purposes. Unless specifically stated, the herbs should not be used for longer than 4-6 weeks (Üstü and Uğurlu, 2018).

TEA BAGS AND PRODUCTION

Tea bags are widely consumed thanks to their advantages such as ease of use, the ability to brew at any time and in any quantity. By weight, 95% of the tea consumed is classic, black bulk tea, while the remaining 5% (900,000,000 tea bags/year) are tea bags, slimming tea and herbal teas such as green tea, rosehip, linden and sage. The tea bag market is increasing by 20-25% every year. Tea bags are mostly consumed by working, studying, educated, middle and upper income, urban consumers, while slimming teas are consumed by women over the age of 25 and green tea is mostly consumed by men.

Tea bags are more preferred than bulk products due to reasons such as easy brewing, practical cleaning from the brewing container, quick preparation in a fast-paced daily life and increased purchasing power (Bassi et al., 2020). There are various rumors about the invention of the tea bag. The first of these is that in 1908, Thomas Sullivan, a merchant in New York, introduced his teas to his customers by putting small amounts in silk bags that had to be opened before brewing tea, instead of metal boxes. Most of the customers brewed tea by dropping the tea bags into the water as they were. When customers realized that it was easier to brew tea this way and demanded smaller packaged teas from Sullivan, Sullivan took the feedback into account and developed tea bags and used cloth bags. Later, however, paper replaced cloth in commercial tea bag production. In the 1920s, commercial production began for tea bags, which grew in popularity in the USA. With the production of different companies, square, pyramid, glass and teapot tea bags were produced (Anonymous. 2021a; Bajaj, 2016). There are two types of tea bags: stapled and knotted, but stapled tea bags are banned by FSSAI (Food Safety and Standards Authority of India) (Bassi et al., 2020).

Tea bags are usually made from filter paper or food-grade nylon mesh. For traditional tea bags, filter paper made from wood pulp or a blend of wood pulp and vegetable fibers is used. It is designed to be porous enough to allow water to flow through it and extract flavors and compounds from the tea leaves while keeping the leaves inside the bag. The filter paper is heat-sealed or glued to form the bag shape (Aguilar-Cruz et al., 2020).

Tea bags are usually made from the leaves of the abaca tree, a banana tree. The abaca tree, also known as Manila hemp, grows in the Philippines and the Philippines produces 85% of the world's Manila hemp. Cellulose fibers and artificial fibers are also preferred as raw materials for making bags. Artificial bags should not release harmful compounds into the water and the use of bags should be approved for human health (Bajaj, 2016; Bassi et al., 2020).



Figure 3. Variety of different shaped and stapled tea bags (Anonymous, 2021b; 2021c)

Tea Bag Production from Abaca Fiber

Abaca fibers, also known as Manila hemp, are obtained from the leaves of the *Musa textilis* tree. Due to their water resistance, abaca fiber is used in many different areas such as

rope making in shipping, in many areas in the textile industry, in the paper industry, especially in the production of banknotes and tea bags, and in the production of sausage casings (Hayase, 2018; Vijayalakshmi et al., 2014). Abaca fiber is traditionally obtained by stripping it from the leaf sheath by manual or mechanical processes. In the production of tea bags from abaca fiber, the wet-laid nonwoven fabric method is applied. This method is derived from the paper production method and is also used in the production of long-fiber specialty papers. The extracted fibers are first suspended by swelling in water. In order for the product to become homogeneous, the water is removed by means of special paper machines. The resulting suspension is transferred to a continuously moving sieve. While the filtering process continues, a net is formed on the sieve. The resulting mesh is dried and glued (Bajaj, 2016; Vijayalakshmi et al., 2014).



Figure 4. Abaka (*Musa textilis*) and abaca fibres (Anonymous, 2021d; 2021e)



Figure 5. Abaca fiber roll used for tea bag packaging (Anonymous, 2021f)

Polilaktik Asitin (PLA) Çay Poşeti Üretiminde Kullanımı

PLA, one of the biodegradable polymers, is a biopolyester formed by the polymerization of lactic acid monomers. It is obtained by fermentation of natural resources such as corn starch, starch and sugar cane. Industrially, PLA is used in the production of milk and yogurt, fruit juice, coating of organic fruits and vegetables, mineral water bottles, tea bags, coffee capsules and cups. Strong sealing properties, low temperature adhesion, transparency, thermoplasticity, and easy processing are among the advantages of using PLA in tea bag production (Kılınç et al., 2017; Söbeli et al., 2019).

Apart from cellulose fibers such as abaca and biodegradable polymers, nylon nets are also used to make tea bags. Nylon tea bags have superior flavor compared to cellulosic papers, easy heat sealing and easy infusion. However, when brewed in hot water, there is a possibility of microplastics migrating into the water. Tea bags should have properties such as heat resistance, strong strength, and suitability for use in high-speed machines, and these factors should be considered when selecting raw materials (Bajaj, 2016).

Today, there are various rumors that tea bags contain carcinogenic substances. The chemical epichlorohydrin, which is used to bleach tea bags, converts to the highly carcinogenic compound 3-monochloropropanediol (3-MPCD) at high temperature and this compound passes from packaging materials to food (Bassi et al., 2020). Due to the frequent preference of herbal teas and the harm of epichlorohydrin to the body, research has been conducted on the raw material, design and properties of tea bags.

Negativities such as the fact that paper tea bags cause dust leakage, are not transparent enough and do not show the plant inside, cannot be sealed with heat and/or do not take shape have led to the production of polymer + cellulose tea bags. In this way, both the dust leakage problem of paper bags was solved and the production of non-woven tea bags that can be shaped at a good level was provided (Yurtsever, 2021).

Yaday et al. (2017) in their study on swelling and infusion of tea in tea bags with bulk tea and tea bags, also they found that tea bags inhibit swelling and infusion kinetics and increase infusion time compared to bulk tea. According to the study, the tea bag should be kept in water for 2 minutes for infusion time and should not be removed immediately. In addition, the infusion time is affected by the reduction of the particle size of the tea and the weight filled, and the infusion kinetics, swelling degree and swelling rate of the bags filled with 0.5 grams of tea were higher than the samples studied with 2 grams. According to the study, it was observed that the infusion quality increased as the inflation rate increased.

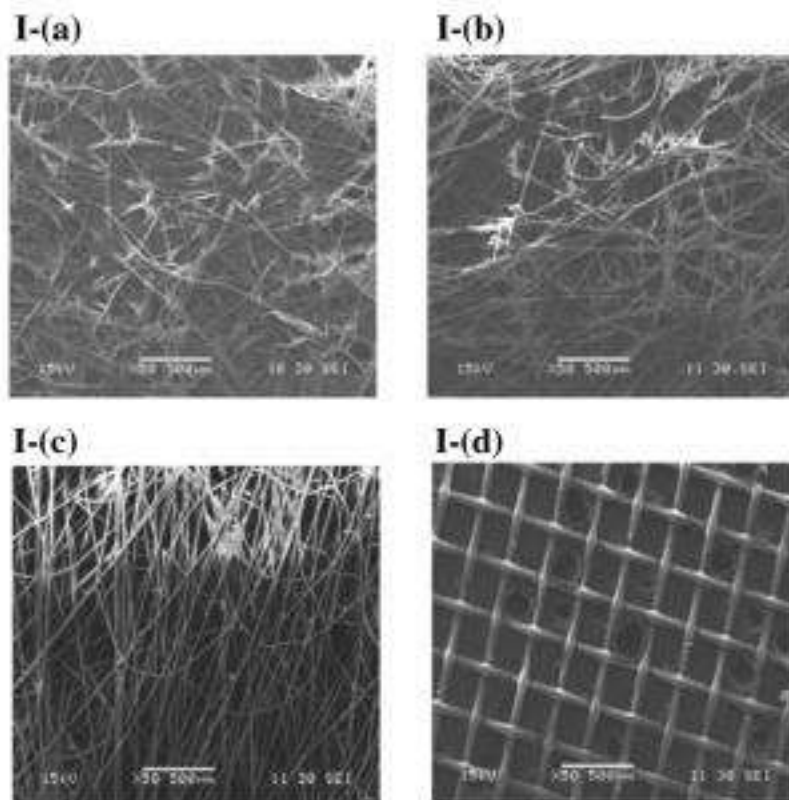

Figure 6. SEM image analysis of different tea bags. I-(a) 100% cellulose, I-(b) cellulose/PP (polypropylene), I-(c) PLA, I-(d) woven nylon (Jha et al., 2020)

Jha et al. (2020) characterized tea bags made of three different materials, cellulosic, PLA (polylactic acid) and nylon, in terms of thickness, pore size, porosity, wettability and permeability to understand the effects of tea bags on infusion kinetics. According to the results of the study, they found a relationship between the permeability and porosity of the tea bag papers, and they saw that as the porosity increased, the passage of tea components through the

tea bag increased. Woven nylon tea bags exhibited higher permeability than non-woven tea bags (cellulosic, PLA). The reason is the homogeneous distribution of the pore structure in the tea bag paper. The study also showed that although the raw material of the tea bags significantly affects the permeability, different tea bag papers have approximately the same infusion profile. In addition to these, there are muslin cloth tea bags that have recently become widespread. These tea bags, which are made of 100% cotton and do not leave nano and microplastic residues in the tea and are completely biodegradable, are seen as a sustainable and environmentally friendly option (Anonymous, 2022).

RESULTS AND DISCUSSION

Improving socio-economic status, consumer preferences, nutraceutical ingredients blended in small sachets are increasing the demand for tea bags with different characteristics such as ease of use and profitability to both consumers and producers. The type of raw material used in the preparation of tea bags (tea, herbs alone or in combination) is the most important factor influencing the success of tea bags in the market; some other factors that can affect the ultimate acceptability of tea bags by consumers include diffusion rate, extraction efficiency, phyto-chemical potential, loading size of the bag and safety considerations. The primary considerations include important parameters such as the type of paper used, pore size, shape, loading capacity, infusion rate, holding time, temperature and so on.

The use of herbal teas in disease treatment is as old as human history. The ease of preparation and cleaning of tea bags, the chemical content of medicines and the active role of plants in diseases requiring mild treatment increase the demand for herbal teas. In order to benefit from herbal teas at the highest level, it is a priority that the cultivation and production steps are carried out by knowledgeable and experienced people. In addition, plant harvesting and drying methods are among the factors that significantly affect the amount of active ingredients. Harvesting should be done at the right time and the drying method that minimizes the loss of active ingredients should be determined and used.

Light-proof material should be used for packaging and the amount of use, method of preparation, production and expiry date, and any side effects and/or health concerns should be indicated on the packaging. The naming of plants should be regulated by the Ministry of Food, Agriculture and Livestock and the name corresponding to the Latin name should be determined and each brand should use this name. Herbal teas should be produced in a way that eliminates the risks of pesticides, heavy metal residues, microbiological contamination and adulteration.

Brewing (infusion), boiling (decoction) and keeping at room temperature (maceration) are herbal tea preparation methods. In the choice of the preparation method to be used, the parts of the plant used (leaf, flower, root, bark, seed), mucilage of the plant, etc. The application should be carried out taking into account that the plant contains substances and sensitive components. The brewing time and temperature of the herbal tea affect the amount of active substance passing into the water. Studies have generally observed an increase in the active substance as the temperature and time increase. The brewing time and temperature suitable for the plant must be included on the package.

Herbs have been proven to cure diseases. For herbs to be effective, they must be used continuously and for a long time. The herb to be used in treatment and the dose to be taken should not be determined randomly, but in consultation with a specialist. It may be necessary to take a larger dose than usual because more of the active ingredient needs to be absorbed into the body.

In today's conditions, the use of tea bags is increasing day by day. Ease of brewing and practical use are among the advantages of tea bags. However, the raw materials used in its production may cause some health problems. Although the abaca fiber used in tea bag

production is a completely natural raw material, it has disadvantages such as inability to heat seal and shape, dust leakage, opacity, difficulty in infusion. PLA, which is used together with cellulose fibers to overcome these disadvantages, is a fully degradable polymer obtained by fermentation of natural resources such as starch, corn and sugar cane. In addition to natural sources, products such as nylon also have advantages such as ease of infusion and not affecting the taste of tea, but microplastics that pose health problems can pass into the water. For tea bags that are frequently used, raw materials that are easy to process and do not cause health problems should be used.

The benefits of herbal teas, which have been used in treatment for thousands of years, are undeniable. In order to fully benefit from their benefits, production steps should be carried out safely and products that will not cause physical, biological and chemical problems in terms of health should be produced.

REFERENCES

- Akgül, A., Ünver, A., 2001. Bitkisel Çaylar, Journal of Food Engineering, 11:21-24.
- Anonymous, 2021a. <https://www.thespruceeats.com/what-is-a-tea-bag-765118>, (Access date: 14.08.2023)
- Anonymous, 2021b. https://www.freepik.com/free-vector/set-round-rectangle-square-pyramid-shaped-tea-bags_3685344.html, (Access date: 19.08.2023)
- Anonymous, 2021c. <https://www.cookist.com/13-surprisingly-useful-reasons-to-keep-your-old-tea-bags/>, (Access date: 19.08.2023)
- Anonymous, 2021d. <https://conservationfoundation.co.uk/projects/growing-abaca/>, (Access date: 19.08.2023)
- Anonymous, 2021e. <https://sosopoetry.blogspot.com/2013/04/abaca-fiber-manila-hemp-usesapplication.html>, (Access date: 19.08.2023)
- Anonymous, 2021f. <http://amsteabag.com/en/product.php?tid=85>, (Access date: 19.08.2023)
- Anonymous, 2022. <https://fdlserver.wordpress.com/2008/09/17/cong-ngh%E1%BB%87-s%E1%BA%A3n-xu%E1%BA%A5t-tra-tui-l%E1%BB%8Dc-tea-bag/>, (Access date: 16.08.2023)
- Arslan, R., 2013. Türkiye’de üretilen bazı organik baharat ve bitkisel çayların aflatoksin B1 düzeyleri ve mikrobiyolojik kaltesinin araştırılması, *Master Thesis*, Celal Bayar University Institute of Science, Manisa.
- Aslan, R., 2019. Gelenekten günümüze tıbbi ve aromatik bitkiler, *Ayrıntı Dergisi*, 7(73).
- Aydın, D., Katar, N., Katar, D., & Olgun, M., 2019. Farklı kurutma sıcaklıklarının anadolu adaçayının (*Salvia fruticosa* Mill.= *Salvia triloba* L.) uçucu yağ oranı ve bileşenleri üzerine etkisinin belirlenmesi, *International Journal of Agricultural and Wildlife Sciences*, 5(1), 103-109.
- Bajaj, S., 2016. Tea bags filter paper-a miniature textile creation, *Editorial Board*, 131.
- Bassi, P., Kumar, V., Kumar, S., Kaur, S., Gat, Y., & Majid, I., 2020. Importance and prior considerations for development and utilization of tea bags: A critical review, *Journal of Food Process Engineering*, 43(1), e13069.
- Can, N., Duraklı Velioglu, S., 2018. Bitki çaylarında mikrobiyal kalite ve mikotoksin varlığı. *Erzincan University Journal of Institute of Science*, 11(3), 362-380.
- Cavlak, S., & Yağmur, C., 2016. Bazı poşet çayların toplam fenolik madde ve antioksidan aktivitelerinin belirlenmesi, *Çukurova University Journal of Natural and Applied Sciences*, 34(4), 11-19.
- Douglas, M., Heyes, J., & Smallfield, B., 2005. Herbs, spices and essential oils: post-harvest operations in developing countries, *UNIDO and FAO*, 61, 1-8.

- Etheridge, C. J., & Derbyshire, E., 2020. Herbal infusions and health: A review of findings from human studies, mechanisms and future research directions. *Nutrition & Food Science*, 50(5), 969-985.
- Göktaş, Ö., Gıdık, B., 2019. Tıbbi ve aromatik bitkilerin kullanım alanları, *Bayburt University Journal of Science*, 2(1), 145-151.
- Güler, H. D., 2019. Biberiye, fesleğen, kekik, nane ve stevyanın toplam fenolik madde ve antioksidan aktivitesi üzerine kurutma yöntemlerinin etkisi, *Master Thesis*, Uludağ University Institute of Science and Technology, Bursa.
- Halt, M., 1998. Moulds and mycotoxins in herb tea and medicinal plants. *European Journal of Epidemiology*, 14, 269-274.
- Hayase, S., 2018. Manila hemp in world, regional, national and local history, *Journal of Asia-Pacific Studies Waseda University*, 3, 171-181.
- Jha, D. K., Dhekne, P. P., & Patwardhan, A. W., 2020. Characterization and evaluation of tea bag papers, *Journal of Food Science and Technology*, 1-11.
- Kabakçı, A., 2016. Paket bitki çayları üzerinde incelemeler, *Master Thesis*, Marmara University Health Sciences Institute, İstanbul.
- Kılınç, M., Tomar, O., & Çağlar, A., 2017. Biyobozunur gıda ambalaj malzemeleri, *Afyon Kocatepe University Institute of Science and Technology*, 17(3), 988-996.
- Kuriş, M. 2022. Gıda temaslı dokumasız kumaşların mikroplastik salım potansiyelinin farklı ayırma yöntemleri ile incelenmesi, *Master Thesis*, Sakarya University Institute of Science and Technology, Sakarya.
- Özer, P., Görgüç, A., Yılmaz, F.M., 2018. Mikrodalga teknolojisinin bitkisel dokulardan makro ve mikro bileşenlerin özütlenmesinde kullanımı, *Journal of Food*, 43(5).
- Pandey, A. K., 2017. Harvesting and post-harvest processing of medicinal plants: Problems and prospects, *The Pharma Innovation Journal*, 6(12), 229-235.
- Perussello, C. A., 2020. Non-thermal processing of herbs and spices, *Herbs, Spices and Medicinal Plants: Processing, Health Benefits and Safety*, 23-44.
- Poswal, F. S., Russell, G., Mackonochie, M., MacLennan, E., Adukwu, E. C., & Rolfe, V., 2019. Herbal teas and their health benefits: a scoping review, *Plant Foods for Human Nutrition*, 74(3), 266-276.
- Ravikumar, C., 2014. Review on herbal teas, *Journal of Pharmaceutical Sciences and Research*, 6(5), 236.
- Sarwar, S., Lockwood, B., 2010. Herbal teas, *Nutrafoods*, 9(2), 7-17.
- Şaşkara, C., Hürkul, M. M., & Güvenç, A., 2010. Aktarlarda satılan *Melisa officinalis* L. (Oğulotu, Melisa) üzerinde morfolojik ve anatomik çalışmalar, *Ankara University Journal of Faculty of Pharmacy*, 39 (2), 123-143.
- Söbeli, C., Uyarcan, M., Kayaardı, S., & Bayar, M. C., 2019. Biyobozunur ambalaj materyallerinin gıda endüstrisinde kullanımı. *Plastik & Ambalaj Teknolojisi*, 57-64.
- Suna, S., 2014. Doğal bitki ekstraktlarından alternatif bitki çayı üretimi üzerine bir araştırma. *Doctoral dissertation*, Bursa Uludag University.
- Toker, R., Gölükcü, M., & Tokgöz, H., 2015. Tıbbi ve aromatik bitkilerin gıda sanayisinde kullanım alanları. *Türkiye Tohumcular Birliği Dergisi*, 4(15), 54-59.
- Üstü, Y., Uğurlu, M., 2018. Fitoterapide bitkisel çaylar, *Ankara Medical Journal*, 18(1), 137-140.
- Varlı, M., Hancı, H., & Kalafat, G., 2020. Tıbbi ve aromatik bitkilerin üretim potansiyeli ve biyoyararlılığı, *Research Journal of Biomedical and Biotechnology*, 1(1), 24-32.
- Vijayalakshmi, K., Neeraja, C. Y., Kavitha, A., & Hayavadana, J., 2014. Abaca fibre, *Transactions on Engineering and Sciences*, 2(9), 16-19.

- Vural, A., Güran, H. Ş., Durmuşođlu, H., & Uçar, U., 2020. Tıbbi amaçla kullanılabilen bitki çaylarında hijyenik kalitenin ve bazı patojenlerin araştırılması, Dicle University Journal of the Faculty of Veterinary Medicine, 13(1), 76-82.
- Yadav, G. U., Joshi, B. S., Patwardhan, A. W., & Singh, G., 2017. Swelling and infusion of tea in tea bags, Journal of Food Science and Technology, 54(8), 2474-2484.
- Yurtsever, M., 2021. Are nonwoven fabrics used in foods made of cellulose or plastic? Cellulose/plastic separation by using Schweizer's reagent and analysis based on a sample of tea bags, Process Safety and Environmental Protection, 151, 188-194.

ANTIMICROBIAL ACTIVITY OF A NEW DEVELOPED CREAM FORMULATION WITH NATURAL ADDITIVES: *Citrus medica* L. var. *sarcodactylis* FRUIT ETHANOL EXTRACT AND PROBIOTIC

Meltem ASAN-OZUSAGLAM¹ and Hilal TASBASI^{1*}

¹ Department of Molecular Biology and Genetic, Faculty of Science and Letters, Aksaray University, Aksaray, Turkey

*Corresponding author e-mail: hhilaltasbasi@gmail.com

ABSTRACT

Citrus medica L. var. *sarcodactylis* is a morphologically remarkable fruit that grows in subtropical regions. It is accepted as food and nutrient rich in bioactive components, with high antioxidant activity and can be consumed safely. The chemicals used in cosmetic products cause skin irritation and allergic reactions. For this reason, herbal compounds offer natural options that support and protect skin health with their antimicrobial properties and skin care effects. In this study, it was aimed to create a new cream formulation by combining plant extract and probiotic as natural ingredients and to determine its antimicrobial activity. For this purpose, the cream formulation was developed using *C. medica* L. var. *sarcodactylis* ethanol extract and *Limosilactobacillus fermentum* MA-7, a probiotic candidate strain derived from human milk and commercial cream. The antibacterial and antifungal activities of the developed cream formulations against test microorganisms were determined using the well diffusion method. In the commercial cream (control, C) group, the inhibition zone diameter was not determined against *Candida glabrata* RSKK 04019, *Staphylococcus aureus* ATCC 25923, *Escherichia coli* O157:H7 and *Listeria monocytogenes* ATCC 7644. The developed groups of cream and *L. fermentum* MA-7 (CL), cream and the extract (CE) and cream containing extract and *L. fermentum* MA-7 (CEL) showed the highest inhibition zone diameters against *S. epidermis* ATCC 12228 (6.52 mm), *S. aureus* ATCC 25923 (6.06 mm) and *E. coli* O157:H7 (15.75 mm), respectively. The CEL group against all tested microorganisms exhibited higher antimicrobial activity compared to other developed cream groups (CE and CL). The results showed that the developed cream formulation with natural content can be used as an antimicrobial agent in the cosmetic and pharmaceutical industries to develop alternative products alternative to chemical substances.

Keywords: skin, cosmetic, antibacterial, probiotic

INTRODUCTION

Plants are among the sources to be used as antimicrobial agents (Ginovyan et al., 2017). The antimicrobial properties of plants are realized thanks to the bioactive compounds such as flavonoids, phenolic compounds, alkaloids, terpenoids, tannins, steroids they contain (Archana and Bose, 2022). *Citrus medica* L. var. *sarcodactylis* (Rutaceae) is a morphologically diverse fruit that can grow in subtropic (Karp and Hu, 2018). It is a rich source of terpenoids (Xu et al., 2019). Various chronic diseases are treated using it as a raw material in traditional Chinese medicines. *C. medica* L. var. *sarcodactylis*, with its high antioxidant activity, is reliably consumed as food and nutrients (Mahdi et al., 2019).

The skin is an organ that provides the first interaction of the human body with the external environment and serves as the primary line of defense (Byrd et. al., 2018). The skin surface creates a protective barrier against environmental factors, preventing the invasion of sun rays, harmful

substances, and harmful microorganisms, and maintaining the moisture balance of the skin (Yousef et al., 2017). Recently, there has been a significant increase in skin problems. For this reason, people show interest in personal care products applied to the skin surface. However, many products cause skin irritations and allergic reactions due to their chemical content (Adu et al., 2020). For this reason, natural substances that do not show allergic reactions are preferred in cosmetic products. The substances contained in the ingredients of cosmetic products applied to the skin surface can also create suitable environments for the reproduction of harmful microorganisms (Ecer, 2019). At the same time, cosmetic products carry a risk of microbial contamination. These microorganisms can pose a health hazard and cosmetic products need to be protected from contamination (Michalek et al., 2019).

Recently, probiotics are natural ingredients that have attracted great attention in the health and cosmetic industry. Probiotics exhibit antimicrobial and protective properties against skin and gastrointestinal tract reactions (Patil et al., 2020; Poruhsy et al., 2018). Probiotics added to creams as a solution to skin problems have topical applications (Patil et al., 2020). Topical probiotics have a promising role in wound healing and the treatment of some inflammatory skin diseases (Poruhsy et al., 2018). The topical use of probiotic products creates direct effects on the application area by strengthening the skin's natural defense barrier (Al-Ghazzewi and Tester, 2014).

In the study, the antimicrobial and antifungal activities of the cream formulation developed with ethanol extract obtained from *C. medica* L. var. *sarcodactylis* fruit and probiotic candidate strain *Limosilactobacillus fermentum* MA-7 originating from human milk was determined against test microorganisms. The potential of the developed cream formulation for use in the cosmetic and pharmaceutical industries has been investigated.

MATERIAL AND METHOD

Supply of plant materials

The *C. medica* L. var. *sarcodactylis* fruit (Figure 1) was obtained from the Alata Horticultural Research Institute (Turkey-Mersin) in November 2022.



Figure 1. A, B: *C. medica* L. var. *sarcodactylis* fruits

Preparation of plant extract

The fruits of *C. medica* L. var. *sarcodactylis* were dried in the shade and powdered with a blender (Waring). A homogeneous mixture of fruit (10 g) and ethanol solvent (30 ml) was obtained. The extraction process was completed using the water bath at 70°C for 2 days (24 hours). The solvent was removed from the extracts by evaporation. The extracts were dissolved with dimethylsulfoxide (DMSO) and sterilized using a 0.45 µm filter. The extract was stored at +4°C and used for in vitro antimicrobial activity study.

Test microorganisms

The antimicrobial activity of the cream formulation developed with plant extracts and/or probiotics was evaluated using six test microorganisms. The strains include Gram-positive bacteria *Staphylococcus aureus* ATCC 25923, *S. epidermis* ATCC 12228 (Nutrient Broth, 37°C), *Listeria monocytogenes* ATCC 7644 (Tryptic Broth, 30°C), Gram-negative bacteria *Escherichia coli* O157:H7 (Nutrient Broth, 37°C) and yeasts *Candida glabrata* RSKK 04019, *C. albicans* ATCC 10231 (Yeast Peptone Dextrose, 30°C). The probiotic candidate lactic acid bacteria *L. fermentum* MA-7 (Man Rogosa and Sharpe, 37°C) were incubated for 24 hours.

Determination of antimicrobial activity of cream formulations containing *C. medica* L. var. *sarcodactylis* ethanol extract and/or *Limosilactobacillus fermentum* MA-7

The antimicrobial and antifungal activities of the cream formulation were determined using the method of Asan-Ozusaglam and Celik (2023). In the cream formulations developed for antimicrobial purposes, *C. medica* L. var. *sarcodactylis* ethanol extract and/or human milk originated probiotic strain *L. fermentum* MA-7 (Asan-Ozusaglam and Gunyakti, 2019) were used. The antimicrobial activity of the cream formulations was determined using the well diffusion method. The petri dishes were incubated at suitable conditions as mentioned above for the test microorganisms.

Statistical Analysis

The antibacterial and antifungal activity assay results of the cream formulations developed with the *C. medica* L. var. *sarcodactylis* extract were analyzed using GNU-SPSS software. Statistical significance level was determined by one-way analysis (ANOVA) with Tukey's post-hoc test. The difference between the results was considered significant ($p < 0.05$).

RESULTS AND DISCUSSION

The antibacterial and antifungal activities of the cream formulation prepared using the ethanol extract obtained from *C. medica* L. var. *sarcodactylis* fruit and/or the probiotic candidate strain *L. fermentum* MA-7 were determined by the well diffusion method. The inhibition zone diameters of the developed cream formulations against test microorganisms are given in Table 1. The biological activity of the control group (C) against *C. glabrata* RSKK 04019, *S. aureus* ATCC 25923, *E. coli* O157:H7 and *L. monocytogenes* ATCC 7644 strains was not determined. The highest inhibition zone diameter was determined against *S. aureus* ATCC 25923 (6.06 mm) for the cream and extract group (CE), while the extract and probiotic containing group (CEL) was observed against *E. coli* O157:H7 (15.75 mm). The cream formulation developed with *C. medica* L. var. *sarcodactylis* ethanol extract and *L. fermentum* MA-7 strain (CEL) shows a significant inhibitory effect on *E. coli* O157:H7 and *S. epidermis* ATCC 12228, indicating that it may have the potential to be used as a natural antimicrobial agent. It was determined that most of CL group had higher inhibitory activity against the tested microorganisms compared to the cream (control, C) group. However, C and CL groups did not show any antibacterial activity against *E. coli* O157:H7 and *L. monocytogenes* ATCC 7644. The inhibitory activity against all tested strains was observed in all CE groups. Especially, CEL group was found to increase the diameters of the inhibition zone against all test microorganisms compared to other cream groups. *C. medica* L. var. *sarcodactylis* ethanol extract and *L. fermentum* MA-7 strain may have increased biological activity by creating a synergetic effect on the test strains.

Table 1. Antimicrobial activity of the developed cream formulations

Microorganisms	Inhibition Zone Diameters (mm±SD)				
	C	CL	CE	CEL	F(Sig)
<i>C. glabrata</i> RSKK 04019	NA ^a	2.21±0.44 ^b	3.63±0.04 ^b	5.70±1.11 ^c	48.782(0.000)
<i>C. albicans</i> ATCC 10231	2.08±0.19 ^a	4.01±1.16 ^b	1.55±0.31 ^a	8.59±0.15 ^c	82.256(0.000)
<i>S. aureus</i> ATCC 25923	NA ^a	1.25±0.10 ^a	6.06±1.40 ^b	9.42±0.96 ^c	79.251(0.000)
<i>S. epidermis</i> ATCC 12228	3.14±0.39 ^a	6.52±0.44 ^b	2.85±0.34 ^a	12.27±0.73 ^c	231.813(0.000)
<i>E. coli</i> O157:H7	NA ^a	NA ^a	3.87±0.38 ^b	15.75±0.89 ^c	716.336(0.000)
<i>L. monocytogenes</i> ATCC 7644	NA ^a	NA ^a	2.36±0.26 ^b	3.27±0.57 ^c	83.814(0.000)

*C: Cream (Control), CL: Cream and *L. fermentum* MA-7, CE: Cream and Extract, CEL: Cream containing *L. fermentum* MA-7 and Extract, NA: No activity

*Different letters indicate significant difference at $p < 0.05$.

Dahmani et al. (2022), the antibacterial activity of the extract obtained from *C. reticulata* peel using methanol solvent was determined against *S. aureus* (ATCC 29213) and *E. coli* (ATCC 25922). The wound healing activities of the ointment prepared using two different concentrations of the extract (5% and 10%) were investigated. It has been determined that the bioactive compounds present in *C. reticulata* peel have the potential for wound healing due to their content. According to Valizadeh et al. (2020) the MBC concentration of *C. aurantifolia* oil against *S. aureus* ATCC 25923, commonly found in wounds, were recorded as 47.61. It was determined that the ointment obtained from *C. aurantifolia* oil may be useful in the development of alternative products to provide tissue repair and accelerate the healing process.

CONCLUSIONS

The antibacterial and antifungal activities of the cream formulation developed with *C. medica* L. var. *sarcodactylis* ethanol extract and *L. fermentum* MA-7 against the tested strains was determined in vitro. It is observed that in the cream formulation, the ethanol extract and the *L. fermentum* MA-7 strain obtained from human milk have a synergetic effect against test microorganisms and increase the inhibition zone diameters. It has been determined that the developed cream formulation can be an alternative to synthetic preservatives used in the cosmetic and pharmaceutical industries as an antimicrobial preservative with natural additives.

REFERENCES

- Adu, S., A. Naughton, P. J. Marchant, R. Banat, I. M. 2020. Microbial Biosurfactants in Cosmetic and Personal Skincare Pharmaceutical Formulations. *Pharmaceutics*, 12(11), 1099. <https://doi:10.3390/pharmaceutics12111099>
- Al-Ghazzewi, F., H. Tester, R. F. 2014. Impact of Prebiotics and Probiotics on Skin Health. *Beneficial Microbes*, 5(2), 99-107. <https://doi:10.3920/BM2013.0040>

- Archana, H., Bose, V. G. 2022. Evaluation of Phytoconstituents from Selected Medicinal Plants and its Synergistic Antimicrobial Activity. *Chemosphere*, 287(4), 132276. <https://doi.org/10.1016/j.chemosphere.2021.132276>
- Asan-Ozusaglam, M., Celik, I. 2023. White Pitahaya as a Natural Additive: Potential Usage in Cosmetic Industry. *Foods & Raw Materials*, 11(1), 57–63. <https://doi.org/10.21603/2308-4057-2023-1-522>
- Asan-Ozusaglam, M., Gunyakti, A. 2019. *Lactobacillus fermentum* Strains from Human Breast Milk with Probiotic Properties and Cholesterol-Lowering Effects. *Food Science & Biotechnology*, 28(2), 501-509. <https://doi.org/10.1007/s10068-018-0494-y>
- Byrd, A. L., Belkaid, Y. Segre, J. A. 2018. The Human Skin Microbiome. *Nature Reviews Microbiology*, 16(3), 143-155. <http://dx.doi.org/10.1038/nrmicro.2017.157>
- Dahmani, S., Chabir, R. Errachidi, F. Berrada, W. Lansari, H. Benidir, M. ... Bour, A. 2020. Evaluation of In Vivo Wound Healing Activity of Moroccan *Citrus reticulata* Peel Extract. *Clinical Phytoscience*, 6(1), 1-9. <https://doi.org/10.1186/s40816-020-00222-8>
- Ecer, E. 2019. Koruyucu İçermeyen Antimikrobiyal Hammaddelerin Kozmetik Ürünlere Entegre Edilmesinin İncelenmesi. YL Tezi, Sivas Üniversitesi Fen Bilimleri Enstitüsü.
- Ginovyan, M., Petrosyan, M. Trchounian, A. 2017. Antimicrobial Activity of Some Plant Materials Used in Armenian Traditional Medicine. *BMC Complementary & Alternative Medicine*, 17(1), 1-9. <https://doi.org/10.1186/s12906-017-1573-y>
- Karp, D., Hu, X. 2018. The Citron (*Citrus medica* L.) in China. *Horticultural Reviews*, 45, 143-196. <https://doi.org/10.1002/9781119431077.ch5>
- Mahdi, A. A., Rashed, M. M. Al-Ansi, W. Ahmed, M. I. Obadi, M. Jiang, Q. ... Wang, H. 2019. Enhancing Bio-recovery of Bioactive Compounds Extracted from *Citrus medica* L. var. *sarcodactylis*: Optimization Performance of Integrated of Pulsed-Ultrasonic/Microwave Technique. *Journal of Food Measurement & Characterization*, 13, 1661-1673. <https://doi.org/10.1007/s11694-019-00083-x>
- Michalek, I. M., John, S. M. Caetano dos Santos, F. L. 2019. Microbiological contamination of cosmetic products—observations from Europe, 2005–2018. *Journal of the European Academy of Dermatology & Venereology*, 33(11), 2151-2157. <https://doi.org/10.1111/jdv.15728>
- Patil, E., Rawtal, B. Sakharwade, S. 2020. Magical Approach of Probiotics in Cosmetic. *World Journal of Pharmaceutical Research*, 9(11), 404-416. <https://doi.org/10.20959/wjpr202011-18670>
- Porubsky, C. F., Glass, A. B. Comeau, V. Buckley, C. Goodman, M. B. Kober, M. M. 2018. The Role of Probiotics in Acne and Rosacea. *Probiotics: Current Knowledge & Future Prospects*, 91-94. <http://dx.doi.org/10.5772/intechopen.79044>
- Valizadeh, A., Shirzad, M. Pourmand, M. R. Farahmandfar, M. Sereshti, H. Amani, A. 2020. Preparation and Comparison of Effects of Different Herbal Oil Ointments as Wound-Healing Agents. *Cells Tissues Organs*, 207(3-4), 177-186. <https://doi.org/10.1159/000503624>
- Xu, Y., Zhu, C. Xu, C. Sun, J. Grierson, D. Zhang, B. Chen, K. 2019. Integration of Metabolite Profiling and Transcriptome Analysis Reveals Genes Related to Volatile Terpenoid Metabolism in Finger Citron (*C. medica* var. *sarcodactylis*). *Molecules*, 24(14), 2564. <https://doi.org/doi:10.3390/molecules24142564>
- Yousef, H., Alhajj, M. Sharma, S. 2017. Anatomy, Skin (Integument), Epidermis. NCBI Bookshelf. A service of the National Library of Medicine, National Institutes of Health.

INVESTIGATION OF CORNELIAN CHERRY FRUIT AS A NATURAL ADDITIVE IN THE INDUSTRY

Sidarhan YATCI, Hilal TASBASI, Meltem ASAN-OZUSAGLAM

Department of Molecular Biology and Genetic, Faculty of Science and Letters, Aksaray University, Aksaray, Turkey

Corresponding author e-mail: hhilaltasbasi@gmail.com

ABSTRACT

In many industries, antimicrobial agents are used as additives against pathogenic microorganisms. Today, these substances, which are used commercially, are replaced by natural antimicrobial agents obtained from plants. Cornelian cherry (*Cornus mas* L.), which has the potential to be an antimicrobial agent, is a fruit grown in Turkey with high antioxidant and anthocyanin content. In this study, the antibacterial and antifungal activities of cornelian cherry extracts prepared with water and chloroform solvents on *Salmonella pullorum*, *Vibrio angillarum* A4, *Aeromonas hydrophila* ATCC 19570, *Candida albicans* ATCC 10231, *Escherichia coli* O157:H7 pathogens were investigated. The antimicrobial activity of the extracts was determined with disc diffusion, minimum inhibitory concentration (MIC) and minimum bactericidal or fungicidal concentration (MBC or MFC) methods. The highest zone diameter of cornelian cherry was determined on *S. pullorum* (18.06 mm) for chloroform extract and on *A. hydrophila* ATCC 19570 (16.06 mm) for water extract. MIC values of the extracts ranged from 5 µg/µl to 40 µg/µl. The lowest cidal value was obtained for the chloroform extract as 10 µg/µl (MBC) against *S. pullorum*. The results determined that cornelian cherry fruit extracts have the potential to be alternative natural antimicrobial additives against synthetic agents in various industries such as food, feed and pharmaceutical.

Keywords: Antimicrobial activity, *Cornus mas* L., Extract, Natural additive

INTRODUCTION

Recently, the use of medicinal plants for disease prevention and treatment purposes has been increasing rapidly. Plants exhibit antimicrobial activity due to biophenols, phenolic compounds and antioxidants in their structures (Rahaiee et al, 2015). Cornelian cherry (*Cornus mas* L.), which has a wide distribution area in our country, belongs to the Cornaceae family. Cornelian cherry fruit has a high biological value and is rich in phenolic compounds, ascorbic acid and anthocyanin content (Kazimierski et al., 2019). It has effects such as anti-inflammatory, antioxidant, antimicrobial, antiparasitic, antidiabetic, hepatoprotective, cardioprotective, nephroprotective and anticancer (Hosseinpour-Jaghdani et al., 2017). It is also used in folk medicine for various diseases such as skin diseases, diarrhea, intestinal inflammation, cancer, fever, urinary tract infections (Uğur et al., 2020).

Candida species are commensal microorganisms found in bronchial secretions, the oral mucosa, skin folds, urine, feces, digestive and vaginal tracts of humans (Hsu et al., 2020). Although about 20 species cause infection in humans, *Candida albicans* is the most common pathogenic strain, especially in immunocompromised person (Sardi et al., 2013).

Foodborne diseases are an important problem that threatens people's health (Takó et al., 2020). Food contamination occurring at various stages of the production process poses a

serious global health issue, leading to foodborne illnesses and severe diseases (Yang et al., 2017). Even animals raised in hygienic conditions can carry many disease-causing bacteria such as *Salmonella* spp., *Escherichia coli* O157:H7, *Staphylococcus aureus* and *Listeria monocytogenes*. These bacteria cause infection by infecting the human body through food and water. Despite significant efforts in the food industry, the presence of these bacteria persists due to contamination and processing procedures in slaughterhouses (Das et al., 2017). This situation can cause economic losses for the food industry and serious damage to public health. In particular, some plant extracts, essential oils and antioxidants inhibit or slow the growth of bacteria and microorganisms in foods (Takó et al., 2020). These natural ingredients help foods last longer and prevent microbial contamination that can threaten human health. In addition, it provides an alternative to the chemicals used and preservatives (Yu et al., 2021).

Aquaculture, a fast-expanding sector, plays a vital role in supplying humans with a crucial source of protein and micronutrients (Carbone and Faggio, 2016). However, diseases caused by pathogens are important problems in this industry. *Vibrio*, *Aeromonas*, *Yersinia*, *Lactococcus*, *Streptococcus*, *Acinetobacter*, *Clostridium* and *Pseudomonas* species are among the pathogens that cause serious financial losses and diseases (Yi et al., 2018). In addition, the excessive use of antibiotics against emerging diseases and the emergence of antibiotic-resistant strains poses a global threat to both humans and animals (Larsson and Flach, 2022). In aquaculture, secondary metabolites contained in plants are used to keep diseases under control. These plant compounds can be added to the feeds used in aquaculture as additives and natural antimicrobial agents and provide an effective solution to combat disease (Ahmadifar et al., 2021).

In study, the antimicrobial activity of water and chloroform extracts of cornelian cherry fruit against various clinical, food-borne and animal origin pathogens and their potential use as natural additives were investigated.

MATERIAL AND METHOD

Preparation of Extracts

The fruits were washed with distilled water and dried in the open air in a sun-free environment. The dried fruit samples were grounded using a Waring blender. The grounded fruit samples were vortexed with chloroform and water solvents (20 grams of fruit powder and 60 ml of solvent) and then sonicated for 20 minutes (for 2 days). After extraction, the solvents were evaporated and then stored (+4°C).

Determination of Antimicrobial Activity

Antimicrobial activity of cornelian cherry water and chloroform extracts was determined using the disc diffusion method. *S. pullorum* (Nutrient Broth (NB)), *V. anguillarum* A4 (2% salt Tryptic Soy Broth (TSB)), *A. hydrophila* ATCC 19570 (Nutrient Broth (NB)), *E. coli* O157:H7 (Nutrient Broth (NB)), *C. albicans* ATCC 10231 (Yeast Extract Peptone Dextrose (YPD)) strains were used as test microorganisms for 24-hours. Test microorganisms were washed twice with saline solution and bacterial concentration (0.5 McFarland) was adjusted. 0.1 ml of the prepared McFarland solution was spread on solid agar. Then, sterile discs (6 mm) were placed in petri dishes in 3 repetitions. 0.02 ml (4 mg/disc) of fruit extracts were dripped onto the discs. The recorded results were obtained by measuring the zone diameters formed around the discs after a 24-hour incubation period, using a caliper.

Determination Minimum Inhibition (MIC) and Minimum Bactericidal and/or Fungicidal Concentration (MBC and/or MFC)

The minimum inhibition and the minimum bactericidal and/or fungicidal concentration of fruit water and chloroform extracts were determined using the micro-dilution method. The fruit extracts were added to the tubes at a final concentration of 40 µg/µl and the mixture was diluted. After the tubes were incubated for 24-hours, MIC values were recorded. After spot dropping the samples from each tube onto solid media, they were incubated for 24 hours. The resulting MBC or MFC values in the solid medium were then recorded.

Statistical Analysis

The antimicrobial activity assay results of cornelian cherry extract were subjected to statistical analysis using GNU-SPSS software. A one-way analysis of variance (ANOVA) followed by Tukey's post-hoc test was performed to assess the significance of differences between the experimental groups.

RESULTS AND DISCUSSION

The biological activities of cornelian cherry extracts (water and chloroform) were determined by disc diffusion and microdilution methods. The inhibition zone diameters against the test microorganisms for the extracts are given in Table 1. The highest inhibition zone diameter of the cornelian cherry water and chloroform extract was determined against *A. hydrophila* ATCC 19570 (16.06 mm) and *S. pullorum* (18.06 mm). The lowest inhibition zone diameter was obtained against *V. anguillarum* A4 for the water extract as 12.15 mm and for the chloroform extract as 11.15 mm. In addition, it was determined that the water and chloroform extracts had an inhibition zone diameter of 13.97 mm and 14.33 mm against *C. albicans* ATCC 10231. It has been determined that cornelian cherry extracts have antibacterial and antifungal effects on the tested microorganisms.

Table 1. Inhibition zone diameter of the extracts from cornelian cherry fruit

Microorganisms	Extracts	
	CW (mm±SD)	CC (mm±SD)
<i>Salmonella pullorum</i>	13.55±0.3	18.06±0.6 ^a
<i>Escherichia coli</i> O157:H7	13.91±1.1	15.35±1.1 ^b
<i>Aeromonas hydrophila</i> ATCC 19570	16.06±1.6	17.37±0.1 ^{a,b}
<i>Vibrio anguillarum</i> A4	12.15±0.2	11.15±0.3 ^c
<i>Candida albicans</i> ATCC 10231	13.97±2.5	14.33±0.9 ^{d,b}
F(Sig)	2.780(0.086)	37.975(0.000)

*CW: Cornelian cherry Water extract, CC: Cornelian cherry Chloroform extract

*Different letters show significant difference at $p < 0.05$ between samples.

In a study, the biological activity of cornelian cherry water and methanol extracts on some clinical isolates was investigated. The water extract showed an inhibition zone diameter of 10 mm against *E. coli*, but no inhibitory activity against *C. albicans*. It was observed that the methanol extract had an inhibition zone diameter of 10 mm against *E. coli* and 8 mm against *C.*

albicans (Yigit, 2018). Milenković-Andelković et al. (2015) was determined the antimicrobial activity against *E. coli* (ATCC 25922) and *C. albicans* (ATCC 10231) pathogens by disc diffusion method. The Cornelian cherry fruit harvested at different times was extracted with methanol/acetone/water/formic acid (30/42/27.5/0.5) solvents. It was determined that the extracts had an inhibition zone diameter of 13.8/14.2 mm against *E. coli* ATCC 25922 and 14.7 mm against *C. albicans* ATCC 10231.

The MIC and MBC or MFC values of the extracts were determined using the micro-dilution method and are given in Table 2. MIC values of cornelian cherry water and chloroform extracts varied between 5 µg/µl to 40 µg/µl and MBC and/or MFC values between 10 µg/µl to >40 µg/µl. The lowest MIC value was 5 µg/µl against *S. pullorum* in both extracts. The lowest MBC value of the extracts was determined as 10 µg/µl against *S. pullorum* for water extract. The MFC value of the water and chloroform extracts was obtained as >40 µg/µl against *C. albicans* (ATCC 10231).

Table 2. MIC and MBC or MFC values of cornelian cherry water and chloroform extracts.

Microorganisms	Extracts			
	MIC(µg/µl)		MBC and/or MFC(µg/µl)	
	CW	CC	CW	CC
<i>Salmonella pullorum</i>	5	5	40	10
<i>Escherichia coli</i> O157:H7	20	40	40	40
<i>Aeromonas hydrophila</i> ATCC 19570	10	20	40	20
<i>Vibrio angillarum</i> A4	10	40	>40	>40
<i>Candida albicans</i> ATCC 10231	10	40	>40	>40

* CW: Cornelian cherry Water extract, CC: Cornelian cherry Chloroform extract

Yiğit (2018) was determined the MIC values of cornelian cherry extracts (water and methanol) using the micro-well dilution method. MIC values of the obtained water and methanol extracts varied between 0.312-0.625 mg/ml. The water and methanol extracts have been determined to have MIC values against *E. coli* as 0.312 mg/ml. The MIC value of methanol extract against *C. albicans* was 0.625 mg/ml. As a result, plants are of great importance due to their strong antimicrobial effects, as well as being a food source.

CONCLUSIONS

In this study, the potential of using cornelian cherry water and chloroform extracts as a natural additive and antimicrobial agent in various industries was investigated. The results showed that fruit water and chloroform extracts had antibacterial and antifungal activities. The Cornelian cherry fruit extracts may have the potential to be used as a natural additive and antimicrobial agent instead of chemical ingredients used in the food, feed, and pharmacology industries.

REFERENCES

- Ahmadifar, E., Pourmohammadi Fallah, H. Yousefi, M. Dawood, M. A. Hoseinifar, S. H. Adineh, H. ... Doan, H. V. 2021. The Gene Regulatory Roles of Herbal Extracts on the Growth, Immune System, and Reproduction of Fish. *Animals*, 11(8), 2167. <https://doi.org/10.3390/ani11082167>
- Carbone, D., Faggio, C. 2016. Importance of Prebiotics in Aquaculture as Immunostimulants. Effects on Immune System of *Sparus aurata* and *Dicentrarchus labrax*. *Fish and Shellfish Immunology*, 54, 172-178. <https://doi.org/10.1016/j.fsi.2016.04.011>
- Das, Q., Islam, M. R. Marcone, M. F. Warriner, K. Diarra, M. S. 2017. Potential of Berry Extracts to Control Foodborne Pathogens. *Food Control*, 73, 650-662. <https://doi.org/10.1016/j.foodcont.2016.09.019>
- Hosseinpour-Jaghdani, F., Shomali, T. Gholipour-Shahraki, S. Rahimi-Madiseh, M. Rafieian-Kopaei, M. 2017. *Cornus mas*: A Review on Traditional Uses and Pharmacological Properties. *Journal of Complementary and Integrative Medicine*, 14(3), 1-16. <https://doi.org/10.1515/jcim-2016-0137>
- Hsu H., Sheth C.C. Veses V. 2020. Herbal Extracts with Antifungal Activity against *Candida albicans*: A Systematic Review. *Mini-Reviews in Medicinal Chemistry*, 21(1), 90-117. <https://doi.org/10.2174/13895575200666200628032116>
- Kazimierski, M., Regula, J. Molska, M. 2019. Cornelian Cherry (*Cornus mas* L.)- Characteristics, Nutritional and Pro-Health Properties. *Acta Scientiarum Polonorum Technologia Alimentaria*, 18(1), 5-12. <http://dx.doi.org/10.17306/J.AFS.2019.0628>
- Larsson, D. J., Flach, C. F. 2022. Antibiotic Resistance in the Environment. *Nature Reviews Microbiology*, 20(5), 257-269. <https://doi.org/10.1038/s41579-021-00649-x>
- Milenković- Anđelković, A. S., Anđelković, M. Z. Radovanović, A. N. Radovanović, B. C. Nikolić, V. 2015. Phenol Composition, DPPH Radical Scavenging and Antimicrobial Activity of Cornelian Cherry (*Cornus mas*) Fruit and Leaf Extracts. *Hemjska Industrija*, 69(4), 331-337. <https://doi.org/10.2298/HEMIND140216046M>
- Rahaiee, S., Moini, S. Hashemi, M. Shojaosadati, S. A. 2015. Evaluation of Antioxidant Activities of Bioactive Compounds and Various Extracts Obtained from Saffron (*Crocus sativus* L.): A Review. *Journal of Food Science and Technology*, 52(4), 1881-1888 <https://doi.org/10.1007/s13197-013-1238-x>
- Sardi, J.C.O., Scorzoni, L. Bernardi, T. Fusco-Almeida, A.M. Mendes Giannini, M.J.S. 2013. *Candida* Species: Current Epidemiology, Pathogenicity, Biofilm Formation, Natural Antifungal Products and New Therapeutic Options. *J. Med. Microbiol.*, 62(1), 10-24. <https://doi.org/10.1099/jmm.0.045054-0>
- Takó, M., Kerekes, E. B. Zambrano, C. Kotogán, A. Papp, T. Krisch, J. Vágvölgyi, C. 2020. Plant Phenolics and Phenolic-Enriched Extracts as Antimicrobial Agents Against Food-Contaminating Microorganisms. *Antioxidants*, 9(2), 1-21. <https://doi.org/10.3390/antiox9020165>

- Ugur, Y., Erdogan, S. Yaman, R. Yanar, M. 2020. The Biochemical Characteristics of Some Cornelian Cherry (*Cornus mas* L.) Genotypes Cultivated in Turkey. 2nd International Eurasian Conference on Science, Engineering and Technology, Gaziantep, Turkey, pp.396.
- Yang, S. C., Lin, C. H. Aljuffali, I. A. Fang, J. Y. 2017. Current Pathogenic *Escherichia coli* Foodborne Outbreak Cases and Therapy Development. Archives of Microbiology, 199, 811-825. <https://doi.org/10.1007/s00203-017-1393-y>
- Yi, Y., Zhang, Z. Zhao, F. Liu, H. Yu, L. Zha, J. Wang, G. 2018. Probiotic Potential of *Bacillus velezensis* JW: Antimicrobial Activity Against Fish Pathogenic Bacteria and Immune Enhancement Effects on *Carassius auratus*. Fish and Shellfish Immunology, 78, 322-330. <https://doi.org/10.1016/j.fsi.2018.04.055>
- Yigit, D. 2018. Antimicrobial and Antioxidant Evaluation of Fruit Extract from *Cornus mas* L. Aksaray University Journal of Science and Engineering, 2(1), 41-51. <http://dx.doi.org/10.29002/asujse.329856>
- Yu, H. H., Chin, Y. W. Paik, H. D. 2021. Application of Natural Preservatives for Meat and Meat Products Against Food-borne Pathogens and Spoilage Bacteria: A Review. Foods, 10(10), 2418. <https://doi.org/10.3390/foods10102418>

THE INFLUENCE OF CLIMATIC FACTORS ON THE BIOECOLOGY OF THE HYBRID SPARROW (*PASSER DOMESTICUS* X *P. HISPANIOLENSIS*) IN THE BOUIRA (ALGERIA)

Sarah KHOUDJA¹, Abdelkrim AIT BELKACEM²

1. Faculty of Nature and Life Sciences, Department of Biology, laboratory for the exploration and development of steppe ecosystems EVES, Ziane Achour University of Djelfa, BP. 3117, 17000 Djelfa, Algeria.

2. Faculty of Nature and Life Sciences, Department of Agro-Veterinarians, Ziane Achour University of Djelfa, BP. 3117, 17000 Djelfa, Algeria.

Corresponding author e-mail: s.khoudja@univ-djelfa.dz

ABSTRACT

The present work is a contribution to the study of sparrows in Algeria by providing more elements concerning the bio-ecology of species and the influence of climatic factors. Monitoring the behavior of sparrows in different localities in Bouira between 2020 and 2021 shows the dominance of global perching (PG) with rates between 56.32 and 63.93%, followed by foraging (RA) with 28.67% and 36.97% . Vol (V.) is in third position (5.19% to 7.88%). For the influence of climatic factors, significant correlations are recorded between the search for drinking water (BRE), grooming (T.) and average temperatures (Tm) with $P < 0.001$, as well as cry activity (Cr) and precipitation (Pre). For the other activities, no significant correlation with climatic factors is noted. The study also reveals a significant difference in the behavior of the Hybrid Passer depending on the locality. The results obtained allow us to say that the behavior of the sparrows is variable according to the months of the year or the seasons, thus defining two periods: a period of intense activity in autumn and a second delimited in spring-summer, coinciding with the breeding period. The period of low activity characterizes the winter and summer period. Two effects of climatic factors on the behavior of sparrows are recorded; a perceptible direct effect and an indirect effect affecting either environmental conditions (food abundance) and/or species phenology. To this can be added other factors encountered such as the human presence (anthropic action), the geographical position of the locality (altitude), and the nature of the open, semi-open or closed environment which can in turn influence the behavior of sparrow species by controlling their numbers in the area.

Keywords: Hybrid Sparrow, Bio-ecology, Behaviour, Climatic factors.

INTRODUCTION

The bioecology of an organism reflects its entire natural history, includes all the biological characteristics related to its life cycle and provides a functional interpretation of the use of its habitat (Henry, 2001). Generally, species that occupy a large geographic range are subject to different ecological conditions and specific constraints specific to each habitat to which they must adapt in order to survive. (Blondel, 1995; Chabi, 1998). Thus, to understand the behavior of animal populations, birds are good biological models for assessing the quality of habitats. They are present in all natural environments, including artificial environments, in all food webs, distributed over the three dimensions of space and are therefore sufficient to formulate an ecological diagnosis of terrestrial environments (Blondel, 1975) . For the implications of birds in climate change, it seems to have many effects on bird species, by induction of phenological responses (success of reproduction, use of food resources, etc.) or modification of the ranges of

species, therefore influencing the numerical evolution of populations (Laudelout & Paquet, 2014). Some of these changes are so noticeable that highlighting them has helped raise awareness of the importance of climate change and the associated risks to biodiversity.

The species considered in this work is the hybrid sparrow (*Passer domesticus* x *P. hispaniolensis*), the best known bird group due to its distribution and dynamics causing serious damage to agricultural crops. Several works have been carried out in Algeria and around the world in the perspective of understanding the bio-ecology of these species and their congeners. We cite as an example the work carried out in Algeria by (Ait Belkacem, 2000, 2004) on the reproduction of the hybrid sparrow, in particular those of (Guezoul et al., 2006), and (Behidj-Benyounes et al., 2013). For studies on the trophic diet of (*Passer domesticus* x *P. hispaniolensis*), mention should be made of the work of (Ait Belkacem 2000, 2004), (Guezoul et al., 2011), (Saad et al., 2019), and (Abbassi et al., 2022). However, these studies were carried out without taking into account the potential effects of climatic factors on the bio-ecology of the species, and no temporal analysis at the regional level was carried out. The present work contributes to the study of sparrows in particular and birds in general by providing more information on the bio-ecology of species and the impact of climate.

Materials and methods

The hybrid sparrow behavior study was conducted in the communes attached to the agricultural subdivisions of the Bouira region (Oued El Berdi and El Hachimia). The 1st study area is located at an altitude of 591m, resting on varied geological substrates of stratified form. The landscape is semi-open characterized by areas of plains occupied by cereals, arboriculture and market gardening. As for the 2nd zone El-Hachimia is at an altitude of 713m, the landscape is open with relief characterized by a low slope: 70% of plains exploited in cereal growing and olive growing and 30% of more or less rugged terrain. Bouira is positioned in the sub-humid bioclimatic stage with a temperate variant.

The experiment lasted eight months from November 2020 until June 2021, two outings are carried out per week, i.e. eight observations per month. The observation took place during the first hours following sunrise and during the afternoon a few hours before dusk. As for the equipment used in the field, it consists of a pair of binoculars to identify and follow the evolution of the various activities of the sparrow, namely: Global Perching (PG), Food Search (RA), Flight (V), Search drinking water (BRE) and theft hunting (CV). A timer to calculate the time spent for each activity in seconds and a mimeographed sheet or behavior sheet to fill out, hour by hour.

The data collected is organized in the tables: Average daily time expressed in seconds and in percentages devoted to each type of activity of the hybrid sparrow in Oued-El-Berdi and El-Hachimia. It should be noted that the rates recorded for the Global Perching (PG) activity for each month only represent the cumulative time devoted to the three activities: Simple perching (Ps), Cry (Cr), and Grooming (T). In addition, the climatic information collected by the Bouira weather station for the period 2020-2021 is taken into account with an altitude adjustment. In particular the average temperature T_m (°C), the average precipitation Pre (mm) and the wind speed V_t (km/h).

For the treatment of the results we used the Principal Component Analysis (PCA). With the aim of highlighting the connections (similarities and differences) which exist in the behavior of the sparrow according to the months of the year and the considered stations, and to detect a possible action of the climatic factors on the activity of the sparrow hybrid. In addition, a bilateral mean test was applied based on a comparison between the two localities. For the implementation of our analyzes we used the R software.

RESULTS AND DISCUSSION

Of all the activities monitored during this study, it turns out that overall perching is the most important activity in terms of time spent, with values fluctuating between (63.93% And 56.32%) in Oued el berdi, and (65.23% and 51.42%)in El hachimia when looking for food, it comes in second place with values between (36.97% ,28.67%) And (42.43%,24.96%) respectively . Theft comes in 3rd position with lower percentages ranging between (7.88% And 4.31%) And (6.55% and 5.53%) The activities which require less time by the sparrow are represented by the two activities looking for drinking water and hunting theft. These results agree with those found by Ait Belkacem (2013) in the Djelfa region; who report that the most important activity of sparrows is Global Perching, followed by Diet and Flight.

The analysis of the Graph (Biplote of the Activities of the Hybrid Sparrow and climatic factors in Oued el Berdi) and the reading of the tables of the relative contributions of the individuals and the variables made it possible to highlight this: that the activity of the Hybrid Sparrow in November opposes that recorded in (January and February); the months belonging to the Fall season share strong values of Simple Perching, Screaming, Foraging and Flying. As for the months of the cold season, the behavior of the passer shows low rates of Foraging and Grooming, but also low temperatures are noted during the months. For (May and June) the activity or behavior is quite different to that denoted in the Autumn-Winter period; thus revealing the strong values of the activities: (flying hunting, Finding Drinking Water, and Grooming). High temperatures can be felt during this summer period. These observations make it possible to determine two periods of activity a period of intense activity in Autumn and a second period can be delimited in spring-summer coinciding with the breeding season. Indeed during the breeding period which begins in mid-March and ends in early July, the activity of hybrid sparrows in Bouira is oriented in several directions (the construction of nests, courtship displays, mating, brooding of eggs , and raising chicks) unlike the autumn season which was more devoted to food supply and the formation of reserves..

As for the study of correlations, the combinations (Ps -RA), (RA-Cr) and, (V-Cr) are almost perfectly correlated variables, positively. Which leads to say that these activities are of close importance for the biology of the sparrow. As for the climatic variables, positive correlations were recorded between the average temperatures (Tm) and the activities: Grooming (T) and the search for drinking water (BRE), as well as the Precipitation (Pre) and the cry (Cr). It is obvious that during high temperatures the water requirement of birds increases; moreover in the dry period the sparrows consume more dry seeds than insects (prey) rich in water. As for the correlation denoted between the (Tm) and the activity (T), it reveals an effect of the temperatures on the ectoparasites of this Passerine. According to (Mennerat et al., 2021) the average annual parasite load increased with minimum spring temperature and decreased with the increase in average temperature of the previous summer. While suggesting a major effect of temperature during the life cycle blowfly, with potential implications for host (Blue Tit) interactions across their geographic range as the climate continues to warm. Elderd & Reilly (2014), Eads & Hoogland (2016) local weather fluctuations can cause ectoparasite intensities to increase or decrease depending on where populations are relative to these optima.

The correlation recorded between monthly rainfall and Call activity in (*Passer domesticus* X *P. hispaniolis*) can be explained by the fact that the sparrow increases the intensity of its calls by emitting more alarming signals during meteorological events. According to (Verboom & Heij, 2018) different types of vocalizations are determined in the house sparrow. Indeed the sparrows in groups produce high frequency chirping, while when taking meals somewhat corresponding chirps are recorded. The alarm call is a hoarse pulsating call consisting of six

identical semi-wideband components. As for the territory call, it is repeated several times and consists of three up/down sweep combinations.

Similarly, the analysis of the graph (biplot of behavior of the hybrid sparrow according to the annual cycle in the two stations) makes it possible to note that in November the activity of the hybrid sparrow is very important in the two localities with high rates of: Global Perching (PG), Food Search (RA), and Flight (V), as well as in April at Oued el Berdi. Therefore opposing the activity of the Passer over the short months (January, February, and June) to El Hachimia. As for the behavior of (*Passer domesticus X P hispaniolis*) in Oued el berdi during the months (April, May and June) and (May and June) in El Hachimia; the two localities share strong activity values: flight hunting (CV) and the search for drinking water (BRE).

It should therefore be said that the hybrid sparrow has differences in its behavior depending on the stations. Indeed during the winter and summer season the reduced activity of the Passer is noted in the two localities. However, it marks more the El Hachimia locality. On the other hand, in the spring-summer period, a delay in the reproduction period was recorded in El Hachimia compared to Oued el Berdi. According to (Pearce Higgins & Green, 2014) the positive effect of temperature on the reproduction of landbirds in temperate zones: increased survival and better reproductive success is less evident in passerines, for which there does not seem to be a clear trend clear. Moreover, in temperate zones, global warming will lead to an increase in the diversity of bird species per station (diversity á). Although in common birds in Britain (Davey et al., 2012), it is however accompanied by a greater “homogenization of communities”. In addition, rainfall has a crucial role in conditioning the extent of many wetlands but also it promotes the growth of vegetation and, indirectly, the availability of food resources and therefore a better body condition in birds, high survival rate, and more abundant populations the following spring. Newton (2004). It is important to mention that the climate differs almost entirely depending on the altitude. Temperatures decrease as height increases. The number of frost days differs/changes between November and March depending on altitude. Almost in the same way, the annual precipitation increases with proximity to the sea. While the wind depends more on the local topography.

On the other hand, it should also be indicated that the behavior of the hybrid sparrow is important in the month of April at Oued el Berdi. According to (Aitbelkacem et al., 2002) during the reproduction period a strong activity of individuals is observed near agricultural plots coinciding with the milky stage of wheat.

In addition, the average test applied to the different recorded rates of Hybrid Sparrow activities in Bouira reveals the existence of a significant difference in the behavior of the Passer between the two localities, for flight activity (V) and overall perching. (PG) with $p=0.016$ and $p=0.011$ respectively. this could be explained by the strong anthropic activity noted at the level of the El Hachimia zone which influenced the activity of the sparrows, as well as their number in the station. Furthermore, we hypothesize that habitat variables at the landscape scale play a crucial role in the reproduction and recruitment of sparrow species. According to (Zhang & Zheng, 2010) heavily urbanized areas, major roads and high-rise buildings are not suitable for tree sparrow habitation. resulting in sparrow numbers declining along urbanization gradients in Pikin. these revelations are consistent with our observations at El Hachimia. On the other hand, the presence of trees belonging to different strata, low-rise constructions as well as the reduced number of pedestals in the locality of Oued el berdi make this area an adequate environment to shelter the hybrid sparrow (especially in period Autumn-Winter and during the breeding period; Spring-Summer). At the 50 m scale, the area of low buildings, the number of conifers and pedestrians are the main factors contributing to the distribution of the Tree Sparrow, while at the 400 m scale, the percentage of the area of tall buildings and vegetation remain important habitat variables. (Zhang & Zheng, 2010). In addition, the presence of plants and the abundance

of food are two key factors that determine the presence of sparrows in the region. In the Faroe Islands (Bengtson et al., 2010) found a positive correlation between Passer patch occupancy and area and amount of vegetation. Vincent (2005) House Sparrow brood biomass increased with the extent of vegetated areas around nest sites, suggesting that breeding success may be relatively low in habitats with low vegetation cover. In Algeria (Benyounes & Doumandji, 2009) reports that the presence of trees and water resources, but also constructions are favorable places for the installation of nests. Ultimately, it is argued that the interaction between climate and local environment provides a mechanism by which spatial synchronization in population dynamics can be reduced even in strongly spatially autocorrelated environments. (Ringsby et al., 2002).

CONCLUSION

The study of the Bio-ecology of the hybrid Sparrow and the influence of climatic factors in the region of Bouira shows that the most important activity requiring more time is Perching followed by Food Search and Flight. For other activities they are less frequent and of less importance. Our observations also make it possible to note: a variation in the evolution of the different activities of the hybrid sparrow according to the months of the year, consequently we can define two periods of activity: a period of intense activity in Autumn and a second period can be delimited in Spring-Summer, coinciding the period of reproduction. The period of low activity characterizes the cold season in Winter and the dry period in Summer. 518obacco action of the climatic factors, correlations between the activities seeking drinking water (BRE), grooming (T) and the average monthly temperature values are recorded, as well as the precipitation (Pre) and the cry (Cri). 518obacco other factors, no correlation is noted. The study also reveals a significant difference in sparrow behavior between the two localities.

This amounts to saying that climatic factors can have a perceptible direct effect on the behavior of sparrows and indirect either by affecting the conditions of the environment; for example an action on the evolution of plants or even the presence of insects in the area, or even an effect on the phenology of species. To this can be added other factors encountered in the environment such as the human presence, the geographical location of the locality, and the 518obacc of the open, semi-open or closed environment which can in turn influence the behavior of sparrow species by control of their numbers in the area.

Months 2020/2021																
	XI		XII		I		II		III		IV		V		VI	
	Sec	%	Sec	%	Sec	%	Sec	%	Sec	%	Sec	%	Sec	%	Sec	%
PG	7302	59,18	5065	58,21	4180	56,32	4719	58,99	5603	63,93	6972	59,21	5301	57,01	5929	61,36
RA	4325	35,05	3031	34,83	2656	35,79	2778	34,73	2513	28,67	4012	34,07	3438	36,97	3031	31,37
v	701	5,68	600	6,89	585	7,88	502	6,27	589	6,72	612	5,19	401	4,31	523	5,41
BRE	10	0,08	5	0,05	0	0	0	0	20	0,23	56	0,47	102	1,09	150	1,55
CV	0	0	0	0	0	0	0	0	39	0,44	123	1,04	56	0,6	29	0,30

Totaux	12338	100	8701	100	7421	100	7999	100	8764	100	11775	100	9298	100	9662	100
--------	-------	-----	------	-----	------	-----	------	-----	------	-----	-------	-----	------	-----	------	-----

Tab01. Average 519obac time expressed in seconds and in percentages devoted to each type of activity of the hybrid sparrow in Oued-el-berdi (Bouira)

	Months2020/2021															
	XI		XII		I		II		III		IV		V		VI	
	Sec	%	Sec	%	Sec	%	Sec	%	Sec	%	Sec	%	Sec	%	Sec	%
PG	5985	57,14	4256	51,42	2487	57,59	3349	61,97	4432	59,97	4667	55,94	4252	54,09	3143	65,23
RA	3888	37,12	3512	42,43	1563	36,19	1701	31,47	2513	34	3067	36,76	3001	38,18	1203	24,96
v	601	5,74	499	6,03	263	6,09	354	6,55	412	5,57	522	6,26	435	5,53	294	6,1
BRE	0	0	10	0,12	5	0,11	0	0	18	0,24	51	0,611	123	1,56	166	3,44
CV	0	0	0	0	0	0	0	0	15	0,2	35	0,42	49	0,62	12	0,25
Totaux	10474	100	8277	100	4318	100	5404	100	7390	100	8342	100	7860	100	4818	100

Tab 02. Average 519obac time expressed in seconds and in percentages devoted to each type of activity of the hybrid sparrow in EL-Hachimia (Bouira).

Biplot of Hybrid Sparrow Behavior according to the Annual cycle
(Oued El-Berdi et El-Hachimia)

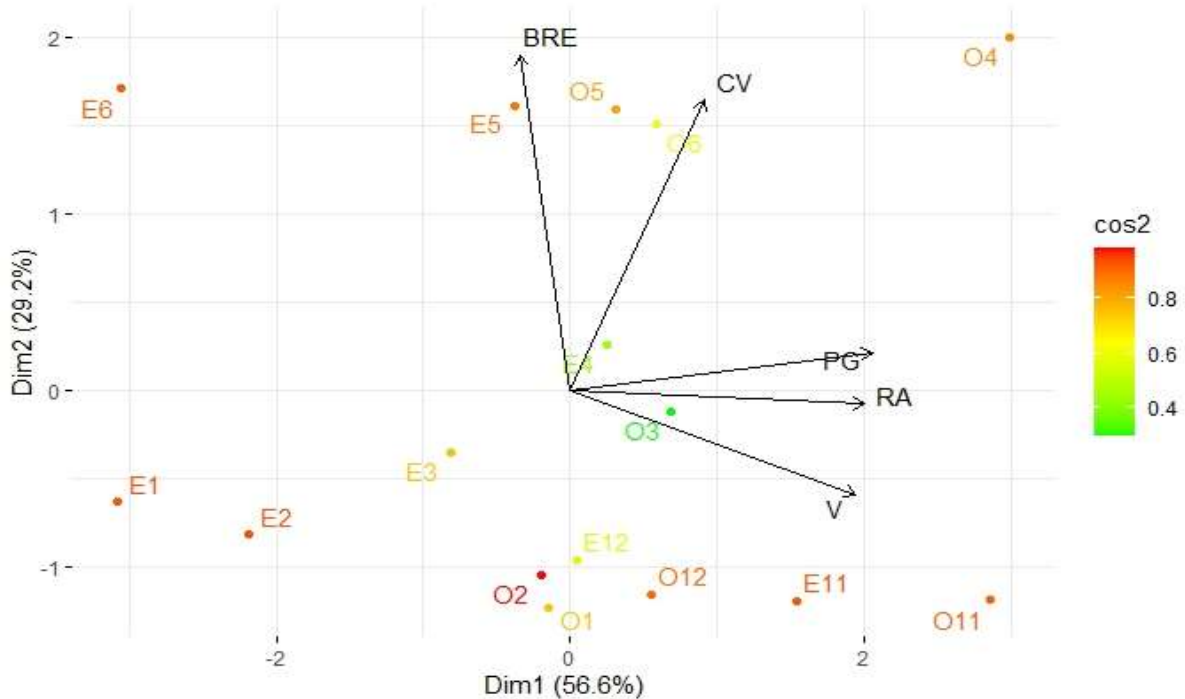

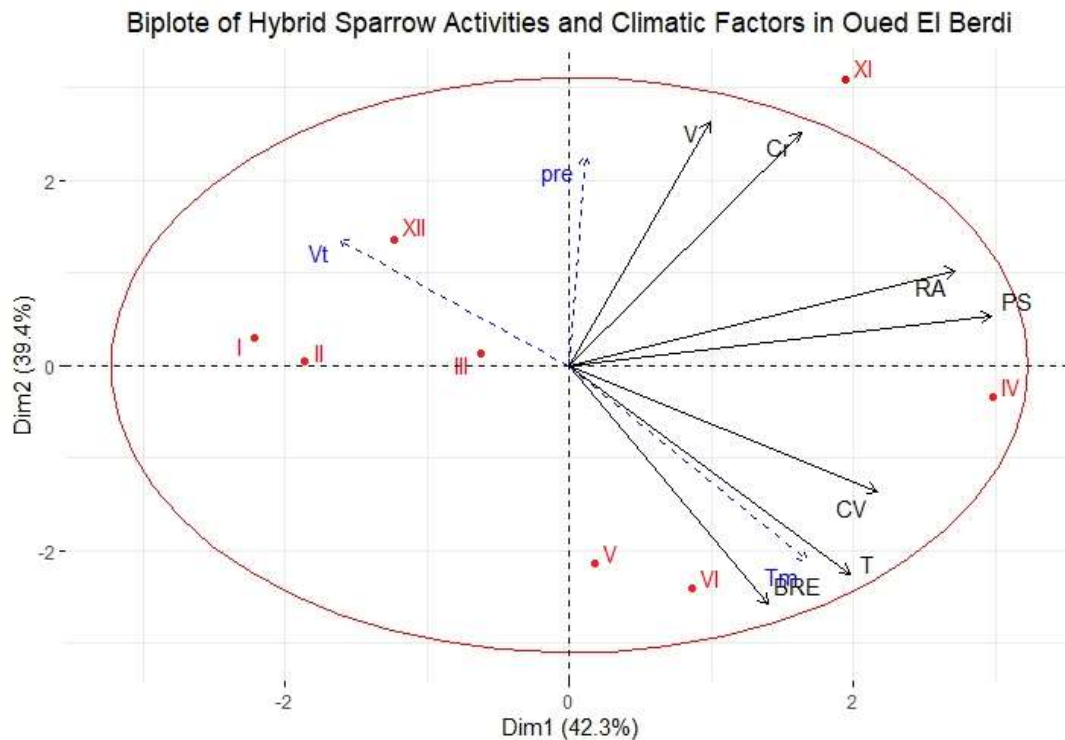

REFERENCES

- Abbassi A., Alioua Y. Benra H. Guezoul O. 2022. Spectre Alimentaire Des Jeunes De *Passer Domesticus* X *P. Hispaniolensis* Dans Une Palmeraie A Hassi Ben Abdellah (Ouargla, Sahara Septentrional-Est Algerien), Bio.Res. 12: 29-38.
- Ait Belkacem A., 2000. Le Moineau Hybride *Passer Domesticus* X *P. Hispaniolensis* Dans La Baulieue d'El Harrach: Reproduction, Disponibilités Trophiques Et Régime Alimentaire. Mémoire Ingénieur, Inst. Nati. Agro., El Harrach, 145 P.
- Ait-Belkacem A., Akrouf F. Benjoudi D. Baziz B. Doumandji S. 2002. Daily intensity of fréquentation in the field of the tender wheat *Triticum sativum* by hybrid sparrow *Passer domesticus* X *P. hispanilensis* at Oued Smar (Mitidja). Ornith.algir.II(1) :25-30
- Ait Belkacem A., 2004. Reproduction Et Régime Alimentaire du Moineau Hybride *Passer Domesticus* X *P. Hispaniolensis* dans La Partie Orientale de La Mitidja. Thèse Magister. Inst. Nati. Agro. El Harrach. 233 P.
- Ait Belkacem A., 2013. Particularités Bioécologiques Des Moineaux sur les Hauts Plateaux et moyens de lutte adéquats. Thèse Doct. Inst. Nati. Agro. El Harrach, 246p.
- Behidj-Benyounes N., Bissaad FZ. Behidj K. Chebouti N. Doumandji S. 2013. Le suivi de la Reproduction chez le Moineau Hybride (*Passer Domesticus* X *P. Hispaniolensis*) dans un milieu agricole de la partie extrême-orientale de la Mitidja. Bull. Soc. Zool. Fr; 138(1-4):331-343.
- Behidj-Benyounes N., Doumandji S. 2009. Les Attaques journalières de trois parcelles d'orge *Hordeum vulgare* L. Par le Moineau hybride (*Passer domesticus* X *P. Hispaniolensis*) dans la Mitidja orientale. Lebanese science journal. 10.(1) : 55 – 62.
- Bengtson P., Buckland P. Enckell H. Fosaa AM. 2010. Man-Dependence Of House Sparrows (*Passer Domesticus*) In The Faroe Islands. Habitat Patch Characteristics As Determinants Of Presence And Numbers. Dorete – Her Book. Annales Societatis Scientiarum Færoensis. Suppl. 52. Pp. 227-243.

- Blondel J., 1975 . L'analyse des Peuplements d'oiseaux, 521obacco d'un Diagnostic Ecologique. Terre et Vie. 29 : 533-589.
- Blondel J., 1995. Biogéographie Approche Ecologique et Evolutive. Ed. Masson. Collection Ecologie (27). Ed. Masson, 297p.
- Chabi Y., 1998. Biologie de la Reproduction des Mésanges dans les Chênaies du Nord Est de l'Algérie. Thèse Doct. Université. Badji .Mokhtar. Annaba.162p.
- Davey CM., Chamberlain DE. Newson SE. Noble D G. Johnston A. 2012. Rise of the Generalists: Evidence For Climate Driven Homogenization in Avian Communities. Global Ecology And Biogeography. 21 : 568-578.
- Eads, D. And Hoogland, J. 2016. Factors That Affect Parasitism Of Black-Tailed Prairie Dogs By Fleas. – Ecosphere 7: E01372.
- Elder BD., And Reilly JR. 2014. Warmer Temperatures Increase Disease Transmission And Outbreak Intensity In A Host-Pathogen System. J. Anim. Ecol. 83: 838-849.
- Guezoul O., 2011. Importance des Dégâts du Moineau Hybride dans différentes régions Agricoles d'Algérie. Thèse de Doctorat. École Nationale Supérieure Agronomique. El Harrach .Alger. 302 P.
- Guezoul O., Chenchouni H. Doumandji S. 2011. Breeding Biology In Hybrid Sparrow (*Passer domesticus* × *P. Hispaniolensis*) In Northern Algerian Sahara .Case Study Of Biskra Date Palm-Grove. Journal Of Advanced Laboratory Research In Biology. 2(1):12-17.
- Henry C., 2001. Biologie des Population Animales et Végétales. Ed. Dunod. Paris. 709 P.
- Laudelout A., Paquet JY. 2014. Les Changements Climatiques et les Oiseaux. Synthèse et Impacts sur l'avifaune Wallonne. Aves 51/4 : 193-215.
- Mennerat A., Charmantier A. Perret P. Hurtrez-Boussès S. Lambrechts MM. 2021. Parasite Intensity Is Driven By Temperature In A Wild Bird. Peer Community Journal. 1 :E60.
- Newton I., 2004. Population Limitation In Migrants. Ibis. 146 : 197- 226.
- Pearce-Higgins JW., Green RE. 2014. Birds And Climate Change. Impacts And Conservation Responses. Cambridge University Press.
- Ringsby TH., Saether BE. Tufto, J. Jensen H. Solberg EJ. 2002. Asynchronous Spatiotemporal Demography Of A House Sparrow Metapopulation In A Correlated Environment. Ecology 83(2) :561-569.
- Saad N., Farhi K. Matallah N. Belhamra M. 2019. Menu Trophique Automnal des Moineaux Hybrides adultes dans l'Est des Ziban. 1^{er} Séminaire National Biodiversité et Valorisation des Produits Biologiques dans les régions Arides et semis Arides, 6 et 7 Mars 2019. Université Echahid Hamma Lakhdar -El-Oued. Algérie.
- Verboom WC., Heij CJ. 2018. Bird Vocalizations. The House Sparrow (*Passer Domesticus*). Junobioacoustics. 2 :201807.
- Vincent KE., 2005. Investigating the Causes of the Decline of the Urban House Sparrow *Passer domesticus* Population In Britain. Phd Thesis. De Montfort University. Leicester. UK.
- Zhang S., Et Zheng G. 2010. Effect Of Urbanization on the Abundance and Distribution of Tree Sparrows (*Passer montanus*) In Beijing. Chinese Birds 1(3) :188–197.

TOBACCO BREEDING FOR LEAVES AND YIELD

Jane Aleksoski¹, Verica Ilieva², Ana Korubin – Aleksoska¹

¹University “St Kliment Ohridski” – Bitola, Scientific Tobacco Institute – Prilep,
²Goce Delcev University – Stip, Faculty of Agriculture, Republic of North Macedonia

Corresponding author e-mail: anakorubin@yahoo.com

ABSTRACT

The aim of this work is to investigate the mode of inheritance for the number of the leaves per stalk, area of the leaves from the middle belt and yield of dry leaf mass per stalk, in four F₁ tobacco hybrids obtained by crossing five varieties, four of which are Oriental in the role of mother and one Broadleaf as a father, in 2020 and 2021. The most common mode of inheritance for the first trait is negative dominance, for the second trait partial dominance and for the third trait intermediate. There is no heterosis. The best results for the size of the leaves from the middle belt and for the yield of dry mass gave P-76/86 x B-1/91. The obtained mode of inheritance is an indicator of good selection of individuals in future generations and quick fixation and stabilization of the traits. The four hybrid combinations represent very interesting starting material for tobacco breeding.

Keywords: *Nicotiana tabacum* L., hybrids, inheritance, F₁ generation, quantitative traits.

INTRODUCTION

The production of oriental tobacco is one of the most important branches in the economy of the Republic of North Macedonia. Most of the tobacco raw material is intended for foreign markets. The participation of our tobacco in the highest quality cigarette brands is proof of top quality and exceptionally pleasant aroma. Because of this, the investigations in genetics and selection of tobacco are of great importance. Using the methods of these sciences, breeders try to create more productive and better quality varieties than the existing ones. By introducing new superior varieties in tobacco production, the economic effect of this culture will increase, thereby improving the standard of producers and increasing the flow of funds in the country.

The aim of this paper is to study the mode of inheritance of the number of leaves per stalk, the area of the leaves of the middle band of the stalk and the yield of dry leaf mass per stalk, in the F₁ generations obtained from different types of tobacco, in order to reveal a possible heterotic effect, as well as to provide material for further successive tobacco breeding activities.

MATERIAL AND METHOD

As material for work, we chose five genotypes from the gene bank of the Scientific Tobacco Institute – Prilep: Prilep P-23, Prilep P 18-50/4, Prilep P 76/86, Basmak MS 8/1 and Burley B-1/91. As a parent-father, we used the broadleaf variety B-1/91, so with its pollen in 2019 and 2020 we made four F₁ hybrids: P-23 x B-1/91 (Figure 6), P 18-50/4 x B-1/91 (Figure 7), P 76/86 x B-1/91 (Figure 8) and MS 8/1 x B-1/91 (Figure 9). The parental varieties and their F₁ hybrids were planted in a randomized block system in four replications, in an experimental field at STI-Prilep, in 2020 and 2021, on a working area of about 291.6 m² or a total area of 655.2 m² (working surface and paths). The broadleaf variety and F₁ hybrids are planted at a planting distance of 90 cm (between rows) x 50 cm (between plants in a row), while the oriental

varieties are planted at a planting distance of 45 cm x 15 cm. The number of leaves per stalk and the dimensions of the leaves from the middle band of the stalk were determined at the full stage of plant development, at the beginning of flowering. The data from the measurements of the number of leaves per stalk were processed variationally-statistically (the standard deviation- σ and the coefficient of variability-CV). The surface area of the leaves was calculated by multiplying the mean values of the length by the mean values of the width and by the coefficient $k=0.6354$. Dry leaf mass was calculated after the manipulation of tobacco.

Mode of inheritance of the components was determined on the basis of test-significance of F_1 generation in relation to the average of both parents.

Parental genotypes:

Prilep P-23 – Kosta Nikoloski and Milan Mitreski are authors of this variety. Belongs to the oriental sun-cured tobaccos (Figure 1). The characteristics of this variety are described by Korubin – Aleksoska (2004).

Prilep P 18-50/4 – Creation by Ana Korubin – Aleksoska. The variety belongs to the group of oriental sun-cured tobaccos (Figure 2).

Prilep P-76/86 – is an oriental sun-cured variety, created by Dimche Chavkaroski and his collaborators (Figure 3). It is distinguished by a long vegetation (from planting to flowering 85-95 days). A description of the variety is given by Korubin – Aleksoska (2004).

Basmak MS 8/1 – created by a group of authors, headed by Dusko Boceski. It belongs to the basmak sun-cured type, which was created from the Jakali type from Greece (Figure 4). The morphological traits of the genotype are described by Korubin – Aleksoska and Ayaz Ahmad (2016).

Burley B-1- 9 – Dimche Cavkaroski and his collaborators are the authors of the variety. Belongs to the group of broadleaf air-cured tobacco (Figure 5). A description of the variety is given by Korubin – Aleksoska (2004).



Figure 1. Prilep P-23



Figure 2. Prilep P 18-50/4



Figure 3. Prilep P-76/86



Figure 4. Basmak MS 8/1



Figure 5. Burley B-1/91



Figure 6. P-23 x B-1/91 (F₁)



Figure 7. P 18-50/4 x B-1/91 (F₁)



Figure 8. P-76/86 x B-1/91 (F₁)



Figure 9. MS 8/1 x B-1/91 (F₁)

Climatic and soil conditions in the area of investigations:

During the scientific research of quantitative traits from the aspect of selection and genetics, it is necessary to take into account the environmental conditions in which the studies were conducted.

The climate parameters in 2020 and 2021 are drastically different. So, in 2020 average temperature (May-September) is 22.15°C, minimum tem. Is 15.6°C, maximum tem. Is 28.8°C, humidity 61.2%. The total amount of rains in the given period is 400.6 mm. In 2021 average temperature is 18.9°C, minimum tem. Is 13.1°C, maximum tem. Is 24.1°C, humidity 52.2%. The total amount of rains in the given period is 174 mm (<https://en.climate-data.org/525obacc/525obaccos525/prilep/prilep-37313/>). Basically in 2021 the temperature from May to September is lower, the humidity in the air is lower, and there is about 43% less rainfall.

Our research was conducted in the experimental field in the Scientific Tobacco Institute – Prilep on a deluvial (colluvial) soil type.

RESULTS AND DISCUSSION

Number of leaves per stalk:

One of the most studied quantitative traits by tobacco breeders is the number of leaves per stalk, because it is directly related to yield.

With the smallest number of leaves among the parents is characterized B-1/91 (30.3), and with the biggest P-76/86 (54.4), while in hybrids the least leaves have P-23 x B-1/91 (29.2), and the most P 18-50/4 x B-1/91 (34.3). The standard deviation ranges from 1.2 (P 18-50/4 and P-76/86 x B-1/91) to 2 (B-1/91). The coefficient of variability ranges from 2.2% (P-76/86 x B-1/91) to 4.5 (B-1/91). The coefficient of variability of the variants has a value less than 10, which means that the tested variants are stable and uniform.

The mode of inheritance of this trait is negative dominant (onli in P 18-50/4 x B-1/91 there is partial dominance). There is no heterosis.

Partial dominance in inheritance of leaf number per stalk and absence of heterosis found: Korubin – Aleksoska (2000), in the crosses of three oriental varieties, Korubin – Aleksoska (2001), in ten oriental genotypes, Gixhari and Sulovari (2010), in a semi-diallel of eight oriental genotypes. Different way of inheritance and a weak heterotic effect received Aleksoski (2010), in a one-way diallel of three oriental and one Burley variety. Dyulgerski and Radoukova (2019), in seven hybrids of the Berlay type in the F₁ generation found the dominance of the parents with a larger number of leaves.

Heterosis with a positive heterotic effect on the trait found: Butorac et al. (1999), in F₁ offspring of four Burley varieties, Lalitha et al. (2006), in crosses on six lines and six testers, Dimanov and Dyulgerski (2012), at ten crosses of local and introduced Burley varieties. (high heterotic effect is detected), Aleksoski et al. (2013), in hybrids of four parent genotypes of tobacco of different types (the heterosis had a weak heterotic effect), Ramachandra et al. (2015), in hybrids obtained from six lines of different types of tobacco and eight testers.

Leaf area of the middle belt of the stalk:

The smallest area of the leaves from the middle belt of the stalk in the parental genotypes has the variety P 18-50/4 (173 cm²), and the biggest B-1/91 (1203.5 cm²), while in F₁ hybrids with the smallest leaf area is characterized MS 8/1 x B-1/91 (847 cm²), and with the biggest P-76/86 x B-1/91 (1270 cm²). The standard deviation and the coefficient of variability are not calculated for this trait, because the values are obtained by applying the formula for area, where the mean values of the length and width of the leaves by repetitions are entered.

The mode of inheritance of this trait is partially dominant (only in P-76/86 x B-1/91 there is positive dominance). There is no heterosis.

The area of the leaves has been studied by many authors, because the value of this trait correlates with the yield. The most common way of inheritance is the partially dominant and intermediate. Similar results were obtained by: Aleksoski (2010), in a one-way diallel of four parental genotypes of Oriental and Burley origin; Gixhari and Sulovari (2010), in a one-way diallel of eight oriental genotypes; Aleksoski et al. (2013), in a diallel of four parent genotypes of tobacco of different types; Aleksoski (2018), in a diallel of four oriental varieties, etc.

Positive heterosis in inheriting of leaf area received: Korubin – Aleksoska (2000), in diallel of three oriental and one semi-oriental variety (a positive heterotic effect appeared in two crosses where one parent is the introduced variety Pobeda-2); Lalitha et al. (2006), in hybrids of six line and six testers (the resulting heterotic effect was low to moderate in both directions); Aleksoski (2010), in a one-way diallel of four parental genotypes – three oriental and one Burley (the weak heterotic effect had no economic justification); Gixhari and Sulovari (2010), in a diallel of eight parent oriental genotypes; Aleksoski et al. (2013), in six diallel crosses of four parent tobacco genotypes of different types; Aleksoski (2018), in hybrids of four oriental varieties.

Yield of dry leaf mass per stalk:

The investigations for the yield of dry leaf mass are always present in programs for the creation of new more productive varieties and improving of existing ones.

The lowest yielding variety between the parental genotypes is MS 8/1 (15.5 g/stalk), and the highest yielding B-1/91 (170.5 g/stalk), while in F₁ hybrids with the lowest yield is P-23 x B-1/91 (72 g/stalk), and with the highest yield P-76/86 x B-1/91 (104 g/stalk).

The mode of inheritance of this trait is intermediate (526oba in P-23 x B-1/91 there is partial dominance). There is no heterosis.

The dry leaf mass per stalk has been studied by many breeders. The most common way of inheritance is the partially dominant and intermediate.

A partially dominant mode of yield inheritance was obtained by Korubin – Aleksoska (2001), in a diallel of three oriental and one semi-oriental variety, and Gixhari and Sulovari (2010), in a one-way diallel of eight oriental genotypes.

Heterosis with a positive heterotic effect on the trait found: Butorac et al. (1999), in F₁ generation of four Burley varieties; Gixhari and Sulovari (2010), in a diallel of eight parental oriental genotypes; Dyulgerski (2019), on eight Berley newly created hybrid combinations of the first generation, Kinay and Yilmaz (2016), in seven hybrids obtained by one-way diallel crosses between oriental varieties. The heterotic effect for dry mass yield was 4%. Kinay et al. (2020), in 21 F₁ half-diallel hybrids of seven oriental tobaccos mostly from the Black Sea region of Turkey.

Table 1 shows the mean values for the number of leaves per stem, leaf area of the middle belt of the stalk and the yield of dry leaf mass per stalk in parents and F₁ hybrids for 2020 and 2021.

Table 1. Mode of inheritance of quantitative traits in parents and F₁ hybrids of tobacco

No	Parents and F ₁ hybrids		Quantitative traits										
			Number of leaves per stalk					Area of the leaves from the middle belt of the stalk			Yield of dry leaf mass per stalk		
			2020	2021	\bar{x}	$\sigma (\pm)$	CV (%)	2020	2021	\bar{x} (cm ²)	2020	2021	\bar{x} (g)
1.	P-23	P1-♀	43.5	42.5	43	1.4	3.5	184	172	178	20	19	19.5
2.	P 18-50/4	P1-♀	46.4	44.4	45.4	1.2	3.6	176	170	173	20	21	20.5
3.	P-76/86	P1-♀	53.6	55.2	54.4	1.5	3.6	174	191	182.5	23	25	24
4.	MS 8/1	P1-♀	40.3	42.1	41.2	1.5	4.1	202	203	202.5	15	16	15.5
5.	B-1/91	P2-♂	32.4	28.2	30.3	2.0	4.5	1197	1210	1203.5	169	172	170.5
6.	P-23 x B-1/91	F ₁	29.7	28.7	29.2 ^d	1.5	2.4	1080	1088	1084 ^{pd}	70	74	72 ^{pd}
7.	P18-50/4xB-1/91	F ₁	34.8	33.8	34.3 ^{pd}	1.5	2.3	937	917	927 ^{pd}	89	86	87.5 ⁱ
8.	P-76/86 x B-1/91	F ₁	30.8	32.2	31.5 ^d	1.2	2.2	1245	1295	1270 ^{+d}	98	110	104 ⁱ
9.	MS 8/1 x B-1/91	F ₁	32.2	30.4	31.3 ^d	1.7	3.2	892	802	847 ^{pd}	84	72	78 ⁱ

CONCLUSIONS

From our studies on parental genotypes and their F₁ hybrids, as well as the mode of inheritance on the number of leaves per stalk, leaves sizes from the middle belt and dry leaves yield per stalk, we have got the following conclusions:

- The varieties that are the subject of these studies are characterized by a high degree of stability and uniformity, as a result of their homozygosity. The parents in the role of mothers and the parent in the role of father, differ significantly in the investigated traits.

- Inheritance of the number of leaves per stalk is negative dominant (only in P 18-50/4 x B-1/91 there is partially dominant).
- Inheritance of the leaf area of the middle belt of the stalk is partially dominant (528oba in P-76/86 x B-1/91 there is positive dominance).
- Inheritance of the dry leaf mass yield per stalk is intermediate (528oba in P-23 x B-1/91 there is partial dominance).
- There is no occurrence of a heterotic effect in the F₁ population in all studied morphological traits, in the two years investigations.
- The best results for leaf area and dry leaf yield per stalk were given by P-76/86 x B-1/91.
- With these investigations we obtained F₁ hybrid offspring, with which we provided material for further breeding activity.
- The results obtained with these studies are useful achievements in the genetics and tobacco breeding, and they have primary importance for science and practice in the process of creating new superior varieties.

REFERENCES

- Aleksoski, J. 2010. Estimation of the heterotic effect in F₁ generation of various tobacco genotypes and their diallel cross. BIOTECHNOL. & BIOTECHNOL. 24(2): 407-411.
- Aleksoski, J., Dimitrieski, M., Korubin – Aleksoska, A. 2013. Investigations of heritability as an indicator of the inheritance of quantitative characters in tobacco. ТУТУН / Tobacco. 63(7-12): 54-62.
- Aleksoski, J. 2018. The effect of Backcross Method in tobacco breeding. Journal of Agriculture and Plant Sciences, JAPS. 16(1): 9-19.
- Butorac, J., Vasilj, D., Kozumplik, V., Beljo, J. 1999. Quantitative parameters of some Burley tobacco traits. Rostlinna Vyroba. 45(4): 149-156.
- Dimanov, D., Dyulgerski, Y. 2012. Heterosis behaviour with regards to the height and number of the leaves by 528obaccos of burley variety group. Acta Agriculturae Serbica. XVII(33): 53-58.
- Dyulgerski, Y. 2019. Estimation of new hybrids in first generation of Burley tobacco. Bulgarian Journal of Crop Science. 56(2): 20–25.
- Dyulgerski, Y., Radoukova, T. 2019. Hybridological analysis of the number and sizes of leaves in hybrid combinations of burley tobacco. Agricultural Sciences – Plant breeding. 72(1): 136-142.
- Gixhari, B., Sulovari, H. 2010. Nature of inheritance and heterosis estimated on some morphological quantitative characters that influence the tobacco yield. Studii și Cercetări (SCSB), Universitatea "Vasile Alecsandri" din Bacău, Romania. XVIII: 46-50.
- Kinay, A., Yilmaz, G. 2016. Effects of heterosis on agronomically important traits of oriental tobacco (*Nicotiana tabacum* L.) hybrids. Süleyman Demirel Üniversitesi Ziraat Fakültesi Dergisi. 11 (1): 89-94.
- Kinay, A., Yilmaz, G., Kandemir, N. 2020. Yield and quality properties of some Oriental tobacco (*Nicotiana tabacum* L.) hybrids. GENETIKA. 52(2): 735-750.
- Korubin – Aleksoska, A. 2000. Mode of inheritance for the more important morphological traits of tobacco varieties and their diallel hybrids. ТУТУН / Tobacco. 50(1-3): 3-12.
- Korubin – Aleksoska, A. 2001. Study of heredity through the genotypic components of variance in some tobacco varieties. ТУТУН / Tobacco. 51(1-2): 3-8.
- Korubin – Aleksoska, A. 2004. Tobacco varieties from Tobacco Institute – Prilep. NITP, Republic of Macedonia: University "St. Kliment Ohridski" – Bitola.
- Korubin – Aleksoska, A., Ayaz Ahmad, M. 2016. Basmak – a new type of tobacco in the Balkans. Journal of Agriculture and Veterinary Science (IOSR-JAVS). 9(8): 12-17.

- Lalitha, D. D., Lakshminarayana, R., Atluri, J.B. 2006. Heterosis for seed and other quantitative characters in Tobacco (*Nicotiana tabacum* L.). Indian Journal of Agricultural Research. (40):10–17.
- Ramachandra, R.K., Nagappa, B.H., Anjenaya Reddy, B. 2015. Heterosis studies on yield and quality parameters in bide tobacco (*Nicotiana tabacum* L.). J.Bio.Innov. 4(4): 126-134.

INVESTIGATING PARTICIPATORY LEARNING AS A TOOL TO ENGAGE STUDENTS AND TO RAISE THEIR AWARENESS ABOUT FOOD WASTE ISSUE

Sarra Jribi¹, Hanen Ben Ismail^{1,2}, Layla Ben Ayed³, Darine Dogui⁴, Hajer Debbabi¹

¹*University of Carthage, National Institute of Agronomy of Tunisia (INAT), UR17AGR01, Department of Agri-Food Industries, 1082 Tunis, Tunisia*

²*University Tunis El Manar, Faculty of Mathematical, Physical and Natural Sciences of Tunis, LR11ES09, 1002 Tunis, Tunisia*

³*University of Carthage, National Institute of Agronomy of Tunisia (INAT). Department of Agricultural Engineering, 1082 Tunis, Tunisia.*

⁴*National Institute for Consumption (INC), 1002 Tunis, Tunisia*
[Sarrajribi@inat.ucar.tn](mailto:Sarra.jribi@inat.ucar.tn)

ABSTRACT:

To face today's issues adapting the path of Responsible Research and Innovation (RRI) becomes a must rather than an option. Food waste is an issue gaining concerns worldwide in recent years because of its multidimensional impacts (economical, social, and environmental). Many strategies were suggested to tackle food waste problem such as awareness campaigns, as a way of affecting consumers' behavior. Engaging young consumers in such awareness campaign would be significant as they are the future leaders. This research aimed to using participatory learning as a tool to raise student's awareness toward food waste issue. Collaborative work was initiated through a brainstorming among restricted student groups (n=3) from different departments in the National Institute of Agronomy of Tunisia (University of Carthage, Tunisia). From this brainstorming, students suggested to organize an education and awareness campaign at the university scale. Posters addressing food waste issues were placed in prominent locations around the Campus. In addition, in order to engage their colleagues, students conducted a face-to-face survey (103 respondents) from September 15th to October 1st, 2021. The first part of the survey assessed students' knowledge and attitudes toward food waste. The second part was about solutions they suggest to reduce food waste at university scale and their opinion about the awareness campaign (did they hear about the event, what do they think about, what do they think about posters, would they attend the event...). Survey results showed that 97.8% of student respondents were aware about food waste issue and its impact on environment. About half (49.5%) of respondents declared to throw food moderately. Regarding the education and awareness campaign, 59.8% noticed the posters mainly at the campus cafeteria (62.1%) and 81.2% heard about it, through social media. The posters' content was appealing for 70.5% of respondents. Students also reported that information clarity, content and graphics were satisfactory. Moreover, 79.6% of students reported that the event and communicated information encouraged them to improve their behavior toward food waste. These results showed that using a participatory learning has engaged students who tried even to engage their colleagues, they felt more responsible as they suggested and implemented a solution. Moreover, our findings have highlighted the importance to take into consideration the specificities of Generation Z and accordingly, to use nontraditional tools (social media, graphical design...).

Key words: Food waste reduction, participatory learning, Responsible Research and Innovation (RRI), Generation Z, awareness campaign.

INTRODUCTION:

According to the Food and Agriculture Organization of the United Nations (FAO), food waste refers to the decrease in the quantity or quality of food resulting from decisions and actions by retailers, food service providers and consumers (FAO, 2019). The financial costs of food wastage are substantial and amount to about USD 1 trillion each year. The impact of food waste exceeds economical dimension to reach social and environmental sustainability ones. Such reflection was already highlighted in the 2030 Agenda for Sustainable Development. In fact, reducing food waste is among ways to meet the second Sustainable Development Goal (SDG 2): Zero hunger. In addition, Target 12.3 (SDG 12: Responsible consumption and production), calls for the halving by 2030 of per capita global food waste at the retail and consumer levels and the reduction of food losses along production and supply chains, including post-harvest losses (FAO, 2019).

To tackle today's issues there is an urgent need to adapt the path of Responsible Research and Innovation (RRI). According to von Schomberg (2013), RRI is defined as “a transparent, interactive process by which societal actors and innovators become mutually responsive to each other with a view to the (ethical) acceptability, sustainability and societal desirability of the innovation process and its marketable products (in order to allow a proper embedding of scientific and technological advances in our society).” In fact, researchers and innovators have a significant role to play in reflecting on and anticipating the future effects of their research and development – both positive and negative social, ethical, and environmental – during their routine decision making practices (Owen et al., 2013). Science education as among “RRI keys”. It can play an important role not only in engaging publics but also in preparing experts for more robust relations between science and society (Lukovics et al., 2019). Thus, combining activities that synergistically enhance scientific creativity and societal responsibility (Lukovics et al., 2019).

Generation Z (Gen Z) includes persons who were born on mid-to-late 1990s and the early 2010s. This generation represents the future consumers and leaders. Gen Z is the generation who will become the successor and who will live and experience various environmental issues (Lemy et al., 2020). Moreover, Gen Z had been raised during the technology boom of the millennium and so was comfortable with and reliant on technology for most aspects of their lives. They can thus be seen as early adopters of new technology-mediated (Kymäläinen et al., 2021). Accordingly, using nontraditional tools with Gen Z would be a must rather than an option.

Numerous strategies were suggested to tackle food waste issue (Vizzoto et al., 2021). Awareness campaigns represent a way of affecting consumer behavior as it targets his beliefs (Kuo & Shih, 2016). Such approach at university scale could be considered a low cost solution contributing in sustainability at university campus (Ellison et al., 2019). A review by Reynolds et al. (2019) reported that information campaigns could reduce up to 28% of food waste. This research aimed to use participatory learning as a tool to raise student's awareness toward food waste issue.

Methodology:

This research was conducted in the National Institute of Agronomy of Tunisia (INAT) from September to November 2021. INAT is the first engineering school in North Africa. In fact, it was established in 1898 under the dual supervision of the Ministry of Agriculture and the Ministry of Higher Education and Scientific Research. Currently, 350 students are enrolled in the engineering cycle and 300 students enrolled between Masters and Doctorates. Work focuses

on a wide range of topics related to climate change and sustainable development issues, including biodiversity, environment, functioning and engineering of natural and cultivated ecosystems, marine ecosystem, water, animal production, and agri-food sciences and technology.

Collaborative inquiry:

Based on evaluation of previous activities and discussion among group researchers from INAT food waste topic was selected. Inter disciplinary groups of students, from engineering cycle, were formed (10 students). Then, participatory learning approach was adapted.

Participatory learning:

Participatory learning is an approach to teaching and learning which focuses on the learner. It encourages learning by doing, using small groups, concrete materials, open questioning, and peer teaching. Collaborative work was initiated through a brain storming among students. From this brain storming students suggested to organize an education and awareness campaign at the university scale. To involve their colleagues who are not in the group students suggested to conduct a survey.

Survey:

An online survey with 103 students from INAT (82.6% women, 17.4% men, average age 23) was conducted from September 15th to October 1st, 2021. The questionnaire is based on two main parts: the first one assessing students knowledge and attitudes toward food waste. The second part focused on involving students outside the group. Microsoft Excel software for frequency analysis of data.

RESULTS:

Students and food waste

Students were asked if they believe there is a link between food waste and environment, 97.8% answered yes and 98.9% declared that there is a need to reduce food waste amounts. This reflects the awareness of student. Meanwhile, it is important to take into consideration that respondents spent at least three years at university. Moreover, they belong to an Agricultural Science university where issues like climate change and sustainability are parts of University's lectures. These results reflecting young consumers' awareness were previously reported by Jribi et al. (2022).

Respondents were then asked about their generated quantity of food waste (Figure 1). Almost half respondents (49%) considered that the food quantity of thrown food is moderate and 32% of them think it is reasonable while only 8% believe it is important. These trends were also observed by Lemy et al. (2020) with Gen Z Indonesian students. Such answers would be expected as it was a self-assessment: there is a trend to underestimate the thrown food to avoid guilt. Such findings suggest the importance of communication and introducing real life examples. In other words, showing the impact of thrown food even low quantities. Although only 8% of respondents declared they throw important amounts of food, 98.9% declared that they need to reduce their food waste and 55.4% set a target to do so.

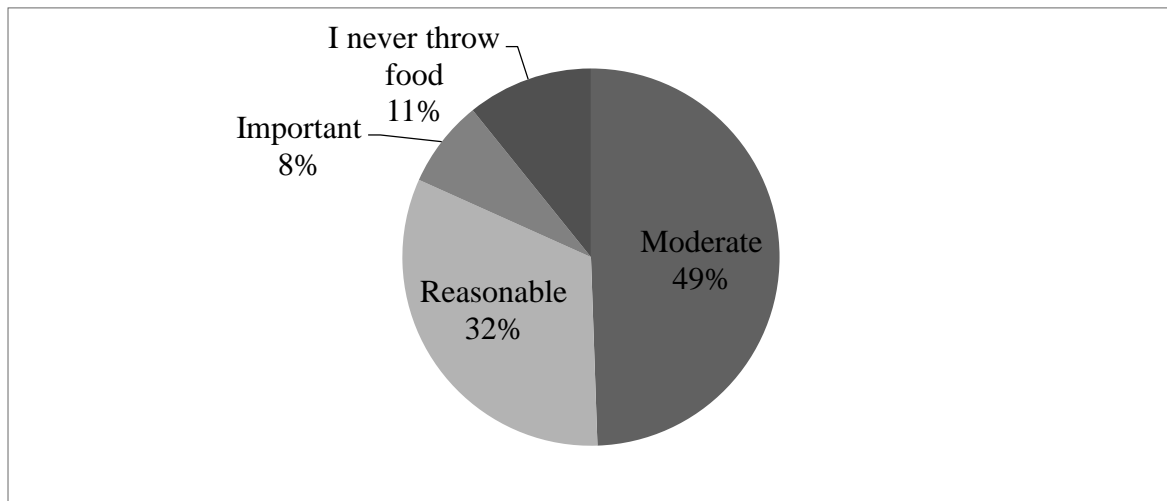
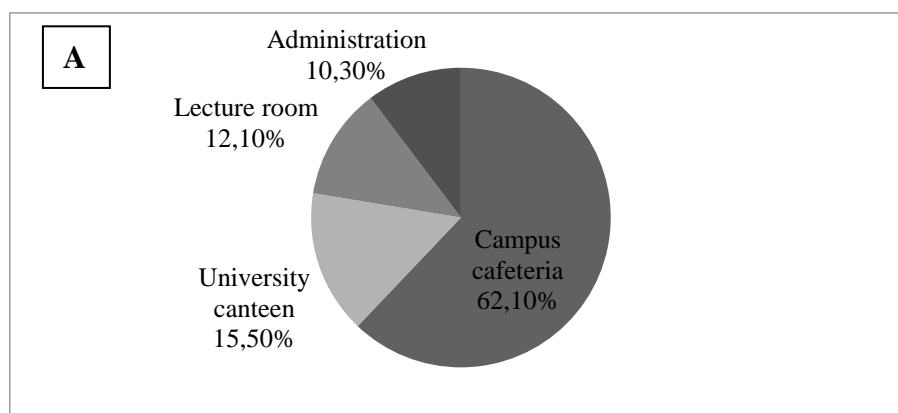

Figure1: Students' self-assessment of their generated food waste

Students were also asked if they know methods to treat waste. Remarkably, 52.7% said yes. The main suggested approaches were: sorting, recycling and composting.

Students and awareness campaign:

The second target of the survey was to raise students' awareness by evolving them in education and awareness campaign. Students were firstly asked if they would be willing to participating in an action to reduce food waste. 91.3% of participants replied positively. An indirect way to inform students about the campaign was used as respondents were asked if they heard about it. It was the case for 59.8%. Campaign posters were developed and placed around the Campus. Since the target of this awareness campaign was students, it was important to assess the main effective places and channels for communication. Results (Figure 2A) revealed that Campus cafeteria, a high-traffic area, was the main place where students noticed campaign posters (62.1%). According to Figure 2B, 81.2% of respondents heard about the campaign through social media. In Tunisia, until January 2022, 72.75% of the population use social media and 25% of them are 18-24 years old. Thus, social media could be considered as a new pedagogical tool that may be used to engage students both inside and outside university. The effectiveness of social media was even reported in engaging students for courses (Al Bahrani et al., 2015; Bal et al., 2015). These results highlight the importance of up-to-date pedagogical tools and approaches with Gen Z.



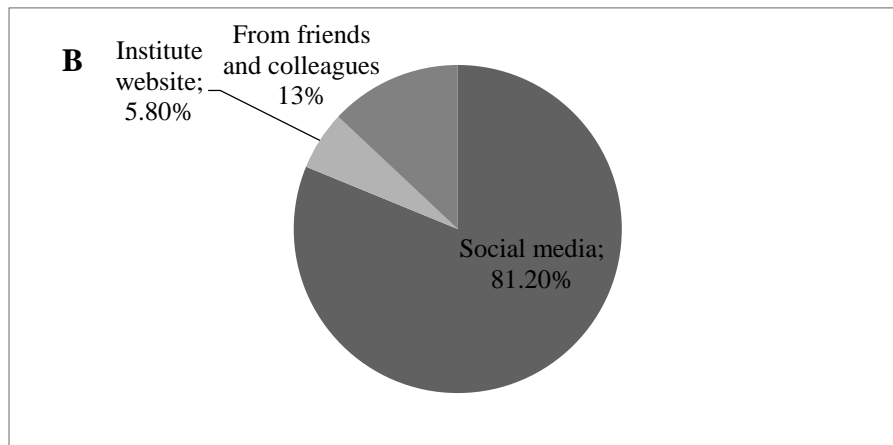

Figure 2: Locations and channels of communication

Regarding evaluation of campaign posters (Figure 3) respondents were asked to rate information clarity, graphical design and to give their global appreciation on a five-point scale. Communicated information were judged clear enough as only 16.2% (8.1 + 8.1%) rated them under the average. Similarly, graphical design and global appreciation were rated up the average for 77.5% and 87.1% of respondents, respectively. Moreover, 70.5% of respondents reported that the posters content was appealing and 67.2% declared that the posters encouraged them to improve their behavior toward food waste.

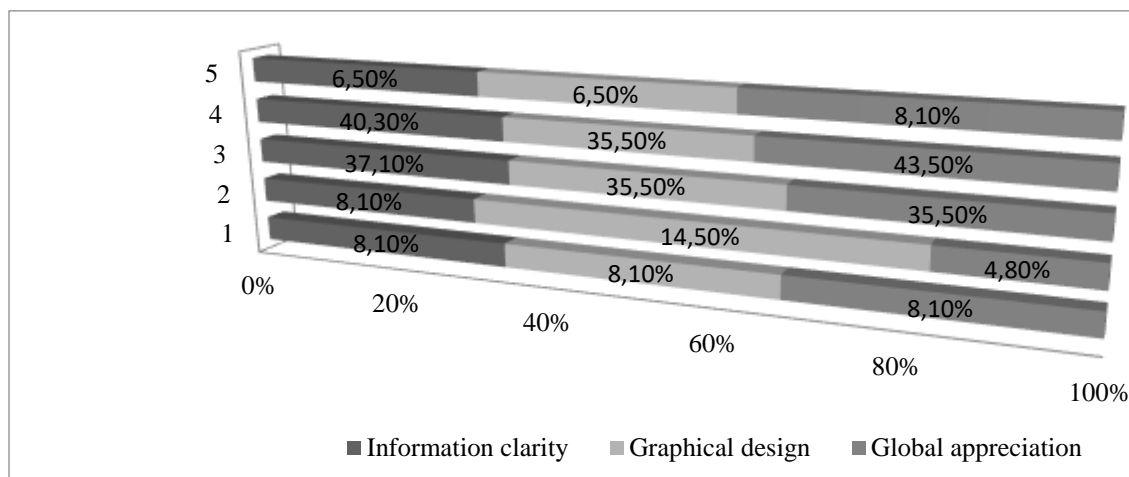

Figure 3: Respondents' campaign posters rating (1:very poor; 5: excellent)

These findings reflect the success of used support of communication but also the self-esteem of students and survey respondents. In fact, students (organizers) communicated in a correct way adapted to their colleagues. Getting good marks would encourage them more. For respondents, rating posters is a way to engage them more by feeling as influencers.

CONCLUSION:

This exploratory research aimed to use participatory approach learning to engage Gen Z students and raise their awareness about food waste issue. This approach of RRI combined enhancing scientific creativity and societal responsibility simultaneously. Results showed that Gen Z Students, particularly agricultural engineer, were already aware about food waste and environmental issues. The used tools (social media, adapted design...) showed their effectiveness in appealing and engaging students. These finding highlight the importance of considering Gen Z specificities and using nontraditional tools. In this way RRI would encourage

responsible citizenship. Our findings may be of special interest for policy makers, researchers, civil society organizations and other actors for designing and implementing successful food waste reduction management strategies.

ACKNOWLEDGEMENTS:

Authors would like to thank INAT students for their contribution and engagement in this project.

REFERENCES:

Al-Bahrani, A., Patel, D., & Sheridan, B. (2015). Engaging students using social media: The students' perspective. *International Review of Economics Education*, 19, 36-50.

Bal, A. S., Grewal, D., Mills, A., & Ottley, G. (2015). Engaging Students With Social Media. *Journal of Marketing Education*, 37,190-203. <https://doi.org/10.1177/0273475315593380>.

Ellison, B., Savchenko, O., Nikolaus, C. J., & Duff, B. R. (2019). Every plate counts: Evaluation of a food waste reduction campaign in a university dining hall. *Resources, Conservation and Recycling*, 144, 276-284.

FAO. 2019. *The State of Food and Agriculture 2019. Moving forward on food loss and waste reduction*. Rome

Jribi, S., Ismail, H. B., & Debbabi, H. (2022). An Exploratory Insight into Young Tunisian Consumers' Perception of Sustainable Diet. *Uluslararası tarım araştırmalarında yenilikçi yaklaşımlar dergisi (Online)*, 6(2), 78-89.

Kuo, C., & Shih, Y. (2016). Gender differences in the effects of education and coercion on reducing buffet plate waste. *Journal of foodservice business research*, 19(3), 223- 235.

Kymäläinen, T., Seisto, A., & Malila, R. (2021). Generation Z Food Waste, Diet and Consumption Habits: A Finnish Social Design Study with Future Consumers. *Sustainability*, 13, 2124. <https://doi.org/10.3390/su13042124>.

Lemy, D. M., Rahardja, A., & Kilya, C. S. (2021). Generation Z awareness on food waste issues (a study in Tangerang, Indonesia). *Journal of Business on Hospitality and Tourism*, 6(2), 329-337.

Lukovics, M., Udvari, B., Nádas, N., & Fisher, E. (2019). Raising awareness of researchers-in-the-making toward responsible research and innovation. *Journal of the Knowledge Economy*, 10, 1558-1577.

Owen, R., Stilgoe, J., Macnaghten, P., Gorman, M., Fisher, E. & Guston, D. (2013): A framework for responsible innovation. In Owen, R.; Bessant, J. & Heintz, M. (Eds.). *Responsible Innovation. Managing the responsible emergence of science and innovation in society*. A John Wiley & Sons, Ltd. United Kingdom, 27-50.

Reynolds, C., Goucher, L., Quested, T., Bromley, S., Gillick, S., Wells, V.K., Evans, D., Koh, L., Carlsson Kanyama, A., Katzeff, C., Svenfelt, Å. & Jackson, P. (2019). Review: Consumption-stage food waste reduction interventions – What works and how to design better interventions. *Food Policy*, 83: 7–27.

Vizzoto, F., Testa, F., & Iraldo, F. (2021). Strategies to reduce food waste in the foodservices sector: A systematic review. *International Journal of Hospitality Management*, 95, 102933.

von Schomberg, R. (2013). A vision for responsible research and innovation. In R. Owen, J. Bessant, & M. Heintz (Eds.), *Responsible Innovation* (pp. 51–74). London: John Wiley.

THE INFLUENCE OF GRASS CARP ON THE SPECIES COMPOSITION AND BIOMASS OF PHYTOPLANKTON

¹ Marsida Bllaca, ¹ Valbona Kolaneci

¹ Agricultural University of Tirana, Albania, Department of Aquaculture and Fishery

Corresponding author email: mblaca@ubt.edu.al

ABSTRACT

The grass carp, brought from China, has been part of the ichthyofauna of the inland waters of Albania since the beginning of the 60s of the last century. The purpose of its introduction has been the cultivation in the polyculture system with other species of the carp family (*Cyprinidae*) for human consumption and the use of this species for the control and management of aquatic macrophytes. The tests to prove the influence of grass carp on the composition of phytoplankton were carried out in Experimental Didactic Center of Tapiza in two ponds with a surface area of 1000 m² and a water depth of 1.0-1.2 m, during a period of 12 months (April - March). The taxonomic study of phytoplankton showed that in both ponds, before grass carp introduction, the dominant groups were green algae (*Chlorophyta*) and diatoms (*Bacillariophyta*). After the introduction of the grass carps in one of the test ponds, some changes were observed, which are mainly related to the shift of algae dominance. The average value of the concentration of *chlorophyll-a*, according to the tests carried out before grass carp introduction, was 10.92 mg/m³. The measurements performed after the introduction of grass carp in the pond showed that the average value of this indicator was 11.73 mg/m³. The increase of the *chlorophyll-a* concentration was also accompanied by the decrease of water transparency. Before the introduction of grass carp, the average value of water transparency was 43.4 cm, while after the introduction of the fish, the transparency value decreased to 32.8 cm.

Key words: grass carp, phytoplankton abundance, polyculture

INTRODUCTION:

Grass carp (*Ctenopharyngodon idella*), brought from China, is now part of ichthyofauna of Albania inland waters from the beginning of the 60th of the past century. The aim was the cultivation ponds both with other species of *Cyprinidae* family and the exploitation of this species for the control and management of aquatic macrophytes.

There exist many works that had as an object the determination of directions of grass carp influence on aquatic biocoenosis and the mechanisms of this influence (Mitchell C.P. and coauthors 1984; Richard D.I. and coauthors 1985; Leslie A.J. and coauthors 1985; Vranovsky M.1991; Kirkagac M., Demir N.2004; Pipalova I.2002, 2006).

A general opinion is that the primary influence of grass carp on aquatic ecosystems are first caused from the exploitation of the macrophytes during grazing since this species manifests phytophagous feeding regime. Secondary influence manifested on plankton and benthos community is caused as a consequence of habitat structure change that result after alterations that suffer water transparency, integrity of sediments and the concentration of nutrients after depositing the excrements by grass carp (Zweerde W. van der, 1982; Richard D.I. and coauthors.,1985).

The aim of this work has been to value some direct and indirect influence of grass carp on species composition and the biomass of some hydrobionts on the ecosystem of cyprinidae cultivation ponds, in application conditions of standard technical populating.

MATERIAL AND METHOD:

The experiments are done in Tapiza plant (Fushe Kruje), Figure 1 in two ponds with a surface of 1000m² and water depth 1.0-1.2m, during the period of 12 months April – March. The work is focused on the comparison of samples taken in one of the ponds populated with grass carp (experiment pond), with the samples taken in the other pond not stocked with grass carp (control pond). On the other side, during one year alterations have been followed in time, which specific components of biocoenosis suffer in the pond stocked with grass carp.

In the beginning of the experiment, two year old (1+) grass carp individuals were stocked in the experiment pond, with a population density of 30kg/ha (94 individuals with individual average weight 0.320+ 0.098kg), whereas the control pond wasn't stocked with this species.



Figure 1 Satellite view of Tapiza plant

The samples from plankton and benthos are taken every month from the beginning of April to the end of November and March. To take the plankton samples, in every pond without preliminary choice eight points are determined. The sampling is done by using Fieldmaster Advanced Water Sampler, that is a bathometric bottle of transparent polybicarbonat with a capacity 1.2lt (sample of every month has been 9.6lt). The equipment is immersed till near the ground of the pond and then is pulled up in the surface so that the sample included all the depth of the water.

The preparation of microscopic preparates for the determination of alga taxon is done immediately after taking the samples, without being necessary the conservation of the material. The determination of *clorophyll-a* is executed every month using Hydrolab D55X Multiparameter Sonde.

The biometric elaboration of data is done by using the variance analysis (ANOVA) with the pond and the year as standard factors. The influence of grass carp on proper studied parameters was considered significant when the relation between two systems comparable had the value $P < 0.05$ (Ter Braak C.J.F and Smilauer P.,1998).

RESULTS AND DISCUSSION:

The taxonomic study of phytoplankton done in the period April-November, showed that in both ponds included in the study the dominant groups were green alga (*Clorophyta*) and diatomea (*Bacillariophyta*). The greater biomass, particularly in the period from the middle of April to beginning of June and from the end of August to the end of October were created from the green alga *Scendesmus quadricauda* (Turp.), *Pediastrum tetras* (Ehrenberg), Ralfs., *Hydrodictyon reticulatum* (Lin., Lagerheim), *Cladophora globulina* (Kutz.), *Diatomea Navicula sp.*, *Pinularia viridis* (Nitzsch.), *Gyrosigma sp.* and green-blue alga (*Cyanophyta*), *Oscillatoria tenuis* (C. Agardh), *Microcystis aeruginosa* (Kutzing) and *Anabaena affinis* (Lemm.).

After stocking the experiment pond with grass carp we observed some alterations mainly focused on the displacement of dominances as in the group of green alga species as between the green alga on one side, and the other groups of alga on the other side. In the period from the middle of May till the beginning of September, we have proved the decrease of biomass of filamentous clorophyta (*H. reticulatum*, *C. globulina*) and *Scendesmus clorophyta* that form a colony with small number of cells. On the other side, two phenomenon were noticed in the experiment pond, particularly from the middle of July till the beginning of November: The rise of green-blue alga biomass, of some green unicellular alga, *Euglenophyta* and the appearance of some species not present in the control pond.

We have information that confirm the fact that filamentous alga of *Cladophora* and *Hydrodictyon* are common components of grass carp diet meanwhile some alga that form a colony might have a determining role in the feeding of this species. It seems that the inclusion of macrophytes and green filamentous alga in the grass carp diet removes from the ecosystem the main nutrient consumers, creating for the phytoplankton better trophic conditions. In such conditions, the abundance values of unicellular clorophyta and others that form small colonies, for the cyanophyta as a searching of high nitrogen concentration rises. A growth is proved for an individual number of some diatomea, particularly in April-June and September-November (Figure 2).

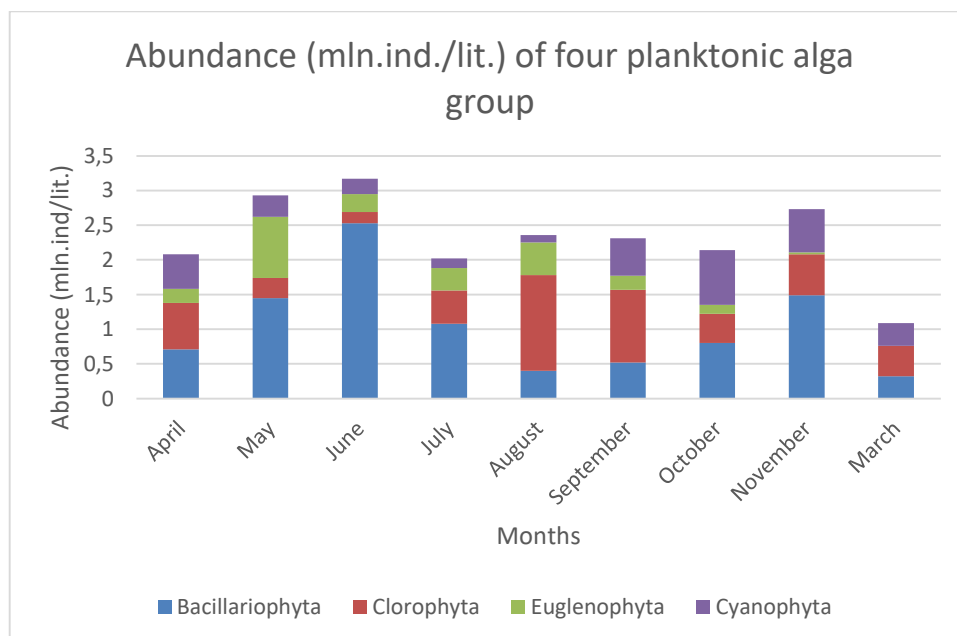

Figure 2 The dynamics of the abundance of four planktonic alga group in experiment pond after stocking with grass carp (*C. idella*) according to sampling done during April-November-March.

With all the alterations that suffer the density of some taxons of filamentous clorophyta alga and those that form a colony after stocking with grass carp, the general abundance of planktonic alga remain almost unchangeable as a consequence of abundance value rise for diatomea, unicellular clorophyta, euglenophyta and cyanophyta.

The fact that the influence of grass carp on *clorophyll-a* concentration wasn't statistically proved ($F = 0.38$; $P = 0.0.57$) is an indicative of the situation noticed during the study of general abundance dynamics of planktonic alga. Average value of *clorophyll-a* according to the tests carried out before grass carp introduction, was 10.92 mg/m^3 . The measurements performed after the introduction of grass carp in the pond showed that the average value of this indicator was 11.73 mg/m^3 . The rise of *clorophyll-a* concentration is accompanied with lessening of water transparency values. Before stoking with grass carp, the average value of water transparency was 43.4 cm, when after stocking with grass carp the average value of this indicator was 32.8cm.

The reduction of water transparency values is connected with the rise of organic and mineral detritus quantities in water, after the sediment displacement from the eradication of plant that happens during the grazing of grass carp (Mitchell C.P. and coauthors., 1984; Bonar S.A. and coauthors, 2002). Pipalova I. and coauthor (2009) underline that when all the plants are eliminated from the pond or when only uneatable plants are present in the pond then the grass carp begins to search the food near the ground causing sediment displacement and rise of water turbulence. On the other side, the rise of biomass of typical planktonic alga that happens after the reduction of filamentous alga abundance influences in reduction of water transparency values (Maceina M.J and coauthors 1992; Pipalova I. and coauthor, 2009).

Based on the working aim, in our experiment we stocked grass carp as a "monoculture". This solution is done for the fact that in comparison with fish fry with a weight of 10g, used for stocking polycultural systems, the two year old individuals we have stocked the experiment pond are directly consumers of aquatic macrophytes. Applied ichtthyomass guarantees full information in respect to influence of this phytophagus ichthtyc species on aquatic macrophytes, on grass carp impacts over the components of biocoenosis basins and simultaneously permits alimentary preference valuation of grass carp.

The presence of grass carp in experiment pond caused some changes in plankton alga community that were mainly focused on dominance displacement within the groups of green alga species and between the green alga in one side and alga of other groups at the other side. The study proved that the stocking of grass carp caused the lessening of filamentous clorophyta (*Hydrodictyon reticulatum*, *Cladophora globulina*) and *Scendesmus* that make a colony with small number of cells. This manifestation was accompanied with rise of general blue green alga biomass, of some green unicellular Euglenophyta alga and with the appearance of some species not present in control pond.

The lessening of values for *C.globulina* alga abundance because of fact that during grazing, grass carp demonstrates chooser ability for this alga, is accepted in other studies too (Pine R.T. and Anderson L.W.J.,1991; Kirkagac M. and Demir N.,2004).

The rise of abundance indexes for some phytoplankton components as green unicellular alga, blue-green alga and euglenoidines are, it seems that it is cause of nutrients exploitation after lessening of strong competitors, as macrophytes (Pipalova I. and coauthor, 2009). Buck D.H and coauthors (1975) observed that *Ceratophyllum demersum* species completed in succesfull way for the nutrients with phytoplankton.

CONCLUSIONS:

Stocking with grass carp caused the rise of abundance indicator for some components of phytoplankton such as unicellular green alga, green-blue alga and euglenoidines. This alteration is a consequence of nutrients utilization, after the reduction of strong concurents presence, such as macrophyta.

RERERENCES:

- Bonar, S.A., Sehgal, S.H., Pauley, G.B,Thomas. (1990). Relationship between the chemical composition of aquatic macrophytes and their consumption by grass carp (*Ctenopharyngodon idella*). *J. Fish Biol.*, 38:149-157.
- Buck D.H., Baur R.J., Rose C.R. (1975). Comparison of the effects of grass carp and the herbicide Diuron in densely vegetated pools containing golden shiners and bluegills. *The Progressive Fish-Culturist*, 37, 185–190.
- Kirkagac M., Demir N. (2004). The effects of grass carp on aquatic plants, plankton and benthos in ponds. *Journal of Aquatic Plant Management*, 42, 32–39.
- Leslie, A. J. Jr. and G. J. Kobylinski. (1985). Benthic macroinvertebrate response to aquatic vegetation removal by grass carp in a north Florida reservoir. *Fla.Sci.* 48:220-231.
- Maceina M.J., Cichra M.F., Betsill R.K., Bettoli P.W. (1992). Limnological changes in a large reservoir following vegetation removal by grass carp.*Journal of Freshwater Ecology*, 7, 81–95.
- Mitchell C.P.,Fish G.R., Burnet A.M.R. (1984). Limnological changes in a small lake stocked with grass carp. *New Zealand Journal of Marine and Freshwater Research*, 18, 103–114.
- Pine, R. T. and L. W. J. Anderson. (1991). Plant preferences of triploid grass carp. *J. Aquat. Plant Manage.* 29:80-82.
- Pípalová I. (2002). The impact of grass carp on aquatic macrophytes community in experimental pond. *Aquatic Botany*, 73, 9–18.
- Pípalová I. (2006). A review of grass carp use for aquatic weed control and its impact on water bodies. *Journal of Aquatic Plant Management*, 44, 1–12.
- Pipalova I.,Kvet J.,Adamek Z.(2009). Limnological changes in a pond ecosystem caused by grass carp (*Ctenopharyngodon idella*) low stocking density. *Czech J. Anim. Sci.*, 54,(1): 31–45
- Richard D.I., Small J.W., Osborne J.A. (1985). Response of zooplankton to the reduction and elimination of submerged vegetation by grass carp and herbicide in 4 Florida lakes. *Hydrobiologia*, 123, 97–108.
- Ter Braak C.J.F., Šmilauer P. (1998). Canoco Reference Manual and User’s Guide to Canoco for Windows.Centre of Biometry Wageningen, Holland, 283–284.
- Vranovský M. (1991). Zooplankton of a Danube side arm under regulated ichthyocoenosis conditions. *Internationale Vereinigung für theoretische und angewandte Limnologie: Verhandlungen*, 24, 2505–2508.
- Zweerde W. van der (1982). The influence of grass carp (*Ctenopharyngodon idella* Val.) on macroinvertebrates in some experimental ditches in the Netherlands. In:Proc. 2nd Internal. Symp. Herbivorous Fish, Novi Sad, Yugoslavia, 158–164.

COMPARATIVE RESISTANCE OF STORED CEREALS AND PULSE TO *Sitophilus zeamais* MOTSCHULSKY (COLEOPTERA: CURCULIONIDAE)

¹AKINBULUMA Mobolade Dele; ²BAMIDELE David Dolapo; ³OLUBIYI Mayowa

^{1,2}Department of Crop Protection & Environmental Biology, University of Ibadan, Nigeria.

³National Centre for Genetic Resources and Biotechnology, Moor Plantation, Ibadan, Nigeria

Corresponding author Tel.: +2348038594189; E-mail address: delebuluma@yahoo.com

ABSTRACT

We hypothesized the degree of resistance of stored grains and pulse to *Sitophilus zeamais*, a cosmopolitan insect pest of stored foods in the tropics. Three varieties each of maize (TZPB SR, DMR 9943, DMR 9928), sorghum (NGBO1354, NGBO1469, NGBO1582) and wheat (NGBO1123, NGBO1124, NGBO1224) and a commonly grown cowpea variety (Ife brown) were used for the experiment. In a no-choice experiment, 20 g of each food variety was weighed into each of ten 1 L Kilner jar and five pairs of *S. zeamais* were introduced and covered with muslin cloth. Similarly, a free choice experiment was conducted on a white circular cardboard divided into ten equal sectors with each containing the food sample. All experiments were laid out in a CRD, $r = 4$. Data were collected on F₁ emergence, percentage survival, days to emergence, seed weight loss and susceptibility index and analyzed using ANOVA and means were separated with the NDMRT ($p < 0.05$). The highest mortality (90%) of *S. zeamais* was observed on Ife-Brown and wheat variety, NGBO 1123 in all the days of the trials. Significantly ($p < 0.05$) higher numbers (10.67, 9.86) of adult *S. zeamais* emerged from NGBO 1582 (sorghum) and NGBO 1124 (wheat) respectively. Susceptibility indices ranged from 0 to 5.8 in both no-choice and free-choice experiments. Cowpea variety (Ife Brown) and the wheat variety (NGBO 1123) were the least suitable host to *Sitophilus zeamais*. Desirable characteristics from these resistant grains could be useful in breeding programs to develop varieties that are resistant to the insect pests.

Keywords: Free choice experiment, Developmental time, Susceptibility index, Breeding programs

Mode of presentation at 2021 AGBIO CONFERENCE: Oral

INTRODUCTION

Cereals are a good source of rich-dietary fibre, vital nutrients like vitamin E, omega 3 fatty acid, phosphorous, magnesium and zinc (Macauley, 2015), constituting the largest source of food for human beings, as well as for animals, especially in Africa. Each cereal, such as maize, rice and sorghum, has its important nutrients that help to boost the body health (Klopčič *et al.*, 2020; Baniwal *et al.*, 2022). Cowpea is one of the most versatile food legumes in the tropics and subtropical regions of the world; the most important seed legume in Africa (Dakora and Belane, 2019), with a particularly high demand in Nigeria. The incessant rise in human population

necessitates growing need for human food and animal feed, and consequently, there is a high demand for the maintenance of quality and quantity grain food products (Garcia-Correia, 2002). Insect pests are among the main biotic agents that disrupt food substances in storage. They do these either by eating grains, contaminate commodities with their faeces, webbing, as well as their body parts (Hodges *et al.*, 2011; Berhe *et al.*, 2022). The maize weevil (*Sitophilus zeamais*) is an important cosmopolitan pest of grains, including, maize, wheat, rice and sorghum, in the tropics. Its infestation begins in the field when the grain moisture content is between 50–55%, allowing the weevils to already complete one generation, and lay eggs for the second generation (Adedire, 2001). Earlier reports have also shown that it attacks other plants like *Carya illinoensis* and *Prunus persica* (Bloem *et al.*, 2002).

During harvest of crops, many smallholder farmers in Africa, especially Nigeria allocate sections of their local storage facilities for their produce and do not usually construct separate structures for each produce, leading to cross infestation of the produce by insect pests. Although cereal grains are the main host crops, infestation and damage caused by *Sitophilus zeamais* of cereal crop varieties are not well documented. As well, members of the genus *Sitophilus*, have been reportedly found in some other classes of crops. For example, in Nigeria, a strain of *S. zeamais* was found in some cowpea cultivars and laboratory observation revealed that the strain utilized the cowpea cultivars as its food, evidenced by the leftover powdery materials in the jars containing the cowpea seeds (Babarinde *et al.*, 2008). Gupta *et al.* (1985) reported that *S. rugicollis*, infested the seeds of sal (*Shorea robusta*) and caused damage on the oil crop and Coombs *et al.* (1977) reported that some strains of *S. oryzae* were found to develop on grain legumes such as peas, lentils and black grams. These developments necessitated the conduct of this current study in other to determine and compare the level of resistance of food host crops to *Sitophilus zeamais*.

MATERIALS AND METHODS

Study location

This study was carried out in the Entomology Research Laboratory of Department of Crop Protection and Environmental Biology, University of Ibadan, Ibadan under ambient temperature of $27 \pm 5^\circ\text{C}$, relative humidity of $72 \pm 6\%$ and 12 hours photoperiod.

Sources of Crop varieties

Three maize varieties (TZPB SR, DMR 9928, DMR 9943) and one cowpea variety (Ife Brown) were obtained from the Institute of Agriculture Research and Training (IAR&T), MOOR plantation, Ibadan, while three sorghum varieties (NGBO1354, NGBO1469, NGBO1582) and three wheat varieties (NGBO1123, NGBO1124, NGBO 1224) were obtained from the National Centre for Genetic Resources and Biotechnology (NACGRAB) Moor Plantation, Ibadan, Nigeria. The food hosts were cleaned and kept in a refrigerator for 7 days to kill existing storage insect pest.

Insect colony

Colony of *Sitophilus zeamais* was established in the laboratory with initial stock obtained from Nigerian Stored product Research Institute (NSPRI), Onireke, Ibadan. Fifty (1 male: 1 female) weevils were introduced into 150 g maize grains in each of three 1- Litre Kilner jars with mesh lids. Old weevils were removed after 10 days of mating and oviposition. Teneral adults were used for the experiments.

Survival of *S. zeamais* on food hosts

Twenty (20) grams of each food varieties (Maize, sorghum, wheat and cowpea), were weighed and placed into each of ten 1 L Kilner jars and five pairs (1:1) of one week old *S. zeamais* were introduced into each jar and covered with lids having muslin cloth. Each jar was replicated four times and the experiment was laid out in a Completely Randomized Design (CRD). The set up was left undisturbed in the laboratory for ten days and data on mortality were collected at 6, 8 and 10 days after infestation.

Percentage mortality was calculated as,

$$\frac{\text{Number of dead weevils}}{\text{Total number of weevils}} \times \frac{100}{1}$$

No - choice experiments

Food varieties (20 g each), were weighed and placed in forty jars and ten one week old *S. zeamais* were introduced and the jars were covered with muslin cloth. All insects, both dead and living, were removed after 12 days. The set-up was left undisturbed until the emergence of F₁ progeny. Daily count of the emerged adults was done (until emergence ceased) and every insect was removed to prevent further egg laying on food samples. Adult *S. zeamais* that emerged from each jar were summed up and compared among food hosts. Median developmental time (MDT) was calculated as the time (days) from the middle of the oviposition period to the emergence of 50% of the F₁ progeny (Akinbuluma and Ewete, 2019). Susceptibility index (SI) for each treatment was then calculated using the formula:

$$SI = \frac{\log_{10} F \times 100}{MDT}$$

The grains were later sieved to remove the dust produced from adult feeding and reweighed using a Digital Pocket Weighing balance and percentage weight loss was determined as follows:

$$W (\%) = \frac{WI - WF}{WI} \times \frac{100}{1}$$

Where, W (%) = weight loss (%), WF = Final weight, WI = Initial weight

Free choice experiments

The same set up as the no-choice experiment was repeated with some modifications. Briefly, a white cardboard was cut to give a circular shape fitting into the bottom of a bowl and ten equal sectors were traced on the circular cardboard. Twenty (20) g of each grain was randomly placed in each sector. Adult insects (100) were placed at the centre of each bowl and covered with muslin cloth. The set up was replicated 4 times. The bowls were left undisturbed for 7 days for insect to oviposit, after which the grains were carefully transferred into Kilner jars and covered with muslin cloths. As described above, data were collected on emergence of F₁ adults (until completion of emergence), MDT and SI and weight loss and compared among food hosts.

RESULTS

Mortality of *S. zeamais*

Table 1 shows the percentage mortality of *S. zeamais* infested on the different varieties of food maize, sorghum, wheat, and cowpea (Ife brown) varieties. There was no mortality of *S. zeamais* on the infested DMR 9943 (maize) and NGBO 1224 (wheat) up till the 10th day of trial. Mortality was significantly higher ($p < 0.05$) in NGBO 1123 (wheat) and Ife brown (cowpea) than in other food host varieties on all days of trials.

F₁ Emergence in *S. zeamais* and weight loss in food hosts

The number of F₁ emergence of adult *S. zeamais* as well as weight loss in maize, sorghum, wheat and cowpea in a no choice experiment and free choice experiments are presented in Tables 2a and 2b. The highest significant ($p < 0.05$) number of adult *S. zeamais* (10.67, 9.86) emerged on NGB0 1582 (sorghum) and NGB01124 (wheat), respectively, while the least emergence was observed on NGB01123 (wheat) and Ife brown (cowpea). Maize variety, TZPB SR-W and sorghum variety, NGB0 1582 had the longest developmental period of 38.63 and 35.75 days, respectively. The highest weight losses in food varieties were recorded on DMR 9943 (maize), NGB0 1582 (sorghum) and NGB0 1124 (wheat), while the least weight losses were found in NGB0 1123 (wheat) and Ife brown (cowpea) (Table 2a). As shown in Table 2b, the highest significant number of adult *S. zeamais* in a free choice test, emerged from maize varieties, DMR 9928 and DMR 9943. The sorghum variety, NGB0 1354 had the longest median developmental time (34.50), even though not significantly different from developmental time in other food hosts apart from NGB0 1224 (wheat) and DMR 9928 (maize). Significantly higher weight losses were recorded on maize varieties, DMR 9943 and TZPB SR, while Ife brown (cowpea) and NGB01123 (wheat) recorded the least percentage weight loss (Table 2b).

Fig. 1 shows the susceptibility indices of the food host varieties used in this study. As we had similar susceptibility indices for the no-choice and free choice experiments, we decided to use a representative index for our reports. Ife Brown (cowpea) and NGB0 1123 (wheat) had the lowest (0) susceptibility index, while NGB0 1469 (sorghum) had the highest (5.8) susceptibility value (Fig. 1).

Table 1: Survival of *Sitophilus zeamais* infested on varieties of food hosts in the laboratory

Food host	Varieties	Mortality (\pm S.E) at days after infestation		
		6	8	10
Maize	DMR 9928	0.00 \pm 0.00a	0.00 \pm 0.00a	5.00 \pm 0.30a
	DMR 9943	0.00 \pm 0.00a	0.00 \pm 0.00a	0.00 \pm 0.00a
	TZBP SR W	4.61 \pm 4.61a	9.22 \pm 5.32a	9.22 \pm 5.32a
Sorghum	NGB0 1354	32.53 \pm 4.91b	41.99 \pm 5.07b	49.87 \pm 5.07b
	NGB0 1469	4.61 \pm 4.61a	9.22 \pm 5.32a	16.22 \pm 5.32a
	NGB0 1582	0.00 \pm 0.00a	0.00 \pm 0.00a	7.00 \pm 3.40a
Wheat	NGB0 1123	78.75 \pm 6.70c	90.00 \pm 0.00c	90.00 \pm 0.00c
	NGB0 1124	9.22 \pm 5.32a	9.22 \pm 5.32a	9.22 \pm 5.32a
	NGB0 1224	0.00 \pm 0.00a	0.00 \pm 0.00a	0.00 \pm 0.00a
Cowpea	IFE-BROWN	80.78 \pm 5.32c	90.00 \pm 0.00c	90.00 \pm 0.00c

Means within a column with the same letter(s) are not significantly different at $p < 0.05$ using New Duncan's Multiple Range Test

Table 2a: Adult Emergence, Median Developmental Time of *Sitophilus zeamais* and weight loss in food hosts in a no-choice test

Food hosts	Varieties	F ₁ Emergence	Median Development Time	Loss in weight (%)
Maize	DMR 9928	4.38±0.12bc	34.5±0.83cd	10.57±0.66bc
	DMR 9943	4.41± 0.15bc	33.75± 0.41bc	15.44±1.12d
	TZBP SR	3.67±0.42b	38.63±1.69e	8.51±0.97b
Sorghum	NGBO 1354	5.77±0.55d	32.25±1.11bc	7.37±1.03b
	NGBO 1469	7.95±0.44e	31.00±0.5b	8.06±0.97b
	NGBO 1582	10.67±0.62f	35.75±1.38de	13.89±1.57d
Wheat	NGBO 1123	1.00±0.00a	0.00± 0.00a	1.11±0.21a
	NGBO 1124	9.86±0.18f	34.25±0.95cd	13.39±1.36cd
	NGBO 1224	5.21± 0.45cd	33.25±0.25bcd	7.50±1.03b
Cowpea	IFE-BROWN	1.00±0.00a	0.00±0.00a	0.88±0.09a

Means within a column with the same letter(s) are not significantly different at $p < 0.05$ using New Duncan's Multiple Range Test

Table 2b: Adult Emergence, Median Developmental Time of *Sitophilus zeamais* and weight loss in food hosts in a free-choice test

Food hosts	Varieties	F ₁ Emergence	Median Development Time	Loss in weight (%)
Maize	DMR 9928	5.07±0.13de	31.5±0.86bc	36.12±1.75de
	DMR 9943	5.58± 0.31e	32.5± 0.86bcd	41.97±2.48ef
	TZPB SR	4.31±0.22c	32.0±0.91bcd	49.28±1.29f
Sorghum	NGBO1354	4.56±0.42cd	34.5±0.65d	17.73±1.79b
	NGBO1469	4.52±0.16cd	31.75±1.1bcd	28.25±1.34b
	NGBO1582	4.87±0.21cd	31.75±0.94bcd	24.67±7.49cd
Wheat	NGBO1123	1.00±0.00a	0.00± 0.00a	4.18±0.89a
	NGBO1124	3.67±0.09b	33.75±0.95cd	17.82±2.60bc
	NGBO1224	3.55± 0.19b	30.75±0.75b	20.57±1.88b
Cowpea	IFE-BROWN	1.00±0.00a	0.00±0.00a	3.13±1.09a

Means within a column with the same letter(s) are not significantly different at $p < 0.05$ using New Duncan's Multiple Range Test

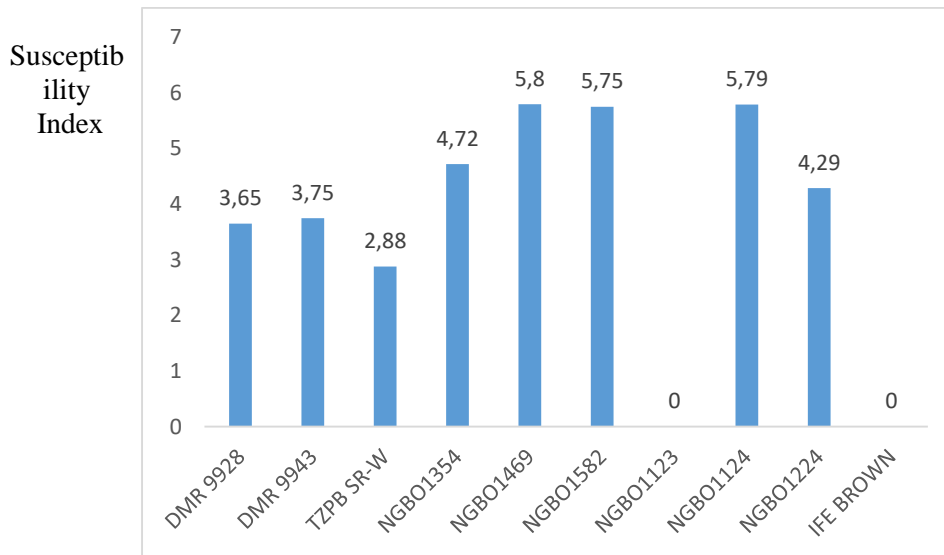

Scales: 0–4.0 = resistant, 4.1–6.0 = moderately resistant, 6.1–8.0 = moderately susceptible, 8.1–10.0 = susceptible and ≥ 10.1 = highly susceptible (Dobie, 1974)

Fig. 1.: Susceptibility index of food host varieties in a no choice test

DISCUSSION

Significantly high mortality of *S. zeamais* was recorded on Ife-Brown and on wheat variety, NGB0 1123, suggesting that *S. zeamais* must have been starved to death since the food host varieties could not supply the appropriate nutrients to the insect. Conversely, little or no mortality was recorded on all the maize host varieties and other wheat and sorghum hosts, agreeing with earlier reports that *Sitophilus zeamais* preferred some food varieties (especially maize) than others.

There was considerable variation in the F₁ progeny of *S. zeamais* across the food hosts. Significantly higher number of adults emerged from the three sorghum varieties than from the other food varieties ($p < 0.05$) could be as a result of the small sizes of sorghum grains, which provided an increase in the number of grains available for oviposition. This finding is in accordance with earlier reports that oviposition and emergence of *S. zeamais* was density dependent (Richards, 1947; Pederson, 1979; Mathias *et al.*, 2015). In this study, *S. zeamais* completed its development on the food hosts between 33 - 39 days, on the choice and no-choice experiments. Similar observations have also been made by Ojo and Omoloye, (2016) where they reported that the comparative developmental cycle of *S. zeamais* from egg to adult was 34.7 days (on maize). Akinbuluma and Ewete (2019) also reported a median developmental time of 33.0 days of *S. zeamais* on DMR-ESY maize variety.

Losses in maize hosts were consistently higher than those in other food hosts and this might be due to the high survival rate of *S. zeamais* on the maize grains. Infestation of *S. zeamais* can cause weight loss of above 30% in stored maize (Paneru *et al.*, 1996; Sharma *et al.*, 2016). Similarly, a range of between 7 – 29% was observed to be lost to *S. zeamais* feeding on sorghum, agreeing with the reports of Patrick and McClure (2009) that stored sorghum incur losses of up to 20%. Suleiman *et al.* (2013) reported that *S. zeamais* is a serious insect pest of sorghum causing grain damage of up to 65.5% after four months of exposure to *S. zeamais* under laboratory conditions, while Gofishu and Belete (2014) also recorded grain damage of about 30.0% after 2 months of *S. zeamais* infestation. The least percentage weight loss in Ife brown (cowpea) and NGB0 1123 (wheat) varieties might be due to the low survival of the insect pest on these food hosts. The range of susceptibility indices suggests that all the food host varieties used in this study were moderately resistant to *S. zeamais* apart from NGB01123

(wheat) and Ife brown (cowpea) which were highly resistant (Dobie, 1974; Akinbuluma *et al.*, 2019). From this study, maize, sorghum and two wheat varieties NGBO 1124 and NGBO 1224 can serve as suitable hosts, while cowpea and wheat variety (NGBO1123) are the least suitable host of *S. zeamais* in relation to feeding and development.

REFERENCES

- Adedire, C. O. (2001). Biology, Ecology and Control of Insect Pests of Stored Cereal Grains. In: Ofuya TI, Lale NES, editors. *Pests of Stored Cereals and Pulses in Nigeria: Biology, Ecology and Control*. Dave Collins Publications, Akure, Nigeria.
- Akinbuluma, M.D. and Ewete, F. K. (2019). Resistance of four maize varieties to *Sitophilus zeamais* (Coleoptera: Curculionidae) infestation. *Annals of West University of Timișoara, ser. Biology*, Vol. 22 (1), pp.3-14.
- Babarinde, S. A., Sosina, A., Oyeyiola, E. A. (2008). Susceptibility of the selected crops in storage to *Sitophilus zeamais* Motschulsky in Southwestern Nigeria. *Journal of Plant Protection Research*, 48: 541 -550.
- Baniwal, P., Mehra, R., Kumar, N., Sharma, S. and Kumar, S. (2022). Cereals: Functional constituents and its health benefits. *Pharma Innovation*, 10 (2): 343-349. DOI: [10.22271/tpi.2021.v10.i2e.5681](https://doi.org/10.22271/tpi.2021.v10.i2e.5681)
- Berhe, M., Subramanyam, B., Chichaybelu, M., Demissie, G., Abay, F. and Harvey, J. (2022). Post-Harvest Insect Pests and Their Management Practices for Major Food and Export Crops in East Africa: An Ethiopian Case Study. *Insects*, 13, 1068. <https://doi.org/10.3390/insects13111068>.
- Bloem, S., Mizell, R. F., III, O'Brien, C. W. (2002). Old traps for new weevils: new records for Curculionids (Coleoptera: Curculionidae), Brentids (Coleoptera: Brentidae) and Anthribids (Coleoptera: Anthribidae) from Jefferson Co., Florida. *Florida Entomologist*, 85(4) 632-644.
- Coombs, C. W., Billings, C. J., Porter, J. E. (1977). The effect of yellow split-peas (*Pisum sativum* L.) and other pulses on the productivity of certain strains of *Sitophilus oryzae* (L.) (Col. Curculionidae) and the ability of other strains to breed thereon. *Journal of Stored Products Research*, 13(2):53-58.
- Dakora F.D. and Belane, A. K. (2019). Evaluation of Protein and Micronutrient Levels in Edible Cowpea (*Vigna Unguiculata* L. (Walp.). Leaves and Seeds. *Front. Sustain. Food Syst.* 3:70. doi: 10.3389/fsufs.2019.00070
- Dobie P. (1974). The laboratory assessment of the inherent susceptibility of maize varieties to post-harvest infestation by *Sitophilus zeamais* Motch. (Coloeptera: Curculionidae). *Journal of Stored Products Research*, 10: 183–197.
- Garcia-Correia, M. A. (2002). Bioatividade da Erva-de-Santa-Maria, *Chenopodium ambrosioides* L. (Chenopodiaceae), em relação a *Sitophilus zeamais* Mots., 1855 (Col.: Curculionidae). Dissert (Mestrado) . Área de Concentração: Entomologia, USP, Brasil.
- García-Correia, M.A., 2002. Bioatividade da Erva-de-Santa-Maria, *Chenopodium ambrosioides* L. (Chenopodiaceae), en relação a *Sitophilus zeamais* Mots., 1855 (Col.: Curculionidae). Dissertação (Mestrado). Área de Concentração: Entomologia, Universidade de São Paulo, São Paulo, Brasil.
- Goftishu, M. and Belete, K. (2014) Susceptibility of sorghum varieties to the maize weevil *Sitophilus zeamais* Motchulsky (Col.: Curculionidae) *African Journal of Agricultural research*, 9(31): 2419-2426.
- Gupta S.S., Ghoshchanduri P., Majundar K.K., Chakrabarty M.M., Raha T.K., Bhattacharyya D.K. (1985). A study of insects and fungal infestation of sal (*Shorea robusta*) seed. *J. Oil Tech. Ass. Ind.* 17 (3): 56–57.

- Klopčič M, Slokan P, Erjavec K. (2020). Consumer preference for nutrition and health claims: A multi-methodological approach. *Food Qual Prefer* 82:103863.
- Macauley H. (2015). Cereal crops: rice, maize, millet, sorghum, wheat. An action plan for African agricultural transformation. In: Proceedings of Feeding Africa Conference
- Mathias, D., Taofic, A., Eric, H. & Frédéric, F. (2015). Oviposition strategy of *Sitophilus zeamais* Motsch. (Coleoptera: Curculionidae) in relation to conspecific infestation. *African Journal of Agricultural Research*, 10(4): 301-307.
- Ojo, J. A. and Omoloye, A. A. (2016). Development and Life History of *Sitophilus zeamais* (Coleoptera: Curculionidae) on Cereal Crops. *Advances in Agriculture*, <http://dx.doi.org/10.1155/2016/7836379>
- Patrick, C. R. and McClure, A. T. (2009). Insect in farm-stored grains. The University of Tennessee Extension, PB 1395
- Pederson, J. R. (1979). Selection of Oviposition Sites on Wheat Kernels by *Sitophilus* spp.: Effect of Moisture, Temperature and Kernel Size, Ph.D. dissertation, Kansas State University, Manhattan.
- Richards, O. W. (1947). Observations on grain weevils *Calandra* (Col. Curculionidae). I. *General Biology and Oviposition*. Proceedings of Zoological Society of London, 117: 1 – 43.
- Sharma, S. D., Tapa, R. B., Kc, G. B., Bhandari, G. and Tiwari, S. (2016). Studies on food preferences of maize weevil, *Sitophilus zeamais* Mots. to different crops in Chitwan, Nepal. *Journal of Maize Research and Development*, Vol. 2, no. 1, pp. 58–65.
- Suleiman, M., Majeed, Q. and Aiki, I. (2013). Efficacy of Four Plant Powders against *Sitophilus zeamais* L. (Coleoptera: Curculionidae) on sorghum grains. *International Journal of Applied Research and Technology*, 2(6): 130-138.

SUSTAINABILITY ASSESSMENT OF ANIMAL HUSBANDRY IN TURKEY

Berrin KURSUN¹

¹ *Marmara University, Engineering Faculty, Chemical Engineering Department, Istanbul, Turkey*

Corresponding author e-mail: berrin.kursun@marmara.edu.tr

ABSTRACT

This study covers analysis of the sustainability of the animal husbandry activities in Edirne and Kastamonu provinces of Turkey through a thermodynamic sustainability assessment technique, emergy analysis (EA). By classifying energy and material flows as renewable, non-renewable and purchased from economy, EA defines metrics to evaluate the sustainability of a system. These metrics provide insight about evaluated system's renewability, environmental loading and dependence on external inputs. In analyzed systems, 3 breeders raise both cows and sheep; 3 breeders raise cows, only. All animal breeding systems we analyzed are found to have renewability lower than 20%, environmental loading ratio (ELR) of higher than 2 and environmental sustainability index (ESI) of lower than 1. Consequently, they are determined to be unsustainable irrespective of the location of husbandry activities. Purchased animal feed is determined to be the main factor behind the systems' unsustainability. Integration of animal breeding with feed crop cultivation and increasing the ratio of farmer grown food in diets of animals can enhance the sustainability performance of animal husbandry systems.

Keywords: Emergy analysis, system renewability, environmental loading, sustainable animal husbandry, system integration

INTRODUCTION

26% of global greenhouse gas (GHG) emissions and 70% of freshwater use are created by food production. 96% of all mammal biomass excluding humans is livestock and 71% of all bird biomass is poultry livestock (Ritchie and Roser, 2022). This shows the extent of increase in animal-sourced-nutrition production due to human population growth. Hence, performing animal rearing activities in a sustainable manner has the utmost importance in today's world.

Emergy analysis is a thermodynamic sustainability assessment tool that provides insights about a system's renewability, environmental loading and dependence on external resources (Odum, 1996). Biological systems are interconnected through an "energy hierarchy" (Brown and Ulgiati, 2004; Hau and Bakshi, 2004). Hence, the interconnected nature and sustainability of these systems can be analyzed thermodynamically through EA.

EA is widely utilized in sustainability assessment of animal rearing activities as in works of He et al., 2019, Zhang et al., 2007 and Wang et al., 2015. However, studies evaluating sustainability of Turkish husbandry sector through EA are not available. Hence, this work evaluates and compares the sustainability of 6 animal husbandry systems in Edirne and Kastamonu provinces of Turkey.

MATERIAL AND METHOD

Background

Table 1 lists properties of 6 husbandry systems analyzed in this work. Performing research in two different locations enables system comparisons and related recommendations.

Table 1: Location, animal number and type, feeding structure and product characteristics of evaluated animal breeding systems.

System	Location	Animal Number	Feed Type	Products
Husbandry 1	Edirne/ Uzunköprü	100 cows	Purchased + Self-grown	18-20 L milk/animal + 25 male calf/year
Husbandry 2	Edirne/ Merkez	25 cows + 3 sheep	Purchased + Self-grown	15L milk/animal + 5 male calf/year + 60 kg sheep meat/year
Husbandry 3	Edirne/ Merkez	11 cows	Purchased + Self-grown	20 L milk/animal + 5 male calf/year
Husbandry 4	Kastamonu/ Tosya	110 cows + 60 sheep	Purchased	400 kg meat/cow + 30 kg meat/sheep
Husbandry 5	Kastamonu/ Tosya	22 cows + 2 sheep	Purchased + Self-grown	10 L milk/animal + 10 male calf/year.
Husbandry 6	Kastamonu/ Tosya	65 cows	Purchased + Self-grown	15L milk/animal + 15 male calf/year

Emergy Analysis (EA)

Methodologically, EA includes the steps of drawing energy systems diagram (a pictorial model of the system), emergy evaluation table formation (an inventory for inputs and outputs) and the calculation of emergy indicators (Odum, 1996; Brown and Ulgiati, 2004).

Figure 1 shows the energy systems diagram (ESD) for an animal rearing system in Edirne. Here, sun wind and rain are renewable inputs that are provided by the natural environment. Water is the non-renewable local input that is under storage category. It is classified as non-renewable since the groundwater levels are declining in both research locations. Inputs that are exchanged from economy are classified as purchased inputs (Odum,1996).

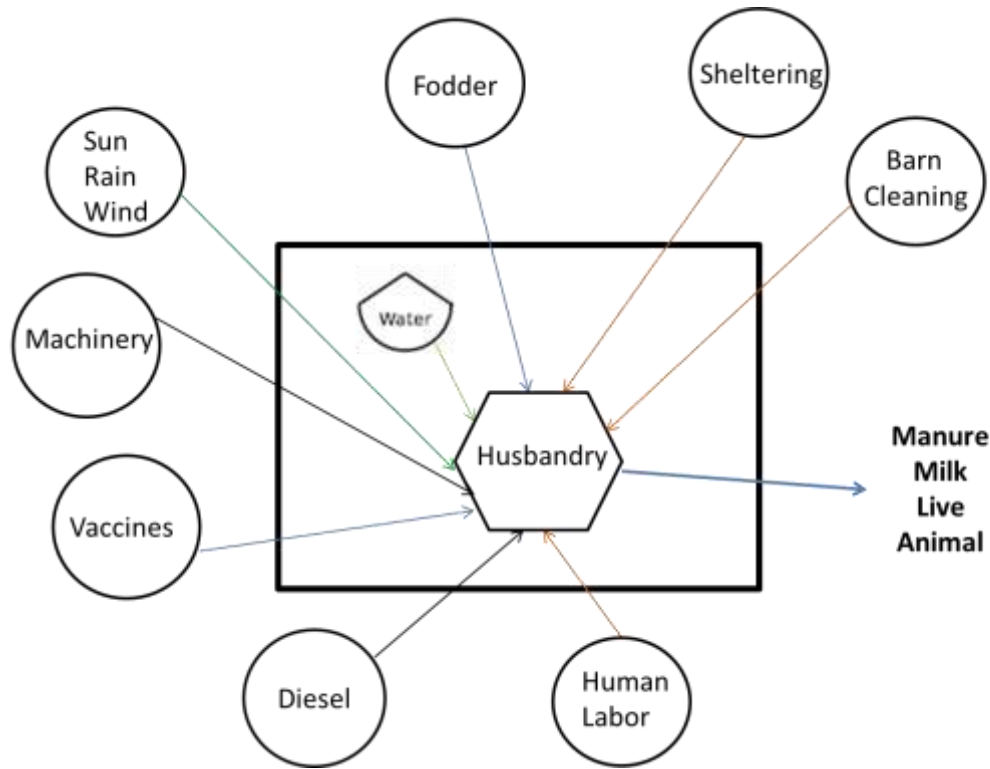

Figure 1: Energy systems diagram for an animal rearing system in Edirne.

Emergy evaluation table (EET) is a listing containing all the energy and material inputs to and the outputs from the system under study. EET is formed based on the determined analysis boundary and the model drawn in the ESD (Odum, 1996).

Calculation of emergy indicators in EA is based on the classification of emergy flows as local renewable (R), non-renewable (N) and purchased (P) (Ulgiati et al, 2010).

The calculation of the emergy indicators is presented in equations 1-6 mathematically.

$$\text{Emergy Yield (Y)} = R + N + P \quad (1)$$

$$\text{Renewability} = \frac{R}{Y} \quad (2)$$

$$\text{Emergy Yield Ratio (EYR)} = \frac{Y}{P} \quad (3)$$

$$\text{Environmental Loading Ratio (ELR)} = \frac{(N+P)}{R} \quad (4)$$

$$\text{Environmental Investment Ratio (EIR)} = \frac{P}{(R+N)} \quad (5)$$

$$\text{Environmental Sustainability Index (ESI)} = \frac{\text{EYR}}{\text{ELR}} \quad (6)$$

Systems having renewability of lower than 20%, EYR of lower than 4, ELR of higher than 2 and ESI of lower than 1 are classified as unsustainable systems. If these systems are improved, they can evolve into being in transition state or sustainable in terms of their sustainability status (Chen et al., 2017). Further information on EA can be found in Kursun and Bakshi (2016).

RESULTS AND DISCUSSION

Figure 2 shows renewability of animal breeding systems evaluated. Out of 6 breeders, 3 have both cow and sheep and 3 breeders solely raise cows. In cow breeding systems renewability changes between 0.42% and 15.9%. In case of sheep, this change is between 1.69 % and 12.1%. The main factor affecting renewability of cow systems is how much of the feed is grown by the farmer. As the integration level of cow rearing and feed crop cultivation systems (feed crops are fertilized with animal manure) increase, renewability of cow rearing increases. The same inclination is also true for sheep rearing, as the portion of farmer grown feed or grazing increases, sheep rearing systems become more renewable.

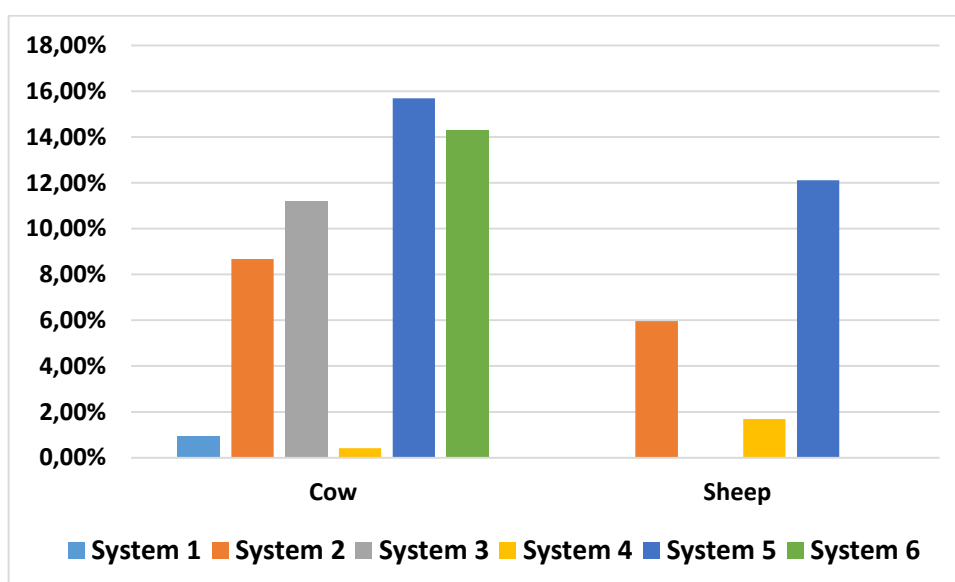

Figure 2: Renewability values for evaluated animal rearing systems.

Figure 3 shows emergy yield ratio (EYR) of animal breeding systems evaluated. In cow breeding systems EYR changes between 1.10 and 1.26. In case of sheep, this change is between 1.02 and 1.17. System renewability and EYR go hand in hand. As renewability increases, system EYR also increases. Here, again how much of the feed is grown by the farmer and level of integration of cow rearing and feed crop cultivation systems are the determining factors that increase EYR value (preferred). For sheep cases as the portion of farmer grown feed or grazing increases, sheep rearing EYR increases.

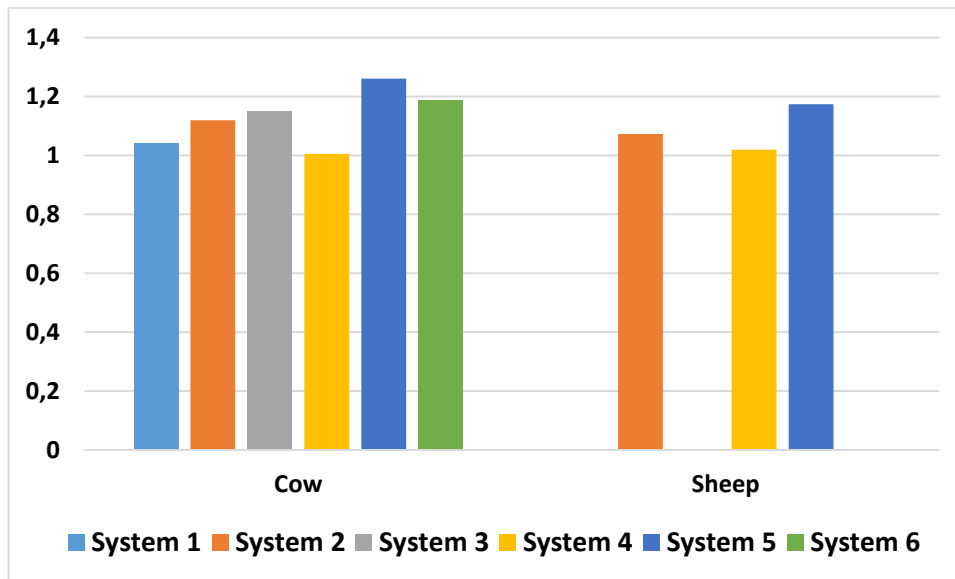

Figure 3: Energy yield ratio (EYR) values for evaluated animal rearing systems.

Figure 4 shows environmental loading ratio (ELR) of animal breeding systems evaluated. In cow breeding systems ELR changes between 5.33 and 238. In case of sheep, this change is between 7.22 and 58.2. Being purchased feed the largest energy input to the system followed by non-renewable water create the environmental loading in cow breeding. For sheep, mainly purchased animal feed is responsible from this impact. Due to grazing, sheep breeding generally has lower environmental loading than cow breeding.

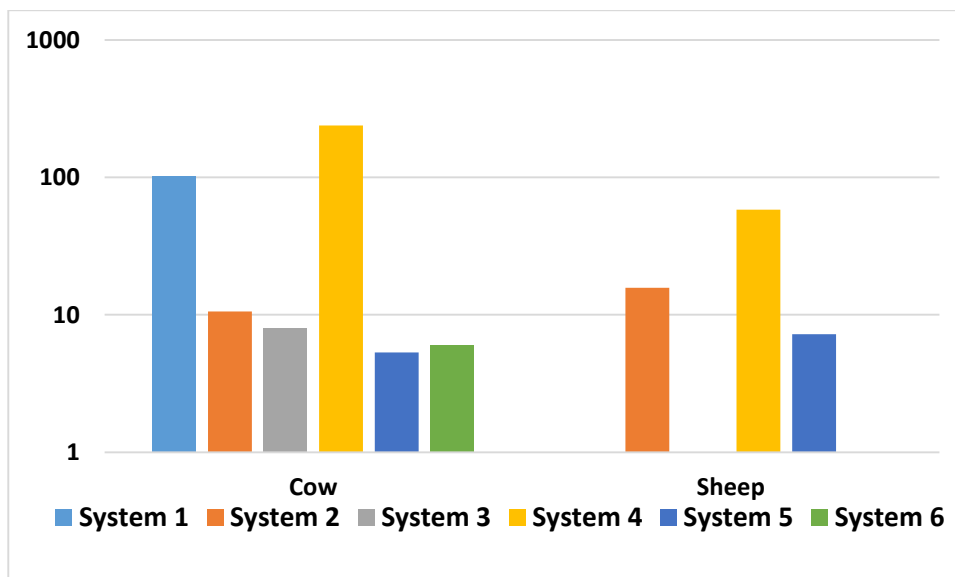

Figure 4: Environmental loading ratio (ELR) values for evaluated animal rearing systems.

Figure 5 shows environmental investment ratio (EIR) of animal breeding systems evaluated. In cow breeding systems EIR changes between 5.36 and 197. In case of sheep, this change is between 5.91 and 13.7. For EIR, dominance of purchased animal feed is the main reason behind high EIR values both for cow and sheep breeding.

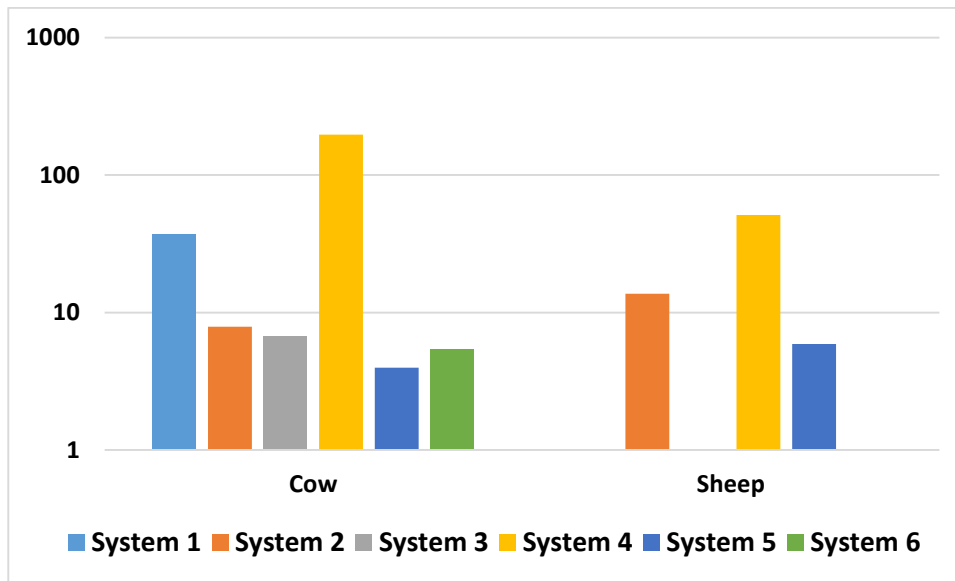

Figure 5: Environmental investment ratio (EIR) values for evaluated animal rearing systems.

Figure 5 shows environmental sustainability index (ESI) of animal breeding systems evaluated. In cow breeding systems ESI changes between 0.01 and 0.24. In case of sheep, this change is between 0.02 and 0.16. ESI is the ratio of EYR to ELR, hence it represents production per environmental loading. Low ESI values obtained both for cow and sheep breeding show that all of the animal breeding systems analyzed are unsustainable.

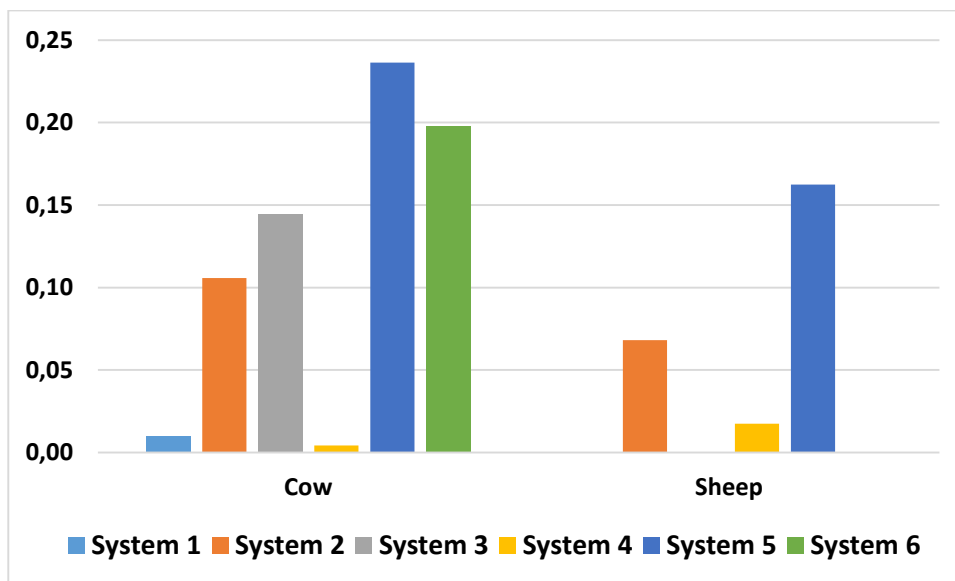

Figure 6: Environmental sustainability index (ESI) values for evaluated animal rearing systems.

CONCLUSIONS

All animal breeding systems studied in this work has renewability lower than 20%, ELR higher than 2 and ESI lower than 1. Consequently, they are found to be unsustainable. Purchased animal feed is determined to be the main factor behind the systems' unsustainability. Integration of animal breeding systems with feed crop cultivation and increasing the ratio of

farmer grown food in diets of animals can enhance sustainability performance of animal breeding systems.

REFERENCES

- Brown MT, Ulgiati S (2004). Energy quality, emergy and transformity: H.T Odum`s contributions to quantifying and understanding systems. *Ecological Modelling* 178(1-2): 201–213.
- Chen W, Zhong S, Geng Y et al (2017). Emergy based sustainability evaluation for Yunnan Province, China. *Journal of Cleaner Production* 162: 1388-1397.
- Hau, J.L., Bakshi, B.R. 2004. Promise and problems of emergy analysis. *Ecological Modelling* 178(1-2): 215–225.
- He, Z., Jiang, L., Wang Z. et al, 2019. The emergy analysis of southern China agro-ecosystem and its relation with its regional sustainable development. *Global Ecology and Conservation*. 20: e00721.
- Kursun B, Bakshi BR (2016). Sustainability Assessment of a Geographical Region and of the Activities Performed in Handbook of Research on Green Economic Development Initiatives and Strategies. Pages:18-43. Prof. Dr. T.G. Arun and Dr. Imran Ahmad, Prof Dr. M. Mustafa Erdogdu (eds).
- Odum, H. T. 1996. *Environmental Accounting: Emergy and Environmental Decision Making*. New York, NY: Wiley.
- Ritchie, H. Rosado, P. Roser, M. 2022. *Environmental Impacts of Food Production*. <https://ourworldindata.org/environmental-impacts-of-food> .
- Ulgiati S, Ascione M, Bargigli S et al. (2010). Multi-method and multi-scale analysis of energy and resource conversion and use. NATO Science for Peace and Security Series C: Environmental Security. University of Florida Center for Environmental Policy.
- Wang, N., Chen, K., Zhang, J. et al. 2014. Emergy analysis of agricultural aco-economic— A case study of Haidong region of Qinghai Province. *Geo-Informatics in Resource Management and Sustainable Ecosystem*. International Conference, GRMSE 2014, Ypsilanti, USA, October 3-5, 2014, Proceedings.
- Zhang, X., Yang, Z.F., Chen, G.Q. 2007. Emergy analysis of cropping–grazing system in Inner Mongolia Autonomous Region, China. *Energy Policy*. 35(7): 3843-3855.

EVALUATION OF ORGANIC LIVESTOCK FARMING EFFICIENCY IN TURKEY WITH DATA ENVELOPMENT ANALYSIS

Melike Kübra EKİZ BOZDEMİR¹, Selen AVCI AZKESKİN¹

¹ *Kocaeli University, Engineering Faculty, Industrial Engineering Department, Kocaeli, Turkey*

Corresponding author e-mail: melike.ekiz@kocaeli.edu.tr

ABSTRACT

In recent times, consumers have been placing great importance on the consumption of healthy, high-quality, and safe food. Organic products to protect human health and raise healthier generations has been increasing the significance of organic agriculture and livestock day by day. The primary objective of organic agriculture and livestock is to preserve the environment, plants, animals, and human health without polluting soil, water resources and compromising air quality. Organic livestock farming is a production method where chemical inputs are avoided, and all stages, from production to consumption, are controlled and certified. Residues of feed and additives used in industrial livestock farming leave significant traces in animal-based food products, causing significant health issues for consumers. Hence, an alternative organic livestock farming approach based on pasture and chemical-free feed is proposed, as it is a more environmentally and ethically sound production system. In this study, the efficiencies of organic livestock farming in the twelve regions of Turkey, which we determined it, were evaluated using Data Envelopment Analysis (DEA) with zero data. The regions were considered as Decision Making Units (DMUs), number of poultry, number of small ruminants, number of large ruminants, number of beehives, and number of farmers were determined as inputs. Produced meat (tons), milk (tons), eggs (number), and honey (tons) were determined as outputs.

Keywords: Organic livestock, Organic livestock farming, Data envelopment analysis, Efficiency, Zero data

INTRODUCTION

Until the 1980s, due to the complementary relationship between plant and animal production in enterprises, fertilizer was obtained for animal husbandry and plant production, while plant production also contributed to animal husbandry with feed crops and by-products. Despite the increase in the world population, the number of animals, milk, and especially meat production, which are very important resources for human nutrition, have not increased at the same level, so livestock farming has begun to be carried out industrially in large-scale enterprises. For this reason, the natural relationship between plant agriculture and livestock farming has been broken and small producers have reached the point of extinction, while many environmental, biological and economic damages have occurred. For example, increased susceptibility to diseases as a result of little movement of animals tethered or walking in narrow spaces, and the resulting animal feces and gases disrupt the natural balance, water, soil and air. In addition, factors that negatively affect the consumer have emerged, such as the formation of fatty acid, insulin and antibiotic residues in products obtained from animals. To address these issues, organic livestock farming has emerged as an alternative to industrial practices. It relies on pasture-based feed production and avoids chemical usage, aligning with consumer demands for a more environmentally friendly and ethically sound production system.

Organic livestock farming is a form of production that is controlled and certified at every stage from production to consumption, without using chemical inputs in production. Çelikyürek & Karakuş (2018) analyze the importance of organic livestock farming in the world and

Türkiye. Aygün and Akbulak (2017), evaluate the organic agriculture potential of Ardahan province, which has large and productive pasture areas and no environmental pollution caused by industrial and agricultural activities with SWOT analysis. Hanoğlu (2013) provides a comprehensive discussion of organic cattle farming for both small and large ruminants in Turkey. Furthermore, organic chicken farming has been experiencing a notable increase in popularity. This surge can be attributed to consumer preferences, as chickens are favored for their efficient conversion of feed into high-quality protein within a short time frame. Additionally, both chicken meat and eggs are considered important components of a healthy diet. Moreover, chicken meat is often priced more affordably than red meat (Uruk & Yenilmez, 2018). Furthermore, in addition to its contribution to ecological balance, organic beekeeping is also practiced in rural areas, especially in certain regions of Turkey. Güler (2021) evaluate the efficiency of the provinces in Turkey in organic beekeeping with DEA. In the study, the number of businesses and the number of hives were determined as inputs, and honey production and beeswax were determined as outputs.

MATERIAL AND METHOD

DEA is a non-parametric and linear programming-based method used to measure the relative efficiencies of alternative units that produce similar outputs using similar inputs. The CCR model, which was developed by Charnes, Cooper, and Rhodes as part of a thesis, was introduced first model of DEA in the literature (Charnes, Cooper, & Rhodes, 1978). In the CCR model, efficient and inefficient Decision-Making Units (DMUs) can be distinguished, where efficient DMUs form the efficiency frontier and provide a preference ranking for inefficient DMUs. However, the classical models, known as the CCR under the Constant Returns to Scale (CRS) assumption and BCC model under the Variable Returns to Scale (VRS) assumption, proposed by Banker, Charnes, and Cooper (Banker, Charnes, & Cooper, 1984), cannot provide rankings for efficient DMUs. Due to the inability of classical DEA models to rank efficient DMUs, many methods have been proposed to enhance the discrimination power of DEA, one of which is the super-efficiency method proposed by Andersen and Petersen which developed the Super Efficiency (SE) model (Andersen & Petersen, 1993).

Firstly, the parameters and decision variables for SE model are defined below, followed by the presentation of the input-oriented SE model (Andersen & Petersen, 1993). The model aims to calculate the efficiency score of DMU_0 , which is the DMU under evaluation. In this context, θ_k represents the efficiency score, where k denotes the number of DMUs.

Parameters:

- N cluster of DMU
- M cluster of input
- S cluster of output
- x_{ik} i -th input value of DMU k
- y_{rk} r -th output value of DMU k

Decision Variables:

- θ_k Efficiency score of DMU k
- λ_k Matrix containing the weights of inputs and outputs for DMU k

(SE Model)

$$\text{Min } \theta_0 \tag{1}$$

$$\sum_{k \in N - \{0\}} \lambda_k x_{ik} \leq \theta_0 x_{i0} \quad \forall i \in M \tag{2}$$

$$\sum_{k \in N - \{0\}} \lambda_k y_{rk} \geq y_{r0} \quad \forall r \in S \tag{3}$$

$$\sum_{k \in N-\{0\}} \lambda_k = 1 \tag{4}$$

$$\lambda_k \geq 0 \quad \forall k \in N \tag{5}$$

In the SE model, DMUs is excluded from the dataset, consequently breaking the existing efficient frontier, and establishing a new one. The DMU under evaluation for efficiency is positioned outside this newly formed efficient frontier, resulting in an efficiency score equal or larger than 1. The greater the efficiency score of an efficient DMU, the preferable it. Inefficient DMUs have the same efficiency scores as those obtained from the CCR model which assumes CRS.

In the VRS assumption, super-efficiency model which may be infeasible when some efficient DMUs are under evaluation. Seiford and Zhu (1999) provide the necessary and sufficient conditions for infeasibility of super-efficiency models, and further show that infeasibility must occur in the case of the variable returns to scale (VRS) super-efficiency model. Several studies have tried to solve the problem of VRS super-efficiency model's infeasibility (Lovell & Rouse, 2003; Chen, 2005; Cook, Liang, Zha, & Zhu, 2009). In a recent study by Lee, Chu, and Zhu (2011), the authors develop a two-stage process to overcome the VRS infeasibility issue by yielding a score that characterizes the super-efficiency in both inputs and outputs. Chen and Liang (2011) further prove that the two-stage process can be solved in a single linear program. Lee, Chu, and Zhu (2011), show that infeasibility exists under input-oriented (output-oriented) model when any output surplus (input saving) exists. Under input-oriented (output-oriented) situation, this new approach identifies the radial efficiency and output surplus (input saving) simultaneously and yields a super efficiency score that characterizes both the radial efficiency and output surplus (input saving) if it exists. The proposed model works when data is positive. If the data is nonnegative, i.e., some of the input or output data is zero, these new super-efficiency models can still be infeasible. In an extension of the research conducted by Lee et al. (2011), Lee and Zu (2012) revised the model and feasible when zero data exist in inputs. They state zero output data does not cause infeasibility the output-oriented super-efficiency models developed in prior studies by Lee et al. (2011), Chen and Liang (2011), and Cook et al. (2009). The reason behind this is that the constraints on the output side can always be satisfied. Lee and Zu model is presented below (Lee and Zu, 2012):

(Lee and Zu model)

$$Min \tau + M \left(\sum_r \beta_r + \sum_i t_i \right) \tag{6}$$

$$\sum_{k \in N-\{0\}} \lambda_k x_{ik} - t_i x_{imax} \leq (1+\tau) x_{i0} \quad \forall i \in M \tag{7}$$

$$\sum_{k \in N-\{0\}} \lambda_k y_{rk} \geq (1-\beta_r) y_{r0} \quad \forall r \in S \tag{8}$$

$$\sum_{k \in N-\{0\}} \lambda_k = 1 \tag{9}$$

$$\lambda_k \geq 0, \beta_r \geq 0, t_i \geq 0, \tau \text{ is unlimited} \tag{10}$$

where $x_{imax} = \max_{k=1}^1 \{x_{ik}\}$, t_i is input saving and β_r output surplus, Input saving index and output surplus index are calculated as follows with $I = \{i | t_i^* > 0\}$ and $R = \{r | \beta_r^* > 0\}$.

$$\hat{\tau} = \begin{cases} 0 & \text{if } I = \emptyset \\ \frac{\sum_{i \in I} \left(\frac{1+\tau_i^*}{1} \right)}{|I|} & \text{if } I \neq \emptyset \end{cases} \quad o = \begin{cases} 0 & \text{if } R = \emptyset \\ \frac{\sum_{r \in R} \left(\frac{1}{1-\beta_r^*} \right)}{|R|} & \text{if } R \neq \emptyset \end{cases}$$

Then, the super-efficiency score can be defined as $\check{\theta} = 1 + \tau^* + o + \hat{\tau}$.

RESULTS AND DISCUSSION

Worldwide and in Türkiye, organic agriculture, and livestock, also known as ecological agriculture, is becoming a growing market day by day. It can be noted that policymakers, along with providing support, grants, and incentives, have played a significant role in fostering this growth. In addition, concern about food crisis around the world and the need for cleanliness of products and environmental protection have led scientists to search for different production models and encouraged organic agriculture and livestock. In our country, organic livestock farming is constantly growing for the reasons mentioned above. Therefore, in this study, Türkiye's organic livestock farming efficiency was evaluated by DEA with zero data. Türkiye's provinces are classified 12 regions, and the regions are determined as DMU. Table 1 shows provinces, classified 12 regions, and number of members. In the study, we consider both small ruminants and large ruminants organic livestock farming, and organic chicken farming and beekeeping. In this context, poultry (number), small ruminants (number), large ruminants (number), beehives (number) and farmers (number) are determined as input, and produced meat (tons), milk (tons), eggs (numbers), honey (tons) are determined as output. Table 2 shows inputs and outputs data. Data were taken from the website of the Ministry of Agriculture (Ministry of Agriculture and Forestry, 2023)

Table 1. Provinces and classified 12 regions.

	DMU	Cities	Number of class member
1	Marmara Region 1	Bursa, Çanakkale, Balıkesir, Yalova, Bilecik	5
2	Marmara Region 2	Edirne, Kırklareli, Tekirdağ, İstanbul, Kocaeli, Sakarya	6
3	Aegean Region	Kütahya, Denizli, Muğla, İzmir, Aydın, Manisa, Uşak, Afyon	8
4	Central Anatolia Region 1	Eskişehir, Ankara, Çankırı, Kırıkkale, Kırşehir, Konya, Karaman	7
5	Central Anatolia Region 2	Aksaray, Yozgat, Niğde, Nevşehir, Kayseri, Sivas	6
6	the Mediterranean Region	Osmaniye, Adana, Isparta, Antalya, Burdur, Mersin, Hatay, Kahramanmaraş	8
7	Black Sea Region 1	Giresun, Gümüşhane, Trabzon, Bayburt, Rize, Artvin	6
8	Black Sea Region 2	Tokat, Samsun, Sinop, Çorum, Amasya, Ordu	6
9	Black Sea Region 3	Düzce, Bolu, Zonguldak, Karabük, Bartın, Kastamonu	6
10	Southeastern Anatolia Region	Şırnak, Siirt, Batman, Mardin, Diyarbakır, Şanlıurfa, Adıyaman, Gaziantep, Kilis	9
11	Eastern Anatolia Region 1	Malatya, Elazığ, Tunceli, Erzincan, Bingöl, Erzurum, Muş	7
12	Eastern Anatolia Region 2	Iğdır, Ardahan, Kars, Bitlis, Ağrı, Van, Hakkâri	7

Table 2. Inputs and outputs data.

DMUs	Poultry (number)	Small ruminants (number)	Large ruminants (number)	Beehives (number)	Farmers (number)	Meat (tons)	Milk (ton)	Eggs (number)	Honey (ton)
1	20 472	1 172	2 844	1 576	67	27.54	2 572.5	2 743 386	15.809
2	99 700	0	202	35	12	0.991	959.496	24 583 110	0.71
3	352 662	22	2 762	664	28	78	16 054	41 117 289	13.146
4	420	1 651	116	438	6	0	0	54 000	8.706
5	0	0	1 206	4 709	60	0	6 910.8	0	88.19665
6	17 000	2 485	60	12 477	42	0	264	3 517 867	481.527
7	0	0	0	14 429	98	0	0	0	184.863
8	113 500	0	0	1 024	14	0	0	2 000	3.14
9	54 500	0	0	0	3	0	0	4 392 140	0
10	0	0	0	5 033	22	0	0	0	40.85
11	43 968	0	0	13 906	66	0	0	13 190 400	185.923
12	0	0	0	18 646	45	0	0	0	329.306

We take into account zero data to evaluate Turkey's organic livestock farming efficiency and use Lee and Zhu model. Table 3 shows super efficiency score and rank. Looking at the results, the Aegean Region has first rank, Marmara Region 2 has second rank, and Marmara Region 1 ranks 4th. While Central Anatolia Region 1 ranks 3rd, Central Anatolia Region 2 ranks 10th. Black Sea Region 3, which is one of the regions rich natural resources and indigenous races, ranks 5th, while Black Sea Region 1 and 2, located further east, rank 11th and 12th, respectively. Eastern Anatolia Regions 1 and 2, known as the source of large ruminants, are ranked 8th and 6th respectively. Finally, Southeastern Anatolia Region is ranked 7th.

Table 3. Super efficiency score and rank.

DMUs	1+alfa*	t ₁ *	t ₂ *	t ₃ *	t ₄ *	t ₅ *	β ₁ *	β ₂ *	β ₃ *	β ₄ *	Input saving index	Output surplus index	Super efficiency score	Rank
1	6.08	0	0	0	0	0	0	0	0	0	0	0	6.08	4
2	10.43	0	0	0	0	0	0	0	0	0	0	0	10.43	2
3	2.92	0	0	0	0	0	0.99	0.94	0.42	0	0	39.46	42.38	1
4	9.6	0	0	0	0	0	0	0	0	0	0	0	9.60	3
5	0.99	0.43	0	0	0	0	0	0	0	0	1.43	0	2.42	10
6	1.47	0	0	0	0	0	0	0	0	0.33	0	1.49	2.96	9
7	0.82	0	0	0	0	0	0	0	0	0	0	0	0.82	11
8	0.44	0	0	0	0	0	0	0	0	0	0	0	0.44	12
9	4.55	0	0	0	0.05	0	0	0	0	0	1.03	0	5.58	5
10	3.28	0	0	0	0	0	0	0	0	0	0.00	0	3.28	7
11	1.81	0	0	0.2	0	0	0	0	0	0	1.16	0	2.97	8
12	2.18	0	0	0	0	0	0	0	0	0.44	0	1.79	3.97	6

CONCLUSIONS

In recent years, there has been a significant increase in the global demand for products grown using organic farming methods. Consumers are increasingly concerned about food safety and the environment, leading to a shift away from previously used systems. To address these concerns, organizations specializing in organic agriculture and livestock certification have been established worldwide. They oversee every step of the process, from farming and processing to packaging, labeling, and storage, ensuring the safety and quality of products until they reach consumers.

In this study, Türkiye's organic livestock farming efficiency was evaluated by DEA with zero data. Türkiye's provinces are classified 12 regions, and the regions are determined as DMU. We consider both small ruminants and large ruminants organic livestock farming, and organic chicken farming and beekeeping. Looking at the results, the Aegean Region ranks first, and the Marmara Region ranks at the top. However, Eastern Anatolia, Southeastern Anatolia and the Black Sea Region, known as regions, where natural resources, local breeds, cattle and sheep breeding are made, ranked lower. As the reason for the low organic livestock efficiency in these regions, one of the important difficulties in the transition to organic livestock farming is that the lands to be used for organic farming are included in the two-year transition period. On the other hand, the expensive control and certification services makes it difficult for small-scale enterprises to transition to organic livestock farming. Finally, policy makers' increase in support and grants to businesses in local and small regions will not only contribute to the development of organic livestock farming but also ensure the economic development of these regions.

REFERENCES

- Andersen, P., & Petersen, N. C. (1993). A Procedure for Ranking Efficient Units In Data Envelopment Analysis. *Management Science*, 39, 1261-1264.
- Aygün, G., & Akbulak, C. (2017). Ardahan İli Organik Hayvancılık Potansiyelinin Değerlendirilmesi. *Dumlupınar Üniversitesi Sosyal Bilimler Dergisi*, 53, 144 - 161.
- Banker, R., Charnes, A., & Cooper, W. (1984). Some Models for Estimating Technical and Scale Inefficiencies in Data Envelopment Analysis. *Management Science*, 30, 1078-1092.
- Charnes, A., Cooper, W., & Rhodes, E. (1978). Measuring The Efficiency of Decision-Making Units. *European Journal of Operational Research*, 2, 429-444.
- Chen, Y., & Liang, L. (2011). Super-Efficiency DEA In the Presence of Infeasibility: One Model Approach. *European Journal of Operational Research*, 213(1), 359-360.
- Chen, Y. (2005). Measuring Super-Efficiency in DEA In the Presence Of Infeasibility. *European Journal of Operational Research*, 161(2), 545-551.
- Cook, W., Liang, L., Zha, Y., & Zhu, J. (2009). A Modified Super-Efficiency Dea Model for Infeasibility. *Journal of the Operational Research Society*, 60(2), 276-281.
- Çelikyürek, H., & Karkuş, K. (2018). Dünya'da ve Türkiye'de Organik Hayvancılığa Genel Bir Bakış. *Iğdır Üni. Fen Bilimleri Enst. Der*, 8(2), 299-306.
- Güler, D. (2021). Türkiye'de İllere Göre Arıcılık Etkinliğinin Veri Zarflama Analizi İle Belirlenmesi. *Uludağ Arıcılık Dergisi*, 21(2), 146-156.
- Hanoğlu, H. (2013). Organik Tarım Mevzuatına Göre Türkiye'de Büyükbaş Ve Küçükbaş Hayvan Yetiştiriciliği. *Tarım Ekonomisi Dergisi*, 19(1), 27-34.
- Lee, H.-S., & Zhu, J. (2012). Super-Efficiency Infeasibility and Zero Data In DEA. *European Journal of Operational Research*, 216, 429-433.
- Lee, H.-S., Chu, C.-W., & Zhu, J. (2011). Super-Efficiency DEA in the Presence of Infeasibility. *European Journal of Operational Research*, 112(1), 141-147.

- Lovell, C., & Rouse, A. (2003). Equivalent Standard DEA Models to Provide Super-Efficiency Scores. *Journal of the Operational Research Society*, 54, 101–108.
- Öztürk, A. K., & Türkoğlu, M. (2012). Türkiye'de Organik Tavukçuluk. *Lalahan Hay. Arast. Enst. Derg.*, 52(1), 41-50.
- Seiford, L., & Zhu, J. (1999). Infeasibility Of Super-Efficiency Data Envelopment Analysis Models. *Information Systems and Operational Research*, 37(2), 174-187.
- Tarım ve Orman Bakanlığı. (2023, 9 15). İstatistikler: <https://www.tarimorman.gov.tr/Konular/Bitkisel-Uretim/Organik-Tarim/Istatistikler>
- Uruk, E., & Yenilmez, F. (2018). Türkiye'de Organik Hayvancılık İçerisinde Organik Tavukçuluğun Yeri. *Çukurova Tarım Gıda Bil. Der.*, 33(2), 33-98.

HEAVY METAL RESISTANCE OF MULTIDRUG RESISTANT *Staphylococcus aureus* ISOLATED FROM MEAT

Fatma Özdemir¹, Seza Arslan¹

¹ Bolu Abant İzzet Baysal University, Faculty of Arts and Sciences, Department of Biology,
14030 Gölköy / Bolu, Turkey

Corresponding author e-mail: ozkardes_f@ibu.edu.tr

ABSTRACT

Staphylococcus aureus is widespread in the environment. It is an opportunistic pathogen that causes a wide variety of infections in humans and animals, resulting in severe morbidity and mortality. *S. aureus* found in food, including meat and meat products, is the common cause of foodborne diseases, which are important public health issues. Various virulence factors, antimicrobial and heavy metal resistance play important roles in expressing the pathogenicity of *S. aureus*. The emergence and dissemination of antimicrobial and heavy metal resistance in foodborne pathogens such as *S. aureus* pose a potential threat to human and animal health as well as environmental pollution. Besides, the use and presence of heavy metals in food, agriculture, and animal farming might promote the development and spread of antimicrobial resistance through co-selection. This study aimed to evaluate the resistance of heavy metals among multidrug-resistant (MDR) *S. aureus* isolates from ground beef and chicken meat. The minimum inhibitory concentration (MIC) of six heavy metals was determined by using the broth microdilution method. MDR *S. aureus* isolates were resistant to chromium (Cr), copper (Cu), mercury (Hg), and zinc (Zn) in 81.8%, 72.7%, 54.5%, and 27.3%, respectively. However, resistance to lead (Pb) and cadmium (Cd) was not observed. The findings regarding heavy metal resistance among the MDR *S. aureus* isolates could be useful in assessing consumer health and food safety risks.

Keywords: *Staphylococcus aureus*, heavy metal resistance, multidrug resistance, meat, broth microdilution test

INTRODUCTION

Staphylococcus aureus is the most significant species in the genus *Staphylococcus*. *S. aureus* is a Gram-positive coccus that appears as grape-like clusters under the microscope, is a facultative anaerobe, is non-motile, and produces golden yellow colonies. *S. aureus* is extensively found in the environment and is also present on the skin and in the nasal regions of humans and animals (Bhunia, 2008; Becker and von Eiff, 2011). It can cause a wide range of illnesses, including skin and soft tissue infections, pneumonia, acute endocarditis, meningitis, toxic shock syndrome, osteomyelitis, impetigo, urinary tract infections, mastitis, and food poisoning (Götz et al., 2006).

Staphylococcal food poisoning is one of the most prevalent types of foodborne diseases and is caused by consuming foods contaminated with *S. aureus* toxins (Bhunia, 2008). *S. aureus* has frequently been isolated from a wide range of foods of animal origin, including meat and meat products (Jackson et al. 2013; Wu et al. 2018; Kim et al., 2020), and milk and milk products (Jorgensen et al., 2005; Papadopoulos et al., 2019).

Various virulence factors, antimicrobial and heavy metal resistance play important roles in expressing the pathogenicity of *S. aureus* (Götz et al., 2006; Bhunia, 2008; Becker and von Eiff, 2011). Antimicrobial resistance is an increasingly serious public health and development

threat. The overuse or improper use of antimicrobial agents in veterinary and human medicine, agriculture and farming, and the husbandry of livestock helps the emergence and development of resistance to antimicrobials (Ibrahim et al., 2020; Guo et al., 2020).

Foods of animal origin can be a significant vehicle for the transmission of resistant bacteria to humans. *S. aureus* is infamous for its ability to become resistant to antimicrobial drugs. They have evolved several resistance mechanisms, both chromosomal DNA and plasmid DNA, to almost all antimicrobials used in the treatment of infections (Jensen and Lyon, 2009; Mlynarczyk-Bonikowska et al., 2022). Increasing numbers of investigations have revealed that *S. aureus* has developed drug resistance and evolved from single drug-resistant to multidrug-resistant (MDR), making antibiotic resistance control increasingly difficult (Gomes and Henriques, 2016; Guo et al., 2020; Mlynarczyk-Bonikowska et al., 2022).

In addition to increasing antimicrobial resistance, heavy metal resistance has become one of the most important environmental pollution problems in developing countries with increasing industrialization activities (He et al., 2016; Dahanayake et al., 2019). Bacteria are known to be exposed to heavy metals in the environment because of mine wastes, wastewater, agricultural wastes, and pollutants from industry (Hu et al., 2016; Vats et al., 2022). High prevalence of heavy metal resistance among various pathogenic bacteria, including *S. aureus* isolated from livestock production systems (Dweba et al., 2019), *Escherichia coli* from chicken, cattle, and sheep (Cufaoglu et al., 2022), and *Vibrio parahaemolyticus* from crustaceans and shellfish (Hu et al., 2016), have been reported.

Heavy metals are naturally occurring environmental chemicals that can induce the spread of antimicrobial resistance (Anedda et al., 2023). Metals can usually be classified as essential or non-essential. Essential metals that are implicated in the fundamental metabolic processes of microorganisms include chromium (Cr), calcium (Ca), sodium (Na), potassium (K), iron (Fe), zinc (Zn), copper (Cu), magnesium (Mg), nickel (Ni), cobalt (Co), and manganese (Mn) (Vats et al., 2022; Anedda et al., 2023). Other metals, including mercury (Hg), lead (Pb), cadmium (Cd), silver (Ag), gold (Au), antimony (Sb), arsenic (As), and aluminium (Al) do not play a critical role in biological processes and are thus classified as "nonessential metals." As a result, they are highly hazardous to microorganisms and are used as broad-spectrum antimicrobials. Toxicity is strongly dependent on the environmental conditions of the cells, such as pH, redox potential, and organic matter concentration, because these factors influence the bioavailability and of valency metals (Seiler and Berendonk, 2012; Vats et al., 2022).

Heavy metals such as Zn, Cu, Fe, Mn, and Co are also extensively used in animal production enhancers as feed additives (Yang et al., 2020). Zn and Cu are the most abundant metals in animal feed because they are often utilized as growth promoters (Yazdankhah et al., 2014; Vats et al., 2022). Hg, Pb, As, and Cd can be found as contaminants in animal feed. However, the use of heavy metals in high amounts causes problems in the food chain due to their toxicity, bioaccumulation, and biomagnification (Seiler and Berendonk, 2012).

It is possible for these toxic metals to enter the human body because of heavy metal contamination of foods, including meats. The risk of heavy metals contaminating foods is increasing day by day, and they are taking place in foods more and more every day. Furthermore, heavy metals can induce and sustain antimicrobial resistance in bacteria isolated from food. The prevalence of heavy metal pollutants in the environment poses increasing risks to both food safety and human health (Seiler and Berendonk, 2012; Vats et al., 2022). Therefore, this study aimed to evaluate the resistance of heavy metals among multidrug-resistant (MDR) *S. aureus* isolates from ground beef and chicken meat. The minimum inhibitory concentration (MIC) of six heavy metals was determined by using the broth microdilution method.

MATERIALS AND METHODS

Bacterial isolates

This study used eleven multidrug-resistant (MDR) *S. aureus* isolates from ground beef consisting of cow's meat (n = 7) and chicken meat consisting of breast and leg parts (n = 4). All isolates were recovered from retail meat samples in Bolu (Northwest Turkey) from several public bazaars, supermarkets, and butchers. Biochemical assays and a PCR for the species-specific fragment (Sa442) and thermonuclease gene (*nucA*) were used to identify the isolates previously (Brakstad et al., 1992; Martineau et al., 1998; Götz et al., 2006; Becker and von Eiff, 2011). All *S. aureus* isolates obtained from retail meats were grown overnight in Brain Heart Infusion broth (BHI) (Merck, Germany).

Determination of heavy metal resistance among MDR *S. aureus* isolates

The heavy metal resistance of MDR *S. aureus* isolates was investigated using six heavy metals, including mercury (HgCl_2), cadmium ($\text{Cd}(\text{NO}_3)_2$), lead ($\text{Pb}(\text{NO}_3)_2$), copper (CuCl_2), chromium ($\text{Cr}(\text{NO}_3)_2$), and zinc (ZnCl_2). All heavy metals were purchased from Sigma-Aldrich (Sinopharm Chemical Reagent Co., Shanghai, China). The minimum inhibitory concentrations (MICs) of heavy metals against the isolates were measured quantitatively in 96-well microplates using the broth microdilution method as previously described (CLSI, 2012; He et al., 2016; Dahanayake et al., 2019). Heavy metal concentrations ranged from 3200 to 62.5 $\mu\text{g/mL}$ for Cr, Cu, Cd, Pb, and Zn, whereas Hg concentration ranged from 400 to 0.78 $\mu\text{g/mL}$. MICs were defined as the lowest concentration of heavy metal that completely inhibited the growth of the organism after 18-20 hours of incubation at 37 °C. The tests were carried out in triplicates. *Escherichia coli* K-12 strain was used as a quality control in the heavy metal resistance test (Dahanayake et al., 2019).

RESULTS AND DISCUSSION

In this study, multidrug-resistant (MDR) *S. aureus* isolates from ground beef and chicken meat were examined for resistance to heavy metals, including chromium (Cr), copper (Cu), cadmium (Cd), mercury (Hg), lead (Pb), and zinc (Zn). As illustrated in Table 1, a maximum MIC of 3200 $\mu\text{g/mL}$ for cadmium and zinc, 1600 $\mu\text{g/mL}$ for copper, and 12.5 $\mu\text{g/mL}$ for mercury were found when compared to the control strain *E. coli* K12. MDR *S. aureus* isolates were resistant to Cr, Cu, Hg, and Zn in 81.8%, 72.7%, 54.5%, and 27.3%, respectively. However, resistance to Pb and Cd was not observed (Table 1).

Most of the *S. aureus* isolates showed resistance to Cr (81.8%) and Cu (72.7%) in the current study. *Vibrio parahaemolyticus* isolates were resistant to Cr (100%) and Cu (93.3%) in a study published by He et al. (2016). Compared to our Hg findings, Dahanayake et al. (2019) observed no Hg resistance in *Aeromonas* spp. isolated from Manila Clam, the most popular food in Korea.

In contrast to our Pb and Cd results, resistance rates of *S. aureus* from ready-to-slaughter horses in Nigeria against the various heavy metals ranged from moderate to high, with 39.4%, 50.7%, 49.3%, and 60.6% of the isolates resistant to Cd, Cu, Pb, and Zn, respectively (Nwobi et al., 2023). This is consistent with the report of Adekanmbi and Falodun (2015) that *S. aureus* isolated from abattoirs in Nigeria showed high resistance to heavy metals including Cu, Pb, Cd, Zn, Cr, and Ni.

Table 1. Heavy metal resistance of multidrug-resistant *S. aureus* isolates from meat

Heavy metal	MIC ($\mu\text{g/mL}$)													Resistant isolates	
	0.78	1.56	3.125	6.25	12.5	25	50	100	200	400	800	1600	3200	No.	%
Chromium (Cr)												MIC ^a 2	9	9	81.8
Copper (Cu)											MIC ^a 3	8		8	72.7
Mercury (Hg)			1	MIC ^a 4	6									6	54.5
Zinc (Zn)								1			MIC ^a 7		3	3	27.3
Cadmium (Cd)							8	3			MIC ^a			0	0
Lead (Pb)								1	6		MIC ^a 4			0	0

^a MIC, minimum inhibitory concentration of the quality control strain *E. coli* K-12

In this study, MDR *S. aureus* isolates originated from ground beef and chicken meat samples showed similar resistance to chromium and mercury (Figure 1). Copper resistance was found in 100% of the isolates from ground beef, but only 25% of the isolates from chicken meat. Furthermore, resistance to zinc was 75% in the isolates from chicken meat, while no resistance was detected in the isolates from ground beef.

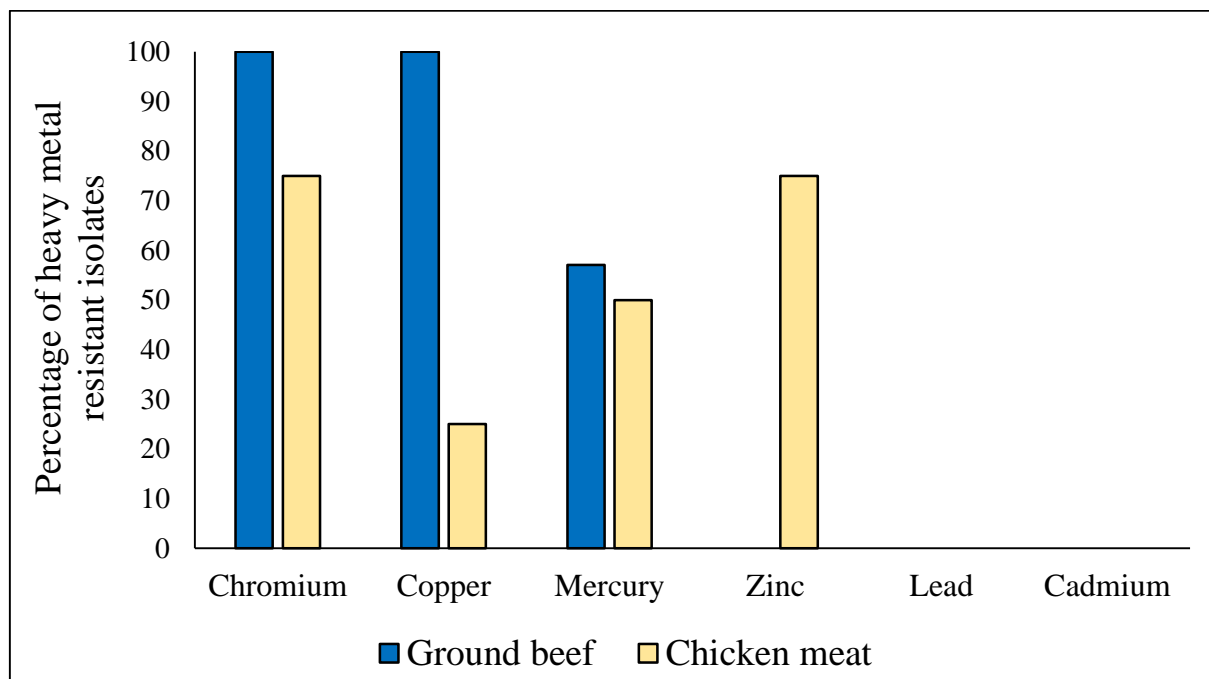

Figure 1. Prevalence of resistance to heavy metals among multi-drug resistant *S. aureus* isolates recovered from ground beef and chicken meat

Zinc has been extensively used in cattle and poultry breeding as a feed additive that helps promote growth and protect animal health (Seiler and Berendonk, 2012). In the present study, the MICs of Zn for the MDR *S. aureus* isolates from ground beef were 800 $\mu\text{g}/\text{mL}$, while the MICs of Zn for the MDR isolates from chicken meat ranged from 200 to 3200 $\mu\text{g}/\text{mL}$. Yang et al. (2020) reported that *E. coli* and *Salmonella* strains from chicken farms and retail meat had the highest MIC was 1600 $\mu\text{g}/\text{mL}$.

None of the MDR *S. aureus* isolates from ground beef and chicken showed resistance to either lead (Pb) or cadmium (Cd) (Figure 1). In agreement with our results, no resistance to lead in *E. coli* isolates from chicken, cattle, and sheep (Cufaoglu et al., 2022). Gufe et al. (2022) documented lead resistance rates among the isolated bacteria, including *Staphylococcus* from Nile tilapia, ranging from 30.8 to 69.2%

Moreover, the results of this study indicated five different heavy metal resistance patterns among the MDR *S. aureus* isolates (Table 2). Four (36.4%) isolates showed Cr, Cu, Hg and four (36.4%) isolates showed Cr, Cu combination patterns. Only one isolate had the Zn pattern. In addition, 45.5% of the isolates were resistant to at least three heavy metals.

Table 2. Resistance patterns of the six heavy metals tested for the MDR *S. aureus* isolated from meat

Resistance pattern	No. of heavy metals	No. (%) of resistant MDR <i>S. aureus</i> isolates
Cr, Cu, Hg	3	4 (36.4%)
Cr, Zn, Hg	3	1 (9.1%)
Cr, Cu	2	4 (36.4%)
Hg, Zn	2	1 (9.1%)
Zn	1	1 (9.1%)

CONCLUSIONS

S. aureus is a significant opportunistic human pathogen and can cause difficult-to-treat severe infections because of its great ability to develop antimicrobial resistance and the emergence of multidrug-resistant strains. This study demonstrated that multidrug-resistant (MDR) *S. aureus* isolates recovered from meats were resistant to heavy metals including mercury, chromium, copper, and zinc. As a result, the presence of heavy metal resistance among the MDR *S. aureus* meat isolates may pose potential risks to human health and food safety.

REFERENCES

- Adekanmbi, A.O., Falodun, O.I. 2015. Heavy metals and antibiotics susceptibility profiles of *Staphylococcus aureus* isolated from several points receiving daily input from the Bodija Abattoir in Ibadan, Oyo State, Nigeria. *Advances in Microbiology*. 5: 871-880.
- Anedda, E., Farrell, M. L., Morris, D., Burgess, C.M. 2023. Evaluating the impact of heavy metals on antimicrobial resistance in the primary food production environment: A scoping review. *Environmental Pollution*. 320: 121035.
- Becker, K., von, Eiff C. 2011. *Staphylococcus, Micrococcus*, and other catalase-positive cocci. In: *Manual of Clinical Microbiology*. Editors: J. Versalovic, K.C. Carroll, g. Funke, J.H. Jorgensen, M.L. Landry, D.W. Warnock. ASM Press, USA. 308-330.
- Bhunia, A.K. (2008). *Foodborne Microbial Pathogens: Mechanisms and Pathogenesis*. New York: Springer.
- Brakstad, O.G., Aasbakk, K., Maeland, J.A. 1992. Detection of *Staphylococcus aureus* by polymerase chain reaction amplification of the *nuc* gene. *Journal of Clinical Microbiology*. 30: 1654-1660.
- Clinical and Laboratory Standards Institute (CLSI). 2012. "Methods for dilution antimicrobial susceptibility tests for bacteria that grow aerobically-Ninth Edition, Approved standard," M7-A9. Wayne, PA, USA.
- Cufaoglu, G., Cengiz, G., Acar, B.O., Yesilkaya, B., Ayaz, N.D., Levent, G., Goncuoglu, M. 2022. Antibiotic, heavy metal, and disinfectant resistance in chicken, cattle, and sheep origin *E. coli* and whole-genome sequencing analysis of a multidrug-resistant *E. coli* O100:H25 strain. *Journal of Food Safety*. 42: e12995.
- Dahanayake, P.S., Hossain, S., Wickramanayake, M.V.K.S., Heo, G-J. 2019. Antibiotic and heavy metal resistance genes in *Aeromonas* spp. isolated from marketed Manila Clam (*Ruditapes philippinarum*) in Korea. *Journal of Applied Microbiology* 127: 941-952.
- Gomes, F., Henriques, M. 2016. Control of bovine mastitis: old and recent therapeutic approaches. *Current Microbiology*. 72: 377-382.

- Götz, F., Bannerman, T., Schleifer, K.H. 2006. The genera *Staphylococcus* and *Micrococcus*. In: The Prokaryotes. Editors: M. Dworkin, S. Falkow, E. Rosenberg, K.H. Schleifer, E. Stackebrandt, Springer: USA. 5-75.
- Guo, Y., Song, G., Sun, M., Wang, J., Wang, Y. 2020. Prevalence and Therapies of Antibiotic-Resistance in *Staphylococcus aureus*. *Frontiers in Cellular and Infection Microbiology*. 10: 107.
- Gufe, C., Karembera, B., Marumurei J., Makuvara, Z. 2022. Lead, silver nitrate and antibiotic resistance in bacteria isolated from Nile tilapia (*Oreochromis niloticus*) in anthropogenically polluted Lake Chivero, Zimbabwe *Cogent Food & Agriculture*. 8: 2082040.
- Ibrahim, M., Ahmad, F., Yaqub, B., Ramzan, A., Imran, A., Afzaal, M., Mirza, S.A., Mazhar, I., Younus, M., Akram, Q., Taseer, M.S.A., Ahmad, A., Ahmed, S. 2020. Current trends of antimicrobials used in food animals and aquaculture. In *Antibiotics and Antimicrobial Resistance Genes in the Environment*, Elsevier, pp. 36-69.
- Jackson, C.R., Davis, J.A., Barret, J.B. 2013. Prevalence and characterization of methicillin-resistant *Staphylococcus aureus* isolates from retail meat and humans in Georgia. *Journal of Clinical Microbiology*. 51: 1199-1207.
- Jensen, S.O., Lyon, B.R. 2009. Genetics of antimicrobial resistance in *Staphylococcus aureus*. *Future Microbiology*. 4: 565-582.
- Jorgensen, H.J., Mork, T., Hogasen, H.R., Rorvik LM. 2005. Enterotoxigenic *Staphylococcus aureus* in bulk milk in Norway. *Journal of Applied Microbiology*. 99(1): 158-166.
- Kim, Y.H., Kim, H.S., Kim, S., Kim, M., Kwak, H.S. 2020. Prevalence and characteristics of antimicrobial resistant *Staphylococcus aureus* and methicillin resistant *Staphylococcus aureus* from retail meat in Korea. *Food Science of Animal Resources*. 40: 758-771.
- Martineau, F., Picard, F.J., Roy, P.H., Quелlette, M., Bergeron, M.G. 1998. Species-specific and ubiquitous-DNA-based assays for rapid identification of *Staphylococcus aureus*. *Journal of Clinical Microbiology*. 36: 618-623.
- Mlynarczyk-Bonikowska, B., Kowalewski, C., Krolak-Ulinska, A., Marusza, W. 2022. Molecular Mechanisms of Drug Resistance in *Staphylococcus aureus*. *International Journal of Molecular Sciences*. 23: 8088.
- Nwobi, O.C., Anyanwu, M.U., Jaja, I.F., Nwankwo, I.O., Okolo, C.C., Nwobi, C.A., Ezenduka, E.V., Oguttu, J.W. 2023. *Staphylococcus aureus* in Horses in Nigeria: Occurrence, Antimicrobial, Methicillin and Heavy Metal Resistance and Virulence Potentials. *Antibiotics*. 12: 242.
- Papadopoulos, P., Angelidis, A.S., Papadopoulos, T., Kotzamanidis, C., Zdragas, A., Papa, A., Filioussis, G., Sergelidis, D. 2019. *Staphylococcus aureus* and methicillin-resistant *S. aureus* (MRSA) in bulk tank milk, livestock and dairy-farm personnel in north-central and north-eastern Greece: prevalence, characterization and genetic relatedness. *Food Microbiology*. 84: 103249.
- Seiler, C., Berendonk, T. U. 2012. Heavy metal driven co-selection of antibiotic resistance in soil and water bodies impacted by agriculture and aquaculture. *Frontiers in Microbiology*. 3: 399.
- Vats, P., Kaur, U.J., Rishi, P. 2022. Heavy metal-induced selection and proliferation of antibiotic resistance: A review. *Journal of Applied Microbiology*. 132: 4058-4076.
- Wu, S., Huang, J., Wu, Q., Zhang, J., Zhang, F., Yang, X., Wu, H., Zeng, H., Chen, M., Ding, Y., Wang, J., Lei, T., Zhang, S., Xue, L. 2018. *Staphylococcus aureus* isolated from retail meat and meat products in China: incidence, antibiotic resistance and genetic diversity. *Frontiers in Microbiology*. 9: 2767.
- Yang, S., Denga, W., Liu, S., Yu, X., Mustafa, G.R., Chen, S., He, L., Ao, X., Yang, Y., Zhou, K., Li, B., Hand, X., Xu, X., Zou, L. 2020. Presence of heavy metal resistance genes in

Escherichia coli and *Salmonella* isolates and analysis of resistance gene structure in *E. coli* E308. Journal of Global Antimicrobial Resistance 21: 420-426.

Yazdankhah, S., Rudi, K., Bernhoft, A. 2014. Zinc and copper in animal feed-development of resistance and co-resistance to antimicrobial agents in bacteria of animal origin. Microbial Ecology in Health & Disease. 25: 25862.

ROOT ROT DISEASES CAUSED BY FUNGAL PATHOGENS IN PEA AND THEIR CONTROL POSSIBILITIES

Mehmet Akif GÜLTEKİN¹, Nuray ÖZER²

¹ Msc. Engineer Republic Of Türkiye Ministry Of Agriculture And Forestry Atatürk Horticultural Central Research Institute

² Prof. Dr. Tekirdağ Namık Kemal University, Faculty of Agriculture, Department of Plant Protection, 59030, Tekirdağ

ABSTRACT

Plant diseases that reduce yield and quality cause serious damage to both the producer and the economy of country. Production is constrained for a number of reasons, including annual yield loss from fungal infections and costs of control. The pea (*Pisum sativum* L.), an important food with regard to nutrients, plays a significant role in our country's agriculture. Some significant fungal pathogens of root rot disease, which were detected in peas, are *Aphanomyces euteiches*, *Fusarium oxysporum* f.sp. pisi, *Fusarium solani* f.sp. pisi, *Rhizoctonia solani* and *Sclerotinia sclerotiorum*. These pathogens infect the pea roots initially, then kill the stem and above-ground tissues by extending through the vascular tissue; as a result of the infection, the pea plants wilt. Significant yield losses ranging from 30% to 57% occur in all pea growing areas, either before or during the flowering stage, as a result of the disease. The use of resistant cultivars combined with cultural control is the most safe, economical and effective method of protecting the pea plant against these disease agents. Within the scope of this review study, the symptoms, short biology, and control strategies of pea root rot pathogens are summarized in light of previous studies carried out by various researchers worldwide.

Keywords: fungal pathogens, root rot, pea, *Pisum sativum*, control

INTRODUCTION

Pea (*Pisum sativum* L.) is a type of vegetable that has a great importance in human nutrition due to its high content of protein and carbohydrate. It is consumed as fresh, canned, or frozen product in our country (Ceyhan et al., 2005). Furthermore, due to nitrogen fixation, which can reduce chemical fertilizer inputs, it is preferred in crop rotations. Türkiye ranks 4th after France, England and Spain among European Union countries, and 12th in the world, with a production amount of 120,455 tons of peas. (Food and Agriculture Organization [FAO], 2021). In our nation, a total of 120,455 tons of fresh peas were cultivated across 124,332 hectares of land in the year 2022, with Bursa leading the production with 42,201 tons (Turkish Statistical Institute [TUIK], 2022).

There are numerous fungal pathogens that contribute to root rot diseases in peas. *Alternaria alternata*, *Aphanomyces euteiches*, *Didymella pinodes*, *Didymella pinodella*, *Fusarium avenaceum*, *Fusarium oxysporum*, *Fusarium redolens*, *Fusarium solani*, *Mycosphaerella pinodes*, *Phytophthora* sp. *Pythium* sp, *Rhizoctonia solani*, *Sclerotinia sclerotiorum* and are among them. These pathogens are capable of inducing root rot diseases either individually or collectively (Kraft and Pflieger, 2001; Xue, 2003; Hossain et al., 2012; Taheri et al., 2017). In our country, the presence of *Fusarium* sp., *Rhizoctonia* sp., and *Pythium* sp. has been identified in the roots of peas cultivated in Samsun province, as well as in diseased plant residues in the

soil. Among these, *Fusarium* spp. was reported to be the most prevalent (Erper et al., 2008). In a study conducted in Hatay province, the most prevalent soil-borne fungal pathogen was identified as *Fusarium oxysporum* f.sp. *pisi* (55.6%). The researchers indicated that other fungal agents contributing to root rot included *Pythium* spp. *Rhizoctonia solani*, *Sclerotinia sclerotiorum* and *Thielaviopsis basicola*, and (Soylu and Derviş, 2011). Within the scope of this review, the symptoms, biology and control of root rot diseases, which are very common in pea production areas and cause great yield losses, are explained in the light of some previous studies.

Pea Root Rot Diseases

Root Rot Disease Caused by *Fusarium solani* f. sp. *pisi* and Control Strategies

As a result of the infection caused by the pathogen, dark black circular lesions with irregular light brown areas are observed on the roots of plants (Figure 1), leading to growth inhibition and eventual plant death (Jung et al., 1999). In susceptible cultivars infected with *Fusarium solani* f.sp. *pisi* (*Fsp*), seeds decay completely (Cook et al., 1968). The pathogen is a soil and seed-borne pathogen that lives in the soil as mycelium and chlamidospores. In seedling or other growing stages, the pathogen enters the plant directly from the epidermal tissue along the epicotyl, hypocotyl, taproot (Kraft and Pflieger 2001), or the root elongation region (Gunawardena et al., 2005). It can also enter through the stoma in the leaves, although this is a less common occurrence compared to direct penetration (Stahl et al., 1994).

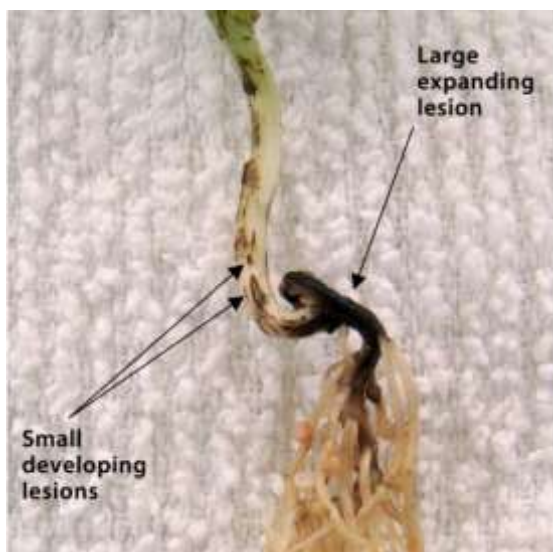

Figure 1. The lesions observed on white epicotyl tissue caused by *Fusarium solani* f. sp. *pisi* of an unknown pea cultivar (Porter et al., 2015).

Cultural practices and biological control agents play a significant role in the management of *Fsp*. In addition to cultural practices such as drainage in the field, rotation, tillage, avoidance of frequent planting, and correct fertilization, weed control before planting are important measures that can be taken to prevent the disease. Cultural practices may decrease the populations of soil-borne pathogens and thus the severity of the root diseases they cause, either directly or indirectly. There have been several important research on the use of specific biological control agents in the management of *Fsp*. Xue (2003), determined that the ACM941 isolate of *Clonostachys rosea* is mycoparasite against *Fsp*. The author reported that seed

germination increased by 44%, growth of seedlings increased by 22% and root rot decreased by 76% after treatment of pea seeds with the ACM941 isolate. According to the same study, using a fungicide with Thiram as the active component increased seed germination by 33%, growth of seedlings by 29%, and root rot incidence by 65%. As a result of the study, it was suggested that *Clonostachys rosea* ACM941 isolate is an effective biological control agent in controlling *Fsp* and may be an alternative to chemical seed treatments. Kapoor et al. (2005) determined that *Trichoderma viride* isolates obtained from soil samples reduced disease development by 80% compared to the control group. In a study conducted by Hamid et al. (2012) under *in vitro* conditions using *Trichoderma harzianum*, *Trichoderma viride*, *Gliocladium virens* and *Pseudomonas fluorescens*, it was recorded that *T. harzianum* inhibited *Fsp* mycelial growth by 78%. The antagonistic fungi *Aspergillus awamori*, *Aspergillus niger*, and *Trichoderma harzianum*, as well as plant growth-promoting rhizobacteria (PGPR) *Bacillus pumilus* and *Pseudomonas putida*, were examined individually or in combination by Akhtar and Azam (2014) in a greenhouse study. They found that *Pseudomonas putida* was more successful in decreasing disease severity compared to *A. niger* and *T. harzianum*.

Root Rot Disease Caused by *Fusarium oxysporum* f. sp. *lisi* and Control Strategies

Fusarium oxysporum f. sp. *lisi* W.C. Snyder and H.N. (*Fop*) is a serious disease that affects peas and causes root rot and wilting in Australia, Algeria, India, Canada, China and the United States (Achari et al., 2020; Merzoug et al., 2014; Deng et al., 2022). Among root rot diseases caused by various fungal pathogens, the disease caused by *Fop* is the most destructive to pea plants. The symptoms observed in the plant generally occur of downward-curling and yellowed leaflets. The plant eventually dies and develops a yellowish-brown color. The pathogen infects pea roots and spreads through vascular tissues, damaging stem and above-ground tissues. When soil temperatures rise beyond 20°C, the disease spread quickly. Under these conditions, wilting symptoms can become severe, and these symptoms may appear during or before pod period. The soil-borne pathogen can remain viable in the soil for more than 10 years as chlamydospore (Kraft, 1994). Under these circumstances, when the pathogen obtains sufficient inoculum and a susceptible variety is planted, serious crop losses occur. Currently, the accepted races of *Fop* include races 1, 2, 5, and 6 (Neumann and AG Xue, 2003). Races 1 and 2 are widespread globally, while races 5 (Figure 2) and 6 have been reported in Algeria, Australia, Canada, China, India and the United States (Achari et al., 2020; Deng et al., 2022).



Figure 2. The response of various pea cultivars to *Fusarium oxysporum* f. sp. *lisi* race 5 isolate PF22b (Deng et al., 2022)

The use of clean, healthy seeds, rotation, and early sowing before the soil temperature is most suitable for fungal growth in are cultural practices that can be taken in terms of disease control. It can be difficult to manage the wilting that *Fop* causes in peas, and no single control strategy is completely successful on its own. Considering the damage and survivability of the fungus, the use of biological control agents and resistant pea varieties is considered an effective control method. The most effective and practical method of disease management worldwide is the use of resistant cultivars (Sakoda et al., 2019). Due to the significant role of using resistant varieties in disease management, pea breeders are making intensive efforts to develop varieties resistant to *Fop* races. Regarding the chemical control of the pathogen, Hannan et al. (2014) conducted a study in Pakistan against *Fop* disease during the years 2012-2013. They applied different active ingredients (Mancozeb, Carbendazim, Copper oxychloride, Metalaxyl + Mancozeb, Trifloxystrobin + Tebuconazole, Thiophanate methyl, Fosetyl-Al, Difenoconazole) at three different concentrations (400, 600, and 800 ppm) under *in vitro* conditions. In the study, it was found that the active ingredients Fosetyl-Al, Trifloxystrobin + Tebuconazole, Thiophanate methyl, and Difenoconazole provided favorable results compared to the control group. As part of alternative control methods, Ali et al. (2014) reported that Aloe vera plant extract inhibited fungal mycelial growth by 69%, while Lantana camera plant extract inhibited it by 50%. The authors observed that essential oil of *Trachyspermum ammi* inhibited fungal mycelial growth by 80%, and *Azadirachta indica* inhibited it by 77%. However, the study suggests that after testing the effectiveness of these plant extracts under field conditions, they could potentially serve as an alternative method of control to fungicides

Root Rot Disease Caused by *Rhizoctonia* sp. and Control Strategies

Rhizoctonia seedling blight caused by *Rhizoctonia* sp. is one of the significant root rot diseases observed in pea production fields. *Rhizoctonia* sp. has several races, which are referred to as anastomosis groups, and they cause disease in numerous plants. Currently, 14 anastomosis groups of *R. solani* have been identified. In studies related to pea root rot, the majority of isolates have been reported to belong to the AG-4 group of strains (Hwang et al., 2007). Regional source, host diversity, morphology and pathogenicity are all different for these groups.

The disease's visible symptoms above ground involve the damping-off of extremely young pea seedlings (Figure 3). After the emergence of seedlings, *Rhizoctonia* sp. attacks the tip of the hypocotyl (approximately 1-2 cm) before the expansion of leaves (Flentje and Hagedorn, 1964). A dark brown-bronze root rot occurs at the root collar of pea seedlings. The pathogen requires warm weather; when the soil surface temperature exceeds 24-29 °C, significant infection occurs. *Rhizoctonia* seedling blight is generally more serious in these soils, as sandy soils warm up faster. Heavy soil and high humidity are more conducive to the disease compared to dry conditions (Hagedorn, 1991). *Rhizoctonia* sp. maintains its viability as a saprophyte in the soil by producing tiny, brown, spherical sclerotia, especially in hot, humid environments. Under favorable conditions, it germinates by producing hyphae that directly invade roots through wounds or natural openings (Anonymous, 2023).



Figure 3. *Rhizoctonia solani* has caused some areas of pea plants to grow poorly. (Sharma-Poudyal et al., 2015)

Effective management against the pathogen includes the use of clean certified seeds, crop rotation, seed treatment with fungicides, and the cultivation of resistant varieties. Crop rotation with crops known to have low susceptibility to the fungus, such as maize, plays a crucial role in disease management. There is currently no commercially available pea variety that is resistant to the disease. It is necessary to avoid dense and deep planting, excessive fertilization, and mechanical damage to roots and stems. Askar and Rashad (2010) reported in their study on the antifungal activity of ethanol-water extracts obtained from cinnamon, anise, black cumin and clove against *Rhizoctonia solani*, which causes root rot in peas, that the highest antifungal activity was observed with clove extract. In this context, it has been reported that while there were no viable plants in the untreated seeds, 40% of peas treated with clove extract and 48% of those treated with Tolclofos methyl (Rhizolex®) active ingredient maintained their viability. Finally, it has been noted that clove plant extract could have the potential to be used as a seed treatment against *Rhizoctonia solani*. Silva et al. (2012) treated pea seeds with various fungicides containing different active ingredients (Captan, Carbendazim, Carbendazim + Thiram, Iprodione, Iprodione + Thiram, Metalaxyl-M + Fludioxonil, Pencycuron, Procymidone and Tolyfluanid), and then sowed them in soil inoculated with the pathogen. They determined the germination rates. In the control group, the seedling emergence rate was 16%, while applications of fungicides containing Iprodione and Carbendazim + Thiram active ingredients resulted in seedling emergence rates of 82% and 78%, respectively. As a result, the authors have reported that the applications of fungicides containing Iprodione and Carbendazim + Thiram active ingredients would be the most effective seed treatments. Rawat et al. (2014) conducted a study to evaluate the efficacy of *Trichoderma* spp. isolates (Th-14 and Th-21) alone or in combination with the fungicide thiophanate-methyl (Topsin-M®) against *Rhizoctonia* sp. root rot in peas under both *in vitro* and *in vivo* conditions. The authors found that the control of the disease was more effective by combining *Trichoderma* isolates (Th-14 and Th-21) with Topsin-M® as compared to the applications carried out individually. In the study, the survival rate of seedlings infected with *Rhizoctonia solani* was 33%, while it was determined as 100% in the Th-14+Topsin-M® mixture and 87% in the Th-21+Topsin-M® mixture. In conclusion, it was noted that the combination of *Trichoderma* spp. isolates with thiophanate-methyl active ingredient fungicides exhibited a significant impact on the control of root rot caused by *Rhizoctonia* sp.

Root Rot Disease Caused by *Aphanomyces* sp. and Control Strategies

This disease is significant in Australia, Japan, New Zealand, North America, and Northern Europe. Severe crop losses occur in the production areas (Holub et al., 1991). The pathogen can

infect the pea plant at any stage, but the most serious problems occur during the seedling emergence period (Figure 4). Root cortex tissue turns yellow 7-14 days after infection and gradually turns brown (Kraft and Boge 1996). The cortex softens and eventually decays, leaving only thin veins behind. A similar decay also occurs in the lower parts of the stems. Secondary pathogens contribute to the darkening and decay of the affected tissues. Severely affected plants remain stunted and produce a limited number of pods. The pathogen can remain viable in the soil for up to 10 years with its oospores (Malvick et al., 1994). Hyphae produced by secondary zoospores penetrate host tissues. After a cool, rainy spring season, the damage caused by the disease begins to increase during the hot and dry summer season, and the severity of the disease becomes visually apparent in the field (McMurray et al., 2011).



Figure 4. The fungus *Aphanomyces* causes field pea root rot. (Anonymous, 2023).

Aphanomyces root rot disease has been recognized as one of the most damaging root diseases in field peas for nearly a century (Jones and Linford, 1925). However, options for controlling this disease are limited. Completely resistant pea varieties against the disease are not available (Pfender 1984; Allmaras et al., 2003), and in some studies, only partial resistance or susceptibility has been reported (Hamon et al., 2013; Conner et al., 2013). Seed fungicide applications, crop rotation, and biological control are effective in controlling the disease. It has been reported that the fungicide containing the active ingredient hymexazol reduces the severity of root rot and increases yield under field conditions (Kotova et al., 1980). Currently, in Canada, the fungicide containing the active ingredient ethaboxam is the only registered fungicide for the control of *Pythium* root rot, *Phytophthora* spp., and *Aphanomyces* root rot (Wu et al., 2018). However, in our country, there is no registered plant protection product available for this disease. Wakelin et al. (2002) conducted a study on the biological control of pea root rot caused by *Aphanomyces euteiches* using bacteria obtained from New Zealand soils under natural conditions. Out of 704 bacterial isolates, 31 of them completely suppressed the pathogen's mycelial growth. They reported that *Bacillus pumilus*, *B. subtilis*, *B. cereus*, *B. mycoides*, and *Paenibacillus polymyxa* reduced root rot symptoms and oospore formation in pea tissues. *B. mycoides* MW27 has been the most effective bacterial isolate, reducing oospore formation in pea roots by 83%. Hossain et al. (2012) reported that the application of isothiocyanate, a

compound produced by members of the Brassicaceae family, has the potential for controlling *Aphanomyces* root rot under controlled conditions.

Root Rot Disease Caused by *Sclerotinia sclerotiorum* and Control Strategies

This disease causes root rot during the seedling stage and, root, stem, leaf and fruit rot during the pod formation stage (Figure 5). Symptoms initially appear on the root collar and lower leaves close to the soil surface. As the disease progresses, dense cottony-white mycelial layers develop on the root collar or stem (Jain et al., 2013). Symptoms appearing on the branches, leaves, fruits (Figure 5) and stem initially take on a water-soaked appearance and then the tissues become covered with the fungus's white thread-like mycelia (Fuller et al., 1984).



Figure 5. Rotting green peas are characterized by fuzzy mycelium growths and black sclerotia on the pod (Aktaruzzaman et al., 2022).

The pathogen of the disease produces abundant resilient reproductive structures called sclerotia in the infected tissues. If these sclerotia germinate by forming apothecia, infection occurs in the above-ground parts of the plants. The ascospores released from apothecia are transported to the plant by wind. Ascospores can remain viable on leaf surfaces for several weeks and require high humidity. Pea leaves are particularly good sources of nutrients for these pathogens. Secondary infections occur through mycelial growth at points of direct contact between diseased and healthy plant organs (Willets and Wong, 1980).

Currently, there are no varieties resistant to the disease. Firstly, non-infested seeds should be planted. Sensitive varieties should not be planted in fields previously heavily infected or known to have white mold issues. Irrigation should be carried out in the morning to ensure that plant leaves and roots remain dry. Excessive nitrogen fertilization should be avoided, and it should be ensured that the soil has sufficient potassium levels (Tu, 1989). Soil sterilization carried out through chemical, vapor or heat treatments can significantly reduce the presence of sclerotia in

the soil. Due to its saprophytic activity and the ability to survive for extended periods as sclerotia under adverse environmental conditions, controlling white mold caused by *Sclerotinia* is challenging (Nasser et al., 1997). Huang and Erickson (2000) conducted a two-year field study to determine the effects of soil treatments with four mycoparasites and one antagonist on the apothecium formation of *Sclerotinia sclerotiorum* in dry beans and peas. Among the five evaluated fungal species, *Coniothyrium minitans* and *Talaromyces flavus* were found to be the most effective in reducing the sclerotium formation of *Sclerotinia sclerotiorum*. They noted that treatment with *C. minitans* reduced apothecium formation of *S. sclerotiorum* by 90% in peas. Elsheshtawi et al. (2016) conducted a study on the efficacy of Contans® (*Coniothyrium minitans*) in combination with fungicides against *Sclerotinia sclerotiorum*. The results of this study indicated that, when taken separately in comparison to the control group, Contans® and Topsin® (Thiophanate-methyl) both significantly decreased the disease incidence caused by *S. sclerotiorum* by 90% and 95%, respectively. Additionally, the authors discovered that the combination of Contans® and Sumisclex® 50 WP (Procymidone) completely suppressed the white rot disease.

CONCLUSION

One of the primary causes of yield and quality losses observed in peas is root rot diseases. This group of diseases causes symptoms in many plants, spreading through plant tissues and leading to significant economic damages. As known, root rot diseases can be caused by multiple pathogens and are highly prevalent. Among the fungal agents causing root rot in peas, *Fusarium* spp. is the most common. In areas where the pathogen's inoculum is abundant in the soil, significant yield losses occur. The presence of races of *Fop* among *Fusarium* species creates challenges in the control efforts. The presence of *Fop* races among *Fusarium* species causes difficulties in its control. The development of resistant varieties against different races of the pathogen has become essential for its control. The use of resistant varieties and cultural practices should be combined as part of integrated pest management. In the future, to minimize damage caused by root diseases, it is necessary to develop and register varieties that are effective against various root diseases and make them available to growers. Moreover, it is important to conduct relevant studies in our country to determine the agents and prevalence of root rot diseases in pea cultivation and to develop strategies for their control.

REFERENCES

- Anonymous, 2023. Field Pea and Lentil Root Rot Risk, Diagnosis and Resources, <https://www.ndsu.edu/agriculture/ag-hub/ag-topics/crop-production/crops/field-pea/field-pea-and-lentil-root-rot-risk-diagnosis-and> (Erişim Tarihi: 16.02.2020).
- Abawi, G.S., and Widmer, T.L., 2000. Impact of soil health management practices on soilborne pathogens, nematodes and root diseases of vegetable crops, *Applied Soil Ecology*, 15(1), 37-47.
- Achari, S.R., Kaur, J., Dinh, Q., Mann, R., Sawbridge, T., Summerell, B.A., ve Edwards, J. (2020). Phylogenetic relationship between Australian *Fusarium oxysporum* isolates and resolving the species complex using the multispecies coalescent model. *BMC genomics*, 21(1):1-20.
- Akhtar, M.S. and Azam, T., 2014. Effects of PGPR and antagonistic fungi on the growth, enzyme activity and *Fusarium* root-rot of pea, *Archives of Phytopathology and Plant Protection*, 47(2): 138-148.
- Aktaruzzaman, M., Afroz, T., & Kim, B. S. (2022). Post-harvest Green Pea Pod Rot Caused by *Sclerotinia sclerotiorum* in Korea. *Research in Plant Disease*, 28(1), 46-50.

- Ali, M., Jain, K.S., Lal, M., Zuhaib, M., Kumar, S., Srivasta, A.S., 2014. Survey, Media Requirement and Management Of Fusarium Wilt Of Pea, *The Bioscan* 9(3): 1213-1216, 2014.
- Allmaras, R.R., Fritz, V.A., Pflieger, F.L., Copeland, S.M., 2003. Impaired internal drainage and *Aphanomyces euteiches* root rot of pea caused by soil compaction in a fine-textured soil. *Soil Tillage Res* ;70(1):41–52.
- Askar, A.A. and Rashad, Y.M., 2010. Efficacy Of Some Plant Extracts Against *Rhizoctonia Solani* On Pea, *Journal Of Plant Protection Research*. Vol. 50, No. 3.
- Conner, R.L., Chang, K.F., Hwang, S.F., Warkentin, T.D., McRae, K.B., 2013. Assessment of tolerance for reducing yield losses in field pea caused by *Aphanomyces* root rot, *The Canadian Journal of Plant Science* 93(3):473–82.
- Cook, R.J., Ford, E.J., Snyder, W.C., 1968. Mating types, sex, dissemination, and possible sources of clones, of *Hypomyces (Fusarium) solani* f. sp. *pisii* in South Australia, *Australian Journal of Agricultural Research*, 19: 253-259.
- Deng, D., Sun, S., Wu, W., Zong, X., Yang, X., Zhang, X., ve Zhu, Z. (2022). Screening for Pea Germplasms Resistant to Fusarium Wilt Race 5. *Agronomy*, 12(6), 1354.
- Elsheshtawi, M., Elkhaky, M.T., Sayed, S.R., Bahkali, A.H., Mohammed, A., Gambhir, D., Mansour, S.A., Elgorbana, A.M., 2016. İntegrated control of white rot disease on beans caused by *Sclerotinia sclerotiorum* using Contans and reduced fungicides application, *Saudi Journal of Biological Scienceds*. 2017 Feb; 24(2): 405–409.
- Erper, I., Karaca, G. H., ve Ozkoc, I. (2008). Root rot disease incidence and severity on some legume species grown in Samsun and the fungi isolated from roots and soils. *Archives of Phytopathology and Plant Protection*, 41(7), 501-506.
- Food and Agriculture Organization (2021). FAO statistical databases. 20 July 2023. <http://www.fao.org/faostat/en/#data/QC>.
- Flentje, N.T. and Hagedorn, D.J., 1964. *Rhizoctonia* tip blight and stem rot of pea, *Phytopathology* 54; 788-791.
- Fuller, P.A., Steadman, J.R., Coyne, D.P., 1984. Enhancement of white mold avoidance and yield in dry bean by canopy elevation, *HortScience* 19: 78–79.
- Gunawardena, U., Rodriguez, M., Straney, D., Romeo, J.T., VanEtten, H.D., Hawes, M.C., 2005. Tissue-specific localization of pea root infection by *Nectria haematococca*. Mechanisms and consequences, *Plant Physiology*, 137:1363-1374.
- Hagedorn, D.J., 1991. *Handbook of pea diseases*, Page:2-3.
- Hamon, C., Coyne, C.J., McGee, R.J., Lesné, A., Esnault, R., Mangin, P., 2013. QTL metaanalysis provides a comprehensive view of loci controlling partial resistance to *Aphanomyces euteiches* in four sources of resistance in pea. *BMC Plant Biol* 13(1):45.
- Hannan, A., Sahi, S.T., Ahmed, I. and Choudhry, A.A., 2014. Differential Impact of *Fusarium oxysporum* f. sp. *pisii* on resistance source of pea genotypes and its chemical management. *Pakistan J. Phytopathology* 26: 91-96.
- Hamid, A., Bhat, N.A., Sofi, T.A., Bhat, K.A., Asif, M., 2012. Management of root rot of pea (*Pisum sativum* L.) through bioagents. *African Journal Microbiology* 6:7156–7161.
- Holub, E.B., Grau, C.R., Parke, J.L., 1991. Evaluation of the forma specialis concept in *Aphanomyces euteiches*, *Mycological Research* 95: 147–157.
- Hossain, S., Bergkvist, G., Berglund, K., Mårtensson, A., & Persson, P. (2012). *Aphanomyces* pea root rot disease and control with special reference to impact of Brassicaceae cover crops. *Acta Agriculturae Scandinavica, Section B-Soil & Plant Science*, 62(6), 477-487.
- Huang, H. C., Erickson, R. S., & Huang, C. (2000). Soil treatment with fungal agents for control of apothecia of *Sclerotinia sclerotiorum* in bean and pea crops. *Plant Pathol. Bull*, 9, 53-58.

- Hwang, S.F., Gossen, B.D., Conner, R.L., Chang, K.F., Turnbull, G.D., Lopetinsky, K., Howard, R.J., 2007. Management strategies to reduce losses caused by *Rhizoctonia* seedling blight of field pea, *Can. J. Plant Sci.* 87 (1): 145–155.
- Jain, A., Singh, A., Singh, S., & Singh, H. B. (2013). Microbial consortium-induced changes in oxidative stress markers in pea plants challenged with *Sclerotinia sclerotiorum*. *Journal of Plant Growth Regulation*, 32, 388-398.
- Jonah, N., Chemining'wa, G.N., Muthomi, J. W., and S.I. Shibairo. 2012. Effect of *Rhizobium* inoculation and nitrogen fertilizer application on growth, nodulation and yield of two garden pea genotypes. *J Anim Plant Sci*, 15, 2147-2156.
- Jones, F.R., Linford, M.B., 1925. Pea disease survey in Wisconsin Madison: Agricultural Experiment Station of the University of Wisconsin.
- Jung, Y.S., Kim, Y.T., Yoo, S.J., Kim, H.G., 1999. Mycological characteristics of *Fusarium solani* f. sp. *pisi* isolated from pea, ginseng and soybean in Korea, *Plant Pathology Journal* 15, 44-47.
- Kapoor, A. S., Paul, Y. S., & Kottaisamy, K. (2005). Management of root rot/wilt complex disease of pea. Integrated plant disease management. Challenging problems in horticultural and forest pathology, Solan, India, 113-120.
- Kotova, Y. Y., & Tsvetkova, N. A. (1980). Effectiveness of chemical control measures against *Aphanomyces* root rot of peas. *Review of Plant Pathology*, 59(7).
- Kraft, J.M., 1994. *Fusarium* wilt of peas (A review), *Agronomie* 14, 561-7.
- Kraft, J.M. and Boge, W.L., 1996. Identification of characteristics associated with resistance to root rot caused by *Aphanomyces euteiches* in pea. *Plant Disease* 80: 1383–1386.
- Kraft, J.M. and Pflieger, F.L., 2001. *Compendium of Pea Diseases and Pests*. Second, The American Phytopathological Society, St. Paul, MN.
- Malvick, D.K., Percich, J.A., Pflieger, F.L., Givens, J. and William, J.L., 1994. Evaluation of methods for estimating inoculum potential of *Aphanomyces euteiches* in soil, *Plant Disease* 78:361–365.
- McMurray, L.S., Davidson, J.A., Lines, M.D., Leonforte, A. and Salam, M.U., 2011. Combining management and breeding advances to improve field pea (*Pisum sativum* L.) grain yields under changing climatic conditions in south-eastern Australia. *Euphytica*, 180(1), 69-88.
- Merzoug, A., Belabid, L., Youcef-Benkada, M., Benfreha, F., ve Bayaa, B. (2014). Pea *Fusarium* wilt races in western Algeria. *Plant Protection Science*, 50(2), 70-77.
- Nasser, L.C.B. and Hall, R., 1997. Practice and precept in cultural management of bean diseases. *Canadian Journal of Plant Pathology*, 18:176–185.
- Neumann ve AG Xue, S. (2003). Reactions of field pea cultivars to four races of *Fusarium oxysporum* f.sp. *pisi*. *Canadian Journal of Plant Science*, 83(2), 377-379.
- Pfender, W.F., 1984. *Aphanomyces* root rot. In: Hagedorn D, editor. *Compendium of pea diseases*. St. Paul: APS Press; p. 25–8.
- Porter, L. D., Pasche, J. S., Chen, W., & Harveson, R. M. (2015). Isolation, identification, storage, pathogenicity tests, hosts, and geographic range of *Fusarium solani* f. sp. *pisi* causing *Fusarium* root rot of pea. *Plant Health Progress*, 16(3), 136-145.
- Rawat, L., Singh, Y., Kumar, B. and Shulkla, A., 2014. Management of *Rhizoctonia* root rot of pea (*Pisum sativum* L.) by integrated biological and chemical approach. *International Journal of Agricultural Sciences* Volume 10: Issue 1: 108-114.
- Sakoda, T., Komuta, K., ve Fujiwara, Y. (2019). The pathogenic variability among Japanese isolates of *Fusarium oxysporum* f.sp. *pisi* to Japanese commercial pea cultivars. *Res Bull Pl Prot Jpn*, 55, 37-41.

- Sharma-Poudyal, D., Paulitz, T. C., Porter, L. D., & du Toit, L. J. (2015). Characterization and pathogenicity of *Rhizoctonia* and *Rhizoctonia*-like spp. from pea crops in the Columbia basin of Oregon and Washington. *Plant Disease*, 99(5), 604-613.
- Silva, P.P., Freitas, R.A., Nascimento, W.M., 2012. Pea seed treatment for *Rhizoctonia solani* control, *Journal of Seed Science*, v.35, n.1, p.17-20, 2013.
- Sindhu, A., Ramsay, L., Sanderson, L.A., Stonehouse, R., Li, R., Condie, J., Shunmugam, A.S.K., Liu, Y., Jha, A.B., Diapari, M., Burstin, J., Aubert, G., Tar'an, B., Bett, K.E., Warkentin, T.D. and Sharpe, A.G., 2014. Gene-based SNP discovery and genetic mapping in pea, *Theoretical and Applied Genetics*, 127: 1-17.
- Soylu, S., ve Dervis, S. (2011). Determination of prevalence and incidence of fungal disease agents of pea (*Pisum sativum* L.) plants growing in Amik plain of Turkey. *Research on Crops*, 12(2), 588-592.
- Stahl, D.J., Theuerkauf, A., Heitefuss, R., Schäfer, W., 1994. Cutinase of *Nectria haematococca* (*Fusarium solani* f. sp. *lisi*) is not required for fungal virulence or organ specificity on pea, *Molecular Plant-Microbe Interactions*, 7: 713-725.
- Taheri, E. A., Chatterton, S., Foroud, N. A., Gossen, B. D., and McLaren, D. L. (2017). Identification and community dynamics of fungi associated with root, crown, and foot rot of field pea in western Canada. *Eur. J. Plant Pathol.* 147, 489–500.
- Tu, J.C., 1989. Management of white mold of beans in Ontario, *Plant Disease* 73: 281–285.
- Türkiye İstatistik Kurumu (2022). (TÜİK), Bitkisel Üretim İstatistikleri. 18 July 2023. <http://www.tuik.gov.tr/>
- Xue, A.G., 2003. Biological Control of Pathogens Causing Root Rot Complex in Field Pea Using *Clonostachys rosea* Strain ACM941, *The American Phytopathological Society* Vol. 93, No. 3, 2003.
- Wakelin, S., Walter, M., Jaspers, M., Stewart, A., 2002. Biological control of *Aphanomyces euteiches* root-rot of pea with spore-forming bacteria. *Australas Plant Pathol* 2002;31(4):401–7.
- Willems, H.J., & Wong, J.A.L., 1980. The biology of *Sclerotinia sclerotiorum*, *S. trifoliorum* and *S. minor* with emphasis on specific nomenclature. *Botanical Review* 46, 101–65.
- Wu, L., Chang, K.F., Conner, R.L., Strelkov, S., Fredua-Agyeman, R., Hwang, S., Feindel, D., 2018. *Aphanomyces euteiches*: A Threat to Canadian Field Pea Production. *Engineering* 4 (2018) 542–551.

EVALUATION OF SURFACE WATER AND SEDIMENT MICROPLASTICS OF SULTANSUYU DAM LAKE (MALATYA) IN TURKEY

Duygu Özhan TURHAN

Department of Biology, Faculty of Arts and Science, Inonu University, Malatya 44280, Turkey

duygu.turhan@inonu.edu.tr

ABSTRACT

Synthetic components made from organic polymers are called plastics, and those smaller than five millimeters are classified in the Microplastics group. The amount of microplastics in the aquatic ecosystem has increased significantly in recent years. In this study, the concentration, type, size and color of MPs in surface water and sediment in Sultansuyu Dam Lake were investigated. Fibers, in surface water and sediment were the dominant microplastics type. Microplastics concentrations in surface waters are 153.33 at St.1 and 160 par.m⁻³ at St.2. Microplastic concentrations in the sediments are 960 and 1320 par.m⁻² in St.1. at St.2. The most common microplastic sizes in surface waters and sediment were 1-2 mm. The dominant color of the detected microplastics was transparent in surface waters and gray in sediment. Of the two stations, St.2 showed a higher microplastic concentration level.

Keywords: Microplastic, Freshwater, Pollution, Sultansuyu Dam Lake

INTRODUCTION

Plastics are materials made of polymers, consisting of many repeating monomer chains. Today, plastic is used in various fields, including chemistry and materials science. Plastic materials that have been included in our lives in various ways, cause irreversible environmental problems in air, water and soil quality (Akçay et al., 2020). Plastics; naturally, and various anthropogenic effects are transformed into microplastics (Yurtsever, 2019). Microplastics are widely dispersed from soil to water and atmosphere. Microplastics can remain in nature for a long time because of their slow degradation rate and cause serious environmental pollution.

Microplastics can be classified using different approaches. They can be divided into primary and secondary microplastics according to their source. Plastics that are discharged directly into the aquatic environment with effects such as human activities are called primary microplastics. Secondary microplastics are plastic parts formed by breaking down larger plastics and reducing their size (Yang et al., 2022).

Studies in marine and freshwater systems have shown that aquatic fauna can ingest microplastics as they mix them with their prey. In laboratory and field observations, microplastics have also been reported to adsorb organic and inorganic contaminants on their surfaces (Egessa et al., 2020). Because of their ubiquity and morphological characteristics, microplastics threaten the life and development of biota through direct and indirect means, including contact, uptake and digestion. Microplastics also pose potential risks to human health as they can be transmitted along the food chain. For this reason, it is very important to determine the environmental conditions and behaviors of MPs. Freshwater systems have many important features such as drinking water and use in fishing. However, these systems are affected by

various pollutants, including microplastics, due to human activities (Su et al., 2016). The aim of this study is to determine the concentrations, color, and size of surface water and sediment microplastic in Sultansuyu Dam Lake, which is a fresh water source.

MATERIAL AND METHOD

Sultansuyu Dam is a dam built between 1986 and 1992 for irrigation purposes on Sultansuyu in Malatya. Microplastics samples were collected in June 2020. 2 sampling stations were determined in Sultansuyu Dam Lake. Station 1 (St.1) (38°31'33.3"N -38°04'54.4"E, Station 2 (St.2) (38°30'44.0"N-38°04'18.1"E).

Surface water sampling from selected stations was taken by filtering 150 L of water with a steel bucket through steel sieves with 5,000 μm , 1,000, 200 and 91 μm pore sizes (Meng et al., 2020). Samples collected from 1000 μm , 200 μm and 91 μm filters were taken into bottles with ultrapure water and preserved in 4% formaldehyde (Aytan et al., 2020).

Sediment samples were taken from the stations by Ekman. Samples taken were stored in jars. (Aytan et al., 2020).

After the water samples were filtered through a filter (10 μm), 30 mL of 30% hydrogen peroxide was added to each sample. Afterwards, the samples were stored in an oven at 50 °C for 3 days. This process is done to digest organic material. After this process, the samples were filtered with a filter (10 μm) (Aytan et al., 2020).

Samples were transferred to beakers and saturated NaCl solution was added for density separation. The supernatant was filtered with 10 μm filters. The residues on the filter were removed. The organic particles were digested with 30% hydrogen peroxide for 168 hours at room temperature, then filtered through 10 μm filters and oven dried.

Microplastic samples were measured with a microscope. Later, microplastics were classified according to their morphological and physical properties.

RESULT AND DISCUSSION

In recent years, microplastic particles have been extensively found in water systems. This can affect aquatic organisms. Therefore, it is becoming increasingly important to observe microplastics in aquatic systems.

Surface water

As a result of this study, total of 47 microplastics particles, 23 particles at St.1 and 24 particles at St.2, were detected in the surface water of Sultansuyu Dam Lake. Microplastics concentrations in surface waters are 153.33 at St.1 and 160 par.m^{-3} at St.2. In the June 2020 sampling, a total of 54 microplastics were detected in the surface water of Sürgü Dam Lake (Turhan, 2022). Compared to Sürgü Dam Lake, the amount of microplastics in Sultansuyu Dam Lake is less.

Microplastic levels of surface water have been determined in some freshwater systems in Turkey. It was determined as 33000 MP/m³ in Küçükçekmece Lagoon, 233 MP/m³ in Cevdet Dünder Pond and 5.25 MP/m³ in Süreyyabey Dam Lake (Çullu et al., 2021; Erdoğan, 2020; Tavşanoğlu et al., 2021).

These determined microplastics were divided into 4 groups as fibers, films, foams and parts. Among these groups, the dominant microplastic group in surface water was determined as fiber at two sampling stations (Figure 1).

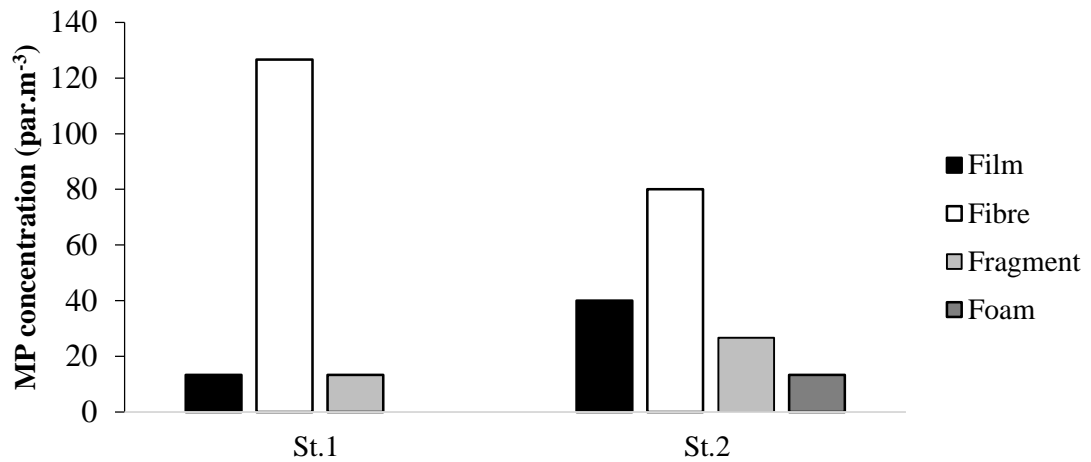

Figure 1. Concentration of microplastics in surface water

It was determined that the microplastics in the surface water consisted of 7 different colors. Among the detected colors, the dominant color was determined as transparent in St.1 and gray in St.2.

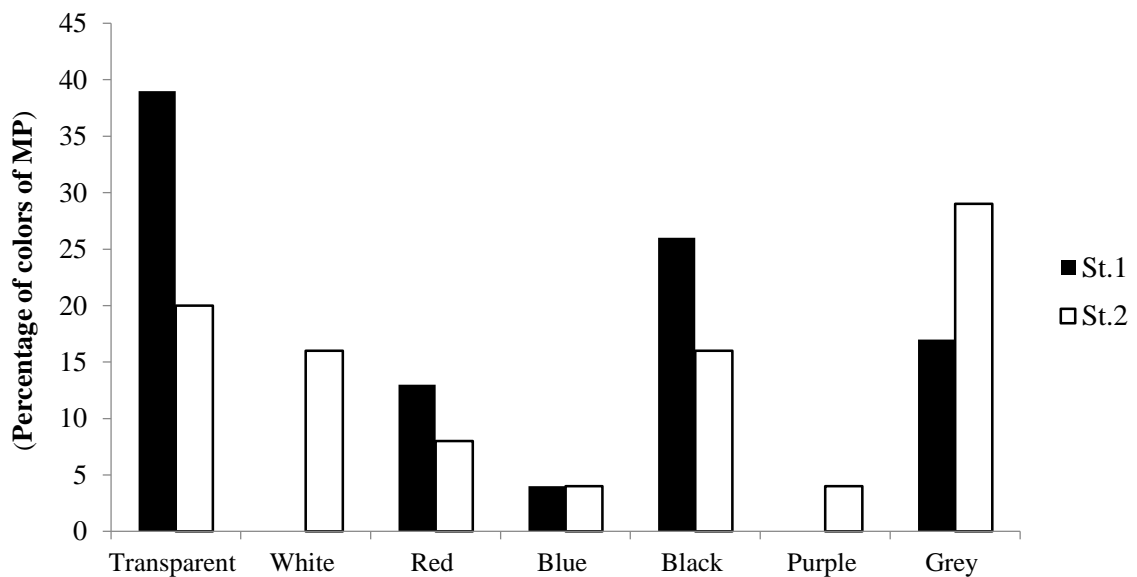

Figure 2. Percentage of colors of MPs in surface water

Microplastics collected from sampling points were classified as <0.2 mm, 0.2-1 mm, 1-2 mm, and 2-5 mm. Microplastics sizes ranged from 0.19 to 4.15 mm. In surface water, microplastics of 1-2 mm size were determined to be more dominant than other sizes at both stations.

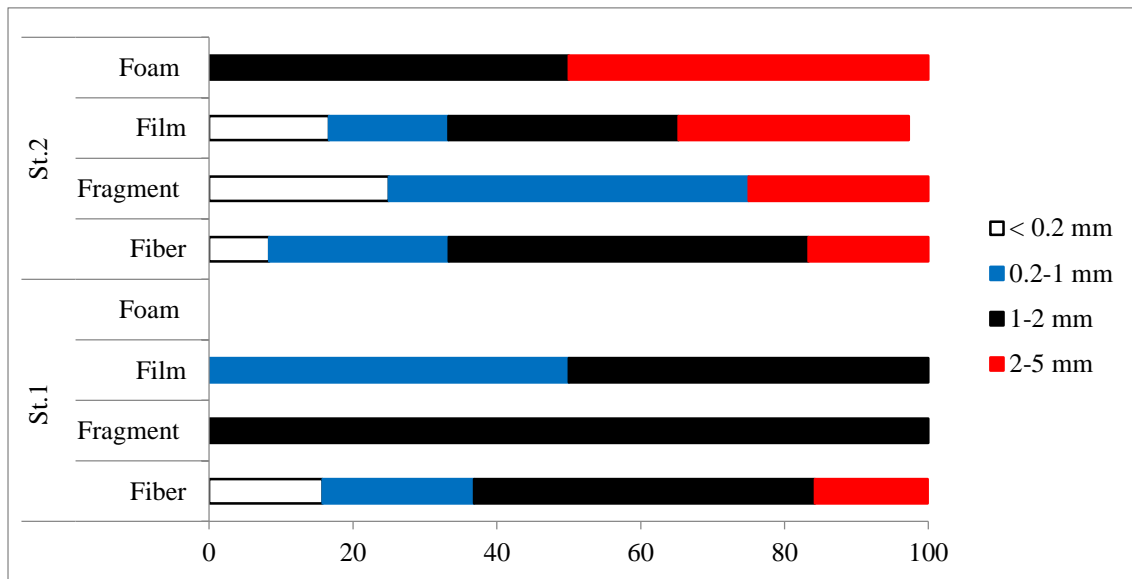

Figure 3. Size composition of microplastics in surface water

Sediment

In this study, total of 58 microplastic particles, 25 particles at St.1 and 33 particles at St.2, were detected in the sediment of Sultansuyu Dam Lake. MP concentrations in the sediments are 960 and 1320 par.m⁻² in St.1. at St. 2. In the June 2020 sampling, a total of 41 microplastics were detected in the sediment of Sürgü Dam Lake (Turhan, 2023). The dominant microplastic group in sediment was determined as fiber at two sampling stations (Figure 4).

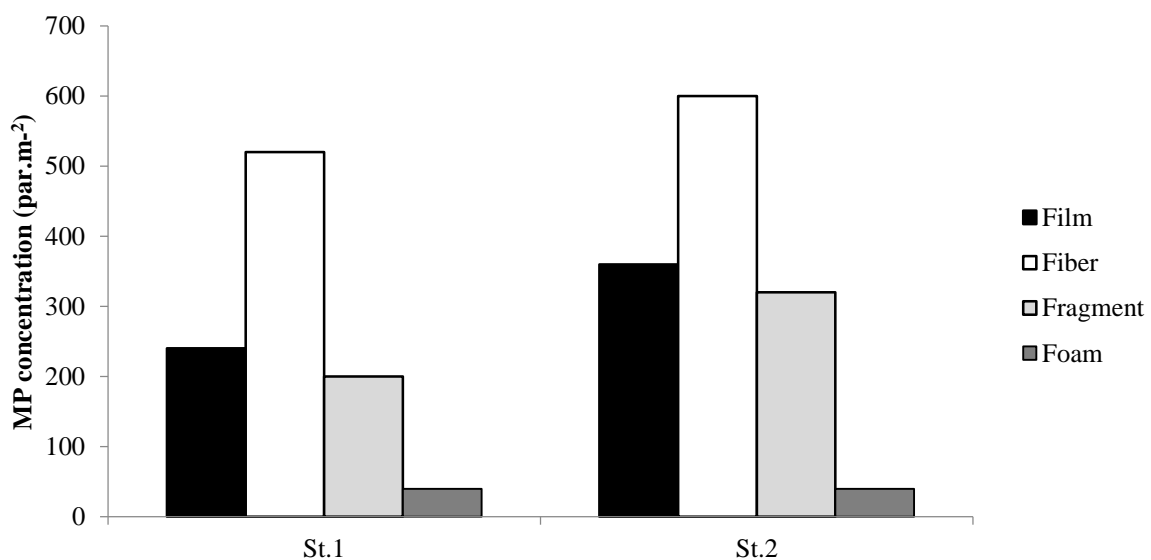

Figure 4. Concentration of microplastics in sediment

It was determined that the microplastics in the sediments consisted of 7 different colors. Among the detected colors, the dominant color was determined as transparent in St.1 and gray in St.2 (Figure 5).

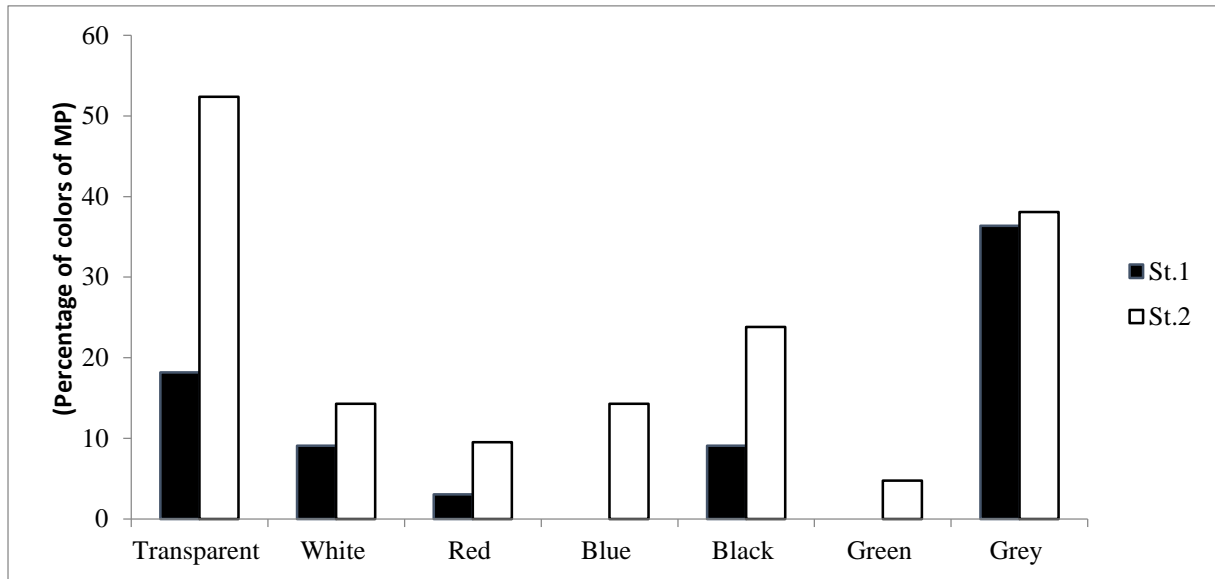

Figure 5. Percentage of colors of microplastics in sediment

Microplastics sizes ranged from 0.1 to 3.98 mm. In sediment, microplastics of 1-2 mm size were determined to be more dominant than other sizes at both stations (Figure 6).

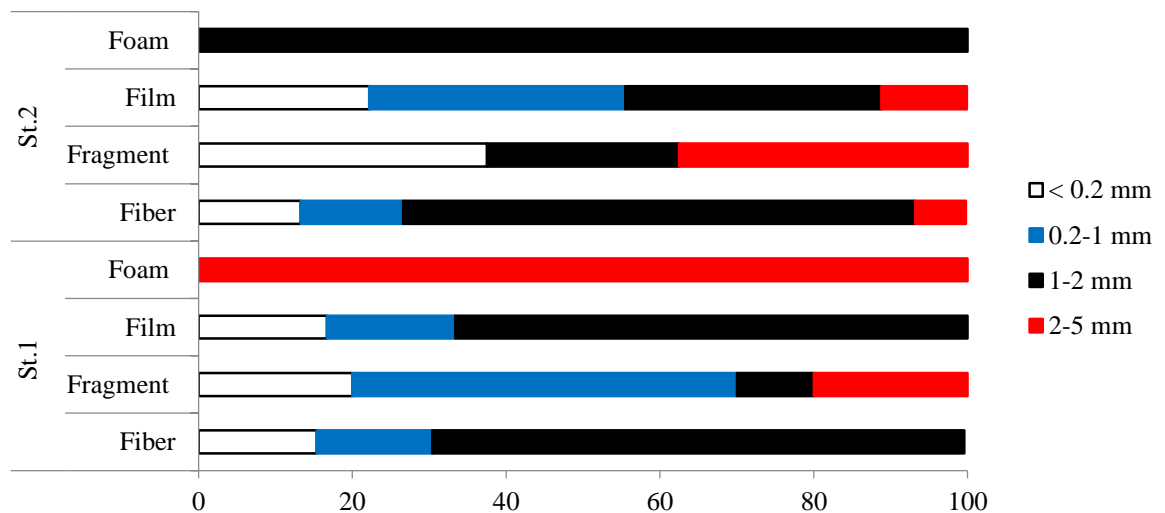

Figure 6. Size composition of microplastics in sediment

CONCLUSIONS

In this research, the concentration, color distribution, and size of microplastics in surface water and sediment of the Sultansuyu Dam Lake were determined. Of the two stations, St.2 showed a higher MP concentration level. Fiber was determined as the dominant microplastic type in surface water and sediment. Microplastics of 1-2 mm in size in surface water and sediment are more dominant than other sizes. Transparent and grey were the predominant colour.

REFERENCES

- Akçay, S., Törnük , F., Hasan Yetim, H. (2020). Mikroplastikler: Gıdalarda Bulunuşu ve Sağlık Üzerine Etkileri, *European Journal of Science and Technology*. 20, 530-538
- Aytan, Ü., Şentürk, Y., F. Esensoy, B., Öztekin, A., Ağırbaş, E., & Valente, A. (2020). Microplastic pollution along the southeastern Black Sea. *Marine Litter in the Black Sea*. Turkish Marine Research Foundation (TUDAV). Publication No: 56, Istanbul, Turkey.361.
- Çullu, A.F., Sönmez, V., & Sivri, N. (2021). Microplastic contamination in surface waters of the Küçükçekmece Lagoon, Marmara Sea (Turkey): Sources and areal distribution. *Environmental Pollution*, 268, 115801
- Egessa, R., Nankabirwa, A., Ocaya, H., Pabire, W.G.(2020). Microplastic pollution in surface water of Lake Victoria. *Science of The Total Environment*. 741, 140201
- Erdoğan, Ş. (2020). Microplastic pollution in freshwater ecosystems: A case study from Turkey. *Ege Journal of Fisheries and Aquatic Sciences*, 37,3, 213-221.
- Meng, Y., Kelly, F.J., & Wright, S.L. (2020). Advances and challenges of microplastic pollution in freshwater ecosystems: A UK perspective. *Environmental Pollution*, 256, 113445.
- Su, L., Xue, Y., Li, L., Yang, D., Kolandhasamy, P., Li, D., Shi, H. (2016). Microplastics in Taihu Lake, China. *Environmental Pollution*. 216, 711-719
- Tavşanoğlu, Ü.N., Kankılıç, G.B., Akca, G., Çırak, T., & Erdoğan, Ş. (2020). Microplastics in a dam lake in Turkey: type, mesh size effect, and bacterial biofilm communities. *Environmental Science and Pollution Research*, 27, 45688-45698.
- Turhan, D.Ö. (2022). Evaluation of Microplastics in the Surface Water, Sediment and Fish of Sürgü Dam Reservoir (Malatya) in Turkey. *Turkish Journal of Fisheries and Aquatic Sciences*, 22(SI), TRJFAS20157
- Yang , S., Zhou, M., Chen, X., Hu, L., Xu, Y., Fu, W., Li, C. (2022). A comparative review of microplastics in lake systems from different countries and regions. *Chemosphere*. 286,2. 131806
- Yurtsever, M. (2019). Nano- ve mikroplastik'lerin insan sağlığı ve ekosistem üzerindeki olası etkileri. *Menba Kastamonu Üniversitesi Su Ürünleri Fakültesi Dergisi*, 5(2), 17-24

ENRICHMENT OF GRAIN LEGUME GENETIC RESOURCES COLLECTION THROUGH BILATERAL PROJECT BETWEEN BULGARIA AND CHINA

Nikolaya VELCHEVA¹, Tsvetelina STOILOVA¹

¹ *Agricultural Academy, Institute of Plant Genetic Resources, Department of Plant Genetic Resources, 2 Druzha Str., 4122 Sadovo, Plovdiv district, Bulgaria*
Corresponding author e-mail: nikolaya_velcheva@abv.bg

ABSTRACT

Conservation of plant genetic resources for food and agriculture is an important goal worldwide from strategically and economically points of view. Almost all the relevant documents on the genetic resources, adopted by international bodies, underline the need of crop conservation, not only for this generation, but most of all, for the future of the humanity. Last decades, more and more old and traditional landraces have been replaced by new and modern varieties. Under these circumstances, a holistic approach for biodiversity conservation by using elements of two strategies: *on farm* and *ex situ* preservation, represents a research priority. Through the implementation of the bilateral cooperation between Bulgaria and China a scientific program on inventory and collection of local plant genetic resources from grain legumes is carried out. According to the work plan the activities are focused on collection of accessions and information from different geographical areas with a view to preserve and sustainable use of the diversity and exchange of experience in characterization and evaluation between the two partners. During the period 2021-2023 seven expeditions with the aim of surveying and inventorying rural areas in South Bulgaria according to the methodology of ECPGR were carried out. As a result, 70 local accessions of bean and cowpea species were collected from diverse agricultural conditions. A database with passport information according to the descriptor of FAO/Bioversity has been created. This research work was carried out with the support of Bulgarian National Science Fund by the project “Enrichment diversity of grain legumes between China and Bulgaria – the introduction and evaluation in correspondence with global climate change” (КП-06-Китай/7/20.11.2020) and the obtained inventory results are applying in the project “Bioactive substances from legumes and medicinal species – features and potential for use in changing climatic conditions” (КП-06-Н56/13/19.11.2021).

Keywords: Local varieties, Collection missions, Rural areas, Descriptor, Documentation.

INTRODUCTION

Global climate change and its impact on the environment pose serious challenges. Actions we take today will affect our future ability to respond and adapt to climate change and reduce its impact on the environment (Ortiz et al., 2021). Based on a number of sources and data, the world population is expected to reach 9.6 billion people by 2050. This means that food production must increase by 70 percent to meet the needs of such a huge population. It is therefore increasingly clear that major reforms in the agricultural sector are needed to ensure that our food system is ready to meet the challenges of a growing world population (Alexandratos and Bruinsma, 2012). Specifically, we need to move our agriculture from the conventional agri-food production system to sustainable agriculture (Khan et al., 2022).

Although most of European agricultural production currently relies on formally registered and genetically uniform cultivars, landraces are still grown *on farm*. However, a European

inventory of landraces is still lacking and, consequently, there is limited and scattered information on where these materials are grown and to which species they belong to (Raggi et al., 2021; 2022). Without knowing where landraces are still present in cultivation and cultivation breadth, the elaboration of adequate conservation plan and their implementation is clearly hindered. In term of use, geographical distribution and pedo-climatic characteristics of involved sites are also of great relevance since landraces, cultivated in diverse environments, can hold different traits for local adaptation and are a rich initial material for the breeding programs. The role of home gardens has been evaluated as a repository of agro biodiversity (Galluzzi et al., 2010; Rocha et al., 2017). Local farmers store specific genetic varieties, known as landraces, within their biological, cultural and socio-economical context (Kehlenbeck et al., 2007; Maxted et al., 2009; Negri et al., 2009).

Conservation of plant genetic resources for food and agriculture is an important goal worldwide from strategically and economically points of view. A holistic approach for biodiversity preservation by using elements of two strategies: *on farm* and *ex situ* store, represents a research priority (CDB, 2011; ITPGRFA, 2009). Germplasm management includes activities as collection of genetic resources, study, documentation, conservation, distribution and use. A positive aspect is implementation of new information technologies with a view of successful maintenance of *ex situ* collections. (ECPGR, 2021).

The geographical latitude, climate and agroecological conditions, as well as the food production of Bulgaria are similar to some of the regions of Northern China (Bachev, 2018). In this context, the exchange of plant genetic resources and associated information between the two countries could assist to achieve the sustainable development common goal and respond to global climate challenges. This is the reason for the successful applicability of the achieved scientific results from joint research projects in the area of plant diversity preservation. Bulgaria provides a solution to developing the agro-food sector because of the following specifics and prerequisites: Unique natural conditions for cultivation of wide diversity of traditional crops; Ecologically clean and fertile soils; Very high quality of organic products (ban on GMOs); Established local producers and a strong tradition in the agricultural sector (Liu, 2017; Kandilarov, 2019).

The aim of the study is to evaluate the development of grain legume plant genetic resources' collection in harmony with the two strategies: *on farm* and *ex situ* conservation through implementation of bilateral project between Bulgaria and China.

MATERIAL AND METHOD

Conservation and sustainable preservation of the plant biodiversity from wild and cultivated flora is the main priority of the IPGR-Sadovo as a National Coordinator in the European Programme for Plant Genetic Resources (ECPGR).

During the period 2021-2023 seven expeditions for surveying and inventorying rural areas in South Bulgaria according to the methodology of Guarino et al. (2011) were carried out. GPS system for latitude, longitude and altitude of the collecting site was used. Ethnobotanic data and other information of interest regarding aspects related to the cultivation, utilization and genetic erosion process were also recorded.

According to the international documentation standard Multi-Crop Passport Descriptor (FAO/Bioversity, 2017) the electronic database contains the following data: catalogue number, taxonomy, accession name, acquisition date, country of origin (FAO code), location of collecting site, geographical coordinates, elevation, collecting date, biological status (traditional variety/landrace), acquisition source (cultivated habitat/local market), donor of the accession, organizer of the collecting mission, type of germplasm storage, etc. The taxonomic description of the crops is under the nomenclature of USDA (GRIN, 2015).

The Bulgarian grain legume collection is published and available with open access in the electronic catalogue on Plant Genetic Resources EURISCO (<http://eurisco.ecpgr.org>).

Collected studies are available based on an electronic database and are a base for creation an *on farm* conservation catalogue of grain legume landraces in Bulgaria according to the Concept of ECPGR (2017).

RESULTS AND DISCUSSION

Status of Phaseolus and Vigna National Inventory in EURISCO

The collection of beans (genus *Phaseolus*) is characterized with one of the largest number of accessions (3,888 acc.), and 47 % from them are with Bulgarian origin (1,837 acc.). The status of Bulgarian *Phaseolus* collection in EURISCO is presented in Table 1.

Table 1. Status of Bulgarian *Phaseolus* collection in EURISCO

Genus	Species	Total number	BGR origin
<i>Phaseolus</i>	<i>acutifolius</i>	31	
<i>Phaseolus</i>	<i>angularis</i>	3	
<i>Phaseolus</i>	<i>angulosus</i>	1	
<i>Phaseolus</i>	<i>aureus</i>	39	
<i>Phaseolus</i>	<i>caffer</i>	3	
<i>Phaseolus</i>	<i>calcaratus</i>	1	
<i>Phaseolus</i>	<i>coccineus</i>	241	139
<i>Phaseolus</i>	<i>calcaratus</i>	1	
<i>Phaseolus</i>	<i>gonospermus</i>	1	
<i>Phaseolus</i>	<i>hysterinus</i>	2	
<i>Phaseolus</i>	<i>lunatus</i>	34	
<i>Phaseolus</i>	<i>multiflorum</i>	5	
<i>Phaseolus</i>	<i>multiflorus</i>	8	
<i>Phaseolus</i>	<i>mungo</i>	7	
<i>Phaseolus</i>	<i>radiatus</i>	8	
<i>Phaseolus</i>	<i>ricciardinus</i>	3	
<i>Phaseolus</i>	<i>semierectus</i>	2	
<i>Phaseolus</i>	<i>trilobus</i>	1	
<i>Phaseolus</i>	<i>vulgaris</i>	3488	1698
<i>Phaseolus</i>	<i>zebra</i>	1	
<i>Phaseolus</i>	<i>sp.</i>	8	
Total number		3888	1837

The collection of cowpea (genus *Vigna*) contains 397 acc., and 40 acc. from them are characterized by Bulgarian origin. The status of Bulgarian *Vigna* collection in EURISCO is presented in Table 2.

Table 2. Status of Bulgarian *Vigna* collection in EURISCO

Genus	Species	Total number	BGR origin
<i>Vigna</i>	<i>catjang</i>	3	
<i>Vigna</i>	<i>mungo</i>	1	
<i>Vigna</i>	<i>radiata</i>	3	
<i>Vigna</i>	<i>sinensis</i>	116	18
<i>Vigna</i>	<i>unguiculata</i>	192	22
<i>Vigna</i>	<i>sp.</i>	82	
Total number		397	40

Enrichment of grain legume collection through the project Bulgaria – China

By the expeditions in Bulgaria through the project between Bulgaria and China the collections are enriched with seed accessions from 51 acc. *Phaseolus vulgaris*, 17 acc. *Phaseolus coccineus* and 2 acc. from *Vigna sp.* Routes for inventory of agricultural areas in South Bulgaria were established using previous results and data in the National Catalogue of Plant Genetic Resources. Accessions from seven areas: Smolyan, Devin, Velingrad, Pazardzhik, Plovdiv, Samokov and Blagoevgrad, including 13 villages were collected.

The bean is one of the most significant crops in the traditional Bulgarian cuisine. With a great value is creation of local beans collection from the mountainous areas in Rhodopes (regions of Smolyan, Devin, Velingrad), which are with the best conditions for growing and the grain legumes are traditional crops with typical dishes. The local populations are local selection and only in the region of collecting these accessions produce seeds with unique traits. This germplasm is one of the best examples where the *on farm* conservation is the most successful practice for its sustainable preservation. In this connection, the information about the specific agro-climatic characteristics of the growing region for further testing and use is very important.

The traditional varieties meet family needs because of the excellent taste quality and biological content. Also, they have economical influence in the mountain areas because they are presented at the local markets as originated food with a very high price.

The analysis of the passport database (Tables 1, 2 and 3) from collecting missions in 2021, 2022 and 2023 shows that expeditions for local grain legumes were carried out in the regions of South Bulgaria, flat, semi-mountainous and mountainous regions with an altitude of 147 to 1185 m. All accessions are collected from small rural and suburban farms or home gardens.

Table 3. Passport data of collected accessions according to the project activities in 2021

N	CAT. N	TAXONOMY	COLLECTING SITE	LATITUDE	LONGITUDE	ELEVATION (m)	SEED DESCRIPTION
1	C1E0014	<i>Phaseolus vulgaris L.</i>	Pavelsko, Smolyan	415200N	244200E	730	medium large, white
2	C1E0015	<i>Phaseolus vulgaris L.</i>	Pavelsko, Smolyan	415200N	244200E	730	medium large, patterned – white and red
3	C1E0016	<i>Phaseolus vulgaris L.</i>	Pavelsko, Smolyan	415200N	244200E	730	medium large, black
4	C1E0017	<i>Phaseolus vulgaris L.</i>	Pavelsko, Smolyan	415200N	244200E	730	medium large, white and black
5	C1E0018	<i>Phaseolus vulgaris L.</i>	Pavelsko, Smolyan	415200N	244200E	730	medium large, brown-black
6	C1E0019	<i>Vigna sp. Savi</i>	Mihalkovo, Smolyan	415200N	244200E	717	small, black

7	C1E0022	<i>Phaseolus vulgaris L.</i>	Mihalkovo, Smolyan	415200N	244200E	717	patterned, white and red
8	C1E0023	<i>Phaseolus vulgaris L.</i>	Mihalkovo, Smolyan	415200N	244200E	717	white
9	C1E0024	<i>Phaseolus coccineus L.</i>	Mihalkovo, Smolyan	415200N	244200E	717	white
10	C1E0025	<i>Phaseolus vulgaris L.</i>	Mihalkovo, Smolyan	415200N	244200E	717	patterned
11	C1E0026	<i>Phaseolus vulgaris L.</i>	Mihalkovo, Smolyan	415200N	244200E	717	beige
12	C1E0027	<i>Phaseolus vulgaris L.</i>	Mihalkovo, Smolyan	415200N	244200E	717	patterned
13	C1E0028	<i>Phaseolus coccineus L.</i>	Mihalkovo, Smolyan	415200N	244200E	717	white
14	C1E0029	<i>Phaseolus coccineus L.</i>	Mihalkovo, Smolyan	415200N	244200E	717	patterned
15	C1E0030	<i>Phaseolus coccineus L.</i>	Mihalkovo, Smolyan	415200N	244200E	717	patterned
16	C1E0031	<i>Phaseolus vulgaris L.</i>	Mihalkovo, Smolyan	415200N	244200E	717	patterned, white and purple
17	C1E0032	<i>Phaseolus vulgaris L.</i>	Mihalkovo, Smolyan	415200N	244200E	717	patterned, brown-black
18	C1E0033	<i>Phaseolus coccineus L.</i>	Mihalkovo, Smolyan	415200N	244200E	717	white
19	C1E0034	<i>Phaseolus vulgaris L.</i>	Mihalkovo, Smolyan	415200N	244200E	717	patterned
20	C1E0035	<i>Phaseolus vulgaris L.</i>	Momchilovtsi, Smolyan	413929N	244633E	1185	white
21	C1E0036	<i>Phaseolus vulgaris L.</i>	Momchilovtsi, Smolyan	413929N	244633E	1185	patterned
22	C1E0037	<i>Phaseolus vulgaris L.</i>	Momchilovtsi, Smolyan	413929N	244633E	1185	patterned
23	C1E0038	<i>Phaseolus vulgaris L.</i>	Momchilovtsi, Smolyan	413929N	244633E	1185	patterned
24	C1E0039	<i>Phaseolus vulgaris L.</i>	Novo selo, Plovdiv	420615N	242906E	196	patterned
25	C1E0040	<i>Phaseolus vulgaris L.</i>	Grohotno, Devin	414121N	242242E	813	white
26	C1E0041	<i>Phaseolus vulgaris L.</i>	Grohotno, Devin	414121N	242242E	813	beige
27	C1E0042	<i>Phaseolus vulgaris L.</i>	Grohotno, Devin	414121N	242242E	813	patterned
28	C1E0043	<i>Phaseolus coccineus L.</i>	Grohotno, Devin	414121N	242242E	813	white, Smilyanski type
29	C1E0044	<i>Phaseolus coccineus L.</i>	Grohotno, Devin	414121N	242242E	813	patterned, Smilyanski type
30	C1E0045	<i>Phaseolus coccineus L.</i>	Grohotno, Devin	414121N	242242E	813	patterned, Smilyanski type
31	C1E0072	<i>Phaseolus vulgaris L.</i>	Raduil, Samokov	421709N	234118E	900	white
32	C1E0073	<i>Phaseolus vulgaris L.</i>	Raduil, Samokov	421709N	234118E	900	patterned
33	C1E0074	<i>Phaseolus coccineus L.</i>	Raduil, Samokov	421709N	234118E	900	white, Smilyanski type
34	C1E0085	<i>Phaseolus vulgaris L.</i>	Raduil, Samokov	421709N	234118E	900	white, flat, Raduilski type
* Data source – National Catalogue of Plant Genetic Resources / IPGR-Sadovo							

Table 4. Passport data of collected accessions according to the project activities in 2022

N	CAT. N	TAXONOMY	COLLECTING SITE	LATITUDE	LONGITUDE	ELEVATION (m)	SEED DESCRIPTION
1	C2E0011	<i>Phaseolus vulgaris</i> L.	Velingrad, Chepino	420139N	235928E	777	beige
2	C2E0012	<i>Phaseolus vulgaris</i> L.	Velingrad, Chepino	420139N	235928E	777	patterned
3	C2E0013	<i>Phaseolus vulgaris</i> L.	Velingrad, Chepino	420139N	235928E	777	brown
4	C2E0014	<i>Phaseolus vulgaris</i> L.	Velingrad, Chepino	420139N	235928E	777	patterned
5	C2E0015	<i>Phaseolus vulgaris</i> L.	Velingrad, Chepino	420139N	235928E	777	light brown
6	C2E0016	<i>Phaseolus vulgaris</i> L.	Velingrad, Chepino	420139N	235928E	777	black
7	C2E0017	<i>Phaseolus vulgaris</i> L.	Velingrad, Chepino	420139N	235928E	777	dark brown
8	C2E0018	<i>Phaseolus vulgaris</i> L.	Velingrad, Chepino	420139N	235928E	777	white with brown
9	C2E0019	<i>Phaseolus vulgaris</i> L.	Velingrad, Chepino	420139N	235928E	777	white
10	C2E0020	<i>Phaseolus vulgaris</i> L.	Velingrad, Chepino	420139N	235928E	777	patterned
11	C2E0021	<i>Phaseolus coccineus</i> L.	Velingrad, Chepino	420139N	235928E	777	white
12	C2E0022	<i>Phaseolus coccineus</i> L.	Velingrad, Chepino	420139N	235928E	777	white
13	C2E0023	<i>Phaseolus coccineus</i> L.	Velingrad, Chepino	420139N	235928E	777	patterned
14	C2E0024	<i>Phaseolus vulgaris</i> L.	Velingrad, Chepino	420139N	235928E	777	light beige
15	C2E0025	<i>Phaseolus vulgaris</i> L.	Velingrad, Chepino	420139N	235928E	777	light beige
16	C2E0026	<i>Phaseolus vulgaris</i> L.	Velingrad, St. Petka	420216N	235228E	1114	medicinal, beige-green
17	C2E0027	<i>Phaseolus vulgaris</i> L.	Fotinovo, Pazardzhik	415257N	242108E	1124	beige
18	C2E0028	<i>Phaseolus vulgaris</i> L.	Fotinovo, Pazardzhik	415257N	242108E	1124	patterned
19	C2E0029	<i>Phaseolus vulgaris</i> L.	Fotinovo, Pazardzhik	415257N	242108E	1124	patterned
20	C2E0030	<i>Phaseolus vulgaris</i> L.	Fotinovo, Pazardzhik	415257N	242108E	1124	patterned
21	C2E0031	<i>Phaseolus vulgaris</i> L.	Fotinovo, Pazardzhik	415257N	242108E	1124	beige with brown
22	C2E0032	<i>Phaseolus vulgaris</i> L.	Fotinovo, Pazardzhik	415257N	242108E	1124	patterned
23	C2E0033	<i>Phaseolus coccineus</i> L.	Fotinovo, Pazardzhik	415257N	242108E	1124	white
24	C2E0034	<i>Phaseolus vulgaris</i> L.	Krichim, Plovdiv	420233N	242752E	253	white
25	C2E0035	<i>Vigna sp. Savi</i>	Rupite, Blagoevgrad	412630N	231430E	147	beige
26	C2E0037	<i>Phaseolus vulgaris</i> L.	Sadovo, Plovdiv	420752N	245557E	156	white

* Data source – National Catalogue of Plant Genetic Resources / IPGR-Sadovo

Table 5. Passport data of collected accessions according to the project activities in 2023

N	CAT. N	TAXONOMY	COLLECTING SITE	LATITUDE	LONGITUDE	ELEVATION (m)	SEED DESCRIPTION
1	C3E0043	<i>Phaseolus vulgaris</i> L.	Mihalkovo, Smolyan	415100N	242600E	717	white
2	C3E0044	<i>Phaseolus vulgaris</i> L.	Mihalkovo, Smolyan	415100N	242600E	717	patterned, beige with brown
3	C3E0045	<i>Phaseolus vulgaris</i> L.	Grohotno, Devin	414121N	242242E	813	brown
4	C3E0046	<i>Phaseolus vulgaris</i> L.	Grohotno, Devin	414121N	242242E	813	white, flat
5	C3E0047	<i>Phaseolus coccineus</i> L.	Grohotno, Devin	414121N	242242E	813	Local name: kitkin
6	C3E0048	<i>Phaseolus coccineus</i> L.	Mogilitza, Smolyan	412944N	243803E	1041	white
7	C3E0049	<i>Phaseolus coccineus</i> L.	Mogilitza, Smolyan	412944N	243803E	1041	white
8	C3E0050	<i>Phaseolus vulgaris</i> L.	Mogilitza, Smolyan	412944N	243803E	1041	white
9	C3E0051	<i>Phaseolus coccineus</i> L.	Arda, Smolyan	412744N	243818E	1003	white
10	C3E0052	<i>Phaseolus vulgaris</i> L.	Arda, Smolyan	412744N	243818E	1003	beige with purple
* Data source – National Catalogue of Plant Genetic Resources / IPGR-Sadovo							

Documentation, dissemination and implementation of the achieved results

Bulgaria and China are countries where there are favorable conditions for the cultivation of a rich variety of species and varieties. Taking into consideration the aging of the population and the depopulation of rural areas, combined with natural disasters such as floods, drought, etc. of an unpredictable nature, the danger of losing the wealth of local varieties and crop wild relatives is substantially high. In 2023 two scientists from the Chinese Academy of Agricultural Sciences visited Institute in Sadovo and took part in the expedition in South Bulgaria. Exchange of descriptors and experience in characterization and evaluation between the two partners was conducted.

In relation with the ECPGR (2017) objective to promote *on farm* conservation and management of European plant diversity, the realization of this project increases the knowledge of grain legume landraces still present in rural regions in Bulgaria, allows also *ex situ* storage and elaboration of data that is of paramount importance for the implementation the preservation plan in Europe. The inclusion of new data in the National Catalogue of Plant Genetic Resources of IPGR-Sadovo increases the value of datasets related to local gene fund. According to already collected data, the collection is describing successful experiences of conservation and sustainable use of plant genetic resources facilitating the definition of good practices for *on farm* management and preservation for increasing the product added value of the crop. Evidences and lessons that are learnt from the development of the project are close relevant for setting-up similar studies on other crops in Bulgaria (cereals, vegetables, etc.). Vegetables and grain legumes are grown in home gardens, and the surplus is exported to the market, in addition to being a subsidiary farm for the household. Old varieties of cereals are maintained for traditional production of area-specific foods related to local customs.

In Bulgaria there are conditions for environmentally sustainable agriculture and production of unique food and beverages by authentic methods. The added value of the activities of home gardens using local resources are socio-economic and environmental benefits for the regions. Organic production is still weak in the country, but the market for organic

products is developing rapidly. The prerequisites for the development of this type of production and the factors motivating farmers in this direction are the rich diversity of natural resources, ecologically preserved areas, the perceived benefits for rural development, the growing demand for healthy food from consumers and the existence of a legal framework. Considering all these positive conditions in Bulgaria and the high economic development of China the partnership is extremely important not only in the field of agricultural science, but also in education and specialization of researchers.

CONCLUSIONS

Based on bilateral partnership IPGR-Sadovo is implementing joint research project with China, focused on conservation of grain legumes. These species are crucial to solve key agriculture-related societal challenges, such as agrobiodiversity conservation, sustainable agriculture, food security and human health.

Expeditions in rural areas of Bulgaria were conducted and 70 local accessions has been collected. Information gathered in the project is useful for *ex situ* back-up of the identified resources for protection and sustainable use.

The study is focused on Inventory of the Bulgarian *on farm* diversity, monitoring and promoting good practices adding value to the crop farm system. Restoration of old varieties in the agricultural practice as well as preservation of traditional knowledge and good practices has attitude to mitigating the effects of the climate change.

Although Bulgaria has gained achievements in collection of local varieties, there are still a large number of unexplored territories rich with landraces which are in danger the plant diversity to be lost.

Exchange of passport descriptor and database with the Chinese partners was carried out. Regarding the access and sustainable use of this valuable source for crop breeding and sustainable agriculture IPGR-Sadovo is open for collaboration in new projects with Chinese research organizations and trainings, focused on documentation and digitalization of plant biodiversity.

ACKNOWLEDGMENTS

This research work was carried out with the support of Bulgarian National Science Fund by the project “Enrichment diversity of grain legumes between China and Bulgaria – the introduction and evaluation in correspondence with global climate change” (KII-06-Китай/7/20.11.2020) and the obtained inventory results are applying in the project “Bioactive substances from legumes and medicinal species – features and potential for use in changing climatic conditions” (KII-06-H56/13/19.11.2021).

REFERENCES

- Alexandratos, N., Bruinsma, J. 2012. World agriculture towards 2030/2050: the 2012 revision. DOI 10.22004/ag.econ.288998.
- Bachev, H. 2018. Comparative Analysis of Governance and Level of Agrarian Sustainability in Bulgaria & China. In: Governing and Assessment of Agrarian Sustainability in Bulgaria & China, Institute of Agricultural Economics, Sofia, ISBN 978-954-8612-12-8.

- CBD. 2011. Nagoya protocol on access to genetic resources and the fair and equitable sharing of benefits arising from their utilization to the Convention on Biological Diversity. United Nations Environmental Programme, <https://www.cbd.int/abs/>.
- ECPGR. 2017. Concept for *on-farm* conservation and management of plant genetic resources for food and agriculture. Rome, IT: European Cooperative Programme for Plant Genetic Resources.
- ECPGR. 2021. Plant Genetic Resources Strategy for Europe. Rome, Italy. https://www.ecpgr.cgiar.org/fileadmin/bioversity/publications/pdfs/PGR_STRATEGY_LP_22_Nov_revised.pdf.
- FAO/Bioversity. 2017. Multi-Crop Passport Descriptors. Rome, Italy, https://www.ecpgr.cgiar.org/fileadmin/templates/ecpgr.org/upload/EURISCO/EURISCO_MCPD2_descriptors_updated_November_2017.pdf
- Galluzzi, G., Eyzaguirre, P., Negri, V. 2010. Home gardens: neglected hotspots of agrobiodiversity and cultural diversity. *Biodiversity and conservation*, 19 (13), 3635-3654, DOI: 10.1007/s10531-010-9919-5.
- GRIN. 2015. Genetic Resources Information Network, Taxonomy for Plants, USDA.
- Guarino, L., Ramanatha, Rao V., Goldberg, E. 2011. Collecting Plant Genetic Diversity: Technical Guidelines – 2011 Update. Bioversity International, Rome, Italy, ISBN 978-92-9043-922-6.
- ITPGRFA. 2009. International Treaty on Plant Genetic Resources for Food and Agriculture. Rome, Italy, <https://www.fao.org/plant-treaty/en/>.
- Kandilarov, E. 2019. Bulgaria External Relations Briefing: Foreign Policy and International Relations of Bulgaria 2019 – Outlook. China – CEE Institute, Weekly Briefing, ISSN: 2560-1601, 14(4), p. 6, <https://china-cee.eu/wp-content/uploads/2019/04/2019er0156-%EF%BC%8815-Bulgaria.pdf>.
- Kehlenbeck, K., Arifin, H. S., Maass, B. L. 2007. Plant diversity in home gardens in a socio-economic and agro-ecological context. In: *Stability of tropical rainforest margins*. Springer, Berlin, Heidelberg. pp. 295-317, DOI: 10.1007/978-3-540-30290-2_15.
- Khan, S. A. K. U., Rahman, M., Islam, M. 2022. Agro-Biodiversity Across the Food Chain. In *Biodiversity, Functional Ecosystems and Sustainable Food Production*. Springer, Cham, p. 1-40, https://doi.org/10.1007/978-3-031-07434-9_1.
- Liu, Z. 2017. The “16+ 1 Cooperation” under the “Belt and Road” initiative. In: *China's Relations with Central and Eastern Europe*. Routledge, 2017. p. 29-47, ISBN 9781315226644.
- Maxted, N., Vetelainen, M., Negri, V. (2009). Landrace inventories: needs and methodologies. in *European Landraces: On-farm Conservation, Management and Use*, eds. M. Vetelainen, V. Negri, and N. Maxted (Rome, IT: Bioversity Technical Bulletin, vol. 15.), 45–52.
- Negri V, Maxted N, Vetelainen M. 2009. European Landrace Conservation: an Introduction. *Bioversity Technical Bulletin*, Bioversity International, Rome, Italy, 15, 1-22.
- Ortiz, A. M. D., Outhwaite, C. L., Dalin, C., Newbold, T. 2021. A review of the interactions between biodiversity, agriculture, climate change, and international trade: research and policy priorities. *One Earth*, 4(1), 88-101. DOI 10.1016/j.oneear.2020.12.008.
- Raggi, L., Caproni, L., and Negri, V. (2021). Landrace added value and accessibility in Europe: what a collection of case studies tells us. *Biodivers. Conserv.* 30, 1031–1048. DOI 10.1007/s10531-021-02130-w.
- Raggi, L., Pacicco, L. C., Caproni, L., Alvarez-mu, C., Barata, A. M., Batir-rusu, D., et al. 2022. Analysis of landrace cultivation in Europe: A means to support in situ conservation of crop diversity. *Biol. Conserv.* 267. DOI 10.1016/j.biocon.2022.109460.

Rocha, F., Gaspar, C., Barata, A. M. 2017. The legacy of collecting missions to the valorization of agro-biodiversity. *Agriculture & Forestry*, 63 (2), 25-38, DOI: 10.17707/AgricultForest.63.2.

EFFECT OF PH-SHIFT TREATMENT AND ULTRASONICATION ON THE PHYSICAL STABILITY AND PROPERTIES OF HEMP SEED MILK

Nour AWAD¹, Mustafa MORTAŞ¹

¹ *Food Engineering Department, Engineering Faculty, Ondokuz Mayıs University, Samsun, Turkey*

Corresponding author; Nour Awad, awadnur5@gmail.com

ABSTRACT

Hemp seed milk is a growing beverage with excellent nutritional content and minimal allergenicity, which offers a tasty substitute for other plant-based milk types. During this research, we investigated the individual and combined impact of pH shift and ultrasound (US) on the stability characteristics of hemp seed milk. The effect of pH shift and US were investigated on the physico-chemical properties of hemp, milk, sedimentation index, rheological properties, color, Brix, physical stability, titratable acidity, and emulsion stability index (ESI) measurements. According to the obtained data, applying individual US techniques showed the best results, with the highest stability characteristics and better rheological properties, the highest L* (lightness) and Brix values, and the lowest titratable acidity values. Interestingly, the individual application of the pH-shift technique showed the lowest physical stability results. In comparison, pH shift treatment combined with the US demonstrated moderate stability. Thus, the pH shift and the US are remarkable non-thermal processing methods for producing stable hempseed milk.

Keywords: hemp seed milk, pH-shift, ultrasonication, viscosity, rheological properties.

INTRODUCTION

The acknowledged nutritional benefits and minimal allergenic potential of hemp seeds have contributed to a surge in the consumption of hemp products in recent years. Hemp seed market size was assessed at \$5.1 billion in 2022 and is expected to reach \$11.7 billion by 2032, rising at a CAGR of 8.9% between 2023 and 2032, according to a recent research by Allied Market Research titled, "Hemp Seed Market" (Hemp Seed Market).

Since both hemp and marijuana are produced from the same plant, useful or industrial hemp is referred to by the Latin term *Cannabis Sativa*. The primary psychoactive ingredient, delta-9 tetrahydrocannabinol (THC), is present in approximately 0.3% to 1.5% of industrial hemp, but it is present in 5% to 10% or more of marijuana (Besir et al., 2022). About 25% of hemp seeds are protein, and 30% are oil. The oil has a high concentration of polyunsaturated fatty acids (PUFAs), particularly linoleic (-6) and -linolenic (-3) acids (Wang et al., 2018). To provide nutritional advantages, hemp seed milk is made from hemp seeds. Most of the original nutrients remain in hemp seed milk, making it a highly nutritious beverage. Hemp seed milk is regarded as a pleasant substitute for dairy, soy, and nut milk, lactose-free, and low in allergens (Besir et al., 2022).

Hemp seed milk is an oil-in-water (O/W) emulsion system that is unstable and tends to flocculate like other milk substitutes created from plant seeds, decreasing quality and shortening shelf life (Wang et al., 2018). Plant-based milk is a colloidal system that contains large-sized dispersed particles such as fat globules, solid raw material particles, proteins, and starch granules. Because of solid particle sedimentation, it is challenging to produce a stable product

that can be kept in stock for an extended period. Therefore, many methods have been applied to increase hemp seed milk's stability, like emulsifiers or stabilizers. However, this method is not recommended due to economic causes and health issues. For instance, several research have indicated that long-term intake of artificial emulsifiers may result in chronic inflammatory diseases linked to obesity and metabolic syndrome. As a result, there is an increasing need for affordable alternative technologies and food items devoid of additives (Cani & Everard, 2015). Such techniques as enzymatic hydrolysis (Yin et al., 2008) and acylation (Yin et al., 2009) have been applied. Wang et al. (2018), in their published research, studied the application of pH-shift and high-pressure homogenization processes to produce additive-free hemp seed milk with a focus on its physical and oxidative stability (Wang et al., 2018). In recent years, high-pressure homogenization (HPH) has also been developed to assist in creating stable O/W food emulsions. Oil is mechanically divided into tiny droplets by HPH, increasing the overall surface area, uniformizing the size distribution, and enhancing stability.

However, a molten globular or fibrous conformation is produced when a protein solution is brought to a high alkaline or acidic pH and maintained briefly to promote structural unfolding, followed by a brief incubation at the neutral pH to allow partial refolding. It has been demonstrated that this procedure is known as pH shift. The resulting structure exhibits molten globule characteristics, which significantly improves proteins' solubility and emulsifying and film-forming capabilities (Jiang et al., 2018). Hence, pH shift has been effectively used to treat soy and pea proteins to increase their emulsifying capabilities (Wang et al., 2018).

Moreover, another promising technique for increasing the stability of plant-based milk is ultrasonication. Ultrasonication is applying high-power ultrasound to a specific product; it may cause cavitation. Cavitation is a process wherein the propagation of high-power sound waves causes the emergence of small gas or vapor bubbles that develop inside the sample. Extreme temperatures and pressures are created as a result of this process. These extreme conditions have the potential to deactivate enzymes and change the secondary structure of proteins, altering both their nutritional value and functional capabilities (Vanga et al., 2020). However, ultrasound is divided into two types: low-intensity ultrasound (with a power intensity of less than one wcm^{-2} and a frequency of five to ten MHz) and high-intensity ultrasound (with a power intensity of ten to one hundred wcm^{-2} and a frequency of twenty to one hundred kHz), the latter of which is used in food processing technologies (Sarangapany et al., 2022). Hence, the effect of US on plant proteins has been evaluated in many previous studies on soy, pea, black bean, almond, and wheat proteins (Vanga et al., 2020) and peanut (Salve et al., 2019). However, no study has evaluated the effect of ultrasonication on the structural properties, organoleptic, and functional properties of hemp seed milk. The objective of the current study was to make additive-free hemp seed milk using a pH shift and US procedure while examining its physical, organoleptic, and functional characteristics.

MATERIALS AND METHODS

Seed material

During this research, defatted hemp seeds have been utilized for milk production. The oil has been previously extracted by cold pressing technique.

Oil extraction by cold pressing

According to the literature, the high lipid content of seeds and nuts may result in undesirable phase separation and decreased product stability; thus these components are eliminated during processing (Tangyu et al., 2019). The current research used cold pressing to extract oil from the hemp seeds. In a technical procedure known as pressing, oil is mainly extracted (drained) from the hemp seeds using mechanical pressure. Cold pressing is performed by directly pressing raw/dried seeds on a continuous screw press at low temperature (Rabrenović et al., 2014).

Hemp Seed Milk Preparation

Each experimental run began with fresh hemp seed milk preparation, according to the method described by Wang et al. (2018), with slight modifications. Briefly, defatted seeds were ground in a 1:8 w/v ratio of deionized water with an ultra-turrax homogenizer (IKA-Werke GmbH & Co. KG, Staufen, Germany) at 12000 rpm for 10 min, then filtered using Stainless Steel Sieve, to ensure the consistency of milk and to remove particles. The produced milk was immediately kept at 4°C in airtight containers.

pH Shifting and Ultrasonication Treatments

The prepared hemp seed milk underwent three treatments: pH shifting alone, ultrasonication alone, and a combination of both. The control sample had not been modified, only stirred. For pH shift, the pH of hemp seed milk samples was adjusted to 12 using 1 M NaOH at room temperature and then brought back to pH 7 using 1 M HCl. US treatment was applied using a VibraCell VC750 ultrasonic processor (Sonics & Materials, Inc., Newtown, CT, USA) at 20 kHz and 750 W. Using a 13 mm diameter probe, the sonic energy was transferred into hemp seed milk. An ice bath was used to prevent overheating from ultrasonication, which might result in protein denaturation (Kahraman et al., 2022).

The sonication pulse duty cycle (5 s on, 5 s off) was set to 100% amplitude. The hemp seed milk samples were sonicated for 5 or 10 minutes during the treatment with ultrasonication alone or with pH shift. For the samples of pH shifting and ultrasonication combined treatments, the hemp seed milk samples were exposed to pH shift and then immediately sonicated for 5 or 10 min.

Physical stability/ Creaming index

Two 20 ml of processed hemp seed milk were immediately transferred to graduated tubes, sealed, and kept in a refrigerator ($4 \pm 2^\circ\text{C}$) to calculate the sedimentation index. According to the Indu et al. (2019) approach, measurements were taken every 24 hours until the samples indicated total separation, at which point the separation index (SI) was determined using the equation given below (Indu et al., 2019).

$$\text{Creaming index (\%)} = \frac{\text{Height of the aqueous layer HA}}{\text{Total height of emulsion HE}} \times 100$$

Color

A colorimeter (CR-400, Konica Minolta, Inc., Japan) was used to measure color properties. The study used the CIE-L* a* b* color coordinate system. L* value is a lightness measuring factor, ranging from blackness (0) to whiteness (100). A* value varies from greenness (-60) to redness (+60), whereas b* value goes from blueness (-60) to yellowness (+60) (Zaaboul et al., 2019).

Total soluble solids (Brix)

On a Brix scale of 0-100, the total soluble solids of the samples were calculated using a refractometer at room temperature (Salve et al., 2019).

Solid particle sedimentation (SPS)

Solid particle sedimentation was conducted according to the method described by (Gul et al., 2017). Each sample was centrifuged at 2500 g for 20 min using 10 mL of the solution. The amount of solid deposition at the bottom of the tube was given as a percentage (w/w)(Gul et al., 2017).

Titrateable acidity

The samples (10 ml) were mixed with 10 ml of deionized water after that, titrated with 0.1 N sodium hydroxide (with indicator phenolphthalein) in order to assess the effect of treatment on the titrateable acidity of hemp seed milk (Salve et al., 2019).

Rheological properties

Rheological characterization of hemp seed milk was carried out by using Haake Mars III rheometer (Thermo Scientific, Germany) with a cone and plate system (35 mm diameter, 0.105 mm gap, 2° angle). The temperature was maintained constant at 25°C by a Peltier plate system. The steady-state shear experiments were measured by shearing the samples at linearly increasing shear rates from 1 to 100 s⁻¹ through 120 s. Product flow behavior was modeled using the Ostwalde-Waele model.

$$\eta_{app} = K\dot{\gamma}^{n-1}$$

where η_{app} is apparent viscosity (Pa s), $\dot{\gamma}$ is the shear rate (s⁻¹), K the consistency index (Pa sn), and n the flow behavior index (dimensionless) (Zaaboul et al., 2019 ; Atalar et al., 2019).

Temperature effects on viscosity

For evaluating the effect of increasing temperature on the viscosity characteristics of hemp seed milk, the temperature of the samples was increased with a heating rate of 0.5°C/min from 10 to 80°C as described perviously by Iskakova & Smanalieva, (2021).

Statistical analysis

Statistical analysis of data was performed by one-way ANOVA analysis of variance using Minitab software. The data was expressed as the mean of triplicate estimation \pm standard deviation and at $p < 0.05$ level, the differences were considered statistically significant.

RESULTS AND DISCUSSION

Creaming index

The creaming index is crucial to assess the stability of hemp and milk. The stability of hemp seed milk increases with a decrease in the creaming index %. As shown in **Fig. (1A, 1B)**, the creaming index of hemp seed milk decreased when the duration of ultrasonication was increased. This could be caused by the cavitation effect, which reduces the size of fat or protein globules and prevents flocculation (Indu et al., 2019). However, the pH-shift treatment showed a noticeable increase in the creaming index. The literature has reported that the pH-shift method, instead of directly changing the pH value to 7-8, could decline the protein solubility and emulsion stability due to the formation of insoluble aggregates (Jiang et al., 2018).

(A)

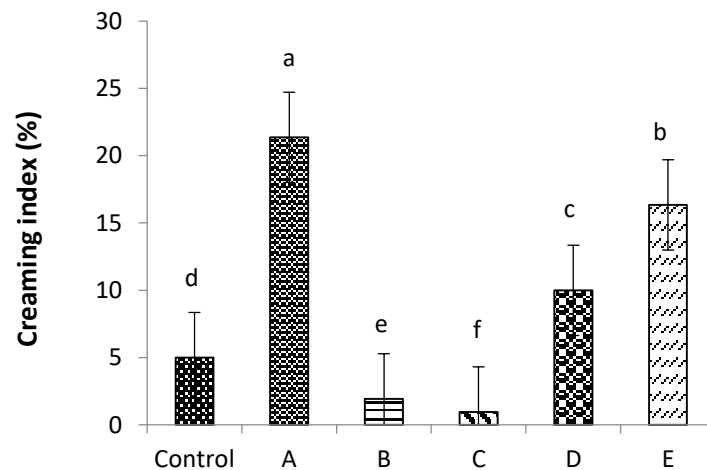

(B)

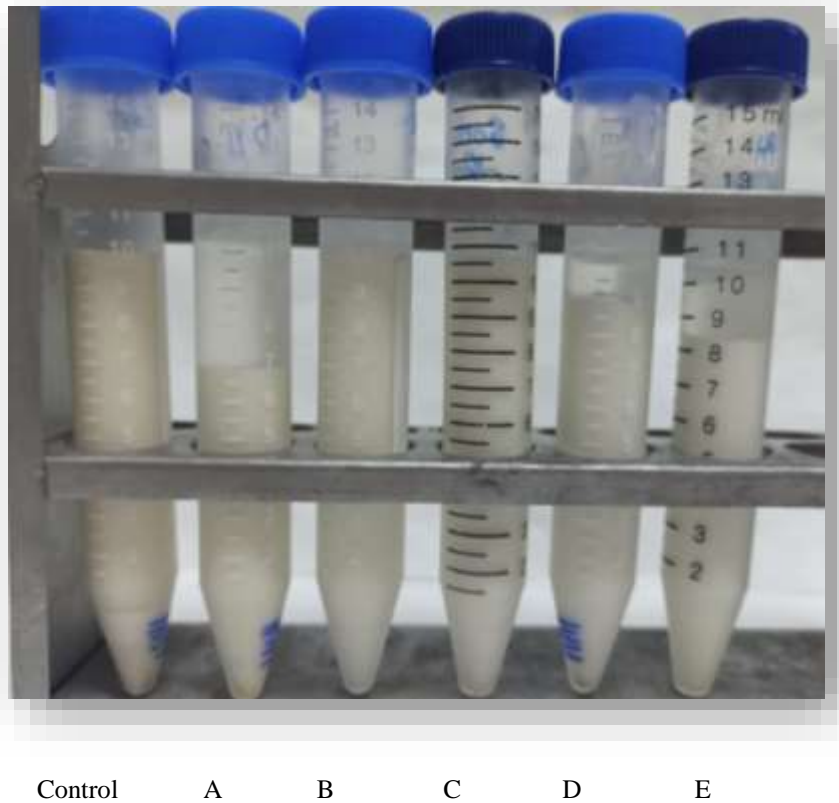

Fig. 1. Creaming index of hemp seed milk after 48 h of low temperature storage (4 ± 2 °C): (A) Creaming index of hempmilk, where a', b', c', d', e', and f represent statistical differences and (B) in sequence photos representing the separation of phases of all treatments. Where Control: without any treatment, A: pH-shift, B: 5 min of US, C: 10 min of US, D: pH-shift & 5 min US, E: pH- shift & 10 min US.

Color properties

The **Table 1.** shows the effect of pH shift and US processing on the colour parameters of hemp seed milk. On analyzing L^* value (lightness), samples treated with with the US statistically showed the highest L^* value. Samples treated with pH-shift and US demonstrated high L^* values with no statistical differences. As well as Control (untreated) and only pH-shift treated samples showed the lowest values with no significant differences. The increase in light scattering and greater lightness values of the samples can be attributed to the tendency of US treatment to cause the dispersed particles to increase by minimizing their size (Sarangapany et al., 2022). The same outcomes have also been found for peanut milk; ultrasonication increased the color characteristics of the milk, particularly the lightness or L^* value (Salve et al., 2019). The* (redness) value showed no statistical differences among all samples except for the control sample, which demonstrated the highest value. For b^* (yellowness) value, control and pH-shift treated samples showed the highest values.

Table 1. Effect of pH shift and US treatment on the colour of hemp seed milk.

Treatments	<i>L</i> *	<i>a</i> *	<i>b</i> *
Control	85.960 ± 0.18 ^c	-0.5333 ± 0.12 ^a	10.7133 ± 0.14 ^a
pH-shift	86.497 ± 0.18 ^c	-0.7600 ± 0.05 ^b	9.9167 ± 0.10 ^b
US-5 min	88.137 ± 0.26 ^b	-0.7033 ± 0.06 ^{ab}	8.8667 ± 0.05 ^c
US-10 min	89.163 ± 0.22 ^a	-0.8467 ± 0.04 ^b	8.5233 ± 0.03 ^d
pH-shift & US-5 min	88.313 ± 0.17 ^b	-0.7633 ± 0.03 ^b	8.27 ± 0.09 ^d
pH-shift & US-10 min	88.117 ± 0.17 ^b	-0.7400 ± 0.02 ^b	8.4233 ± 0.11 ^d

Each value is represented by its mean and standard deviation (n=3). Values in the same column that are vertically present the same superscript letters do not differ statistically ($p > 0.05$).

Soluble solids (Brix) and titratable acidity

The effects of treating hemp seed milk with pH- shift and/or US on total soluble solids (TSS) and titratable acidity of hemp seed milk are shown in **Table 2**. It has been observed that the sonicated samples have shown to have the highest TSS value 4.8 Brix. Increasing the US time significantly affected the Brix value of treated samples ($p < 0.05$). However, similar results have been reported in previously published studies (Salve et al., 2019)(Maghsoudlou et al., 2016). Employing the power of sonication can enhance the breaking down of cell walls to speed up the release of their contents. The control, pH-shift, and pH and US-treated samples presented no significant difference. Additionally, it was shown that the titratable acidity of hemp seed milk decreased significantly as the US treatment duration increased. This may be caused by a change in the charge of particles by the sonication process (Salve et al., 2019). However, pH-shift treatment alone or combined with US showed a statistically increased titratable acidity value.

Table.2 Effects of pH shift and US processing on physicochemical properties of hemp seed milk

Treatments	Brix (%)	Titratable acidity	Sedimentation index
Control	1.95 ± 0.212 ^c	0.043 ± 0.002 ^d	37.16 ± 0.1 ^e
pH-shift	1.95 ± 0.283 ^c	0.166 ± 0.007 ^b	42.47 ± 0.2 ^c
US-5 min	3.95 ± 0.141 ^b	0.058 ± 0.004 ^C	37.38 ± 0.1 ^d
US-10 min	4.8 ± 0.07 ^a	0.048 ± 0.006 ^{cd}	34.04 ± 0.2 ^f
pH-shift & US-5 min	1.95 ± 0.141 ^c	0.207 ± 0.002 ^a	46.95 ± 0.08 ^a
pH-shift & US-10 min	2.0 ± 0.07 ^c	0.154 ± 0.005 ^b	45.97 ± 0.2 ^b

Each value is represented by its mean and standard deviation (n=3). Values in the same column that are vertically present the same superscript letters do not differ statistically ($p > 0.05$).

Sedimentation index

The higher sedimentation value is associated with lower product stability. The results showed that ultrasonication significantly ($p < 0.05$) lower sedimentation values, Fig.2 In another

word, treated hemp seed milk without pH- shift resulted in a more stable emulsion. The same result has been reported by Wang et al. when they studied the effect of pH shift and homogenization pressure on hemp seed milk stability (Wang et al., 2018). Whereas the application of pH-shift or the combined application of pH-shift and the US unexpectedly statistically ($p < 0.05$) increased the sedimentation values. The improvement in the sedimentation index in the US-treated samples is driven by some factors, including the reduction in particle size that facilitated intermolecular interactions. Additionally, denaturing hemp proteins aided in their unfolding, revealing their active sites and raising the hydrophobicity of their surfaces (Salve et al., 2019). On another hand, it has been discussed in the literature that the pH-shift process could have resulted in undesirable molten globule conformation in some cases. It is known that the pH-shift process increases the solubility of proteins, but after an excessive pH treatment, solubilized proteins must immediately go through refolding; otherwise, the pH-shift process results in a decreased protein solubility due to the formation of insoluble aggregates; this was observed in the literature on soy globulins (Jiang et al., 2018), a similar result was found out during our study.

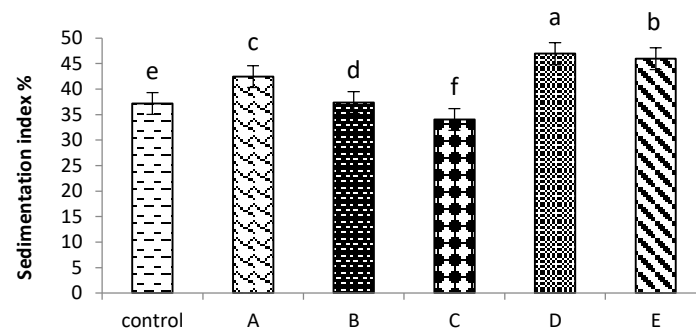

Fig. 2. Sedimentation index of hemp seed milk, where a', b', c', d', e' and f' represent statistical differences. Control: without any treatment, A: pH-shift, B: 5 min of US, C: 10 min of US, D: pH-shift & 5 min US, E: pH- shift & 10 min US.

Rheological properties

Effect of pH shift and US on rheological parameters

The pH shift and US treatments considerably impacted the viscosity of the hemp seed milk sample **Table. 3** Compared to the untreated (control) milk sample (42.4 mPa.s). For all samples, hemp seed milk had non-Newtonian fluid flow characteristics - have varying relationships with shear stress and non-constant viscosity-. Viscosity was estimated with a Herschel–Bulkley equation. According to the results, only pH-shift treated samples showed significantly reduced viscosity values (12,68 mPa.s) compared to the control samples. As previously discussed, the pH-shift process causes the protein structure to unfold, and when the pH is returned to neutral, where intramolecular charge repulsions are significantly reduced, some degree of refolding occurs. During this study, we noticed phase separation and aggregation, which could be associated with the formation of undesired molten structures during the pH-shift process. However, in their previous published research, Nicoud et al. (2015) claimed that the aggregate distribution's polydispersity is why an aggregated protein solution has a lower viscosity than a monomeric protein solution (Nicoud et al., 2015). Likewise, the viscosity of pH-shift treated samples was statistically lower than those treated with pH shift and US (5 and 10 min). It is worth mentioning that according to the literature, US treatment (400, 600, and 200 W) alone has decreased the viscosity of peanut milk (Salve et al., 2019), and this

is consistent with our results for only US-treated samples (5 and 10 min) which had similar results with no statistical differences. The US impacts the milk by changing the balance and reducing the larger particles into smaller ones. The cavitation treatment caused rheological changes in milk samples that reduced their viscosity, increased their fluidity, and decreased their tendency to behave in a pseudoplastic manner (Salve et al., 2019) **Table.3**.

Table.3 Rheological parameters of pH-shift and US treated hemp seed milk.

	K (Pa sn)	n (-)	R ²	η_{50} (mPa s)
Control	0.0016± 0.000 ^b	0.885 ± 0.044 ^a	0.757 ± 0.069 ^b	42.48 ± 1.92 ^a
pH-shift	0.053± 0.002 ^b	0.636 ± 0.008 ^b	0.994± 0.000 ^a	12.68± 1.39 ^c
US-5 min	0.006± 0.004 ^b	0.643± 0.069 ^b	0.732 ± 0.053 ^b	1.332± 0.57 ^d
US-10 min	0.002± 0.008 ^b	0.881 ± 0.105 ^a	0.964 ± 0.008 ^a	1.368± 0.04 ^d
pH-shift & US-5 min	0.475± 0.002 ^a	0.253 ± 0.035 ^c	0.992± 0.003 ^a	24.88± 2.72 ^b
pH-shift & US-10 min	0.369 ± 0.05 ^a	0.298 ± 0.02 ^c	0.994 ± 0.003 ^a	23.46± 1.53 ^b

Each value is represented by its mean and standard deviation (n=3). Values in the same column that are vertically present the same superscript letters do not differ statistically (p>0.05).

Temperature effects on viscosity

Food flow behavior can be affected by temperature variations (Forster & Ferrier, 1979). Likewise, Simuang et al., (2004), in their study, showed that the viscosity of coconut milk was significantly affected by heat treatment. Thus, the flow behavior of hemp seed milk at various temperatures was investigated. The temperature influence on rheological parameters is shown **Fig. 3**.

Data showed that after the viscosity of all samples demonstrated reduction over continuous heating until it reached a certain extent, the apparent viscosity changed slightly and started to increase at higher temperatures. The literature has reported that increasing temperatures cause liquid viscosity to decrease. The result of increasing a liquid's temperature is a decrease in cohesive forces and an increase in the rate of molecular interchange. In other words, the increase in temperature causes kinetic or thermal energy and the molecules become more mobile (Baily, 2013)(Iskakova & Smanalieva, 2021). On the other hand, increasing viscosity with continuous heating is suggested to be due to protein denaturation and subsequent association/polymerization. However, Liu & Chang, (2007) reported the same result: soy milk's viscosity increased as the heating time increased. They claimed that heating caused both 11S and 7S proteins to dissociate. The dissociated polypeptides and subunits of the 7S and 11S proteins then interacted (Liu & Chang, 2007). Hence, the maximum denaturation of 7S protein, which caused a sharp increase of soymilk viscosity, was observed at 70°C. Likewise, according to the literature, hemp proteins are sensitive and have a lower denaturation temperature, therefore, it is suggested to keep heat treatment below 80°C in order to retain their heat stability and solubility (Besir et al., 2022). The maximum denaturation temperature of hemp protein was not observed during the current study, but it has been noted that the maximum decline and the start of an increase in hemp seed milk viscosity of all samples occurred between 50 and 70°C. We propose that an increase in viscosity at these levels indicates the beginning of protein structural changes, however it may not be a complete denaturation or coagulation. For investigating the effect of pH-shift and US treatment on hemp seed milk viscosity during the application of various temperatures, after a steady and moderate drop in the viscosity of samples treated with pH-shift alone or with US (5 and 10 min), we observed a sharp increase in the

viscosity, which indicates the highly sensitivity and heat instability of those samples Fig.3. These results are highly compatible with the results we discussed previously for measuring sedimentation and creaming indexes for these samples. Whereas, control and only US (5 and 10 min) treated hemp seed milk samples showed a less severe increase in the viscosity, which indicates a more cohesive structure and consequently more heat stability.

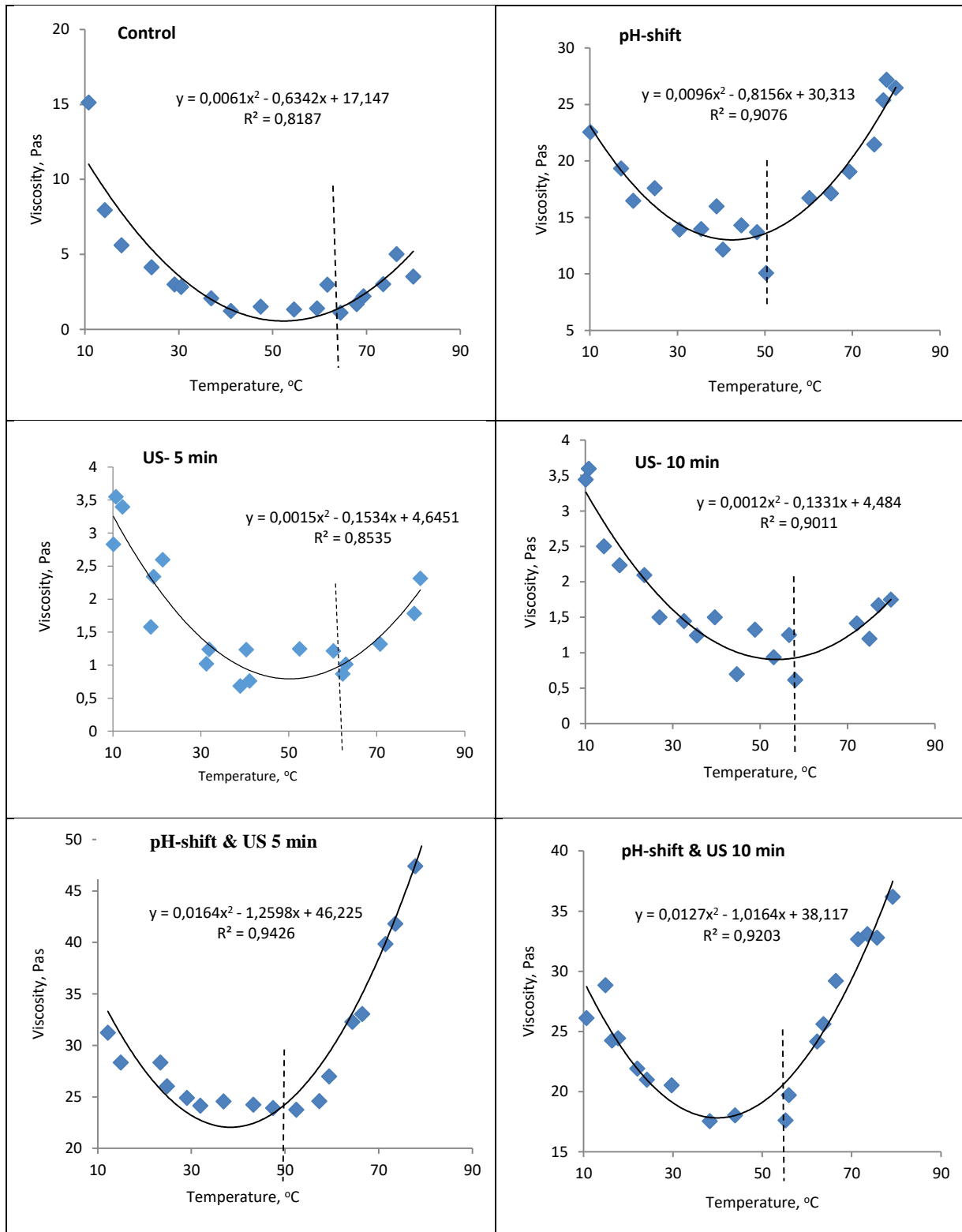

Fig. 3. Temperature effect on the viscosity characteristics of hemp seed milk samples.

CONCLUSION

Even though each of the pH shifts and US processes had a different stabilizing impact on the hemp seed milk emulsion, their combination did not yield the best results. The pH shift treatment encouraged protein interactions that eventually resulted in large clusters and aggregates, which negatively impact the stabilization of the emulsion. Hemp seed milk treated only with US showed such interactive structures that were stable against coalescence coagulation and showed better temperature-related viscosity characteristics. Since the pH-shift process showed unstable emulsion, it is suggested for the future to apply the direct change of pH to 7-8 (without incubation period), which is expected to be more effective. Finally, last but not least, using US or combining pH shift with US with various modifications may present new potential for producing non-thermally hemp seed milk without stabilizers or emulsifiers.

Data Availability

The datasets of their study are available from the corresponding author upon request.

Conflicts of Interest

The authors declare no conflict of interest.

REFERENCES

- Atalar, I., Gul, O., Saricaoglu, F. T., Besir, A., Gul, L. B., & Yazici, F. (2019). Influence of thermosonication (TS) process on the quality parameters of high pressure homogenized hazelnut milk from hazelnut oil by-products. *Journal of Food Science and Technology*, 56(3), 1405–1415. <https://doi.org/10.1007/s13197-019-03619-7>
- Baily, S. (2013). *How does Temperature Change Viscosity in Liquids and Gases?* <https://www.azom.com/article.aspx?ArticleID=10036>
- Besir, A., Awad, N., Mortas, M., & Yazici, F. (2022). A Plant-Based Milk Type: Hemp Seed Milk. *Akademik Gida*, 20(2), 170–184. <https://doi.org/10.24323/AKADEMIK-GIDA.1149875>
- Cani, P. D., & Everard, A. (2015). Keeping the gut lining at bay: impact of emulsifiers. *Trends in Endocrinology & Metabolism*, 26(6), 273–274. <https://doi.org/10.1016/J.TEM.2015.03.009>
- Forster, L. L., & Ferrer, L. K. (1979). Viscometric Characteristics Of Whole Soybean Milk. *Journal of Food Science*, 44(2), 583–590. <https://doi.org/10.1111/J.1365-2621.1979.TB03841.X>
- Gul, O., Turker, F., Mortas, M., Atalar, I., & Yazici, F. (2017). Effect of high pressure homogenization (HPH) on microstructure and rheological properties of hazelnut milk. *Innovative Food Science and Emerging Technologies*, 41(March), 411–420. <https://doi.org/10.1016/j.ifset.2017.05.002>
- Hemp Seed Market Expected to Reach \$11.7 Billion by 2032*. (n.d.). Retrieved August 22, 2023, from <https://www.alliedmarketresearch.com/press-release/hemp-seed-market.html>
- Indu, C., Thangavel, K., & Amirtham, D. (2019). Influence of ultra-sonication on the stability and physicochemical properties of coconut milk. *Journal of Pharmacognosy and Phytochemistry*, 8(3), 3565–3570. <https://www.phytojournal.com/archives/2019.v8.i3.8570/influence-of-ultra-sonication->

- on-stability-and-physicochemical-properties-of-coconut-milk
- Iskakova, J., & Smanalieva, J. (2021). Determination of Flow and Viscoelastic Properties of the Kyrgyz Ethnic Food “Süzmö” Depending on Temperature and Moisture Content. *Trakya University, Journal of Natural Sciences*, 22(2), 199–205. <https://doi.org/10.23902/TRKJNAT.925710>
- Jiang, J., Wang, Q., & Xiong, Y. L. (2018). A pH shift approach to the improvement of interfacial properties of plant seed proteins. *Current Opinion in Food Science*, 19, 50–56. <https://doi.org/10.1016/J.COFS.2018.01.002>
- Kahraman, O., Petersen, G. E., & Fields, C. (2022). Physicochemical and Functional Modifications of Hemp Protein Concentrate by the Application of Ultrasonication and pH Shifting Treatments. *Foods (Basel, Switzerland)*, 11(4). <https://doi.org/10.3390/FOODS11040587>
- Liu, Z. S., & Chang, S. K. C. (2007). Soymilk Viscosity As Influenced By Heating Methods And Soybean Varieties. *Journal of Food Processing and Preservation*, 31(3), 320–333. <https://doi.org/10.1111/J.1745-4549.2007.00128.X>
- Maghsoudlou, Y., Alami, M., Mashkour, M., & Shahraki, M. H. (2016). Optimization of Ultrasound-Assisted Stabilization and Formulation of Almond Milk. *Journal of Food Processing and Preservation*, 40(5), 828–839. <https://doi.org/10.1111/JFPP.12661>
- Nicoud, L., Lattuada, M., Yates, A., & Morbidelli, M. (2015). Impact of aggregate formation on the viscosity of protein solutions. *Soft Matter*, 11(27), 5513–5522. <https://doi.org/10.1039/C5SM00513B>
- Rabrenović, B. B., Dimić, E. B., Novaković, M. M., Tešević, V. V., & Basić, Z. N. (2014). The most important bioactive components of cold pressed oil from different pumpkin (*Cucurbita pepo* L.) seeds. *LWT - Food Science and Technology*, 55(2), 521–527. <https://doi.org/10.1016/J.LWT.2013.10.019>
- Salve, A. R., Pegu, K., & Arya, S. S. (2019). Comparative assessment of high-intensity ultrasound and hydrodynamic cavitation processing on physico-chemical properties and microbial inactivation of peanut milk. *Ultrasonics - Sonochemistry*, 59(August), 104728. <https://doi.org/10.1016/j.ultsonch.2019.104728>
- Sarangapany, A. K., Murugesan, A., Annamalai, A. S., Balasubramanian, A., & Shanmugam, A. (2022). An overview on ultrasonically treated plant-based milk and its properties – A Review. *Applied Food Research*, 2(2), 100130. <https://doi.org/10.1016/j.afres.2022.100130>
- Simuang, J., Chiewchan, N., & Tansakul, A. (2004). Effects of fat content and temperature on the apparent viscosity of coconut milk. *Journal of Food Engineering*, 64(2), 193–197. <https://doi.org/10.1016/J.JFOODENG.2003.09.032>
- Tangyu, M., Muller, J., Bolten, C. J., & Wittmann, C. (2019). Fermentation of plant-based milk alternatives for improved flavour and nutritional value. *Applied Microbiology and Biotechnology*, 103(23–24), 9263–9275. <https://doi.org/10.1007/S00253-019-10175-9/FIGURES/6>
- Vanga, S. K., Wang, J., Orsat, V., & Raghavan, V. (2020). Effect of pulsed ultrasound, a green food processing technique, on the secondary structure and in vitro digestibility of almond milk protein. *Food Research International*, 137, 109523. <https://doi.org/10.1016/J.FOODRES.2020.109523>
- Wang, Q., Jiang, J., & Xiong, Y. L. (2018). High pressure homogenization combined with pH shift treatment : A process to produce physically and oxidatively stable hemp milk. *Food Research International*, 106(September 2017), 487–494. <https://doi.org/10.1016/j.foodres.2018.01.021>
- Yin, S. W., Tang, C. H., Cao, J. S., Hu, E. K., Wen, Q. B., & Yang, X. Q. (2008). Effects of limited enzymatic hydrolysis with trypsin on the functional properties of hemp (*Cannabis*

sativa L.) protein isolates. *Food Chemistry*, 106(3), 1004–1013.

<https://doi.org/10.1016/J.FOODCHEM.2007.07.030>

Yin, S. W., Tang, C. H., Wen, Q. B., & Yang, X. Q. (2009). Functional and structural properties and in vitro digestibility of acylated hemp (*Cannabis sativa* L.) protein isolates. *International Journal of Food Science & Technology*, 44(12), 2653–2661. <https://doi.org/10.1111/J.1365-2621.2009.02098.X>

Zaaboul, F., Raza, H., Cao, C., & Yuanfa, L. (2019). The impact of roasting, high pressure homogenization and sterilization on peanut milk and its oil bodies. *Food Chemistry*, 280(September 2018), 270–277. <https://doi.org/10.1016/j.foodchem.2018.12.047>

THE EFFECT OF DIFFERENT DRYING METHODS ON SOME CHEMICAL AND BIOACTIVE COMPONENTS OF ORANGE AND BLACK CARROT POWDERS

¹Hilal Arslan Bayrakcı ²Nermin Bilgiçli

¹ Karapınar Aydoğanlar Vocational School, Selçuk University, Konya, Turkey

² Department of Food Engineering, Engineering Faculty, Necmettin Erbakan University, Köyceğiz Campus, Konya, 42050, Turkey.

Corresponding author e-mail: hilalbayrakci@gmail.com

ABSTRACT

In this study, two different varieties of carrots (orange and black carrots) were dried with three different drying methods (hot air, microwave and freeze-drying) and ground to obtain carrot powders. Color values, ash, protein, fat, antioxidant activity, total phenolic content (TPC), β -carotene, total anthocyanin (TA) and mineral matter of the carrot powders were determined. Orange carrot powders showed higher lightness, redness and yellowness values than black carrot powders. The freeze-drying method provided higher lightness value in both carrot powder varieties. Different drying methods did not cause a significant ($p>0.05$) change on the ash, protein and fat content of carrot powders. The antioxidant activities and TPC of orange and black carrot powders varied between 75.16-76.60% and 87.52-95.75%, 263.50-470.90 mgGAE/100g and 596.10-1353.40 mgGAE/100g, respectively. β -carotene content of orange carrot powders dried with different methods ranged between 39.34 mg/100g and 48.72 mg/100g, and β -carotene content of freeze-dried samples was found to be higher than other drying methods. The TA amount of black carrot powders varied between 259.08 mgCGE/100g and 424.66 mgCGE/100g. The freeze-drying method resulted in the highest TA content, while the hot air drying method revealed the lowest TA content. Black carrot powders for all drying methods had higher Fe, K, Mg and P contents than orange carrot powders. Different drying methods did not change the mineral amounts in both carrot powders.

Keywords: Drying, orange carrot, black carrot, powder, bioactive component

INTRODUCTION

Carrot (*Daucus carota L.*) is one of the most widely produced root vegetables in world agriculture. *Daucus*, which includes sixty species of several cultivars, has color ranging from white to yellow, orange, light purple, deep red or violet (Rodriguez et al., 1975). Orange carrots are an important source of carotenoids. Approximately 60% of the total carotenoid content of ripe orange carrots is β -carotene, 20% α -carotene, and the remainder is lycopene, γ -carotene, ζ -carotene, and/or β -zeacarotene (Banga & De Bruyn, 1964; Gabelman, 1974; Simon & Wolff, 1987). Although orange color is the dominant color for carrots, black carrot has been attracting attention for its bluish color with high levels of anthocyanins. The origin of black carrot is Turkey, Middle and Far East, and it has been cultivated for at least 3000 years (Kamiloglu et al., 2016). Carrot varieties are also rich sources of vitamins, minerals and dietary fiber. The nutritional properties and bioactive content and also attractive colors of orange and black carrots have led to research on the usage areas of carrots.

There are some studies in the literature on the powdering of carrots using different methods and the use of its powder in various products. Wang & Xi, (2005) used the microwave drying method for drying carrots. The technological and nutritional differences between the dried samples were investigated by changing the amount of carrots placed in the microwave

tray (100g, 200g and 300g) and the applied microwave power (120, 160 and 240 W). A decrease in the amount of β -carotene was observed as the microwave power increased. Gong et al. (2015) compared the effects of different drying methods on the color characteristics and β -carotene contents of carrot powders. Carrot powder was obtained by using vacuum drying, hot air drying, microwave drying and freeze-drying methods. Carrot powders dried with hot air had the lowest β -carotene content (114.4 mg/kg), while the highest value (344.8 mg/kg) was obtained by freeze-drying method.

In this study, it was aimed to determine the effects of different drying methods (hot air, microwave and freeze-drying) on the color, some chemical and bioactive components of carrot powders obtained from orange and black carrots.

MATERIAL AND METHODS

Materials

Orange and black carrots were obtained from the cold storages of Kaşınhanı town in Konya, Turkey. All chemicals used in analysis were of analytical grade quality.

Production of carrot powders

Carrots were washed, peeled and cut into thin slices. Carrot slices were first heat treated in boiling water (3 minutes at 90 °C) and then the following drying methods were applied to the carrots. Drying in hot air flow: carrots were dried in a drying cabinet (Nüve KD 200, Ankara, Turkey) at 60 °C for 10 hours (Akubor & John Ike, 2012). Microwave drying: Carrot samples were dried in a household microwave oven (LG Solardom, Seoul, South Korea) at 360 W power for 45 minutes according to (Prakash et al., 2004). Freeze-drying: carrots were dried in a freeze-drying device (Scanvac, CoolSafe, Denmark) at -54 °C for 24 hours (Lee et al., 2003). After all the dried samples were ground, they were sieved through a sieve with a diameter of 500 micrometer and stored under refrigerator conditions for analysis.

Color measurement

The color values of the carrot powders were measured using Hunter Lab Chroma Meter (Minolta CR-400, Osaka, Japan) in terms of the Hunter L*, a* and b* values. Also, according to a* and b* values, chroma ($(a^{*2}+b^{*2})^{1/2}$) and Hue angle (if $a^{*}>0$ and $b^{*}>0$ Hue= $\arctan [b^{*}/a^{*}]$; if $a^{*}>0$ and $b^{*}<0$ Hue= $360+\arctan [b^{*}/a^{*}]$) were calculated.

Chemical and bioactive components analysis

Ash, protein and fat content of carrot powders were determined according to AACC 08-01.01, 46-12.01 and 30-25.01 standard methods (AACC, 1999). The TPC was determined colorimetrically using the Folin Ciocalteu method. Extraction was conducted according to Gao et al. (2002) and Beta et al. (2005). Absorbance was measured at 760 nm using a spectrophotometer (Hitachi-U1800, Japan) and results were expressed as mg Gallic acid equivalent (Gámez-Meza et al., 1999; Slinkard & Singleton, 1977). Antioxidant activity was determined by 2,2-Diphenyl-2-picrylhydrazyl (DPPH) method (Beta et al., 2005; Gyamfi et al., 1999). Absorbances were measured at 517 nm and the inhibition percentage was calculated. The β -carotene content of the samples was determined according to Prakash et al. (2004) with some modification of the method. The analysis of TA in the samples was carried out according to the method specified by (Ficco et al., 2014). For the analysis of Ca, Fe, K, Mg, P and Zn elements 1 g dry sample was dissolved by the wet burning method in the microwave combustion system (Mars 5, CEM Corporation, USA) using 10 ml of sulfuric acid + nitric acid. The mineral substance amounts of the obtained filtrates were measured on an ICP-AES (inductively coupled

plasma atomic emission spectrophotometer) instrument (Vista Series, Varian International, AG, Switzerland) (Skujins, 1998).

Statistical analysis

Minitab version 16 statistical program was used for statistical analysis. Means were compared at the $p < 0.05$ level.

RESULTS AND DISCUSSION

Color values

Color values of carrot powders produced with different drying methods are given in Table 1. L^* , a^* , b^* , C^* and hue° values of carrot powders varied between 39.28 and 81.25, 12.19 and 26.78, -4.02 and 44.26, 12.84 and 51.80 and 57.11 and 346.75, respectively. The highest L^* value was determined in the orange carrot powder obtained by freeze-drying. The L^* value of the powders obtained by freeze-drying method in both carrot cultivars was found to be higher than the L^* value of the powders obtained by other drying method. Exposure of samples to heat in hot air and microwave drying methods may have caused this situation. In general, orange carrot powders gave higher a^* and b^* values than black carrot powders. The yellow and red color of the carrot is attributed to the presence of carotenes (Wagner & Warthesen, 1995). The fact that orange carrots are richer in carotenes than black carrots may have caused these results. When a^* value of orange carrot powders was evaluated in terms of drying method; it was seen that a^* value of the orange carrot powders obtained by freeze-drying was higher than a^* value of the powders obtained by applying hot air. Although the a^* value of black carrot powders did not show a statistical difference depending on the drying methods, the powders obtained by freeze-drying method showed the highest a^* value numerically. When the orange carrot powders were examined in terms of b^* value; as with a^* value, the b^* value of the powders obtained by freeze-drying method was found to be higher than the b^* value of the powders obtained by hot air. The use of different drying methods in the production of black carrot powder did not cause a statistical difference on the b^* value. The fact that the drying time is longer in the hot air drying method compared to the microwave drying method, and the temperature is higher than the freeze-drying method may have caused more loss in carotenoid pigments and a decrease in a^* and b^* values. Freeze-drying method gave higher C^* values in orange carrot powders than hot air and microwave drying methods, and no significant difference was observed between hot air and microwave drying methods in terms of C^* value. Although the C^* values of black carrot powders did not show a statistical difference according to the drying method, the carrot powder obtained by freeze-drying method gave the highest numerical value. Drying methods were not effective on the hue° value of orange and black carrot powder samples, and no statistical difference was determined between the results. Howard et al. (1996) reported that the lightness of the carrot is affected by the processing temperatures, and higher temperatures cause a darker color. It was reported in another study that the L^* , a^* and b^* values of the dried carrot samples decreased with the increase in the temperature applied during drying (Xiao et al., 2010). In a study, freeze-dried, vacuum-microwave and hot air drying methods were used for the drying of carrots; It was determined that freeze-dried carrot slices had the highest L^* , a^* and b^* values. It has been reported that drying in hot air causes more reduction in lightness value due to greater exposure to oxygen and higher temperature (Cui et al., 2008).

Table 1. Color values of carrot powders produced with different drying methods

Carrot varieties	C	Drying method	Dry			C*	Hue°
			L*	a*	b*		
Orange	O	Hot	70.8	19.20	35.75	40.5	61.78
		air	1±2.07b	±1.34bc	±1.94b	8±2.35b	±0.37b
		Microwave	72.2	23.88	36.90	43.9	57.11
		Freeze-drying	6±0.01b	±2.25ab	±0.73ab	8±0.60b	±2.98b
Black	B	Hot	81.2	26.78	44.26	51.8	58.72
		air	5±3.78a	±1.72a	±4.22a	0±2.71a	±4.06b
		Microwave	39.2	12.19	-	12.8	341.7
		Freeze-drying	8±2.59d	±0.1d	4.02±0.15c	4±0.05c	3±0.77a
Black	B	Hot	41.5	12.84	-	13.4	342.9
		air	3±0.82d	±1.02d	3.92±0.15c	3±0.94c	4±1.89a
		Microwave	51.1	13.36	-	13.7	346.7
		Freeze-drying	1±0.77c	±1.50cd	3.12±0.17c	3±1.40c	5±2.10a

Means with the different letter within a column are significantly different ($p < 0.05$).

Chemical and bioactive components

The chemical analysis results of orange and black carrot powders dried with three different methods are given in Table 2. Average ash, protein and fat amounts of carrot powders were determined as 5.77%, 8.232% and 2.34%, respectively. When the orange and black carrot powders were evaluated in terms of drying method, it was seen that the drying methods did not cause any change on the ash, protein and fat contents of the carrot powders. In general, black carrot powders had higher ash content than orange carrot powders.

Antioxidant activity and TPC of carrot powders obtained by different drying methods are presented in Table 2. Although the drying method is statistically insignificant on the amount of antioxidant activity of orange carrot powders, the lowest value was determined numerically in the samples prepared by the hot air drying method, and the highest value in the samples prepared by the freeze-drying method. When the black carrot powders were evaluated in terms of drying method, the carrot powders obtained by freeze-drying method had numerically higher antioxidant activity than the carrot powders dried in hot air and microwave. These changes may be resulted from the applied temperature during drying and long drying times. Similar results were found in other studies comparing the hot air method with other methods in drying carrots, and it was reported that the losses in microcomponents determined as a result of hot air drying were caused by the length of the process time, high temperature and oxidation (as a result of the presence of oxygen) (Chen et al., 2017; Cui et al., 2008; Lin et al., 1998).

The highest amount of TPC in carrot powders was determined in black carrot powder produced by freeze-drying method. Regardless of the drying method, black carrot powders yielded higher TPC than orange carrot powders. When the orange carrot powders were compared in terms of drying method, drying method did not change the TPC statistically, but the powders obtained by the hot air drying method had a lower TPC numerically. When the black carrot powders were evaluated among themselves in terms of drying method, it was determined that the TPC of black carrot powder obtained by freeze-drying method was significantly higher than the TPC of black carrot powder obtained by other methods. Presence of phenolic compounds in carrots contributes to sensory qualities such as color (Zhang et al., 2005), bitterness (Kreutzmann et al., 2008) and aroma (Nacz & Shahidi, 2003). Therefore, the response of phenolic compounds can be used as a good indicator to evaluate the quality of vegetables during processing and storage (Gonçalves et al., 2010). In general, it was determined that black carrot powders had higher antioxidant activity and TPC amount than orange carrot powders.

For the orange carrot powders, β -carotene content obtained by freeze-drying method (48.72 mg/100g) was found to be higher than that of powders dried in microwave and hot air (39.34 and 40.35 mg/100g) (Table 2). For black carrot powders, the highest amount of TA was determined in the freeze-drying powder (424.66 mgCGE/100g), followed by microwave (344.24 mgCGE/100g) and hot air (259.08 mgCGE/100g) dried samples. The amounts of β -carotene and TA of orange and black carrot powders obtained by freeze-drying method were found to be higher than powders obtained by other methods. By the fact that the application temperature of the freeze-drying process is low and the drying process takes place under a high vacuum, which reduces the oxidation and degradation of β -carotene and similar microcomponents (Cui et al., 2008; Lin et al., 1998).

Mineral contents

The mineral analysis results of orange and black carrot powders prepared with different drying methods are given in Table 3. Ca, Fe, K, Mg, P and Zn content of carrot powders ranged between 396.27-418.13 mg/100g, 1.29-1.92 mg/100g, 224.23-297.13 mg/100g, 288.98-368.74 mg/100g, and 1.42-2.92 mg/100g. The applied drying methods did not cause a statistical change on the mineral substance content of orange and black carrot powders. Fe, K, Mg and P content of black carrot powders had higher than that of orange one.

DISCUSSION

In this study, the color values, some chemical and bioactive components of orange and black carrot powders prepared using different drying methods were compared. When the results are evaluated in terms of carrot variety; black carrot powder had lower L*, a* and b* color values and generally higher ash, antioxidant activity, TPC and mineral substance amounts than orange carrot powder. In the comparison made according to the drying method; higher lightness, TPC, β -carotene and TA values were obtained in the carrot powders obtained by the freeze-drying method compared to other drying methods.

Table 2. Chemical and bioactive component results of carrot powders produced with different drying methods

Carrot varieties	Drying method	Ash (%)	Protein (%)	Fat (%)	Antioxidant activity (%)	TPC (mgGAE/100g)	β-carotene (mg/100g)	TA (mgCGE/100g)
Orange	Hot air	5.71±0.07 b	7.93±1.95 a	2.16±0.25 a	75.16±5.40 b	263.50±5.50d	40.35±1.12 b	nd
	Microwave	5.69±0.07 b	7.93±0.40 a	2.08±0.14 a	75.70±5.02 b	430.00±17.80c	39.34±0.85 b	nd
	Freeze-drying	5.68±0.03 b	7.97±0.21 a	2.15±0.18 a	76.60±4.74 b	470.90±16.80c	48.72±0.69 a	nd
Black	Hot air	5.88±0.92 a	8.49±0.52 a	2.55±0.76 a	87.52±1.19 ab	596.10±16.70b	nd	259.08±9.76c
	Microwave	5.84±0.03 a	8.54±0.28 a	2.53±0.20 a	87.69±0.89 ab	742.80±21.70b	nd	344.24±6.67b
	Freeze-drying	5.83±0.03 a	8.55±0.23 a	2.59±0.20 a	95.75±3.50 a	1353.40±134.6 0a	nd	424.66±9.01a

Means with the different letter within a column are significantly different ($p < 0.05$). Results are dry matter basis. TPC: Total phenolic content. TA: Total anthocyanin.

Table 3. Mineral matters (mg/100g) of carrot powders produced with different drying methods

Carrot varieties	Drying method	Ca	Fe	K	Mg	P	Zn
Orange	Hot air	403.48±3.18a	1.30±0.06b	1630.90±58.8b	224.23±5.47b	293.19±4.16b	2.92±0.14a
	Microwave	396.27±8.40a	1.29±0.10b	1619.20±24.0b	234.23±7.10b	290.88±12.55b	2.84±0.17a
	Freeze-drying	396.27±4.65a	1.31±0.04b	1623.70±30.4b	235.44±8.75b	288.98±12.40b	2.83±0.23a
Black	Hot air	418.13±3.20a	1.89±0.03a	2296.90±101.0a	296.00±14.90a	361.48±8.79a	1.42±0.23b
	Microwave	414.94±7.13a	1.92±0.04a	2295.50±1.60a	287.07±4.31a	368.74±3.52a	1.50±0.03b
	Freeze-drying	417.69±7.25a	1.90±0.06a	2299.70±4.80a	297.13±7.28a	355.64±10.51a	1.47±0.04b

Means with the different letter within a column are significantly different ($p < 0.05$). Results are dry matter basis.

REFERENCES

- AACC, (1999). American Association of Cereal Chemists (AACC), Method 14–50.01, in *Approved Methods of the AACC*. AACC, St Paul, MN
- Akubor, P. I., & John Ike, E. Z. E. (2012). Quality evaluation and cake making potential of sun and oven dried carrot fruit. *International Journal of Biosciences*, 2(10).
- Banga, O., & De Bruyn, J. W. (1964). Carotenogenesis in carrot roots. *Netherlands Journal of Agricultural Science*, 12(3), 204–220. <https://doi.org/10.18174/njas.v12i3.17521>
- Beta, T., Nam, S., Dexter, J. E., & Sapiststein, H. D. (2005). Phenolic Content and Antioxidant Activity of Pearled Wheat and Roller-Milled Fractions. *Cereal Chemistry Journal*, 82(4), 390–393. <https://doi.org/10.1094/CC-82-0390>
- Chen, Q., Bi, J., Chen, R., Liu, X., Wu, X., & Zhou, M. (2017). Comparative study on drying characteristic, moisture diffusivity, and some physical and nutritional attributes of blanched carrot slices. *Journal of Food Processing and Preservation*, 41(5). <https://doi.org/10.1111/jfpp.13201>
- Cui, Z. W., Li, C. Y., Song, C. F., & Song, Y. (2008). Combined microwave-vacuum and freeze drying of carrot and apple chips. *Drying Technology*, 26(12), 1517–1523. <https://doi.org/10.1080/07373930802463960>
- Ficco, D. B. M., De Simone, V., Colecchia, S. A., Pecorella, I., Platani, C., Nigro, F., Finocchiaro, F., Papa, R., & De Vita, P. (2014). Genetic variability in anthocyanin composition and nutritional properties of blue, purple, and red bread (*Triticum aestivum* L.) and durum (*Triticum turgidum* L. ssp. *turgidum* convar. *durum*) wheats. *Journal of Agricultural and Food Chemistry*, 62(34), 8686–8695. <https://doi.org/10.1021/jf5003683>
- Gabelman, W. H. (1974). The Prospects for Genetic Engineering to Improve Nutritional Values. In *Nutrition Qualities of Fresh Fruits and Vegetables*, White, P., Selvey, N., Eds.; Academic Press: New York, 147-155
- Gómez-Meza, N., Noriega-Rodríguez, J. A., Medina-Juárez, L. A., Ortega-García, J., Cázarez-Casanova, R., & Angulo-Guerrero, O. (1999). Antioxidant activity in soybean oil of extracts from thompson grape bagasse. *Journal of the American Oil Chemists' Society*, 76(12), 1445. <https://doi.org/10.1007/s11746-999-0182-4>
- Gao, L., Wang, S. D., Oomah, B. D. D., & Mazza, G. (2002). Wheat quality: Antioxidant activity of wheat millstreams. In *Wheat quality elucidation*.
- Gonçalves, E. M., Pinheiro, J., Abreu, M., Brandão, T. R. S., & Silva, C. L. M. (2010). Carrot (*Daucus carota* L.) peroxidase inactivation, phenolic content and physical changes kinetics due to blanching. *Journal of Food Engineering*, 97(4). <https://doi.org/10.1016/j.jfoodeng.2009.12.005>
- Gong, Y., Deng, G., Han, C., & Ning, X. (2015). Process optimization based on carrot powder color characteristics. *Engineering in Agriculture, Environment and Food*, 8(3). <https://doi.org/10.1016/j.eaef.2015.07.005>
- Gyamfi, M. A., Yonamine, M., & Aniya, Y. (1999). Free-radical scavenging action of medicinal herbs from Ghana. *General Pharmacology: The Vascular System*, 32(6), 661–667. [https://doi.org/10.1016/S0306-3623\(98\)00238-9](https://doi.org/10.1016/S0306-3623(98)00238-9)
- Howard, L. R., Braswell, D. D., & Aselage, J. (1996). Chemical composition and color of strained carrots as affected by processing. *Journal of Food Science*, 61(2), 327–330. <https://doi.org/10.1111/j.1365-2621.1996.tb14187.x>
- Kamiloglu, S., Capanoglu, E., Bilen, F. D., Gonzales, G. B., Grootaert, C., Van de Wiele, T., & Van Camp, J. (2016). Bioaccessibility of Polyphenols from Plant-Processing Byproducts of Black Carrot (*Daucus carota* L.). *Journal of Agricultural and Food Chemistry*, 64(12), 2450–2458. <https://doi.org/10.1021/acs.jafc.5b02640>

- Kreutzmann, S., Christensen, L. P., & Edelenbos, M. (2008). Investigation of bitterness in carrots (*Daucus carota* L.) based on quantitative chemical and sensory analyses. *LWT*, *41*(2).
<https://doi.org/10.1016/j.lwt.2007.02.024>
- Lee, J., Kim, M., Park, K., & Choe, E. (2003). Lipid oxidation and carotenoids content in frying oil and fried dough containing carrot powder. *Journal of Food Science*, *68*(4).
<https://doi.org/10.1111/j.1365-2621.2003.tb09634.x>
- Lin, T. M., D. Durance, T., & Scaman, C. H. (1998). Characterization of vacuum microwave, air and freeze dried carrot slices. *Food Research International*, *31*(2), 111–117.
[https://doi.org/10.1016/S0963-9969\(98\)00070-2](https://doi.org/10.1016/S0963-9969(98)00070-2)
- Naczki, M., & Shahidi, F. (2003). Phenolic Compounds in Plant Foods: Chemistry and Health Benefits. *Preventive Nutrition and Food Science*, *8*(2).
<https://doi.org/10.3746/jfn.2003.8.2.200>
- Prakash, S., Jha, S. K., & Datta, N. (2004). Performance evaluation of blanched carrots dried by three different driers. *Journal of Food Engineering*, *62*(3), 305–313.
[https://doi.org/10.1016/S0260-8774\(03\)00244-9](https://doi.org/10.1016/S0260-8774(03)00244-9)
- Rodriguez, G. R., Raina, B. L., Pantastico, E. B., Bhatti, M. B., (1975). Quality of raw material for processing-postharvest physiology: Harvest indices in Postharvest Physiology, Handling and Utilization of Tropical and Subtropical Fruits and Vegetables (E.B. Pantastico, Ed.), AVI, Westport, CT, p.56.
- Simon, P. W., & Wolff, X. Y. (1987). Carotenes in Typical and Dark Orange Carrots. *Journal of Agricultural and Food Chemistry*, *35*(6). <https://doi.org/10.1021/jf00078a038>
- Skujins, S. (1998). Handbook for ICP – AES (Vartian-Vista), a short guide to vista series ICP–AES operation, *Variant Int. AG, Zug, version 1.0*, Switzerland.
- Slinkard, K., & Singleton, V. L. (1977). Total Phenol Analysis: Automation and Comparison with Manual Methods. *American Journal of Enology and Viticulture*, *28*(1).
<https://doi.org/10.5344/ajev.1974.28.1.49>
- Wagner, L. A., & Warthesen, J. J. (1995). Stability of Spray-Dried Encapsulated Carrot Carotenes. *Journal of Food Science*, *60*(5). <https://doi.org/10.1111/j.1365-2621.1995.tb06290.x>
- Wang, J., & Xi, Y. S. (2005). Drying characteristics and drying quality of carrot using a two-stage microwave process. *Journal of Food Engineering*, *68*(4), 505–511.
<https://doi.org/10.1016/j.jfoodeng.2004.06.027>
- Xiao, H. W., Gao, Z. J., Lin, H., & Yang, W. X. (2010). Air impingement drying characteristics and quality of carrot cubes. *Journal of Food Process Engineering*, *33*(5), 899–918.
<https://doi.org/10.1111/j.1745-4530.2008.00314.x>
- Zhang, Q., Tan, S., McKay, A., & Yan, G. (2005). Carrot browning on simulated market shelf and during cold storage. *Journal of the Science of Food and Agriculture*, *85*(1).
<https://doi.org/10.1002/jsfa.1931>

NUTRITIONAL VALUE AND UTILIZATION POSSIBILITIES OF BULGUR INDUSTRY BY-PRODUCTS IN CEREAL PRODUCTS

Öznur EYMİR¹, Selman TÜRKER²

¹*Necmettin Erbakan University, Meram Vocational School, Department of Food Processing, Konya, Turkey*

²*Necmettin Erbakan University, Engineering Faculty, Food Engineering Department, Konya, Turkey*

Corresponding author e-mail: oznuireymir@gmail.com

ABSTRACT

Bulgur is a semi-ready-to-eat cereal product with high nutritional and functional properties. Bulgur is commonly produced from *Tr. durum*. The bulgur production process basically consists of cooking, drying, grinding and classification stages. By-products rich in functional and nutritional components emerge in the intermediate stages of the bulgur production process. Some of these products are used as animal feed. However, bulgur by-products such as bulgur bran, bulgur flour and düğürcük are rich in protein, dietary fiber, bioactive components and mineral contents. In addition, phytic acid in bulgur bran and bulgur flour is quite low compared to untreated ones due to the application of pressure cooking during bulgur production. Bulgur by-products can be used in different ratios in the production of various cereal products such as bread, pasta, noodles, biscuits, crackers and tarhana, and contribute to the nutritional and functional properties of these products. In this study, the use of bulgur process by-products in various cereal products and their effects on the nutritional, functional and technological properties of these products were compiled.

Keywords: Bulgur, bulgur bran, bulgur flour, düğürcük.

INTRODUCTION

Bulgur, which has been consumed in Anatolia and Mesopotamia for centuries, is a gelatinized whole wheat product produced from durum wheat. Bulgur is also one of the first foodstuffs processed in the world and the main stages in its production are cleaning, cooking, drying, peeling, crushing, sieving and sorting.

Bulgur is an important wheat product with high dietary fiber content and low glycemic index, with 18.3 grams of dietary fiber per 100 grams. Its dietary fiber content is 3.5, 6.8, 1.8, 2.3, 2.3, 1.3 and 4.3 times higher than rice, wheat flour, oatmeal, wholemeal bread, soybeans and pasta, respectively (Bayram and Öner, 2007; Yıldırım et al., 2008a, 2008b).

Nutritionally, bulgur contains relatively high protein and fiber content, resistant starch, B vitamins, minerals and phytochemicals such as lutein and ferulic acid (Stone et al., 2020).

In the production process, especially in the cooking process; bulgur, in which nutrient loss is prevented by absorbing the vitamins, minerals and other nutrients that pass into the cooking water into the wheat, is a food close to whole wheat in terms of essential nutrients and has a very high nutritional value (Öner, 2002).

As a result of the production technique, bulgur preserves the water-soluble nutrients carried to the inner parts of the grain more effectively, while the hard-glassy grain structure

consisting of gelatinized starch and coagulated protein increases the resistance to long-term storage and pests by destroying biological and biochemical activity (Elgün et al., 1986).

During the processing of wheat into various products, high amounts of by-products are obtained. As a result of bulgur production, 20% of by-products such as bulgur bran, bulgur flour and bagels are produced. Bulgur bran is a by-product obtained as a result of stoning wheat in peeling machines after boiling and drying it in bulgur production. Bulgur flour is a by-product separated by passing through a 0.25 mm sieve in the classification process applied to wheat after the peeling and crushing processes. Simit (dügürçük) is a by-product that is separated by passing through a 0.75 mm sieve during the classification of crushed wheat (Hançer, 2010).

Cereal bran is a good source of dietary fiber. However, they contain high amounts of phytic acid, which can lead to some nutritional problems. In addition, cereal bran supplementation reduces the technological quality of food products. Reducing substances and proteolytic enzymes in the aleurone part of wheat bran weaken the gluten structure of dough and adversely affect the rheological properties of dough (Grosch and Wieser, 1999; Every et al. 2006). Bulgur bran does not contain an aleurone layer and its phytic acid content is low and its dietary fiber content is quite high due to the heat treatment applied during the production process (Balcı and Bayram, 2015). The total dietary fiber contents of bulgur flour, bulgur bran and düğürçük were found to be 56.2%, 69.0% and 21.1%, respectively (Hançer, 2010).

In this study, the use of bulgur bran, bulgur flour and düğürçük, which are produced as waste during bulgur production, in cereal products was reviewed.

USE IN CEREAL PRODUCTS

The by-products of bulgur, which is widely consumed in our country and in many countries around the world, have become more important with the determination of its nutritional value and have started to be used by researchers to increase the nutritional and functional value of the product to which it is added in many formulations, especially bread and pasta.

Baumgartner (2018) applied the microfluidization process to bulgur and chickpea bran and used it in bread production. The addition of microfluidized bran at an increasing rate negatively affected the rheological properties of the dough and the textural and sensory properties of the bread. However, the microfluidization process slightly reduced the negative effects of the bran. As a result of this study, microfluidized bulgur and chickpea bran were reported to be sources of dietary fiber with low phytic acid content. The addition of bran increased the dietary fiber, phenolic content and antioxidant activity of the bread depending on the amount added, and this increase was more pronounced in microfluidized bran.

To develop short-cut pasta-type couscous, *Triticum durum* semolina and bulgur flour (sifted bulgur) were substituted at various concentrations. It was determined that weight gain, total flavonoid content, protein, ash and crude fiber content, hardness, stickiness, stickiness, gumminess, chewiness and elasticity values of the samples were affected by bulgur flour substitution, but elasticity, bulk density, total phenolic content and DPPH antioxidant activity values were not affected (Yüksel, Öner, & Bayram, 2017).

In a study conducted by adding bulgur bran of 3 different particle sizes (200µm, 400µm and 850µm) at different ratios (0, 5, 10, 15 and 20%) to two different biscuit flours (A and B), bulgur bran significantly increased the total, soluble and insoluble dietary fiber amounts of biscuits depending on the ratio and particle size, and the highest values were observed in samples obtained by adding 20% of bulgur bran at 850µm size (Özkeser, 2015).

Wheat flour was used to make biscuits by replacing 10% of wheat flour with cereal by-products such as wheat, barley, oat and bulgur bran, poppy meal and germ. Some physical and sensory properties of the biscuits were measured and water absorption capacity and dough development time were slightly affected by the addition of these by-products. Apart from the addition of germ, the addition of cereal by-products mostly decreased the whiteness, spreading rate and general acceptability of the biscuit samples and increased the hardness (Yağcı, 2019).

In a study investigating the effects of bulgur by-products (bulgur flour: BU, bulgur bran: BK, düğürcük: D) on tarhana quality; bulgur by-products were used at the rates of 5%, 10%, 15%, 20%, 25% and 30%, the additions of BU, BK and D increased the protein and ash contents of tarhana, and the total dietary fiber contents of tarhana containing 20% BU and 15% BK, which were found to be sensory acceptable, were found to be 4 times higher than the total dietary fiber content of the control sample (Hançer, 2010).

In a study in which instant soup production was aimed by using düğürcük in tarhana, tarhana was produced by using two different proportions (50 and 100%) of düğürcük and the sensory properties and solubility values of the tarhana samples obtained were examined. It was concluded that tarhana containing 50% düğürcük could be used as instant soup and was liked in terms of appearance, structure and mouthfeel (Yurttaş et al., 2003).

RESULTS AND DISCUSSION

Wheat bran consists of the outer pericarp, inner pericarp, testa, hyaline layer, aleurone layer and some attached starchy endosperm residues (Hemery et al., 2011). However, bulgur bran is obtained from the outer layers of the bulgur grain, but unlike wheat bran, it does not contain the aleurone layer. While the phytic acid content of bulgur bran is very low due to the heat treatment applied during the production process (Balçı and Bayram, 2015), the dietary fiber content of bulgur bran is quite high compared to other cereal bran. Despite these advantages, studies on the inclusion of bulgur bran in foods are limited.

Bulgur flour, bulgur bran and düğürcük (simit) are by-products that occur during bulgur production. According to research (depending on the yield, process and technique used), the amount of by-products constitutes approximately 15% of the total amount of bulgur produced and the price is around 100-200 USD/ton. These products, which have high nutritional value, are currently used only as animal feed. It is important to increase the studies on their utilization in cereal products and to transform them into value-added products.

REFERENCES

- Balçı, F., & Bayram, M. 2015. Improving the color of bulgur: New industrial applications of tempering and UV/sun-light treatments. *Journal of Food Science and Technology*, 52, 5579–5589. <https://doi.org/10.1007/s13197-014-1687-x>
- Baumgartner, B. 2018. Mikrofludizasyon ve mekanik öğütme uygulanmış bulgur ve nohut kepeğinin ekmeğin fonksiyonel özellikleri ve kalitesi üzerine etkisi.
- Bayram M., Öner M.D. 2003. Bulgur sektör incelemesi, Gaziantep Üniversitesi Müh. Fak., Gaziantep.
- Bayram M., Öner M.D. 2005. Stone, disc and hammer milling of bulgur. *J Cereal Sci* 41:291–296.
- Bayram M., Öner M.D. 2007. Bulgur milling using roller, double disc and vertical disc mills. *J Food Eng* 79:181–187.

- Elgün, A., Ertugay, Z. ve Certel, M. 1986. Mısır bulguru üzerine bir araştırma. Gıda Sanayi Araştırma Geliştirme Sempozyumu, 7-10 Nisan, 77-83, İzmir.
- Every, D., Morrison, S., Simmonds, L. and Ross, M. 2006. Distribution of glutathione in millstreams and relationships to chemical and baking properties of flour. *Cereal Chemistry*, 83(1), 57-61.
- Grosch, W. and Wieser, H. 1999. Redox reactions in wheat dough as affected by ascorbic acid. *Journal of Cereal Science*, 29(1), 1-16.
- Hançer, A. 2010. Besinsel liflerin tarhana üretiminde kullanımı. Yüksek lisans tezi, İnönü Üniversitesi, Fen Bilimleri Enstitüsü, Gıda Mühendisliği Anabilim Dalı, Malatya.
- Hemery, Y., Holopainen, U., Lampi, A.M., Lehtinen, P., Nurmi, T., Piironen, V., Edelman, M., Rouau, X. 2011. Potential of dry fractionation of wheat bran for the development of food ingredients, part II: Electrostatic separation of particles, *Journal of Cereal Science*, Volume 53, Issue 1, Pages 9-18, <https://doi.org/10.1016/j.jcs.2010.06.014>.
- Öner, M.D. 2002. Bulgur sanayi, sorunları ve çözüm önerileri. *Hububat 2002*, Hububat Ürünleri Teknolojisi Kongre ve Sergisi, 3-4 Ekim, 39-48, Gaziantep.
- Özboy Özbaş, Ö., Hançer, A., & Gökbulut, İ. 2014. Utilization of Bulgur By-Products in the Production of Tarhana. *Academic Journal of Science*, 3(2).
- Özkeser, I. 2015. Lif kaynağı olarak bulgur kepeğinin bisküvide kullanım olanakları. Yüksek lisans tezi, Ankara Üniversitesi, Fen Bilimleri Enstitüsü, Gıda Mühendisliği Anabilim Dalı, Ankara.
- Saka, İ., Özkaya, H., & Özkaya, B. 2020. Potential utilization of bulgur bran as a source of dietary fiber in cookies. *Cereal Chemistry*, 97(5), 930-939.
- Stone, A. K., Wang, S., Tulbek, M., Koksel, F., & Nickerson, M. T. 2020. Processing and quality aspects of bulgur from Triticum durum. *Cereal Chemistry*, 97(6), 1099-1110.
- Yağcı, S. 2019. Rheological properties and biscuit production from flour blends prepared from cereal based by-products. *Harran Tarım ve Gıda Bilimleri Dergisi*, 23(2), 142-149.
- Yıldırım A., Bayram M., Öner M.D. 2008a. Bulgur milling using a helical disc mill. *J Food Eng* 87:564–570
- Yıldırım A., Bayram M., Öner M.D. 2008b. Ternary milling of bulgur with four rollers. *J Food Eng* 84:394–399
- Yuksel, A. N., Öner, M. D., Bayram, M. 2017. Usage of undersize bulgur flour in production of short-cut pasta-like couscous. *Journal of Cereal Science*, 77, 102-109.
- Yurttaş, Ö. , Bilgiçli, N. & Elgün, A. 2003. Dügürçük Katkılı İntant Tarhana Çorbası Üretimi Üzerine Bir Araştırma. *Akademik Gıda*, 1 (5), 10-14. Retrieved from <https://dergipark.org.tr/en/pub/akademik-gida/issue/55872/765453>

UTILIZATION OF DILL, PARSLEY AND GREEN ONION POWDERS IN THE CRACKER FORMULATION

Öznur EYMİR

*Necmettin Erbakan University, Meram Vocational School, Department of Food Processing,
Konya, Turkey*

Corresponding author e-mail: oznuireymir@gmail.com

ABSTRACT

In this study, dill, parsley and green onion powders were used in functional cracker production. After dill, parsley and green onions were dried and ground, they were sieved through a 500 µm sieve and used in the cracker formulation at four different ratios (0, 1, 3, 5%). The effect of dill, parsley and green onion powders on color, physical, textural and sensory properties of crackers was determined. Some quality characteristics of cracker samples containing dill, parsley and green onion powder were compared with control crackers prepared with refined wheat flour. L*, a*, b*, SI and Hue values of the cracker samples changed between 55.81-72.95, -6.37-2.22, 37.79-41.51, -87.47-86.63 and 37.86-41.58, respectively. All utilization levels of dill, parsley and green onion powder decreased the lightness of the cracker samples. As the proportion of dill, parsley and green onion powder increased in the cracker formulation, the thickness value of the cracker samples decreased, and the spread values increased. While the use of dill, parsley and green onion powder in cracker formulation did not have a significant effect on the hardness value of the samples, the fracturability values of the samples containing green onions were found to be higher.

Keywords: Cracker, dill powder, Parsley powder, green onion powder.

INTRODUCTION

Functional and nutritional products such as herbs, fruits and vegetables can be added to wheat flour to improve the nutritional value and health-promoting properties of food products (Dziki et al., 2014). Spices and herbs have been added to foods since ancient times, not only as flavoring agents but also as food preservatives. It has also been used in folk medicine (Kabić et al., 2008).

Anethum graveolens L. or European dill grows mostly in the European Mediterranean region, in the central and southern parts of Asia. India, Pakistan, USA, Mexico, Germany and the Netherlands are the top producers of dill (Kulkarni et al., 2012). Dill has long been used as a spice in different countries to season and flavor a variety of foods such as rice, sauces, salads, side dishes and soups (Jana and Shekhawat, 2010). A recent systematic review and meta-analysis of the effects of dill ingestion on glycemic index and lipid profiles and in adults shows that dill improves insulin resistance and serum low-density lipoprotein. A recent publication evaluating the effectiveness of dill supplementation on lipid profile in adults with cardiovascular risk factors showed significant improvement in all lipid profile components: Triglycerides, low-density lipoprotein cholesterol, Total cholesterol, and high-density lipoprotein cholesterol (Mansoori et al., 2021).

Parsley (*Petroselinum Crispum* Mill.) is a popular vegetable of the Apiaceae family and is native to Southwestern Europe and Western Asia. Parsley is a medicinal herb and has been

widely used in the Mediterranean for over 2000 years. It is currently grown as a spice for use in cuisines around the world (Punoševac et al., 2021). Parsley leaves are a rich source of essential oils, vitamins A and C, potassium, iron and ascorbic acid (Dobričević et al., 2019). Dirim and Koç (2019) investigated the properties of noodles enriched with parsley (2, 4, 6 and 8 weight percent); and reported that vitamin C, chlorophyll and carotenoid contents increased with the addition of parsley. They reported that noodles enriched with 2% parsley had the highest score in sensory evaluation. Sęczyk et al. (2015) reported that enrichment of pasta with dried and powdered PL increased the antioxidant capacity of pasta.

Onion has many medicinal properties such as antibiotic effect, lowering blood sugar and plasma cholesterol levels, antihyperlipidemia, thrombolysis, antiplatelet aggregation, prevention of rheumatoid arthritis and diuretic effects. Onions are also known to contain characteristic volatile substances that are produced enzymatically when tissue is injured. The substrates for the production of these volatiles are known to be alkyl cysteine sulfoxides and amino acid derivatives of cysteine. These derivatives cause various reactions to the sulfur-containing volatile substances of disulfides (Seguchi and Abe, 2003).

This study aimed to investigate the effects of dill, parsley and green onion powders on cracker's L*, a*, b*, Hue and SI color values, physical properties such as diameter, thickness and spread rate, as well as textural properties such as hardness and fracturability.

MATERIALS AND METHODS

Materials

Fresh dill, parsley and green onion, wheat flour (Hekimoğlu, Konya, Turkey), shortening, salt, powdered sugar, baking powder, and baker's yeast were obtained from the local bazaar in Konya (Turkey). Protease enzyme was procured from Vatan Enzyme (İstanbul, Turkey).

Preparation of the dill, parsley and green onion powders

The fresh dill, parsley and green onion were dried in a dry air dryer at 60 ± 2 °C for 12 hours. After drying, the dried dill, parsley and green onion samples were ground and sieved through a 212 µm sieve to obtain the dill powder, parsley powder and green onion powder.

Cracker production

Crackers were prepared according to a slight modification of the procedure reported by Davidson (2016). For control cracker preparation wheat flour (100 g), shortening (20 g), table salt (1.6 g), powdered sugar (1.5 g), baking powder (1.5 g), baker's yeast (0.2 g) and protease (0.01 g) were mixed in the mixer (Hobart N50, Canada Inc., North York, Ontario, Canada) until a homogeneous dough was obtained. The dough was fermented at room conditions for 20 minutes. Then, the fermented dough was formed into a 1 mm thick layer between two glass plates and shaped with a 50 mm diameter biscuit mold. It was baked in an oven (Vestel SF8401, Manisa, Turkey) for 11 minutes at 180°C. Other crackers were prepared by replacing wheat flour with 1%, 3%, and 3% levels of dill powder, parsley powder and green onion powder.

Color properties

Color measurement of cracker samples was performed using the Minolta CR 400 (Chroma Meter, Osaka, Japan). The measurement was made on the five different points on the surface of the crackers. L* (lightness, darkness), a* (red, green) and b* (yellow, blue) values were measured in cracker samples. Hue (color essence) value was calculated with $\arctan(b^*/a^*)$ formula and SI (saturation index) value was calculated with $(a^{*2}+b^{*2})^{1/2}$ formula.

Physical properties

The diameter, thickness, spread ratio and textural properties of the end products were determined. The diameter and thickness were measured using five sample pieces by a caliper (Mitutoyo, Tokyo, Japan) according to the AACC method 10-54 (AACC, 2010) and values were reported in millimeters. The cracker spread ratio was determined by dividing the diameter by thickness.

The hardness and fracturability value of the crackers were evaluated by three-point bending (HDP/3 PB) tests on a TA-XT plus texture analyzer (Stable Micro Systems, Surrey, UK) equipped with 5 kg loading cell. The measurement conditions of the texture analyzer were as follows: pre-test speed, 1.0 mm/s; test speed 1.0 mm/s; post-test speed, 10.0 mm/s. In the hardness value measurements, 5 measurements were made for each sample and it was studied in 2 replications.

Statistical analysis

All analyses were performed in duplicate. For statistical analysis, the JMP statistical program, version 10.0 (SAS Institute Inc., Cary, NC, USA) was used.

RESULTS AND DISCUSSION

Color properties

Color values of cracker samples prepared with dill, parsley and onion powder are given in Table 1. When the results were evaluated in terms of the type of powder used, the use of dill powder produced statistically darker crackers than parsley and onion powder ($p < 0.05$). However, the a^* value of the cracker samples produced using onion powder was higher than the average a value of the samples with dill and parsley powder, and the b and SI values were numerically lower, but this difference was statistically insignificant. These observed effects might be related to the color properties of the raw materials (data not shown). Values of L^* , a^* , and b^* attributes were found at 72.76, 2.22, and 37.57 for control crackers. With the increasing use of dill, parsley and green onion powder compared to the control, the L^* and a^* values decreased, while the b^* value showed an increasing trend in the cracker samples ($p \leq 0.05$). Such color changes in crackers may be contributed by pigments such as chlorophyll a and b , which provide greenery in purslane, as well as β -carotene, which provides yellowness.

Table 1. Color values of dill, parsley and onion powder-enriched crackers

	n	L^*	a^*	b^*	Hue	SI
<i>Powder type</i>						
Dill	8	62.98±7.00b	-2.68±3.39a	39.33±1.60a	93.72±4.81a	39.54±1.78a
Parsley	8	67.32±4.96a	-1.99±2.82a	39.35±1.43a	92.79±4.07a	39.48±1.49a
Onion	8	65.71±6.25a	-1.99±3.14a	38.74±1.32a	91.73±3.30b	38.81±1.33a
<i>Additive ratio (%)</i>						
0	6	72.76±0.19a	2.22±0.34a	37.57±0.76c	86.60±0.43d	37.64±0.78c
1	6	68.27±2.87b	-2.21±0.22b	38.55±0.84b	93.10±0.49c	38.61±0.84c
3	6	62.02±2.67c	-3.47±0.76c	39.76±0.71a	94.80±1.05b	39.91±0.72b
5	6	58.30±2.89d	-5.40±1.73d	40.66±0.94a	96.50±2.23a	40.95±1.07a

¹Means with the same letter within a column are not significantly different ($p > 0.05$). Hue: Hue angle. SI: Saturation index.

Physical properties of crackers

The effects of the dill, parsley and green onion powder on diameter, thickness and spread ratio and textural properties (hardness and fracturability) of the cracker samples are shown in Table 2. The diameter value of crackers containing parsley powder (48.12 mm) was higher than crackers prepared with dill and green onion powders (48.16 mm and 48.11 mm). Although there are numerical differences between the thickness and spread values of the crackers produced from different powders, they were found to be statistically similar. The increasing dill, parsley and green onion powder ratio from 0 to 5% increased the diameter and spread ratio value of crackers samples but decreased the thickness value. The diameter, thickness and spread ratio values of crackers ranged between 47.65 and 48.68 mm, between 3.85 and 4.63 mm and between 10.29 and 12.66, respectively. The spreading rate indicates the rising ability of the biscuits and is controlled by the viscosity of the dough as low viscosity allows the biscuits to spread more quickly (Ho et al., 2016; Zouri et al., 2016). Increasing the use of dill, parsley and green onion powder increased the spread rate, which may be associated with low gluten content. Ramashia, et al. (2021) reported that the incorporation of *P. curatellifolia* peel flour decreased the gluten protein of composite flours, and this caused a low viscosity of the dough. Similar results were observed by Nassar et al. (2008) where the inclusion of citrus peel flour improved the diameter of biscuits.

Table 2. Physical properties of dill, parsley and onion powder-enriched crackers

	n	Diameter (mm)	Thickness (mm)	Spread ratio (W/T)	Hardness (g)	Fracturability (mm)
<i>Powder type</i>						
Dill	8	48.16±0.39b	4.35±0.37a	11.15±1.05a	40104.82±84.21a	3.54±0.43b
Parsley	8	48.42±0.65a	4.22±0.35a	11.56±1.10a	40165.33±77.15a	3.76±0.40ab
Onion	8	48.11±0.34b	4.15±0.39a	11.68±0.93a	40109.04±108.58a	3.99±0.62a
<i>Additive ratio</i> (%)						
0	6	47.65±0.11c	4.63±0.17a	10.29±0.42d	40217.34±22.80a	3.39±0.38b
1	6	48.16±0.41b	4.36±0.38b	11.10±0.71c	40158.72±67.08ab	3.62±0.27b
3	6	48.46±0.23a	4.12±0.16bc	11.78±0.50b	40091.95±54.66bc	3.81±0.25ab
5	6	48.68±0.32a	3.85±0.09c	12.66±0.32a	40037.57±91.32c	4.23±0.67a

¹Means with the same letter within a column are not significantly different ($p > 0.05$).

The textural properties of the samples are shown in Table 2. The hardness of crackers was not significantly affected by incorporating the dill, parsley and green onion powders. The partial replacement of wheat flour with dill, parsley and green onion powders led to a decrease in crackers' hardness and a decrease in crackers' fracturability. The hardness and fracturability values, which were determined as 40217.34 g and 3.39 mm in the control cracker samples, changed at 40037.57 g and 4.23 mm, respectively, with the use of 5% dill, parsley and green onion powders. Similarly, Sadeghzadeh Benam et al. (2021) reported that the hardness values (4.70-3.85 N) of bread enriched with 5% and 15% purslane leaf powder decreased depending on the increase in the enrichment level.

CONCLUSION

The findings of this study showed that dill, parsley and green onion powders can be used in cracker production. The powder type affected the L*, Hue, diameter and fracturability properties. The use of dill powder led to more dark crackers and green onion powder to lower the Hue value of crackers. When cracker samples were compared in terms of textural properties, no significant difference was observed between the hardness values of dill, parsley and green

onion powder added samples. Usage of dill, parslane and onion powders, L* and a* values were decreased in the samples. While the cracker samples with 3-5% powder added showed higher diameter and spread rate and breakability values than the others, the addition of dill, increasing parsley and onion powder made the cracker samples thinner and softer.

REFERENCES

- AACC, (2010). Approved Methods of Analysis, 11th Ed. Methods 10-52, 10-54, and 56-11. Available online only. AACC International: St. Paul, MN.
- Davidson, I. (2018). *Biscuit, cookie and cracker production: process, production and packaging equipment*. Academic Press.
- Dirim, S. N., & Koç, G. Ç. (2019). Functional properties of parsley fortified homemade Turkish noodles (Erişte). *Croatian journal of food science and technology*, 11(1), 88-96.
- Dobričević, N., Šic Žlabur, J., Voća, S., Pliestić, S., Galić, A., Delić, A., & Fabek Uher, S. (2019). Bioactive compounds content and nutritional potential of different parsley parts (*Petroselinum crispum* Mill.). *Journal of Central European Agriculture*, 20(3), 900-910.
- Dziki, D., Różyło, R., Gawlik-Dziki, U., & Świeca, M. (2014). Current trends in the enhancement of antioxidant activity of wheat bread by the addition of plant materials rich in phenolic compounds. *Trends in Food Science & Technology*, 40(1), 48-61.
- Ho, L. H., & Abdul Latif, N. W. B. (2016). Nutritional composition, physical properties, and sensory evaluation of cookies prepared from wheat flour and pitaya (*Hylocereus undatus*) peel flour blends. *Cogent Food & Agriculture*, 2(1), 1136369.
- Jana, S., & Shekhawat, G. S. (2010). *Anethum graveolens*: An Indian traditional medicinal herb and spice. *Pharmacognosy reviews*, 4(8), 179.
- Kabić, D., A. Mišan, M. Sakač, Đ. Psodorov and I. Milovanović, 2008. Medical plant mixtures as additives in functional bakery food production. *Food Processing, Quality and Safety* 35(3):119- 123.
- Kulkarni, R., Girish, K. J., & Kumar, A. (2012). Nootropic herbs (Medhya Rasayana) in Ayurveda: an update. *Pharmacognosy reviews*, 6(12), 147.
- Mansoori, A., Salimi, Z., Hosseini, S. A., Hormoznejad, R., & Asadi, M. (2021). The Effect of *Anethum Graveolens* L.(Dill) on Lipid Profile in Adults with Cardiovascular Risk Factors: A Systematic Review and Meta-Analysis of Controlled Clinical Trials. *Critical Comments in Biomedicine*, 2(1), 100-2.
- Nassar, A. G., AbdEl-Hamied, A. A., & El-Naggar, E. A. (2008). Effect of citrus by-products flour incorporation on chemical, rheological and organoleptic characteristics of biscuits. *World Journal of Agricultural Sciences*, 4(5), 612-616.
- Punoševac, M., Radović, J., Leković, A., & Kundaković-Vasović, T. (2021). A review of botanical characteristics, chemical composition, pharmacological activity and use of parsley. *Archives of Pharmacy*, 71(Notebook 3), 177-196.]
- Ramashia, S. E., Mamadisa, F. M., & Mashau, M. E. (2021). Effect of *Parinari curatellifolia* peel flour on the nutritional, physical and antioxidant properties of biscuits. *Processes*, 9(8), 1262.
- Sadeghzadeh Benam, N., Goli, M., Seyedain Ardebılı, S. M., & Vaezshoushtari, N. (2021). The quality characteristics of dough and toast bread prepared with wheat flour containing different levels of *Portulaca oleracea* leaf powder. *Food Science and Technology*, 42.
- Sęczyk, Ł., Świeca, M., & Gawlik-Dziki, U. (2015). Changes of antioxidant potential of pasta fortified with parsley (*Petroselinum Crispum* Mill.) leaves in the light of protein-phenolics interactions. *Acta Scientiarum Polonorum Technologia Alimentaria*, 14(1), 29-36.
- Seguchi, M., & Abe, M. (2003). Effect of Welsh onion (*Allium fistulosum* L.) on breadmaking properties. *Journal of food science*, 68(5), 1810-1813.

Zouari, R., Besbes, S., Ellouze-Chaabouni, S., & Ghribi-Aydi, D. (2016). Cookies from composite wheat–sesame peels flours: Dough quality and effect of *Bacillus subtilis* SPB1 biosurfactant addition. *Food chemistry*, *194*, 758-769.

BIOACTIVE COMPAUNDS IN COMMON MEDLAR FRUITS (*Mespilus germanica* L.) IN DEPENDANCE OF RIPENESS STATE

Suzana Jordanovska

¹ University "Mother Teresa" in Skopje, Faculty of Technological Sciences, Skopje, Republic of North Macedonia

Corresponding author e-mail: suzana.jordanovska@unt.edu.mk

ABSTRACT

Medlar (*Mespilus germanica* L.) is a plant rich in phytonutrients and antioxidants as bioactive compounds (BAC). It has numerous medical benefits on human health, especially in detoxification and purification from accumulated toxins. Its strong genetic potential and the ability to grow without using pesticides and similar chemical preparations gives it an advantage over almost all other fruits that can be consumed in the autumn and early winter days. In total 15 samples were purchased from the markets and the trade network, laboratory samples were prepared from them and the following parameters were analyzed in the laboratory, such as total solid soluble content (TSS, °Brix), total acidity (TA, %), ascorbic acid (AscA, mg 100 g⁻¹), total phenolics (TPh, mg GA/g FW), total flavonoids (TFl, mg CE/g FW) and anthocyanins (Ant, mg·g⁻¹ FW). The laboratory analyzes were carried out in two phases of medlar ripening, in phase 1 when the stone cells were 35-40% softened and in a second phase with 75-80% softening. With the ripening/softening of the fruits, the content of the investigated parameters TSS (28.93 phase 1 to 30.52 ph2), the content of TPh (6.72 phase 1 to 8.01 phase 2), the content of TI (3.11 phase 1 to 3.72 phase 2) and the content of anthocyanins (2.224 phase 1 to 2.76 phase 2) increases. Only the total acidity and the content of ascorbic acid decrease as the ripening of the fruits progresses (0.91 phase 1 to 0.78 phase 2; 44.51 phase 1 to 36.25 phase 2), respectively. Fluctuations in phytonutrient and antioxidant content with fruit ripening are expected and research indicates that fruit maturity should be above 70-75% to utilize the maximum potential of medlar fruit.

Keywords: Medlar, BAC, phytonutrients, antioxidants, ripeness.

INTRODUCTION

The food production and processing industry continuously develops through modeling and optimization new, renewed and adapted technological processes to adapt to new trends. But the most important role consists in incorporating biologically active components either in the form of whole plants or their organs (root, stem, leaf, fruit, seed). For this purpose, the focus is on fruit and vegetable plants that are "forgotten", are not intensively cultivated, have no commercial value in terms of generating income, but are extremely adapted to local conditions and do not need additional agro-ecological measures, especially not from using chemical plant protection products (PPPs).

The medlar (*Mespilus germanica* L.), fam. *Rosaceae*, is consumed exclusively in the stage of technical maturity, because of the stone cells, which are similar to the quince (Hacıseferoğulları et al., 2005). Medlar fruits have a rich and diverse vitamin composition, minerals, but are especially abundant in components that have antioxidant (Kamal et al., 2015), anti-inflammatory, antimicrobial effects according to scientific studies ([Ayaz et al., 2019](#); Xianfei et al., 2007) and even in Alzheimer's disease (Baptista et al., 2014). Recognizable by the softened fruit with a wrinkled surface, they are ready to be consumed fresh, which is the

most valuable feature to take advantage of active enzyme complexes (Gruz et al., 2011) and biologically active components (BAC) such as phenols (Manach et al., 2004), flavonoids, tannins, anthocyanins, organic acids, and vitamin C (Glew et al., 2003). The medlar is one of the climacteric fruits in which, with the ripening that can take place by leaving the fruits on a branch, the content of total soluble solids content increases, and the titratable acidity decreases (Gómez-Caravaca et al., 2013). The health benefits of medlar are known, especially its antibacterial and antiviral effect (Safari and Ahmady-Asbchin, 2019), but also antidiabetic (Donnelly and Boland 1995; Bahadoran et al., 2013; Vinayagam and Xu, 2015), although the studies were conducted in vitro, which is why food technology has a particular interest in using their BACs, adding them to other food products to increase their nutritional and general value (Kris-Etherton et al., 2002).

Precisely because of its rich nutritional and bioactive profile, medlar was chosen as the subject of research. The obtained results and information have potential health benefits (Żołnierczyk et al., 2021), and for the food industry they mean the isolation of certain antioxidants that keep the products fresh and unchanged for a longer time, and have a natural origin and an advantage over other chemically synthesized ones (Sadeghinejad et al., 2022). In addition, we believe that the changing consumer mentality will include in the fall procurement for fresh consumption.

MATERIAL AND METHOD

Genetic origin of the material. The medlar trees from which the fruits were taken are old and indigenous to the locality where they have been grown for more than 20 years in four regions of Macedonia, namely v.Volkovo-Skopje (v.Vol), v.Radozda-Struga (v.Rdz), v.Ribarci-Kavadarci (v.Rib) and v.Gorni Disan-Negotino (v.GD). They are mainly individual trees that are cultivated in the backyards of the owners. According to their statements, the trees are not treated with chemical means of protection and are mainly resistant to diseases, so they can be declared as organic fruits.

Plant sample. The fruits are collected in two phases, namely the first phase when they are 30-40% ripe and in certain parts along the peel they begin to soften, and the second phase when they are 70-80% ripe and softened and are considered technologically ripe. Until the moment of laboratory analysis, they were kept at +4°C in the refrigerator, and on the day of the analysis, they were adapted for 3 hours at room temperature +24°C. The fruits were mashed with a manual press and the peel and pulp were analyzed.

Qualitative Analysis. The qualitative analyzes refer to the determination of the taste, the surface of the exocarp, the shape of the fruit and the content of the obtained pulp (g/100g). The taste was determined by involving 15 local locals (testers) and a scale of 4 tastes was created, namely 1-sour, 2-sour-sweet, 3-sweet-sour, and 4-sweet. The surface of the fruits, i.e., their peel, was ascertained through touch by the same 15 testers and was declared as rough and mostly smooth, as well as the shape of the fruit oval-round, round, and properly round. The fruit diameter (FD) was determined with a Digital Caliper (6 Inch/ 150mm Vernier Caliper Measuring Tool) (mm), and the fruit pulp content weight (PCW), with manual maceration, removal of seeds and weight measurement on a digital scale (Globe Scientific GBP-602 Series GBP Toploading Portable Precision Balance, 600g x 0.01g).

Phytochemical Analysis. The biologically active components in the pulp are essential for the nutritional and antioxidant profile of the medlar fruit. The potential parameters are analyzed as follows: the content of total soluble solid compounds (TSSC) ($\text{Brix}^{\circ} \pm \text{SD}$) by using refraktometer, the titratable acidity (TA) ($\% \pm \text{SD}$) measured by titration with 0.1 N NaOH to pH 8.1 expressed as a percentage of citric acid (g/L), total phenols (TPh) by the Folin-Ciocalteu colorimetric method expressed as mg gallic acid equivalents $\text{GAE mg} \cdot 100^{-1} \text{FW} \pm \text{SD}$, total

flavonoids (TFlav) determined as milligram quercetin equivalent $\text{mg QE}\cdot 100^{-1}$), total anthocyanins (TAnt) ($\text{mg}\cdot 100^{-1} \text{FW}\pm\text{SD}$) and ascorbic acid (AscA) ($\text{mg}\cdot 100^{-1} \text{FW}\pm\text{SD}$).

Determination of correlation. The R oemer-Orphal table was used to determine the correlation between the content of total phenols and the content of total flavonoids, titratable acidity, ascorbic acid and the total soluble solid compounds (nc-no correlation, vvc-very weak, wc-weak, mc-moderate, sc-strong, vsc-very strong, cc-complete).

RESULTS AND DISCUSSION

According to the examined quality parameters of medlar fruit, interesting and very useful results were obtained, especially in terms of the utilization of nutritional properties depending on maturity. In the first phase (Table 1), when the fruit is 30-40% ripe, the amount of pulp obtained, total soluble solid content and titration acidity were examined. At the same time, the largest amount of pulp was obtained from medlars from v.Rdz ($34.28 \text{ g}\cdot 100^{-1} \text{FW}$), and the least from those from v.GD ($27.92 \text{ g}\cdot 100^{-1} \text{FW}$). TSSCs are the most represented in medlars from v.Vol. (10.05 Brix $^\circ$), and the least in fruits from v.Rib (10.05 Brix $^\circ$), where TA is the highest (1.15%). The fruits of v.GD have the lowest TA (0.79%). In the second phase, when the fruits were technologically ripe (70-80% ripened and softened), the taste, exocarp surface, shape and diameter were determined. The taste varies from sour-sweet (v.Vol) through sweet-sour (v. Rdz) to sweet (v. Rib and v.GD). The surface of the exocarp is rough in the fruits from v.Rib to mostly smooth in those from v.Rdz and v.GD, where they have the smallest diameter of 27.8mm (v.GD), and the largest in those from v.Rdz (32.7mm) (Haciseferogulları et al., 2005). Regarding the first stage, it can be concluded that the amount of fruit pulp increases with ripening ($29.62 \text{ g}\cdot 100^{-1} \text{FW}$ in c.GD to $38.49 \text{ g}\cdot 100^{-1} \text{FW}$ in v.Rdz. Although the amount of TSSC is slightly higher in the second stage, but still noteworthy and varies from 11.6 Brix $^\circ$ (v.Rib) to 15.3 Brix $^\circ$ (v.Vol).As ripening, the acidity decreases significantly, so the TA is quite low in fruits from the GD region (0.57%), and the highest in those from the Vol region (0.81%), which is quite expected for fruits that have a specific way of ripening (lodge, quince, pear) and are called climacteric fruits.

Table 1. Qualitative characteristics of medlar fruits in the two stages of examination

Characteristics	Region (village, nearest town)			
	Phase 1 st			
	Volkovo, Skopje	Radozda, Struga	Ribarci, Kavadarci	G.Disan, Negotino
Exocarp surface	Rough	Almost smooth	Rough	Almost smooth
Fruit shape	Oval-round	Properly round	Round	Round
FD (\varnothing)	29.5	32.7	28.3	27.8
PCW (g/100g)	31.57	34.28	28.15	27.92
TSSC (Brix $^\circ$)	14.16	12.79	10.05	11.12
TA (%)	1.15	0.95	0.82	0.79
	Phase 2 nd			
Taste	Sour-sweet	Sweet	Sweet-sour	Sweet
PCW (g/100g)	33.92	38.49	30.15	29.62
TSSC (Brix $^\circ$)	15.3	14.9	11.6	12.9
TA (%)	0.81	0.63	0.66	0.57

The importance of fruits is due to the amount and representation of BAC (Table 2) which determine the antioxidant (İlhami et al., 2011; Nabavi et al., 2011) and nutritional profile (Slavin and Lloyd, 2012) and even antimicrobial profile (Zheng et al., 2018). Total phenolic compounds in fruit peel range from 28.85 (v.Rib) to 34.12 GAE mg·100⁻¹ FW (v.Rdz), which is significantly more than in fruit pulp from 23.17 (v.Voll) up to 28.64 mg·100⁻¹ FW (v.GD). The total representation of phenols in medlar fruit is the lowest in the region of Vol (53.45), and the highest in GD (62.11). Total flavonoids in fruit peel and fruit pulp vary in a relatively wide range, and in fruit peel from 2.12 (v.Rib) to 2.59 mg QE·100⁻¹ FW (v.Rdz), and in fruit pulp from 1.98 (v.Rib) to 2.69 mg QE·100⁻¹ (v.GD) which is similar to phenolic compounds. The total content of flavonoids in medlar fruit is 4.10 mg (v.Rib) to 5.22 mg QE·100⁻¹ FW (v.GD). In the research study, the total anthocyanins were determined, which were found the least in c.Vol (0.152 mg·100⁻¹ FW), and the most in c.Rdz (0.691 mg·100⁻¹ FW). And while anthocyanins are the highest represented in v.Rdz, ascorbic acid is the lowest (0.152 mg·100⁻¹ FW), and in v.GD the content is the highest (0.188 mg·100⁻¹ FW).

Table 2. Biological active compounds of medlar fruits in the two stages of examination

BAC		Region (village, nearest town)			
		Phase 1			
		Volkovo, Skopje	Radozda, Struga	Ribarci, Kavadarci	G.Disan, Negotino
TPh in	Peel	28.42	32.76	29.38	30.64
	Pulp	22.81	26.43	23.58	27.89
TFlav in	Peel	2.12	2.35	2.07	2.48
	Pulp	1.97	2.01	1.83	2.04
TPh peel+pulp, GAE mg/100 g		53.45	61.06	55.18	62.11
TFlav		4.67	4.97	4.10	5.22
Anthocyanines CE, mg/100 g		0.528	0.691	0.663	0.684
Ascorbic acid, mg/100 mL		0.173	0.152	0.166	0.188
		Phase 2			
TPh in	Peel	30.28	34.12	29.85	33.47
	Pulp	23.17	26.94	25.33	28.64
TFlav in	Peel	2.46	2.59	2.12	2.53
	Pulp	2.21	2.38	1.98	2.69
TPh peel+pulp, GAE mg/100 g		51.23	59.19	52.96	58.53
TFlav		4.09	4.36	3.90	4.52
Anthocyanines CE, mg/100 g		0.629	0.935	0.716	0.792
Ascorbic acid, mg/100 mL		0.146	0.138	0.105	0.116

In the second stage (Table 2) when the fruit is technologically mature, the content of total phenols in both fruit peel and fruit pulp is somewhat lower than in the first stage. It is the lowest in the fruits from the Vol region (28.42 GAE mg·100⁻¹ FW – peel; 22.81 GAE mg·100⁻¹ FW – pulp), and the highest in those from the Rdz region (32.76 GAE mg·100⁻¹ FW) in fruit peel, that is, in GD (27.89 GAE mg·100⁻¹ FW) in fruit pulp. The average total representation of phenols ranges from 51.23 GAE mg·100⁻¹ FW (v.Vol) to 59.19 GAE mg·100⁻¹ FW (v.Rdz). Flavonoid compounds are less represented in fruit peel (2.07 mg QE·100⁻¹ FW, v.Rib to 2.48 mg QE·100⁻¹ FW, v.GD), while in fruit pulp the minimum content is higher in the second phase 2.04 mg QE·100⁻¹ FW (c.GD) although insignificant, and lower the maximum 1.83 mg QE·100⁻¹ FW (v.Rib). The total average representation of flavonoids varies from 3.90 mg QE·100⁻¹ FW

(v.Rib) to $4.52 \text{ mg QE} \cdot 100^{-1} \text{ FW}$ (v.GD) which means that it is lower in the stage of technological maturity. Anthocyanins are significantly more represented in the second phase and amount to $0.629 \text{ mg} \cdot 100^{-1} \text{ FW}$ (v.Vol) to $0.935 \text{ mg} \cdot 100^{-1} \text{ FW}$ (v.Rdz). The content of vitamin C is determined through the concentration of ascorbic acid, which is maximally represented in $0.146 \text{ mg} \cdot 100^{-1} \text{ FW}$ in the fruits of v.Vol, and minimally ($0.105 \text{ mg} \cdot 100^{-1} \text{ FW}$) in those of v.Rib.

Greater variations (Figures 1 and 2) between total phenols and total flavonoids were found in relation to the representation in fruit pulp in the first phase, and almost insignificantly less in fruit peel in the second phase, where the variations in relation to the content of phenols and flavonoids. The variation in the average total content of these BACs is almost twice as small, unlike the others where the variations are much larger and more obvious on the graph for anthocyanins and less noticeable for ascorbic acid (Figure 1 and 2).

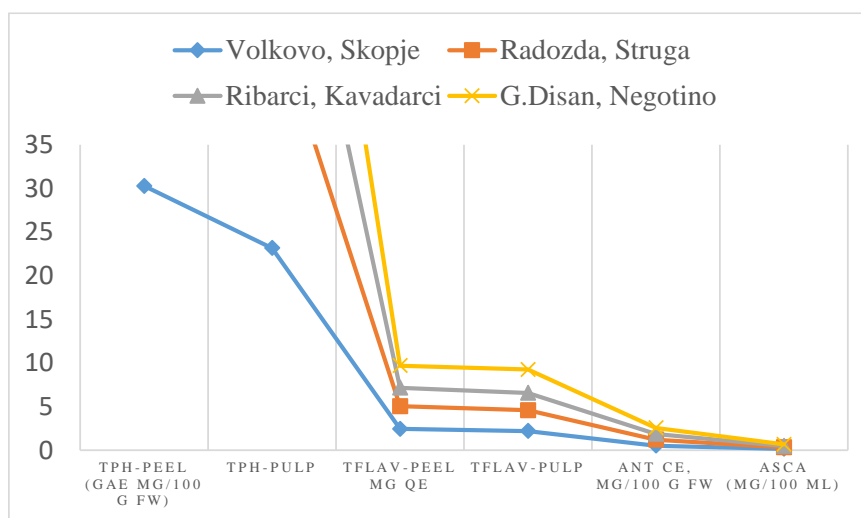

Figure 1. Variation in BAC level during investigation in 1st phase of maturity

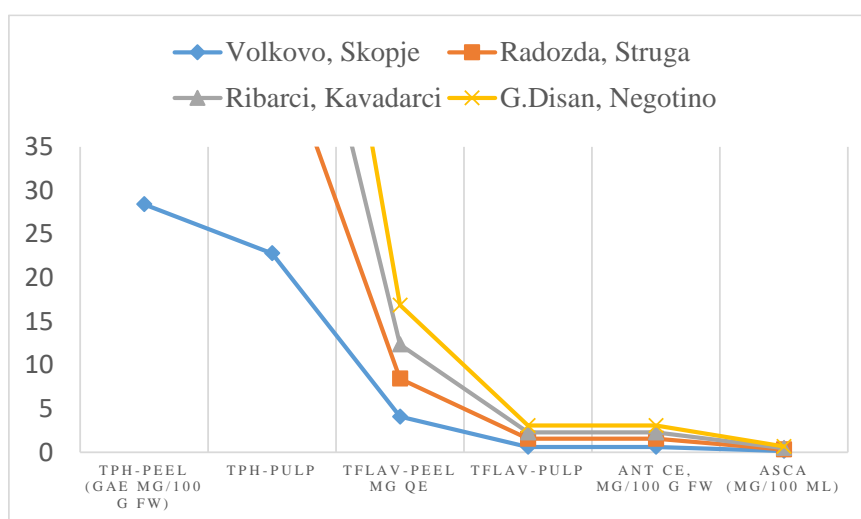

Figure 2. Variation in BAC level during investigation in 2nd phase of maturity

Such trends and the highly variable content of total phenols and flavonoids are also reflected in the correlative dependence between them and the rest of the examined BACs (Table 3). In the first phase of the research, a complete (absolute) correlation was found between total phenols and total flavonoids (0.902), a strong correlation between phenols and anthocyanins (0.763), a negative weak correlation with TSSC (-0.24) and no correlation with pso ascorbic acid (-0.096). Total flavonoids were weakly correlated with anthocyanins (0.205), ascorbic acid (0.266) and TSSC (0.28). Anthocyanins have a strong negative correlation with TSSC (-0.73), and a very weak negative correlation with ascorbic acid (-0.117). A very weak negative correlation (-0.19) was found between TSSC and ascorbic acid. In the stage of technological maturity (second stage), total phenols are in very strong correlation with total flavonoids (0.802), strong correlation with TSSC (0.76), negative weak with ascorbic acid and independent of anthocyanin content. A weak correlation was found between total flavonoids and the content of anthocyanins, ascorbic acid and TSSC, respectively (0.208; 0.326; 0.41). The content of synthesized anthocyanins depends almost completely (0.93) on TSSC and not on ascorbic acid (0.020), while between TSSC and ascorbic acid there is a very weak negative correlation (-0.15).

As a characteristic fruit that shows climacteric ripening, the concentration of the quality properties and BAC content changes (Graph 1 and 2). As can be seen from Tables 1 and 2, with the ripening and softening of the fruits, the TSSC content increases (10.05-14.16 in the first stage; 11.6-15.3 in the second stage), and the titration acidity significantly decreases (0.79-1.15 in the first stage; 0.57-0.82 in the second stage) which coincides with the research of Selcuk and Erkan, 2015. Taking into account that medlar can suddenly soften and fail the fruit for consumption, it is recommended that at a stage like the second of this study when the fruits are 70-80% softened, to avoid a significant reduction in total phenolics and flavonoids. But the handling of these fruits should be careful to avoid mechanical injury (Zheng et al., 2018). With ripening and softening, the concentration of ascorbic acid also decreases significantly (0.152-0.188 in the first stage; 0.105-0.146 in the second stage). An increase in the concentration of anthocyanins is observed only with ripening (0.528-0.691 in the first phase; 0.629-0.935 in the second phase).

Table 3. Correlation coefficient between certain traits at pomegranate landraces

Traits	TFlav	AC	AscA	TSSC
	Phase 1st			
TPh	0.902cc	0.763sc	0.096nc	-0.24wc
TFlav	-	0.205wc	0.266wc	0.28wc
AC	-	-	-0.117vwc	-0.73sc
AscA	-	-	-	-0.19vwc
Phase 2				
	TFlav	AC	AscA	TSSC
TPh	0.802vsc	0.045mc	-0.290wc	0.761sc
TFlav	-	0.208wc	0.326wc	0.413mc
AC	-	-	0.020nc	0.932cc
AscA	-	-	-	-0.154vwc

Conducted research indicates the fact that the polyphenolic and flavonoid profile of medlar fruits are higher in fruit peel compared to macerated fruit pulp, which coincides with previous research on medlar and quince (Żołnierczyk et al., 2023). The content of phenolic compounds is a genetic trait (Ayaz et al., 2008) and a stable trait that should be used in pre-selection and selection purposes and creation of new medlar genotypes (Ayaz et al., 2008). As

the fruits ripen, the concentration of phenolic and flavonoid components decreases, which is why it is recommended to consume the fruits already at 70-80% ripeness, especially due to the fact that the reduced content is not drastic or much lower and the benefits of these compounds can be used (et al, 2002; Ayaz Dincer et al., 2002). Although ripening is recommended at temperatures between 20-25°C, taking into account the genetic constitutional characteristic of the local populations, it can be concluded that the content of total phenols and flavonoids decreases minimally, hence it does not depend much on the temperature regime as in other fruits (Ayaz et al., 2008).

CONCLUSIONS

The examined genotypes differ among themselves in terms of qualitative properties and the content of biologically active components. With the ripening of medlar fruits, the content of total solid soluble content increases, and the acidity decreases. The medlar fruits originating from the region of Negotino, v.Gorni Disan village contain the most total phenols, total flavonoids and ascorbic acid, but also the fruits originating from the v.Radozda village have a high content of the examined parameters. As the medlar fruit ripens and softens, the concentration of total phenols, total flavonoids, and ascorbic acid decreases, so it is recommended to consume them at 70-80% ripeness. The indisputable quality and high content of biologically active components count medlar high on the list of fruits with health benefits.

REFERENCES

- Ayaz, F.A., Glew, R.H., Huang, H.S., Chuang, L.T., VanderJagt D.J. and Strnad, M. 2002. Evolution of fatty acids in medlar (*Mespilus germanica* L.) mesocarp at different stages of ripening. *Grasas Aceites*, 53: 352- 356.
- Ayaz, F.A., Demir, O., Torun, H., Kolcuoglu, Y., Colak A. 2008. Characterization of polyphenoloxidase (PPO) and total phenolic contents in medlar (*Mespilus germanica* L.) fruit during ripening and over ripening. *Food Chemistry*, 106: 291-298. <https://doi.org/10.1016/j.foodchem.2007.05.096>
- Ayaz, M., Sadiq, A., Junaid, M., Ullah, F., Ovais, M., Ullah, I., Ahmed, J., Shahid, M. 2019. Flavonoids as Prospective Neuroprotectants and Their Therapeutic Propensity in Aging Associated Neurological Disorders. *Front Aging Neurosci.*, 11: 155.
- Bahadoran, Z., Mirmiran, P., Azizi, F. 2013. Dietary polyphenols as potential nutraceuticals in management of diabetes: A review. *J. Diabetes Metab. Disord.*, 12: 43.
- Baptista, F.I., Henriques, A.G., Silva, A.M., Wiltfang, J., da Cruz e Silva, O.A. 2014. Flavonoids as therapeutic compounds targeting key proteins involved in Alzheimer's disease. *ACS Chem. Neurosci.* 5: 83–92. 10.1021/cn400213r
- Dincer, B., Colak, A., Aydin, N., Kadioglu, A., Güner, S.. 2002 Characterization of polyphenoloxidase from medlar fruits (*Mespilus germanica* L., Rosaceae). *Food Chemistry*, 77: 1-7. [https://doi.org/10.1016/S0308-8146\(01\)00359-4](https://doi.org/10.1016/S0308-8146(01)00359-4)
- Donnelly, D., Boland, G. 1995. Isoflavonoids and neoflavonoids: naturally occurring O-heterocycles. *Nat. Prod. Rep.* 12: 321–338. 10.1039/np9951200321
- Glew, R.H., Ayaz, F.A., Sanz, C., VanderJagt, D., Huang, H., Chuang, L., Strnad, M. 2003. Effect of postharvest period on sugars, organic acids and fatty acids composition in commercially sold medlar (*Mespilus germanica* 'Dutch') fruit. *Eur. Food Res. Technol.*, 216: 390–394.
- Gómez-Caravaca, A.M., Verardo, V., Toselli, M., Segura-Carretero, A., Fernández-Gutiérrez, A., Caboni, M.F. 2013. Determination of the major phenolic compounds in pomegranate juices by HPLC–DAD–ESI-MS. *J. Agric. Food Chem.*, 61: 5328–5337.

- Gruz, J., Ahmet Ayaz, F., Torun, H., Strnad, M. 2011. Phenolic acid content and radical scavenging activity of extracts from medlar (*Mespilus germanica* L.) fruit at different stages of ripening. *Food Chemistry*, 124(1): 271-277.
- Hacıseferoğulları, H., Özcan, M., Sonmete, M.H., Özbek, O. 2005. Some physical and chemical parameters of wild medlar (*Mespilus germanica* L.) fruit grown in Turkey. *J. Food Eng.*, 69: 1–7.
- İlhami, G., Topal, F., Beyza Öztürk Sarıkaya, S., Bursal, E., Bilsel, G., Gören, A.C. 2011. Polyphenol Contents and Antioxidant Properties of Medlar (*Mespilus germanica* L.). *Rec. Nat. Prod.*, 5(3): 158-175.
- Kamal, Z., Ullah, F., Ayaz, M., Sadiq, A., Ahmad, S., Zeb, A., et al. 2015. Anticholinesterase and antioxidant investigations of crude extracts, subsequent fractions, saponins and flavonoids of *atriplex laciniata* L.: potential effectiveness in Alzheimer's and other neurological disorders. *Biol. Res.*, 48:21. [10.1186/s40659-015-0011-1](https://doi.org/10.1186/s40659-015-0011-1)
- Kris-Etherton, P.M., Hecker, K.D., Bonanome, A., Coval, S.M., Binkoski, A.E., Hilpert, K.F., Griel, A.E., Etherton, T.D. 2002. Bioactive compounds in foods: Their role in the prevention of cardiovascular disease and cancer. *Am. J. Med.*, 113: 71–88.
- Manach, C., Scalbert, A., Morand, C., Rémésy, C., Jiménez, L. 2004. Polyphenols: food sources and bioavailability. *Am. J. Clin. Nutr.*, 79: 727–747. [10.1093/ajcn/79.5.727](https://doi.org/10.1093/ajcn/79.5.727)
- Nabavi, S.F., Nabavi, S.M., Ebrahimzadeh, M.A., Asgarirad, H. 2011. The antioxidant activity of wild medlar (*Mespilus germanica* L.) fruit, stem bark and leaf. *Afr. J. Biotechnol.*, 10: 283–289.
- Safari, M., Ahmady-Asbchin, S. 2019. Evaluation of antioxidant and antibacterial activities of methanolic extract of medlar (*Mespilus germanica* L.) leaves. *Biotechnol. Biotechnol. Equip.*, 33: 372–378.
- Selcuk, N., Erkan, M. 2015. The effects of 1-MCP treatment on fruit quality of medlar fruit (*Mespilus germanica* L. cv. Istanbul) during long term storage in the palliflex storage system. *Postharvest Biology and Technology*, 100: 81–90
[10.1016/j.postharvbio.2014.09.018](https://doi.org/10.1016/j.postharvbio.2014.09.018)
- Slavin, J.L., Lloyd, B. 2012. Health benefits of fruits and vegetables. *Adv. Nutr.*, 3: 506–516.
- Sadeghinejad, Z., Erfani-Moghadam, J., Khadivi, A. 2022. Bioactive content and phenolic compounds of common medlar (*Mespilus germanica* L.) and Stern's medlar (*M. Canescens Phipps*). *Food Sci. Nutr.*, 10: 1988–1993.
- Vinayagam, R.; Xu, B. 2015. Antidiabetic properties of dietary flavonoids: A cellular mechanism review. *Nutr. Metab.*, 12: 60.
- Xianfei, X., Xiaoqiang, C., Shunying, Z., Guolin, Z. (2007). Chemical composition and antimicrobial activity of essential oils of *Chaenomeles speciosa* from China. *Food Chem.*, 100: 1312–1315.
- Zheng, X.; Wang, H.; Zhang, P.; Gao, L.; Yan, N.; Li, P.; Liu, X.; Du, Y.; Shen, G. 2018. Chemical composition, antioxidant activity and α -glucosidase inhibitory activity of *Chaenomeles speciosa* from four production areas in China. *Molecules*, 23: 2518.
- Żołnierczyk, A.K., Ciałek, S., Styczyńska, M., Oziembłowski, M. 2021. Functional properties of fruits of common medlar (*Mespilus germanica* L.) extract. *Appl. Sci.*, 11: 7528.
- Żołnierczyk, A.K., Pachura, N., Bąbalewski, P., Taghinezhad, E. 2023. Sensory and Biological Activity of Medlar (*Mespilus germanica*) and Quince 'Nivalis' (*Chaenomeles speciosa*): A Comparative Study. *Agriculture*, 13(5): 922. <https://doi.org/10.3390/agriculture13050922>

CHIA SEEDS (*Salvia hispanica* L.) IN DIETETIC REGIMES

Suzana Jordanovska

¹ University “Mother Teresa” in Skopje, Faculty of Technological Sciences, Skopje, Republic of North Macedonia

Corresponding author e-mail: suzana.jordanovska@unt.edu.mk

ABSTRACT

Chia (*Salvia hispanica* L.) is a very often used plant using seed material in the preparation of dietary meals. Apart from being rich in minerals potassium, calcium, magnesium, and iron, it has a favorable nutritional composition along with a wealth of dietary fibers, it is a prebiotic for GUT bacteria which increases the absorption of nutrients and maintains good health. Ten average seed samples of organically produced commercial cultivars (CV1-10) were used in the study obtained from local health food stores. Of the parameters determined by laboratory analyses, the focus is on the content of total carbohydrates, proteins, fats, and fibers. The average content of total carbohydrates is 40.58 g/100 g, and of total fat 32.89 g/100 g. The average protein content indicates the fact that chia meals are high in protein with an average protein content of 18.6 g/100 g. The fact that fibers are on average represented by 38.36 g/100 g is particularly important, which confirms the conclusion that the breakfast meal in the form of chia meals prepares the body for a good start of the day from an energetic, protein-structural, and prebiotic supported aspect.

Keywords: Chia seeds, Carbohydrates, Proteins, Fat, Fibers, Seeds, Dietetic.

INTRODUCTION

Today, chia, originating from southern Mexico and Guatemala, receives maximum attention from nutritionists, and it is increasingly common in daily meals in combination with other ingredients (milk, soy, nuts, fruit) (Ding et al., 2017; Breeson, 2009). Given its macro-thermal character and the difficulty of obtaining seeds, it complicates the production of local and indigenous genotypes, for which the commercial production of hybrid genotypes is part of selection programs that are very profitable especially due to the high demand in the market (Ayerza and Coates, 2009; Jambunsri et al., 2012). A major tool in the development of new genotypes is recombinant DNA technology focused on creating early-flowering genotypes (de Falco et al., 2017). Research studies point to the protective effect of chia seeds on the cardiovascular system, support in diabetes, reduction of metabolic syndrome and improvement of lifestyle (Peiretti and Gai, 2009; Bueno et al., 2010; Ayerza and Coates, 2011; Vedtofte et al., 2011; Martha et al., 2012). Chia seeds contain a very high content of saturated and unsaturated fatty acids, but also a representative amino acid composition. Black coloration of the seeds usually dominates, but white colored seeds are also found significantly (Ayerza 2013). In terms of biologically active components, chia shows similarities with sage seeds, primarily flavonoids, quercetin, genistein, caffeoyl derivatives and caffeic, chlorogenic and rosmarinic acids (Coelho et al., 2014; Mohd et al., 2012).

The rich fatty acid profile in chia seeds is increasingly being used in food technology, primarily as an additive and improver of the nutritional quality and composition of products and processing of animal origin (Porrás-Loaiza et al., 2014; Scapin et al., 2015) with the so-called omega-3 fatty acids, namely alpha-linolenic acid (ALA), eicosapentaenoic acid (EPA), and docosahexaenoic acid (DHA). Of the oils of vegetable origin, the richest in ALA are those

from flaxseed, canola, and soybean, while fish, fish products and seafood contain DHA and EPA in significant quantities. The value of chia seeds is growing as a result of the exceptionally high content of vegetable fibers that means that they have a high water-holding capacity (Capitani et al., 2012). Chia mainly contains insoluble fibers, and very few soluble fibers (Ding et al., 2018), which is why they are widely used and added to the bakery and confectionery industry, as well as in meat processing (Sudha et al., 2007).

Considering that chia seeds contain bioactive components that directly affect health positively, they do not contain gluten and chia plants can be grown in arid areas (Bochicchio, 2015), the objective was challenging to investigate the quality of commercial seeds in the state. Hence, the recommendation from this research study is that chia seeds should be grown in the country, their health benefits should be used and it should be included in prepared meals daily.

MATERIAL AND METHOD

Origin of the material. The chia seed material was purchased from the commercial network, from 10 different organic food stores, spread over the territory of the city of Skopje. All ten commercial varieties (CV1-10) originate from imports and are available to citizens.

Plant sample. Purchased commercial varieties (CV1-10) chia seeds were dried at room temperature 20-22°C for 48 hours. Then each CV is ground on a small laboratory mill, sifted through sieves \varnothing 0.5mm, \varnothing 0.2mm and \varnothing 0.1mm and an average laboratory sample is prepared for analysis on an automatic laboratory separator. For the laboratory analyses, an extract was prepared in which the content of carbohydrates, crude proteins, crude fats and crude fibers was determined.

Qualitative Analysis. Total carbohydrates were determined with a refractometer and determining the refractive index ($^{\circ}$ Brix). The total protein content was determined by using the Kjeldahl method, and this method actually determines the total nitrogen content ($N \times 6.25$ coeff.) and after is used to calculate the protein content as $g \cdot 100^{-1} DW \pm Sx$ (Varelis, 2016). The crude fat content was extracted by Soxhlet extraction ($g \cdot 100^{-1} DW \pm Sx$). The determination of crude fibers was performed according to the Kürschner-Hanak method ($g \cdot 100^{-1} DW \pm Sx$), therefore the moisture content was measured by drying method for plants, and the plant material is dried $105 \pm 2^{\circ}C$ to constant weight ($\% DW \pm Sx$).

Phytochemical Analysis. The quality of chia commercial varieties is complemented by the analysis of biologically active components (BAC), total phenols (TPh) and total flavonoids (TFlav), and the ratio between them TPh:TFlav is also determined. The total phenols (TPh) are quantified by the Folin-Ciocalteu colorimetric method expressed as mg gallic acid equivalents $GAE \text{ mg} \cdot 100^{-1} DW \pm Sx$, while total flavonoids (TFlav) are determined as milligram quercetin equivalent $mg \text{ QE} \cdot 100^{-1} \pm Sx$.

Determination of correlation. To determine the correlation dependence between certain parameters is used the Røemer-Orphal table. The correlation between the following parameters was examined: hygroscopic moisture (HM) and the content of carbohydrates (CH), crude proteins (CP), crude fat (CF), crude fibers (CFb); CH and CP, CH and CF, CH and CFb; CP and CF, CP and CFb. Correlative dependence is evaluated according to the above table as follows nc-no correlation, vwc-very weak, wc-weak, mc-moderate, sc-strong, vsc-very strong and cc-complete.

RESULTS AND DISCUSSION

The research study was conducted on commercially available varieties (CV1-10) of chia seeds that are available to consumers over the counter. The hygroscopic moisture, which is of particular importance for proper preservation and storage of the seed, is within the legally

permissible limits, i.e. it does not exceed 16%, when the biochemical processes in the seed would be activated, reducing the amount of endosperm due to the respiration of the seed and its consumption. This would lead to declassified quality and reduced nutritional aspect. At the same time, the average hygroscopic moisture found is $12.75\% \pm 0.06$ (Table 1), and it varies from 11.6 - 13.67% (Figure 1) and a difference of 2.04% was found between CV1-10, which is also the smallest difference for the examined properties.

Chia meals are usually prepared at the beginning of the day or during a part of the day when there is an energy drop, because it contains polysaccharides whose degradation is gradual and provides a solid energy platform for the body's needs (Ixtaina, 2011). The average representation is high and amounts to $40.58 \text{ g} \cdot 100^{-1} \text{ DW} \pm 0.05$ (Table 1). The variation between the commercial varieties (CV1-10) ranges from 38.29 – $43.28 \text{ g} \cdot 100^{-1} \text{ DW}$ (Figure 2) with an evident highest difference between them of 4.99 which coincides with the results of Ayerza (2009).

Chia seeds have added value due to their high protein content, which averages $18.6 \text{ g} \cdot 100^{-1} \text{ DW} \pm 0.07$ (Table 1), and the differences between genotypes is acceptable (3.56) given the different supply of traders and imports from abroad and varies within relatively narrow limits. $16.86 - 20.42 \text{ g} \cdot 100^{-1} \text{ DW}$ (Figure 3). The fatty acid profile in chia seeds is dominated by saturated fatty acids and the presence of omega x-3 fatty acids ALA, EPA and DHA, which belong to polyunsaturated fatty acids (PUFA) and are very important for lipid metabolism, the physiological functioning of the body and the dietary regime (Garg, 2006; Piretti and Gai, 2009). In CV1-10 fats are represented on average $32.89 \text{ g} \cdot 100^{-1} \text{ DW} \pm 0.04$ (Table 1), with a rather high variation (4.56) from 30.69 to $36.25 \text{ g} \cdot 100^{-1} \text{ DW}$ (Figure 4).

Table 1. Qualitative characteristics of medlar fruits in the two stages of examination

Seed traits	Moisture	Carbohydrates	Crude proteins	Crude fats	Crude fiber
CV1	12.57	41.37	20,42	33,18	37,09
CV2	13.25	38.75	18,91	31,47	39,24
CV3	13.67	42.28	19,32	30,69	40,14
CV4	12.79	42.42	16,86	32,51	38,07
CV5	11.63	39.57	17,34	31,77	37,16
CV6	12.09	38.29	20,03	34,18	38,21
CV7	13.42	42.16	18,41	32,29	39,24
CV8	12.89	43.28	17,17	33,37	39,17
CV9	13.53	41.09	17,62	33,79	37,79
CV10	11.68	38.46	18,22	35,25	37,22
$\bar{x} \pm S_x^*$	12.75 ± 0.75	40.58 ± 12.95	18.6 ± 5.96	32.89 ± 10.49	38.36 ± 12.18

* Data are given as mean \pm standard error of the mean (n=3)

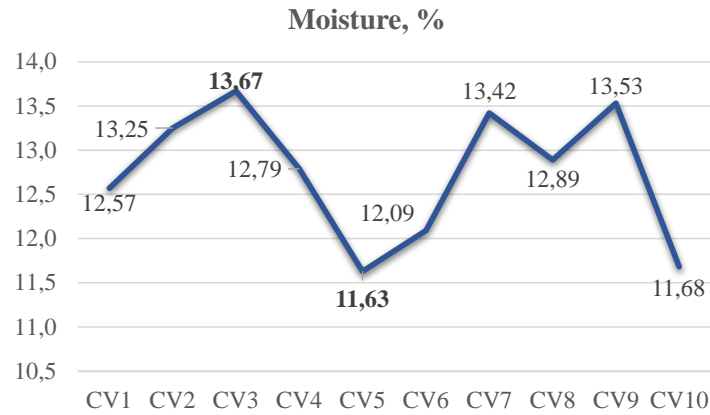

Figure 1. Variation in moisture content at investigated chia seed commercial varieties (CV1-10), %/DW

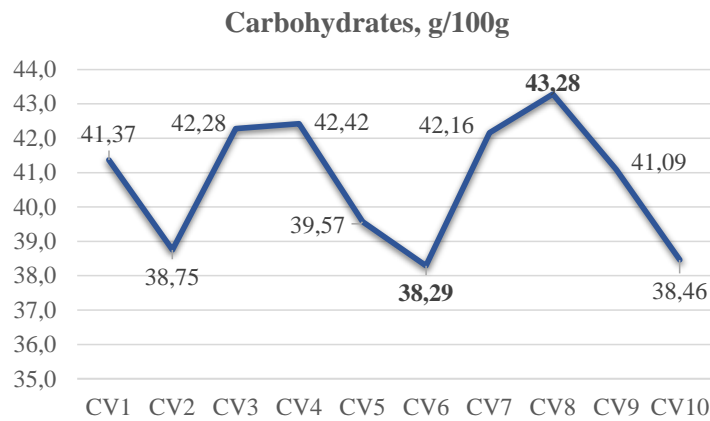

Figure 2. Variation in carbohydrate content at investigated chia seed commercial varieties (CV1-10), g·100⁻¹ DW

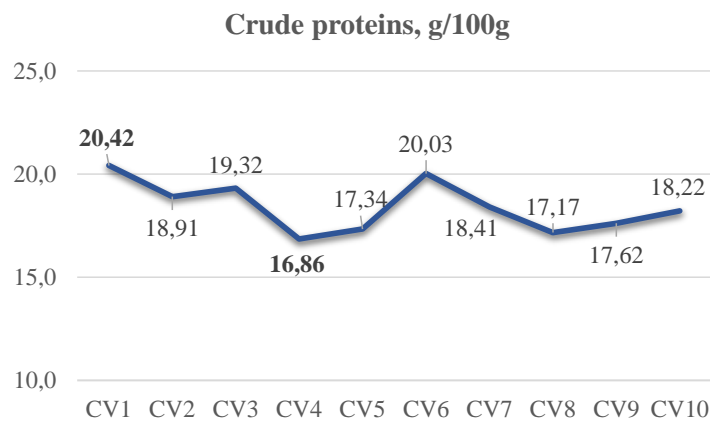

Figure 3. Variation in crude protein content at investigated chia seed commercial varieties (CV1-10), g·100⁻¹ DW

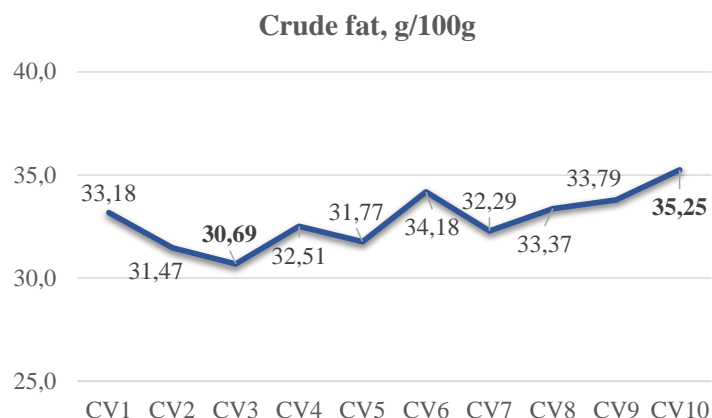

Figure 4. Variation in crude fat content at investigated chia seed commercial varieties (CV1-10), $g \cdot 100^{-1}$ DW

Plant fibers present in chia seeds have a special significance for dietary regimes, whether it is for a healthy organism or with certain disorders/diseases of the cardiovascular system, diabetes, metabolic syndrome or simply improving and managing one's own health by cultivating a correct lifestyle (Meineri and Peiretti, 2007). More than 80% are insoluble fibers, and according to some studies even more (Lairon et al., 2005), which serve as a prebiotic for probiotics in the GIT and maintain a rich intestinal microflora (Simopoulos, 2002). At the same time, it means immune support of the body, maintaining a stable level of glycemia and satiety for more than several hours (up to 5), which is why nutritionists must include chia in the daily menu (Marineli et al., 2015). The average content of crude fibers in CV1-10 is $38.36 g \cdot 100^{-1}$ DW ± 0.03 (Table 1), and the variations between varieties range from 30.69 to 35.25 $g \cdot 100^{-1}$ DW with a mutual difference of 3.05 (Figure 5).

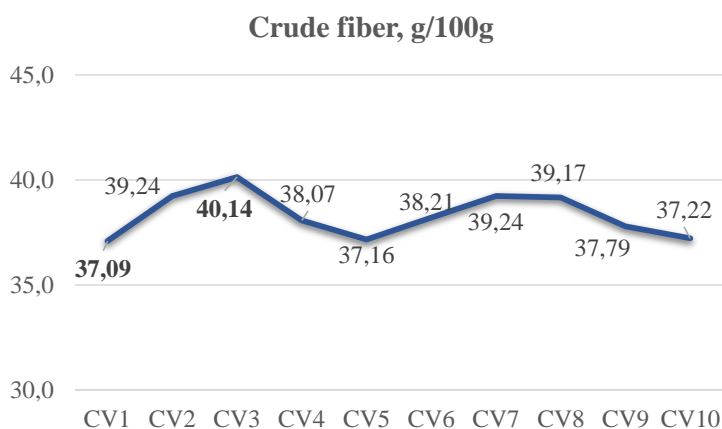

Figure 5. Variation in crude fiber content at investigated chia seed commercial varieties (CV1-10), $g \cdot 100^{-1}$ DW

Between hygroscopic moisture (HM) and total carbohydrates (CH) as well as between HM and crude fibers (CFb) a strong correlation was found, respectively (0.61; 0.73), and between HM and CFb it was negative moderate (-0.49). Correlative dependence between CH and CFb is moderate (0.46). A weak negative dependence was found between CH and CP (-0.22), between CH and CF (-0.32), while between HM and CP (0.04), CP and CFb (0.02) and CP and CF (-0.04) have no correlative dependence, which indicates the fact that these properties

(content of proteins, carbohydrates, fibers) are mainly genetically determined (Mohd et al., 2012) (Table 2).

Table 2. Correlation coefficient between certain traits at chia varieties

Traits	CH	CP	CF	CFb
M	0.61sc	-0.04nc	-0.49mc	0.73sc
CH	-	-0.22wc	-0.32wc	0.46mc
CP	-	-	-0.04nc	0.02nc

Biologically active components that show an antioxidant effect and affect the physiological state of cells by fighting free radicals such as total phenols (TPx) and total flavonoids (TFlav) are represented in high concentration in chia seeds and it is to them that the numerous health benefits are due (de Falco et al., 2017) in a continuous process of use and consumption. The average content of TPh is 228.17 GAE mg·100⁻¹ DW±0.06, and it varies in wide ranges from 37.09 – 40.14 GAE mg·100⁻¹ DW with a difference of 43.17. Total flavonoids (TFlav) varied within narrower limits of 158.29 – 188.59 QE mg·100⁻¹ DW, a difference of 30.30 and an average concentration in CV1-10 of 179.38 QE mg·100⁻¹ DW (Figure 6). By determining the ratio between the content of total phenols and total flavonoids there is not always a linear relationship that indicates the antioxidant potential (Monroy-Torres et al., 2008). However, the ascertained high concentrations of TPH and TFlav serve to predict established synergistic relationships between these bioactive components that favor greater antioxidant activity. In the researched varieties, it is 1.28±0.08 with variations from 1.07 - 1.43 (Figure 7).

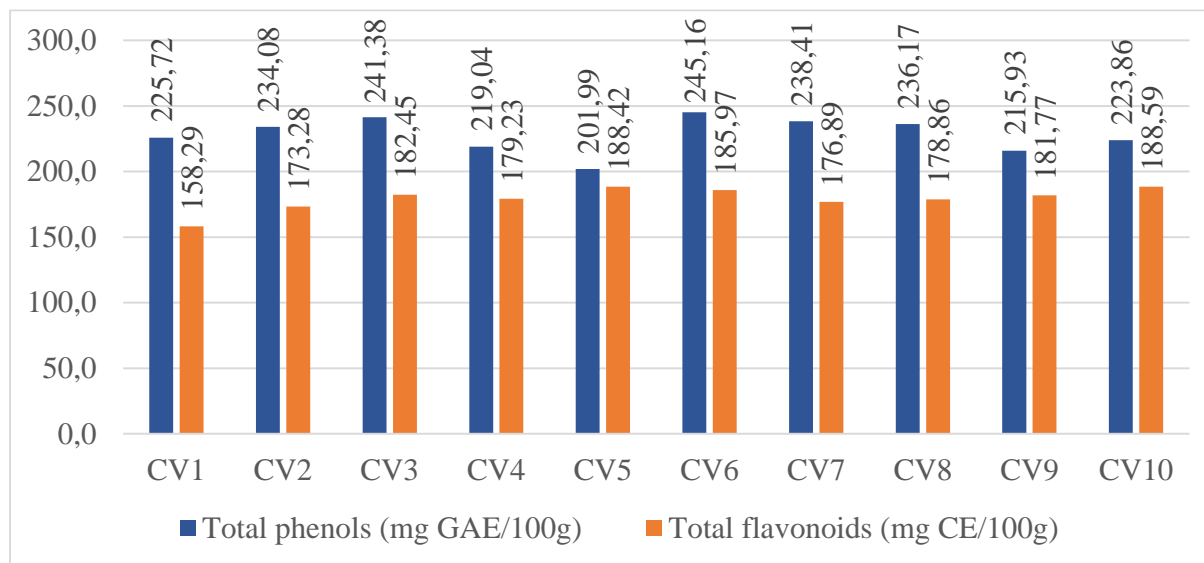

Figure 6. Content of total phenols and total flavonoids as biological active compounds in chia seeds (CV1-10)

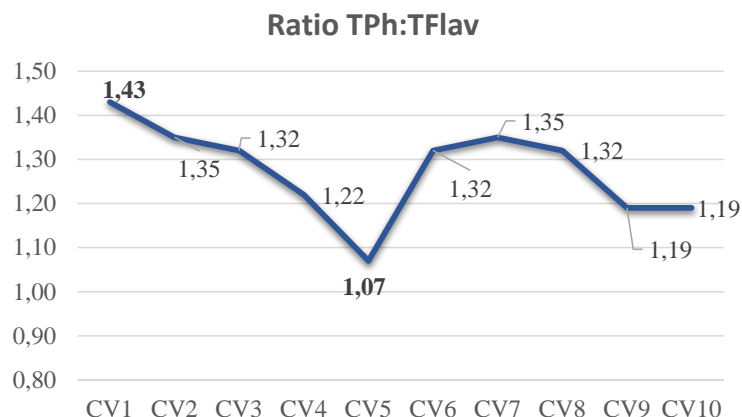

Figure 7. Ratio of total phenol (TPH) content and total flavonoids (TFlav), (CV1-10)

CONCLUSIONS

The research study was conducted in 10 commercial varieties (CV1-10) of chia seeds. The content of total carbohydrates ($38.29 - 43.28 \text{ g} \cdot 100^{-1} \text{ DW}$, average $40.58 \text{ g} \cdot 100^{-1} \text{ DW}$, CV1-10), crude protein ($16.86 - 20.42 \text{ g} \cdot 100^{-1} \text{ DW}$, average $18.6 \text{ g} \cdot 100^{-1} \text{ DW}$, CV1-10), crude fat ($30.69 - 35.2 \text{ g} \cdot 100^{-1} \text{ DW}$, average $32.89 \text{ g} \cdot 100^{-1} \text{ DW}$, CV1-10) and crude fiber ($37.09 - 40.14 \text{ g} \cdot 100^{-1} \text{ DW}$, average $38.36 \text{ g} \cdot 100^{-1} \text{ DW}$, CV1-10). The high content of total phenols ($201.99 - 188.59 \text{ GAE mg} \cdot 100^{-1} \text{ DW}$, average 228.17 , CV1-10) and total flavonoids ($158.29 - 188.59 \text{ QE mg} \cdot 100^{-1} \text{ DW}$, average 179.38 , CV1-10) as biologically active components make chia a superior food due to the fact that these components have an antioxidant effect and they improve and maintain the physiological state of the cells, and have numerous health benefits. For those reasons, chia seeds are part of the daily menu prepared by nutritionists and accepted en masse by the healthy population that takes care of immune support for health and well-being, as well as by the population with certain diseases (cardiovascular, diabetes, anemia and metabolic syndrome).

REFERENCES

- Ayerza, R. 2009. The seed's protein and oil content, fatty acid composition and growing cycle length of a single genotype of chia (*Salvia hispanica* L.) as affected by environmental factors. *J Oileo Sci*, 58: 347–354.
- Ayerza, R., Coates, W. 2009. Some quality components of fourchia (*Salvia hispanica* L.) genotypes grown under tropicalcoastal desert ecosystem conditions. *Asian J Plant Sci*, 8:301-307.
- Ayerza, R. 2013. Seed composition of two chia (*Salvia hispanica* L.) genotypes which differ in seed color *Emir.J Food Agric* 25:495–500.
- Ayerza, R., Coates, W. 2011. Protein content, oil content and fatty acid profiles as potential criteria to determine the origin of commercially grown chia (*Salvia hispanica* L.). *Industrial Crops and Products*, 34(2): 1366–1371.
- Bochicchio, R., Philips, T. D., Lovelli, S., Labella, R., Galgano, F., DiMarsico, A., Perniola, M., Amato, M. 2015. Innovative cropproductions for healthy food: the case of chia (*Salvia hispanica* L.). In: Vastola A (ed) *The sustainability of agro-food and natural resource systems in the mediterranean basin*. Springer, Berlin, pp. 15–27.
- Breeseon, J. L., Flynn, A., Heinonen, M. 2009. Opinion on the safety of chia seeds (*Salvia hispanica* L.) and ground whole chia seeds as a food ingredient. *EFSA J*, 996: 1-26.

- Bueno, M., di Sapia, O., Barolo, M., Busilacchi, H., Quiroga, M., Severin, C. 2010. Quality tests of *Salvia hispanica* L. (Lamiaceae) fruits marketed in the city of Rosario (Santa Fe province, Argentina). *Boletín Latinoamericano y del Caribe de Plantas Medicinales y Aromáticas*, 9(3): 221–227.
- Capitani, M. I., Sportono, V., Nolasco, S. M., Tomas, M. C. 2012. Physicochemical and functional characterization of byproducts from chia (*Salvia hispanica* L.) seeds of Argentina. *LWT-Food Sci Technol*, 45: 94-102.
- Coelho, S. M., de las Mercedes Salas-Mellado, M. 2014. Chemical characterization of chia (*Salvia hispanica* L.) for use in food product. *J Food Nutr Res* 2:263–269
- de Falco, B., Amato, M., Lanzotti, V. 2017. Chia seeds products: an overview. *Phytochem Review*, 16: 745-760. DOI: [10.1007/s11101-017-9511-7](https://doi.org/10.1007/s11101-017-9511-7)
- Ding, Y., Lin, H. W., Lin, Y. L., Yang, D. J., Yu, Y. S., Chen, J. W., Wang, S. Y., Chen, Y. C. 2017. Nutritional composition in the chia seed and its processing properties on restructured ham-like products. *J Food Drug Anal.*, 26(1): 124-134. doi:10.1016/j.jfda.2016.12.012 Dixon
- Ding, Y., Hui-Wen, L., Yi-Ling, L., Deng-Jye, Y., Yu-Shan, Y., Jr-Wei, Ch., Sheng-Yao, W., Yi-Chen, Ch. 2018. Nutritional composition in the chia seed and its processing properties on restructured ham-like products. *Journal of Food and Drug Analysis*, 26(1): 124-134. doi.org/10.1016/j.jfda.2016.12.012
- Garg, M. L., Wood, L. G., Singh, H., Moughan, P.J. (2006) Means of delivering recommended levels of long chain n - 3 polyunsaturated fatty acids in human diets. *J Food Sci*, 71: 66–71.
- Ixtaina, V. Y., Martínez, M. L., Sportono, V., Mateo, C. M., Maestri, D. M., Diehl, B. W. K., Nolasco, S. M., Tomás, M. C. 2011. Characterization of chia seed oils obtained by pressing and solvent extraction. *J Food Compos Anal*, 24: 166–174.
- Jamboonsri, W., Phillips, T. D., Geneve, R. L., Cahill, J. P., Hildebrand, D. F. 2012. Extending the range of an ancient crop, *Salvia hispanica* L.—a new x3 source. *Gen Resour Crop Evolut*, 59: 171–178.
- Lairon, D., Arnault, N., Bertrais, S., Planells, R., Clero, E., Hercberg, S., Boutron-Ruault, M. C. 2005. Dietary fiber intake and risk factors for cardiovascular disease in French adults. *Am J Clin Nutr*, 82: 1185–1194.
- Martha, G.C., Armando, R.T., Carlos, A. A., et al. 2012. A dietary pattern including Nopal, Chia seed, soy protein, and oat reduces serum triglycerides and glucose intolerance in patients with metabolic syndrome. *Journal of Nutrition*, 142(1): 64–69.
- Marineli, R. S., Lenquiste, S. A., Moraes, E. A., Maróstica, M. R. 2015. Antioxidant potential of dietary chia seed and oil (*Salvia hispanica* L.) in diet-induced obese rats. *Food Res Int*, 76(3): 666-674.
- Meineri, G., Peiretti, P. G. 2007. Apparent digestibility of mixed feed with increasing levels of chia (*Salvia hispanica* L.) seeds in rabbit diets. *Italian Journal of Animal Science*, 6(1): 778–780.
- Mohd, N.A., Yeap, S.K., Ho, W.Y., Beh, B.K., Tan, S.W., Tan, S.G.. 2012. The promising future of chia, *Salvia hispanica* L. *J Biomed Biotechnol*, p. 171956
- Monroy-Torres, R., Mancilla-Escobar, M. L., Gallaga-Solórzano, J. C., Medina-Godoy, S., Santiago-García, E. J. 2008. Protein digestibility of chia seed *Salvia Hispanica* L. *Revista Salud Pública y Nutrición*, 9(1):1-9.
- Peiretti, P.G., Gai, F. 2009. Fatty acid and nutritive quality of chia (*Salvia hispanica* L.) seeds and plant during growth. *Animal Feed Science and Technology*, 148(2–4): 267–275.

- Porras-Loaiza, P., Jiménez-Munguía, M. T., Sosa-Morales, M. E., Palou, E., López-Malo, A. 2014. Physical properties, chemical characterization and fatty acid composition of Mexican chia (*Salvia hispanica* L.) seeds. *Int J Food Sci Technol* 49: 571–577.
- Scapin, G., Schimdt, M. M., Prestes, R. C., Ferreira, S., Silva, A. F. C., daRosa, C. S. 2015. Effect of extract of chia seed (*Salvia hispanica*) as an antioxidant in fresh pork sausage. *Int Food Res J* 22: 1195–1202
- Simopoulos, A. P. 2002. Omega-3 fatty acids in inflammation and autoimmune diseases. *J Am Coll Nutr*, 21: 495–505.
- Sudha, M. L., Vetrmani, R., Leelavathi, K. 2007. Influence of fibre from different cereals on the rheological characteristics of wheat flour dough and on biscuit quality. *Food Chem*, 100: 1365-70.
- Vedtofte, M. S., Jakobsen, M. U., Lauritzen, L., et al. 2011. Dietary alpha linoleic acid, linoleic acid and n-3 long-chain PUFA and risk of ischemic heart disease. *The American Journal of Clinical Nutrition*, 94: 1097–1103.

STUDY OF BIOFILM FORMATION IN *Pseudomonas savastanoi* BY MICROTITER PLATE

Soukaina MITRO¹, Doha MAZIGH¹, Rabha El Othmany¹, Taoufik Hakim¹, Chorouk Zanane¹, Mostafa EL LOUALI¹, Hassan LATRACHE¹, Hafida ZAHIR¹

¹Sultan Moulay Slimane University, Faculty of Science and Technology, Department of Biology, Beni Mellal, Morocco

Corresponding author e-mail: mitrosoukaina@gmail.com

ABSTRACT

Olive tuberculosis is a disease caused by *Pseudomonas savastanoi*. This bacterium often coexists with non-pathogenic bacterial species, forming multispecific biofilms responsible for nodule formation. The development of this biofilm leads to the synthesis of higher levels of 3-indoleacetic acid (IAA), which can lead to a significant increase in nodule size and disease progression. The aim of this research was therefore to evaluate the formation of *P. savastanoi* B97 biofilm over a period of 6 days using the microtiter plate (MTP) method. The results obtained were classified by comparing the optical densities of the bacteria studied and those of the control. The optical density measured reflects the intensity of the biofilm attached to the walls of the microtiter plate. Our results showed that *P. savastanoi* B97 is capable to forming biofilms and that this ability increases with the incubation time ($0.086 < OD_{630nm} < 0.107$). Understanding the mechanisms of biofilm production by *P. savastanoi* B97, together with establishing the kinetics of biofilm formation on different parts of the olive tree, could help us to prevent and control the infection.

Keywords: Biofilm formation, *Pseudomonas savastanoi*, Olive tuberculosis, Microtiter Plate.

INTRODUCTION

Olive knot is a bacterial disease caused by *Pseudomonas savastanoi*. It is characterized by the appearance of nodules on the branches, leaves and fruits of the olive tree (Sisto et al., 2004). These nodules can vary in size from a few millimeters to several centimeters. Olive knot can cause significant damage to olive trees, up to and including the death of the tree (Godena et al., 2012). The nodules can block the flow of sap in the tree, leading to weakening of the tree and a decrease in its production (Lamichhane et al., 2014). The nodules can also facilitate the entry of other diseases and pests, which can aggravate the damage.

Olive scald is caused by a multi-species biofilm of *P. savastanoi* and other bacteria (Buonaurio et al., 2015). This biofilm, which is a community of bacteria living together, is responsible for the formation of nodules on the branches, twigs and trunk of the olive tree. These nodules are caused by indole-3-acetic acid (IAA), a substance produced by the bacteria in the biofilm (Smidt, M., and Kosuge, 1978; Surico et al., 1985). Indole-3-acetic acid stimulates plant cell growth and causes the formation of nodules. The progression of the disease is characterized by an increase in the number and size of the nodules, which can lead to a weakening of the olive tree and a decrease in its production.

The aim of this study was to quantify the biofilm formation of *Pseudomonas savastanoi* over a period of 6 days. We used the microtiter plate method, which allows us to measure the amount of biofilm formed on a solid surface.

MATERIAL AND METHOD

The bacterial strain used in this study was *P. savastanoi* B97, purchased from the Moroccan Coordinated Collections of Microorganisms (CCMM) of the National Centre for Scientific and Technical Research (CNRST) in Morocco and isolated from the Beni mellal-Morocco region at $28\text{ }^{\circ}\text{C} \pm 2$ for 24 h.

Stepanovic's method was used to grow biofilms in microtiter plates (Stepanović et al., 2007). The tests are performed in 96-well, flat-bottomed polystyrene microtiter plates. The concentration of the bacterial suspension is then measured at a wavelength of 630 nm and adjusted to 0.7-0.8. Under aseptic conditions, 200 μl of the adjusted bacterial suspension is added to each well. Plates are incubated at $28\text{ }^{\circ}\text{C}$. After 24 hours, the wells were rinsed three times with sterile water to remove non-adherent bacteria. The adherent biomass was exposed to $80\text{ }^{\circ}\text{C}$ for 30 minutes to fix it. Biofilm formation was evaluated every 24 hours for 6 days. The negative control consists of wells filled only with liquid LB medium without bacterial cells.

The attached biomass was stained with 5% crystal violet for 5 minutes per well. Excess dye was removed by rinsing with tap water. The crystal violet bound to the biomass was then dissolved in an ethanol/acetone solution (80/20, v/v) at a rate of 200 μl per well. The concentration of bound biomass was determined by measuring the absorbance (OD) of the resulting solutions at 630 nm using a microplate reader. The amount of biomass bound to the microplate wells is proportional to the OD of the resulting solutions. The experiment was repeated three times to assess the reliability of the results.

Biofilm production was classified into four categories, based on the cutoff value, negative, weak, moderate, and strong, calculated according to the following formula (Folliero et al. 2021):

$\text{OD}_{\text{cutoff}} = \text{Average OD of the negative control} + (3 \times \text{standard deviation of the ODs of the three repetitions of the negative control}).$

The following criteria were used:

- $\text{OD}_{\text{exp}} \leq \text{OD}_{\text{cut off}} = \text{Non biofilm former}$
- $\text{OD}_{\text{cut off}} < \text{OD}_{\text{exp}} \leq 2 \times \text{OD}_{\text{cutoff}} = \text{Weak biofilm former}$
- $2 \times \text{OD}_{\text{cut off}} < \text{OD}_{\text{exp}} \leq 4 \times \text{OD}_{\text{cutoff}} = \text{Moderate biofilm former}$
- $\text{OD}_{\text{exp}} > 4 \times \text{OD}_{\text{cut off}} = \text{Strong biofilm former}$

RESULTS AND DISCUSSION

The figure shows the quantification of *P. savastanoi* B97 biofilm formation over 6 days. The absorbance of crystal violet is an indicator of biofilm strength. Biomass attached to the microtiter wells is stained with crystal violet as described in the Methods section. The crystal violet contained in the cells is extracted by dissolving in an ethanol/acetone mixture. The amount of biomass adhering to the well walls can be estimated from the absorbance of the mixture at 630 nm. Based on the Stepanovic classification, which refers to a comparison between OD_{exp} and OD_{test} , it is possible to describe biofilm formation as strong, moderate, weak or absent (Stepanović et al., 2007).

The *P. savastanoi* B97 strain is capable of forming a biofilm after 3 days of incubation. The intensity of the biofilm gradually increases with time and becomes strong after 6 days. The bacterium is able to strongly adhere to the wells, which facilitates biofilm formation. The colonization and kinetics of biofilm formation depend primarily on the surface properties of the bacterium and the walls of the microtiter plates.

The measured density of crystal violet is an indicator of the amount of biomass attached to the wall, which is composed of cells and extracellular matrix. Crystal violet is dissolved in ethanol/acetone and added to microtiter plate wells. A high optical density of the mixture indicates a large number of cells attached to the wells. The literature indicates that few studies

have been conducted on *P. savastanoi* biofilms. In 2019, Moretti et al., characterized the formation of *P. savastanoi* biofilms using crystal violet staining. He observed that biofilm formation did not occur until the second day of incubation. These results contrast with our own observations, which show that biofilm formation begins on the first day of incubation. However, *P. savastanoi* has been shown to form mutualistic biofilms when infected with the biofilm-forming bacteria *Pantoea agglomerans* and *Erwinia toletana*.

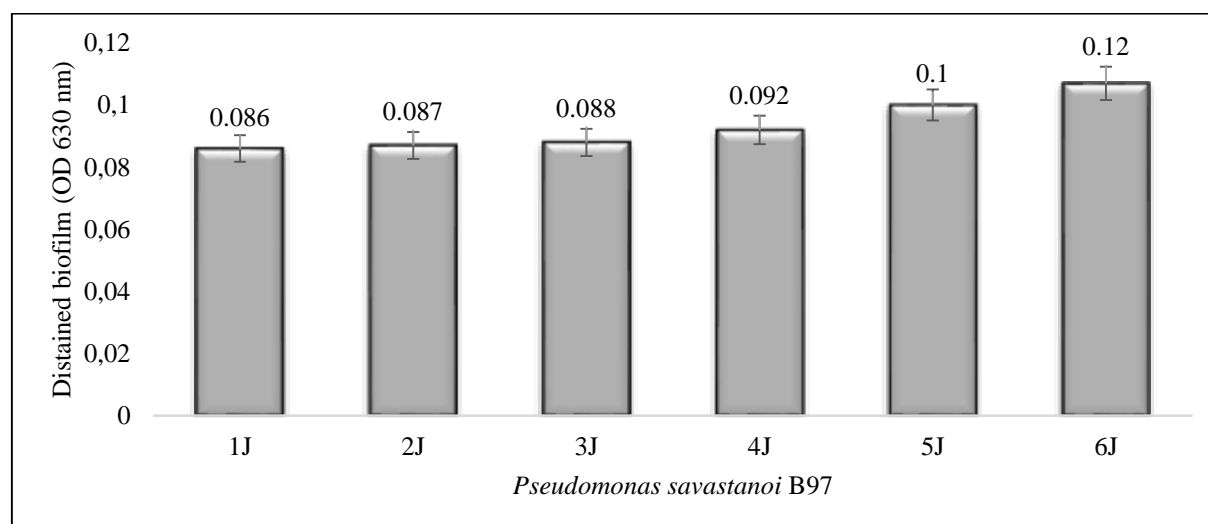

Figure 1. Quantification and following of biofilm formation *P. savastanoi* B97 strain using microtiter plate method

CONCLUSIONS

The microtiter plate assay showed that the strain *P. savastanoi* B97 is able to form strong biofilms from day one. The intensity of the biofilm increased with time. The optimized assay is an effective tool to evaluate the biofilm forming ability of *P. savastanoi* strains. This information is important for controlling the virulence of this bacterium.

REFERENCES

- Buonauro, R., Moretti, C., da Silva, D. P., Cortese, C., Ramos, C., & Venturi, V. 2015. The olive knot disease as a model to study the role of interspecies bacterial communities in plant disease. *Frontiers in plant science*, 6, 434.
- Godena, S., Dminić, I. & Đermić, E. 2012. Differential susceptibility of olive varieties to olive knot disease in Istria. *Journal of central European agriculture*, 13(1), 85-94.
- Lamichhane, J. R., Varvaro, L., Parisi, L., Audergon, J. M., & Morris, C. E. 2014. Disease and frost damage of woody plants caused by *Pseudomonas syringae* : seeing the forest for the trees. *Advances in agronomy*, 126, 235-295.
- Moretti, C., Trabalza, S., Granieri, L., Caballo-Ponce, E., Devescovi, G., Del Pino, A. M., ... & Palmerini, C. A. 2019. A Na⁺/Ca²⁺ exchanger of the olive pathogen *Pseudomonas savastanoi* pv. *savastanoi* is critical for its virulence. *Molecular plant pathology*, 20(5), 716-730.
- Sisto, A., Cipriani, M.G. & Morea, M. 2004. Knot formation caused by *Pseudomonas syringae* subsp. *savastanoi* on olives is hrp-dependent. *Phytopathology*, 94(5), 484-489.

- Smidt, M., & Kosuge, T. 1978. The role of indole-3-acetic acid accumulation by alpha methyl tryptophan-resistant mutants of *Pseudomonas savastanoi* in gall formation on oleanders. *Physiological Plant Pathology*, 13(2), 203-213.
- Stepanović, S., Vuković, D., Hola, V., Bonaventura, G. D., Djukić, S., Ćirković, I., & Ruzicka, F. 2007. Quantification of biofilm in microtiter plates: overview of testing conditions and practical recommendations for assessment of biofilm production by *Staphylococci*. *Apmis*, 115(8), 891-899.
- Surico, G., Iacobellis, N. S., & Sisto, A. 1985. Studies on the role of indole-3-acetic acid and cytokinins in the formation of knots on olive and oleander plants by *Pseudomonas syringae* pv. *savastanoi*. *Physiological Plant Pathology*, 26(3), 309-320.

EVALUATION OF SACCHAROMYCES AND NON-SACCHAROMYCES YEASTS ISOLATED FROM ALBANIAN AUTOCHTHONOUS GRAPE VARIETIES FOR CRAFT BEER PRODUCTION

Julian Karauli*¹, Nertil Xhaferaj³, Mamica Ruci¹, Bruno Testa, Francesco Letizia, Gianluca Albanese⁴, Renata Kongoli³, Fatbardha Lamçe¹, Onejda Kyçyk¹, Kapllan Sulaj² and Massimo Iorizzo⁴.

¹ Faculty of Biotechnology and Food, Food Research Center, Agricultural University of Tirana, Albania

² Faculty of Biotechnology and Food, Food Science and Biotechnology Department, Agricultural University of Tirana, Albania

³ Faculty of Biotechnology and Food, Department of Agri-Food Technology, Agricultural University of Tirana, Albania

⁴ Department of Agriculture, Environmental and Food Sciences, University of Molise, 86100 Campobasso, Italy

Corresponding author e-mail: jkarauli@ubt.edu.al

ABSTRACT

In recent years, researchers have been working to create and expand the pool of yeasts for the brewery sector including the use of new strains isolated from non-brewing environments. In this context, the non-*Saccharomyces* and *Saccharomyces* yeasts use has attracted great interest from both researchers and commercial brewers for the production of novel beer styles. Recent research has shown that enzymatic activities of these non-conventional yeasts contribute during the fermentation process to the production of esters and higher alcohols that define the sensory characteristics of beer. Therefore, the selection and use of new yeast strains with peculiar metabolic properties could represent the key point in differentiating products in the brewery sector, especially for local producers of craft beer. Our study aims to evaluate some preliminaries fermentative characteristics of *Saccharomyces* and non-*Saccharomyces* strains isolated from the Albanian autochthonous grape varieties in the craft beer production. Specifically, the tested yeasts were isolated from the autochthonous grape varieties Kallmet and Shesh i Zi, collected from the Valias and Shkodra regions in Albania. Isolation was performed using WL as culture medium, followed by laboratory screening to assess the fermentation characteristics of the isolated yeasts. Our results showed that *Saccharomyces cerevisiae* SHZV3 strain has excellent aptitudes to be used as a new starter in craft beer production as it shows low levels of hydrogen sulphide (H₂S) production and also negative results in production of biogenic amines, conversely with other strains, which exhibited undesirable production of hydrogen sulphide (H₂S) and biogenic amines, rendering them unsuitable for beer production.

Keywords: *Saccharomyces cerevisiae*, craft beer, fermentation characteristics, hydrogen sulphide, biogenic amines.

INTRODUCION

The development of viticulture and oenology in Albania dates back to ancient times, due to the soil and favourable climatic conditions (Ruci et al ,2022). In the traditional context, grapes and wine have conventionally been employed for yeast isolation, primarily intended for application in the wine industry, with no consideration for their utilization in craft beer production. Many physiological parameters allow *Saccharomyces* to dominate grape juice fermentations, but its tolerance to high concentrations of ethanol is the principal feature of this yeast that allows its survival in this specific environment (Štefàniková et al, 2014). Non- *Saccharomyces* are the predominant yeasts species isolated at early stages of the spontaneous fermentation of *Vitis vinifera* L. Grape musts (Combina et al, 2005). As the fermentation progresses, the population of non-*Saccharomyces* species decreases and the wine yeasts *Saccharomyces cerevisiae* completes the fermentation process. The ability of *S. cerevisiae* to outcompete non-*Saccharomyces* species is associated with its higher fermentative power as well as its additional advantageous phenotypes that include alcohol tolerance and the secretion of killer-like compounds (Albergaria and Arneborg et al, 2016).

While many yeast strains are commercially available, the availability of new starter strains could be a useful differentiating factor among beers (Rossi et al, 2018). The aim of this study was to investigate yeast strains for their brewing ability and to test the promising strains in small brewing trials (Hutzler et al, 2019). For this reason, yeast isolated from grape must and finished fermented wine were tested in screening laboratory in order to discern new yeast strain possessing elevated abilities as a starter for beer production.

MATERIALS AND METHODS

Yeasts isolation

To carry out this study, two autochthonous varieties of black grapes (*Vitis vinifera* L.) were chosen such as: Shesh i Zi, from the area Valias in Tirana and Kallmet from the area of Kolplik in Shkodra. The samples, was harvest in optimal ripping and were transported to the Research Centre of the Faculty of Biotechnology and Food. Fermentation was carried out spontaneously in small vessels without adding Kalium Metabisulfite.

The progress of fermentation was checked daily (% sugar and temperature). Samples were taken every day during the fermentation. Yeast isolation was carried out in WL nutrient agar (Thermo Fisher Scientific, Waltham, MA, USA). Appropriate serial dilutions of each sample were made using a physiological saline solution (0.9% w/v NaCl). Subsequently, 0.1 mL of each dilution was distributed on Petri plates containing WL nutrient agar and incubated at 28° C for 1-3 days. After the incubation, 5 colonies from each sample were picked on the basis of typical *Saccharomyces* and non- *Saccharomyces* morphology. Purification of the strains was performed on the YEPD agar (Thermo Fisher Scientific, Waltham, MA, USA) by successive subculturing. Stock cultures were maintained in YEPD broth (Thermo Fisher Scientific, Waltham, MA, USA) for daily use and were preserved in YEPD broth with 40% (v/v) sterile glycerol (Merck KGaA, Darmstadt, Germany) for long-term storage at -80 °C until further characterization.

Screening of Isolated Yeasts Strains

Morphological Yeast Features Evaluation

Evaluation of the cellular Morphological of the yeast was done by using optical Microscope (Zeiss Axiophot, Carl Zeiss, Germany).

Pulcherrimin production.

Pulcherrimin production was evaluated according to method described by Pawlikowska et al 2020 using a specific culture media. Plates were incubated at 12°C and 28°C for 3-5 days. Positive result was given by the formation of a red pigment produced by the yeasts tested on the surface of the culture media.

Antimicrobial Activity.

Antimicrobial Activity was evaluated by Agar Well Diffusion method using BHI Agar medium (Brain Heart Infusion) as described by Iorizzo et al 2020 with some modification. The test was performed against beer spoilage bacteria, which: *Pediococcus damnosus* DSM 20289, *Levilactobacillus brevis* DSM 6235, *Lactiplantibacillus plantarum* DSM 20174 and *Fructilactobacillus lindneri* DSM 20690. Beer spoilage bacteria were provided by German Collection of Microorganism and Cell Cultures del Leibniz-Institute DSMZ and were incubated in MRS broth at 28 °C 24h before the screening evaluation. Negative and positive control tests were performed in order to control the validity of the test. Plates were incubated at 28°C for 72h. After incubation, evaluation of the antimicrobial activity of each isolated yeast consisting in the measuring of the diameter (mm) of the clear zone of inhibition (ZOI) around the inoculated wells.

Hydrogen Sulphide (H₂S) Production.

H₂S production of all the 8 yeast isolates was evaluated on BIGGY agar (Bismuth Sulphite Glucose Glycine Yeast; Thermos Fisher Scientific, Waltham, MA, USA). On this medium H₂S-negative strains showed white colonies, while H₂S-producing colonies were characterized by a brown or dark brown colour. Plates were incubated with 48-h yeast cultures at 12° C, 20° C and 28 °C for 3 days as described by Comitini et al 2011. For results, the following chromatic scale was considered: 0 (white colonies, no hydrogen sulphide production), 1 (cream colonies), 2 (light brown colonies), 3 (brown colonies), 4 (dark brown or black colonies, very intensive hydrogen sulphide production). The test was performed in triplicate.

Qualitative Screening of the β -Glucosidase Activity

β -Glucosidase activity was carried out into Esculin agar medium as described by Jose Juan Mateo et al 2023. The presence of the enzymatic activity was visualized as a dark halo around yeast growth.

Qualitative Screening of the β -lyase Activity

Qualitative screening of β -lyase activity was carried out on YCS with the addition of SMC (Yeast Carbone Base in addition S-methyl-l-cysteine) medium as described by Santos et al 2016.

. Plates were incubated for 48-72-h at 20 °C for 3 days. The presence of the enzymatic activity was visualized by yeast colony growth.

Biogenic Amines production

Biogenic Amines production was carried out in a modified YPD medium supplemented with 10 g/L of phenylalanine, tyrosine, lysine, ornithine and histidine (i.e., the decarboxylase medium) as described by Romano et al 2022 with some modification. The decarboxylation of the amino acid to the corresponding biogenic amine results in an increase in pH, detected by the change in color of the medium. While histamine, putrescine and cadaverine producing strains were identified by purple coloration, tyramine production was detected by the decolorization of the culture medium.

Cryotolerance.

The capacity to grow at 4 °C of all the 8 isolated yeast was evaluated by inoculating (10^6 cfu/mL) the yeast cultures into Erlenmeyer flasks (working volume of 100 mL) containing 80 mL of YEPD broth and maintained under stirring using a digital orbital shaker (Heathrow Scientific, IL, USA) set at 150 rpm as described by Iorizzo et al 2021. The growth was determined visually after 24 h of incubation.

Molecular identification

DNA extraction was carried out by using a DNA extraction kit (Norgen Biotek Corp., Thorold, ON, Canada) according to the manufacturer's instructions as described in Iorizzo et al 2021. Amplification of 28S rDNA region was carried out using U1 and U2 primers (Hertel et al 2003 and OIV-OENO 408-2011). PCR was performed using a Master cycler nexus gradient (Eppendorf, Hamburg, Germany).

RESULTS AND DISCUSSIONS

Eight yeast strains were isolated from autochthonous grape varieties, specifically Shesh i Zi and Kallmet, originating from the Tirana and Shkodër regions. These yeast isolates underwent comprehensive laboratory screening to assess their potential viability as starters for craft beer production. According to the morphological characteristics, and biochemical reactions only SHZV3 strain exhibited significant attributes suitable for utilization as a starter in the brewing industry. After DNA sequencing, this yeast was identified as *Saccharomyces cerevisiae* isolated from Shesh i Zi variety after 6 days of fermentation.

a. Pulcherrimin Production

Pulcherrimin is an insoluble iron chelate formed via a non-enzymic reaction between Fe^{3+} and the water-soluble and diffusible pulcherriminic acid secreted by the cells of the antagonistic microorganism (Spiczki, et al 2020). Pulcherrimin production resulted positive in all selected yeasts in the Kallmet variety in both incubation temperature 12°C and 28°C as shown in Fig.1. In the Shesh i Zi variety only SHZV3T6 tested negative in both incubation temperature 12°C and 28°C and all other strains from Shesh i Zi tested negative. There have been numerous studies on the biocontrol ability and action mechanisms of large numbers of strains belonging

to the *M. pulcherrima* clade, isolated from various substrates which exhibit antagonist activity against spoilage bacteria. (Kriegel et al 2022).

Table 1 Pulcherrimin production from isolated yeasts in both Shesh and Kallamet varieties at 12°C and 28°C

Cultivars	Area	Yeast	Pulcherrimin Production in 12°C	Pulcherrimin Production in 28°C
Shesh i Zi	Valias Tiranë	SHZV4T3	+	+
		SHZV2T6	+	+
		SHZV6T6	+	+
		SHZV1T6	+	+
		SHZV3T6	-	-
Kallmet	Koplik , Shkodër	KG1T6	+	+
		KG2T6	+	+
		KG5T6	+	+



Figure 1. Pulcherrimin production by Yeasts strains from Shesh i Zi variety on Minimum Medium.

b. Antimicrobial Activity

In winemaking and brewing, an interesting application of biological activities is seen by the use of killer yeast to control the proliferation of spoilage microorganisms during the pre-fermentation phase (Comitini et al 2014). In past two decades, there are few research conducted to investigate the role of naturally occurring yeasts for inhibiting the growth of foodborne bacteria with various mechanisms (Younis et al 2017). As seen on Table 2 all conducted examinations yielded negative results, leading to the absence of any halo formation as shown in the Figure 2.

Table 2. Antimicrobial activity screening in BHI Agar medium

Cultivars	Area	Yeast	<i>P. damnosus</i> DSM 2030031	<i>L. brevis</i> DSM 6235	<i>LB. plantarum</i> DSM 2010074	<i>FB. lindneri</i> DSM 2060090
Shesh i Zi	Valias Tiranë	SHZV4T3	-	-	-	-
		SHZV2T6	-	-	-	-
		SHZV6T6	-	-	-	-
		SHZV1T6	-	-	-	-
		SHZV3T6	-	-	-	-
Kallmet	Koplik, Shkodër	KG1T6	-	-	-	-
		KG2T6	-	-	-	-
		KG5T6	-	-	-	-

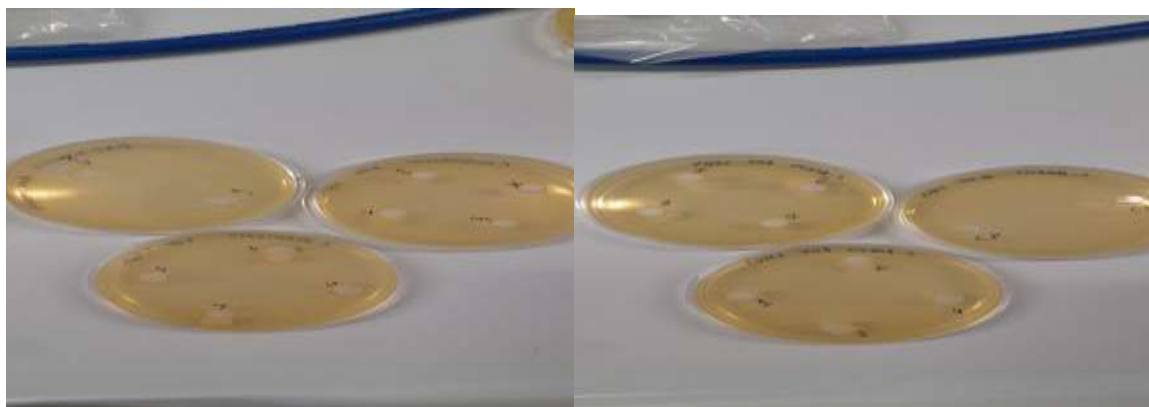

Figure 2. Antimicrobial activity in both Shesh i Zi and Kallmet varieties

c. Hydrogen Sulphide (H₂S) Production

Hydrogen sulphide (H₂S) is produced by yeast during winemaking and brewing and possesses off-flavours reminiscent of rotten eggs (Kinzurik et al 2016). As H₂S is produced all along fermentation, it is necessary to trap this gas to assess the total production of one alcoholic fermentation (De Guidi et al 2021). Samples were put in thermostat respectively at 12°C, 20°C and 28°C to assess H₂S production as shown in table 3. SHZV3T6 did not produce detectable quantities of H₂S at 20°C and 28°C forming a light brown colony and white colonies at 12°C. All the other strains produced elevated quantities of H₂S in 20°C and 28°C. Only at 12°C the yeasts should be considered as low producers of H₂S forming a light brown colony as shown in the Figure 3.

Table 3. Screening of H₂S production by isolated yeasts from Shesh i Zi and Kallmet varieties in Biggy Agar

Cultivars	Area	Yeast	Temp Incubation	Temp Incubation	Temp Incubation
			12°C	20°C	28°C
Shesh i Zi	Valias Tiranë	SHZV4T3	2	3	4
		SHZV2T6	2	3	4
		SHZV6T6	2	3	4
		SHZV1T6	2	3	4
		SHZV3T6	0	2	2
Kallmet	Koplik, Shkodër	KG1T6	2	3	4
		KG2T6	2	3	4
		KG5T6	2	3	4



Fig.3 Dark brown colonies formed by some yeasts at 28°C and cream colonies by SHZV3T6 at 12°C

d. β-Glucosidase and β-Lyase assessment

The enzymatic ability of yeasts to hydrolyse glycosides due to β-Glucosidase activity (Han et al 2023) and to release thiols via the enzyme β-Lyase activity (Michell et al 2019) was performed in order to evaluate the enzymatic properties of isolated yeasts strains. β-Glucosidase activity gave positives results for 7 yeasts strains and negative results only for SHZV3T6. β-Lyase activity gave positive results only for SHZV3T6 as shown on Table 4.

Table 4 Screening of β-Glucosidase and β-Lyase activity on both Kallmet and Shesh i Zi isolated yeasts

Cultivars	Area	Yeast	β-Glucosidase activity	β-Lyase activity
Shesh i Zi	Valias Tiranë	SHZV4T3	+	-
		SHZV2T6	+	-
		SHZV6T6	+	-
		SHZV1T6	+	-
		SHZV3T6	-	+
Kallmet	Koplik, Shkodër	KG1T6	+	-
		KG2T6	+	-
		KG5T6	+	-

β-Glucosidase activity was visualized by yeast colony growth as shown in Figure 4.

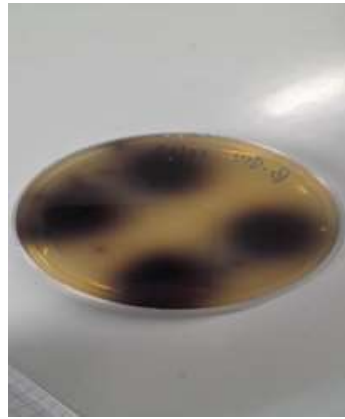

Fig. 4 β -Glucosidase activity of isolated yeast

e. Biogenic Amines Production

Yeast strain used for fermentation, can cause desirable as well as undesirable changes in beer as they could contain high concentrations of undesirable compounds, such biogenic amines (Bartkiene et al 2022). Laboratory screening was performed in order to evaluate Biogenic Amine production by isolated yeasts. Biogenic Amines screening gave positive results for most of the yeasts in YPD medium supplemented with 10 g/L of phenylalanine, tyrosine, lysine, ornithine and histidine producing biogenic amines respectively tyramine, cadaverine, putrescine and histamine. SHZV3T6 gave negative results in producing biogenic amines as shown on Table 5.

Table 5. Screening of Biogenic Amines production on both Kallmet and Shesh i Zi isolated yeasts

Cultivars	Area	Yeast	Phenylalanine	Tyrosine	Lysine	Ornithine	Histidine
Shesh i Zi	Valias Tiranë	SHZV4T3	+	+	+	+	+
		SHZV2T6	+	+	+	+	+
		SHZV6T6	+	+	+	+	+
		SHZV1T6	+	+	+	+	+
		SHZV3T6	-	-	-	-	-
Kallmet	Koplik, Shkodër	KG1T6	+	+	+	+	+
		KG2T6	+	+	+	+	+
		KG5T6	+	+	+	+	+



Fig. 5 Biogenic Amines screening test on both Shesh i Zi and Kallmet varieties.

f. Cryotolerance

Each strain of yeast exhibited the capacity for growth at a temperature of 4°C. This phenomenon was assessed through visual observation, wherein pellet formation at the base of the slant was observed. It is noteworthy, however, that the growth rate at 4°C was comparatively lower when contrasted with the growth rates observed at temperatures of 12°C, 20°C, and 28°C.

g. Molecular Identification

From all the strains isolated only SHZV3T6 was subject of molecular identification as the other were not suitable for beer industry. Based on the analysis of rDNA using the primers U1 and U2 performed in the laboratory of Technology and Microbiology in the Department of Agriculture, Environmental and Food Sciences at the University of Molise, Italy SHZV3T6 yeast isolate turned out to belong to the *S. cerevisiae* species.

CONCLUSIONS

The results shows that there are great possibilities isolating suitable yeasts from the Albanian autochthonous vineyard as potential starter in craft beer production even though most of the yeasts isolated during spontaneous fermentation were not suitable for beer production as they produce elevated quantities of H₂S and Biogenic Amines. This may be due to stress or H₂S may be generated through the degradation of sulfur-containing amino acids. These yeasts produce Pulcherrimin in Minimum Medium but didn't have any antibacterial activity against beer spoilage bacteria tested but may have for other bacteria. Although pulcherrimin itself does not exhibit antimicrobial activity, production of this metabolite leads to depletion of iron from the environment, which is the major mechanism of antimicrobial activity of the pulcherrimin producers. The ability to produce biogenic amines makes them not suitable for beer production. Only SHZV3T6 should be considered suitable for both Ale and Lager beer as didn't produce elevated quantities of H₂S, especially in 12°C for lager beer production and resulted negative in production in Biogenic Amines. This yeast has β-Lyase activity which enhanced ability to release hop-derived flavours through enzymatic activity. Future work will focus on the use of these yeasts in both lager and ale beer styles, particularly in the hoped beers such as IPAs to assess the fermentation characteristics and aroma profile of the finished beer.

ACKNOWLEDGMENT

This paper is made due to the work of all the people mentioned in the authors list. Thanks to Laboratory of Technology and Microbiology in the Department of Agriculture, Environmental and Food Sciences at the University of Molise and Food and Research Centre in the Faculty of Biotechnology and Food at the Agricultural University of Tirana

REFERENCES

Ruci, M. Lamce, F. Karauli, J. Naka, A. Sulaj, K. Kycyk, O., “Biochemical characteristics of wine from autochthonous grape cultivars in various areas of Albania” AgBiol IV, International Conference on Agricultural Biological and Life Science 2022.

Stefaniková, J. Priesolová, L. Jankura, E. “Isolation and identification of yeasts isolated from grapes and spontaneously fermented wines” November 2014 37th World Congress of Vine and Wine At: Mendoza, Republic of Argentina.

Combina, M., Elía, A., Mercado, L., Catania, C., Ganga, A., and Martinez, C. (2005) “Dynamics of digenous yeast populations during spontaneous fermentation of wines from Mendoza, Argentina.” *Int. J. Food Microbiol.* 99, 237–243. doi: 10.1016/j.ijfoodmicro.2004.08.017.

Albergaria, H., and Arneborg, N. (2016). Dominance of *Saccharomyces cerevisiae* in alcoholic fermentation processes; role of physiological fitness and microbial interactions. *Appl. Microbiol. Biotechnol.* 100, 2035–2046. doi: 10.1007/s00253-015-7255-0.

Rossi, S. Turchetti, B. Sileoni, V. Marconi, O. Perretti, G. “ Evaluation of *Saccharomyces cerevisiae* strains isolated from non-brewing environments in beer production” *Journal of the Institute of Brewing* , Volume 24, Issue 4 , Pages 381-388 2018.

Yvonne, M. Mattias, H. Dagmar, M. Fritz, J. M. Michel “Screening for the Brewing Ability of Different Non-*Saccharomyces* Yeasts” *MDPI Journals* Volume 5 Issue 4 December 2019.

Pawlikowska, E. Kolesińska, B. Nowacka, M. Kregiel, D. “A New Approach to Producing High Yields of Pulcherrimin from *Metschnikowia* Yeasts” *MDPI Journals*, Volume 6 , Issue 4 , November 2020.

Iorizzo, M. Letizia, F. Albanese, G. Coppola, F. Gambuti, A. Testa, B. Aversano, R. Forino, M. Coppola, R. “Potential for Lager Beer Production from *Saccharomyces cerevisiae* Strains Isolated from Vineyard Environment” *MDPI Journals*, Volume 9, Issue 9, September 2021.

Meroth, C.B.; Hammes, W.P.; Hertel, C. Identification and Population Dynamics of Yeasts in Sourdough Fermentation Processes by PCR-Denaturing Gradient Gel Electrophoresis. *Appl. Environ. Microbiol.* **2003**, *69*, 7453–7461.

OIV—International Organisation of Vine and Wine. Molecular Tools for Identification of *Saccharomyces cerevisiae*. Wine Yeast and Other Yeast Species Related to Winemaking. *Resolut. OIV-OENO* **2011**, *408*, 1–7.

Comitini, F.; Gobbi, M.; Domizio, P.; Romani, C.; Lencioni, L.; Mannazzu, I.; Ciani, M. Selected Non-*Saccharomyces* Wine Yeasts in Controlled Multistarter Fermentations with *Saccharomyces cerevisiae*. *Food Microbiol.* 2011, *28*, 873–882.

Iorizzo, M. Testa, B. Lombardi, S. Ganassi, S. Ianiro, M. Letizia, F. Succi, M. Tremonte, P. Vergalito, F. Cozzolino, A. Sorrentino, E. Coppola, R. Petrarca, S. Mancini, M. De Cristofaro, A. “Antimicrobial Activity against *Paenibacillus plantarum* Functional Properties of *Lactiplantibacillus plantarum* Strains: Potential Benefits for Honeybee Health” *MDPI, Journals* Volume 9, Issue 8, July 2020.

Jose Juan Mateo “Physico-Chemical Characterization of an Exocellular Sugars Tolerant B-Glucosidase from Grape *Metschnikowia pulcherrima* Isolates” MDPI Journals, Volume 11, Issue 4 April 2023.

Santos, A. Belda, I. Ruiz, J. Navascues, E. Marquina, D. “Improvement of aromatic thiol release through the selection of yeasts with increased β -lyase activity” International Journal of Food Microbiology, Volume 225, Pages 1-8, May 2016.

Siesto, G. Corbo, M.R. Pietrafesa, R. Sinigaglia, M. Romano, P. Bevilacqua, A. “Screening of *Saccharomyces* and Non-*Saccharomyces* Wine Yeasts for Their Decarboxylase Activity of Amino Acids” MDPI Journals, Volume 11, Issue 22 November 2022.

Spiczki, M. “*Metschnikowia pulcherrima* and Related Pulcherrimin-Producing Yeasts: Fuzzy Species Boundaries and Complex Antimicrobial Antagonism” MDPI Journals, Volume 8, Issue 7 July 2020.

Younis, G. Awad, A. Dawod, R. Yousef, N. “Antimicrobial activity of yeasts against some pathogenic bacteria” Vet World Journal 2017 Aug; 10(8): 979–983.

Comitini, F. Oro, L. Ciani, M. “Antimicrobial activity of *Metschnikowia pulcherrima* on wine yeast” Journal of Applied Microbiology, Volume 116, Issue 5, 1 May 2014, Pages 1209–1217.

Kinzurik, M. Herbst-Johnstone, M. Gardner, R. Fedrizzi, B. “Hydrogen sulfide production during yeast fermentation causes the accumulation of ethanethiol, S-ethyl thioacetate and diethyl disulfide” Food Chemistry, Volume 209, Pages 341-347, October 2016.

De Guidi, I. Farines, V. Legras, J. Blondin, B. “Development of a New Assay for Measuring H₂S Production during Alcoholic Fermentation: Application to the Evaluation of the Main Factors Impacting H₂S Production by Three *Saccharomyces cerevisiae* Wine Strains”, MDPI Journal, Volume 7, Issue 4 , September 2021.

Han,X. Qin, Q. Li, C. Zhao, X. Song F. An, M. Chen, Y. Wang, X. Huang, W. Jicheng Zhan, Y. “Application of non-*Saccharomyces* yeasts with high β -glucosidase activity to enhance terpene-related floral flavor in craft beer” , Food Chemistry, Volume 404, Part B , March 2023.

Michel, M. Terzi, K. Ampenberger, F. Dornberg, T. Stertz, D. Hutzler, M. Coelhan, M. Jacob, F. Liu, Y. “Screening of brewing yeast β -lyase activity and release of hop volatile thiols from precursors during fermentation” Brewing Science Journal, 72(11/12):179-186, December 2019.

Matukas, M. Starkute, V. Zokaityte, E. Zokaityte, G. Klupsaite, D. Mockus, E. Rocha, M. Ruibys, R. Bartkiene, E. “Effect of Different Yeast Strains on Biogenic Amines, Volatile Compounds and Sensory Profile of Beer” MDPI Journal, Volume 11, Issue 15 July 2022.

Kriegel, D. Nowacka, M. Rygala, A. Vadkeritova, R. “Biological Activity of Pulcherrimin from the *Metschnikowia pulcherrima* Clade” MDPI Journals, Volume 27, Issue 6 March 2022.

Linderholm, A. Findelton, C. Kumar, G. Hong, Y. Bisson, L. “Identification of Genes Affecting Hydrogen Sulfide Formation in *Saccharomyces cerevisiae*” Applied and Environmental Microbiology Journal 2008 Mar; 74(5): 1418–1427.

Krogerus, K. Rettberg, N. Gibson, B. “Increased volatile thiol release during beer fermentation using constructed interspecies yeast hybrids” *European Food and Research Technology Journal* 249, pages55–69 (2023).

UV LIGHT-DRIVEN PHOTOCATALYTIC DEGRADATION OF METHYLENE BLUE USING TiO₂, ZnO, and SnO₂ as CATALYSTS: A COMPARATIVE STUDY

Nazli TURKTEN, Yunus KARATAS*

*Kirsehir Ahi Evran University, Faculty of Arts and Sciences, Department of Chemistry,
40100, Kirsehir, Turkiye*

Corresponding author e-mail: nazli.turkten@yahoo.com

ABSTRACT

The improper disposal of wastewater from the textile industry is a crucial global challenge that addresses various adverse effects on the aquatic environment. Methylene blue (MB) is a thiazine dye most widely used as a textile dye. Since MB is entirely stable, this dyestuff is very difficult to degrade in nature. Hence, different physical, chemical, and biological treatment technologies, including adsorption electrocoagulation, and electrochemical have been utilized to remove MB from contaminated water. Among them, heterogeneous photocatalysis is a cost-effective and sustainable method for the efficient breakdown of organic compounds into smaller and safer components without contributing to secondary contamination. For photocatalysis applications, TiO₂, ZnO, and SnO₂ are well-known semiconductors that play a vital role in mineralizing dyes into H₂O and CO₂ through the generation of reactive oxygen species.

In this study, the structural and morphological differences of TiO₂, ZnO, and SnO₂ nanoparticles were determined by FT-IR, XRD, SEM, and Raman spectroscopy. The photocatalysts were investigated comparatively for the degradation of MB dye under UV light irradiation. The percent degradation of MB in the presence of TiO₂ and ZnO was found to be 73% and 97 %, respectively, within 60 min irradiation. This value was lower for SnO₂ nanoparticles compared to TiO₂ and ZnO photocatalysts.

Keywords: Decolorization, heterogeneous photocatalysis, methylene blue, SnO₂, TiO₂, ZnO,

INTRODUCTION

The significant origin of wastewater management issues facing the world today is the heavy industries related to textiles (Islam et al., 2023). Textile wastewater contains various persistent pollutants such as non-biodegradable organics, dyes, heavy metals, surfactants, and phenols that detrimentally affect the environmental system (Kumar et al., 2023). Therefore, in order to comply with the national rules and international standards, dye wastewater must be treated before being discharged into any water bodies (Solayman et al., 2023). Although various efficient techniques have been reported to ensure the safe disposal of dye effluents, conventional wastewater treatment processes involving biological, physical, and chemical wastewater treatment processes have not been sufficient for the treatment of dye wastewater (Valli Nachiyar et al., 2023). However, advanced oxidation processes (AOPs) are cost-effective, environmentally friendly, and effective methods. These methods are extensively applied in dye wastewater treatment. Among AOPs, photocatalysis is the most popular and effective process using a semiconductor and UV light. A variety of photocatalysts have been used for the purification of wastewater in photocatalytic applications (Kurian, 2020; Solayman et al., 2023; Yadav et al., 2023). TiO₂ and ZnO have received much more attention compared to SnO₂ (Al-Hamdi et al., 2017).

In the present study, Fourier transform infrared spectrometer (FTIR) used with attenuated total reflection (ATR), Raman spectroscopy, X-ray diffraction (XRD), and Scanning electron microscopy (SEM) spectroscopic techniques were used to identify possible structural and morphological differences of TiO₂, ZnO, and SnO₂ nanoparticles. A comparative photocatalytic study was performed on the degradation of MB, a cationic dye, in the presence of TiO₂, ZnO, and SnO₂ photocatalysts under UV light irradiation.

MATERIAL AND METHOD

Tin(II) chloride dihydrate (SnCl₂·2H₂O), 25% ammonia solution (NH₃) and ZnO (Merck) powder were purchased from Merck. TiO₂ P-25 (Evonik) MB (C₁₆H₁₈ClN₃S·2H₂O) was obtained from Merck. TiO₂ P-25 powder was a product of Evonik. All the other chemical reagents were analytical grade and used without further treatment. All aqueous solutions were prepared with distilled water (conductivity 2 μS/cm at 25 °C). The chemical structure of MB dye was given in Figure 1.

SnO₂ nanoparticles were prepared by precipitation method with reference to the methodology reported by Yousefi and colleagues with minor modifications (Yousefi et al., 2021). Briefly, NH₃ (8 mL) was added dropwise into a 0.1 M SnCl₂·2H₂O (100 mL) solution in a flat-bottomed flask with vigorous stirring by a magnetic stirrer and stirring continued for 40 min. The white precipitate was obtained after the solution was kept at room temperature for 18 h. The precipitate was then filtered and washed thoroughly with distilled water and ethanol, respectively. Finally, the residue was dried in an air oven at 80 °C for 24 h, calcined in a muffle furnace at 500 °C for 3h. TiO₂ P-25 and ZnO powders were used as photocatalysts as provided by the supplier.

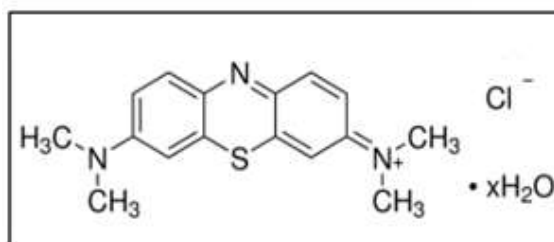

Figure 1. The chemical structure of MB (λ_{\max} = 664 nm, MW= 319.85 g/mol).

FTIR spectroscopy was performed using Thermo Scientific Nicolet 6700 spectrometer equipped with an attenuated total reflection accessory. All spectra were obtained by 32 scans at a resolution of 4 cm⁻¹ in the range of 4000–500 cm⁻¹. Dispersive Raman spectroscopic measurements were carried out by a Thermo Scientific DXR Raman Microscope with a spectral resolution of 4 cm⁻¹. The applied Ar⁺ laser power was 10 mW at λ =532 nm. XRD diffractograms were acquired by a Rigaku-D/MAX-Ultima diffractometer with Cu K α radiation (λ =1.54 Å) as X-ray source. The accelerating voltage and the applied current were 40 kV and 40 mA, respectively. The diffraction intensity was recorded in the range of 5-80° with a scan rate of 2° min⁻¹. SEM analysis was performed on FEI-Philips XL30 Scanning Electron Microscope with an accelerating voltage of 10 kV.

Testing of the photocatalytic activity was carried out in a cylindrical Pyrex reaction vessel. A 125W black light fluorescent lamp (λ_{\max} 365 nm) was used as the light source and irradiated from top of the reactor. The light intensity reaching the reaction medium was I_0 =1.65 × 10¹⁶ quanta/sec (Parker, 1997). The photocatalytic experiments were performed without pH adjustment. The catalyst dose amount used in experiments was 0.25 g/L and the initial MB concentration was 10 mg/L. The photocatalysts were dispersed in 50 mL of MB solution. The irradiated solution was immediately filtered through 0.22 μm cellulose acetate filters to remove

catalysts. The absorbance values of the samples were acquired by a Thermo Scientific Genesys 10S double beam spectrophotometer using 1 cm quartz cells.

RESULTS AND DISCUSSION

FTIR spectroscopy was used to identify the functional groups of the synthesized TiO₂, ZnO, and SnO₂ nanoparticles and the spectra was shown in Figure 2. A broad peak centered at around 3366 cm⁻¹ and a medium peak at 1639 cm⁻¹ located in the spectrum of TiO₂ corresponding to the stretching and bending vibration of OH groups on TiO₂ surface (Yalçın et al., 2010) (Figure 2 (a)). A wide peak centered at 3375 cm⁻¹ attributed to the stretching of water molecules in ZnO spectrum (Moosavian and Moazezi, 2015) (Figure 2 (b)). Another peak observed at 1699 cm⁻¹ related to H–O–H bending due to the presence of H₂O in the ZnO nanoparticles (Ashokkumar and Muthukumaran, 2014). The FTIR spectrum of SnO₂ was shown in Figure 2 (c). The weak bands at 3445 cm⁻¹ and 1650 cm⁻¹ were assigned to the OH stretching of adsorbed water molecules. The observed intense bands at 600 cm⁻¹ and 516 cm⁻¹ were related to the Sn-O and O-Sn-O stretching and bending modes of SnO₂ nanoparticles, respectively (Gnanamoorthy et al., 2021; Zhang et al., 2011).

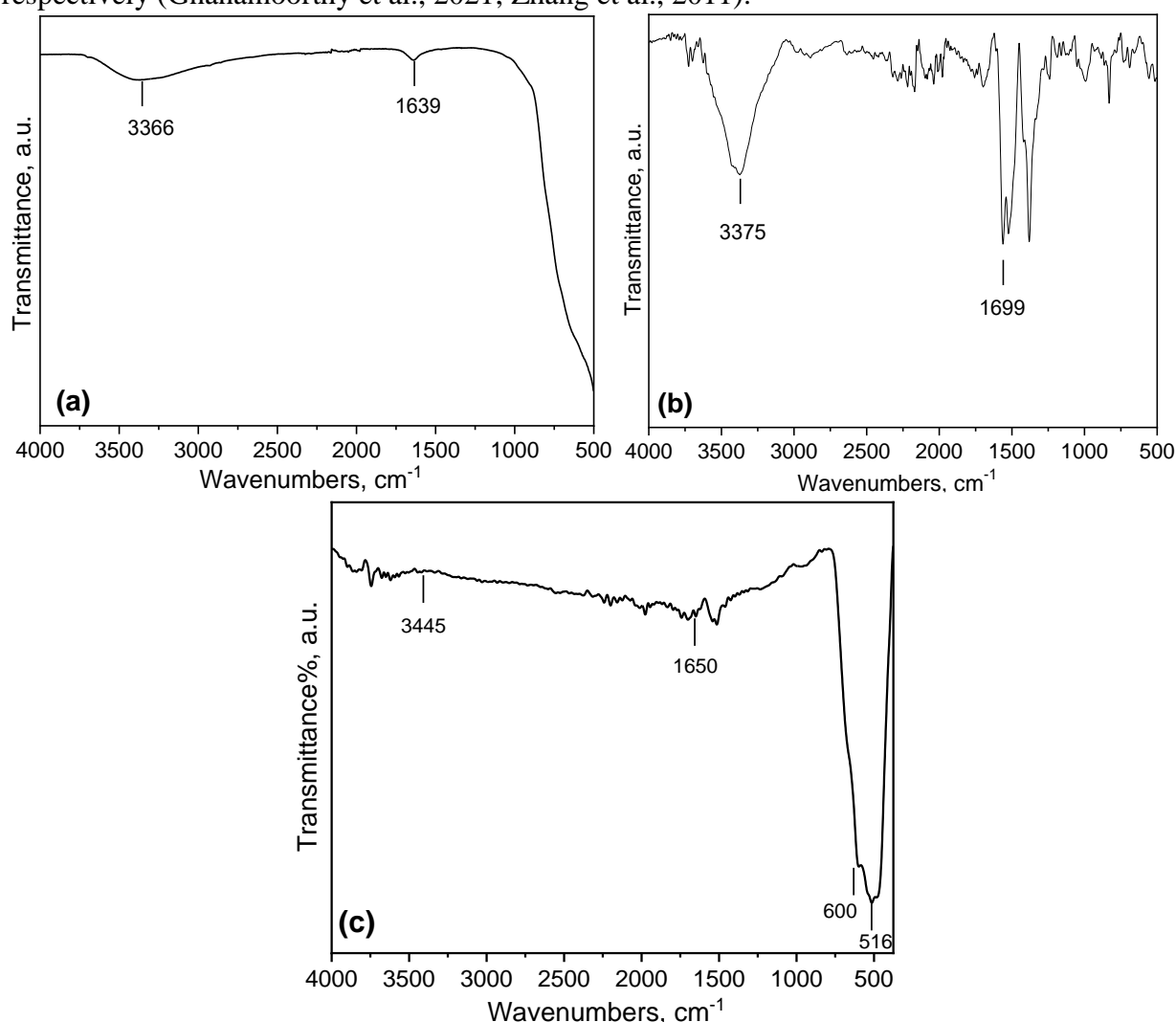

Figure 2. FTIR spectra of (a) TiO₂, (b) ZnO, and (c) SnO₂ nanoparticles.

Raman spectra of TiO₂, ZnO, and SnO₂ nanoparticles were presented in Figure 3. The Raman spectrum of TiO₂ (Figure 3 (a)) revealed five characteristic anatase bands at 630 cm⁻¹ (E_g), 508 cm⁻¹ (A_{1g}), 388 cm⁻¹ (B_{1g}), 188 cm⁻¹ (E_g), and 134 cm⁻¹ (E_g) (Ohsaka et al., 1978).

The Raman spectrum of ZnO displayed a main and intense band located at 435 cm^{-1} corresponding to E_2 (high) mode (Figure 3 (b)). The other bands at 329 cm^{-1} , 384 cm^{-1} , 578 cm^{-1} , 663 cm^{-1} and 1151 cm^{-1} attributed to $2E_2$ mode, A_1 (TO) mode, A_1 (LO) modes, TA+LO, contributions of $2A_1$ (LO) and $2E_1$ (LO) modes, respectively (Dhingra et al., 2013; Pei et al., 2014; Šćepanović et al., 2010; Tao et al., 2007).

The Raman spectrum of SnO_2 nanoparticles was displayed in Figure 3 (c). The spectrum revealed three Raman bands at 766 cm^{-1} , 626 cm^{-1} , and 478 cm^{-1} corresponding to the tetragonal rutile structure SnO_2 active modes, B_{2g} , A_{1g} , and E_g , respectively (Sangeetha et al., 2011).

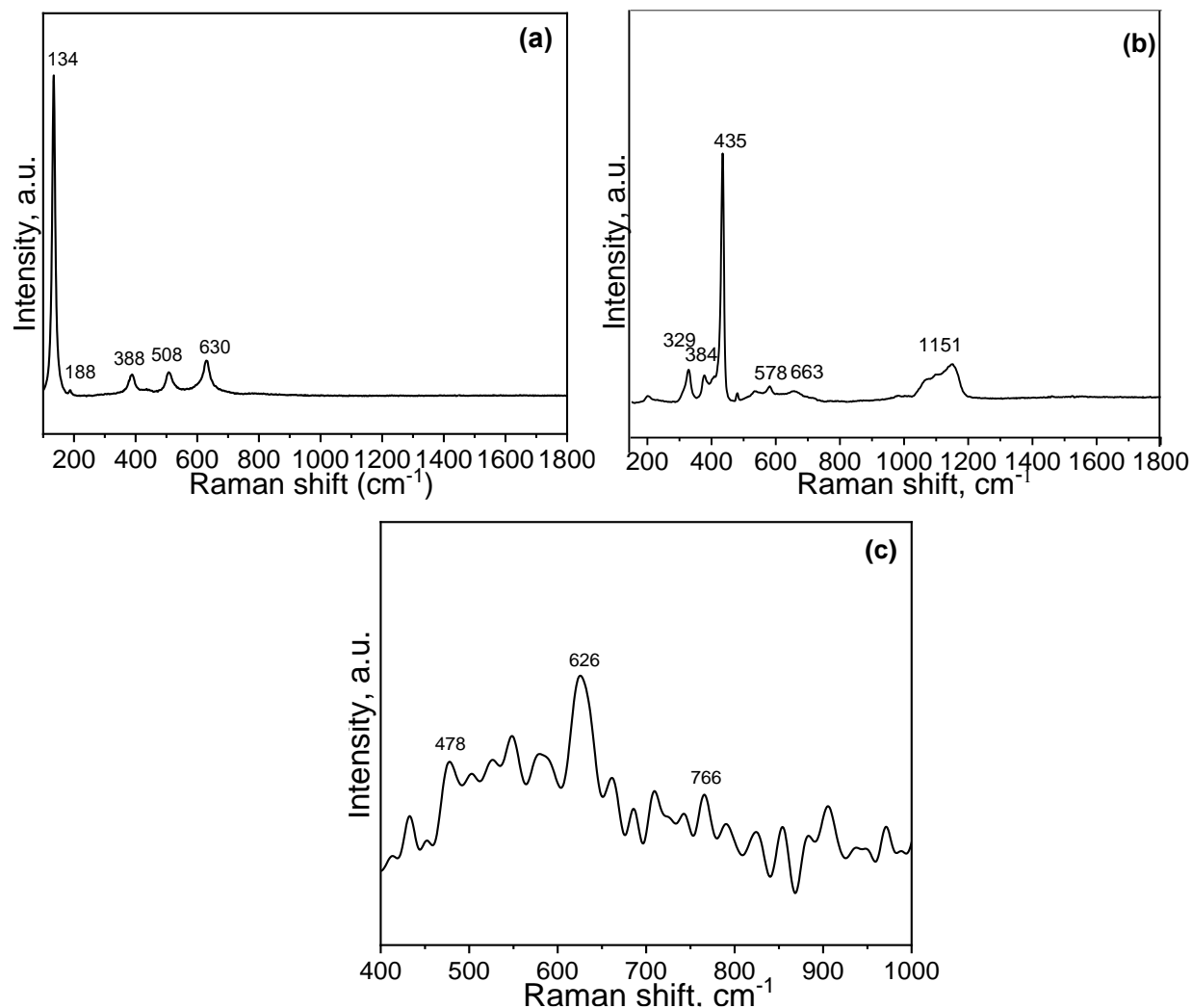

Figure 3. Raman spectra of (a) TiO_2 , (b) ZnO , and (c) SnO_2 nanoparticles.

The XRD spectra of TiO_2 , ZnO , and SnO_2 nanoparticles were presented in Figure 4. The crystallite phases of TiO_2 were presented by anatase (JCPDS No. 73-1764) and rutile (JCPDS No. 99-0090) crystal structures (Figure 4 (a)). A series of characteristic peaks at $2\theta = 25.36^\circ$, 37.08° , 37.89° , 38.69° , 48.08° , 53.98° , 55.12° , 62.82° , 69.09° , 70.38° , 75.18° , 76.19° were attributed to (1 0 1), (1 0 3), (0 0 4), (1 1 2), (2 0 0), (1 0 5), (2 1 1), (0 0 2), (1 1 6), (2 2 0), (2 1 5), and (3 0 1) planes of anatase, while peaks at $2\theta = 27.52^\circ$, 36.14° , 41.34° , 44.10° , 56.74° corresponded to (1 1 0), (1 0 1), (1 1 1), (2 1 0), and (2 0 0) planes of rutile, respectively. The diffractogram of ZnO (JCPDF 36-1451) exhibited the characteristic peaks at $2\theta = 31.92^\circ$, 34.58° , 36.40° , 47.68° , 56.72° , 62.99° , 66.52° , 68.08° and 69.20° related to (1 0 0), (0 0 2), (1 0 1), (1 0 2), (1 1 0), (1 0 3), (2 0 0), (1 1 2) and (2 0 1) planes of zincite, respectively (Figure 4 (b)). The XRD diffractogram of SnO_2 nanoparticles was revealed in Figure 4 (c). The

observed diffraction peak positions were well matched with JCPDS No. 41-1445 and verified the tetragonal rutile structure of SnO₂. The diffraction peaks at $2\theta = 26.58^\circ, 33.88^\circ, 37.90^\circ, 51.80^\circ, 54.80^\circ, 57.98^\circ, 62.00^\circ, 66.08^\circ, 71.40^\circ,$ and 78.80° corresponded to the (110), (101), (200), (211), (220), (002), (310), (301), (202), and (321) planes (Tammina et al., 2018).

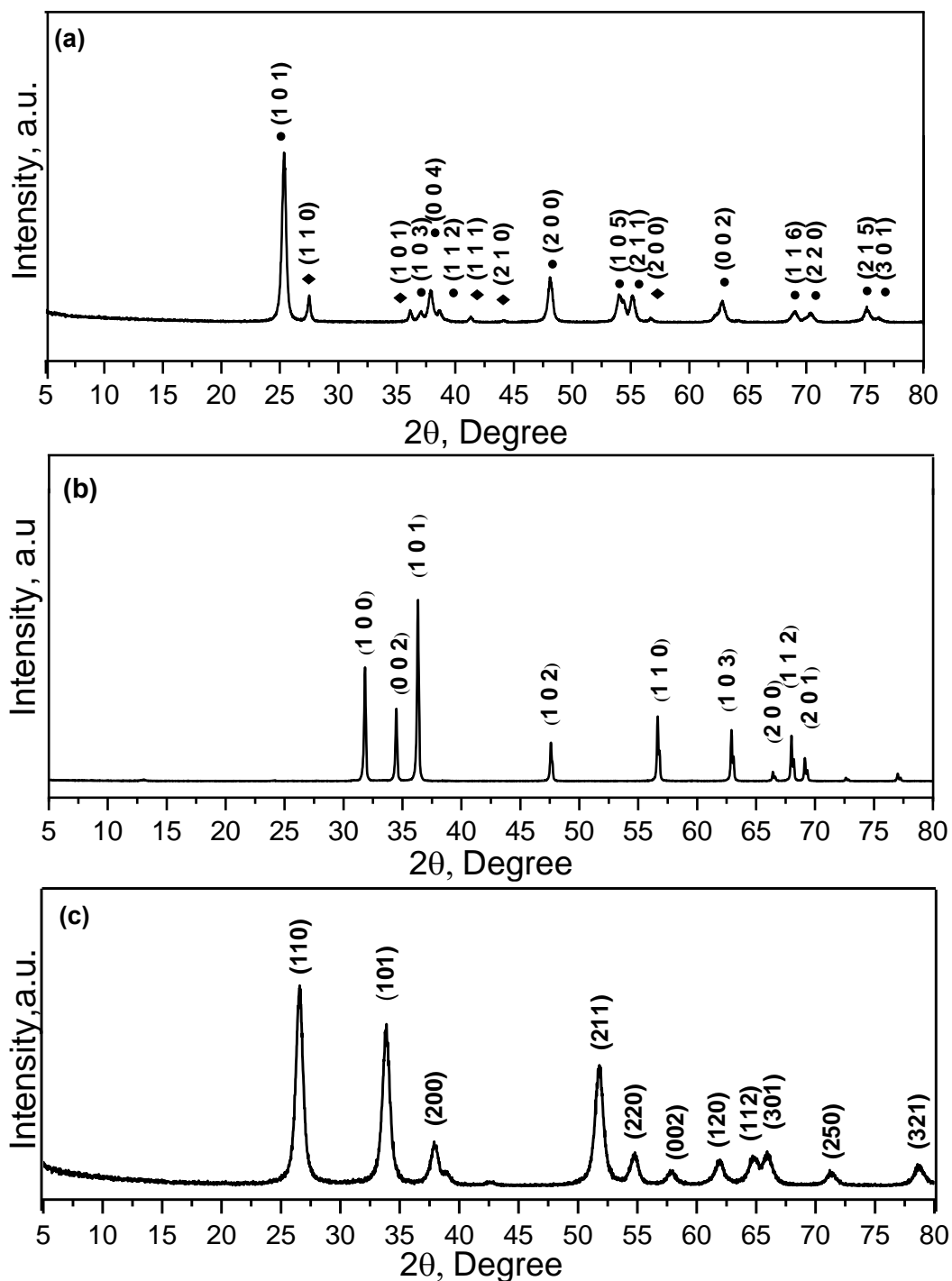

Figure 4. XRD spectra of (a) TiO₂, (b) ZnO, and (c) SnO₂ nanoparticles.

The morphologies of TiO₂, ZnO, and SnO₂ nanoparticles were examined by SEM analysis and SEM images were presented in Figure 5.

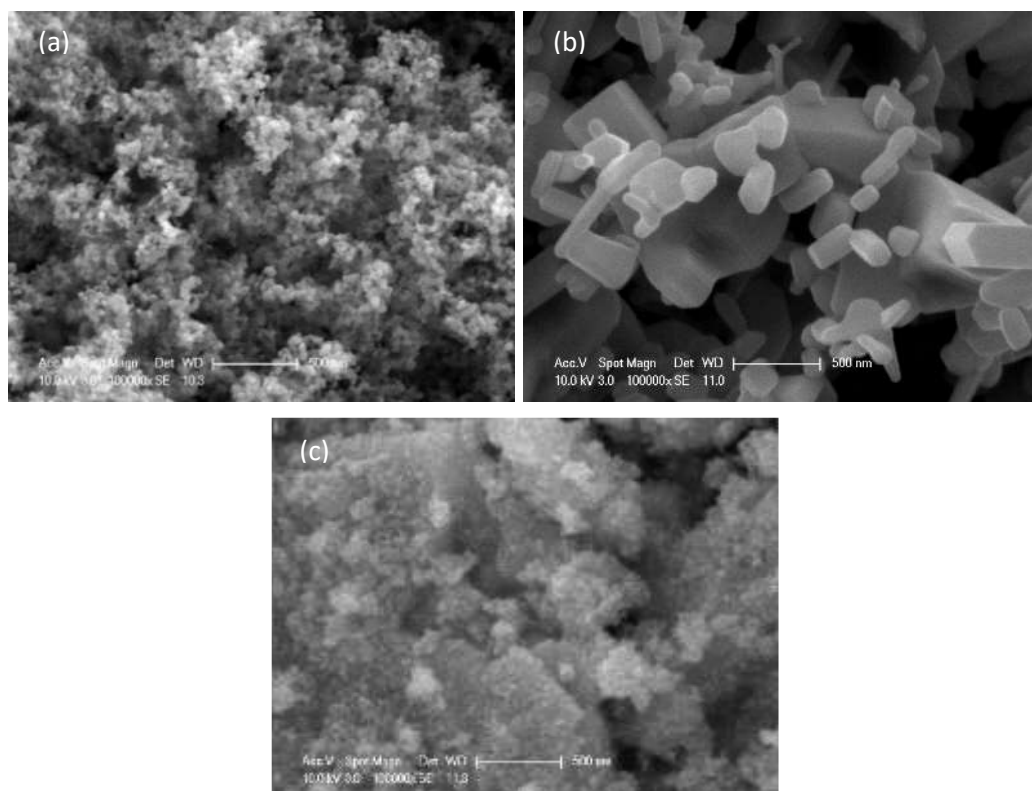

Figure 5. SEM images of (a) TiO₂, (b) ZnO, and (c) SnO₂ nanoparticles.

SEM image of TiO₂ nanoparticles (Figure 5 (a)) revealed almost spherical shapes with a slight agglomeration while ZnO consisted of a variety polyhedral shape (Figure 5 (b)). The SEM image of SnO₂ (Figure 5 (c)) showed that the nanoparticles were almost spherical, however the particle size and distribution were not homogeneous due to the presence of agglomeration (Habte et al., 2020).

The degree of MB decolorization by using TiO₂, ZnO, and SnO₂ nanoparticles (Figure 6) was calculated by the following equation (1).

$$\text{Decolorization, \%} = ((A_o - A)/A_o) \times 100 \quad (1)$$

where,

A_o = initial absorbance of MB and A = absorbance of MB at irradiation time t.

The percent degradation of MB in the presence of TiO₂ and ZnO was found to be 73% and 97 % respectively upon 60 min irradiation. TiO₂ and ZnO catalysts revealed a better photocatalytic efficiency than SnO₂ nanoparticles. An almost complete degradation of 93% and 99, respectively, was observed for TiO₂ and ZnO after 120 min under UV light. On the other hand, the removal efficiency of MB in the presence of SnO₂ was 22% even after 300 min irradiation.

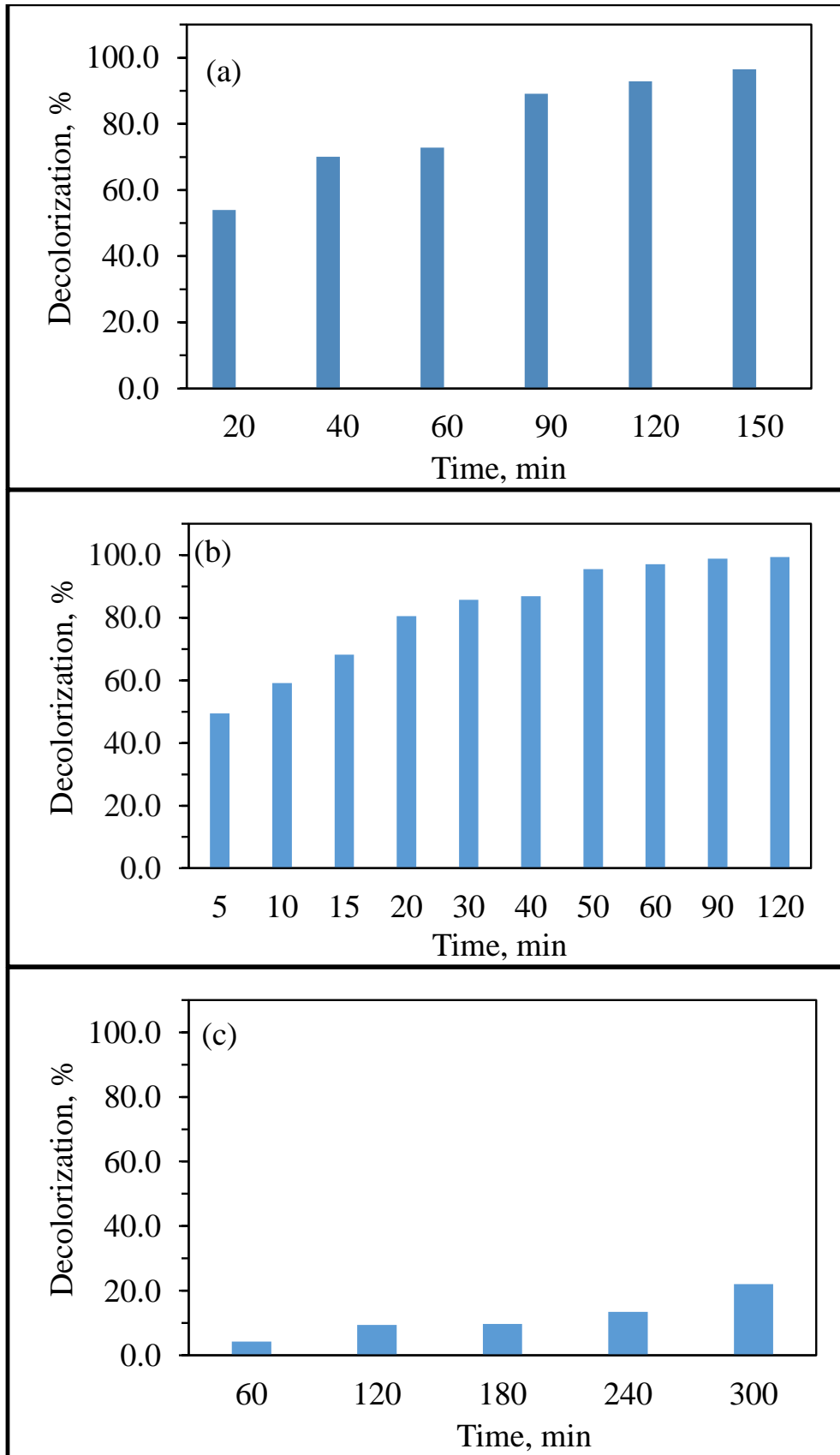

Figure 6. Removal efficiencies of MB upon using (a) TiO₂, (b) ZnO, and (c) SnO₂.

CONCLUSIONS

Based on the comparative study, SnO₂ nanoparticles were developed by using a facile precipitation method. FTIR spectra of catalysts confirmed the presence of functional groups of TiO₂, ZnO, and SnO₂ vibrational bands. XRD and Raman spectroscopy results indicated the evidence of tetragonal rutile structure of SnO₂. In addition, XRD and Raman confirmed the anatase and rutile phases of TiO₂ and the zincite phase for ZnO. The surface morphology of TiO₂, ZnO, and SnO₂ was identified by SEM analysis. TiO₂ and ZnO revealed an efficient MB removal compared to SnO₂.

REFERENCES

- Al-Hamdi, A.M., Rinner, U. and Sillanpää, M. 2017. Tin dioxide as a photocatalyst for water treatment: A review. *Process Safety and Environmental Protection* 107, 190-205.
- Ashokkumar, M. and Muthukumaran, S. 2014. Microstructure, optical and FTIR studies of Ni, Cu co-doped ZnO nanoparticles by co-precipitation method. *Opt. Mater.* 37, 671-678.
- Dhingra, M., Shrivastava, S., Senthil Kumar, P. and Annapoorni, S. 2013. Polyaniline mediated enhancement in band gap emission of Zinc Oxide. *Composites Part B: Engineering* 45(1), 1515-1520.
- Gnanamoorthy, G., Yadav, V.K., Yadav, K.K., Ramar, K., Alam, J., Shukla, A.K., Ali, F.A.A. and Alhoshan, M. 2021. Fabrication of different SnO₂ nanorods for enhanced photocatalytic degradation and antibacterial activity. *Environ. Sci. Pollut. Res.*
- Habte, A.G., Hone, F.G. and Dejene, F.B. 2020. Influence of annealing temperature on the structural, morphological and optical properties of SnO₂ nanoparticles. *Physica B: Condensed Matter* 580, 411760.
- Islam, M., Kumar, S., Saxena, N. and Nafees, A. 2023. Photocatalytic Degradation of Dyes Present in Industrial Effluents: A Review. *ChemistrySelect* 8(26), e202301048.
- Kumar, N., Pandey, A., Rosy and Sharma, Y.C. 2023. A review on sustainable mesoporous activated carbon as adsorbent for efficient removal of hazardous dyes from industrial wastewater. *J. Water Process. Eng.* 54, 104054.
- Kurian, M. 2020. Cerium oxide based materials for water treatment – A review. *J. Environ. Chem. Eng.* 8(5), 104439.
- Moosavian, M.A. and Moazezi, N. 2015. Removal of cadmium and zinc ions from industrial wastewater using nanocomposites of PANI/ZnO and PANI/CoHCF: a comparative study. *Desalination and Water Treatment*, 1-20.
- Ohsaka, T., Izumi, F. and Fujiki, Y. 1978. Raman spectrum of anatase, TiO₂. *J. Raman Spectrosc.* 7(6), 321-324.
- Parker, C.G.H.a.C.A. 1997. A new sensitive chemical actinometer - II. Potassium ferrioxalate as a standard chemical actinometer. *Proceedings of the Royal Society of London. Series A. Mathematical and Physical Sciences* 235(1203), 518-536.
- Pei, Z., Ding, L., Lu, M., Fan, Z., Weng, S., Hu, J. and Liu, P. 2014. Synergistic effect in polyaniline-hybrid defective ZnO with enhanced photocatalytic activity and stability. *J. Phys. Chem. C.* 118(18), 9570-9577.
- Sangeetha, P., Sasirekha, V. and Ramakrishnan, V. 2011. Micro-Raman investigation of tin dioxide nanostructured material based on annealing effect. *Journal of Raman Spectroscopy* 42(8), 1634-1639.
- Šćepanović, M., Grujić-Brojčin, M., Vojisavljević, K., Bernik, S. and Srećković, T. 2010. Raman study of structural disorder in ZnO nanopowders. *J. Raman Spectrosc.* 41(9), 914-921.
- Solayman, H.M., Hossen, M.A., Abd Aziz, A., Yahya, N.Y., Leong, K.H., Sim, L.C., Monir, M.U. and Zoh, K.-D. 2023. Performance evaluation of dye wastewater treatment technologies: A review. *J. Environ. Chem. Eng.* 11(3), 109610.

- Tammina, S.K., Mandal, B.K. and Kadiyala, N.K. 2018. Photocatalytic degradation of methylene blue dye by nonconventional synthesized SnO₂ nanoparticles. *Environ. Nanotechnol. Monit. Manag.* 10, 339-350.
- Tao, S., Hong, B. and Kerong, Z. 2007. An infrared and Raman spectroscopic study of polyanilines co-doped with metal ions and H⁺. *Spectrochim Acta A Mol Biomol Spectrosc* 66(4-5), 1364-1368.
- Valli Nachiyar, C., Rakshi, A.D., Sandhya, S., Britlin Deva Jebasta, N. and Nellore, J. 2023. Developments in treatment technologies of dye-containing effluent: A review. *Case Studies in Chemical and Environmental Engineering* 7, 100339.
- Yadav, S., Shakya, K., Gupta, A., Singh, D., Chandran, A.R., Varayil Aanappalli, A., Goyal, K., Rani, N. and Saini, K. 2023. A review on degradation of organic dyes by using metal oxide semiconductors. *Environ. Sci. Pollut. Res.* 30(28), 71912-71932.
- Yalçın, Y., Kılıç, M. and Çınar, Z. 2010. Fe⁺³-doped TiO₂: A combined experimental and computational approach to the evaluation of visible light activity. *Appl. Catal. B* 99(3-4), 469-477.
- Yousefi, A., Nezamzadeh-Ejhieh, A. and Mirmohammadi, M. 2021. SnO₂-BiVO₄ mixed catalyst: Characterization and kinetics study of the photodegradation of phenazopyridine. *Environmental Technology & Innovation* 22, 101433.
- Zhang, B., Tian, Y., Zhang, J.X. and Cai, W. 2011. The FTIR studies of SnO₂:Sb(ATO) films deposited by spray pyrolysis. *Mater. Lett.* 65(8), 1204-1206.

RECENT TRENDS AND FUTURE PROSPECTS ON THE POLYMERIC-BASED CATALYSTS FOR PHOTOCATALYTIC DEGRADATION

Nazli TURKTEN, Yunus KARATAS*

*Kirsehir Ahi Evran University, Faculty of Arts and Sciences, Department of Chemistry,
40100, Kirsehir, Turkiye*

Corresponding author e-mail: nazli.turkten@yahoo.com

ABSTRACT

Photocatalytic technology is viewed as an efficient wastewater treatment that is proficient in removing pollutants completely using UV/visible or solar energy. With this technology, there is an increasing interest in the development of polymer-based semiconductor materials, which leads to higher photocatalytic activity due to the modification of the structure. The main advantages of using polymers as catalysts in photocatalytic systems are their good photostability, moderating band gap, low-cost, and easy accessibility. Hence, the combination of various semiconductors with mostly preferred polyaniline, polythiophene, and polypyrrole conducting polymers appears to improve the photocatalytic performance. The recent synthesis of green polymeric catalysts composed of safe monomers makes them popular in photocatalysis. On the other hand, biopolymers also act as a support material for metallic oxides to avoid environmental toxicity from the use of chemical compounds. The current perspectives and prospects for advancement in green technology can be helpful in the potentiality of large-scale applications of polymeric-based catalysts that are utilized for photocatalysis.

Keywords: Biopolymers, catalyst, conducting polymers, green technology, photocatalysis,

INTRODUCTION

Water pollution is a global issue that can arise rapidly in developing as well as advanced countries due to the inappropriate disposal of chemicals, toxins, and microorganisms from industries. The contamination of carcinogenic and hardly biodegradable pollutants into water bodies can lead to either a short or long-term threat to the environment (Rafaie et al., 2023).

Conventional techniques are not sufficient for the water treatment of a variety of pollutants including dyes, pharmaceuticals, and various endocrine disrupting compounds (Srikanth et al., 2017). The most used physical methods are sedimentation, adsorption, activated carbon, ultra filtration, reverse osmosis, incineration, and membrane separation. In this inadequate water treatment method, typical physical processes are applied to remove organics that can cause a potentially harmful secondary effluent. Biological processes are applied in wastewater treatment by using activated sludge, microalgae, fungi, bacteria strains, and enzymes. The major drawbacks of biological processes are operating costs, the tendency of sludge swelling, and long pre-preparation cycles. Moreover, biodegradation is a slow and insufficient process for high chemical oxygen demand and total organic carbon removal of persistent pollutants. Chemical methods are expensive since they require a high dose of chemicals and the production of a large amount of sludge. Hence, it is necessary to improve effective processes that can destroy recalcitrant pollutants in wastewater as an alternative to conventional methods (Hansen et al., 2021; Ma et al., 2021; Zangeneh et al., 2015).

Advanced oxidation processes (AOPs) are promising novel, economically feasible, and widely applicable methods based on the formation of highly reactive and oxidizing free radicals.

These reactive oxygen species such as hydroxyl radicals lead to change the chemical structure of a wide diversity of contaminants (Zangeneh et al., 2015). AOPs can be classified into various types to generate hydroxyl radicals using chemical, photochemical, sonochemical, and electrochemical reactions (Oturán and Aaron, 2014). Photochemical AOPs are the most preferred, as the possible utilization of solar energy as a light source makes this process green and sustainable. Among the photochemical AOPs, photocatalysis and photo-Fenton processes are popular and modern technologies for the treatment of industrial effluents (Byrne et al., 2018).

PHOTOCATALYSIS

Photocatalysis is an effective AOPs and a photoinduced reaction occurs in the presence of a photocatalyst. In general, semiconductor-based oxides such as TiO₂, ZnO, CeO₂, ZrO₂, WO₃, V₂O₅, Fe₂O₃, CdSe, ZnSe, and NiO are used. It has also been found that sulphides (MoS₂, ZnS, In₂S₃, CdS, etc.) and halides (AgCl, BiOI, etc.) are increasingly employed as photocatalysts. (Pastre et al., 2023; Srikanth et al., 2017; Zangeneh et al., 2015).

TiO₂ and ZnO are commonly studied photocatalysts due to their high stability and strength in photocatalysis. Besides, they exhibit a high photocatalytic activity without or with low toxicity and low-cost properties. However, a limitation is encountered in the utilization under the visible range of the solar spectrum irradiation, as it has a wide band. Consequently, the advance of new photocatalyst designs can overcome this limitation and improve their photocatalytic performance under solar light (Pastre et al., 2023; Puri and Gupta, 2023). In this respect, numerous studies have been performed to extend the optical absorption toward the visible region by using doping ions (cations or anions) or coupling semiconductors (Birben et al., 2017; Birben et al., 2016; Gurkan et al., 2017; Gurkan et al., 2012; Khaki et al., 2017; Turkten and Bekbolet, 2020; Turkten et al., 2019; Zhu and Zhou, 2019). Nowadays, polymers are used to modify and upgrade photocatalytic properties of catalysts (Ahuja et al., 2023; Mohammed et al., 2023).

CONDUCTING POLYMER BASED PHOTOCATALYSTS

Polyaniline (PANI), polypyrrole (PPy), and polythiophene (PTh) are prominent and well-studied conducting polymers (CPs) in photocatalysis. These members of the polymer class exhibit unique properties such as stability, ease of handling, charge carrier mobility, and compatibility that can qualify them to be employed as efficient photocatalysts. The coupling of CPs with a semiconductor could lead a synergistic effect to destroy aquatic pollutants (Mohammed et al., 2023; Taghizadeh et al., 2020; Turkten et al., 2021a).

Recently, the preparation of PANI based catalysts especially complexing with common semiconductors TiO₂ and ZnO have been employed to enhance the photocatalytic activity and reduce the rate of photo-generated electron-hole recombination. The photocatalytic properties of PANI-TiO₂ and PANI-ZnO photocatalysts are generally investigated by the degradation of dyes for example, methylene blue (Turkten et al., 2021a; Zia and Riaz, 2021). PANI-TiO₂ photocatalysts have been employed for photocatalytic degradation of bisphenol A (Sambaza et al., 2020), humic acid (Uyguner-Demirel et al., 2023), methylene blue (Lee et al., 2020; Rahman and Kar, 2020a; b; Wang et al., 2010; Yang et al., 2017), reactive black 5 (Jumat et al., 2017), rhodamine B and methylene blue (Radoičić et al., 2017; Radoičić et al., 2013), rhodamine B (RhB), methylene blue (MB) and phenol (Reddy et al., 2016), and sulfaquinoxaline (Sandikly et al., 2021). Photocatalytic performances of PANI-ZnO photocatalysts have been investigated by the degradation of Acid Blue 25 (Gilja et al., 2018; Gilja et al., 2020), (Nosrati et al., 2012), methylene blue (Turkten et al., 2021b), methylene blue and malachite green (Eskizeybek et al., 2012).

Several studies have been reported on the preparation and photocatalytic activity of PPy-TiO₂ (Baig et al., 2017; Gao et al., 2016; Kratofil Krehula et al., 2019; Luo et al., 2011; Silvestri et al., 2020; Villabona-Leal et al., 2020; Yuan et al., 2020), PPy-ZnO (Balakumar and Baishnisha, 2021; Ceretta et al., 2020; González-Casamachin et al., 2019; Silvestri et al., 2019), PTh-TiO₂ (Ravi Chandra et al., 2015; Xu et al., 2011; Zhu et al., 2010), and PTh-ZnO (Khatamian et al., 2014) photocatalysts.

BIOPOLYMER BASED PHOTOCATALYSTS

In recent years, biopolymer based photocatalysts have gained increasing scientific interest due to their non-toxicity, compatibility, and flexibility, as well as their effects on pore size and surface morphology (Balakrishnan et al., 2022; Mohd Adnan et al., 2020).

Chitosan (CS) is one of the widely used natural biopolymers, which is the N-acetyl derivative of chitin found in the exoskeletons of crustaceans and obtained by deacetylation of chitin (Balakrishnan et al., 2022; Divya and Jisha, 2018). This biopolymer has been used with various semiconductors or sulphides to develop new photocatalysts, and their photocatalytic efficiencies have also been evaluated. There are many reports available on utilizing CS/nano-CdS composite (Zhu et al., 2009), CdS nanoparticles on CS microspheres (Zhang et al., 2014), CS/CoFe₂O₄ nanocomposite (Taleb, 2014), CS-ZS nanoparticles (Aziz et al., 2020), CS modified N, S doped TiO₂/ZnO (Farhadian et al., 2019), TiO₂/CS beads (Balakrishnan et al., 2020), CS/TiO₂ composite (Karthikeyan et al., 2017; Rejek et al., 2021), as catalysts for wastewater treatment. In general, CS-based photocatalysts could be promising candidates with superior photocatalytic functionalities in this field.

CONCLUSIONS

Based on photocatalysis studies, the development of polymeric-based catalysts results in various synergistic benefits on surface area, morphology, and photocatalytic properties. However, most of photocatalytic activity tests are performed in lab-scale applications. For future work, these photocatalysts are expected to be applied on an industrial scale for photocatalytic degradation of recalcitrant pollutants.

REFERENCES

- Ahuja, T., Brighu, U. and Saxena, K. 2023. Recent advances in photocatalytic materials and their applications for treatment of wastewater: A review. *J. Water Process. Eng.* 53, 103759.
- Aziz, A., Ali, N., Khan, A., Bilal, M., Malik, S., Ali, N. and Khan, H. 2020. Chitosan-zinc sulfide nanoparticles, characterization and their photocatalytic degradation efficiency for azo dyes. *Int. J. Biol. Macromol.* 153, 502-512.
- Baig, U., Gondal, M.A., Ilyas, A.M. and Sanagi, M.M. 2017. Band gap engineered polymeric-inorganic nanocomposite catalysts: Synthesis, isothermal stability, photocatalytic activity and photovoltaic performance. *J. Mater. Sci. Technol.* 33(6), 547-557.
- Balakrishnan, A., Appunni, S., Chinthala, M. and Vo, D.-V.N. 2022. Biopolymer-supported TiO₂ as a sustainable photocatalyst for wastewater treatment: a review. *Environmental Chemistry Letters* 20(5), 3071-3098.
- Balakrishnan, A., Appunni, S. and Gopalram, K. 2020. Immobilized TiO₂/chitosan beads for photocatalytic degradation of 2,4-dichlorophenoxyacetic acid. *Int. J. Biol. Macromol.* 161, 282-291.

- Balakumar, V. and Baishnisha, A. 2021. Rapid visible light photocatalytic reduction of Cr^{6+} in aqueous environment using ZnO-PPy nanocomposite synthesized through ultrasonic assisted method. *Surf. Interfaces* 23, 100958.
- Birben, N.C., Uyguner-Demirel, C.S., Kavurmaci, S.S., Gürkan, Y.Y., Turkten, N., Cinar, Z. and Bekbolet, M. 2017. Application of Fe-doped TiO_2 specimens for the solar photocatalytic degradation of humic acid. *Catal. Today* 281, 78-84.
- Birben, N.C., Uyguner-Demirel, C.S., Sen-Kavurmaci, S., Gürkan, Y.Y., Türkten, N., Kılıç, M., Çınar, Z. and Bekbolet, M. 2016. Photocatalytic Performance of Anion Doped TiO_2 on the Degradation of Complex Organic Matrix. *Journal of Advanced Oxidation Technologies* 19(2), 199-207.
- Byrne, C., Subramanian, G. and Pillai, S.C. 2018. Recent advances in photocatalysis for environmental applications. *J. Environ. Chem. Eng.* 6(3), 3531-3555.
- Ceretta, M.B., Vieira, Y., Wolski, E.A., Foletto, E.L. and Silvestri, S. 2020. Biological degradation coupled to photocatalysis by ZnO/polypyrrole composite for the treatment of real textile wastewater. *J. Water Process. Eng.* 35, 101230.
- Divya, K. and Jisha, M.S. 2018. Chitosan nanoparticles preparation and applications. *Environmental Chemistry Letters* 16(1), 101-112.
- Eskizeybek, V., Sarı, F., Gülce, H., Gülce, A. and Avcı, A. 2012. Preparation of the new polyaniline/ZnO nanocomposite and its photocatalytic activity for degradation of methylene blue and malachite green dyes under UV and natural sun lights irradiations. *Appl. Catal. B* 119-120, 197-206.
- Farhadian, N., Akbarzadeh, R., Pirsaeheb, M., Jen, T.-C., Fakhri, Y. and Asadi, A. 2019. Chitosan modified N, S-doped TiO_2 and N, S-doped ZnO for visible light photocatalytic degradation of tetracycline. *Int. J. Biol. Macromol.* 132, 360-373.
- Gao, F., Hou, X., Wang, A., Chu, G., Wu, W., Chen, J. and Zou, H. 2016. Preparation of polypyrrole/ TiO_2 nanocomposites with enhanced photocatalytic performance. *Particuology* 26, 73-78.
- Gilja, V., Vrban, I., Mandić, V., Žic, M. and Hrnjak-Murgić, Z. 2018. Preparation of a PANI/ZnO composite for efficient photocatalytic degradation of acid blue. *Polymers (Basel)* 10(9).
- Gilja, V., Živković, I., Klaser, T., Skoko, Ž., Kraljić Roković, M., Hrnjak-Murgić, Z. and Žic, M. 2020. The Impact of In Situ Polymerization Conditions on the Structures and Properties of PANI/ZnO-Based Multiphase Composite Photocatalysts. *Catalysts* 10(4), 400.
- González-Casamachin, D.A., Rivera De la Rosa, J., Lucio-Ortiz, C.J., De Haro De Rio, D.A., Martínez-Vargas, D.X., Flores-Escamilla, G.A., Dávila Guzman, N.E., Ovando-Medina, V.M. and Moctezuma-Velazquez, E. 2019. Visible-light photocatalytic degradation of acid violet 7 dye in a continuous annular reactor using ZnO/PPy photocatalyst: Synthesis, characterization, mass transfer effect evaluation and kinetic analysis. *Chem. Eng. J.* 373, 325-337.
- Gurkan, Y., Kasapbasi, E., Turkten, N. and Cinar, Z. 2017. Influence of Se/N Codoping on the Structural, Optical, Electronic and Photocatalytic Properties of TiO_2 . *Molecules* 22(3), 414.
- Gurkan, Y.Y., Turkten, N., Hatipoglu, A. and Cinar, Z. 2012. Photocatalytic degradation of cefazolin over N-doped TiO_2 under UV and sunlight irradiation: Prediction of the reaction paths via conceptual DFT. *Chem. Eng. J.* 184, 113-124.
- Hansen, É., Monteiro de Aquim, P. and Gutterres, M. 2021. Current technologies for post-tanning wastewater treatment: A review. *Journal of Environmental Management* 294, 113003.

- Jumat, N.A., Wai, P.S., Ching, J.J. and Basirun, W.J. 2017. Synthesis of Polyaniline-TiO₂ Nanocomposites and Their Application in Photocatalytic Degradation. *Polym. Polym. Compos.* 25(7), 507-514.
- Karthikeyan, K.T., Nithya, A. and Jothivenkatachalam, K. 2017. Photocatalytic and antimicrobial activities of chitosan-TiO₂ nanocomposite. *Int. J. Biol. Macromol.* 104, 1762-1773.
- Khaki, M.R.D., Shafeeyan, M.S., Raman, A.A.A. and Daud, W.M.A.W. 2017. Application of doped photocatalysts for organic pollutant degradation - A review. *Journal of Environmental Management* 198, 78-94.
- Khatamian, M., Fazayeli, M. and Divband, B. 2014. Preparation, characterization and photocatalytic properties of polythiophene-sensitized zinc oxide hybrid nanocomposites. *Mater. Sci. Semicond. Process.* 26, 540-547.
- Kratofil Krehula, L., Stjepanović, J., Perlog, M., Krehula, S., Gilja, V., Travas-Sejdic, J. and Hrnjak-Murgić, Z. 2019. Conducting polymer polypyrrole and titanium dioxide nanocomposites for photocatalysis of RR45 dye under visible light. *Polym. Bull.* 76(4), 1697-1715.
- Lee, Y.-J., Lee, H.S., Lee, C.-G., Park, S.-J., Lee, J., Jung, S. and Shin, G.-A. 2020. Application of PANI/TiO₂ Composite for Photocatalytic Degradation of Contaminants from Aqueous Solution. *Appl. Sci.* 10(19), 6710.
- Luo, Q., Li, X., Wang, D., Wang, Y. and An, J. 2011. Photocatalytic activity of polypyrrole/TiO₂ nanocomposites under visible and UV light. *Journal of Materials Science* 46(6), 1646-1654.
- Ma, D., Yi, H., Lai, C., Liu, X., Huo, X., An, Z., Li, L., Fu, Y., Li, B., Zhang, M., Qin, L., Liu, S. and Yang, L. 2021. Critical review of advanced oxidation processes in organic wastewater treatment. *Chemosphere* 275, 130104.
- Mohammed, A.M., Aziz, F., Mohtar, S.S., Mhamad, S.A., Ahmadu, B., Nasir, M.U., Muhammad, K.Y. and Aziz, M. 2023. A review of research trends on the usage of photocatalysis for wastewater treatment: bibliometric analysis. *Sustainable Water Resources Management* 9(3), 88.
- Mohd Adnan, M.A., Phoon, B.L. and Muhd Julkapli, N. 2020. Mitigation of pollutants by chitosan/metallic oxide photocatalyst: A review. *Journal of Cleaner Production* 261, 121190.
- Nosrati, R., Olad, A. and Maramifar, R. 2012. Degradation of ampicillin antibiotic in aqueous solution by ZnO/polyaniline nanocomposite as photocatalyst under sunlight irradiation. *Environ Sci Pollut Res Int* 19(6), 2291-2299.
- Oturan, M.A. and Aaron, J.-J. 2014. Advanced Oxidation Processes in Water/Wastewater Treatment: Principles and Applications. A Review. *Critical Reviews in Environmental Science and Technology* 44(23), 2577-2641.
- Pastre, M.M.G., Cunha, D.L. and Marques, M. 2023. Design of biomass-based composite photocatalysts for wastewater treatment: a review over the past decade and future prospects. *Environ. Sci. Pollut. Res.* 30(4), 9103-9126.
- Puri, N. and Gupta, A. 2023. Water remediation using titanium and zinc oxide nanomaterials through disinfection and photo catalysis process: A review. *Environ. Res.* 227, 115786.
- Radoičić, M., Ćirić-Marjanović, G., Spasojević, V., Ahrenkiel, P., Mitrić, M., Novaković, T. and Šaponjić, Z. 2017. Superior photocatalytic properties of carbonized PANI/TiO₂ nanocomposites. *Appl. Catal. B* 213, 155-166.
- Radoičić, M., Šaponjić, Z., Janković, I.A., Ćirić-Marjanović, G., Ahrenkiel, S.P. and Čomor, M.I. 2013. Improvements to the photocatalytic efficiency of polyaniline modified TiO₂ nanoparticles. *Appl. Catal. B* 136-137, 133-139.

- Rafaie, H.A., Ramli, N.I.T., Khusaimi, Z., Mohd Sarjidan, M.A., Dulyaseree, P. and Hir, Z.A.M. 2023. Ag₂CO₃-Based Photocatalyst with Enhanced Photocatalytic Activity for Endocrine-Disrupting Chemicals Degradation: A Review. *Catalysts* 13(3), 540.
- Rahman, K.H. and Kar, A.K. 2020a. Effect of band gap variation and sensitization process of polyaniline (PANI)-TiO₂ p-n heterojunction photocatalysts on the enhancement of photocatalytic degradation of toxic methylene blue with UV irradiation. *J. Environ. Chem. Eng.* 8(5), 104181.
- Rahman, K.H. and Kar, A.K. 2020b. Titanium-di-oxide (TiO₂) concentration-dependent optical and morphological properties of PANi-TiO₂ nanocomposite. *Mater. Sci. Semicond. Process.* 105, 104745.
- Ravi Chandra, M., Siva Rao, T., Pammi, S.V.N. and Sreedhar, B. 2015. An enhanced visible light active rutile titania–copper/polythiophene nanohybrid material for the degradation of rhodamine B dye. *Mater. Sci. Semicond. Process.* 30, 672-681.
- Reddy, K.R., Karthik, K.V., Prasad, S.B.B., Soni, S.K., Jeong, H.M. and Raghu, A.V. 2016. Enhanced photocatalytic activity of nanostructured titanium dioxide/polyaniline hybrid photocatalysts. *Polyhedron* 120, 169-174.
- Rejek, M., Grzechulska-Damszel, J. and Schmidt, B. 2021. Synthesis, Characterization, and Evaluation of Degussa P25/Chitosan Composites for the Photocatalytic Removal of Sertraline and Acid Red 18 from Water. *J. Polym. Environ.* 29(11), 3660-3667.
- Sambaza, S.S., Maity, A. and Pillay, K. 2020. Polyaniline-Coated TiO₂ Nanorods for Photocatalytic Degradation of Bisphenol A in Water. *ACS Omega* 5(46), 29642-29656.
- Sandikly, N., Kassir, M., El Jamal, M., Takache, H., Arnoux, P., Mokh, S., Al-Iskandarani, M. and Roques-Carnes, T. 2021. Comparison of the toxicity of waters containing initially sulfaquinolone after photocatalytic treatment by TiO₂ and polyaniline/TiO₂. *Environ. Technol.* 42(3), 419-428.
- Silvestri, S., Burgo, T.A.L., Dias-Ferreira, C., Labrincha, J.A. and Tobaldi, D.M. 2020. Polypyrrole-TiO₂ composite for removal of 4-chlorophenol and diclofenac. *React. Funct. Polym.* 146, 104401.
- Silvestri, S., Ferreira, C.D., Oliveira, V., Varejão, J.M.T.B., Labrincha, J.A. and Tobaldi, D.M. 2019. Synthesis of PPy-ZnO composite used as photocatalyst for the degradation of diclofenac under simulated solar irradiation. *J. Photochem. Photobiol. A* 375, 261-269.
- Srikanth, B., Goutham, R., Badri Narayan, R., Ramprasath, A., Gopinath, K.P. and Sankaranarayanan, A.R. 2017. Recent advancements in supporting materials for immobilised photocatalytic applications in waste water treatment. *J. Environ. Manage.* 200, 60-78.
- Taghizadeh, A., Taghizadeh, M., Jouyandeh, M., Yazdi, M.K., Zarrintaj, P., Saeb, M.R., Lima, E.C. and Gupta, V.K. 2020. Conductive polymers in water treatment: A review. *J. Mol. Liq.* 312, 113447.
- Taleb, M.F.A. 2014. Adsorption and photocatalytic degradation of 2-CP in wastewater onto CS/CoFe₂O₄ nanocomposite synthesized using gamma radiation. *Carbohydr. Polym.* 114, 65-72.
- Turkten, N. and Bekbolet, M. 2020. Photocatalytic performance of titanium dioxide and zinc oxide binary system on degradation of humic matter. *J. Photochem. Photobiol. A* 401.
- Turkten, N., Cinar, Z., Tomruk, A. and Bekbolet, M. 2019. Copper-doped TiO₂ photocatalysts: application to drinking water by humic matter degradation. *Environ Sci Pollut Res Int* 26(36), 36096-36106.
- Turkten, N., Karatas, Y. and Bekbolet, M. 2021a. Conducting Polymers and Photocatalysis: A Mini Review on Selected Conducting

- Polymers and Photocatalysts as TiO₂ and ZnO. *Journal of Photocatalysis* 2(4), 252-270.
- Turkten, N., Karatas, Y. and Bekbolet, M. 2021b. Preparation of PANI Modified ZnO Composites via Different Methods: Structural, Morphological and Photocatalytic Properties. *Water* 13(8).
- Uyguner-Demirel, C.S., Turkten, N., Karatas, Y. and Bekbolet, M. 2023. Photocatalytic performance of PANI modified TiO₂: Degradation of refractory organic matter. *Environ. Sci. Pollut. Res.* 30(36), 85626-85638.
- Villabona-Leal, E.G., Escobar-Villanueva, A.G., Ovando-Medina, V.M., Pérez-Pérez, E.B., Díaz-Flores, P.E., Romero-Galarza, A. and Marquez-Herrera, A. 2020. Semiconducting polypyrrole@TiO₂ pure anatase nanoparticles for photodegradation of reactive red 120 azo dye. *J. Mater. Sci.: Mater. Electron.* 31(15), 12178-12190.
- Wang, F., Min, S., Han, Y. and Feng, L. 2010. Visible-light-induced photocatalytic degradation of methylene blue with polyaniline-sensitized TiO₂ composite photocatalysts. *Superlattices Microstruct.* 48(2), 170-180.
- Xu, S., Jiang, L., Yang, H., Song, Y. and Dan, Y. 2011. Structure and Photocatalytic Activity of Polythiophene/TiO₂ Composite Particles Prepared by Photoinduced Polymerization. *Chinese Journal of Catalysis* 32(3), 536-545.
- Yang, C., Dong, W., Cui, G., Zhao, Y., Shi, X., Xia, X., Tang, B. and Wang, W. 2017. Enhanced photocatalytic activity of PANI/TiO₂ due to their photosensitization-synergistic effect. *Electrochim. Acta* 247, 486-495.
- Yuan, X., Kobylanski, M.P., Cui, Z., Li, J., Beaunier, P., Dragoe, D., Colbeau-Justin, C., Zaleska-Medynska, A. and Remita, H. 2020. Highly active composite TiO₂-polypyrrole nanostructures for water and air depollution under visible light irradiation. *J. Environ. Chem. Eng.* 8(5), 104178.
- Zangeneh, H., Zinatizadeh, A.A.L., Habibi, M., Akia, M. and Hasnain Isa, M. 2015. Photocatalytic oxidation of organic dyes and pollutants in wastewater using different modified titanium dioxides: A comparative review. *J. Ind. Eng. Chem.* 26, 1-36.
- Zhang, L., Sun, F., Zuo, Y., Fan, C., Xu, S., Yang, S. and Gu, F. 2014. Immobilisation of CdS nanoparticles on chitosan microspheres via a photochemical method with enhanced photocatalytic activity in the decolourisation of methyl orange. *Appl. Catal. B* 156-157, 293-300.
- Zhu, D. and Zhou, Q. 2019. Action and mechanism of semiconductor photocatalysis on degradation of organic pollutants in water treatment: A review. *Environ. Nanotechnol. Monit. Manag.* 12, 100255.
- Zhu, H., Jiang, R., Xiao, L., Chang, Y., Guan, Y., Li, X. and Zeng, G. 2009. Photocatalytic decolorization and degradation of Congo Red on innovative crosslinked chitosan/nano-CdS composite catalyst under visible light irradiation. *J. Hazard. Mater.* 169(1), 933-940.
- Zhu, Y., Xu, S. and Yi, D. 2010. Photocatalytic degradation of methyl orange using polythiophene/titanium dioxide composites. *React. Funct. Polym.* 70(5), 282-287.
- Zia, J. and Riaz, U. 2021. Photocatalytic degradation of water pollutants using conducting polymer-based nanohybrids: A review on recent trends and future prospects. *J. Mol. Liq.* 340, 117162.

POTENTIAL FOR RAINWATER HARVESTING IN LAYING HEN HOUSE: THE CASE OF BURSA

Busra Yayli¹, Ilker Kilic¹

¹ *Bursa Uludag University, Agriculture Faculty, Biosystem Engineering Department, Bursa, Turkey*

Corresponding author e-mail: busrayayli@uludag.edu.tr

ABSTRACT

Rapid industrial development, population growth, and climate change pressure on water resources. Existing water resources are depleted rapidly or become polluted and fall to a quality that cannot be used for consumption. Therefore, the creation and sustainability of alternative water resources have become essential for our future. Especially in the agricultural sector, the availability of water resources is vital for ensuring continuity in production and food supply. In addition, approximately 70% of clean water resources are used in agriculture. In addition to crop production, animal production is an important water user. Therefore, saving water in agricultural production is of great importance. The use of rainwater in both plant and animal production is one of the savings tools in recent years. Water consumption in livestock farms is realized as drinking water and water for daily use. This study determined the potential of rainwater harvesting from the roof of a layer hen house in the Bursa region, and the system design was made. As a result of the study, it was determined that rainwater harvesting from the poultry house roof was highest in December with 44,7 m³ and lowest in August with 8,3 m³. It has been determined that collected rainwater can supply an annual average of 35,5% of water consumption and usage in the poultry house. When a water tank with a capacity of 45 tonnes is designed to collect rainwater, the system will pay for itself in 24 years.

Keywords: Bursa, Drought, Water harvest, Water consumption, Laying hens

INTRODUCTION

Global climate change, which has impacted water resources significantly in recent years, poses severe threats for the future. In addition, the rapid development of industry, accelerated population growth, and increased consumption significantly impact water resources' pollution and rapid disappearance. For this reason, it is essential for our future to find alternative and sustainable water resources and to carry out studies and implement them.

Water resources' primary source is rainfall and related to how much rainwater can be captured and stored. Rainwater harvesting, which is an advantageous method for saving water and reducing surface runoff, especially for non-potable water uses, stands out as a good alternative that reduces the flow, peaks, and volumes of rainwater (Kilic and Yayli, 2019; Palermo et al., 2019). The utilization and supply of water resources are vital to ensure the continuity of production, especially in the agricultural sector. In farming, 70% of clean water resources are used in crop and animal production. Water consumption in livestock production is realized as drinking water and water for daily use. Therefore, studies on using rainwater harvesting in agricultural output are critical.

This study it is aimed to determine the potential of rainwater harvesting from the roof of a commercial laying hen house operating in the Bursa region and to design the system.

MATERIAL AND METHOD

This study investigated rainwater harvesting potential on the roof of a laying hen farm operating in Bursa Uludag University Faculty of Agriculture Agricultural Research and Application Center (Figure 1). There are 5500 laying hens in the henhouse. The roof area of the house was measured as 625 m² with a laser meter. The place where rainwater will be collected is directly proportional to the amount of rainwater harvested.



Figure 1. Satellite image of the laying hen house in this study

The rainwater harvesting potential of the poultry house considered in the study was calculated by Equation 1 (TEMA, 2023).

$$\text{Rainwater capacity: Rain collection area} * \text{rainfall quantity} * \text{roof coefficient} * \text{filter efficiency coefficient} \quad (1)$$

Rain collection area (m²): It is the area where rainfall falls. In this study, the roof area of the poultry house was taken.

Rainfall quantity (mm): It is the amount of precipitation.

Roof coefficient: It expresses that not all the rain falling on the roof can be recycled. It is specified as 0,8 by DIN1989 German Standards (DIN, 1989).

Filter efficiency coefficient: The efficiency coefficient of the first filter passed for separation from solids indicates that some rain falling on the roof cannot pass through it. It is specified as 0,9 by DIN1989 German Standards (DIN, 1989).

The official website of the General Directorate of Meteorology was used for the average rainfall data of Bursa (Table 1) (MGM, 2023). The official website shows average values for the measurement period 1928-2022. The maximum precipitation fell in December, while the minimum precipitation was observed in August. The average annual rainfall is 707,4 mm.

Table 1. Bursa average annual precipitation (mm) (MGM, 2023)

Month	Average Monthly Total Rainfall (mm)
January	89,1
February	75,9
March	69,9
April	61,5
May	50,6
June	35,4
July	22
August	18,4
September	43,7
October	65,9
November	75,7
December	99,3
Total	707,4

The required storage volume was calculated by Equation 2 during the system design of the rainwater tank of the laying hen house considered in the study. The month with the highest rainfall is regarded as the rainfall parameter specified in Equation 2. For this study, December is taken into consideration.

$$\text{Tank volume} = \text{rainfall volume} * \text{roof area} * 0,8 * 0,9 \quad (2)$$

RESULTS AND DISCUSSION

In the study, the rainwater harvesting potential is directly proportional to the rainfall. The most rainwater harvested was realized in December, while the least was in August (Table 2). The rainwater harvesting obtained from the roof of the investigated poultry house was approximately 320 m³.

Table 2. Potential for roof rainwater harvesting (m³)

Months	Rainwater capacity
January	40,1
February	34,2
March	31,5
April	27,7
May	22,8
June	15,9
July	9,9
August	8,3
September	19,7
October	29,7
November	34,1
December	44,7
Total	318,3

In calculating the daily water requirement of poultry, the amount of water required for each poultry was accepted as 0,25 L/day (Kilic and Abus, 2018). Drinking water consumption

in the poultry house considered in the study is 1,4 m³/day and 501,9 m³/year. The domestic water consumption used for cleaning the poultry house is 396 m³/year. The lowest rainwater harvesting potential is in summer, with 34 m³. Coverage of water consumption with rainwater is directly proportional to the harvested rainwater harvest. Harvested rainwater meets 35,5% of the water consumption in the poultry house (Table 3).

Table 3. Rainwater harvesting and consumption coverage ratio by season

	Winter	Spring	Summer	Autumn	Total
Collected water (m ³)	118,9	81,9	34,1	83,4	318,33
Coverage ratio (%)	53,4	36,8	15,3	37,4	35,5

Rainwater Harvesting System Design

The system required to collect the calculated rainwater harvest has been designed, and its economic analysis has been made. The materials planned to be used in the system design and their numbers are given in Table 4. Underground and surface storage systems are used to collect rainwater. In this study, the storage design is planned to be located underground, and the galvanized steel water tank with a capacity of 45 tonnes can meet the need. The entire system design is calculated as 117,494 TL.

The annual water bill is approximately 8000 TL. The amount of savings obtained annually with the water obtained from rainwater harvesting is about 5000 TL. So, the new bill will be around 3000 TL. The rainwater harvesting design system will be able to amortize itself in 24 years.

Table 4. Economic analysis of rainwater harvesting system design

No	Material	Piece	Price
1	45 tonne galvanised steel water tank	1	35,249
2	Transport and installation costs	1	60,000
3	T pipe	1	100
4	11 Ø Pipe	50 meter	6495
5	Three-way valve	1	4000
6	Filter	1	11650

CONCLUSIONS

In the study, the potential of rainwater harvesting collected on the roof of a commercial hen house operating in the Bursa region has been theoretically demonstrated. To store the collected rainwater, a galvanized steel water tank with a capacity of 45 tons can supply the need. When the cost of the rainwater collection system and the annual cost of tap water are compared, the depreciation period of the system is found to be 24 years.

Rainwater harvesting is directly proportional to the collected roof area and the amount of rainfall. Therefore, the geographical region where rainwater is collected and the amount of rain received are also important parameters. Rainwater harvesting is an essential sustainable water resource alternative in the agricultural sector, constituting significant water use. More impressions should be placed on this alternative method by associating it with agriculture, and studies should be carried out for rainwater harvesting applications.

REFERENCES

- DIN, 1989. Regenwassernutzungsanlagen. Deutsches Institut Normung DIN: 1989, German.
- Kilic, M.Y., M.N. Abuş. 2018. Rain Water Harvesting in a Garden House Sample. *International Journal of Agriculture and Wildlife Science*. 4(2): 209-215.
- Kilic, I., B. Yayli, 2019. A research on the use of rainwater in the faculty of agriculture of Uludag University in Bursa: Rainwater Harvesting. 6th International Conference on Sustainable Agriculture and Environment. 3-5 October. Konya, Turkey. 51-53.
- MGM, 2023. Turkish State Meteorological Service. <https://www.mgm.gov.tr/veridegerlendirme/il-ve-ilceler-istatistik.aspx?k=A&m=BURSA> (Accessed on 7 July 2023).
- Palermo, S. A., V. C. Talarico, B. Pirouz. 2019. Optimizing rainwater harvesting systems for non-potable water uses and surface runoff mitigation. In *International Conference on Numerical Computations: Theory and Algorithms* (pp. 570-582). Cham: Springer International Publishing.
- TEMA, 2023. The Turkish Foundation for Combating Soil Erosion, for Reforestation and the Protection of Natural Habitats, Water of the Future. <https://sutema.org/yagmur-hasadi> (Accessed on 2 August 2023).

RED DRAGON FRUIT: ALTERNATIVE USE OF FRUIT EXTRACTS IN VARIOUS INDUSTRIES

Irem CELIK^{1*}, Meltem ASAN-OZUSAGLAM¹

¹Aksaray University, Faculty of Science and Letters, Department of Molecular Biology and Genetic, Aksaray, Turkey.

*Corresponding author e-mail: iremceelkk@gmail.com

ABSTRACT

Plants known to have antimicrobial properties are very rich in secondary metabolites. Dragon fruit is one of the tropical fruits whose popularity has increased in recent years, especially in our country. Dragon fruit is known as a phytochemical store with bioactive components such as phenolic compounds, betacyanin, terpenoids and polysaccharides. In the present study, it was aimed to investigate the potential of using methanol extracts of red dragon fruit obtained from Turkey as a natural additive in various industries. The antimicrobial activity and photoprotective activity of the flesh and peel methanol extracts obtained by the hot water bath method were investigated in vitro. Firstly, the antimicrobial activity of the extracts was determined using disc diffusion and microdilution methods. Afterwards, the photoprotective activity was determined spectrophotometrically. The results determined that the highest inhibition zone diameter of the flesh extract was 11.84 mm against *P. aeruginosa* ATCC 27853 and *A. hydrophila* ATCC 19570. The highest inhibition zone diameter of the peel extract against the test microorganisms was determined as 11.38 mm in *C. glabrata* RSKK 04019. The minimum inhibition concentration (MIC) value was 10-40 µg/µl for flesh extract, it was determined in the range of 10-80 µg/µl for peel extract. The minimum bactericidal concentration (MBC) was determined in the range of 20->80 µg/µl for the flesh extract and in the range of 20-80 µg/µl for the peel extract. The sun protection factors of flesh and peel methanol extracts were determined as 10.64 and 14.34. These results revealed that methanol extracts obtained from dragon flesh have the potential to be used as natural additives in the pharmaceutical, food, feed, and cosmetic industries. At the same time, the data obtained from the study has the potential to lead to further studies for various industries.

Keywords: *Hylocereus polyrhizus*, Antimicrobial Activity, Sun Protection Factor, Natural Additive

INTRODUCTION

Plants are one of the alternative natural antimicrobial sources that can be used against various pathogens. Many plants with antimicrobial activity have been identified and more than 30000 natural antimicrobial compounds have been defined (Tajkarimi et al., 2010). The red dragon fruit (*Hylocereus polyrhizus*) is of great interest due to its remarkable red-purple color and biological activities (anti-obesity, anti-bacterial, antioxidant capacity and anti-inflammatory) (Celli and Brooks 2017; Liao et al. 2020). Dragon fruit is among the fruits rich in fiber and

vitamins, which remove toxic substances such as heavy metals, control cholesterol and blood pressure, block diabetes, aid the digestive system (Gunasena et al., 2006).

Pathogens, which pose a great threat to human health, cause millions of infectious diseases in developed countries (Jin et al. 2009). The discovery of antibiotics, combined with significant advances in antimicrobial drug development, has become one of the most effective methods used in the treatment of microbial diseases. However, today, due to the misuse of antibiotic drugs, the resistance developed by microorganisms negatively affects the treatment of many diseases (Aminov, 2010; Tenover, 2006). Natural plant-derived substances can be a solution as an alternative to synthetic antimicrobials.

Solar UV rays are divided into three regions: UV-A (320–400 nm), UV-B (290– 320 nm), and UV-C (200–290 nm) (Mishra et al., 2011). Excessive exposure to sunlight can cause adverse diseases such as skin cancer (Kamell et al., 2011). Prolonged exposure to UV rays can cause sunburns, skin spots, skin aging and the onset of skin cancer (Ferrari et al. 2007). Chemical sunscreen creams cause various side effects such as allergic reactions in people with sensitive skin. In recent years, demands for using natural products to reduce or eliminate these side effects have increased (Mishra et al., 2011; Ahmady et al., 2020).

The purpose of our study is primarily the alternative use of red dragon fruit extracts as natural additives instead of synthetic additives in the pharmaceutical, food, feed, and cosmetics industries. Firstly, the antimicrobial activity of red dragon fruit extracts was investigated in vitro. Then, its alternative use as a natural preservative in sunscreens in the cosmetic industry was calculated spectrophotometrically.

MATERIAL and METHODS

Preparation of Red Dragon Fruit Methanol Extracts

The red dragon fruit was obtained from the red dragon fruit production greenhouse in Antalya (Kumluca). The flesh and peel parts of the red dragon fruit samples were separated from each other and thinly sliced. Afterwards, the sliced samples were air-dried separately in conditions. The samples were extracted every day (2 days) with a hot water bath for 9 hours. The red dragon fruit methanol extracts were dissolved in dimethyl-sulfoxide (DMSO) and then sterilized with a 0.22 µm syringe filter. The sterile extracts were stored under suitable conditions (at 4°C) until used.

Microbial Culture

Pseudomonas aeruginosa ATCC 27853, *Escherichia coli* O157:H7 and *Aeromonas hydrophila* ATCC 19570 were grown in Nutrient Broth (NB) for 24 hours at 37°C. *Candida glabrata* RSKK 04019 was cultured at 30°C for 24 hours in Yeast Peptone Dextrose (YPD).

Antimicrobial Assay of Red Dragon Fruit Extracts

Disc Diffusion Assay

The microorganism strains were washed twice in isotonic media and the concentration was adjusted to 0.5 McFarland. 100 µL of prepared microbial culture suspension (0.5 McFarland)

was spread on specific agar medium. The sterile discs (6mm, Whatman no: 1) were placed on specific agar media. Afterwards, 20 µL (4 mg/disc) of red dragon fruit extract was dropped onto the discs. The prepared petri dishes were kept at +4 °C for 2 hours and then incubated for 24 hours at appropriate temperatures. After incubation, the inhibition zone diameters formed around the discs were measured with a calliper and recorded.

Microdilution Assay

The minimum inhibitory concentration (MIC) and bactericidal or fungicidal concentrations (MBC or MFC) of red dragon fruit extracts were obtained by microdilution method. The red dragon fruit extracts were added to growth medium and diluted by a two-fold serial dilution method to obtain a final concentration of 80-5µg/µl. The microbial suspension was added to each tube and then incubated under the conditions required for each microorganism as mentioned above. After incubation, the extract concentration in the tube without microbial growth was determined according to turbidity and the lowest concentration was recorded as the MIC value. The MBC or MFC values were determined by inoculating samples from the mixture onto agar medium. The culture dishes were incubation period at the appropriate temperature for 24 hours. The lowest concentration without eventually growth of incubation was defined as MBC values.

Determination Sun Protection Factor of Dragon Fruit Extracts

The sun protection factor (SPF) of red dragon fruit extracts was determined by spectrophotometric method in vitro conditions. The extracts (0.002 g/ml) were mixed with 96% ethanol. The mixture was read in the UV-VIS spectrophotometer in the wavelength range of UV-B (290-320 nm). The Mansur equation was used to calculate the SPF value. Mansur's equation (Mansur et al., 1986):

Mansur's equation (Mansur et al., 1986):

$$\text{SPF} = \text{CF} \times \sum_{290}^{320} \text{EE}(\lambda) \times \text{I}(\lambda) \times \text{Abs}(\lambda)$$

CF is the correction factor (= 10);

EE(λ) is the erythemogenic effect radiation wavelength (λ);

I(λ) is the intensity of sunlight at wavelength (λ);

Abs(λ) is the absorbance of extracts at wavelength (λ).

RESULTS and DISCUSSION

The biological activity of red dragon fruit methanol extracts was investigated on test microorganisms using disc diffusion and microdilution assays. The disc diffusion assay results of the extracts are presented in Table 1. The inhibition zone diameters of the flesh extract against the test microorganisms were determined in the range of 7.30-11.84 mm. The highest inhibition zone diameter of the flesh extract was determined against *P. aeruginosa* ATCC 27853 and *A. hydrophila* ATCC 1970. The inhibition zone diameters of the peel extract against the test microorganisms ranged from 7.52-11.38 mm. The highest inhibition zone diameter was determined against *C. glabrata* RSKK 04019.

Table 1. Disc diffusion assay results of red dragon fruit extracts.

Microorganism Strains	Inhibition Zone Diameter (mm±sd)		
	Extracts (2 mg/disc)		Antibiotic
	Flesh	Peel	Kanamycin
<i>P. aeruginosa</i> ATCC 27853	11.84±0.00	10.71±0.02	20.37±0.20
<i>E. coli</i> ATCC O157:H7	7.30±0.41	7.52±0.28	19.33±0.40
<i>A. hydrophila</i> ATCC 19570	11.84±1.01	10.89±0.31	19.00±0.09
<i>C. glabrata</i> RSKK 04019	11.35±0.30	11.38±0.02	Fluconazole
			20.35±0.10

In the study of Cheong et al. (2021), the inhibition zone diameter of the methanol extract obtained from *Hylocereus polyrhizus* fruit was determined as 14.10 mm against *E. coli* ATCC 25922. The zone of inhibition against *P. aeruginosa* ATCC 14149 could not be determined. In our previous study, the methanol extracts from *H. undatus* (white dragon) fruit and peel extracted with hot water bath were determined by disc diffusion method against test microorganisms (*E. coli* O157:H7, *P. aeruginosa* ATCC 27853, and *C. glabrata* RSKK 04019). As a result of the study, the inhibition zone diameters in the peel extract were determined as 7.81, 9.68 and 11.23 mm, respectively. It was determined as 7.86, 8.90 and 12.14 mm in fruit extract (Celik and Asan-Ozusaglam, 2023).

MIC is the lowest concentration that inhibits microorganism growth in vitro. The minimum bactericidal or fungicidal concentration is the lowest concentration that reduces the number of microorganisms in the medium containing the bacterial inoculum by 99.9 in vitro conditions (Kowalska and Dudek, 2021). In the current study, the MIC value of the flesh extract was determined in the range of 10-40 µg/µl and the MIC value of the peel extract was determined in the range of 10-80 µg/µl. The lowest MBC or MFC value (20 µg/µl) was determined for flesh extract on *P. aeruginosa* ATCC 27853 and for peel extract on *C. glabrata* RSKK 04019.

Table 2. Micro-dilution assay results of red dragon fruit extracts.

Microorganism Strains	Micro-dilution Assay			
	MIC (µg/µl)		MBC or MFC (µg/µl)	
	Flesh	Peel	Flesh	Peel
<i>P. aeruginosa</i> ATCC 27853	10	40	20	80
<i>E. coli</i> ATCC O157:H7	40	80	>80	80
<i>A. hydrophila</i> ATCC 19570	40	40	40	40
<i>C. glabrata</i> RSKK 04019	20	10	40	20

Yong et al., in their study (2012), determined the antimicrobial activity of red pitahaya methanol extract on *E. coli* ATCC 25922, *P. aeruginosa* ATCC 10145 and *P. aeruginosa* ATCC BAA-47 using the MIC assay. The results were shown as 12.5 mg/ml, 25 mg/ml, and 25 mg/ml, respectively.

The safety and toxic effects of chemicals in commercially produced sunscreen products are questioned by researchers (Yanishlieva vd., 2006). Investigations are carried out against the potential of using alternative natural preservatives against the dangers of the synthetic substances used (Korać ve Khambholja, 2011). In the present study, the sun protection potential of red dragon fruit extracts was determined as a result of spectrophotometrically measurement. The sun protection factor results of the flesh and peel methanol extracts are given in Table 3 and Table 4. SPF values of flesh and peel extracts were calculated as 10.64 and 14.34.

Table 3. SPF values of red dragon fruit flesh extract

Flesh			
Wavelength	EE(λ) \times I(λ)	Abs	CF \times \sum_{290}^{320} EE(λ) \times I(λ) \times Abs(λ)
290	0.0150	1.6783	0.2517
295	0.0817	1.3040	1.0653
300	0.2874	1.1500	3.3051
305	0.3278	1.0693	3.5052
310	0.1864	0.9743	1.8161
315	0.0839	0.9046	0.7572
320	0.0180	0.8256	0.1486
Sun protection factor (SPF)			10.64

In a study conducted by Celik and Asan-Ozusaglam (2023), SPF values of *H. undatus* (white dragon) peel and fruit extracts were determined as 25.92 and 24.84 for peel and fruit extracts, respectively. The literature studies on determination of SPF value of dragon fruit extracts are limited, therefore, more studies are needed.

Table 4. SPF values of red dragon fruit peel extract

Peel Extract			
Wavelength	EE(λ) \times I(λ)	Abs	CF \times \sum_{290}^{320} EE(λ) \times I(λ) \times Abs(λ)
290	0.0150	1.9633	0.2945
295	0.0817	1.7126	1.3992
300	0.2874	1.5233	4.3780
305	0.3278	1.4036	4.6012
310	0.1864	1.3136	2.4486
315	0.0839	1.2196	1.0208
320	0.0180	1.1390	0.2050
Sun protection factor (SPF)			14.34

CONCLUSION

In this study, antimicrobial activity and photoprotective activity of methanol extracts of red dragon fruit obtained from Turkey were investigated to determine their potential to be used as natural additives in various industries. The red dragon fruit extracts exhibited good activity against test microorganisms. In line with this conclusion, there is an alternative use of red dragon fruit extracts as natural additives in the pharmaceutical, food, and feed industries. In addition, the fact that the extracts have high SPF values is an indication that they have the potential to be used as a natural preservative in the cosmetic industry. As a result, it was determined that red dragon fruit extracts may have the potential to be used as natural additives instead of synthetic additives in various industries.

REFERENCES

- Ahmady, A., Amini, M. H., Zhakfar, A. M., Babak, G. ve Sediqi, M. N., 2020. Sun protective potential and physical stability of herbal sunscreen developed from afghan medicinal plants, Turkish Journal of Pharmaceutical Sciences, 17, 3, 285.
- Aminov, R. I., 2010. A brief history of the antibiotic era: lessons learned and challenges for the future, Frontiers in Microbiology, 1, 134.
- Celik, I., & Asan-Ozusaglam, M. (2023). Investigation of Antimicrobial and Photoprotective Activity of *Hylocereus undatus* Methanol Extracts. Eurasian Journal of Food Science and Technology, 7(1), 12-22.
- Celli GB, Brooks MSL. Impact of extraction and processing conditions on betalains and comparison of properties with anthocyanins—A current review. Food Research International. 2017: 100; 501-509.

Ferrari, M., Oliveira, M. S., Nakano, A. K. ve Rocha-Filho, P. A., 2007. Determinação do fator de proteção solar (FPS) in vitro e in vivo de emulsões com óleo de andiroba (*Carapa guianensis*), Revista Brasileira de Farmacognosia, 17, 4, 626630.

Gunasena HPM, Pushpakumara DKNG, Kariyawasam M. Dragon fruit: *Hylocereus undatus* (Haw.) Britton and Rose. In: Pushpakumara DKNG, Gunasena HPM, Singh VP, editors. Underutilized fruit trees in Sri Lanka, New Delhi: World Agroforestry Centre, South Asia Office; 2006. pp. 110–141.

Hassan Cheong, N. D., Hasan Kashfi, A. F., & Yusof, H. (2021). The antibacterial effects of *Hylocereus polyrhizus* fruit extracts against selected bacteria. ESTEEM Academic Journal, 17, 157-165.

Jin S-Q, Yin B-C, Ye B-C. Multiplexed bead-based mesofluidic system for detection of food-borne pathogenic bacteria. Applied and Environmental Microbiology. 2009;75(21):6647–6654.
<https://doi.org/10.1128/AEM.00854-09>

Kamell, J. M., Rietkerk, W., Lam, K., Phillips, J. M., Wu, J. J., McCullough, J.L., Linden, K. G. ve Osann, K., 2011. Medical students educate teens about skin cancer: what have we learned? Journal of Cancer Education, 26, 1, 153-5.

Korać, R. R. ve Khambholja, K. M., 2011. Potential of herbs in skin protection from ultraviolet radiation, Pharmacognosy Review, 5, 10, 164–173.

Kowalska-Krochmal B. and Dudek-Wicher R. 2021. The Minimum Inhibitory Concentration of Antibiotics: Methods, Interpretation, Clinical Relevance, Pathogens, 10(2), 165-186.

Liao H, Zhu W, Zhong K, Liu Y. Evaluation of colour stability of clear red pitaya juice treated by thermosonication. Lwt. 2020; 121: 108997.

Mishra AK, Mishra A, Chattopadhyay P. Herbal cosmeceuticals for photoprotection from ultraviolet B radiation: A review. Tropical Journal of Pharmaceutical Research. 2011;10(3):351–360.
<https://doi.org/10.4314/tjpr.v10i3.7>

Tajkarimi MM, Ibrahim SA, Cliver DO. Antimicrobial herb and spice compounds in food. Food Control. 2010;21(9):1199–1218. <https://doi.org/10.1016/j.foodcont.2010.02.003>

Tenover, F. C., 2006. Mechanisms of antimicrobial resistance in bacteria, The American Journal of Medicine, 119, 6, 3-10.

Yanishlieva, N. V., Marinova, E. ve Pokorný, J., 2006. Natural antioxidants from herbs and spices, European Journal of Lipid Science and Technology, 108, 9, 776-793.

Yong, Y. Y., Dykes, G., Lee, S. M., & Choo, W. S. (2017). Comparative study of betacyanin profile and antimicrobial activity of red pitahaya (*Hylocereus polyrhizus*) and red spinach (*Amaranthus dubius*). *Plant foods for human nutrition*, 72, 41-47.

RISKS RELATED TO PHYTOSANITARY PRACTICES OF APPLE GROWERS IN THE KHENCHELA REGION -ALGERIA

Loubna BOUDRAA^{1,2}, Hassina Hafida BOUKHALFA^{1,3}

¹ Department of Agronomic Sciences, Université Mohamed Khider-Biskra.

² Ecosystem Diversity and Dynamics of Agricultural Production Systems in Arid Zones

³ Laboratoire Promotion de l'Innovation en Agriculture dans les Régions Arides.

loubna.boudraa@univ-biskra.dz

ABSTRACT

The main objective of the agricultural spraying process is to ensure optimum biological efficacy of the phytosanitary treatment under the constraints of technical aspects and economic considerations. In this context, mastering the techniques for applying plant protection products can help reduce their undesirable impact on the environment and on health. This may justify a search for the best technical conditions applicable to local conditions, with the aim of optimizing and rationalizing phytosanitary treatments. Our survey-based study took place in 2019/2020 in the wilaya of Khenchela on 368 farmers spread over 08 communes belonging to 03 main daïra in agricultural activity. Our approach was to collect data on the phytosanitary practices of farmers in the region through a questionnaire used to estimate the risks associated with these practices. The questions asked concerned the operator's ability to characterize the product packaging, protective measures (PPE), preparation of the spray mixture, product storage, climatic preference for treatment, information on the sprayer, type of product, formulation, dose and frequency. The data collected was used to feed a mathematical model estimating farmers' exposure rates to plant protection products, and to assess the health risks associated with their practices. Most farmers neglect to wear PPE during spray preparation and crop treatment, which amplifies their exposure to the products and consequently increases the risk incurred. Indeed, the respondents declaring to have suffered at least one of the health problems are farmers who use their protective equipment little or poorly, or who do not respect product use instructions and directions for use, and mainly treatment doses.

Key words : Phytosanitary practices, farmers, exposure, risk, PPE.

INTRODUCTION

In industrial agriculture, an apple undergoes an average of 35 phytosanitary treatments. Herbicides, insecticides, fungicides... Apple growers can choose from over 2,500 toxic

products. Most pesticides are sprayed directly onto the fruit, leaving the skin saturated with chemicals (**Anonyme, 2016**).

Phytosanitary applications refer to measures taken to prevent the spread of plant pests and diseases. Apple-growing is an important agricultural activity that requires phytosanitary measures to ensure the quality and safety of the produce (**Guy J. Hallman, 2011**). Wireless monitoring systems can be used to reduce the level of pesticides while ensuring high-quality production (**Viani F. and all, 2016**). Fixed spraying systems have also been developed to improve working conditions, safety, timing, and performance of plant protection products' application in heroic viticulture areas (**Imperatore G. and all, 2021**). Additionally, beneficial fungi have been studied for their potential to manage phytosanitary problems in the tea agro-ecosystem (**Pandey A. K., 2021**). Overall, phytosanitary applications are crucial in apple-growing to ensure the safety and quality of the produce.

MATERIALS AND METHODS

Our study was conducted from 2020 to 2021 (over a period of 14 months) during the main production and processing period for the cereal crop the data collection method is an individual farmer survey conducted at different sites in the study area, involving 368 producers, including 177 apple farmers in the Daïra Bouhmama and Daïra Kais represent. The questionnaire included questions on: Farm presentation, farmers' knowledge, use of phytosanitary products and methods of storage and personal protective equipment (PPE).

The data collected concerns the treatment methods used to control crop diseases and pests, the equipment used for spraying, as well as the various plant protection products used (formulation, dose, frequency, active ingredient, etc.) and protection measures (product-related risk to farmers). The list of products used was completed by examining empty packaging in the field, agricultural product vendors and packaging stored in the plant. Observations focused mainly on the preparation of the slurry, since this is a major risk phase for the operator (direct contact with the product).

RESULTS AND DISCUSSIONS

In order to obtain representative results for Khenchela, farms throughout the region were surveyed, including apple growing sectors in Daïra Bouhmama and Daïra Kais (48,10% apple producers).

The study shows that 92% of the 177 farms surveyed have a surface area of [0;10 ha], 3% have a surface area of [10;20 ha] and 1% have a surface area of [20;30 ha], while only 4% have a surface area over [+30 ha].

Yabous, Taouzient, Bouhmama and Chelia are the most productive apple-growing communes in the Khenchela region by successive order (24%, 21%, 18% and 16% growers).

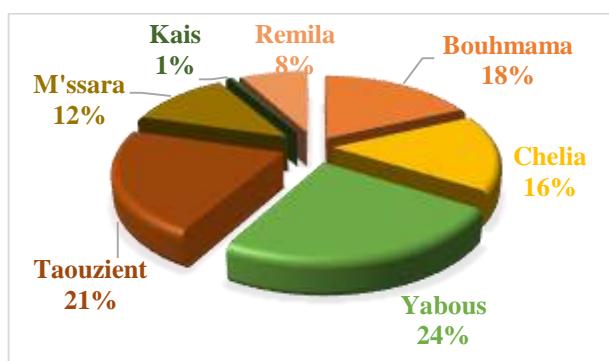

Figure 21 : Farms investigated of apple growing.

Application of phytosanitary products

As farm managers are responsible for spraying crop protection products, explaining treatment methods to applicators, they are the ones most exposed to potential health risks. In order to 51% of farmers wear personal protective equipment (fig. 02).

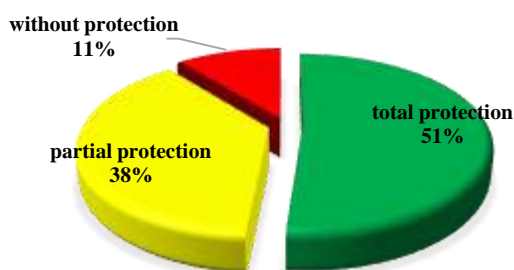

Figure 22 : Personal protection equipment.

Phytosanitary products for cereal treatments

A total of 177 farms surveyed in the region were found to use commercial specialties, all of them synthetic chemicals. Insecticides and fungicides were the most widely used, accounting for 66% and 33% respectively. Followed by herbicide-based products (1%).

The list of products was completed by examining stored packaging and the sellers of phytosanitary products.

The study shows that the most useful products in the study area are: Voliam flexi 59 farmers (insecticide), Bayfidan by 34 farmers (fungicide), Score by 19 farmers (fungicide), Movento by 18 farmers (insecticide) and Voliam targo by 16 farmers (insecticide).

13 actives substance were inventoried, with Chlorantraniliprole et du Thiamethoxam (33,3%), Triadiménol with (19,2%), Difenocanazole with (10,7%), Spirotetramat 100 g/l with (10,2%) and 1,8% Abamectin et 4,5% Chlorantraniliprole with (9%).

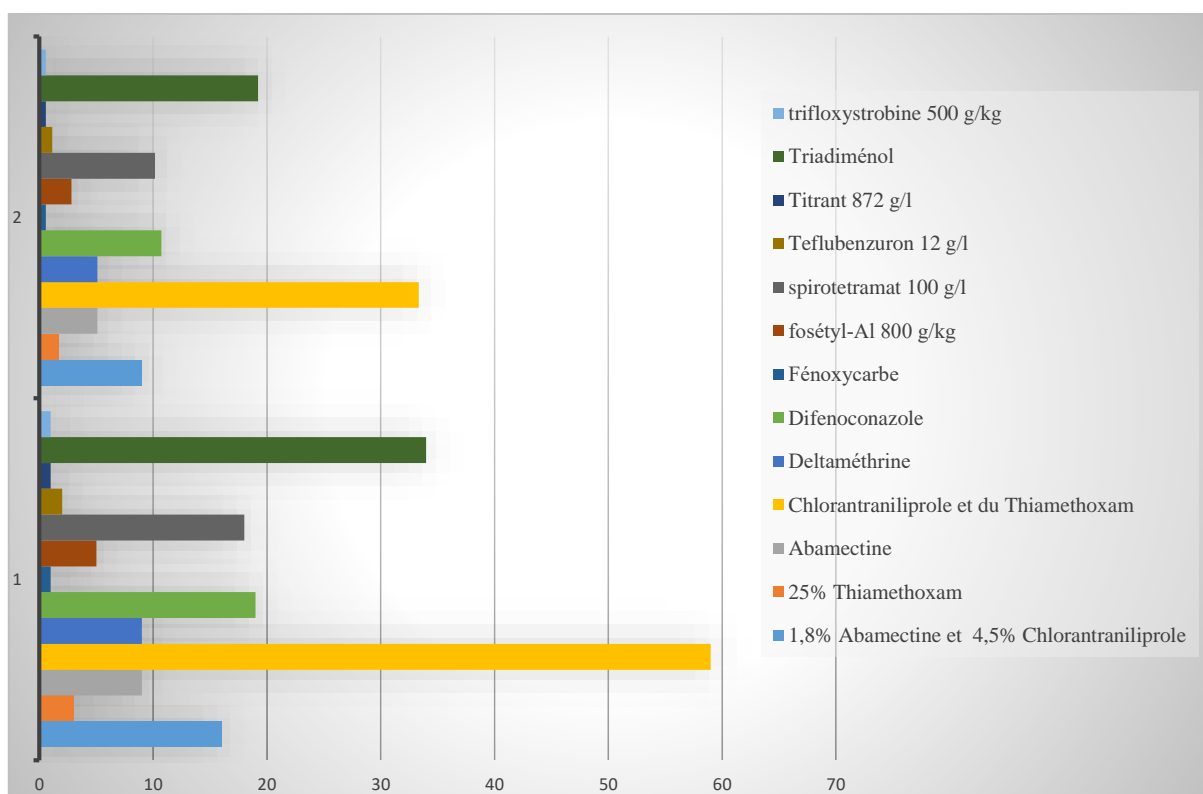

Figure 23 : Distribution of active material handled.

EXPOSURE RISK

In the Khenchela region, several noxious or toxic active ingredients have been identified on local markets, on packaging stored at growers' premises or on empty packaging burnt by

local farmers after spraying. Estimation of potential exposure of growers over a working day (mg/kg body weight / day). The following data are integrated: application method, product name, active ingredient, concentration, formulation, PPE, dose and AOEL for each active ingredient. This model enables results to be compared with the AOEL (EU Pesticides database).

Estimated operator exposure without wearing protection, expressed as a percentage of the AOEL, represents 283% (without protection) of the AOEL for Spirotetramat, 179 % (without protection) of the AOEL for Abamectin, 107% (without protection) of the AOEL for Chlorantraniliprole (fig.04).

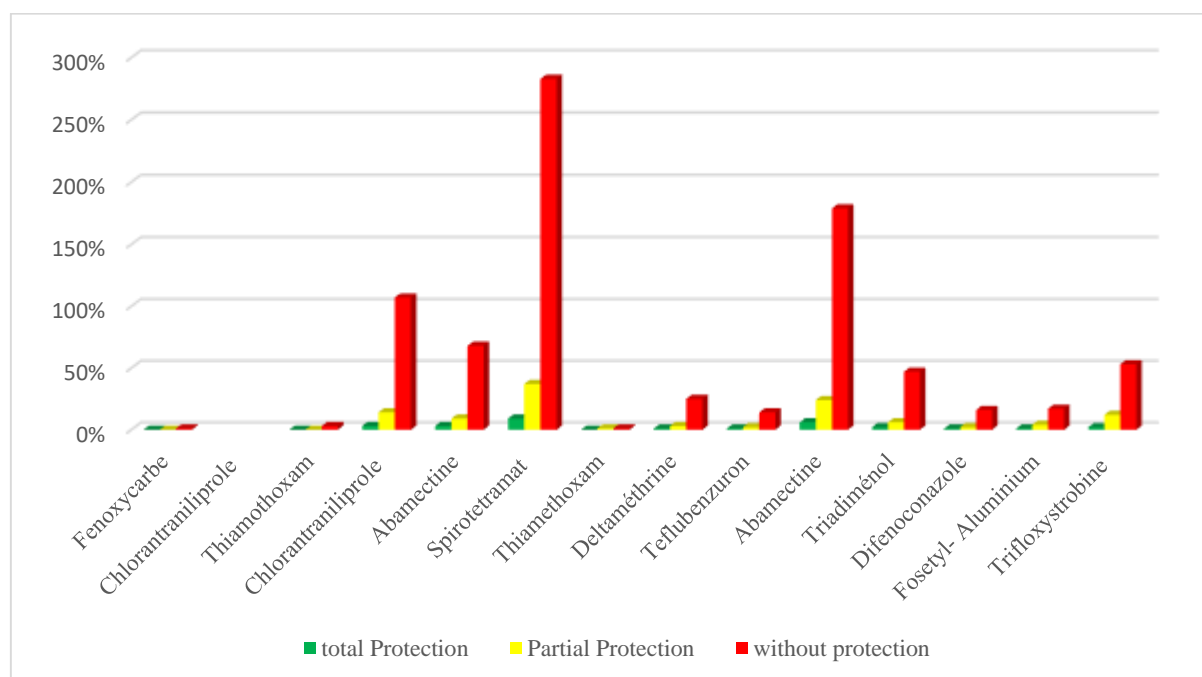

Figure 24 : Operator's exposure level.

The health risk for operators is considered unacceptable, without wearing protection during all phases of treatment. The risk diminutions when the operator dresses PPE.

CONCLUSION

Apple growers recognize the risks associated with poor phytosanitary practices: the supply of pesticides from informal channels, the use of toxic phytosanitary products, the total or partial absence of personal protective equipment, and the burning of empty packaging are all practices that expose these operators to danger.

The results tell us that some of the most frequently used active ingredients, mainly insecticides such as Spirotetramat (Movento) and Abamectin (Vertimec), exceed the tolerated limits. These active ingredients are known to be toxic and could have harmful effects after

exposure, especially for farmers who fail to protect themselves when preparing bolls or applying plant protection products.

REFERENCES

1. Anonyme, 2016. <https://www.greenpeace.fr/pomme-souvent-empoisonnee-pesticides/>
2. Hallman, G. J. (2011). Phytosanitary applications of irradiation. *Comprehensive Reviews in Food Science and Food Safety*, 10(2), 143-151.
3. Viani, F., Robol, F., Bertolli, M., Polo, A., Massa, A., Ahmadi, H., & Boualleague, R. (2016, June). A wireless monitoring system for phytosanitary treatment in smart farming applications. In *2016 IEEE International Symposium on Antennas and Propagation (APSURSI)* (pp. 2001-2002). IEEE.
4. Imperatore, G., Ghirardelli, A., Strinna, L., Baldoin, C., Pozzebon, A., Zanin, G., & Otto, S. (2021). Evaluation of a fixed spraying system for phytosanitary treatments in heroic viticulture in north-eastern italy. *Agriculture*, 11(9), 833.
5. Pandey, A. K., Deka, B., Varshney, R., Cheramgoi, E. C., & Babu, A. (2021). Do the beneficial fungi manage phytosanitary problems in the tea agro-ecosystem?. *BioControl*, 66, 445-462.

SCREENING OF POLYPHENOL OXIDASE ENZYME IN LYCOPEN-RICH FRUITS

Simge ÇOLAK¹, Yonca YÜZÜGÜLLÜ KARAKUŞ²

¹ *Graduate School of Natural and Applied Sciences, Department of Biology, Kocaeli University, Kocaeli, Turkey*

² *Department of Biology, Kocaeli University, Kocaeli, Turkey*

Corresponding Author: yonca.yuzugullu@kocaeli.edu.tr

ABSTRACT

Polyphenol oxidases (PPOs), which have been the subject of numerous studies in recent years and have attracted the attention of researchers, are enzymes that catalyze the oxidation of phenolic compounds. Although PPOs are generally found in plants, they are also found in many microorganisms and fungi. Therefore, PPOs have a wide distribution. PPOs are used in many fields, especially in medicine, cosmetics, and industry. The aim of this study was to investigate PPO by selecting fruits with high lycopene content. For this purpose, 9 different fruits (watermelon, bell pepper, fig, pomegranate, blood orange, grapefruit, cranberry, rosehip, potency pomegranate) were extracted in vitro using 13 different extraction methods (10 mM ascorbic acid in extraction buffer, 2 mM phenylmethylsulfonyl fluoride, 1% polyvinylpyrrolidone (w/v), 1% Triton X-100 (v/v), pH 7.0) and enzyme activity was measured spectrophotometrically.

Keywords: Polyphenol oxidase, Lycopene, Spectrophotometer, Enzyme purification, Enzyme isolation, Industry

INTRODUCTION

While a long shelf life is highly desirable for fruit and vegetable products, enzymatic browning is the main cause of quality loss in fruit and is generally considered nutritionally detrimental to food quality (Falguera et al., 2012). Therefore, enzymatic browning is a fundamental problem for the food industry. The degree of browning depends on the type and number of phenolic compounds, the presence of oxygen, reducing agents, metal ions, pH, temperature, and polyphenol oxidase (PPO) activity (Yoruk and Marshall, 2003).

The enzyme polyphenol oxidase (PPO) belongs to the oxidoreductase enzymes (EC 1) (Sekme, 2011). PPOs are divided into three main types according to their substrate specificity and mechanism of action. Laccases (EC 1.10.3.2, p-benzenediol: oxygen oxidoreductase), catechol oxidases (o-diphenol oxidoreductase; EC 1.10.3.1), and tyrosinases (EC 1.14.18.1, monophenol monooxygenase) (Griffith, 1994). These metalloenzymes belong to the oxidoreductase family (EC 1); they are found in the thylakoid membrane, cytoplasm, mitochondria, peroxisome, and chloroplast. Polyphenol oxidase is a copper ion containing enzyme. It can catalyze two different reactions using molecular oxygen. These reactions are hydroxylation of monophenols to o-diphenols (cresolase activity) and oxidation of o-diphenols to o-quinones (catecholase activity) (Spagna et al., 2005). cresolase and substances released because of catecholase activities cause the formation of brown, black and red pigments (Friedman, 1997; Sekme, 2011).

Polyphenol oxidases are used in many fields, such as the food industry, chemistry, pharmaceuticals, wine, beer, and fruit juice production (removal of phenolic substances), wastewater treatment, the plastics and paper industry, and melanin synthesis (Gasmalla et al., 2015; Maki et al., 2006).

Phenolic substances are natural antioxidants. Antioxidants act as radical scavengers and, due to these properties, prevent food components from reacting with oxygen. Thus, they delay the spoilage of perishable products. To this end, natural antioxidants such as lycopene have gained importance in preventing food oxidation. Lycopene is a lipophilic carotenoid hydrocarbon pigment found in red, pink, and orange fruits and vegetables such as tomatoes, apricots, melons, and cranberries (Sevindik et al., 2021).

The purpose of this study was to investigate the presence of the enzyme polyphenol oxidase by selecting fruits with high lycopene content. For this purpose, 9 different fruits were extracted under in vitro conditions by 13 different methods and the enzyme activity was measured by the spectrophotometric method.

MATERIAL AND METHOD

Fruit samples were purchased at various public markets and markets in Kocaeli. The fruits were stored at -80°C .

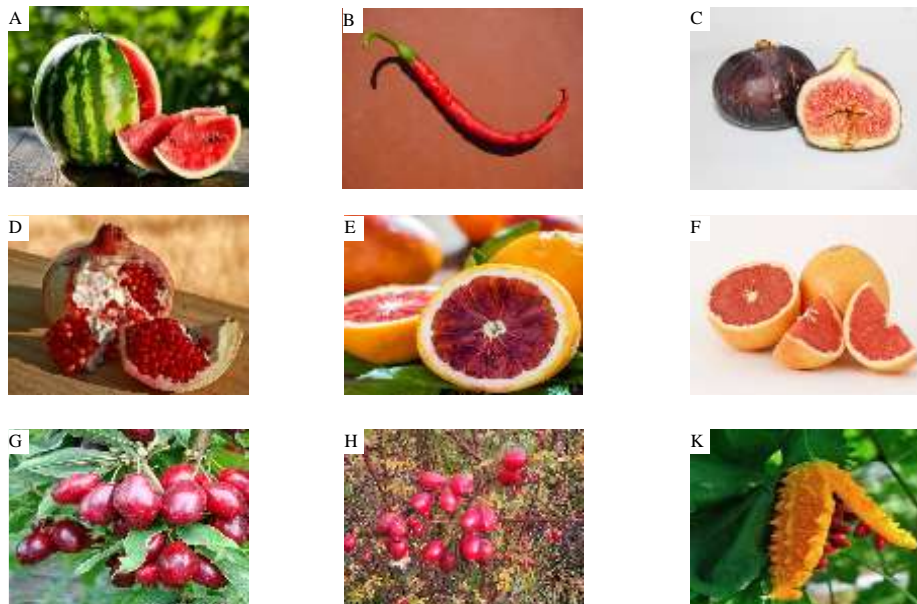

Figure 1. *Citrullus lanatus* (A), *Capsicum annum* (B), *Ficus carica* (C), *Punica granatum* (D), *Citrus sinensis* (Blood orange) (E), *Citrus paradisi* (F), *Cornus mas* (G), *Rosa canina* (H), *Momordica charantia* (K)

Extraction: the fruits were washed with distilled water (dH_2O). Then 200 g of the fruits were crushed with a blender and homogenized. 15 g of the pureed fruits were weighed and placed in 13 Falcon tubes. 15 ml of the prepared 0.1 M sodium phosphate buffer (pH 7.0) was added to them. Then, optimization was performed separately for each Falcon. 10 mM ascorbic acid, 2 mM for optimization phenylmethylsulfonyl fluoride, 1% polyvinylpolypyrrolidone (w/v) and 1% Triton X-100 (v/v) were used. The prepared mixture was shaken for 1 minute. The homogenate obtained was kept at $+4^{\circ}\text{C}$ for 30 minutes and then at $10000\times\text{g}$ for 30 minutes. After centrifugation, the mixture was filtered through a cheesecloth, the remaining pellet was removed, and crude enzyme extract was obtained.

Table 1. 13 methods used for extraction of PPO from various fruits.

		Ascorbic acid	Polyvinylpolypyrrolidone (PVPP)	Phenylmethylsulfonyl fluoride (PMSF)	Triton X-100
1	0.1 M Sodium phosphate buffer (pH 7.0)				
2			+		+
3		+	+	+	+
4			+		
5					+
6			+	+	+
7				+	+
8			+	+	
9				+	
10			+		
11			+		+
12			+		+
13			+		+

It is important to minimize the formation of o-quinones during extraction. For this reason, PVPP and ascorbic acid were used to remove or reduce the phenolic compounds in the medium, Triton X-100 was used to dissolve the enzyme when bound to the cell organelle, and PMSF was used to increase PPO activity (Gauillard et al., 1997; Sojo et al., 1998).

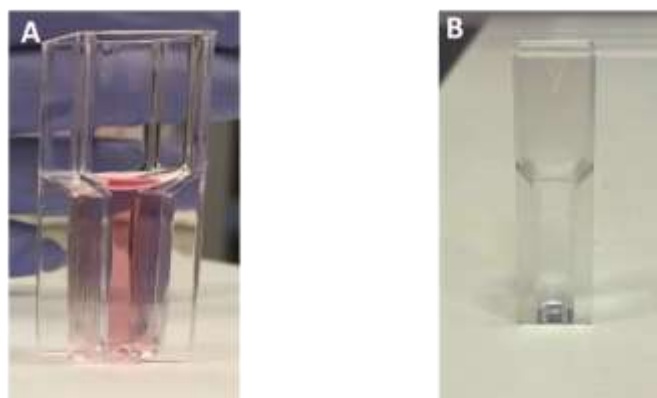
**Figure 2.** Enzyme activity assay. A – Sample cuvette, B – Blank cuvette

To measure enzyme activity, the sample cuvette was prepared by adding 900 μ l substrate (pyrocatechol) + sodium citrate buffer (0.1 M pH 5.4) and 100 μ l enzyme solution with a final concentration of 100 mM. The empty control cuvette was prepared by adding 900 μ l substrate (pyrocatechol) + sodium citrate buffer (0.1 M pH 5.4) and 100 μ l sodium phosphate buffer (0.1 M pH 7.0). PPO activity was measured using a spectrophotometer at room temperature and 420 nm. The activity measurement was repeated twice in each experiment.

RESULTS AND DISCUSSION

PPO enzymes in, biosensor development, they are widely used in industry, especially in food, paper, textile, cosmetics, industrial wastewater treatment, and in the treatment of many diseases such as Parkinson's disease, cancer, and some infections. Due to their widespread use, their isolation and purification from various sources has gained great importance in recent years. Although PPOs are generally found in plants, they are also found in many microorganisms and fungi. PPO was isolated from these sources and purified using common purification methods

(ammonium sulphate precipitation, temperature-induced phase separation (TIPS), three-phase partitioning (TPP), aqueous two-phase extraction (ATPS), chromatographic purification). After the characterization studies of the enzyme, it was put into practice.

There are few studies in the literature investigating the relationship between lycopene, the antioxidant substance responsible for red color that occurs naturally in fruits, and PPO. Therefore, in this study, PPO activity was investigated using watermelon, red bell pepper, fig, pomegranate, blood orange, grapefruit, cranberry, rosehip, and bitter melon, which are rich in lycopene. The PPO activity of the fruits was compared with optimization performed by 13 different methods.

Table 2. PPO activity results

PPO Activity (U/mL)									
	Watermelon	Red pepper	Fig	Pomegranate	Blood orange	Grapefruit	Cranberry	Rosehip	Potency pomegranate
1	83	22	120	*	*	*	*	*	87
2	*	*	*	42	*	*	*	455	*
3	*	*	*	14	*	*	*	*	*
4	*	*	*	28	*	*	41	*	*
5	*	*	*	106	*	*	*	*	*
6	*	*	*	40	*	1135	66	*	95
7	*	*	*	29	*	*	*	*	*
8	*	*	*	23	*	*	123	*	*
9	85	26	91	8	*	*	*	*	*
10	60	20	*	*	*	1019	*	*	*
11	*	*	*	33	*	1774	*	*	115
12	*	*	*	12	99	*	*	*	*
13	85	13	60	*	*	*	*	*	*

(* = activity measurement could not be performed because a clear solution could not be obtained.)

CONCLUSIONS

Subsequently, crude enzyme extract samples obtained from fruits were prepared under optimal conditions and compared in terms of polyphenol oxidase activities. Accordingly, grapefruit fruit was found to have higher polyphenol oxidase activity towards catechol substrate at a concentration of 10 Mm ascorbic acid and 1% Triton X-100 compared to other fruits.

REFERENCES

- Falguera V., Aliguer N., Falguera M., 2012. An Integrated Approach to Current Trends in Food Consumption: Moving Toward Functional and Organic Products. *Food Control*. 26, 274-281. doi.org/10.1016/j.foodcont.2012.01.051
- Friedman M., 1997. Chemistry, Biochemistry, and Dietary Role of Potato Polyphenols. A Review. *Journal of Agricultural and Food Chemistry*. 45, 5, 1523-1540. doi.org/10.1021/jf960900s

Gaillard F., Richard-Forget F., 1997. Polyphenoloxidases from Pear (*Williams Pyrus communis* L, cv Williams): Activation, Purification and Some Properties. *Journal of the Science of Food and Agriculture*. 74,49-56.

Gasmalla M. A., Kamal-Alahmad, Alyousef, H., 2015. Efficient Methods for Polyphenol Oxidase Production. *International Journal of Nutrition and Food Sciences*. 4: 656-659. doi: 10.11648/j.ijnfs.20150406.19

Griffith G. W., 1994. Phenoloxidases, *Progress in Industrial Microbiology*. 29, 763- 788

Maki, H., Morohashi, Y., 2006. Development of Polyphenol Oxidase Activity in the Micropylar Endosperm of Tomato Seeds. *Journal of Plant Physiology*. 163(1): 1-10. doi: 10.1016/j.jplph.2005.04.036.

Sekme S., 2011. Investigation of polyphenol oxidase induction in various fungi. Master Thesis. Istanbul, Turkey: Yıldız Technical University, Institute of Science and Technology, Department of Chemistry.

Sevindik M., Khan U. M., Zarrabi A., Nami M., Ozdemir B., Kaplan D. N., Selamoglu Z., Hasan M., Kumar M., Alshehri M., Sharifi-Rad J., 2021. Lycopene: Food Sources, Biological Activities, and Human Health Benefits. *Oxidative Medicine and Cellular Longevity*. doi.org/10.1155/2021/2713511

Spagna G., Barbagallo R. N., Chisari M., Branca F., 2005. Characterization of a Tomato Polyphenol Oxidase and Its Role in Browning and Lycopene Content. *Journal of Agricultural and Food Chemistry*. 53, 6, 2032–2038. doi.org/10.1021/jf040336i

Sojo, M.M., Nun, E., Garcı, F., 1998. Partial Purification of a Banana Polyphenol Oxidase Using Triton X-114 and PEG 8000 for Removal of Polyphenols. *J.Agric.FoodChem*. 46, 4924–4930. doi.org/10.1021/jf980473.

URL 1- <https://www.bahcetohum.com/karpuz-tohumu-crimson-sweet-bt-096>

URL 2- https://tr.wikipedia.org/wiki/Capsicum_annuum

URL 3- <https://tr.wikipedia.org/wiki/%C4%B0ncir#>

URL 4- <https://tr.wikipedia.org/wiki/Nar>

URL 5- <https://fidansepetim.com/urun/3-Yas-Asili-Kan-Portakali-Fidani/129>

URL 6- <https://tr.wikipedia.org/wiki/Greyfurt#>

URL 7- <https://www.bursatarimmarket.com/kizilcik-fidani-asi>

URL 8- <https://tr.wikipedia.org/wiki/Ku%C5%9Fburnu#>

URL 9- <https://www.tohumcenneti.com.tr/urun/dogal-kudret-nari-tohumu-3-tohum>

Yoruk R., Marshall Maurice R., 2007. Physicochemical Properties and Function of Plant Polyphenol Oxidase: A review. *Journal of Food Biochemistry*. 27, 361-422. doi.org/10.1111/j.1745-4514.2003.tb00289.x

LETHAL EFFECTS OF LAUREL, SENNA AND FENNEL PLANT EXTRACTS ON *TENEBRIO MOLITOR*

Eyrim SÖNMEZ¹ Orhan ŞİMŞEK²

¹Sinop University, Faculty of Education, Department of Mathematics and Science Education, Sinop- Türkiye

²Sinop University, Institute of Graduate Studies, 57000, Sinop-Türkiye
Corresponding author e-mail:esonmez@sinop.edu.tr

ABSTRACT

This study was designed to determine the effects of laurel (*Laurus nobilis*), senna (*Cassia angustifolia*) and fennel (*Foeniculum vulgare*) plant extracts on lethality, larval, pupal and adult developmental period, adult longevity on *T. molitor*. Trials were carried out under laboratory conditions of 26±2 and 75±5% relative humidity. Five experimental groups were formed for each plant extract. 10 *T. molitor* larvae were placed in each experimental group (in petri dishes). Flour+wheat flour was added for nutritional needs and potatoes were added for water needs. On the first day, small cotton pieces impregnated with 10% plant extract were placed in the experimental groups and the petri dishes were wrapped with parafilm. After 24 hours, the numbers of surviving and dead larvae in the petri dishes were recorded. After pupae become adults, each one was taken into a separate petri dish to prevent intraspecific cannibalism. The longevity of the adult insects was calculated by recording the day they died. According to statistical analysis, the rate of dead larvae in the first 24 hours was 83.32±8.43% in laurel, 48.88±11.45% in cassia, and 62.00±18.54% in fennel. Pupal development time was 37.63±3.69 in laurel, 39.60±1.78 in senna, 34.05±1.05 in fennel, while the adult development time was 8.60±0.77 in laurel, 8.96±0.33 in cassia, 8.29±0.43 in fennel. The longevity was 37.87±2.52 in laurel, 28.28±2.71 in senna and 31.94±1.35 in fennel. No statistical difference was observed between other parameters except lethality percentages. This study reveals that plant extracts can be developed as new environmentally friendly control agents against stored product pests.

Keywords: *Laurus nobilis*, *Cassia angustifolia*, *Foeniculum vulgare*, Pests, Herbal Essential Oils, Ecological Insecticide

INTRODUCTION

Tenebrio molitor L. 1758 is a pest that causes very serious economic losses in stored products such as oats, barley, wheat, corn, bran and flour. *T. molitor* larvae feed on the product and cause deterioration of product quality with their feces. They usually hatch within 10-12 days and the larval development periods vary depending on temperature and humidity for 3-18 months. Pupal developmental periods can also take 5-10 days depending on temperature and humidity. After they become adults, they can live for 2-3 months and can reach a weight of 300 mg. Adult insects can lay eggs 4-17 days after mating (Baş and Ersoy, 2020). Adult females can lay up to 300-500 bean-shaped, white and sticky eggs (Rayees et al., 2021).

Producers try to fight against this damage caused by *T. molitor* to stored products with chemical methods. However, in recent years, with the understanding of the damage caused by chemical control to human and environmental health, producers are looking for new alternative control methods. Researchers are also working to produce biopesticides that are environmentally friendly and do not harm environmental health. Studies in this field with medicinal and aromatic plant essential oils and extracts have come to the fore in recent years (Rayees et al., 2021). As

it is known, medicinal aromatic plants have been used in alternative medicine since ancient times, as well as insect repellent and insecticide. Plants produce some chemicals to adapt to changing environmental conditions or to protect themselves from other harmful organisms (Ayдын and Mammadov, 2017). Among these chemicals, which are called secondary metabolites, saponins, terpenoids, phenols, alkaloids, glycosides and tannins are very important and have been used for centuries against harmful insects. At the same time, they are used as raw materials in many sectors such as medicine, chemistry, food, textile, cosmetic industry and agriculture (Bourgauđ et al., 2001). The effect of these metabolites is through contact, ingestion or inhalation. They provide protection to the plant by affecting the nervous system of insects. Or, they act as allelochemicals used to ensure interspecies interaction, causing the insect to move away from the plant, prevent its feeding or die (Ebadollahi et al., 2022). The laurel (*Laurus nobilis*) plant is an evergreen plant belonging to the Lauraceae family. The oil of the laurels, which are grown in abundance in the Sinop region and grown in the Sinop Province, is also extracted in the province of Samsun (Alacam district), which is close to the region. For this reason, it is economically very important in the region and is a serious source of employment. This is the main reason for choosing it in this study. In this study, it was aimed to contribute to the field of biological control by determining lethal, pupal, adult developmental periods and longevity on *T. molitor* of laurel (*Laurus nobilis*), senna (*Cassia angustifolia*) and fennel (*Foeniculum vulgare*).

MATERIAL AND METHOD

This study was designed to determine the effects of laurel (*Laurus nobilis*), senna (*Cassia angustifolia*) and fennel (*Foeniculum vulgare*) plant extracts on lethality, larval, pupal and adult developmental period, adult longevity on *T. molitor*. Trials were carried out under laboratory conditions of 26 ± 2 °C and $75\pm 5\%$ relative humidity.

Obtaining plant extracts: The laurel plant extract was taken from a factory that produces laurel oil in the Samsun-Alaçam region, while the others were obtained from herbalists. All plant extracts were dissolved in 95% (Merck) ethanol to create 10% (v/v) solutions. These 10% extract solutions of the plants were used in the experiments.

5 experimental groups were formed for each plant extract. 10 larvae ($5\times 10=50$) were placed in each experimental group. A total of 50 larvae were used for each plant extract. Flour+wheat flour was added for nutritional needs and potatoes were added for water needs. On the first day, small cotton pieces impregnated with 10% plant extract were placed in the experimental groups, and the petri dishes were wrapped with parafilm. After 24 hours, the numbers of surviving and dead larvae in the petri dishes were recorded. Lethality percentages were corrected and calculated according to the Abbott (1925) formula. Surviving larvae were left in the specified laboratory conditions and expected to pupae. Insects that died as pupae were also recorded on the day they died. The pupation day of the pupae was recorded. The surviving pupae were kept in the specified laboratory conditions to become adults. The day they became adult was also recorded. Each one was taken into separate petri dishes to prevent intraspecies cannibalism. The longevity of the adult insects taken into separate petri dishes were also recorded on the day they died, and their longevity were calculated. The same method was used for the control groups. Distilled water was used instead of plant extract in the control groups.

10 larvae (50 larvae) in 5 replicates for each plant, 10 larvae (50 larvae) in 5 replicates for the control groups, a total of $50\times 3= 150$ for the experiments and 50 larvae for the control group were used.

Statistical analyzes: SPSS 22.0 program was used in data analysis. First of all, Abbott formula was used in determining lethality rates.

$[(A - B) / A] \times 100,$

A, number of live insects in control group, %;
 B, number of live insects in application group, %;
 and corrected lethality rates (%) (Abbott, 1925).

Whether the data were normally distributed was evaluated according to Shapiro–Wilk test ($p > 0.05$). It was determined that all sample groups were normally distributed. One-Way Anova test was performed because the percentage of deaths while pupae, pupal developmental period, adult developmental period and the sample number of larvae and insects used in longevity experiments were not equal. Scheffe test was performed to determine between which groups there was a difference. Since the sample size of the larvae used for pupal development time was equal, the One-Way Anova test was applied to these groups, and the TUKEY-HSD test was performed to determine between which groups there was a difference. The significance level was taken as 0.05 for all statistical comparisons in the study.

RESULTS AND DISCUSSION

Table 1*. Lethality percentage of insects that die as larvae and pupa in the first 24 hours.

	Larvae	Pupae
Control	0.00±0.00 a	14.22±6.75 a
Laurel	83.32±8.43 b	70.77±7.70 b
Senna	48.88±11.45 c	43.73±9.86 ab
Fennel	62.00±18.54 b	30.47±6.66 a
	$F_{3,16}= 9.142$ $p=0.001$	$F_{3,12}= 7.321$, $p=0.005$

*There is a difference between values indicated by different letters in the same column $p < 0.05$

Table 2*. Larval, pupal developmental periods and longevity of *Tenebrio molitor*.

	Larval Developmental Period	Adult Developmental Period	Longevity
Control	37.10±1.30 a n=50	9.32±0.35 a n=50	29.72±1.24 a n=50
Laurel	37.63±3.69 a n=8	8.60±0.77 a n=8	37.87±2.52 a n=8
Senna	39.60±1.78 a n=25	8.96±0.33 a n=25	28.28±2.71 a n=25
Fennel	34.05±1.05 a n=19	8.29±0.43 a n=17	31.94±1.35 a n=17
	$F_{3,97}=1.523$, $p= 0.213$	$F_{3,96}=1.024$, $p=0.386$	$F_{3,96}=2.192$, $p=0.94$

*There is a difference between values indicated by different letters in the same column $p < 0.05$

According to statistical analysis, the rate of dead larvae in the first 24 hours was 83.32±8.43% in laurel, 48.88±11.45% in cassia, and 62.00±18.54% in fennel. Lethality rates after pupae were 70.77±7.70 in laurel, 43.73±9.86 in cassia, and 30.47±6.66 in fennel (Table 1).

Pupal developmental period was 37.63±3.69 in laurel, 39.60±1.78 in senna, 34.05±1.05 in fennel, while the adult development period was 8.60±0.77 in laurel, 8.96±0.33 in senna, 8.29±0.43 in fennel. The longevity were 37.87±2.52 in laurel, 28.28±2.71 in senna and 31.94±1.35 in fennel. No statistical difference was observed between other parameters except lethality percentages (Table 2).

Crop and stored product protection mainly relies on the application of synthetic insecticides. However, in recent years, although pesticides have suppressed the population of pests, their harm to human and environmental health has been understood. For this reason, researchers have turned to alternative methods. One of these control methods is plant-derived extracts and essential oils obtained from environmentally friendly medicinal and aromatic plants. In fact, these essential oils are secondary metabolites produced in nature by many plant species to protect themselves against harmful plants and animals. It has also been known since ancient times that they exhibit toxic and/or repellent activity against various insects (Isman, 1995; Aydın and Mammadov, 2017). It is generally accepted that essential oils are promising active ingredients for biopesticides (Ebadollahi et al., 2022).

In the current study, the most sensitive life form to laurel from essential oils is the larva. In pupa form, the highest sensitivity was observed in senna plant extract. Plata-Rueda et al. (2017) in a study where they examined the lethal and repellent effects of 6 different concentrations of garlic oil on *T. molitor*, they found the highest lethal effect in the larval form. Adult and pupal forms followed this. They also determined that plant extracts had a repellent effect. Diallyl disulfide was found to have the most lethal effect among the components of garlic oil. Plata-Rueda et al. (2021) investigated the death, survival, respiratory and behavioral responses of thyme (Oregano) in a study with *T. molitor* larvae and pupae. They determined that the main component in Oregano essential oil is carvacrol (25.6%). High mortality was observed in larvae (LD₅₀ = 3.03 µg insect⁻¹), pupae (LD₅₀ = 5.01 µg insect⁻¹) and adults (LD₅₀ = 5.12 µg insect⁻¹) treated with Oregano, with survival rates of 65-54%, respectively, 38-44%, 30-23% and 6-2%. Low respiratory rates were observed at different developmental stages of *T. molitor* after exposure to the oil. It also showed the behavioral avoidance response from the essential oil, causing a repellent effect in larvae and adults.

Extracts and essential oils are obtained from many plant species belonging to Lamiaceae, Meliaceae, Asteraceae, Apiaceae, Labiateae, Piperaceae and Annonaceae plant families. These essential oils are used in many areas such as medicine, insect repellent, insecticide, cosmetics and raw materials in the pharmaceutical industry (Schoonhoven, 1982; Isman, 1995; Ramya et al., 2013). Plants of the Apiaceae family contain furanocoumarins, which have toxic effects against insects (Hekimoğlu and Altındağ, 2006). Plant essential oils contain compounds such as terpenoids, alkaloids, and flavonoids.

Plant-based essential oils are not only toxic to harmful insects, but also have a feeding inhibitory and repellent effect (Adamski et al., 2016; Çetin and Elma, 2017). In the present study, there was no statistical difference between pupal and adult developmental periods of insects that did not die after being exposed to essential oils and became pupal stage. Pupal period was 37.63±3.69 in laurel, 39.60±1.78 in senna and 34.05±1.05 in fennel. Adult developmental periods were determined as 8.60±0.77 in laurel, 8.96±0.33 in senna and 8.29±0.43 in fennel. Longevity of insects was determined as 38.87±2.52 in laurel, 28.28±2.71 in senna and 31.94±1.35 in fennel (Table 2). There was no statistical difference between all these values and control groups. Therefore, we can say that these plants do not affect biological parameters such as longevity, pupal developmental period, adult developmental period, however, they definitely have a mortality effect in terms of lethality. The main components of laurel extract are eucalyptol and terpinyl acetate. The main components in the plant extract affect the tested parameters. Plant essential oils and extracts contain many compounds such as monoterpenoid, sesquiterpene, diterpenoid. While these compounds kill some insects directly, they may not kill others. However, the fact that these compounds do not kill insects does not mean that they are not effective. Essential oils can cause developmental disorders. It can also affect their activities such as laying eggs, courtship behavior or mating. The egg-killing effect of monoterpenoids occurs only when the nervous system begins to develop and is a neurotoxin (Wang and Wang, 2003; Campolo et al., 2018). Sönmez (2022) determined that eucalyptus

(*Eucalyptus globulus*), thyme (*Thymus vulgaris*), laurel (*Laurus nobilis*) ve walnut (*Juglans regia*) extracts had an inhibitory effect on ovulation as well as lethality in a study on *Acanthoscelides obtectus* and *Callosobruchus maculatus* adults. Sönmez (2021) investigated the effects of fennel (*Foeniculum vulgare*), senna (*Cassia angustifolia*), St. John's Wort (*Hypericum perforatum*), ginger (*Zingiber officinale*) and zirnik (*Teucrium kotschyianum*) herb extract on the mortality rate and number of eggs laid by *C. maculatus*. As a result of the study, mortality rates were determined as $98.3 \pm 1.6\%$ in fennel and $5.00 \pm 2.33\%$ in senna. The number of eggs they laid was also found to be significantly lower than the control group.

Studies investigating the insecticidal, insect repellent, nutritional and growth inhibitory, and egg laying effects of plant-based essential oils against unwanted harmful insects are continuing rapidly (Ebadollahi et al., 2022). Bunerı et al. (2019) investigated the lethal effect of Himalayan cedar (*Cedrus deodara*) on *T. molitor* larvae. They stated that the mortality effect was high, protein levels increased and feeding inhibitory activity was observed in insects treated with Himalayan cedar oil. Martinez et al., (2018) found that *T. molitor*, cinnamon and clove oil showed toxic activity in adult, larval and pupal stage insects in a study. They stated that the chemical composition of eugenol contained in the cinnamon plant showed the strongest toxic activity in all three life forms of the insect. Bař and Ersoy (2020) reported that essential oils obtained from *H. perforatum* plant increased the mortality rate of *T. molitor* in parallel with the increase in the concentration of essential oil exposed and has an important potential in the fight against this insect. Adamski et al., (2016) investigated the effects of *Solanum tuberosum* and *Lycopersicon esculentum* leaf extracts on *T. molitor* and *Harmonia axyridis*. It has been stated that different concentrations (1, 10, 100 and 1000 ppm) can be repellent or attractive, although they are not toxic to insects.

CONCLUSIONS

The insecticidal effect of the plant extracts used on insects has been proven by many studies. In addition, in recent years, studies on the effect of ovulation physiology and reduction of adult emergence are gaining momentum. In the present study, it was determined that laurel > fennel > senna plant extracts had a lethal effect on *T. molitor* larvae. Therefore, various plant extracts can be developed as new environmentally friendly control agents against harmful insects. In particular, long-release tablets can be developed to combat these insects both in the field and in warehouses.

REFERENCES

- Abbott, W.S. 1925. A method of computing the effectiveness of an insecticide. Journal of Economic Entomology, 18. 265– 267. <https://doi.org/10.1093/jee/18.2.265a>
- Adamski, Z., M. Kabzinska, A. Pruskaya, S. Konwerski, P. Marciniak, M. Szymczak, S. Chowanski, M. Spochacz, L. Scrano, A.S. Bufo, K. Büyüküznel. 2016. Sublethal effects of *Solanum tuberosum* and *Lycopersicon esculentum* leaf extracts on *Tenebrio molitor* and *Harmonia axyridis*. Karaelmas Fen ve Mühendislik Dergisi, 6(1): 59-66.
- Aydın, Ç., R. Mammadov. 2017. İnsektisit aktivite gösteren bitkisel sekonder metabolitler ve etki mekanizması. Marmara Pharmaceutical Journal 21: 30-37. doi: 10.12991/marupj.259878
- Bař, H., D.E. Ersoy. 2020. Fumigant toxicity of essential oil of *Hypericum perforatum* L., 1753 (Malpighiales: Hypericaceae) to *Tenebrio molitor* L., 1758 (Coleoptera: Tenebrionidae). Türkiye Entomoloji Dergisi, 44(2): 237-248. <http://dx.doi.org/10.16970/entoted.656071>

- Bourgau, F., A. Gravot, S. Milesi, E. Gontier. 2001. Production of plant secondary metabolites: a historical perspective. *Plant Science*, 5: 839-851. [https://doi.org/10.1016/S0168-9452\(01\)00490-3](https://doi.org/10.1016/S0168-9452(01)00490-3)
- Buneri, I. D., M. Yousuf, M. Attaullah, S. Afridi, S. Anjum, H. Rana, N. Ahmad, M. Amin, M. Tahir, M. J. Ansari. 2019. A comparative toxic effect of *Cedrus deodara* oil on larval protein contents and its behavioral effect on larvae of mealworm beetle (*Tenebrio molitor*) (Coleoptera: Tenebrionidae). *Saudi Journal of Biological Sciences*, 26:2, 281-285.
- Campolo, O., G. Giunti, A. Russo, V. Palmeri, L. Zappala. 2018. Essential oils in stored product insect pest control. *Journal of Food Quality*, 4: 1-18.
- Çetin H., F.N. Elma. 2017. Effects of some plant extracts on adults of Cowpea Weevil [*Callosobruchus maculatus* F. (Coleoptera: Chrysomelidae)]. *Harran Journal of Agricultural Sciences*, 21(4): 404-411
- Ebadollahi, A., J.J. Sendi, W.N. Setzer, T. Changbunjong. 2022. Encapsulation of *Eucalyptus largiflorens* essential oil by mesoporous silicates for effective control of the cowpea weevil *Callosobruchus maculatus* (Fabricius) (Coleoptera: Chrysomelidae). *Molecules*, 27: 3531. <https://doi.org/10.3390/molecules27113531>
- Hekimoğlu, B., M. Altındağ. 2006. Organik Tarım ve Bitki Koruma Açısından Organik Tarımda Kullanılacak Yöntemler, TC. Samsun Valiliği, Tarım İl Müdürlüğü, Çiftçi Eğitimi ve Yayım Şube Müdürlüğü, Samsun. 167 sf.
- Isman, M.B. 1995. Leads and prospects for the development of new botanical insecticides. *Review Pesticide Toxicology*, 3: 1-20.
- Martínez, L. C., A. Plata-Rueda, H. C. Colares, J. M. Campos, M. H. Dos Santos, F. L. Fernandes, J. E. Serrão, J. C. Zanuncio. 2018. Toxic effects of two essential oils and their constituents on the mealworm beetle, *Tenebrio molitor*. *Bulletin Entomological Research*, 108(6):716-725. DOI: 10.1017/S0007485317001262.
- Plata-Rueda, A., L. C. Martínez, M. H. Dos Santos, F. L. Fernandes, C. F. Wilcken, M. Soares, J. E. Serrão, J. Zanuncio. 2017. Insecticidal activity of garlic essential oil and their constituents against the mealworm beetle, *Tenebrio molitor* Linnaeus (Coleoptera: Tenebrionidae). *Scientific Reports*, 7:46406, 1-11. DOI: 10.1038/srep46406
- Plata-Rueda, A., J. Zanuncio, J. E. Serrão, L. C. Martínez. 2021. *Origanum vulgare* essential oil against *Tenebrio molitor* (Coleoptera: Tenebrionidae): composition, insecticidal activity and behavioral response. *Plants*, 10:2513: 1-13. DOI: 10.3390/plants10112513
- Ramya, H.G., V. Palanimuthu, S. Rachna. 2013. An introduction to patchouli (*Pogostemon cablin* Benth.). A medicinal and aromatic plant: It's importance to mankind. *Agricultural Engineering International: CIGR Journal*, 15(2): 243-250.
- Rayees, A., S. Hassan, S. Ahmad, S. Nighat, Y.K. Devi, K. Javeed, S. Usmani, M. J. Ansari, S. Erturk, M. Alkan, B. Hussain. 2021. Stored Grain Pests and Current Advances for Their Management. *J-INTECH* 100(109):1-37.
- Schoonhoven, L.M. 1982. Biological aspects of antifeedants. *Entomologia Experimentalis Applicata*, 31: 57-69.
- Sönmez E. 2021. The effect of some plant extracts on the mortality rate of *Callosobruchus maculatus* (Coleoptera: Chrysomelidae) and the number of egg left. 4th International Congress on Agriculture, Environment and Health, 20-22 May 2021, Aydın, Türkiye.
- Sönmez E. 2022. The effects of four plant extracts on longevity, the number of eggs laid and reproductive physiology of *Acanthoscelides obtectus* (Coleoptera: Bruchidae) and *Callosobruchus maculatus* (Coleoptera: Bruchidae). *Biology Bulletin*, 48(2): 82-91.
- Wang S.Y., G.K. Wang. 2003. Voltage-gate sodium channels as primary targets of diverse lipid-soluble neurotoxins. *Cell Signal*, 15: 151-9.

THE IMPORTANCE OF LAUREL PLANT EXTRACT IN FIGHTING HARMFUL INSECTS

Evrım SÖNMEZ¹

¹Sinop University, Faculty of Education, Department of Mathematics and Science Education,
Sinop- Türkiye

Corresponding author e-mail: esonmez@sinop.edu.tr

ABSTRACT

Stored product pests are responsible for the loss of significant amounts of product in silos. Pests cause a great deal of damage and economic loss to the harvested crop every year. Many control methods are used in the fight against these pests, both in the field and in the warehouses. Due to the easy and economically cheap application of pesticides, it forces the producers to fight with insecticides. However, in recent years, with the development of insect resistance to insecticides and the understanding of their damage to the environment, many producers and researchers are looking for alternative ways to fight these harmful insects. One of these alternative methods is the use of plant essential oils to fight harmful insect species. Aromatic plants have been used as insect repellent and killer since ancient times. Laurel (*Laurus nobilis* L.) belongs to the Lauraceae family and is an evergreen tree. Its leaves and fruits are used extensively in the pharmaceutical and perfumery industries. The most important product of laurel is its oil and essence. Its fruit contains 17-25% fixed oil. Fruits contain more oil than leaves. 41 different compounds were detected in essential oils obtained from laurel leaves. The main components of laurel extract are 1,8-cineole (52.88%), α -terpinyl acetate (11.77%) and sabinene (8.05%). Laurel essential oil has attracted a lot of attention in recent years due to the repellent and lethal effect of these compounds on harmful insects. In this study, the biological properties of the laurel plant and its extracts are emphasized, especially in the fight against harmful pests.

Keywords: Plant Essential Oils, Pests, Insecticide, Pesticide, Odor

INTRODUCTION

The laurel plant belongs to the subfamily Lauroideae of the Lauraceae family. There are two species: Mediterranean laurel (*Laurus nobilis* L.) and Azores laurel (*Laurus azorica* (Seub.) Franco). Laurel is a perennial, evergreen, about two meters tall and densely branched plant species (Sharma, 2017). The homeland of laurel is Anatolia and it is seen in many parts of Turkey's Mediterranean, Aegean, Marmara and Black Sea regions. The provinces where the plant is widely seen are Bursa, Balıkesir, Yalova, Istanbul, Kastamonu, Sinop, Zonguldak, Rize, Trabzon, Muğla, İzmir, Mersin, Antalya and Kahramanmaraş (Koçer and Ayanoğlu, 2021). Although it has been seen on the entire coastline of the Mediterranean since ancient times, today it spreads in the western Mediterranean Basin as well as in countries such as Türkiye, Greece, Romania, Algeria, Morocco, France, Libya, Belgium, Crimea, Mexico, Albania, Spain, Syria, Portugal, Canary Islands (Figure 1; Ayanoğlu et al., 2010). Its leaves are fragrant. Its fruit is similar to an olive. Apart from its black, chickpea-sized seeds, it has a very oily thin wall. The used part of the plant is the leaves and fruits. Laurel leaves and fruit are aromatic and stimulating. It has been determined that there is approximately 17-25% fixed oil in the fruit (Özer et al., 2019). 41 different compounds were detected in essential oils obtained from laurel

leaves. These detected compounds constitute 90-94% of the herbal essential oil obtained from the laurel leaf. In essential oils obtained from laurel leaves, 1,8-cineol is the main compound, as well as pinene, sabinene, linalool, eugenol, eugenol acetate, methyleugenol, terpinol acetate, phelandrene, other esters and terpenoids. Laurel essential oil is obtained from the leaves, bark or fruit of the plant by solvent extraction or steam distillation method. The chemical content of the obtained oil varies according to the harvest period, harvest time, geographical region and the organs from which the oil is extracted. In contrast to the sesquiterpenes in the wood part, monoterpenes such as α -pinene, β -pinene and 1,8-cineol were found to be the main components in the essential oil extracted from the bark part (Özer et al., 2019). It has been stated that the essential oil ratios of the laurel plant obtained from 100 locations in the 4 geographical regions (Black Sea, Marmara, Aegean and Mediterranean) where the laurel plant is most grown in Turkey vary between 0.4% and 4.5%, and the average essential oil ratio is 1.78%. The essential oil components are 1,8-cineole (31.87-67.56%), α -terpinyl acetate (4.09 - 22.22%), α -terpineol (0.94-16.08%), linalool (0.40 -13.04%), terpinene (2.31- 9.22%) and sabinene (0.56 -9.08%) (Karık et al., 2015). In another study comparing the chemical content of laurel essential oil from different locations in Hatay, 1,8-cineole (46.61-59.94%), α -terpinyl acetate (11.94-25.70%), α -pinene (3.66-2.61%) sabinene (14.05-7.83%), terpinene (1.82 - 2.20%) were determined (Sangun et al., 2007). As can be seen, many parameters such as the criteria during and after the harvest, the development period of the plant, the harvest time, the climatic conditions of the region where the plant is located, the direction of the plant cause the content of the oil obtained to change.

In addition to all these, the laurel plant has a special place in world cuisine and alternative medicine. The leaves, which are rich in essential oil, can be used as a spice to give a nice smell to the dishes and as a preservative in canned food. Laurel tea is also used extensively in alternative medicine. In addition to its appetizing, blood circulation and blood sugar regulator, carminative, digestive, diuretic, antipyretic, muscle relaxant properties, it is known to be good for tonsillitis and colds when taken by mouthwash. It is also known that laurel oil, which is used safely on dry, oily or allergic skin, nourishes the hair and gives softness and shine. Laurel oil is also used in the production of perfumed soap, in the food, beverage, pharmaceutical, chemical and cosmetic industries. It is the raw material of traditional laurel soap. 1 kg of laurel oil is obtained from approximately 10 kg of laurel seeds. The oil obtained from its leaves and fruits also finds use in the cosmetics, pharmacology and food industries (Sharma, 2017).

The leaves of the laurel plant are highly aromatic. Therefore, it is grown commercially. Among the countries that trade the laurel plant are Türkiye, Mexico, Portugal, Italy, Spain, France, Algeria and Morocco. In Turkey, the natural spread of the laurel plant is also quite common (Figure 2). It is the largest exporting country in the world (Yilmaz and Çiftçi, 2021). The Latin *baccalaureus* means laurel fruit. In ancient times, athletes who were successful in Olympic competitions were awarded with a crown made of laurel leaves on their foreheads. In the Roman period, in 342 BC, there was a wreath of laurel plants on the gold coins. It is known that the Greeks and Romans used wreaths made of the leaves of this plant as a crown in sports and war victories. It is also known that during the ancient Romans, laurel leaves were believed to have a protective effect against lightning strikes and that they had a laurel branch in stormy weather (Yilmaz and Çiftçi, 2021). The Romans believed that standing under a laurel tree would protect a person from plague infection. Laurel wreaths were worn by healers during healing ceremonies and when treating patients, to increase positive healing energy and to ward off negative energy that could circulate around the sick room. The laurel leaf was also burned in the sick room after the illness had passed to purify it and remove any remaining sickness vibrations. The Romans called it the plant of good angels. In the Middle Ages, laurel was believed to provide protection against both lightning and witches. In addition to these, the laurel plant has also been used in the treatment of many diseases. It has been used mainly as an aid to

digestion and in the treatment of bronchitis and flu, to treat rheumatism, earaches, indigestion, sprains, and to promote sweating, as well as to treat various types of cancer.

In recent years, studies with alternative medicine and aromatic medicinal plants have shown that laurel can be used in many other areas in addition to its known benefits. Various pharmacological activities such as wound healing property, neuroprotective activity, antioxidant activity, antiulcerogenic activity, anticonvulsant activity, analgesic and anti-inflammatory, antimutagenic activity, immunostimulant activity, antiviral activity, anticholinergic activity, antibacterial activity, insecticidal and repellent, antifungal and acaricidal activity have been reported.

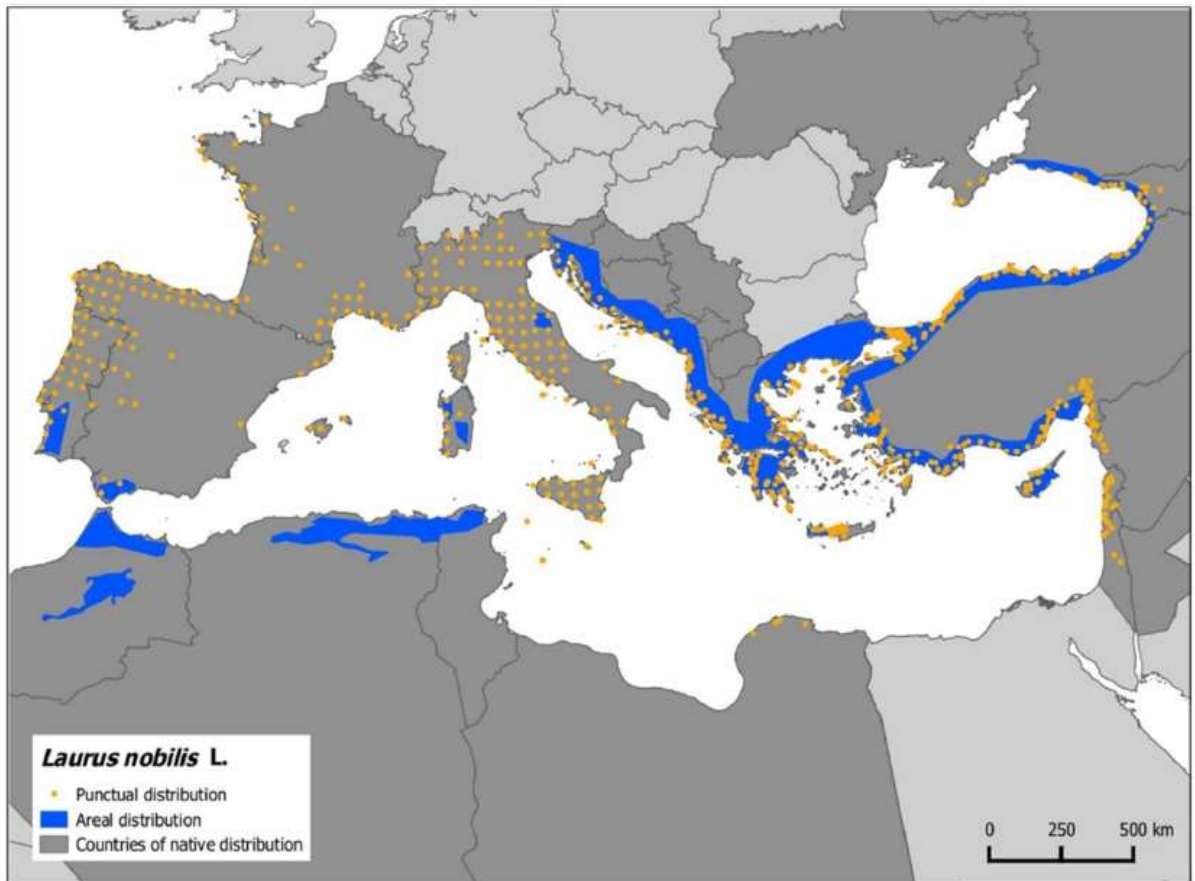

Figure 1: Distribution of *Laurus nobilis* L. (FAO)



Figure 2: Laurel (Provincial Basis) Distribution Map (OGM, 2022).

Major consumer countries in the world meet 95% of their laurel needs from Türkiye. Türkiye, dry laurel leaf in the world; It is the most important producer and seller. Laurel has a share of 10% in our country's natural plant exports.

Uses of laurel plant as insecticide and insect repellent

Approximately 7-50% of the crops harvested each year are destroyed by harmful insects. Tons of pesticides are used every year to prevent this yield loss. The use of pesticides is increasing every year in the world. 48.000 tons of pesticides are used in Germany, 24.000 tons in Poland, more than 18.000 tons in Great Britain, 62.000 tons in Italy and 1.7 million tons in China (FAOSTAT, 2017). Pests also harm the economy of many countries as they are responsible for the loss of harvested crops. Harmful insects can contaminate food products both in the field and in silos, pollute with their excrement, and cause weight loss as insect larvae feed on these products. Pesticides used can kill or suppress population size of these pest populations. But in addition to all these benefits, they cause serious damage to the ecosystem. Because insects develop resistance to these pesticides used every year, these pesticides leave residues on agricultural products, and pollute the soil and water, producers now prefer to use environmentally friendly methods. For example, methyl bromide and ethylene dibromide are banned in many countries due to their carcinogenic effects or their role in ozone depletion (Rajendran and Sriranjini, 2008). However, the ease of application of pesticides and the fact that they are quite cheap still cause them to be preferred. One of the methods that has attracted attention in this field in recent years is plant extracts and essential oils. In fact, since ancient times, aromatic plants have been used either by burning or their essential oils have been used as a killer or repellent against insects. With the increasing interest in organic agriculture, the use of these natural products is also increasing. Despite this, the percentage of use is still very low. Natural products make up a low percentage of available products. However, the use of plant-derived extracts in Integrated Pest Managements (IPM) has become one of the applied methods. Some researchers use the term biopesticide very cautiously. And excludes plant extracts from this term, while others include it. According to European Union regulations, plant extracts are evaluated in the group of bioinsecticides (Marchand, 2017). In addition, the United States Food and Drug Administration (FDA) has recognized plant essential oils (botanical pesticides) as safer than synthetic pesticides, which cause an increased risk of ozone depletion, neurotoxic, carcinogenic, teratogenic, and mutagenic effects in non-target organisms, and resistance in insects (Regnault-Roger et al., 2012).

It has been proven that plant essential oils stimulate the sense of smell and receptors of insects, keeping them away from agricultural products and giving positive results on the ecosystem (Hikal et al., 2017). At the same time, some essential oils prevent harmful insects from feeding, causing them to starve. Some have harmful effects on the growth and development of insects, reducing the weight of the larva, pupa and adult stages and prolonging the development stages (Spochacz et al., 2018). It reduces the survival rates of larvae and pupae as well as the adult emergence rates. Chemosterilants prevent insects from reaching sexual maturity by causing temporary or permanent sterility of one or both sexes and are chemicals used to control pest populations. Some plant essential oils are used as chemosterilants (Shalan et al., 2005). For example, at the physiological level, azadirachtin blocks the synthesis and release of molting hormones from the prothoracic gland, causing inhibition of molting (ecdysis) in immature insects and leading to sterility in adult insects (Isman, 2006).

The aroma given to the laurel plant, especially by 1,8-cineol, which is the main compound of the laurel plant, causes insects to move away from this plant. The main components of laurel extract are 1,8-cineol (eucalyptol) and terpinyl acetate. The chemical compounds of laurel have been identified as 1,8-cineol, sabinene, α -terpinyl acetate, α -pinene and β -pinene. The chemical composition of laurel essential oils has been studied by many researchers. All researchers

identified 1,8-cineol as the main component. The amount of 1,8-cineol varies between 31.4% and 56.0%, depending on the geographical location of the laurel plant and the country in which it is located (Karik et al., 2015; Alejo-Armijo et al., 2017; Anzano et al., 2022). The effects of plant essential oils on insects are manifested by contact, inhalation or ingestion. In particular, monoterpenoids paralyze the nervous system of insects and cause them to die. In addition, in recent years, the effects of medicinal aromatic plants as well as laurel to prevent egg laying, prevent mating, and prevent courtship behavior have been determined, and they show promise in the fight against these harmful insects in the long term. Pinto et al. (2022), in a study they conducted against *Tuta absoluta* with essential oils including laurel plant, they found that laurel essential oil had an inhibitory effect on ovulation. Kanat et al. (2003), the essential oils of many plants against pine processionary beetle, *Thaumetopoea pityocampa* larvae, Jemaa et al. (2012) determined that *L. nobilis* essential oil has an insecticidal effect against *Rhyzopertha dominica* and *Tribolium castaneum*. Plant essential oils have different effects depending on the plant species or the physiological characteristics of insect species. Botanical insecticides can be classified into six groups; insect repellents, feed blockers, toxicants, growth retardants, chemosterilants and attractants (Rajashekar et al., 2012). Chahal et al. (2016) and Isikber et al. (2006) showed that essential oil obtained from the leaves of the laurel plant was associated with *T. castaneum*, Rozman et al. (2006) found that it had a toxic effect against *Sitophilus granarius*.

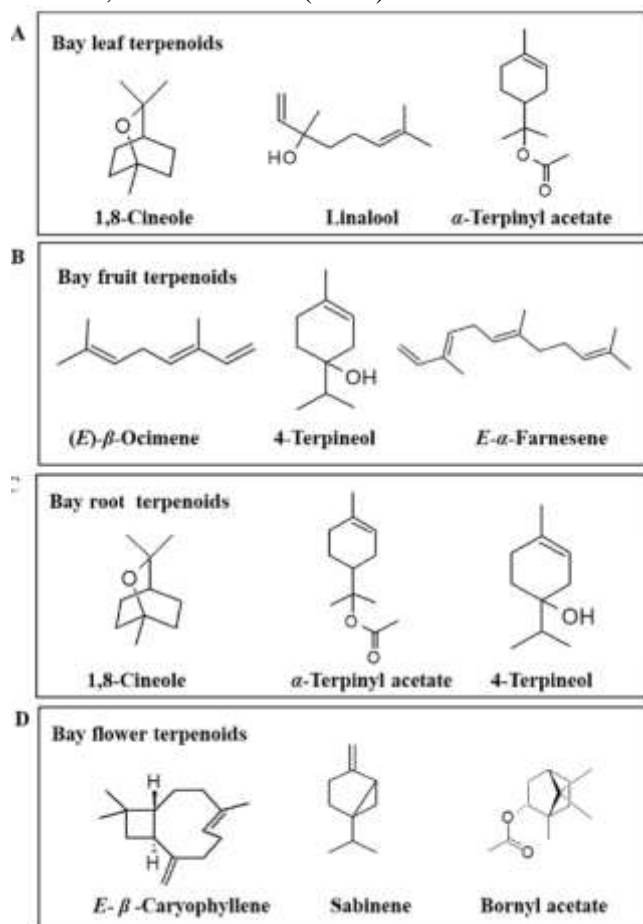

Figure 3. Representative terpenoids biosynthesized by Laurel (*Laurus nobilis* L.). (A) Laurel leaf terpenoids; (B) Laurel fruit terpenoids. (C) Laurel root terpenoid; (D) Laurel flower terpenoid (Paparella et al., 2022).

Kırpık et al. (2019) laurel and zahter (*Thymbra spicata* L.) essential oils on *R. dominica* and *Oryzaephilus surinamensis* in a study they found the fumigant toxicity rate of laurel to be 100% after the first 24 hours. Teke and Mutlu (2021) investigated 6 types of essential oils,

including laurel, against *S. granarius* and *T. castaneum*. They found that all plant essential oils had fumigant, lethal and repellent effects, and there was a significant decrease in the F1 generation compared to the control groups. Papachristos and Stamopoulos (2002) conducted a repellent, toxic and reproductive inhibitory study of thirteen essential oils of plants, including *L. nobilis*, against *Acanthoscelides obtectus*. They found that laurel essential oil has a high repellent and toxic effect, reducing fecundity and adult emergence. Regnault-Roger and Hamraoui (1994) in a study they conducted with the plant extracts of *L. nobilis* and *A. obtectus*, found that the life span of the adults, the number of eggs laid, the number of adults hatched and the adult hatching/egg-laying ratios differed according to the plant species, but all plant extracts provided a decrease in the specified parameters.

CONCLUSIONS

Essential essential oils obtained from medicinal aromatic plants have insecticidal properties. It is an excellent alternative to chemical pesticides to avoid the negative side effects of synthetic insecticides and protect crops from harmful insects. Laurel essential oil also has different forms of action on different types of insects. Therefore, it has the potential to be used safely to suppress or prevent harmful insect populations in products in forests, fields or warehouses.

REFERENCES

- Alejo-Armijo, A., J. Altarejos, S. Salido. 2017. Phytochemicals and Biological Activities of Laurel Tree (*Laurus nobilis*). Natural Product Communications, 12(5): 743 - 757
- Anzano, A., B. Falco, L. Grauso, R. Motti, V. Lanzotti. 2022. Laurel, *Laurus nobilis* L.: a review of its botany, traditional uses, phytochemistry and pharmacology. Phytochemistry Review, 21:565–615. <https://doi.org/10.1007/s11101-021-09791-z>
- Ayanoğlu, F., A. Mert, A. Kaya ve E. Köse. 2010. Hatay Yöresinde Doğal Olarak Yetişen Defne (*Laurus nobilis* L.) Bitkisinin Kalite Özelliklerinin Belirlenmesi ve Seleksiyonu, Tübitak Proje No: 108O878, 268s, Hatay.
- Chahal, K.K., R. Bansal, R. Kaur. 2016. Chemistry and insecticidal potential of bay leaf essential oil against stored grain pest of wheat. Journal of Applied and Natural Science, 8(4): 2049-2054.
- Hikal W.M., R.S. Baeshen, H.A.H.S. Ahl. 2017. Botanical insecticide as simple extractives for pest control. Cogent Biology, 3(1404274):1-16. <https://doi.org/10.1080/23312025.2017.1404274>
- FAOSTAT (Food and Agriculture Organization of the United Nations). 2017. Pesticides use [webpage]. Retrieved from <http://www.fao.org/faostat/en/#data/RP>.
- Isikber, A.A., M.H. Alma, M. Kanat, A. Karci. 2006. Fumigant toxicity of essential oils from *Laurus nobilis* and *Rosmarinus officinalis* against all life stages of *Tribolium confusum*. Phytoparasitica, 34(2): 167-177.
- Isman, M.B. 2006. Botanical insecticides, deterrents, and repellents in modern agriculture and an increasingly regulated world. Annual Review of Entomology, 51: 45–66. <https://doi.org/10.1146/annurev.ento.51.110104.151146>
- Jemaa, J.M.B., N. Tersim, K.T. Toudert, M.L. Khouja. 2012. Insecticidal activities of essential oils from leaves of *Laurus nobilis* L. from Tunisia, Algeria and Morocco, and comparative chemical composition. Journal of Stored Products Research, 48: 97–104.
- Kanat, M., M. Hakk, M. Alma. 2003. Insecticidal effects of essential oils from various plants against larvae of pine processionary moth (*Thaumetopoea pityocampa* Schiff) (Lepidoptera: Thaumetopoeidae). Pest Management Science, 60: 173–177.

- Karık, Ü., F. Çiçek, E. Oğur, M. Tutar, F. Ayas. 2015. Türkiye Defne (*Laurus nobilis* L.) populasyonlarının uçucu yağ bileşenleri. ANADOLU Ege Tarımsal Araştırma Enstitüsü Dergisi, 25(1): 1 - 16
- Kırpık, M.A., P.A. Kılıçler, Y.Y. Asker. 2019. Investigation of fumigant effects of Laurel (*Laurus nobilis* L.) and Zahter (*Thymbra spicata* L.) essential oils in different concentrations on *Rhyzopertha dominica* (Coleoptera: Bostrichidae) and *Oryzaephilus surinamensis* (Coleoptera: Silvanidae), Journal of the Institute of Science and Technology, 9(3): 1234-1242. <https://doi.org/10.21597/jist.488946>
- Koçer, O., F. Ayanoglu. 2021. Dişi Defne (*Laurus nobilis* L.) genotiplerinde meyve yağ asitleri kompozisyonlarının belirlenmesi. Uluslararası Doğu Anadolu Fen Mühendislik ve Tasarım Dergisi, 3(1): 72-88.
- Marchand, P. A. 2017. Basic substances as renewable and affordable crop protection products. Chronicle of Bioresource Management, 1(2): 065–66.
- OGM (2022). Defne Eylem Planı
- Özer, T., F.Z. Sert, A.İ. Öztürk. 2019. Defne bitkisi (*Lauris nobilis*) ve yağı üzerine bir araştırma. 8(2): 25-34.
- Papachristos, D.P., D.C. Stamopoulos. 2002. Repellent, toxic and reproduction inhibitory effects of essential oil vapours on *Acanthoscelides obtectus* (Say) (Coleoptera: Bruchidae), Journal Stored of Product Research, 38:117–128. [https://doi.org/10.1016/S0022-474X\(01\)00007-8](https://doi.org/10.1016/S0022-474X(01)00007-8)
- Paparella, A., B. Nawade, L. Shaltiel-Harpaz, M. Ibdah. 2022. A eeviw of the botany, volatile composition, biochemical and molecular aspects, and traditional uses of *Laurus nobilis*. Plants, 11(1209): 1-24. <https://doi.org/10.3390/plants11091209>
- Pinto, M.L., L. Vella, A. Agrò. 2022. Oviposition deterrence and repellent activities of selected essential oils against *Tuta absoluta* Meyrick (Lepidoptera: Gelechiidae): laboratory and greenhouse investigations. International Journal of Tropical Insect Science, 42: 3455–3464. <https://doi.org/10.1007/s42690-022-00867-7>
- Rajashekar, Y., N. Bakthavatsalam, T. Shivanandappa. 2012. Botanicals as grain protectants. Psyche, 1–13.
- Rajendran, S., V. Sriranjini. 2008. Plant products as fumigants for storedproduct insect control. Journal of Stored Products Research, 44(2): 126–135.
- Regnault-Roger, C., A. Hamraoui. 1994. Comparison of the insecticidal effects of water extracted and intact aromatic plants on *Acanthoscelides obtectus*, a bruchid beetle pest of kidney beans, Chemoecology, 5/6(1): 1-5. <https://doi.org/10.1007/BF00987383>
- Regnault-Roger, C., C. Vincent, J.T. Arnason. 2012. Essential oils in insect control: low-risk products in a high-stakes world. Annual Review of Entomology, 57:405-24. <https://doi.org/10.1146/annurev-ento-120710-100554>
- Rozman, V., I. Kalinovic, A. Liska. 2006. Insecticidal activity of some aromatic plants from Croatia against Granary Weevil (*Sitophilus granarius* l.) on stored wheat. V. Alps-Adria Scientilic Workshop, Opatija. Croatia, 2006.
- Sangun, M.K., E. Aydın, M. Timur, H. Karadeniz, M. Çalışkan, A. Özkan. 2007. Comparison of chemical composition of the essential oil of *Laurus nobilis* L. Leaves and fruits from different regions of Hatay, Turkey. Journal of Environmental Biology, 28(4):731-733.
- Shalan, E.A.S., D. Canyon, M.W.F. Younes, H. Abdel-Wahab, A.H. Mansour. 2005. A review of botanical phytochemicals with mosquitocidal potential. Environment International, 31(8): 1149–1166. <https://doi.org/10.1016/j.envint.2005.03.003>
- Sharma, S.A. 2017. Bay Laurel. In: Genesis and evolution of horticultural crops (Ed. K. V. Peter). Kruger Brentt Publishers, 85-91
- Spochacz, M., S. Chowański, K. Walkowiak-Nowicka, M. Szymczak, Z. Adamski. 2018. Plant-derived substances used against beetles–pests of stored crops and food–and their

mode of action: A review. *Comprehensive Reviews in Food Science and Food Safety*,17: 1339-1366.

Teke, M.A., Ç. Mutlu. 2020. Insecticidal and behavioral effects of some plant essential oils against *Sitophilus granarius* L. and *Tribolium castaneum* (Herbst), *Journal of Plant Disease and Protection*, 128(5):1-11. <https://doi.org/10.1007/s41348-020-00377-z>.

Yılmaz, A., V. Çiftçi. 2021. Türkiye’de defne (*Laurus nobilis* L.) bitkisinin durumu. *European Journal of Science and Technology*, Special Issue 22: 325-330.

INFLUENCE OF POWDERS OBTAINED FROM DIFFERENT PARTS OF STINGING NETTLE (*URTICA DIOICA* L.) ON TECHNOLOGICAL PROPERTIES AND BIOACTIVE COMPONENTS OF NOODLES

Tekmile CANKURTARAN KÖMÜRÇÜ¹, Nermin BILGIÇLI¹

¹ *Necmettin Erbakan University, Engineering Faculty, Food Engineering Department, Konya, Turkey*

Corresponding author e-mail: tekmilecankurtaran@gmail.com

ABSTRACT

In this study, different parts of the stinging nettle (leaf and stem) were dried and ground to obtain stinging nettle leaf powder (SNLP) and stinging nettle stem powder (SNSP). Those powders were used in noodle production as replaced with wheat flour at 0, 2, 4, 6 and 8% ratios. Color values (raw and cooked), cooking properties (water uptake, volume increase and cooking loss), firmness, antioxidant activity (DPPH, FRAP and CUPRAC) and phenolic contents (free, bound and total) of noodles were determined. L*, a* and b* values of raw control noodle was found as 72.69, -0.52 and 31.72, respectively. Those color values were 35.63, -7.67 and 8.66 for raw noodles containing 8% SNLP and 52.75, -4.41 and 22.23 for raw noodles containing 8% SNSP, respectively. SNLP and SNSP addition significantly ($p < 0.05$) affected all color parameters in raw and cooked noodle samples. Compared to the raw noodle samples, the yellowness value of SNLP and SNSP added noodles decreased with cooking. Water uptake and volume increase values of the noodles containing %4 and more SNLP and SNSP reduced compared to control. Even the lowest SNLP and SNSP addition ratio (2%) increased the free, bound and total phenolic content of the noodles, while antioxidant activity (measured by different methods) of noodles increased with 4% and more addition ratios.

Keywords: Stinging nettle, leaf powder, stem powder, noodle

INTRODUCTION

The stinging nettle (*Urtica dioica* L.) is a perennial herbaceous plant with spiny leaves, belonging to the nettle family (Urticaceae) (Bhusal et al., 2022). Stinging nettle leaves are good sources of protein, dietary fiber, minerals (calcium, iron, magnesium, manganese, zinc, phosphorus, potassium, copper and selenium), vitamins and bioactive compounds (Shonte et al., 2020). Stinging nettle leaves are generally used in dishes such as spinach. And also, it is added to soups, salads, herbal tea or decocted tea as well as in dried form for winter use (Guil-Guerrero et al., 2003). Stinging nettle has antiproliferative, anti-inflammatory, antioxidant, analgesic, anti-infectious, hypotensive, and antiulcer characteristics, as well as the ability to prevent cardiovascular disease, in all parts of the plant (leaves, stems, roots, and seeds) (Bhusal et al., 2022). In the literature, there are various studies in which nettle leaves and seeds are used as an ingredient in cereal products such as pasta, noodles, bread, biscuits, etc. (Adhikari et al., 2016; Alemayehu et al., 2016; Man et al., 2019; Đurović et al. 2020; Foret, 2021; Krawecka et al., 2021; Perez, 2022).

In this study, it was aimed to investigate the effects of powders obtained from the leaves and stems of stinging nettle on some technological and sensory properties noodle.

MATERIAL AND METHOD

Materials

Fresh stinging nettle (*Urtica dioica* L.) plant was hand-picked from Meram, Konya, Turkey. Raw materials (flour, egg and salt) used in noodle production were obtained from a local market in Konya.

Methods

Production of stinging nettle powders

The leaves and stems of fresh stinging nettle were separated and dried at 55 C until the moisture content reached below 10%. Dry leaves and stem ground a grinder (particle size below 500 μm) for obtaining stinging nettle leaf powder (SNLP) and stinging nettle stem powder (SNSP).

Noodle production

Control noodle was prepared from 100 g refined white flour, 40 g whole egg, 0.5 g salt and 30 ml distilled water. For other noodle formulations, refined wheat flour was replaced by SNLP and SNSP at 2, 4, 6 and 8 % levels. The noodles were made according to the procedure described by Özkaya et al. (2001). Briefly, noodle ingredients were mixed in the mixer (Hobart N50, Offenburg, Germany) at a low speed for 8 min and the dough obtained after mixing rested for 20 min. Noodle strips were obtained by passing the dough pieces through the noodle machine (Shule Pasta Machine, China), and the noodles were left to dry under room conditions for 3 days.

Color measurement

Color measurement was carried out by Minolta CR-400 (Minolta Camera, Co., Ltd., Osaka, Japan) in terms of L^* , a^* and b^* values. Hue angle and saturation index (SI) values were calculated using a^* and b^* values. Hue angle; $a^* > 0$ and $b^* > 0$, if $\arctan [b^*/a^*]$; $a^* < 0$ and $b^* > 0$, $\arctan [b^*/a^*] + 180^\circ$, SI; $(a^{*2} + b^{*2})^{1/2}$.

Cooking properties and firmness

Water uptake and volume increase values of gluten-free pasta samples were determined according to Oh et al. (1985) and Özkaya and Kahveci (1990). For determination of weight increase values, 20 g of noodle sample was cooked in 250 ml of boiling distilled water. The weight differences of raw and cooked noodle samples were determined as %. For the volume increase test, the cooked and filtered noodle samples were taken into measuring cylinders filled with pure water, the volume of the water they overflowed was determined, and the volume increase values were calculated from the values obtained. Cooking loss was determined after filtering 20 g of noodle sample cooked in 250 ml of boiling water. The filtrate water was dried in a drying cabinet at 135 °C.

The firmness of the noodle samples was determined using a texture analyzer (Model TA-XT Plus, Stable Micro System Limited, Surrey, UK) based on the AACC Standard Method No: 66-50 (AACC, 2000).

Phenolic content and antioxidant activity

The free and bound phenolic content was determined based on Folin-Ciocalteu colorimetric method as described by Naczk and Shahidi (2004). Total phenolic content was calculated as the sum of free and bound phenolic content. Phenolic content was expressed as gallic acid equivalents (mg of GAE/100 kg). The antioxidant activity of samples was determined using 2,2-diphenyl-1-picrylhydrazyl (DPPH) radical scavenging assay (Gyamfi et al., 1999; Beta et al., 2005), ferric reducing antioxidant power assay (FRAP) (Yilmaz, 2019) and cupric ion reducing antioxidant activity assay (CUPRAC) (Apak et al., 2008).

Statistical analysis

SPSS statistical program version 22.0 (SAS Institute Inc., Cary, NC, USA) was used for statistical data analysis. Mean values were compared with Duncan's multiple range test.

RESULTS AND DISCUSSION

Color values of noodle samples

Color values of raw and cooked noodles containing SNLP are given in Table 1. Increasing SNLP ratio in noodle formulation decreased L^* , a^* and b^* color values of raw and cooked noodles compared to their control. The lowest L^* , a^* and b^* values in raw noodle samples were obtained at the highest SNLP usage ratio. In the cooked samples, the lowest a^* value was obtained at the ratio of 2-4% SNLP, and the lowest b^* value was obtained at the ratio of 6-8% SNLP. When the raw and cooked noodle samples were compared among themselves, it was seen that the color values of L^* , a^* and b^* decreased in general with the cooking process. This decrease may be related to the leaching of color pigments into the cooking water during cooking.

Table 1. Color values of raw and cooked noodle samples containing different ratios of SNLP

	Raw			Cooked		
	L^*	a^*	b^*	L^*	a^*	b^*
Control	72.69±0.30a	-0.52±0.03a	31.72±0.63a	69.66±0.31a	-3.99±0.16a	23.35±0.32a
2% SNLP	56.55±0.40b	-3.56±0.07b	26.51±0.02b	47.66±0.13b	-8.18±0.28c	18.11±0.30b
4% SNLP	42.84±0.33c	-6.09±0.11c	16.33±0.13c	41.72±0.38c	-7.86±0.12c	14.22±0.15c
6% SNLP	37.08±0.17d	-6.60±0.09d	10.26±0.31d	32.39±0.88d	-6.95±0.19b	10.77±0.40d
8% SNLP	35.63±0.23e	-7.67±0.08e	8.66±0.12e	33.77±0.11e	-6.76±0.12b	10.37±0.37d

Means followed by the different letters within a column are significantly ($P < 0.05$) different.

Table 2. Color values of raw and cooked noodle samples containing different ratios of SNSP

	Raw			Cooked		
	L^*	a^*	b^*	L^*	a^*	b^*
Control	72.69±0.30a	-0.52±0.03a	31.72±0.63a	69.66±0.31a	-3.99±0.16a	23.35±0.32b
2% SNSP	63.14±0.53b	-3.25±0.08b	27.73±0.36b	66.31±0.10b	-5.25±0.00b	25.72±0.14a
4% SNSP	61.78±0.16c	-4.59±0.06c	25.17±0.20c	61.56±0.33c	-5.15±0.51b	21.27±0.21c
6% SNSP	55.17±0.54d	-4.53±0.05cd	22.88±0.58d	55.93±0.63d	-5.08±0.10b	20.85±0.90c
8% SNSP	52.75±0.65e	-4.41±0.06d	22.23±0.75d	55.14±0.76d	-4.75±0.10b	20.67±0.85c

Means followed by the different letters within a column are significantly ($P < 0.05$) different.

The color values of the raw and cooked noodle samples prepared with SNSP addition are shown in Table 2. As in the samples containing SNLP, the addition of SNSP also reduced the all color values of the raw noodles. High SNSP usage ratios resulted in the lowest raw noodle color values. In the cooked noodle samples, the L^* value decreased with increasing SNSP ratio. All SNSP utilization ratios gave a lower a^* value in the cooked samples than the control sample. The use of 2% SNSP resulted in the highest b^* value among cooked noodle samples. When the cooked and raw noodle samples were compared among themselves, cooked noodle samples had lower a^* and b^* values than raw ones.

L^* , a^* and b^* values of wheat flour, SNLP and SNSP which are used as raw material in noodle formulation were 93.86, -5.03 and 13.99; 36.54, -7.67 and 11.66; 65.23, -7.50 and 25.72, respectively (data not shown). The lower L^* , a^* and b^* color values of SNLP and SNSP compared to wheat flour were also reflected in the color values of the noodle samples. In studies where green leafy herbs (spinach, fresh mints) were included in the noodle or pasta formulation, it was reported that the color values of the product changed significantly (Dirim and Çalışkan,

2007; Shere et al., 2018). Sobota et al. (2020) used vegetable concentrates and powders in pasta production as natural coloring components and reported that the color of the products was unstable and less resistant to cooking.

Cooking properties and firmness of noodle samples

Cooking properties and firmness values of noodle samples containing SNSP are presented in Table 3. Water uptake and volume increase values of noodles prepared with %4 or more SNLP were found higher than control noodles. Cooking loss was not affected by the SNLP addition ratio. The use of 6-8% SNLP reduced the firmness values of the noodles.

All addition level of SNSP decreased the water uptake compared to the control (Table 4). Volume increase values ranged between 93.75 and 118.75%, and the SNSP usage above 4% decreased the volume increase. The highest SNLP ratio (8%) increased the cooking loss value significantly ($p < 0.05$) compared to the control sample. The firmness value of the noodles using 2% SNSP was in the same group as the control sample, the use of 4% or more SNSP caused an increase in the firmness value of the noodles.

Table 3. Cooking properties and firmness values of noodle samples containing different ratios of SNLP

	Water uptake (%)	Volume increase (%)	Cooking loss (%)	Firmness (g)
Control	94.02±0.79a	118.75±1.74a	3.21±0.06a	1702±31.11a
2% SNLP	92.75±1.49ab	117.65±0.76a	3.23±0.16a	1709±29.70a
4% SNLP	90.91±0.65b	112.50±1.47b	3.22±0.14a	1649±45.25a
6% SNLP	83.90±0.41c	112.50±1.48b	3.36±0.11a	1411±15.56b
8% SNLP	82.44±1.02c	106.25±2.83c	3.48±0.24a	1132±18.38c

Means followed by the different letters within a column are significantly ($P < 0.05$) different.

Krawęcka et al. (2021) found cooking loss values and weight increase of pasta prepared 5% stinging nettle powder as 6.19% and 2.45, respectively. Those values were 3.74% and 2.21 in the control sample prepared with durum wheat semolina. In addition, the use of stinging nettle powder up to 5% ratio did not cause a statistical change in the firmness (determined with sensory analysis) values of the pasta samples. Teterycz et al. (2021) reported increasing dry matter losses by the utilization of hemp flour in pasta. Increasing cooking loss values may be due to the disintegration and weakening of the gluten network as a result of the incorporation of the high-fiber component (Krawęcka et al., 2021).

Table 4. Cooking properties and firmness values of noodle samples containing different ratios of SNSP

	Water uptake (%)	Volume increase (%)	Cooking loss (%)	Firmness (g)
Control	94.02±0.79a	118.75±1.74a	3.21±0.06b	1702±31.11d
2% SNSP	90.00±0.64b	118.75±2.49a	3.26±0.21b	1750±11.31d
4% SNSP	90.00±0.79b	112.50±1.30b	3.46±0.08ab	1842±18.38c
6% SNSP	87.05±0.75c	100.00±1.77c	3.49±0.11ab	2025±21.21b
8% SNSP	86.22±0.94c	93.75±1.15d	3.62±0.17a	2283±18.38a

Means followed by the different letters within a column are significantly ($P < 0.05$) different.

Antioxidant activities and phenolic contents of noodle samples

Antioxidant activities of noodle samples containing different ratios of SNLP are given in Table 5. DPPH antioxidant activity values increased with increasing use of SNLP in noodle samples. DPPH antioxidant activity value, which was 266.56 mg TE/kg in control noodles,

increased up to 736.78 mg TE/kg in 8% SNLP added noodles. FRAP and CUPRAC antioxidant activity values of noodles increased with the use of 4% and more SNLP usage.

Table 5. Antioxidant activities of noodle samples containing different ratios of SNLP

	DPPH (mg TE/kg)	FRAP (μmol TE/g)	CUPRAC (μmol TE/g)
Control	266.56 \pm 5.41e	0.53 \pm 0.05d	92.89 \pm 3.44b
2% SNLP	318.78 \pm 4.71d	0.61 \pm 0.01cd	130.99 \pm 2.81b
4% SNLP	395.14 \pm 11.76c	0.67 \pm 0.03c	228.39 \pm 12.36a
6% SNLP	513.24 \pm 11.11b	1.11 \pm 0.11b	261.18 \pm 4.99a
8% SNLP	736.78 \pm 7.04a	1.74 \pm 0.09a	289.26 \pm 3.40a

Means followed by the different letters within a column are significantly ($P < 0.05$) different. DPPH: 2,2-diphenyl-1-picrylhydrazyl radical scavenging (TE: Trolox equivalent). FRAP: Ferric reducing antioxidant power CUPRAC: Cupric ion reducing antioxidant capacity.

Table 6. Antioxidant activities of noodle samples containing different ratios of SNSP

	DPPH (mg TE/kg)	FRAP (μmol TE/g)	CUPRAC (μmol TE/g)
Control	266.56 \pm 5.41c	0.53 \pm 0.05c	92.89 \pm 3.44c
2% SNSP	268.32 \pm 4.39c	0.53 \pm 0.06c	112.78 \pm 8.26b
4% SNSP	311.79 \pm 9.29b	0.72 \pm 0.01b	132.78 \pm 8.24b
6% SNSP	327.56 \pm 4.68b	1.05 \pm 0.09a	157.83 \pm 1.10b
8% SNSP	370.36 \pm 15.77a	1.14 \pm 0.13a	276.97 \pm 9.12a

Means followed by the different letters within a column are significantly ($P < 0.05$) different. DPPH: 2,2-diphenyl-1-picrylhydrazyl radical scavenging (TE: Trolox equivalent). FRAP: Ferric reducing antioxidant power CUPRAC: Cupric ion reducing antioxidant capacity.

Antioxidant activities of noodle samples containing different ratios of SNLP are presented in Table 6. DPPH and FRAP antioxidant activity values increased with the use of 4% or more SNSP in noodle samples while CUPRAC values increased at all SNSP usage ratios. When the noodle samples containing SNLP and SNSP were compared among themselves, noodles containing SNLP generally have higher antioxidant activity values than samples containing SNSP.

Phenolic contents of noodle samples containing different ratios of SNLP are shown in Table 7. Free, bound and total phenolic content of noodles ranged between 1945.58-2917.70 mg GAE/kg, 2918.38-4143.14 mg GAE/kg and 4863.96-7060.84 mg GAE/kg, respectively. Even the lowest SNLP usage ratio increased the free, bound and total phenolic content of the noodles. Noodles with 8% SNLP exhibited the highest free, bound and total phenolic content.

When the phenolic content of the noodles containing SNSP was evaluated, the amount of free, bound and total phenolic content increased with the increasing SNSP ratio (Table 8). Compared to the control noodle, with the addition of 8% SNSP, the amounts of free, bound and total phenolic content increased by 1.37, 1.30 and 1.33 times, respectively. When the noodle samples containing SNLP and SNSP were compared among themselves, noodles containing SNLP generally have higher free, bound and total phenolic content values than samples containing SNSP. Nettle leaves are rich in phyto-constituents, mainly polyphenols, flavonoids (kaempferol, isorhamnetin, quercetin, isoquercitrin and rutin) and phenolic acids (caffeic acid and chlorogenic acid), and carotenoids (β -carotene, hydroxyl- β -carotene, luteoxanthin, lutein epoxide, and violaxanthin) (Joshi et al., 2014). Maietti et al. (2021) reported that nettle leaf enrichment of bread provides an increase in total phenols and antioxidant activity. Đurović et al. (2020) determined that the total phenolic content and DPPH antioxidant activity increased

significantly in the breads produced using stinging nettle leaf and stinging nettle extract at different ratios.

Table 7. Phenolic contents of noodle samples containing different ratios of SNLP

	FPC (mg GAE/kg)	BPC (mg GAE/kg)	TPC (mg GAE/kg)
Control	1945.58±11.29d	2918.38±5.22d	4863.96±13.00d
2% SNLP	2495.31±10.51c	3668.10±5.55c	6163.41±13.72c
4% SNLP	2634.87±3.22b	3557.07±4.33c	6191.94±10.42c
6% SNLP	2706.38±16.26b	3816.00±6.34b	6522.38±13.36b
8% SNLP	2917.70±22.21a	4143.14±6.72a	7060.84±16.05a

Means followed by the different letters within a column are significantly ($P < 0.05$) different. FPC: Free phenolic content, BPC: Bound phenolic content, TPC: Total phenolic content (GAE, gallic acid equivalent).

Table 8. Phenolic contents of noodle samples containing different ratios of SNSP

	FPC (mg GAE/kg)	BPC (mg GAE/kg)	TPC (mg GAE/kg)
Control	1945.58±11.29e	2918.38±5.22e	4863.18±13.00e
2% SNSP	2201.69±10.34d	3236.48±10.34d	5438.17±25.51d
4% SNSP	2456.61±10.95c	3316.42±10.95c	5773.02±25.72c
6% SNSP	2532.81±5.52b	3571.26±5.52b	6104.07±13.35b
8% SNSP	2671.27±5.31a	3793.20±5.31a	6464.47±12.95a

Means followed by the different letters within a column are significantly ($P < 0.05$) different. FPC: Free phenolic content, BPC: Bound phenolic content, TPC: Total phenolic content (GAE, gallic acid equivalent).

CONCLUSIONS

In this study, the usability of powders obtained from leaves and stems of stinging nettle in noodle production was investigated. The effects of SNLP and SNSP, which were used at different ratios in noodle production, on some technological properties and functional components of noodle were revealed. The use of SNLP and SNSP in noodle production was found significant ($p < 0.05$) on all color values of raw and cooked noodles. The use of 4% and more powders obtained from different parts of stinging nettle decreased the water uptake and volume increase values of the noodles. High SNSP usage ratio (8%) resulted in a significant ($p < 0.05$) increase in cooking loss. The use of 4% or more SNLP or SNSP increased the antioxidant activity values measured by all methods. On the other hand, even the lowest usage ratios of SNLP and SNSP improved the free, bound and total phenolic content.

REFERENCES

- AACC, 2000. American Association of Cereal Chemists, Approved Methods of the AACC, 10th ed., St. Paul, MN, USA.
- Adhikari, B. M., Bajracharya, A., Shrestha, A. K. 2016. Comparison of nutritional properties of Stinging nettle (*Urtica dioica*) flour with wheat and barley flours. Food Science & Nutrition. 4(1), 119-124.
- Alemayehu, D., Desse, G., Abegaz, K., Desalegn, B. B., Getahun, D. 2016. Proximate, mineral composition and sensory acceptability of home made noodles from stinging nettle (*Urtica simensis*) leaves and wheat flour blends. International Journal of Food Science and Nutrition Engineering. 6(3), 55-61.

- Apak, R., Güclü, K., Özyürek, M., Celik, S. E. 2008. Mechanism of antioxidant capacity assays and the CUPRAC (cupric ion reducing antioxidant capacity) assay. *Microchimica Acta*. 160 (4), 413-419. DOI 10.1007/s00604-007-0777-0.
- Beta, T., Nam, S., Dexter, J. E., Sapirstein, H. D. 2005. Phenolic content and antioxidant activity of pearled wheat and roller-milled fractions. *Cereal Chemistry*. 82 (4), 390-393. <https://doi.org/10.1094/CC-82-0390>.
- Bhusal, K. K., Magar, S. K., Thapa, R., Lamsal, A., Bhandari, S., Maharjan, R., Shrestha, J. 2022. Nutritional and pharmacological importance of stinging nettle (*Urtica dioica* L.): A review. *Heliyon*.
- Dirim, S. N., Çalışkan, G. 2017. Enhancement of the functional properties of home-made style turkish noodles (erişte) with the addition of fresh mints. *Journal of Food Physics*. 30, 4-14.
- Đurović, S., Vujanović, M., Radojković, M., Filipović, J., Filipović, V., Gašić, U., Zeković, Z. 2020. The functional food production: Application of stinging nettle leaves and its extracts in the baking of a bread. *Food Chemistry*. 312, 126091.
- Foret, R. de la. 2021. Healthy holiday cookies with nettle and rosehips. <https://learningherbs.com/remedies-recipes/holiday-cookies/#fn-43406-1>.
- Guil-Guerrero, J. L., Reboloso-Fuentes, M. M., Isasa, M. T. 2003. Fatty acids and carotenoids from Stinging Nettle (*Urtica dioica* L.). *Journal of Food Composition and Analysis*. 16(2), 111-119.
- Gyamfi, M. A., Yonamine, M., Aniya, Y. 1999. Free radical scavenging action of medical herbs from ghane: *Thonningia sanguinea* on experimentally-induced liver injuries. *General Pharma*. 32 (6), 661-667. [https://doi.org/10.1016/S0306-3623\(98\)00238-9](https://doi.org/10.1016/S0306-3623(98)00238-9).
- Joshi, B. C., Mukhija, M., Kalia, A. N. 2014. Pharmacognostical review of *Urtica dioica* L. *International Journal of Green Pharmacy (IJGP)*. 8(4).
- Krawęcka, A., Sobota, A., Pankiewicz, U., Zielińska, E., Zarzycki, P. 2021. Stinging nettle (*Urtica dioica* L.) as a functional component in durum wheat pasta production: Impact on chemical composition, in vitro glycemic index, and quality properties. *Molecules*. 26(22), 6909.
- Maietti, A., Tedeschi, P., Catani, M., Stevanin, C., Pasti, L., Cavazzini, A., Marchetti, N. 2021. Nutrient composition and antioxidant performances of bread-making products enriched with stinging nettle (*Urtica dioica*) leaves. *Foods*, 10(5), 938.
- Man, S., Păucean, A., Chiş, M., Muste, S., Pop, A., Mureşan, A., Martis, G. 2019. Effect of nettle leaves powder (*Urtica dioica* L.) addition on the quality of bread. *Journal of Herbal Medicine*. 27, 104-112.
- Naczka, M., Shahidi, F. 2004. Extraction and analysis of phenolics in food. *Journal of Chromatography A*. 1054(1-2), 95–111.
- Oh, N. H., Seib, P. A., Chung, D. S. 1985. Noodles. III. Effects of processing variables on quality characteristics of dry noodles. *Cereal Chemistry*. 62 (6), 437-440.
- Özkaya, B., Özkaya, H., Büyükkiz, E. 2001. The cooking properties of, Eriste (Turkish noodle) produced by traditional methods. *Getreide Mehl und Brot*. 55(2):120–125
- Özkaya, H. ve Kahveci, B. 1990. Tahıl ve Ürünleri Analiz Yöntemleri, Gıda Teknolojisi Derneği Yayınları. 14, 152.
- Perez, J. 2022. Food as medicine stinging nettle (*Urtica dioica* L., Urticaceae). <https://www.herbalgram.org/resources/herbalegram/volumes/volume-15/number-7-july/food-as-medicine-stinging-nettle-urtica-dioica-urticaceae/food-as-medicine/>.
- Shere, P. D., Devkatte, A. N., Pawar, V. N. 2018. Studies on production of functional noodles with incorporation of spinach puree. *International Journal of Current Microbiology and Applied Sciences*. 7(6), 1618-1628.

- Shonte, T. T., Duodu, K. G., de Kock, H. L. 2020. Effect of drying methods on chemical composition and antioxidant activity of underutilized stinging nettle leaves. *Heliyon*. 6(5).
- Sobota, A., Wirkijowska, A., Zarzycki, P. 2020. Application of vegetable concentrates and powders in coloured pasta production. *International Journal of Food Science & Technology*. 55(6), 2677-2687.
- Teterycz, D., Sobota, A., Przygodzka, D., Łysakowska, P. 2021. Hemp seed (*Cannabis sativa* L.) enriched pasta: Physicochemical properties and quality evaluation. *Plos one*. 16(3), e0248790.
- Yilmaz, V. A. 2019. Effects of different cooking and drying methods on phenolic acids, carotenoids, and antioxidant activity of emmer (*Triticum turgidum* ssp. *dicoccum*) bulgur. *Cereal Chemistry*. 96(6), 1093-1102. <https://doi.org/10.1002/cche.10219>.

STUDY OF THE ANTIOXIDANT ACTIVITY OF EXTRACTS OF CONES OF CUPRESSUS SEMPERVIRENS

BOUCIF Ouarda El Wahida¹, RACHED-KANOUNI Malika¹, BENHAMMOU-BELYAGOUBI Nabila², ARHAB Rabah¹, CHOUIER Norhane¹

¹Laboratory of natural substances, biomolecules and biotechnological applications, Department of Natural and Life Sciences, Faculty of Exact Sciences and Natural and Life Sciences, Larbi Ben M'Hidi University, Oum El Bouaghi, **Algeria**

² Natural Products Laboratory (LAPRONA), Department of Biology, Faculty of Nature and Life Sciences and Earth and Universe Sciences, University of Tlemcen, **Algeria**

Corresponding author: fatibiosnv@gmail.com

ABSTRACT

Substances such as antioxidants are found in abundance in plants. The objective of this study is to determine the content of phenolic compounds and the antioxidant potential of *Cupressus sempervirens* L. cones from the Terni forest (Tlemcen, Algeria). An assay of total polyphenol and flavonoid contents by spectrometry, estimation of antioxidant potential by the DPPH free radical trapping method are carried out on extracts of the cones. The yield was 98.12% and 81.22% for the two extracts obtained by ultrasound and maceration respectively; the average contents of total polyphenols and flavonoids were 534.65 ± 1.14 mg (EAG)/g (ES) and 335.75 ± 4.72 mg quercetin equivalents/g (ES) respectively for the ultrasonic extract. The mean EC50 values for the DPPH test were 0.109 ± 0.030 mg/ml for the ultrasonic extract and 0.294 ± 0.002 mg/ml for the macerated extract. The quantitative estimation of flavonoids and total phenols by the colorimetric method showed that the extracts are rich in these compounds and have good antioxidant activity; it can be deduced that the cones of this species can be a source of antioxidant bioactive.

Keywords: *Cupressus sempervirens*, Antioxidants, total polyphenols, flavonoids.

INTRODUCTION

Polyphenols are natural compounds that are widely distributed in the plant kingdom and are of increasing importance, in particular thanks to their beneficial effects on health (Koechlin-Ramonatxo, 2006). They are also used as additives in the food, pharmaceutical and cosmetic industries (Bougandoura and Bendimerad, 2012). The main properties of phenolic compounds are mainly antiseptic (Epifano et al., 2007). Algeria, because of its varied climate and the nature of its soils, has an extremely rich flora in terms of medicinal and aromatic plants (Merdji and Guemache, 2023). To this end, and as part of the contribution to the enhancement of the Algerian flora, we were interested in the study of *Cupressus sempervirens* L. because this plant has a wide spectrum of therapeutic interests thanks to the polyphenols of its cones and needles. The green cypress is a conifer with fragrant evergreen foliage. The cypress family includes a large group of species, and it has many advantages. Research has confirmed that the fruits (cones) of green cypress are useful in many areas. Cypress nuts contain active ingredients with antiviral properties (Amouroux et al., 1998). These molecules have a direct action on the virus and thus suppress the infection (Amouroux et al., 1998; Bruneton, 1999). Cypress is also traditionally used to reduce the symptoms of 'venous insufficiency'. In this context, our study

focuses on the in vitro antioxidant activity and the determination of secondary compounds (total polyphenols and flavonoids) of the extracts of *Cupressus sempervirens* L. cones from the Terni forest (Tlemcen, Algeria).

MATERIALS AND METHODS

Plant material

The species *C. sempervirens* was identified by Benabadji N. (2002), Professor at the Laboratory of Ecology and Management of Natural Ecosystems, University Abou Bakr Belkaid-Tlemcen (Algeria).

The cones of *C. sempervirens*, family Cupressaceae were harvested in the spring of 2022 according to a random sampling at the level of the forest of Terni, they were cleaned then dried in a dry, ventilated place sheltered from direct sunlight light (Cecchini, 2003). After drying, the samples were ground. Then passed through a sieve to obtain a homogeneous powder. The powder obtained was put in glass pillboxes and stored until extraction.

Preparation of extracts

There are several methods for extracting polyphenols. The most effective method that was chosen for this study is solid-liquid extraction using two techniques, ultrasonic extraction and cold extraction or maceration (Penchev, 2010).

A sample of 1g of the dry cones is subjected to maceration in 10 ml of Methanol/water (8:2 v/v) for 24 hours at room temperature and in the dark (Extract maceration) and a sample of 1g of the dry cones is added to 10 ml of a mixture of water/formic acid/nitrile acetate led to ultrasound (ultrasound Extract); the extracts obtained are filtered, then concentrated under vacuum using a rotary evaporator at 45°C.

Yield

Extraction yield is calculated by the following formula (Falleh et al., 2008):

$$R (\%) = 100 * (M_{ext} / M_{ech})$$

R: the yield in (%).

M_{ext}: the mass of the extract after evaporation in mg.

M_{ech}: the dry mass of the plant sample in mg.

Dosage of total phenols

The dosage of total phenols is determined by the Folin-Ciocalteu reagent according to the method of (Singleton et al., 1999). The reagent is reduced during the oxidation of phenol, in a mixture of blue oxide of tungsten and molybdenum, the absorption is measured using a spectrophotometer at 765nm. A calibration curve is produced using gallic acid as a positive control in order to express the contents in milligram (mg) equivalents of gallic acid per gram of dry matter (mg EAG / g DM).

Dosage of flavonoids

The flavonoid dosage is determined using the technique of (Zhishen et al., 1999). A calibration curve is produced in parallel under the same operating conditions using catechin as a positive control. The flavonoid content is expressed in milligram (mg) catechin equivalents per gram of dry matter (mg EC/g DM).

Evaluation of antioxidant activity

The evaluation of the antioxidant activity was carried out according to the DPPH (2,2-diphenyl-1-picrylhydrazyl) method. In this test, antioxidants reduce the purple-colored 2,2-diphenyl-1-picrylhydrazyl to a yellow compound, diphenylpicrylhydrazine. Free radical scavenging activity was measured as shown (Lee et al., 2003). The percentage decolorization of the DPPH radical was calculated from the following formula:

Anti-radical activity = $100 (1 - \text{sample absorbance} / \text{control absorbance})$.

Statistical analysis

All experiments were performed in triplicate. Results expressed as mean \pm standard deviation.

RESULTS AND DISCUSSION

The phenolic compound extraction yield results of the two extracts obtained from the cypress cones are shown in Figure 1. They are expressed as a percentage. The extraction yield is the ratio of the quantity of natural substances extracted by the extractive action of a solvent to the quantity of these substances contained in the plant material (Gélébart, 2016). It depends on several parameters such as: the solvent, the pH, the temperature, the extraction time and the composition of the sample (Nait Sidi Ahmed, 2012).

The results showed that the best yield is recorded for the extract obtained by the Ultrasonic extraction technique; it is 98.12% and for the extract obtained by maceration is 81.22%, these yields are very close to the mass of dry plant matter used.

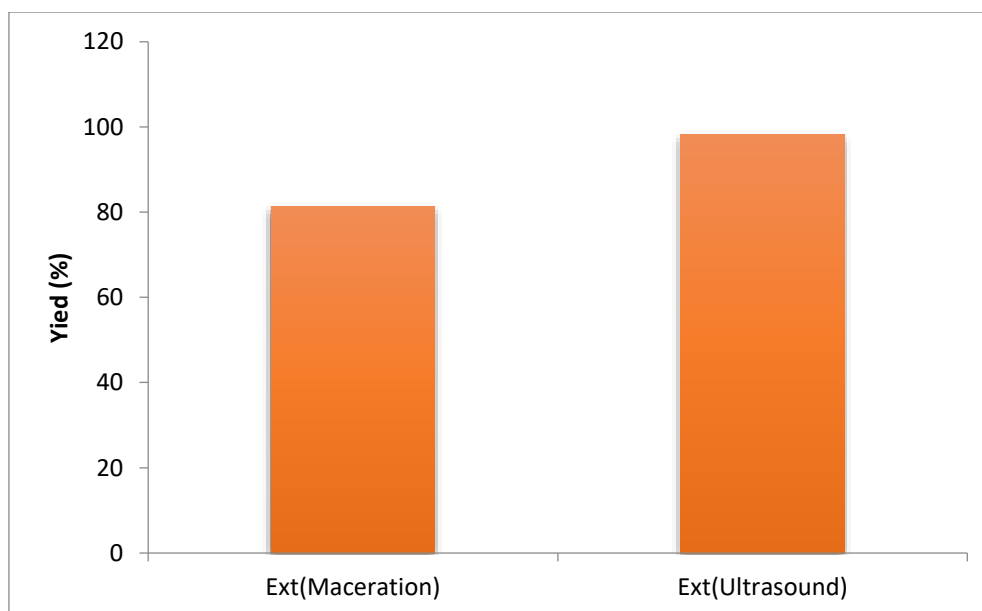

Figure 1. Extraction yield of phenolic compounds from two extracts of green cypress cones.

The results of the content of total polyphenols, flavonoids of the two extracts obtained are illustrated in Figure 2.

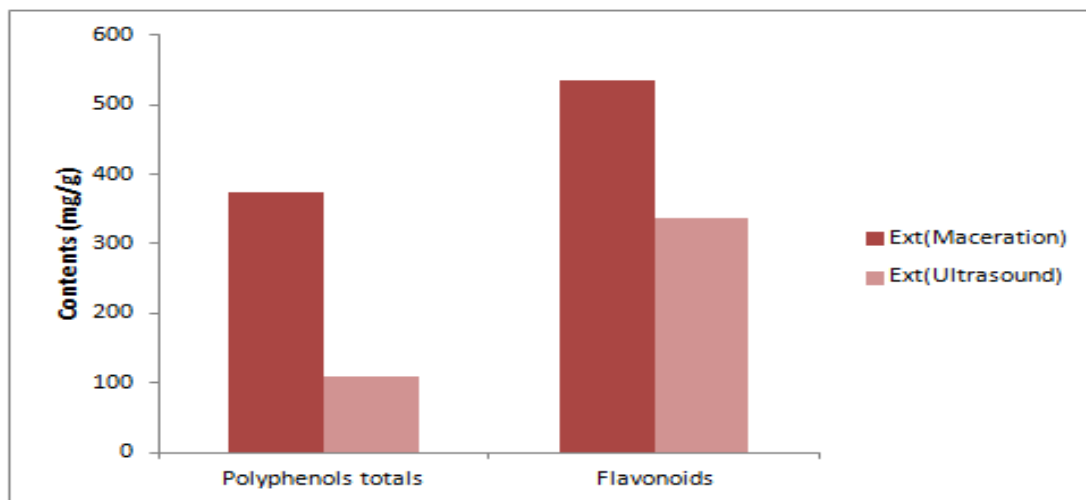

Figure 2. The content of total polyphenols and flavonoids of the two extracts (Ext) obtained from cypress cones.

The quantification of phenolic compounds in the two extracts obtained from the evergreen cypress cones showed that the best average contents of total polyphenols and flavonoids were 534.65 ± 1.14 mg (EAG) / g (ES) and 335.75 ± 4.72 mg equivalents of quercetin/g (ES) respectively are obtained by ultrasound and 374.5 ± 1.37 mg (EAG)/g (ES) and 108.88 ± 4.33 mg equivalents of quercetin/g (ES) are also obtained by maceration. Polyphenols are commonly found in plants (Kim et al., 2003). Flavonoids and phenolic compounds constitute a beneficial effect on human health (Basalan et al., 2011). The comparison of our results with those of (Aloui et al., 2020), which aims to study the phytochemical composition of the methanolic and aqueous extracts and to evaluate their antioxidant potential in the needles and cones of *C. sempervirens*, shows that the contents of total polyphenols and flavonoids are lower than our results in both case.

The antioxidant activity of the extracts of *C. sempervirens* cones was evaluated in vitro by the DPPH test and the result was expressed in terms of percentage reduction of DPPH/concentration of the extracts. The values obtained are shown in figure 3, the efficiency of the two cone extracts in trapping the DPPH radical, expressed by the inhibition rate (I %) as a function of the different concentrations.

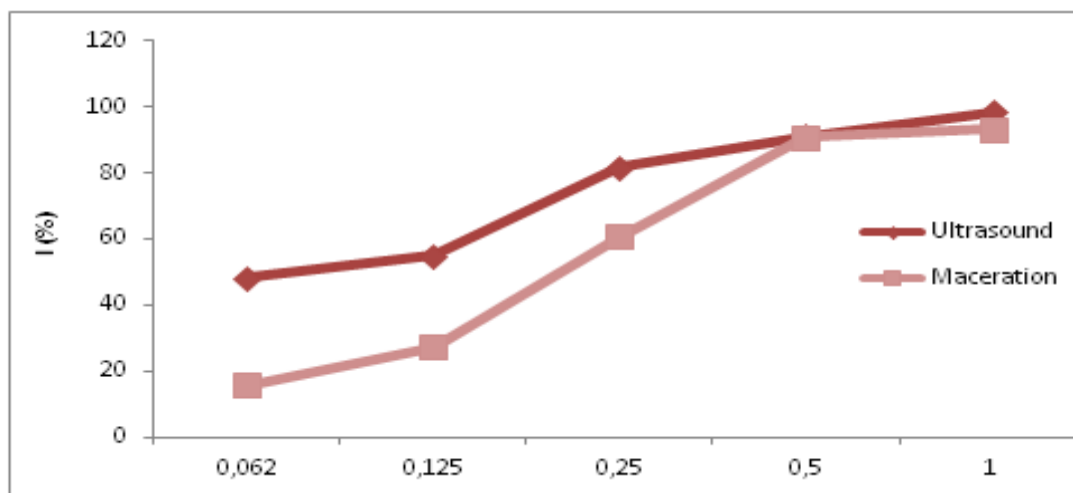

Figure 3. Inhibition (I %) as a function of different concentrations of two extracts.

These results showed that the two extracts of cypress cones obtained by the two extraction methods have antioxidant activity. The anti-radical activity revealed an EC50 of 0.109 ± 0.030 mg / ml for the extract obtained by ultrasound, the latter has a more intense free radical scavenging activity than the EC50 0.294 ± 0.002 mg / ml of the extract obtained by maceration. Polyphenols and flavonoids play an important role in the defense against free radicals (Govindarajan et al., 2006) and they are considered among the most powerful antioxidants. According to these results, cypress cones are a natural source of antioxidants.

CONCLUSION

The present study proposed to carry out the quantification of polyphenolic compounds (total phenols, flavonoids) by spectrophotometry of the extracts of the cones of *Cupressus sempervirens* L. of the Cupressaceae family from the region of Terni Mont of Tlemcen (Algeria) obtained by two methods of extraction (maceration and ultrasound) whose study results have shown that the best method of extraction of phenolic compounds is ultrasound. Several studies have been carried out on the quantification of secondary metabolites and especially polyphenols including flavonoids. Given the importance of these metabolites in biomedical, biochemical and other research. The antioxidant activity of these extracts evaluated in vitro by the DPPH test showed that the cypress cones studied are characterized by a strong antioxidant power. The application of natural antioxidants is a very promising field in full development. This leads to more and more research, aimed at diversifying the resources of its natural substances. The results obtained by our study allow us to deduce that cypress cones constitute a natural source of antioxidants which remain to be exploited for future use in the fields of food, cosmetics and health. It is necessary to complete this research with other methods to identify, isolate and purify the constituents of this organ (cone).

REFERENCES

- Koehlin-Ramonatxo, C., 2006. Oxygen, oxidative stress and antioxidant supplementation, or another way for nutrition in respiratory diseases. *Clinical and Metabolic Nutrition*. 20: 165-177.
- Bougandoura, N., Bendimerad, N., 2012. Evaluation of the antioxidant activity of aqueous and methanolic extracts of *Satureja calamintha* ssp. *Nepeta* (L.) Briq. *Nature & Technology*. 9: 14-19.

- Epifano, F., Genovese, S., Menghini, L., Curini, M., 2007. Chemistry and pharmacology of oxyprenylated secondary plant metabolites. *Phytochemistry*. 68: 939-953.
- Merdji, M., Guemache, D., 2023. Aromatic and medicinal plants: A sector to be strengthened. *EcoTimes*.
- Amouroux, P., Jean, D., Lamaison, J.L., 1998. Antiviral activity in vitro of *Cupressus sempervirens* on two human retroviruses HIV and HTLV. *Phytother Res*. 12: 36-78.
- Bruneton, J., 1999. *Pharmacognosy, Phytochemistry, Medicinal Plants*. 400p.
- Cecchini, T., 2003. *Encyclopedia of Medicinal Plants*. Ed. De Vecchi S.A. Paris. 351p.
- Penchev, P.I., 2010. Study of processes for the extraction and purification of bioactive products from plants by coupling separation techniques at low and high pressures, Doctoral thesis in Process and Environmental Engineering. University of Toulouse, France. 239p.
- Falleh. H., Ksouri. R., Chaieb. K., Karray-Bouraoui. N., Trabelsi. N., Boulaaba. M., Abdelly. C., 2008. Phenolic composition of *Cynara cardunculus* L. organs and their biological activities, *C R Biologies. Flight* . 331: 372-379.
- Singleton, V-L., Orthofer, R., Lamuela-Raventos, R-M., 1999. Analysis of total phenols and other oxidation substrates and antioxidants by means of Folin Ciocalteu reagent. *Method. Enzymol*. 299: 152-178.
- Zhishen, J., Mengcheng, T., Jianming, W., 1999. The determination of flavonoid contents in mulberry and their scavenging effects on superoxide radicals. *Food Chemistry*. 64: 555-559.
- Lee, K.W., Lee, H.J., Surh, Y., J., Lee, C. Y., 2003. Vitamin C and chemoprevention: reappraisal. *American Journal of Clinical Nutrition*. 78: 1074-1078.
- Gélébart, B., 2016. Optimization of the extraction, in a "batch" reactor, of energy biomass using ultrasonic emulsions of green solvents. [Master's thesis in chemical engineering]. University of Sherbrooke (Quebec) Canada. 138p.
- Nait Sidi Ahmed, A., 2012. Implementation of a process for the extraction and pre-purification of bioactive molecules from an energy culture "Salix miyabeana SX67". [Master's thesis in chemical engineering]. University of Sherbrooke, Canada. 105p.
- Kim, D., Jeond, S., Lee., Ch., 2003. Antioxidant capacity of phenolic phytochemicals from various cultivars of plums. *Food Chem*. 81: 321-326.
- Basalan, M., Gungor, T., Owens, F.N., Yalcinkaya, I., 2011. Nutrient content and in vitro digestibility of Turkish grape pomaces. *Animal feed Science and Technology*. 169(3-4): 194-198.
- Aloui, F., Nefzi, A., Jedidi, S., Selmi, H., Hasnaoui, F., Dallali, S., Bouraoui, H., Mouhbi, R., Abbes, C. 2020. Phytochemical analysis and in vitro digestibility evaluation of leaf and cones parts of *Cupressus sempervirens* originating from Tunisia. *Journal of new sciences, Agriculture and Biotechnology*. 71(2): 4311-4318.
- Govindarajan, R., Vijayakumar, M., Pushpangadan, P., 2006. Antioxidant approach to disease management and the role of Rasayana herbs of Ayurveda. *J. Ethopharmacol. Epub* 2005. 99(2):165-78.

THE EFFECT OF DIFFERENT PROBIOTIC MIXTURES ADDED TO THE LAYING HENS DIET ON PERFORMANCE AND EGG QUALITY PROPERTIES

Barişcan CURABAY¹, Yusuf CUFADAR¹, Seyit Ahmet GÖKMEN¹

¹*Selcuk University, Faculty of Agriculture, Department of Animal Science, Konya, Turkey*
Corresponding author e-mail: bcurabay@hotmail.com

ABSTRACT

This study was conducted to determine the effect of adding two different types of probiotics and their mixtures to the diets of laying hens on performance and egg quality. In the study, a total of 105 laying hens at 59 weeks of age were fed with five different diets created by adding *Bacillus megaterium* (1×10^{10} g/cfu) and *Bacillus amyloliquefaciens* (1×10^{10} g/cfu) to the corn-soybean meal-based diet (positive control) and the diet containing 35% barley (negative control) at a level of 0.5 g/kg and equal amounts (0.25+0.25 g/kg) of these probiotics. The study was conducted for 42 days with 7 replicates in 5 treatment groups. As a result of the study, the initial body weight, final body weight, body weight change, feed intake, egg production, egg mass and feed conversion ratio of the treatment groups were statistically insignificant ($P > 0.05$). Egg weight was significantly higher in groups containing *Bacillus megaterium* and *Bacillus amyloliquefaciens* compared to the positive control group ($P < 0.01$). The rate of damaged eggs was higher in the group containing *Bacillus megaterium* than in both control groups ($P < 0.05$). The addition of *Bacillus megaterium* and *Bacillus amyloliquefaciens* to laying hen diets did not statistically affect the lightness index (L^*) and b^* value from egg yolk color criteria, Haugh unit, shell breaking strength, egg shell weight, egg shell thickness, and egg shell ratio examined while a^* value was lower in all barley-containing groups ($P < 0.01$). According to the results of the study, it can be said that adding both probiotics alone to the diet may be beneficial in terms of increasing egg weight in laying hens.

Keywords: *Bacillus amyloliquefaciens*, *Bacillus megaterium*, Performance, Laying hen, Egg quality

INTRODUCTION

Large-scale poultry farming facilities expose poultry to stressful conditions such as ration problems, diseases, and inadequate environmental conditions. Since these difficulties lead to significant economic losses, such problems should either be prevented beforehand or effectively controlled. Various feed additives are used in poultry nutrition to prevent such problems, including probiotics.

Probiotics are live microorganisms that are known to provide benefits to the host when given in appropriate amounts. These benefits include improving the intestinal structure, strengthening immunity against pathogens, increasing the intestinal microflora, suppressing pathogen colonization, and/or regulating intestinal colonization by symbiotic bacteria, thereby affecting the health, physiology, or production performance of poultry (Callaway et al., 2008; Gaggia et al., 2010; Xiang et al., 2019). *Lactobacillus*, *Streptococcus*, *Saccharomyces*, *Aspergillus*, and *Bacillus* are some of the probiotic species that have been used in poultry nutrition in the past (Tannock, 2001). Previous findings have shown that adding probiotics to the diet of laying hens not only increases egg production but also improves feed utilization, performance, and eggshell quality (Mikulski et al., 2012; 2020).

Grains are the most important and commonly used feed components in poultry nutrition. Barley is commonly used in poultry feed as an energy source. However, the carbohydrates in barley, especially non-starch polysaccharides such as beta-glucans, are not as easily digestible as those in corn. The β -glucans contained in barley are released from cell walls and bind with water in the intestine to form a gel, which increases the viscosity of the intestinal contents. This increase in intestinal viscosity adversely affects the digestion and absorption of nutrients (Zielke et al., 2017). Hooda et al. (2011) found that high viscosity prevented mixing of the intestinal contents and altered the transport properties of nutrients on the mucosal surface. Therefore, barley β -glucans are considered anti-nutritional factors that limit the nutritional quality of barley (Stein et al., 2016). Enzyme addition to barley-based diets for poultry reduces intestinal viscosity and increases the utilization of barley. Enzymes also improve litter quality in poultry fed barley-based diets (Smits and Anisson, 1996). Probiotic addition to barley-based diets can also increase the digestibility of nutrients as an alternative to enzymes. The addition of oligosaccharides and *Lactobacillus* to broiler diets has been reported to increase the activity of β -glucosidase, alpha-galactosidase, aminopeptidase, maltase, and alkaline phosphatase enzymes (Mehrabadi and Jamshidi, 2019).

Bacillus species of probiotics are suitable feed additives for poultry health due to their ability to produce various enzymes such as protease, amylase, and lipase and their stability in the presence of stress.

Bacillus amyloliquefaciens is an effective among *Bacillus* species and is a probiotic isolated from soil. It has been reported in various studies that it can be used as an alternative to antibiotics to modulate the intestinal flora of broiler chickens, improve the intestinal epithelial barrier, and enhance immune function (Du et al., 2018; Wang et al., 2021). In another study, the addition of *Bacillus amyloliquefaciens* to layer diets reduced stress and improved their immune systems, thereby increasing their performance and egg quality (Zhou et al., 2020). *Bacillus amyloliquefaciens* can improve egg production, sperm production quality, egg quality/hatchability, and slow down the reproductive aging of chickens (Prazdnova et al., 2019). However, the effects of *Bacillus amyloliquefaciens* on the performance and healthy status of laying hens remain uncertain.

Among *Bacillus* species, *Bacillus megaterium* has become a research material as a probiotic due to its unique properties such as resistance to stress conditions and high temperature and easy storage (Vary et al., 2007; De Vos, 2009). *Bacillus megaterium* is a gram-positive bacterium that can produce spores as a new type of microecological additive isolated from chicken manure. Ding and Wang (2015) found that adding 100 mg/kg *Bacillus megaterium* to the diets of laying hens significantly increased egg weight and egg production compared to the control group, while significantly reducing fecal ammonia nitrogen and uric acid contents. Some researchers have suggested that the addition of *Bacillus megaterium* to the diets of broiler chickens can improve feed consumption, live weight, feed conversion ratio, and growth performance (Ding et al., 2016; Chen et al., 2016).

The aim of this study is to evaluate the effects of *Bacillus amyloliquefaciens* and *Bacillus megaterium* separately and mixture as feed additives on the performance and egg quality characteristics of laying hens fed barley-based diets. We aim to inform the researchers in this direction according to the comparison of data between these two probiotics.

MATERIAL AND METHOD

In the study, 105 Tinted laying hens aged 59 weeks were used as animal material. The experiment was carried out in a total of 35 subgroups, consisting of 5 different treatments and 7 replications for each treatment, according to the randomized design. Laying hens were randomly distributed as 3 in each sub-group. Feed and water were supplied to hens as ad

libitum, and the lighting program is 16 hours of daylight was applied during the experiment. Hens were fed with five different diets created by adding *Bacillus megaterium* (1×10^{10} g/cfu) and *Bacillus amyloliquefaciens* (1×10^{10} g/cfu) to the corn-soybean meal-based diet (positive control) and the diet containing 35% barley (negative control) at a level of 0.5 g/kg and equal amounts (0.25+0.25 g/kg) of these probiotics. The study was carried out for 42 days (two periods of 21 days). The trial diets were prepared according to the requirements reported by NRC (1994) for laying hens (Table 1).

Table 1. Ingredients and calculated nutrient composition of diets with and without barley used in the study

Ingredients	Control (+)	Control (-)
	%	%
Maize	56.00	23.20
Barley	-	35.00
Soybean meal (% 47 CP)	18.75	14.00
Sunflower meal (% 28 CP)	10.00	10.00
Vegetable oil (8800 ME/kg)	3.90	6.45
Limestone	9.15	9.20
Dicalcium phosphate	1.60	1.50
Salt	0.25	0.25
Premix ¹	0.10	0.10
L-Lysine	0.10	0.15
DL-Methionine	0.15	0.15
Total	100	100
Calculated Chemical Composition		
Metabolizable energy (kcal/kg)	2748.70	2748.70
Crude Protein (%)	15,81	15.79
Crude Fiber (%)	4,49	5.05
Calcium (%)	3,93	3.92
Available phosphorus (%)	0,41	0.39
Lysine (%)	0,78	0.76
Methionine (%)	0,38	0.37
Methionine + Cystine (%)	0,61	0.43

¹Premix is supplied per kg of diet; vitamin A, 4 mg; vitamin D₃, 0,055 mg; vitamin E, 11 mg; vitamin B₁₂, 0,66 mg; nicotine acid, 44 mg; calcium-D-pantothenate, 8,8 mg; riboflavine, 5,8 mg; thiamine, 2,8 mg; folic acid, 1 mg; biotine, 0,11 mg; coline, 220 mg; manganese: 60 mg; iron: 30 mg; zinc: 60 mg; copper: 5 mg; iodine: 1 mg; selenium: 0,1 mg.

The body weights of hens were determined by weighing them on a scale with a sensitivity of 1 g at the beginning and end of the experiment, and the body weight gain were calculated from these data. Egg production (%) was calculated using the formula (Total number of eggs in the period (pieces) / Number of animals in the group (pieces)) × 100. Egg weights were determined by weighing all eggs collected from each subgroup during the last two days of each 18-day period on a digital scale with a sensitivity of 0.01 g. Egg mass was calculated by multiplying the percentage egg yields for each period by the average egg weights and dividing by 100. Hens were weighed and fed in groups, and daily feed intake was calculated. The feed conversion ratio was calculated by dividing the average daily feed intake per chicken for each period by the egg mass for that period (g feed/g egg mass). Broken, cracked, and damaged eggs were recorded daily and calculated as a percentage of the total number of eggs.

The eggshell breaking strength, eggshell membrane weight and thickness, albumen index, yolk index, Haugh unit, and yolk color were determined in a total of 6 eggs collected from each subgroup during the last two days of each 21-day period. The eggshell breaking strength was measured using an Egg Force Reader (Orka Food Technology, Israel). The eggshell weight (without contents) was determined by washing the eggs thoroughly after they

were broken and separated, then drying them for 3 days at room temperature and weighing them on a precise digital scale. The eggshell ratio was calculated by dividing the eggshell weight by the egg weight. Eggshell thickness was determined by taking the average of measurements made with a digital micrometer on the mass, pointed, and equatorial regions of broken eggshells. The egg quality parameters were also determined in the eggs used to determine the eggshell quality parameters. For this purpose, the eggs were broken on a glass table and the egg internal quality parameters were determined. The height of the yolk and albumen was measured with a digital height gauge, while the yolk diameter and egg albumen length and width were measured with a digital caliper (Mutitoyo, Japan). The yolk index = (yolk height/yolk diameter) \times 100; Albumen index = (albumen height/(albumen length + albumen diameter)) \times 100; Haugh unit = $100 \times \log(\text{albumen height} + 7.57 - 1.7 \times \text{egg weight}^{0.37})$ was calculated using a formula. Yolk color was measured as CIELab (L*, a*, b*) values using a Konica Minolta CR-200 colorimeter. Egg internal quality analyses were completed within 12 hours after the eggs were collected.

To determine whether the treatments had an effect on the parameters examined, one-way analysis of variance (ANOVA) was applied to the data obtained using Minitab 17 statistical package program, and Duncan Multiple Comparison Test was applied to determine differences between treatment groups (Düzgüneş et al., 1987).

RESULTS AND DISCUSSION

According to Table 2, the effects of adding 0.5 g/kg *Bacillus amyloliquefaciens* (1×10^{10} cfu/g), 0.5 g/kg *Bacillus megaterium* (1×10^{10} cfu/g), and these probiotic mixtures to the diets of laying hens on initial body weight, final body weight, body weight gain, egg production, feed intake, and feed conversion ratio were not statistically significantly different from those of the control group ($P > 0.05$).

According to Table 2, the addition of probiotics only affected egg weight and damaged eggs among the performance parameters ($P < 0.01$; $P < 0.05$). The addition of *Bacillus megaterium* and *Bacillus amyloliquefaciens* to the diets of laying hens significantly increased egg weight compared to both the control group (+) and the probiotic mixture (BM+BA) ($P < 0.01$). The enhancing effect between these two probiotic species on egg weight was the same ($P > 0.05$). According to Table 2, the addition of *Bacillus megaterium* to the diets of laying hens has significantly increased damaged eggs compared to both of the control groups ($P < 0.05$).

Previous studies have shown that probiotics affect numerous performance parameters of laying hens. These parameters include the dynamics of body weight (body weight gain), feed conversion ratio, egg production, and egg quality (improved shell thickness, egg weight) (Lei et al., 2013; Chaucheyras-Durand and Durand, 2010; Smith, 2014; Bai et al., 2016). *Bacillus* type probiotics are commonly used in poultry feeding and have emerged as a promising approach to improving poultry health (Jia et al., 2016). These probiotics exhibit resistance to different climatic conditions and have a long shelf life. *Bacillus* species, including *B. amyloliquefaciens*, are found in normal intestinal microbiota and have the ability to grow and produce spores in the gastrointestinal system (Cartman et al., 2008; Cutting, 2011; Barbosa et al., 2005).

Furthermore, their ability to form biofilms is medically important (Ushakova et al., 2009). Our study's findings have shown that adding different types of probiotic mixtures to the diets of laying hens has a significant effect on egg weight and the rate of damaged eggs. According to previous studies, Tsai et al. (2023) compared the addition of 0.3% *Bacillus subtilis* with 0.1% *Bacillus amyloliquefaciens* to the diets of laying hens and reported that *Bacillus subtilis* increased final body weight and body weight gain more than *Bacillus amyloliquefaciens* and the control group ($P < 0.05$). They attributed this to *Bacillus subtilis*' better promotion of nutrient

absorption. Some researchers found that *Bacillus amyloliquefaciens* did not affect egg yield, feed intake, egg mass, and the rate of damaged eggs. In contrast, Mazanko et al. (2018) reported that adding various *Bacillus* species probiotics to the diets of laying hens; among species *Bacillus amyloliquefaciens* increased egg production of hens. However, Weili et al. (2014) claimed that *Bacillus megaterium* improved the performance of laying hens and reduced ammonia emission in feces.

The results of the studies reported are partially consistent with the results of our study. However, the reason why the performance parameters reported in our study were not affected by treatments may be due to the difference in the levels of probiotics used, the absence of any stress factors in the animals, and the provision of optimal conditions (temperature, humidity, ventilation, etc.) within the coop.

Table 2. The effect of different probiotic mixtures in the diets of laying hens on performance

Performance parameters	CON (+)	CON (-)	BM	BA	BM+BA	P-Value
IBW, g	1784,14±48,52	1867,29±40,71	1838,29±54,71	1820,00±52,80	1818,86±44,00	0,811
FBW, g	1805,86±49,55	1875,14±32,34	1821,00±36,13	1793,43±44,97	1836,57±38,14	0,661
BWG, g	21,57±13,55	7,57±18,34	-17,14±23,32	-26,86±15,22	17,86±17,54	0,243
FI, g/hen/day	107,14±1,36	106,27±1,83	107,55±1,99	108,00±1,11	110,96±0,43	0,228
Egg production, %	91,20±1,30	85,93±3,24	85,69±2,58	84,25±1,40	91,05±2,03	0,101
Egg weight, g	64,13±1,11 ^B	66,36±1,05 ^{AB}	69,15±1,57 ^A	69,64±0,73 ^A	65,36±0,85 ^B	0,004
Egg mass, g/day	58,43±0,98	57,19±2,71	59,10±1,26	58,63±1,04	59,46±1,12	0,871
FCR, FI/EM	1,84±0,03	1,90±0,08	1,82±0,01	1,85±0,04	1,85±0,02	0,789
Damaged eggs, %	6,45±0,85 ^b	4,45±0,48 ^b	14,77±3,32 ^a	8,47±2,52 ^{ab}	10,41±1,10 ^{ab}	0,024

^{a, b}: Means with different superscripts in the same row were significantly different (P<0,05),

^{A, B}: Means with different superscripts in the same row were significantly different (P<0,01),

CON (+): Barley-free control; CON (-): Barley based control; BM: *Bacillus megaterium* (0,5 g/kg); BA: *Bacillus amyloliquefaciens* (0,5 g/kg); BM+BA: *Bacillus megaterium* + *Bacillus amyloliquefaciens* (0,25 g/kg + 0,25 g/kg); IBW: Initial body weight; FBW: Final body weight; BWG: Body weight gain; FI: Feed intake; EM: Egg mass; FCR: Feed conversion ratio

Table 3 shows the effect of adding 0.5 g/kg *Bacillus amyloliquefaciens* (1×10^{10} cfu/g) and *Bacillus megaterium* (1×10^{10} cfu/g) and their probiotic mixtures to the diets of laying hens on egg quality characteristics.

According to the table, the values of albumen index, yolk index, Haugh unit, eggshell breaking resistance, eggshell weight, eggshell thickness, eggshell ratio, L*, and b* values were not significantly different from those of the control group for the mixtures of *Bacillus megaterium* and *Bacillus amyloliquefaciens* (P>0.05).

Adding probiotic mixtures to the diets of laying hens of different types only statistically significantly affected the a* values of yolk color measurements (P<0.01) compared to the control group (+) and significantly reduced them. The addition of *Bacillus megaterium* and *Bacillus amyloliquefaciens* to the diets of laying hens significantly reduced a* values compared to the control group (+), and the most reducing effect between these two probiotics was detected in the group with *Bacillus amyloliquefaciens* addition. Additionally, the effect of the probiotic mixture on a* value was the same as that of the control group (-) (P>0.05).

Egg quality generally encompasses various parameters such as eggshell weight, albumen and yolk quality. Egg quality has a genetic basis and varies among breeds of laying hens. However, egg quality is also affected by the housing conditions, age, and diets used for the hens (Jha et al., 2020). In their studies examining egg quality characteristics of laying hens, Abd El-Hack et al. (2017) reported that *Bacillus subtilis* increased yolk index, yolk color, and eggshell thickness compared to the control group. However, it did not affect Haugh unit values. However, Tsai et al. (2023) reported that *Bacillus subtilis* and *Bacillus amyloliquefaciens* did not affect eggshell thickness, eggshell weight, and yolk color. In another study, *Bacillus*

amyloliquefaciens significantly improved eggshell quality, and researchers attributed this to the increase in calcium absorption due to the increase in nutrient utilization. This is possible because probiotics create an acidic environment suitable for mineral ionization and lower intestinal pH, which is necessary for the dissolution and optimal absorption of both calcium and phosphorus (Resta-Lenert and Barrett, 2003).

Haugh unit is an important measure of egg protein quality. A higher value indicates increased egg albumen viscosity and, therefore, better quality. Lei et al. (2013) reported that the addition of *Bacillus amyloliquefaciens* at different doses resulted in different increases in Haugh unit, which could improve egg quality by increasing egg protein metabolism. Although our findings do not match those of various researchers reported so far, it is thought that this may be due to the absence of any stress factors in the animals. Jia et al. (2016) supported this idea by stating that probiotic addition could be more effective than normal conditions when animals are stressed, thus reducing the negative effects of mycotoxins on laying performance and effectively improving egg quality while reducing the accumulation of aflatoxin residues in eggs.

Table 3. The effect of different probiotic mixtures in the diets of laying hens on egg quality characteristics

Egg quality parameters	CON (+)	CON (-)	BM	BA	BM+BA	P-Value
Albumen index, %	9,81±0,42	8,58±0,37	8,90±0,41	8,79±0,25	9,09±0,36	0,185
Yolk index, %	42,25±0,37	41,61±0,47	42,74±0,31	42,83±0,65	42,96±0,48	0,265
Haugh unit	86,21±1,55	80,46±1,75	81,46±1,62	80,95±1,07	82,50±1,27	0,068
Eggshell breaking strength, kg	4,04±0,14	4,09±0,15	3,77±0,18	3,84±0,13	3,92±0,11	0,498
Eggshell weight, g	6,01±0,18	6,42±0,09	6,31±0,14	6,64±0,13	6,26±0,16	0,061
Eggshell thickness, mm	0,351±0,008	0,370±0,005	0,356±0,007	0,379±0,008	0,386±0,014	0,498
Eggshell ratio, %	9,37±0,20	9,68±0,16	9,15±0,25	9,54±0,20	9,58±0,19	0,382
Yolk color traits						
L*	46,95±0,34	47,72±0,46	47,39±0,32	47,59±0,48	47,92±0,41	0,515
a*	8,33±0,48 ^A	3,78±0,39 ^{BC}	4,31±0,35 ^B	3,15±0,32 ^C	3,26±0,28 ^{BC}	0,000
b*	31,91±0,55	30,70±0,48	30,94±0,42	30,25±0,71	30,49±0,43	0,240

^{A,B}: Means with different superscripts in the same row were significantly different (P<0,01),

CON (+): Barley-free control; CON (-): Barley based control; BM: *Bacillus megaterium* (0,5 g/kg); BA: *Bacillus amyloliquefaciens* (0,5 g/kg); BM+BA: *Bacillus megaterium* + *Bacillus amyloliquefaciens* (0,25 g/kg + 0,25 g/kg)

CONCLUSIONS

In conclusion, it has been determined that the addition of 0.5 g/kg *Bacillus megaterium* and 0.5 g/kg *Bacillus amyloliquefaciens* and their mixtures to the diets of laying hens has a statistically significant effect on egg weight, the rate of damaged eggs, and the a* value of yolk color measurements. While the individual addition of these two probiotics significantly increased egg weight and it reduced the a* value. *Bacillus amyloliquefaciens* increased egg weight the most at a level of 1×10^{10} cfu/g compared to the control group. According to the results, *Bacillus amyloliquefaciens* can be added to laying hen diets due to its ability to increase egg weight in 59-week-old hens.

REFERENCES

Abd El-Hack, M.E., Mahgoub, S.A., Alagawany, M., Ashour, E.A. 2017. Improving productive performance and mitigating harmful emissions from laying hen excreta via feeding on graded levels of corn DDGS with or without *Bacillus subtilis* probiotic. Journal of Animal Physiology and Animal Nutrition, 101: 904-913.

- Bai, W.K., Zhang, F.J., He, T.J., Su, P.W., Ying, X.Z., Zhang, L.L., Wang, T. 2016. Dietary probiotic *Bacillus subtilis* strain fmbj increases antioxidant capacity and oxidative stability of chicken breast meat during storage. *PloS One*, 11(12): e0167339.
- Barbosa, T.M., Serra, C.R., La Ragione, R.M., Woodward, M.J., Henriques, A.O. 2005. Screening for *Bacillus* isolates in the broiler gastrointestinal tract. *Applied and Environmental Microbiology*, 71(2): 968-978.
- Callaway, T.R., Edrington, T.S., Anderson, R.C., Harvey, R.B., Genovese, K.J., Kennedy, C.N., Venn, D.W., Nisbet, D.J. 2008. Probiotics, prebiotics and competitive exclusion for prophylaxis against bacterial disease. *Animal Health Research Review*, 9: 217-225.
- Cartman, S.T., La Ragione, R.M., Woodward, M.J. 2008. *Bacillus subtilis* spores germinate in the chicken gastrointestinal tract. *Applied and Environmental Microbiology*, 74(16): 5254-5258.
- Chaucheyras-Durand, F., Durand, H. 2010. Probiotics in animal nutrition and health. *Beneficial Microbes* 1(1): 3-9.
- Chen, L.M., Luo, Y., Li, Z.B., Yu, L.H., Zhang, Y.Y. 2016. Effect of *Bacillus megaterium* 1259 on eggshell quality of hens during late period. *Journal of China Agricultural University*, 21(9): 97-104.
- Cutting, S.M. 2011. *Bacillus* probiotics. *Food Microbiology*, 28(2): 214-220.
- De Vos, P. 2009. *Bergey's manual of systematic bacteriology*, Volume 3: The Firmicutes. Springer, New York, U.S.A.
- Ding, W.J., Wang, Q. 2015. Effects of *Bacillus megaterium* 1259 on performance and fecal nitrogen concentration of laying hens. *Chinese Journal of Animal Nutrition*, 27: 3140-3145.
- Ding, W.J., Wang, Q., Dai, M.M., Zhang, W.L., Zhang, Y.Y. 2016. Effects of dietary inclusion of *Lactobacillus* and inulin on growth performance, gut microbiota, nutrient utilization, and immune parameters in broilers. *Chinese Journal of Animal Nutrition*, 28(5): 1566-72.
- Du, W., Xu, H., Mei, X., Cao, X., Gong, L., Wu, Y. 2018. Probiotic *Bacillus* enhance the intestinal epithelial cell barrier and immune function of piglets. *Beneficial Microbes*, 9: 743-54.
- Düzgüneş, O. 1975. İstatistik metodlar (İstatistiğe giriş). A. Ü. Ziraat Fakültesi Yayınları, 576. Ankara.
- Gaggia, F., Mattarelli, P., Biavati, B., 2010. Probiotics and prebiotics in animal feeding for safe food production. *International Journal of Food Microbiology*, 141: 15-28.
- Hooda, S., Metzler-Zebeli, B.U., Vasanthan, T., Zijlstra, R.T. 2011. Effects of viscosity and fermentability of dietary fibre on nutrient digestibility and digesta characteristics in ileal-cannulated grower pigs. *British Journal of Nutrition*, 106: 664-674.
- Jha, R., Das, R., Oak, S., Mishra, P. 2020. Probiotics (Direct-fed microbials) in poultry nutrition and their effects on nutrient utilization, growth and laying performance, and gut health: A systematic review. *Animals*, 10: 1863.
- Jia, R., Ma, Q., Fan, Y., Ji, C., Zhang, J., Liu, T., Zhao, L. 2016. The toxic effects of combined aflatoxins and zearalenone in naturally contaminated diets on laying performance, egg quality and mycotoxins residues in eggs of layers and protective effect of *Bacillus subtilis* biodegradation product. *Food and Chemical Toxicology*, 90: 142-50.
- Lei, K., Li, Y.L., Yu, D.Y., Rajput, I.R., Li, W.F. 2013. Influence of dietary inclusion of *Bacillus licheniformis* on laying performance, egg quality, antioxidant enzyme activities, and intestinal barrier function of laying hens. *Poultry Science*, 92(9): 2389-2395.
- Mazanko, M.S., Gorlov, I.F., Prazdnova, E.V., Makarenko, M.S., Usatov, A.V., Bren, A.B., Chistyakov, V.A., Tutelyan, A.V., Komarova, Z.B., Mosolova, N.I. 2018. *Bacillus*

- probiotic supplementations improve laying performance, egg quality, hatching of laying hens, and sperm quality of roosters. *Probiotics and Antimicrobial Proteins*, 10: 367-373.
- Mehrabadi, M., Jamshidi, R. 2019. Effect of antibiotic, probiotic and prebiotic in diets containing barley on performance, digestibility, intestinal morphology, blood parameters and immunological response in broilers. *Iranian Journal of Applied Animal Science*, 9(3): 497-507.
- Mikulski, D., Jankowski, J., Mikulska, M., Demey, V., 2020. Effects of dietary probiotic (*Pediococcus acidilactici*) supplementation on productive performance, egg quality, and body composition in laying hens fed diets varying in energy density. *Poultry Science* 99: 2275-2285.
- Mikulski, D., Jankowski, J., Naczmanski, J., Mikulska, M., Demey, V. 2012. Effects of dietary probiotic (*Pediococcus acidilactici*) supplementation on performance, nutrient digestibility, egg traits, egg yolk cholesterol, and fatty acid profile in laying hens. *Poultry Science*, 91: 2691-2700.
- N.R.C. 1994. Nutrient requirements of poultry: 1994. National Academies Press.
- Prazdnova, E.V., Mazanko, M.S., Chistyakov, V.A., Denisenko, Y.V., Makarenko, M.S., Usatov, A.V, 2019. Effect of *Bacillus subtilis* KATMIRA1933 and *Bacillus amyloliquefaciens* B-1895 on the productivity, reproductive aging, and physiological characteristics of hens and roosters. *Beneficial Microbes*, 10: 395-412.
- Resta-Lenert, S., Barrett, K.E. 2003. Live probiotics protect intestinal epithelial cells from the effects of infection with enteroinvasive *Escherichia coli* (EIEC). *Gut*, 52: 988-997.
- Smith, J.M. 2014. A review of avian probiotics. *Journal of Avian Medicine and Surgery*, 28(2): 87-94.
- Smits, C.H.M., Anisson, G. 1996. Non-starch plant polysaccharides in broiler nutrition-towards a physiologically valid approach to their determination. *World's Poultry Science*, 52: 203-221.
- Stein, H.H., Lagos, L.V., Casas, G.A. 2016. Nutritional value of feed ingredients of plant origin fed to pigs. *Animal Feed and Science Technology*, 218: 33-69.
- Tannock, G.W. 2001. Molecular assessment of intestinal microflora. *The American Journal of Clinical Nutrition*, 73: 410-414.
- Tsai, M.Y., Shih, B.L., Liaw, R.B., Chen, W.T., Lee, T.Y., Hung, H.W., Hung, K.H., Lin, Y.F. 2023. Effect of dietary supplementation of *Bacillus subtilis* TLRI 211-1 on laying performance, egg quality and blood characteristics of Leghorn layers. *Animal Bioscience*, 36(4): 609-618.
- Ushakova, N.A., Brodskii, E.S., Kozlova, A.A., Nifatov, A.V. 2009. Anaerobic solid-phase fermentation of plant substrates by *Bacillus subtilis*. *Prikladnaia Biokhimiia i Mikrobiologiia*, 45(1): 70-77.
- Vary P.S, Biedendieck R, Fuerch T, Meinhardt F, Rohde M, Deckwer W.D, Jahn D. 2007. *Bacillus megaterium*-from simple soil bacterium to industrial protein production host. *Applied Microbiology and Biotechnology*, 76, 957-967.
- Wang, B., Zhou, Y., Tang, L., Zeng, Z., Gong, L., Wu, Y. 2021. Effects of *Bacillus amyloliquefaciens* instead of antibiotics on growth performance, intestinal health, and intestinal microbiota of broilers. *Frontiers in Veterinary Science*, 8: 679368.
- Weili, Z., Yu, L., Xiao, T. 2014. Comparison of BM1259 and yucca extract on ammonia nitrogen emission of manure during storage period in laying hens. *Feed Industry*, 35, 13-16. (In Chinese).
- Xiang, Q., Chao Wang, C., Zhang, H., Lai, W., Wei, H., Pen, J., 2019. Effects of different probiotics on laying performance, egg quality, oxidative status, and gut health in laying hens. *Animals*, 9: 1110.

- Zhou, Y., Li, S., Pang, Q., Miao, Z. 2020. *Bacillus amyloliquefaciens* BLCC1-0238 can effectively improve laying performance and egg quality via enhancing immunity and regulating reproductive hormones of laying hens. *Probiotics and Antimicrobial Proteins*, 12: 246-52.
- Zielke, C., Kosik, O., Ainalem, G., Lovegrove, A., Stradner, A., Nilsson, A. 2017. Characterization of cereal β -glucan extracts from oat and barley and quantification of proteinaceous matter. *Infection and Immunity*, 72: 4159-4171.

THE EFFECTS OF DIFFERENT ROW SPACING ON AGRICULTURAL CHARACTERISTICS OF SAFFLOWER (*Carthamus tinctorius* L.) GROWN IN DRY CONDITIONS

Nursel ÇÖL KESKİN¹*, Mustafa ÖZTÜRK¹

¹ Selcuk University, Agricultural Faculty, Department of Field Crops, Konya, Türkiye

Corresponding author e-mail: nurselcol@selcuk.edu.tr

ABSTRACT

This research was carried out to determine the effects of different row spacing on agricultural characteristics of some safflower varieties under dry conditions in the Ölmez District of Konya Province during the 2022 safflower growing season (April-August). Three safflower varieties, namely Göktürk, Olein, and Servetağa, were used as experimental materials, with different row spacings of 20 cm, 30 cm, and 40 cm. The intra-row spacing was maintained at a constant 10 cm in all parcels. The experimental design was “Randomized Complete Block Design in Split Plots” with three replications. In the study, row spacings were placed in main plots and varieties were placed in sub-plots for ease of application. The seed yield, plant height, first branch height, number of branch per plant, number of head per plant were examined, and significant interactions were noted among number of head per plant and seed yield for row spacings × varieties. According to variety averages in the study, the highest yield of 125.9 kg da⁻¹ was obtained from the Servetağa variety, while the lowest yield of 103.6 kg da⁻¹ was obtained from the Olein variety. When the average values were taken into consideration, the highest seed yield was found in 30 cmxGöktürk as 138.1 kg da⁻¹. When looking at the average of interactions of row spacings × varieties; there were determined that the plant height was between 65.7-87.7 cm, the first branch height was 37.5-52.9 cm, the number of branch per plant was 5.3-6.9 pieces, the number of head per plant was 8.1-15.0 pieces, seed yield 63.3-138.1 kg da⁻¹. In addition, the research revealed the relationships between agricultural characteristics by both correlation and principal component analysis. A significant and positive relationships were found between same characteristics according to both analyzes. Consequently, the Göktürk variety demonstrated superior performance compared to other varieties under the rain-deficient conditions of the Ölmez District in Konya Province, and a row spacing of 30 cm was found to be the most suitable for this region.

Keywords: Safflower, *Carthamus tinctorius* L., row space, yield, agricultural characteristics.

INTRODUCTION

The safflower plant is one of the important oil plants that can be grown in nearly 60 countries worldwide, including marginal cultivation areas. Among the advantages of safflower cultivation are its deep-rooted structure, which helps improve soil quality, its ability to grow in arid conditions, its high-water retention capacity in heavy soils, and its lower demand for irrigation and fertilization compared to other oil crops such as sunflower and soybeans (Gilbert et al., 2008). The safflower plant is used in the vegetable oil industry; its flowers are used in dyeing food, fabrics, rugs, etc., for medicinal purposes and as animal feed. Safflower is an annual, multi-branched cultivated plant that can grow between 30-150 cm. Its flower colors can vary from yellow, orange, and red, and its oil content can vary from 20% to 45% (Dajue & Mündel, 1996). Safflower oil, which is also used as biodiesel, contains 90% unsaturated fatty

acids, including oleic and linoleic, and 10% saturated fatty acids (Velasco & Fernandez-Martinez, 2001; Emongor & Emongor, 2023).

Vegetable oil consumption per capita in our country increases with the increasing population, which causes the import figures of vegetable oil to increase yearly. Sunflower is one of our country's most cultivated oil plants, followed by cotton, soybean, peanut, rapeseed, and safflower plants. Safflower is among the priority oil crops in order to close the vegetable oil deficit of our country, as it enables the cultivation of safflower in arid areas reserved for fallow. In addition, the importance of safflower agriculture has increased daily with government subsidies (Yilmaz et al., 2021).

Yield and yield factors in safflower cultivation vary according to genotype, climatic conditions, soil structure, and agronomic practices (Eryiğit et al., 2015). It has been recorded in many studies that plant density within agronomic practices has a significant effect on the development and yield elements of a safflower plant (Ivanova et al., 2017; Gürsoy et al., 2018; Arslan & Güler, 2022; Sefaoğlu & Özer, 2022).

In this study, it has aimed to determine the effects of different row spacing on agricultural characteristics in some safflower varieties under dry conditions.

MATERIAL AND METHOD

The experiment was conducted in the 2022 growing season (April-August) in the farmer's field in Ölmez District of Altınekin District of Konya Province. Soil samples taken from different points of the test field at a depth of 0-30 cm before sowing are given in Table 1. As can be understood from the examination of Table 1, the soil texture of the experimental area is loamy, with a slightly alkaline soil pH, very low salt content, moderate organic matter content, and high lime content. The phosphorus content is sufficient, and the potassium level is high. In addition, trace elements such as Mg, Cu, and Mn are adequate, while Ca and Zn are abundant, and the iron (Fe) content is at a sufficient level.

Table 1. Soil analysis of the trial area

Texture (%)	48.28	Mg (me/100 g)	3.52
pH	7.46	Ca (me/100 g)	18.91
EC (mhos cm⁻¹)	0.15	Cu (ppm)	0.63
CaCO₃ (%)	72.66	Fe (ppm)	3.48
Organic Matter (%)	2.32	Mn (ppm)	21.02
P₂O₅ (kg P₂O₅ da⁻¹)	11.34	Zn (ppm)	4.96
K₂O (kg K₂O da⁻¹)	79.69		

*Soil analysis was performed in BSK analysis laboratories.

The average temperature (°C), total precipitation (mm), and relative humidity (%) values for the Altınekin District of Konya Province, covering the growing season of the research (April-August), are provided in Table 2. When we look at the average temperature values during the research period, it can be observed that the data for the year 2022 are close to the long-term averages. In terms of total precipitation, the values for April, May, and June in 2022 (5.4 mm, 32.9 mm, and 30.5 mm, respectively) were recorded much higher compared to the long-term averages (24.0 mm, 44.3 mm, 57.5 mm, respectively) (Table 2). The relative humidity values for the long-term average were found to be lower than the values for the year 2022, except for April (Table 2).

Table 2. Climatic data of the growing seasons (April-August) in which the experiment was conducted

Months	Average Temperature (°C)		Total Rainfall (mm)		Relative Humidity (%)	
	Long Years**	2022	Long Years	2022	Long Years	2022
April	11.6	13.6	24.0	5.4	55.5	43.9
May	16.4	14.9	44.3	32.9	50.8	59.0
June	19.6	19.6	57.5	30.5	57.4	59.5
July	23.5	21.4	9.2	7.9	42.6	47.5
August	23.4	20.0	15.7	9.8	44.1	45.4
Total/Average	18.9	17.9	150.7	86.5	50.1	51.1

*The data was obtained from the records of the Konya Regional Directorate of Meteorology, and the data for Altıekin District in Konya Province is provided. **Long-Term Average: It covers the years 2014-2021.

The study was established with three replications according to the "Randomized Complete Block Design in Split Plots" experimental design, with different row spacings (20 cm, 30 cm, 40 cm) in the main plots and varieties (Göktürk, Olein, Servetağa) in the sub-plots. The Göktürk variety used in the study is thorny in plant type, with flowers initially appearing in yellow and gradually turning orange. Additionally, it is registered by Konya Bahri Dağdaş International Agricultural Research Institute. The Olein variety is of thorny type, with orange-colored flowers, and it was developed by the Department of Field Crops at Isparta Applied Sciences University Faculty of Agriculture. The Servetağa variety is also thorny in type, with yellow flowers, and it was developed by the Department of Field Crops at Selçuk University Faculty of Agriculture.



Figure 1. Images of the varieties used in the experiment during the flowering period.

In the study, each plot was 5 meters long and arranged in 5 rows with a spacing of 70 cm between plots and 1 meter between blocks. Planting was performed manually on April 1, 2022, with row spacing determined by markers at 3-5 cm depth. When the plants reached a 15-20 cm height, they were thinned to achieve a row spacing of 10 cm along with the first hoeing. During this period, the seedhead weevil (*Bangasternus planifrons*) pest was detected in the experiment field, and two insecticide applications were made using an insecticide containing 25% Malathion to control this pest. Harvesting was done by hand on August 25, 2022, when the crown leaves of the plants had dried, the seeds had whitened, the leaves had turned brown, and

the head had completely dried. Before planting, 8 kg da⁻¹ of phosphorus and 6 kg da⁻¹ of nitrogen were applied to the subplots as DAP (Diammonium Phosphate) and Ammonium Sulfate (%21 N) along with the planting. Prior to harvest, parameters of plant height (cm), first branch height (cm), number of head per plant, number of branch per plant were measured and calculated from 10 randomly selected plants from each plot, and values of seed yield (kg da⁻¹) from each parcels were detected and recorded.

The analyses of variance were done by JMP (8.1) statistical software package (Anonymous, 2009), and mean values were compared using multiple ranges of the Least Significant Difference (LSD) test at a 5% and 1% significance level using the MSTAT-C package program (Anonymous, 1993). In addition, Pearson's correlation and the principal component analysis was performed by JMP (8.1) software's.

RESULTS AND DISCUSSION

The variance analysis regarding the agricultural characteristics of different row spacings in some safflower varieties has been provided in Table 3.

Table 3. The variance analysis for agricultural characteristics of different row spacings in some safflower varieties

Source of variations	df	F Values				
		Plant height	First branch height	The number of brach per plant	The number of head per plant	Seed yield
Replication	2	1.77	0.17	3.41	1.72	0.29
Row spacing (R.S.)	2	0.49	12.71*	0.11	20.24**	7.84*
Error ₁	4	-	0.95	-	-	-
Variety (V)	2	8.26**	4.03*	15.26**	7.89**	4.64*
R.S. x V	4	0.89	1.10	0.41	3.86*	3.95*
Error ₂	12	-	-	-	-	-
Total	26	-	-	-	-	-

**p<0.01, *p<0.05

Plant Height (cm)

According to Table 3, concerning plant height, variety differences were statistically significant at the 1% level, while row spacing and row spacing x variety interaction were found to be insignificant. In this study, where variety differences in plant height were significant, the Servetađa variety led the first group (a) with 81.3 cm, followed by the Gökürk variety in group (ab) with 71.2 cm, and the Olein variety in group (b) with 68.2 cm. Although statistically insignificant, with respect to row spacing, the narrowest row spacing, 20 cm, resulted in the lowest plant height (70.4 cm), while the highest plant height values (75.5 cm) were obtained at 30 cm row spacing, and they were in the same group. When numerically evaluated in the row spacing x variety interaction, the longest plant height was determined at 40 cm x Servetađa

interaction (87.7 cm), while the shortest plant height was recorded at 20 cm x Olein interaction (65.7 cm) (Table 4).

Table 4. Mean values (cm) of plant height determined in different row spacings in safflower varieties and groupings

Plant height				
Variety	Row spacing x Variety			Means of variety**
	20 cm	30 cm	40 cm	
Göktürk	70.3	74.1	69.2	71.2 ab
Olein	65.7	71.3	67.6	68.2 b
Servetağa	75.1	81.2	87.7	81.3 a
Means of row spacing	70.4	75.5	74.8	73.6
CV	11.88%			
LSD	Row spacing: n.s.; Variety: 10.34; Row spacing x Variety: n.s.			

As seen in Table 4, plant height values increased from 20 cm to 30 cm then decreased again at 40 cm, except for the Servetağa variety. In a study conducted by Köse and Bilir (2017), various row spacings (15 cm, 30 cm, 45 cm) and sowing rates (1.5 kg ha⁻¹, 3.0 kg ha⁻¹, 4.5 kg ha⁻¹, 6.0 kg ha⁻¹, 7.5 kg ha⁻¹) were applied. The researchers reported that plant height values also increased as row spacing and sowing rates increased. They suggested that this may be due to the ability of plants to utilize temperature and sunlight better with decreasing row spacing and increasing sowing rates, leading to increased competition. On the other hand, in another study conducted by Sefaoğlu and Özer (2022), row spacings were noted at 20 cm, 40 cm, and 60 cm, and sowing rates at 20 kg ha⁻¹, 40 kg ha⁻¹, 60 kg ha⁻¹. When examining plant height values, it was determined that as row spacing increased, plant height values also increased. The lowest value was obtained at the narrowest row spacing (20 cm) with 64.9 cm, followed by 66.3 cm at 40 cm and 69.6 cm at 60 cm. Factors such as the genetic structures of varieties, differences in cultural practices, and the climate and soil conditions in which they are grown can explain the variability in plant height values obtained from safflower in many studies (Öztürk et al., 2009; Gürsoy et al., 2018). However, the plant height values recorded in this study were close to the upper limit of the values recorded in studies related to different row spacings, such as Atakan (1992) (55.80-69.07 cm), Sefaoğlu (2017) (64.87-69.63 cm), and Erpay (2022) (60.9-67.0 cm); they were considerably lower than the findings of Gürsoy et al. (2018) (101.8-126.1 cm) and Arslan and Güler (2022) (173.7-170.5 cm).

First Branch Height (cm)

According to Table 3, variety differences were statistically significant at the 1% level, while row spacing and row spacing x variety interaction were found to be insignificant. Among row spacing averages, the tallest first branch height was recorded at 30 cm with 49.9 cm, followed by 46.6 cm at 40 cm row spacing within the same group. The shortest first branch height was observed at 20 cm row spacing, measuring 39.4 cm in length. In the study, concerning first branch height, the highest value according to variety averages was recorded in the Servetağa variety (48.3 cm) and classified in group (a). The Olein variety was categorized as group (ab) with 45.3 cm, while the lowest first branch height was determined at 42.2 cm in the Göktürk variety, representing group (b). Although statistically insignificant, when examining the row spacing x variety interaction for first branch height, the longest first branch

height was recorded at 52.9 cm in the 40 cm x Servetağa interaction, while the shortest first branch height was observed at 37.5 cm in the 20 cm x Göktürk interaction (Table 5).

Table 5. Mean values (cm) of first branch height determined in different row spacings in safflower varieties and groupings

First branch height				
Variety	Row spacing x Variety			Means of variety*
	20 cm	30 cm	40 cm	
Göktürk	37.5	48.3	40.7	42.2 b
Olein	39.0	50.8	46.1	45.3 ab
Servetağa	41.7	50.4	52.9	48.3 a
Means of row spacing*	39.4 b	49.9 a	46.6 a	45.3
CV	14.5%			
LSD	Row spacing: 5.89; Variety:4.73; Row spacing x Variety: n.s.			

In a study conducted by Erpay (2022) on safflower varieties with different row spacings (15, 30, 45 cm), it was stated that row spacing and first branch height values increased proportionally. The lowest row spacing (15 cm) was recorded as 28.3 cm, while 30 cm had 30.2 cm, and 45 cm had 34.3 cm. In this study, as row spacing increased in the Servetağa variety, the first branch height increased, while in other varieties, there was an increase in values from 20 cm to 30 cm, followed by a slight decrease after 30 cm. The first branch height is crucial for mechanical harvesting (Atan et al., 2019). The values obtained for the first branch height in our study are in line with the findings of Aydın (2012) (33.85-40.95 cm) and Erpay (2022) (28.3-34.3 cm).

Number of Branch per Plant (pieces)

Variety differences in terms of the number of branch per plant were found to be statistically significant at the 1% level, while row spacing and row spacing x variety interaction were detected insignificant (Table 3). When examining the numerical values of row spacings in the study, the lowest value of 6.3 pieces was obtained from 20 cm and 40 cm, while the highest value of 6.4 pieces was recorded at 30 cm. Regarding varieties, according to the LSD test results, the first group (a) was determined to have 6.7 pieces in the Göktürk and Servetağa varieties, with the lowest number of branch per plant, 5.5 pieces, counted in the Olein variety. Although statistically insignificant, when the row spacing x variety interaction for the number of branch per plant was examined, it was observed that varieties responded differently to row spacings, with only the Göktürk variety showing an increase in the number of branch per plant as row spacing increased (Table 6).

A study by Kaya et al. (2015) conducted with safflower lines and varieties under Eskişehir conditions reported the highest number of branch per plant as 4.6. In a study by Koç and Güneş (2021) aimed at determining the relationships between flower yield and some morphological characteristics in different safflower genotypes, the values for the number of branch per plant were found to range from 6.0 to 13.2. In a study by Sefaoğlu and Özer (2022), the number of branch per plant was recorded as follows: 3.5 at 20 cm, 4.0 at 40 cm, and 5.0 at 60 cm row spacing. Generally, an increase in row spacing is expected to lead to an increase in the number of branch per plant, and there is also a close relationship between the number of branch and the number of head (Weiss, 2000). The variation in the number of branch observed in this study across different row spacings is thought to be due to variety characteristics, the

location of the research, and ecological factors. The values for the number of branch per plant determined in this study are in line with the findings of Erpay (2012) (5.8-7.8) and Sefaoğlu and Özer (2022) (3.54-5.02).

Table 6. Mean values number of branch per plant determined in different row spacings in safflower plant varieties and groupings

Number of branch per plant				
Variety	Row spacing x Variety			Means of variety**
	20 cm	30 cm	40 cm	
Göktürk	6.6	6.8	6.9	6.7 a
Olein	5.4	5.8	5.3	5.5 b
Servetağa	6.9	6.7	6.7	6.7 a
Means of row spacing	6.3	6.4	6.3	6.3
CV	13.17%			
LSD	Row spacing: n.s ; Variety: 0.79; Row spacing x Variety: n.s			

Number of Head Per Plant (pieces)

As can be observed from Table 3, significant differences were statistically determined at the 1% level for the number of head per plant concerning row spacing and varieties, while the row spacing x variety interaction was found to be significant at the 5% level. According to row distance, the highest number of head per plant, 14.2, was recorded in the 40 cm and 30 cm row spacings, representing group (a). The lowest number of head per plant, 11.7, was observed in the 20 cm row spacing and included in group (b). Significant differences among varieties were also noted in the study, with the highest number of head per plant being 14.5 head from the Göktürk variety (group a), followed by 13.8 head from the Servetağa variety (group ab), and 11.9 head from the Olein variety (group b). Regarding the row spacing x variety interaction, the lowest value was 8.1 in the 20 cm x Olein interaction, while all other interactions represented group (a).

In their study examining the effects of different row spacings and planting densities on safflower plants, Köse and Bilir (2017) reported an increase in the number of head with increasing row spacing and decreasing planting density. They found that the number of head varied between 10.6 and 20.9 depending on row spacing and planting density, with the highest value obtained from applications with a 45 cm row spacing (16.8) and a 1.5 kg planting density (17.2). In a study conducted by Arslan and Güler (2022), as row spacing increased, the number of head also increased and was found to range between 12.29 and 16.14 head. The close relationship between the number of branch and the number of head in the plant was reported in many studies, suggesting that as row spacing increases and the number of branch increases, the number of head also increases, indirectly positively affecting seed yield (Weiss, 2000; Moghaddasi & Omid, 2015). The variation in the number of head among the varieties used in this study can be attributed to not only variety differences but also ecological factors. Furthermore, the number of head is considered one of the most important selection criteria for determining seed yield in safflower plants, with an expected increase in seed yield as the number of head increases (Uysal et al., 2006).

Table 7. Mean values number of head per plant determined in different row spacings in safflower varieties and groupings

Number of head per plant				
Variety	Row spacing x Variety*			Means of variety**
	20 cm	30 cm	40 cm	
Göktürk	13.8 a	15.0 a	14.7 a	14.5 a
Olein	8.1 b	13.9 a	13.7 a	11.9 b
Servetağa	13.3 a	13.7 a	14.3 a	13.8 ab
Means of row spacing **	11.7 b	14.2 a	14.2 a	13.4
CV	16.77%			
LSD	Row spacing: 2.06; Variety: 2.05; Row spacing x Variety: 2.54			

Seed Yield (kg da⁻¹)

In the study investigating the agricultural characteristics of different row spacings in safflower varieties, the variance analysis results for seed yield are presented in Table 3, while the mean values and groupings are provided in Table 8.

Table 8. Mean values (kg da⁻¹) of seed yield determined in different row spacings in safflower varieties and groupings

Seed yield				
Variety	Row spacing x Variety*			Means of variety*
	20 cm	30 cm	40 cm	
Göktürk	104.6 b	138.1 a	116.7 ab	119.8 ab
Olein	63.3 c	125.6 ab	121.8 ab	103.6 b
Servetağa	126.5 ab	135.1 ab	116.2 ab	125.9 a
Means of row spacing*	98.1 b	132.9 a	118.2 ab	116.4
CV	21.76%			
LSD	Row spacing: 24.49; Variety: 16.53; Row spacing x Variety: 28.63			

In the study, row spacing, variety, and row spacing x variety interaction were found to be significant at the 5% level for seed yield (Table 3). Concerning row spacing, the highest seed yield was observed at 30 cm with 132.9 kg da⁻¹, while the lowest seed yield was obtained at 20 cm with 98.1 kg da⁻¹. According to variety averages, the highest seed yield of 125.9 kg da⁻¹ was determined for the Servetağa variety, and the lowest seed yield was obtained from the Olein variety (103.6 kg da⁻¹). Regarding row spacing x variety interactions, the highest seed yield was calculated for the 30 cm x Göktürk interaction (138.1 kg da⁻¹), while the lowest seed yield was recorded for the 20 cm x Olein interaction (63.3 kg da⁻¹).

Seed yield is a parameter that can be affected by cultural practices and environmental conditions, as well as being a cultivar characteristic of safflower (Polat, 2007). Ozlem and Bilir (2017) reported values obtained from different row spacings in their studies as 1451.9 kg ha⁻¹ at 15 cm, 1997.1 kg ha⁻¹ at 30 cm, and 1875.9 kg ha⁻¹ at 45 cm, respectively. In research conducted by Gürsoy et al. (2018), considering values obtained from different row spacings, the lowest seed yield was recorded as 121.4 kg da⁻¹ for the 20 cm x Ayaz interaction, while the highest value was determined as 157.7 kg da⁻¹ for the 20 cm x Ayaz interaction. In another study focused on different row spacings as the sole variable, seed yield was found to be 146.2

kg da⁻¹ at 15 cm, 144.3 kg da⁻¹ at 30 cm, and 105.4 kg da⁻¹ at 45 cm (Erpay, 2022). In a study conducted by Sefaoğlu (2017), it was reported that as planting distances increased, the decrease in seed yield due to increased soil evaporation was more pronounced compared to denser planting. Therefore, practices such as the appropriate row spacing and plant density per unit area are of utmost importance for seed yield.

On the other hand, one of the main reasons for the low yield of safflower, which has difficulty competing with other oilseed crops such as sunflower, canola, and soybean, is that the average safflower yield in our country is around 90 kg da⁻¹. With breeding efforts and cultural practices such as appropriate planting frequency, it is expected that safflower yield will increase day by day (Bayramin, 2006). The seed yield values in this study partially align with the findings of the researchers mentioned above, but the responses to different row spacings have shown variation. Row spacings increased from 20 cm to 30 cm, and decreases in yield were observed at 40 cm.

Pearson's Correlation Estimation

Table 9. Pearson's correlation estimation between agricultural traits in some safflower varieties cultivated under dry conditions and different row spacing.

	PH	FBH	NB	NH	SY
PH	1				
FBH	0.706**	1			
NB	0.487**	0.082	1		
NH	0.380	0.392*	0.530**	1	
SY	0.477*	0.564**	0.378	0.689**	1

* p < 0.05, ** p < 0.01 (PH: Plant height, FPH: First plant height, NB: Number of branch, NH: Number of head, SY: Seed Yield)

Pearson's correlation estimation (Table 9) showed that plant height had a significant positive correlation with the first plant height (r= 0.706**), the number of branch per plant (r= 0.487**) and seed yield (r= 0.477*). The first plant height showed a significant positive correlation with the number of head per plant (r= 0.392*), seed yield (r= 0.564**). The number of branch per plant showed a highly significant positive correlation with the number head per plant (r= 0.530**). The number of head per plant had a highly significant positive correlation with seed yield (r= 0.689**).

Principal Components Analysis

The principal component (PC) axes, eigenvalues, variation, and cumulative variation ratios were obtained as a result of Principal Component Analysis (PCA) and factor coefficients indicating the weight values of principal components based on traits are presented in detail in Table 10. As a result of the analysis, 3 independent principal component axes were obtained concerning the 5 traits examined. The eigenvalues of the first 3 basic components were found from 0.74 to 3.06. The first principal component axis accounts for 61.23% of the total variation. The second and third principal components cover 21.07% and 14.86% of the total variation, respectively (Table 10).

Table 10. Eigenvalue, variation and principal component axes of the traits examined as a result of principal component analysis

Eigenvalue	3.06	1.05	0.74
Variation (%)	61.23	21.07	14.86
Cumulative Variance (%)	61.23	82.30	97.16
Traits	PC1	PC2	PC3
Plant height	0.44	0.17	0.71
First plant height	0.39	0.71	0.02
Number of branch	0.38	-0.66	0.34
Number of head	0.50	-0.19	-0.44
Seed Yield	0.51	-0.00	-0.44

It is known that the features examined in principal component analysis have significant weight when the weight values in the components are 0.6 and above (Jeffers, 1967). As a result of the analysis, the first plant height and the number of head per plant were determined as features with high factor coefficients on the second PC axis, which covers 21.07% of the total variation. The third PC axis represents only the plant height feature. In order for the biplot plot to adequately explain the total variation, the total principal component ratio must be greater than 50% (Kroonenberg, 2016). In this study, this value was 61.23%. A loading plot graph was created for the evaluation of 3 safflower varieties with 3 different row spacing using PC1 and PC2 components (Figure 2). A score plot was created to evaluate 3 safflower varieties with 3 different row spacing using PC1 and PC2 components (Figure 3). It was reported that if the angle between the vectors in the figure is $<90^\circ$, there is a positive relationship, if it is $>90^\circ$, there is a negative relationship, and if the angle between the vectors is 90° , there is no significant relationship (Seymen et al., 2019). Plant height, first branch height, number of head and number of branch when the angle is less than 90° (Figure 2). Accordingly, there is a positive relationship between plant height and first branch height, and between the number of branch and the number of head. The results observed in the loading plot graph (Figure 2) and the results in the Pearson's correlation estimation (Table 9) largely support each other. The stability of the safflower varieties with different row spacings in terms of agricultural traits are given in Figure 3. While the varieties to the right of the line that represents the average agricultural traits according to the average center of the coordinates and cuts the axis in the middle gave higher data than the average, the varieties to the left gave lower data than the average. Genotypes close to the line that crosses the origin horizontally are also considered the most stable genotypes (Karaman, 2019). Accordingly, the 30*Göktürk variety is the interaction closest to the stability line, the lowest results were obtained from the 40*Olein and 20*Göktürk interactions, and good results were obtained from the other interactions.

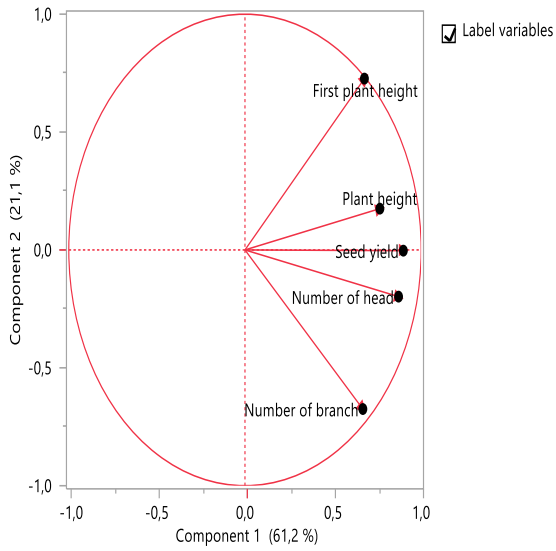

Figure 2: Loading plot graph obtained from PC1 and PC2 as a result of PCA

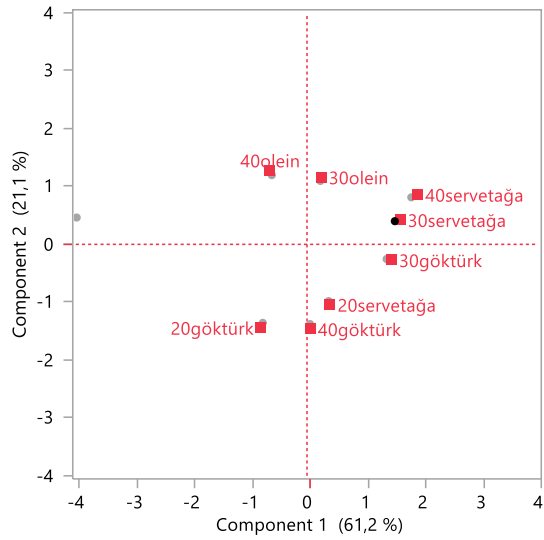

Figure 3: Score plot graph obtained from PCA result PC1 and PC2

CONCLUSIONS

In this study conducted under dry conditions in Ölmez District, which is located in Altınekin District of Konya Province, with the aim of determining the agricultural characteristics of different row spacings in some safflower varieties, the best overall results in terms of the examined characteristics were obtained from the Göktürk variety at a spacing of 30 cm. Particularly, research on the appropriate row spacing for the safflower plant, which can be cultivated in dry areas, is of great importance since it directly affects seed yield. Conducting experiments in different climates and soil conditions, especially in locations with higher rainfall and for a minimum duration of two years, is essential to improve seed yield and other agricultural parameters and to facilitate better interpretation.

REFERENCES

- Anonymous, 1993. *User's Guide to MSTAT-C*. Michigan State University U.S.A.
- Anonymous, 2009. *JMP User Guide*. 2nd Edt. Cary, NC: SAS Institute Inc.
- Arslan, H., Güler, D. 2022. The Effect of Different Row Spacing on Yield and Yield Components of Safflower (*Carthamus tinctorius* L.). *ISPEC Journal of Agricultural Sciences*, 6(2), 294-306.
- Atakan, M., 1992. A Research on The Yield and Yield Components of Different Varieties of Safflower (*Carthamus tinctorius* L.) under Kahramanmaraş Conditions, *Master's Thesis, Gaziantep University, Graduate School of Natural and Applied Sciences*, p. 58.
- Atan, M., Şahin, C. B., İşler, N. 2019. Determination of Yield, Yield Components and Oil Content of Different Safflower Varieties Grown under Hatay Conditions. *KSU J. Agric Nat* 22(5):678-684.
- Aydın, O. 2012. The Effect of Different Sowing Densities on Yield and Quality of Safflower (*Carthamus tinctorius* L.), *Master's thesis, Selçuk University, Graduate School of Natural and Applied Sciences*, p.41.
- Bayramin, S. 2006. Safflower (*Carthamus tinctorius* L.) –Rapeseed (*Brassica napus* spp. *oleifera* L.) Cultivation and Breeding. *Biotech Studies*, 15(1-2), 74-85.
- Dajue, L., Mündel, H. H. 1996. Safflower, *Carthamus tinctorius* L (Vol. 7). *Biodiversity International*.
- Emongor, V. E., Emongor, R. A. 2023. Safflower (*Carthamus tinctorius* L.). In *Neglected and Underutilized Crops* (pp. 683-731). Academic Press.
- Eryiğit, T., Yıldırım, B., Kumlay, A. M., Sancaktaroğlu, S. 2015. The Effects of Different Row Distances and Nitrogen Fertilizer Rates on Yield and Yield Components Of Safflower (*Carthamus tinctorious*) under Micro-Climate Conditions of Iğdır Plain-Turkey. In *3rd International Conference on Biological, Chemical & Environmental Sciences (BCES-2015) Sept.* pp. 21-22.
- Ercan, A., 2022. Effects of Different Row Spacings on the Yield and Yield Components of Safflower (*Carthamus tinctorius* L.) Cultivars. *Master's thesis, Selçuk University, Graduate School of Natural and Applied Sciences*, p.81.
- Gilbert, J., Knights, S. E., Potter, T. D. 2008. International Safflower Production-an Overview. In *International Safflower Conference. Australian Oilseeds Federation. Wagga Wagga, Australia*.
- Gürsoy, M., Başalma, D., Nofouzi, F. 2018. Effects of Safflower Cultivars (*Carthamus tinctorius* L.) on Yield and Yield Components of Different Row and Row Spaces. *Selçuk Journal of Agriculture and Food Sciences*, 32(1), 20-28.
- Hussain, M. I., Lyra, D. A., Farooq, M., Nikoloudakis, N., Khalid, N. 2016. Salt and Drought Stresses in Safflower: A Review. *Agronomy for sustainable development*, 36, 1-31.

Ivanova, R., Mascenco, N., Bejinari, M. 2017. Influence of Row Spacing and Bio-Regulators Application on Safflower Yield. *Scientific Papers Series A. Agro*, 23, 281-286.

Jeffers, J. N. 1967. Two Case Studies in The Application of Principal Component Analysis. *Journal of the Royal Statistical Society: Series C (Applied Statistics)*, 16(3), 225-236.

Karaman, M. 2019. The Evaluation Terms of Agricultural Properties of Some Bread Wheat (*Triticum aestivum L.*) Genotypes in Irrigated Conditions, *Turkish Journal Of Agricultural And Natural Sciences* , 6(2): 296-304.

Kaya, M., Bayramin, S., Kulan, E., Özaşık, İ., 2015. Performance of Some Improved Safflower Lines Under Eskişehir Conditions .*Journal of Agricultural Faculty of Uludag University* , 29, 1, 57-65.

Köse, A., Bilir, Ö. 2017. The Effect of Different Row Spacing and Sowing Rate of Petal Yields and Some Agronomic Characters in Safflower (*Carthamus tinctorius L.*). *Turkish Journal of Agricultural and Natural Sciences*, , 4(1), 40-47.

Kose, A., Bilir, O. 2017. The Influence of Row Spacing and Seeding Rate on Yield and Yield Components of Safflower (*Carthamus tinctorius L.*). *Journal of Field Crops Central Research Institute*, 26(1), 45-52.

Kroonenberg P.M., 2016. Introduction to biplot for G x E tables. Department of Mathematics. Research Report5. Available from: <http://three-mode.leidenuniv.nl/document/biplot.pdf>.

Moghaddasi M.S., Omid A.H. 2015. Determination of optimum row-spacing and plant density in Goldasht safflower variety. 46 *Scientific Papers, Series A. Agronomy*, Vol. LVIII, 301-306.

Öztürk, Ö., Ada, R., Akınerdem, F., 2009. Determination Of Yield And Yield Components Of Some Safflower Cultivars Under Irrigated and Dried Conditions. *Selcuk Journal of Agriculture and Food Sciences*, 23 (50): 16-27.

Sefaoglu, F. 2017. The Effects of Different Sowing Norms and Row Spacings on Yield and Yield Components of Safflower (*Carthamus tinctorius L.*). Doctoral dissertation, *Atatürk University Graduate School of Natural and Applied Sciences*, p. 149.

Sefaoglu, F., Özer, H. 2022. Response of Safflower (*Carthamus tinctorius L.*) to Planting Rate and Row Spacing in a High Altitude Environment. *Erciyes Journal of Agriculture and Animal Sciences*, 5(1), 1-10.

Seymen, M., Yavuz, D., Dursun, A., Kurtar, E. S., Türkmen, Ö. 2019. Identification of drought-tolerant pumpkin (*Cucurbita pepo L.*) genotypes associated with certain fruit characteristics, seed yield, and quality. *Agricultural Water Management* 221, 150-159.

Uysal, N., Baydar, H., Erbaş, S., 2006. Uysal, N., Baydar, H., Erbaş, S., 2006. Determination of Agricultural and Technological Properties of Safflower (*Carthamus tinctorius L.*) Lines Developed from Isparta Population. *University of Süleyman Demirel, J. Faculty Agric.* 1(1): 52-63.

Velasco, L., Fernandez-Martinez, J. M. 2001. Breeding for Oil Quality in Safflower. In *Proceedings of the 5th International Safflower Conference, Williston, North Dakota and Sidney, Montana, USA, 23-27 July, 2001. Safflower: a multipurpose species with unexploited potential and world adaptability* (pp. 133-137). Department of Plant Pathology, North Dakota State University.

Yılmaz, A., Yılmaz, H., Arslan, Y., Çiftçi, V., Baloch, F. 2021. Status of Alternative Oilseed Crops in Our Country. *European Journal of Science and Technology Special Issue*, (22), 93-100.

Weiss, E. A. 2000. Safflower. In *Oilseed Crops*. Blackwell Science, London. p. 12.

**COMPARISON OF TOTAL PHENOLIC AND TOTAL FLAVONOID CONTENTS
OF BOTH AQUEOUS AND METHANOLIC EXTRACTS OF *MARRUBIUM
VULGARE L.***

Dilek GÜNEY¹, Aslı Can AĞCA ², Murat KOÇ²

¹Bayat Devlet Hospital, Unit of Traditional, Complementary and Integrative Medicine, Bayat, Türkiye.

²Ankara Yıldırım Beyazıt University, Public Health Institute, Department of Traditional, Complementary and Integrative Medicine, Ankara, Türkiye.

ABSTRACT

Marrubium vulgare L. is a member of the Lamiaceae family, which is significant in medicine. It was defined by Paracelsus as the “doctor of the lung”. Traditionally; it was applied externally to treat skin conditions as well as ingested for disorders of the mouth, respiratory system, and digestive system, jaundice, menstrual pain and as a stimulant. In the past, In Tunisia, this plant is used to treat hypertension, diabetes, and heart disease; in Mexico, its decoction is known for its antidiabetic properties. In our country, it is traditionally used as a diuretic, carminative, pain killer, antipyretic, and appetite stimulant. The major compounds of the plant are known to be the phenolic compounds and flavonoids, which are categorized as natural sources of antioxidants and the goal of this study is to determine the total phenolic and total flavonoid contents of both aqueous and methanol extracts of aerial parts of *M. vulgare L.*

Total phenolic content was calculated by using the Folin Ciocalteu method. The absorbance of the samples was measured at 750 nm using a spectrophotometer. The results were given as gallic acid equivalents. The total flavonoid content was measured using the aluminum chloride colorimetric method and was calculated as quercetin equivalent. The absorbance of the mixtures was measured at 415 nm in a spectrophotometer.

In conclusion; it was determined that the methanolic extract of the aerial part of the plant had a higher phenolic content (38.60 mg ± 4.8 mg GAE/g) than the aqueous extract (27.83 mg± 4.61mg GAE/g). On the other hand, it was determined that the aqueous extract of the plant (4.02 mg± 0.1mg QE/g) had a higher total flavonoid content than the methanol extract (3.25 mg ± 0.19mg QE/g).

Keywords: *Marrubium vulgare L.*, total flavonoid, total phenol content

INTRODUCTION

M.vulgare L belongs to the medicinally important family Lamiaceae. *Marrubium L* genus has total of 23 taxons in our country. Since 14 of them are endemic and their endemic rate is high, so they are valuable in terms of genetic diversity (Bakış, Babac, & Uslu, 2011). Originating Central Asia and the Mediterranean, this plant is common throughout the Americas, Central Europe, Australia and South Africa (Fleming, 2000). It spread along the Black Sea, Marmara, Aegean, Mediterranean, Southeast, and Central Anatolia coasts in our country and commonly found in the provinces of Amasya, Antalya, Balıkesir, Bursa, Çanakkale, Denizli, Eskişehir, Hatay, İçel, İzmir, Karabük, Konya, Manisa ve Şanlıurfa (Bakış, Babac, & Uslu, 2011). Among the people, names such as ‘gray grass, Karaderme, false nettle, dog grass, dog fly, kukas grass and mayasıl grass,, are given (Baytop, 1994). Scientific studies have also established the effects of the plant, which have been widely used historically and culturally. These effects include anti-inflammatory, analgesic, antinociceptive, antiedematous,

antispasmodic, gastroprotective, antihypertensive, hepatoprotective, antioxidant, antihyperlipidemic, antimicrobial, anticancer, immunomodulation, parasitic, antiprotozoal, and neuroprotective. (Bühning, 2005; Fleming, 2000; transl. Beck, 2005; Lodhi, Vadenere, & Sharma, 2017).

Phytochemicals are bioactive substances produced by the secondary metabolism of plants that are not edible but have health benefits (Demir & Akpınar, 2020). The major compounds of this plant are known to be the phenolic compounds and flavonoids, which are recognized secondary compounds, have a significant impact on the antioxidative pathway. It shows this effect by neutralizing free radicals and as a positive potentiator (Demir & Akpınar, 2020; Pukalskas, Venskutonis, Salido, de Waard, & van Beek, 2012; Vanderjagt, Ghattas, Vanderjagt, Crossey, & Glew, 2002; Feyerer, 2021). This study was conducted to measure the *M. vulgare* L. aerial parts' total phenolic and total flavonoid contents of the methanol and aqueous extracts.

MATERIAL AND METHOD

Marrubium vulgare L. plant was collected during the vegetation period, the aerial parts were separated and dried under suitable conditions, and it was taken to Ankara Yıldırım Beyazıt University Herbarium with the barcode number Koç 3634. The dried samples were pulverized in the mill for processing.

Methanol and water extracts were prepared for each of the plants. To prepare the methanol extract, 10 g of a ground plant sample was added to 150 ml of MeOH and the extraction was carried out in an ultrasonic bath for 1 hour. After extraction, the methanol extract was filtered through filter paper and then the solvent was removed using a rotary evaporator. To prepare the water extract, 10 g of the ground plant and 150 ml of water were added and the extraction was carried out in an ultrasonic bath for 1 hour. Then the water extract was filtered and frozen and the water removed by lyophilization. All extracts were stored at +4 °C until analysis.



Figure 1. Methanol and water extracts of *Marrubium vulgare* L.

Total phenolic content was calculated by using the Folin Ciocalteu method(modified) (Kabach, Mrid, Bouchmaa, Bouargaine, & Nhiri, 2010). 150 ml of (2% Na₂CO₃) Sodium carbonate and 100 ml of extract were combined with 250 ml of the Folin-Ciocalteu reagent.

After being vortexed, the mixture was left at room temperature for 30 minute. The absorbance of the samples was measured at 750 nm using a spectrophotometer. A calibration curve for gallic acid was created using various gallic acid concentrations (0.1, 0.5, 5, 10, 25, 50, 75, 100, 125, 250, 500), and the equation $Y = 0.0018X - 0.0056$ (R^2 determined = 0.9996) was used to calculate the amount of phenolic compounds in the extracts as acid equivalents (mg GAE/g).

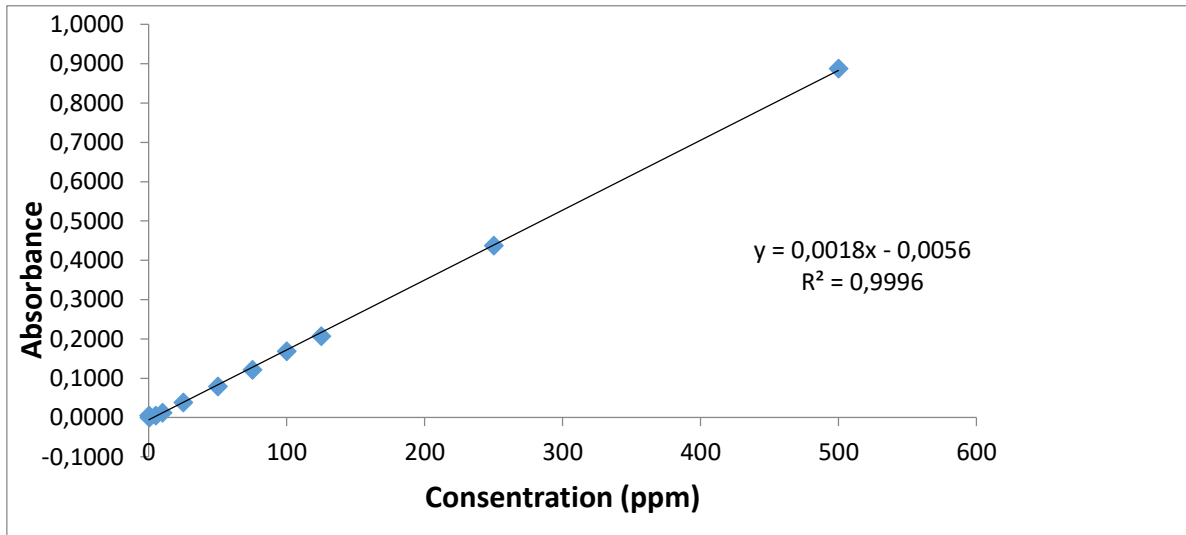

Graphic 1. Gallic acid calibration curve

The total flavonoid content was measured using the aluminum chloride colorimetric method (modified) and was calculated as quercetin equivalent (Khaled-Khodha, Boulekbache-Makhlouf, & Madani, 2014). The following ingredients were combined with 200 μ l of extract; 600 μ l ethyl alcohol, 200 μ l aluminum chloride, 200 μ l sodium acetate, and 2 ml distilled water. After being vortexed, the mixture was left to cool for 30 minutes. Different quercetin concentrations (0.1, 0.5, 5, 10, 25, 50, 75, 100, 125, 250, 500) were used to generate the quercetin calibration curve, and the flavonoid content of the extracts was converted to quercetin equivalent using the equation $Y = 0.0027X - 0.0098$ ($R^2 = 0.9998$) (mg of QE/g). The absorbance of the mixtures was measured at 415 nm.

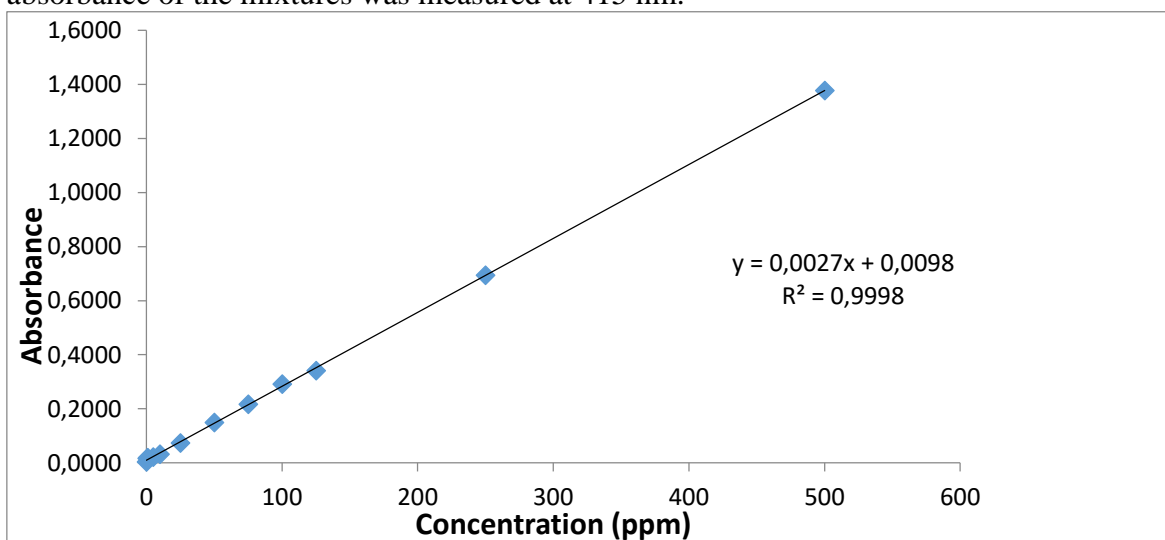

Graphic 2. Quercetin calibration curve

RESULTS AND DISCUSSION

The results of the study with repeated measurements are as shown in the tables;

Table 1. Results of total amount of phenolic content

Total Phenol Experiment									
Control	A. Measure	A. Blank	A. Sample	x (µg/ml)	X(mg/ml)	Equivalent of the Gallic acid (mg GAE/g)	Average (mg GAE/g)	STD EV	KTF±SD
<i>Marrubium vulgare</i> -MeOH	0,122	0,067	0,055	33,440	0,033	33,44	38,60	4,80	38,60±4,80
<i>Marrubium vulgare</i> -MeOH	0,121	0,055	0,065	39,450	0,039	39,45			
<i>Marrubium vulgare</i> -MeOH	0,122	0,051	0,072	42,918	0,043	42,92			
<i>Marrubium vulgare</i> -Aqueous	0,103	0,067	0,035	22,718	0,023	22,718	27,83	4,61	27,83±4,61
<i>Marrubium vulgare</i> -Aqueous	0,102	0,055	0,047	29,112	0,029	29,112			
<i>Marrubium vulgare</i> -Aqueous	0,102	0,051	0,051	31,665	0,032	31,665			

Table 2. Result of Total amount of flavonoid content

Total Flavonoid Experiment									
Controll	A.Measure	A. Blank	A. Sample	x (µg/ml)	X(mg/ml)	Equivalent of the Quercetin (mgQE/g)	Average (mgQE/g)	STD EV	KTF±SD
<i>Marrubium vulgare</i> -MeOH	0,083	0,065	0,018	3,035	0,003	3,04	3,25	0,19	3,25±0,19
<i>Marrubium vulgare</i> -MeOH	0,081	0,062	0,019	3,403	0,003	3,40			
<i>Marrubium vulgare</i> -MeOH	0,082	0,063	0,019	3,309	0,003	3,31			
<i>Marrubium vulgare</i> -Aqueous	0,086	0,065	0,021	4,004	0,004	4,00	4,02	0,10	4,02±0,10
<i>Marrubium vulgare</i> -Aqueous	0,083	0,062	0,020	3,937	0,004	3,94			
<i>Marrubium vulgare</i> -Aqueous	0,084	0,063	0,021	4,126	0,004	4,13			

As a result, the methanolic extract obtained from the aerial part of *Marrubium vulgare* L. had a richer phenolic content (38.60 mg ± 4.8 mg GAE/g) than the aqueous extract. The total phenolic content of the aqueous extract (27.83 mg± 4.61mg GAE/g) was measured. However, it was obtained that the aqueous extract (4.02 mg± 0.1mg QE/g) had a higher total flavonoid content than the methanol extract (3.25 mg ± 0.19mg QE/g).

Table 1. Comparison of total phenolic and total flavonoid contents of both aqueous and methanolic extracts of *Marrubium vulgare* L.

<i>Marrubium vulgare</i> L.	Total amount of phenolic content	Total amount of flavonoid content
Aqueous extract	27.83 mg± 4.61mg GAE/g	4.02 mg± 0.1mg QE/g
Methanol extract	38.60 mg ± 4.8 mg GAE/g	3.25 mg ± 0.19mg QE/g

CONCLUSIONS

With sales of more than 146 million USD in the USA in 2018, *Marrubium vulgare* L, a plant with a great potential and widespread use, is also the one of the most popular herbal dietary supplement (Sağlam, 2019). It is important to evaluate this plant, which has a wide distribution in our country and has antioxidative activity.

REFERENCES

- Bakış, Y., Babac, M., & Uslu, E. (2011, May). *Updates adn improvements of Turkish Plants Data Service(TÜBİVES). In Proceedings of the 6 th international symposium on health informatics and bioinformatics (pp.136-144). Ieee.*
- Baytop, T. (1994). *Türkçe Bitki Adları Sözlüğü*. Ankara: Türk Dil Kurumu,s 52.
- Bühring, U. (2005). *Praxis-Lehrbuch der modernen Heilpflanzenkunde*. Stuttgart: Sonntag.
- Demir, T., & Akpınar, Ö. (2020). Biological activities of phytochemicals in plants. *Turkish Journal of Agriculture-Food Science and Technology*, 8(8), 1734-1746.
- Feyerer, G. (2021). *Padma Die Kraft tibetischer Pflanzenmedizin*. Basel: Synergia Verlag.
- Fleming, T. (2000). *PDR for herbal medicines* (s. 253). içinde New Jersey: USA: From Medical Economics Company.
- Kabach, I., Mrid, R., Bouchmaa, N., Bouargaine, Y., & Nhiri, A. (2010). Phytochemical screening, antioxidant and cytotoxic activities of *M. vulgare*. . *Int. J. Pharm. Res.*, 11, 338-345.
- Khaled-Khodha, N., Boulekbache-Makhlouf, L., & Madani, K. (2014). Phytochemical screening of antioxidant and antibacterial activities of methanolic extracts of some Lamiaceae. *Industrial crops and products*, 61, 41-48.

- Lodhi, S., Vadenere, G., & Sharma, V. (2017). Marrubium vulgare L.: A review on phytochemical and pharmacological aspects. *J. Intercult. Ethnopharmacol*, 6(4), 429-452.
- Pukalskas, A., Venskutonis, P., Salido, S., de Waard, P., & van Beek, T. (2012). Isolation, identification and activity of natural antioxidants from horehound (Marrubium vulgare L.) cultivated in Lithuania. *Food chemistry*, 130(3), 695-701.
- Sağlam, A. (2019). ABD'de bitkisel gıda takviyesi kullanımı ve bitkisel gıda takviyesi pazarına genel bir bakış. *Gıda ve Beslenme Dergisi*, yıl 2, sayı 5, s 38.
- transl. Beck, L. (2005). *Pedanius Dioscorides of Anazarbus (2005), De materia medica, Altertumswissenschaftliche Texte und Studien, Band 38*. Hildesheim: Olms- Weidmann.
- Vanderjagt, T., Ghattas, R., Vanderjagt, D., Crossey, M., & Glew, R. (2002). Comparison of the total antioxidant content of 30 widely used medicinal plants of New Mexico. *Life Sciences*, 70(9), 1035-1040.

EXPERIMENTS ON REVEALING EFFECTS OF DIFFERENT MEDIA STRENGTH, AND SUCROSE-DEPENDENT IN ADVENTITIOUS ROOT CULTURES OF RADISH (*Raphanus Sativus L.*)

Tugce OZSAN KILIC

Department of Horticulture, Faculty of Agriculture, Akdeniz University, Antalya, TURKEY

ABSTRACT

Radish (*Raphanus sativus L.*), one of the important vegetables of the *Cruciferae* family, has attracted attention due to its nutritional content and health-improving properties. The adventitious root culture technique not only supports the propagation of medicinally valuable plants but also offers an alternative method to harvest valuable bioactive components from plants. In the current study, hypocotyls obtained after germination of red and black radish seeds were used as explant material, the effect of MS basic medium at different strengths ($\frac{1}{4}$, $\frac{1}{2}$, $\frac{3}{4}$, and 1) and the effect of different amounts of sucrose (20, 25, 40 and 50 mg L⁻¹) on adventitious root formation were evaluated in terms of biomass formation. Within the framework of the results obtained, it is thought that adventitious root cultures of radish can be used as a complementary method in the large-scale production of valuable bio-compounds to be used in the pharmaceutical industry.

Keywords: *in vitro*, root cultures, medium strength, biomass

INTRODUCTION

Plants are used as a model system and a taxonomic marker for the discovery of new compounds. Increasing awareness of the health hazards and toxicity associated with the indiscriminate use of synthetic drugs has increased interest in the use of plants and plant-based medicines. The complex structure of the compounds and the high cost of chemicals make the synthesis of bioactive compounds a difficult process. However, the production of these compounds is also affected by some factors, such as the growing period of the plant and the season in which it is collected, species and variety differences, the plant being in a certain growth and development period, and the lack of adequate methods for the production and standardization of the plant (Ahmad et al., 2015).

As an alternative solution to such problems faced by the phytopharmaceutical industry, biotechnological approaches, especially plant tissue culture methods, attract a lot of attention. Since plant tissue culture methods offer a controlled supply of biochemicals independent of plant availability with consistent product quality, it is thought that they could provide a great potential to boost the conventional agriculture for the industrial-scale production of bioactive plant metabolites (Ramachandra Rao and Ravishankar, 2002; Ahmad et al., 2015). Plant cell, tissue, and organ culture techniques are promising techniques that have the potential to be used in obtaining valuable plant metabolites, including pharmaceuticals (Murthy et al., 2008; Ahmad et al., 2015). These techniques both provide a reliable source for plant-based pharmaceutical products and can be used for large-scale cultures of plant metabolites. The increasing commercial importance of secondary metabolites in recent years has led to great interest in the diversification of the production of bioactive plant metabolites through tissue culture technology. At this point, the adventitious root culture system provides an alternative approach for the improvement and development of plant-based pharmaceutical compounds (Ahmad et al., 2015).

Plant roots serve as a source of bioactive molecules, including a surprising variety of metabolites, agrochemicals, flavors, dyes, and fragrances (Fulzele et al., 2002). Recently, organ culture, especially adventitious root culture, has been applied to many medicinal plants due to their rapid growth as well as stable production of secondary metabolites of pharmaceutical and nutraceutical interest (Murthy et al., 2008). Adventitious roots induced under aseptic conditions in a suitable nutrient medium supplemented with plant growth regulators have a good growth rate and have a potential for accumulation and sustained production of secondary metabolites (Hahn et al., 2003).

Adventitious root formation is a complex process involving various endogenous and exogenous factors (Sorin et al., 2005). The adventitious root formation process is divided into four stages: (a) the pre-emergence stage of the root, which includes the molecular and biochemical process changes that occur prior to any cytological formation up to the emergence of primordial roots, (b) the early stage of root development, (c) the root growth stage (weight and volume increase) and (d) the final stage of root configuration (emergence of the first root) (Zhang et al., 2017). The initiation and differentiation process during the physiological stages of rooting can be triggered by changes in endogenous auxin concentrations and external addition of specific auxins (Praveen et al., 2009).

Adventitious roots show high stability, high growth rate, and continuous secondary metabolite production when stimulated in an aseptic artificial nutrient medium supplemented with optimal phytohormone (Hahn et al., 2003). These roots produce high amounts of alkaloids, terpenoids, and phenols in cell and tissue spaces and show high stability and growth rates; they can be easily produced in a suitable hormone-supplemented environment with a low amount of inoculum (Sivakumar et al., 2006). Adventitious root cultures also provide an experimental system to study the link between primary and secondary metabolism (Ahmad et al., 2015).

Radish (*Raphanus sativus* L.), one of the important vegetables of the *Cruciferae* family, is one of the functional foods that have an important place in meeting people's fresh vegetable needs and attracts attention with its nutritional content and health-improving properties (Akan et al., 2013) such as antibacterial, antioxidant, antimutagenic, hepatoprotective, nephroprotective, antidiabetic, anti-inflammatory activities (Rosés et al., 2023).

In the current study, hypocotyls obtained from red and black radish seeds germinated *in vitro* were used as starting material, and Murashige and Skoog (MS) basic medium at different strengths ($\frac{1}{4}$, $\frac{1}{2}$, $\frac{3}{4}$, and 1) and various amounts of sucrose (20, 25, 40 and 50 mg L⁻¹) were used to reveal their effect on adventitious root formation regarding biomass accumulation.

MATERIALS AND METHODS

The study was carried out in the Tissue Culture Laboratory of Akdeniz University, Faculty of Agriculture, and Department of Horticulture.

Explant and Media Preparation, Explant Culturing

Seeds of red and black radish cultivars were used in the study. Seeds of the cultivars were subjected to surface sterilization before being cultured. The seeds were first kept in 70% ethanol solution for 1 minute and then sterilized in 50% sodium hypochlorite solution for 12 minutes, and then, it was rinsed 3 times with sterile distilled water.

Sterilized seeds were cultured in MS (Murashige and Skoog, 1962) medium (MS0) containing 30 g L⁻¹ sucrose and 6 g L⁻¹ agar, without the addition of plant growth regulators, to germinate under *in vitro* conditions. Cultured seeds were incubated under 24±2 °C temperature and 16/8 hour light/dark photoperiod conditions. For seed germination under *in vitro* conditions, 15 glass jars with a volume of 660 mL were used for both cultivars, and 15 seeds were planted in each jar.

The 15-day-old hypocotyls from the germinated plantlets were used as starting material for the adventitious root culture study. Hypocotyls were cut into 0.5 - 1 cm pieces in a laminar flow and cultured in the combinations of media presented in Table 1 for the initiation of adventitious root cultures. For each cultivar, 90 mm 5 petri dishes/medium were used while 15 hypocotyl explants were cultured in each petri dish and the study was carried out in 3 replications.

Table 1. Media combinations used in the study

Media Codes	Media Combinations			
	MS	IBA (mg L ⁻¹)	Sucrose (g L ⁻¹)	Agar (g L ⁻¹)
1	¼	2	30	6
2	½	2	30	6
3	¾	2	30	6
4	1	2	30	6
5	¾	2	20	6
6	¾	2	25	6
7	¾	2	40	6
8	¾	2	50	6
Control	1	-	30	6

Establishing and Propagating of Adventitious Root Cultures

Adventitious root cultures were initiated with 2-month-old roots consisting of hypocotyl explants cultured in different combinations of media. Adventitious roots (0.15 - 0.20 g/petri) obtained from hypocotyls of black and red radish cultivars were inoculated into 100 mL conical flasks containing 30 mL of nutrient medium. The medium combinations used in the initiation of adventitious root cultures were used as liquid medium without adding agar for adventitious root propagation. Cultures were shaken at 130 rpm on an orbital shaker under dark conditions at 24±2°C for 4 weeks. Three subcultures with 4-week intervals were conducted in the study, and the weights of the proliferating adventitious roots at the end of each subculture were measured and recorded.

Statistical analysis

The experiments of the current study were conducted in three replicates with a completely random factorial design. The data obtained were made in the JMP package program and the differences between the averages were determined by the 'least significant difference' (LSD) test, and the differences were found to be statistically significant at the $p < 0.05$ level.

RESULT AND DISCUSSION

In this study, the effects of MS media of various strengths and sucrose at different concentrations on the initiation of adventitious root cultures and biomass accumulation in 2 different radish cultivars were evaluated (Figure 1 - 3).

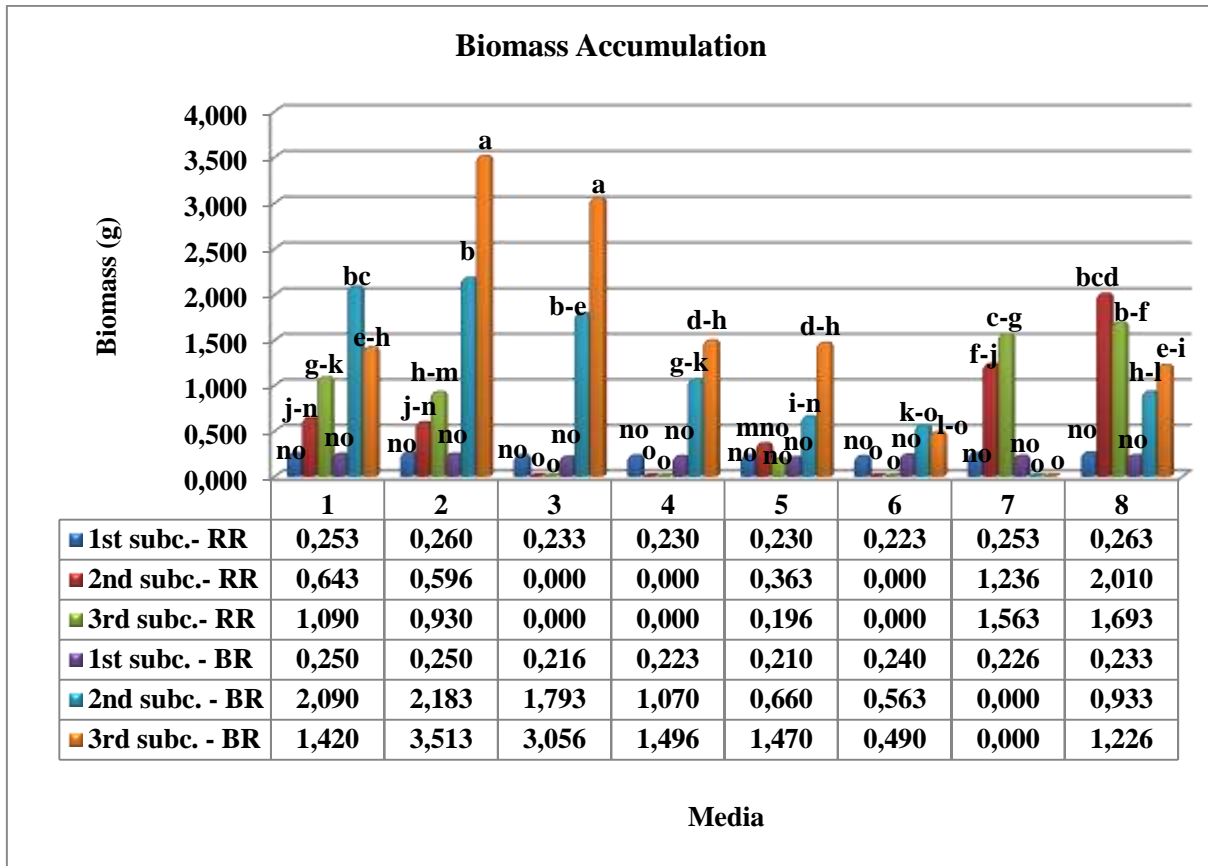

Figure 1. Biomass accumulation in radish cultivars regarding different media and subcultures (1): Different letters among cultivars, media and subcultures denote significant differences (LSD test, $p < 0.05$). (2): LSD cultivars* = 0.115; LSD media* = 0.231; LSD subculture* = 0.142*; (b) LSD cult. x media x subc.* = 0.568 (3): Abbreviations; subc.= subculture; RR = Red Radish; BR = Black Radish

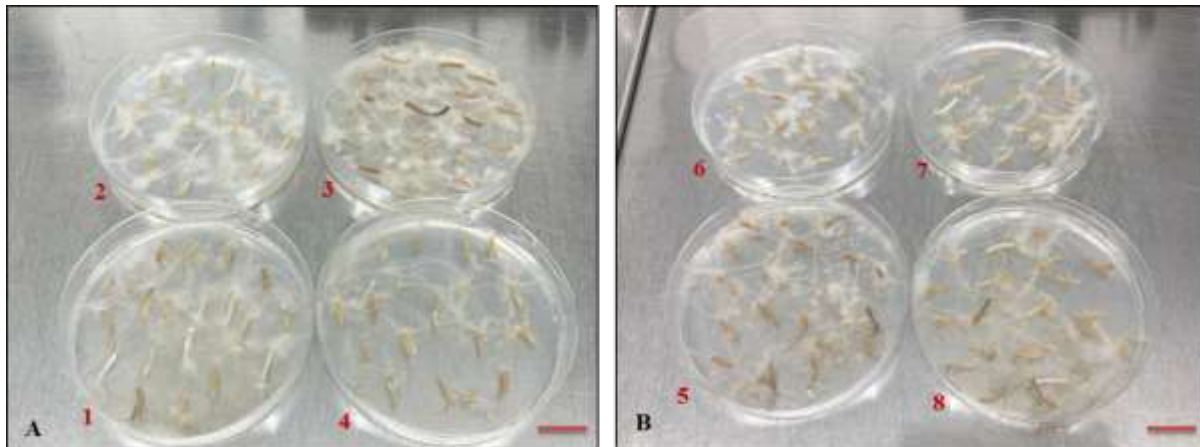

Figure 2. Adventitious root formation from hypocotyls of black (A) and red radish (B) cultivars in different media

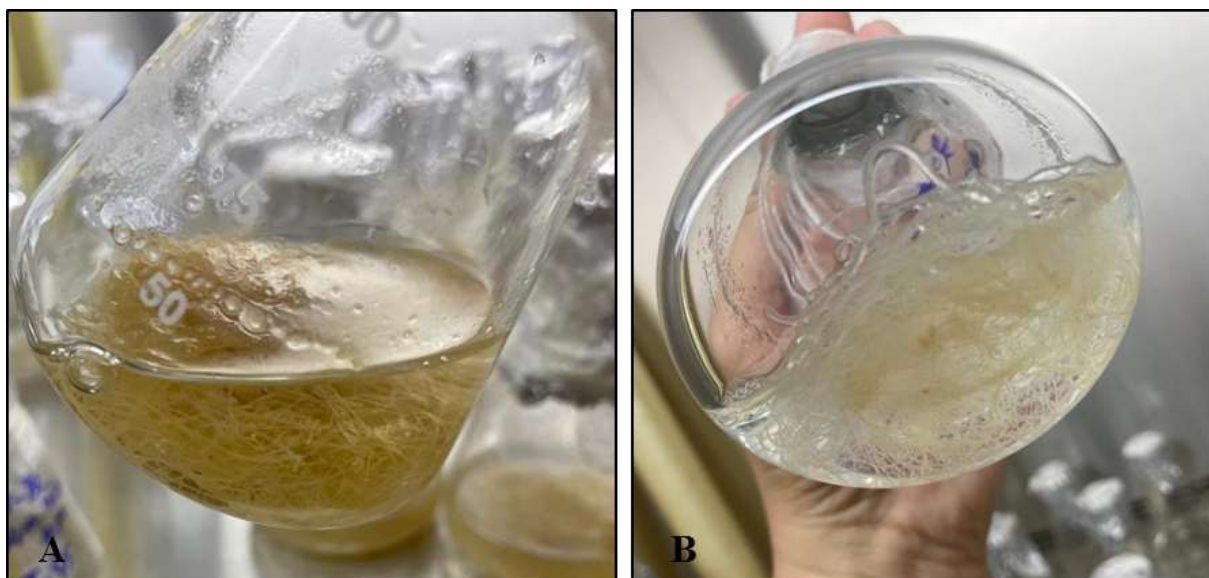

Figure 3. Adventitious root cultures of black (A) and red radish (B) cultivars in different media

According to the findings, statistical differences were determined regarding biomass accumulation between radish cultivars. The responses of the cultivars to adventitious root cultures were found to be different in terms of biomass accumulation, and it was observed that the black radish cultivar provided higher biomass accumulation than the red radish cultivar.

Differences were detected in terms of the nutrient media combinations evaluated. The combination of media in which the $\frac{1}{2}$ MS strength supplemented with 30 g L^{-1} sucrose (medium combination No. 2) gave the most positive value in terms of biomass accumulation, which was followed by the medium No. 8, contained $\frac{3}{4}$ MS strength and 50 g L^{-1} sucrose.

Among various plant cell and organ cultures, adventitious root culture is an alternative and complementary tool to whole plant cultivation to produce high-value phytochemicals (Hao and Guan, 2011; Baque et al., 2012b; Sivanandhan et al., 2013), a wide range of physiological It has a complex molecular process involving several factors (Sorin et al., 2005).

Previous studies have reported that auxins play a very important role in the adventitious root formation process, and that exogenous auxin applications as well as endogenous auxins are important in promoting the initiation and division of adventitious roots (Baque et al., 2009; Hussein et al., 2012). Indole butyric acid, IBA, is known as synthetic auxin and is among the first plant hormones used to increase root formation in plant stems (Deloso et al., 2020). For example, in a study, it was reported that IBA was more effective than IAA and NAA in stimulating adventitious roots from hypocotyl explants of *Psoralea coryfolia* (Baskaran and Jayabalan, 2009). In current study, IBA (2 mg L^{-1}) was used and had a positive effect on adventitious root development.

Success in adventitious root cultures is affected by various factors. As stated before, in addition to the effect of auxins, the salt strength of the medium, sucrose concentration, or explant type are among the determining factors for success in adventitious root cultures.

There are many studies showing that low salt strength may boost root induction and growth. Wu et al. (2006) found that *Echinacea angustifolia* adventitious roots required low levels of ambient salt strength for the production of root biomass. Baque et al. (2010) reported that a gradual decrease in fresh and dry weight was observed as the salt strength of the nutrient medium increased in the adventitious root culture study of *Morinda citrifolia*. Zhang et al. (2011) reported that a medium containing low salt strength provided a good performance in terms of induction and growth of adventitious root cultures of *Periploca sepium*. It is thought

that one reason why low salt strength produces positive results on root biomass in different plant species may be that low salt strength leads to a decrease in osmotic pressure in cultures, which may be suitable for root primordium induction and growth (Zhang et al., 2011). Another possible reason is that favorable interactions between nutrients in low salt strength cultures make it easy ions to reach to the roots (Wu et al., 2006).

In vitro plantlets require carbon sources in their artificial media for biological processes such as survival, growth, development and accumulation of bioactive compounds under aseptic and controlled conditions. Carbohydrates are an important source of carbon and energy in plant cell and organ cultures. Sugar added to the culture medium not only acts as a carbon source but also plays a role in the osmotic regulation of water stress (Hilae and Te-chato, 2005). The growth rate of biomass is directly associated with sugar consumption. It is thought that the increase in growth in adventitious roots may be due to the adventitious roots needing high sucrose for growth at the differentiation stage and structural integrity (Tremblay and Tremblay, 1995). Muthoharoh et al. (2019) investigated the effects of different sugar types and concentrations on root biomass in *in vitro* adventitious root culture of *Gynura procumbens* (Lour) Merr. Researchers obtained the highest fresh root biomass when 5% and 3% sucrose were used as carbon sources, respectively. Similarly, Manuhara et al. (2017) reported that an increase in fresh root weight was observed by increasing sucrose concentration, and the highest root weight value was obtained with the use of 5% sucrose. In another study, Ahmad et al., (2021) reported that there was an increase in biomass accumulation in stevia (*Stevia rebaudiana*) by adding a sucrose concentration as high as 50 g L⁻¹ to the growing medium.

In an adventitious root culture study conducted by Adil and Abbasi (2019) in leaf cabbage (*Brassica oleracea* var. *acephala*) they found that the sucrose concentration significantly affected the adventitious root formation. Researchers, who revealed maximum adventitious root formation in MS medium supplemented with 40 g L⁻¹ concentration of sucrose, reported that increasing the sucrose concentration to a level higher than 40 g L⁻¹ adversely affected adventitious root formation in cotyledon explants. Similar results were reported by Wang and Weathers (2007) on *Artemisia annua* L. and by Baque et al. (2012a) on the plant *Morinda citrifolia* (L.).

Different explants, including leaves, stems, petioles, roots, and hypocotyl parts, can be used for the induction of adventitious roots *in vitro* in many industrially important plant species (Paek et al., 2009; Sharma et al., 2013; Kawakami et al., 2015; Khan et al., 2015; Khan et al., 2017; Saeed et al., 2017). For this reason, it is thought that the different results obtained in terms of biomass in adventitious root cultures of various plant species may be also due to differences in species, varieties, and explants.

CONCLUSION

In light of the results obtained from the study, differences were determined among the cultivars. Decreasing the MS strength to a certain extent or increasing the sucrose concentration added to the medium with decreasing MS strength led to an increase in the biomass obtained from adventitious root cultures in radish. Considering that adventitious root cultures are an important alternative method for producing high-value phytochemicals, it is thought that within the framework of the results obtained, adventitious root cultures of radish can be used as a complementary method in the large-scale production of valuable phytochemicals to be used in different industries such as pharmaceutical industry.

REFERENCES

- Adil, M., Abbasi, B.H. 2019. Adventitious roots formation for enhanced and sustainable production of antioxidants in *Brassica oleracea* var. *acephala* (*Brassicaceae*). International Journal of Secondary Metabolite, 6(2):162-171. <https://dx.doi.org/10.21448/ijsm.530027>
- Ahmad, N., Fatima, N., Ahmad, I., Anis, M. 2015. Effect of PGRs in adventitious root culture *in vitro*: present scenario and future prospects. Rend. Fis. Acc. Lincei, 26:307-321. DOI: 10.1007/s12210-015-0445-y
- Ahmad, N., Rab, A., Sajid, M., Ahmad, N., Fazal, H., Ali, M., Egertsdotter, U. 2021. Sucrose-dependent production of biomass and low-caloric steviol glycosides in adventitious root cultures of *Stevia rebaudiana* (Bert.). Industrial Crops & Products, 164:113382. <https://doi.org/10.1016/j.indcrop.2021.113382>
- Akan, S., Veziroğlu, S., Özgün, Ö., Ellialtıoğlu, Ş. 2013. Turp (*Raphanus sativus* L.) Sebzesinin Fonksiyonel Gıda Olarak Değerlendirilmesi. YYÜ TAR BİL DERG, (YYU J AGR SCI), 23(3):289-295.
- Baque, M.A., Elgirban, A., Lee, E.J., Paek, K.Y. 2012a. Sucrose regulated enhanced induction of anthraquinone, phenolics, flavonoids biosynthesis and activities of antioxidant enzymes in adventitious root suspension cultures of *Morinda citrifolia* (L.). Acta physiologia Plantarum, 34:405-415.
- Baque, M.A., Hahn, E.J., Paek, K.Y. 2009. Induction Mechanism of Adventitious Root From Leaf Explants of *Morinda citrifolia* as Affected by Auxin and Light Quality. *In Vitro Cell. Dev. Biol.*– Plant, 46:71-80.
- Baque, M.A., Lee, E.J., Paek, K.Y. 2010. Media salt strength induced changes in growth, physiology and secondary metabolite content in adventitious roots of *Morinda citrifolia*: the role of antioxidant enzymes and phenylalanine ammonia lyase. Plant Cell Rep., 29:685-694. <https://doi.org/10.1007/s00299-010-0854-4>
- Baque, M.A., Moh, S-H., Lee, E-J., Zhong, J-J., Paek, K-Y. 2012b. Production of biomass and useful compounds from adventitious roots of high-value added medicinal plants using bioreactor. Biotechnol Adv., 30:1255-1267.
- Baskaran, P., Jayabalan, N. 2009. Psoralen Production in Hairy Roots and Adventitious Roots Cultures of *Psoralea coryfolia*. Biotechnol. Lett., 31:1073-1077.
- Deloso, B.E., Lindström, A.J., Camacho, F.A., Marler, T.E. 2020. Highly Successful Adventitious Root Formation of *Zamia* L. Stem Cuttings Exhibits Minimal Response to Indole-3-Butyric Acid. Hortscience, 55(9):1463-1467. <https://doi.org/10.21273/HORTSCI15212-20>
- Fulzele, T.B., Satdive, R.K., Pol, B.B. 2002. Untransformed root cultures of *Nothapodytes foetida* and production of camptothecin. Plant Cell Tissue Organ Culture, 69:285-288.
- Hahn, E.J., Kim, Y.S., Yu, K.W., Jeong, C.S., Paek, K.Y. 2003. Adventitious root cultures of *Pranax ginseng*, Meyer CA and ginsenoside production through large scale bioreactors systems. J Plant Biotechnol., 5:1-6.

Hao, J-P., Guan, Q. 2011. Synthesis of saikosaponins in adventitious roots of *Bupleurum chinense* by semi-continuous culture. *Plant Cell Tiss Organ Cult.*, 108:159-165.

Hilae, A., Te-chato, S. 2005. Effects of carbon sources and strength of MS medium on germination of somatic embryos of oil palm (*Elaeis quineensis* Jacq.). *Songklanakarin J. Sci. Technol.*, 27(3):629-635.

Hussein, S., Pick Kiong Ling, A., Ng, T.H., Ibrahim, R., Paek, K.Y. 2012. Adventitious Roots Induction of Recalcitrant Tropical Woody Plant, *Eurycoma longifolia*. *Romanian Biotechnological Letters*, 17(1):7026-7035.

Kawakami, H., Hara, K., Komine, M., Yamamoto, Y. 2015. Production of secoiridoids by adventitious root culture of *Swertia japonica*. *In vitro Cell. Dev. Biol. Plant*, 51:524-529.

Khan, M.A., Abbasi, B.H., Shah, N.A., Yücesan, B., Ali, H. 2015. Analysis of metabolic variations throughout growth and development of adventitious roots in *Silybum marianum* L. (Milk thistle) a medicinal plant. *Plant Cell Tiss. Org. Cult. (PCTOC)*, 123:501-510.

Khan, T., Abbasi, B.H., Ali Khan, M.A., Azeem, M. 2017. Production of biomass and useful compounds through elicitation in adventitious root cultures of *Fagonia indica*. *Industrial Crops & Products*, 108:451-457. <http://dx.doi.org/10.1016/j.indcrop.2017.07.019>

Manuhara, Y.S.W., Kusuma, D.Y., Sari, R.L.K, Kristanti A.N. 2017. Biomass production of *Gynura procumbens* adventitious roots in different type of liquid culture. *Biosaintifika: Journal of Biology & Biology Education*, 9(3):523-529. <https://doi.org/10.15294/biosaintifika.v9i3.9670>

Murashige, T., and Skoog, F. 1962. A revised medium for rapid growth and bio assays with tobacco tissue cultures. *Physiol. Plant*, 15:473-497.

Murthy, H.N., Dijkstra, C., Anthony, P., White, D.A., Davey, M.R., Powers, J.B., Hahn, E.J., Paek, K.Y. 2008. Establishment of *Withania somnifera* hairy root cultures for the production of Withanoloid. *A. J Integr Plant Biol.*, 50:915-981.

Muthoharoh, L., Faizah, H., Hardjo, P.H., Kristanti, A.N., Manuhara, Y.S.W. 2019. Effect of carbon source on biomass and flavonoid content of *Gynura procumbens* (Lour.) Merr adventitious root in liquid culture. *Biosciences Biotechnology Research Asia*, 16(1):121-127.

Paek, K.Y., Murthy, H.N., Hahn, E.J. 2009. Establishment of adventitious root cultures of *Echinacea purpurea* for the production of caffeic acid derivatives. *Methods Mol. Biol. (Clifton, N.J.)*, 547:3-16.

Praveen, N., Manohar, S.H., Naik, P.M., Nayeem, A., Jeong, J.H., Murthy, H.N. 2009. Production of andrographolide from adventitious root cultures of *Andrographis paniculata*. *Current Sci.*, 96:694-697.

Ramachandra Rao, S., Ravishankar, G.A. 2002. Plant cell cultures: chemical factories of secondary metabolites. *Biotechnol Adv.*, 20:101-153.

Rosés, C., Garcia-Ibañez, P., Agudelo, A., Viadel, B., Tomás-Cobos, L., Gallego, E., Carvajal, M., Milagro, F.I. and Barceló, A. 2023. Effects of Glucosinolate-Enriched Red Radish

(*Raphanus sativus*) on *in vitro* Models of Intestinal Microbiota and Metabolic Syndrome-Related Functionalities. ACS Omega 8 (26), 23373-23388. DOI: 10.1021/acsomega.2c08128

Saeed, S., Ali, H., Khan, T., Kayani, W., Khan, M.A. 2017. Impacts of methyl jasmonate and phenyl acetic acid on biomass accumulation and antioxidant potential in adventitious roots of *Ajuga bracteosa* Wall ex Benth., a high valued endangered medicinal plant. Physiol. Mol. Biol. Plants, 23:229-237.

Sharma, S.N., Jha, Z., Sinha, R.K. 2013. Establishment of *in vitro* adventitious root cultures and analysis of andrographolide in *Andrographis paniculata*. Nat. Prod. Commun., 8:1045-1047.

Sivakumar, G., Yu, K., Paek, K., 2005. Production of biomass and ginsenosides from adventitious roots of *Panax ginseng* in bioreactor cultures. Eng. Life Sci., 5:333-342. <https://doi.org/10.1002/elsc.200520085>.

Sivanandhan, G., Kapil Dev, G., Jeyaraj, M., Rajesh, M., Arjunan, A., Muthuselvam, M., Manickavasagam, M., Selvaraj, N., Ganapathi, A. 2013. Increased production of withanolide A, withanone, and withaferin A in hairy root cultures of *Withania somnifera* (L.) Dunal elicited with methyl jasmonate and salicylic acid. Plant Cell Tiss Organ Cult., 114:121-129.

Sorin, C., Bussell, J.D., Camus, I. 2005. Auxin and light control of adventitious rooting in *Arabidopsis* required ARGONAUTE1. Plant Cell, 17:1343-1359.

Tremblay, L., Tremblay, F.M., 1995. Maturation of black spruce somatic embryos: sucrose hydrolysis and resulting osmotic pressure of the medium. Plant Cell Tiss. Org. Cult., 42:39-46.

Wang, Y., Weathers, P. 2007. Sugars proportionately affect artemisinin production. Plant Cell Reports, 26:1073-1081.

Wu, C.H., Dewir, Y.H., Hahn, E.J., Paek, K.Y. 2006. Optimization of culturing conditions for the production of biomass and phenolics from adventitious roots of *Echinacea angustifolia*. J Plant Biol, 49:193-199.

Zhang, J., Gao, W-Y., Wang, J., Li, X-L. 2011. Effects of explant types and media salt strength on growth and secondary metabolite accumulation in adventitious roots of *Periploca sepium* Bunge. Acta Physiol Plant, 33:2447-2452. <https://doi.org/10.1007/s11738-011-0785-x>

Zhang, Z., Zou, D., Liu, M., Cong, M., Cheng, N., Gao, H., Wang, S., Liu, Z., Li, G. 2017. Induction of *Psammosilene tunicoides* adventitious roots and the accumulation of triterpenoid saponins as affected by culture conditions. Int. J. Agric. Biol., 19:1535-1540.

RECENT OBSERVATIONS ON *TURSIOPS TRUNCATUS* (DELPHINIDAE) AT THE SEA-CAGE FISH FARMS IN THE TURKISH AEGEAN SEA

Okan ERTOSLUK^{1*}, Okan AKYOL², Halil ŞEN³

¹Aydın Adnan Menderes University, Bozdoğan Vocational School, 09760 Aydın, Türkiye

²Ege University Faculty of Fisheries, Dept. of Fishing Tech., 35440 Urla, İzmir, Türkiye

³Ege University Faculty of Fisheries, Dept. of Aquaculture, 35440 Urla, İzmir, Türkiye

Corresponding author e-mail: okan.ertosluk@adu.edu.tr

ABSTRACT

This paper reports on the recent observations on *Tursiops truncatus* displaying the opportunistic feeding behaviour at a sea-cage fish farm in the Aegean Sea. On 27 March 2022, at least ten specimens of *Tursiops truncatus* were observed during the SCUBA diving beneath a sea-cage of a fish farm in Gerence Bay, İzmir at a depth of about 60 m. The dolphins were taken by an underwater camera video. For details, we interviewed with diver as a staff of the fish farm. Occasionally, during the cleaning of the dead reared fish bag at the bottom of the sea-cage, bottlenose dolphins and bluefin tunas (*Thunnus thynnus*) are retrieved together around the diver. A part of dolphins and bluefin tunas seem to be cooperatively fishing. Then, bluefin tunas swim in the lower layer, while dolphins swim in the epi-layer. Namely, dolphins outperform in the race for grabbing bait versus tunas. Additionally, dolphins push wild fish into the cage net in a coordinated manner, and then, rip them out of the net and eat them one by one.

Keywords: Bottlenose dolphin, bluefin tuna, feeding behaviour, SCUBA, İzmir

INTRODUCTION

Thirteen cetacean species are known to exist along the Turkish waters, of which 8 species among them are considered regular: *Delphinus delphis*, *Tursiops truncatus*, *Phocoena phocoena*, *Stenella coeruleoalba*, *Grampus griseus*, *Physeter macrocephalus*, *Ziphius cavirostris* and *Balaenoptera physalus* (Öztürk and Tonay, 2019). Among them, only *D. delphis* and *T. truncatus* are existed in all Turkish seas, while only three odontocete species (*D. delphis*, *T. truncatus*, and *P. phocoena*) occur in the Black Sea and the Sea of Marmara (Öztürk and Öztürk, 2002).

The bottlenose dolphin, *Tursiops truncatus* (Montagu, 1821) is pelagic, oceanodromous at a depth range of 0 - 1316 m (Palomares and Pauly, 2022). They are distributed in tropical and temperate waters of all oceans, as well as in semi-enclosed seas such as the Gulf of Mexico, the Gulf of California, and the Mediterranean, Black and Red Seas (Notarbartalo di Sciara, 2002). Specifically, it is the highest common cetacean in the Mediterranean Sea. Key areas of distribution include the Alboran, Balearic, Adriatic Seas, the Algerian coastal waters, Tunisia and Malta, the Aegean Sea, the Turkish straits system, and it is widely distributed along the Black Sea continental shelf as well, where, according to some authors it is represented by the sub-species *T. truncatus ponticus* (Notarbartalo di Sciara, 2002).

Today, the interaction between coastal marine mammals and anthropogenic-related activities along the coastline is increasing due to intensive settlements (i.e. urbanization) and some marine jobs (marine traffic, fisheries, mariculture, etc.). The sea-cage fish farms as an element of mariculture have been well-developed in the Mediterranean since the 1980s. Sea-

cages as floating structures can be a type of FADs (fish aggregation devices) and can ever serve as mega FADs (Dempster and Taquet, 2004; Sanchez-Jerez et al., 2007). Therefore, wild fish species (mostly pelagics) are attracted to fish farms. Probably, the primary attractive mechanism is food availability, either in the form of direct predation on stock, or an indirect trophic level in the form of farm waste (Fernandez-Jover et al., 2008; Barrett et al., 2018). As a secondary attraction effect (i.e. predation), wild fish populations around the sea-cage fish farms attract some sea mammals (Ceyhan et al., 2020). Beveridge (2001) stated that there was an enormous range of predatory species such as squid, fish, sea turtles, birds, and marine mammals at Mediterranean fish farms. These predators can kill or wound fish, damage equipment, resulting in losses through escapes (Beveridge, 2001).

Nowadays, some studies on predators (e.g. seabirds, seals and dolphins) near sea-cage fish farms have been documented (Güçlüsoy and Savaş, 2003; Nelson et al., 2006; Díaz López, 2006, 2017; Díaz López and Shirai, 2007; Gerovasileiou et al., 2017; Aguado-Giménez et al., 2018; Ceyhan et al. 2020). However, there are many unknown behaviours of marine mammals regarding anthropogenic-related activities that need explanation. The paper aims to contribute toward a more detailed understanding of the relationships between bottlenose dolphins and sea-cage fish farms in the Aegean Sea.

MATERIAL AND METHOD

On 27 March 2022, at least ten specimens of *Tursiops truncatus* (in Turkish, 'afalina' or 'şişe burunlu yunus' Figure 1) were observed during the SCUBA diving beneath a sea-cage of a fish farm in Gerence Bay, İzmir (Coordinates: 38°26' N - 26°27' E) at a depth of about 60 m. Opportunistic video recordings were made to document and verify group size, presence of immatures and behavioural interaction. Videos were taken by GoPro Hero 7 underwater camera. For details, we interviewed with diver, who is a staff of fish farm.



Figure 1. *Tursiops truncatus* and *Thunnus thynnus* (BFT) specimens beneath a sea-cage in Gerence Bay, İzmir (photo: G. Subakan)

RESULTS AND DISCUSSION

At least ten specimens of *Tursiops truncatus* were observed beneath a sea-cage fish farm in İzmir, northern Aegean Sea. According to G. Subakan (pers. comm.), *T. truncatus* were usually existing with 10-12 individuals grouping around the fish farm, all year round. It is obviously that *T. truncatus* swimming together with crowd groups in the Aegean Sea. Dolphins

(here *T. truncatus*) that come to fish farms to feed have gotten used to divers, swim with them and never harm the divers (G. Subakan, pers. comm.).

Occasionally, during the cleaning of the dead reared fish bag at the bottom of the sea-cage, bottlenose dolphins and bluefin tunas (*Thunnus thynnus*, BFT) are retrieved together around the diver. However, a part of dolphins chases BFT in coordination. Then, BFTs swim in the lower layer, while dolphins swim in the epi-layer. Namely, dolphins outperform in the race for grabbing bait versus BFTs. Additionally, dolphins push wild fish into the cage net in a coordinated manner, and then, rip them out of the net and eat them one by one. Rarely, dolphins can damage the net of a cage. Regarding to Subakan (pers. comm.), a few years ago, a dolphin entered in fish farm cage in Muğla region, southeastern Aegean Sea, which allowed to fish escape. Diaz-López (2006) mentioned that bottlenose dolphins appear capable of modifying their hunting tactics according to the abundance of prey. On the other hand, Ceyhan et al. (2020) reported that dolphins had the highest interaction rate (68.1%) with sea-cage fish farms as predators (following 47.8% for BFT), no attack into the sea-cages has been observed or reported by fish farmers during the study. Moreover, Ceyhan et al. (2020) emphasized that the dolphins showed cunning behaviour, and wild fishes such as *Boops boops*, *Scomber colias* and *Sardinella aurita* swimming around sea-cages were chased by dolphins towards the protection nets in order to entanglement their operculum, then they ate prey easily.

CONCLUSIONS

This paper presents the first photographic record of *T. truncatus* that swims with BFT and diver at a sea-cage fish farm in the southeastern Aegean Sea. Additionally, as opportunistic feeding behaviour, dolphins are chasing the wild fish towards the protection nets in order to entanglement their operculum. This feeding behaviour was confirmed the second time with this study.

ACKNOWLEDGEMENTS

The authors thank Mr Gökhan Subakan for his courtesy of using video, and interviews.

REFERENCES

- Aguado-Giménez F., Eguie-Martinez, S., Cerezo-Valverde, J., & Garcia-Garcia, B. (2018). Spatio-temporal variability of ichthyophagous bird assemblage around western Mediterranean open-sea cage fish farms. *Marine Environmental Research*, 140: 126-134. <https://doi.org/10.1016/j.marenvres.2018.06.008>
- Ceyhan, T., Akyol, O., Demir-Sağlam, Y., Şen, H., Özgül, A., & Düzbastılar, F.O. (2020). The gathering of predators around the sea-cage fish farms in the Aegean Sea. *Cahiers de Biologie Marine*, 61: 361-368. <https://doi.org/10.21411/CBM.A.F8856C42>
- Barrett, L.T., Swearer, S.E., & Dempster, T. (2018). Impacts of marine and freshwater aquaculture on wildlife: a global meta-analysis. *Reviews in Aquaculture*, 11: 1022-1044. <https://doi.org/10.1111/raq.12277>
- Beveridge M.C.M. (2001). Aquaculture and wildlife interactions. In: Uriarte, A., Basurco, B. (eds.), *Environmental impact assessment of Mediterranean aquaculture farms*, CIHEAM: Zaragoza. pp. 57-66.

- Dempster, T., & Taquet, M. (2004). Fish aggregation device (FAD) research: gaps in current knowledge and future directions for ecological studies. *Reviews in Fish Biology and Fisheries*, 14: 21–42. <https://doi.org/10.1007/s11160-004-3151-x>
- Díaz López, B. (2006). Bottlenose dolphin (*Tursiops truncatus*) predation on a marine fin fish farm: some underwater observations. *Aquatic Mammals*, 32: 305-310. <https://doi.org/10.1578/AM.32.3.2006.305>
- Díaz López, B. (2017). Temporal variability in predator presence around a fin fish farm in the Northwestern Mediterranean Sea. *Marine Ecology*, 38: e12378. <https://doi.org/10.1111/maec.12378>
- Díaz López, B., & Shirai, J.A.B. (2007). Bottlenose dolphin (*Tursiops truncatus*) presence and incidental capture in a marine fish farm on the north-eastern coast of Sardinia (Italy). *Journal of the Marine Biological Association of the U.K.*, 87: 113-117. <https://doi.org/10.1017/S0025315407054215>
- Fernandez-Jover, D., Sanchez-Jerez, P., Bayle-Sempere, J.T., Valle, C., & Demster, T. (2008). Seasonal patterns and diets of wild fish assemblages associated with Mediterranean coastal fish farms. *ICES Journal of Marine Science*, 65: 1153–1160. <https://doi.org/10.1093/icesjms/fsn091>
- Gerovasileiou V., Akel, E., Akyol, O., Alongi, G., Azevedo, F., Babali, N. *et al.* (2017). New Mediterranean Biodiversity Records (July 2017). *Mediterranean Marine Science*, 18: 355-384. <https://doi.org/10.12681/mms.13771>
- Güçlüsoy, H., & Savaş, Y. (2003). Interaction between monk seal, *Monachus monachus* (Hermann, 1779) and marine fish farms in the Turkish Aegean and management of the problem. *Aquaculture Research*, 34: 777-783.
- Nelson M.L., Gilbert, J.R., & Boyle, K.J. (2006). The influence of siting and deterrence methods on seal predation at Atlantic salmon (*Salmo salar*) farms in Maine, 2001-2003. *Canadian Journal of Fisheries and Aquatic Sciences*, 63: 1710-1721. <https://doi.org/10.1139/f06-067>
- Notarbartolo di Sciara, G. (2002). Cetacean species occurring in the Mediterranean and Black Seas. In: Notarbartolo di Sciara, G. (ed.), *Cetaceans of the Mediterranean and Black Seas: state of knowledge and conservation strategies*. A report to the ACCOBAMS Secretariat, Monaco, February 2002. Section 3, 17 p.
- Öztürk, B., & Öztürk, A.A. (2002). Marine mammals in Turkey. *Fisheries Science*, 68: 282-285.
- Öztürk, A.A., & Tonay, A.M. (eds.) (2019). *Cetacean Studies in Turkey by TUDAV*. Istanbul, Turkey. TUDAV Publication No: 52.
- Palomares, M.L.D., & Pauly, D. (eds.) (2022). SeaLifeBase. World Wide Web electronic publication. [version 04/2022] Retrieved on June 12, 2022 from <http://www.sealifebase.org>
- Sanchez-Jerez, P., Bayle-Sempere, J., Fernandez-Jover, D., Valle, C., & Dempster, T. (2007). Ecological relationship between wild fish populations and Mediterranean aquaculture in floating fish cages. Impact of mariculture on coastal ecosystems. Lisboa, 21-24 Feb., CIESM Workshop Monographs No. 32 86.

DYNAMICS OF THE APHID POPULATION ON TOBACCO IN PRILEP REGION

Vesna Krsteska¹, Stanislava Lazarevska², Marija Srbinoska¹,
Valentina Pelivanoska¹

¹ University St. "Kliment Ohridski"-Bitola, Scientific Tobacco Institute-Prilep

²Ss. Cyril and Methodius University in Skopje, Faculty of Agricultural Sciences and Food-Skopje

Corresponding author e-mail: vkrsteska@yahoo.com

ABSTRACT

Leaf aphids are among the most important pests on tobacco. They directly affect tobacco yield and quality. Investigation was carried out in 2017-2021 on tobacco plants in Prilep, by application of Method of survey of 20 randomly selected tobacco stalks infested with aphids. During the summer 2017-2021, aphids developed many parthenogenic generations of apterous aphids on tobacco, which depends primarily on temperature fluctuations and precipitation, as well as on the physiological state of the plant and soil nitrogen fertilization. Aphid infestations were often found first along the field margins nearest the direction of prevailing winds. Aphid colonization begins with the movement of few winged females into tobacco fields that give birth to live nymphs. These offspring will become mature, wingless aphids that in turn will deposit more live nymphs and make colonies on top tobacco leaves and flowers. *M. persicae* was present on tobacco plants from the beginning of July until the end of October. Following the dynamics of the aphid population in Prilep region in 2017-2021, the most intensive attack of aphids on tobacco occurs in August. The maximum incidence of aphids was on the 10th of August 2017, on the 20th of August 2018-2020 and on the 1st of August 2021, when aphids form large, dense colonies at the growing points. On the examined stalks, in 2017 were observed 70.707 aphids, 48.527 in 2018, 54.036 in 2019, 59369 in 2020 and 20738 aphids in 2021.

Keywords: Sunflower, Sustainable production, Drought tolerance, Hybrid, Yield traits, Yield performance,

INTRODUCTION

The green peach aphid, *M. persicae*, is a highly polyphagous species, colonizing over 500 species of host plants from at least 40 different families (Blackman and Eastop, 2000, cit. Srigiriraju, 2008; Grigorov, 1979).

The holocycle of *M. persicae*, with sexual reproduction and overwintering of eggs on *Prunus*, occurs in the temperate regions of every continent, and although anholocycle is widespread in warm climates there are indications that the potential for sexual reproduction may be retained throughout the whole range of the species (Blackman, 2009).

During each annual cycle, cyclically parthenogenetic *M. persicae* aphids reproduce asexually several times on herbaceous plants (secondary hosts) and once sexually on peach trees -*Prunus persica* L. (Guillemaud et al. 2003).

In field conditions of Macedonia, it has a holocyclic life cycle where the sexual phase is completed on a peach and asexual phase occurs on tobacco and other secondary host species (Janusevska, 2001; Krsteska, 2007).

In addition to damaging the field, it easily attacks vegetables and ornamental plants grown in greenhouses (Krsteska, 2016).

Aphid diet causes damages on tobacco leaves and reduction of carbohydrates, soluble sugars and glucoses. They may also cause water stress and reduced growth rate of tobacco plant (Todoroski, 1965; Todoroski and Maceljiski, 1983; Srigiriraju et al., 2010; Maric and Camprag, 1982).

The main goal of the investigations was to perform analysis of population dynamics of aphids in tobacco fields.

MATERIAL AND METHOD

Investigations were carried out during 2017-2021, on tobacco plants in Prilep. The observations were made with application of Method of survey of 20 randomly selected tobacco stalks infested with aphids.

Tobacco stalks were sampled from the whole area of the trial at 10-days interval, starting from June 1, up to the beginning of October. The investigations were performed on parts of tobacco (leaves, tobacco flowers, seed capsules).

Table 1. Observation of tobacco leaves 2017-2021
Method of survey of 20 tobacco stalks

Date of control	N ⁰ of tobacco leaves/year				
	2017	2018	2019	2020	2021
01.07.	326	287	257	221	247
10.07.	362	351	362	376	356
20.07.	517	501	505	498	508
01.08.	598	536	566	562	561
10.08.	642	611	602	623	622
20.08.	699	678	692	687	658
01.09.	724	713	717	705	679
10.09.	655	619	609	613	601
20.09.	617	596	587	520	515
01.10.	587	567	569	548	534
Total	5727	5459	5466	5353	5281

10 checks were made by this method in each of the years of investigations, i.e. 200 stalks per year, or 1000 stalks in total.

The investigation included a total of tobacco leaves (5727 in 2017, 5459 in 2018, 5466 in 2019, 5353 in 2020, 5218 in 2021).

RESULTS AND DISCUSSION

The aphid attack commercial varieties of *Nicotiana tabacum* L. and they appear in all tobacco producing regions in Macedonia.

During investigation of the species of Aphididae family, tobacco was attacked only by *Myzus persicae* Sulzer (Figure 1).



Figure 1. Aphid collonies on top tobacco leaves and flowers

M. persicae developed many parthenogenic generations of apterous aphids on tobacco, which depends primarily on temperature fluctuations and precipitation, as well as the physiological state of the plant and soil nitrogen fertilization.

Aphid infestations were often found first along the field margins nearest the direction of prevailing winds. Aphid colonization begins with the movement of few winged females into tobacco fields that give birth to live nymphs. These offspring will become mature, wingless aphids that in turn will deposit more live nymphs and make collonies on top tobacco leaves (Figure 2) and flowers.



Figure 2. Aphid colonies on tobacco leaves

Following the dynamics of the aphid population in Prilep tobacco producing region during 2017-2021, the most intensive attack of aphids on tobacco occurs in August (Graph. 1). *M. persicae* was present on tobacco plants from the beginning of July to the beginning of October.

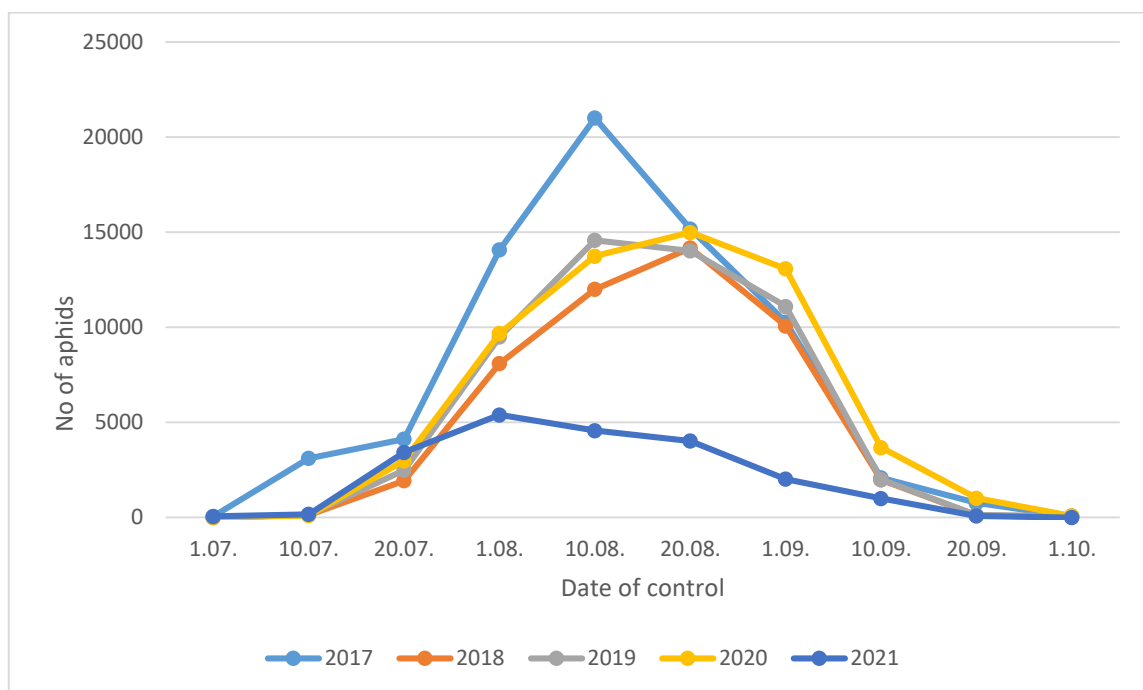

Graph. 1 Dynamics od aphid population on tobacco

Climate conditions lower the plant defense system against insect pests, and cause tobacco plant to be more vulnerable to pests attack.

Aphids were identified in large quantitative representation in 2017, 70.707 aphids were found on the examined stalks (Table 1). In 2018 aphid population decreased and 48.527 aphids were observed. In 2019 a slightly higher population of aphids was determined compared to the previous year i.e. 54.036 aphids. This increasing trend continued in the following year and 59369 aphids were found in 2020. Unfavorable climatic conditions caused the development of a smaller population of aphids in 2021 when a total of 20738 aphids were determined.

The maximum incidence of aphids was on the 10th of August 2017, on the 20th of August 2018-2020 and on the 1st of August 2021, when aphids form large, dense colonies at the growing points on tobacco plants.

M. persicae make colonies on young tobacco leaves, buds and flowers and in strong attack, they are dried and covered with an abundance of honeydew, which is populated with black sooty mold. Infected tobacco plants lag behind in growth and are susceptible to attack by other plant pests and pathogens.

On tobacco leaves 2017-2021 the apterous (wingless) aphids have various shades of green, orange, red or yellow color with oval body, approximately 2.15 mm long (Figure 3).



Figure 3. Wingless aphids on tobacco

This color morphism in *M. persicae* results from the presence of a series of glycosides in the aphid hemolymph (Blackman, 1974).

According to Capinera (2020) the wingless (apterous) aphids are yellowish or greenish in color. They measure about 1.7 to 2.0 mm in length. A medial and lateral green stripes may be present. The cornicles are moderately long, unevenly swollen along their length, and match the body in color. The appendages are pale.

According to Blackman, Eastop (2017) adult apterous parthenogenetic female are small to medium sized, pale greenish-yellow or various shades of green, pink red or almost black.

On tobacco leaves nymphs resemble parthenogenetic, apterous aphids and their color is green, yellow or red (Figure 4).



Figure 4. Nymphs on tobacco leaves

According to Capinera (2020) nymphs initially are greenish, but soon turn yellowish, greatly resembling viviparous (parthenogenetic, nymph-producing) adults. The nymphs that give rise to winged females (alatae) may be pinkish.

According to Blackman, Eastop (2017) immature female alatae are often red or pink, and immature males are always some shade of yellow or yellow-green.

As aphid densities on tobacco increase 2017-2021, winged forms are produced to aid dispersal. Alate aphids have a black head and black-redish thorax, and a yellowish green abdomen with a large dark patch dorsally. Their body is oval and although they looked bigger than apterous aphids (because of the wings) they measure approximately 2.05 mm in length.

Capinera (2020) winged (alate) aphids have a black head and thorax, and a yellowish green abdomen with a large dark patch dorsally. They measure 1.8 to 2.1 mm in length.

Table 2. Quantitative representation of aphid population on tobacco

Date of control	N ^o of aphids/year				
	2017	2018	2019	2020	2021
01.07.	54	-	-	7	56
10.07.	3111	132	154	98	167
20.07.	4120	1938	2488	2987	3421
01.08.	14072	8098	9492	9678	5397
10.08.	21005	12004	14574	13745	4567
20.08.	15176	14176	14023	14990	4021
01.09.	10272	10073	11098	13082	2021
10.09.	2090	1982	1995	3678	1001
20.09.	766	107	127	1021	87
01.10.	41	17	85	83	-
Total	70707	48527	54036	59369	20738

CONCLUSIONS

During investigation of the species of Aphididae family, tobacco was attacked only by *M. persicae*. It has high potential for reproduction and development.

M. persicae was present on tobacco plants from the beginning of July until the beginning of October. The most intensive attack of aphids on tobacco occurs in August when aphids form large, dense colonies at the growing points of tobacco plants.

In tobacco biocenosis in the region of Prilep 2017-2019, *M. persicae* developed many generations with high quantitative representations of aphids. Due to the unsuitable climate conditions in 2021, the number of its generations on tobacco was reduced.

On the examined stalks, in 2017 were observed 70.707 aphids, 48.527 in 2018, 54.036 in 2019, 59369 in 2020 and 20738 aphids in 2021.

REFERENCES

- Blackman R. L. 2009. Life-cycle variation of *Myzus persicae* (Sulz.) (Hom., Aphididae) in different parts of the world, in relation to genotype and environment Cambridge University, <https://www.cambridge.org/core/journals/bulletin-of-entomological-research/article/as/lifecycle-variation-of-myzus-persicae-sulz-hom-aphididae-in-different-parts-of-the-world-in-relation-to-genotype-and-environment/A99FCB85C480D14C25864B78C81E43F6>
- Blackman R. L., Eastop V.F. 2017. Taxonomic Issues Aphids as Crop Pests, CAB International 2nd edition (eds H.F. van Emden and R. Harrington). pp. 1–36 https://9781780647098_1stChap_849f3e8d238e7c388fa84ba316caec09.pdf
- Capinera J. L. 2001. Green Peach Aphid, *Myzus persicae* (Sulzer) (Insecta:Hemiptera: Aphididae) Publication Number: EENY222 <https://edis.ifas.ufl.edu/publication/IN379>
- Grigorov S. 1979. Study on the biology of the peach aphid *Myzus persicae* Sulz. (Homoptera, Aphididae). Rasten. Nauk, 1979, 15-9/10, p. 184-193.
- Guillemaud T., Mieuze L., Simon J. C. 2003. Spatial and temporal genetic variability in French populations of the peach–potato aphid, *Myzus persicae* Heredity (2003) 91, 143–152 <https://www.nature.com/articles/6800292.pdf>
- Helmut F. E., Harrington R., 2007. Aphids as Crop Pests. CAB International.
- Janusevska V. 2001. Predators and parasites on leaf aphid *Myzus persicae* Sulz on tobacco. Master's work, Faculty of Agricultural Sciences and Food Skopje
- Krsteska V. 2007. Aphidophagous hoverflies (Diptera, Syrphidae) on tobacco in the region of Prilep, doctoral dissertation, Faculty of Agricultural Sciences and Food Skopje
- Krsteska V. 2016, Peach aphid *Myzus persicae* (Sulzer) on tobacco. Тyтyн/Tobacco, Vol. 66, No 1-6, 30-39, 2016
- Maric A., Camrag D. 1982. Stetocine i bolesti secerne repe. Nolit, Beograd.
- Srigiriraju L. 2008. Quantification of Insecticide Resistance in the Tobacco-Adapted Form of the Green Peach Aphid, *Myzus persicae* (Sulzer) (Hemiptera: Aphididae) dissertation Faculty of the Virginia Polytechnic Institute and State University, Virginia
- Srigiriraju L., Semtner P. J., Anderson T. D., Bloomquist J. R. 2010. Monitoring for MACE resistance in the tobacco-adapted form of the green peach aphid, *Myzus persicae* (Sulzer) (Hemiptera: Aphididae) in the eastern United States. Crop Protection 29: 197–202.
- Todorovski B. 1965. Lisna vaš *Myzus* (*Myzodes*) *persicae* Sulz. i rezultati uporednih ogleda njenog suzbijanja različitim pesticidama. Tutun, br. 7-8, Prilep.
- Todorovski B., Maceljski M. 1983. *Myzus* (*Myzodes*) *persicae*, Priracnik izvestajne I prognozne sluzbe zastite poljoprivrednih kultura. Kolektiv autora, 1983, Beograd.

STUDY OF THE ADHESIVE BEHAVIOR OF *ESCHERICHIA COLI* AND *STAPHYLOCOCCUS AUREUS* ON GLASS

Doha Mazigh¹, Soukaina Mitro¹, Oumaima Ameslek², Chorouk Zanane¹, Rabha El Othmany¹,
Mostafa El Louali¹, Hassan Latrache¹, Hafida Zahir¹

¹Sultan Moulay Slimane University, Faculty of Science and Technology, Department of
Biology, Beni Mellal, Morocco.

²Sultan Moulay Slimane University, Faculty of Science and Technology, Department of
Geology, Beni Mellal, Morocco.

Corresponding author e-mail: dohamazigh22@gmail.com

ABSTRACT

Bacterial adherence and growth on biotic and non-biotic surfaces, are considered to be the primary steps leading to pathogenic biofilms formation responsible of bacterial infections and contaminations in many fields. Therefore, the prevention of bacterial attachment remains the best strategy to face these problems. In this context, this in vitro investigation aimed to study predictive and experimental adhesion of two of the most common strains; *Escherichia coli* CIP54127 (Gram-negative) and *Staphylococcus aureus* CIP5315 (Gram-positive) on microscope slides, using the contact angle method. The physicochemical properties (hydrophobicity, electron donor/acceptor properties and free energy) were calculated by the XDLVO theory. From the results, both strains were classified as qualitatively hydrophilic with relatively low contact angles with water ($33.4^\circ < \theta_w < 48.3^\circ$). In addition, *E. coli* CIP54127 showed a positive free energy value of the interaction between the bacterium and water ($\Delta G_{wi} = 56.6 \text{ mJ.m}^{-2}$), while a negative free energy value was observed for *S. aureus* CIP5315 ($\Delta G_{wi} = (-4.5) \text{ mJ.m}^{-2}$). As a result, *E. coli* CIP54127 and *S. aureus* CIP5315 were characterized quantitatively hydrophilic and hydrophobic respectively. The electron donor (base) character of the bacterial surface of *E. coli* CIP54127 ($\gamma^- = 63.7 \text{ mJ.m}^{-2}$) was more prominent than the *S. aureus* CIP5315 character ($\gamma^- = 25.5 \text{ mJ.m}^{-2}$), yet the electron acceptor (acid) characters of both strains were weak ($0 \text{ mJ.m}^{-2} < \gamma^+ < 1.6 \text{ mJ.m}^{-2}$). Moreover, theoretical adhesion suggested that glass colonization by the tested bacteria was thermo-dynamically favorable in the case of *E. coli* CIP54127 ($\Delta G_{Tot} = (-49.20) \text{ mJ.m}^{-2} < 0$) and relatively unfavorable for *S. aureus* CIP5315 ($\Delta G_{Tot} = 5.79 \text{ mJ.m}^{-2}$). Subsequently, experimental adhesion on microscope slides revealed that the percentage of surface occupied by *E. coli* CIP54127 (51%) was higher than that occupied by *S. aureus* CIP5315 (26%). Thus, predictive and experimental adhesions were in the same direction. These results could later be applied in research aiming to understand and control interfacial phenomena in order to prevent biocontamination of various surfaces.

Keywords: Adhesion, Physicochemical properties, *Escherichia coli*, *Staphylococcus aureus*, Contact angle.

INTRODUCTION

Biocontamination of biotic and abiotic surfaces by microbial biofilms is a natural phenomenon. In particular, negative biofilms cause significant damage in many vital fields such as medicine (Monteiro et al., 2009; Odo et al., 2021) biotechnology (Jullien et al., 2003; Arreguin-Campos., 2023) and the environment (de Kerchove and Elimelech, 2007; Elgoulli et al., 2021). Biofilm formation always starts with microbial adhesion resulting from the combination of physicochemical and energetic interactions between the surface of the microorganism and the

support (Hamadi et al., 2005, 2009; Soumya et al., 2011; Hamadi et al., 2012; Cheng et al., 2019). The XDLVO approach considers Van der Waals (dispersive) interactions electrostatic interactions and acid-base (non-dispersive) interactions (Roosjen et al., 2006; Boks et al., 2008; Gardner et al., 2008) to play the most important role in estimating of the total energy of interaction between two entities. These interactions are crucial in the adhesion process and therefore in the formation of biofilms. Thus, it seems more efficient to understand and control the physicochemical parameters involved in the initial steps preceding the attachment of bacteria to the surface in order to prevent bio-adhesion and biofilm formation.

The primary objective of this work was to predict the adhesion of two model bacteria *Escherichia coli* CIP54127 (Gram-negative) and *Staphylococcus aureus* CIP5315 (Gram-positive), known for their pathogenic potential (Valaperta et al., 2010; Fetsch et al., 2014; Tanih et al., 2015; Elmonir et al., 2018; Silva, 2023), on one of the most countlessly used materials: glass. According to the XDLVO theory, the surface physicochemical properties, including hydrophobicity, donor-acceptor components and the total interaction energy of the surfaces were characterized using contact angle measurements (sessile drop method). Secondly, to evaluate the adhesive behavior of the studied strains studied by quantifying the adherent cells on the glass supports.

MATERIAL AND METHOD

1. Preparation of bacterial suspensions

In this study, *Escherichia coli* CIP54127 and *Staphylococcus aureus* CIP5315 were cultivated in a solid Luria Bertani (LB) medium at 37°C. After 24 hours of incubation, precultures were suspended in a KNO₃ (0.1 M) solution and washed twice by centrifugation at 5 000 g for 15 min (Hamadi et al., 2014). The optical densities of each bacterial suspension were then adjusted between 0.7 and 0.8 at 600 nm (approximately 10⁸ FCU/ml) ((Busscher et al., 1984). Afterwards, the adjusted suspensions were filtered under negative pressure using a 0.45 µm cellulose acetate membrane filter, in order to obtain a uniform layer of bacterial cells. Contact angle measurements repeated separately in triplicate (Hamadi and Latrache, 2008).

2. Theoretical adhesion

2.1. Contact angle measurement

The physicochemical characterization of the surface was carried out by the contact angle method using a goniometer (GBX instruments, France). Contact angles were standardized using three liquids as reference (Table.1): diiodomethane (non-polar), formamide (polar) and distilled water (polar) (Van Oss., 1993; Van Oss., 1997). A drop of each solvent was deposited on solid substrate or bacterial layer, and three to six contact angle measurements were taken.

The approach of Van Oss et al (1988) enabled us to determine: Lifshitz-Van der Waals (γ_{LW}), electron donor (Lewis base (γ^-)) and electron acceptor (Lewis acid (γ^+)) components of the support (glass) and the bacterial surface. In this approach, Young's formula (A) was used to express the contact angle (Θ) where (L) and (S) denote the liquid phase and the solid surface respectively:

$$(A) \quad \cos \theta = -1 + 2 \frac{\sqrt{\gamma_S^{LW} \gamma_L^{LW}} + \sqrt{\gamma_S^+ \gamma_L^-} + \sqrt{\gamma_S^- \gamma_L^+}}{\gamma_L}$$

The surface free energy is defined as: $\gamma_S = \gamma_S^{LW} + \gamma_S^{AB}$; where the Lewis acid-base component of the surface tension is expressed by (B):

$$(B) \quad \gamma_S^{AB} = 2\sqrt{\gamma_S^- \times \gamma_S^+}$$

Surface hydrophobicity is generally represented by the free energy of interaction ΔG_{iwi} between two entities of a given material (i) immersed in water (w) (Van Oss et al., 1988). The surface is considered hydrophobic if the surface free energy was negative ($\Delta G_{iwi} < 0$). In contrast, the surface is considered hydrophilic, if the ΔG_{iwi} was positive. This free energy ΔG_{iwi} can be estimated through the following equation (C):

$$(C) \quad \Delta G_{iwi} = -2\gamma_{iw} = -2 \left[\left(\sqrt{\gamma_i^{LW}} - \sqrt{\gamma_w^{LW}} \right)^2 + 2 \left(\sqrt{\gamma_i^+ \gamma_i^-} + \sqrt{\gamma_w^+ \gamma_w^-} - \sqrt{\gamma_i^+ \gamma_w^-} - \sqrt{\gamma_w^+ \gamma_i^-} \right) \right]$$

Table 1. Contact angle solvents energetic properties (Van Oss., 1997).

Solvents	γ^{LW} (mJ.m ⁻²)	γ^+ (mJ.m ⁻²)	γ^- (mJ.m ⁻²)
Diiodomethane	50.5	0.7	0.0
Formamide	38.7	2.3	39.4
Water	21.6	25.4	25.4

γ^{LW} : Lifshitz-van der Waals components of the surface tension; γ^- : electron donor surface tension component; γ^+ : electron acceptor surface tension component

2.2. Adhesion prediction

According to the XDLVO theory (Van Oss., 1997), the measurement of the total free energy of interaction (ΔG_{Tot}) predicts the adhesion between different surfaces and colloids by calculating the sum (D) of the Lifshitz Van-der- Waals (LW), acid-base (AB) and electrostatic double layer (EL) interactions (Missirlis and Katsikogianni, 2007):

$$(D) \quad \Delta G^{Tot} = \Delta G^{LW} + \Delta G^{AB} + \Delta G^{EL}$$

The electrostatic double layer interactions were neglected, since our studied bacterial mass was previously treated with high ionic strength KNO₃ solution (0.1 M). Adhesion could be favorable or unfavorable if this energy is negative ($\Delta G_{Tot} < 0$) or positive ($\Delta G_{Tot} > 0$), respectively.

3. Experimental adhesion

3.1. Glass coupons preparation

In this study, glass was chosen as the substrate because of its hydrophilic nature and simple molecular structure. Glass coupons were obtained by cutting microscope slides into small squares (1 cm x 1 cm). The substrates were disinfected by soaking in ethanol 70% (vol/vol) for

15 min, and washed six times with sterile distilled water and then autoclaved at 120°C for 15 min (Hamadi et al., 2014).

3.2. Adhesion assay

The already adjusted bacterial suspensions (10^8 FCU/ml) of *E. coli* CIP54127 and *S. aureus* CIP5315 were incubated for 3 h at 25 °C, in Petri dishes containing the sterilized glass coupons. After incubation, the glass surfaces were carefully rinsed with sterilized distilled water to remove non-adherent cells (Hamadi et al., 2014). The adherent bacteria were stained by Gram coloration and each surface was observed by optical microscopy ($\times 100$). Each experiment was performed in triplicate.

The percentage of the surface occupied by the adherent cells, was obtained by treating microscope images using an open software for processing and analyzing scientific images. This Java-based program was developed at the National Institute of Health and the Laboratory for Optical and Computational Instrumentation (LOCI, University of Wisconsin).

RESULTS AND DISCUSSION

Generally, microbial adhesion is governed by surface physicochemical properties of both the cells and the substrates, these properties are commonly measured by contact angle method (Bellon-Fontaine., 1996; Li and Logan, 2004). Tables 2 and 3 presented the surface physicochemical characteristics of the glass and the bacteria studied respectively, where total surface free energy, acid-base, non-polar and polar contribution to surface free energy, were calculated. Based on the study results, glass is a hydrophilic ($\Delta G_{iwi} = 16.2 \text{ mJ.m}^{-2}$), strong electron donor ($\gamma^- = 40.36 \text{ mJ.m}^{-2}$), and weak electron acceptor ($\gamma^+ = 1.54 \text{ mJ.m}^{-2}$) material (table.2). As shown in Table 3, *E. coli* CIP54127 had a hydrophilic character ($\theta_w = 33.4^\circ$; $\Delta G_{iwi} = 56.6 \text{ mJ.m}^{-2}$), while *S. aureus* CIP5315 surface was relatively more hydrophobic with a higher value of $\theta_w = 48.3^\circ$ and a negative surface free energy ($\Delta G_{iwi} = (-4.5) \text{ mJ.m}^{-2}$). According to the literature, it is highly acceptable to correlate the physicochemical properties of a bacterial surface with its chemical composition (Mozes et al., 1988; Van der Mei et al., 1989; Mozes et al., 1989; Latrache et al., 1994; Van der Mei and Busscher, 1997; Boonaert and Rouxhet, 2000; El Ghmari et al., 2002; Hamadi et al., 2005, 2008, 2012). Indeed, the decrease in the water contact angle (θ_w) could be due to the interaction between oxygen from surface functional groups (OH, CO-C) and water molecules through hydrogen bonding, which subsequently reduces the hydrophobicity of the cell surface. (Latrache et al., 1994 ; Van der Mei and Busscher, 1997 ; Latrache et al., 2002). This is the case for *E. coli*, whose hydrophilicity has been explained in particular by the concentration of polysaccharides on its surface (Latrache et al., 2002). Moreover, both strains surfaces showed an electron donor property between $\gamma^- = 63.7 \text{ mJ.m}^{-2}$ and $\gamma^- = 25.5 \text{ mJ.m}^{-2}$ and a limited electron acceptor parameter ($0 \text{ mJ.m}^{-2} < \gamma^+ < 1.6 \text{ mJ.m}^{-2}$) (table.3). This result could be explained by the fact that most bacteria are likely to have negatively charged surfaces with a dominant donor character (Van Der Mei et al., 1998).

According to thermodynamic model of Van Oss (1997), the adhesion total free energy of the investigated bacteria had been calculated (Table.4). Therefore, predictive adhesion of *E. coli* CIP54127 to glass was favorable ($\Delta G_{Tot} = (-49.20) \text{ mJ.m}^{-2} < 0$), and relatively unfavorable for *S. aureus* CIP5315 ($\Delta G_{Tot} = 5.79 \text{ mJ.m}^{-2}$). In addition, during the experimental adhesion examination on glass (Figure.1), *E. coli* CIP54127 also presented the most important number of adherent cells (51%) versus a lower percentage in the case of *S. aureus* CIP5315(26%). There is no doubt in the literature that the adhesion of bacteria depends on the nature of the surface. In general, hydrophobic bacteria tend to adhere to hydrophobic surfaces and hydrophilic cells tend to adhere to hydrophilic substrates (Boulang'e-Petermann et al., 1997; Kerr et al., 1999;

Cerca et al., 2005; Krasowska and Sigler, 2014). This may explain the ability of *E. coli* CIP54127 (hydrophilic) to adhere better to glass (hydrophilic) than *S. aureus* CIP5315 (hydrophobic). However, it is highly probable that in addition to the combination of surface hydrophobicity and acid-base interactions which play an important role in microbial adhesion process (Otto et al., 1999; Garrett et al., 2008), ionic strengths could also directly influence this phenomenon by altering the surface properties (Hamadi et al., 2005).

Table 2. Contact angles, tensions and free energy of microscope slide surface

Substrate	Contact angles (°)			Surface tension (mJ.m ⁻²): components and parameters			ΔGiwi (mJ.m ⁻²)
	Θ Diiodomethane	Θ Formamide	Θ Water	γ ^{LW}	γ ⁺	γ ⁻	
Glass	46.6 (1.4)	45.8 (3.3)	36.5 (3.1)	36.3	1.54	40.36	16.2

Standard deviations were given in parentheses. Contact angle (Θ) of the glass surface with tree solvents: diiodomethane, formamide and water; γ^{LW}: Lifshitz-van der Waals components of the surface tension; γ⁻: electron donor surface tension component; γ⁺: electron acceptor surface tension component; ΔGiwi: The free energy of interaction between glass and water

Table 3. Contact angles, tensions and free energies of *E. coli* CIP54127 and *S. aureus* CIP5315 surfaces

Strains	Contact angles (°)			Surface tension (mJ.m ⁻²): components and parameters			ΔGiwi (mJ.m ⁻²)
	Θ Diiodomethane	Θ Formamide	Θ Water	γ ^{LW}	γ ⁺	γ ⁻	
<i>E. coli</i> CIP54127	51.1 (0.27)	5.03 (0.27)	33.4 (0.19)	33.7	0	63.7	56.6
<i>S. aureus</i> CIP5315	43 (0.04)	30.4 (0.27)	48.3 (0.31)	38.1	1.6	25.5	-4.5

Standard deviations were given in parentheses. Contact angle (Θ) of the glass surface with tree solvents: diiodomethane, formamide and water; γ^{LW}: Lifshitz-van der Waals components of the surface tension; γ⁻: electron donor surface tension component; γ⁺: electron acceptor surface tension component; ΔGiwi: The free energy of interaction between the surface of the bacteria and the water

Table 4. Total free energy of adhesion between strain surfaces and glass

Strains	ΔG ^{LW} (mJ.m ⁻²)	ΔG ^{AB} (mJ.m ⁻²)	ΔG ^{Tot} (mJ.m ⁻²)
<i>E. coli</i> CIP54127	-3.19	-46.02	-49.2
<i>S. aureus</i> CIP5315	-4.2	9.99	5.79

ΔG^{LW}: Lifshitz-Van der Waals interactions; ΔG^{AB}: Lewis acid–base interactions; ΔG^{Tot}: total free energy of interaction

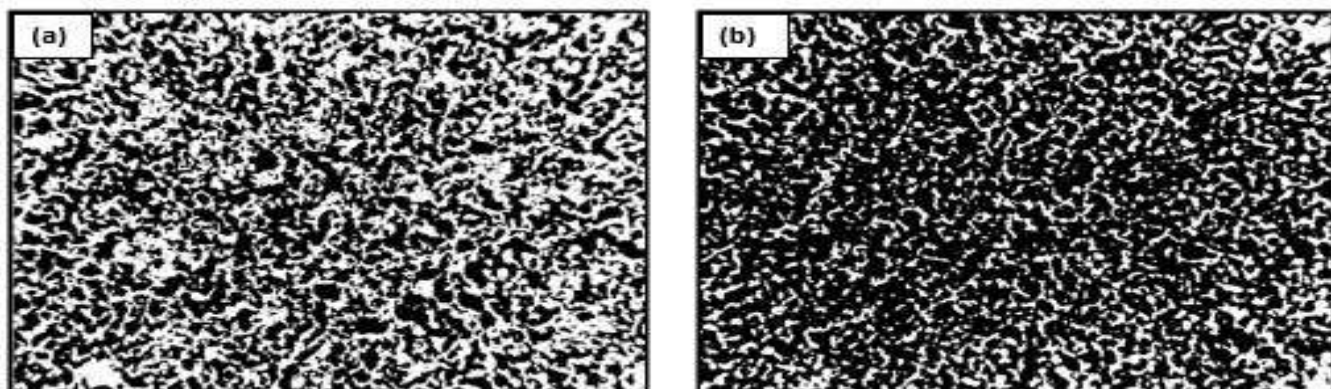

Figure 1. Imagej treated images ($\times 100$) of *E. coli* CIP54127 and *S. aureus* CIP5315 after three hours of adhesion to glass. Adhered bacterial cells are in white. (a): the area occupied by *E. coli* (51%); (b): the area occupied by *S. aureus* (26%)

CONCLUSIONS

This study investigated, the predictive and the experimental adhesion of two common and widely distributed bacteria to glass. Experimentally, *E. coli* CIP54127 showed a greater ability to adhere to glass surfaces than *S. aureus* CIP5315. Based on our results, the XDLVO thermodynamic model associated this affinity with the hydrophilic nature of the *E. coli* CIP54127 surface compared to a relatively hydrophobic character for *S. aureus* CIP5315. However, both strains were electron donors. Thus, *E. coli* CIP54127 has a higher affinity for hydrophobic surfaces than *S. aureus* CIP5315. The process of microbial adhesion to a surface involves interactions between the bacteria, the substrate and the surrounding environment. Further research is needed to understand the interfacial parameters that control this phenomenon so that contamination can be reduced or even prevented in many applications.

REFERENCES

- Arreguin-Campos, R., Frigoli, M., Caldara, M., Crapnell, R. D., Ferrari, A. G. M., Banks, C. E., ... & van Grinsven, B. (2023). Functionalized screen-printed electrodes for the thermal detection of Escherichia coli in dairy products. *Food Chemistry*, 404, 134653.
- Bellon-Fontaine, M. N., Rault, J., & Van Oss, C. J. (1996). Microbial adhesion to solvents: a novel method to determine the electron-donor/electron-acceptor or Lewis acid-base properties of microbial cells. *Colloids and surfaces B: Biointerfaces*, 7(1-2), 47-53.
- Boonaert, C. J., & Rouxhet, P. G. (2000). Surface of lactic acid bacteria: relationships between chemical composition and physicochemical properties. *Applied and environmental microbiology*, 66(6), 2548-2554.
- Boks, N. P., Norde, W., van der Mei, H. C., & Busscher, H. J. (2008). Forces involved in bacterial adhesion to hydrophilic and hydrophobic surfaces. *Microbiology*, 154(10), 3122-3133.
- Boulangé-Petermann, L., Rault, J., & Bellon-Fontaine, M. N. (1997). Adhesion of *Streptococcus thermophilus* to stainless steel with different surface topography and roughness. *Biofouling*, 11(3), 201-216.
- Busscher, H. J., Weerkamp, A. H., van der Mei, H. C., Van Pelt, A. W., de Jong, H. P., & Arends, J. (1984). Measurement of the surface free energy of bacterial cell surfaces and its relevance for adhesion. *Applied and environmental microbiology*, 48(5), 980-983.

- Cheng, Y., Feng, G., & Moraru, C. I. (2019). Micro-and nanotopography sensitive bacterial attachment mechanisms: a review. *Frontiers in microbiology*, 10, 191.
- Cerca, N., Pier, G. B., Vilanova, M., Oliveira, R., & Azeredo, J. (2005). Quantitative analysis of adhesion and biofilm formation on hydrophilic and hydrophobic surfaces of clinical isolates of *Staphylococcus epidermidis*. *Research in microbiology*, 156(4), 506-514.
- de Kerchove, A. J., & Elimelech, M. (2007). Impact of alginate conditioning film on deposition kinetics of motile and nonmotile *Pseudomonas aeruginosa* strains. *Applied and environmental microbiology*, 73(16), 5227-5234.
- El Ghmari, A., Latrache, H., Hamadi, F., El Louali, M., El Bouadili, A., Hakkou, A., & Bourlioux, P. (2002). Influence of surface cell structures on physicochemical properties of *Escherichia coli*. *The New microbiologica*, 25(2), 173-178.
- Elgoulli, M., Aitlahbib, O., Tankiouine, S., Assaidi, A., Louali, M. E., Zahir, H., & Latrache, H. (2021). The theoretical adhesion of *Pseudomonas aeruginosa* and *Escherichia coli* on some plumbing materials in presence of distilled water or tap water. *Folia Microbiologica*, 66, 607-613.
- Elmonir, W., Abo-Remela, E., & Sobeih, A. (2018). Public health risks of *Escherichia coli* and *Staphylococcus aureus* in raw bovine milk sold in informal markets in Egypt. *The Journal of Infection in Developing Countries*, 12(07), 533-541.
- Fetsch, A., Contzen, M., Hartelt, K., Kleiser, A., Maassen, S., Rau, J., ... & Strommenger, B. (2014). *Staphylococcus aureus* food-poisoning outbreak associated with the consumption of ice-cream. *International journal of food microbiology*, 187, 1-6.
- Garrett, T. R., Bhakoo, M., & Zhang, Z. (2008). Bacterial adhesion and biofilms on surfaces. *Progress in natural science*, 18(9), 1049-1056.
- Gardner, D. J., Oporto, G. S., Mills, R., & Samir, M. A. S. A. (2008). Adhesion and surface issues in cellulose and nanocellulose. *Journal of adhesion science and technology*, 22(5-6), 545-567.
- Hamadi, F., Asserne, F., Elabed, S., Bensouda, S., Mabrouki, M., & Latrache, H. (2014). Adhesion of *Staphylococcus aureus* on stainless steel treated with three types of milk. *Food Control*, 38, 104-108.
- Hamadi, F., & Latrache, H. (2008). Comparison of contact angle measurement and microbial adhesion to solvents for assaying electron donor–electron acceptor (acid–base) properties of bacterial surface. *Colloids and surfaces B: Biointerfaces*, 65(1), 134-139.
- Hamadi, F., Latrache, H., Mabrouki, M., Elghmari, A., Outzourhit, A., Ellouali, M., & Chtaini, A. (2005). Effect of pH on distribution and adhesion of *Staphylococcus aureus* to glass. *Journal of adhesion science and technology*, 19(1), 73-85.
- Hamadi, F., Latrache, H., Mallouki, B., Mliji, E., El Ghmari, A., Mabrouki, M., ... & Ellouali, M. (2008). Adhesion of *Escherichia coli* to glass under different pH. *Journal of Pure and Applied Microbiology*, 2, 295-302.
- Hamadi, F., Latrache, H., Zahir, H., El Abed, S., Ellouali, M., & Saad, I. K. (2012). The relation between the surface chemical composition of *Escherichia coli* and their electron donor/electron acceptor (acid-base) properties. *Research Journal of Microbiology*, 7(1), 32.
- Hamadi, F., Latrache, H., Zekraoui, M., Ellouali, M., & Bengourram, J. (2009). Effect of pH on surface energy of glass and Teflon and theoretical prediction of *Staphylococcus aureus* adhesion. *Materials Science and Engineering: C*, 29(4), 1302-1305.
- Jullien, C., Bénézech, T., Carpentier, B., Lebret, V., & Faille, C. (2003). Identification of surface characteristics relevant to the hygienic status of stainless steel for the food industry. *Journal of Food Engineering*, 56(1), 77-87.

- Kerr, A., Beveridge, C. M., Cowling, M. J., Hodgkiess, T., Parr, A. C. S., & Smith, M. J. (1999). Some physical factors affecting the accumulation of biofouling. *Journal of the Marine Biological Association of the United Kingdom*, 79(2), 357-359.
- Krasowska, A., & Sigler, K. (2014). How microorganisms use hydrophobicity and what does this mean for human needs?. *Frontiers in cellular and infection microbiology*, 4, 112.
- Latrache, H., El, G. A., Karroua, M., Hakkou, A., Ait, M. H., El, B. A., & Bourlioux, P. (2002). Relations between hydrophobicity tested by three methods and surface chemical composition of *Escherichia coli*. *The new microbiologica*, 25(1), 75-82.
- Latrache, H., Mozes, N., Pelletier, C., & Bourlioux, P. (1994). Chemical and physicochemical properties of *Escherichia coli*: variations among three strains and influence of culture conditions. *Colloids and surfaces B: Biointerfaces*, 2(1-3), 47-56.
- Li, B., & Logan, B. E. (2004). Bacterial adhesion to glass and metal-oxide surfaces. *Colloids and surfaces B: Biointerfaces*, 36(2), 81-90.
- Missirlis, Y. F., & Katsikogianni, M. (2007). Theoretical and experimental approaches of bacteria-biomaterial interactions. *Materialwissenschaft und Werkstofftechnik: Entwicklung, Fertigung, Prüfung, Eigenschaften und Anwendungen technischer Werkstoffe*, 38(12), 983-994.
- Monteiro, D. R., Gorup, L. F., Takamiya, A. S., Ruvollo-Filho, A. C., de Camargo, E. R., & Barbosa, D. B. (2009). The growing importance of materials that prevent microbial adhesion: antimicrobial effect of medical devices containing silver. *International journal of antimicrobial agents*, 34(2), 103-110.
- Mozes, N., Amory, D. E., Leonard, A. J., & Rouxhet, P. G. (1989). Surface properties of microbial cells and their role in adhesion and flocculation. *Colloids and Surfaces*, 42(2), 313-329.
- Mozes, N., Léonard, A., & Rouxhet, P. G. (1988). On the relations between the elemental surface composition of yeasts and bacteria and their charge and hydrophobicity. *Biochimica et Biophysica Acta (BBA)-Biomembranes*, 945(2), 324-334.
- Odo, S. E., Uchekukwu, C. F., & Ezemadu, U. R. (2021). Foodborne diseases and intoxication in Nigeria: Prevalence of *Escherichia coli* 0157: H7, *Salmonella*, *Shigella* and *Staphylococcus aureus*. *Journal of Advances in Microbiology*, 20(12), 84-94.
- Otto, K., Elwing, H., & Hermansson, M. (1999). Effect of ionic strength on initial interactions of *Escherichia coli* with surfaces, studied on-line by a novel quartz crystal microbalance technique. *Journal of bacteriology*, 181(17), 5210-5218.
- Roosjen, A., Busscher, H. J., Norde, W., & Van der Mei, H. C. (2006). Bacterial factors influencing adhesion of *Pseudomonas aeruginosa* strains to a poly (ethylene oxide) brush. *Microbiology*, 152(9), 2673-2682.
- Silva, F. V. M. (2023). Pasteurization of Food and Beverages by High Pressure Processing (HPP) at Room Temperature: Inactivation of *Staphylococcus aureus*, *Escherichia coli*, *Listeria monocytogenes*, *Salmonella*, and Other Microbial Pathogens. *Applied Sciences*, 13(2), 1193.
- Soumya, E. A., Mohamed, M., Fatimazahra, B., Hassan, L., Abdellah, H., Fatima, H., & Saad, I. K. (2011). Study of microbial adhesion on some wood species: theoretical prediction. *Microbiology*, 80, 43-49.
- Tanih, N. F., Sekwadi, E., Ndip, R. N., & Bessong, P. O. (2015). Detection of pathogenic *Escherichia coli* and *Staphylococcus aureus* from cattle and pigs slaughtered in abattoirs in Vhembe District, South Africa. *The Scientific World Journal*, 2015.
- Van der Mei, H. C., Bos, R., & Busscher, H. J. (1998). A reference guide to microbial cell surface hydrophobicity based on contact angles. *Colloids and surfaces B: Biointerfaces*, 11(4), 213-221.

- Van der Mei, H. C., Brokke, P., Dankert, J., Jan, F. J., Rouxhet, P. G., & Busscher, H. J. (1989). Physicochemical surface properties of nonencapsulated and encapsulated coagulase-negative staphylococci. *Applied and environmental microbiology*, 55(11), 2806-2814.
- Van der Mei, H. C., & Busscher, H. J. (1997). The use of X-ray photoelectron spectroscopy for the study of oral streptococcal cell surfaces. *Advances in Dental Research*, 11(4), 388-394.
- Van Oss, C. J. (1993). Acid—base interfacial interactions in aqueous media. *Colloids and Surfaces A: Physicochemical and Engineering Aspects*, 78, 1-49.
- Van Oss, C. J. (1997). Hydrophobicity and hydrophilicity of biosurfaces. *Current opinion in colloid & interface science*, 2(5), 503-512.
- Van Oss, C. J., Chaudhury, M. K., & Good, R. J. (1988). Interfacial Lifshitz-van der Waals and polar interactions in macroscopic systems. *Chemical reviews*, 88(6), 927-941.
- Valaperta, R., Tejada, M. R., Frigerio, M., Moroni, A., Ciulla, E., Cioffi, S., ... & Costa, E. (2010). *Staphylococcus aureus* nosocomial infections: the role of a rapid and low-cost characterization for the establishment of a surveillance system. *New Microbiologica*, 33(3), 223-232.

ASHWAGANDHA (*Withania somnifera*) AS A MEDICINAL PLANT

Büşra TİK¹ , Ali Kemal AYAN¹ Mert ARSLANBAYRAK¹

¹19 Mayıs Üniversitesi, Ziraat Fakültesi, Tarla Bitkileri Bölümü, Samsun, Turkey

Corresponding author e-mail: btik952@gmail.com

ABSTRACT

Ashwagandha (*Withania somnifera*) is a medicinal plant species in the Solanaceae family. *Withania somnifera* contains therapeutically important secondary metabolites, alkaloids, and withanolides. Among the secondary metabolites found in the plant, phenolic compounds, sterols, glycovitanolides, and flavonol glycosides can be counted. The most potent part of *Withania somnifera* (L.) is its roots, which are rich in alkaloids, steroidal lactones, and saponins. The leaves of the plant are bitter and have some medicinal uses for fever and painful swelling. The flowers are astringent, depurative, diuretic and aphrodisiac. The seeds are anti-helminthic and remove white spots on the cornea. The fruits have traditionally been used as a topical treatment for tumors, tuberculous glands, carbuncles, and skin ulcers. This review study searched and presented literature on ashwagandha morphological features, secondary metabolites, and usage areas.

Keywords: Ashwagandha, secondary metabolites, root, medicinal plant

INTRODUCTION

Ashwagandha (*Withania somnifera*) is a small shrub belonging to the *Solanaceae* family, which also includes tomatoes, potatoes, and peppers. The history of Ashwagandha dates back thousands of years and has played a significant role in India's medical and cultural traditions (Singh et al., 2011). Traditionally, the plant has been believed to help reduce stress, increase energy, support the immune system, and improve overall health (Raut et al., 2012). The plant has small greenish-yellow flowers and small orange-red fruits. It is native to India, the Middle East, and some regions of Africa, with its roots being the most commonly used part for medicinal purposes. *Withania somnifera* is a short, perennial shrub that can grow to a height of approximately 30 to 150 cm. Its leaves are simple and arranged oppositely along the stem. The stem is woody, cylindrical, and grayish-brown in color. Ashwagandha's flowers are small and bell-shaped, typically ranging from greenish-yellow to pale green. The fruit turns from orange to red when ripe and contains numerous seeds. The roots of Ashwagandha vary in color from pale tan to brown.



Figure 1. The general appearance of the Ashwagandha plant.

Ashwagandha is commonly used in alternative medicine. Some common uses of Ashwagandha include reducing stress and anxiety, increasing energy levels, supporting neuroprotective properties, balancing the immune system, supporting adrenal glands, enhancing muscle strength, and regulating blood sugar (Chandrasekhar et al., 2012; Sharma & Arora, 2006).

Botanical Features

The plant *Withania somnifera* is a short, perennial shrub that can grow to a height of approximately 30 to 150 cm. Its leaves are simple and arranged oppositely along the stem. They are oval to lance-shaped, with lengths ranging from approximately 5 to 10 cm. The leaves are green and possess a slightly rough texture. The stem is woody and cylindrical, covered with a grayish-brown bark. It branches out and can grow both upright and in a spreading manner. Ashwagandha's flowers are small and bell-shaped, usually ranging from greenish-yellow to pale green. They are arranged in clusters called cymes and are found in the leaf axils.



Figure 2. The overall appearance of *Withania somnifera* L. plant with flowers, fruit, and seeds.

The flowers have a unique, somewhat tubular appearance. The plant's fruits produce small, round fruits that start green and turn orange-red when ripe. Each fruit contains numerous small seeds. The seeds are small, flat, yellow, kidney-shaped, approximately 2 mm long, 1.5-2 mm wide, and 0.5 mm thick (Rajeswara Rao et al., 2012). The roots of *Withania somnifera* are the plant's most well-known and commonly used part. They are fleshy, long, and conical, resembling carrots, and their color ranges from light tan to brown.

Chemical Characteristics

The Ashwagandha (*Withania somnifera*) is a rich source of various bioactive compounds. The medicinal content of this plant includes various alkaloids, steroidal lactones (withanolides), flavonoids, and other bioactive compounds. Here are some key compounds found in Ashwagandha and their roles:

Withanolides: The most significant compounds found in Ashwagandha are withanolides. These compounds are associated with various pharmacological effects of the plant, such as helping the body cope with stress, supporting the immune system, exhibiting anti-inflammatory effects, and having antioxidant activity (Ames, 1993).

Alkaloids: Ashwagandha contains alkaloids, including somnin, somniferin, anaferin, and tropin. These alkaloids may contribute to the plant's pharmacological effects (Atasü & Petters, 1981).

Flavonoids: The flavonoids present in Ashwagandha contribute to its antioxidant properties. Antioxidants neutralize harmful free radicals, protecting the body against oxidative stress (Gupta & Rana, 2007).

Phytosterols: Phytosterols found in Ashwagandha may contribute to its anti-inflammatory and immune-supporting effects (Singh et al., 2011).

Areas of Usage

Ashwagandha, thanks to its adaptogenic properties, may help manage stress. Research suggests that it can help balance the levels of the stress hormone cortisol and reduce anxiety (Chandrasekhar et al., 2012).

Ashwagandha can also assist in increasing energy levels and promoting overall well-being. Its use in enhancing both physical and mental performance is widespread (Raut et al., 2012).

The plant possesses immune-boosting properties. It can be used to strengthen the immune response and protect the body against infections (Mishra et al., 2000).

There is evidence of Ashwagandha's neuroprotective effects. It is used to protect nerve cells and support brain health. Due to its adaptogenic properties, Ashwagandha is also studied for its potential to increase muscle strength (Wankhede et al., 2015).

Ashwagandha is one of the herbal remedies used for thyroid disorders. In India, different parts of the plant such as leaves, roots, flowers, seeds, and bark are traditionally used in folk medicine for liver tonic, anti-inflammatory agents, bronchitis, asthma, ulcers, emaciation, insomnia, and dementia. The use of the plant in anxiety, cognitive and neurological disorders, inflammation, and Parkinson's disease is supported by clinical research. Steroidal lactones isolated from the leaves of the plant (Withaferin-A, Withanolide D, Vitanolide G) are antitumoral and are based on the biological effects of the plant (Verma & Kumar, 2011).

Research and studies on the inhibition and reduction of tumor growth by *Withania somnifera* provide promising evidence that this impressive plant may be highly effective in the treatment of tumor-related diseases, including cancer (Singh et al., 2011).

There are dozens of studies demonstrating that *Withania somnifera* slows down, halts, reverses, or eliminates neurotic activity. Therefore, *Withania somnifera* can be used for the treatment of Alzheimer's, Parkinson's, and other neurodegenerative diseases at any stage, even before a diagnosis is made, such as in cases of mild forgetfulness (Verma & Kumar, 2011).

Withania somnifera's anti-inflammatory effect has been observed in studies conducted on mice. *Withania somnifera* has suppressed inflammation by affecting the levels of inflammatory markers (Gupta & Rana, 2007).

CONCLUSION

Ashwagandha (*Withania somnifera*), a plant belonging to the Solanaceae family, holds significant importance in India's medical and cultural traditions. With a history spanning thousands of years, it has been believed to offer a range of benefits, including stress reduction, energy enhancement, immune system support, and overall health improvement. Ashwagandha is widely utilized in alternative medicine. It is used for reducing stress and anxiety, increasing energy levels, supporting neuroprotective properties, balancing the immune system, supporting adrenal glands, enhancing muscle strength, and regulating blood sugar. Key compounds found in the plant include withanolides, alkaloids, steroidal lactones, flavonoids, and tannins. Withanolides are associated with Ashwagandha's adaptogenic properties, while alkaloids may have effects on the nervous system. Steroidal lactones, on the other hand, possess adaptogenic and anti-stress qualities.

In conclusion, Ashwagandha is a medicinal plant of significant importance in both traditional and modern alternative medicine. Its adaptogenic properties, stress-coping abilities, energy-boosting effects, and immune system support have made it a popular herbal supplement. To further its integration into agricultural practices and pharmacological studies, research on Ashwagandha's adaptation, cultivation techniques, and pharmacological activities should be conducted, leading to its inclusion in the list of Medicinal Plants by the Ministry of Agriculture in our country.

REFERENCES

- Ames, B. (1993). Shigenaga MK, Hagen TM. *Oxidants, antioxidants, and the degenerative diseases of aging. Proc Natl Acad Sci USA, 90, 7915-7922.*
- Atasü, E., & Petters, İ. K. (1981). Constituents of *Withania somnifera* Dun. Growing in Turkey. *Journal of Faculty of Pharmacy of Ankara University, 11(1), 48-52.*
- Chandrasekhar, K., Kapoor, J., & Anishetty, S. (2012). A prospective, randomized double-blind, placebo-controlled study of safety and efficacy of a high-concentration full-spectrum extract of ashwagandha root in reducing stress and anxiety in adults. *Indian journal of psychological medicine, 34(3), 255-262.*
- Gupta, G. L., & Rana, A. C. (2007). Protective effect of *Withania somnifera* dunal root extract against protracted social isolation induced behavior in rats. *Indian J Physiol Pharmacol, 51(4), 345-353.*

- Mishra, L.-C., Singh, B. B., & Dagenais, S. (2000). Scientific basis for the therapeutic use of *Withania somnifera* (ashwagandha): a review. *Alternative medicine review*, 5(4), 334-346.
- Rajeswara Rao, B., Rajput, D., Nagaraju, G., & Adinarayana, G. (2012). Opportunities and challenges in the cultivation of Ashwagandha {*Withania somnifera* (L.) Du-nal}. *Journal of Pharmacognosy, ISSN*.
- Raut, A. A., Rege, N. N., Tadvi, F. M., Solanki, P. V., Kene, K. R., Shirolkar, S. G., Pandey, S. N., Vaidya, R. A., & Vaidya, A. B. (2012). Exploratory study to evaluate tolerability, safety, and activity of Ashwagandha (*Withania somnifera*) in healthy volunteers. *Journal of Ayurveda and integrative medicine*, 3(3), 111.
- Sharma, R. K., & Arora, R. (2006). Herbal drugs: a twenty first century perspective. *Herbal drugs: a twenty first century perspective*.
- Singh, N., Bhalla, M., de Jager, P., & Gilca, M. (2011). An overview on ashwagandha: a Rasayana (rejuvenator) of Ayurveda. *African journal of traditional, complementary and alternative medicines*, 8(5S).
- Verma, S. K., & Kumar, A. (2011). Therapeutic uses of *Withania somnifera* (Ashwagandha) with a note on withanolides and its pharmacological actions. *Asian J Pharm Clin Res*, 4(1), 1-4.
- Wankhede, S., Langade, D., Joshi, K., Sinha, S. R., & Bhattacharyya, S. (2015). Examining the effect of *Withania somnifera* supplementation on muscle strength and recovery: a randomized controlled trial. *Journal of the International Society of Sports Nutrition*, 12(1), 43.
- Singh, N., Sharma, R., & Arora, R. (2006). Ayurvedo-Herbal Medicines–The Need of the Time–Herbal Drugs, A twenty first century perspective. Delhi: Institute of Nuclear Medicine and Allied Sciences, Defence Research and Development Organization (DRDO), Govt. of India, 535-547.

WHITE OLEANDER: INVESTIGATION OF POTENTIAL USAGE IN AQUACULTURE AND COSMETICS INDUSTRIES

Ali SAGLAM^{1*}, Irem CELIK¹, Hilal TASBASI¹, Meltem ASAN-OZUSAGLAM¹

¹Department of Molecular Biology and Genetic, Faculty of Science and Letters, Aksaray University, Aksaray, TURKEY

*Corresponding author:saglamali801@gmail.com

ABSTRACT

Plants have been used since ancient times to treat many diseases and are the source of therapeutic agents. In this study, biological activity of acetone and ethanol extracts from white oleander flowers and leaves was determined against fish pathogens. The disc diffusion and microdilution assays were used to determine the biological activity of the extracts on fish pathogens. The highest zone diameter of inhibition was determined as 12.67 mm in flower acetone extract against *Vibrio anguillarum* A4. The lowest inhibition zone against *Lactococcus garvieae* for leaf ethanol extract was determined as 7.09 mm. The MIC value was between 5-40 mg/mL for white oleander extracts against the fish pathogens. The lowest value of MBC was determined as 5 mg/mL in leaf ethanol extract against *Aeromonas hydrophila* ATCC 19570. In addition, sun protection factor (SPF) values of white oleander extracts were evaluated. The SPF values of the extracts were obtained as 25.72-26.52. The extracts from white oleander which is used as an ornamental plant can be used as natural additives in the aquaculture and cosmetics industries.

Keywords: Antimicrobial activity, Cosmetic, Fish pathogens, *Nerium oleander*, SPF

INTRODUCTION

Nerium oleander belong to the Apocynaceae family. It spreads in the warm and subtropical regions of the Mediterranean. It is an evergreen plant that grows spontaneously in dry stream beds and can reach up to five meters in height. Oleander, a plant species with pink or white flowers that is usually grown as a garden ornamental plant, is a perennial plant that can be grown all over the world (Abdou et al., 2019). Although oleander is known as a poisonous plant species, it has been reported to have important bioactive compounds according to toxicological, pharmacological, biochemical, and ethnobotanical studies in various dose studies (Bavunoğlu et al., 2016; Farkhondeh et al., 2020). In recent years, it has been determined that the *Nerium oleander* has many effects, for example, antioxidant, antileukemia, anti-inflammatory, anticancer, antidiabetic, hepatoprotective, diuretic, antimicrobial, immunomodulatory effects (Hase et al., 2016).

The decrease of fish from natural water sources and the increasing demand for aquaculture by consumers are the two main factors for the expansion of aquaculture today (Zeybek et al., 2008). Various infections causing epidemics in fish are a major concern in the aquaculture industry, possibly causing significant economic loss due to disease and death (Irshath et al., 2023). Antibiotics have been used for many years in the treatment of bacterial infections in fish (Haniffa and Kavitha., 2012). One of the main problems in the use of antibiotics is that fish pathogens are resistant to antibiotics and cause water pollution (Rahman et al., 2017). Plants can produce active molecules with many different biological activities and act against pathogens. Thus, it is expected that plant extracts will influence drug-resistant pathogenic

bacteria (Amenu, 2014). There are many plants used for therapeutic purposes in society (El Sawi et al., 2010).

It has been reported that plant phenolics have a photoprotective role against UV light (Del Valle et al., 2019). Overexposure to UV radiation causes health problems such as eye diseases, immunosuppression, and skin cancer (Norval., 2006; Hussein., 2005). UV-B rays from the UV class can cause adverse effects such as sunburn on the skin. In addition, UV-B can cause disturbances of the immune system and problems such as photo carcinogenesis (DeBuys et al., 2000). UV-A and UV-B rays cause skin aging and release of toxic radicals (Farrukh et al., 2014). UV-C has a high energy level. Its damage is quite high, but it cannot reach the earth by being swallowed by ozone and oxygen in the stratosphere (Allen and Bain., 1994).

In the current study, it was aimed to determine the biological activity of acetone and ethanol extracts obtained from the leaves and flowers of *Nerium oleander* on fish pathogens to obtain usage potential as natural antimicrobials for the aquaculture industry. Then, the sun protection factor (SPF) of the extracts was determined for cosmetic industry.

MATERIAL-METHOD

Plant Material

White oleander flower and leaf samples were obtained from Alata Horticultural Research Institute (Mersin/Turkey) in June 2021.

Preparation of White Oleander Flower and Leaf Extracts

The white oleander flower and leaf samples were washed with distilled water and dried at room temperature, and the dried samples were ground. The extraction, 50% acetone and 50% ethanol were added separately to the plant material. The extracts were obtained in 3 repetitions for 30 minutes with a sonication device (Hielscher). Then, the crude extract was obtained by evaporating of solvents. The obtained extracts were stored at 4°C during use.

Fish Bacterial Pathogens

The fish bacterial pathogens as test microorganisms (*Vibrio anguillarum* A4, *Aeromonas hydrophila* ATCC 19570, *Vibrio alginolyticus*, *Yersinia ruckeri* and *Lactococcus garvieae*) were used. *A. hydrophila* ATCC 19570 in Nutrient-Broth (NB) at 37°C, *L. garvieae* and *Y. ruckeri* in Tryptic-Soy-Broth (TSB) at 25°C, *V. anguillarum* A4 and *V. alginolyticus* in TSB with 2% NaCl at 25°C were cultured.

Determination of Antibacterial Activity

Disc Diffusion Assay

The disc diffusion assay was applied to determine the biological activity of the acetone and ethanol extracts from the white oleander flower and leaf. 100 µl of suspensions of fish pathogenic test microorganisms (0.5 McFarland) were spread on agar medium. 20 µl (2 mg/disc) extract-impregnated discs (No: 6 mm) were placed on solid agar in triplicate. After incubation for 24 hours, the inhibition zones were measured using a caliper.

Micro-dilution Method

The minimum inhibition (MIC) and bactericidal concentration (MBC) values of white oleander leaf and flower extracts were determined using a micro-dilution method. Bacterial suspension (0.5 McFarland) was added to each tube containing the extract and nutrient medium. Tubes with different extract concentrations were incubated. At the end of the incubation, the concentration of the extract in the tube without bacterial growth was recorded as MIC values.

Samples taken from the tubes were inoculated into solid medium using the spot cultivation method. After incubation, the extract concentrations without bacterial growth on solid media were determined as the MBC values of the extract.

Determination Sun Protection Factor (SPF) of White Oleander Extract

The sun protection factor (SPF) of white oleander extracts was determined using the in-vitro method (spectrophotometrically). The extract was stirred in 96% ethanol. The absorbance values of the homogeneous mixture were measured using a spectrophotometer (Beckman-Coulter) (wavelength: 290nm and 320 nm). Absorbance values were calculated using Mansur's equation (1) (Mansur et al., 1986).

Mansur's equation:

$$\text{SPF: CF} \times \sum_{290}^{320} \text{EE}(\lambda) \times \text{I}(\lambda) \times \text{Abs}(\lambda) \quad (1)$$

Correction Factor (10) (CF), Erythemogenic Effect (λ) (EE), Intensity of Sunlight at Wavelength (λ) (I), Absorbance of Extracts at Wavelength (λ) (Abs).

RESULTS AND DISCUSSION

Antibacterial activities of white oleander flower and leaf extracts were investigated on fish pathogens by disc diffusion and microdilution experiments. Inhibition zone diameters formed by the extracts on the test bacteria are given in Table 1. The inhibition zone diameters were determined in the range of 7.09 mm and 12.67 mm. The flower acetone extract (WOFA) has the highest zone diameter of inhibition against *V. anguillarum* A4.

Table 1. Inhibition Zone Diameters of White Oleander Extracts

Microorganisms	Inhibition zone diameter (mm)			
	WOFA	WOFE	WOLA	WOLE
<i>V. anguillarum</i> A4	12.67±0.66	12.06±0.77	11.98±0.83	11.18±0.41
<i>A. hydrophila</i> ATCC 19570	11.40±0.50	10.57±0.91	11.11 ±0.66	10.36±0.35
<i>V. alginolyticus</i>	12.01±0.98	11.80±0.01	12.53±0.52	9.56±0.53
<i>Y. ruckeri</i>	11.17±1.01	10.01±0.13	10.68±0.40	9.14±0.23
<i>L. garvieae</i>	7.96±0.65	8.35±0.99	7.68±0.43	7.09±0.16

*WOFA: White Oleander Flower Acetone WOFE: White Oleander Flower Ethanol WOLA: White Oleander Leaf Acetone WOLE: White Oleander Leaf Ethanol

In a study conducted with oleander acetone extract, the highest disc diffusion diameters were determined against *Pseudomonas* spp. and *Candida albicans* as 17.23 mm and 15.75 mm (ThamaraiSelvi and Deepthi, 2018). In a study by Boyraz and Koçak (2006), the oleander methanol extract prepared by the soxhlet method determined its antimicrobial activity on fungal microorganisms (*Alternaria mali*, *Sclerotinia sclerotiorum*, *Colletotrichum circinans*, *Fusarium oxysporum* and *Botrytis cinerea*). It has been indicated that oleander extract has an antifungal effect on all phytopathogenic fungi at doses of 1% and 2%.

The MIC values of white oleander extracts are given in Table 2. According to the MIC value results of white oleander flower and leaf extracts, among the test microorganisms, the highest effect was detected against *A. hydrophila* ATCC 19570 and *V. anguillarum* A4 at a concentration of 5 mg/mL. The MIC values of the extracts varied from 5 mg/mL to 40 mg/mL.

Table 2. MIC Values of White Oleander Flower and Leaf Extracts.

Microorganisms	MIC (mg/mL)			
	WOFA	WOFE	WOLA	WOLE
<i>V. anguillarum</i> A4	10	5	10	20
<i>A. hydrophila</i> ATCC 19570	20	10	5	5
<i>V. alginolyticus</i>	20	40	40	40
<i>Y. ruckeri</i>	40	40	40	20
<i>L. garvieae</i>	40	40	40	20

*WOFA: White Oleander Flower Acetone WOFE: White Oleander Flower Ethanol WOLA: White Oleander Leaf Acetone WOLE: White Oleander Leaf Ethanol

MBC values in white oleander extracts are given in Table 3. The lowest concentration of MBC on *A. hydrophila* ATCC 19570 was determined in leaf ethanol extract (WOLE) with 5 mg/mL. In general, the lowest MBC value against fish pathogens was determined in leaf ethanol extract.

Table 3. MBC Values of White Oleander Flower and Leaf Extracts

Microorganisms	MBC (mg/mL)			
	WOFA	WOFE	WOLA	WOLE
<i>V. anguillarum</i> A4	20	10	10	20
<i>A. hydrophila</i> ATCC 19570	20	10	10	5
<i>V. alginolyticus</i>	40	40	40	40
<i>Y. ruckeri</i>	40	40	40	20
<i>L. garvieae</i>	40	40	40	20

*WOFA: White Oleander Flower Acetone WOFE: White Oleander Flower Ethanol WOLA: White Oleander Leaf Acetone WOLE: White Oleander Leaf Ethanol

If the MBC/MIC ratio of the determined extract is ≤ 4 , it indicates bactericidal activity, and if the MBC/MIC ratio is >4 , it has bacteriostatic activity (Krishnan et al., 2010). The MBC ratio was found below 4. White oleander extracts have a bactericidal effect against all tested pathogens (Table 4).

Table 4. MBC/MIC Results of White Oleander Flower and Leaf Extracts

Test Microorganisms	MBC/MIC			
	WOFA	WOFE	WOLA	WOLE
<i>V. anguillarum</i> A4	2	2	1	1
<i>A. hydrophila</i> ATCC 19570	1	1	2	1
<i>V. alginolyticus</i>	2	1	1	1
<i>Y. ruckeri</i>	1	1	1	1
<i>L. garvieae</i>	1	1	1	1

*WOFA: White Oleander Flower Acetone WOFE: White Oleander Flower Ethanol WOLA: White Oleander Leaf Acetone WOLE: White Oleander Leaf Ethanol

Sun Protection Factor (SPF)

SPF values of the oleander extracts determined by spectrophotometric method are given in Table 5. The SPF values of the white oleander leaf extracts were found to be close to each other, between 25.72 and 26.52. The highest SPF value belongs to WOFE extract.

Table 5. SPF Values of White Oleander Flower and Leaf Extract.

Extracts	SPF Value
WOFA	26.49±0.04
WOFE	26.52±0.17
WOLA	25.72±0.02
WOLE	26.23±0.01

*WOFA: White Oleander Flower Acetone WOFE: White Oleander Flower Ethanol WOLA: White Oleander Leaf Acetone WOLE: White Oleander Leaf Ethanol

In the literature, *Nerium oleander* leaf extract showed significant cytotoxic activity against tumor cells and a potent antioxidant effect against non-cancer cells (Mouhcine et al., 2019). Therefore, white Oleander extracts can be used as safe photoprotective agents in the cosmetic industry.

CONCLUSION

Antibacterial activities of flower and leaf extracts from white oleander prepared with two different solvents (ethanol and acetone) against fish pathogens and also SPF were investigated. It has been determined that the flower and leaf extracts of white oleander have antibacterial activity against all the tested fish pathogens. The SPF values of the white oleander flower and leaf extracts were high. Suitable concentrations of flower and leaf extracts of white oleander can be used as natural ingredients in cosmetic and feed industries.

ACKNOWLEDGEMENTS

We would like to thank the Alata Horticultural Research Institute (Mersin/Turkey) for providing samples of red oleander flowers and leaves.

REFERENCES

- Abdou, R.H., Basha, W.A., Khalil, W.F. (2019). Subacute toxicity of *Nerium oleander* ethanolic extract in mice. *Toxicological Research*, 35(3), 233-239.
- Allen, M.W., & Bain, G. (2008). Measuring the UV protection factor of fabrics. Retrieved March 25, 2008, from Varian Australia Pty Ltd. Web site: http://www.thermo.com/eThermo/CMA/PDFs/Articles/articlesFile_6716.pdf.
- Amenu, D. (2014). Antimicrobial activity of medicinal plant extracts and their synergistic effect on some selected pathogens. *American Journal of Ethnomedicine*, 1(1), 18-29.
- Bavunoğlu, I., Balta, M., Türkmen, Z. (2016). Oleander poisoning as an example of self-medication attempt. *Balkan Medical Journal*, 33(5), 559.
- Boyras, N., Koçak, R. (2006). In vitro antifungal effects of some plant extracts. *Selcuk Journal of Agriculture and Food Sciences*, 20(38), 82-87.

- DeBuys, H.V., Levy S.B., Murray, J.C., Madey, D.L. 2000. Modern Approaches to Photoprotection. *Dermatologic Clinics*, 18:577–590.
- Del Valle, J.C., Buide, M.L., Whittall, J.B., Valladares, F., Narbona, E. (2020). UV radiation increases phenolic compound protection but decreases reproduction in *Silene littorea*. *PloS One*, 15(6), e0231611.
- El Sawi, N.M., Geweely, N.S., Qusti, S., Mohamed, M., & Kamel, A. (2010). Cytotoxicity and antimicrobial activity of *Nerium oleander* extracts. *Journal of Applied Animal Research*, 37(1), 25-31.
- Farkhondeh, T., Kianmehr, M., Kazemi, T., Samarghandian, S., Khazdair, M.R. (2020). Toxicity effects of *Nerium oleander*, basic and clinical evidence: A comprehensive review. *Human & Experimental Toxicology*, 39(6), 773-784.
- Farrukh, M.R., Nissar, U.A., Afnan, Q., Rafiq, R.A., Sharma, L., Amin, S., ... & Tasduq, S.A. (2014). Oxidative stress mediated Ca²⁺ release manifests endoplasmic reticulum stress leading to unfolded protein response in UV-B irradiated human skin cells. *Journal of Dermatological Science*, 75(1), 24-35.
- Haniffa, M.A., Kavitha, K. (2012). Antibacterial activity of medicinal herbs against the fish pathogen *Aeromonas hydrophila*. *Journal of Agricultural Technology*, 8(1), 205-211.
- Hase, G.J., Deshmukh, K.K., Murade, V.D., Pokharkar, R.D., Phatanagre, N.D., Hase, D.P., Gosavi, A.B. (2016). Phytopharmacology of *Nerium oleander* L. A review. *International Journal of Phytopharmacology*, 7(2), 0975-9328.
- Hussein, M.R. (2005). Ultraviolet radiation and skin cancer: molecular mechanisms. *Journal of Cutaneous Pathology*, 32(3), 191-205.
- Irshath, A.A., Rajan, A.P., Vimal, S., Prabhakaran, V.S., & Ganesan, R. (2023). Bacterial pathogenesis in various fish diseases: Recent advances and specific challenges in vaccine development. *Vaccines*, 11(2), 470.
- Krishnan, N., Ramanathan, S., Sasidharan, S., Murugaiyah, V., Mansor, S.M. 2010. Antimicrobial Activity Evaluation of *Cassia spectabilis* Leaf Extracts. *International Journal of Pharmacology*. 6(4): 510–514.
- Mansur, J. de S., Breder, M.N.R., Mansur, M.C. d'Ascensão, Azulay, R.D. 1986. "Correlação Entre a Determinação do Fator de Proteção Solar em Seres Humanos e Por Espectrofotometria". *Anais Brasileiros de Dermatologia*. 61(4): 167-72.
- Mouhcine, M., Amin, L., Saaid, A., Khalil, H., Laila, B. (2019). Cytotoxic, antioxidant and antimicrobial activities of *Nerium oleander* collected in Morocco. *Asian Pacific Journal of Tropical Medicine*, 12(1), 32.
- Norval, M. (2006). *The mechanisms and consequences of ultraviolet-induced immunosuppression*. *Progress in Biophysics and Molecular Biology*, 92(1), 108-118.
- Rahman, M., Rahman, M., Deb, S.C., Alam, M., Islam, M. (2017). Molecular identification of multiple antibiotic resistant fish pathogenic *Enterococcus faecalis* and their control by medicinal herbs. *Scientific Reports*, 7(1), 1-11.
- ThamaraiSelvi, B., Deepthi, R. (2018). Envirosafe dyeing and antimicrobial activity of cotton fabrics finished with floral extract from *Nerium oleander*. *International Journal of Basic and Applied Research*, 8(3), 159-163.
- Zeybek, Z., Dogruoz, N., Karagoz, A. (2008). Antibacterial activity of some plant extracts. *European Journal of Biology*, 67(1), 17-21.

PREPARATION AND COMPARISON OF WATER-SOLUBLE MAGNETIC NANOPARTICLES MODIFIED WITH DIFFERENT FLUORESCENT DYES

Yeliz AKPINAR^{1*}

¹ *Kırşehir Ahi Evran University, Art and Science Faculty, Department of Chemistry, Kırşehir, Türkiye*

Corresponding author e-mail: yeliz.akpinar@ahievran.edu.tr

ABSTRACT

Nanoparticles have a very important role in the field of science and technology today. It is defined in the literature as a particle with a size in the range of 0-100 nm. In today's conditions, the main goal is to achieve high efficiency and low toxicity with less material and energy. In this direction, it is adopted to prepare particles with a sustainability approach and use them in applications. Particles in metallic, polymeric, or hybrid structures can be prepared by chemical and physical methods. They have different properties according to both the structure of the material they are prepared and their size and shape. It is used and will be used in many application areas such as biomedicine, electronics, environment, agriculture, and energy. In R&D studies, existing nanostructures are functionalized and made more useful. The weak optical properties of magnetic nanoparticles, which are very attractive thanks to their magnetic properties, cause weakness in many application areas. To eliminate this deficiency, magnetic particles can be modified with molecules or particles with optical properties such as dyes, molecules, or quantum dots. In this study, cobalt ferrite magnetic nanoparticles were modified with chitosan to make their surfaces suitable for functionalization, and then the attachment of different dye molecules (eosin y, fluorescein, and rhodamine B) to the particle surface by bonding reactions were examined with spectrophotometric methods.

Keywords: Magnetic Nanoparticles, Biomedical Applications, Fluorescent Dyes

INTRODUCTION

Nanotechnology is a trendy issue in the field of science right now. The products and techniques that have arisen because of these studies make daily living more efficient. The need for sustainable energy, the detection and treatment of new diseases, the rising demand for food because of population growth, and other factors are driving the advancement of nanoscience. Nanostructures are the fundamental building blocks for the scientific approach to product development. Because of their unique features, nano-sized materials are very useful in biomedical research(Khan et al., 2019).

Magnetic nanoparticles have properties especially suitable for use in both imaging and treatment methods. The fact that they have high contrast in the MR imaging system and are suitable for magnetic targeting processes gives these particles an important role in the diagnosis of cancer disease(Cabuil, 2015; Frey et al., 2009a; Laurent et al., 2010). In addition, the heat release of magnetic particles under an alternating magnetic field makes them a very effective tool for the application of hyperthermia therapy in cancer treatment. So much so that while the currently used hyperthermia treatments are only effective in cancer cells near the surface, in the magnetic hyperthermia approach, cancer cells in deep regions also undergo apoptosis thanks to magnetic nanoparticles agglomerated by targeting within the tumor(Hoopes, 2013; Salunkhe et al., 2014).

They can be prepared with a functional surface of different shapes and sizes, so this feature makes them preferred in biomedical applications. However, the absence of optical properties of magnetic nanoparticles is an important feature. This makes it difficult to monitor the instantaneous state of magnetic particles in both experimental and applications (Cabuil, 2015; Frey et al., 2009b). This problem can be handled by modifying magnetic particles with optical properties of dyes (fluorescent or chromophore dye etc.) and nanostructures (quantum dots or plasmonic nanoparticles etc.). The resulting nanostructures have both magnetic and optical properties. Especially in intracellular studies, magnetic particles with optical properties are becoming a unique tool for determining particle or drug concentration (Sun et al., 2016; Wei et al., 2018).

Rhodamine b is a water-soluble molecule with fluorescence used for staining. It is used for labeling muscle and other tissue to image sub-cellular structures and for imaging in liquid with a fluorescence microscope. While its excitation value is 545 nm, it emits strongly at 575 nm (Chen & Wood, 2009). The Eosin yellow dye is frequently employed in the identification of bacterial species as a gram staining type due to the red hue and significant absorption by red blood cells. Its excitation and emission wavelengths are 488 nm and 537 nm, respectively (Thabet & Ismaiel, 2016).

MATERIAL AND METHOD

1.) Co-precipitation was used to produce CoFe_2O_4 nanoparticles (MNPs). In a flask, a 1:2 mole solution of CoCl_2 and FeCl_3 salts was made, and it was combined with a NaOH solution at 80°C for one hour. With the use of a magnet, the resultant black particles were collected, and three magnetic washing procedures were carried out using a solution of ethanol, 2-propanol, methanol, and water. It was then dissolved in ionized water (Aşik et al., 2016).

2.) MNPs and chitosan solutions were combined in order to cover the surface of MNPs with chitosan. 1.0 mL of MNPs solution was diluted to 50.0 ml with DI water and its Ph was adjusted to about 10 by using sodium hydroxide solution. Then this solution was added to 3mg, 5.0 mL of chitosan (in 0.5 M acetic acid) solution, drop by drop. The mixtures were stirred for 12 hours, chitosan-MNPs was collected by using a magnet, and the supernatants having excess chitosan were discarded. Final particles were suspended in di water.

3.) Aqueous solutions of 1×10^{-5} M, 10.0 ml of Rhodamine b, Fluorescein and Eosin Y were prepared separately. EDC/NHS reactant solutions of solutions were added and mixed for 30 minutes. Then the MNPs solution (10.0 ml chitosan-MNPs + 5.0 ml DI water) was added dropwise to the previous solutions. and stirred for 2 hours. The mixtures were washed 5 times using the magnetic washing technique. In the last step, chitosan -MNPs particles with dye molecules attached to the magnet were dispersed in 10.0 ml of DI water. Procedure photography is given in Figure 1 and Figure 2 (Sahoo et al., 2017).

4.) After stability observations the optimization study was performed by using Rhodamine B dye at different concentrations. The procedure used in the previous step was followed by using 2×10^{-6} M, 6×10^{-6} M, 1×10^{-5} M, 1.4×10^{-5} M, and 2×10^{-5} M rhodamine B solutions.

5.) After the optimum value was determined, the concentration of the dye molecule attached to the surface was determined as an approximate value by drawing a 5-point calibration curve.



Figure 1. a) Dye solutions, b) Dye solutions after chitosan-MNPs addition

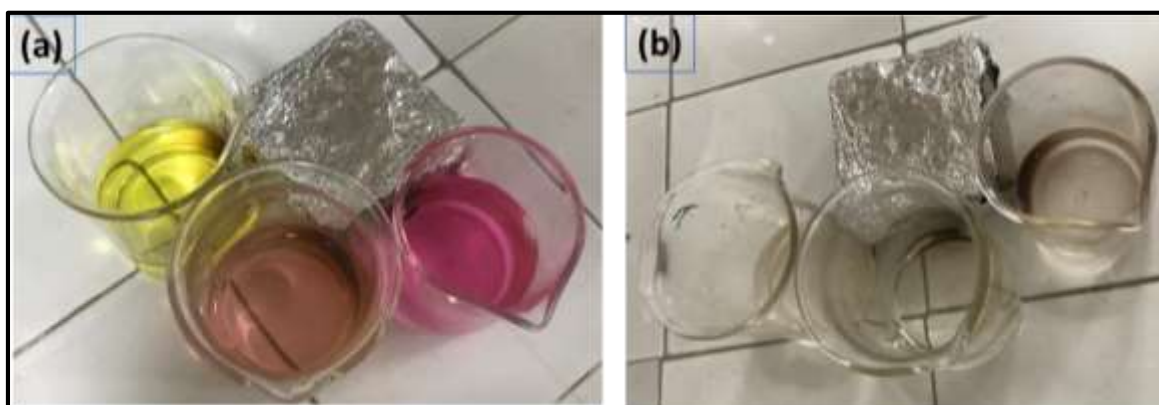

Figure 2. Magnetic washing procedure of Dye-MNPs a) 1st washing, b) 2nd washing.

RESULTS AND DISCUSSION

FTIR Spectroscopy and Zeta Potential measurement methods were used to characterize the prepared Chitosan-MNPs particles.

In Figure 3, the FTIR spectra of bare MNP and Chitosan-coated MNP particles are given. The spectrum in black represents MNPs, while the red one represents chitosan-coated MNPs. In the red spectrum, the NH_2 group bend scissoring peak at 1656 cm^{-1} and C-N stretching peak at 1317 cm^{-1} are seen (Pineda et al., 2014). These peaks are not seen in the spectrum of bare MNPs, proving the presence of the amine group in chitosan. According to these FTIR spectra, the surface was coated with chitosan.

According to zeta potential measurements, the values changed from $-0.0775 \pm 0.0561\text{ mV}$ in bare-MNPs solution to $37.8468 \pm 2.3337\text{ mV}$ after coating with chitosan. This change in surface charge indicates that the surface of MNPs particles is coated with chitosan and that the chitosan-MNP particles are homogeneously dispersed in the solution obtained after coating.

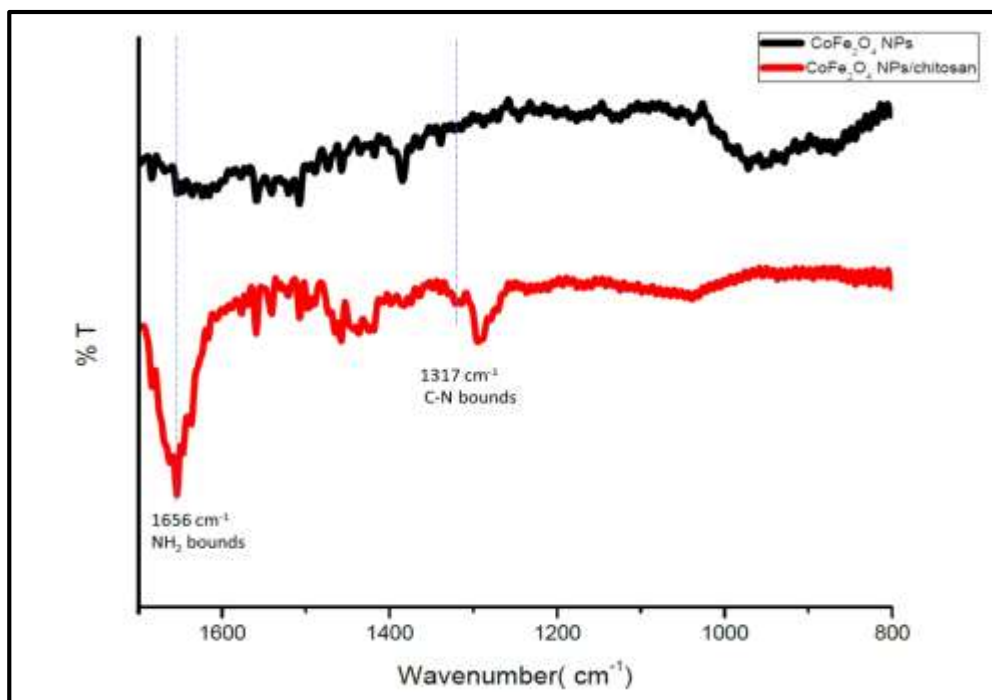

Figure 3. FTIR spectra of MNPs (CoFe_2O_4 NPs), and chitosan-Chitosan-MNPs

The solutions obtained as a result of the experimental 3rd part studies showed similar emission colors with the dye solutions when viewed under a UV lamp at 365 nm in Figure 4. In Figure 4 a) the image of the dyes under UV light(365 nm) is given, while in Figure 4b) the image of the dye-attached MNPs particle solutions is given. Emissions belong to dye-attached particles, as the dye-attached particles were magnetically washed five times and the supernatants were discarded.

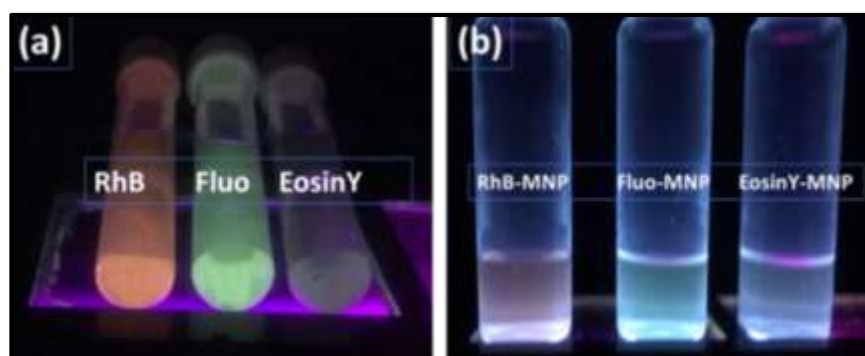

Figure 4. Image of a.) dye solutions, b.) dye-MNPs solutions under UV light.

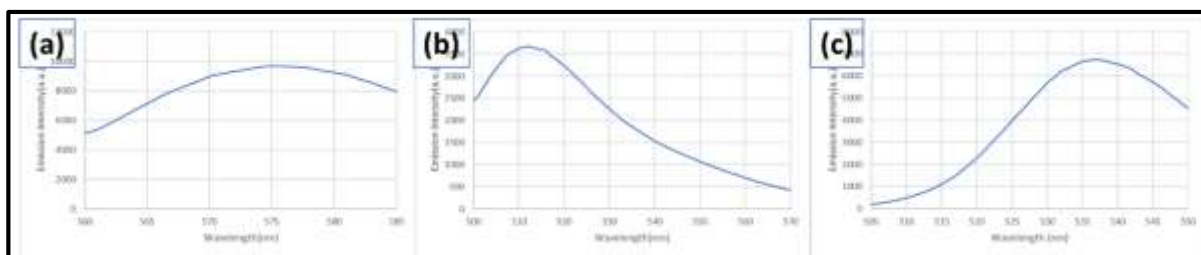

Figure 5. Spectrum of $2 \times 10^{-3} \text{M}$ a.) Rhodamine B solutions, b.) Fluorescein solutions, and c.) Eosin Y solutions.

In Figure 5, the fluorometric measurements of the dye solutions were taken and it was seen that they were compatible with the literature (El Kurdi & Patra, 2018; Herbrik et al., 2020; Slyusareva et al., 2011). Figure 5. a) Rhodamine B, Figure 5. b) fluorescein and Figure 5. c) eosin y dye emission spectra are given.

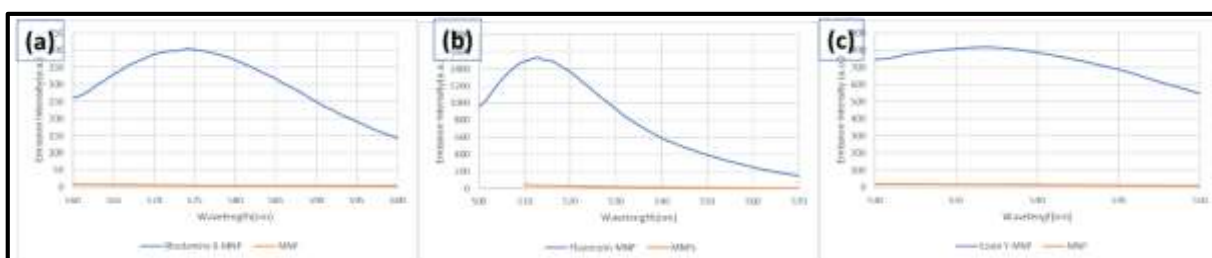

Figure 6. Spectrum of a.) Rhodamine B-MNPs solutions, b.) Fluorescein- MNPs solutions, and c.) Eosin Y- MNPs solutions, which are prepared by adding $1 \times 10^{-5} \text{M}$ dye solutions

Spectrums of spectrofluorometric measurements of the solutions obtained in the experimental part 3 were made and are given in Figure 6. Orange lines in the spectra belong to MNPs (given as background.) Blue spectra belong to Figure 6. a) rhodamine B-MNPs, b) fluorescein-MNPs, and c) eosin y -MNPs, respectively. When the individual spectra are compared, it is seen that the dyes are attached to the surface of the MNPs. The emission values obtained coincide with the wavelength values obtained in the dyes. The highest intensity value was obtained from the particles using fluorescein dye (b spectrum).

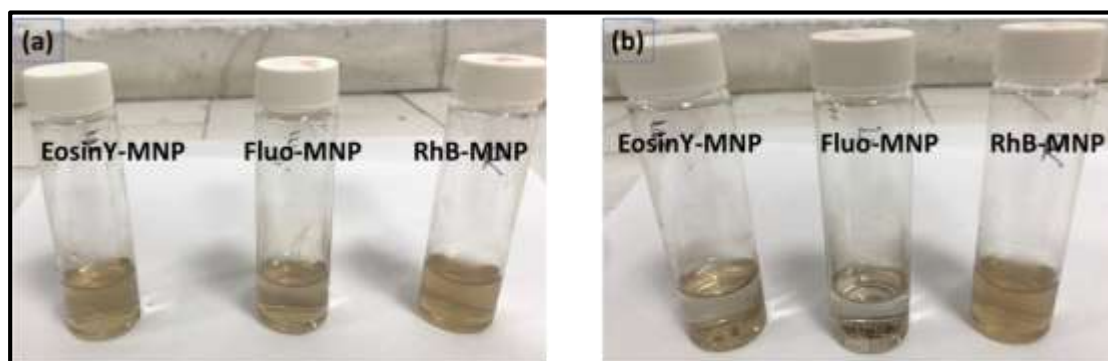

Figure 7. Image of dye-MNPs solution a.) immediately after preparation, b.) 24 hours after preparation.

The images of the dye-MNPs solutions are prepared in Figure 7. a) After preparation are given. In Figure 7. b), the images after keeping the same solutions at room temperature for 24 hours are given. According to Figure 7. b), the stability of Eosin-Y and Fluorecein-MNPs solutions was observed to be quite low. According to Figure 7. b), the Rhodamine B-MNPs particle retains its homogeneous dispersed appearance and is more stable.

Although fluorescein-MNPs gave better results according to emission intensity, Rhodamine B-MNPs gave the best results according to stability observation. For this reason, we continued to work with Rhodamine B-MNPs nanomaterials.

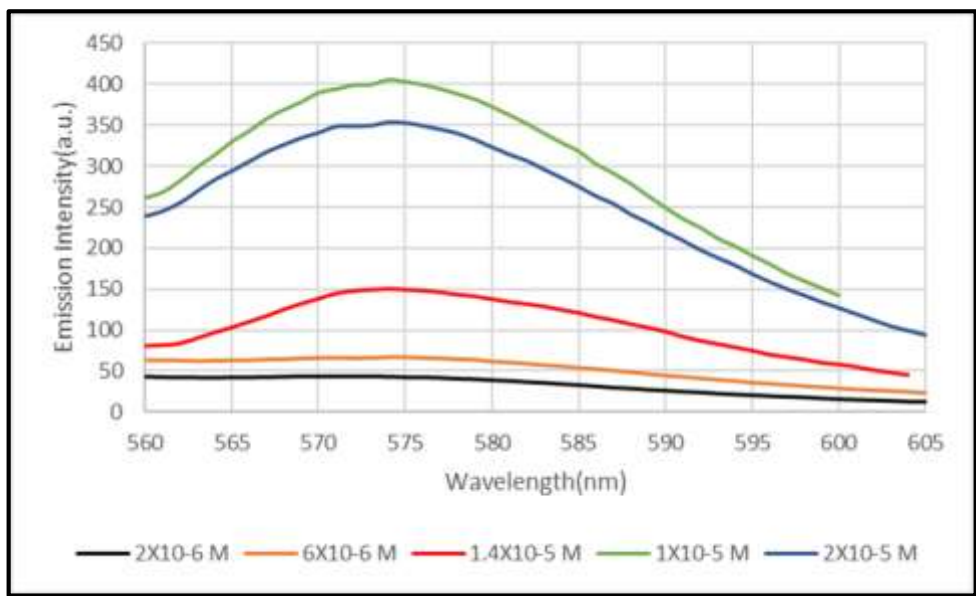

Figure 8. Spectra of rhodamine B-MNPs solution which are prepared by using various Rhodamine B concentrations.

In Experimental part 4, dye attaching procedur was performed using Rhodamine B solution at different concentrations. According to Figure 8, the optimum results were obtained when 1x10⁻⁵ M rhodamine B solution was used.

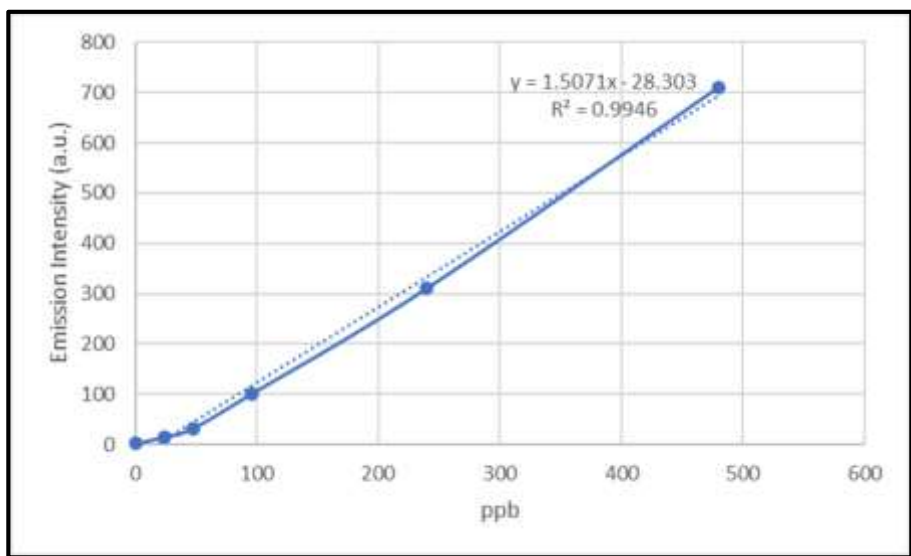

Figure 9. Calibration curve of Rhodamine B solutions

A calibration curve was drawn using a blank and five different concentrations in experimental part 5. In the calibration curve (Figure 9), the amount of dye on the surface of RhB-MNPs prepared under optimum conditions (prepared by adding 1×10^{-5} M Rhodamine B) was calculated as approximately 286 ppb.

CONCLUSIONS

In this study, different dye molecules were attached to the magnetic nanoparticle surface coated with chitosan, a biocompatible polymer, by EDC/NHS coupling reaction, and a comparison study was made. Magnetic nanoparticles were given optical properties and nanomaterials were prepared especially for use in intracellular imaging. The optimum value was obtained when Rhodamine B dye was used. This work can be improved by using different dyes and polymeric materials.

REFERENCES

- Aşık, E., Akpınar, Y., Tülin Güray, N., Işcan, M., Demircigil, G. Ç., & Volkan, M. (2016). Cellular uptake, genotoxicity and cytotoxicity of cobalt ferrite magnetic nanoparticles in human breast cells. *Toxicology Research*, 5(6), 1649–1662. <https://doi.org/10.1039/c6tx00211k>
- Cabuil, V. (2015). Magnetic Nanoparticles: Preparation and Properties. *Encyclopedia of Surface and Colloid Science, Third Edition*, 3934–3948. <https://doi.org/10.1081/e-escs3-120000188>
- Chen, Y. Y., & Wood, A. W. (2009). Application of a temperature-dependent fluorescent dye (Rhodamine B) to the measurement of radiofrequency radiation-induced temperature changes in biological samples. *Bioelectromagnetics*, 30(7), 583–590. <https://doi.org/10.1002/bem.20514>
- El Kurdi, R., & Patra, D. (2018). Nanosensing of ATP by fluorescence recovery after surface energy transfer between rhodamine B and curcubit[7]uril-capped gold nanoparticles. *Microchimica Acta*, 185(7). <https://doi.org/10.1007/s00604-018-2901-8>
- Frey, N. A., Peng, S., Cheng, K., & Sun, S. (2009a). Magnetic nanoparticles: Synthesis, functionalization, and applications in bioimaging and magnetic energy storage. *Chemical Society Reviews*, 38(9), 2532–2542. <https://doi.org/10.1039/b815548h>
- Frey, N. A., Peng, S., Cheng, K., & Sun, S. (2009b). Magnetic nanoparticles: Synthesis, functionalization, and applications in bioimaging and magnetic energy storage. *Chemical Society Reviews*, 38(9), 2532–2542. <https://doi.org/10.1039/b815548h>
- Herbrik, F., González, P. C., Krstic, M., Puglisi, A., Benaglia, M., Sanz, M. A., & Rossi, S. (2020). Eosin Y: Homogeneous photocatalytic in-flow reactions and solid-supported catalysts for in-batch synthetic transformations. In *Applied Sciences (Switzerland)* (Vol. 10, Issue 16). MDPI AG. <https://doi.org/10.3390/app10165596>
- Hoopes, P. J. (2013). *Magnetic Nanoparticle Hyperthermia in Cancer Treatment*. 1, 1–23. <https://doi.org/10.1142/S1793984410000067>. MAGNETIC
- Khan, I., Saeed, K., & Khan, I. (2019). Nanoparticles: Properties, applications and toxicities. In *Arabian Journal of Chemistry* (Vol. 12, Issue 7, pp. 908–931). Elsevier B.V. <https://doi.org/10.1016/j.arabjc.2017.05.011>
- Laurent, S., Bridot, J. L., Elst, L. Vander, & Muller, R. N. (2010). Magnetic iron oxide nanoparticles for biomedical applications. *Future Medicinal Chemistry*, 2(3), 427–449. <https://doi.org/10.4155/fmc.09.164>
- Pineda, M. G., Torres, S., López, L. V., Enríquez-Medrano, F. J., De León, R. D., Fernández, S., Saade, H., & López, R. G. (2014). Chitosan-coated magnetic nanoparticles prepared in

- one-step by precipitation in a high- Aqueous phase content reverse microemulsion. *Molecules*, *19*(7), 9273–9287. <https://doi.org/10.3390/molecules19079273>
- Sahoo, S. L., Liu, C. H., & Wu, W. C. (2017). Lymphoma cell isolation using multifunctional magnetic nanoparticles: Antibody conjugation and characterization. *RSC Advances*, *7*(36), 22468–22478. <https://doi.org/10.1039/c7ra02084h>
- Salunkhe, A. B., Khot, V. M., & Pawar, S. H. (2014). Magnetic Hyperthermia with Magnetic Nanoparticles: A Status Review. *Current Topics in Medicinal Chemistry*, *14*(5), 572–594. <https://doi.org/10.2174/1568026614666140118203550>
- Slyusareva, E. A., Gerasimov, M. A., Sizykh, A. G., & Gornostaev, L. M. (2011). Optics and Spectroscopy Spectral and Fluorescent Indication of the Acid-Base Properties of Biopolymer Solutions. In *Russian Physics Journal* (Vol. 54, Issue 4).
- Sun, M., Sun, B., Liu, Y., Shen, Q. D., & Jiang, S. (2016). Dual-Color Fluorescence Imaging of Magnetic Nanoparticles in Live Cancer Cells Using Conjugated Polymer Probes. *Scientific Reports*, *6*. <https://doi.org/10.1038/srep22368>
- Thabet, M. S., & Ismaiel, A. M. (2016). Sol-Gel A-Al₂O₃ Nanoparticles Assessment of the Removal of Eosin Yellow Using: Adsorption, Kinetic and Thermodynamic Parameters. *Journal of Encapsulation and Adsorption Sciences*, *06*(03), 70–90. <https://doi.org/10.4236/jeas.2016.63007>
- Wei, X., Yu, M., Li, C., Gong, X., Qin, F., & Wang, Z. (2018). Magnetic nanoparticles coated with a molecularly imprinted polymer doped with manganese-doped ZnS quantum dots for the determination of 2,4,6-trichlorophenol. *Microchimica Acta*, *185*(4). <https://doi.org/10.1007/s00604-018-2742-5>

CYTOTOXICITY OF ORANGE PEEL (*Citrus sinensis*) ESSENTIAL OIL NANOEMULSIONS ON THE RAINBOW TROUT GONADAL CELLS

Semra ÇİÇEK¹

¹ Department of Agriculture Biotechnology, Faculty of Agriculture, Atatürk University, Erzurum, Turkey
semra.cicek@atauni.edu.tr

ABSTRACT

The citrus industry holds a significant position in the agricultural industry. However, it also generates substantial amounts of orange peel (*Citrus sinensis*) wastes. Essential oil production is one of the widely used bio-economical methods for the evaluation of these wastes. Essential oils are evaluated below their potential for use in different sectors due to their volatile nature and low stability against environmental stress conditions, which the nanoemulsion can overcome. Therefore, this study aimed to form and characterize of the nanoemulsion of orange peel essential oil (OPEON) and investigate its cytotoxicity on the rainbow trout gonadal (RTG-2) cells. The OPEON (0.1:0.3:0.6:99 w/w, EO: Tween 80: Ethanol: water) was successfully created using an ultrasonic homogenizer. The OPEON was characterized using TEM (~100 nm), zeta sizer (the ζ -potential value of -12.6 mV, and the polydispersity index of 0.657, conductivity of 0.00547 mS/cm), and FT-IR analysis. Treatments of 125, 250, 500, 1000 ppm of the OPEON have statistically significant toxic effects on the RTG-2 cells after 24 hours of exposure. Based on the study results and considering the toxic effect on cells, there is a potential for effective use of nanoemulsion forms of essential oils, especially in the pesticide industry.

Keywords: Orange peel essential oil, Nanoemulsion, Zeta sizer, Cytotoxicity, Rainbow trout gonadal cells

INTRODUCTION

Citrus fruit, a valuable plant grown worldwide, has a crucial position in fruit consumption, fruit juice, marmalade, jelly, canned food, and essential oil production. In terms of usage area, orange (*Citrus sinensis*) is the most used citrus species (Sandhu et al., 2021). However, up to 60% of the processed fruit weight emerges as solid waste containing highly valuable bioactive compounds (essential oils, flavones, polyphenols, etc.), which creates an economic burden (Omran et al., 2018; Victor et al., 2021). Considering the rich functional components of orange peel, essential oil extraction is one of the widely used bioeconomic methods in the evaluation of these wastes (Gavahian et al., 2019; Siddiqui et al., 2022).

Essential oils are concentrated hydrophobic liquids and complex compounds characterized by a strong odor and composed of various plant metabolites. Essential oils are clear and soluble in lipid/organic (ether, alcohol, fixed oils) solvents and have less density than water (Kar et al., 2018). The biological activities of essential oils vary depending on the chemical composition, which varies according to the plant parts used for extraction, the extraction method, the phenolic stage of the plant, the harvest season, the age of the plant, the nature of the soil and environmental conditions (Said-Al Ahl et al., 2017). Citrus essential oils are widely used in sectors such as beverages, ice cream, cookies, biscuits, cakes, room fresheners, household products, perfumes, pharmaceuticals, aromatherapy, and detergents

(Geraci et al., 2017; Hanif et al., 2019). However, there are some drawbacks that limit the high usage potential of essential oils. The high volatility and sensitivity of essential oils to chemical conversion or degradation reactions such as oxidation, isomerization, polymerization and rearrangement depending on environmental parameters such as temperature, light and atmospheric oxygen limit their potential for use in the field (Pavoni et al., 2020; Oladipupo et al. al., 2022). In addition, essential oils have poor physico-chemical properties, such as fast half-life and low solubility in water. As a way to deal with this, nano formulations are being developed that can retain essential oils without interfering with their bioactivity, provide deeper tissue penetration, increase bioactivity as they allow easier cellular uptake, and achieve the desired slow release (Pavoni et al., 2020; Mustafa and Hussein, 2020).

Nanoemulsions are two-phase dispersion of two immiscible liquids in nanosizes, which are water-in-oil (W/O) or oil-in-water (O/W) formulations and droplets stabilized by amphiphilic surfactants. Nanoemulsions have droplet sizes of 20–200 nm in diameter. The large surface area provided by their nanometric size provides higher loading capacity and improved solubility, resulting in increased bioavailability of poorly soluble compounds. Nanoemulsions are kinetically stable (Feng et al., 2018; Barradas and de Holanda e Silva, 2021; Sharma et al., 2022). Although there are a few studies in which nanoemulsion forms of orange peel essential oil (OPEON) are obtained by different methods and its antifungal, antibacterial and larvicidal activities are shown, there is no study showing toxicity *in vitro* according to our best knowledge (Azmy et al., 2019; Das et al., 2020; Farouk et al., 2022). Based on these observations, this study was modeled to generate data to create and characterize of the OPEON and its cytotoxicity on rainbow trout gonadal (RTG-2) cells.

MATERIAL AND METHOD

The orange peel essential oil was purchased from a local company, BIOMESI Bioagrotechnology R&D, located in Adana, Turkey (Durmuş et al., 2023). The RTG-2 cell line (Registration Number: 95121808) was purchased from Türkiye ŞAP Enstitüsü (Ankara, Turkey) (Çiçek, 2023).

The OPEON was formed using an ultrasonic homogenizer (BANDELIN electronic GmbH & Co. KG, Berlin, Germany) following the method described by Durmuş (2020) with minor changes. 30 µL of essential oil, 90 µL of ethanol, 180 µL of Tween 80 and 29.7 µL of distilled water (0.1:0.3:0.6:99 w/w) were placed in a glass beaker and exposed to an ultrasonic homogenizer. Ultrasonic homogenizer operating conditions were set as 15 min, 70 amplitude, 20 kHz and 500 W, and a titanium probe (2 mm diameter and 1950 mm height (MS72)) was used. In addition, ice was used around the beaker to avoid thermal effects during the process (Durmuş, 2020).

Transmission electron microscope (TEM) (Hitachi High Tech HT7700, Japan), zeta sizer (Malvern Zeta sizer Nano ZSP, Malvern Instruments Pvt Ltd, UK) and Fourier transform infrared spectroscopy (FTIR) (Bruker VERTEX 70v brand, Germany) was used to determinate of surface morphology, zeta potential and molecular structure of the OPEON, respectively (Sogan et al., 2023). These analyzes were carried out with service procurement at the Eastern Anatolia High Technology Application and Research Center (DAYTAM, Erzurum, Turkey).

The RTG-2 cells were cultured 89.5% Eagle's minimal essential medium (EMEM: with L-glutamin medium, ATCC 30-2003) supplemented with 10% fetal bovine serum (Biowest S1810-500) and 0.5% penicillin-streptomycin (Sigma P4333) in 25 cm² culture flasks (Isolab 120.11.025) at 23.7 °C without CO₂ respiration (Çiçek, 2023).

The OPEON were prepared at different concentrations (125, 250, 500, and 1000 ppm) by dissolving in ethanol:distilled water solution prepared in a 1:1 ratio. Experimental groups were applied on the RTG-2 cells seeded 24 hours ago at a density of 3x10⁴ cells/well. For the control

groups, ethanol: distilled water and Tween 80: ethanol were used. Then, a cell viability test was carried out after 24 hours of incubation.

Sulforhodamine B test was performed for cell viability testing. Briefly, after 24 hours of incubation with the experimental groups, 100 μ L of cold 10% trichloroacetic acid solution (CAS No: 76-03-9, Sigma Aldrich, USA) was applied to the RTG-2 cells (4 $^{\circ}$ C, 1.5 hours). Following washing 5 times with distilled water and air drying, the cells were fixed with 50 μ L of 0.4% SRB dye (CAS No: 3520-42-1, Sigma Aldrich, USA) was prepared in 1% acetic acid (CAS No: 64-19-7, Sigma Aldrich, USA) (30 min in the dark). Washing was done 5 times with 5% acetic acid solution and air drying. Then, 150 μ L of 10 mM Tris base (CAS No: 77-86-1, Sigma Aldrich, USA, pH 10.5) was added to each well and kept in an orbital shaker (15-20 min, 150 rpm). The absorbance values were read in a micro-plate reader (EpochTM, BioTek, USA) at 564 nm (Vichai and Kirtikara, 2006).

The study data (n= 6 independent experiments) were evaluated using the GraphPad Prism 9.00 Statistical Software (GraphPad Software, Inc., California, USA). Experimental groups were analyzed using One-way analysis of variance (ANOVA) and the statistical significance was accepted at $p \leq 0.05$ level (Çiçek, 2023).

RESULTS AND DISCUSSION

Detailed characterization is necessary to confirm the presence of nanostructures in the production of nanomaterials. Therefore, in this study, TEM, Zetasizer, and FTIR were utilized for the characterization of the OPEON. During the nanoemulsion process, the reaction mixture turned milky white (as observed macroscopically) after ultrasonication process. Eventually, this mixture became translucent and dispersed. TEM images of the OPEON are shown in Figure 1 at different scales. According to TEM images, the OPEON consisted of spherical droplets and was obtained in sizes of 100 nm and above. The Ostwald maturation phenomenon, in which a possible solubility in the aqueous phase of the emulsion system transferred from small droplets to large droplets, may have led to the obtaining of nanoemulsions of different sizes (Farouk et al., 2022). In this study, negative staining (uranyl acetate) was used to remove water from the outer layer of nanoemulsion droplets and visualize it (Klang et al., 2012; Somala et al., 2022). TEM images show that the OPEON has no physical deformation, no agglomeration and a smooth structure.

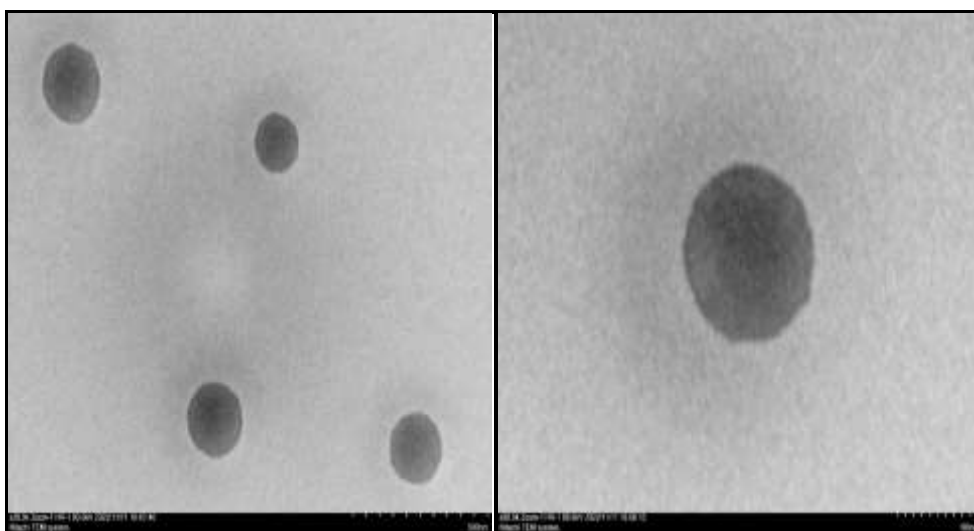

Figure 1. TEM images of the OPEON at 500 nm and 100 nm scales

Zetasizer analysis was performed to measure the particle size, zeta potential values, and polydispersity indexes of the OPEON droplets at a constant temperature of 25°C (as shown in Figure 2). The average droplet particle sizes of the OPEON ranged from 405 to 1291 nm, with a 701.2 nm of mean droplet particle. Considering the size distribution graph, it is understood that nanoemulsions with sizes around 10 nm and 100 nm are obtained at the same density percentage, and there are also emulsion forms, with sizes around 1000 nm and above. This explains the visualization of nanoemulsions with sizes around 100 nm in TEM analysis. Increases in the size of the emulsion structure may depend on the type of surfactant and its chemical composition in the essential oil (Mohammad et al., 2019).

The mean zeta potential (ζ -potential) value of the OPEON was determined as -12.6 mV. High negative and positive ζ -potential values may indicate that repulsive forces are more dominant than attractive forces. In this study, the OPEON was obtained using an ultrasonicator. Mechanical stress occurring during the ultrasonication process can cause the release of free -OH and -COOH groups from the essential oil, leading to an increase in the negative charge on the surface of the nanoemulsion. The ζ -potential value of nanoemulsion, which is considered electrostatically stabilized, is expected to be in the range of ± 30 mV (Gurpreet and Singh, 2018). Therefore, based on the mean ζ -potential value, it can be assumed that the OPEON has a suitable shelf life and can be used effectively and with long-term effect in various areas for different purposes (Farouk et al., 2022).

The mean polydispersity index (PDI) of the OPEON was determined as among 0.509-0.943. The PDI shows a narrow distribution of nanoemulsions size if it is below 0.2 or 0.25 (Kaci et al., 2018). In this study, the OPEON was obtained in different sizes, and the dispersions of nanoemulsions between 10 nm and 100 nm are less than the dispersions of nanoemulsions with sizes close to 1000 nm. This explains the high PDI values. If the PDI value is greater than 0.5, the system is called broad size distribution (Golfomitsou et al., 2018). Tween 80 concentration is the most crucial factor affecting the PDI value of nanoemulsions (Pongsumpun et al., 2020). This suggests that the concentration of Tween 80 used in this study should be kept higher in other studies.

Sample	Z-average (d.nm)	ZP (mV)	PDI
P11	405	-14.8	0.509
P12	407.5	-13.1	0.519
P13	1291	-10	0.943
Mean	701.2	-12.6	0.657
Std. Dev.	510.8	2.43	0.248

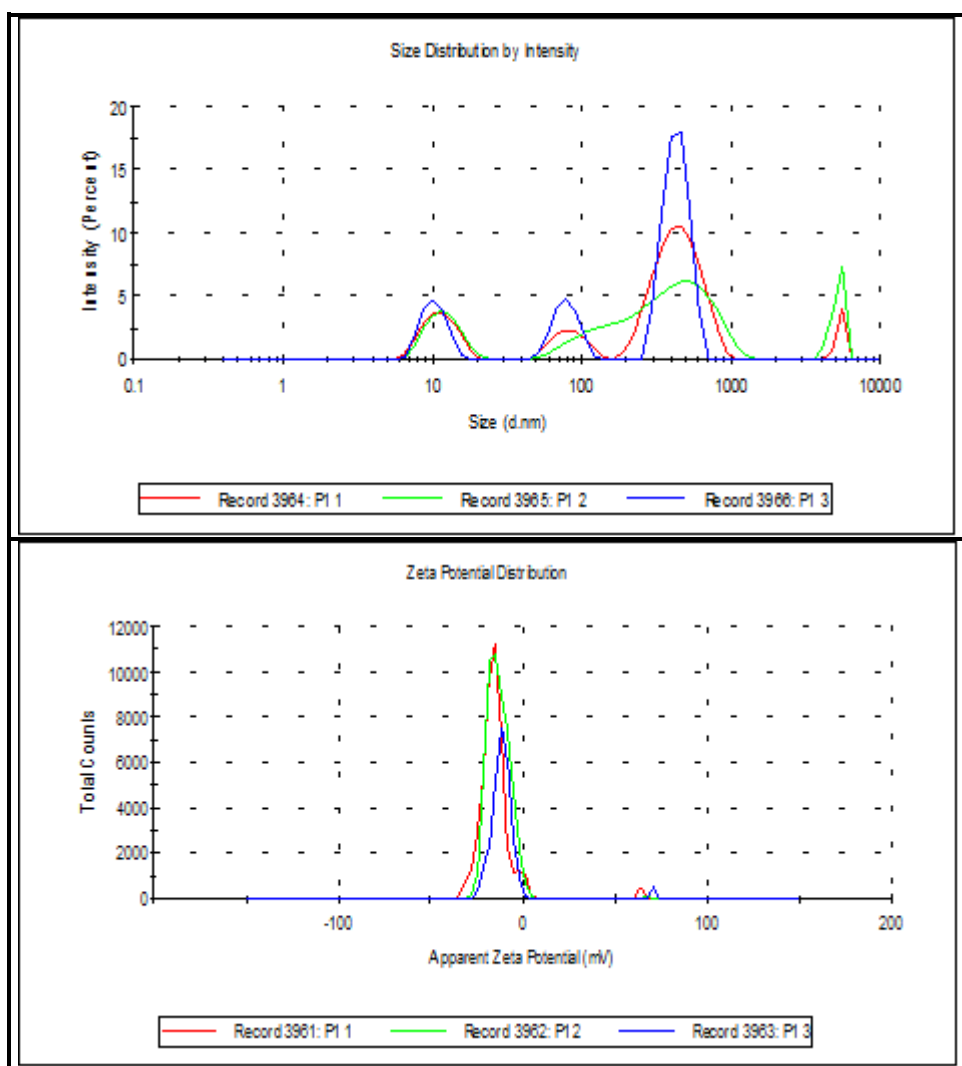

Figure 2. The droplet particle size distribution, zeta potential distribution, polydispersity indexes of the OPEON (P11, P12, P13: three repetitions; ZP: Zeta potential, PDI: Polydispersity index)

FTIR analysis was performed to characterize the molecular structure and functional groups of the OPEON, as shown in Figure 3. The peaks observed at 3753 cm^{-1} , 3496 cm^{-1} and 3481 cm^{-1} corresponds to O-H stretching of alcohol, phenol, and hydroxyl groups, the peak at 2921 cm^{-1} indicates to C-H and O-H stretches of the alkanes, and the peak at 2856 cm^{-1} is -C-H aldehydic stretching and -C-H stretch, as well as carboxylic acid O-H stretch (Opoku et al., 2021; Soni et al., 2022). An absorption band at 2368 cm^{-1} indicates the O=C=O stretching of carbon dioxide. In this study, the C=O ester groups at 1733 cm^{-1} may be associated with the ester groups found in Tween 80 (Osanloo et al., 2022). The peak was observed at 1652 cm^{-1} corresponds to vibratory stretching bonds of groups C=O (Amide type I), the band at 1558 cm^{-1} indicates amide II and N-H bending (Hosseinnia et al., 2017; Al-Hilifi et al., 2022). The peaks observed at 1458 cm^{-1} , 1350 cm^{-1} , and 1297 cm^{-1} are related to CH_2 bending vibration, NO_2 stretch and CH_3 bend, respectively (Zhang et al., 2017; Michelina et al., 2019). The peak at 1247 cm^{-1} represents the C-O-C stretch, while the peak at 1099 cm^{-1} indicates the C-O stretching. The peaks among at $500\text{-}950\text{ cm}^{-1}$ refer to C-H and C=C bends (Min et al., 2021).

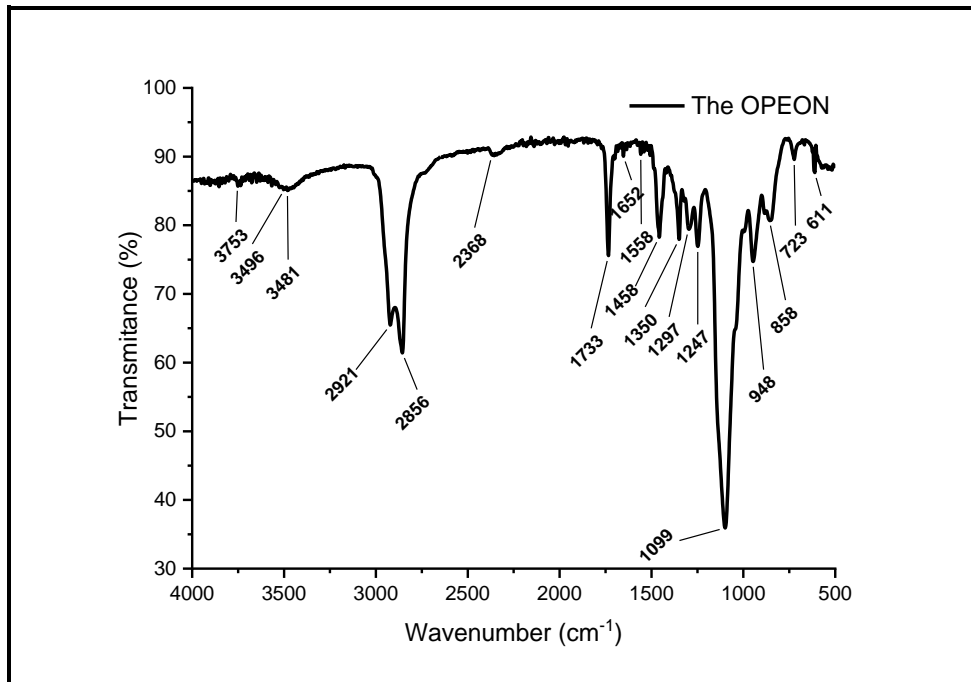

Figure 3. The FTIR spectra of the OPEON

The cytotoxic effect of the OPEON prepared at different concentrations on the RTG-2 cells after 24 hours of exposure is shown in Figure 4. Treatments of the OPEON (125, 250, 500, and 1000 ppm) showed significantly higher cytotoxic effects compared to the control group. Although 1:1 ethanol and Tween 80 treatments showed toxic effects compared to the control group, they did not reduce the RTG-2 cell viability as much as the OPEON treatments. The cytotoxic effects of nanoemulsion forms of essential oils are generally higher than that of free essential oils, depending on surfactant, nano size, electrical properties, chemical composition of the essential oil, dose, and time. In addition, the interaction between the surface charges of nanoemulsions and the charges of cell membranes can increase the cytotoxic effect (Yoon et al., 2018; Marchese et al., 2020).

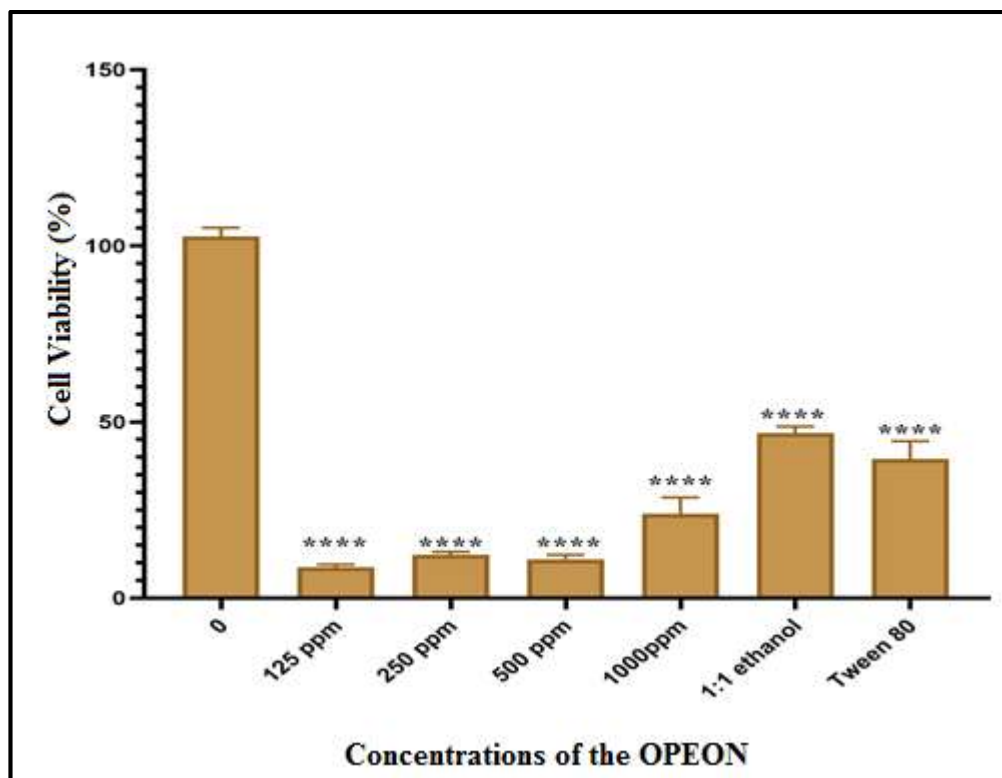

Figure 4. The cytotoxic effects of the OPEON on the RTG-2 cells for 24 hours

CONCLUSIONS

This study demonstrated that the OPEON was successfully obtained at different sizes. However, for long-term stability, it is recommended to change the formulation ratios for subsequent processes. Considering the toxic effect of the OPEON on the RTG-2 cells, future studies may focus on its potential for use in fields such as pesticide production, antibiotic agent.

REFERENCES

- Al-Hilifi, S. A., Al-Ali, R. M., Petkoska, A.T. 2022. Ginger essential oil as an active addition to composite chitosan films: development and characterization. *Gels*. 8(6): 327. <https://doi.org/10.3390/gels8060327>
- Azmy, M.R., El Gohary, E.G., Mahmoud, D.M., Salem, D.A.M., Abdou, M.A., Salama, M. S. 2019. Assessment of larvicidal activity of nanoemulsion from *Citrus sinensis* essential oil on *Culex pipiens* L.(Diptera: Culicidae). *Egyptian Journal of Aquatic Biology and Fisheries*, 23(3): 61-67. <https://dx.doi.org/10.21608/ejabf.2019.35100>
- Barradas, T.N., de Holanda e Silva, K.G. 2021. Nanoemulsions of essential oils to improve solubility, stability and permeability: a review. *Environ Chem Lett* 19, 1153–1171. <https://doi.org/10.1007/s10311-020-01142-2>
- Çiçek, S. 2023. α -Tocopherol ameliorates copper II oxide nanoparticles-induced cytotoxic, biochemical, apoptotic, and genotoxic damage in the rainbow trout gonad cells-2 (RTG-2) culture. *Environmental Toxicology and Pharmacology*. 104168. <https://doi.org/10.1016/j.etap.2023.104168>
- Das, S., Vishakha, K., Banerjee, S., Mondal, S., Ganguli, A. 2020. Sodium alginate-based edible coating containing nanoemulsion of *Citrus sinensis* essential oil eradicates planktonic and sessile cells of food-borne pathogens and increased quality attributes of

- tomatoes. *International Journal of Biological Macromolecules*, 162: 1770-1779. <https://doi.org/10.1016/j.ijbiomac.2020.08.086>
- Durmuş, M. 2020. The effects of nanoemulsions based on citrus essential oils (orange, mandarin, grapefruit, and lemon) on the shelf life of rainbow trout (*Oncorhynchus mykiss*) fillets at 4 ± 2 °C", *J. Food Saf.*, 40(1):e12718. <https://doi.org/10.1111/jfs.12718>
- Durmuş, M., Özogul, Y., Ozyurt, G., Ucar, Y., Kosker, A. R., Yazgan, H., Ibrahim S.A., Özogul, F. 2023. Effects of citrus essential oils on the oxidative stability of microencapsulated fish oil by spray-drying. *Front. Nutr.*, 9: 3216. <https://doi.org/10.3389/fnut.2022.978130>
- Farouk, A., Hathout, A. S., Amer, M. M., Hussain, O. A., Fouzy, A.S.M. 2022. The impact of nanoencapsulation on volatile constituents of *Citrus sinensis* L. essential oil and their antifungal activity. *Egyptian Journal of Chemistry*, 65(3): 527-538. <https://dx.doi.org/10.21608/ejchem.2021.95579.4485>
- Farouk, A., Hathout, A.S., Amer, M.M., Hussain, O.A. 2022. The impact of nanoencapsulation on volatile constituents of *Citrus sinensis* L. essential oil and their antifungal activity. *Egyptian Journal of Chemistry*. 65(3): 527-538. <https://dx.doi.org/10.21608/ejchem.2021.95579.4485>
- Feng, J., Zhang, Q. I., Liu, Q. I., Zhu, Z., McClements, D. J., Jafari, S.M. 2018. Application of nanoemulsions in formulation of pesticides. In *Nanoemulsions* (pp. 379-413). Academic Press. <https://doi.org/10.1016/B978-0-12-811838-2.00012-6>
- Gavahian, M., Chu, Y.H., Mousavi Khaneghah, A. 2019. Recent advances in orange oil extraction: An opportunity for the valorisation of orange peel waste a review. *Int J Food Sci Technol*. 54 (4):925-932. <https://doi.org/10.1111/ijfs.13987>
- Geraci, A., Di Stefano, V., Di Martino, E., Schillaci, D., Schicchi, R. 2017. Essential oil components of orange peels and antimicrobial activity. *Natural Product Research*. 31(6): 653-659. <https://doi.org/10.1080/14786419.2016.1219860>
- Golfomitsou, I., Mitsou, E., Xenakis, A., Papadimitriou, V. 2018. Development of food grade O/W nanoemulsions as carriers of vitamin D for the fortification of emulsion based food matrices: A structural and activity study. *Journal of Molecular Liquids*. 268:734-742. <https://doi.org/10.1016/j.molliq.2018.07.109>
- Gurpreet, K., Singh, S.K. 2018. Review of nanoemulsion formulation and characterization techniques. *Indian J. Pharm. Sci.* 80(5): 781-789. <https://doi.org/10.4172/pharmaceutical-sciences.1000422>
- Hanif, M. A., Nisar, S., Khan, G. S., Mushtaq, Z., Zubair, M. 2019. Essential oils. *Essential Oil Research*, 3–17. https://doi.org/10.1007/978-3-030-16546-8_1
- Hosseinnia, M., Khaledabad, M. A., Almasi, H. 2017. Optimization of *Ziziphora clinopodiodes* essential oil microencapsulation by whey protein isolate and pectin: A comparative study. *International Journal of Biological Macromolecules*. 101: 958-966. <https://doi.org/10.1016/j.ijbiomac.2017.03.190>
- Kaci, M., Belhaffef, A., Meziane, S., Dostert, G., Menu, P., Velot, E., Desobry, S., Arab-Tehrany, E. 2018. Nanoemulsions and topical creams for the safe and effective delivery of lipophilic antioxidant coenzyme Q10. *Colloids Surf. B: Biointerfaces*. 167: 165-175. <https://doi.org/10.1016/j.colsurfb.2018.04.010>
- Kar, S., Gupta, P., Gupta, J. 2018. Essential oils: Biological activity beyond aromatherapy. *Natural Product Sciences*, 24(3):139-147. <https://doi.org/10.20307/nps.2018.24.3.139>
- Marchese, E., D'onofrio, N., Balestrieri, M. L., Castaldo, D., Ferrari, G., Donsì, F. 2020. Bergamot essential oil nanoemulsions: Antimicrobial and cytotoxic activity. *Zeitschrift für Naturforschung C*. 75(7-8): 279-290. <https://doi.org/10.1515/znc-2019-0229>
- Michelina, C., Naviglio, D., Gallo, M., Severina, P. 2019. FT-IR and GC-MS analyses of an antioxidant leaf essential oil from sage plants cultivated as an alternative to tobacco

- production. *Journal of Essential Oil Research*. 31(2): 138-144. <https://doi.org/10.1080/10412905.2018.1540364>
- Min, T., Sun, X., Yuan, Z., Zhou, L., Jiao, X., Zha, J., Zhu, Z., Wen, Y. 2021. Novel antimicrobial packaging film based on porous poly (lactic acid) nanofiber and polymeric coating for humidity-controlled release of thyme essential oil. *LWT*. 135: 110034. <https://doi.org/10.1016/j.lwt.2020.110034>
- Mohammad, T.G.M., El-Nahas, S.E.M., Edris, A.E. 2019. Formulation and evaluation of solvent-free microemulsions of lemongrass oil and citral as natural antifungal agent against some phytopathogenic fungi. *Plant Archives*. 19(2): 2097-2107.
- Mustafa, I. F., Hussein, M. Z. 2020. Synthesis and technology of nanoemulsion-based pesticide formulation. *Nanomaterials*, 10(8): 1608. <https://doi.org/10.3390/nano10081608>
- Oladipupo, S.O., Hu, X. P., Appel, A.G. 2022. Essential oils in urban insect management—A review. *Journal of Economic Entomology*, 115(5): 1375-1408. <https://doi.org/10.1093/jee/toac083>
- Omran, B.A., Nassar, H.N., Fatthallah, N.A., Hamdy, A., El-Shatoury, E.H., El-Gendy, N.S. 2018. Waste upcycling of *Citrus sinensis* peels as a green route for the synthesis of silver nanoparticles. *Energy Sources A: Recovery Util Environ Eff*. 40(2): 227-236. <https://doi.org/10.1080/15567036.2017.1410597>
- Opoku, B.K., Isaac, A., Micheal, A.A., Bentum, J.K., Muyoma, W.P. 2021. Characterization of chemically activated carbons produced from coconut and palm kernel shells using SEM and FTIR analyses. *American Journal of Applied Chemistry*. 9(3): 90-96. <https://doi.org/10.11648/j.ajac.20210903.15>
- Osanloo, M., Firoozian, S., Abdollahi, A., Hatami, S., Nematollahi, A., Elahi, N., Zarenezhad, E. 2022. Nanoemulsion and nanogel containing *Artemisia dracunculus* essential oil; larvicidal effect and antibacterial activity. *BMC Res. Notes*. 15: 276. <https://doi.org/10.1186/s13104-022-06135-8>
- Pavoni, L., Perinelli, D. R., Bonacucina, G., Cespi, M., Palmieri, G. F. 2020. An overview of micro-and nanoemulsions as vehicles for essential oils: Formulation, preparation and stability. *Nanomaterials*, 10(1): 135. <https://doi.org/10.3390/nano10010135>
- Pongsumpun, P., Iwamoto, S., Siripatrawan, U. 2020. Response surface methodology for optimization of cinnamon essential oil nanoemulsion with improved stability and antifungal activity. *Ultrasonics sonochemistry*. 60: 104604. <https://doi.org/10.1016/j.ultsonch.2019.05.021>
- Said-Al Ahl, H. A., Hikal, W. M., Tkachenko, K. G. 2017. Essential oils with potential as insecticidal agents: A review. *Int. J. Environ. Plan. Manag*, 3(4): 23-33.
- Sandhu, H. K., Sinha, P., Emanuel, N., Kumar, N., Sami, R., Khojah, E., Al-Mushhin, A. A. 2021. Effect of ultrasound-assisted pretreatment on extraction efficiency of essential oil and bioactive compounds from citrus waste by-products. *Separations*. 8(12): 244. <https://doi.org/10.3390/separations8120244>
- Sharma, K., Babaei, A., Oberoi, K., Aayush, K., Sharma, R., Sharma, S. 2022. Essential oil nanoemulsion edible coating in food Industry: a review. *Food Bioprocess Technol* 15: 2375–2395. <https://doi.org/10.1007/s11947-022-02811-6>
- Siddiqui, S.A., Pahmeyer, M.J., Assadpour, E., Jafari, S.M. 2022. Extraction and purification of d-limonene from orange peel wastes: Recent advances. *Ind Crops Prod*. 177:114484. <https://doi.org/10.1016/j.indcrop.2021.114484>
- Sogan, N., Kala, S., Kapoor, N., Singh, H., Verma, P., Nautiyal, A., Nagpal, N. 2023. Utilization and re-use of orange peel derived oil by formulating nanoemulsion for efficient vector control application. *Waste Biomass Valorization*. <https://doi.org/10.1007/s12649-023-02094-8>

- Somala, N., Laosinwattana, C., Teerarak, M. 2022. Formulation process, physical stability and herbicidal activities of *Cymbopogon nardus* essential oil-based nanoemulsion. Scientific Reports, 12(1): 10280. <https://doi.org/10.1038/s41598-022-14591-2>
- Soni, A., Yusuf, M., Mishra, V. K., Beg, M. 2022. An assessment of thermal impact on chemical characteristics of edible oils by using FTIR spectroscopy. Materials Today: Proceedings. 68: 710-716. <https://doi.org/10.1016/j.matpr.2022.05.568>
- Vichai, V., Kirtikara, K. 2006. Sulforhodamine B colorimetric assay for cytotoxicity screening. Nature protocols, 1(3): 1112-1116. <https://doi.org/10.1038/nprot.2006.179>
- Victor, M.M., David, J.M., Cortez, M.V.M., Leite, J.L., da Silva G.S.B. 2021. A high-yield process for extraction of hesperidin from orange (*Citrus sinensis* L. osbeck) peels waste, and its transformation to diosmetin, A valuable and bioactive flavonoid. Waste Biomass Valor. 12: 313–320: <https://doi.org/10.1007/s12649-020-00982-x>
- Yoon, H. J., Zhang, X., Kang, M. G., Kim, G. J., Shin, S. Y., Baek, S.H., Lee, B.N., Hong, S.J., Kim, J.T., Hong, K., Bae, H. 2018. Cytotoxicity evaluation of turmeric extract incorporated oil-in-water nanoemulsion. International Journal of Molecular Sciences. 19(1): 280. <https://doi.org/10.3390/ijms19010280>
- Zhang, W., Huang, C., Kusmartseva, O., Thomas, N. L., Mele, E. (2017). Electrospinning of polylactic acid fibres containing tea tree and manuka oil. Reactive and Functional Polymers, 117, 106-111. <https://doi.org/10.1016/j.reactfunctpolym.2017.06.013>

SPATIAL-TEMPORAL ANALYSIS OF TEMPERATURE VALUES IN THE THRACE REGION USING INNOVATIVE TREND METHOD

Zinnur Yılmaz^{1*}, Mustafa Bünyamin Karagözoğlu²

^{1,2} Sivas Cumhuriyet Üniversitesi, Mühendislik Fakültesi, Çevre Mühendisliği Bölümü,
58140, Merkez/SİVAS
zinnuryilmaz@cumhuriyet.edu.tr

ABSTRACT

Climate change is one of the most significant environmental challenges the world is facing, and the increasing temperature values serve as one of its most prominent indicators. In this context, climate scientists and researchers are focusing on regional analyses to comprehend the impacts of climate change at a local scale and shape future mitigation strategies. Understanding temperature trends and patterns in the Thrace region, characterized by diverse landscapes and agricultural importance, holds paramount importance for informed decision-making and sustainable development. This study aims to examine the spatial-temporal trends of temperature values occurring between 1982 and 2021 for three provinces (Edirne, Kırklareli and Tekirdağ) situated in the Thrace region of Turkey. For this purpose, an Innovative Trend Analysis (ITA) method is employed to identify how temperature data has changed over time and its regional distribution. The ITA method is utilized to detect low, moderate, and high-density temperature trends. Subsequently, the identified trends from the ITA method are cross-validated using the widely accepted Mann-Kendall (MK) test. Ultimately, this study is expected to contribute to a deeper understanding of climate dynamics in the Thrace region, providing a foundation for evidence-based policies to conserve natural resources and enhance resilience against the ever-changing climate.

Keywords: Climate Change, Mann-Kendall, Temperature, Trend, Innovative Trend Analysis

INTRODUCTION

Climate change represents one of the most pressing global challenges we face today (Newell, 2010). The rapid growth of industry, the consumption of fossil fuels, deforestation, and various human activities have resulted in heightened concentrations of greenhouse gases in the atmosphere, accelerating global warming (Wuebbles & Jain, 2001). Climate change is a critical global issue with far-reaching consequences for the environment, ecosystems, and human societies (Vitousek, 1994).

One prominent consequence of climate change is the significant rise in the global mean temperature, which has led to various impacts and risks. Notably, this has caused shifts in seasons, resulting in changes in their timing and temperature variations (J. Wang vd., 2021). Extreme temperature events have become more frequent and intense, with a projected increase in heatwaves, especially in urban areas (Tsai vd., 2023). The relationship between temperature changes and influencing factors is intricate, involving natural variability, topography, and human activities (Huang vd., 2021).

Elevated temperatures also influence precipitation patterns, leading to alterations in drought occurrences and rainfall variability (Kamal vd., 2021). As temperatures continue to rise, the frequency of cold weather extremes decreases, while heatwaves become more frequent and severe (Arnell vd., 2021). Extreme heat events carry significant socioeconomic consequences and are a growing concern (P. Wang vd., 2021). In summary, climate change is driving a substantial increase in temperatures, leading to a range of impacts on seasons, extreme temperature events, precipitation patterns, and socioeconomic factors.

It is essential to assess the consequences of climate change at various levels of warming to comprehend the associated risks (Arnell vd., 2021). The distribution of seasonal mean temperature anomalies has shifted towards higher temperatures, leading to an increase in extremely hot outliers. However, discerning long-term climate change can be challenging due to the inherent variability of local weather and climate (Hansen vd., 2012). Temperature and trend analysis are closely related in the study of climate change. Trend analysis is a method used to examine long-term changes in temperature patterns over time. By analyzing temperature data, trends can be identified and used to make predictions about future changes. One study examined the maximum and minimum temperature trends and found evidence of increasing temperature trends (Easterling vd., 1997). The relationship between temperature and trend analysis is a crucial connection in understanding climate change and predicting future climate scenarios (Amjad vd., 2023). Consequently, climate change and the associated rising temperature trends have become fundamental subjects of scientific research.

Trend analysis methods are used to have information about the increase or decrease of meteorological factors. Innovative trend analysis is one of these analysis methods. Innovative trend analysis methods have been used in various studies to analyze temperature and precipitation trends and their implications for climate change. Gobin et al. compared statistical downscaling methods for climate change impact analysis and found that dry day frequency is projected to increase significantly in the summer months, while total precipitation is projected to decrease significantly (Tabari vd., 2021). Agbo et al. compared different trend analysis methods and found that Şen's innovative trend method was useful in identifying trends even for parameters with non-monotonic variations (Agbo vd., 2021). These studies highlight the importance of trend analysis in understanding climate change impacts and informing water resource management and agricultural practices.

The Thrace region, located in the northwestern part of Turkey, holds significant agricultural areas and is economically important. Temperature, being a vital climatic parameter, directly influences agricultural production in this region, making it essential to understand temperature trends and variability.

In this article, the temporal-spatial variation of the temperature values between 1982 and 2021 in the Thrace region using the "Innovative Trend Method" is examined. This method serves as a powerful statistical tool to identify long-term trends and reveal seasonal variations in temperature variables. The study aims to provide valuable insights into temperature changes over the past four decades and offer essential information for future climate scenarios. Understanding the regional impacts of climate change and taking appropriate measures necessitate conducting spatial-temporal analyses. The results of this study will inform policy makers, environmental experts and other stakeholders about the temperature trends in the Thrace region.

MATERIAL AND METHOD

Study Area

The Thrace Region is located in the northwestern part of Turkey. Geographically, it lies between the Marmara Sea and the Aegean Sea, forming the European part of Turkey ("Trakya",

2023). The region generally experiences a temperate climate, with mild winters and hot summers, influenced by its proximity to the sea. These climatic conditions create a favorable environment for agricultural activities. In the Thrace Region, it has been determined that the average temperature is 13.6°C, with the lowest temperatures occurring in January and the highest temperatures in June and July. Among the provinces in the Thrace Region, Edirne has the highest temperatures during the summer months, while during the winter months, Kırklareli and Edirne have the lowest temperatures according to long-term average data (Hanedar vd., 2019).

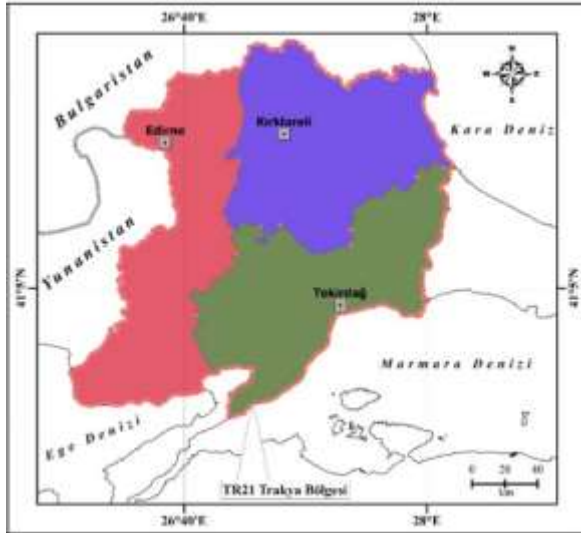

Figure 1. Study Area

Data Collection

Meteorological data used in this study were obtained from the NASA POWER website in the provinces of Edirne, Kırklareli and Tekirdağ in the Thrace region (NASA Langley Research Center., t.y.). The primary variable of interest is the temperature record for the period 1982 to 2021.

Data quality checks were performed to ensure the accuracy and consistency of temperatures records. All missing or inconsistent data points were properly resolved and a high level of data integrity is maintained to increase the reliability of the analysis.

Data for monthly average, maximum, and minimum temperatures from three locations (Edirne, Kırklareli, and Tekirdağ) in the Thrace region have been acquired from NASA POWER for the period 1982-2021 (Table 1).

Table 1. Meteorological stations' information.

No	Stations	Elevation (m)	Latitude (N)	Longitude (E)	Period
1	Edirne	199.14	41.6776	26.5559	1982-2021
2	Kırıkale	175.48	41.7359	27.2247	
3	Tekirdağ	98.23	41.0846	27.3848	

Methodology

In the period between 1982 and 2021, Innovative Trend Analysis was employed to determine temperature trends. Additionally, the results obtained from Innovative Trend

Analysis in the study area were compared with the values obtained from the Mann-Kendall and Sen's Slope Estimator analyses to strengthen the findings.

Innovative trend method

The Innovative Trend Analysis method is an approach that allows for the prediction of future trends by statistically analyzing climate data. This method is used to understand the effects of climate change and develop strategies to combat climate change (Esen, 2022). Climate data includes time series of parameters such as precipitation, temperature, relative humidity, evaporation, and sunshine duration, recorded on a monthly basis (Topçu & Karaçor, 2021). These data are analyzed using statistical methods such as regression analysis and correlation analysis. Regression analysis is used to determine changes and long-term averages in time series, while correlation analysis is used to examine the relationship between parameters. As a result of these analyses, trends related to climate change and potential issues like drought or water scarcity in the future can be predicted (Esen, 2022). This Innovative Trend Analysis method can contribute to the development of effective strategies in the fight against climate change.

In the Innovative Trend Analysis, the existing data series is divided into two equal halves. Both sub-series are separately sorted in ascending order. Then, the first sub-series (X_i), arranged according to the Cartesian coordinate system, is placed on the X-axis, and the second sub-series (X_j) is placed on the Y-axis. If the data points are above the 1:1 line, it indicates no trend. If the data points are in the lower triangle area of the 1:1 line, it suggests a downward trend, and if they are in the upper triangle area, it suggests an upward trend (Ceribası, 2018; Ceribası & Dogan, 2016; Çeribaşı, 2018; Şen, 2012, 2012; Yıldırım, 2015).

The implementation stages for Innovative Trend Analysis are as follows:

1. The fact that the time data is n pieces is divided into two.

$$(X_1, X_2, \dots, X_n), \{y_{1,n/2}\} = \{X_1, X_2, \dots, X_{n/2}\} \text{ ve } \{y_{2,n/2}\} = \{X_{n/2+1}, X_{n/2+2}, \dots, X_n\} \quad (1)$$

2. The resulting data is sorted from large to small or small to large.

$$\{r_1\} = \{\min(y_{1,n/2}), \dots, y_i, \dots, \max(y_{1,n/2})\} \quad (1 < i < n/2) \quad (2)$$

$$\{r_2\} = \{\min(y_{2,n/2}), \dots, y_j, \dots, \max(y_{2,n/2})\} \quad (1 < j < n/2) \quad (3)$$

3. To obtain the scatter plot, mark the values in data set $\{r_2\}$ that correspond to the values in data set $\{r_1\}$ on the graph. The graph has the same scale on both the horizontal and vertical axes and includes the minimum value of data set $\{r_1\}$ and the minimum value of data set $\{r_2\}$ [$\min(y_{1,n/2}), \min(y_{2,n/2})$], and it includes the maximum value of data set $\{r_1\}$ and the maximum value of data set $\{r_2\}$ [$\max(y_{1,n/2}), \max(y_{2,n/2})$]. Here, the $\{r_1\}$ data represents the first half of the series on the horizontal axis, while the $\{r_2\}$ data represents the second half of the series on the vertical axis.

4. In the same scatter chart, place a line with a 45° angle (that is, a 1:1 slope) passing through the origin on the chart.

5. Examine the distribution of values on the graph with respect to the 1:1 line to determine the trend. If most of the data points are clustered above the line, this is considered an upward trend; if most of the data points are clustered below the line, it is interpreted as a downward trend. If the values are evenly distributed along the line, there is no trend.

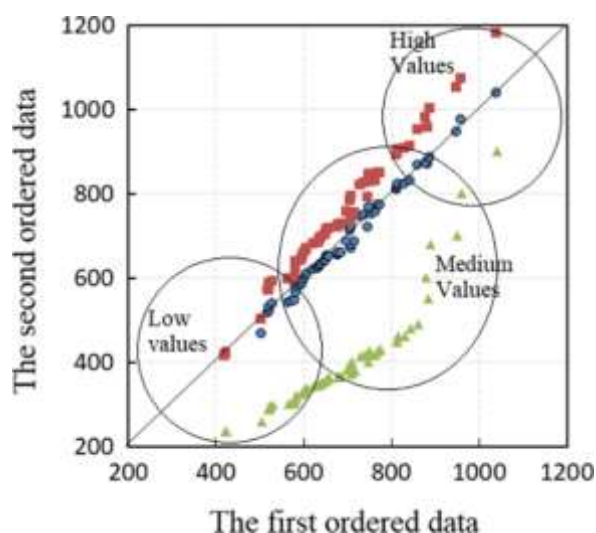

Figure 2. ITA scatter plot illustrating increasing (squares), decreasing (triangles), and trendless time series (circles)

An ITA scatter plot is a graphical representation commonly employed to depict trends within time series data. This plot utilizes distinct shapes or symbols to denote increasing (squares), decreasing (triangles), and trendless or stable (circles) time series. This visual representation serves as a convenient method to swiftly assess data and identify the presence of different trends over time (Figure 2).

Mann-Kendall Test

Mann-Kendall and Sen's slope analysis methods are statistical methods used to determine trends and changes in time series data. The Mann-Kendall test is used to determine the trends of ordered pairs in the data. This test allows for the comparison of ordered data to detect increasing or decreasing trends. Sen's slope analysis method, on the other hand, is used to calculate the slopes in the data. This method is used to determine the rate and direction of change in the data. These methods are used in various fields. For example, Mann-Kendall and Sen's slope analysis methods are used for trend analysis of meteorological parameters (Agbo vd., 2021).

Mann-Kendall and Sen's slope analysis methods have been widely used to analyze temperature trends in various studies. For example, Navatha et al. applied these methods to investigate the trends in temperature in the Jagtial district of Telangana state. The Mann-Kendall test and Sen's slope estimate test were used to identify the existing trend direction and magnitude of change over time. The results of the study showed that the annual average maximum temperature in Jagtial exhibited an increasing trend (Navatha vd., 2021). Similarly, Kasimu et al. conducted a study on the spatial and temporal variation of land surface temperature in an urban agglomeration in Northwest China. Although the study did not explicitly mention the use of Mann-Kendall and Sen's slope analysis methods, it focused on the analysis of temperature trends over time. The study highlighted the spatially heterogeneous response of land surface temperature in the region (Zhang vd., 2022).

These references demonstrate the application of Mann-Kendall and Sen's slope analysis methods in analyzing temperature trends and provide valuable insights into the direction and magnitude of temperature changes over time. In this analysis, the MK test was employed to detect noteworthy trends in precipitation parameters throughout the research period. This test functions by comparing the rankings of data points within the time series to determine the presence of a systematic upward or downward trend. The significance of the trend is assessed

using the calculated test statistic and its corresponding p-value. The mathematical formula for the MK test is as follows:

$$S = \sum_{i=1}^{n-1} \sum_{j=i+1}^n \text{sgn}(x_j - x_i) \tag{4}$$

Here, 'n' represents the total count of data points, 'xi' and 'xj' denote data values in time series 'i' and 'j' (where 'j' > 'i'), respectively. Additionally, 'sgn(xj-xi)' refers to the sign function defined as follows:

$$\text{sgn}(x_j - x_i) \begin{cases} +1, & \text{if } x_j - x_i > 0 \\ 0, & \text{if } x_j - x_i = 0 \\ -1, & \text{if } x_j - x_i < 0 \end{cases} \tag{5}$$

The MK test is applicable to time series of elements 'xi' taken from 'i=1,2,...,n-1,' and elements 'xj' taken from classes 'j=i+1,2,...,n' in such a manner that...

The variance is calculated as:

$$\text{Var}(S) = \frac{n(n-1)(2n+5) - \sum_{i=1}^m t_i(t_i-1)(2t_i+5)}{18} \tag{6}$$

Here, 'n' represents the total count of data points, 'm' represents the number of connected groups, and 'ti' indicates the number of connections within group 'i.' For situations where the sample size exceeds 10 (n > 10), the standard normal test statistic is computed using the ZS Equation (7):

$$Z_S \begin{cases} \frac{S-1}{\sqrt{\text{Var}(S)}}, & \text{if } S > 0 \\ 0, & \text{if } S = 0 \\ \frac{S-1}{\sqrt{\text{Var}(S)}}, & \text{if } S < 0 \end{cases} \tag{7}$$

A positive value of ZS indicates an increasing trend, while a negative ZS value suggests a decreasing trend. To assess these trends, a specific level of significance denoted as α is employed. The p-value (probability) is utilized to gauge the statistical significance and the strength of evidence for any differences (Dawson & Trapp, 2004). The MK analysis examines 'k' years of temperature data for a specific location to determine whether trends exist across these years.

The analysis was indeed conducted at the significance level of α=0.05, implying that trends with p-values less than 0.05 were considered statistically significant (|Zs|>1.96). Therefore, this indicates the presence of a significant trend in the precipitation data over the years.

Sen's Slope Estimator Test

While the MK test effectively detects linear trends, it may not capture non-linear trends that could exist in the precipitation data. To overcome this limitation, the SS Estimator test was utilized in this study. The SS test offers a robust and flexible approach for estimating the magnitude and direction of trends, even when non-linear trends are present. By combining the SS test with other statistical methods such as the MK trend test, a comprehensive approach to trend analysis in climate data is achieved (Dwevedi vd., 2022; Jiqin vd., 2023; Toma vd., 2022). These tests assist researchers in identifying and quantifying long-term trends, detecting changes in trends over time, and assessing the significance of these trends. The SS Estimator calculates the median of all possible slopes between data points, providing a resistant estimator that is less affected by outliers (Sen, 1968).

The equation for SS concerning a set of N data sample pairs can be expressed as follows:

$$Q_i = \frac{X_j - X_k}{j - k} \tag{8}$$

When considering 'Xj' and 'Xk' as the data values at times 'j' and 'k' (where 'j' > 'k'), if there is only one data point per time period, the total number of data sample pairs 'N' can be calculated using the formula N = n(n - 1)/2, where 'n' represents the number of time periods. However, if there are multiple observations in one or more time periods, 'N' will be less than

$n(n - 1)/2$. The values of Q_i are then arranged in ascending order, and subsequently, the average of the 'n' values or the slope of the SS estimator is determined as follows:

$$Q_{med} = \begin{cases} Q_{[(n+1)/2]}, & \text{if } n \text{ is odd} \\ \frac{Q_{[\frac{n}{2}]} + Q_{[\frac{n+2}{2}]}}{2}, & \text{if } n \text{ is even} \end{cases} \quad (9)$$

The symbol Q_{med} represents the data trend, and its value reflects the magnitude of that trend. To determine whether the median slope significantly deviates from zero, it's necessary to calculate a confidence interval for Q_{med} with a predetermined probability. The confidence interval for the time slope can be determined using the following method (Gilbert, 1987):

$$C_{\alpha} = Z_{1-\alpha/2} \sqrt{Var(S)} \quad (10)$$

In this context, $Var(S)$ is defined as specified in Equation (3), and $Z_{1-\alpha/2}$ is obtained from the standard normal distribution table. Next, we compute two values: $M1=(N-C\alpha)/2$ and $M2=(N+C\alpha)/2$, where N represents the total number of slope estimates Q_i . To determine the lower and upper limits of the confidence interval, denoted as Q_{min} and Q_{max} , respectively, we identify the $M1$ -th largest and $(M2+1)$ -th largest slope estimates among the N ordered slope estimates Q_i . In cases where $M1$ is not an integer, we interpolate to determine the lower limit Q_{min} accordingly. Similarly, if $M2$ is not an integer, interpolation is used to find the upper limit Q_{max} . This rigorous process ensures the derivation of a reliable confidence interval for the time slope estimate.

RESULTS AND DISCUSSION

Analysis of Annual Temperature

For the provinces of Tekirdağ, Edirne, and Kırklareli located in the Thrace region, the annual average air temperature, temperature at 2 meters above ground, and minimum and maximum temperatures are presented in Figure 3. According to this figure, the highest average air temperature in the region is in Tekirdağ (14.899°C), while the lowest value is in Kırklareli (13.365°C). When the values measured at 2 meters above ground level are averaged, the highest value is in Tekirdağ (14.320°C), and the lowest value is again in Kırklareli (13.072°C).

The year with the highest average temperature in the region is observed to be 2019. In this year, the air temperature was measured as 16.11°C in Tekirdağ, 15.18°C in Edirne, and 14.76°C in Kırklareli. For temperatures at 2 meters above ground level in 2019, it was recorded as 15.57°C in Tekirdağ, 14.80°C in Edirne, and 14.48°C in Kırklareli.

When examining the maximum temperatures measured in the Thrace region between 1982 and 2021, it is observed that the highest maximum temperatures in Tekirdağ (40.88°C) and Edirne (45.12°C) were recorded in the year 2000, while in Kırklareli (44.04°C), it was in 2007. On the other hand, for minimum temperatures, the lowest minimum temperatures in Tekirdağ (-13.03°C) and Kırklareli (-19.85°C) were reported in 1985, while in Edirne (-23.42°C), it was in the year 2010.

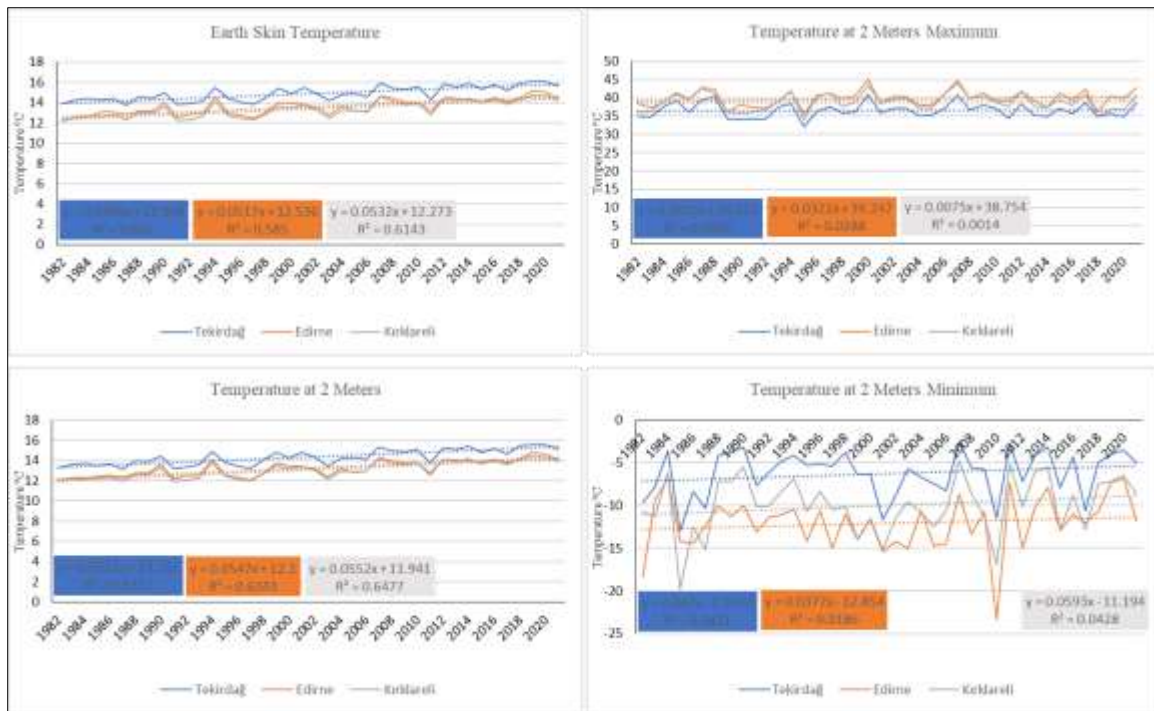

Figure 3. The annual mean, minimum, and maximum temperature values for the provinces by year

The results of the Innovative Trend Method applied to temperature data are presented in Figures 4, 5, 6, 7 and Table 2, respectively.

Applying the Innovative trend analysis method to the annual average temperature data for the years 1982-2021 in the regions of Tekirdağ, Edirne, and Kırklareli, an increasing trend is observed for low, medium, and high values. Based on these findings, it can be concluded that the annual average temperatures have increased for low, medium, and high levels (Figure 4).

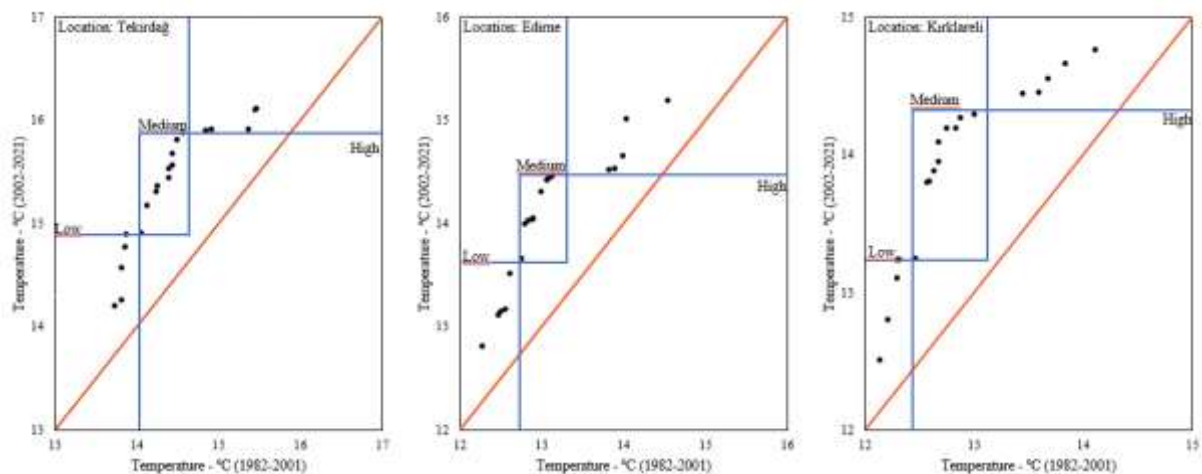

Figure 4. Earth's mean temperature

A trend analysis of the annual average temperature data at a height of 2 meters above the Earth's surface for Tekirdağ, Edirne, and Kırklareli during the same period is presented in Figure 5. According to these data, an increasing trend is observed for low, medium, and high values of annual temperature averages using the Innovative Trend analysis method. Consequently, it can be inferred that the values of annual average temperatures have increased

for low, medium, and high categories. These results show similarities with the average temperature data of the Earth's surface, while also indicating a faster trend in the 2-meter height temperature data compared to the surface temperature, especially for Tekirdağ.

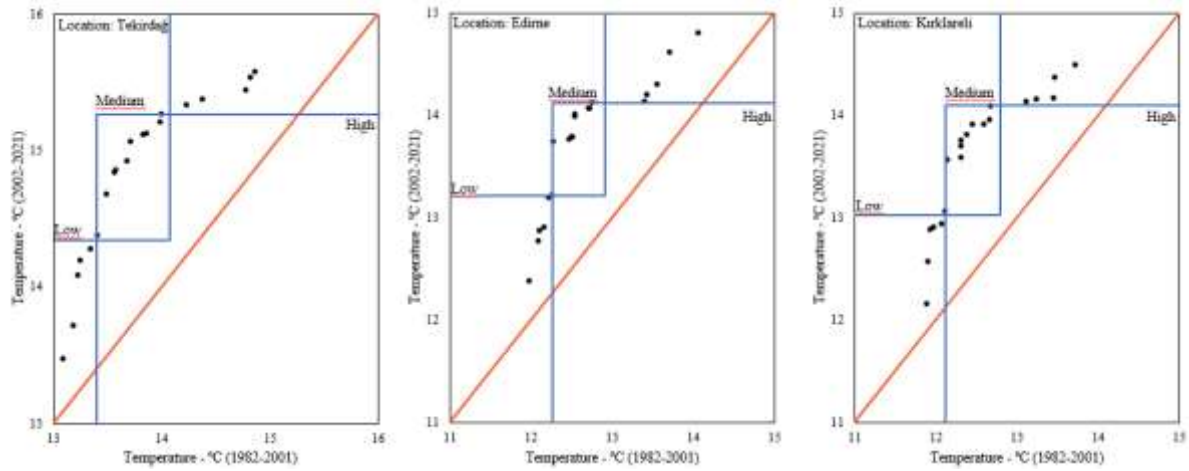

Figure 5. Mean temperature at 2 meters

The trend analysis of maximum temperatures at 2 meters for Tekirdağ, Edirne, and Kırklareli during the same period is presented in Figure 6. According to these data, maximum temperatures over the years have been classified as low, medium, and high values using the Innovative Trend Analysis method. For Tekirdağ, the results indicate an increasing trend in low temperature values, a pattern of initial increase followed by a decrease in medium values, and a decreasing trend in high values. In the case of Edirne, the analysis of maximum temperatures shows an increasing trend in low temperature values, an initial increase followed by a period of no trend in medium values, and then a resurgence in the increasing trend. High values, on the other hand, show no clear trend. In the analysis of maximum temperatures for Kırklareli, there is an increasing trend in low temperature values, an initial increase followed by a sudden decrease in medium values, and then a return to an increasing trend, followed by a decrease. High values initially exhibit a decreasing trend, but the highest values show an increase.

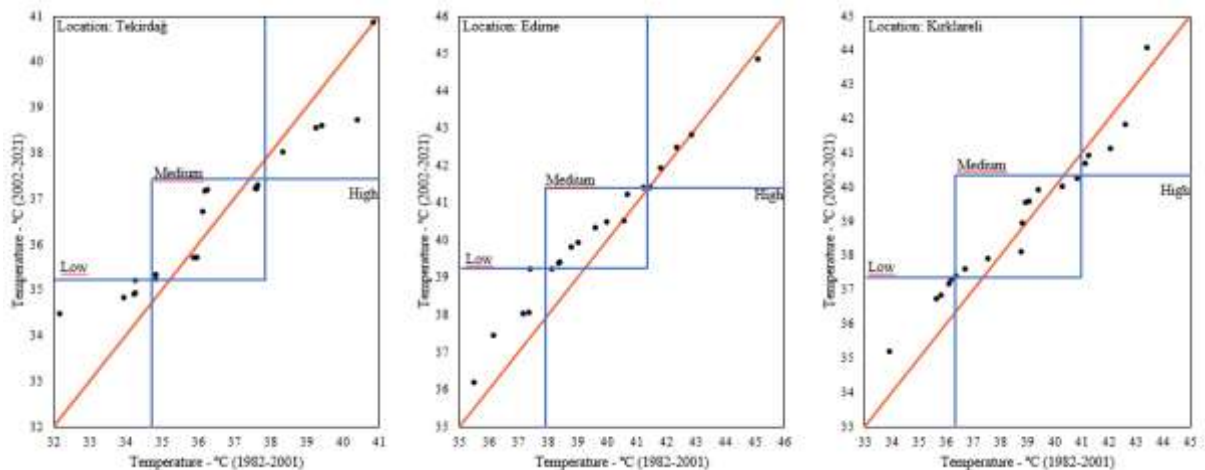

Figure 6. Maximum temperature at 2 meters

The trend analysis of minimum temperatures at 2 meters for Tekirdağ, Edirne, and Kırklareli during the same period is presented in Figure 7. For Tekirdağ, there is an increasing trend in low temperature values, an initial increase followed by a period of no trend in medium values, and then a resurgence in the increasing trend for high values. In the case of Edirne, the

analysis of minimum temperatures shows an initial decrease followed by a period of no trend in low temperature values, generally an increasing trend in medium values, and initially an increase followed by a period of no trend in high values. For Kırklareli, the analysis of minimum temperatures reveals an increasing trend in low, medium, and high temperature values.

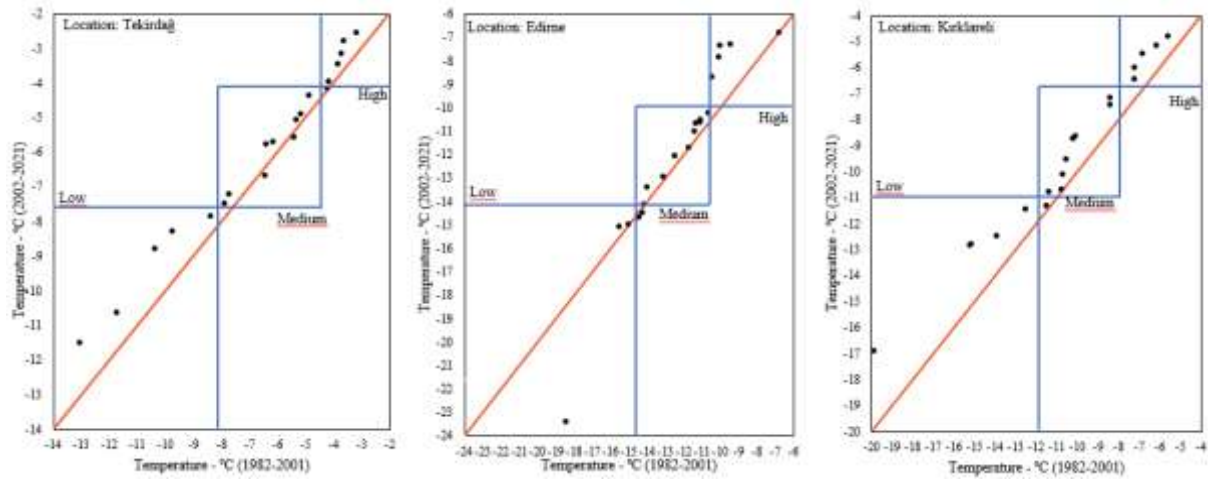

Figure 7. Minimum temperature at 2 meters

When examining the MK and SS analysis results for Tekirdağ, Edirne, and Kırklareli, it has been reported that surface and 2-meter height temperatures show a significant ($p < 0.05$) increasing trend. In contrast, no trend has been observed in maximum and minimum temperatures at 2 meters height ($p > 0.05$). According to Sen's slope analysis, the highest slope values for surface and 2-meter height temperatures are calculated as $0.05418 \text{ }^\circ\text{C year}^{-1}$ and $0.05637 \text{ }^\circ\text{C year}^{-1}$ in Kırklareli, respectively (Table 2). Additionally, a $0.03634 \text{ }^\circ\text{C year}^{-1}$ increase in maximum temperature at 2 meters height has been calculated in Edirne, and a $0.04854 \text{ }^\circ\text{C year}^{-1}$ increase in minimum temperature has been calculated in Kırklareli.

Table 2. Comparison of the results of MK and SS analyses with Innovative Trend Analysis

Parameter	Location	Innovative Trend Method					Mann Kendall and Sen's Slope				
		Slope (S)	Upper Confidence Limit at 95%	Lower Confidence Limit at 95%	Decision	Direction of Trend	MK (Z)	p	Sen's Slope	Decision	Direction of Trend
Earth Skin Temperature	Tekirdağ	0.04602	0.00525	-0.00525	YES	↗	5.1861	0.000	0.04921	YES	↗
	Edirne	0.04722	0.00585	-0.00585	YES	↗	5.0576	0.000	0.05266	YES	↗
	Kırklareli	0.0505	0.00602	-0.00602	YES	↗	5.2327	0.000	0.05418	YES	↗
Temperature at 2 Meters	Tekirdağ	0.0498	0.0057	-0.0057	YES	↗	5.2899	0.000	0.0531	YES	↗
	Edirne	0.05072	0.00655	-0.00655	YES	↗	5.5004	0.000	0.05537	YES	↗
	Kırklareli	0.05247	0.00659	-0.00659	YES	↗	5.3719	0.000	0.05637	YES	↗
Temperature at 2 Meters Maximum	Tekirdağ	0.00715	0.00914	-0.00914	NO	○	0.2679	0.789	0.00834	NO	○
	Edirne	0.02735	0.00538	-0.00538	YES	↗	0.967	0.333	0.03634	NO	○
	Kırklareli	0.0124	0.00799	-0.00799	YES	↗	0.3146	0.753	0.01445	NO	○
Temperature at 2 Meters Minimum	Tekirdağ	0.02672	0.00613	-0.00613	YES	↗	0.967	0.333	0.04	NO	○
	Edirne	0.01572	0.0147	-0.0147	YES	↗	0.8039	0.421	0.04031	NO	○
	Kırklareli	0.05805	0.00924	-0.00924	YES	↗	0.8622	0.389	0.04854	NO	○

According to Table 2, some interesting results were obtained in the analyzes made in regions such as Edirne, Kırklareli and Tekirdağ based on data from the NASA POWER site between 1982 and 2021. These results show that the average temperature values are increasing, and this increase is confirmed by trend analysis. Innovative Trend Analysis, Mann-Kendall and Sen's Slope analyses show a marked upward trend in the average temperature in these regions.

However, when the same analyses are applied to changes in the maximum and minimum temperature data at a height of 2 meters, different results emerge. In these regions, the Innovative Trend Analysis shows that there is a trend, while the Mann-Kendall and Sen's Slope analyses also reach the conclusion that there is no trend, that is, statistically at maximum and minimum temperature, these two methods of analysis do not find a trend of change that is the same and significant.

These results may indicate that climate change or temperature changes in these regions are affected in different ways at different altitude levels.

CONCLUSIONS

Changes in mean temperature, minimum and maximum temperatures reflect the multifaceted effects of climate change. These impacts can affect natural ecosystems, agriculture, water resources, energy production, and human settlements. Therefore, it is important to understand climate change and adapt to these changes.

As a result, it was concluded that while there is strong data and analysis that average temperatures are increasing in Edirne, Kırklareli and Tekirdağ, this trend does not appear similarly at maximum temperatures at a height of 2 meters. These results suggest that more research needs to be done to examine climate change impacts and understand the differences between regions.

When considering the temperatures between 1982 and 2021, an analysis of the increases was conducted by separating the first 30 years from the last 10 years. It was observed that the highest increase, with 1.245 °C (9.54%) for earth temperatures and 1.264 °C (9.91%) for temperatures at 2 meters above ground level, occurred in Kırklareli.

Furthermore, when the temperature differences between ground-level and temperatures at 2 meters above ground level were compared, it was determined that the highest difference was 0.580 °C in Tekirdağ, while the smallest difference was 0.292 °C in Kırklareli. The widening difference between ground-level temperature and temperature at 2 meters above ground level suggests that Tekirdağ and Edirne have been subjected to more urbanization compared to Kırklareli.

REFERENCES

- Agbo, E. P., Ekpo, C. M., & Edet, C. O. (2021). Analysis of the effects of meteorological parameters on radio refractivity, equivalent potential temperature and field strength via Mann-Kendall test. *Theoretical and Applied Climatology*, 143(3), 1437-1456. <https://doi.org/10.1007/s00704-020-03464-1>
- Amjad, M., Khan, A., Fatima, K., Ajaz, O., Ali, S., & Main, K. (2023). Analysis of Temperature Variability, Trends and Prediction in the Karachi Region of Pakistan Using ARIMA Models. *Atmosphere*, 14(1), Article 1. <https://doi.org/10.3390/atmos14010088>
- Arnell, N. W., Freeman, A., Kay, A. L., Rudd, A. C., & Lowe, J. A. (2021). Indicators of climate risk in the UK at different levels of warming. *Environmental Research Communications*, 3(9), 095005. <https://doi.org/10.1088/2515-7620/ac24c0>

- Ceribası, G. (2018). Analysis of Meteorological and Hydrological Data of Iznik Lake Basin by Using Innovative Sen Method. *Journal of Environmental Protection and Ecology*, 19, 15-24.
- Ceribası, G., & Dogan, E. (2016). Application of Trend Analysis Method on Rainfall Stream Flow-Suspended Load Datas of West And East Black Sea Basins And Sakarya Basin. *Fresenius Environmental Bulletin*, 25, 300-306.
- Çeribaşı, G. (2018). Batı Karadeniz Havzasının Yağış Verilerinin Yenilikçi Şen Yöntemi İle Analizi. *Academic Platform Journal of Engineering and Science*, 6(3), 166-171. <https://doi.org/10.21541/apjes.431965>
- Dawson, B., & Trapp, R. G. (2004). Basic & clinical biostatistics. İçinde *Basic & clinical biostatistics* (ss. 438-438). <https://pesquisa.bvsalud.org/portal/resource/pt/sus-24141>
- Dwevedi, R., Gupta, R., & Sethy, J. (2022). A comparative study of regional climate trends in the Keoladeo and Bhitarkanika wetlands, India. *Journal of Applied and Natural Science*, 14(2), Article 2. <https://doi.org/10.31018/jans.v14i2.3381>
- Easterling, D. R., Horton, B., Jones, P. D., Peterson, T. C., Karl, T. R., Parker, D. E., Salinger, M. J., Razuvayev, V., Plummer, N., Jamason, P., & Folland, C. K. (1997). Maximum and Minimum Temperature Trends for the Globe. *Science*, 277(5324), 364-367. <https://doi.org/10.1126/science.277.5324.364>
- Esen, F. (2022). Tunceli iklim parametrelerine ait zaman serilerinin farklı istatistiksel analiz yöntemleriyle değerlendirilmesi. *Türk Coğrafya Dergisi*, 81, 7-22. <https://doi.org/10.17211/tcd.1151639>
- Gilbert, R. O. (1987). *Statistical Methods for Environmental Pollution Monitoring*. John Wiley & Sons.
- Hanedar, A., Çağlar, F., Gorgun, E., Konukcu, F., Altürk, B., & Albut, S. (2019). *TR21(Trakya) Bölgesi İklim Değerlendirmesi: Mevcut Durum ve Projeksiyonlar* (s. 22).
- Hansen, J., Sato, M., & Ruedy, R. (2012). Perception of climate change. *Proceedings of the National Academy of Sciences*, 109(37), E2415-E2423. <https://doi.org/10.1073/pnas.1205276109>
- Huang, X., Ma, L., Liu, T., Sun, B., Chen, Y., Qiao, Z., & Liang, L. (2021). Response relationship between the abrupt temperature change-climate warming hiatus and changes in influencing factors in China. *International Journal of Climatology*, 41(11), 5178-5200. <https://doi.org/10.1002/joc.7123>
- Jiqin, H., Gelata, F. T., & Chaka Gameda, S. (2023). Application of MK trend and test of Sen's slope estimator to measure impact of climate change on the adoption of conservation agriculture in Ethiopia. *Journal of Water and Climate Change*, 14(3), 977-988. <https://doi.org/10.2166/wcc.2023.508>
- Kamal, A. S. M. M., Hossain, F., & Shahid, S. (2021). Spatiotemporal changes in rainfall and droughts of Bangladesh for 1.5 and 2 °C temperature rise scenarios of CMIP6 models. *Theoretical and Applied Climatology*, 146(1), 527-542. <https://doi.org/10.1007/s00704-021-03735-5>
- NASA Langley Research Center. (t.y.). *Prediction Of Worldwide Energy Resource (POWER) Project: Monthly 2.0.0 version [Data set]*. NASA Power. Geliş tarihi 18 Haziran 2023, gönderen <https://power.larc.nasa.gov/>
- Navatha, N., Sreenivas, G., & Umareddy, R. (2021). Rainfall and Temperature Trends in Jagtial District of Telangana State. *International Journal of Environment and Climate Change*, 47-59. <https://doi.org/10.9734/ijecc/2021/v11i1130515>
- Newell, H. B., Peter. (2010). *Governing Climate Change*. Routledge. <https://doi.org/10.4324/9780203858295>

- Sen, P. K. (1968). Estimates of the Regression Coefficient Based on Kendall's Tau. *Journal of the American Statistical Association*, 63(324), 1379-1389. <https://doi.org/10.2307/2285891>
- Şen, Z. (2012). Innovative Trend Analysis Methodology. *Journal of Hydrologic Engineering*, 17(9), 1042-1046. [https://doi.org/10.1061/\(ASCE\)HE.1943-5584.0000556](https://doi.org/10.1061/(ASCE)HE.1943-5584.0000556)
- Tabari, H., Paz, S. M., Buekenhout, D., & Willems, P. (2021). Comparison of statistical downscaling methods for climate change impact analysis on precipitation-driven drought. *Hydrology and Earth System Sciences*, 25(6), 3493-3517. <https://doi.org/10.5194/hess-25-3493-2021>
- Toma, M. B., Belete, M. D., & Ulsido, M. D. (2022). Trends in climatic and hydrological parameters in the Ajora-Woybo watershed, Omo-Gibe River basin, Ethiopia. *SN Applied Sciences*, 5(1), 45. <https://doi.org/10.1007/s42452-022-05270-y>
- Topçu, E., & Karaçor, F. (2021). Erzurum İstasyonunun Standartlaştırılmış Yağış Evapotranspirasyon İndeksi Ve Bütünleşik Kuraklık İndeksi Kullanılarak Kuraklık Analizi. *Politeknik Dergisi*, 24(2), Article 2. <https://doi.org/10.2339/politeknik.682168>
- Trakya. (2023). İçinde *Vikipedi*. <https://tr.wikipedia.org/w/index.php?title=Trakya&oldid=30050524>
- Tsai, I.-C., Hsieh, P.-R., Cheng, C.-T., Tung, Y.-S., Lin, L.-Y., & Hsu, H.-H. (2023). Impacts of 2 and 4°C global warmings on extreme temperatures in Taiwan. *International Journal of Climatology*, 43(2), 702-719. <https://doi.org/10.1002/joc.7815>
- Vitousek, P. M. (1994). Beyond Global Warming: Ecology and Global Change. *Ecology*, 75(7), 1861-1876. <https://doi.org/10.2307/1941591>
- Wang, J., Guan, Y., Wu, L., Guan, X., Cai, W., Huang, J., Dong, W., & Zhang, B. (2021). Changing Lengths of the Four Seasons by Global Warming. *Geophysical Research Letters*, 48(6), e2020GL091753. <https://doi.org/10.1029/2020GL091753>
- Wang, P., Yang, Y., Tang, J., Leung, L. R., & Liao, H. (2021). Intensified Humid Heat Events Under Global Warming. *Geophysical Research Letters*, 48(2), e2020GL091462. <https://doi.org/10.1029/2020GL091462>
- Wuebbles, D. J., & Jain, A. K. (2001). Concerns about climate change and the role of fossil fuel use. *Fuel Processing Technology*, 71(1), 99-119. [https://doi.org/10.1016/S0378-3820\(01\)00139-4](https://doi.org/10.1016/S0378-3820(01)00139-4)
- Yıldırım, A. (2015). *Trend Analizi Yöntemleri: Orta Fırat Havzası Uygulaması*. <http://hdl.handle.net/11527/15322>
- Zhang, X., Kasimu, A., Liang, H., Wei, B., & Aizizi, Y. (2022). Spatial and Temporal Variation of Land Surface Temperature and Its Spatially Heterogeneous Response in the Urban Agglomeration on the Northern Slopes of the Tianshan Mountains, Northwest China. *International Journal of Environmental Research and Public Health*, 19(20), Article 20. <https://doi.org/10.3390/ijerph192013067>

PHYTOCHEMICAL ANALYSIS AND IDENTIFICATION OF BIOACTIVE COMPOUNDS IN SPINACH LEAVES (*Spinacia oleracea* L.)

Ayodele OGUNDOLIRE¹, Hüseyin OK¹, İsmail Emrah TAVALI²

¹ Department of Plant Production and Technologies, Faculty of Agricultural Sciences and Technologies, Cyprus International University, 99258 Nicosia, Turkey

² Department of Soil Science and Plant nutrition, Faculty of Agriculture, Akdeniz University, 07070 Antalya, Turkey

Corresponding author e-mail: hok@ciu.edu.tr

ABSTRACT

Green vegetables contain various phytochemicals in suitable amounts, which are very helpful in preventing and fighting numerous diseases. They also have different types of vitamins and minerals for the effective functioning of the body system. Spinach is a leafy green flowering plant with edible leaves. The bioactive components and phytochemicals, such as flavonoids, polyphenols, carotenoids, and ascorbic acid present in the spinach (*Spinacia oleracea* L.) leaves, are responsible for their nutritional and medicinal properties. The study analyzed the bioactive compounds and phytochemicals present in spinach leaves. Phytochemicals in the spinach, including saponins, steroids, tannins, glycosides, flavonoids, phenols, phlorotannin, and ascorbic acids, were determined and screened according to the standard method using extracts from different solvents like water, ethanol and ethyl acetate. The leaf samples were collected, dried, and ground for extraction. The solvents, water, ethanol and ethyl acetate used for the extracts were incubated for 72 hours, then filtered and centrifuged. The centrifuged extracts were subjected to Gas Chromatography-Mass Spectroscopy (GC-MS) for further analysis of the bioactive compounds present. This analysis was achieved on a GC-MS Shimadzu GC-MSQP2010 Plus system equipped with an RTX-5 M.S. capillary column (0.25 mm x 30 m x 0.25 lm). The result established from the GC-MS analysis of the ethyl acetate extract and the ethanol extract of the spinach leaves was identified from 25 compounds in the chromatogram of each extract. The active compounds' names, compound structures, and molecular weights in the ethyl acetate and ethanol extracts were identified. This GC-MS spectrum proved the similarity percentage of these components as compared to the Wiley online library (WILEY8.LIB), which was the library source. This phytochemical composition's medicinal and nutritional value makes the plant highly essential for good health. However, these plant phytoconstituents have not been lost due to cooking. As a result of these positive effects seen in spinach, it is a green vegetable consumed everywhere in the world.

Keywords: Bioactive compounds, Gas Chromatography-Mass Spectroscopy, Phytochemicals, Spinach

INTRODUCTION

Agriculture is a major sustainable aspect that has immensely contributed to TRNC in terms of production, and commercial revenue. Cyprus is a semiarid island with insufficient rainfall. Out of about 329,890 hectares in northern Cyprus, 56% that is equivalent to 187,068 hectares is adequate for agricultural practices. The climatic conditions and to some extent shortage of water have been the major constraint. However, irrigation of lands is supposedly done for the growing of fruits and vegetables of different varieties. From 1985 to 2001, the land

for Agricultural purpose has decreased by 6% and this was as a result of the urban development that has occurred over time (Agricultural Statistics, 2001). The farmers who grow fruits and vegetables have extensively adopted the consistent use of the modern irrigation systems with the most appropriate method of irrigation (Metochis and Eliades, 2002).

In Africa, western region especially and using Nigeria as a case study, Agriculture is still and will continue to stand as the most important sector that boost the economy of Nigerian. Not less than 65% of Nigerian population in general is evaluated to survive on agricultural products for adequate living, while 35% of the Gross Domestic Product are accompanied with agricultural contribution through the sector of modern agriculture. (FAO, 2006). Agriculture right from time immemorial has pose relevance in the development of Nigeria especially in the areas of economy and commerce. The merits of this has assisted in the availability of food for the vast population, employment for more than half of the entire population with the conversion of raw material for the earnings foreign exchange in the fast growing sector of industry (Adeboye, 1996).

Spinach (*Spinacia oleracea L.*) is a leafy and at the same time highly nutritious vegetable, which is adequately rich in nutrients and phytochemicals. Vitamins A (from β -carotene), C and K are the micronutrients that are present in spinach, with common minerals like calcium, iron and potassium. The phytochemicals present includes carotenoids, flavonoids, steroids, phlobatannins, saponins and phenolic compounds just to mention but a few of them (Bergquist, 2006). Various researchers have worked on identifying the bioactive compounds that are present not just in vegetables but also in fruits when considering the pre-harvest and postharvest factors.

One of the main reasons why the consumption of spinach is annually increasing is because people are now being conscious and more sensitive with their health than before and spinach which has always remains as one of the healthy vegetables rich in most of these essential nutrients needed for a healthy living. The vegetable is easy to grow with a short life span, which makes it possible for the vegetable to be grown all through the year.

The top five countries in the world that grow spinach include China, which is leading with the production of 27,540,167 tons per year. This is followed by the United States of America with a total production of 435,721 tons annually and followed by Turkey with a production of 229,793 tons. While Japan is the fourth with a production of 226,865 tons and Kenya the fifth and leading in Africa with an annual production of 178,707 tons annually. Nevertheless, Cyprus is quite rich in wild spinach.

Thus, the intention of this research is to investigate the different bioactive compounds and identify the phytochemicals present in the spinach leaves which could have a great impact on our nutrition and health benefits.

MATERIAL AND METHOD

The Bloomsdale variety leaves belong to the savoy species, which is the most popularly grown in Cyprus usually 30cm long and 15cm broad on the average, was selected and collected with plastic zip lock bags from a vegetable farm in northern Cyprus and taken to the laboratory. The spinach leaves were washed four times with water from the tap; this is to remove any debris from the leaves. This is then rinsed with distilled water and leave to be well dried to be suitable for extraction (Olasupo et al., 2018, Tiwari et al., 2005).

The qualitative studies of the bioactive compounds from plant materials depends mostly on the selection of the proper extraction method (Smith, 2003, Sasidharan et al., 2011). This extraction is the initial step taken in any medicinal or nutritional study of plants because it has significance on the result of the research. Sample preparation techniques are also known as the extraction methods.

The collected samples that are already well dried through the use of oven for 24 hours at 100 degree celcius were grinded to powder form. 5 grams of this powdered sample were then soaked in centrifuge bottles with 50 ml of water, ethanol, and ethyl acetate separately. The whole mixture was then incubated at 4°C for 72 hours. Immediately after this incubation period, the mixtures were carefully filtered with the use of the filter paper and centrifuged at 6,000 rpm at 4°C for a period of 60 minutes. The extracts were then concentrated to dryness in a rotary evaporator (IKA-RV 10 Control) at and were stored at 4°C for further use (Romanik et al., 2007, Moldoveanus and David 2015, Roshanak et al., 2016).

Phytochemical analysis of the test samples were carried out according to standard methods (Trease and Evans, 1989; Harborne, 1998) on test for;

1. Saponin

5ml of each of the plant extracts were added to 20ml of distilled water in a test tube. They were vigorously shaken and then mixed with 3 drops of olive oil. A stable persistent froth forms an emulsion. (Ejikeme et al., 2014).

2. Taninns

1 ml of each extract were boiled in 20 ml of water in a test and then filtered. A few drops of 0.1% ferric chloride were added and once green or a blue-black coloration is observed, it confirms the presence of tannin (Alhakmani et al., 2013).

3. Phenol

5 ml of the extract will be pipetted into a 30 ml test tube, then 10 ml of distilled water will be added. 2 ml of ammonium hydroxide solution and 5 ml of concentrated amyl alcohol will also be added and left to react for 30 min. Development of bluish green colour is a positive presence of phenol. (Alhakmani et al., 2013).

4. Flavonoids

3 ml of 1% Aluminium chloride solution was carefully added to 5 ml of each extract. A persistent yellow coloration appeared, indicating the presence of flavonoids. 5 ml of dilute ammonia solution was further added to the above mixture followed by the addition of concentrated H₂ SO₄. The yellow coloration disappeared. The yellow coloration which disappeared indicates a positive test for flavonoids (Chang et al., 2002),

5. Glycosides

5 ml of each extract was treated with 2 ml of glacial acetic acid containing one drop of ferric chloride solution and underplayed with 1 ml of concentrated sulphuric acid. A brown ring at the interface indicates a deoxysugar characteristic of cardenolides which confirms a positive presence of cardenolides. A violet-green ring appearing below the brown ring, in the acetic acid layer, indicates that glycoside is present (Rangari 2002, Roshanak et al., 2016).

6. Steroids,

2 ml of acetic anhydride were added to 2 ml extract of each sample followed by careful addition of 2 ml H₂ SO₄. The color will change from violet to blue or green which confirms the presence of steroids (Rangari 2002).

7. Terpenoids (salkowski test),

5 ml of each extract were mixed with 2 ml of chloroform, and followed by a 3 ml concentrated H₂ SO₄ carefully added to form a layer. A reddish brown coloration of the interface was formed showing the positive presence of terpenoids (Rangari 2002).

8. Phlobatannins

2 ml of extract of each plant samples was boiled with 1% aqueous hydrochloric acid and a red precipitate showed the presence of phlobatannins (Rangari 2002, Roshanak et al., 2016).

RESULTS AND DISCUSSION

The results of the phytochemical test carried out on each of the extracts were recorded as shown in Table 1. This preliminary screening on each of the extracts show significant quantity of the phytochemical constituents, revealing the presence of saponins, flavonoids, terpenes, phenols, tannins, alkaloids, phlobatanin, glycoside and steroids. However, the phytochemical constituents in the various part of the spinach plant vary as well (Uraku 2016, Altemimi et al., 2017).

This present investigation revealed that the aqueous extract of spinach shows abundant presence of terpenes, and flavonoids, with moderate presence of saponins and less presence of phlobatanin and cardenolides but steroids, glycosides, phenol, glycosides and tannins are absent in the aqueous extract.

For the ethanol extract, tannins and glycosides are moderately present, while steroids and phenol are less present but saponins, flavonoids, terpenes, cardenolides and phlobatanin are absent.

The investigation also revealed much abundant presence of saponins and cardenolides in ethyl acetate extract, with a moderate presence of phenol and less presence of tannins and flavonoids, but showed absence of phlobatanin, terpenes, steroids, glycosides.

Phytochemicals are non-nutritive plant chemicals that have disease preventive properties (Kumar et al., 2009). Different phytochemicals have been found to possess a wide range of activities. The phytochemicals are known to have antimicrobial activity (Ebana, 1995).

Different studies have proved that spinach has a high nutritional value (Maeda et al., 2005). Many researchers also reported that, glycosides play very crucial role in reducing blood pressure. They could also be used in treating heart failure (Nyarko AA & Addy M E 1990).

The spinach leaf extract with their phytoconstituents are reportedly known for anti-inflammatory, antidiarrheal, antimicrobial, antioxidant and insecticidal activities (Chouhan HA & Singh SK, 2011). Steroids are very much important in pharmacy because of their relationship with compounds like sex hormones and can be used for drug production (Okwu DE 2007).

Tannin and flavonoid are thought to be responsible for antidiarrheal activity (Enzo, 2007). Usman and Osuji reported that tannin has been widely used topically to sprains, bruises and superficial wounds as such. Similarly, Elmarie and Johan reported tannin to have antibacterial. Phytochemicals such as terpenoid, flavonoid, tannin, steroid, and alkaloid have anti-inflammatory effects (Liu, 2003) Flavonoids show anti allergic, anti-inflammatory, anti-microbial and anti-cancer activity (Yamato and Gayor, 2002).

The result established from the GC-MS analysis that was carried out from the ethyl acetate extract and the ethanol extract of the spinach leaves were identified from 25 compounds from the chromatogram on each of the extract, and this is well summarized in Table 2 and Table 3 respectively. The active compounds name, compound structures and molecular weight in the ethyl acetate and ethanol extract were identified. This GC-MS spectrum confirmed the similarity percentage of these various components when compared to the Wiley online library (WILEY8.LIB) which was the library source.

Table 1. Phytochemical screening of spinach leaf in different solvent

Compounds	Water	Ethanol	Ethyl acetate
Cardenolides	+	-	+++
Flavonoids	+++	-	+
Glycosides	-	++	-
Phenol	-	+	++
Phlobatamin	+	-	-
Saponins	++	-	+++
Steroids	-	+	-
Tannins	-	++	+
Terpenes	+++	-	-

+++ (Abundant); ++ (Moderate); + (Less); - (Absent)

Table 2. GC-MS analysis of the Ethyl acetate extract of spinach leaf

Similarity Percentage	Name of Compound	Molecular Formula	Molecular Weight
1	1,2,2-Trimethylcyclopropylamine	C ₆ H ₁₃ N	99
2	Ethyl 1-Hexyl-4-Hydroxy-2(1h)-Oxo-3-Quinolinecarboxylate, 4-Hydroxy-3-(2-Oxo-2h-1-Oxa-3-Phenanthryl)-2(1h)-Quinolinone	C ₂₂ H ₁₃ NO ₄	355
3	8,9,9,10,10,11-Hexafluoro-4,4-Dimethyl-3,5-Dioxatetracyclo[5.4.1.0(2,	C ₁₂ H ₁₂ F ₆ O ₂	302
4	Didecyl1,4-Dihydro-2,6-Dimethyl-3,5-Pyridinedicarboxylate,3,4,5,6,9,10-Hexahydro-9-(4-Hydroxyphenyl)-3,3,6,6-Tetramethylacridine-	C ₂₃ H ₂₇ NO ₃	365
5	2,2-dimethyl-4-(2-propyl)aminobutanone 2-Butanone,3,3-dimethyl-4-[(1-methylethyl)amino]-(CAS)	C ₉ H ₁₉ NO	157
6	N-(P-Anisidinomethyl)-4-Methylphthalimide 4-Bromo-N-[(6-Methyl-2-Pyridyl)Aminomethyl]Phthalimide	C ₁₅ H ₁₂ BRN ₃ O ₂	345
7	2-isopropylthio-5-trifluoroacetyl-1,3-oxathiolium-4-olat. 1,3-Oxathiol-1-ium, 4-hydroxy-2-[(1-methylethyl)thio]-5-(trifluoroacetyl)-, hydroxide, inner salt (CAS)	C ₈ H ₇ F ₃ O ₃ S ₂	272
8	3,3-Dimethyl-2-Phenyl-2-(1-Oxo-1,2,3,4-Tetrahydronaphthalen-2-Yl)Azirane,1(2h)-	C ₂₀ H ₂₁ NO	291

	Naphthalenone, 2-(3,3-Dimethyl-2-Phenyl-2-Aziridinyl)-3,4-Dihydro- (CAS)		
9	5-Methoxy-1-Aza-6-Oxabicyclo(3.1.0)Hexane,6-Oxa-1-Azabicyclo[3.1.0]Hexane, 5-Methoxy- (Cas)	C ₅ H ₉ N O ₂	115
10	1,2,5-Oxadiazole Furazan (CAS), Azoxazole, 1-Oxa-2,5-diazacyclopentadiene	C ₂ H ₂ N ₂ O	70
11	Borane, compd. with carbon monoxide (1:1) (CAS) Borane carbonyl, Borane, carbonyl- Carbon monoxide-borane, Borine carbonyl (BH ₃ CO), Borane-carbon monoxide (1:1) Boron, carbonyltrihydro-, (T-4)- BH ₃ CO	CH ₃ BO	42
12	Borane, triethyl- (CAS) Triethylborane Triethylboron (C ₂ H ₅) ₃ B, Triethylborine	C ₆ H ₁₅ 10B	98
13	[10b]-Triethylborane	C ₆ H ₁₅ 10B	98
14	pnz-sar, Glycine, N-[[[4-methoxyphenyl)methoxy]carbonyl]-N-methyl- (CAS)	C ₁₂ H ₁₅ NO ₅	253
15	[1R*,2R*]-1-acetyl-1,2-dihydroxycyclohex-3-ene	C ₈ H ₁₂ O ₃	156
16	4-(Mesyloxy)-3,3-dimethyl-2-butanone	C ₇ H ₁₄ O ₄ S	194
17	1,1'-bibicyclo(2.2.2)octyl-4-carboxylic acid [1,1'-Bibicyclo[2.2.2]octane]-4-carboxylic acid (CAS)	C ₁₇ H ₂₆ O ₂	262
18	2-ethylsulfenyl-3,4-dimethoxycarbonyl-5-trifluoroacetyl-furane 3,4-Furandicarboxylic acid, 2-(ethylthio)-5-(trifluoroacetyl)-, dimethyl ester (CAS)	C ₁₂ H ₁₁ F ₃ O ₆ S	340
19	3-Butyn-1-ol (CAS) 3-Butynol 1-Butyn-4-ol 3-Butyne-1-ol 3-Butynyl alcohol 4-Hydroxy-1-butyne 2-Hydroxyethylacetylene HC..CCH ₂ CH ₂ OH (2-Hydroxyethyl)acetylene 1-Hydroxy-3-butyne	C ₄ H ₆ O	70
20	3-chloromethylfuran, Furan, 3-(chloromethyl)- (CAS) 3-(Chloromethyl)furan, 3-Furylmethyl chloride	C ₅ H ₅ ClO	116
21	2-[3'-(1"-Hydroxy-1"-methyl)ethyl]-2',2'-dimethylcyclobutyl] ethanal	C ₁₁ H ₂₀ O ₂	184
22	7-hydroxy-5,6,7,8-tetrahydroindolizine 7-Indolizinol, 5,6,7,8-tetrahydro- (CAS)	C ₈ H ₁₁ NO	137
23	1,2,5-Oxadiazole, Furazan (CAS), Azoxazole, 1-Oxa-2,5-diazacyclopentadiene	C ₂ H ₂ N ₂ O	70
24	3-Butyn-1-ol (CAS) 3-Butynol, 1-Butyn-4-ol, 3-Butyne-1-ol, 3-Butynyl alcohol, 4-Hydroxy-1-butyne 2-Hydroxyethylacetylene HC.CCH ₂ CH ₂ OH (2-Hydroxyethyl)acetylene 1-Hydroxy-3-butyne	C ₄ H ₆ O	70
25	3-Butyn-1-ol (CAS) 3-Butynol 1-Butyn-4-ol \$\$ 3-Butyne-1-ol 3-Butynyl alcohol \$\$ 4-Hydroxy-1-butyne 2-Hydroxyethylacetylene HC.\$\$.CCH ₂ CH ₂ OH (2-Hydroxyethyl)acetylene \$\$ 1-Hydroxy-3-butyne	C ₄ H ₆ O	70

Table 3. GC-MS analysis of the Ethanol extract of spinach leaf

Similarity Percentage	Name of Compound	Molecular Formular	Molecular Weight
1	8,9,9,10,10,11-Hexafluoro-4,4-Dimethyl-3,5-Dioxatetracyclo[5.4.1.0(2,	C ₁₂ H ₁₂ F ₆ O ₂	302
2	Didecyl1,4-Dihydro-2,6-Dimethyl-3,5-Pyridinedicarboxylate,3,4,5,6,9,10-Hexahydro-9-(4-Hydroxyphenyl)-3,3,6,6-Tetramethylacridine-	C ₂₃ H ₂₇ NO ₃	365
3	Trimer From Isobutyroyl Pyrazine	C ₂₄ H ₂₅ CL N ₆ O ₃	480
4	N-(P-Anisidinomethyl)-4-Methylphthalimide,4-Bromo-N-[(6-Methyl-2-Pyridyl)Aminomethyl]Phthalimide	C ₁₅ H ₁₂ BR N ₃ O ₂	345
5	Ethyl 1-Hexyl-4-Hydroxy-2(1h)-Oxo-3-Quinolinecarboxylate,4-Hydroxy-3-(2-Oxo-2h-1-Oxa-3-Phenanthryl)-2(1h)-Quinolinone	C ₂₂ H ₁₃ NO ₄	355
6	Tetradecane,2,6,10-trimethyl- (CAS),2,6,10-Trimethyltetradecane	C ₁₇ H ₃₆	240
7	Cyclohexane,1,1'-[1-(2,2-Dimethylbutyl)-1,3-Propanediyl]Bis- (Cas) Heptan, 1,3-Dicyclohexyl-5,5-Dimethyl-	C ₂₁ H ₄₀	292
8	1,2,2-Trimethylcyclopropylamine	C ₆ H ₁₃ N	99
9	Piperidine, 1-nitro- (CAS) N-Nitropiperidine 1-Nitropiperidine	C ₅ H ₁₀ N ₂ O ₂	130
10	2,4(1H,3H)-Pyrimidinedione, 5-nitro-,5-Nitouracil,2,4-Dihydroxy-5-nitropyrimidine Uracil, 5-nitro-	C ₄ H ₃ N ₃ O ₄	157
11	1-(3-Fluorobenzyl)-2(1h)-Imino-3-Methylpyridine Hydrobromide 1,4-Dihydro-4-Imino-1-(4-Phenylbenzoylmethyl)Pyridine Hydrobromide,2-(4-Phenylbenzoylmethylthio)Benzoxazole Hydrobromide 2(3h)-Imino-3-	C ₁₉ H ₁₇ BR N ₂ O	368
12	2-Tetradecanol (CAS) sec-Tetradecyl alcohol Tetradecanol-2	C ₁₄ H ₃₀ O	214
13	2-isopropylthio-5-trifluoroacetyl-1,3-oxathiolium-4-olat. 1,3-Oxathiol-1-ium, 4-hydroxy-2-[(1-methylethyl)thio]-5-(trifluoroacetyl)-, hydroxide, inner salt (CAS)	C ₈ H ₇ F ₃ O ₃ S ₂	272
14	1h-Imidazole, 1-(1-Oxoocetadecyl)-	C ₂₁ H ₃₈ N ₂ O	334
15	2-Hexadecanol (CAS) Hexadecanol-2	C ₁₆ H ₃₄ O	242
16	Octadecane, 6-Methyl- (Cas) 6-Methyl Octadecane	C ₁₉ H ₄₀	268
17	9,12-Octadecadienoic Acid (Z,Z)-, 2,3-Bis(Acetyloxy)Propyl Ester (Cas) 1-Linoleyl-2,3-Diacetin	C ₂₅ H ₄₂ O ₆	438
18	2-(4,5-Dihydro-3-Methyl-5-Oxo-1-Phenyl-4-Pyrazolyl)-5-Nitrobenzoic Acid	C ₁₇ H ₁₃ N ₅ O ₅	367
19	Nonadecane (CAS) n-Nonadecane	C ₁₉ H ₄₀	268

20	Thiophene, 3-methyl-2-pentadecyl-	C ₂₀ H ₃₆ S	308
21	2-Isononenal (Cas) Branched Chain 2-Nonenal	C ₉ H ₁₆ O	140
22	Tridecane, 6-methyl- (CAS) 6-Methyltridecane	C ₁₄ H ₃₀	198
23	Piperidine, 1-nitro- (CAS) N-Nitropiperidine \$ 1-Nitropiperidine	C ₅ H ₁₀ N ₂ O ₂	130
24	Octadecane, 3-ethyl-5-(2-ethylbutyl)- (CAS) 3-Ethyl-5-(2'-ethylbutyl)octadecane	C ₂₆ H ₅₄	366
25	3-Tert-Butyl-5-Chloro-2-Hydroxybenzophenone	C ₁₇ H ₁₇ ClO ₂	288

CONCLUSIONS

For this present research, the commonly consumed spinach variety in north Cyprus, the Bloomsdale variety leaves which belongs to the savoy species contains adequate quantity of phytochemicals that are helpful in the prevention deadly diseases to mankind.

The GC-MS analysis of these phytochemicals, and the studies of the bio active compounds, indicate positive results for ethyl acetate, ethanol and aqueous extract of the spinach leaves. The phytochemical screening also shows the presence of saponins, terpenoids, phlobatannins, flavonoids, tannins, glycosides, steroids and phenols.

This current research has also explained that the spinach is one of the vegetables in north Cyprus that is consumed on daily basis, not only because it is cheap to get, but it's a green vegetable that is very rich in most of the phytochemicals and bio active compounds present in leafy green vegetables. The medicinal and nutritional values which are of these phytochemical composition, makes the plant to be highly essential for good health and also with its properties that can be useful in combating health challenges. However, there have not been losses of these plant phytoconstituents, as a result of cooking, except for vitamins and minerals. As a result of these positive effects seen in spinach, it is a green vegetable that is consumed everywhere in the world. It is best consumed cooked, except for a very few places where little amounts are added to meals like salad and eaten raw.

REFERENCES

- Alhakmani, F., Kumar, S., and Khan, S. A. (2013). Estimation of total phenolic content, *in-vitro* antioxidant and anti-inflammatory activity of flowers of *Moringa oleifera*. *Asian Pac. J. Trop. Biomed.* 3, 623–627.
- Altemimi A, Lakhssassi N, Baharlouei A, Watson DG, Lightfoot DA. Phytochemicals: Extraction, Isolation, and Identification of Bioactive Compounds from Plant Extracts. *Plants (Basel)*. 2017 Sep 22; 6(4):42. doi: 10.3390/plants6040042. PMID: 28937585; PMCID: PMC5750618
- Bergquist, S. 2006. Bioactive compounds in baby spinach (*Spinacia oleracea* L.). Effects of pre- and postharvest factors. Doctoral dissertation. ISSN 1652-6880, ISBN 91-576-7111-7.
- Budisan L., Gulei D., Zanoaga O.M., Irimie A.I., Chira S., Braicu C., Gherman C.D., Berindan-Neagoe I (2017). Dietary intervention by phytochemicals and their role in modulating coding and non-coding genes in cancer. *Int. J. Mol. Sci.*
- Chang, S., Liao, S. F., Wu, Z. L., Chang, C. W., and Wu, J. Y. (2002). Estimation of total flavonoid content in propolis by two complementary colorimetric methods. *J. Food Drug Anal.* 10, 178–182.
- Chaudhry AU, Ullah MI. Influence of seed size on yield, yield components and quality of threemaizegenotypes. *JBiolSci*.2001;1:150–151.

- Chouhan HS, Singh SK (2011) A review of plants of genus *Leucas*. *Journal of Pharmacognosy and Phytotherapy* 3: 13-26.
- Ebana RU, Essien AI, Ekpa OD. Nutritional and potential medicinal value of the leaves of *Lasianthera Africana* (Beauv) Global J Pure and Applied Sci. 1995; 1:1-7.
- Ejikeme, C. M., Ezeonu, C. S., and Eboatu, A. N. (2014). Determination of physical and phytochemical constituents of some tropical timbers indigenous to Niger Delta Area of Nigeria. *Eur. Sci. J.* 10, 247–270.
- Enzo AP. Traditional plants and herbal remedies used in the treatment of diarrheal disease: Mode of action, quality, efficacy and safety considerations. In: Ahmad I, Aqil F, Qwais M, Modern Phytomedicine Turning Medicinal Plants in to Drugs. WILEY-VCH Verlag GmbH & Co. KGaA, Weinheim, 2007, 248-260
- Grubben, G.J.H. and Denton, O.A. (2004) Plant Resources of Tropical Africa 2. Vegetables. PROTA Foundation, Wageningen, Netherlands. PROTA Foundation, Wageningen
- Harborne, J. B. (1998). *Phytochemical methods*. 3rd Edn. London: Chapman and Hall, Ltd, 1–302.
- Kim, D., Shang, X., Assefa, A., Keum, Y., & Saini, R. (2018). Metabolite profiling of green, green/ red, and red lettuce cultivars: Variation in health beneficial compounds and antioxidant potential. *Food Research International*, 105, 361–370. doi:10.1016/j.foodres.2017.11.028.
- Kumar A, Ilavarasan R, Jayachandran T, Decaraman M, Aravindhan P. Phytochemicals Investigation on a Tropical Plant, *Syzygium cumini* from Kattuppalayam, Erode District, Tamil Nadu, South India, *Pakistan Journal of Nutrition*. 2009; 8:83-85
- Lafarga, T., Villaro, S., Rivera, A., Bobo, G., & Aguilo- Aguayo, I. (2020). Bioaccessibility of polyphenols and antioxidant capacity of fresh or minimally processed modern or traditional lettuce (*Lactuca sativa* L.) varieties. *Journal of Food Science and Technology*, 57(2), 754–763.
- Liu R.H. Health benefits of fruit and vegetables are from additive and synergistic combinations of phytochemicals. *Am. J. Clin. Nutr.* 2003; 78:517.
- Maeda, N., Hada, T., Murakami-Nakai, C., Kuriyama, I., Ichikawa, H., Fukumori, Y., et al. (2005). Effects of DNA polymerase inhibitory and antitumor activities of lipase-hydrolyzed glycolipid fractions from spinach. *The Journal of Nutritional Biochemistry*, 16, 121–128.
- Moldoveanu, S.; David, V. The role of sample preparation. In *Modern Sample Preparation for Chromatography*, 3rd ed.; Elsevier: Amsterdam, the Netherlands, 2015; pp. 33–49.
- Nyarko A. A, Addy M. E. *Phytotherapy Res* 1990; 4(1): 25-28.
- Okwu DE (2001) Evaluation of the chemical composition of medicinal plants belonging to Euphorbiaceae. *Pakistan Veterinary Journal* 14: 160-162.
- Olasupo AD, Aborisade AB, Olagoke OV (2018) Phytochemical Analysis and Antibacterial Activities of Spinach Leaf. *Am J Phytomed Clin Ther* Vol.6 No.2:8.
- Probst Y.C., Guan V.X., Kent K. Dietary phytochemical intake from foods and health outcomes: A systematic review protocol and preliminary scoping. *BMJ Open*. 2017.
- Rangari VD (2002) *Pharmacognosy and Phytochemistry*. Carrier Publication, Nasik, p: 132.
- Romanik, G.; Gilgenast, E.; Przyjazny, A.; Kamiński, M. Techniques of preparing plant material for chromatographic separation and analysis. *J. Biochem. Biophys. Methods* 2007, 70, 253–261.
- Roshanak, S.; Rahimmalek, M.; Goli, S.A. Evaluation of seven different drying treatments in respect to total flavonoid, phenolic, vitamin C content, chlorophyll, antioxidant activity and color of green tea (*Camellia sinensis* or *C. assamica*) leaves. *J. Food Sci. Technol.* 2016, 53, 721–729.

- Srivastava A, Subhashini, Keshari AK, Srivastava R (2021). Phytochemical and GC-MS Analysis of Hydro Ethanolic Leaf Extract of *Ocimum sanctum* (L). *Pharmacog Res.* 2021; 13(4):233-7.
- Tiwari, R.K.S.; Chandravanshi, S.S.; Ojha, B.M. Efficacy of extracts of medicinal plant species on growth of *Sclerotium rolfsii* root rot in tomato. *Indian J. Mycol. Plant Pathol.* 2005, 3, 461–464.
- Trease, G. E., and Evans, W. C. (1989). *A textbook of Pharmacognosy*. 13th Edn. London: Bacilliere Tindall.
- Upadhyay S., Dixit M. Role of polyphenols and other phytochemicals on molecular signaling. *Oxid. Med. Cell. Longev.* 2015.
- Usman H, Osuji JC. Phytochemical and in vitro antimicrobial assay of the leaf extract of *Newbouldia leavis*. *Afr. J Trad. CAM.* 2007; 4(4):476-480.
- Yamato, Gayor. Thepeutic potential of inhibitory of the NF.KB pathway in the treatment of inflammation and cancer, *Journal of clinical investigation.* 2002, 493-503.

EFFECT OF SALINITY STRESS ON BIOCHEMICAL, GROWTH, AND YIELD CHARACTERISTICS OF WHEAT

Waseem Haider¹, Hüseyin OK¹, İsmail Emrah TAVALI²

¹ Department of Plant Production and Technologies, Faculty of Agricultural Sciences and Technologies, Cyprus International University, 99258 Nicosia, Turkey

² Department of Soil Science and Plant Nutrition, Faculty of Agriculture, Akdeniz University, 07070 Antalya, Turkey

Corresponding author e-mail: hok@ciu.edu.tr

ABSTRACT

Wheat is crucial in providing food and nutritional security, but rapidly increasing soil and water salinity severely threatens its production worldwide. Salinity has a direct impact on soil productivity and limits global yield potential. It also deleteriously impacts wheat growth and development, reducing grain production and quality. Wheat plants use a variety of physiological, biochemical, and molecular mechanisms to adapt to salt stress at the cell, tissue, and whole plant levels to optimize growth and yield while mitigating the harmful impacts of the saline environment. An experiment was conducted at the Institute of Graduate Studies and Research Department of Plant Sciences and Technologies, Cyprus International University, to examine the effect of salinity stress. In the present experiment, wheat varieties V1, V2, and V3 were tested under EC control, 7.5 dS m⁻¹, 10 dS m⁻¹, and 12 dS m⁻¹ following a completely randomized design (CRD) with factorial arrangement. The findings revealed that wheat growth and yield characteristics decreased dramatically as saline levels increased. Among V1, V2, and V3, the highest reduction in plant height, SFW, SDW, RFW, RDW, number of tillers, spike length, and grain yield were noted in V3 when treated with 12 dS m⁻¹. Furthermore, V1 performed best as compared to all other varieties.

Keywords: Salinity, Wheat, Antioxidants, Growth, Yield

INTRODUCTION

Earth contains different type of salts. Major portion of earth is covered with water and there is approximately 3% NaCl in that water (Breiman & Graur, 1995; Royo & Abió, 2003; Hajihashemi et al., 2009). However, the total area of the earth that becomes salt-affected is not precisely known according to an estimate about 930Mha of the earth is salt affected and distributed throughout the world (Robin et al., 2016).

Soil salinization is a severe environmental issue worldwide, primarily affecting soil and crop productivity in arid and semi-arid areas due to high temperature and low rainfall (de Sa et al., 2021). Over the previous 45 years, the salt-affected soil area has expanded by 77 million ha, becoming a severe hazard, particularly for irrigated agriculture (Munns, 2002). Salt-affected soils cover an area of around 1060.1 Mha in the world and their area is gradually increasing due to the influence of climate change; soil salinity tends to increase with increase in sea level intrusion and temperature, decrease in precipitation and improper irrigation management (Eswar et al., 2021). It is a major challenge to modern agriculture, impeding and impairing crop growth and development, especially in coastal areas and most arid regions of the world (Zaman et al., 2018).

It has been reported that salt stress has affected 20% of agricultural land. However, this problem is enhancing gradually owing to anthropogenic activities as well as different changes

within climatic conditions (Arora, 2019). Due to salinity stress according to an estimate 50% reduction in crop production has been recorded (Acquaah, 2007). While, there is need to increase food supply up to 70% by 2050 in order to fulfill the demands of continuously increasing population (FAO, 2009).

Salinity has a detrimental effect on the chemical, physical, and biological properties of soil because of the high concentration of salts of basic cations in the soil and yield because of osmotic and ionic stress besides inhibit seed germination, structure and functions of the photosynthetic machinery, resulting in less economical agricultural production and rural poverty (Jahan et al., 2020). However, soil parent material, anthropogenic activities, and arid and semiarid climatic conditions contribute to unfavorable soil conditions like low rainfall which limits leaching of salts, causing accumulation of Ca-minerals that strongly changing soil organic matter turnover and nutrient recycling resultantly crop production decrease (Acquaah, 2007; FAO, 2009.; Wiese, 1977). Improving future agricultural management demands that soil salinity should be taken into consideration (Ennaji et al., 2018).

Variation in climatic conditions, increase in temperature and low rainfall are the red signals indicating that there is need to bring salt affected soils under cultivation to fulfil day by day increasing demands of food (Akhiyarova et al., 2005; Akbari et al., 2007). So, it is important to examine the maximum adverse outcome of excessive salts in the crop growth along with isolate salt tolerant varieties for maximum yield (Huang et al., 2010; Turan et al., 2009; Çelik & Atak 2012).

The growth and production of wheat is reducing throughout the world due to several factors such a decrease in agricultural land, environmental variations, extensive application of chemical fertilizer and less application of organic fertilizers (Masuda, 2016). Many sections of the world are vulnerable to stressors such as salt, which has a harmful effect on plant growth and yield production (Hasanuzzaman et al., 2014a; Hasanuzzaman et al., 2014b; Shabala & Munns 2012). Around 20% of agricultural fields are saline, and because of the significant issue of global warming, increasingly cultivable lands are becoming salty. Because many stressors, including salinity, result in yield decreases of up to 50% (Munns and Tester, 2008; Munns et al., 2019), while it is important to enhance food production up to 70% by 2050 (FAO, 2009).

Salinity effect plant growth and development via various mechanisms, among them two most important are discussed here (1) the harmful impacts of sodium (Na^+) and chloride (Cl^-) ions, and (2) the osmotic capacity influencing plant physiology. Though, plants can tolerate salinity stress (Rahman et al., 2016; Afzal et al., 2005). Based on their ability to tolerate salinity plants can be tolerant, moderately tolerant, and sensitive. Different researchers classified wheat as a tolerant crop. However, wheat can tolerate salinization to some extent, but its production decrease under heigh level of salinity stress (Poustini & Siosemardeh, 2004; James et al., 2006). Plant synthesis energy via photosynthesis, this energy is utilized in maintenance, plant growth, and to survive under several types of abiotic and biotic hassles during growth stages (Miransari & Smith, 2019).

Under salinity stress plants activate various type of signaling pathways. Salinity stress give rise to artificial drought conditions under such conditions water is present in high amount but due to high concentration of soluble salts plants are unable to absorb water. In response to salinity coupled with drought stress production of reactive oxygen species (ROS) increases. These ROS negatively effects plant metabolism and reduces its ability to cope under stress conditions (Miransari & Smith, 2019).

Keeping in view the above-mentioned adverse impact of salinity on crop yield. This trail aims to define the influence of salt stress on three wheat varieties. Our objectives are;

- I. To examine the impact of soil salinity on biochemical parameters of wheat under different salinity levels.
- II. To determine salinity level at which maximum yield can be obtained under climatic conditions of Nicosia.

MATERIAL AND METHOD

Experiment

A pot experiment was performed at Institute of Graduate Studies and Research department of Plant sciences and technologies, Cyprus International University. The wheat varieties were grown in pots containing 20 kg by weight. Soil for the experiment was taken from the farm. The soil was air-dried and sieved through a 2 mm sieve. Before the start of experiment soil properties, such as E_{Ce}, pHs, saturation percentage, SAR, texture and NPK was determined following standard methods.

Development of salinity

After preliminary analysis, four different levels of soil salinity i.e. control (C), S₁ = 7.5, S₂ = 10 and S₃ = 12 dSm⁻¹ was prepared by using a calculated amount of NaCl, Na₂SO₄, CaCl₂, CaSO₄ salts and mixing along with the soil in a mixing tub to achieve maximum homogeneity so that the required salinity levels can be establish in soil samples (Muhammed and Ghafoor, 1992).

Pot filling, fertilization, seed sowing and irrigation

Each pot was filled with 10 kg soil, after developing the required salinity levels, and seeds of wheat shall be sown in each pot. As per requirement thinning was carried out 45 days after planting, leaving 4 plants in each pot. The recommended dose of NPK for wheat was be applied before sowing according to planned treatments. Each pot was treated as per the following treatments.

Treatments layout

Four salinity levels and wheat varieties were used to determine effect of salinity stress on wheat growth, and yield parameters. A completely randomized design with factorial arrangements of 12 treatments each with 3 replications was used.

Varieties = V₁, V₂, V₃ (Perre, Cumhuriyet 75, Gori)

Salinity levels = C, S₁, S₂, S₃

Number of pots = V*S*Replications = 3*4*3 = 36

Plant parameters

Following parameters of crop will be measured after harvesting the wheat crop.

Shoot length (cm)

To measure the length of wheat shoot, meter rod will be used. Later, mean of shoot length will be calculated.

Root length (cm)

Plants root length of all samples will be estimated with meter rod. After those values of mean shall be determined.

Shoot fresh weight (g)

Fresh weight of shoot will be measured using electronic weighing balance.

Shoot dry weight (g)

Weight of dry shoot will be measured after putting shoot samples in an oven at 65± 5°C temperature for 24 hours.

Number of tillers

At maturity after randomly selecting one plant per pot total numbers of tillers of that plant were counted and mean value for number of tillers per plant were calculated.

Spike length (cm)

Spike lengths of three randomly chosen plants were measured by using meter rod. For measuring spike length, length from start point of spike to the upper tip of the spike was noted and it's mean length was calculated.

Grains per spike

After harvesting the spikes were manually threshed and separately counted the number of grains per spike and then average was calculated.

100 grain weight

Grains were counted by using seed counter, weighted on an electrical balance at the time of harvesting from each replication. At the end mean value for 100 grain weight was estimated.

Grain yield

Grains of each pot were manually harvested, and their weight was recorded by weighing balance.

Straw yield

Plants of each pot were harvested manually, tied into bundled and sun dried for a week. By means of digital balance total biomass of sun-dried samples were recorded.

Harvest index

Harvest index % (HI%) can be calculated by the given formula.

$$HI(\%) = \frac{\text{Grain Yield(g)}}{\text{Straw yield(g)}} \times 100$$

Biochemical parameters

Total chlorophyll content

The chlorophyll content of fully mature wheat leaf will be determined using Chlorophyll meter (SPAD-value) at three different points (Welburn, 1994) and then averaged.

RESULTS AND DISCUSSION

Shoot length (cm)

Salinity stress adversely effects different physiological along with biochemical developments of plant in addition to reduces its growth along with improvement. ANOVA table 4.1.1 shows the impact of soil salinity on shoot length of three varieties of wheat i.e., V1, V2, and V3. ANOVA table showed that the interaction between salinity stress and plant height is highly significant in all wheat varieties. Furthermore, it can be depicted from the Fig 4.1.1 that with increase in salinity considerable reduction in shoot length was observed. However, highest shoot length (115cm) was observed in V1 under controlled conditions. While lowest shoot length i.e., was observed in V3 treated with 12 dS m⁻¹ salt stress.

Moreover, the results of this research demonstrated that salinity stress reduced shoot length by 21.7%, 39%, and 52% in V1 treated with SL1, SL2, and SL3 respectively as compared to control. In V2 a reduction in shoot length was also observed. The results showed 25%, 40%, and 63% reduction in shoot length as associated to control. Lastly the outcomes of this study indicated a reduction of 29%, 44.8%, and 65.4% in shoot length in pots treated with 7.5 dSm⁻¹, 10 dS m⁻¹, and 12 dS m⁻¹ correspondingly. According to our findings V1 performed best as linked to V2 and V3. The outcomes of our research demonstrated that with increasing level of salinity plant height was reduced. Our conclusions are also justified by Nazeer et al. (2021) who stated that salinity negatively effects growth of wheat by decrease in tissue water contents. Elevated absorption of salts in soil solution induces osmotic stress. Osmotic influence reduces activity of meristematic cells in shoot axis thereby cell elongation and consequently plant height (Qiong et al., 2016).

Siddiqui et al. (2021); EL Sabagh et al. (2021) also reported the adverse impact of salinity on plant height. Salinity stress increases the concentration of Na and Cl ions that leads to ionic stress which adversely effects biochemical and metabolic processes in older leaves that resultantly causes decrease in leaf expansion and photosynthetic capacity. Leaves are the production houses of plant and because of impaired functioning of leaves the ability of plant to generate energy decreases that ultimately decreases plant height (Fathalla and El-Mageed,

2020). In another research Kalhorro et al. (2016) reported reduction in plant height, spike size, quantity of spikelets spike⁻¹, 1000 grain mass, as well as yield. However, salinity level of 10 dS m⁻¹ has more harmful effect as associated to 2.16, 4.0, 6.0, 8.0 dS m⁻¹. The impact of soil salinity on shoot arid weight, and wheat yield was observed by Elgharably et al. (2010). In this experiment wheat response to EC level 2.2, 6.7, 9.2 and 11.8 dS m⁻¹ and four different concentrations of N and P was recorded. The results showed that EC level 11.8 dS m⁻¹ considerably decreased the shoot, and grain yield but application of N and P increased the growth and yield related components.

Root length (cm)

Salinity stress adversely effects different biological as well as bio-chemical methods of plant and reduces its growth and development. ANOVA table 4.2.1 shows the impact of soil salinity on root length of three varieties of wheat i.e., V1, V2, and V3. ANOVA table showed that the interaction between salinity stress and plant height is highly significant in all wheat varieties. Furthermore, it can be depicted from the Fig 4.2.1 that with increase in salinity significant an increase in root length was observed. However, highest root length (40 cm) was observed in V1 treated with 12 dS m⁻¹ salinity stress. While lowest root length i.e., 19 was observed in V2 under controlled conditions.

In addition, the findings of this study showed that salinity stress increased root length by 29%, 54%, and 62% in V1 treated with SL1, SL2, and SL3 respectively as compared to control. In V2 an increase in root length was also observed. The results showed 29%, 46%, and 61% increase in root length as compared to control. Lastly the results of this study showed an increase of 22%, 60%, and 72% in root length in pots treated with 7.5 dSm⁻¹, 10 dS m⁻¹, and 12 dS m⁻¹ correspondingly. According to our findings V1 performed best versus V2 and V3.

The outcomes of our study revealed that with increasing level of salinity plant height was reduced. Our outcomes are also justified by Nazeer et al. (2021) who described that salinity negatively effects growth of wheat by decrease in tissue water contents. High intensity of salts in soil mixture stimulates osmotic effect. Osmotic influence reduces activity of meristematic cells in shoot axis thereby cell elongation and consequently plant height (Qiong et al., 2016).

Siddiqui et al. (2021); EL Sabagh et al. (2021) also reported the adverse effect of salinity on plant height. Salinity stress increases the concentration of Na and Cl ions that leads to ionic stress which adversely effects biochemical and metabolic processes in older leaves that resultantly causes decrease in leaf expansion and photosynthetic capacity. Leaves are the production houses of plant and because of impaired functioning of leaves the ability of plant to generate energy decreases that ultimately decreases plant height (Fathalla and El-Mageed, 2020). In another research Kalhorro et al. (2016) reported reduction in plant elevation, spike size, quantity of spikelets spike⁻¹, 1000 grain mass, along with yield. However, salinity level of 10 dS m⁻¹ has additional unfavorable effect as associated to 2.16, 4.0, 6.0, 8.0 dS m⁻¹. The impact of soil salt on shoot dry weight, root dry weight and wheat yield was observed by Elgharably et al. (2010). In this experiment wheat response to EC level 2.2, 6.7, 9.2 and 11.8 dS m⁻¹ and four different concentrations of N and P was recorded. The results showed that EC level 11.8 dS m⁻¹ considerably decreased dry weight of shoot and root and also reduced grain yield, but application of N and P increased the yield related components. So, from the previous studies it can be concluded that salinity reduces root size.

Grains per spike

Salinity stress adversely effects different physiological and biochemical processes of plant and reduces their growth and development. ANOVA table 4.9.1 shows the impact of soil salinity on grains per spike of three varieties of wheat i.e., V1, V2, and V3. ANOVA table showed that the interaction between salinity stress and plant height is highly significant in all

wheat varieties. Furthermore, it can be depicted from the Fig 4.9.1 that with increase in salinity significant reduction in grains per spike was observed. However, a highest grain per spike (51) was observed in V1 under controlled conditions. While a lowest grain per spike i.e., 22 was observed in V2 treated with 12 dS m⁻¹ salinity stress.

In addition, the findings of this research showed that salinity stress reduced grains per spike by 8%, 37%, and 45% in V1 treated with SL1, SL2, and SL3 respectively as compared to control. In V2 a reduction in grains per spike was also observed. The outcomes showed 10%, 22%, and 55% reduction in grains per spike as associated to control. Lastly the results of this study showed a reduction of 4%, 25%, and 44% in grains per spike in pots treated with 7.5 dSm⁻¹, 10 dS m⁻¹, and 12 dS m⁻¹ correspondingly. According to our findings V1 performed best as assessed to V2 and V3. The findings of our research demonstrated that with increasing level of salinity plant height was reduced. Our outcomes are also justified by Nazeer et al. (2021) who stated that salinity negatively effects growth of wheat by decrease in tissue water contents. High-level absorption of salts in soil mixture causes osmotic stress. Osmotic impact reduces activity of meristematic cells in shoot axis thereby cell elongation and consequently plant height (Qiong et al., 2016).

Siddiqui et al. (2021); EL Sabagh et al. (2021) also stated the adverse effect of soil salinity on plant height. Salinity stress increases the concentration of Na⁺ as well as Cl⁻ ions that leads to ionic stress which adversely effects biochemical and metabolic processes in older leaves that resultantly causes decrease in leaf expansion and photosynthetic capacity. Leaves are the production houses of plant and because of impaired functioning of leaves the ability of plant to generate energy decreases that ultimately decreases plant height (Fathalla and El-Mageed, 2020). In another research Kalhor et al. (2016) reported reduction in plant elevation, grains per spike, quantity of spikelets spike⁻¹, 1000 grain weight, as well as yield. Though, salinity level of 10 dS m⁻¹ has additional unfavorable effect as linked to 2.16, 4.0, 6.0, 8.0 dS m⁻¹. The impact of salt on grains per spike, grains per spike and wheat yield was observed by Elgharably et al. (2010). In this experiment wheat response to EC level 2.2, 6.7, 9.2 and 11.8 dS m⁻¹ and four different concentrations of N and P was recorded. The results showed that EC level 11.8 dS m⁻¹ significantly reduced the shoot, grains per spike, and grain yield but application of N and P increased the yield related components. So, from the previous studies it can be concluded that salinity reduces grains per spike.

Grain Yield (g/pot)

Salinity stress adversely effects different physiological as well as biochemical processes of plant and reduces their growing along with development. ANOVA table 4.10.1 shows the impact of soil salinity on grain yield of three varieties of wheat i.e., V1, V2, and V3. ANOVA table showed that the interaction between salinity stress and plant height is highly significant in all wheat varieties. Furthermore, it can be depicted from the Fig 4.10.1 that with increase in salinity significant reduction in grain yield was observed. However, highest grain yield (38g) was observed in V1 under controlled conditions. While lowest grain yield i.e., 7g was observed in V3 treated with 12 dS m⁻¹ salt stress. Additionally, the consequences of this investigation indicated that salinity stress lowered grain yield by 19%, 25%, and 76% in V1 treated with SL1, SL2, and SL3 respectively as linked to control. In V2 a reduction in grain yield was also observed. The findings indicated 2.7%, 31%, and 76% reduction in grain yield as compared to control. Lastly the results of this study showed a reduction of 6%, 35%, and 78% in grain yield in pots treated with 7.5 dSm⁻¹, 10 dS m⁻¹, and 12 dS m⁻¹ correspondingly. According to our findings V1 performed best as linked to V2 and V3.

The outcomes of our research demonstrated that with increasing level of salinity plant height was reduced. Our results are also explained by Nazeer et al. (2021) who described that salinity negatively effects growth of wheat by decrease in tissue water contents. High-level

absorption of salts into soil solution stimulates osmotic stress. Osmotic impact reduces activity of meristematic cells in shoot axis thereby cell elongation and consequently plant height (Qiong et al., 2016). Siddiqui et al. (2021); EL Sabagh et al. (2021) also informed the unfavorable effect of soil salinity on plant height. Salinity stress increases the concentration of Na along with Cl ions that leads to ionic stress which adversely effects biochemical and metabolic processes in older leaves that resultantly causes decrease in leaf expansion and photosynthetic capacity. Leaves are the production houses of plant and because of impaired functioning of leaves the ability of plant to generate energy decreases that decreases plant height (Fathalla and El-Mageed, 2020). In another research Kalhor et al. (2016) reported reduction in plant height, grain yield, number of spikelets spike⁻¹, 1000 grain weight, and yield. However, salinity level of 10 dS m⁻¹ has additional unfavorable effect as linked to 2.16, 4.0, 6.0, 8.0 dS m⁻¹. The effect of salinity on grain yield, grain yield and wheat yield were observed by Elgharably et al. (2010). In this experiment wheat response to EC level 2.2, 6.7, 9.2 and 11.8 dS m⁻¹ and four different concentrations of N and P was recorded. The results showed that EC level 11.8 dS m⁻¹ significantly reduced the shoot, grain yield, and grain yield but application of N and P increased the yield related components.

In addition, the findings of this experiment showed that salinity stress reduced grain yield by 19%, 24%, and 76%, in V1 treated with SL1, SL2, and SL3 respectively as compared to control. In V2 a reduction in grain yield was also observed. The results showed 3%, 33%, and 77 % reduction in grain yield as associated to control. Lastly the results of this study demonstrated a reduction of 20.5 %, 25 %, and 76.9 % in grain yield in pots treated with 7.5 dSm⁻¹, 10 dS m⁻¹, and 12 dS m⁻¹ correspondingly. In accordance with our findings V1 performed best as compared to V2 and V3.

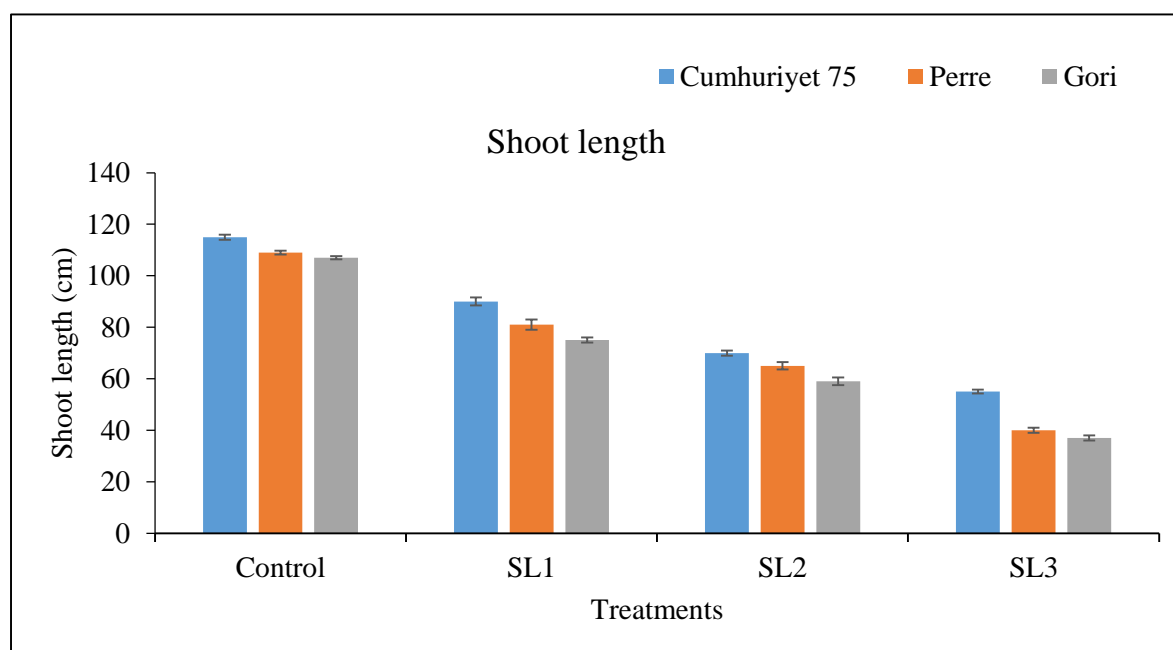

Figure 1. Effect of salinity on shoot length

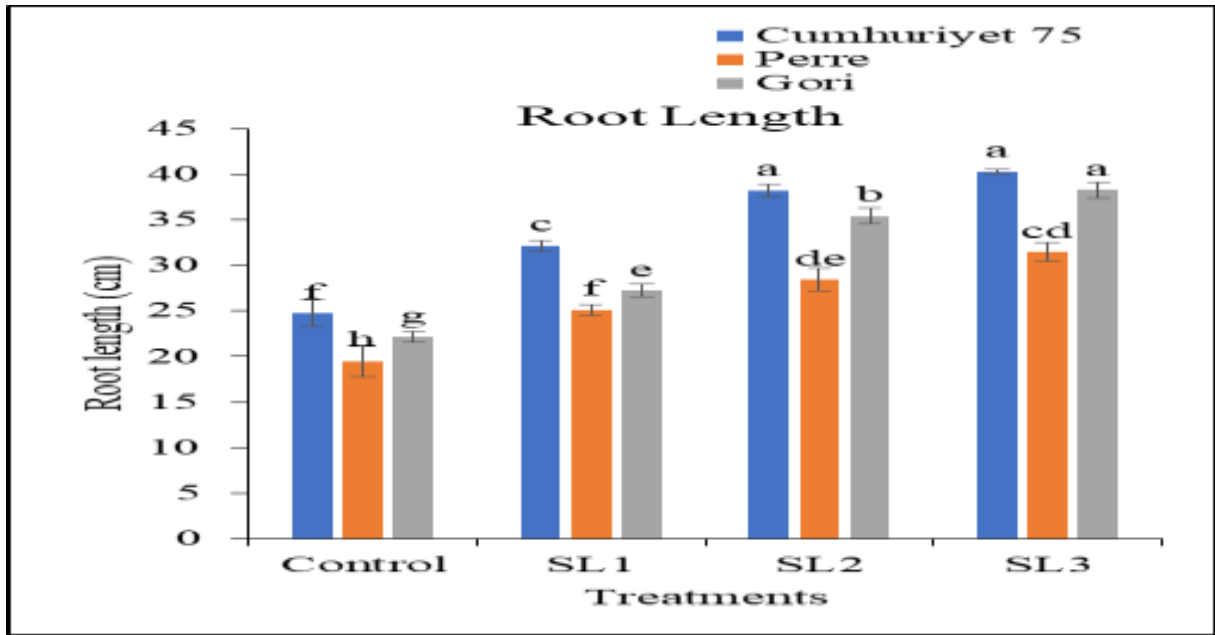

Figure 2. Effect of salinity on root length

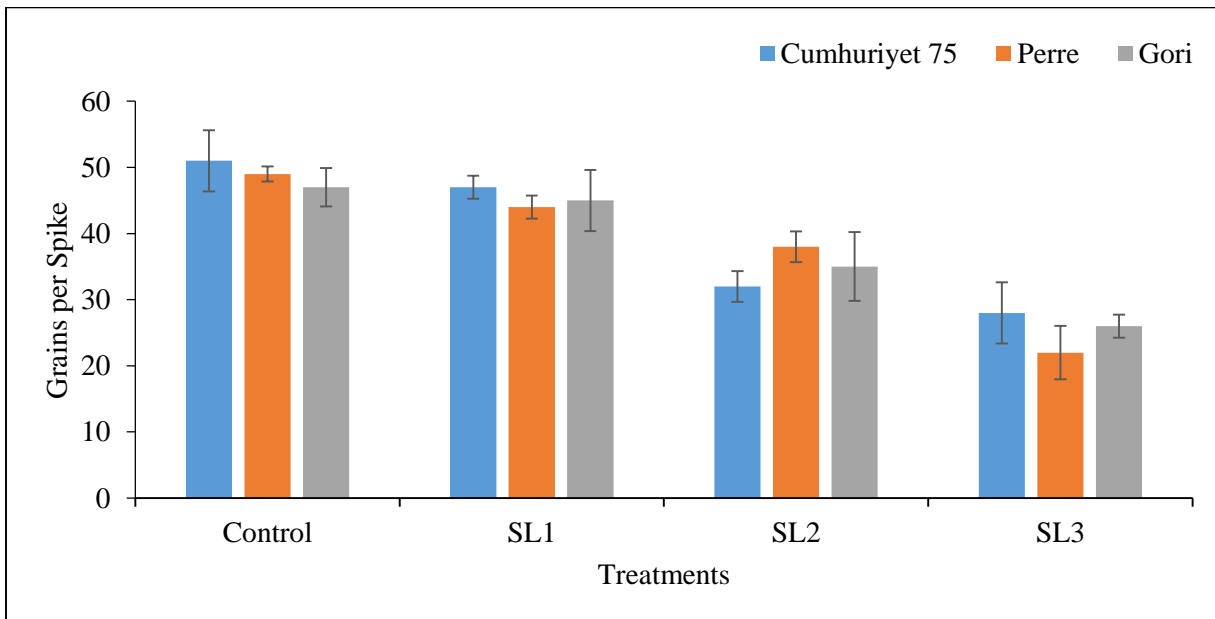

Figure 3. Effect of Salinity on grains per spike

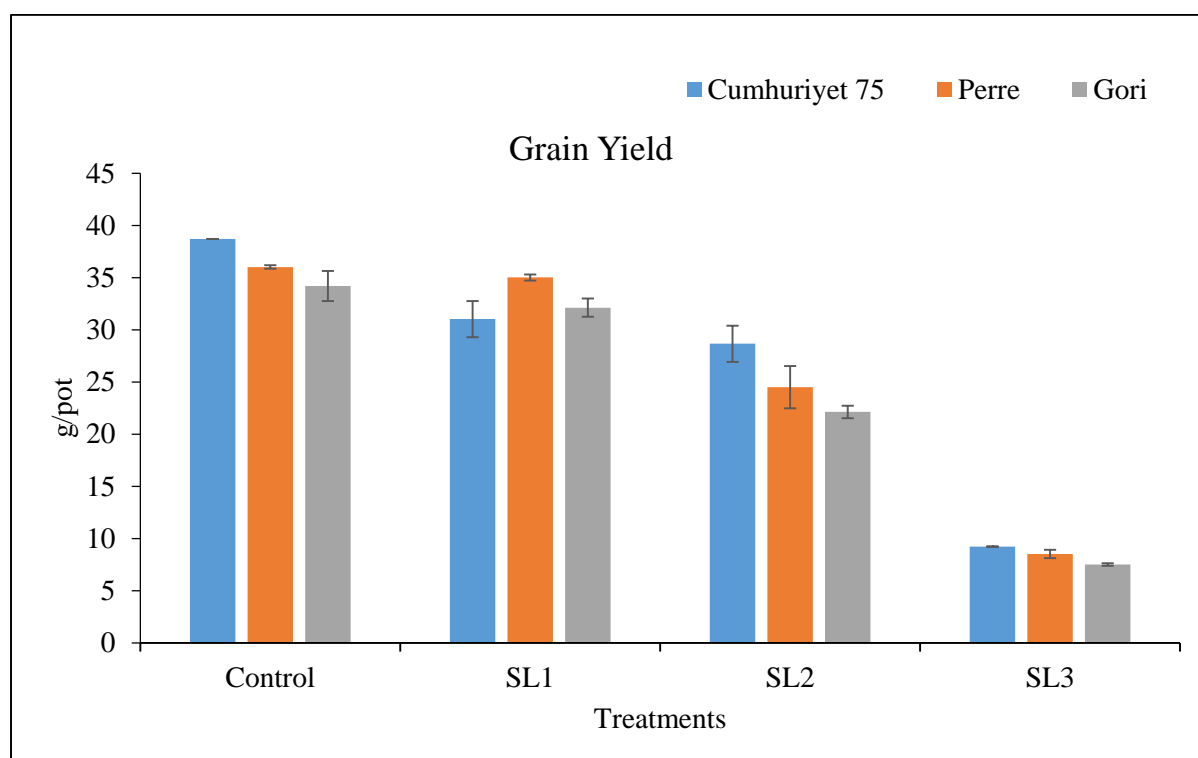

Figure 4. Effect of Salinity on grain yield of wheat

CONCLUSIONS

Keeping under consideration the interactive effect of salinity levels and varieties best results of plant height, spike length, number of tillers, 1000 grain weight, along with grain yield were observed in V1 under control conditions. However, this experiment suggested that improving salt acceptance of wheat varieties can be an effective strategy to increase crop growth and production under saline conditions. While using salt tolerant varieties and applying organic amendments along with salt tolerant microbes can be more effective.

REFERENCES

- Breiman A, Graur D (1995). Wheat evolution. *Israel Journal of Plant Sciences* 43:85–98.
- Royo A, Abió D. Salt tolerance in durum wheat cultivars. *Spanish Journal of Agricultural Research* 2003; 1:27–35.
- Hajhashemi S, Kiarostami K, Enteshari S, Saboora A. Effect of paclobutrazol on wheat salt tolerance at pollination stage. *Russian Journal of Plant Physiology* 2009; 56:251–257.
- Robin, A. H. K., Matthew, C., Uddin, M. J., & Bayazid, K. N. (2016). Salinity-induced reduction in root surface area and changes in major root and shoot traits at the phytomer level in wheat. *Journal of Experimental Botany*, 67(12), 3719–3729. <https://doi.org/10.1093/JXB/ERW064>
- de Sá, C. S. B., Shiosaki, R. K., dos Santos, A. M., & Campos, M. A. da S. (2021). Salinization causes abrupt reduction in soil nematode abundance in the Caatinga area of the Submedio San Francisco Valley, Brazilian semiarid region. *Pedobiologia*. <https://doi.org/10.1016/j.pedobi.2021.150729>

- Munns, Rana. (2002). Comparative physiology of salt and water stress. *Plant, Cell and Environment*, 25, : 659-151. <https://doi.org/10.1046/j.0016-8025.2001.00808>
- Eswar, D., Karuppusamy, R., & Chellamuthu, S. (2021). Drivers of soil salinity and their correlation with climate change. In *Current Opinion in Environmental Sustainability* (pp. 50: 1877-3435). <https://doi.org/10.1016/j.cosust.2020.10.015>
- Zaman, M., Shahid, S. A., Heng, L., Shahid, S. A., Zaman, M., & Heng, L. (2018). Soil Salinity: Historical Perspectives and a World Overview of the Problem. In *Guideline for Salinity Assessment, Mitigation and Adaptation Using Nuclear and Related Techniques* (pp. 43–53). https://doi.org/10.1007/978-3-319-96190-3_2
- Arora, N. K. (2019). No Title Impact of climate change on agriculture production and its sustainable solutions. *Environ. Sustain*, 2, 95–96. <https://doi.org/10.1007/s42398-019-00078-w>
- Acquaah, G. (2007). *Principles of Plant Genetics and Breeding* (2nd Edn.). Oxford: Blackwell.
- FAO. (2009). *How to feed the world - 2050: High-level Expert Forum, Rome 12-13 Oct 2009 - Investment - World | ReliefWeb*. <https://reliefweb.int/report/world/how-feed-world-2050-high-level-expert-forum-rome-12-13-oct-2009-investment>
- Jahan, B., AlAjmi, M. F., Rehman, M. T., & Khan, N. A. (2020). Treatment of nitric oxide supplemented with nitrogen and sulfur regulates photosynthetic performance and stomatal behavior in mustard under salt stress. *Physiologia Plantarum*. <https://doi.org/10.1111/ppl.13056>
- Acquaah, G. (2007). *Principles of Plant Genetics and Breeding* (2nd Edn.). Oxford: Blackwell.
- Wiese MV. *Compendium of Wheat Diseases*. American Phytopathological Society, USA; 1977.
- Ennaji, W., Barakat, A., El Baghdadi, M., Oumenskou, H., Aadraoui, M., Karroum, L. A., & Hilali, A. (2018). GIS-based multi-criteria land suitability analysis for sustainable agriculture in the northeast area of Tadla plain (Morocco). *Journal of Earth System Science*, 127, 79. <https://doi.org/10.1007/s12040-018-0980-x>

COMPARATIVE ANALYSIS OF BIOFILM MORPHOTYPES OF TYPE 1 FIMBRIAE N-TERMINAL DOMAIN DISRUPTED MUTANT AND WILD-TYPE STRAIN IN *SALMONELLA* TYPHIMURIUM

Tuba Nur SÜRKAÇ¹, Nefise AKÇELİK², Mustafa AKÇELİK¹

¹ *Ankara University, Graduate School of Natural and Applied Science, Biology Department, Ankara, Türkiye*

² *Ankara University, Biotechnology Institute, Ankara, Türkiye*

Corresponding author e-mail: akcelik@science.ankara.edu.tr

ABSTRACT

Type 1 fimbriae can be found in most *Salmonella* strains and many other members of Type 1 fimbriae are found in most *Salmonella* strains and many other members of the family *Enterobacteriaceae*. Type 1 fimbriae are one of the structures that allow *Salmonella* to attach itself effectively onto abiotic surfaces and different host cells. In this study, the aim was to determine the effects of N-terminal domain on biofilm in *S. Typhimurium* ATCC 14028 strain, which was cloned only N-terminal domain of the *fimF* gene. In the *S. Typhimurium fimF* mutant, the biofilm formation was found to be statistically significantly reduced compared to the wild-type strain ($p < 0.05$), and the biofilm forming capacity of the *fimF* gene N-terminal domain cloned construct increased compared to the *fimF* mutant ($p < 0.05$). When the morphotypes of biofilms formed by wild-type and other strains are examined; The wild-type strain displayed the 'rdar' morphotype, while the *fimF* mutant strain and its N-terminal domain cloned construct be detected changed to the 'bdar' morphotype.

Keywords: *Salmonella Typhimurium*, Type 1 fimbriae, N-Terminal Domain, Biofilm formation, Biofilm morphotypes, Cellulose production

INTRODUCTION

Members of the *Salmonella* genus are significant food pathogens that create a major public health problem throughout the world, due to their long-term persistence ability on the surface and tissues of the plants, along with using human and animal's systems as a host. These bacteria, which cause hospital or food related epidemics in developing countries, are described as the members of the family *Enterobacteriaceae*, rod-shaped, Gram-negative and anaerobic (Crump, 2004; Threlfall, 2002; Su, 2007; Roy, 2021).

When *Salmonella* bacteria form a biofilm by attaching onto the surfaces, it causes serious health problems. Biofilms are communities formed by microorganisms, irreversibly adhering to abiotic and biotic surfaces. The formation of biofilm begins with adhesion to biotic and abiotic surfaces. Getting bacteria close enough to a surface is a pre-requisite for biofilm formation. As bacteria get close to a surface, both attractive and repulsive forces are activated. At a distance of approximately 10-20 nm from the surface, the negative charges on the bacterial surface are repelled by the negative charges on most environmental surfaces. The repulsive force can be overcome by the attractive van der Waals forces between bacterial cells and surface, and the usage of fimbriae and flagella to provide mechanical attachment to the surface (Gonzalez-Escobedo & Gunn 2013; Rabin et al. 2015).

Some bacterial pathogens are equipped with multiple adhesive structures (Rehman et al., 2019). Adhesion of bacteria to mucosal surfaces plays an important role in the pathogenesis of most bacterial infectious diseases in animals and humans (Beachey, 1981). The characterization of fimbrial operons *fim*, *lpf* and *pef* found in *Salmonella* Typhimurium display that fimbrial adhesins perform multiple functions during the initial phase of an infection. Adhesins mediate first contact with epithelial cells. This event demonstrates a role for fimbrial adhesins in the elicitation of invasion and inflammatory response. Therefore, fimbriae are important virulence factors for *S. Typhimurium* (Baumler et al., 1997).

Type 1 fimbriae characteristically consist of fibrils of 1 μm in length and 6 nm in diameter (Korhonen et al., 1980; Wagner & Hensel 2011). Type 1 fimbriae are enterocytes specific adhesins (Althouse et al., 2003). Another characteristic feature of *S. Typhimurium* type 1 fimbriae is their ability to mannose-sensitive hemagglutination. It was found that this fimbriae type is combined with the Chaperon-Usher pathway. Biochemical and immunological tests carried out has shown that type 1 fimbriae of *S. enterica* serovar Typhimurium direct the relationship between pathogen and the host by mediating binding to mannose-containing glycoconjugates on eukaryotic cell surfaces (Boddicker et al., 2002).

Type 1 fimbrial proteins in *S. Typhimurium* are encoded by the *fim* gene cluster (*fimAICDHFZYW*). *FimAICDHF* is expressed as a single transcriptional unit. *Fim* gene cluster consists of six structural genes, three regulatory genes and a tRNA specific to rare arginine codons (AGA and AGG). *FimA*, *fimI*, *fimC*, *fimD*, *fimH* and *fimF* structural genes are all expressed as a single transcript from the P_{fimA} promoter. *FimZ*, *fimY* and *fimW* regulators are all expressed by independent promoters. The structural components of fimbriae are *FimA* (main subunit), *FimI*, *FimH* (adhesin) and *FimF* (adapter) (Zeiner et al., 2012).

FimF gene and therefore the *FimF* protein it encodes, act as adapters for insertion of terminal adhesins into the fimbrial structure. It is thought that in absence of this gene and protein, adhesin binding activation cannot be achieved. On the other hand, in the study conducted with type 1 fimbriae adapter proteins of many pathogens, including *E. coli*, it was suggested that only the N-terminal ends of the adapter subunits act as adapters for the addition of fimbrial subunits (Kloppsteck et al., 2016).

N-terminal region of a protein regulates the function of that protein and ensures that it functions correctly and also determines the role of the protein in question in biological processes. In this study, it was aimed to clarify whether the function of *S. Typhimurium* type 1 fimbrial protein, *FimF*, which causes it to act as an adapter protein, originates from the N-terminal region, the role of the *fimF* gene encoding this protein in biofilm formation.

MATERIAL & METHODS

Bacterial Strains and Culture Conditions

S. Typhimurium ATCC 14028 wild-type strain and its *fimF* gene mutant were obtained from the culture collection created by the Prokaryotic Genetics working group (Ankara University, Faculty of Science, Department of Biology). *S. Typhimurium* ATCC 14028 wild-type strain, *fimF* gene mutant ($\Delta fimF$) and the N-terminal domain cloned strain ($\Delta fimFpBADfimF^N$) were incubated in Luria Bertani (LB) medium at 37 °C in a 200 rpm rotating incubator for 18 hours. *S. Typhimurium* ATCC 14028 *fimF* gene mutant strain, which underwent deletion using

homologous region recombination technique, was grown in medium containing chloramphenicol ($20 \mu\text{g}/\text{mL}^{-1}$) and *S. Typhimurium* ATCC 14028 strain, in which only the N-terminal domain of the *fimF* gene was cloned, was grown in medium containing ampicillin ($100 \mu\text{g}/\text{mL}^{-1}$) and arabinose (0.01%).

Determination of Biofilm Formation Amounts and Biofilm Morphotypes on Polystyrene Surfaces

The biofilm forming properties of bacteria were quantitatively determined in systems with 96 well polystyrene surfaces. *Salmonella* strains were grown in NaCl-free LB broth ($\text{LB}^{-\text{NaCl}}$) at 37°C in a 200 rpm shaking incubator for 18 hours. $30 \mu\text{L}$ of bacterial cultures prepared at a concentration of 1×10^9 CFU/mL (colony forming unit) were taken and transferred to 96 well polystyrene microplate wells containing $100 \mu\text{L}$ of $\text{LB}^{-\text{NaCl}}$ broth. Microplates were incubated at 20°C for 72 hours under static conditions. The supernatants were discarded at the end of the incubation, after that the wells were washed thrice with phosphate-buffered saline (PBS, pH 7.0 ± 2.0). After the washing process, $140 \mu\text{L}$ of 95% methanol was added to fixation of the biofilm structures attached to the wells and kept at room temperature for 20 minutes. Biofilm structures were dyed for 15 minutes using 1% crystal violet. The plates were washed with sterile distilled water and the microplates were dried at room temperature after removing the dye that did not adhere to the biofilm structures. In order to dissolve the dye penetrating into the produced biofilm $140 \mu\text{L}$ (33%) of glacial acetic acid was added to the medium, and these plates were kept at 24°C for 30 minutes. The dye adhered to the biofilm was determined at $\text{OD}_{595 \text{ nm}}$ using an ELISA reader (Biorad, USA). The study was conducted in three parallels and two repetitions (Stepanovic et al., 2004; Vestby et al., 2009).

To determine biofilm morphotypes, active bacterial cultures were inoculated on $\text{LB}^{-\text{NaCl}}$ agar containing Congo red ($40 \text{ mg}/\text{L}$, Sigma-Aldrich, Germany). Petri plates were incubated at 20°C for 8 days. Colonies formed on the petri plate surface were visualized using a stereo microscope (Leica DMS1000, Germany). The study was conducted in six parallels and three repetitions (Römling & Rohde, 1999).

The pellicle forming properties of *S. Typhimurium* ATCC 14028

Wild-type and mutant strains of *S. Typhimurium* ATCC 14028 were inspected for their pellicle forming properties in the liquid-air interface. *Salmonella* strains were developed at 37°C for 18 hours at 200 rpm. $500 \mu\text{L}$ of active cultures were taken and inoculated into test tubes containing $4500 \mu\text{L}$ of salt-free LB medium. Tubes were photographed after 8 days of incubation in a 20°C static incubator. The results were evaluated according to the pellicle formation in the liquid-air surface and the amount of the decomposition of this pellicle. The pellicle was classified as fragile if it broke very easily, and as rigid if it did not break up or broke slightly (Römling et al. 2000; Solano et al. 2002).

Statistical Analysis

GraphPad Prism 8 Software was used to perform the necessary statistical analyzes for the data obtained from the study. In determining the differences between the experimental groups, the 'F' value was taken as the basis and one-way ANOVA test was applied. Variations between groups were evaluated using the Turkey accuracy test.

RESULTS

Biofilm production characteristics on a polystyrene surface

When the biofilm formation abilities of *S. Typhimurium* ATCC 14028 wild-type and mutant strains on polystyrene surfaces at 24., 48. and 72. hours were examined; Compared to the wild-type strain, at the rates of % 93,1, % 55,3 and % 68,6 respectively in *S. Typhimurium* ATCC 14028 $\Delta fimF$ strain and also at the rates of % 80,2, % 4,86 and % 13,6 in *S. Typhimurium* ATCC 14028 $\Delta fimF(pBADfimF^N)$ strain decreases were observed in these time periods (Figure 1).

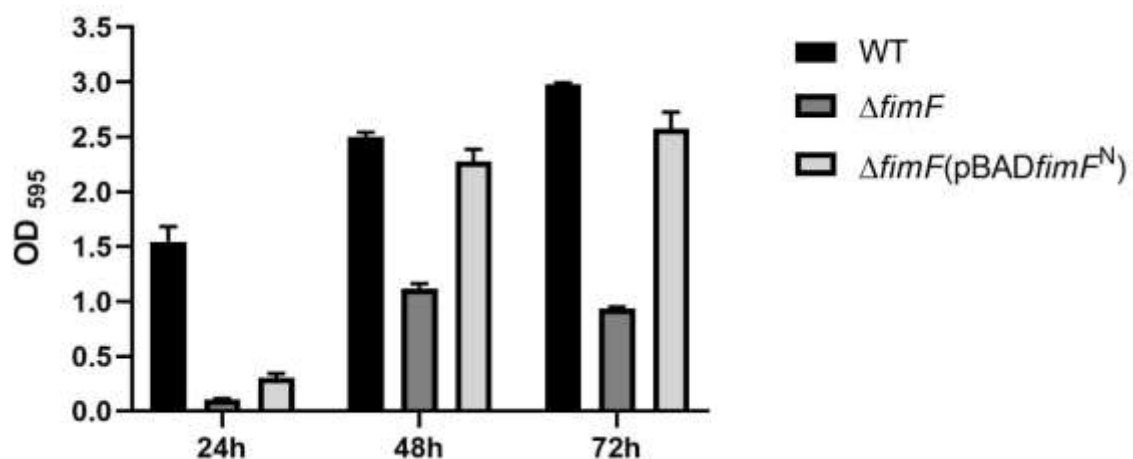

Figure 1. Biofilm production characteristics of wild-type and mutant strains of *S. Typhimurium* ATCC 14028 on polystyrene substrates.

Biofilm morphotypes produced on solid media with Congo Red

Biofilm morphotypes produced by *S. Typhimurium* wild-type and mutant strains on solid medium with Congo Red; biofilm EPS 'rdar' (red, dry and rough) with thin aggregative fimbriae (curli fimbriae) and cellulose, 'bdar' (brown, dry and rough) containing only curli fimbriae, 'pdar' (pink, dry and rough) containing only cellulose, 'saw' (smooth and wet) with neither curli fimbriae nor cellulose. The biofilm morphotype of *S. Typhimurium* wild-type strain was determined as 'rdar', *S. Typhimurium* $\Delta fimF$ 'bdar' and *S. Typhimurium* $\Delta fimF(pBADfimF^N)$ 'bdar' (Figure 2).

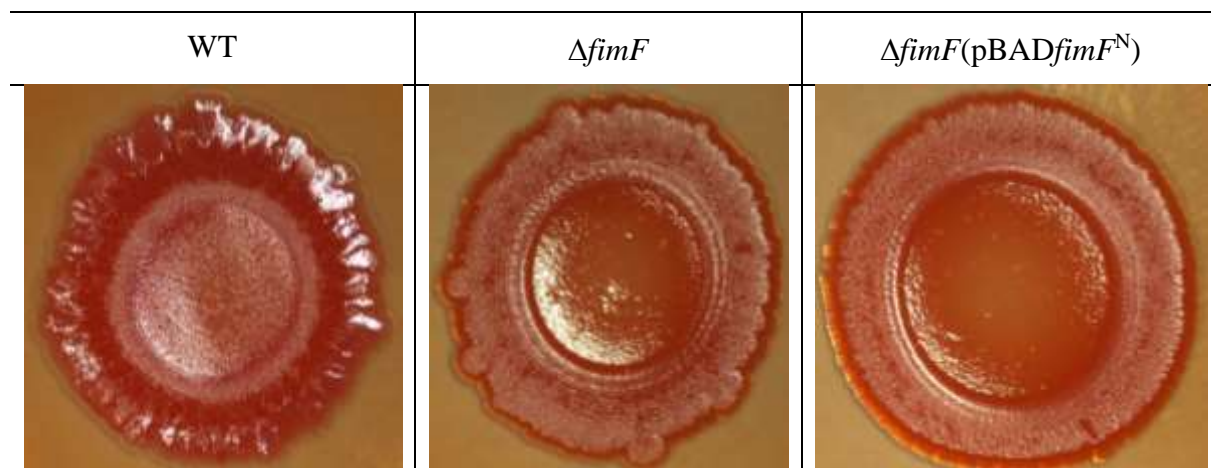

Figure 2. Stereo microscope image of biofilm morphotypes of *S. Typhimurium* ATCC 14028 wild-type and mutant strains formed on Congo Red agar surface

Amount of pellicle formation and characteristics of pellicle structures

S. Typhimurium wild-type and mutant strains were tested on salt-free LB medium with Congo red. As a result, the wild-type strain with the 'rdar' morphotype had a rigid pellicle structure, while $\Delta fimF$ (pBAD*fimF*^N) strain with the 'bdar' morphotype had a durable pellicle structure, although not as much as the wild-type strain; The $\Delta fimF$ strain with the 'bdar' morphotype was found to be vulnerable to physical factors such as pellicle structure, shaking and mixing (Figure 3).

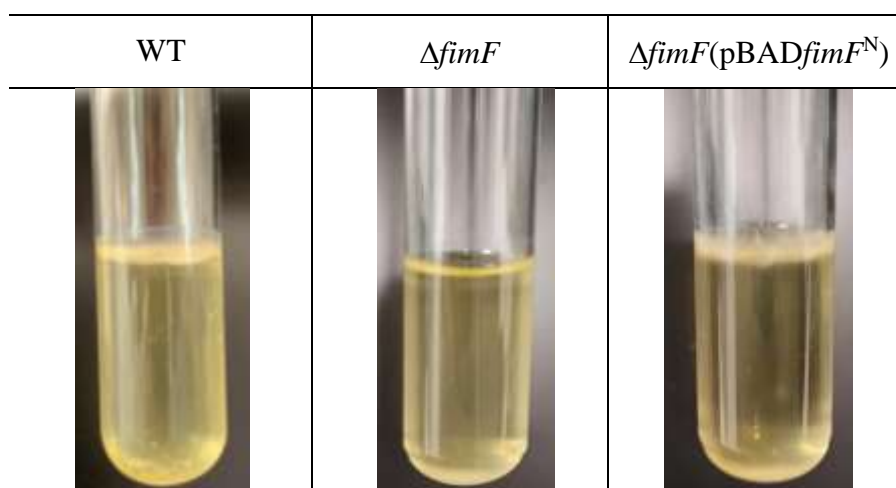

Figure 3. Amounts of pellicle formation of *S. Typhimurium* ATCC 14028 wild-type and mutant strains in salt-free LB medium

The observations made according to the turbidity change in the medium, the formation of pellicle and ring structure in the liquid-air interface, and the durability of the pellicle structure as a result of shaking and mixing are given in Table 1.

Table 1. Characteristics of pellicle structures formed by *S. Typhimurium* ATCC 14028 wild-type and mutant strains

Bacterial Cultures	Turbidity in the medium (turbidity)	The pellicle structure formed in the liquid-air interface	The ring structure formed in the liquid-air interface	Durability of the pellicle structure
Wild-type	More	Rigid	More	More (+)
$\Delta fimF$	Less	Fragile	Less	Less
$\Delta fimF$ (pBAD <i>fimF</i> ^N)	Less	Rigid	More	More

DISCUSSION

Type 1 fimbriae characterized by mannose-sensitive hemagglutination in *S. Typhimurium* are important for attachment to eukaryotic host cells. The type 1 fimbriae *fim* gene cluster

(*fimAICDHFZYW*) consists of six structural genes (*fimA*, *fimI*, *fimC*, *fimD*, *fimH* and *fimF*) and three regulatory genes (*fimZ*, *fimY* and *fimW*). The first condition for the biofilm formation process is the attachment of the microorganism to a suitable surface. *FimF*, a type 1 fimbriae gene, acts as an adapter in cell adhesion. *FimF*, which is one of the elements involved in the adhesion of planktonic cells to the surface in *S. Typhimurium*, has an important role in biofilm formation.

According to the results of our study, a statistically significant ($p < 0.05$) decrease was determined in the biofilm forming capacity of the mutant strain in terms of the *fimF* gene compared to the wild-type strain. As cellulose production in microorganisms increases, the biofilm structures (pellicle) formed in the liquid-air interface acquire robust physical property characteristics, which makes the pellicle structures stable against physical disintegrating forces. In Δ *fimF* and the N-terminal domain of the *fimF* gene showing the 'bdar' morphotype, while it was determined that cellulose production of Δ *fimF* strain was low, the pellicle structure of this strain was not resistant to physical dispersant, while a rigid pellicle structure was determined in the mutant strain obtained by cloning the N-terminal domain of the *fimF* gene, although not as much as in the wild-type.

In the lights of all these results, the N-terminal domain of the *S. Typhimurium fimF* gene was restored by cloning into the pBAD vector and re-expressed the biofilm phenotype at a statistically significant level ($p < 0.05$), although not as much as in the wild-type strain; This proves that the N-terminal domain of the gene in question is the region of the protein that carries the adapter function, thus proving that the *fimF* gene is a fimbrial gene that has an important role in biofilm formation in *S. Typhimurium*.

REFERENCES

- Althouse, C., Patterson, S., Fedorka-Cray, P., & Isaacson, R. E. 2003. Type 1 fimbriae of *Salmonella enterica* serovar Typhimurium bind to enterocytes and contribute to colonization of swine in vivo. *Infection and Immunity*, 71(11), 6446–6452.
- Bäumler, A. J., Tsolis, R. M., & Heffron, F. 1997. Fimbrial adhesins of *Salmonella typhimurium*. Role in bacterial interactions with epithelial cells. *Advances in Experimental Medicine and Biology*, 412, 149–158.
- Beachey, E.H. 1981. Bacterial Adherence: Adhesin Receptor Interaction Mediating the Attachment of Bacteria to Mucosal Surface. *The Journal of Infectious Diseases*, 143, 325-345.
- Boddicker, J. D., Ledebor, N. A., Jagnow, J., Jones, B. D., & Clegg, S. 2002. Differential binding to and biofilm formation on, HEp-2 cells by *Salmonella enterica* serovar Typhimurium is dependent upon allelic variation in the *fimH* gene of the *fim* gene cluster. *Molecular Microbiology*, 45(5), 1255–1265.
- Crump, J.A., Luby, S.P., Mintz, E.D. 2004. The global burden of typhoid fever. *Bull World Health Organ*. May;82(5):346-53.
- Gonzalez-Escobedo, G., & Gunn, J. S. 2013. Identification of *Salmonella enterica* serovar Typhimurium genes regulated during biofilm formation on cholesterol gallstone surfaces. *Infection and Immunity*, 81(10), 3770–3780.
- Kloppsteck, P., Hall, M., Hasegawa, Y., & Persson, K. 2016. Structure of the fimbrial protein Mfa4 from *Porphyromonas gingivalis* in its precursor form: implications for a donor-strand complementation mechanism. *Scientific reports*, 6, 22945.
- Korhonen, T.K., Lounatmaa, K., Ranta, H., Kuusi, N. 1980. Characterization of type 1 pili of *Salmonella typhimurium* LT2. *Journal of Bacteriology*, 144:800–805

- Rabin, N., Zheng, Y., Opoku-Temeng, C., Du, Y., Bonsu, E., & Sintim, H. O. 2015. Biofilm formation mechanisms and targets for developing antibiofilm agents. *Future Medicinal Chemistry*, 7(4), 493–512.
- Rehman, T., Yin, L., Latif, M. B., Chen, J., Wang, K., Geng, Y., Huang, X., Abaidullah, M., Guo, H., & Ouyang, P. 2019. Adhesive mechanism of different *Salmonella* fimbrial adhesins. *Microbial Pathogenesis*, 137, 103748.
- Roy, P. K., Ha, A. J., Mizan, M., Hossain, M. I., Ashrafudoulla, M., Tousehik, S. H., Nahar, S., Kim, Y. K., & Ha, S. D. 2021. Effects of environmental conditions (temperature, pH, and glucose) on biofilm formation of *Salmonella enterica* serotype Kentucky and virulence gene expression. *Poultry Science*, 100(7), 101209.
- Römling, U., & Rohde, M. 1999. Flagella modulate the multicellular behavior of *Salmonella typhimurium* on the community level. *FEMS microbiology letters*, 180(1), 91–102.
- Römling, U., Rohde, M., Olsén, A., Normark, S., & Reinköster, J. 2000. AgfD, the checkpoint of multicellular and aggregative behaviour in *Salmonella typhimurium* regulates at least two independent pathways. *Molecular microbiology*, 36(1), 10–23.
- Solano, C., García, B., Valle, J., Berasain, C., Ghigo, J. M., Gamazo, C., & Lasa, I. 2002. Genetic analysis of *Salmonella enteritidis* biofilm formation: critical role of cellulose. *Molecular microbiology*, 43(3), 793–808.
- Stepanović, S., Cirković, I., Ranin, L., & Svabić-Vlahović, M. 2004. Biofilm formation by *Salmonella* spp. and *Listeria monocytogenes* on plastic surface. *Letters in applied microbiology*, 38(5), 428–432.
- Su, L.H., Chiu, C.H. 2007. *Salmonella*: clinical importance and evolution of nomenclature. *Chang Gung Medical Journal*, May-Jun;30(3):210-9.
- Threlfall, E.J. 2002. Antimicrobial Drug Resistance in *Salmonella*: Problems and Perspectives in Food- and Water-Borne Infections. *Federation of European Microbiological Societies Microbiology Reviews*, 26, 141-148.
- Vestby, L. K., Møretrø, T., Langsrud, S., Heir, E., & Nesse, L. L. 2009. Biofilm forming abilities of *Salmonella* are correlated with persistence in fish meal- and feed factories. *BMC veterinary research*, 5, 20.
- Wagner, C., & Hensel, M. 2011. Adhesive mechanisms of *Salmonella enterica*. *Advances in Experimental Medicine and Biology*, 715, 17–34.
- Zeiner, S. A., Dwyer, B. E., & Clegg, S. 2012. FimA, FimF, and FimH are necessary for assembly of type 1 fimbriae on *Salmonella enterica* serovar Typhimurium. *Infection and Immunity*, 80(9), 3289–3296.

SYNTHETIC SOIL CONDITIONERS USED IN SOIL REMEDIATION: A REVIEW

¹Coşkun GÜLSER*²Füsun GÜLSER

¹Prof. Dr., Ondokuzmayıs University, Faculty of Agriculture, Soil Science & Plant Nutrition
Department, Samsun, Türkiye

Corresponding Author*: Prof. Dr. ¹Coşkun GÜLSER, e mail: cgulser@omu.edu.tr

²Prof. Dr., Van Yüzüncü Yıl University, Faculty of Agriculture, Soil Science & Plant Nutrition
Department, Van, Türkiye

ABSTRACT

Soil conditioning in agriculture refers to the formation and stabilization of aggregates that allow proper aeration and drainage in the root zone and can therefore increase crop yields. Soil conditioners are beneficial as they make the soil more functional as an ecosystem and more productive as a support for crop production. Soil conditioners create a suitable environment for the proliferation and survival of beneficial microorganisms and earthworms in the soil. Soil conditioners can be classified into four categories as organic, inorganic, synthetic and other soil conditioners according to their origin and composition. The new generation soil conditioners are highly cross-linked polyacrylamides in which 40% of the amides are hydrolyzed to carboxylic groups. The roots of the plant grow through the matrix of these hydrogelled particles and draw water from them as needed. Polysaccharides and polyacrylamides, which are among the synthetic soil conditioners, are generally used to improve aggregate stability and maintain productivity.

Key words: Soil, remediation, synthetic soil conditioner

INTRODUCTION

In our age, agricultural areas are getting narrower due to reasons such as wrong land cultivation, non-purpose land use, barrenness, not using the land in accordance with the land use capability class, erosion, soil pollution, as well as rapid industrialization and urbanization. Scarcity of water resources, desertification of soil and excessive use of fertilizers are the main factors that lead to the degradation of cultivated areas (Thakur et al., 2015). Soil conditioning in agriculture refers to the formation and stabilization of aggregates that allow proper aeration and drainage in the root zone and can therefore increase crop yields. Soil conditioners create a suitable environment for the proliferation and survival of beneficial microorganisms and earthworms in the soil. They also add nutrients to the soil, allowing plants to grow healthier, stronger and more productive. The new generation soil conditioners are highly cross-linked polyacrylamides in which 40% of the amides are hydrolyzed to carboxylic groups. These polymers do not interact directly with soil matrices, but form aqueous gels and act as water reservoirs for the plant-soil system. The roots of the plant grow through the matrix of these hydrogelled particles and draw water from them as needed (Quchi et al., 1989, Bouranis et al., 1995). Polysaccharides and polyacrylamides, which are among the synthetic soil conditioners, are generally used to improve aggregate stability and maintain productivity (De Boodt, 1975, Azzam, 1980, Wallace and Nelson, 1986). Polysaccharides (PSD), polyacrylamides (PAM), polyvinyl coride (PVC), polyphenol hydrochloride (PPH), hydrolyzed polyacrylonitrile (HPAN), Polyvinyl alcohol (PVA) and Vinyl acetate-maleic acid (VAMA) copolymers are used as synthetic soil conditioners.

EFFICIENCY OF SYNTHETIC SOIL CONDITIONERS ON SOIL AMELIORATION PROCESSES

Soil hydrogels consist of either natural sources containing the most common and degradable components such as polysaccharides (PS) and polypeptides (PP) or synthetic material containing petrochemical-based acrylic acid (AA), its salts and acrylamide (AM) (Zhou et al., 2018). Over the last two decades, synthetic hydrogels and the combination of natural and synthetic hydrogels have become increasingly important and have replaced traditional natural hydrogels (Behera and Mahanwar, 2020). Different soil hydrogels have varying degrees of these properties depending on the nature of the monomers used and the polymerization process. All soil hydrogels basically exhibit the following three properties: swelling, water absorbency and nutrient release (Palmqvist, 2017). The swelling property of superabsorbent hydrogels overcomes worldwide problems related to water consumption in agriculture, helps improve soil water retention and reduce plant wilting rate (Cheng et al., 2018). The swelling behavior of the superabsorbent hydrogel facilitates water absorption in sandy soils with low water retention capacity and allows the water content to settle in the plant slowly and for a long time (Ogieglo et al., 2015). Another marvelous property of the hydrogel, besides its swelling, is its water retention or water holding capacity, which is different in each soil type (Akhter et al., 2004).

Over the past few decades, various types of polysaccharide-based superabsorbent hydrogels have been proposed for agricultural applications due to their excellent hydrophilic properties (high swelling capacity and high swelling rate), excellent biocompatibility and biodegradability (Bhattacharyya, et al., 2013, Hemvichian, et al., 2014). The high water absorption of these materials is attributed to interconnected superporous structures of several hundred microns in diameter, forming open channels that allow capillary action (Kuang et al., (2011). The properties of superabsorbent hydrogels vary depending on the nature of their components, the polymerization process (grafting or cross-linking) and other parameters. The use of superabsorbent hydrogels in agriculture comparatively increases the swelling rate up to 60-80%, provides maximum water retention and provides gradual release of nutrients to plants for a longer period of time (Rizvan et al., 2021). Abd El-Rehim, et al., (2004) reported that the polyacrylamide (PAAm), and polyacrylate (PAAcK) hydrogels improve sandy soil properties because they often absorb and keep water one thousand times more than their own weight, reduce watering frequency of the plants, and enhance water retention in soil. On the other hand, when superabsorbent hydrogel is added to soil, it reduces irrigation water consumption and improves the physical properties of the soil (Hemvichian, et al., 2014, Özdemir et al., 2014). It was reported that polyvinyl alcohol (PVA), polyacrylamide (PAM) applications decreased the plasticity index and increased plastic limit values in surface soils samples with three different textures as clay, loam and sandy loam. Additionally these synthetic materials increased aggregate stability and decreased the dispersion ratio (Kassım and Özdemir, 2022, Özdemir and Civelek, 2023).

Yangyuoru et al. (2006) reported that water retention ability improved of the soils amended with the polymeric absorbents over the control. Superabsorbent hydrogel (SH) acts as a water reservoir and releases water into the soil or directly into the rhizosphere in a controlled manner. Therefore, the use of superabsorbent hydrogel in agriculture reduces the death rate of plants and increases crop production in arid zones (Zhong et al., 2012). According to Demitri et al. (2013), the main advantages of cellulose-based SH applied in arid and desert areas are that it can control the release of stored water as the soil dries, maintains soil moisture for a relatively long time, and provides better oxygen supply to plant roots by increasing the porosity of the soil. Parvathy and Jyothi (2014) investigated the effect of a superabsorbent hydrogel

based on saponified cassava starch-g-poly(acrylamide) on the physical-chemical and biological properties of soil.

As a result, they stated that the amount of moisture retained in the soil depends on the concentration of superabsorbent matrices, which provide better control of the release of adsorbed water. They also reported that these SHs are potential candidates to be applied as alternatives in combating global climate change, as they can improve soil properties in cases where moisture availability decreases. Many researchers (Mitchell 1986, Lentz and Sojka 1994, Sojka and Lentz 1996), have reported that adding high molecular weight anionic PAM to irrigation water at a very low concentration (at 2-10 g m⁻³ or 2-10 ppm) reduces soil runoff and increases water infiltration during the first few hours. Superabsorbent hydrogel plays an amazing role in preventing nutrient loss during intense runoff of rainwater from the upper surface of the soil because these superabsorbent hydrogels (SAHs) absorb water and swell to retain water for longer periods of time. SAHs facilitate the growth of plants with limited use of water and fertilizer. It also improves the health of the soil and makes it fertile in horticulture and drought areas. The major quantity of applied fertilizers, containing phosphates and nitrates, is lost during rainfall that definitely pollutes the environment and sea water (Sarkar et al., 2015). Soil hydrogels increase the availability of nutrients for plants, as they have a controlled slow release of nutrients at the required rate (Kaur and Purewal., 2019). Çağlar and Demir (2021) reported that the applications of polyacrylamide and polyvinylalcohol had a positive effect on the nitrogen, phosphorus and potassium uptake of the canola and jute plant species.

CONCLUSION

Soil hydrogels are widely used in agriculture as soil conditioners and plant growth promoters. Hydrogels are biodegradable, environmentally friendly, cost-effective, and increase nutrient availability through slow release of fertilizer. Due to their low cost, abundance, and environmentally friendly properties, polysaccharides have been shown to be able to replace petroleum derivatives in the preparation of superabsorbent hydrogels.

REFERENCES

- Abd El-Rehim, H. A., El-Sayed A. H., Abd El-Mohdy, H. L. 2004. Radiation Synthesis of Hydrogels to Enhance Sandy Soils Water Retention and Increase Plant Performance. Published online in Wiley Inter Science (www.interscience.wiley.com).
- Akhter J, Mahmood K, Malik KA, Mardan A, Ahmad M, Iqbal MM. 2004. Effects of hydrogel amendment on water storage of sandy loam and loam soils and seedling growth of barley, wheat and chickpea. *Plant, Soil Environ.* 2004;50 (10):463–9. doi: <https://doi.org/10.17221/4059-pse>.
- Azzam R. A. I. (1980). Agricultural polymers, Polycrylamide preparation, application and prospects in soil conditioning. *Comm. Soil Sci. Pl. Anal.* 11: 767–834.
- Behera S, Mahanwar PA. 2020. Superabsorbent polymers in agriculture and other applications: a review. *Polym Technol Mater*;59(4):341–56. doi:
- Bhattacharyya, R., S.K. Ray, B. Mandal, 2013. A systematic method of synthesizing composite superabsorbent hydrogels from crosslink copolymer for removal of textile dyes from water, *J. Indust. Eng. Chem.* 19 (4) (2013) 1191–1203
- Cheng D, Liu Y, Yang G, Zhang A. 2018. Water- and fertilizer-integrated hydrogel derived from the polymerization of acrylic acid and urea as a slow-release N fertilizer and water retention in agriculture. *J Agric Food Chem*;66 (23):5762–9. doi: <https://doi.org/10.1021/acs.jafc.8b00872>.

- Civelek, Z., Özdemir, N., 2021. The Effect of Organic Waste and Synthetic Conditioner Applications on Consistency Limits. *Toprak Su Dergisi*, 2021, 10 (2): (120-126).
- Çağlar, F.D., Demir, Y. 2021. Toprak Düzenleyicisi Bazı Polimerlerin (Poliakrilamid ve Polivinil Alkol) Kanola (*Barassica napus* L.) ve Jüt (*Corchorus olerius* L.) Bitkilerinin Besin Elementi Alımına Etkisi. *Türk Tarım ve Doğa Bilimleri Dergisi* 8(1): 8–16, 2021 <https://doi.org/10.30910/turkjans.762898>
- De Boodt M. (1975). Use of soil conditioners around the world. In *Soil Conditioners*. (B. A. Stewart, M. Stelly, R. C. Dinauer and J. M. Padrutt, ed.), pp. 1–12. Special Publ. Series, Madison, SSSA Soil Science Society of America Inc.
- Demitri, C., F. Scalera, M. Madaghiale, A. Sannino, A. Maffezzoli, 2013. Potential of cellulose-based superabsorbent hydrogels as water reservoir in agriculture, *Int. J. Polym. Sci.* 2013 (2013) 1–6.
- Hemvichian, K., A. Chanthawong, P. Suwanmala, 2014. Synthesis and characterization of superabsorbent polymer prepared by radiation-induced graft copolymerization of acrylamide onto carboxymethyl cellulose for controlled release of agrochemicals, *Radiat. Phys. Chem.* 103 (2014) 167–171. <https://doi.org/10.1080/25740881.2019.1647239>.
- Kassım, H., Özdemir, N., 2022. Polimer ve hümik asit uygulamalarının toprağın strüktürel gelişimi üzerine etkileri. *Toprak Bilimi ve Bitki Besleme Dergisi* 10(1) 19 - 28
- Kaur P, Purewal SS. 2019. Biofertilizers and their role in sustainable agriculture. Published online 2019:285–300. https://doi.org/10.1007/978-3-030-18933-4_12.
- Kuang, J., K.Y. Yuk, K.M. Huh, 2011. Polysaccharide-based superporous hydrogels with fast swelling and superabsorbent properties, *Carbohydr. Polym.* 83 (1) 284–290.
- Lentz, R. D., and Sojka, R. E. (1994). "Field results using polyacrylamide to manage furrow erosion and infiltration." *Soil Sci.*, 158(4), 274-282.
- Miller, W.P., Willis, R.L. and Levy, G.J., 1998. Aggregate stabilization in kaolinitic soils by low rates of anionic polyacrylamide. *Soil use and management*, 14(2), pp.101-105.
- Mitchell, A. R. (1986). "Polyacrylamide application in irrigation water to increase infiltration." *Soil Sci.*, 141(2), 353-358.
- Ogieglo W, Wormeester H, Eichhorn KJ, Wessling M, Benes NE 2015. In situ ellipsometry studies on swelling of thin polymer films: A review. *Prog Polym Sci* 42:42–78. doi: <https://doi.org/10.1016/j.progpolymsci.2014.09.00>
- Ouchi S., Nishikawa A. and Fujita F. (1989). Soil-improving effect of a super-water-absorbent polymer. I. Total volume, three-phase distribution, and available water of super-water-absorbent polymer mixed soils. *Jap. J. Soil Sci. Pl. Nutr.* 60: 15–21.
- Özdemir, N., Civelek, Z., 2023. Hümik asit ve polimer uygulamalarının kıvam limitleri üzerine etkileri. *Toprak Bilimi ve Bitki Besleme Dergisi* 11(1) 14 – 25.
- Özdemir, N., Gülser, C., Ekberli, İ., Kop, Ö.T. 2014. Asit toprakta düzenleyici uygulamalarının bazı toprak özellikleri ve verime etkileri. *Toprak Bilimi ve Bitki Besleme Dergisi* 2 (1) 27 – 32.
- Palmqvist NGM. 2017. Nanoparticles: case studies of their synthesis, properties and biological interaction.; 2017. https://pub.epsilon.slu.se/14677/7/palmqvist_m_171101.pdf
- Parvathy, P.C., Jyothi, A.N. 2014. Rheological and thermal properties of saponified cassava starch-g-poly(acrylamide) superabsorbent polymers varying in grafting parameters and absorbency, *J. Appl. Polym. Sci.* 131 (11) (2014) 40368–40379.
- Rizwan, M, Gilani, S.R., Durani, A.I., Naseem, S., 2021. Materials diversity of hydrogel: Synthesis, polymerization process and soil conditioning properties in agricultural field. *Journal of Advanced Research* 33 (2021) 15–40

- Sarkar S, Datta SC, Biswas DR. 2015. Effect of fertilizer loaded nanoclay/superabsorbent polymer composites on nitrogen and phosphorus release in soil. *Proc Natl Acad Sci India Sect B- Biol Sci* 2015;85(2):415–21.
<https://doi.org/10.1007/s40011-014-0371-2>.
- Seddik, W., Osman, M.A. and Kenawy, M.H., 2019. Physico-Chemical Behavior of Natural Minerals along with Synthetic Soil Conditioners on Nutritional Status and Yield Productivity. *Journal of Soil Sciences and Agricultural Engineering*, 10(7), pp.397-403.
- Sojka, R. E., and Lentz, R. D. (1996). "Polyacrylamide for furrowirrigation erosion control." *Irrig. J.*, 64(1), 8-11.
- V.K. Thakur, M.K. Thakur, 2015. Recent advances in green hydrogels from lignin: a review, *Int. J. Biol. Macromol.* 72 834–847.
- Wallace A, and Nelson S. D. (1986). Foreword (special issue on soil conditioners) *Soil Sci.* 141: 311–312.
- Yangyuoru, M., Boateng, E., Adiku, S.G.K., Acquah, D., Adjadeh, T.A., Mawunya ,F. 2006. Effects of Natural and Synthetic Soil Conditioners on Soil Moisture Retention and Maize Yield West Africa *Journal of Applied Ecology (WAJAE)* –ISSN: 0855-4307 Volume 9 (Jan – Jun 2006) www.wajae.org.
- Zhong, K., X.-L. Zheng, X.-Y. Mao, Z.-T. Lin, G.-B. Jiang, 2012. Sugarcane bagasse derivative-based superabsorbent containing phosphate rock with water– fertilizer integration, *Carbohydr. Polym.* 90 (2) (2012) 820–826.
- Zhou T, Wang Y, Huang S, Zhao Y. 2018. Synthesis composite hydrogels from inorganic-organic hybrids based on leaf cover rice for environment-friendly controlled-release urea fertilizers. *Sci Total Environ*; 615:422–30.
<https://doi.org/10.1016/j.scitotenv.2017.09.084>.

CHANGES IN THE SOIL PROPERTIES OF AGRICULTURAL LANDS AROUND ORGANIZED INDUSTRIAL ZONE CAUSED BY INDUSTRY IN VAN, TÜRKİYE

*Prof. Dr. Füsün GÜLSER**, *Dr. Öğretim Üyesi Siyami KARACA*, *Araş. Gör. Bulut SARGİN*

Van Yüzüncü Yıl University, Faculty of Agriculture, Department of Soil Science and Plant Nutrition, Van/Turkey

Corresponding author: Prof. Dr. Füsün GÜLSER* e-mail:fgulser@yyu.edu.tr*

ABSTRACT

In this study, it was aimed to investigate some properties of the soils around the Van organized industrial zone. Different six sampling points within each direction were determined in the north, south, and east directions of industrial zone. The total set of 54 soil samples were taking from 0-20 cm depth in different three positions as 0.2 km, 1.0 km and 2.0 km far away to pollutant source. GPS readings were recorded for each sampling points. Generally, electrical conductivity (EC) and lime (CaCO₃) content means decreased while the distance to industrial zone increased in soils. In soil samples the highest pH, EC and lime content means as 9.19, 326.70 $\mu\text{mhos cm}^{-1}$ and 42.34 % in 0.2 km far away to industrial zone; the lowest means of these parameters in 2.0 km far away to pollutant source were obtained. Van Organized Industrial Zone operates in the paint production, tile adhesive and joint filler, packaging cardboard and bag manufacturing, vehicle plate manufacturing, PVC and drilling pipes, styrofoam and thermal insulation materials manufacturing/foam packaging manufacturing, food, electricity, marble processing, facade cladding, textile clothing, detergent and cosmetic products, construction, petroleum products, paper and napkin production, furniture, metal, automotive, cable and plastic production sectors. It is thought that the waste materials released to the environment from these industrial activities cause changes in the soil properties studied.

Key words: Industry, soil reaction, soil electrical conductivity, lime content

INTRODUCTION

After the Industrial Revolution, depletion of natural resources, carbon emissions, pollution and human health problems have become threats worldwide. The developing world generally appears to have high levels of polluting activities in the industrial sector. Nowadays, problems related to industrialization such as increasing greenhouse gas emissions, air and water pollution, increasing waste volumes, desertification and soil chemical or heavy metal pollution are increasing. Diffuse pollution is a significant threat to soil conservation, and this is much more pronounced in urban communities with multiple emissions sources (Biasoli and Ajmone-Marsan, 2007). Depending on the properties of the soil, chemicals emitted can either react with other soil factors, be absorbed by soil substances, or mix directly with groundwater, causing other types of pollution. Due to the behavior of these chemicals in the soil, it is very difficult to determine their fate in the soil. With the onset of widespread chemical degradation, some soil functions are inhibited. The most important of these functions are the buffering, filtering and transformation capacity of the soil (EEA, 2014). With the loss or inhibition of these functions, the soil loses its capacity to remove harmful chemicals or reduce their impact on crop growth and yield (Halm and Grathwohl, 2005).

MATERIAL AND METHOD

The research was carried out in a location with the coordinates of 38° 33' north and longitude 43° 17' east (Figure 1). The research area is located within the continental climate zone (Anonymous, 2019). Van Organized Industrial Zone operates in the paint production, tile adhesive and joint filler, packaging cardboard and bag manufacturing, vehicle plate manufacturing, PVC and drilling pipes, styrofoam and thermal insulation materials manufacturing/foam packaging manufacturing, food, electricity, marble processing, facade cladding, textile clothing, detergent and cosmetic products, construction, petroleum products, paper and napkin production, furniture, metal, automotive, cable and plastic production sectors.

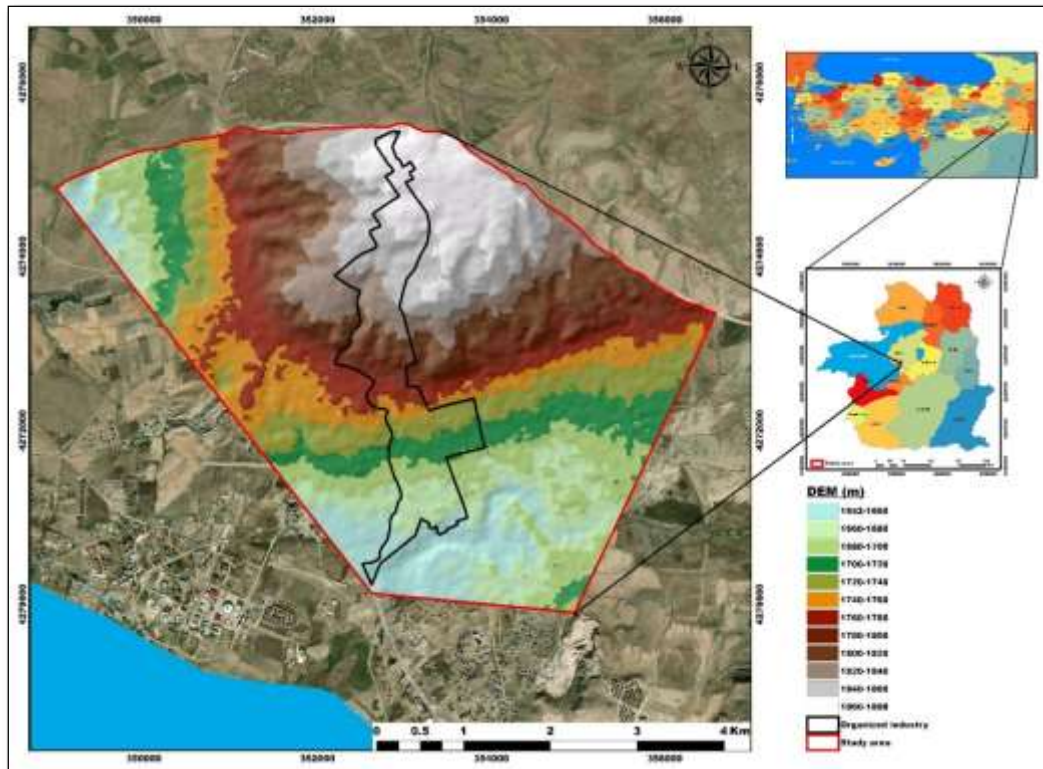

Figure 1. The study area.

Different six sampling points within each direction were determined in north, south and east directions of industrial zone. The total set of 54 soil samples were taking from 0-20 cm depth in different three positions as 0.2 km, 1.0 km and 2.0 km far away to pollutant source. GPS readings were recorded for each sampling points (Figure 2)



Figure 2. Locations where soil samples were taken in the study area.

Some chemical properties of soil samples taken from 0-20 cm depth were determined as follows; soil reaction in 1:2.5 (W:V) soil:water suspension by meter and soil salinity by EC meter, in the same suspension (Black,1965), lime content by Scheibler calcimeter (Goh et al.,1993). SAS package program was used for statistical analysis (SAS, 1998).

RESULTS AND DISCUSSION

According to variance analyzes results, effects of distance to pollutant source were found significant for electrical conductivity (EC) means and lime (CaCO_3) contents at 1% significance level in east direction of organized industrial zone. The lime contents were also significantly (5%) affected by distances to the pollutant source in south direction of organized industrial zone. The effect of distance on all of investigated soil chemical properties was non significant in west direction of organized industrial zone. The changes in pH means were not found significant in all directions statistically. (Table1).

Table1. The results of variance analyses results of some chemical properties of soil samples taken from different distance and direction to organized industrial zone.

Directions				
	Df	CaCO ₃	EC	pH
East	F	23.54**	10.35**	1.21 ns
West	F	2.18 ns	1.06 ns	1.33 ns
South	F	4.44*	0.37 ns	0.33 ns

Generally, electrical conductivity and lime content means decreased while the distance to industrial zone increased in soils. As that seen in Figure 3,4,5 the highest EC and CaCO₃ means were obtained in 0.2 km far away from pollutant source as 8.47, 138.34 $\mu\text{mhos cm}^{-1}$ and 26.90 % respectively for east direction. The lowest means of these parameters were 8.37, 106.91 $\mu\text{mhos cm}^{-1}$ and 8.06 % respectively in 2.0 km far away from pollutant source. For south direction the highest pH, EC and CaCO₃ means were obtained as 8.51, 151.55 $\mu\text{mhos cm}^{-1}$ and 17.67 % in 0.2 km far away from pollutant source while the lowest means of, EC and CaCO₃ were 8.44, 131.24 $\mu\text{mhos cm}^{-1}$ and 8.07 % in 2.0 km far away from pollutant source (Figure 3,4,5). In soil samples taken from the west direction, as the distance to the industrial zone increased, the decreases in the pH, EC and CaCO₃ means occurred in a very narrow range as following 8.53-8.31, 177.55 $\mu\text{mhos cm}^{-1}$ – 202.120 $\mu\text{mhos cm}^{-1}$ and 13.42 % -16.67 %.

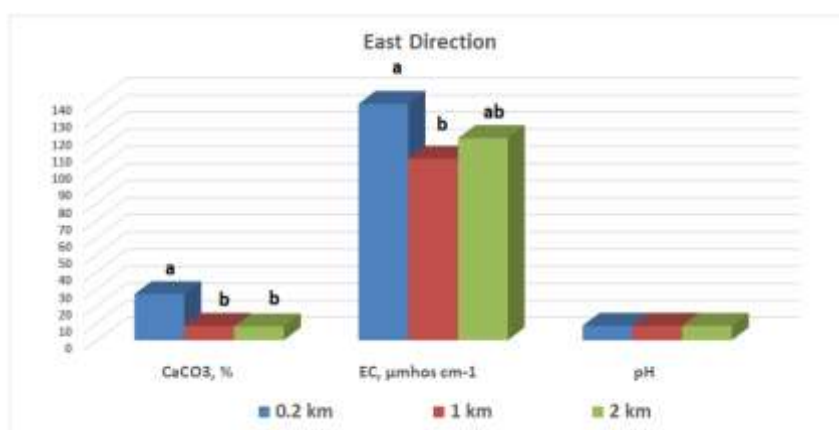

Figure 3. The changes in pH, EC and CaCO₃ means depending on distance in the east direction.

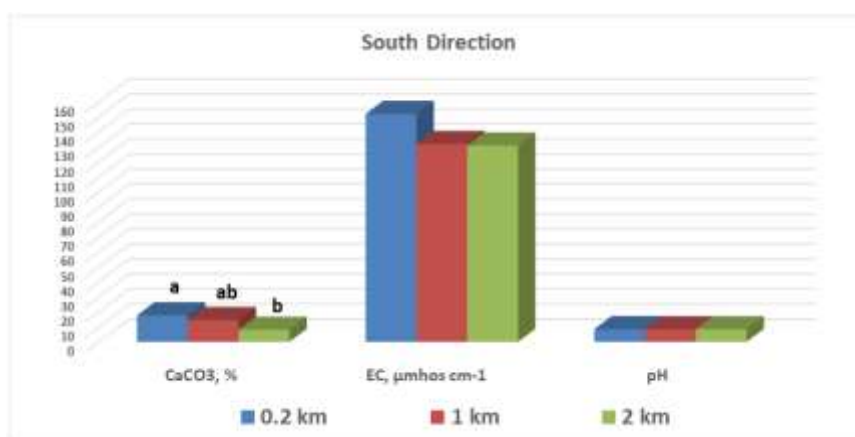

Figure 4. The changes in pH, EC and CaCO₃ means depending on distance in the south direction.



Figure 5. The changes in pH, EC and CaCO₃ means depending on distance in the west direction.

When taking into account analyses results soil it was determined that pH, EC and CaCO₃ means of soil samples taken from away to 0.2 km were higher than those taking from more far away distances to organized industrial zone. Although the pH means (for east, south and west directions: 8.47, 8.51 and 8.53) were found to be higher at a distance of 0.2 km from the zone, they were considered slightly alkaline according to the reported limit value. Similarly, higher EC means (for east, south and west directions: 138 µmhos cm⁻¹, 151 µmhos cm⁻¹ and 202 µmhos cm⁻¹) closer to the source were also considered nonsaline according to the reported limit values (Müftüoğlu et al., 2014). In this study CaCO₃ means (for east, south and west directions: 26.90%, 17.67% and 16.67%) of soil samples taken from away to 0.2 km to organized industrial zone were found in high level according to reported limit values.

In this study, it is thought that the very high CaCO₃ values found in the agricultural lands close to the organized industrial zone are caused by industrial activities such as marble processing, construction, food detergent and cosmetic products. It is known that high CaCO₃ in soil reduces the availability of plant nutrients (Marschner, 1995).

It was reported that since many agricultural sustainability issues are related to soil quality, its assessment is very important. Thus, its assessment and the direction of change with time is a primary indice of whether agriculture is sustainable. (Karlen et al., 1997; Mastro et al., 2007; Glanz, 1995). Rojas (2018) reported that pH, EC and CaCO₃ parameters are among the chemical soil quality indexes. A further increase in the lime level in the research area of the Van Lake basin soil, which is reported as calcareous (Gülser and Karaçal, 1992), will create problems in terms of the sustainability of plant production.

CONCLUSIONS

In our study, it was concluded that wastes should be disposed of in a controlled manner to ensure sustainability in the lands around the industrial zone and to protect soil health and quality. In addition, the results of this research are considered as stimulating and guiding for the industrial branches in the research area to operate within the framework of solid waste regulations that can prevent environmental pollution.

REFERENCES

Anonymous, 2019. Ministry of Agriculture and Forestry, General Directorate of Meteorology <https://www.mgm.gov.tr/>.

- Biasioli, M., Ajmone-Marsan, F. 2007. Organic and inorganic diffuse contamination in urban soils: the case of Torino (Italy). *Journal of Environmental Monitoring*, 9(8), 862-868.
- Black, C.A., 1965. *Methods of Soil Analysis: Part I, Physical and Mineralogical Properties*. American Society of Agronomy, Madison, Wisconsin.
- European Environment Agency (EEA) (2014). Soil degradation. Accessed [20/11/2014]. Available at: www.eea.europa.eu/publications/92-9157-202-0/page306.html.
- Glanz, A.A., 1995. *Saving our soil: solutions for sustaining Earth's vital resource*. Johnson Books, Boulder, Colorado, USA.
- Goh T.B., Arnaud R.J.St., Mermut A.R., 1993. Aggregate stability to water. In: *Soil sampling and methods of analysis* (Cartner M.R., ed). Canadian Society of Soil Science. Lewis Publ, Boca Raton, Canada. pp. 177-180.
- Gülser, F., Karaçal, İ. 1992. Gülser, F. 1992. Van Gölü Havzası Büyük Toprak Gruplarının Verimlilik Durumları, Yüksek Lisans Tezi. Yüzüncü Yıl Üniversitesi, Fen Bilimleri Enstitüsü, Van.
- Halm D, Grathwohl P 2005. Integrated Soil and Water protection against diffuse pollution. *Geophys. Res.* 7:05086.
- Karlen, D. L., Mausbach, M. J., Doran, J. W., Cline, R. G., Harris, R. F., Schuman, G. E. 1997. Soil quality: a concept, definition, and framework for evaluation (a guest editorial). *Soil Science Society of America Journal*, 61(1), 4-10.
- Marschner, H. 1995. *Mineral Nutrition of Higher Plants*. Academic Press, San Diego, CA, USA.
- Masto, R.E.; Chhonkar, P.K.; Singh, D.; Patra, A.K., 2007. Soil quality response to long-term nutrient and crop management on a semi-arid Inceptisol. *Agric. Ecosyst. Environ.*, 118, 130–142.
- Müftüoğlu, N. M., Türkmen, C., Çıkılı, Y. 2014. *Fertility analysis of soil and plants*. Nobel Academic Publishing.
- Rojas, M.M., 2018. Soil quality indicators: critical tools in ecosystem restoration. *Current Opinion in Environmental Science Health* 2018, 5:47–52. <https://doi.org/10.1016/j.coesh.2018.04.007>
- SAS 1998. *Lecture Notes in Computer Science* 1503, Springer 1998, ISBN 3-540-65014

EFFECTS OF CYCOCEL (CCC) DOSES AND APPLICATION STAGES ON SEED YIELD AND YIELD COMPONENTS OF MUNG BEAN (*Vigna radiata* (L.) Wilczek)

Aybegün TON^{1,*}

¹ Cukurova University, Agriculture Faculty, Field Crops Department, Adana, Turkey

*Corresponding author e-mail: aybeguntoncu@gmail.com

ABSTRACT

The aim of this study was to reveal the effects of different cycocel doses and application stages on seed yield and yield components in mung beans. The field experiment was conducted in Adana, Turkey during summer season of 2020 and 2021. Experimental design was split plots based on randomized complete blocks with three replication. The main plots were application stages (seedling and beginning of flowering) and sub-plots were cycocel doses (0, 500, 750, 1000 ppm). In present study, KPS1 exotic genotype was used as a research material. As mean of the years the highest pods per plant, branches per plant, seed weight per plant were observed at 1000 ppm CCC. Cycocel application reduced the plant height and the first podding height. According to combined analysis, greatest seed yield was produced by cycocel application of 1000 ppm with 2530 kg ha⁻¹ at seedling stage while minimum seed yield was found in control dose (no cycocel) at seedling stage with 1944 kg ha⁻¹.

Keywords: Application Stages, Cycocel, Mung bean, Seed yield, Yield components

INTRODUCTION

Mung bean (*Vigna radiata* L.) Wilczek) can be grown arid and semi-arid region at the world. Its seeds contain high protein, carbohydrates and vitamins and its cultivation is widely in Avustralia, Asia, Africa and America (Li et al., 2010; Singh et al., 2013; Dahiya et al., 2015; Abdul Rahman, 2018). Seeds of mung bean can be evaluated as a feed for livestock and food for human and green manure in the world (Azadi et al., 2013; Nair et al., 2013). Consumption of mungbean is gradually increasing at the world. Mungbean cultivation is not spreading in Turkey, but of landraces of mungbean genotypes are grown in some regions of Turkey (Akdağ, 1995; Dalkılıç, 2010) and it can be successfully produced for seed in Turkey (Pekşen et al., 2015; Karaman, 2019; Ton, 2021).

Plant growth regulators are natural or synthetic compounds and they are important for increasing seed yield and quality in legumes as in other crops (Kumar, 2021) Cycocel is retarding the plant growth and it is used to prevent lodging in cereals (Kumlay and Eryiğit, 2011). The effect of cycocel application was investigated in some crops, but there are limited studies on the use of growth retards in legumes. It is reported that maximum dry matter in chickpea was obtained from cycocel application of 2000 ppm (Verma et al., 2018). Some studies on various legume crops showed that cycocel application increased some morphological and agronomical traits compared to control in pea (Alan, 1990), in faba bean (Beşer and Adak, 1999), in chickpea (Hajyzadeh, 2008) and in mung bean (Kshirsagar et al., 2008). Güler (2010) reported that the greatest seed yield in chickpea was obtained from 1000 ppm cycocel dose applied in the beginning of flowering. Bora and Sarma (2006) reported that cycocel increased the seed yield and protein content in pea. The studies on mung bean showed that application of cycocel and some plant growth retards improved seed yield and yield components in comparison to control. (Bhadane et al., 2020). Some plant growth regulators and cycocel

inhibites flower shedding, so it can be increased yield in mung bean (Khwaitrakpam and Kumar, 2019a).

The aim of this study was to reveal the effects of different cycocel doses and applications stages on seed yield and yield components.

MATERIALS AND METHODS

The field experiment was conducted at the research area of Field Crops Department, Faculty of Agriculture, University of Çukurova, Adana, Turkey during summer season of 2020 and 2021. Some meteorological values of Adana for experimental years are present in Table1. Table 1. Some meteorological values in the experimental years

Meterological Parameters	Min Temperature (°C)		Max Temperature (°C)		Mean Temperature (°C)		Relatively Humidity (%)		Total Rainfall (mm)	
	2020	2021	2020	2021	2020	2021	2020	2021	2020	2021
Years Months										
May	12.9	14.9	40.3	34.0	23.3	23.9	61.0	64.9	66.6	4.1
June	16.4	18.9	39.5	37.7	25.0	25.9	70.9	67.2	38.2	0.4
July	22.9	23.8	37.6	41.0	29.4	30.0	74.3	68.0	0.0	15.8
August	21.7	22.7	41.3	39.8	29.7	30.5	65.9	64.1	1.2	1.2

The texture of experiment soil was silty-clay loam. The values of pH, salt content, lime and organic matter were 7.25, 0.25 mmhos cm⁻¹, 36.8%, 1.19% respectively. In present study KPS1 exotic genotype provided from Field Crop Department, Faculty of Agriculture, University of Ondokuz Mayıs was used as a research material. This variety showed a good adaptation in the previous experiments conducted in Çukurova conditions. The study was organized in split plots experimental design over randomized complete blocks (RCBD) with three replications. The main plots were application stages (seedling and beginning of flowering) and sub-plots were cycocel (chlormequat chloride 460 g/lit) doses (0, 500, 750, 1000 ppm). The experiment was established on 2th of June in 2020 and 24th of May in 2021. Each plot was sown in 5 rows of 4m length with an inter row spacing of 45 cm and intra row spacing of 5 cm. Fertilizer was applied at a rate of 40 kg N ha⁻¹, 100 kg P₂O₅ ha⁻¹ before sowing. Rhizobia inoculant was not applied in the experiment. Insufficient nodule formation was observed in the root, hence addition nitrogen fertilizer (Ammonium sulphate, 21% N) was also applied 80 kg N ha⁻¹ to plots at seedling stage of plant. The plots was irrigated 4 times during growing period in germination, before flowering and pod stages in both of the years. Harvest was applied in the middle of three rows after eliminating the border rows on September 12, 2020 and August 31, 2021. Net plot area was 3 m x1.35 m=4.05 m². Data were recorded from five randomly selected plant in each plot. Plant height (cm), number of main branches per plant, number of pods per plant, number of seed per pod, 100-seed weight (g), seed weight per plant,(g), seed yield (kg ha⁻¹) were observed.

Data were analyzed according to the split plots experiment design for combined years by using the MSTAT-C a computer software package. Comparisons among the means were made by using LSD (5%).

RESULTS AND DISCUSSION

Plant height

As shown in Table 2, as mean of the years, differences among the application stages were not significant, but plant height was significantly affected by cycocel doses. Plant height varied from 62.4 (1000 ppm) to 74.8 cm (no cycocel). Increasing cycocel doses led to decrease in plant height. Similarly, previous studies recorded that cycocel application reduced plant height in mung bean (Kshirsagar et al., 2008) in chickpea (Güler, 2010). Cycocel application of 500 ppm in faba bean and 300 ppm in chickpea at three leaves stage reduced plant height (Beşer and Adak, 1999; Haiyzadeh, 2008)

Statistical analysis revealed that year x application stage and year x cycocel dose interactions were no significant effect on plant height. Plant height was also not affected by interaction between cycocel dose and application stage. Plant height was significantly higher in 2020 (73.6 cm) due to greater precipitation and relatively humidity and lower temperature in the vegetative stage (June) compared to 2021 (64.1 cm).

Table 2. The effects of cycocel doses and application stages on plant height first podding height and branches per plant in mung bean

Treatments	Plant Height (cm)			First Podding Height (cm)			Main Branches per plant		
	2020	2021	Mean	2020	2021	Mean	2020	2021	Mean
Stages (S)									
1	74.9	63.9	69.4	41.6	24.7	33.2	3.2	2.7	2.9
2	72.3	64.3	68.3	35.0	28.6	31.9	3.2	2.7	2.9
LSD 5%	YXS: N.S.		N.S	YXS: N.S.		N.S	YXS: N.S		N.S
Doses (D)									
ppm									
0	78.6	71.1	74.8a	42.5	30.0	36.3a	3.1	2.5	2.8b
500	77.0	64.5	70.8ab	38.8	27.7	33.3ab	2.9	2.8	2.9b
750	73.2	61.5	67.3b	36.1	23.2	29.6c	2.9	2.5	2.7b
1000	65.6	59.3	62.4c	35.8	25.8	30.8bc	3.8	3.1	3.4a
Mean	73.6A	64.1B	68.8	38.3A	26.7B	32.5	3.2A	2.7B	2.9
LSD 5%	YXD:N.S.		D:4.85	YxD:N.S.		D:3.29	YXD:N.S.		0.38
CV %	8.3			12			15		

1: Seedling 2: Beginning of flowering

First Podding height

According to mean of the years, application stages didn't affected the first podding height (Table 2). However, effect of cycocel doses was significant on this trait. Increasing cycocel doses reduced the first podding height due to decreasing in plant height. The highest value was obtained from control dose (no cycocel) with 36.3 cm whereas the lowest value was found at cycocel dose of 750 ppm with 29.6 cm These results are in line with report of Beşer and Adak (1999) who recorded that 500 ppm cycocel dose at pods formation reduced first podding height in faba bean. Statistical analysis exhibited that there are no significant interactions of year x stages and year x doses. First podding height was higher in the first experimental year (38.3 cm) due to plant height than in the second experimental year (26.7 cm).

Number of main branches per plant

Combined mean showed that branches per plant was not significantly influenced by application stages, but there were significant differences among the cycocel doses in the branches per plant (Table 2). According to mean of the years, branches per plant ranged between 2.8 (0 ppm)-3.4 (1000 ppm) in different cycocel doses. There were no differences among the cycocel doses up to 750 ppm. However, main branches number were improved by application of 1000 ppm cycocel. It is also reported that branches per plant in pea increased with cycocel application (Bora and Sarma, 2006). On the other hand interactions of year x application stages, year x cycocel doses and of application stages x cycocel doses were non-significant for this trait. Main branches per plant in the first year was greater than in interaction was non-significant the second year as in plant height.

Number of pods per plant

As mean of the years, differences among the applications stages were non-significant for pods per plant, but the pods per plant were affected by interaction of year and application stages (Table 3). Pods per plant obtained from cycocel applications at flowering stage were greater in 2020 (34.2) than 2021 (21.8). In mean of years pods per plant was affected by cycocel doses and increase in cycocel doses significantly increased pods per plant and the highest value was achieved by 1000 ppm doses with 33.6 while the lowest value was at control doses with 22.6. Interaction between year and cycocel doses was also significant for pods per plant. The highest value was obtained from 1000 ppm (40.2) in 2020 while the lowest value was found at doses of 0 ppm in 2021 (21.9). Similar to our findings some studies reported that cycocel application increased pods per plant compared to control in mung bean (Bhadane et al., 2020; Khwairakpam and Kumar, 2019b). However, contrary to our findings Güler (2010) reported that the highest pods per plant was obtained from at beginning of flowering in no cycocel application in chickpea. Pods per plant in the first year which is lower temperature and rainfall during the flowering period (July) was greater than in the second year. It was also reported by Warrag and Hall (1984) who more pods per plant was obtained in cowpea at 27/19 °C than at 33/19 °C day/ night air temperature.

Number of seeds per pod

Seeds per pod were not affected by application stages in mean of years (Table 3). However year x stage interaction were significant found for this trait. The highest value was obtained from seedling stage in 2021 while the lowest value was observed in both of applications stages in 2020. Effects of cycocel doses on seeds per pod were significant in mean of the years. Control application (no cycocel) produced minimum seeds per pod (9.1) while maximum value was found in 750 ppm dose (9.8). Nevertheless differences among the other cycocel doses except in control were non-significant for seeds per pod. Interaction of year x cycocel dose was not significant. Seeds per pod in the second year (10.5) were significantly greater compared to the first year (8.6). Increase in pods per plant led to decreasing seeds per pod in the first year. Razzaque et al. (2015) reported that increasing pods per plant decreased the seeds per pod because assimilation used during seed filling is limited.

Seed weight per plant

According to mean of years, significant differences among the stage applications were not observed in seed weight per plant (Table 3). Interaction between year and application stage was significant for this trait. The highest value was achieved by cycocel application at beginning of flowering stage with 14.7 g in 2020. Seed weight per plant was significantly affected by year x dose interaction. Increase in cycocel doses increased the seed weight per plant in 2020 and the highest value was obtained from doses of 1000 ppm. In 2021, the seed weight per plant increased up to 500 ppm and then decreased in higher cycocel doses. As mean of the years,

1000 ppm cycocel dose produced maximum seed weight per plant (15.9 g) while lowest value was obtained from control dose. Similarly, Khwairakpam and Kumar et al. (2019b) recorded that cycocel application improved seed yield per plant in mung bean. Similarly, Bhadane et al. (2020) reported that cycocel application improved seed yield per plant in mung bean. Application stage x dose interaction and differences among the years were not significant.

Table 3. The effects of cycocel doses and application stages on pods per plant, seeds per pod and seed weight per plant in mung bean

Treatments	Pods Per Plant			Seeds Per Pod			Seed Weight Per Plant (g)		
	2020	2021	Mean	2020	2021	Mean	2020	2021	Mean
Stages (S)									
1	26.3b	26.6b	26.4	8.5c	10.7a	9.6	12.1b	14.5a	13.3
2	34.2a	21.8b	27.9	8.7c	10.3b	9.5	14.7a	13.7ab	14.2
LSD 5%	YXS: 6.82		N.S.	YXS: 0.29		N.S.	YXS: 1.89		N.S.
Doses (D)									
0	23.2cd	21.9d	22.6c	8.1	10.1	9.1b	10.6d	13.7bc	12.2b
500	27.1bc	24.1cd	25.6bc	8.6	10.6	9.6a	11.8cd	15.2b	13.5b
750	30.4b	23.8cd	27.1b	8.7	10.7	9.8a	12.7bcd	14.2bc	13.5b
1000	40.2a	26.9bc	33.6a	8.9	10.4	9.7a	18.4a	13.4bcd	15.9a
Mean	30.2A	24.2B	27.2	8.6B	10.5A	9.5	13.3	14.1	13.8
LSD 5%	YXD:4.53		3.21	YXD:N.S.		0.5	YXD:2.93		2.1
CV %	13			6.5			17.8		

1: Seedling 2: Beginning of flowering

100-seed weight

Application stages had no influence on 100-seed weight in mean of years. Effect of year x application stage interaction was also not significant (Table 4). The effect of cycocel doses on 100-seed weight was significant. The highest value was observed in 500 ppm (7.22 g) and thereafter decreased in increased dose. However, differences between control and cycocel doses up to 1000 ppm were non-significant. The lowest value was obtained from 1000 ppm of cycocel. Bhadane et al. (2020) reported that cycocel application improved 100 seed weight in mung bean. Combined analysis showed that year x dose and stage x dose interactions were found insignificant. 100-seed weight in the first year (7.35 g) was greater than the second year (6.48 g). The increase in 100 seed weight in the first year may be due to the decrease of in the seeds per pod.

Seed yield

Application stages and cycocel doses had insignificant effect on seed yield mean of the years (Table 4). Year x stage interaction was also no significant. Mean of the years showed seed yield varied from 2096 (no cycocel) to 2330 kg ha (750 ppm). Seed yield in the first year (1912 kg ha⁻¹) which is higher plant height, lower seeds per pod and later maturation was significantly less compared to second year (2511 kg ha⁻¹).

Table 4. The effects of cycocel doses and application stages on 100-seed weight and seed yield in mung bean

Treatments	100-Seed Weight (g)			Seed Yield (kg ha ⁻¹)		
	2020	2021	Mean	2020	2021	Mean
Stages (S)						
1	7.45	6.36	6.91	1949	2599	2274
2	7.26	6.59	6.92	1875	2422	2148
LSD 5%	YXS: N.S.		N.S.	YXS: N.S.		N.S.
Doses (D)						
ppm						
0	7.29	6.66	6.97ab	1783	2409	2096
500	7.76	6.68	7.22a	1797	2520	2159
750	7.39	6.44	6.91ab	2085	2575	2330
1000	6.99	6.13	6.56b	1983	2538	2261
Mean	7.35A	6.48B	6.92	1912B	2511A	2211
LSD 5%	YXD:0.44		0.43	YxD:N.S.		N.S.
CV %	7.4			10.0		

1: Seedling stage 2: Beginning of flowering

According to combined analysis over the years interaction of application stage x cycocel dose was significant for seed yield (Table 5). The greatest seed yield was produced by cycocel application of 1000 ppm with 2530 kg ha⁻¹ at seedling stage application. However, the seed yield obtained from cycocel application of 1000 ppm at seedling stage was similar to cycocel applications of 500 and 750 ppm at seedling stage and dose of 750 ppm at beginning of flowering. The minimum seed yield was found in no cycocel at seedling stage. These results were close agreement with the finding of some studies which cycocel application may improve seed yield in various crops such as mung bean (Bhadane et al., 2020) pea (Bora and Sarma, 2006), chickpea (Güler, 2010) and rape (Pourmohammad et al., 2013).

Table 5. Interaction between application stage and cycocel doses for seed yield in combined mean over the years.

Treatments	Seed Yield (kg ha ⁻¹)			
	0 ppm	500 ppm	750 ppm	1000 ppm
1	1944d	2323ab	2301ab	2530a
2	2248bc	1995cd	2360ab	1992cd
LSD 5%	SXD: 266			

1: Seedling 2: Beginning of flowering

CONCLUSIONS

As mean of the years, the highest pods per plant, branches per plant, seed weight per plant was observed in 1000 ppm CCC. All of the traits were not affected by application stages according to mean of years. Increase in cycocel doses reduced the plant height and the first podding height. Seeds per pod were significant lower in control doses compared to other cycocel applications. Seed yield was affected by cycocel doses x application stages interaction. Greatest seed yield was produced by cycocel application of 1000 ppm at seedling stage. However, the seed yield obtained from cycocel application of 1000 ppm in seedling stage was

similar to doses of 500, 750 ppm in seedling stage and doses of 750 ppm in flowering stage. Other traits were not affected application stage x cycocel dose interaction. Present study revealed that cycocel application in mung bean may improve the seed yield.

ACKNOWLEDGEMENT:

Materials used in this study were provided by Prof.Dr. Erkut PEKSEN. Author Aybegun TON would like thanks for your material support.

REFERENCES

- Abdul Rahman, S. 2018. Chemical composition and some functional properties of flour and isolated protein from mung bean seeds (*Vigna radiata*) cultivated in Iraq. *Iraqi Journal of Agricultural Sciences*, 49(3): 418-425.
- Akdağ, C. 1995. The determining of sowing date effects on mas bean (*Vigna radiata* (L.) Wilczek) seed yield and others some features in Tokat conditions. *Gaziosmanpaşa University. Journal of. Agricultural Faculty*, 12: 135-140. (in Turkish).
- Alan, R. 1990. The effects of CCC treatments on growth and yield of garden peas (*Pisum sativum* cvs. Kelvedon and W. Record) grown at different sowing dates in Erzurum. *Atatürk University Journal of Agricultural Faculty*, 21(1): 28-42. (in Turkish).
- Azadi, E., M. Rafiee, H. Nasrollahi. 2013. The effect of different nitrogen levels on seed yield and morphological characteristic of mungbean in the climate condition of Khorramabad. *Annals of Biological Research*, 4(2): 51-55.
- Beşer, E., M.S. Adak. 1999. Bakla (*Vicia faba* L.)'da değişik miktar ve zamanlarda verilen cycocel'in verim ve verim öğelerine etkisi. *Tarla Bitkileri Merkez Araştırma Enstitüsü Dergisi*, 8(1-2): 100-109.
- Bhadane, R., K. Prajapati, K. Ombase, D. Patel. 2000. Effect of seed priming and foliar spraying of pgrs on morpho-physiology, growth and yield in green gram (*Vigna radiata* L.). *Legume Research-An International Journal*, 1: 1-10.
- Bora, R., C. Sarma. 2006. Effect of gibberellic acid and cycocel on growth, yield and protein content of pea. *Asian Journal of Plant Sciences*, 5: 324-330.
- Dahiya, P., A. Linnemann, M. Van Boekel, N. Khetarpaul, R. Grewal, M. Nout. 2015. Mung bean: Technological and nutritional potential. *Critical Reviews in Food Science and Nutrition*, 55(5): 670-688.
- Dalkılıç, M. 2010. Determination of Yield and Some Agricultural Characteristics of Mung bean (*Vigna radiata* (L.) Wilczek) Populations That Different Sowing Dates in Konya Ecological Conditions. MSc Thesis. Graduate School of Natural and Applied Sciences Department of Field Crops. Selcuk University. Konya, Turkey. (in Turkish).
- Güler, M. 2010. CCC (Cycocel) Uygulama Zamanı ve Dozlarının Nohutta Verim, Verim Unsurları ve Protein Oranına Etkileri. *Yüzüncü Yıl Üniversitesi Tarım Bilimleri Dergisi*, 20(1): 6-15.
- Hajyzadeh, M. 2008. *Effect of CCC (Cycocel) Doses Applied At Different Growth Stages on Yield Components of Chickpea (Cicer arietinum L.)*. MSc Thesis. Graduate School of Natural and Applied Sciences. Ankara University, Ankara, Turkey. (in Turkish).
- Karaman, R. 2019. Characterization in Terms of Phenological, Morphological, Agronomic and Some Technological Properties of Mung Bean (*Vigna radiata* Wilczek) Genotypes/ Local Populations in Isparta Conditions. PhD Thesis. Isparta University of Applied Sciences The Institute of Graduate Education Department of Field Crops. Isparta, Turkey. (in Turkish).

- Kshirsagar, S., B. Chavan, G. Sawargaonkar, S. Ambhore. 2008. Effect of cycocel on growth parameters of green gram (*Vigna radiata*) cv. BPMR-145. International Journal of Agriculture Science, 4(1): 346-347.
- Khwairakpam, R., A. Kumar. 2019a. Study on Vegetative attributes and yield components of mungbean (*Vigna radiata* L. Wilczek) influenced by plant growth regulators. International Journal of Current Microbiology and Applied Sciences, 8(7): 1051-1056.
- Khwairakpam, R., A. Kumar. 2019b. Effect of plant growth regulators on yield attributes and productivity of mungbean (*Vigna radiata* L. Wilczek) .International Journal of Chemical Studies, 7(2): 1480-1483.
- Kumar, B. 2021. Plant bio-regulators for enhancing grain yield and quality of legumes: A review. Agricultural Reviews, 42(2): 175-182.
- Kumlay, A.M., T. Eryiğit. 2011. Bitkilerde büyüme ve gelişmeyi düzenleyici maddeler: Bitki hormonları. Journal of the Institute of Science and Technology, 1(2): 47-56.
- Li, W, C. Shu, S. Yan, Q. Shen. 2010. Characteristics of sixteen mung bean cultivars and their protein isolates. International Journal of Food Science and Technology, 45(6): 1205-1211.
- Nair, R.M., R.Y. Yang, W.J. Easdown, D. Thavarajah, P. Thavarajah, J. Hughes, J.D.H. Keatinge. 2013. Biofortification of mungbean (*Vigna radiata*) as a whole food to enhance human health. Journal of the Science of Food and Agriculture, 93(8): 1805-1813.
- Pekşen, E., C. Toker, F. Ceylan, A. Tariq, M. Farooq. 2015. Determination of promising high yielded mungbean (*Vigna radiata* (L.) Wilczek) genotypes under Middle Black Sea Region of Turkey. Anadolu Tarım Bilimleri Dergisi, 30(2): 169-175.
- Pourmohammad, A., F. Shekari, V. Soltaniband. 2013. Cycocel priming and foliar application affect yield components of rapeseed (*Brassica napus* L.). Cercetari Agronomice In Moldova, XLVII(1(157):59-69.
- Razzaque, M., M. Haque, M. Karim, A. Solaiman, M. Rahman. 2015. Effect of nitrogen on different genotypes of mungbean as affected by nitrogen level in low fertile soil. Bangladesh Journal of Agricultural Research, 40(4): 619-628.
- Singh, V., R.K., Yadav, R. Yadav, R. Malik, N.R. Yadav, J. Singh. 2013. Stability analysis in Mungbean [*Vigna Radiata* (L.) Wilczek] for nutritional quality and seed yield. Legume Reserach, 36(1): 56-61.
- Ton, A. 2021. Agro-morphological and quality characters in two summer legume crops: Mung bean [*Vigna radiata* (L.) Wilczek] and guar [*Cyamopsis tetragonoloba* (L.) Taub] genotypes grown in Mediterranean climate conditions. Legume Research-An International Journal, 44(9): 1072-1076.
- Verma, US., R. Bahadur, M.P. Singh. 2018. Effect of PGR on different stages of chickpea (*Cicer arietinum* L.). Journal of Pharmacognosy and Phytochemistry, 7(5): 3358-3360.
- Warrag, M., A. Hall. 1984. Reproductive responses of cowpea (*Vigna unguiculata* (L.) Walp.) to heat stress. I. Responses to soil and day air temperatures. Field Crops Research, 8: 3-16.

DETERMINATION OF LOW TEMPERATURE RESISTANCE IN *LOLIUM PERENNE* L. GENOTYPES COLLECTED FROM HIGH ALTITUDE REGION

Mustafa TAN¹, Zeynep GÜL², M. Kerim GÜLLAP³, Binali ÇOMAKLI³, Abdullah YAZICI³, İsmail GÜL³

¹*Trakya University Havsa Vocational College Park and Garden Plants, Edirne-Türkiye*

²*Atatürk University Plant Production, Application and Research Center, Erzurum-Türkiye*

³*Atatürk University, Faculty of Agriculture, Department of Field Crops, Erzurum-Türkiye*

Corresponding author e-mail: zdumlu@atauni.edu.tr

ABSTRACT

Perennial ryegrass (*Lolium perenne* L.) is an important species both as a forage plant and as a turfgrass. One of the most important reasons limiting the use of the plant is low temperatures. This research is planned to provide material for the breeding program to be started for low temperature resistance in perennial ryegrass. For this purpose, approximately 1000 clones of genotypes were collected from the high altitude regions of the Eastern Anatolia Region (Erzurum, Erzincan, Kars, Bayburt, Ardahan, Ağrı) in 2019. These clones were planted in Atatürk University Plant Production and Research Center experimental field and evaluated in terms of turfgrass and forage plant parameters for two years (2020 and 2021). Considering the two-year results, 46 turfgrass type and 62 forage type plants were selected from these genotypes. These selected plants were cloned and grown in viols in 2022 and subjected to cold resistance tests together with control cultivars. As a result of the test carried out in the growth chamber, the deaths of the genotypes from low temperature were between -1 °C and -15 °C. Forage type control variety (Lipresso) was completely damaged by cold at -9 °C, and 43 lines more resistant than this variety were determined. On the other hand, the control variety (Esquine), which is a turfgrass type, was frozen at -13 °C, and 5 lines were determined that were based on a lower temperature than the control variety. Studies should continue to develop new varieties related to these lines that are more resistant to low temperature than control varieties.

Keywords: Perennial ryegrass, genotypes, cold resistance

INTRODUCTION

Native to Europe, Asia, and North Africa, the perennial ryegrass (*Lolium perenne* L.) is a worldwide cultivated perennial cool season forage crop that has been cultivated and bred for over 100 years (Sun et al., 2020; Zhang et al., 2020). Perennial ryegrass, also known as English ryegrass, is known as the most used turfgrass type in green areas (Yılmaz and Kısakürek, 2018). It is used for green or dry hay production or silage material in humid and regular rainfall areas.

It is a suitable roughage because it is easy to grow, resistant to form and grazing, fast growth and development, and its grass is delicious and nutritious. It is a suitable roughage because it is easy to grow, resistant to mowing and grazing, fast growing, and its grass is delicious and nutritious. (McGrath, 2008; Açıkgöz 1991; Herridge et al., 2021). Türkiye is in the natural spreading areas of perennial ryegrass, it is not cultivated in agricultural lands and is only found in natural pasture areas as a forage crop (Elçi, 2005).

It has been reported that the genetic diversity of perennial ryegrass is high in natural vegetations because it has cross-pollination (Bolaric et al., 2005; Humphreys et al., 2003). Elçi (2005), stated that perennial ryegrass grows naturally in every region of Türkiye, Bolaric et al.

(2005) also stated that the limits of the genetic diversity of this plant are not known and that it is an interesting plant for breeding programs. Drought, high salinity and extreme temperatures are the main limiting factors frequently encountered in the production of perennial ryegrasses, as with many plants. Among these stresses, which have become more complex with the effect of climate change, it is estimated that the incidence of abnormal temperatures will be higher in the future (Miao et al., 2022).

One of the most important problems of perennial ryegrass culture is that it is not resistant to low temperatures. It is known that perennial grass has low tolerance to cold stress compared to other cool season grasses (Tan, 2018). However, some sources reported that more resistant perennial ryegrass genotypes were found than species such as red fescue and bentgrass (Jones, 1984). In a study investigating the cold resistance of perennial grass cultivars, it was stated that there was a close relationship between the maturity of the cultivars and their cold resistance and survival rates (Fuller and Eagles, 1978). Perennial ryegrass genotypes collected in Romania were subjected to artificial freezing tests and their survival temperatures (LT50) were found to be in line with the average temperature in the coldest months of the place where they were collected (Tcacenco et al., 1989). Therefore, local genotypes need to be evaluated in order to develop new low temperature tolerant varieties. Especially natural genotypes grown at high altitudes are materials that can be used for this purpose. This research was planned to determine the low temperature tolerance of genotypes collected from high altitude regions in order to develop low temperature tolerant cultivars in perennial ryegrass.

MATERIAL AND METHODS

The plants that make up the material of the research were collected from the provinces in the Northeast Anatolian Region (Erzurum, Ağrı, Ardahan, Bayburt, Erzincan, Kars and Iğdır) in 2019. Material collection was done in the form of removing the plants with soil. Random sampling method was used in these collection studies (Tan and Taşkın, 2018; Şehirali and Özgen, 2012). At least 10 plants were removed by looking at the phenotype of the plants at each stop where the collection was made. During the collection, location information, altitude and coordinates were recorded. As a result of the collection studies carried out from 100 points, 1000 genotypes were included in the study. The plants, which were removed from the field with soil, were brought to Atatürk University Herbal Production Application and Research Center greenhouses and transferred to pots without wasting time. The shoots of the plants were cut with the help of scissors and planted in separate pots. The rooted plants were transferred to Atatürk University Herbal Production and Application Center experimental areas in April 2020.

In the field study established in 2020, individual plant investigations were carried out for two years (2020 and 2021) and phenological and morphological observations and measurements were carried out. According to the data obtained, the result of forage and turf type plants were determined. These studies were carried out according to the principles of the UPOV and Certification Center Directorate of the Ministry of Food, Agriculture and Livestock (Anonymous, 2002). According to the data obtained, 62 forage and 46 turf type plants were selected. Clones were taken from these selected plants, grown in viols and subjected to cold resistance tests together with control varieties. The cold resistance tests, which were taken as the basis for the determination of crown measurements, were carried out in the growth cabinet of Atatürk University Faculty of Agriculture, Department of Field Crops. Each plant was cloned and placed in 10 plant growing cabinets. When the plants, which were initially kept at 15-25 °C for 1 month, grew 10-15 cm, the cabin temperature was gradually reduced to 5 °C and acclimation was provided to the low temperature. Then, the temperature was decreased by 2 °C

every 24 hours and it was determined to what temperature the genotypes could survive (Humphreys and Eagles, 1988; Tcacenco *et al.*, 1989; Crosatti *et al.*, 2008). The simple statistical values of the obtained data were calculated and lettered at the 5% probability level according to the Duncan multiple comparison test.

RESULTS AND DISCUSSIONS

Field conditions are not only a widely used method to determine the cold resistance of the plant, but also very easy and important in terms of being the main place of the plant (Fowler *et al.*, 1981). However, definite results cannot be obtained in determining the temperature range in which plants are resistant to cold (Fowler and Gusta, 1979). Because the concept of enduring winter is a very complex subject. For this reason, cold tests carried out under controlled conditions are more suitable for determining the cold tolerance of plants. In addition, the detection of cold resistance differences between plants and obtaining results in a shorter time than field conditions are other advantages (Roberts and Grant, 1968; Fowler *et al.*, 1981, Pomeroy and Fowler, 1973). It is known that cold tolerance studies in which field conditions and controlled laboratory conditions are carried out together, as in this study, give safer results.

In November 2021, 10 pieces of each of the selected plants were cloned and transferred to large-size viols. Plants kept under controlled conditions for 1 month in Atatürk University Herbal Production, Research and Application Center greenhouses were ensured to root and sprout. Plants reaching a plant height of 10-15 cm were then gradually reduced from 15 °C to 5 °C in the growth cabinet in the Department of Field Crops of the Faculty of Agriculture, and acclimatization to low temperature was provided first. Then, the temperature was decreased by 2 °C every 24 hours and it was determined to what temperature the genotypes could survive (Humphreys and Eagles, 1988; Tcacenco *et al.*, 1989; Crosatti *et al.*, 2008). In order to test the resistance of plants to low temperature with control varieties, control varieties planned in the project were also grown in greenhouses under pot conditions. At the same time, clones of these cultivars were taken and included in the cold resistance tests. The results revealed that both forage and turf type genotypes showed variation in cold tolerance (Table 1).

Table 1. Some simple statistical values of selected forage and turf type genotypes in perennial grass (*Lolium perenne* L.)

Genotypes	Minimum	Maximum	Mean	Standart Deviation	Coefficient of Variation
Turf Types	-15	-1	-11	3.751	35.09
Forage Types	-15	-1	-12	3.724	35.40

The results of the turf type genotypes of perennial grass (*Lolium perenne* L.) and the temperatures at which crown deaths occur are shared in Table 2. The degrees of death from low temperature of the genotypes varied. It is an expected result that the death rates of plant material with different properties and collected from different places are different. The death rates of the genotypes varied between -1 °C and -15 °C. University, Kuşçu-1, Gökdağ, Gümüşsu, Yoğurtlu and Güzeltepe are the genotypes that die at -15 °C with higher tolerance to cold than the others. Çayırköprü, Yamaçlı and Pişkidağ genotypes, on the other hand, have the lowest cold tolerance with a death temperature of -1 °C. Perennial grass is known to be more sensitive to low temperature than many cool season grasses in the same category (Tan, 2018). In this study, the

presence of genotypes that can survive down to $-15\text{ }^{\circ}\text{C}$ is promising for the results of the research. The control variety lost its viability at $-13\text{ }^{\circ}\text{C}$. Six of the local genotypes withstood lower temperature than the control. It has also been reported by other researchers that low temperature resistance among local genotypes is high (Küçüközdemir, 2016). Researchers have reported that the frost tolerance of wild forms of perennial ryegrass plants in natural vegetation has a significant genetic variation (Wilkins 1991; Hulke *et al.*, 2007). In another study, it has been reported that the cold acclimation process or exposure to low non-lethal temperatures in perennial ryegrass significantly increases frost tolerance (Ebdon *et al.*, 2002).

Table 2. Low temperature death rates of selected turf type genotypes in perennial ryegrass (*Lolium perenne* L.)

No	Genotypes	Degree of Death ($^{\circ}\text{C}$)	No	Genotypes	Degree of Death ($^{\circ}\text{C}$)
1	University	-15 I	25	Maden	-11 F
2	Kalor	-13 GH	26	Gez	-13 GH
3	Arıbahçe-1	-13 GH	27	Eğerti-2	-9 E
4	Arıbahçe-2	-11 F	28	Büyükgeçit	-11 F
5	Uzunyayla-1	-13 GH	29	Alaca	-7 D
6	Uzunyayla-2	-11 F	30	Gümüşsu	-15 I
7	Kuşcu-1	-15 HI	31	Dadaşkent	-9 E
8	Kuşcu-2	-13 F G	32	Yamaçlı	-1 A
9	Kahramanlar	-9 E	33	Pişkidağ	-1 A
10	Çiftlikköy-1	-13 GH	34	Bayırbağ	-9 E
11	Çayırlar-2	-13 GH	35	Altınbaşak	-13 GH
12	Çayırca	-13 GH	36	Yoğurtlu	-15 I
13	Uluköy-1	-3 B	37	Kömürköy	-7 D
14	Uluköy-2	-5 C	38	Akdağ	-11 F
15	Demirbağ	-9 E	39	Ağıl	-13 GH
16	Halitpaşa	-13 GH	40	Ahmetli	-11 F
17	Beyler	-9 E	41	Eymür	-11 F
18	Gökdağ	-15 I	42	Bayrampaşa	-13 GH
19	Aksu	-11 F	43	Göldere	-13 GH
20	Güllük	-11 F	44	Söğütlü	-13 GH
21	Aşağıkırzı	-13 GH	45	Güzeltepe	-15 I
22	Çayırköprü	-1 A	46	Posof-2	-7 D
23	Taşkesen	-9 E	Control	Esquine	-13 GH
24	Alıççık	-11 F	Mean		-10,69

Means marked with the same letter are indistinguishable at the 0.05 level.

The results of the death rates of the forage genotypes of the perennial ryegrass (*Lolium perenne* L.) plant are given in Table 3. Similarly, the temperatures at which the crown death of the genotypes occurred varied between $-1\text{ }^{\circ}\text{C}$ and $-15\text{ }^{\circ}\text{C}$. The number of damaged genotypes increased with decreasing temperature. University, Kuşcu-1, Gümüşsu, Saztepe, Yoğurtlu and Güzeltepe are the genotypes that die at $-15\text{ }^{\circ}\text{C}$ with higher tolerance to cold than the others. Yarbaşı, Çayırköprü, Yamaçlı and Pişkidağ genotypes are the ones with the lowest cold tolerance, dying at $-1\text{ }^{\circ}\text{C}$. It is known that the cold tolerance of plants differs even in the species and variety of the same plant, depending on the region where they are grown, growing

conditions, age and crown structure (Alnuaimi, 2019). As a matter of fact, in our study, the cold tolerance thresholds of the plants collected from different growing environments were determined to be different, and there are genotypes that come to the fore by surpassing the commercial varieties (Table 3). Control variety Lipresso lost its viability at -9 °C. However, many genotypes collected from the region showed greater resistance than the control.

Table 3. Low temperature death rates of selected forage genotypes in perennial ryegrass (*Lolium perenne* L.)

No	Genotypes	Degree of Death (°C)	No	Genotypes	Degree of Death (°C)
1	Üniversite	-15 H	33	Eskipolat	-11 F
2	Kuşcu-1	-15 H	34	Eğerti-1	-13 G
3	Kuşcu-2	-13 G	35	Eğerti-2	-9 E
4	Kahramanlar	-9 E	36	Büyükgeçit	-11 F
5	Çiftlikköy-1	-13 G	37	Alaca	-7 D
6	Çiftlikköy-2	-11 F	38	Kandilli	-11 F
7	Dadaşköy-1	-13 G	39	Çayköyü	-13 G
8	Dadaşköy-2	-9 E	40	Gümüşsu	-15 H
9	Çayırlar-1	-13 G	41	Dadaşkent	-9 E
10	Çayırlar-2	-13 G	42	Yarımca	-13 G
11	Beypınarı-1	-11 F	43	Yamaçlı	-1 A
12	Beypınarı-2	-7 D	44	Pişkidag	-1 A
13	Çayırca	-13 G	45	Saztepe	-15 H
14	İlica	-13 G	46	Akyazı	-13 G
15	Gürlevik-1	-7 D	47	Beşiktaş	-11 F
16	Gürlevik-2	-11 F	48	Yoğurtlu	-15 H
17	Çağlayan-1	-13 G	49	Ulalar	-13 G
18	Uluköy-1	-3 B	50	Kömürköy	-7 D
19	Uluköy-2	-5 C	51	Akdağ	-11 F
20	Yarbaşı	-1 A	52	Tütenli	-5 C
21	Arpalı	-13 G	53	Kınalıtaş	-13 G
22	Nişantaşı	-11 F	54	Gökçedere	-13 G
23	Aşağıkırzı	-13 G	55	Bayrampaşa	-13 G
24	Çayırköprü	-1 A	56	Kitre	-11 F
25	Taşkesen	-9 E	57	Çayıryolu	-13 G
26	Alıççık	-11 F	58	Göldere	-13 G
27	Maden	-11 F	59	Söğütlü	-13 G
28	Gez	-13 G	60	Güzeltepe	-15 H
29	Masat	-11 F	61	Posof-1	-11 F
30	Sındıran	-9 E	62	Posof-2	-7 D
31	Başçakmak	-7 D	Control	Lipresso	-9 E
32	Gelinkaya	-11 F	Mean		- 10,52

Means marked with the same letter are indistinguishable at the 0.05 level.

CONCLUSION

Perennial ryegrass genotypes collected from the natural vegetation of the Northeast Anatolian Region showed a high variation in mortality from low temperature. This is an expected and desirable situation in order to develop low temperature tolerant varieties. 6 genotypes in turf type and 42 genotypes in forage type showed a more resistant performance to cold stress than commercial (control) varieties. In this research, which includes field and laboratory studies, genotypes with high cold tolerance can be used as materials for the development of new cold-resistant varieties.

ACKNOWLEDGEMENTS

This study was supported by the Scientific and Technological Research Council of Turkey (TÜBİTAK Project No: TOVAG-119O287)

REFERENCES

- Açıkgöz, E. 1991, Yembitkileri, Uludağ Üniversitesi Basımevi, Bursa.
- Alnuami, O.M.G. 2019. Kütahya vişne çeşidinde tomurcuk ve çiçeklerin soğuğa dayanıklılık düzeylerinin belirlenmesi. Yüksek Lisans Tezi. Selçuk Üniversitesi, Fen Bilimleri Enstitüsü, Bahçe Bitkileri Anabilim Dalı, Konya.
- Anonim, 2002. International union for the protection of new varieties of plants. UPOV. http://www.upov.int/en/publications/tg-rom/tg001/tg_1_3.pdf, 20.02.2018.
- Bolaric, S., S. Bart, A. E. Melchinger, and U. K. Posselt. 2005. Genetic diversity in European perennial ryegrass cultivars investigated with RAPD markers. *Plant Breed.* 124: 161-166.
- Byrne, S.L., I. Nagy, M. Pfeifer, I. Armstead, S. Swain, B. Studer, K. Mayer, J. D. Campbell, A. Czaban, S. Hentrup, et al. 2015. A synteny-based draft genome sequence of the forage grass *Lolium perenne*. *Plant J.*, 84: 816-826.
- Crosatti, C., D. Pagani, L. Cattivelli, A. M. Stanca, and F. Rizza. 2008. Effects of growth stage and hardening conditions on the association between frost resistance and the expression of the cold-induced protein COR14b in barley. *Environmental and Experimental Botany*, (62): 93-100.
- Ebdon, J.S., R. A. Gagne, R. C. Manley. 2002. Comparative cold tolerance in diverse turf quality genotypes of perennial ryegrass. *Hortic. Sci.*, 37:826–830
- Elçi, Ş. 2005. Baklagil ve Buğdaygil Yem Bitkileri. Ankara: T.C. Tarım ve Köyişleri Bakanlığı Yayınları.
- Fowler, D.B. and L.V. Gusta. 1979. Selection for Winterhardiness in wheat 1. Identification of genotypic variability. *Crop Sci.* 19 :769–772.
- Fowler, D.B., L. V. Gusta, N.J. Tyler. 1981. Selection for winter hardiness in wheat. 111. Screening methods. *Crop Sci* 21: 896-901.
- Fuller, M.P. and C.F. Eagles. 1978. A seedling test for cold hardiness in *Lolium perenne* L., *The Journal of Agricultural Science*, 91(1): 217–222.

- Herridge, R., L. Samarth, Brownfield, R. Macknight. 2021. Identification and characterization of perennial ryegrass (*Lolium perenne*) vernalization genes. *Frontiers in Plant Science*, 12: 640324.
- Hulke, B.S., E. Watkins, D. Wyse, and N. Ehlke. 2007. Winterhardness and turf quality of accessions of perennial ryegrass (*Lolium perenne* L.) from public collections, *Crop Science*, 47: 1596-1602
- Humphreys, M., L. Turner, L. Skøt, I. King, I. Armstead, P. Wilkins. 2003. The use of genetic markers in grass breeding. *Czech Journal of Genetics and Plant Breeding*, 39 (Special issue): 112-119.
- Humphreys, M.O. and C. F. Eagles. 1988. Assessment of perennial ryegrass (*Lolium perenne* L.) for breeding. I Freezing tolerance, *Euphytica*, 38: 75-84.
- Jensen, L.B., H. Muylle, P. Arens, C. H. Andersen, P. B. Holm, M. Ghesquiere, B. Julier, T. Lubberstedt, K. K. Nielsen, J. De Riek, et al. 2005. Development and mapping of a public reference set of SSR markers in *Lolium perenne* L. *Mol. Ecol. Notes* 5, 951–957.
- Jones, P.K. 1984. The winter hardiness of *Festuca rubra*, *Holcus lanatus* and *Agrostis* spp. in comparison with *Lolium perenne*, *Grass and Forage Science*, 39(4): 381-389.
- Kubik, C., M. Sawkins, W. A. Meyer, B. S. Gaut. 2001. Genetic diversity in seven perennial ryegrass (*Lolium perenne* L.) cultivars based on SSR markers. *Crop Sci.* 41: 1565–1572.
- Küçüközdemir, Ü. 2016. Doğu Anadolu Yerel Buğday Çeşitlerinin Erzurum Koşullarındaki Performansı ve Soğuğa Dayanıklılık Derecelerinin Belirlenmesi, Doktora Tezi, Atatürk Üniversitesi Fen Bilimleri Enstitüsü.
- McGrath, S.K. 2008, The characterisation of genetic diversity of a collection of perennial ryegrass (*Lolium perenne* L.), submission for Ph.D., September 2008, University of Dublin, Trinity College.
- Miao, C., Y. Zhang, X. Bai, T. Qin. 2022. Insights into the Response of Perennial Ryegrass to Abiotic Stress: Underlying Survival Strategies and Adaptation Mechanisms. *Life*, 12(6): 860.
- Pomeroy, M.K., D. B. Fowler. 1973. Use of lethal dose temperature estimates as indices of frost tolerance for wheat acclimated under natural and controlled environments. *Can J Plant Sci* 53: 489-494
- Roberts, D.W.A., M. N. Grant. 1968. Changes in cold hardiness accompanying development in winter wheat. *Can J Plant Sci.*, 48: 369-376.
- Sun, T.X., K. Shao, Y. Huang, Y. Y. Lei, L. Y. Tan, Z. L. Chan. 2020. Natural variation analysis of perennial ryegrass in response to abiotic stress highlights LpHSFC1b as a positive regulator of heat stress. *Environ. Exp. Bot.* 179: 104192.
- Şehirli, S., A. M. Özgen. 2012. Bitkisel Gen Kaynakları. Ankara: Ankara Üniversitesi, Ziraat Fakültesi Yayın No: 557.
- Tan, A., T. Taşkın, 2018. Bitki gen kaynaklarının toplanması. Teknik Broşür, No: 7. Erişim: <https://arastirma.tarimorman.gov.tr/etae/Belgeler/TeknikBrosur/7-bgk-toplama.pdf>
- Tan, M. 2018. Baklagil ve buğdaygil yem bitkileri. Atatürk Üniversitesi Ziraat Fakültesi Ders Yayınları No: 190, Erzurum, 286 s.
- Tcacenco, F.A., C. F. Eagles, B. F. Tyler. 1989. Evaluation of winter hardiness in Romanian introductions of *Lolium perenne*, *The Journal of Agricultural Science*, 112(2): 249-255.
- Wilkins, P.W. 1991. Breeding perennial ryegrass for agriculture. *Euphytica*, 52: 201–214

- Yılmaz, M. B., Ş. Kısakürek. 2018. Bazı çok yıllık çim (*Lolium perenne* L.) çeşitlerinde tuz stresinin çimlenme ve erken fide gelişimi üzerine etkisi. Mustafa Kemal Üniversitesi Ziraat Fakültesi Dergisi, 23(2): 204-217.
- Zhang, J., H. Li, Y. Jiang, H. Li, Z. Zhang, Z. Xu, B. Xu, B. Huang. 2020. Natural variation of physiological traits, molecular markers, and chlorophyll catabolic genes associated with heat tolerance in perennial ryegrass accessions. BMC Plant Biol. 20, 520.

THE EFFECTIVENESS OF TWO DIFFERENT GnRH ANALOGUES WITH OR WITHOUT BETA CAROTENE + VITAMIN-E USED IN OVULATION SYNCHRONIZATION IN HOLSTEIN HEIFERS

Murat ABAY¹, Tayfur BEKYÜREK¹

¹ Erciyes University, Faculty of Veterinary Medicine. Department of Obstetrics and Gynecology, Kayseri, Türkiye

Corresponding author e-mail: mabay@erciyes.edu.tr

ABSTRACT

In this study, it was aimed to investigate the effects of Ovsynch protocol using two different GnRH analogues with or without β -carotene + Vitamin E on pregnancy rates and ovulation time. For this purpose, 80 Holstein breed heifers aged at least 15 months and 350 kg weight were used. All animals were divided into four groups and subjected to the same Ovsynch® procedure (Groups 1, 2, 3, and 4). As the GnRH agent for the Ovsynch protocol, Buserelin acetate in Groups 1 and 2, and Lesireline acetate in Groups 3 and 4 were used. In addition, a single injection of β -Carotene+Vitamin-E was implemented in the heifers in Groups 2 and 4 on 7 days before the initiation of Ovsynch. All heifers were inseminated 20 hours after the last GnRH administration. In the study, the transrectal ultrasonographic examination was performed on heifers during the Ovsynch protocol, 20, 36, and 48 hours after the second GnRH injection, and 30 days after insemination. On the specified days, blood samples were also taken for the evaluation of β -Carotene, vitamin E, and progesterone (P4) levels. The highest pregnancy rate was detected in Group 4 (60%), and pregnancy rates in Groups 1, 2, and 3 were obtained at 40%, 50%, and 50% respectively ($P > 0.05$). While β -carotene and vitamin E levels were found significant ($P < 0.05$) between non-pregnant and pregnant heifers in all groups, no significant changes in serum progesterone levels were observed ($P > 0.05$). However, the difference between all groups was statistically significant when ovulation rates were evaluated ($P < 0.05$). In conclusion, it was detected that the long-action GnRH analogues and the combination of β -carotene and Vitamin E used in the Ovsynch protocol increased the pregnancy rates in heifers. The combinations are thought to can be used especially as an effective and inexpensive method for getting pregnant in a short time after puberty in heifers.

Keywords: β -carotene, GnRH, Heifer, Synchronization of Ovulation, Vitamin E

INTRODUCTION

Fertility programs for dairy cows and heifers are essential to raise dairy herd profitability. (William et al., 2020). Generally, a calving interval of about one year is considered to be an optimal indicator of the fertility and profitability of dairy herds (Temesgen et al., 2022). Holstein heifers achieve mating maturity when they reach 21.2-24.8 months of age and at least 340-363 kg body weight. Puberty in heifers is dependent on many factors including, but not limited to, breed, age, and body weight (Stevenson and Ahmadzadeh, 2011). There is considerable variability between farms in the way that heifer fertility is managed (Wathes et al., 2014). One of the important problems in dairy heifers is their inability to become pregnant on time after reaching mating maturity. If cows cannot become pregnant after their first artificial insemination, it leads to further economic losses and expenses. These included expenses for replacement heifers, the added cost of extra feed provided for additional days, increased labor expenses involved in managing the animals, additional breeding costs, and the financial implications of calf loss and reduced milk production due to the extended open period. (Tadesse et al., 2022). Due to these factors timely artificial insemination of heifers is economically very

important. For this purpose, numerous oestrus synchronization protocols have been developed in recent years (Bisinotto et al., 2014). Fertile timed insemination is achieved through the strategic administration of gonadotropin releasing hormone (GnRH), Prostaglandin (PG) F₂ α , and Progesterone (P₄) (William et al., 2020). The success rates of pregnancies achieved through these protocols in heifers vary (Akçay et al., 2022). To increase the pregnancy rate in heifers, it is important to synchronize ovulation as well as estrus. In recent years, different ovulation synchronization methods have been used extensively to increase fertility.

In the presented study, the effect of the Ovsynch procedure performed by applying two different GnRH analogues and β carotene vitamin E in heifers on ovulation time and pregnancy rate was investigated.

MATERIAL AND METHOD

Animals

The study was conducted on a farm located in Güneşli town of Kayseri province. Eighty Holstein heifers, aged between 15-24 months, and with no reproductive problems according to the records, were used in this study. The heifers were housed in free-roaming paddocks and had access to water ad libitum. They were fed twice a day with a ration that included alfalfa and corn silage. Furthermore, all animals were negative for diseases such as IBR-IPV, BVD-MD, Brucella, Tuberculosis, and Leptospirosis. Ethical approval was obtained from the Erciyes University Local Ethics Committee for Animal Experiments (2008/12).

Synchronization Procedure

The following substances were used in this study for synchronization: Dalmavital (15 mg β -Carotene and 20 mg dl- α -Tocopherol acetate/ml, Vetaş, Turkey), which contains β -Carotene and vitamin E; Dalmarelin (Lesirelin acetate, Vetaş Turkey) and Receptal (0.004 mg Buserelin acetate/ml, Intervet, Turkey), both of which are GnRH analogues; and Dalmazin (0.075 mg D-Cloprostenol/ml, Vetaş Turkey), a prostaglandin.

Eighty heifers included in the study were divided into four groups and the Ovsynch procedure was applied to all animals (Groups 1, 2, 3, and 4).

Fifteen milliliters Dalmavital was intramuscularly (im) administered to the heifers in Groups 2 and 4 on seven days before the application of GnRH. On day 0, 2.5 ml Dalmarelin (62.5 mg lesirelin acetate) and 2.5 ml Receptal (0.0105 mg buserelin acetate) were administered im to the heifers in groups 3-4 and groups 1-2, respectively. Seven days after the first GnRH administration, 2 ml Dalmazin (0.150 mg D-cloprostenol) was administered im to animals in all groups.

48 h after the injection of Prostaglandin F₂ α , 2.5 ml of Dalmarelin was administered im to the heifers in Groups 3 and 4 while 2.5 ml of Receptal was administered to the heifers in Groups 1 and 2. All animals in the groups were inseminated once via the rectovaginal route, 20 hours after the last GnRH application. The sperms were thawed at 35°C for 45 seconds.

Ultrasonographic Examination

Transrectal ultrasonographic examination was performed to determine ovarian structures, follicle dynamics, and ovulation times at -7, 0, 7, 9, and 10-12 days and to check pregnancy on the 40th day on all heifers.

Blood Samples

Blood samples were collected from animals in order to determine and compare the hormonal and biochemical parameters in Dalmavital administration, in the first and second administration of GnRH, at the stage of PGF2 α injection and at 24-hour intervals until 48 hours after the second GnRH injection. The obtained serum samples were stored at -20°C for later use.

Analysis of Serum β -Carotene, Vitamin E, and P4

Serum β -Carotene and vitamin E levels were determined according to the methods described by Suzuki and Katoh, (1990) and Martinek (1964), respectively. Serum progesterone analyzes were performed using the microtitration plate enzyme immunoassay method reported by Prakash et al. (1987).

Statistical Analysis

Pregnancy rates, CL and follicle findings, and ovulation rates obtained in the study were analyzed using the chi-square method. Variance (ANOVA) analysis and t-test methods were used to compare β -carotene and vitamin E levels within and between groups.

The Kruskal-Wallis test and Mann-Whitney test were utilized to compare progesterone levels between the groups, and evaluate them within themselves, respectively. These tests were performed with the SPSS 15.0 statistical program. Friedman two-way analysis of variance was used in the SigmaStat program to evaluate the β -carotene, vitamin E, and progesterone values between days.

RESULTS AND DISCUSSION

The mean age of the heifers (n=80) included in the study groups was 17.45 \pm 2.49 months, and their live weight was 400.97 \pm 60.28 kg. The pregnancy rates in Groups 1, 2, 3, and 4 were determined as 40% (8/20), 50% (10/20), 50% (10/20), and 60% (12/20), respectively. In the statistical evaluation of the pregnancy rates obtained, although there was a numerical increase observed between the groups, it was detected that this increase was not statistically significant (P>0.05).

In the ultrasonography examinations, no statistical difference was found in the numbers of animals with and without CL on the -7, 0, 7, and 9 days of the study when comparing groups (P>0.05). Also, there was no statistically significant difference observed in the numbers of animals with and without follicles in the groups, at the 9th day of the study, at the time of insemination, and 36 and 48 hours after the second GnRH injection (P>0.05).

The study groups were compared in terms of the numbers of ovulations determined in ultrasonographic examinations performed at 20, 36, and 48 h after the second GnRH injection, a statistically significant difference was observed between the groups (P<0.05) (Table 1). The ovulation occurred between 20-36 hours in Group 4, where the highest pregnancy rate was obtained, while it occurred between 36-48 hours in the other groups (Groups 1, 2, and 3).

Table 1. Ovulation findings determined in ultrasonography examinations performed 20, 36, and 48 h after the second GnRH injection in the study groups.

Groups	0-20. h	20-36. h	36-48. h
Group 1	1	2	10
Group 2	2	2	12
Group 3	3	2	9
Group 4	3	10	1
P<0.05			

While there was no statistical difference between the β -carotene levels on day -7 in serum samples taken from heifers that conceived and those that did not conceive, significant differences were observed between the β -carotene levels on days 0, 7, 9, 10, and 11.

When the β -carotene levels of the heifers that were pregnant and did not conceive within the study groups at -7, 0, 7, 9, 10, and 11 days were compared, it was determined that there was no difference in Groups 1 and 2 ($P>0.05$). A statistical difference was found between β -carotene levels in Groups 3 and 4, on day 7 and day 0, respectively, ($P<0.05$).

In heifers that conceived or did not conceive, no difference was detected in β -carotene levels on days -7, 0, 7, 9, 10, and 11 between Groups 1 and 3 ($P>0.05$), while a significant difference was found in Groups 2 and 4 ($P>0.001$) (Table 2). A significant statistical difference was found in the vitamin E levels of the animals that conceived and did not conceive in Groups 2 and 4 on days -7, 0, 7, 9, 10, and 11 ($P<0.05$). There was a statistically significant difference between the vitamin E levels of the nonpregnant and pregnant heifers in groups 1 and 3 on the specified days ($P<0.05$) (Table 3). It was found that there was no statistical difference between the progesterone levels at -7, 0, 7, 9, 10, and 11 days in pregnant and nonpregnant animals in Groups 1 and 4. However, a significant statistical difference in the progesterone levels was detected on the -7th and 7th days in Groups 2 and 3 (Table 4).

Table 2. Comparison of β -carotene values of pregnant and non-pregnant animals in the study groups ($\mu\text{g/dl}$) (Mean \pm SD)

		-7. Day	0. Day	7. Day	9. Day	10. Day	11. Day
Group 1	Pregnant	66.26 \pm 11.53	67.49 \pm 12.35	75.87 \pm 19.97	73.26 \pm 18.53	71.08 \pm 13.27	74.81 \pm 18.17
	Non-Pregnant	75.13 \pm 16.55	72.67 \pm 20.72	75.75 \pm 14.78	77.39 \pm 24.38	75.71 \pm 18.69	77.42 \pm 17.30
P>0.05							
Group 2	Pregnant	76.82 \pm 26.99	139.53 \pm 29.45	113.95 \pm 22.88	113.18 \pm 16.10	109.46 \pm 18.75	100.97 \pm 27.70
	Non-Pregnant	81.92 \pm 15.10	139.03 \pm 21.11	115.08 \pm 17.86	111.98 \pm 10.89	100.93 \pm 16.01	91.47 \pm 14.92
P>0.05							
Group 3	Pregnant	68.64 \pm 17.21	69.42 \pm 21.24	62.83 \pm 9.74	67.71 \pm 10.80	68.18 \pm 11.66	70.27 \pm 10.95
	Non-Pregnant	71.78 \pm 17.57	79.30 \pm 25.98	73.64 \pm 26.03	67.10 \pm 18.50	72.87 \pm 22.42	71.20 \pm 11.90
		P>0.05		P<0.05		P>0.05	
Group 4	Pregnant	73.29 \pm 11.64	144.70 \pm 25.64	126.23 \pm 17.46	119.25 \pm 18.22	124.94 \pm 15.58	117.86 \pm 17.70
	Non-Pregnant	68.60 \pm 10.60	125.44 \pm 14.45	131.59 \pm 20.18	117.68 \pm 17.77	117.59 \pm 16.06	108.50 \pm 13.51
		P>0.05	P<0.05			P>0.05	

Table 3. Comparison of Vitamin E values of pregnant and non-pregnant animals in the study groups (mg/dl) (Mean±SD)

		-7.Day	0. Day	7.Day	9.Day	10.Day	11.Day
Group 1	Pregnant	0.33±0.09	0.33±0.09	0.45±0.16	0.44±0.09	0.45±0.16	0.50±0.13
	Non-Pregnant	0.34±0.076	0.36±0.10	0.42±0.10	0.44±0.11	0.45±0.15	0.48±0.14
P>0.05							
Group 2	Pregnant	0.35±0.07	0.57±0.11	0.60±0.11	0.55±0.18	0.64±0.11	0.53±.007
	Non-Pregnant	0.36±0.14	0.61±0.13	0.52±0.09	0.52±0.07	0.54±0.11	0.57±0.07
		P<0.05	P>0.05	P<0.05	P>0.05		
Group 3	Pregnant	0.31±0.08	0.31±0.08	0.35±0.12	0.43±0.12	0.37±0.06	0.35±0.06
	Non-Pregnant	0.37±0.18	0.37±0.19	0.39±0.11	0.33±0.09	0.41±0.18	0.37±0.12
		P>0.05		P<0.05	P>0.05	P<0.05	
Group 4	Pregnant	0.49±0.11	0.74±0.10	0.72±0.15	0.58±0.08	0.66±0.10	0.59±0.12
	Non-Pregnant	0.52±0.12	0.76±0.15	0.70±0.15	0.57±0.09	0.59±0.12	0.59±0.10
P>0.05							

Table 4. Comparison of progesterone levels of pregnant and non-pregnant animals in the study groups (ng/ml) (Median (25-75%))

		-7. Day	0. Day	7. Day	9. Day	10. Day	11. Gün	
Group 1	Pregnant	2.04 (0.40-3.40)	2.04 (0.32-3.86)	3.41 (0.30-4.01)	0.12 (0.08-0.18)	0.13 (0.09-0.18)	0.08 (0.05-0.14)	
	Non-Pregnant	2.59 (1.23-4.01)	2.76 (1.23-4.61)	0.91 (0.23-3.43)	0.09 (0.05-0.36)	0.18 (0.08-0.23)	0.14 (0.11-0.24)	
P>0.05								
Group 2	Pregnant	0.13 (0.04-0.48)	1.47 (0.14-2.90)	2.93 (1.99-4.27)	0.15 (0.07-0.26)	0.03 (0.02-0.15)	0.06 (0.03-0.13)	
	Non-Pregnant	1.65 (0.10-4.47)	0.70 (0.05-1.75)	1.46 (0.19-3.60)	0.12 (0.09-0.16)	0.08 (0.05-0.20)	0.08 (0.05-0.17)	
		P<0.05	P>0.05					
Group 3	Pregnant	3.37 (2.49-4.01)	4.02 (1.49-5.06)	3.47 (1.46-8.01)	0.20 (0.08-0.35)	0.10 (0.04-0.21)	0.09 (0.03-0.20)	
	Non-Pregnant	0.42 (0.08-3.10)	0.17 (0.07-3.15)	0.31 (0.17-0.71)	0.17 (0.12-0.29)	0.16 (0.10-0.43)	0.19 (0.09-0.91)	
		P>0.05	P<0.05		P>0.05			
Group 4	Pregnant	1.46 (0.11-3.57)	1.11 (0.20-1.66)	2.12 (0.46-5.12)	0.08 (0.05-0.15)	0.07 (0.04-0.13)	0.14 (0.06-0.18)	
	Non-Pregnant	1.79 (0.62-2.73)	0.24 (0.15-1.27)	0.37 (0.06-1.89)	0.16 (0.08-0.21)	0.13 (0.04-0.26)	0.25 (0.06-0.49)	
P>0.05								

The aim of treatments to control the estrous cycle is to provide optimal pregnancy rates after estrus or ovulation synchronization (Bo et al., 1995; Burke et al., 2000). Although classical estrus synchronization programs in which prostaglandins or progestagens are used alone can produce an adequate estrus response, they cannot sufficiently provide an ovulation synchronization to allow fixed-time insemination (Bo et al., 1995; Burke et al., 2000; DeJarnette et al., 2001; Macmillan et al., 1996; Pursley et al., 1995; Stevenson et al., 1999). The variable responsiveness of the ovaries to synchronization programs is the most limiting factor in the application of new and effective reproductive technologies in cattle (Bo et al.,

1995). Control of the estrous cycle has a wide range of applications, including lengthening or shortening the luteal phase and altering the follicular wave design using GnRH or estradiol. At the end of the synchronization programs, it is necessary to have a healthy dominant follicle in the growth phase to effectively control the development of the follicular wave (Rivera et al., 1998).

It is stated that under normal conditions, 66% of non-pregnant cows in the farm will be in the diestrus period of the cycle (Cartmill et al., 2001). Cirit (2002) reported that on the first day of hormone administration, an average of 41.70% of the cows in the groups were in the luteal phase. In the present study, CL was detected in 15 (75%), 13 (65%), 13 (65%), and 11 (55%) heifers in groups 1, 2, 3, and 4, respectively, on the 7th day before the study. On the day of the first GnRH injection (day 0), presence of the CL was detected in 15 (75%), 14 (70%), 13 (65%) and 16 (80%) heifers in the groups, respectively. It was determined that these results are consistent with results of previous studies.

Many researchers reported that the first GnRH administered in protocols based on GnRH-PGF2 α increased the rate of having an active CL at the time of PGF2 α injection, by causing ovulation or luteinization (Stevenson et al., 2000; Peters et al., 1999; Stevenson et al., 1999). Pursley et al. (1997) stated that the presence of CL in PGF2 α injection affects the success of ovulation synchronization. Similarly, Demiral et al. (2006) support this theory in their study. In current study, an increase was observed in the number of heifers with CL in groups 1, 2, 3, while a decrease was detected in group 4 compared to the day of the first GnRH administration on the day of PGF2 α injection (7th day). It is difficult to attribute this situation to a reason with the data obtained in the study.

In many studies using the Ovsynch protocol, the success of ovulation synchronization is determined by considering the rate of animals that ovulate after the GnRH injection between 24 to 48 hours. (Vasconcelos et al., 1999; Fricke et al., 1998; Cordoba and Fricke, 2001). Cirit (2002) reported that the rate of ovulation varied between 73.7% and 87.0% after the last PGF2 α injection, between the 48-96h. These reported data are consistent with the data found in the presented study.

Pursley et al. (1995) reported that ovulation occurred within 24–32 h after the last GnRH injection in 100% of lactating dairy cows. Demiral et al. (2006) reported that ovulation (99.7%) was distributed to the until 42nd hour and the highest ovulation rate (%35) occurred the between 24 and 30 h in the heifers which they applied the cosynch protocol, in the examinations performed at 6-hour intervals after the last GnRH injection. In the present study, the highest ovulation rate was found in Groups 1 (76.92%), 2 (75%), and 3 (64.29%) between the 36-48 h after the second GnRH injection. But it was determined in Group 4 (71.43%) after the second GnRH injection between the 20-36 h. It was concluded that the difference between the reported results and the findings of the present study could be attributed to variations in the care, nutrition, age of the heifers, and differences in the application dosages of the preparations used.

Yıldız et al. (2005) reported that the difference between the mean Vitamin E and β -carotene levels in pregnant and non-pregnant cows was statistically significant in their study on pregnant and non-pregnant cows after mating. In the present study, the statistical difference was found to be significant in the comparison of vitamin E and β -carotene levels between the days of indicated in the study the pregnant and non-pregnant heifers in all groups. However, no difference was found in vitamin E and β -carotene levels in heifers that pregnant and nonpregnant after insemination.

Parmigiani et al. (2003) reported that calving-first estrus and calving-conception intervals were shortened, and pregnancy rates increased in cows in their study, where they used the preparation containing β -carotene and vitamin E used in the present study. Data obtained in the present study is consistent with the results reported by Parmigiani et al. (2003).

Graves Hoagland et al. (1989) and Schweigert and Zucker (1988) reported that a positive relationship was found between the levels of vitamin E and β -carotene and the levels of progesterone in their studies. Naziroglu et al. (1997) and Yıldız et al. (2005) reported that there was a negative relationship between vitamin E and β -carotene levels and progesterone levels in pregnant cows, but there was no relationship in non-pregnant cows. In the present study, no correlation was found between vitamin E and β -carotene levels and progesterone levels in all groups. It was thought that the difference between the data obtained in the present study and the data reported in the studies could be attributed to the difference in the methods applied in the studies and the maintenance nutritional status of the subjects.

Pursley et al. (1995) reported a pregnancy rate of 55% in cows treated with Ovsynch, Schmitt et al. (1996) reported a pregnancy rate of 53% in the group in which they used hCG instead of the second GnRH injection, and 45.5% in the ovsynch group in which GnRH was used. In the present study, pregnancy rates in Groups 1, 2, 3, and 4 were determined as 40%, 50%, 50%, and 60%, respectively. It was thought that the results obtained in Groups 2, 3, and 4 agreed with the reported studies, and also the low pregnancy rate obtained in Group 1 might be because the present study was conducted in heifers.

Demiral et al. (2006) reported 41% and 51% pregnancy rates in cows and heifers with the co-synch program. In the present study, the pregnancy rate in heifers in Groups 1 and 3 in which the ovsynch protocol was applied was 40% and 50%, respectively; and the pregnancy rate in the heifers in Groups 2 and 4 in which the ovsynch protocol was applied in combination with β -carotene and vitamin E was 50% and 60%, respectively. The pregnancy rates obtained in the present study was consistent with results of pregnancy rates reported by Demiral et al. (2006).

Kırbaş et al. (2007) and Öztürk (2007) reported that pregnancy rates ranged from 23.1% to 41.9% in the ovsynch protocol in which they used lesirelin acetate as a GnRH analogue. In the present study, pregnancy rates were determined as 50% and 60%, respectively, in Groups 3 and 4 where lesirelin acetate was used. It was thought that the high rates obtained in the presented study may be due to the differences in the geographical regions where the studies were conducted, the dose of the preparation used, the care and feeding conditions of the animals, their age, and their live weight.

CONCLUSION

As a result, it was concluded that β -carotene+Vitamin E applications before the Ovsynch procedure with long-acting GnRH analogues in heifers can play a positive role in increasing pregnancy rates and especially in the conception of heifers reaching mating maturity in a short time.

ACKNOWLEDGEMENT

This study was prepared from PhD dissertation of the first author and financially supported by The Scientific Research Council of Erciyes University, Kayseri, Türkiye (Project No: TSD-08-322).

REFERENCES

- Akçay, A., Abay, M., Çelik, E. 2022 The Meta-Analysis of Conception Rates of Dairy Cattle Treated with the Ovsynch Protocol in Türkiye. *Kafkas Univ Vet Fak Derg.* 28(4): 481-490.
- Bisinotto, R.S., Ribeiro, E.S., Santos, J.E.P. 2014. Synchronization of Ovulation for Management of Reproduction in Dairy Cows. *Animal.* 8(1): 151-159.
- Bo, G.A., Adams, G.P., Pierson, R.A., Mapletoft, R.J. 1995. Exogenous Control of Follicular Wave Emergence in Cattle. *Theriogenology.* 43: 31-40.

- Burke, C.R., Day, M.L., Bunt, C.R., Macmillan, K.L. 2000. Use of a Small Dose of Estradiol Benzoate During Diestrus to Synchronize Development of the Ovulatory Follicle in Cattle. *J Anim Sci.* 78 (1): 145-151.
- Cartmill, J.A., El-Zarkouny, S.Z., Hensley, B.A., Lamb, G.C., Stevenson, J.S. 2001. Stage of Cycle, Incidence, and Timing of Ovulation, and Pregnancy Rates in Dairy Cattle after Three Timed Breeding Protocols. *J Dairy Sci.* 84(5): 1051-1059.
- Cirit, Ü. 2002. Siyah Alaca İneklerde PGF 2α ve GnRH'nın Farklı Kombinasyonları ile Östrus Senkronizasyonu Çalışmaları, Doktora Tezi, İstanbul Üniversitesi Sağlık Bilimleri Enstitüsü, İstanbul. ss 90.
- Cordoba, M.C., Fricke, P.M. 2001. Evaluation of Two Hormonal Protocols for Synchronization of Ovulation and Timed Insemination in Dairy Cows Managed in Grazing-Based Dairies. *J. Dairy Sci.* 84: 2700-2708.
- DeJarnette, J.M., Wallace, R.W., House, R.B., Salverson, R.R., Marshall, C.E. 2001. Attenuation of Premature Estrous Behavior in Postpartum Beef Cows Synchronized to Estrus using GnRH and PGF 2α Theriogenology. 56: 493-501.
- Demiral, O., Ün, M., Abay, M., Bekyürek, T., Öztürk, A. 2006. The Effectiveness of Cosynch Protocol in Dairy Heifers and Multiparous Cows. *Turk J Vet Anim Sci.* 30: 213-217.
- Fricke, P.M., Guenther, J.N., Wiltbank, M.C. 1998. Efficacy of Decreasing The Dose Of GnRH Used in a Protocol for Synchronization of Ovulation and Timed AI in Lactating Dairy Cows. *Theriogenology.* 50(8): 1275-1284.
- Graves-Hoagland, R.L., Hoagland, T.A., Woody, C.O. 1989. Relationship of plasma β -carotene and vitamin A to luteal function in postpartum cattle. *J Dairy Sci.* 72(7): 1854-1858.
- Hafez, E.S.E., Dyer, I.A. 1969. Animal Growth and Nutrition. Animal Reproduction, Lea and Febiger. Philadelphia, 402.
- Kırbaş, M., Çoyan, K., Bülbül, B., Ataman, M.B., Köse, M., Akman, O., Dursun, Ş. 2007. İnek ve Düvelerde Luteal Akyivitenin Ovsynch Protokolüne Etkisi. IV. Ulusal Reprodüksiyon ve Suni Tohumlama Kongresi, Antalya, Türkiye. ss 142-143.
- Macmillan, K.L., Burke, C.R. 1996. Effects of Oestrous Cycle Control on Reproductive Efficiency. *Anim Reprod Sci.* 42: 307-320.
- Martinek, R.G. 1964. Method for Determination of Vitamin E (total tocopherols) in Serum. *Clin Chem,* 10(12): 1078-1086.
- Naziroglu, M., Çay, M., Aksakal, M., Çetin, H., Kaygusuzoglu, E., Kalkan, C. 1997. Effects of Administration of hCG and GnRH at the Time of Insemination on Serum Vitamin E and Progesterone Levels in Prostaglandin F 2α -Synchronized Cows. *Turk J Vet Anim Sci.* 21: 393-398.
- Öztürk, A. 2007. Postpartum Dönemdeki Siyah Alaca İneklerde Ovsynch Protokolünden İki Gün Önce PGF 2α İlavésinin Östrus Siklusu ve Fertiliteye Etkisi. Doktora tezi, İstanbul Üniversitesi Sağlık Bilimleri Enstitüsü, İstanbul, ss81.
- Parmigiani, E., Di Ianni, F., Bigliardi, E., Morini, G., Ambrosi, V., Persona, P. 2003. Correlazione fra Fertilita'e Somministrazione di Vitamina E, β -carotene * e Cobamamide Nella Bovina da latte. Pubblicato negli Atti della "Società Italiana di Buiatria" vol. XXXV.
- Peters, A.R., Mawhinney, I., Drew, S.B., Ward, S.J., Warren, M.J., Gordon, P.J. 1999. Development of a Gonadotropin-Releasing Hormone and Prostaglandin Regimen for Planned Breeding of Dairy Cows. *Vet Rec.* 145: 516-521.
- Pursley, J.R., Mee, M.O., Wiltbank, M.C. 1995. Synchronization of Ovulation in Dairy Cows using PGF 2α and GnRH. *Theriogenology.* 44: 915-923.
- Prakash, B.S., Meyer, H.H.D., Schallenberger, E., Van De Wiel, D.F.M. 1987. Development of Sensitive Enzymimmunoassay (EIA) for Progesterone Determination in Unextracted Bovine Plasma Using the Second Antibody Technique. *J Steroid Biochem.* 28: 623-627.

- Rivera, G.M., Gohi, C.G., Chaves, M.A., Ferrero, S.B., Bo, G.A. 1998. Ovarian Follicular Wave Synchronization, and Induction of Ovulation in Postpartum Beef Cows. *Theriogenology*. 49: 1365-1375.
- Schweigert, F.J., Zucker, H. 1988. Concentrations of Vitamin A, B-Carotene and Vitamin E in Individual Bovine Follicles of Different Quality. *J Reprod Fertil*. 82: 575-579.
- Stevenson, J.S., Kobayashi, Y., Thompson, K.E. 1999. Reproductive Performance of Dairy Cows in Various Programmed Breeding Systems Including OvSynch and Combinations of Gonadotropin-Releasing Hormone and Prostaglandin F₂ α . *J Anim Sci*. 82 (3): 506-515.
- Stevenson, J.S., Thompson, K.E., Forbes, W.L., Lamb, G.C., Grieger, D.M., Corah, L.R. 2000. Synchronizing Estrus and (or) Ovulation in Beef Cows after Combinations of GnRH, Norgestomet, and Prostaglandin F₂ α with or without Timed Insemination. *J Anim Sci*. 78: 1747-1758.
- Stevenson, J.S., Ahmadzadeh, A. 2011. Replacement Management in Cattle | Breeding Standards and Pregnancy Management. *Encyclopedia of Dairy Sciences*. 410-416.
- Suzuki, J., Katoh, N. 1990. A Simple and Cheap Methods for Measuring Serum Vitamin A in Cattle Using Only A Spectrofotometer, *Jpn J Vet Sci*. 52(6):1281-1283.
- Tadesse, B., Reda, A.A., Kassaw, N.T., Tadek, W. 2022. Success Rate of Artificial Insemination, Reproductive Performance and Economic Impact of Failure of First Service Insemination: A Retrospective Study. *BMC Vet Res* 18: 226.
- Temesgen, M.Y., Assen, A.A., Gizaw, T.T., Minalu, B.A., Mersha, A.Y. 2022. Factors Affecting Calving to Conception Interval (Days Open) in Dairy Cows Located at Dessie and Kombolcha Towns, Ethiopia. *PLoS ONE*. 17(2): e0264029.
- Thatcher, W.W., Santos, J.E.P. 2020. Chapter 8-Reproductive Management of Dairy Cattle, Editor(s): Fuller W. Bazer, G. Cliff Lamb, Guoyao Wu, *Animal Agriculture*, Academic Press. 131-155.
- Vasconcelos, J.L.M., Silcox, R.M., Rosa, G.C., Pursley, J.R., Wiltbank, M.C. 1999. Synchronization Rate, Size of Ovulatory Follicle, and Pregnancy Rate after Synchronization of Ovulation Beginning on Different Days of Estrous Cycle in Lactating Dairy Cows. *Theriogenology*. 52(6): 1067-1078.
- Wathes, D.C., Pollott, G.E., Johnson, K.F., Richardson, H., Cooke, J.S. 2014. Heifer Fertility and Carry Over Consequences for Lifetime Production in Dairy and Beef Cattle. *Animal*. 8(1): 91-104.
- Yildiz, H., Kaygusuzoğlu, E., Kizil, Ö. 2005. Serum Progesterone, Vitamin A, E, C and β -carotene Levels in Pregnant and Nonpregnant Cows Post-mating. *Journal of Animal and Veterinary Advances*. 4(3): 381-384.

EFFECTS OF DIFFERENT ETHANOL CONCENTRATIONS IN PEPPER (*Capsicum annuum*) EXPOSED TO SALINITY

Safiye AŞIKLI¹, Armağan KAYA²

¹Alanya Alaaddin Keykubat University, Gazipaşa MRB Vocational School, Department of Plant and Animal Breeding, Gazipaşa, Antalya/ TURKEY

²Alanya Alaaddin Keykubat University, Faculty of Engineering, Department of Fundamental Engineering Sciences, Alanya, Antalya/ TURKEY

Corresponding author e-mail: armagan-kaya@hotmail.com

ABSTRACT

Plants are exposed to various stress factors such as drought, salinity, heat or chemical compounds in agricultural fields. These stress factors adversely affect plant growth and development, reduce the yield and quality of plant products, and cause economic losses. Plants can cope with stress conditions by using various defense and acclimation mechanisms. Besides, exogenous application of various compounds is known to increase the stress tolerance of plants. In this study, the effects of different ethanol concentrations on stress tolerance in pepper seedlings exposed to salt stress were investigated. For this purpose, 0 and 150 mM NaCl were applied to pepper seedlings pre-treated with 20 and 40 mM ethanol. Plants were harvested 10 days after NaCl treatment. Some physiological and morphological parameters were examined in the harvested plants. According to our findings, especially 20 mM ethanol pre-treatment changed plant growth parameters such as plant height, leaf number, fresh weights of root and stem as well as carotenoid contents in plants exposed to salt stress.

Keywords: Pepper, NaCl, Ethanol, Plant Growth Parameters, Pigment, Total Phenolic Compounds

INTRODUCTION

Salinity is one of the most important abiotic stress factors affecting plant growth. Salinity negatively affects plant growth and development by causing osmotic stress and ion stress. Salt stress affects many metabolic processes in plants, including photosynthesis. (Çulha and Çakırlar, 2011). In addition, salt stress reduces plant height, fresh and dry weight of plants and the number of leaves, as well as adversely affects seed yield and root development (Munns, 2003; Ashraf et al., 2004; Kaya and İnan, 2017). The negative effects of salinity on plants reduce the yield and quality of plant products and ultimately lead to economic losses.

Stress tolerance of plants is essential for their survival in extreme environmental conditions. Plants have developed various defense responses at physiological, biochemical and gene levels to cope with the negative effects of environmental stresses. Besides, exogenous application of various compounds is known to increase the stress tolerance of plants (Kaya and Doganlar 2019; Das et al. 2022; Kaya, 2023).

The aim of this study is to determine the effects of different ethanol (EtOH) concentrations on stress tolerance in plants exposed to salt stress. For this purpose, various morphological and physiological parameters were investigated in pepper seedlings which are treated with ethanol and salt stress.

MATERIAL AND METHOD

This study was conducted at research field Alanya Alaaddin Keykubat University Gazipaşa Vocational School. In this study, *Capsicum annuum* sp. (Üç Burun Cv.) seedlings were used as plant

material. Seedlings were grown in pots containing a 3:1 mixture of peat:perlite (v/v) under natural conditions having an average temperature of 30 °C and an average humidity of 65%. At the about 6 th week of growth, 20 and 40 mM EtOH were applied as foliar for some plants (every day for a week). EtOH concentrations were determined according to the literature (Das et al. 2022; Rahman et al. 2022). One day after last EtOH treatment, both ethanol pre-treated and non-treated plants were irrigated with 150 mM NaCl, every three days for 10 days. Control plants were irrigated with distilled water. (Table 1). At the 10th day of NaCl application, plants were harvested. Some of the plants were used to determine growth parameters (plant height, root length, number of leaves as well as leaf, shoot and root fresh weight /dry weight). Others were used to determine contents of chlorophyll, carotenoid (De Kok and Graham, 1980; Lichtenthaler and Welburn, 1983) and total phenolics (Singleton et al 1999).

Groups	Treatments
1	Distilled water (Control)
2	20 mM EtOH
3	40 mM EtOH
4	150 mM NaCl
5	150 mM NaCl+20 mM EtOH
6	150 mM NaCl+40 mM EtOH

Table 1. Treatment groups

Experiments were repeated three times and statistical analyses were performed with SPSS software 20.0. The differences between the treatment groups were determined according to the Tukey test ($p < 0.05$).



Figure 1. Pepper seedlings treated with EtOH and NaCl

RESULTS AND DISCUSSION

A. Morphological parameters

Table 2 shows the effects of EtOH and NaCl treatments for plant height, root length and number of leaves. According to our findings, salt stress decreased plant height, root length and number of leaves in all treatment groups, regardless of EtOH application. However, 20 mM EtOH pre-treatment increased plant height and number of leaves ($p < 0.05$). However, EtOH pre-treatment did not show a significant effect on root length.

Treatments	Plant Height (cm)	Root Length (cm)	Number of Leaves (cm)
Control	30,16±0,44a	26,00±0,57a	20,67±1,52a
20 mM EtOH	24,83±0,52b	21,33±1,66b	18,33±0,57ab
40 mM EtOH	30,33±1,45a	23,83±1,16ab	21,67±2,51a
150 mM NaCl	24,33±0,88b	23,83±0,72ab	17,67±0,57b
150 mM NaCl+20 mM EtOH	26,50±0,28ab	21,83±0,60ab	18,67±1,51ab
150 mM NaCl+40 mM EtOH	22,33±1,30b	21,50±0,28ab	18,33±0,57ab

Table 2. The effects of EtOH and NaCl treatments on plant height, root length and number of leaves in pepper seedlings. The different lowercase letters are significantly different from each other ($P < 0.05$) among different treatment groups according to Tukey test.

Table 3 shows the effects of EtOH and NaCl treatments on fresh weights (FW) of root, shoot and leaves. 150 mM NaCl treatment decreased FW of root, shoot and leaves in all plants compare to the control. However, FW of root and shoot in plants treated with 20 mM EtOH + 150 mM NaCl are found to be higher compared to plants treated with 150 mM NaCl ($p < 0.05$).

Treatments	Leaf FW (g)	Shoot FW (g)	Root FW (g)
Control	13,14±1,36a	10,91±0,64a	11,95±0,36ab
20 mM EtOH	10,41±0,38b	8,96±0,48ab	9,90±0,80bc
40 mM EtOH	11,73±1,54ab	11,36±1,13a	13,23±1,41a
150 mM NaCl	10,24±0,98b	8,31±1,31b	10,45±1,10b
150 mM NaCl+20 mM EtOH	9,65±0,86c	8,54±0,47ab	11,10±0,61ab
150 mM NaCl+40 mM EtOH	8,10±1,03c	7,74±1,73b	8,14±1,48c

Table 3. Effects of EtOH and NaCl treatments on FW of root, shoot and leaves in pepper seedlings. The different lowercase letters are significantly different from each other ($P < 0.05$) among different treatment groups according to Tukey test.

NaCl treatment generally reduced dry weights (DW) of root, shoot and leaves of pepper seedlings. While the combined application of 150 mM NaCl + 40 mM EtOH decreased DW of the shoot and leaf compared to the 150 mM NaCl application alone, 150 mM NaCl + 20 mM EtOH treatment did not cause any significant change. However, the combined application of 150 mM NaCl and 20 mM EtOH increased the root dry weight ($p < 0.05$) (Table 4).

Treatments	Leaf DW (g)	Shoot DW (g)	Root DW (g)
Control	1,87±0,15a	1,58±0,07a	1,14±0,09ab
20 mM EtOH	1,36±0,04ab	1,26±0,03ab	0,81±0,05ab
40 mM EtOH	1,81±0,18a	1,69±0,13a	1,30±0,19a
150 mM NaCl	1,46±0,12ab	1,36±0,18ab	0,69±0,20b
150 mM NaCl+20 mM EtOH	1,46±0,08ab	1,41±0,06ab	1,10±0,07ab
150 mM NaCl+40 mM EtOH	1,05±0,13b	1,00±0,08b	0,72±0,05b

Table 4. Effects of EtOH and NaCl treatments on DW of root, shoot and leaves in pepper seedlings. The different lowercase letters are significantly different from each other ($P < 0.05$) among different treatment groups according to Tukey test.

B. Physiological parameters

Both combined and separate EtOH and NaCl treatments increased the contents of Chl a, total Chl and carotenoids and ratio of Chl a/b compared to the control and decreased the Chl b content. (Table 5 and 6). 150 mM NaCl treatment did not cause any significant change on total phenolic contents. However, 20 and 40 mM EtOH treatments decreased total phenolic content in plants exposed to salt stress ($p < 0.05$) (Table 5).

Treatments	Chl a (µg/g)	Chl b (µg/g)	Chl a/b
Control	4,53±0,12c	5,33±0,68a	0,90±0,16d
20 mM EtOH	11,72±0,28a	2,00±0,05bc	5,85±0,28c
40 mM EtOH	10,93±0,53b	2,15±0,10b	5,11±0,49c
150 mM NaCl	12,87±0,67a	1,83±0,09c	7,09±0,76a
150 mM NaCl+20 mM EtOH	11,96±0,17a	1,96±0,04c	6,09±0,18b
150 mM NaCl+40 mM EtOH	10,87±0,70b	2,17±0,15b	5,07±0,63c

Table 5. Effects of EtOH and NaCl treatments on contents of Chl a and Chl b and ratio of Chl a/b in pepper seedlings. The different lowercase letters are significantly different from each other ($P < 0.05$) among different treatment groups according to Tukey test.

Treatments	Total Chl ($\mu\text{g/g}$)	Carotenoids ($\mu\text{g/g}$)	Total Phenolic (mg/g)
Control	9,87 \pm 0,19b	1,58 \pm 0,19c	17,73 \pm 0,15ab
20 mM EtOH	13,72 \pm 0,28a	5,52 \pm 0,42ab	16,38 \pm 0,20c
40 mM EtOH	13,09 \pm 0,49a	7,23 \pm 0,64a	18,07 \pm 0,13a
150 mM NaCl	14,70 \pm 0,76a	2,97 \pm 0,32bc	17,55 \pm 0,20ab
150 mM NaCl+20 mM EtOH	13,93 \pm 0,18a	5,35 \pm 0,70ab	16,24 \pm 0,18c
150 mM NaCl+40 mM EtOH	13,05 \pm 0,63a	2,48 \pm 0,43bc	16,86 \pm 0,24bc

Table 6. Effects of EtOH and NaCl treatments on contents of Total Chl, Carotenoids and Total Phenolic in pepper seedlings. The different lowercase letters are significantly different from each other ($P<0.05$) among different treatment groups according to Tukey test.

CONCLUSIONS

According to the literature, EtOH pre-application increases plant stress tolerance in plants exposed to different stresses (Das et al. 2022; Rahman et al. 2022). Similar to that, salt stress decreased growth in pepper seedlings by negatively affecting all growth parameters. 20 mM EtOH pre-treatment had a positive effect on plant length, number of leaves, fresh and dry weights of root and shoot in salt-stressed plants. However, detailed studies are needed to elucidate the effects of ethanol on stress tolerance.

REFERENCES

- Ashraf, M., Mukhtar, N., Rehman, S., Rha, E.S., 2004. Salt-induced changes in photosynthetic activity and growth in a potential medicinal plant Bishops weed (*Ammi majus* L). *Photosynthetica*. 42 (4): 543-550.
- Çulha, Ş., Çakırlar, H., 2011. Tuzluluğun Bitkiler Üzerine Etkileri ve Tuz Tolerans Mekanizmaları, Afyon Kocatepe Üniversitesi Fen Bilimleri Dergisi. 11:11-34.
- Das AK, Anik TR, Rahman MM, Keya SS, Islam MR, Rahman MA, Sultana S, Ghosh PK, Khan S, Ahamed T, Ghosh TK, Tran LS, Mostofa MG. 2022. EtOH Treatment Enhances Physiological and Biochemical Responses to Mitigate Saline Toxicity in Soybean. *Plants* (Basel). 20;11(3):272.
- De-Kok, L., Graham, M., 1980. Levels of pigments, soluble proteins, amino acids and sulfhydryl compounds in foliar tissue of *Arabidopsis thaliana* during dark induced and natural senescence. *Plant Physiology and Biochemistry*. 27: 133-142.
- Kaya A. and İnan M. 2017. Tuz (NaCl) Stresine Maruz Kalan Reyhan (*Ocimum basilicum* L.) Bitkisinde Bazı Morfolojik, Fizyolojik ve Biyokimyasal Parametreler Üzerine Salisilik Asidin Etkileri, *Harran Tarım ve Gıda Bilimleri Dergisi*, 21(3): 332-342.
- Kaya, A. 2023. Ascorbate Alleviates Phytotoxic Effects of Enrofloxacin in Pepper (*Capsicum annuum*) Seedlings. *Russ J Plant Physiol* 70, 40.
- Kaya, A. and Doganlar Z.B. 2019. Melatonin improves the multiple stress tolerance in pepper (*Capsicum annuum*). *Scientia Horticulturae*, 256, 108509.

Lichtenthaler, K., Welburn, A.R., 1983. Determination of total carotenoids and chlorophylls a and b of leaf extracts in different solvents. *Botanisches Institut der Universität, Kaiserstrasse 12, Postfach* pp. 591-592.

Munns, R., 2003. Comparative physiology of salt and water stress. *Plant Cell & Environmental*. 25: 239–50.

Rahman, MM, Mostofa, MG, Das, AK, Anik, TR, Keya, SS, Ahsan, SM, Khan, MAR, Ahmed, M, Rahman, MA, Hossain, MM, et al. 2022. Ethanol Positively Modulates Photosynthetic Traits, Antioxidant Defense and Osmoprotectant Levels to Enhance Drought Acclimatization in Soybean. *Antioxidants*. 11, 516.

Singleton, VL., Orthofer, R. and Lamuela-Raventos, RM. 1999. Analysis of Total Phenols and Other Oxidation Substrates and Antioxidants by Means of Folin-Ciocalteu Reagent. *Methods in Enzymology*, 299, 152-178.

THE DYNAMIC DUO: EXPLORING THE SYNERGISTIC EFFECTS OF SOIL INVERTASE ACTIVITY AND BIOCHAR

Burak Koçak¹

¹ *Çukurova University, Faculty of Arts and Sciences, Department of Biology, Adana, Turkey*
Corresponding author e-mail: bkocak@cu.edu.tr

ABSTRACT

Soil enzymes have been recognized as crucial components of ecosystems since their initial report over a century ago. While enzymes in soil systems were initially used as descriptive parameters, they are now appreciated for their various properties in soil processes, microbial activities, and ecosystem responses to changes in management and climate. Invertase, an enzyme that plays a key role in the hydrolysis of sucrose into glucose and fructose, is present in microorganisms, plants, and animals. Biochar, a carbon-rich organic material obtained by carbonizing biomass such as manure, wood, or leaves at high temperatures between 300°C and 1000°C, has been applied for centuries to enhance agricultural soils, potentially leading to more sustainable plant production and reduced greenhouse gas emissions such as CO₂ or CH₄. Biochar can benefit soil microorganisms in numerous ways, including nutrient provision and protection from predators by adsorption in soil surfaces and pores. While the agricultural, economic, and practical applications of biochar have been extensively discussed in published books and book chapters, little information is available regarding the effects of biochar addition on soil invertase activity. The aim of this study was to investigate the impact of different biochar derived from various materials on invertase activity in soil based on the existing literature.

Keywords: Microbial activities, Biochar, Soil enzymes, Invertase, Soil microorganisms

INTRODUCTION

Soil enzymatic activities are one of the biological parameters for assessing soil fertility. The activity of a soil enzyme can serve as an indicator for various biological processes taking place in the soil. However, there is limited information available regarding the functions of soil enzymes in plant-soil systems and their responses to soil amendments (Antonious, 2003). Soil enzyme activities are of great interest to soil biologists and scientists as they provide valuable insights into the biogeochemical processes occurring in the soil. Moreover, they are useful for understanding the effects of anthropogenic management, such as agriculture and forestry, as well as pollution on soils. Additionally, these analyses are generally accurate and cost-effective to perform (Nannipieri et al., 2018).

Soil, as a living ecosystem, is a dynamic and complex entity that can be influenced by various factors, affecting its health and quality (Zhang et al., 2014). Soil enzymes and microorganisms are commonly used as biomarkers to assess the environmental quality of soils (Karlen et al., 1997; Sukul, 2006). Soil enzymes play active and crucial roles in catalyzing biochemical reactions, facilitating the mineralization and immobilization of organic matter, regulating nutrient cycling, removing pollutants, and providing energy for microorganisms and plants (Kizilkaya et al., 2004). Natural disturbances, climate change, and human activities often lead to changes or modifications in soil enzymatic activities (Gianfreda & Rao, 2008; Zhu et al., 2010) (Fig. 1). Additionally, soil microorganisms play a critical role in carbon (Cenkseven et al., 2017), nitrogen (Aka & Darici, 2005), and phosphorus (Barea & Richardson, 2015)

cycling, as well as the mineralization of organic residues (Kocak & Darici, 2016). It is evident that microorganisms residing in the soil ecosystem are highly susceptible to changes in the soil environment and are regarded as early warning indicators for monitoring soil health (Kocak & Cenkseven, 2021; Kocak & Darici, 2022; Nielsen et al., 2002).

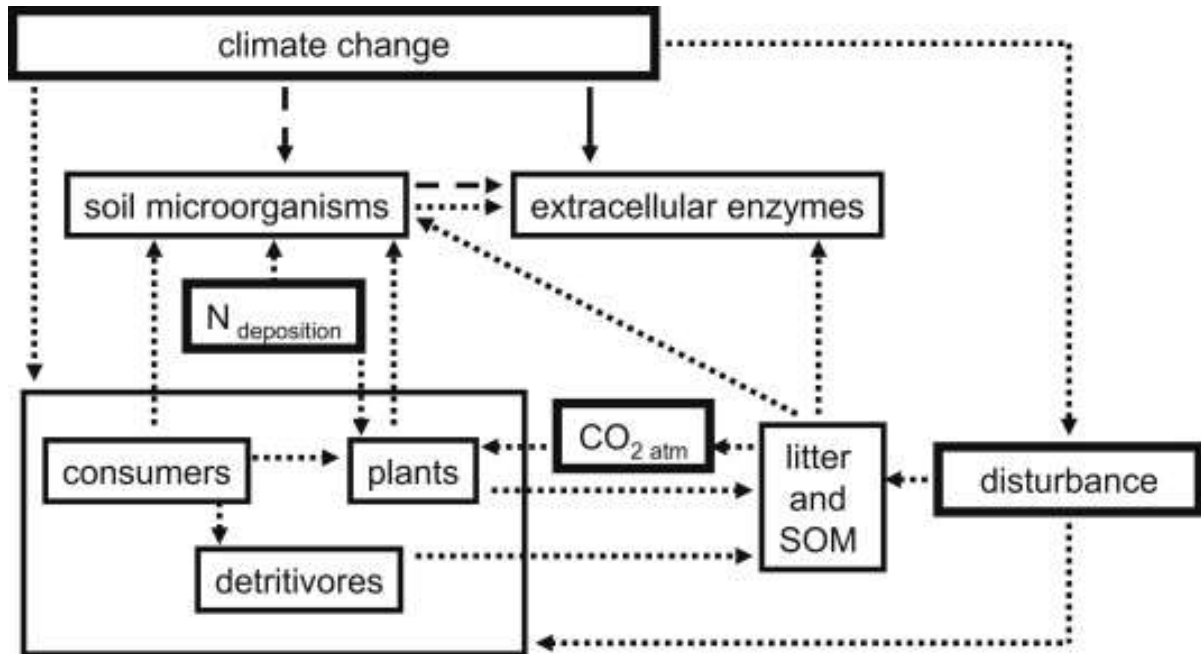

Figure 1. Effects of climate change on microorganisms and enzymatic activities in the soil ecosystems (Henry, 2012)

Biochar is a high-carbon product (Fig. 2) derived from various sources such as wood products (e.g., bark), industrial or organic residues (e.g., manure, purification sludge), and agricultural products (e.g., seeds, bark, leaves, stems). It is produced through pyrolysis, a process conducted under low or oxygen-depleted conditions (Razzaghi et al., 2020). When applied to soil, biochar can enhance the soil's organic carbon content, exhibiting long-term stability and reducing carbon release from the soil (Cross & Sohi, 2011). The high carbon content of biochar results in a negative charge, enabling it to sequester soil organic matter. As a consequence, it supports the accumulation of organic carbon in the soil, making biochar a sustainable energy source (Lehmann, 2007; Zhang et al., 2019). Additionally, biochar's ability to accumulate carbon in the soil helps mitigate CO₂ emissions into the atmosphere and contributes to mitigating the adverse effects of global warming due to its resistance to decomposition (Kocak & Ortas, 2021; Lehmann et al., 2021).

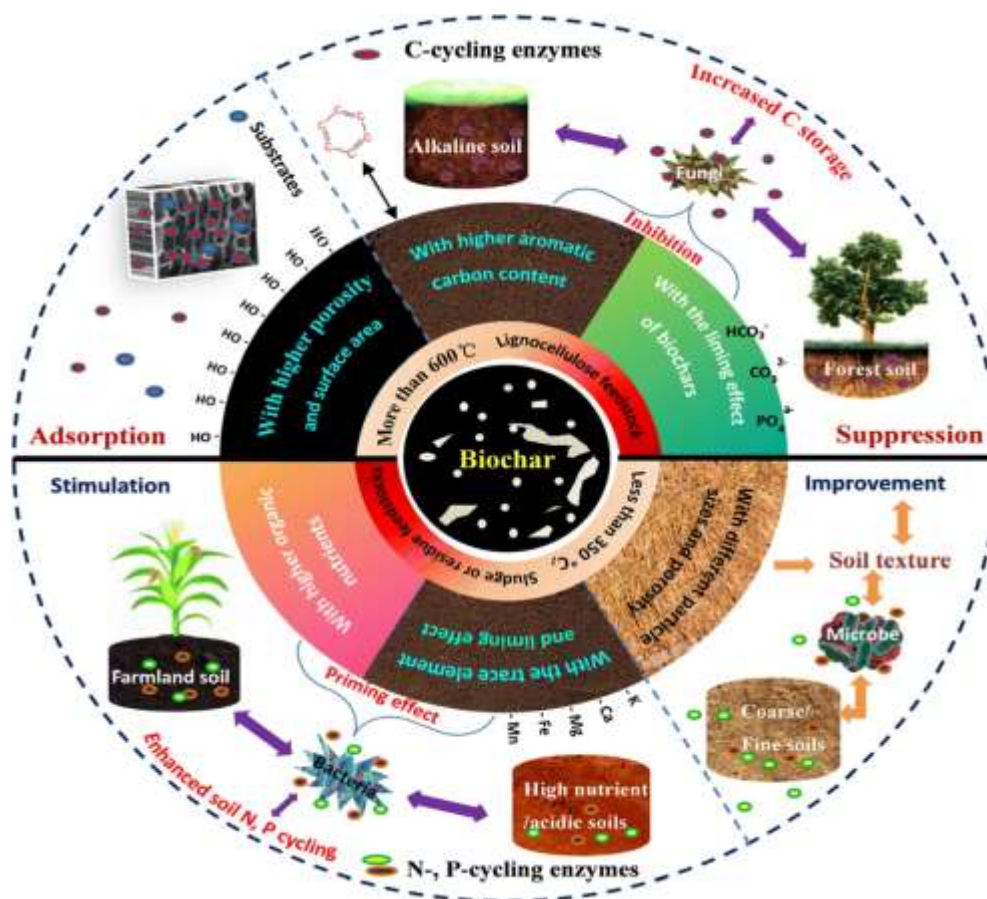

Figure 2. Effects of biochar on soil nutrient cycles and enzymatic activities (Zhang et al., 2019)

In this mini review, soil invertase activity, which is a considered as an important enzymatic activity in carbon metabolism, and effects of biochar on this activity were evaluated and discussed.

EXPLORING THE EFFECTS OF DIFFERENT ORGANIC SOURCES ON SOIL INVERTASE ACTIVITY

Invertase is a unique enzyme that catalyzes the conversion of sucrose into glucose and fructose. This enzyme is present in plants, animals, and microorganisms (Naga Raju et al., 2017). Sucrose is a crucial carbohydrate in plants, and therefore, invertase is among the soil enzymes that actively participate in litter decomposition (Ge et al., 2017).

In general, it has been observed that the introduction of organic sources into the soil stimulates soil invertase activity. Zi et al. (2022) reported that the addition of N and P (0, 10, 20, and 30 g m⁻² year⁻¹) increased soil urease activity in an alpine meadow in Hongyuan County, China. Zhu et al. (2022) indicated that the addition of *Bacillus* biofertilizer stimulated invertase activity in Cd-stressed soil in Xinjiang Province, China. Shen et al. (2022) found that three different forms of nitrogen [(NH₂)₂CO, NaNO₃, and NH₄Cl] stimulated soil invertase activity in an acidic soil in the Jiaodong Peninsula of China. Xie et al. (2021) observed that chicken manure and combinations of chicken manure with polyacrylamide, straw mulching, buried straw, and bio-organic manure significantly increased soil invertase activity compared to the control group with no treatment in an oat field in Jiangsu Province, eastern China. In another study, Xu et al. (2022) investigated the effect of exogenous indole-3-acetic acid (IAA) on the growth and development of ryegrass in cadmium (Cd)-contaminated soil and its impact on soil physiology, biochemistry, and microbial activity. The study found that Cd pollution increased

soil basal respiration and invertase and catalase activity, while decreasing fluorescein diacetate (FDA) hydrolase activity. The addition of exogenous IAA reduced soil basal respiration and increased FDA hydrolase activity, thus enhancing the survival of soil microorganisms. Xu et al. (2022) also found a negative correlation between soil invertase activity and soil FDA hydrolase activity. Furthermore, Iqbal et al. (2022) investigated the effect of adding cattle or poultry manure to chemical fertilizers on soil invertase activity. The study revealed that the addition of manure significantly increased soil enzymatic activities, including soil invertase, compared to solely applying chemical fertilizer. Overall, the addition of organic sources to soils generally stimulates soil invertase activity.

EFFECTS OF BIOCHAR ON SOIL INVERTASE ACTIVITY

In a subtropical Moso bamboo forest, Zhang et al. (2023) found that urea applications at rates of 100 and 300 kg N ha⁻¹ increased soil invertase activity, while biochar-based urea applications at the same rates significantly decreased this enzyme activity. In the study, soil invertase activity showed correlation with CO₂ emissions and was associated with N₂O emissions (P<0.05), without considering the urea and biochar-based urea treatments (Zhang et al., 2023).

In another study on Cd-contaminated soils, Zhu et al. (2022) discovered that the addition of cotton straw biochar at a rate of 3% (w/w) significantly increased invertase activity by 17.51% (P<0.05) compared to the control. The authors suggested that cotton straw biochar may have created a beneficial soil environment for the development of soil microorganisms (Zhu et al., 2022).

Furthermore, Zhou et al. (2022) investigated the combined effects of bacterivorous nematodes and organic materials on microbial activities in petroleum-contaminated soils. They reported that the addition of 1% biochar and nematodes stimulated soil invertase activity by 12.4% compared to the control group with no treatment (Zhou et al., 2022).

In an orchard experiment conducted in Zhejiang Province, China, Song et al. (2022) found that a combination of rice straw biochar and an organic-inorganic fertilizer (4 kg biochar + 1.7 kg organic-inorganic mixed fertilizer per plant) increased soil invertase activity by 41% compared to the control treatment without biochar and fertilizer.

In another study, Sial et al. (2022) obtained walnut shells biochar at three different temperatures [300 °C (WSB-300), 450 °C (WSB-450), or 600 °C (WSB-600)] and incorporated them into soil incubation for 120 days with a constant treatment of 1.5% (w/w). The percentage increase in invertase activity, compared to the control treatment, followed the order: WSB-300 (9.7%) < WSB-450 (19.0%) < WSB-600 (29.4%).

Furthermore, Mei et al. (2022) investigated the combined effects of rice straw biochar and *Bacillus cereus* RC-1 on soil urease activity in a 120-day incubation experiment on a Cd-contaminated paddy soil. The study revealed that all treatments (control, sole biochar, sole *Bacillus cereus* RC-1, and combination of biochar and soil microorganism) increased invertase activity in the soil by 21.13% to 31.20%.

In a winter wheat field experiment conducted in Shannxi province, China, Li et al. (2022) found that straw biochar, pyrolyzed at temperatures ranging from 350 °C to 550 °C and applied at a rate of 4000 kg ha⁻¹ resulted in the highest soil invertase activity compared to the control and other non-pyrolyzed straw incorporations. The authors of the study additionally claimed that the incorporation of biochar significantly increased soil enzymatic activities at different growing stages.

In a 90-day incubation experiment, Khan et al. (2022) investigated the effects of pristine and Mg-modified rice-straw biochar (RBC and MRBC), pyrolyzed at 350 °C, at different application rates (0%, 1%, and 2.5%). They observed that MRBC2.5 > RBC2.5 > MRBC1 >

RBC1 > Control (0%) in terms of the increase in soil invertase activity. The authors suggested that the addition of both RBC and MRBC increased soil pH, which was beneficial for soil enzymatic activities.

Furthermore, Zheng et al. (2021) found that different straw biochar amendments, pyrolyzed at 500 °C and added at rates of 0, 2, 10, and 50 g/kg dry soil, increased soil invertase activities in a tobacco pot experiment compared to the control. The authors suggested that the addition of biochar may have increased soil enzymatic activity and affected bacterial community populations by increasing the levels of soil organic carbon and nitrogen.

In another study conducted in a subtropical Moso bamboo plantation, Zhang et al. (2021) investigated the effects of chemical fertilizer (CF), biochar-based fertilizer (BF) derived from the same chemical fertilizer (pyrolyzed at 500 °C), and a mixture of these fertilizers (BCF) on soil invertase activity. They reported that CF and BCF treatments significantly increased soil invertase activity by 15% and 9.5%, respectively, compared to the control with no treatments. In contrast, BF application significantly reduced soil invertase activity by 8.2% in the same study (Zhang et al., 2021).

CONCLUSIONS

Microorganisms play a vital role in the soil by driving nutrient cycles, enabling plants to utilize essential macro and micro elements. Without their activity, plants would be unable to access these nutrients. Conversely, plants are responsible for supplying carbon and energy to the soil. Without their presence, soil would consist solely of mineral particles resulting from the weathering of parent material and rocks. Additionally, soils serve not only as a substrate for plants but also as a habitat for microorganisms, as well as micro, meso, and macrofauna. Soil enzymes are crucial for the decomposition of organic matter and the breakdown of toxic substances within soil ecosystems. In this study, it was observed that biochar derived from organic sources generally stimulated soil invertase activity. Overall, when incorporated into the soil, biochar has the ability to regulate the physical, chemical, and biological properties of the soil. As a result, it has positive effects on soil bacterial and fungal communities, promoting soil invertase activities.

REFERENCES

- Aka, H., C. Darici. 2005. Carbon and Nitrogen Mineralization in Carob Soils with Kermes Oak and Aleppo Pine Leaf Litter. *European Journal of Soil Biology*, 41(1-2), 31-38.
- Antonious, G. F. 2003. Impact of Soil Management and Two Botanical Insecticides on Urease and Invertase Activity. *Journal of Environmental Science and Health Part B-Pesticides Food Contaminants and Agricultural Wastes*, 38(4), 479-488.
- Barea, J.-M., A. E. Richardson. 2015. Phosphate Mobilisation by Soil Microorganisms. In B. Lugtenberg (Ed.), *Principles of Plant-Microbe Interactions: Microbes for Sustainable Agriculture* (pp. 225-234). Springer International Publishing. https://doi.org/10.1007/978-3-319-08575-3_24
- Cenkseven, S., B. Kocak, S. B. Kuzu, H. Korkmaz-Guvenmez, C. Darici. 2017. Response of Microbial Activity to Addition of Nerium Oleander L. Leaves in Soil under Different Moisture Conditions. *Fresenius Environmental Bulletin*, 26(12a), 377-385.
- Cross, A., S. P. Sohi. 2011. The Priming Potential of Biochar Products in Relation to Labile Carbon Contents and Soil Organic Matter Status. *Soil Biology & Biochemistry*, 43(10), 2127-2134.
- Ge, X. G., W. F. Xiao, L. X. Zeng, Z. L. Huang, B. Z. Zhou, M. Schaub, M. H. Li. 2017. Relationships Between Soil-Litter Interface Enzyme Activities and Decomposition in *Pinus massoniana* plantations in China. *Journal of Soils and Sediments*, 17(4), 996-1008.
- Gianfreda, L., M. A. Rao. 2008. Interactions Between Xenobiotics And Microbial And Enzymatic Soil Activity. *Critical Reviews in Environmental Science and Technology*, 38(4), 269-310.
- Henry, H. A. L. 2012. Soil Extracellular Enzyme Dynamics in a Changing Climate. *Soil Biology & Biochemistry*, 47, 53-59.

- Iqbal, A., H. Liang, S. G. McBride, P. L. Yuan, I. Ali, M. Zaman, M. Zeeshan, R. Khan, K. Akhtar, S. Q. Wei, Z. X. Guo, L. G. Jiang. 2022. Manure Applications Combined with Chemical Fertilizer Improves Soil Functionality, Microbial Biomass and Rice Production in a Paddy Field. *Agronomy Journal*, 114(2), 1431-1446.
- Karlen, D. L., M. J. Mausbach, J. W. Doran, R. G. Cline, R. F. Harris, G. E. Schuman. 1997. Soil Quality: A Concept, Definition, and Framework for Evaluation. *Soil Science Society of America Journal*, 61(1), 4-10.
- Khan, M. N., D. C. Li, A. Shah, J. Huang, L. Zhang, A. Nunez-Delgado, T. F. Han, J. X. Du, S. Ali, T. A. Sial, Z. L. Lan, S. Hayat, Y. Song, Y. J. Bai, H. M. Zhang. 2022. The Impact of Pristine and Modified Rice Straw Biochar on the Emission of Greenhouse Gases from a Red Acidic Soil. *Environmental Research*, 208.
- Kizilkaya, R., T. Askin, B. Bayrakli, N. Saglam. 2004. Microbiological characteristics of soils contaminated with heavy metals. *European Journal of Soil Biology*, 40(2), 95-102.
- Kocak, B., S. Cenkseven. 2021. Effects of Three Commonly Used Herbicides in Maize on Short-Term Soil Organic Carbon Mineralization. *Water Air and Soil Pollution*, 232(9).
- Kocak, B., C. Darici. 2016. Priming effects of leaves of *Laurus nobilis* L. and 1,8-cineole on carbon mineralization. *Chilean Journal of Agricultural Research*, 76(1), 100-104.
- Kocak, B., C. Darici. 2022. How Did Soil Depth and Sampling Time Influence on Soil Organic Carbon, Soil Nitrogen, and Soil Biological Properties in a Mediterranean Olive Grove? *Communications in Soil Science and Plant Analysis*, 53(1), 30-44.
- Kocak, B., I. Ortas. 2021. Short-Term Eucalyptus and Phragmites Biochar's Efficiency in Mineralization of Soil Carbon. *Journal of Soil Science and Plant Nutrition*, 21(4), 3346-3353.
- Lehmann, J. 2007. A handful of carbon. *Nature*, 447(7141), 143-144.
- Lehmann, J., A. Cowie, C. A. Masiello, C. Kammann, D. Woolf, J. E. Amonette, M. L. Cayuela, M. Camps-Arbestain, T. Whitman. 2021. Biochar in Climate Change Mitigation. *Nature Geoscience*, 14(12), 883- 892.
- Li, Y., H. Feng, J. Chen, J. S. Lu, W. J. Wu, X. Z. Liu, C. Li, Q. E. Dong, K. H. M., Siddique. 2022. Biochar Incorporation Increases Winter Wheat (*Triticum aestivum* L.) Production with Significantly Improving Soil Enzyme Activities at Jointing Stage. *Catena*, 211.
- Mei, C., H. Wang, K. Z. Cai, R. B., Xiao, M. L., Xu, Z. S. Li, Z. Y. Zhang, J. Y. Cui, F. Huang, 2022. Characterization of Soil Microbial Community Activity and Structure For Reducing Available Cd by Rice Straw Biochar and *Bacillus cereus* RC-1. *Science of the Total Environment*, 839, 156202.
- Naga Raju, M., N. Golla, R. Vengatampalli. 2017. Soil Invertase. In *Soil Enzymes: Influence of Sugar Industry Effluents on Soil Enzyme Activities* (pp. 41-46). Springer International Publishing.
- Nannipieri, P., C. Trasar-Cepeda, R. P. Dick. 2018. Soil Enzyme Activity: A Brief History and Biochemistry As A Basis For Appropriate Interpretations And Meta-Analysis. *Biology and Fertility of Soils*, 54(1), 11-19.
- Nielsen, M. N., A. Winding, S. J. Binnerup, B. M. Hansen, N. B. Hendriksen, N. Kroer. 2002. Microorganisms as Indicators of Soil Health.
- Razzaghi, F., P. B. Obour, E. Arthur. 2020. Does Biochar Improve Soil Water Retention? A Systematic Review and Meta-Analysis. *Geoderma*, 361, 114055.
- Shen, Y. W., W. S. Gao, H. T. Lin, X. Z. Song, P. Liu, M. L. Li, J. Q. Chen. 2022. Effects of Byproduct Amendments and Nitrogen on Carbon Mineralization and Soil Enzyme Activities in Acidic Brown Soil from Jiaodong Peninsula of China. *Communications in Soil Science and Plant Analysis*, 53(19), 2608-2621.
- Sial, T. A., S. M. Shaheen, Z. L. Lan, P. K. Korai, M. I. Ghani, M. N. Khan, A. U. A. Syed, M. N. H. A. Ali, I. Rajpar, M. Memon, S. M. Bhatti, H. Abdelrahman, E. F. Ali, J. Rinklebe, J. G. Zhang. 2022. Addition of Walnut Shells Biochar to Alkaline Arable Soil Caused Contradictory Effects on CO₂ and N₂O Emissions, Nutrients Availability, and Enzymes Activity. *Chemosphere*, 293, 133476.
- Song, Y., Q. Zhao, X. Z. Guo, I. Ali, F. Y. Li, S. S. Lin, D. F. Liu. 2022. Effects of Biochar and Organic-Inorganic Fertilizer on Pomelo Orchard Soil Properties, Enzymes Activities, and Microbial Community Structure. *Frontiers in Microbiology*, 13.

- Sukul, P. 2006. Enzymatic Activities and Microbial Biomass in Soil as Influenced by Metalaxyl Residues. *Soil Biology & Biochemistry*, 38(2), 320-326.
- Xie, X. F., L. J. Pu, M. Zhu, M. Meadows, L. C. Sun, T. Wu, X. G. Bu, Y. Xu. 2021. Differential Effects of Various Reclamation Treatments on Soil Characteristics: An Experimental Study of Newly Reclaimed Tidal Mudflats on the East China Coast. *Science of the Total Environment*, 768, 144996.
- Xu, X. Y., J. H. Zhou, K. Chen, Y. Wang, Y. M. Ai, C. Y. Zhang, S. B. Zhou. 2022. Effect of Indole-3-Acetic Acid Supplementation on the Physiology of *Lolium perenne* L. and Microbial Activity in Cadmium-Contaminated Soil. *Environmental Science and Pollution Research*, 29(35), 52483-52492.
- Zhang, L. Y., Y. Z. Xiang, Y. M. Jing, R. D. Zhang. 2019. Biochar Amendment Effects on the Activities of Soil Carbon, Nitrogen, And Phosphorus Hydrolytic Enzymes: A Meta-Analysis. *Environmental Science and Pollution Research*, 26(22), 22990-23001.
- Zhang, Q. M., L. S. Zhu, J. Wang, H. Xie, J. H. Wang, F. H. Wang, F. X. Sun. 2014. Effects of Fomesafen on Soil Enzyme Activity, Microbial Population, and Bacterial Community Composition. *Environmental Monitoring and Assessment*, 186(5), 2801-2812.
- Zhang, S. B., Y. F. Li, B. P. Singh, H. L. Wang, X. Q. Cai, J. H. Chen, H. Qin, Y. C. Li, S. X. Chang. 2021. Contrasting Short-Term Responses of Soil Heterotrophic and Autotrophic Respiration to Biochar-Based and Chemical Fertilizers in a Subtropical Moso Bamboo Plantation. *Applied Soil Ecology*, 157, 103758.
- Zhang, S. B., J. S. Zhou, J. Chen, T. D. Ge, Y. J. Cai, B. Yu, H. L. Wang, J. C. White, Y. F. Li. 2023. Changes in Soil CO₂ and N₂O Emissions in Response to Urea and Biochar-Based Urea in a Subtropical Moso Bamboo Forest. *Soil & Tillage Research*, 228, 105625.
- Zheng, J. Y., J. X. Zhang, L. Gao, R. Wang, J. M. Gao, Y. C. Dai, W. Li, G. M. Shen, F. Y. Kong, J. G. Zhang. 2021. Effect of Straw Biochar Amendment on Tobacco Growth, Soil Properties, and Rhizosphere Bacterial Communities. *Scientific Reports*, 11(1): 20727.
- Zhou, J. H., Y. Wang, G. M. Huang, C. Y. Zhang, Y. M. Ai, W. Li, X. P. Li, P. J. Zhang, J. Zhang, Y. J. Huang, S. B. Zhou, J. Y. Zheng. 2022. Variation of Microbial Activities and Communities in Petroleum-Contaminated Soils Induced by the Addition of Organic Materials and Bacterivorous Nematodes. *Ecotoxicology and Environmental Safety*, 237, 113559.
- Zhu, W., L. Liu, P. Zou, L. Xiao, L. Y. Yang. 2010. Effect of Decabromodiphenyl Ether (BDE 209) on Soil Microbial Activity and Bacterial Community Composition. *World Journal of Microbiology & Biotechnology*, 26(10):1891-1899.
- Zhu, Y. Q., X. Lv, J. H. Song, W. D. Li, H. J. Wang. 2022. Application of Cotton Straw Biochar and Compound Bacillus Biofertilizer Decrease the Bioavailability of Soil Cd Through Impacting Soil Bacteria. *Bmc Microbiology*, 22(1):35.
- Zi, H. B., L. Hu, C. T. Wang. 2022. Differentiate Responses of Soil Microbial Community and Enzyme Activities to Nitrogen and Phosphorus Addition Rates in an Alpine Meadow. *Frontiers in Plant Science*, 13:141.

WHEAT BIOFORTIFICATION IN TURKEY: CURRENT STATUS, CHALLENGES, AND PROMISING OPPORTUNITIES

Elif ÖZTÜRK¹, Bhaskara Anggarda Gathot SUBRATA^{1,2*}, İsmail SEZER¹, Hasan AKAY¹

¹ Department of Field Crops, Faculty of Agriculture, Ondokuz Mayıs University, Kurupelit, 55139 Samsun, Turkey

² Department of Agronomy, Faculty of Agriculture, Gadjah Mada University, Bulaksumur, 55281, Yogyakarta, Indonesia

Corresponding author e-mail: bhaskara.anggarda@mail.ugm.ac.id

ABSTRACT

Wheat biofortification is a promising strategy to address nutrient deficiencies and improve nutrition security in Turkey. This comprehensive review analyzes wheat biofortification's current status, challenges, and opportunities in Turkey. The findings demonstrate the potential of biofortified wheat varieties in delivering essential micronutrients to vulnerable populations, thereby improving public health outcomes. Interdisciplinary collaborations among researchers, breeders, policymakers, and farmers are crucial to developing and disseminating locally tailored biofortified wheat varieties. Optimization of breeding strategies ensures high nutritional quality, yield potential, and agronomic suitability across diverse regions of Turkey. Farmer engagement, capacity building, and knowledge dissemination through extension services are essential to promote awareness and acceptance of biofortified wheat. Active involvement of farmers in the development and evaluation process, along with training programs and knowledge exchange, facilitates widespread adoption. Integrating biofortification with sustainable agricultural practices and crop management techniques enhances wheat production systems' nutritional value and climate resilience. Overall, this review emphasizes the significance of wheat biofortification as a solution to nutrient deficiencies, highlighting the importance of interdisciplinary collaborations, farmer engagement, and sustainable approaches.

Keywords: Wheat biofortification, Nutrient deficiencies, Nutrition security, Interdisciplinary collaborations, Farmer engagement

INTRODUCTION

Biofortification is a strategy to improve the nutritional quality of staple crops by increasing their concentration of essential micronutrients, such as iron (Fe), zinc (Zn), and selenium (Se) (Szerement et al., 2021). Biofortification can be achieved through agronomic practices, conventional breeding, or genetic engineering. Biofortification can potentially reduce the prevalence of micronutrient deficiencies, especially in developing countries where cereal-based diets are predominant and dietary diversification is limited (Gupta et al., 2020).

Wheat is one of the most important cereal crops and a major source of calories and protein for millions of people worldwide. Turkey is the seventh-largest wheat producer and the fourth-largest wheat exporter globally (Xu et al., 2023). Wheat accounts for about 40% of the total cultivated area and 20% of Turkey's agricultural gross domestic product (Ozkan et al., 2004). However, wheat production and consumption in Turkey face several challenges, such as climate change, soil degradation, pests and diseases, low productivity, and poor quality. Moreover, wheat grains grown in Turkey have low Fe, Zn, and Se levels, contributing to the high prevalence of micronutrient malnutrition among the Turkish population, especially children and women (Hincal, 2007).

Biofortification of wheat in Turkey faces specific challenges and opportunities. Evaluating the current status and identifying strategies to overcome barriers for successful implementation is essential. Challenges may include selecting appropriate biofortified wheat varieties suitable for local conditions, ensuring farmer adoption and acceptance, and establishing effective delivery mechanisms to reach the target populations. Moreover, it is important to consider the socio-economic and cultural factors influencing the acceptance and utilization of biofortified wheat. This review paper will provide a comprehensive analysis of the current state of wheat biofortification in Turkey, identify the challenges involved, and explore promising opportunities for scaling up biofortification efforts to improve wheat's nutritional value and effectively address micronutrient deficiencies.

WHEAT PRODUCTION AND CONSUMPTION IN TURKEY

Wheat is a staple crop in Turkey, as it is the main ingredient of bread consumed daily by most of the population. Wheat also has a cultural and historical significance, as it was one of the first crops cultivated in Anatolia, the Asian part of Turkey. Wheat accounts for about 60% of the total cereal production in Turkey and is grown in almost every region of the country. According to the US Department of Agriculture (USDA), Turkey is expected to produce 17 million tonnes of wheat in 2022-23, up from 16 million tonnes in 2021-22. This increase is due to improved weather conditions expected to boost yields. However, wheat production is still below domestic consumption, forecast at 21 million tonnes in 2022-23, up from 20.6 million tonnes in 2021-22. The rising consumption is driven by increasing household demand for wheat-based products, such as bread, pasta, biscuits and cakes.

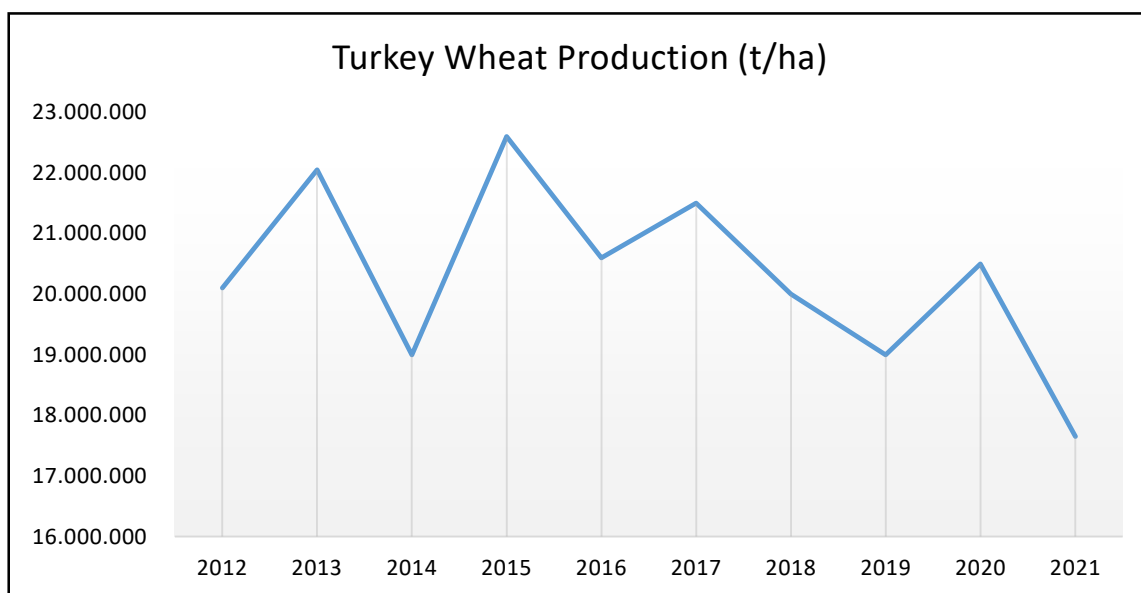

Figure 25. Turkey wheat production 2012-2021 (t/ha) (FAOSTAT, 2023)

The role of wheat in Turkish diets is equally noteworthy. Turkey has a per capita wheat consumption rate of approximately 190 kilograms per year, demonstrating the profound reliance on this grain in daily nutrition (Pekcan & Karaagaoglu, 2000). Wheat-based products such as bread, pasta, and traditional dishes like "pide" and "lahmacun" are dietary staples people of all ages and backgrounds enjoy. This heavy reliance on wheat places it at the core of the Turkish culinary heritage, emphasizing the importance of addressing any nutritional deficiencies that may arise from the wheat-centric diet.

Turkey imports wheat from various countries, mainly Russia and Ukraine, to meet the domestic demand. In 2022-23, wheat imports are projected to reach 11 million tonnes, up from 10 million tonnes in 2021-22 (Oxford, 2022). Turkey also re-exports some imported wheat as

processed products, such as flour and pasta. Turkey is the world's largest flour exporter, with Iraq being the leading destination. In 2022-23, wheat exports are expected to reach 6.65 million tonnes, up from 6.55 million tonnes in 2021-22 (Reidy, 2022). Wheat has a nutritional significance in the Turkish diet, providing carbohydrates, protein, fiber, vitamins, and minerals. Wheat also has health benefits, such as lowering cholesterol, blood pressure, and blood sugar levels and preventing constipation and obesity. However, excessive wheat consumption may cause some adverse effects, such as gluten intolerance, inflammation, and weight gain.

MICRONUTRIENT DEFICIENCIES AND BIOFORTIFICATION STRATEGIES IN TURKEY

Micronutrient deficiencies are a major public health problem in many developing countries, affecting millions of people's growth, development, and well-being. One of the most prevalent micronutrient deficiencies is zinc (Zn) deficiency, which impairs the immune system, increases the risk of infections and contributes to stunting and mortality in children (Kiran et al., 2022). Wheat is a staple food crop in Turkey, providing more than 50% of the daily energy intake and 40% of the protein intake for the population. However, wheat grown in Turkey is often low in Zn concentration due to the country's widespread occurrence of Zn-deficient soils (Cakmak & Kutman, 2018). According to a survey conducted by (Cakmak, 2008), about 70% of the arable land in Turkey has less than 0.4 mg kg^{-1} of DTPA-extractable Zn, which is considered the critical level for wheat production. Zn deficiency in wheat reduces crop yield and quality and affects the Zn status of consumers, especially those who rely on wheat as their primary source of Zn (Rehman et al., 2017).

The health implications and socioeconomic costs associated with Zn deficiency are significant. Zn deficiency is estimated to cause about 800,000 deaths per year worldwide, mostly among children under five years old (Ackland & Michalczyk, 2016). In Turkey, Zn deficiency is associated with an increased incidence of diarrhoea, pneumonia, malaria, and other infectious diseases and impaired cognitive development and learning outcomes in children (Cakmak, 2008). Zn deficiency also reduces the productivity and income of farmers and workers, leading to economic losses and poverty. A study by (Cakmak, 2008) estimated that the annual economic benefits from Zn wheat fertilization in Turkey are about US\$100 million, based on the increased grain yield and reduced seeding rate.

Biofortification is a promising strategy to increase the micronutrient content of staple food crops, such as wheat, and to improve the micronutrient status of consumers. Biofortification can be achieved by different approaches, including agronomic, genetic, and breeding methods. Agronomic biofortification involves the application of micronutrient fertilizers or foliar sprays to enhance the uptake and accumulation of micronutrients in the edible parts of plants (Szerement et al., 2021). Genetic biofortification exploits the natural variation in micronutrient concentration among different genotypes or species of plants and selects or introduces those with higher micronutrient levels (Kumar et al., 2017). Breeding biofortification combines agronomic and genetic methods to develop new varieties of crops with improved micronutrient traits.

The selection of appropriate biofortification methods for wheat in Turkey depends on several factors, such as the availability and cost of micronutrient fertilizers, the adoption rate and preference of farmers and consumers, the environmental conditions and soil characteristics, and the genetic potential and diversity of wheat germplasm (Saltzman et al., 2017). Agronomic biofortification with Zn fertilizers is effective and profitable in increasing wheat grain yield and Zn concentration in Turkey (Cakmak, 2008). However, this method requires continuous application of fertilizers and may have negative environmental impacts due to leaching or runoff of excess nutrients. Genetic biofortification with Zn-efficient or Zn-enriched wheat varieties may offer a more sustainable and long-term solution to Zn deficiency (Jaiswal et al.,

2022). However, this method requires more research and development efforts to identify or create suitable genotypes that perform well under different agroecological conditions and consumer preferences. Breeding biofortification may combine the advantages of both agronomic and genetic methods by using Zn fertilizers as a selection tool to enhance the expression of desirable micronutrient traits in wheat plants.

CURRENT STATUS OF WHEAT BIOFORTIFICATION IN TURKEY

In Turkey, both genetic and agronomic biofortification strategies have been implemented for wheat in recent years, with promising results. For genetic biofortification, several research projects have been conducted by national and international institutions, such as Sabanci University, International Center for Agricultural Research in the Dry Areas (ICARDA), International Maize and Wheat Improvement Center (CIMMYT), HarvestPlus Program, and Ministry of Agriculture and Forestry. These projects have identified wheat genotypes with high zinc and iron concentrations in their grains, using screening methods based on atomic absorption spectrometry (AAS), X-ray fluorescence (XRF), or near-infrared reflectance spectroscopy (NIRS). Some of these genotypes have been released as new varieties or used as parents in breeding programs. For example, 'Zinco', 'Demir2000', 'Demir99', 'Sahin', 'Kiziltan', 'Karatopak', 'Gerek79', and 'Seri82' are some of the wheat varieties that have been developed or registered for high zinc and/or iron content in Turkey.

According to a recent review by (Mishra et al., 2022), Turkey has participated in several international projects on wheat biofortification, such as HarvestPlus and AgroSalud, which aim to develop and disseminate zinc-enriched wheat varieties using conventional and molecular breeding approaches. Moreover, Turkey has conducted extensive field trials and experiments to evaluate zinc fertilization's effects on wheat yield, quality, and human health outcomes (Cakmak, 2009; Cakmak et al., 2010, 2017; Rehman et al., 2017). For example, (Niyigaba et al., 2019) reported that foliar zinc application significantly increased grain zinc concentration from 27 mg kg⁻¹ to 48-49 mg kg⁻¹ across seven countries, including Turkey. Furthermore, Turkey has established a national biofortification program, which involves collaboration among various stakeholders, such as farmers, extension agents, seed companies, policymakers, and consumers, to promote the adoption and consuming biofortified wheat varieties.

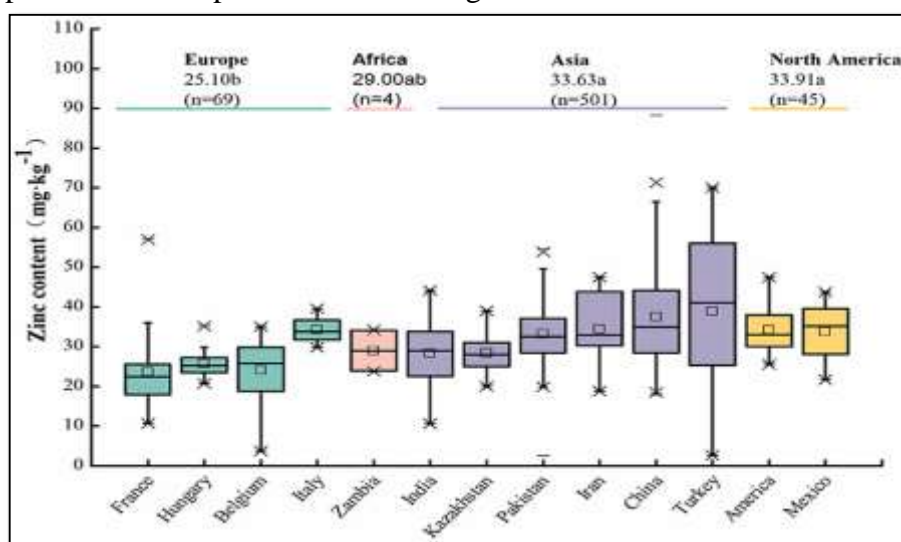

Figure 26. Zinc content of wheat among different countries and continents (Wang et al., 2020)

The findings on the levels of key micronutrients in wheat varieties cultivated in Turkey are promising but variable. (Wang et al., 2020) summarized the results of several studies that measured the iron and zinc concentrations in different wheat genotypes grown in Turkey under different soil and climatic conditions. They found that the average iron concentration ranged from 28 to 46 mg kg⁻¹, while the average zinc concentration ranged from 24 to 40 mg kg⁻¹. These values are higher than the global averages of 20 mg kg⁻¹ for iron and 17 mg kg⁻¹ for zinc (Cakmak, 2008). However, they also noted a large variation among genotypes, locations and years, indicating that genetic and environmental factors influence the micronutrient content of wheat grains.

CHALLENGES IN WHEAT BIOFORTIFICATION IN TURKEY

Wheat biofortification is a strategy to increase the micronutrient content of wheat grains, especially iron (Fe) and zinc (Zn), to improve the population's nutritional status. Wheat is one of the major staple crops in Turkey, where micronutrient deficiency is a public health problem affecting millions of people, especially children and women. However, wheat biofortification faces several challenges in Turkey, such as:

Soil quality: The availability and uptake of Fe and Zn by wheat plants depend on the soil properties, such as pH, organic matter, and cation exchange capacity (Dhaliwal et al., 2019). Turkey has diverse soil types, ranging from calcareous to acidic, affecting micronutrients' mobility and solubility (Cetin, 2016). Therefore, wheat biofortification requires soil-specific management practices to optimize plant micronutrient supply.

Crop management: The agronomic practices, such as fertilization, irrigation, and pest control, also influence the micronutrient content of wheat grains (Verma et al., 2023). For example, spraying Zn fertilizer at the grain development stage improved grain Zn concentration by 68% (Wu et al., 2020). However, farmers' adoption of these practices may be limited by the availability, affordability, and accessibility of inputs and technologies. Moreover, crop management should also consider the trade-offs between yield and quality, as some practices may increase micronutrients but reduce grain size or protein content.

Awareness among farmers and consumers: The success of wheat biofortification depends on farmers' and consumers' acceptance and demand for biofortified wheat varieties. Farmers need to know the benefits of growing biofortified wheat, such as improved crop performance, higher market value, and lower production costs. Consumers must be aware of the health benefits of consuming biofortified wheat products, such as reduced risk of anemia, stunting, and infections. However, awareness and knowledge about wheat biofortification are still low among both farmers and consumers in Turkey. Therefore, effective communication and extension strategies are needed to promote wheat biofortification and increase its adoption and consumption.

PROMISING OPPORTUNITIES AND INNOVATIONS

Wheat biofortification is a strategy to improve the nutritional quality of wheat grains by increasing the concentration of micronutrients such as iron (Fe) and zinc (Zn), which are essential for human health and development. Wheat is a major staple crop and food source for many people in Turkey and other developing countries, where micronutrient deficiency and hidden hunger are widespread problems affecting children, women, and vulnerable groups. Recent research and innovations in wheat biofortification techniques include exploiting natural genetic variation among wheat varieties and wild relatives, using conventional breeding and transgenic technology, applying agronomic practices such as fertilization and irrigation, and enhancing post-harvest processing and storage methods.

Potential collaborations between research institutions, government agencies, and agricultural stakeholders are needed to strengthen the value chain of biofortified wheat, increase the adoption and dissemination of biofortified wheat varieties, evaluate the impact of biofortification on nutritional outcomes and health benefits, and raise awareness and demand among consumers and policymakers. According to a recent study, genetic biofortification has more potential than agronomic biofortification in increasing wheat grains' Fe and Zn contents in Turkey, with an average increase of 74% and 79%, respectively (Cakmak, 2008, 2009; Cakmak et al., 2010, 2017; Cakmak & Kutman, 2018). Another study reported that durum wheat (*Triticum durum*), widely used for pasta production in Turkey, can be biofortified with Fe and Zn using natural genetic diversity or transgenic approaches (Hocaoğlu et al., 2020).

FUTURE DIRECTIONS AND POLICY IMPLICATIONS

Wheat biofortification is a promising strategy to improve the nutritional status of millions of people who suffer from micronutrient deficiencies, especially iron and zinc. Wheat is one of the major staple crops in Turkey, where about 20% of children under five years old and 30% of women of reproductive age are anemic. Therefore, increasing wheat grains' iron and zinc content through agronomic or genetic approaches can have significant health and economic benefits for the Turkish population.

However, wheat biofortification faces several challenges that need to be addressed by future research and policy measures. Some of these challenges are: (a) identifying and developing wheat varieties with high micronutrient density and agronomic performance, (b) evaluating the bioavailability and bioefficacy of the micronutrients in biofortified wheat products, (c) assessing the consumer acceptance and willingness to pay for biofortified wheat products, (d) scaling up the production and distribution of biofortified wheat seeds and products, and (e) monitoring and evaluating the impact of wheat biofortification on nutritional outcomes and food security.

To overcome these challenges, wheat biofortification requires a multidisciplinary and multi-stakeholder approach that involves researchers, breeders, farmers, processors, consumers, policymakers, and extension agents. Government policies, incentives, and regulatory frameworks are crucial in supporting biofortification efforts. Some of the policy actions that can facilitate wheat biofortification in Turkey are: (a) providing subsidies or tax exemptions for biofortified wheat seeds and products, (b) creating awareness and demand for biofortified wheat products through public education and promotion campaigns, (c) establishing quality standards and certification systems for biofortified wheat products, (d) integrating biofortified wheat products into public food distribution programs such as school feeding or social safety nets, and (e) strengthening the institutional capacity and coordination among different actors involved in biofortification.

CONCLUSION

Wheat biofortification presents a promising strategy to address nutrient deficiencies and improve nutrition security in Turkey. The key findings highlight the significance of biofortified wheat varieties in delivering essential micronutrients to vulnerable populations, combating hidden hunger, and improving public health outcomes. To ensure successful adoption and dissemination of biofortified wheat, collaboration among researchers, breeders, policymakers, and stakeholders is essential. Optimizing breeding strategies, ensuring agronomic suitability, and addressing technical challenges are crucial areas that require interdisciplinary collaboration. Policy support, incentives, and well-defined regulatory frameworks are needed to create an enabling environment for biofortification. Integrating biofortification into agricultural and health policies, providing incentives, and strengthening market linkages can

promote widespread adoption and sustained production of biofortified wheat. Further research is necessary to advance the field of wheat biofortification. Optimizing breeding strategies, conducting long-term sustainability assessments, and evaluating the impact on human health outcomes are important areas of focus. Biofortification has the potential to contribute to sustainable development goals related to nutrition security, food production, and health in Turkey. By addressing nutrition security, enhancing climate resilience, and promoting sustainable agriculture, biofortification can improve the overall well-being and resilience of the population.

REFERENCES

- Ackland, M. L., & Michalczyk, A. A. (2016). Zinc and infant nutrition. *Archives of Biochemistry and Biophysics*, 611, 51–57. <https://doi.org/10.1016/J.ABB.2016.06.011>
- Cakmak, I. (2008). Zinc deficiency in wheat in Turkey. In *Micronutrient Deficiencies in Global Crop Production* (pp. 181–200). Springer Netherlands. https://doi.org/10.1007/978-1-4020-6860-7_7/COVER
- Cakmak, I. (2009). Enrichment of fertilizers with zinc: An excellent investment for humanity and crop production in India. *Journal of Trace Elements in Medicine and Biology*, 23(4), 281–289. <https://doi.org/10.1016/J.JTEMB.2009.05.002>
- Cakmak, I., Kalayci, M., Kaya, Y., Torun, A. A., Aydin, N., Wang, Y., Arisoy, Z., Erdem, H., Yazici, A., Gokmen, O., Ozturk, L., & Horst, W. J. (2010). Biofortification and Localization of Zinc in Wheat Grain. *Journal of Agricultural and Food Chemistry*, 58(16), 9092–9102. <https://doi.org/10.1021/JF101197H>
- Cakmak, I., & Kutman, U. B. (2018). Agronomic biofortification of cereals with zinc: a review. *European Journal of Soil Science*, 69(1), 172–180. <https://doi.org/10.1111/EJSS.12437>
- Cakmak, I., Prom-u-thai, C., Guilherme, L. R. G., Rashid, A., Hora, K. H., Yazici, A., Savasli, E., Kalayci, M., Tutus, Y., Phuphong, P., Rizwan, M., Martins, F. A. D., Dinali, G. S., & Ozturk, L. (2017). Iodine biofortification of wheat, rice and maize through fertilizer strategy. *Plant and Soil*, 418(1–2), 319–335. <https://doi.org/10.1007/S11104-017-3295-9/FIGURES/3>
- Cetin, M. (2016). Sustainability of urban coastal area management: A case study on Cide. <Http://Dx.Doi.Org/10.1080/10549811.2016.1228072>, 35(7), 527–541. <https://doi.org/10.1080/10549811.2016.1228072>
- Dhaliwal, S. S., Naresh, R. K., Mandal, A., Singh, R., & Dhaliwal, M. K. (2019). Dynamics and transformations of micronutrients in agricultural soils as influenced by organic matter build-up: A review. *Environmental and Sustainability Indicators*, 1–2, 100007. <https://doi.org/10.1016/J.INDIC.2019.100007>
- FAOSTAT. (2023). FAOSTAT. <https://www.fao.org/faostat/en/#data/QCL>
- Gupta, S., Brazier, A. K. M., & Lowe, N. M. (2020). Zinc deficiency in low- and middle-income countries: prevalence and approaches for mitigation. *Journal of Human Nutrition and Dietetics*, 33(5), 624–643. <https://doi.org/10.1111/JHN.12791>
- Hincal, F. (2007). Trace elements in growth: Iodine and selenium status of Turkish children. *Journal of Trace Elements in Medicine and Biology*, 21(SUPPL. 1), 40–43. <https://doi.org/10.1016/J.JTEMB.2007.09.012>
- Hocaoğlu, O., Akçura, M., & Kaplan, M. (2020). Changes in the Grain Element Contents of Durum Wheat Varieties of Turkey Registered between 1967–2010, 51(4), 431–439. <https://doi.org/10.1080/00103624.2019.1709487>
- Jaiswal, D. K., Krishna, R., Chouhan, G. K., de Araujo Pereira, A. P., Ade, A. B., Prakash, S., Verma, S. K., Prasad, R., Yadav, J., & Verma, J. P. (2022). Bio-fortification of minerals in crops: current scenario and future prospects for sustainable agriculture and human health. *Plant Growth Regulation* 2022 98:1, 98(1), 5–22. <https://doi.org/10.1007/S10725-022-00847-4>

- Kiran, A., Wakeel, A., Mahmood, K., Mubarak, R., Hafsa, & Haefele, S. M. (2022). Biofortification of Staple Crops to Alleviate Human Malnutrition: Contributions and Potential in Developing Countries. *Agronomy* 2022, Vol. 12, Page 452, 12(2), 452. <https://doi.org/10.3390/AGRONOMY12020452>
- Kumar, S., Palve, A., Joshi, C., & Srivastava, R. K. (2017). Crop biofortification for iron (Fe), zinc (Zn) and vitamin A with transgenic approaches. *Heliyon*, e01914. <https://doi.org/10.1016/j.heliyon.2019.e01914>
- Mishra, G. P., Dikshit, H. K., Priti, Kukreja, B., Aski, M., Yadava, D. K., Sarker, A., & Kumar, S. (2022). Historical Overview of Biofortification in Crop Plants and Its Implications. In *Biofortification of Staple Crops* (pp. 31–61). Springer Singapore. https://doi.org/10.1007/978-981-16-3280-8_2/COVER
- Niyigaba, E., Twizerimana, A., Mugenzi, I., Ngnadong, W. A., Ye, Y. P., Wu, B. M., & Hai, J. B. (2019). Winter Wheat Grain Quality, Zinc and Iron Concentration Affected by a Combined Foliar Spray of Zinc and Iron Fertilizers. *Agronomy* 2019, Vol. 9, Page 250, 9(5), 250. <https://doi.org/10.3390/AGRONOMY9050250>
- Oxford, A. (2022). Russia's grain future in doubt despite good harvest. In *Emerald Expert Briefings: Vol. oxan-db* (Issue oxan-db). Oxford Analytica. <https://doi.org/10.1108/OXAN-DB272690>
- Ozkan, B., Akcaoz, H., & Fert, C. (2004). Energy input–output analysis in Turkish agriculture. *Renewable Energy*, 29(1), 39–51. [https://doi.org/10.1016/S0960-1481\(03\)00135-6](https://doi.org/10.1016/S0960-1481(03)00135-6)
- Pekcan, G., & Karaagaoglu, N. (2000). State of nutrition in Turkey. *Nutrition and Health*, 14(1), 41–52. https://doi.org/10.1177/026010600001400105/ASSET/026010600001400105.FP.PNG_V03
- Rehman, A., Farooq, M., Ozturk, L., Asif, M., & Siddique, K. H. M. (2017). Zinc nutrition in wheat-based cropping systems. *Plant and Soil* 2017 422:1, 422(1), 283–315. <https://doi.org/10.1007/S11104-017-3507-3>
- Reidy, S. (2022). *Turkey expected to produce more wheat in 2022-23 | World Grain*. <https://www.world-grain.com/articles/16796-turkey-expected-to-produce-more-wheat-in-2022-23>
- Saltzman, A., Birol, E., Oparinde, A., Andersson, M. S., Asare-Marfo, D., Diressie, M. T., Gonzalez, C., Lividini, K., Moursi, M., & Zeller, M. (2017). Availability, production, and consumption of crops biofortified by plant breeding: current evidence and future potential. *Annals of the New York Academy of Sciences*, 1390(1), 104–114. <https://doi.org/10.1111/NYAS.13314>
- Szerement, J., Szatanik-Kloc, A., Mokrzycki, J., & Mierzwa-Hersztek, M. (2021). Agronomic Biofortification with Se, Zn, and Fe: An Effective Strategy to Enhance Crop Nutritional Quality and Stress Defense—A Review. *Journal of Soil Science and Plant Nutrition* 2021 22:1, 22(1), 1129–1159. <https://doi.org/10.1007/S42729-021-00719-2>
- Verma, H. P., Sharma, O. P., Shivran, A. C., Yadav, L. R., Yadav, R. K., Yadav, M. R., Meena, S. N., Jatav, H. S., Lal, M. K., Rajput, V. D., & Minkina, T. (2023). Effect of Irrigation Schedule and Organic Fertilizer on Wheat Yield, Nutrient Uptake, and Soil Moisture in Northwest India. *Sustainability* 2023, Vol. 15, Page 10204, 15(13), 10204. <https://doi.org/10.3390/SU151310204>
- Wang, M., Kong, F., Liu, R., Fan, Q., & Zhang, X. (2020). Zinc in Wheat Grain, Processing, and Food. *Frontiers in Nutrition*, 7, 546141. <https://doi.org/10.3389/FNUT.2020.00124/BIBTEX>
- Wu, C., Dun, Y., Zhang, Z., Li, M., & Wu, G. (2020). Foliar application of selenium and zinc to alleviate wheat (*Triticum aestivum* L.) cadmium toxicity and uptake from cadmium-contaminated soil. *Ecotoxicology and Environmental Safety*, 190, 110091. <https://doi.org/10.1016/J.ECOENV.2019.110091>
- Xu, Y., Wang, Z., Dong, W., & Chou, J. (2023). Predicting the Potential Impact of Emergency on Global Grain Security: A Case of the Russia–Ukraine Conflict. *Foods*, 12(13), 2557. <https://doi.org/10.3390/FOODS12132557/S1>

INNOVATIVE IRRIGATION MANAGEMENT IN AEROBIC RICE CULTIVATION: A COMPREHENSIVE REVIEW OF TECHNOLOGIES AND PRACTICES

Bhaskara Anggarda Gathot SUBRATA^{1,2*}, Elif ÖZTÜRK², Hasan AKAY², İsmail SEZER²

¹. Department of Agronomy, Faculty of Agriculture, Gadjah Mada University,
Bulaksumur, 55281, Yogyakarta, Indonesia

². Department of Field Crops, Faculty of Agriculture, Ondokuz Mayıs University, Kurupelit,
55139 Samsun, Turkey

Corresponding author e-mail: bhaskara.anggarda@mail.ugm.ac.id

ABSTRACT

Aerobic rice cultivation has gained recognition as a promising approach to sustainable agriculture. This review paper comprehensively assesses innovative irrigation management in aerobic rice cultivation, focusing on technologies and practices that optimize water use efficiency, enhance nutrient management, and promote sustainable crop production. The paper examines various aspects of aerobic rice systems, including water-saving strategies, integrated nutrient management, and the challenges in adopting these practices. The review highlights the significant role of innovative irrigation technologies in water conservation. Techniques such as drip irrigation, alternate wetting and drying (AWD), and precision irrigation have shown substantial water savings compared to traditional flooding. Studies have reported reductions in water consumption from 30% to 50% through adopting these technologies while maintaining or improving crop yields. Furthermore, innovative irrigation management practices improve nutrient availability, uptake, and utilization. Proper irrigation scheduling based on crop water requirements and soil moisture monitoring optimizes nutrient uptake efficiency, enhancing nitrogen, phosphorus, and potassium utilization. Despite the potential benefits, adopting innovative irrigation management practices faces challenges. Technical barriers, economic limitations, and policy-related constraints hinder widespread adoption. Farmers may lack knowledge and training in these technologies, and the initial investment and operational costs may pose financial challenges. Inadequate policy support and limited access to extension services further impede adoption. To overcome these challenges, the review suggests the need for capacity-building programs, supportive policies, and collaborations among stakeholders.

Keywords: Aerobic rice, Innovative irrigation, Water use efficiency, Nutrient management, Sustainable agriculture

INTRODUCTION

In recent years, more people are beginning to understand the need for environmentally friendly and resource-conserving farming methods. Aerobic rice cultivation is a method that integrates cutting-edge technology with environmentally responsible water use (Datta et al., 2017; Matloob et al., 2022; Sandhu et al., 2021). Drip and subsurface irrigation are two of the most innovative irrigation methods used in aerobic rice production because they allow water to be delivered directly to the plant's roots, maximizing water use efficiency and minimizing water loss through evaporation and runoff (Mallareddy et al., 2023). Compared to conventional flooded rice systems, these cutting-edge irrigation methods can cut water use by as much as half. As a result, water is saved, energy spent on water pumping is reduced, and agricultural output becomes more environmentally friendly.

Using cutting-edge sensor-based technologies has further transformed aerobic rice cultivation irrigation management. Using remote sensing devices, weather-based controllers, and soil moisture sensors, water is only used when and where necessary (Keswani et al., 2019). These tools let farmers make more informed decisions about their irrigation systems, leading to less water being wasted and more efficiently irrigated crops. Improved crop yields, water savings, and resource conservation have all been shown to emerge from sensor-based irrigation management in aerobic rice system (Mallareddy et al., 2023).

Aerobic rice cultivation has widely implemented water-saving methods, including alternating wetting and drying (AWD) and other creative approaches. Instead of keeping the ground permanently flooded, AWD requires letting it dry out at regular intervals and then soaking it again. Soil health is improved, methane emissions are reduced, and more nutrients are available thanks to this water conservation method. Water savings of up to 30% are possible with AWD compared to continuous flooding, and yields are kept constant or even increased (Lampayan et al., 2015). The vast potential of innovation and technology in revolutionizing irrigation management in aerobic rice farming is displayed in the convergence of precision irrigation, sensor-based technologies, and water-saving strategies like AWD. In this review, we hope to shed light on how innovation and technology have contributed to the development of sustainable agricultural production, especially in aerobic rice farming.

Importance of Efficient Irrigation Management in Aerobic Rice Cultivation

Effective irrigation management is of paramount importance in the growth of aerobic rice, as it optimizes water usage efficiency, minimizes water loss, and enhances crop output. The presence of limited water supplies and the escalating competition for water resources underscore the need to implement suitable water management strategies within the agricultural sector. The utilization of precision irrigation techniques, such as drip irrigation and subsurface irrigation, has been observed to enhance water use efficiency in aerobic rice systems. Research findings indicate that implementing new irrigation technologies has demonstrated substantial water conservation benefits, with potential savings ranging from 30% to 50% compared to conventional flooded rice systems (Champness et al., 2023; Satyanarayana et al., 2007). By implementing methods that transport water directly to the roots of plants, these strategies effectively reduce water loss caused by evaporation and runoff, optimizing water utilization.

Furthermore, implementing efficient irrigation management strategies in aerobic rice production enhances water use efficiency and increases crop productivity (Wang et al., 2020). Sufficient provision of water, in appropriate quantities and at optimal timings, is necessary for the cultivation and maturation of crops. Sensor-based technologies and precision irrigation systems have emerged as significant tools (Canaj et al., 2021). These technologies facilitate accurate irrigation scheduling by enabling real-time soil moisture and crop water demand monitoring. Previous research has indicated that the implementation of sensor-based irrigation management techniques can enhance crop yields and optimize water production in the context of aerobic rice cultivation (Adeyemi et al., 2017; Gonçalves et al., 2022; Mallareddy et al., 2023). The performance of effective irrigation management strategies contributes to improving nutrient absorption, mitigating plant stress, and, ultimately, facilitating crop growth and output (Abioye et al., 2020; Dhaliwal et al., 2022).

Sustainable farming methods benefit from careful irrigation management since they reduce water waste. Water conservation, lower energy needs for water pumping, and less water-related emissions are all benefits of aerobic rice production, which uses less water than conventional methods. The negative impacts of overwatering can be lessened by using modern irrigation methods, such as subsurface irrigation, which minimizes water loss due to evaporation and runoff (Abioye et al., 2020). Subsurface irrigation has been shown to significantly reduce water waste compared to more conventional surface irrigation techniques.

By minimizing the amount of water used in irrigation and the related carbon emissions, as well as by preserving water quality, these methods contribute to environmental sustainability.

Exploring Innovative Irrigation Technologies for Enhancing Water Use Efficiency in Aerobic Rice Cultivation

To achieve sustainable crop production, the cultivation of aerobic rice necessitates the implementation of new irrigation technology and techniques designed to enhance water use efficiency. An example of a method employed in this context is alternate wetting and drying (AWD), when the soil is intentionally subjected to a partial drying phase before being re-flooded. Implementing alternate wetting and drying (AWD) systems in vehicles creates aerobic conditions, decreasing water consumption and mitigating methane emissions. Several studies have documented substantial reductions in water usage, up to 30%, in aerobic rice systems that employ alternate wetting and drying (AWD) techniques while maintaining rice yields at satisfactory levels (LaHue et al., 2016; Lampayan et al., 2015). This is in contrast to the conventional practice of continuous flooding. This methodology not only facilitates water conservation but also aids in mitigating climate change by reducing greenhouse gas emissions.

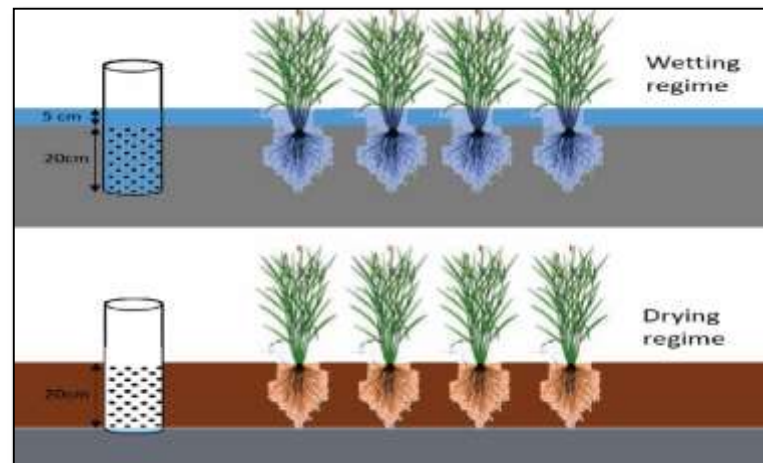

Figure 27. Illustration of management of alternate drying and wetting (AWD) (Riaz et al., 2018).

Drip irrigation is a prevalent novel method employed in aerobic rice production. The process entails the accurate distribution of water precisely to the area surrounding the roots via a system of tubes or emitters. Drip irrigation is a water application method that allows precise control, reducing water loss due to evaporation and runoff (Kisekka et al., 2017). Numerous empirical studies have substantiated the assertion that drip irrigation can curtail water usage by as much as 50% compared to the typical flooding method (Rizwan et al., 2018). In addition, it promotes increased efficiency in water utilization and nutrient absorption, resulting in enhanced agricultural productivity and the preservation of valuable resources. Drip irrigation facilitates the accurate delivery of fertilizers, diminishing nutrient losses and mitigating environmental repercussions.

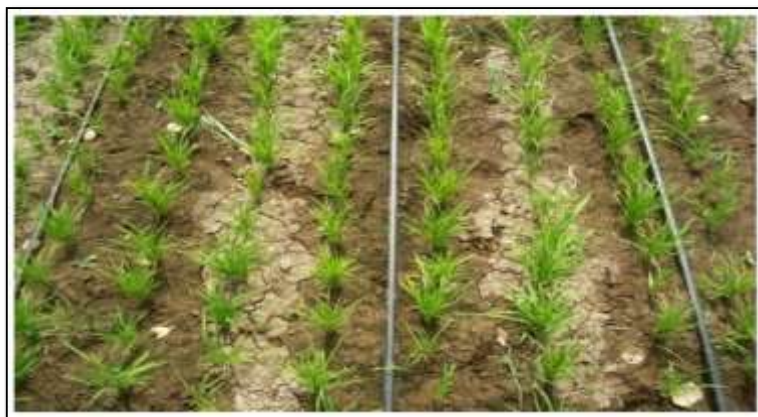

Figure 28. Rice cultivation through drip irrigation (Mallareddy et al., 2023)

Precision irrigation systems provide cutting-edge technology that enables the optimization of water utilization in the growing of aerobic rice. These systems use real-time monitoring of soil moisture levels, meteorological conditions, and crop water demands to deliver precise irrigation scheduling. Precision irrigation is a method that aims to optimize water distribution by providing water at the exact time and location it is required. This approach effectively reduces water wastage and enhances overall water use efficiency (Abioye et al., 2020; Daccache et al., 2015). Sensor-based technology, including soil moisture sensors and weather-based controllers, is critical in implementing precision irrigation strategies. According a study conducted by(Adeyemi et al., 2017), it has been demonstrated that implementing precision irrigation techniques can lead to a notable reduction in water usage, reaching up to 40%. Furthermore, this approach has been found to sustain or even enhance rice yields compared to conventional irrigation methods. This technology empowers farmers to make well-informed decisions about irrigation, optimizing water resource utilization and strengthening overall output.

Specific Water-Saving Strategies for Aerobic Rice Cultivation

The issue of water scarcity and the imperative for sustainable water management has spurred the investigation of targeted water conservation measures in the context of aerobic rice growing. A productive strategy involves using an irrigation schedule tailored to meet the specific water demands of crops. The proposed approach entails evaluating the crop's water requirements at various growth phases and administering irrigation to those needs. Numerous studies have demonstrated that the judicious timing and appropriate application of irrigation by crops' water needs can deliver substantial reductions in water usage without compromising and, in some cases, enhancing agricultural productivity.

Table 3. Water use efficiency and water productivity of aerobic rice systems.

Location	Water Use Efficiency (WUE), Water Productivity (WP) or % Water Saving	Reference
IRRI, Philippines	Using the alternate flooding strategy resulted in 0.54–0.66 kg grain m ⁻³ water productivity for aerobic rice. Aerobic plots utilized 27% less water than the alternative flooding irrigation approach.	(Grassi et al., 2009)
University of Tokyo and Kyoto	The water productivity of aerobically grown rice ranged from 1.4% to 37.5% higher than that of rice that had been transplanted, or 0.75 to 0.96 kg grain m ⁻³ . There was no discernible difference	(Kato et al., 2009)

University, Japan	in grain output between aerobic and transplanted rice grown in Japanese clay loam soils.	
IARI, New Delhi	Water productivity ranged from 3.52 to 3.07 kg ha ⁻¹ mm ⁻¹ for the aerobic rice system, 3.07 to 2.28 kg ha ⁻¹ mm ⁻¹ for the SRI method, and 2.28 to 2.28 kg ha ⁻¹ mm ⁻¹ for transplanted rice. Compared to traditionally transplanted rice, the aerobic rice system reduced water usage by 50.8%.	(Shahane et al., 2019)
Hyderabad, India	The water yield of aerobic rice (0.70 kg grain m ⁻³) is higher than transplanted rice (0.55 kg grain m ⁻³). Aerobic management saved almost 50% more water than traditional rice-growing methods in sandy clay soils.	(Ramulu et al., 2020)
UAS, Bangalore	Aerobic rice systems use water more efficiently (3.84 q acre ⁻¹ inch) than conventional fields (1.64 q acre ⁻¹ inch). Also, the economic WUE of the aerobic rice system was greater (₹ 1643.54 acre inch ⁻¹) than conventional farms (₹ 269.41 acre inch ⁻¹).	(Thejaswi Kumar et al., 2021)

Soil moisture monitoring is a practical water conservation approach employed in the growth of aerobic rice. Through the constant monitoring of moisture content in the root zone, growers can precisely ascertain the optimal timing and volume of irrigation. Soil moisture monitoring systems offer instantaneous data regarding soil moisture levels, facilitating accurate irrigation scheduling and mitigating the risks associated with excessive or insufficient irrigation. (Champness et al., 2023) conducted a study that demonstrated the effectiveness of soil moisture-based irrigation scheduling in aerobic rice systems. The findings revealed that this approach led to significant water savings of up to 35% while maintaining satisfactory crop yields. This approach guarantees water's application solely when required, mitigating water wastage and enhancing water use efficiency.

Remote sensing technologies, including satellite-based photography and unmanned aerial vehicles (UAVs), offer a broader scope for evaluating agricultural water stress and vegetation indices across extensive regions (Olson & Anderson, 2021). These technologies facilitate the identification of fluctuations in water availability throughout the agricultural field, allowing farmers to make appropriate adjustments to irrigation practices. Research indicates that moisture sensors and remote sensing technologies can reduce water usage to range from 20% to 40% during anaerobic rice production (Mallareddy et al., 2023). This novel methodology optimizes water utilization efficiency and mitigates water wastage, thereby contributing to the sustainable management of water resources in aerobic rice cultivation systems.

Integrated Nutrient Management and Irrigation Practices in Aerobic Rice Cultivation

The optimization of nutrient availability and utilization in aerobic rice production is highly dependent on the combination of nutrient management strategies with irrigation management. The effective management of irrigation is of considerable importance in the context of nutrient dynamics since it exerts influence over critical factors such as soil moisture levels, oxygen availability, and the transportation of nutrients (Nair, 2019). When irrigation is effectively controlled, it has the potential to optimize fertilizer uptake, minimize nutrient losses caused by leaching, and promote overall nutrient usage efficiency. According to (Midya et al., 2021), research has indicated that implementing controlled irrigation methods can enhance fertilizer availability and reduce the potential for nutrient leakage by promoting aerobic soil conditions. Hence, embracing a comprehensive strategy combining nutrient management and

irrigation is imperative to achieve sustainable and effective usage of nutrients in aerobic rice systems.

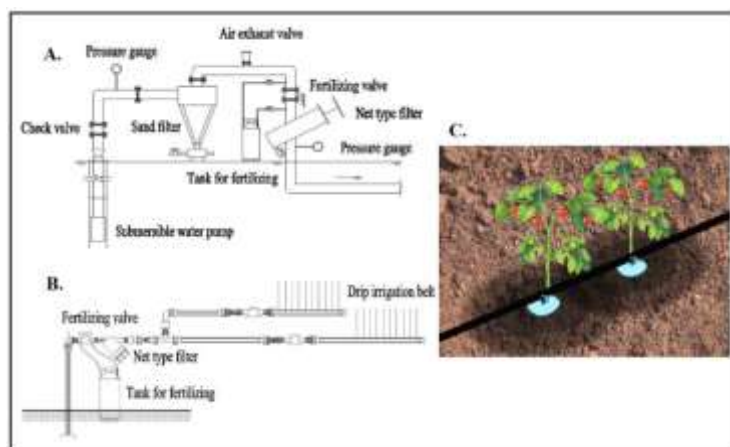

Figure 29. Layout of drip irrigation and fertilization system (Yang et al., 2023)

One of the primary advantages associated with effective irrigation management in aerobic rice farming is the enhancement of nutrient accessibility for plant growth. Insufficient water availability or extreme flooding can reduce oxygen levels within the root zone, constraining plants' ability to absorb nutrients. Efficient nutrient uptake is facilitated by maintaining aerobic soil conditions through well-managed irrigation practices, which helps sustain optimal oxygen levels in the root zone. This practice enhances plant development, optimizes nutrient consumption, and augments agricultural output. The literature has provided evidence that effective irrigation management is crucial in improving nutrient uptake efficiency in aerobic rice production. This leads to notable improvements in the plants' uptake of nitrogen, phosphorus, and potassium (Sarkar et al., 2020; Whetton et al., 2022). By implementing a strategic irrigation schedule, it is possible to coordinate nutrient availability with the various growth stages of the crop. This synchronization facilitates the effective uptake and utilization of nutrients.

Implementing efficient irrigation practices in aerobic rice production can reduce nutrient losses caused by leaching, mitigating the environmental consequences of nutrient runoff (Chen et al., 2021; Zinkernagel et al., 2020). The leaching of nutrients, namely nitrogen, below the root zone can occur due to excessive irrigation or inadequate water management measures. This phenomenon can contribute to water contamination and the inefficient utilization of fertilizers. The implementation of precision irrigation methods, such as drip irrigation or controlled deficit irrigation, enables the regulated application of water, aligning with the specific water needs of the crop and reducing excessive leaching (Zinkernagel et al., 2020). The reduction of nutrient losses not only enhances the efficiency of nutrient utilization but also aids in promoting environmental sustainability through the mitigation of water pollution and the prevention of water body eutrophication.

Challenges and Constraints in Adopting Innovative Irrigation Management in Aerobic Rice Cultivation

Various hurdles and limits hinder the broad implementation of new irrigation management strategies in aerobic rice production despite their potential benefits. Technical impediments encompass a range of challenges, such as farmers' restricted knowledge and comprehension of modern technologies, insufficient training opportunities, and the complexities associated with adopting novel methods. For example, adopting precision irrigation systems may necessitate the utilization of specialized machinery, technical

proficiency, and ongoing surveillance, hence presenting obstacles for farmers with low resources. Given the substantial upfront investment and ongoing operational expenses associated with implementing novel irrigation technology, economic limitations pose a significant barrier. Farmers may encounter challenges in obtaining financial resources and resist adopting technologies without comprehending the enduring economic advantages. Moreover, the accessibility and cost-effectiveness of irrigation infrastructure and resources, including dependable electrical provision and water supplies, can constrain the implementation of novel methodologies in some geographical regions.

Policy-related hurdles are a crucial factor that hinders the extensive implementation of new irrigation management strategies in aerobic rice growing. Insufficient policy support, characterized by the lack of suitable rules and incentives, may deter farmers from embracing these methods. The lack of comprehensive extension services and outreach programs explicitly targeting novel irrigation technologies presents a significant obstacle to effectively transferring knowledge and capacity development in this field. The lack of enough financing for research and development in these technologies and the failure to address difficulties specific to different regions present further limitations. To address these difficulties, it is imperative to establish supportive policies that incentivize farmers to embrace novel irrigation practices. Policymakers must allocate resources toward research and development, extension services, and capacity-building programs to augment farmers' knowledge and skills. Furthermore, establishing partnerships among governmental entities, academic institutions, and industry participants can effectively facilitate the exchange of technology and expertise. Moreover, public-private collaborations can serve as a means to tackle economic limitations by implementing inventive financing mechanisms and sharing costs.

CONCLUSION

In summary, this comprehensive analysis underscores the possibility of employing innovative irrigation management techniques in the growth of aerobic rice to promote sustainable agriculture. The results emphasize the efficacy of technologies such as drip irrigation, alternate wetting and drying (AWD), and precision irrigation in enhancing water use efficiency, nutrient administration, and ecological sustainability. However, additional study, the distribution of knowledge, and joint endeavors are necessary to surmount obstacles and facilitate the general adoption. Through the progression of scientific inquiry, dissemination of knowledge, and cultivation of cooperative relationships, it is possible to establish enduring and adaptable food production systems within the context of aerobic rice agriculture, promoting sustainability and resilience.

REFERENCES

- Abioye, E. A., Abidin, M. S. Z., Mahmud, M. S. A., Buyamin, S., Ishak, M. H. I., Rahman, M. K. I. A., Otuoze, A. O., Onotu, P., & Ramli, M. S. A. (2020). A review on monitoring and advanced control strategies for precision irrigation. *Computers and Electronics in Agriculture*, 173, 105441. <https://doi.org/10.1016/J.COMPAG.2020.105441>
- Adeyemi, O., Grove, I., Peets, S., & Norton, T. (2017). Advanced Monitoring and Management Systems for Improving Sustainability in Precision Irrigation. *Sustainability* 2017, Vol. 9, Page 353, 9(3), 353. <https://doi.org/10.3390/SU9030353>
- Canaj, K., Parente, A., D'imperio, M., Boari, F., Buono, V., Toriello, M., Mehmeti, A., & Montesano, F. F. (2021). Can Precise Irrigation Support the Sustainability of Protected Cultivation? A Life-Cycle Assessment and Life-Cycle Cost Analysis. *Water* 2022, Vol. 14, Page 6, 14(1), 6. <https://doi.org/10.3390/W14010006>

- Champness, M., Vial, L., Ballester, C., & Hornbuckle, J. (2023). Evaluating the Performance and Opportunity Cost of a Smart-Sensed Automated Irrigation System for Water-Saving Rice Cultivation in Temperate Australia. *Agriculture* 2023, Vol. 13, Page 903, 13(4), 903. <https://doi.org/10.3390/AGRICULTURE13040903>
- Chen, Z., Li, P., Jiang, S., Chen, H., Wang, J., & Cao, C. (2021). Evaluation of resource and energy utilization, environmental and economic benefits of rice water-saving irrigation technologies in a rice-wheat rotation system. *Science of The Total Environment*, 757, 143748. <https://doi.org/10.1016/J.SCITOTENV.2020.143748>
- Daccache, A., Knox, J. W., Weatherhead, E. K., Daneshkhah, A., & Hess, T. M. (2015). Implementing precision irrigation in a humid climate – Recent experiences and on-going challenges. *Agricultural Water Management*, 147, 135–143. <https://doi.org/10.1016/J.AGWAT.2014.05.018>
- Datta, A., Ullah, H., & Ferdous, Z. (2017). Water management in rice. In *Rice Production Worldwide* (pp. 255–277). Springer International Publishing. https://doi.org/10.1007/978-3-319-47516-5_11/COVER
- Dhaliwal, S. S., Sharma, V., & Shukla, A. K. (2022). Impact of micronutrients in mitigation of abiotic stresses in soils and plants—A progressive step toward crop security and nutritional quality. *Advances in Agronomy*, 173, 1–78. <https://doi.org/10.1016/BS.AGRON.2022.02.001>
- Gonçalves, J. M., Nunes, M., Ferreira, S., Jordão, A., Paixão, J., Eugénio, R., Russo, A., Damásio, H., Duarte, I. M., & Bahcevandziev, K. (2022). Alternate Wetting and Drying in the Center of Portugal: Effects on Water and Rice Productivity and Contribution to Development. *Sensors* 2022, Vol. 22, Page 3632, 22(10), 3632. <https://doi.org/10.3390/S22103632>
- Grassi, C., Bouman, B. A. M., Castañeda, A. R., Manzelli, M., Vecchio, V., Akpo, L.-E., Grouzis, M., Paterniani, M. L. S., Pardini, A., Pratesi, V., Oladele, O. I., Lepetu, J., Subair, S. K., Obuh, J., Odunze, A. C., & Kureh, I. (2009). Aerobic rice: crop performance and water use efficiency. *Journal of Agriculture and Environment for International Development (JAEID)*, 103(4), 259–270. <https://doi.org/10.12895/JAEID.20094.35>
- Kato, Y., Okami, M., & Katsura, K. (2009). Yield potential and water use efficiency of aerobic rice (*Oryza sativa* L.) in Japan. *Field Crops Research*, 113(3), 328–334. <https://doi.org/10.1016/J.FCR.2009.06.010>
- Keswani, B., Mohapatra, A. G., Mohanty, A., Khanna, A., Rodrigues, J. J. P. C., Gupta, D., & de Albuquerque, V. H. C. (2019). Adapting weather conditions based IoT enabled smart irrigation technique in precision agriculture mechanisms. *Neural Computing and Applications*, 31(1), 277–292. <https://doi.org/10.1007/S00521-018-3737-1/TABLES/5>
- Kisekka, I., Oker, T., Nguyen, G., Aguilar, J., & Rogers, D. (2017). Revisiting precision mobile drip irrigation under limited water. *Irrigation Science*, 35(6), 483–500. <https://doi.org/10.1007/S00271-017-0555-7/TABLES/3>
- LaHue, G. T., Chaney, R. L., Adviento-Borbe, M. A., & Linquist, B. A. (2016). Alternate wetting and drying in high yielding direct-seeded rice systems accomplishes multiple environmental and agronomic objectives. *Agriculture, Ecosystems & Environment*, 229, 30–39. <https://doi.org/10.1016/J.AGEE.2016.05.020>
- Lampayan, R. M., Rejesus, R. M., Singleton, G. R., & Bouman, B. A. M. (2015). Adoption and economics of alternate wetting and drying water management for irrigated lowland rice. *Field Crops Research*, 170, 95–108. <https://doi.org/10.1016/J.FCR.2014.10.013>
- Mallareddy, M., Thirumalaikumar, R., Balasubramanian, P., Naseeruddin, R., Nithya, N., Mariadoss, A., Eazhilkrishna, N., Choudhary, A. K., Deiveegan, M., Subramanian, E., Padmaja, B., & Vijayakumar, S. (2023). Maximizing Water Use Efficiency in Rice Farming: A Comprehensive Review of Innovative Irrigation Management Technologies. *Water* 2023, Vol. 15, Page 1802, 15(10), 1802. <https://doi.org/10.3390/W15101802>

- Matloob, A., Jabran, K., Farooq, M., Khaliq, A., Aslam, F., Abbas, T., Ehsanullah, Zaman, U., Irshad, S., & Chauhan, B. S. (2022). Water-Wise Cultivation of Basmati Rice in Pakistan. In *Modern Techniques of Rice Crop Production* (pp. 187–229). Wiley.
https://doi.org/10.1007/978-981-16-4955-4_13
- Midya, A., Saren, B. K., Dey, J. K., Maitra, S., Praharaj, S., Gaikwad, D. J., Gaber, A., Alhomrani, M., & Hossain, A. (2021). Crop Establishment Methods and Integrated Nutrient Management Improve: Part II. Nutrient Uptake and Use Efficiency and Soil Health in Rice (*Oryza sativa* L.) Field in the Lower Indo-Gangetic Plain, India. *Agronomy* 2021, Vol. 11, Page 1894, 11(9), 1894. <https://doi.org/10.3390/AGRONOMY11091894>
- Nair, K. P. (2019). Soil Fertility and Nutrient Management. In *Intelligent Soil Management for Sustainable Agriculture* (pp. 165–189). Springer, Cham. https://doi.org/10.1007/978-3-030-15530-8_17
- Olson, D., & Anderson, J. (2021). Review on unmanned aerial vehicles, remote sensors, imagery processing, and their applications in agriculture. *Agronomy Journal*, 113(2), 971–992.
<https://doi.org/10.1002/AGJ2.20595>
- Ramulu, V., Reddy, M. D., & Umadevi, M. (2020). Evaluation of water saving rice production systems. *Journal of Pharmacognosy and Phytochemistry*, 9(2), 658–660.
<https://doi.org/10.22271/PHYTO.2020.V9.I2K.10927>
- Riaz, A., Khaliq, A., Fiaz, S., Noor, M. A., Nawaz, M. M., Mahboob, W., & Ullah, S. (2018). Weed Management in Direct Seeded Rice Grown under Varying Tillage Systems and Alternate Water Regimes. *Planta Daninha*, 36, e018179036. <https://doi.org/10.1590/S0100-83582018360100059>
- Rizwan, M., Bakhsh, A., Li, X., Anjum, L., Jamal, K., & Hamid, S. (2018). Evaluation of the Impact of Water Management Technologies on Water Savings in the Lower Chenab Canal Command Area, Indus River Basin. *Water* 2018, Vol. 10, Page 681, 10(6), 681.
<https://doi.org/10.3390/W10060681>
- Sandhu, N., Sagare, D. B., Singh, V. K., Yadav, S., & Kumar, A. (2021). Environment-Friendly Direct Seeding Rice Technology to Foster Sustainable Rice Production. In *Scaling-up Solutions for Farmers* (pp. 279–305). Springer International Publishing.
https://doi.org/10.1007/978-3-030-77935-1_8/COVER
- Sarkar, S., Skalicky, M., Hossain, A., Brestic, M., Saha, S., Garai, S., Ray, K., & Brahmachari, K. (2020). Management of Crop Residues for Improving Input Use Efficiency and Agricultural Sustainability. *Sustainability* 2020, Vol. 12, Page 9808, 12(23), 9808.
<https://doi.org/10.3390/SU12239808>
- Satyanarayana, A., Thiyagarajan, T. M., & Uphoff, N. (2007). Opportunities for water saving with higher yield from the system of rice intensification. *Irrigation Science*, 25(2), 99–115.
<https://doi.org/10.1007/S00271-006-0038-8/TABLES/4>
- Shahane, A. A., Singh Shivay, Y., Prasanna, R., Kumar, D., Shahane, A. A., Shivay, Y. S., Kumar, D., & Prasanna, R. (2019). Improving Water and Nutrient Use Efficiency in Rice by Changing Crop Establishment Methods, Application of Microbial Inoculations, and Zn Fertilization. *Global Challenges*, 3(10), 1800005. <https://doi.org/10.1002/GCH2.201800005>
- Thejaswi Kumar, J., Loksha, H., & Thapa, S. (2021). Resource Use Efficiency Among Aerobic and Conventional Rice Farms in Eastern Dry Zone of Karnataka: A Comparative Analysis. *Economic Affairs (New Delhi)*, 66(3), 439–446. <https://doi.org/10.46852/0424-2513.3.2021.12>
- Wang, H., Zhang, Y., Zhang, Y., McDaniel, M. D., Sun, L., Su, W., Fan, X., Liu, S., & Xiao, X. (2020). Water-saving irrigation is a ‘win-win’ management strategy in rice paddies – With both reduced greenhouse gas emissions and enhanced water use efficiency. *Agricultural Water Management*, 228, 105889. <https://doi.org/10.1016/J.AGWAT.2019.105889>

- Whetton, R. L., Harty, M. A., & Holden, N. M. (2022). Communicating Nitrogen Loss Mechanisms for Improving Nitrogen Use Efficiency Management, Focused on Global Wheat. *Nitrogen 2022, Vol. 3, Pages 213-246, 3(2), 213–246.*
<https://doi.org/10.3390/NITROGEN3020016>
- Yang, P., Wu, L., Cheng, M., Fan, J., Li, S., Wang, H., & Qian, L. (2023). Review on Drip Irrigation: Impact on Crop Yield, Quality, and Water Productivity in China. *Water 2023, Vol. 15, Page 1733, 15(9), 1733.* <https://doi.org/10.3390/W15091733>
- Zinkernagel, J., Maestre-Valero, J. F., Seresti, S. Y., & Intrigliolo, D. S. (2020). New technologies and practical approaches to improve irrigation management of open field vegetable crops. *Agricultural Water Management, 242, 106404.*
<https://doi.org/10.1016/J.AGWAT.2020.106404>

ASSESSMENT OF AGRICULTURAL USE OF SLUDGE IN THE CONTEXT OF CIRCULAR ECONOMY (CE) APPROACH

Deniz Dölgen¹, M. Necdet Alpaslan²

¹ *Dokuz Eylul University, Engineering Faculty, Environmental Engineering Department, Izmir, Turkey*

² *MNA Engineering & Consultancy, Izmir, Turkey,
Corresponding author e-mail: deniz.dolgen@deu.edu.tr*

ABSTRACT

The objectives of the study are to investigate the land use potential of agro-industry wastewater treatment plants (WWTPs) sludge for agricultural purposes and assess it in the context of circular economy (CE). Because WWTPs sludge is generally disposed off in sanitary landfills as waste material. Its use in land again for plant production is a substantial action in terms of circularity and contributes the economy of agriculture and industry as well as environmental sustainability. The important factors in this attempt are (i) the characteristics of the sludge, (ii) the amount of the sludge applied to the land (sludge loadings) and (iii) the behavior (reaction) of plants to the sludge application. In this framework, presented research was conducted by the sludge samples obtained from wastewater treatment plants of two different agro-industry WWTPs, namely, vegetable processing and vegetable oil manufacturing factories. The pH, salinity, organic matter, nitrogen, phosphorus, potassium, iron, magnesium, sodium, calcium as well as heavy metals were analyzed in order to find out the physical and chemical properties of the sludge samples. The sludge samples were amended with soil mixture and applied at various rates to promote the growth of lettuce plants. Plants growth were assessed by counting plants and leaves. In addition, heavy metal uptake by plants were investigated by measuring the metal concentrations in leaves and roots. The results stated that plant growth was affected from sludge loading, plant nutrients such as nitrogen, phosphorus and potassium, and salt content. High nutrient content of the vegetable processing sludge resulted in enhanced plant growth. Additionally, insignificant metal accumulations were measured in plants due to lower metal contents of the raw sludge. However, all those findings reveal that agro-industry WWTPs sludge are potential asset for farming and may be a typical examples of circular economy activities in sludge management.

Keywords: Sludge, Recycling, Land use, Biosolid, Circular Economy

INTRODUCTION

Treatment of wastewater produces sludge that must be disposed off properly. The old approach so far was to digest and dewater the sludge and then store it in sanitary landfills as waste material. However emerging attempts showed that reuse and recycling of sludge in agricultural land or soil is economically attractive and environmental friendly disposal alternative. Because it contains nitrogen (N), phosphorus (P), potassium (K), and organic materials, thereby it can be used as potential substitutes for conventional fertilizers in agricultural production (Dolgen et. al. 2011). Therefore, agricultural use of wastewater treatment plant sludge is promoted as a part of a solution for resource conservation and also strongly encouraged as a practice in transition to circular economy (CE). One of the key elements in transition towards CE is to ensure more sustainable waste management practices. As sludge contain high mineral contents, recycling of sludge via land application can be

accepted as one of the sustainable sludge management strategies in CE approach (Dolgen and Alpaslan, 2023).

However, there are also concerns that must be addressed to ensure a safe, economical, and environmentally sound approach to apply sludge to the soil. The application of sludges in agriculture may lead to a risk for humans and the environment as a result of heavy metals and toxic organic compounds accumulating to levels high enough to cause damage (Dolgen et. al. 2007). In order to prevent buildup of these compounds to unhealthy levels in soils and plants, extensive scientific research has been conducted to understand the potential risk. In addition, environmental hazards caused by the potentially toxic compounds have been controlled by setting limits on the amounts of such compounds in the sludge as well as in the soils. However, extensive scientific researches on sludge use on cropland are still needed because of their effects, e.g. organic matter enrichment and the possible accumulation of toxic elements in soil evolve slowly and are difficult to predict.

The objective of this study is to investigate the land use potential of the sludge generated from the wastewater treatment plants (WWTPs) of agro-industries. In this framework, sludge samples from WWTPs of vegetable processing and vegetable oil factories were used. In the study, sludge samples were taken from two different dewatering units of the treatment plant, namely, drying beds (SL-I) and filter press (SL-II) for vegetable processing and vegetable oil industries, respectively. Characterization study was carried out and parameters limiting reuse potential were determined, as first. Then, the sludge samples were amended with soil mixture (SM-I and SM-II) and applied at various rates to promote the growth of lettuce plants and to investigate the metal accumulation.

MATERIAL AND METHOD

Characterization Study

The pH, salinity, organic matter, nitrogen, phosphorus, potassium, iron, magnesium, sodium, as well as heavy metals (Cu, Zn, Cd, Cr, Pb, Ni) were analyzed in order to find out the physical and chemical properties of the sludge samples. The analyses of the sludge were performed according to the APHA-AWWAWEF (1992). Dry matter was measured gravimetrically (Method 505A) using furnace. Total nitrogen and phosphorus in the form of phosphate (PO₄-P), were analyzed calorimetrically using a Nova 60 spectrophotometer (Merck, Darmstand, Germany); Salinity (Method 2520) and conductivity (Method 2510) were measured using a DC 144 69 DR conductivity meter (HACH, Iowa, USA); and pH was measured using an NEL 890 pH meter (NEL, Ankara, Turkey). Total extractable heavy metals (Ni, Zn, Cu, Pb, Cd, Cr, Mn, and Fe) were measured by means of the direct air-acetylene flame method (Method 3111 B) by means of atomic absorption spectrophotometry (AAS) using a UNICAM 9229 spectrophotometer. The Method 3111 B was used to measure K, Mg, and Na contents. The EDTA titrimetric method was used (Method 3500-Ca D) to measure Ca contents.

Plant Growth Experiments

In the experiments, five sludge treatments (Sets 1 to 5, including a control unit) were used with five replications in a greenhouse. The sludge was applied to the pots at various rates (Set 1: 0%, Set 2: 25%, Set 3: 50%, Set 4: 75%, and Set 5: 100%) before cultivation of the plants. For the control (Set 1), only soil mixture created from a mixture of soil, sand, and manure was used. The characteristics of the soil mixture was also tested before the experiments. No fertilization was provided before or during the study. Three lettuce plants (aysberg) were transplanted in each pot for SL-I whereas two lettuce plants (hugard) were transplanted in each pot for SL-II. The pots were watered to field capacity at the same time whenever the soil mixtures in the pots became dry. The seedlings were grown under controlled conditions for 2

months (between November and February), with constant temperature (21°C) and humidity (60%). During this period, no additional sludge or soil mixture were supplied, but measures to control insects and pathogens were taken after emergence of the plants and 20 days later. At harvesting, the plants were carefully removed without damaging their roots. The number of live plants and the number of leaves were counted. Then, the leaves and roots were washed with de-ionized water to remove any attached particles, and then dried them at 60°C for 1 week. Afterward, the dry weight of green parts and roots were measured to determine the effect of various sludge loadings on growth of the lettuce plants.

RESULTS AND DISCUSSION

As stated before, three factors, (i) characteristics of sludge, (ii) sludge loadings to the plants, and (iii) behavior (reaction) of plants to sludge should be examined prior sludge application to the land. In the following, those factors are explained from the view of the selected industry sludge characteristics, application ratios and selected plant behavior.

The physical and chemical properties of the sludge samples (SL-I and SL-II) used in the experiments are presented in Table 1 and Table 2. The characteristics of the soil mixtures used in pots are also presented in Table 1 (SM-I and SM-II). The results obtained from characterization study was shown that organic matter contents of SL-I and SL-II were high (Table 1), however nitrogen content of SL-II is relatively low.

Table 1. The characteristics of the dewatered sludge samples and soil mixtures

Parameter	SL-I	SM-I	SL-II	SM-II
pH	6.7	7.5	11.2	7.6
Salinity (‰)	0.2	0.1	0.1	0.1
EC (µmhos)	1500	500	2750	620
Organic Matter (%)	25.2	17.4	38.3	10.8
T. Nitrogen (mg/L)	862.9	2402.1	16.8	60.63
T. Phosphorus (mg/L)	4199.3	709.2	64.83	121.7
Magnesium (mg/L)	5841.5	4673.6	289.2	582.8
Potassium (mg/L)	5273.4	2157.3	120.85	1528.4
Sodium (mg/L)	13902.6	3595.5	1217.7	2501.3

Nutrients in sludge such as phosphorus, magnesium and potassium are important because they support growth of plants and increases the potential for agricultural application. Therefore, it is thought that the low nitrogen content of the SL-II obtained from the vegetable oil factory may adversely affect the plant growth. The observations that turning the color of the leaves from green to yellow in SL-II supported this situation. In addition, due to use of caustic in the production process, the sodium concentration in vegetable processing sludge (SL-I) was found

to be high. Heavy metals are one of the most important parameters in terms of agricultural applications. It is seen that the heavy metal contents of both the sludge and the soil used in the experiments are low. This situation presents a significant advantage for the selected industries.

The growth of the lettuce plants was evaluated by counting the numbers of live plants and leaves. For vegetable processing, after the growing period (i.e. 2 months), treatments Set 1 (control), Set 3 (50%), Set 4 (75%), Set 5 (100%) yielded more plants per pot than the other treatments. Even though, treatments Set 2 (25%) yielded less plants per pot than the other treatments, the differences were not significant. Therefore, one may conclude that none of the sludge loadings decreased seed germination or early seedling survival. The high levels of nitrogen, phosphorus and potassium made positive effect on plant growth, in general. The leave number was significantly high in Set 4 (75%). The mean leave number was counted as 16.8 leave/pot. The lowest mean number of leaves per pot was found both in the Set 2 (25%) and Set 5 (100%) treatments, and this represented a significant decrease in the number of leaves compared with the other treatments.

Table 2. Heavy metal concentrations in the dewatered sludge samples and soil mixtures

Heavy Metals as mg/kg SM	SL-I	SM-I	SL-II	SM – II
Nickel (Ni)	40	4	14,74	34,2
Zinc (Zn)	62	5	3,85	134
Copper (Cu)	42	nd	7,08	72
Lead (Pb)	Nd	nd	0,19	57.8
Cadmium (Cd)	0.7	nd	2,15	1.27
Chromium (Cr)	30	nd		
Manganese (Mg)	36	63	39.2	nd
Iron (Fe)	367	189	1.27	1.10

For vegetable oil production sludge (SL-II), treatments Set 2 (25%) and Set 5 (100%) yielded more plants per pot than the other treatments. Similar to SL-I, although other treatments yielded less plants per pot than the other treatments, the differences were not significant (between 2.4-2.8 plants/pot). The high levels of nitrogen, phosphorus and potassium made positive effect on plant growth, in general. The maximum leave numbers were obtained for control (0%) set (i.e. 30.8 leaves/pot). The leave number was significantly high in Set 4 and Set 5 (i.e. 18 and 20 leaves/pot). The lowest mean number of leaves per pot was found both in the Set 2 (25%) and Set 3 (50%) treatments, and this represented a significant decrease in the number of leaves compared with the other treatments.

Uptake of heavy metals was also determined by the lettuce plants in the green parts and roots of the plants for the 75% and 100% sludge loadings. The results are shown in Table 3 and 4. The measured concentrations are evaluated using the standards given in Table 5. Since specific standards for lettuce have not been included yet in the Codex Standards except lead and cadmium, maximum limits for other metals are adopted from recent literature. Maximum limits of iron and manganese were stated as 425.5 and 500 mg/kg, respectively (Ewers, 1991; Pendas and Pendas, 1992). The limits of chromium, copper, nickel, and zinc are taken from the Weigert (1991). According to Wiegert, maximum limits of chromium, copper, nickel, and zinc are set as 2.3, 73.3, 67.9, and 99.4 mg/kg DS, respectively. In addition, according to the results of another study, limits of nickel, zinc and copper are revealed as 50, 300 and 150 mg/kg for lettuce plants (<http://soilslab.cfr.washington.edu/esc311-507/1997>).

Table 3. Metal concentrations measured at leaves and roots of SL-I

Vegetable Processing Sludge (SL-I)					
Parameter	Unit	Leave		Root	
		75%	100%	75%	100%
Nickel (Ni)	mg/kg DS	Nd	nd	Nd	0,8
Zinc (Zn)	mg/kg DS	146	188	96	110
Copper (Cu)	mg/kg DS	19,4	18	76	58
Lead (Pb)	mg/kg DS	Nd	nd	Nd	nd
Cadmium (Cd)	mg/kg DS	Nd	nd	Nd	nd
Chromium (Cr)	mg/kg DS	88	80	108	92
Manganese (Mn)	mg/kg DS	142	264	152	110
Iron (Fe)	mg/kg DS	5200	1092	3028	6254

The sludge did not significantly increase the amount of nickel, zinc, and cadmium. This is explained with high pH values of both sludge and soil mixtures (Dolgen et. al. 2004). Studies to determine the metal accumulation in the leaves of lettuce at high sludge rates showed that there was no significant increase in nickel, lead, cadmium and manganese concentrations, but the permissible concentrations for chromium, iron, copper and zinc were exceeded. Although zinc, copper and manganese elements are essential nutrients for plant growth, it should not be ignored if they are taken in large amounts, they may adversely affect plant growth (phytotoxicity).

Table 4. Metal concentrations measured at leaves and roots of SL-II

Vegetable Oil Processing Sludge (SL-II)					
Parameter	Unit	Leave		Root	
		75%	100%	75%	100%
Nickel (Ni)	mg/kg DS	2,14	5,91	0,64	3,77
Zinc (Zn)	mg/kg DS	19,27	25	0,42	29,54
Copper (Cu)	mg/kg DS	5,73	7,05	2,25	7,23
Lead (Pb)	mg/kg DS	0,68	1,59	0,23	2,54
Cadmium (Cd)	mg/kg DS	0,21	0,23	0,08	0,15
Chromium (Cr)	mg/kg DS	0,52	0,46	0,12	0,43
Manganese (Mn)	mg/kg DS	10,70	4,43	10,15	4,46
Iron (Fe)	mg/kg DS	4,74	21,59	17,71	45,39

Table 5. The permissible heavy metal concentrations for leafy vegetables

Parameter	Unit	Standard	References
Nickel	mg/kg	67.9; 50	Weigert (1991); http://soilslab.cfr.washington.edu
Zinc	mg/kg	99.4; 300	Weigert (1991); http://soilslab.cfr.washington.edu
Copper	mg/kg	73.3; 150	Weigert (1991); http://soilslab.cfr.washington.edu
Lead	mg/kg	0.3	FAO/WHO (CODEX) (2001)
Cadmium	mg/kg	0.2	FAO/WHO (CODEX) (2001)
Chromium	mg/kg	2.3	Weigert (1991)
Manganese	mg/kg	500	Ewers (1991); Pendias ve Pendias (1992)
Iron	mg/kg	425.5	Ewers (1991) ; Pendias ve Pendias (1992)

The experiments carried out using SL-II stated that the values exceeding the limit values were not measured in the concentrations of nickel, zinc, copper, chromium, manganese and iron in lettuce plants. However, the excess cadmium and lead elements in the raw sludge caused higher uptake by the plant. In particular, the lead concentration exceeded the limit values in both leaves and roots in 75% and 100% sludge applications. Besides that, for all metals except manganese, there was an increase in concentration in leaves at high sludge ratios.

CONCLUSIONS

The conducted study reveals that the wastewater treatment plant sludge of the vegetable processing and vegetable oil manufacturing industries have a potential for land applications. The results emphasized the significance of the sludge characteristics, sludge loading rate, and appropriate plant species for such applications. Sludge characterization studies demonstrated that the sludge used in this study was poor in heavy metals but rich in organic matter, macronutrients, and micronutrients thus it can be used as a partial substitute of chemical fertilizer and as a soil conditioner. Accumulation of heavy metals are related to plant species and their tolerance, and the loading rate. Therefore, extensive scientific researches on sludge use on land are still needed. Considering all discussions, one may state that the sludges of agro-industry WWTPs have high potential for agricultural use in the context of circular economy (CE) approach.

REFERENCES

- APHA-AWWA-WEF. (1992) "Standard methods for the examination of water and wastewater", (18th ed.), Washington, D.C., American Public Health Assoc.
- Codex Alimentarius Commission. Food additives and contaminants. Joint FAO/WHO Food Standards Programme 2001; ALINORM 01/12A:1-289.
- Dolgen, D., Alpaslan, M.N., Delen, N. 2004. Use of an agro -industry treatment plant sludge on iceberg lettuce growth. *Ecological Engineering* 23, 117-125
- Dolgen, D., Alpaslan, M.N., Delen, N. 2007. Agricultural recycling of treatment-plant sludge: A case study for a vegetable-processing factory, *Journal of Environmental Management*, 84 (3) 274-281.
- Dolgen, D.; Şengün, T.; Alpaslan, M.N. 2011. Recycling potential of agro-industrial treatment plant sludges (AITPS). In *Proc. of the 8th International Symposium on Waste Management problems in Agro-Industries*, (Eds. Orhon, D., et.al.), Volume 1, pp.325-332, June 22-24, Ilica, Çeşme, İzmir, Turkey.
- Dolgen, D., Alpaslan, M. N. 2023. A Reuse of Wastewater from the Circular Economy (CE) Perspective. *Sustainable Green Future: Perspectives on Energy, Economy, Industry, Cities and Environment*, Oncel, S.S., Editör, Springer, ss.385-408
- Ewers, U. 1991. Standards, guidelines and legislative regulations concerning metals and their compounds. In: *Metals and Their Compounds in the Environment: Occurrence, Analysis and Biological Relevance*. Weinheim: VCH, pp.458 -68.
- Pendias A.K., Pendias, H. 1992. Elements of group VIII. In: *Trace Elements in Soils and Plants*, CRC Press, Boca Raton, Florida, pp. 271 -76
- Weigert, P. 1991. Metal loads of food of vegetable origin including mushrooms. In: Merian, E. (Ed), *Metals and their compounds in the environment: Occurrence, analysis and biological relevance*. Weinheim: VCH, pp. 458 -68.

INVESTIGATION OF HUMAN ACTIVITIES IN THE COASTAL AREA AND ITS IMPACT ON BEACH LITTER IN THE SOUTHEAST BLACK SEA

Neira Purwanty ISMAIL¹, Koray ÖZŞEKER², Coşkun ERÜZ³, Bilal ÖNMAZ¹

¹Karadeniz Technical University, Marine Sciences Faculty, Fisheries Technology Engineering Department, Trabzon, Turkey

²Karadeniz Technical University, Marine Sciences Institute, Trabzon, Turkey

³Karadeniz Technical University, Marine Sciences Faculty, Marine Sciences and Technology Engineering Department, Trabzon, Turkey

Corresponding author e-mail: neira.ismail@gmail.com

ABSTRACT

The main objective of the present paper is to investigate the impact of human activities on beach marine litter pollution along the Southeast Black Sea coast of Turkey. Two sandy beaches, Balıklı and Yeniay beaches (designated as T1 and T2 stations), known for attracting local visitors for recreational purposes, were selected as representative pilot study locations to assess the level of beach litter pollution in the region. During the summer of 2022, beach marine litter, specifically macro litter (human-made litter larger than 2.5 cm), was collected and cleaned from these sites. The collected litter was counted to gauge the extent of beach marine litter pollution and determine the Coastal Clean Index (CCI). As a result, a total of 287 items were gathered and removed from the beaches, with plastic emerging as the predominant material, followed by paper and various other types of litter. Commonly found items at the stations included single-use items such as cigarette butts, beverage containers, and plastic fragments. The results pointed to a high level of pollution along the Southeast Black Sea coast, with Balıklı and Yeniay beaches exhibiting litter densities of 1.42 and 1.45 items per square meter, respectively. According to the Coastal Clean Index (CCI), both beaches fell under the category of "extremely dirty," surpassing an index value of 20. The outcomes of this study emphasize that human activities on the beaches play a significant role in the accumulation of marine litter, revealing a lack of awareness among beachgoers regarding the environmental impact of beach marine litter.

Keywords: Beach litter, marine litter, pollution, anthropogenic, Black Sea

INTRODUCTION

A variety of valuable resources that are necessary for human habitation and subsistence are provided by the coastal region in significant quantities (Yılmaz & Terzi, 2018). These resources cover a wide range of purposes, from scenic natural areas and leisure activities to vital industries like fishing, agriculture, and tourism (Salas-Leiton et al., 2021). Coastal areas often function as crucial transit hubs, allowing both local and international trade and business (Citra & Nugraha, 2021; Konstantinus & Woxenius, 2022). The coastal environment also supports diverse sectors like mariculture and aquaculture that have significant beneficial effects on the regional economy and the world's food supply (Mehvar et al., 2018). Additionally, coastal areas support rich biodiversity, also the scenic beauty and recreational opportunities of the coastal region draw visitors, promoting tourism as a significant economic engine for coastal communities (Barbier et al., 2011; Christie et al., 2015). Because of the diverse resources they provide, coastal areas are therefore essential for sustaining both human life and economic prosperity (Lakshmi, 2021).

Coastal regions are frequently confronted with the challenge of waste generation stemming from human activities. The dynamic blend of urban development, thriving tourism, fishing industries, and agricultural practices along the coast collectively contribute to the substantial amount of solid waste produced in these areas (Lotze et al., 2006). Urban development projects create more consumer goods, construction materials, and packaging waste, while tourism brings an influx of visitors, often leading to a higher volume of disposable items (Qiang et al., 2020; Student et al., 2020; Tsai et al., 2021). Additionally, fishing and agriculture activities generate organic waste and packaging materials. As populations grow and coastal areas become popular destinations for both residents and visitors, the demand for resources and services increases, leading to a surge in waste generation.

Increasing global population, rising consumption rates, and depletion of natural resources, the industrial sector is under increasing pressure to maximize manufacturing efficiency and cost-effectiveness. Industry has introduced products like plastics, which are versatile and economical to produce, to address these issues (Geyer et al., 2017). Due to their adaptability, plastics have become commonplace in a wide range of human-made products (North & Halden, 2013). However, a serious issue is raised by the fact that the rate of plastic degradation cannot keep up with their quick production, which causes an accumulation of litter in our environment (Bergmann et al., 2015; Geyer et al., 2017). In order to lessen the negative effects of plastic pollution on the environment, ecosystems, and marine life, effective waste management strategies, recycling programs, and sustainable alternatives are urgently needed.

The allure of the coastal areas has led to a rise in human-generated waste, driven by the region's popularity as a sought-after tourist destination and a hub for fishing, mariculture, agriculture, and various other human activities (Berkun et al., 2005; Kibria et al., 2023). Consequently, the proliferation of beach litter has become a multifaceted environmental challenge that demands urgent action and effective mitigation strategies to safeguard the region's natural beauty and ecological balance. Addressing this pressing issue requires a collaborative approach from all stakeholders to implement immediate and sustainable solutions for waste management and conservation in the coastal areas. For sustainable coastal management and the preservation of the area's distinctive biodiversity, it is essential to comprehend how human activities affect beach litter pollution. Tourism-related garbage, incorrect waste disposal, and recreational activities are just a few anthropogenic elements that significantly contribute to the degradation of beach habitats. Further endangering the delicate coastal ecosystems are the surge in single-use plastic use and the improper management of medical and sanitary waste (Brouwer et al., 2017; Dahms et al., 2019).

This study attempts to explore the link between human activity and beach litter pollution in Turkey's Southeast Black Sea region. This study aims to provide insight on the causes of beach litter pollution and its implications for the marine ecosystem and nearby communities by investigating the composition, distribution, and density of beach litter at several coastal sites. In the end, the results of this research will aid in the development of efficient conservation methods and policy interventions that can aid in the prevention of beach litter pollution and the preservation of the ecological health of the coastal areas along the Southeast Black Sea. In order to ensure the long-term prosperity and health of these coastal regions for future generations, the effective execution of such policies would be essential. To ensure the long-term sustainability of areas and minimize the effects of human generated waste it is vital to implement waste management techniques and raise awareness through campaigns.

MATERIAL AND METHOD

Study area

The study was conducted in the coastal area of Sürmene district, which is situated within Trabzon Province in the Southeast Black Sea Region of Turkey. Specifically, this research focused on the Sürmene districts, which are positioned along the coastline of Trabzon Province (Figure 1). These districts were deliberately chosen as the primary research sites due to their strategic location among the nine districts bordering the coastal areas of Trabzon Province. This selection makes them highly relevant and significant locations for investigating human activity's impact on beach marine litter pollution in the region.

The level of human activity is quite intense along Turkey's southeast Black Sea coast. The region has experienced ongoing coastal development projects that involve land reclamation, which has significantly altered the region's original coastal landscape. Additionally, a sizeable portion of the local population lives close to the riverbanks and coastal areas. The population of Sürmene was estimated at 25,950 according to statistics from 2022 (TUİK, 2022). But it's crucial to understand that there are seasonal variations in the population in this area, with lower numbers in the winter and a noticeable increase in the summer because of the influx of both domestic and foreign tourists attracted to the rural tourism destinations in the area (Efe et al., 2022). The main industries that characterize the region's economy are fishing, mariculture, agriculture, and tourism.

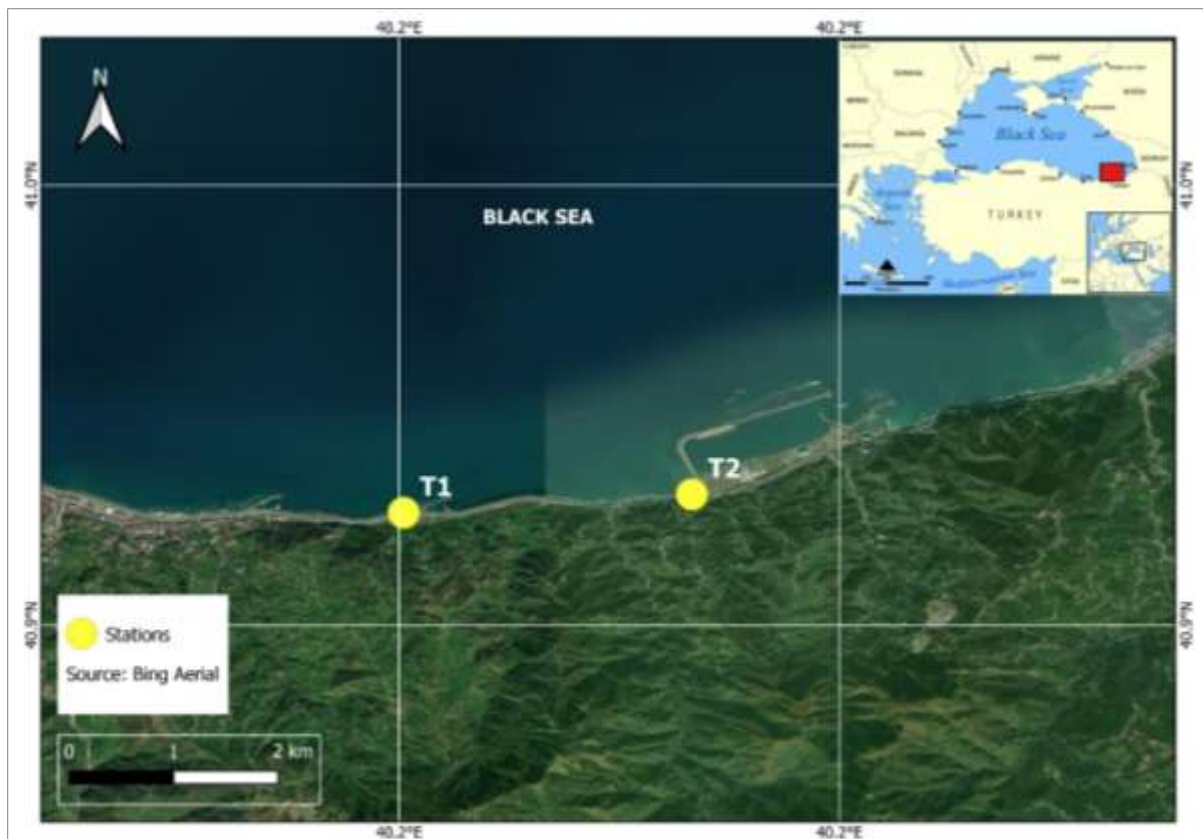

Figure 1. Map of study area includes two recreational beaches (T1 and T2) in the Southeast Black Sea coasts of Turkiye

Marine litter sampling was conducted at two data stations located along the Sürmene and Of coasts. The collection of beach litter samples was carried out during the summer season of 2022. Summer attracts a significant surge in human activities in the coastal area, as people engage in various outdoor activities, including visiting beaches for swimming, sunbathing,

picnics, and camping. The selection of data stations considered several factors, such as their designation as recreational beaches.

Litter sampling

All human-generated litter categorized as macro litter with size larger than 2.5 cm found within the designated transect areas of 100 square meters was meticulously gathered and recorded at each data station. However, it should be highlighted that natural debris, such as seaweed, animal bones, and untreated wood, was intentionally excluded from the litter collection process. The collected litter was categorized into 42 subcategories and nine primary categories (plastic, rubber, fabric, wood, metal, glass, sanitary waste, and medical waste) following the OSPAR classification system (Aytan et al., 2019; Terzi et al., 2020; Wenneker et al., 2010). The collected items were counted meticulously for the purpose of estimating the litter density in terms of quantity (numbers). This comprehensive approach allowed valuable insights to be gained into the types and quantities of litter present within the study area.

Litter analysis

An analysis was undertaken to assess the extent of litter pollution in the study area, with a focus on the litter composition, distribution, and density at all stations throughout the study period. To ascertain the litter composition, the percentages of each litter category were calculated in relation to the overall collected litter. The measurement was expressed as items per square meter (items/m²). The litter density was derived using the provided equation (Eq. 1). The density of litter items (D) was calculated by considering the total number of litter items collected from the transect (N), the width of the transect (w), and the length of the transect (l), which were measured in meters (Terzi et al., 2020; Terzi & Seyhan, 2017).

$$D = N/(w * l) \quad (1)$$

The evaluation of the cleanliness status of the beaches was accomplished using the Clean Coast Index (CCI) formulated by (Alkalay et al., 2007). The CCI, represented by Eq (2):

$$CCI = \left(\frac{\text{Total litter on transect}}{\text{Total area of transect}} \right) * K \quad (2)$$

The CCI scale consists of four categories, ranging from "very clean" (0–2), "clean" (2–5), "moderately clean" (5–10), to "dirty" (10–20), and "extremely dirty" (>20). To prevent values from falling between 0 and 1, a coefficient of 20, denoted as K, was utilized as a multiplier (Akarsu et al., 2022; Alkalay et al., 2007; Chen et al., 2020).

RESULTS AND DISCUSSIONS

In the summer of 2022, two distinct beach stations within the study area located in the Sürmene district of Trabzon Province, situated in the Southeast Black Sea region of Turkey, underwent a comprehensive collection of beach marine litter as part of this research investigation. Every item that falls within the designated transect underwent meticulous registration and counting to facilitate its subsequent classification into 42 subcategories and 9 major litter categories in accordance with the OSPAR classification system. Once this detailed categorization process was completed, the entire collection of litter was promptly removed from the beaches and relocated to the garbage bins, as an important step to reduce litter pollution in the area and protect the coastal and marine environment.

The study focused on assessing the abundance of beach marine litter items found within the designated study area. The results of the investigation revealed that a total of 287 items of beach marine

litter from two stations were collected during the study period. The analysis further demonstrated that plastic materials constituted the most prevalent material, accounting for a significant majority of the litter composition in both study locations when assessed based on the number of items (quantity). Subsequently, other materials with paper being the most prominent, constituted the remaining portion of the beach marine litter found at the study sites. Specifically, the total beach marine litter, based on item count, 75,6% plastics, 20,2% paper, 1,4% metals, 0,7% glass, 0,7% cloth, 0,7% medical waste, and 0,7% sanitary waste (Figure 2).

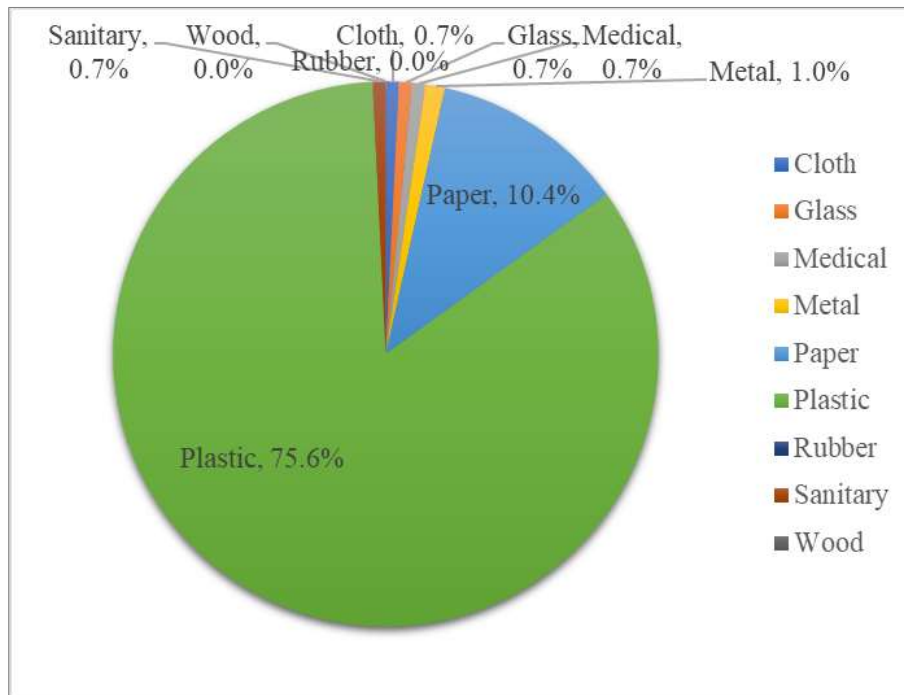

Figure 2. Aggregate beach litter composition in both station

Despite the relatively lower composition of plastic materials in the Balıklı (T1) station compared to the Yeniay (T2) station, plastic remains the predominant litter type in both locations (Figure 3). These study findings are in line with previous research conducted on beach marine litter at both regional and global levels, which consistently highlighted plastic materials as the dominant component in marine litter (Aytan et al., 2019; Bergmann et al., 2015; Galgani, 2014; Terzi et al., 2020; Terzi & Seyhan, 2017). However, it is worth noting that the proportion of plastic materials in marine litter observed in the current study area is relatively lower when compared to more recent investigations on beach marine litter at both regional and global scales. In certain studies, plastics have been reported to account for as much as 85% of the total beach marine litter.

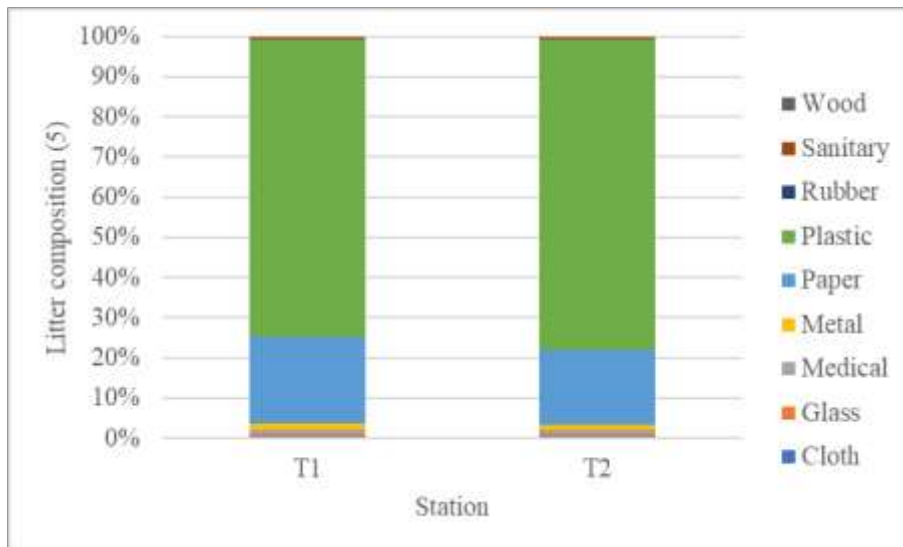

Figure 3. Beach litter composition in Balıklı (T1) and Yeniay (T2)

The examination of marine litter composition clearly demonstrated that plastic is the most predominant material in the study areas. The top twenty commonly found litter categories in both stations were dominated by plastic and plastic-coating items (Figure 4). Notably, plastic pieces exhibited a higher density in the study areas compared to other materials. Additionally, there was a significant abundance of single-use plastic litter, including cups, caps/lids, plastic bottles, cigarette butts, and beverage containers, indicating a substantial utilization of single-use plastic items that contribute significantly to beach litter pollution. The presence of commonly found items such as cigarette butts, beverage containers, plastic bottles, bags, and packages underscores the impact of leisure activities and waste generated by beachgoers because of personal consumption on the beach environment (Portman & Brennan, 2017).

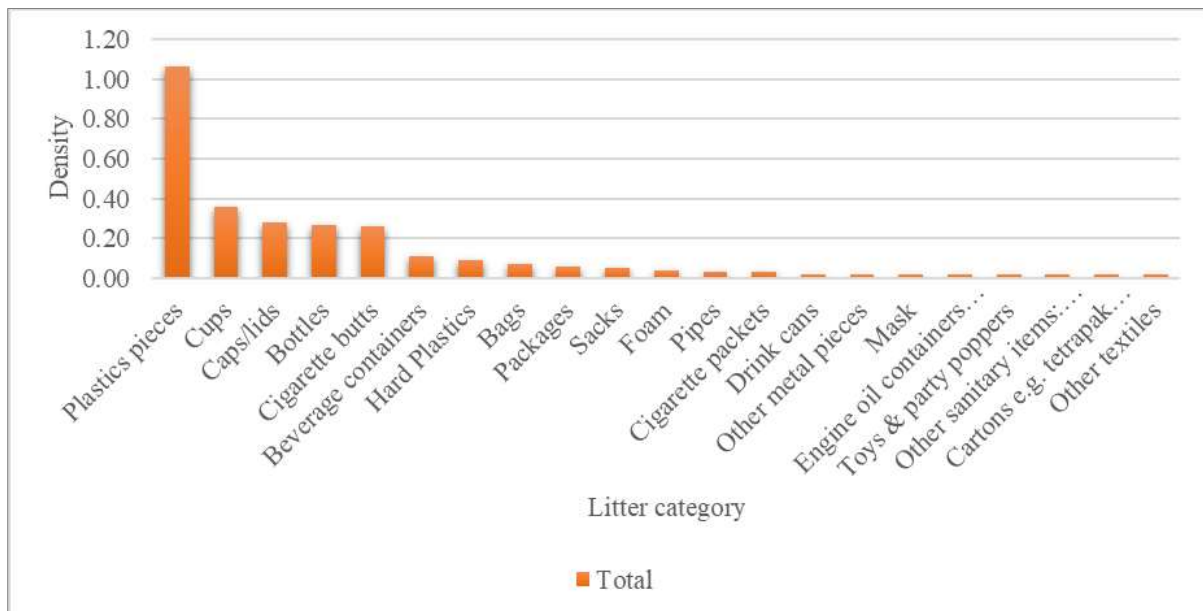

Figure 4. Top twenty most abundant litter categories

The assessment of litter density, quantified as items per square meter (items/m²), revealed a concerning level of beach litter pollution along the Southeast Black Sea coast of Turkey. Both Balıklı

(T1) and Yeniay (T2) beaches exhibited high litter densities of 1.42 and 1.45 items per square meter, respectively, classifying them under the category of "extremely dirty" based on the Coastal Clean Index (CCI) (Figure 5). In comparison, the Black Sea coasts generally have litter densities ranging from 0 to 5 items per square meter (Aytan et al., 2019; Terzi et al., 2020; Terzi & Seyhan, 2017). These findings highlight the severity of the litter pollution issue in the study area, indicating an urgent need for effective waste management and pollution mitigation measures to preserve the coastal environment's integrity and protect marine ecosystems. Implementing strategies to reduce litter and promoting responsible waste disposal practices will be essential to address this pressing environmental challenge and ensure the long-term sustainability of the Southeast Black Sea region.

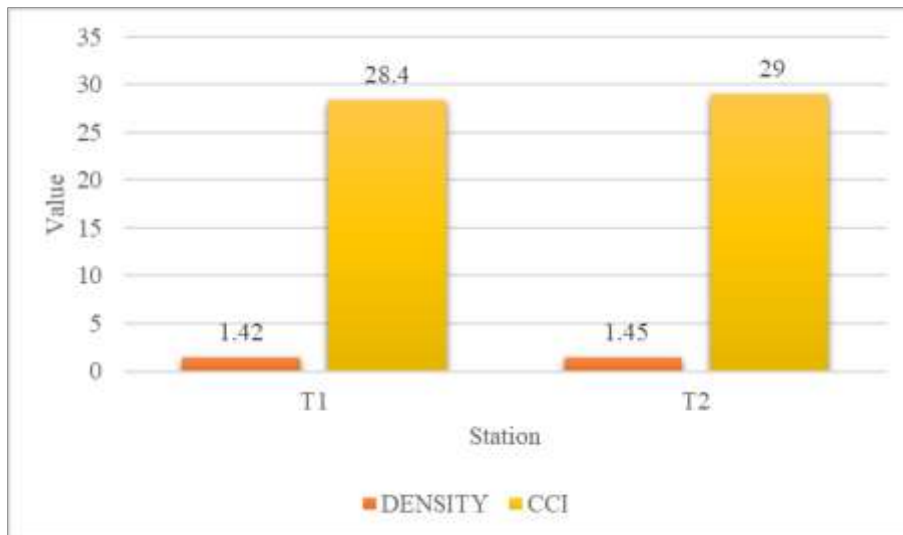

Figure 5. Litter density and Coastal Clean Index (CCI)

The investigation into beach marine litter pollution along the Southeast Black Sea coast has unveiled significant impacts of human activities on the coastal environment, evident by the abundance of human-generated waste in the study area. This discovery highlights the substantial visitation and public consumption of food and beverages, even though the beach is categorized as an underdeveloped recreational area. The research findings underscore the crucial role that human activities play in the buildup of marine litter. Notably, the prevalence of single-use items like cigarette butts, beverage containers, and plastic fragments emphasizes the importance of raising awareness among beachgoers about the consequences of beach marine litter. The lack of awareness regarding marine litter pollution issues contributes to the continuous accumulation of litter on the beaches, posing negative implications for the coastal environment and marine life.

In an effort to curb the usage of single-use plastic bags, Turkey has implemented regulations in 2019 to charge for plastic bags (Çevre ve Şehircilik Bakanlığı, 2019; Dursun, 2020). Similar practices in other parts of the world have shown promising results, leading to a reduction of up to 85% in plastic bag consumption (Cabrera et al., 2021). However, despite these regulations, the cost of plastic bags in Turkey remains relatively low, and some vendors even continue to offer them for free. This practice could undermine the intended purpose of the regulations and potentially encourage unrestrained and excessive use of plastic bags. As a consequence, the persistent issue of plastic waste in the country may be exacerbated by the continued availability and affordability of single-use plastic bags. To achieve the desired reduction in plastic bag usage and address the plastic waste problem effectively, it will be crucial to enforce the regulations more strictly and create awareness among consumers about the importance of reducing plastic usage and embracing reusable alternatives.

These results emphasize the significance of human activities in the accumulation of marine litter and underscore the necessity for increased awareness and responsible waste management practices among beachgoers. The findings shed light on the urgent need to address overconsumption and improper disposal of single-use plastic products to mitigate the growing marine litter problem and safeguard the coastal environment. Effectively tackling beach marine litter requires collective efforts from local communities, authorities, and stakeholders to promote sustainable behaviors and reduce reliance on single-use plastic items. Implementing effective waste management strategies and raising awareness about the environmental consequences of beach litter pollution are essential in preserving the pristine coastal environment of the Southeast Black Sea region for future generations. By raising awareness and enforcing responsible waste management practices, we can combat beach marine litter pollution and contribute to the long-term ecological health and sustainability of the region's coastal areas.

CONCLUSIONS

The findings revealed a concerning state of beach litter pollution, with a total of 389 items collected and removed from the beaches. Plastic emerged as the most prevalent material, followed by paper and various other types of litter. Disturbingly, single-use items like cigarette butts, beverage containers, and plastic pieces were frequently encountered at the study stations. The litter density measurements, using the Coastal Clean Index (CCI), exposed a high level of pollution at both Çavuşlu and Yeniay beaches, exceeding an index value of 20. These results classify both beaches as "extremely dirty," underscoring the severity of the litter pollution issue. Overall, the research highlights the substantial role human activities play in contributing to beach marine litter pollution. It also emphasizes the importance of raising awareness among beachgoers regarding the detrimental environmental consequences of beach litter. Sustainable waste management practices, coupled with education and public outreach, are essential to mitigate the growing problem of beach litter pollution in the Southeast Black Sea region of Turkey. Implementing effective strategies will not only preserve the natural beauty of these coastal areas but also safeguard the well-being of marine life and ecosystems for generations to come.

RECOMMENDATIONS

Based on the study's findings, a number of important suggestions can be made to address the problem of increasing beach litter pollution in the Southeast Black Sea region, particularly in the Balkl and Yeniay beaches. First of all, there is a critical need for focused public awareness campaigns and educational initiatives that target both visitors and local populations. The main goal of these initiatives should be to draw attention to the harmful environmental effects of marine litter, especially that caused by single-use items like cigarette butts, drink cans, and plastic fragments. People can be empowered to actively contribute to the reduction of beach litter pollution by increasing awareness and promoting ethical waste management practices. In order to effectively combat the issue of beach marine litter, it is imperative to implement sustainable waste management techniques. In order to create and implement rules that limit the use of single-use plastics and non-recyclable materials in coastal areas, local authorities and stakeholders should collaborate. Additionally, encouraging the use of environmentally friendly substitutes and providing incentives for recycling will significantly help to reduce litter pollution in the marine ecosystem. Furthermore, community involvement should be encouraged in regular, organized beach clean-up efforts. Along with assisting in the removal of existing litter, involving locals and volunteers in these initiatives fosters a sense of ownership and responsibility for protecting the coastal environment. In addition, ongoing research and monitoring are necessary to evaluate the success of adopted strategies and spot new difficulties.

In order to effectively combat beach litter pollution, regular assessments of litter composition, distribution, and density will offer insightful policymaking and adaptive measures. These suggestions can help the Southeast Black Sea region significantly reduce beach litter pollution and protect the health of the marine ecosystem for the benefit of current and future generations. In order to maintain the natural beauty and ecological integrity of the region's coastal areas, everyone must put forth an effort and make a commitment to sustainable practices.

REFERENCES

- Akarsu, C., Sönmez, V. Z., Altay, M. C., Pehlivan, T., & Sivri, N. (2022). The spatial and temporal changes of beach litter on Istanbul (Turkey) beaches as measured by the clean-coast index. *Marine Pollution Bulletin*, 176, 113407. <https://doi.org/10.1016/J.MARPOLBUL.2022.113407>
- Alkalay, R., Pasternak, G., & Zask, A. (2007). Clean-coast index—A new approach for beach cleanliness assessment. *Ocean & Coastal Management*, 50(5–6), 352–362. <https://doi.org/10.1016/J.OCECOAMAN.2006.10.002>
- Aytan, U., Sahin, F. B. E., & Karacan, F. (2019). Beach Litter on Sarayköy Beach (SE Black Sea): Density, Composition, Possible Sources and Associated Organisms. *Turk. J. Fish. & Aquat. Sci*, 20(2), 137–145. https://doi.org/10.4194/1303-2712-v20_2_06
- Barbier, E. B., Hacker, S. D., Kennedy, C., Koch, E. W., Stier, A. C., & Silliman, B. R. (2011). The value of estuarine and coastal ecosystem services. *Ecological Monographs*, 81(2), 169–193. <https://doi.org/10.1890/10-1510.1>
- Bergmann, M., Gutow, L., & Klages, M. (2015). Marine anthropogenic litter. *Marine Anthropogenic Litter*, 1–447. <https://doi.org/10.1007/978-3-319-16510-3>
- Berkun, M., Aras, E., & Nemlioglu, S. (2005). Disposal of solid waste in Istanbul and along the Black Sea coast of Turkey. *Waste Management*, 25(8), 847–855. <https://doi.org/10.1016/J.WASMAN.2005.04.004>
- Brouwer, R., Hadzhiyska, D., Ioakeimidis, C., & Ouderorp, H. (2017). The social costs of marine litter along European coasts. *Ocean & Coastal Management*, 138, 38–49. <https://doi.org/10.1016/J.OCECOAMAN.2017.01.011>
- Cabrera, J. M., Caffera, M., & Cid, A. (2021). Modest and incomplete incentives may work: Pricing plastic bags in Uruguay. *Journal of Environmental Economics and Management*, 110, 102525. <https://doi.org/10.1016/J.JEEM.2021.102525>
- Çevre ve Şehircilik Bakanlığı. (2019). Çevre ve Şehircilik Bakanlığı 12 Ocak 2019 tarihli internet sitesi haberi. <https://www.csb.gov.tr/yerel-yonetimlere-plastik-poset-kullaniminin-azaltilmasina-yonelik-genelge-gonderildi-bakanlik-faaliyetleri-25415>
- Chen, H., Wang, S., Guo, H., Lin, H., & Zhang, Y. (2020). A nationwide assessment of litter on China's beaches using citizen science data. *Environmental Pollution*, 258, 113756. <https://doi.org/10.1016/J.ENVPOL.2019.113756>
- Christie, M., Remoundou, K., Siwicka, E., & Wainwright, W. (2015). Valuing marine and coastal ecosystem service benefits: Case study of St Vincent and the Grenadines' proposed marine protected areas. *Ecosystem Services*, 11, 115–127. <https://doi.org/10.1016/J.ECOSER.2014.10.002>
- Citra, I. P., & Nugraha, A. S. (2021). *The Right Strategy for Coastal Zone Development*. <https://doi.org/10.4108/EAI.10-11-2020.2303424>
- Dahms, H. U., Galgani, L., Beiras, R., Galgani, F., Panti, C., & Borja, A. (2019). Editorial: Impacts of Marine Litter. *Frontiers in Marine Science | Www.Frontiersin.Org*, 1, 208. <https://doi.org/10.3389/fmars.2019.00208>
- Dursun, İ. (2020). PLASTİK POŞETLERİN ÜCRETLENDİRİLMESİ UYGULAMASINA GÖSTERİLEN TUTUMSAL VE DAVRANIŞSAL DESTEĞİN AÇIKLANMASINA

YÖNELİK MODEL ÖNERİSİ. *Ömer Halisdemir Üniversitesi İktisadi ve İdari Bilimler Fakültesi Dergisi*, 13(1), 129–148. <https://doi.org/10.25287/ohuiibf.563177>

- Efe, B., Gözet, E., Özgür, E., Lupo, A. R., & Deniz, A. (2022). Spatiotemporal Variation of Tourism Climate Index for Türkiye during 1981–2020. *Climate 2022*, Vol. 10, Page 151, 10(10), 151. <https://doi.org/10.3390/CLI10100151>
- Galgani, F. (2014). Distribution, composition and abundance of marine litter in the Mediterranean and Black Seas. *CIESM 2014. Marine Litter in the Mediterranean and Black Seas. CIESM Workshop Monograph N° 46 [F., 18-21 June.*
- Geyer, R., Jambeck, J. R., & Law, K. L. (2017). Production, use, and fate of all plastics ever made. *Science Advances*, 3(7). <https://doi.org/10.1126/SCIADV.1700782>
- Kibria, M. G., Masuk, N. I., Safayet, R., Nguyen, H. Q., & Mourshed, M. (2023). Plastic Waste: Challenges and Opportunities to Mitigate Pollution and Effective Management. *International Journal of Environmental Research*, 17(1), 1–37. <https://doi.org/10.1007/S41742-023-00507-Z/FIGURES/26>
- Konstantinus, A., & Woxenius, J. (2022). Case study: Coastal shipping in sub-Saharan Africa. *Case Studies on Transport Policy*, 10(4), 2064–2074. <https://doi.org/10.1016/J.CSTP.2022.09.008>
- Lakshmi, A. (2021). Coastal ecosystem services & human wellbeing. *The Indian Journal of Medical Research*, 153(3), 382. https://doi.org/10.4103/IJMR.IJMR_695_21
- Lotze, H. K., Lenihan, H. S., Bourque, B. J., Bradbury, R. H., Cooke, R. G., Kay, M. C., Kidwell, S. M., Kirby, M. X., Peterson, C. H., & Jackson, J. B. C. (2006). Depletion degradation, and recovery potential of estuaries and coastal seas. *Science*, 312(5781), 1806–1809. https://doi.org/10.1126/SCIENCE.1128035/SUPPL_FILE/LOTZE.SOM.PDF
- Mehvar, S., Filatova, T., Dastgheib, A., de Ruyter van Steveninck, E., & Ranasinghe, R. (2018). Quantifying Economic Value of Coastal Ecosystem Services: A Review. *Journal of Marine Science and Engineering 2018*, Vol. 6, Page 5, 6(1), 5. <https://doi.org/10.3390/JMSE6010005>
- North, E. J., & Halden, R. U. (2013). Plastics and Environmental Health: The Road Ahead. *Reviews on Environmental Health*, 28(1), 1. <https://doi.org/10.1515/REVEH-2012-0030>
- Portman, M. E., & Brennan, R. E. (2017). Marine litter from beach-based sources: Case study of an Eastern Mediterranean coastal town. *Waste Management*, 69, 535–544. <https://doi.org/10.1016/J.WASMAN.2017.07.040>
- Qiang, M., Shen, M., & Xie, H. (2020). Loss of tourism revenue induced by coastal environmental pollution: a length-of-stay perspective. *Journal of Sustainable Tourism*, 28(4), 550–567. <https://doi.org/10.1080/09669582.2019.1684931>
- Salas-Leiton, E., Vieira, L. R., & Guilhermino, L. (2021). Sustainable Fishing and Aquaculture Activities in the Atlantic Coast of the Portuguese North Region: Multi-Stakeholder Views as a Tool for Maritime Spatial Planning. *Sustainability 2021*, Vol. 13, Page 663, 13(2), 663. <https://doi.org/10.3390/SU13020663>
- Student, J., Kramer, M. R., & Steinmann, P. (2020). Simulating emerging coastal tourism vulnerabilities: an agent-based modelling approach. *Annals of Tourism Research*, 85. <https://doi.org/10.1016/j.annals.2020.103034>
- Terzi, Y., Erüz, C., & Özşeker, K. (2020). Marine litter composition and sources on coasts of south-eastern Black Sea: A long-term case study. *Waste Management*, 105, 139–147. <https://doi.org/10.1016/J.WASMAN.2020.01.032>
- Terzi, Y., & Seyhan, K. (2017). Seasonal and spatial variations of marine litter on the south-eastern Black Sea coast. *Marine Pollution Bulletin*, 120(1–2), 154–158. <https://doi.org/10.1016/j.marpolbul.2017.04.041>
- Tsai, F. M., Bui, T. D., Tseng, M. L., Lim, M. K., & Tan, R. R. (2021). Sustainable solid-waste management in coastal and marine tourism cities in Vietnam: A hierarchical-level approach.

Resources, Conservation and Recycling, 168, 105266.

<https://doi.org/10.1016/J.RESCONREC.2020.105266>

TUİK. (2022). *Trabzon Sürmene Nüfusu*. <https://www.nufusune.com/156793-trabzon-koprubasi-arpali-mahallesi-nufusu>

Wenneker, B., Oosterbaan, L., & Intersessional Correspondence Group on Marine Litter (ICGML). (2010). *Guideline for Monitoring Marine Litter on the Beaches in the OSPAR Maritime Area* (1.0). OSPAR Commission. www.ospar.org

Yılmaz, M., & Terzi, F. (2018). The importance of coastal city morphology in terms of ecosystem and natural environment. *International Journal of Architecture and Urban Studies*, 3(3), 68–78. <https://dergipark.org.tr/en/pub/ijaus/issue/55402/759708>

GASTROINTESTINAL HELMINTS OF CATTLE IN SEMI INTENSIVE BREEDING AT BELGRADE AREA

Acc. Res.Fell. Ivan PAVLOVIC¹, Sen. Res.Ass. Nemanja ZDRAVKOVIC², Sen. Res.Ass. Violeta CARO PETROVIC³, Prof. Jovan BOJKOVSKI⁴, Res.Ass.Aleksandra TASIC⁵, Res.Ass.Marija PAVLOVIC⁶

¹ Scientific Institute of Veterinary Medicine of Serbia, Belgrade, Serbia
ORCID: ID /0000-0003-4751-6760
dripavlovic58@gmail.com, 0000-0003-4751-6760

² Scientific Institute of Veterinary Medicine of Serbia, Belgrade, Serbia
ORCID: ID / 0000-0002-3925-4409
nemanja.zdravkovich@gmail.com, +381643206063

³ Institute for Animal Husbandry, Belgrade-Zemun, Serbia
ORCID: ID /0000-0002-6126-3846
violycaro@yahoo.com, +381648291222

⁴ University in Belgrade, Faculty of Veterinary Medicine, Belgrade, Serbia
ORCID: ID /0000-0001-7097-2559
bojkovski@vet.bg.ac.rs, +381644475682

⁵ Scientific Institute of Veterinary Medicine of Serbia, Belgrade, Serbia
ORCID: ID /0000-0002-8361-5697
alekstasic79@gmail.com, +381659094904

⁶ Scientific Institute of Veterinary Medicine of Serbia, Belgrade, Serbia
ORCID: ID /0000-0003-1709-0412
majaspavlovic@gmail.com, +381652573492

ABSTRACT

The spread area of Belgrade has extremely favorable conditions for modern agricultural production (climate, agricultural land, watercourses, developed processing industry). This economic branch is of strategic importance for supplying Belgrade with food products, along with the resources that abound in the wider environment (Vojvodina and Šumadija). There are numerous villages here, where households keep cattle in small herds or mini-farm, usually in semi-intensive breeding. During our study performed on 2018 we examined faeces of 190 cattle from 42 herds and 29 cattle by post-mortem examination. Determination of eggs and adult parasites performed on their morphological characteristics. The coprological examination established the presence of gastrointestinal helminth eggs in 39.6% of samples. The majority of cattle were infected with two and fewer number with three or four parasite species. At post-mortem examination of cattle we found *Haemonchus contortus* we occurred in 57.53%, *Ostertagia ostertagi* in 55.63%, *Trichonstrongylus axei* in 49.37%, *Cooperia oncophora* in 32.57%, *Ostertagia trifurcata* in 29.79%, *Oesophagostomum radiatum* 21.22%, *Toxocara vitulorum* 17.52%, *Dicocelium dendriticum* 15.26%, *Paramphistomum ichikawai* in 14.21%, *Strongyloides papillosus* 11.51%, *Moniezia benedeni* in 9.47% and *Trichuris discolor* in 6.52%.

Keywords: gastrointestinal helminths, cattle, Belgrade, Serbia

INTRODUCTION

Gastrointestinal helminthiasis is a parasitic infection caused by a group of helminth parasites, which affect the gastrointestinal tract (GIT), associated organs, and whose eggs are excreted to the environment through animals' faeces. GIT helminths are ubiquitous parasitic agents of livestock especially ruminants and are known to limit cattle production in many areas and countries worldwide. The prevalence variations of specific GIT across different regions suggest the influence of several epidemiological factors on the magnitude of the infection. Of many epidemiological factors, husbandry management in general one of the main conditions for the spread and prevalence of infections. Pasture borne gastrointestinal nematode (GIN) parasites are very common in grazing cattle and thereby represent a significant economic and welfare burden to the global ruminant livestock industry (Spence *et al.*, 1996; Stancampiano *et al.*, 2007) Mortality of cattle due to parasitic diseases not be alarming at times but their indirect effects on livestock productivity like reduction in productive potential such as decreased growth rate and milking or weight loss are considerably greater (Eckstein *et al.* 2015; Forbes *et al.* 2004; Sprriinger *et al.* 2021)

In Serbia, in the past period, cattle breeding was mostly done by agro-industrial companies on large farms with thousands of animals. The cattle breeding in rural communities are within backyard or at small farms with agro-pastoral feeding, and is considered an important economic sector of the food industry

Research on the parasitofauna of cattle in Serbia has not been done sporadically and that was the reason why we renewed these examination (Babić, 1965; Aleksić, 1976; Vučković, 1976; Toplica, 1987; Marusić, 1988; Stankovic, 2007; Pavlovic *et al.* 2022a,b).. In our paper we presented results of examination performed in semi intensive breeding at Belgrade area

MATERIAL AND METHODS

The study of GIT infection performed during 2018 we were carried out in herds of cattle originated from from 6 Belgrade districts Mladenovac, Lazarevac, Obrenovac, Grocka, and Vozdovac (from the village Mladenovac, Vlaska, Mala Krsna, Velika Krsna, Medjuluzje, Senjak, Velika Ivanca, Orašac, Mala Vrbica, Rajkovac, Dubona, Šepšin, Resnik, Ritopek, Vrčin, Vinča, Leštane, Pinosava, Grocka, Velike Granice, Granice, Koracica, Jagnjilo, Markovac, Lazarevac, Arapovac, Junkovac, Leskovac, Sokolovo, Rabrovac, Vrbovno, Zvecka, Krtinska and Stepojevac).

During our study we examined faeces of 190 cattle from 42 herds and 29 cattle by post-mortem examination. During study we collected fecal samples and exaitinatioills performed using standard coprological technique with saturated NaCl solution and seditrentatioir (Euzebry, 1981, Pavlovic and Rogozarski, 2017), Determination of eggs and adult parasites performed on their morphological characteristics. Examinations we performed with Carl Zeiss AxioLab A1 microscope with the AxioCam 105 Color microscope camera and Zen Lite software.

RESULTS AND DISCUSSION

The coprological examination established the presence of gastrointestinal helminth eggs in 39.47% of samples. The majority of cattle were infected with two and fewer number with three or four parasite species. Our examination showed a high overall prevalence of Nematodes infection (39.47%) than Trematodes (15.26%) and Cestodes (9.74%).

During post-mortem examination we found twelve helminth species. In rumen we occurred *Paramphistomum ichikawai*, in abomasus we found *Ostertagia ostertagi*, *O.trifurcata* and *Trichostrongylus axei* (which are also found in the small intestines), in small intestine we found *Moniezia benedeni*, *Toxocara vitulorum*, *Strongyloides papillosus*, *Cooperia oncophora* and *Trichuris discolor*, in large intestine we found *Haemonchus contortus* and *Oesophagostomum radiatum* and in bile ducts and in the gall bladder *Dicocelium dendriticum*.

The prevalence of established parasites was as follows: *Haemonchus contortus* we occurred in 57.53%, *Ostertagia ostertagi* in 55.63%, *Trichostrongylus axei* in 49.37%, *Cooperia oncophora* in 32.57%, *Ostertagia trifurcata* in 29.79%, *Oesophagostomum radiatum* 21.22%, *Toxocara vitulorum* 17.52%, *Dicocelium dendriticum* 15.26%, *Paramphistomum ichikawai* in 14.21%, *Strongyloides papillosus* 11.51%, *Moniezia benedeni* in 9.47% and *Trichuris discolor* in 6.52%.

In the current study, high rate of infection were closely associated with animals in poor body condition. Study showed that in older animals both the prevalence and number of GIT were higher than in younger ones. Family Trichostrongylidae contains most of the important gastro-intestinal nematodes of cattle around the world (Harding and Threlfall, 1989; Nwosu *et al.*, 2007; Surbu *et al.*, 2020). The life cycle of the trichostrongyles is direct. For most species first-stage larvae develop in, and hatch from, the eggs passed in faeces. These larvae moult twice to the ensheathed third-stage, which are infective and are ingested by the cattle. Under ideal environmental conditions this translation takes approximately one week, but the rate of development is temperature-dependent. The infective larvae continue their development in the mucosa of that part of the gut in which the adults live, then emerge into the lumen and become adults. Most of found helminths are pathogenic to their hosts leading, besides other disorders, to anemia, gastroenteritis and depressed growth rates and mortality (Forbes *et al.* 2004; Stancampiano *et al.*, 2007; Högberg *et al.* 2019; Springer *et al.* 2021).

The disease is related to the grazing diet and the biological cycle of the parasite, which takes place without transitional hosts. The developmental cycle of the parasite is straightforward. From these reason presence of tapeworm and fluke was only at hilly-mountain region of Belgrade were good condition to development of intermediate hosts of this parasites species. The seasonal dynamics of certain types of parasites, the degree of infection and the occurrence of diseases vary not only in different areas but also in the same area during the year.

At the beginning of the grazing season pastures are essentially parasite-free, except for *Nematodirus*. Any free-living stages of the other trichostrongyles remaining on the pasture at the end of the previous summer have died over the winter or during the early spring, before the cattle are put out to graze (Forbes *et al.*, 2004; Hesterberg *et al.*, 2007). Where there is essentially no overwinter survival of the parasites on pasture, it is the eggs in the feces of the cows, and other older animals, that introduce trichostrongyle infection to the pastures in the spring. The rate of development and hatching of these eggs increases with seasonal warming of the environmental temperatures, and when the calves begin to graze significantly the pasture contains plentiful infective larvae. These larvae establish infections in the calves, which are more susceptible to infection than are older animals, sometimes at high levels (Larson *et al.*, 2007) The adult parasites in the calves then produce more eggs which, if environmental temperatures are sufficiently warm, develop into a second generation of infective larvae (Chihai 2006; Yevstafieva *et al.*, 2020). As temperatures cool in the fall, egg hatching and larval development on the pasture slow then stop. Same was happened with intermediate hosts of tapeworm and fluke (Irie *et al.*, 2013; Ayalew *et al.*, 2016; Pavlovic *et al.* 2022a,b

The parasite-host relationship is complex: physiological state and general condition, method of cultivation and nutrition, time of calving, configuration and macroclimate of the soil. In natural conditions, every animal is infected - constant contamination of the pasture. This is contributed by the increased susceptibility of the already infected herd, the introduction of

susceptible animals into the infected herd and the increase in the intensity of the infection in the already infected herd (Forbes *et al.*,2004; Szyszka, and Kyriazakis,2013).. Immunity develops through continuous infections, and then there is the elimination of the present parasites (self cure mechanism), complete or partial inhibition of the development of newly introduced larvae (spring rise) and complete or partial inhibition of the reproductive abilities of female parasites.

CONCLUSION

The result of our study shows a moderate prevalence of gastrointestinal helminth infection. Temporary breeding on pastures in the presence of cattle of all age categories creates favorable conditions for the development and survival of preparasitic forms and their intermediate hosts outdoors, which enables the infection of calves with gastrointestinal strongyles, flukes and tapeworm. This indicates the need to continue these researches in order to control parasitic infections in cattle.

ACKNOWLEDGMENT

The study was funded by the Serbian Ministry of Education, Science and Technological Development (Contract No 451- 03-68/2022- 14/200030).

REFERENCE

- Aleksic, D. (1976) Helminthosis of cattle and sheep of Timočka Krajina with special reference to fasciolosis and dicroceliosis. BSc thesis, Faculty of Veterinary Medicine, University of Belgrade, Belgrade.
- Ayalew, G., Tilahun, A., Aylate, A., Teshale, A., & Getachew, A. (2016) A study on prevalence of Paramphistomum in cattle slaughtered in Gondar Elfora Abattoir, Ethiopia. *Journal of Veterinary Medicine and Animal Health*, 8(8), 107–111.
- Babić, P. (1965) Helminths of the digestive organs of Serbian cattle with special reference to their occurrence and insufficiently described species. PhD thesis, Faculty of Veterinary Medicine, University of Belgrade, Belgrade
- Chihai, O. (2006) Cattle polyparasitism in different regions of the Republic of Moldova. *Buletin USAMV*, 63, 217- 221.
- Eckstein C., Lopes, L., Nicolino, R.R., Stefanie, C., Oliveira, F. (2015) Economic impacts of parasitic diseases in cattle. *CABI Reviews: Perspectives in Agriculture, Veterinary Science, Nutrition and Natural Resources*, 10-11.
- Euzeby, J. (1981) *Diagnostic experimental de helminthoses animals*", ITVC, Paris, France.
- Forbes, A.B., Huckle, C.A., Gibb, M.J. (2014) Impact of eprinomectin on grazing behaviour and performance in dairy cattle with sub-clinical gastrointestinal nematode infections under continuous stocking management. *Veterinary Parasitology*, 125, 353–364.
- Harding, R.M., Threlfall, W. (1989) Gastrointestinal helminth prevalence and intensity of infection in dairy cattle from Avalon Peninsula, New Founland. *Parasitologica Hungarica*, 22, 67-74.
- Hesterberg, U.W., Bagnall, R., Perrett, K., Horner, R., Gummow, B. (2007) A questionnaire survey of perceptions and preventive measures related to animal health amongst cattle owners of rural communities in KwaZulu-Natal, South Africa. *Journal of the South African Veterinary Association*, 78, 4, 205–208.

- Högberg, N., Lidfors, L., Hesse, A., Arvidsson, K., Herlin, A., Höglund, J. (2019) Effects of nematode parasitism on activity patterns in first-season grazing cattle. *Veterinary Parasitology* 276, Supplement 100011
- Irie, T., Sakaguchi, K., Ota-Tomita, A., Tanida, M., Hidaka, K., Kirino, Y., Nonaka, N., Horii, Y. (2013) Continuous *Moniezia benedeni* infection in confined cattle possibly maintained by an intermediate host on the farm. *The Journal of Veterinary Medical Science*, 75(12), 1585–1589.
- Larsson, A., Dimander, S.O., Rydzik, A., Uggla, A., Waller, P.J., Höglund, J. (2007) A 3-year field evaluation of pasture rotation and supplementary feeding to control parasite infection in first-season grazing cattle—dynamics of pasture infectivity. *Veterinary Parasitology*, 145, 129–137.
- Marusić, S. (1988) Endoparasitoses of cattle in the field of veterinary stations in Smederevo and measures for their control (in Serbian). BSc thesis, Faculty of Veterinary Medicine, Belgrade.
- Nwosu, C.O., Madu, P.P., Richards, W.S. (2007) Prevalence and seasonal changes in the population of gastrointestinal nematodes of small ruminants in the semi-arid zone of northeastern Nigeria. *Veterinary Parasitology*, 144 (1-2), 118–124.
- Pavlović, I., Rogožarski, D. (2017) Parasitic diseases of domestic animals with basics of parasitology and diagnostics of parasitic diseases. Naučna KMD, Beograd
- Pavlovic, I., Caro Petrovic, V., Bojkovski, J., Mederle, N., Tasic, A. (2022a) Prevalence of gastrointestinal helminths in cattle in northeastern part of Serbia (Banat). Full Text Book 8th International Black Sea Coastline Countries Scientific Research Symposium, 29-30.8.2022., Sofia, Bulgaria, 442-445
- Pavlovic, I., Bojkovski, J., Csordás, F., Mederle, N. (2022b) Occurrence of paramphistomidae (Trematoda: Digenea) in cattle in northeastern part of Serbia (Banat). ABSTRACTs Book of VI-International European Conference on Interdisciplinary Scientific Research, 26-27.8.2022., Bucharest, Romania, 299
- Sirbu, C.B., Imre, K., Darabus, G., Suici, T., Mates, B., Morariu, S. (2020) Prevalence of gastrointestinal parasitic infections in cattle and sheep in two regions of Romania. *Turkish Journal of Veterinary and Animal Sciences*, 44, 581-587.
- Springer, A., Jordan, D., Kirse, A., Schneider, B., Campe, A., Knubben-Schweizer, G., Müller, K.E., Hoedemaker, M., Strube, C. (2021). Seroprevalence of major pasture-borne parasitoses (Gastrointestinal nematodes, liver flukes and lungworms) in German dairy cattle herds, association with management factors and impact on production parameters. *Animals*, 11, 2078.
- Spence, S.A., Fraser, G.C., Chang, S. (1996) Responses in milk production to the control of gastrointestinal nematode and paramphistome parasites in dairy cattle. *Australian Veterinary Journal*, 74, 456–459.
- Stanković, D. (2007) Parasitic infection of the digestive tract of calves in the Pirot area. BSc thesis, Faculty of Veterinary Medicine, University of Belgrade, Belgrade.
- Stancampiano, L., Corradini, D., Bulgarelli, M., Micagni, G., Battelli, G. (2007) Parasites of the digestive tract in beef cattle imported from France to Italy. *Parassitologia*, 49 (1-2), 101-106.
- Szyska, O., Kyriazakis, I. (2013) What is the relationship between level of infection and “sickness behaviour” in cattle? *Apply Animal Behaviour Science*, 147, 1–10.
- Toplica, D. (1987) Parasitic disease of the digestive tract of calves in individual producers in the area of the municipality Raca (in Serbian). BSc thesis, Faculty of Veterinary Medicine, Belgrade.

- Vučković, D. (1976) Important endoparasites of cattle in the area of Titovo Užice and measures for their control. BSc thesis, Faculty of Veterinary Medicine, University of Belgrade, Belgrade.
- Yevstafieva, V., Kruchynenko, O., Melnychuk, V., Mykhailiutenko, S., Korchan, L., Shcherbakova, N., Dolhin O. (2020) Epizootological peculiarities of the course of cattle and sheep parasitoses in the summer pasture period. Bulletin of Poltava State Agrarian Academy, 3, 205–212.

EFFECT OF MUSHROOM EXTRACTS ON COLOR CHANGE AND SOME CHEMICAL PROPERTIES OF DEHYDRATED SOUPS

Monika STOJANOVA^{1*}, Milena PANTIC², Dragana MIHAJLOVIC²,
Marina T. STOJANOVA³, Miomir NIKSIC²

¹Association for Scientific-research, Educational and Cultural Activities "Open Science",
North Macedonia

²Faculty of Agriculture, University of Belgrade, Belgrade, Serbia

³Faculty of Agricultural Sciences and Food, Ss. Cyril and Methodius University, Skopje,
North Macedonia

Corresponding author: stojanova.monika@yahoo.com

ABSTRACT

The aim of this research was to produce lyophilized water extract from several mushroom species (*Suillus granulatus*, *Coriolus versicolor*, *Fuscoporia torulosa*) and to determine its influence on some chemical properties as well as on the color changes of the industrially produced Bio Soups, without the addition of monosodium glutamate. The realisation of the planned research was carried out by designing four variants of dehydrated soup. The content of mineral matters was significantly ($p < 0.05$) higher in all soup variants enriched with lyophilized extracts. Moreover, the moisture content in all analyzed soup variants is in accordance with the regulations. From the aspect of the instrumental color value, constancy was established for all parameters in all tested variants from the 0th to the 90th day after production, i.e. all soups had a stable color during storage, which means that there were no changes in other chemical or biological parameters that would lead to a change in the color of the product. Therefore, statistically significant ($p < 0.05$) differences were observed only between the control variant in relation to the other variants, i.e. the darker shade in the analyzed variants enriched with lyophilized extracts is a consequence of the applied extracts. In this way, a new product is obtained that does not contain chemical additives, which further increases its value.

Key words: Mushroom extracts, Color, Moisture, Dehydrated soups.

INTRODUCTION

Functional food is food that, in addition to its important nutrients, has a beneficial effect on human health. Interest in functional foods is increasing, and edible mushrooms (fresh or dried) or their extracts can be consumed as functional foods (Niva, 2007).

Dehydrated soups belong to the category of products that are prepared very quickly, and on the other hand, they are safe in terms of microbiological contamination, primarily due to their low water content. In addition to stability during storage, dehydrated soups have beneficial nutritional properties, and often therapeutic ones. Due to these characteristics, soups are an acceptable product for all types of consumers. Generally, commercial dehydrated soups are prepared from various types of vegetables, poultry and beef, mushrooms and the like (Stojanova et al., 2023).

Mushroom soups are a traditional food in China. They have been consumed since ancient times due to their nutritional value, excellent taste and functional properties (Tharshika et al., 2016). Such soups contain important nutrients, such as amino acids, monosaccharides, dietary

fiber and numerous other bioactive components isolated from mushrooms. Dehydrated soups with the addition of mushrooms or mushroom extracts are characterized by anti-cancer effects and have anti-atherogenic and immunomodulatory properties (Prameela and Prameela, 2020).

Vegetable soup, as a functional food, is rich in bioactive compounds such as antioxidants, dietary fibers, essential amino acids and oligosaccharides. It is believed that vegetables and mushrooms included in soups can prevent many chronic conditions of the body (Chandramouli et al., 2012).

The presence of a wide range of dehydrated soups on the market largely replaces the use of homemade soups. On the other hand, the industrial production of dehydrated soups, in addition to other ingredients, includes the use of synthetic additives, which are part of the composition of soups. However, the increased interest and greater need for safe food that does not contain chemical additives, but retains the desired sensory characteristics, implies the use of alternative compounds (Amal et al., 2014).

The science of color (colorimetry) was developed due to the need for objective assessment of color characteristics, which cannot be achieved only by human perception of color, i.e. due to the need to quantify color and express it in numerical values. The color of the object does not depend only on the characteristics of the object itself, but also on the light with which the object is illuminated, as well as on the state in which the observer is, because a tired eye has a reduced sensitivity to color (Đurišić et al., 2007). There are several definitions of color, and according to the SRPS ISO standard (SRPS EN ISO 5492:2012), color is a sensation caused by stimulation of the retina with light rays of different wavelengths. MacDougall (2002) defines color as a combination of visually perceived information contained in light reflected from a sample.

From the aspect of full realization of the mentioned potential, research on the influence of mushrooms and their extracts on the quality of food products is of great importance. Application of mushroom extracts in the food industry can reduce or replace many chemical additives, which contributes to the creation of new and attractive products of increased biological value with reduced content of synthetic additives.

The aim of this research was to produce lyophilized water extract from several mushroom species (*Suillus granulatus*, *Coriolus versicolor*, *Fuscoporia torulosa*) and to determine its influence on some chemical properties as well as on the color changes of the industrially produced Bio Soups, without the addition of monosodium glutamate.

MATERIAL AND METHODS

Mushroom collection

In this research, as a work material three Variants of mushrooms collected from the territory of the Republic of North Macedonia were used, as follows: *Suillus granulatus* (L.) Roussel, edible mushroom (collected from Bistra Mountain near the village Sretkovo at an altitude of 1100 m, in a pine forest (Pinus), on a soil substrate); *Coriolus versicolor* (L.) Lloyd, medicinal mushroom (collected from Maleshevska Mountain– Klepalo, at an altitude of 1340 m, in beech forest (Fagetum), on a substrate of *Fagus sylvestris* trunk); and *Fuscoporia torulosa* (Pers.) T. Wagner & M. Fisch, medicinal mushroom (collected from Ganustiana, near the river Bregalnica, at an altitude of 182 m, on acacia stump [*Robinia pseudoacacia*]).

Preparation of water extract

The water extract was prepared according to the methods of Slawinska et al. (2013) and Ribeiro et al. (2015). Measured mass of dried and finely powdered mushroom sample (10 g) was poured with approximately 200 mL of distilled water and then extracted in a boiling water bath for 1 h.

Bio-soup production

Dehydrated soups were produced in the industry in North Macedonia. The control variant, that is the soup that is conventionally available on the market, was produced according to the following recipe: mixed dried vegetables (carrot, parsnip, onion and parsley); salt; sugar; oil; monosodium glutamate and pasta. The recipe was modified so that instead of monosodium glutamate, lyophilised water extracts were added, separately. Due to the characteristic taste, compensating for the absence of monosodium glutamate and improving the sensory properties of the final product, dried and ground boletus (*Boletus edulis*) commercially available was added. After production, the soups were packed in 45 g bags and stored at room temperature until further analysis.

The realisation of the planned research was carried out by designing four variants of dehydrated soup:

- Variant 1 – control variant;
- Variant 2 – dehydrated vegetable soup without monosodium glutamate, enriched with lyophilised water extract of *S. granulatus*;
- Variant 3 – dehydrated vegetable soup without monosodium glutamate, enriched with lyophilised water extract of *C. versicolor*;
- Variant 4 – dehydrated vegetable soup without monosodium glutamate, enriched with lyophilised water extract of *F. torulosa*;

Energetic value

The energy value of the soup was calculated based on the content of carbohydrates, proteins and fats according to the following formula:

$$\text{Energy (kJ)} = (\% \text{ protein} \cdot 17) + (\% \text{ fat} \cdot 37) + (\% \text{ carbohydrates} \cdot 17)$$

Content of moisture and mineral substances (ash)

The content of moisture and mineral matter (ash) in dehydrated soups was determined on three randomly taken samples of each variety separately, according to the methodology of Stojanova (2017).

Instrumental color analysis

In order to measure the instrumental color parameter, 5 soup bags from each variety were randomly selected. To determine this parameter, a Dr. Lange colorimeter, spectro color (d/8° portable, The Netherlands) was used.

Before each series of measurements, the instrument was calibrated using a CR-A43 white calibration plate, according to standard operating instructions. Color characteristics are expressed according to CIE L* a* b* (CIE, 1976), which is based on three coordinates that define the color of the samples: L* (lightness of color), a* (proportion of red color (+a*) or green color (-a*)) and b* (proportion of yellow color (+b*) or blue color (-b*)).

The measured values L* a* b* are directly read on the colorimeter, and based on these three values with the help of appropriate mathematical relations, the following color parameters are calculated:

Total color change (ΔE):

The total color change (ΔE) is calculated in relation to the standard sample, which determines the influence of the factor (in this research, the influence of mushroom extracts) on the characteristics and quality of the color.

$$\Delta E = \sqrt{(L_0^* - L^*)^2 + (a_0^* - a^*)^2 + (b_0^* - b^*)^2}$$

where: $L0^*$, $a0^*$ and $b0^*$ – parameters of the standard (control variant 1 was taken as the reference value in this research)

L^* , a^* and b^* – sample parameters

Color saturation (C^*):

Color saturation (C^*) is a measure of the degree of color purity. In the center of the coordinate system it is 0 and increases with the distance of the color from the center to the peripheral parts. It is calculated based on parameters a^* and b^* .

$$C^* = \sqrt{a^{*2} + b^{*2}}$$

Color shade (h):

The shade of color (h) is calculated on the basis of parameters a^* and b^* , and the value of the angle at which the corresponding color is located (points A, B, C) is determined, calculated in relation to the $+a^*$ axis of the coordinate system.

$$h = \tan^{-1} (b^*/a^*)$$

The obtained results were statistically processed using ANOVA test in SPSS 20 package program.

RESULTS AND DISCUSSION

The composition of the soup depends on the starting material from which it is prepared. All types of soups have a high water content after cooking; meat soups contain more protein and minerals such as zinc, calcium, iron and electrolytes, and vegetable soups are rich in dietary fiber, vitamins and phytochemicals (Buren et al., 2019). The great advantage of soup is that, as an independent meal, it simultaneously provides the necessary liquid and nutritional value in the form in which the body absorbs them most easily and is therefore the easiest to use in order to maintain health.

According to the data for the chemical composition of the soups (Table 1), it can be noted that the moisture content in all analyzed variants is in accordance with the regulations according to the Regulations on the quality of soups (Official Gazette of the Republic of Macedonia, 95/2012; Official Gazette of the SC, 56/2003 and 4/2004—other regulations), i.e. $<10\%$ and no statistically significant ($p<0.05$) difference was found in any of the analyzed variants. The content of mineral substances was statistically significant ($p<0.05$) higher in all variants enriched with lyophilized extracts ($\approx 5.45\%$ in soup variant 2 to $\approx 5.59\%$ in soup variant 3), compared to soup from the control variant ($\approx 5.05\%$). Soup variant 4 (≈ 1122.49 kJ) were characterized by the statistically significantly ($p<0.05$) highest energy value compared to the control and other analyzed variants.

In general, all soup variants enriched with lyophilized extracts showed a statistically significant ($p<0.05$) higher energy value compared to the control variant, which is expected due to the higher content of the total nutritional composition (carbohydrates, proteins and fats). From the data for the chemical analysis of dehydrated soups, it can be noted that similar results were obtained during all test days after production (minimal differences in values are within the so-called laboratory error), which is why it can be concluded that the obtained soups of all tested variants are characterized by stability and consistency in terms of chemical composition. Higher values for the investigated parameters in the soups in which lyophilized mushroom extracts were applied compared to the control variant, are the result of the favorable chemical

and nutritional composition of the applied extracts, which only supplement the basic composition of the conventionally produced soup.

Table 1: Chemical properties of dehydrated soups on different days after production

Parameter	n	Day of production	Variant 1 (control)	Variant 2	Variant 3	Variant 4
			$\bar{x} \pm SD$	$\bar{x} \pm SD$	$\bar{x} \pm SD$	$\bar{x} \pm SD$
Moisture (% d.m.)	3	0	4,92 ± 0,03 ^{aA}	5,03 ± 0,03 ^{bA}	4,98 ± 0,05 ^{aA}	4,85 ± 0,01 ^{aA}
	3	15	4,90 ± 0,05 ^{aA}	5,06 ± 0,03 ^{bA}	4,93 ± 0,03 ^{aA}	4,89 ± 0,01 ^{aA}
	3	30	4,95 ± 0,02 ^{aA}	5,01 ± 0,01 ^{bA}	4,99 ± 0,01 ^{aA}	4,83 ± 0,04 ^{aA}
	3	45	4,93 ± 0,02 ^{aA}	5,05 ± 0,05 ^{bA}	4,92 ± 0,01 ^{aA}	4,87 ± 0,02 ^{aA}
	3	60	4,95 ± 0,01 ^{aA}	5,02 ± 0,03 ^{bA}	4,98 ± 0,02 ^{aA}	4,90 ± 0,02 ^{aA}
	3	90	4,94 ± 0,02 ^{aA}	5,03 ± 0,03 ^{bA}	4,96 ± 0,07 ^{aA}	4,92 ± 0,03 ^{aA}
Mineral matters (% d.m.)	3	0	5,05 ± 0,01 ^{aA}	5,50 ± 0,01 ^{bA}	5,59 ± 0,06 ^{bA}	5,55 ± 0,02 ^{bA}
	3	15	5,06 ± 0,03 ^{aA}	5,45 ± 0,02 ^{bA}	5,52 ± 0,07 ^{bA}	5,50 ± 0,00 ^{bA}
	3	30	5,07 ± 0,05 ^{aA}	5,48 ± 0,02 ^{bA}	5,51 ± 0,02 ^{bA}	5,52 ± 0,01 ^{bA}
	3	45	5,05 ± 0,03 ^{aA}	5,47 ± 0,03 ^{bA}	5,53 ± 0,02 ^{bA}	5,51 ± 0,01 ^{bA}
	3	60	5,06 ± 0,01 ^{aA}	5,45 ± 0,02 ^{bA}	5,55 ± 0,01 ^{bA}	5,50 ± 0,04 ^{bA}
	3	90	5,05 ± 0,02 ^{aA}	5,42 ± 0,02 ^{bA}	5,54 ± 0,05 ^{bA}	5,51 ± 0,02 ^{bA}
Energy value (kJ)	3	0	1067,86 ± 0,05 ^{aA}	1116,20 ± 0,02 ^{bA}	1101,28 ± 0,03 ^{cA}	1122,49 ± 0,07 ^{bA}
	3	15	1069,11 ± 0,03 ^{aA}	1116,84 ± 0,01 ^{bA}	1101,50 ± 0,03 ^{cA}	1121,00 ± 0,05 ^{bA}
	3	30	1068,32 ± 0,02 ^{aA}	1113,28 ± 0,07 ^{bA}	1100,71 ± 0,05 ^{cA}	1121,60 ± 0,01 ^{bA}
	3	45	1067,81 ± 0,03 ^{aA}	1114,95 ± 0,03 ^{bA}	1100,77 ± 0,04 ^{cA}	1121,19 ± 0,01 ^{bA}
	3	60	1067,72 ± 0,01 ^{aA}	1114,16 ± 0,07 ^{bA}	1101,51 ± 0,06 ^{cA}	1120,68 ± 0,09 ^{bA}
	3	90	1068,46 ± 0,01 ^{aA}	1112,86 ± 0,02 ^{bA}	1100,86 ± 0,03 ^{cA}	1121,14 ± 0,06 ^{bA}

^{a,b,c} - values on the same day of different soup variants marked with different letters are statistically significantly different (p<0.05), ANOVA, post hoc Tukey's test.

^{A,B} - values of the same variant on different days marked with different letters are statistically significantly different (p<0.05), ANOVA, post hoc Tukey's test.

Table 2: Average values for the instrumental color analysis on different days after production

Parameter	n	Day of production	Variant 1 (control)	Variant 2	Variant 3	Variant 4
			$\bar{x} \pm SD$	$\bar{x} \pm SD$	$\bar{x} \pm SD$	$\bar{x} \pm SD$
<i>L*</i>	5	0	79,65 ± 0,11 ^{aA}	77,53 ± 0,09 ^{bA}	77,61 ± 0,07 ^{bA}	77,68 ± 0,09 ^{bA}
	5	15	79,59 ± 0,06 ^{aA}	77,56 ± 0,05 ^{bA}	77,63 ± 0,10 ^{bA}	77,50 ± 0,17 ^{bA}
	5	30	79,61 ± 0,13 ^{aA}	77,47 ± 0,09 ^{bA}	77,60 ± 0,10 ^{bA}	77,71 ± 0,06 ^{bA}
	5	45	79,68 ± 0,05 ^{aA}	77,52 ± 0,09 ^{bA}	77,64 ± 0,09 ^{bA}	77,63 ± 0,12 ^{bA}
	5	60	79,67 ± 0,10 ^{aA}	77,53 ± 0,08 ^{bA}	77,65 ± 0,03 ^{bA}	77,61 ± 0,15 ^{bA}
	5	90	79,65 ± 0,05 ^{aA}	77,50 ± 0,1 ^{bA}	77,61 ± 0,07 ^{bA}	77,60 ± 0,09 ^{bA}
<i>a*</i>	5	0	2,35 ± 0,09 ^{aA}	2,39 ± 0,15 ^{aA}	2,25 ± 0,31 ^{bA}	2,31 ± 0,14 ^{aA}
	5	15	2,37 ± 0,09 ^{aA}	2,36 ± 0,05 ^{aA}	2,29 ± 0,03 ^{bA}	2,35 ± 0,11 ^{aA}
	5	30	2,35 ± 0,05 ^{aA}	2,31 ± 0,19 ^{aA}	2,27 ± 0,15 ^{bA}	2,37 ± 0,27 ^{aA}
	5	45	2,31 ± 0,09 ^{aA}	2,37 ± 0,08 ^{aA}	2,22 ± 0,04 ^{bA}	2,35 ± 0,16 ^{aA}
	5	60	2,30 ± 0,15 ^{aA}	2,35 ± 0,17 ^{aA}	2,25 ± 0,14 ^{bA}	2,33 ± 0,26 ^{aA}
	5	90	2,33 ± 0,21 ^{aA}	2,38 ± 0,06 ^{aA}	2,27 ± 0,30 ^{bA}	2,36 ± 0,09 ^{aA}
<i>b*</i>	5	0	42,14 ± 0,06 ^{aA}	32,17 ± 0,21 ^{bA}	32,26 ± 0,13 ^{bA}	32,08 ± 0,35 ^{bA}
	5	15	42,17 ± 0,05 ^{aA}	32,14 ± 0,25 ^{bA}	32,30 ± 0,16 ^{bA}	32,11 ± 0,04 ^{bA}
	5	30	42,11 ± 0,11 ^{aA}	32,19 ± 0,31 ^{bA}	32,31 ± 0,19 ^{bA}	32,15 ± 0,14 ^{bA}
	5	45	42,13 ± 0,02 ^{aA}	32,18 ± 0,10 ^{bA}	32,38 ± 0,03 ^{bA}	32,09 ± 0,19 ^{bA}
	5	60	42,15 ± 0,11 ^{aA}	32,17 ± 0,14 ^{bA}	32,37 ± 0,26 ^{bA}	32,12 ± 0,17 ^{bA}
	5	90	42,17 ± 0,09 ^{aA}	32,18 ± 0,23 ^{bA}	32,39 ± 0,11 ^{bA}	32,10 ± 0,10 ^{bA}

^{a,b,c} - values on the same day of different soup variants marked with different letters are statistically significantly different (p<0.05), ANOVA, post hoc Tukey's test.

^{A,B} - values of the same variant on different days marked with different letters are statistically significantly different (p<0.05), ANOVA, post hoc Tukey's test.

Table 3: Average values for the instrumental color analysis on different days after production

Parameter	n	Day of production	Variant 1 (control)	Variant 2	Variant 3	Variant 4
			$\bar{x} \pm SD$	$\bar{x} \pm SD$	$\bar{x} \pm SD$	$\bar{x} \pm SD$
ΔE	5	0	Ref.*	10,19 ± 0,02 ^{aA}	10,08 ± 0,10 ^{aA}	10,25 ± 0,01 ^{aA}
	5	15	Ref.	10,23 ± 0,10 ^{aA}	10,06 ± 0,06 ^{aA}	10,27 ± 0,01 ^{aA}
	5	30	Ref.	10,15 ± 0,11 ^{aA}	10,00 ± 0,09 ^{bA}	10,14 ± 0,01 ^{aA}
	5	45	Ref.	10,18 ± 0,19 ^{aA}	9,96 ± 0,16 ^{bA}	10,25 ± 0,09 ^{cA}
	5	60	Ref.	10,21 ± 0,13 ^{aA}	9,99 ± 0,17 ^{bA}	10,23 ± 0,22 ^{cA}
	5	90	Ref.	10,22 ± 0,11 ^{aA}	10,19 ± 0,10 ^{bA}	10,28 ± 0,12 ^{cA}
C	5	0	42,21 ± 0,05 ^{aA}	32,26 ± 0,12 ^{bA}	32,34 ± 0,15 ^{bA}	32,16 ± 0,02 ^{bA}
	5	15	42,23 ± 0,05 ^{aA}	32,22 ± 0,05 ^{bA}	32,38 ± 0,23 ^{bA}	32,19 ± 0,11 ^{bA}
	5	30	42,18 ± 0,03 ^{aA}	32,27 ± 0,03 ^{bA}	32,39 ± 0,1 ^{bA}	32,24 ± 0,02 ^{bA}
	5	45	42,19 ± 0,08 ^{aA}	32,27 ± 0,05 ^{bA}	32,45 ± 0,15 ^{bA}	32,18 ± 0,07 ^{bA}
	5	60	42,21 ± 0,07 ^{aA}	32,26 ± 0,09 ^{bA}	32,45 ± 0,21 ^{bA}	32,15 ± 0,14 ^{bA}
	5	90	42,23 ± 0,15 ^{aA}	32,27 ± 0,06 ^{bA}	32,47 ± 0,09 ^{bA}	32,19 ± 0,27 ^{bA}
h	5	0	86,81 ± 0,03 ^{aA}	85,75 ± 0,03 ^{bA}	86,01 ± 0,04 ^{aA}	85,88 ± 0,03 ^{bA}
	5	15	86,78 ± 0,02 ^{aA}	85,80 ± 0,13 ^{bA}	85,94 ± 0,17 ^{bA}	85,81 ± 0,09 ^{bA}
	5	30	86,81 ± 0,07 ^{aA}	85,89 ± 0,09 ^{bA}	85,98 ± 0,04 ^{bA}	85,78 ± 0,05 ^{bA}
	5	45	86,86 ± 0,05 ^{aA}	85,78 ± 0,05 ^{bA}	86,07 ± 0,07 ^{aA}	85,81 ± 0,09 ^{bA}
	5	60	86,87 ± 0,09 ^{aA}	85,82 ± 0,06 ^{bA}	86,02 ± 0,20 ^{aA}	85,84 ± 0,14 ^{bA}
	5	90	86,84 ± 0,12 ^{aA}	85,77 ± 0,16 ^{bA}	85,99 ± 0,09 ^{aA}	85,79 ± 0,26 ^{bA}

^{a,b,c} - values on the same day of different soup variants marked with different letters are statistically significantly different (p<0.05), ANOVA, post hoc Tukey's test.

^{A,B} - values of the same variant on different days marked with different letters are statistically significantly different (p<0.05), ANOVA, post hoc Tukey's test.

Stability of the quality and nutritional properties of soups during storage occurs as a result of the addition of mushroom extracts (Mohamed et al., 2020), and lyophilization of the extracts only reduces the water content, which can lead to the concentration of some of the parameters (Fissore and Pisano, 2015). On the other hand, the low moisture content contributes to even greater stability of the final product from the microbiological, chemical and antioxidant aspects, which is in agreement with the results of this research. Higher moisture content increases the possibility of physico-chemical and microbiological changes of the product during its storage (Mohamed et al., 2020).

Kumar (2015) investigated the shelf life of dehydrated soups with the addition of *A. bisporus* mushroom. Several variants were prepared with different concentrations of added ingredients. The author states that the fat content ranged from 5.68 to 5.84%, mineral content from 2.89 to 3.64%, fiber from 0.88 to 1.42% of dry matter of all formulations. The moisture content increased in proportion to the storage period, reaching the highest value of 4.37% in the 12th month, and the author concludes that this is the optimal storage period for the tested dehydrated soups.

According to the data presented in Table 2 and Table 3 related to the instrumental values for the color of the soups, constancy can be observed for all color parameters in all tested variants from 0 to 90 days after production. This indicates the fact that all analyzed soups had a stable color during storage, which means that there were no changes in other chemical or biological parameters that would lead to a change in the color of the product. Namely, the soups from control variant were characterized by the lightest color ($L^* \approx 79.65$). All other variants were characterized by statistically significant ($p < 0.05$) lower values for the L^* parameter compared to the control variant. Regarding the proportion of red color, no statistically significant differences were observed between the variants in relation to the control variant, nor between the tested variants. With a statistically significant ($p < 0.05$) highest share of yellow color ($b^* \approx 42.14$) was characterized control variant compared to other variants.

According to the obtained data, it can be noted that the values for the parameters L^* (lightness of color), a^* (proportion of red/green color) and b^* (proportion of yellow/blue color) were similar in all tested variants of soup enriched with lyophilized extracts mushroom. These results are due to the fact that the lyophilized water extracts of the examined mushroom had the same color, and on the other hand, the base to which they were added (dehydrated soup) was the same for all product variants.

Therefore, statistically significant ($p < 0.05$) differences were observed only between the control variant in relation to the other variants, i.e. the darker shade in the analyzed variants enriched with lyophilized extracts is a consequence of the applied extracts and added porcini mushrooms.

Based on the instrumentally measured values for color brightness, the proportion of red and yellow colors, the values for total color change, color saturation and color hue are calculated. Namely, from the data in Table 3, it can be noted that the color change in the variants after the addition of extracts compared to the control amounted to $\Delta E \approx 9.96$ to 10.28. There were no statistically significant differences between the analyzed variants. Statistically ($p < 0.05$) highest value of color saturation was found in control variant ($C \approx 42.21$) compared to the other variants. From the aspect of color shade, minimal differences were observed between all tested variants. The values for ΔE , C and h are correlated with the values for L^* , a^* and b^* , so that no significant differences were observed either among the variants enriched with different types of extracts, or during the storage of soups.

The values of the color parameters are proportional to the share of the various components of the dehydrated soups. Each of them has a different color that affects the overall color of the final product. Therefore, the color differences between the analyzed soups are minimal probably due to the minimal variability of the vegetables.

In general, the color brightness L^* depends on the moisture content of the product, i.e. its value increases with increasing moisture content (Sun and Muthukumrappan, 2002). A darker color usually develops during sugar caramelization (the Maillard reaction) as well as with increasing temperature (Takahashi et al., 2005).

In a study by Amal et al. (2014) dehydrated soups with the addition of potatoes, lentils, peas and chickpeas were produced, where the pea soup was characterized by the lightest color ($L^*=82.44$, $a^*=2.39$, $b^*=30.55$, $C=30.64$, $h=85.53$), and from the aspect of sensory characteristics, the soup with the addition of lentils (9.10) received the highest score for taste.

CONCLUSION

According to the obtained results, it can be concluded that the wild edible and medicinal mushrooms *Suillus granulatus*, *Coriolus versicolor* and *Fuscoporia torulosa* are favorable for obtaining water extract, while lyophilized extracts are advantageous for application in dehydrated vegetable soup, produced in industrial conditions. The content of mineral matters was significantly ($p<0.05$) higher in all soup variants enriched with lyophilized extracts. Moreover, the moisture content in all analyzed soup variants is in accordance with the regulations.

From the aspect of the instrumental color value, constancy was established for all parameters in all tested variants from the 0th to the 90th day after production, i.e. all soups had a stable color during storage, which means that there were no changes in other chemical or biological parameters that would lead to a change in the color of the product.

In this way, a new product is obtained that does not contain chemical additives, which further increases its value.

REFERENCES

- Amal, M., Abdel-Haleem, H., Azza Omran, A. (2014). Preparation of Dried Vegetarian Soup Supplemented with Some Legumes. *Food and Nutrition Sciences*, 5, 2274-2285. <https://doi:10.4236/fns.2014.522241>.
- Buren, L.V., Grün, C.H., Basendowski, S., Spraul, M., Newson, R., Eilander, A. (2019). Nutritional Quality of Dry Vegetable Soups. *Nutrients*, 11, 1270. <http://doi:10.3390/nu11061270>.
- Chandramouli, P., Bharathi, V.S.D., Sivakami, A., et al. (2012). Standardisation and Nutritional Analysis of Soup Powder Prepared from *Moringa oleifera*, *Solanum trilobatum*, *Centella asiatica*. *International Journal of Future Biotechnology*, 1, 1-20.
- CIE (1976). *International Commission on Illumination, Colorimetry: Official Recommendation of the International Commission on Illumination Publication CIE No. (E-1.31)*. Paris, France: Bureau Central de la CIE.
- Fissore, D., Piano, R. (2015). Computer-aided framework for the design of freeze-drying cycles: optimization of the operating conditions of the primary drying stages. *Processes*, 3(2), 406-421. <http://doi:10.3390/pr3020406>.
- Đurišić, S., Milić-Lemić, A., Obradović-Đuričić, K., Popović, O. (2007). Instrumentalno određivanje boje zuba u protetsoj rekonstrukciji. *Stomatološki Glasnik Srbije*, 54, 240-247. <http://doi:10.2298/SGS0704240D>.
- Kumar, K. (2015). Studies on development and shelf life evaluation of soup powder prepared by incorporation of white button mushroom (*Agaricus bisporus* L.). *South Asian Journal of Food Technology and Environment*, 1(3&4), 219-224.

- MacDougall, D.B. (2002). *Colour measurement of food: principles and practice*. In: Colour in food, edited by D. B. MacDougall, Woodhead Publishing in food science and technology, Boca Raton, Cambridge, England, pp. 33-60.
- Mohamed, R.S., Abozed, S.S., El-Damhougy, S., Salama, M.F., Hussein, M.M. (2020). Efficiency of newly formulated functional instant soup mixtures as dietary supplements for elderly. *Heliyon*, 6, e03197. <http://doi:10.1016/j.heliyon.2020.e03197>.
- Niva, M. (2007). All foods affect health: Understandings of functional foods and healthy eating among health-oriented Finns. *Appetite*, 48, 384–393. <http://doi:10.1016/j.appet.2006.10.006>.
- Prameela, P., Prameela, K. (2020). Formulation, nutritional, sensory, antioxidant activity and shelf life studies of instant soup mix. *International Journal of Pharmaceutical Sciences and Research*, 11(12), 6114-6123. [http://doi:10.13040/IJPSR.0975-8232.11\(12\).6114-23](http://doi:10.13040/IJPSR.0975-8232.11(12).6114-23).
- Ribeiro, A., Ruphuy, G., Carlos Lopes, J., Maria Dias, M., Barros, L., Barreiro, F., C.F.R. Ferreira, I. (2015). Spray-drying microencapsulation of synergistic antioxidant mushroom extracts and their use as functional food ingredients. *Food Chemistry*, 188, 612–618. <https://doi.org/10.1016/j.foodchem.2015.05.061>.
- Stojanova, T.M. (2017). *Plant nutrition*, Academic Press, Skopje.
- Stojanova, M., Pantic, M., Klaus, A., Mihajlovic, D., Miletic, D., Sobajic, S., Stojanova, M.T., Niksic, M. (2023). Bio soups – new functional dehydrated soups enriched with lyophilised *Fuscoporia torulosa* extracts. *International Journal of Food Science and Technology*, Vol 58(7), 3628-3636. <https://doi.org/10.1111/ijfs.16462>
- Sławińska, A., Radzki, W., Kalbarczyk, J. (2013). Antioxidant activities and polyphenolics content of *Flammulina velutipes* mushroom extracts. *Kerla polonica, De Gruyter*, 59(3), 26-36. <https://doi.org/10.2478/hepo-2013-0014>.
- Sun, Y., Muthukumrappan, K. (2002). Changes in functionality on soy-based extrudates during single-screw extrusion processing. *International Journal of Food Properties*, 5, 379-389. <https://doi.org/10.1081/JFP-120005793>.
- Tharshikaa, T., Arrosana, A., Shruti Awasthia, D. (2016). Protein determination and phytochemical analysis of different edible mushroom varieties. *ABSTRACT/Track: Agriculture & Food Science*, University of Jaffna, Srilanka.
- Takahashi, T., Miura, M., Ohisa, N., Mori, K., Kobayashi, S. (2005). Heat treatments of milled rice and properties of the flours. *Cereal Chemistry*, 82, 228-232. <http://doi:10.1094/CC-82-0228>.

A REVIEW OF THE RELATIONSHIP BETWEEN CANCER CASES- ENVIRONMENTAL CARCINOGENS AND POLLUTING AGENTS IN TURKISH THRACE REGION

Şeyma AKBAŞ¹, Yılmaz ÇAMLITEPE¹

¹Trakya University, Faculty of Science, department of Biology, Edirne, Turkey

Corresponding author e-mail: yilmazc@trakya.edu.tr

ABSTRACT

Cancer occurs as a result of the combination of various factors (environmental, genetic). Factors brought by personal or social life change the working system of cells over time. All factors that cause a person to have cancer are called carcinogens (cancer-causing). When environmental factors are examined in cancer cases, obesity, viruses and bacteria, UV rays, alcohol and chemicals, especially smoking, have been identified as the most important carcinogens. When genetic factors were examined in cancer cases, oncogenes, tumor suppressor genes, DNA repair genes and other carcinogenic gene concepts were determined. As a result of the statistical studies conducted by the WHO (World Health Organization), approximately 19.2 million new cancer cases were seen in the world in 2021. It has been determined that 9.9 million deaths occurred due to cancer. According to the Ministry of Health HSGM (General Directorate of Public Health) Cancer Department Turkey Cancer Control Program 2021 Report, it was determined that between the years 2009-2021, an average of 200,000 to 240,000 people were diagnosed with cancer annually in Turkey. With the increase in the world population, this number is expected to increase gradually in the coming years. The significant increase in cancer cases we have seen in recent years, especially in Turkish Thrace Region, is one of the most important factors in our handling of this issue. In this review, the relationship between cancer cases-environmental carcinogens and polluting agents in Turkish Thrace Region is discussed by scanning the existing literature. The high rate of elderly population in Turkish Thrace Region, the uncontrolled dumping of industrial wastes into the Ergene River in this region, the effects in the region after the Chernobyl disaster and the excessive use of pesticides (pesticides) in agriculture in the Thrace Region, which is a grain warehouse, completely affect the serious increase in cancer cases. From this point of view, it is important to examine Turkish Thrace Region.

Keywords: environmental carcinogens, Turkish Thrace, oncogenes, carcinogens, cancer

INTRODUCTION

The disease that results in abnormal and rapid increase of cells due to damage to DNA is called cancer. Cancer occurs as a result of the combination of various factors (environmental, genetic) (Yokuş and Çakır 2012). All factors that cause a person to get cancer are called carcinogens (Baran et al., 2021). Considering the increase in cancer cases worldwide, it has been determined that it has become the most important disease burden. Cancer, which is one of the biggest causes of death in recent years, is seen as an important problem in terms of shortening or eliminating life expectancy. As a result of statistical studies conducted by WHO (World Health Organization) and IARC (International Agency for Research on Cancer), approximately 19.2 million new cancer cases were seen in the world in 2021. It has been determined that 9.9 million deaths occur due to cancer (WHO and IARC, 2021). According to the Ministry of Health HSGM (General Directorate of Public Health) Cancer Department Turkey Cancer Control Program 2021 Report, it was determined that an average of 200,000 to

240,000 people were diagnosed with cancer annually in Turkey between 2009 and 2021. With the increase in the world population, this number is expected to increase gradually in the coming years (Figure 1) (HSGM Cancer Department, 2021). One of the most important reasons for our work on this subject is the serious increase in cancer cases that we have seen in recent years, especially in the Thrace Region, and the fact that the region has been heavily influenced by environmental carcinogens and pollutants in recent years.

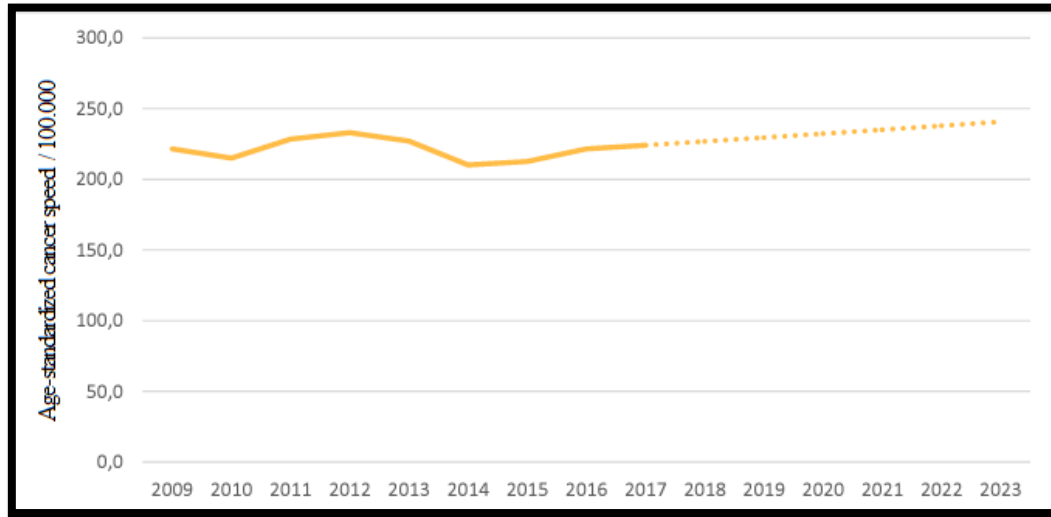

Figure 1: Cancer Incidence in Turkey 2017-2023 (HSGM Cancer Department 2021).

1. Environmental Carcinogens

It is of great importance to minimize the risk of cancer in individuals and societies by recognizing environmental carcinogens and taking the necessary precautions. Smoking, one of the environmental carcinogens, is an important factor as it is 30% effective in the occurrence of all cancers. The most important environmental carcinogen after smoking is obesity. Following these, some bacteria and viruses such as HPV (Human Papilloma Virus), EBV (Epstein-Barr virus) and Hepatitis viruses, *H. pylori* (*Helicobacter pylori*), unhealthy eating habits, alcohol consumption and ultraviolet rays (sun, radiation), Other carcinogens such as air-water-soil pollution are also important factors in the formation of cancer (Bayık, 1989, Özdoğan, 2021a).

1.1. Smoking

The most important factor among the environmental causes of cancer is cigarette consumption. Many types of cancer, especially lung cancer, occur in individuals who smoke. The effect of cigarette consumption on cancer formation was first revealed as a result of an observational study conducted in the middle of the last century (Figure 2). In this observational study, it was noted that most of the patients diagnosed with lung cancer smoked. According to these first observational studies, the fact that 50-60% of the population smoked and that 90% of the patients diagnosed with lung cancer in those years were smokers was seen as an important indicator. The behavior of lung cancer patients, both smokers and non-smokers, has been the subject of many scientific studies in the following years. According to the results of the research, it was determined that the risk of developing lung cancer decreased significantly over time in individuals who stopped smoking (Doll and Hill, 1950). In another study, it was found that patients diagnosed with cancer consumed more cigarettes than patients without a diagnosis of cancer (Doll et al. 1994).

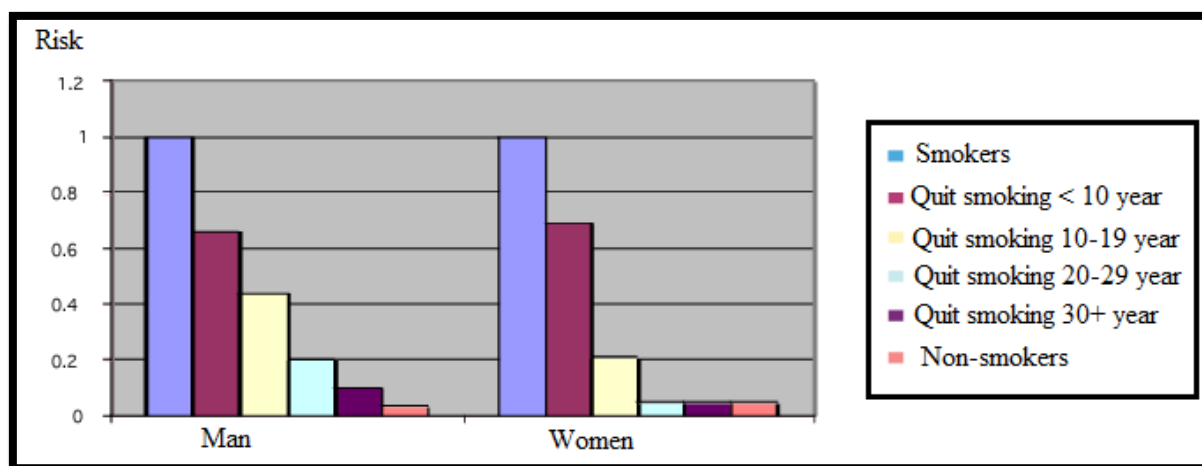

Figure 2: Decrease in lung cancer risk after quitting smoking (Bilir, 2008).

1.2. Obesity

Abnormally high amounts of fat in adipose tissue lead to deterioration in the health of individuals. This is how obesity is defined by WHO (Dönder and Önalın, 2018).

As a result of research on obesity, it has been seen that approximately 1.1 billion people in the world are dealing with obesity or overweight problems. At the same time, the irregular increase in body weight and fat tissue in obesity patients also affects the hormonal metabolism in individuals. This interaction also causes many chronic diseases and various types of cancer in the individual (Urhan and Akbulut, 2017).

Insulin signals produced in beta cells in the pancreas secrete insulin in response to the amount of glucose in the blood. IGF-1 (Insulin Growth Factor-1) is secreted from the liver in response to growth hormones. It is known that IGF-1 and insulin increase the risk of many cancers in case of obesity. They are especially important factors in breast, pancreas, kidney, endometrium and colon cancer. Hyperinsulinemia has been revealed to affect breast cancer and cancer metastases in many mouse model studies. Obesity is associated with these types of cancer, increasing the crude death rate and decreasing response to cancer treatment. Obesity causes changes in the functions of adipose tissue in the body. These changes in adipose tissue activate the mechanisms that cause cancer over time. Obesity causes adipose tissue dysfunction, insulin resistance, and excessive production of adipokines and cytokinins. At the same time, obesity causes cancer cell development by increasing leptin level and decreasing adiponectin level. It is known that the change in the levels of these two adipokine (leptin and adiponectin) molecules is effective in the relationship between obesity and cancer. Adrenal steroid, estrogen, progesterone and androgen hormones also support this relationship. Estrogen hormone signals increase cancer cell growth (Yiğit et al. 2019).

1.3. Virus and Bacteria

In order to survive in a cell, viruses attach their genetic structure to the nucleus of the cell. Viruses continue their existence as obligate intracellular parasites. During this struggle of viruses to survive, they cause the increase of some oncogenes that are harmful to living things. The increase in oncogenes results in cancer of the cell and then of the tissue, resulting in the death of the organism. At the same time, the virus adds these oncogenes to its genetic material and then releases the oncogenes in the tissues and organs it reaches, causing cancer in that area (metastasis). Oncogenes are genes that are necessary for the proliferation and growth of that cell when present in a certain proportion in the cell. When the cell is attacked by microorganisms such as viruses, the number of oncogenes reaches high levels within the cell, which cannot help the cell to multiply and grow in a healthy way, causing tumor formation.

These interactions of microorganisms on cells explain tumor formation (Table 1) (Özdoğan, 2021b).

Carcinogenic microorganisms	Types of cancer they cause
Human Papilloma virus (HPV)	Cervical cancer
Helicobacter pylori	Stomach cancer, MALT lymphoma, Oral cancer
Epstein-Barr virus	Nasopharynx (nasal) cancer
Merkel Cell Polyomavirus	Merkel cell cancer
Hepatitis B and C viruses	Liver (Hepocellular) cancer
Human cytomegalovirus	Glioblastoma multiforme (Brain cancer)
Simian virus 40	Brain cancer, Malignant, Lung cancer
Streptococcus anginosus	Esophageal cancer, Head and neck cancer
Salmonella typhi	Gallbladder cancer, Cholangiocarcinoma
Tropheryma whippelli	Extraintestinal lymphoma, stomach cancer
Herpes virus	Kaposi sarcoma (vascular cancer)
Mycoplasma penetrans, M. tuberculosis	Kaposi sarcoma
Chlamydia trachomatis	Ovarian cancer
Chlamydia pneumoniae	Lung cancer
Chlamydia psittaci	Ocular lymphoma

Table 1: Carcinogenic microorganisms and the types of cancer they cause (Banerjee et al., 2015; Özdoğan, 2021b).

1.4. UV Rays

When an individual is exposed to ultraviolet rays, these rays first reach DNA, the genetic material in the cell. DNA is definitely damaged after exposure to ultraviolet. Some DNA repair enzymes are activated to repair this damage. However, if the damage is not repaired, cell death (apoptosis) occurs in order to eliminate the cancerous cell. If cell death does not occur, genes in the unregulated genetic material mutate. When ultraviolet rays reach the individual, they disrupt the immune system in the skin, thereby directly damaging the genetic material and enabling the formation and growth of cancer cells. UV-C rays cause cancer by causing damage to genetic material (Figure 3) (Herring, 2010, Özdoğan, 2017).

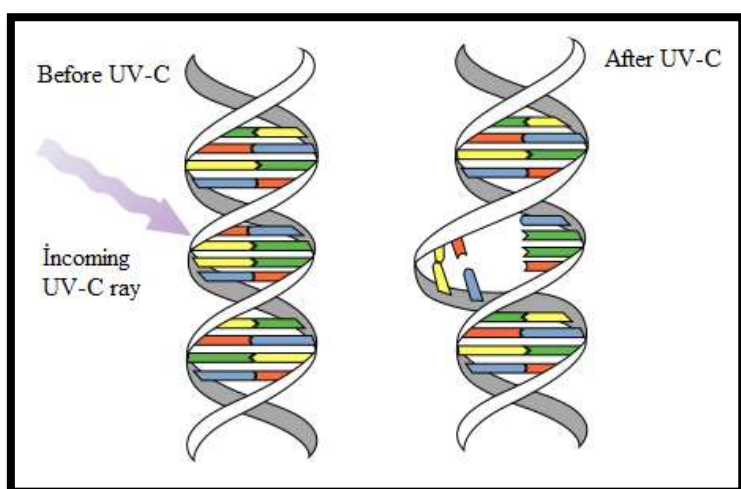

Figure 3: Effect of UV rays on DNA (Herring, 2010)

Ultraviolet rays are divided into 3 categories: UV-A, UV-B and UV-C. UV-A rays, which are the least dangerous, have low energy and the longest wavelength. UV-A rays are divided into two as UVA-1 and UVA-2 according to their energy levels. UVA-2, which has higher energy, is closer to UV-B. It is known that UVA-2 causes premature skin aging (Krutmann et al. 2017). Skin cancer is defined by the Centers for Disease Control and Prevention (CDC) as 'a disease caused by the uncontrolled and spread of cells in the skin'.

The wavelength of UV-A rays is 320-400 nm. These rays can pass through the atmosphere and reach the earth. UV-A rays penetrate the skin and cause skin wrinkles, premature skin aging and skin cancer (Perincek et al. 2007). When exposed to UV-A rays for a long time, keratinocytes in the epidermis layer of the skin are damaged and this increases the risk of skin cancer. At the same time, UV-A rays increase the risk of visual impairment and eye cataracts (Altun, 2019).

UV-B rays create effects at the biochemical level. UV-B rays cause our skin to change color by staying in the sun for too long (Krutmann et al. 2017). The wavelength of UV-B rays is 280-300 nm. UV-B rays are in the middle of the UV band and are 1000 times stronger than UV-A rays. The most important effects of UV-B rays on human health include weakening of the immune system, vision problems and skin cancer. When exposed to UV-B rays, changes in the skin structure occur, as well as tumor formation and cancer in older ages (Perincek et al. 2007). When exposed to UV-B rays for a long time, the epidermis layer of the skin is damaged. This damage causes premature aging of the skin and loss of elasticity. It is also known for certain that UV-B rays are an environmental carcinogen (Narayanan et al. 2010).

UV-C, known as the riskiest ultraviolet rays, has the highest energy and the shortest wavelength (Krutmann et al. 2017). The wavelength of UV-C rays is 200-280 nm. UV-C rays from solar sources cannot pass through the ozone layer or are trapped by gases in the atmosphere. Serious health problems related to vision and skin cancer occur as a result of direct exposure to these rays without taking any precautions (Perincek et al. 2007).

1.5. Alcohol

The factor that increases the risk of cancer in alcohol consumption is not the type of alcoholic beverage consumed, but how long and in what quantity it is consumed. Research shows that the factor that increases the risk of cancer in alcohol consumption is the ethanol contained in alcoholic beverages. While the risk of developing cancer as a result of alcohol consumption is 10% for men, this rate is 3% for women. These rates were revealed as a result of a scientific research conducted by Schutze and his colleagues on 350,000 individuals in 8 countries (Schutze et al. 2011). After alcohol consumption, alcohol molecules are converted into acetaldehyde, a toxic molecule, by enzymes within the cell. Acetaldehyde creates replication errors in oncogenes or tumor suppressor genes. It also causes functional and morphological changes by binding to proteins in the cell (Jelski and Szmitkowski 2008, Alpertunga and Yıldız 2010). This molecule creates free radicals, increasing lipid peroxidation and hepatic collagen synthesis, causing damage to chromosomes and DNA. This situation causes toxicity in the liver (Lee et al. 2001, Alpertunga and Yıldız 2010).

Continuous occurrence of this damage to DNA causes the mechanism within the cell to malfunction and the cell to proliferate uncontrollably. Acetaldehyde is converted into acetate molecule in the body. Acetate plays a role in energy production. Scientific research has found that acetate is mutated in some individuals (Garaycoechea et al. 2018). This mutation increases cancer as a result of the increase in acetaldehyde (Figure 4). Individuals who consume excessive alcohol for many years are likely to develop esophageal cancer. If we look at the damage of alcohol on DNA, some people have high DNA repair capacity, while some people have low DNA repair capacity. Excessive breaks in the DNA structure and genetic material damage have been detected in people with low DNA repair capacity due to

continuous alcohol consumption. This evidence was revealed as a result of scientific experiments conducted on mice. In this experiment, mice were given alcohol at regular intervals. When the results were observed, excessive DNA breaks were detected in the genes of mice with low DNA repair capacity, and blood production stopped for 7-10 days. The result obtained from this experiment is that people with low system repair capacity in DNA repair and restoration due to alcohol consumption have a high risk of developing cancer (Özdoğan 2023, Garaycochea et al. 2012).

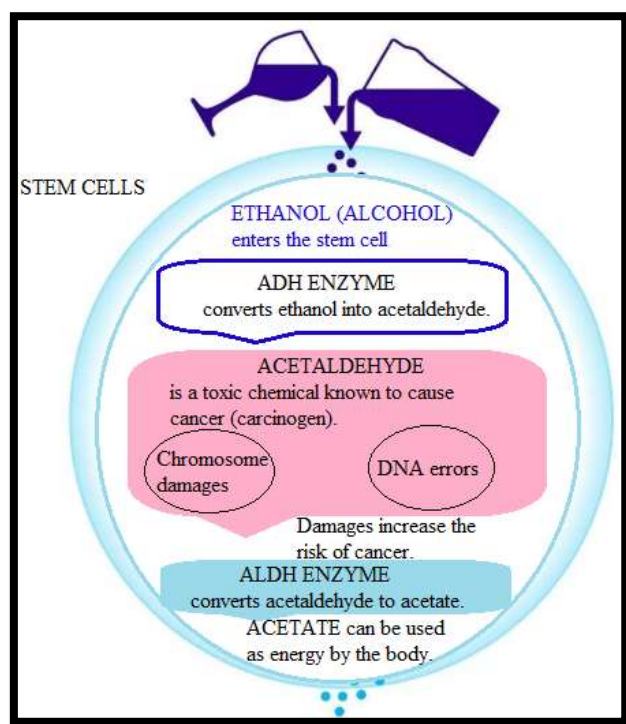

Figure 4: Mechanism by which alcohol causes cancer (Özdoğan, 2023)

1.6. Chemicals

Many chemicals have a carcinogenic effect when exposed to them for a long or short time. Carcinogenic chemicals can be structurally divided into organic chemicals and inorganic chemicals. These compounds, which have been proven to have carcinogenic effects, are shown in Table 2 (Coşkunes, 2008).

Carcinogenic organic compounds	Carcinogenic inorganic compounds
Halogenohydrocarbons	Beryllium and some of its compounds
Aromatic Amines	Cadmium and some of its compounds
Aromatic Hydrocarbons	Cobalt and some of its compounds
Nitro compounds	Chromium and some of its compounds
Azo compounds	Lead and some of its compounds
Nitroso compounds	Nickel and some of its compounds
Epoxides	Arsenic and some of its compounds
Acrylic acid derivatives	Some aluminum compounds
Chloroalkyl and bromoalkyl groups	Potassium bromate

Table 2: Carcinogenic organic and inorganic compounds (Coşkunes, 2008).

There are many chemicals used indoors and outdoors as biocides in agriculture. Biocides used in the market, such as carbamate, organic chlorine and carbinol groups, have been declared chemical carcinogens with the approval of EPA (US Environmental Protection Agency) and IARC (International Agency for Research on Cancer) (Vural, 2005).

In a study, the cancer risk of children whose parents were occupationally employed in a pesticide-contact sector and whose parents were not exposed to pesticides was evaluated. It has been revealed that the risks of cancer such as leukemia and central nervous system (CNS) tumors are higher in children whose parents are occupationally exposed to pesticides compared to the other group. Many cancer risks such as leukemia, brain tumors and lymphoma have been detected in children directly exposed to pesticides (Bhatia et al. 1999).

Water is the source of life and is absolutely necessary for the continuation of life. Water, which covers 2/3 of the world, causes the formation of colon and bladder tumors if it is not taken into the body in a clean and pure form. It has been proven by some in vivo and in vitro animal model experiments that if the phenol compound in water is above the limit determined by WHO (0.2 mg/L), it causes leukemia and lymphoma in older age groups. As a result of these experiments, cell changes that cause mutation and cancer were also detected (Saito, 1999).

2. Genetic Factors

Reproductive and Somatic cell mutation:

It occurs as a result of mutation of reproductive cells. Germline mutation, which is the cause of hereditary cancers, can be transmitted genetically (Klug et al. 2009). Somatic cell mutation occurs as a result of the mutation of body cells. Somatic mutation is not inherited (Knippers, 2006).

Proto- oncogenes:

Cell proliferation occurs in a controlled manner in line with physiological needs. Proto-oncogenes are known as genes that have a negative effect on cell proliferation. The functions of proto-oncogenes are as follows;

- Transcription factors
 - Growth factor and growth factor receptors
 - Suppression of apoptosis and modification of chromatin
 - Intracellular signal transduction pathways
 - The relationship of G proteins with the cell membrane
- Oncogenes occur when proto-oncogenes mutate and remain in constant activity (Croce, 2008).

Tumor suppressor genes:

These genes, also called "guardian genes" that suppress proliferation, have a negative effect on cell proliferation. Genes that lead the cell to apoptosis are included in this group. TP53 gene is a tumor suppressor gene that controls the cell cycle and directs the cell to apoptosis (McKusick, 2006). These genes; There are guard type genes that suppress the proliferation of cells, and caretaker type genes that prevent mutation by providing DNA repair that ensures genome integrity. If caretaker type genes, guard type genes and proto-oncogenes are mutated, mutations also occur in the genomes. Mutation of germline tumor suppressor genes is associated with genetic types of cancer (Çefle, 2009)

“Two strikes” hypothesis

The "two-hit" hypothesis put forward by Alfred Knudson regarding genetic and sporadic retinoblastoma is known as an eye tumor that occurs in childhood (Knudson, 1971). 40% of retinoblastoma factors occur through germline mutations. This constitutes genetic phenomena. Genetic phenomena cause mutation in RB1 genes located on the chromosome. 60% of

retinoblastoma factors are known to be sporadic. Due to genetic factors, tumors occur at earlier ages compared to sporadic ones (Newsham et al. 1998).

According to the hypothesis put forward by Alfred Knudson in 1971, there must be two types of mutations for the development of retinoblastoma. The first is the occurrence of somatic mutations in two copies of the RB1 gene. The other one is familial and one of the mutations is genetically transferred to the individual via germline mutation. Due to this situation, it shows the presence of congenitally heterozygous RB1 gene mutation in all cells of the body. Since this situation is not sufficient for tumor development, its effectiveness must be eliminated by somatic mutation of one copy. As can be understood from here, there should be a "two hit" pattern in the types of retinoblastoma (Knudson, 1971). In sporadic and hereditary cancers, both copies of the tumor suppressor gene are inactivated by a "double hit". The difference with the genetic one is that the first of the strokes is present from birth. Loss of the other copy is sufficient for the tumor to develop. In sporadic cases, there must be two consecutive hits in the same cell after birth (Figure 5) (Çefle, 2009).

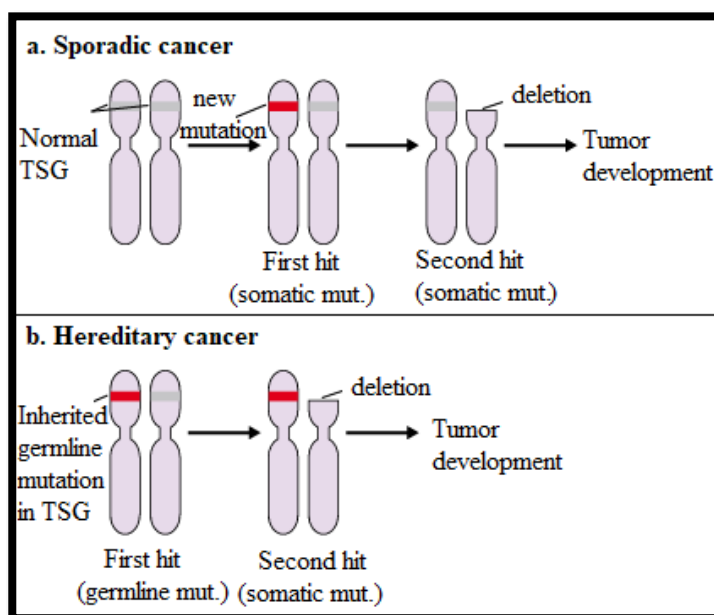

Figure 5: Two-hit hypothesis (Çefle, 2009).

Loss of heterozygosity (LOH):

In genetic eye tumors (retinoblastoma), heterozygous individuals have the RB1 mutant allele in the cancer area but the normal allele is absent. Because during oncogenesis, interstitial losses occur in the 13q14 area of RB1. Low heterozygosity in the RB1 gene region in the tumor is detected by genetic and molecular tests. Apart from interstitial deletions, chromosomal deletions are another striking mechanism. In this mechanism, in cases where LOH cannot be detected, a point mutation occurs during the second hit. LOH has been found in the RB1 gene sequence in sporadic eye tumors. These observations are not only related to retinoblastoma but are also valid for other types of cancer. In sporadic cancer cells, loss of heterozygosity is observed in chromosome areas carrying suppressor genes. The two-hit mechanism has been found to be effective in the emergence of many cancers, especially breast and colon tumors (Table 3) (McKusick, 2006).

LOH	TSG	Associated cancer
17p	<i>P53</i>	Colon, breast cancer
10q	<i>PTEN</i>	Prostate cancer
3p	<i>VHL</i>	Central nervous system hemangioblastoma
5q	<i>APC</i>	Colon cancer
13q	<i>RBI</i>	Osteosarcoma
18q	<i>DCC</i>	Colon cancer

Table 3: Chromosomal regions with LOH in various types of cancer (Çefle, 2009).

2. Oncogenesis:

It is known that during the process of a tissue becoming cancerous, gene parts within the cell mutate and initiate tumorization. These genes are generally known to be pro-oncogenes or suppressor genes. When scientific studies examine the onset and development of the tumor for oncogenesis in the colon, pro-oncogenes and tumor suppressor genes must also be mutated in addition to hereditary events. Oncogenesis is inherited multistage. In this multi-stage process, mutation formation occurs spontaneously or due to radiation (Fearon and Vogelstein, 1990).

2.1 Oncogenes

It has been determined that the cell culture medium obtained from cancerous tissues and the cell culture medium obtained from non-cancerous tissues have different properties. In this type of cell culture, the description transformed is used. Transformation is the development of a cell by feeding on fewer resources. Transformed cells can be round or elliptical and can adhere to soft surfaces. They can continue their lives with lower serum levels than normal. Instead of spreading as a layer on the ground surface, it can continue to develop as a mass structure. When these types of cells are added to the physiology of experimental animals, they provide the cells with the ability to become immortal, creating chain genetic changes and allowing tumor initiation. Many genetic factors must change for a cell or tissue to become cancerous. These genetic changes increase the transformation process of many carcinogenic substances in the cell. The cell often acts as a promoter and initiator of tumor formation through the transformations it undergoes after being exposed to carcinogenic substances for many years. The fact that this is the case tells us that there are different stages in cancer cases. There are two gene groups that cause transformation as a result of mutagens. Genes of viruses that cause transformation within the cell are called oncogenes. Uncontrolled development of genes within the cell called proto-oncogenes is associated with tumor growth. To date, 100 different oncogenes have been identified. The random transformations caused by these oncogenes combine with some chemical agents in the body and cause infection. When transformation occurs within the cell, oncogenes produce large amounts of oncogene proteins. By inhibiting the normal physiological functioning in the cell, it first copies itself as a single chain in RNA, and then turns itself into a double chain in DNA, taking over the functioning of the cell and using the cell to reproduce itself. As a result of the transformation event, some genes are integrated into the genetic structure of the cell and expressed differently. These oncogenes have no cellular similarities but produce transformed proteins called "oncoproteins" that inhibit cellular cancer cell suppressors (Pazarbaşı and Kasap, 2003).

2.2. Tumor Suppressor Genes

The balance that exists between life and death signals in a cell, which is known to be constantly monitored, determines the lifespan of that cell. Cell growth and cell proliferation are achieved when more than one genetic material functions together. Cells; maintaining its vitality, reproduction, division, etc. It synthesizes some special proteins in order to carry out its actions such as (growth factors in the cell). If a possible problem occurs in the repair of an acid or base error in a DNA sequence, deviations in life and death signals occur. Life signals stop functioning and death signals come into play. In other words, the cell's growth factors (proliferation, division) stop and the cell transitions to the death phase. Genes that produce proteins that can prevent the cell from growing and dividing are called 'tumor suppressor genes'. Proteins that trigger cell growth and division are called 'proto-oncogenes'. It is observed that an error in proto-oncogenes causes proteins to be released in larger amounts than normal in these genes. This excess protein triggers the uncontrolled proliferation of cells, leading the cell to cancer. Now, proto-oncogenes appear as an 'oncogene (tumor-triggering gene)' as a result of this cancer. With mutations in tumor suppressor genes, proteins in the gene may lose their function. With the loss of function in proteins, there is no obstacle to cell proliferation and the cell does not transition to the death phase. This maintains the cell's growth factors, but creates an environment for the cell to become cancerous (Köse, 2018).

2.3. DNA Repair Genes

Cancer Genes and Syndromes

TP53 (Tumor Protein 53) Gene:

TP53 gene, a tumor suppressor gene, is the guardian of the genome and is known as the molecule gene of the century. The TP53 gene takes part in DNA repair mechanisms, preventing the cell from reproducing and multiplying when there is damage to the genetic material in the cell and preventing this damage from reaching other cells. If this damage cannot be repaired, the apoptosis (cell death) mechanism comes into play and death occurs in the damaged cell. Tumor protein 53 is a gene active in cancer formation. This gene is found mutated in 50% of cancer patients. Mutated TP53 gene can cause Li-Fraumeni syndrome (LFS). Patients with LFS syndrome, which plays a dominant role during gene transfer, are particularly likely to suffer from diseases such as bone cancer, breast cancer, brain cancer and blood cancer (Özdoğan, 2021c).

- Von Hippel- Landau (VHL) Gene:

The Von Hippel-Landau gene, known as a growth-inactivating gene in cancer cells, provides dominant transition during gene transfer (Figure 6). Patients with VHL syndrome are especially likely to be diagnosed with CNS (Central Nervous System) cancers, kidney cancer and neuroendocrine tissue pancreatic cancers (Özdoğan, 2021c).

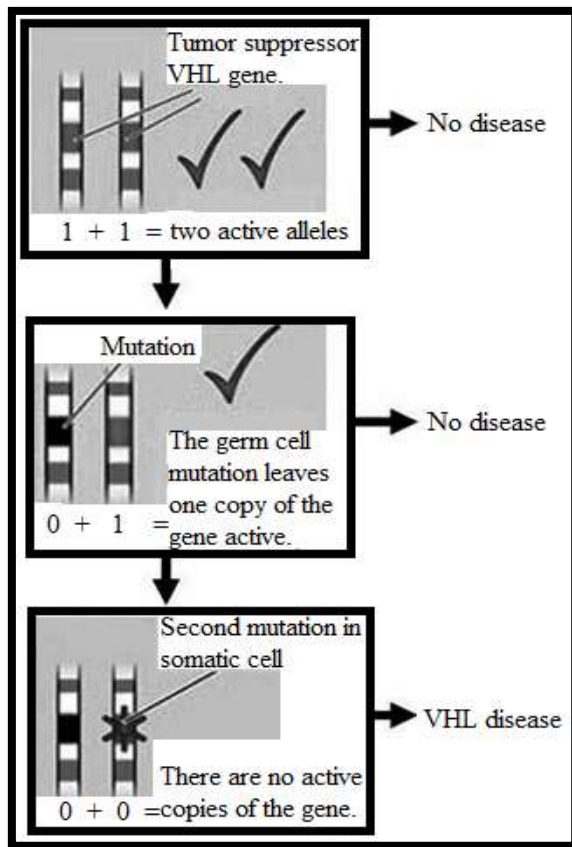

Figure 6: Von Hippel-Landau gene. (Bayraklı vd. 2009).

MutL homolog1 (MLH1) Gene:

The MLH 1 gene causes Lynch syndrome. MutL homolog1 gene plays a damage repair role in genetic material. Patients with Lynch syndrome, caused by the MHL1 gene, are particularly likely to suffer from diseases such as colon cancer, uterine cancer, ovarian cancer and stomach cancer (Figure 7 and figure 8) (Özdoğan, 2021d).

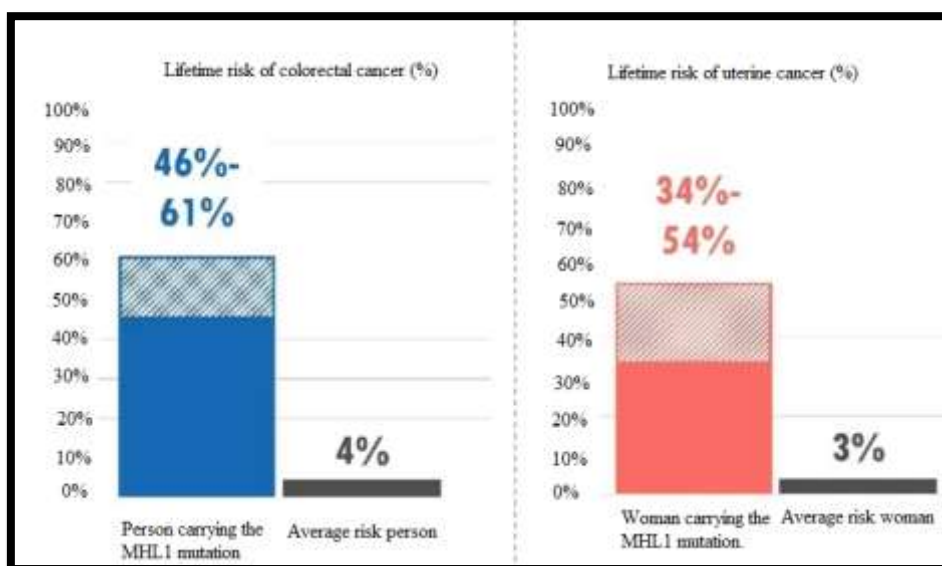

Figure 7: Risk of colorectal and uterine cancer in individuals with MHL1 mutation (Özdoğan, 2021d)



Figure 8: Risk of ovarian and pancreatic cancer in individuals with MHL1 mutation (Özdoğan, 2021d).

Excision Repair (ERCC) Gene:

ERCC gene, like other DNA cancer genes, is a DNA repair gene. It causes Xeroderma Pigmentosum syndrome, which causes recessive transmission during gene transfer. Individuals with this syndrome have a particularly high risk of skin cancer, and they need to protect themselves against sun and UV rays (Özdoğan, 2021c).

Breast Cancer (BRCA1 and BRCA2) Genes:

BRCA1 and BRCA2 genes are DNA repair genes that cause ovarian and breast cancer syndrome. The type of cancer in which genetic mutations are mostly seen in these genes is breast cancer. As a result of research conducted in recent years, it has been reported that BRCC genes can also cause prostate cancer (Özdoğan, 2021c).

MATERIAL AND METHOD

In this review, it is aimed to identify environmental carcinogens, pollution agents and genetic factors that cause cancer by scanning existing scientific resources. The evaluation of cancer cases caused by environmental carcinogens and pollution agents was handled in the Thrace Region. Carcinogenic factors that cause cancer in the Thrace Region have been identified by scanning scientific studies and research conducted in this region.

RESULTS AND DISCUSSION

Thrace Region is known as the region with the highest cancer death rates, according to the 2018 data of the Turkish Statistical Institute (TUIK). Looking at the data of TUIK, Thrace Region is one of the regions with the highest cancer cases in our country (Korkusuz, 2019).

When we consider the increase in cancer cases in the Thrace Region in recent years, 4 main factors stand out in terms of carcinogens. These are the old age rate of the people living in this region, the exposure of the Ergene River and agricultural areas to industrial pollution, the excessive use of pesticides and the fact that the fertile soils in the region are affected by acid rain after the Chernobyl disaster.

Old age is defined by the World Health Organization as the life span of 65 years and above. The incidence of cancer is high in people aged 65 and above, which we call the last quarter of the human life cycle. Since cancer formation requires a long process, it is normal that this disease is more common in older individuals (Çınar and Taş, 2015).

According to TÜİK data, while the average rate of the elderly population in Turkey is 9.9%, the elderly population rate of Edirne is 16.2% compared to the total population. Edirne is among the provinces with the highest proportion of elderly population (TUIK, 2022).

As risk factors increase and cell repair mechanisms weaken as we age, a history of cancer occurs in various tissues and organs, and the incidence of cancer also increases. There is an increase in trachea, bronchus, lung, prostate, bladder, stomach, kidney and colorectal cancers in male individuals at older ages (Figure 9). In older female individuals, there is an increase in thyroid, trachea, bronchus, lung, uterine corpus, stomach, ovary, cervix, breast and colorectal cancers, depending on age (Figure 10) (Kaygusuz, 2018).

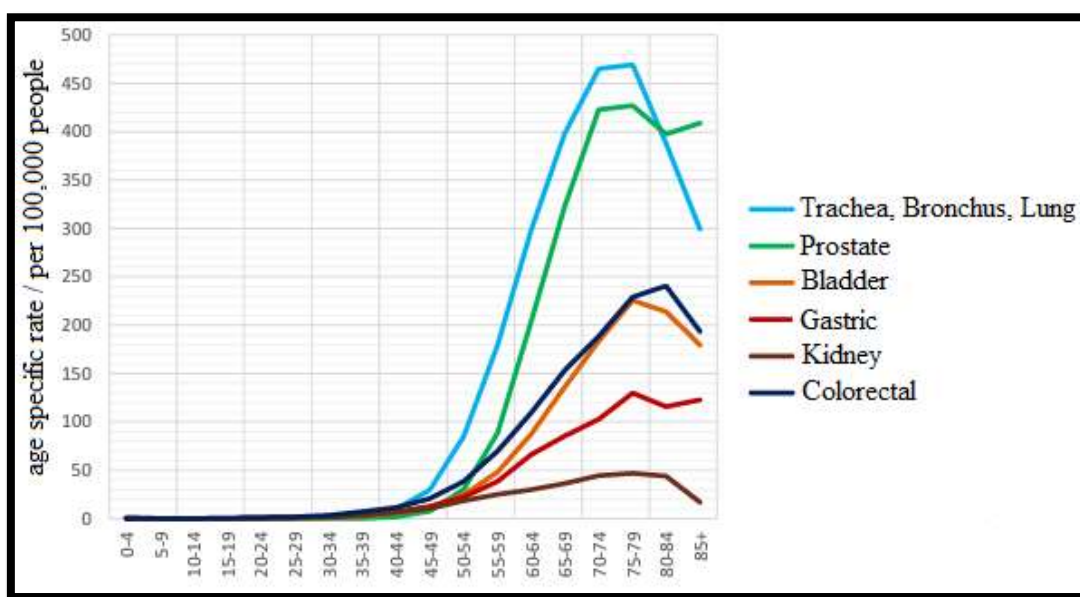

Figure 9: Age-specific rates of some cancer types seen in men (Kaygusuz et al. 2018).

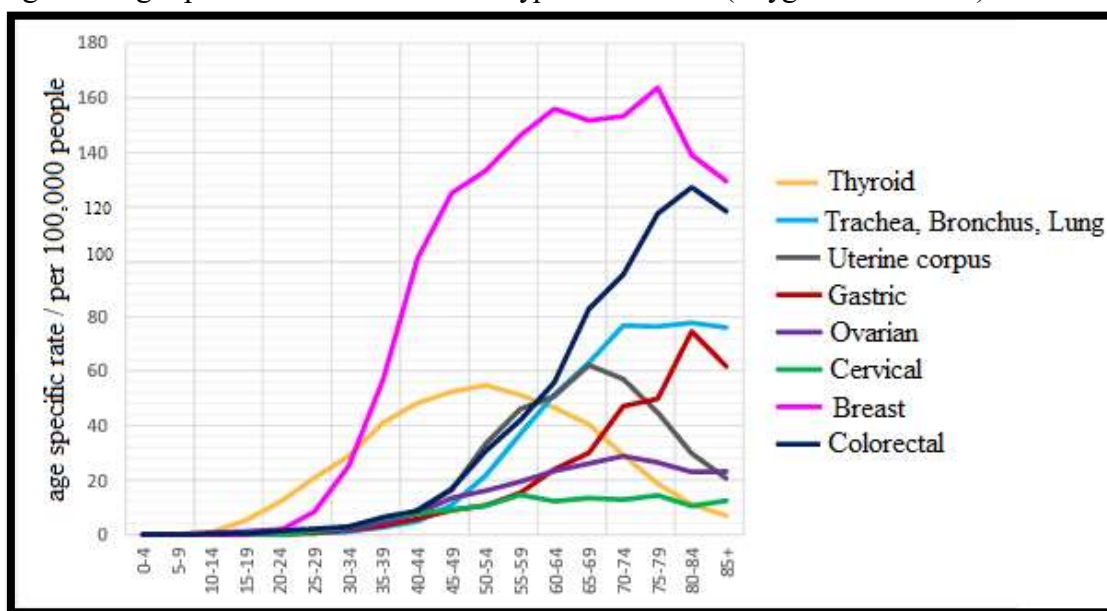

Figure 10: Age-specific rates of some cancer types seen in women (Kaygusuz et al. 2018).

Ergene River is an approximately 285 km long river that starts from the Yıldız Mountains that feed the agricultural lands of the Thrace Region, merges with the Meriç River and flows into the Aegean Sea (Figure 11). Since the 1970s, industrial areas in the Thrace region, especially the industrial facilities in Çorlu and Çerkezköy, have been dumping all their waste and poison into the Ergene River, polluting this river, which is the water source of the region. Ergene River, where wastewater is dumped by industrial facilities, feeds the agricultural lands of the region. Thrace Region is a region with fertile agricultural lands in terms of food production such as rice, wheat and sunflower. However, these agricultural lands are exposed to Ergene's polluted waters containing heavy metals. The foods grown here negatively affect human health. Heavy metals, which are strong carcinogens, have been detected in foods grown in the region (Kocaman et al. 2011). 12% of Turkey's wheat production, 61% of sunflower production and 54% of rice production are produced in the Ergene basin (Bağdatlı, 2014, figure 11).

Ergene River is polluted by industrial facilities and contains heavy metals (cadmium, mercury, etc.) and toxic chemicals (paint, arsenic, etc.). Because of this problem that has not been solved for many years, people living around the Ergene River are exposed to diseases such as cancer and other health problems. In a study conducted on cancer patients and non-cancer individuals living around the Ergene River (Babaeski, Çerkezköy, Enez, Muratlı, İpsala, Meriç, Çorlu and Uzunköprü), it was found that individuals with cancer had higher levels of cadmium, mercury, dye and arsenic in their bodies than others. Heavy metals and chemicals were found in the river (Yolal, 2014). This shows that the Ergene River contains large amounts of carcinogenic substances.

The poisoning of the Ergene River by industrial waste not only pollutes the fertile agricultural lands in this region, but also causes pollution in many areas. It pollutes all food products fed by river water, all groundwater it passes through, and causes air pollution as a result of water evaporation. Individuals who breathe the air, consume agricultural foods whose soil is fed by river water, and directly consume groundwater mixed with the river also take many carcinogenic substances into their bodies. This causes other health problems, especially cancer (Yolal, 2014).

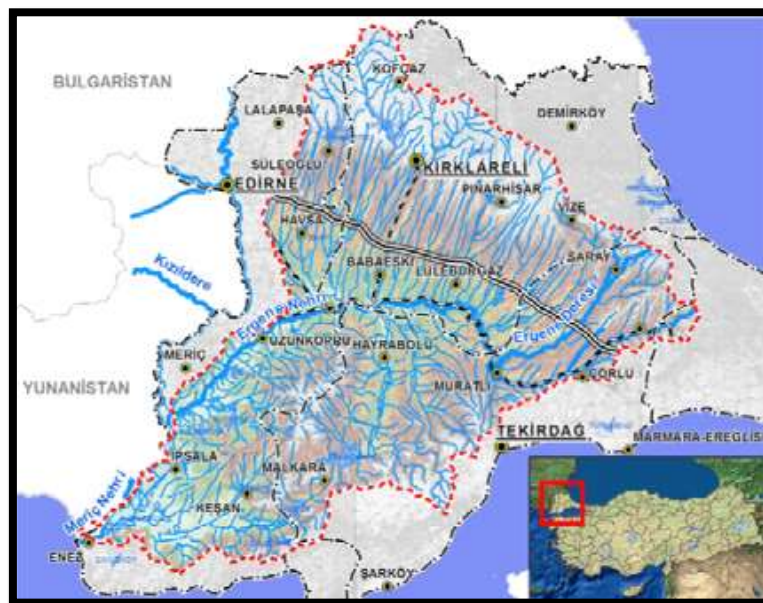

Figure 11: Geographical location of Ergene River (Bağdatlı, 2014)

In another study conducted in the region, high levels of heavy metals such as cadmium, zinc and lead were found in the nail pathologies of individuals with bladder, prostate and kidney tumors living around the Ergene River (İnci et al. 2013a). In this study, patients with kidney tumors were specifically considered. Two groups were examined in the study. The groups are as follows; These are individuals with kidney cancer living around the Ergene River and individuals with the same diagnosis living in an area far from the river. As a result of the kidney histology and blood analysis examinations of the patients, it was seen that lead and cadmium elements were found in higher amounts in patients living near the river compared to others. Particularly as a result of blood analysis, it was seen that the amount of cadmium was 4 times higher than normal (İnci et al. 2013b).

The Chernobyl disaster is the nuclear power plant accident that took place on April 26, 1986 in the city of Pripyat, Ukraine, known as the largest nuclear accident according to the International Nuclear Event Scale (Figure 12 and Figure 13) (WHO, 2002).



Figure 12: Chernobyl disaster nuclear explosion (Demircan, 2019).



Figure 13: Chernobyl disaster after the nuclear explosion (Demircan, 2019).

It is known that approximately 8 tons of radioactive material was released into the air in this accident, which occurred during the electrical safety test at the power plant. The poisonous clouds loaded with radioactive material that emerged after the explosion reached from Ukraine, Belarus, to Russia, parts of Europe, Turkey, America, Canada and Japan day by day. Approximately 7-8 million people were exposed to radiation after the accident, and the effects of the accident still continue today. The Chernobyl accident caused many deaths and diseases by exposing the air, soil and environment to intense radiation, affecting the food and plants grown in the region (Figure 14). Approximately 50 thousand square kilometers of agricultural land has become unproductive for 30-40 years. After the disaster, vision disorders and pathological diseases in newborns, especially thyroid cancer cases, increased (Figure 15) (Saraçoğlu 2006; TTB 2006).



Figure 14: Radioactive effects seen in foods after the Chernobyl accident (<https://www.tarim.com.tr>)



Figure 15: Anomaly in newborns and thyroid cancer in children after the Chernobyl accident (<https://www.radyasyon.gen.tr>).

In a study conducted on milk in the region 25 years after the Chernobyl disaster, cesium-137, known as a long-lived isotope, was found in 93% of the milk. Scientists say that currently

there is still 1 ton of plutonium and 190-200 tons of uranium under the power plant, and all this residue can only be cleaned in 48-50 thousand years. As a result of the research, it was reported that approximately 30-60 thousand people were diagnosed with a deadly type of cancer after the Chernobyl accident (Saraçoğlu 2006; TTB 2006).

While the normal radiation level measured in the Thrace Region before the Chernobyl accident was measured as 8-10 microroentgens/hour, after the disaster, this level was recorded as 30-40 microroentgens/hour. With the rain that fell in the Thrace region about a week after the Chernobyl accident, the air, soil and water in the region were completely under the influence of radiation (Saraçoğlu, 2006).

Although 37 years have passed since the disaster, the Thrace Region and the Black Sea Region are still experiencing the effects of this nuclear accident (Kara and Günay, 2013; TTB, 2006).

Agricultural drugs used to destroy organisms that harm the food produced are called pesticides. There are many types of these pesticides. Those used for insects are called insecticides, those used for fungi are called fungicides, and those used to destroy weeds are called herbicides. On the other hand, there are many commercial pesticides used against rodents, mollusks, nematodes and mites (Kaymak et al. 2015).

In a study conducted on rice samples collected from 25 different points around the Meriç River in the Thrace Region, many pesticide residues were determined in the rice. In this study, the pesticides azoxystrobin, cyproconazole, epoxyconazole, prochloraz, profoxdim, propoconazole, tebuconazole and trifloxystrobin were determined in the rice collected. Although the pesticide residue amounts are in accordance with the Turkish Food Codex and EU legislation, the fact that pesticides were obtained in the paddy fields in this region shows that higher doses of pesticides were used than necessary during pesticide application (Kulaksız and Akgün, 2020).

When pesticides were first discovered, it was predicted that they would break new ground in the field of agriculture. Because it is known that if thrown into the soil, it increases the yield by preventing the products from spoiling. Later, extensive studies on pesticides revealed that after using pesticides in agricultural lands, the products to be harvested mix with soil, groundwater and the atmosphere, causing great harm to the environment. Farmers who apply pesticides experience health problems by being exposed to both hormonal disorders and carcinogenic substances by inhaling the pesticide directly during application (Akdoğan et al. 2012, Tudi et al. 2022) (Figure 16).

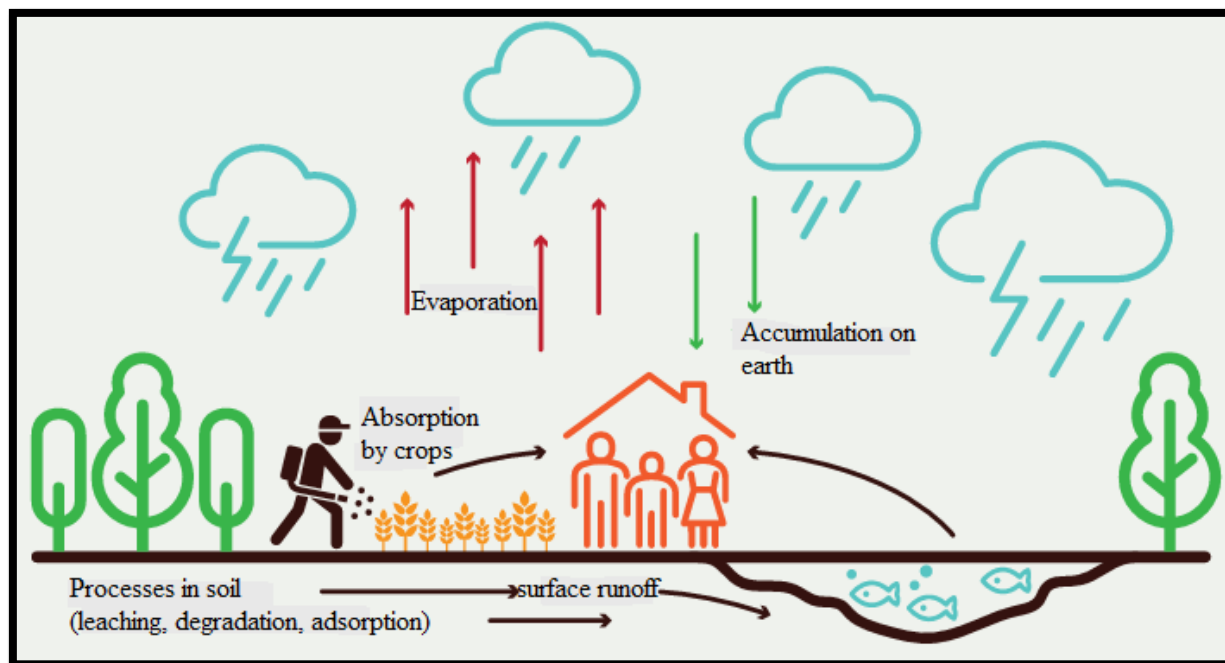

Figure 16: Environmental cycle of pesticides (Çağlayan et al. 2023).

Some specific types of cancer such as blood cancer, Hodkin's, non-Hodkin's lymphoma, stomach cancer, prostate cancer, breast cancer, and brain cancer are observed in agricultural workers who apply pesticides. A scientific study was conducted on rats to prove that pesticides are carcinogenic and to detect their negative effects (Ito et al. 1995). In this study conducted by Ito et al., rats were given a mixture of 19 phosphorus and 1 chlorine pesticide for 2 months. At the end of the 8th week, it was determined that there was an increase in the number and area of preneoplastic lesions in the subject's liver. DNA insertion is the state of cancer-causing compounds covalently bonded to genetic material. As another result of pesticide application, when some leukocytes were examined for genetic material, a significant increase in DNA inclusion was detected. This research conducted on rats proved that pesticides are carcinogenic chemicals by causing DNA damage, oxidative damage, liver enzyme system disorders and increased DNA admixture in living organisms (Kurutaş and Kılınç 2003).

CONCLUSION

By scanning the scientific studies and existing literature, pollution agents, environmental carcinogens and genetic factors in the Thrace Region were identified. The evaluation of cancer cases caused by these carcinogens and agents was handled in the Thrace Region. Environmental carcinogens have been identified as smoking, obesity, viruses and bacteria, ultraviolet rays, alcohol consumption and chemicals. According to scientific studies, it has been observed that cancer patients smoke more than patients who are not diagnosed with cancer (Doll et al. 1994). As a result of the irregular increase in body weight and fat tissues of obesity patients, hormonal diseases, chronic diseases and various types of cancer occur in these individuals (Urhan and Akbulut, 2017). As a result of oncogenes being attacked by microorganisms, the cell does not multiply and grow in a healthy way, resulting in tumor formation (Özdoğan, 2021b). As a result of UV rays reaching the individual, the immune system in the skin is disrupted and DNA is damaged and cancer cells are formed (Herring, 2010, Özdoğan, 2017). According to the results of scientific studies, it has been observed that individuals with low system repair capacity in the repair and restoration of genetic material due to alcohol consumption have a high risk of developing cancer (Garaycochea et al. 2012). As a

result of a scientific study, it was revealed that the risk of leukemia and CNS tumors is higher in the children of parents who have occupational contact with pesticides. This shows us that pesticides are chemical carcinogens (Bhatia, 1999).

When we consider environmental carcinogens as the Thrace Region; The high rate of old age, the dumping of industrial and other wastes into the Ergene River, the negative impact of the region after the Chernobyl disaster, and the excessive use of pesticides in agriculture have been identified as the main reasons for the high number of cancer cases in this region.

As we get older, the risk of getting cancer increases as our genetic structure begins to deteriorate (Kaygusuz, 2018). It has been determined that cancer cases and the risk of developing cancer are higher in Edirne, especially as a result of the high old age rate and lower birth rates in Edirne (TUIK, 2022).

As a result of industrial facilities in the Thrace Region throwing their waste and poison into the Ergene River, known as the water source of the region; Foods grown in these soils also contain other carcinogenic substances such as heavy metals. It has been determined that people who consume these foods have an increased risk of many diseases and cancer (Kocaman et al. 2011).

As a result of the nuclear explosion that occurred during a safety test at a nuclear power plant in Ukraine, the Thrace Region, along with many countries and cities, was greatly affected by this nuclear accident. As the radioactive poison clouds that emerged after the explosion reached the region and acid rain fell on Thrace, the air and the soil and the environment were exposed to intense radiation. Therefore, in the Thrace Region; Living people have a high risk of contracting cancer as well as many diseases as a result of consuming grown plants and foods. As a result of the Chernobyl disaster; Along with many human deaths, 7-8 million people were exposed to radiation. Approximately 50 thousand kilometers of agricultural land has become unproductive for many years. Thyroid cancer cases have increased, especially in children, and visual impairments and pathological diseases have been observed in newborns. According to the results of the research, it was reported that 30-60 thousand people were diagnosed with a deadly type of cancer after the disaster (Saraçoğlu 2006; TTB 2006).

As a result of the excessive use of pesticides in agricultural areas in the Thrace Region, it has been determined that pesticides cause great harm to the environment by mixing with the harvested products, soil, groundwater and the atmosphere. It has been observed that the risks of hormonal disorders and cancer are high in farmers who apply pesticides, which are known to be carcinogenic substances, and in people who consume food and breathe the atmosphere (Akdoğan et al. 2012, Tudi et al. 2022).

In this study, genetic carcinogens; Oncogenes, tumor suppressor genes, DNA repair genes and other carcinogenic gene concepts have been identified. It has been observed that hereditary cancers occur as a result of mutations in somatic and reproductive cells (Knippers, 2006), proto-oncogenes (Croce, 2008) and tumor suppressor genes (McKusick, 2006). Retinoblastoma, explained by the two-hit hypothesis, occurs as a result of 40% germline mutations and 60% sporadic gene mutations (Newsham et al. 1998).

It has been determined that tumor protein 53 gene, Von Hippel-Landau (VHL) gene, MLH1 gene, Excision repair gene, BRCA1 and BRCA2 genes, also known as DNA repair genes, cause some syndromes in the body and that individuals have a higher risk of developing various types of cancer. (Özdoğan, 2021c).

REFERENCES

- Akdoğan, A., Divrikli, Ü., Latif, E. L. Ç. İ. (2012). Pestisitlerin önemi ve ekosisteme etkileri. Akademik Gıda, 10(1), 125-132.

- Alpertunga, B., Yıldız, E. S. (2010). Genotype and allele frequencies of polymorphic ADH and ALDH in the Turkish population. *Toxicology Letters*, (196), S112.
- Altun, T. (2019). Hemşirelik Öğrencilerinin Deri Kanseri ve Güneşten Korunmaya Yönelik Bilgilerinin Belirlenmesi (Master's thesis, Eastern Mediterranean University (EMU)-Doğu Akdeniz Üniversitesi (DAÜ)).
- Bağdatlı, M. C. (2014). Ergene Nehri Hayat Buluyor. *Düzce Üniversitesi Bilim ve Teknoloji Dergisi*, 2(1), 108-111.
- Banerjee, J., Mishra, N., Dhas, Y. (2015). Metagenomics: A new horizon in cancer research. *Meta gene*, 5, 84-89.
- Baran, Y., Kiraz Y., Ulu G.T. (2018). *Kanser Moleküler Biyolojisi*. Hipokrat yayınevi, Ankara, 536s.
- Bayık, A. (1989). *Kanser Epidemiyolojisi*. Ege Üniversitesi Hemşirelik Fakültesi Dergisi, 5(3), 58-71.
- Bayraklı, F. Çankaya, T. Bayri, Y. Güney, İ. (2009) von Hippel-Lindau Hastalığının Moleküler Genetiği
- Bhatia, S., Spector, L. G., Ross, J. A., Robinson, L. L. (2006). Epidemiology and etiology. *Childhood leukemias*, 3, 49-71.
- Bilir, N. (2008). *Sigara ve kanser*. Ankara: Klasmat Matbaacılık.
- Centers for Disease Control and Prevention (CDC), https://www.cdc.gov/cancer/skin/basic_info/
- Coşkunes, F. I. (2008). *Kanserojen kimyasal maddeler ve iş sağlığı ve güvenliği*. Çalışma ve Sosyal Güvenlik Bakanlığı, İş Sağlığı ve Güvenliği Genel Müdürlüğü.
- Croce, C. M. (2008). *Oncogenes and cancer*. *New England journal of medicine*.
- Çağlayan Ç., Yavuz M., Şehiroğlu B. ve Jensen G.K. (2023). *Pestisitler ve sağlığa etkileri*. Çevre, İklim ve Sağlık için İş birliği Projesi.
- Çefle, K. (2009). *Kanser Genetiği*, İstanbul Üniversitesi, İstanbul Tıp Fakültesi, İç Hastalıkları Anabilim Dalı, Tıbbi Genetik Bilim Dalı, İstanbul. http://www.klinikgelisim.org.tr/eskisayi/kg22_3/9.pdf
- Çınar, D., Taş, D. (2015). *Cancer in the elderly*. *Northern clinics of Istanbul*, 2(1), 73.
- Demircan, K. (2019). *Çernobil nükleer reaktörü neden patladı?* <https://khosann.com/cernobil-nukleer-reaktoru-neden-patladi/>
- Doll, R., Hill, A. (1950). *Bradford: Smoking and Carcinoma of Lung*. *Brit. Med. J.*, (4682), 739-748.
- Doll, R., Peto, R., Wheatley, K., Gray, R., Sutherland, I. (1994). *Mortality in relation to smoking: 40 years' observations on male British doctors*. *Bmj*, 309(6959), 901-911.
- Dönder, E., Önalın, E. (2018). *Obezitenin tanımı, epidemiyolojisi ve klinik değerlendirmesi*. *Fırat Tıp Dergisi*, 23, 1-4.
- Fearon, E. R., Vogelstein, B. (1990). *A genetic model for colorectal tumorigenesis*. *cell*, 61(5), 759-767.
- Garaycochea, J. I., Crossan, G. P., Langevin, F., Daly, M., Arends, M. J., Patel, K. J. (2012). *Genotoxic consequences of endogenous aldehydes on mouse haematopoietic stem cell function*. *Nature*, 489(7417), 571-575.
- Garaycochea, J. I., Crossan, G. P., Langevin, F., Mulderrig, L., Louzada, S., Yang, F., Patel, K. J. (2018). *Alcohol and endogenous aldehydes damage chromosomes and mutate stem cells*. *Nature*, 553(7687), 171-177.
- Herring, D. (2010). *DNA UV mutasyonu* https://commons.wikimedia.org/wiki/File%3ADNA_UV_mutation.svg.
- HSGM (Halk Sağlığı Genel Müdürlüğü) Cancer Department (2021). *Türkiye Kanser Kontrol Programı*, Ankara. <https://hsgm.saglik.gov.tr/depo/birimler/kanser->

- db/yayinlar/raporlar/2021_Kanser_Kontrol_Programi_/17.Agustos_2021_Kanser_Kontrol_Programi_versiyon-1.pdf. <https://www.radyasyon.gen.tr/radyasyon-etkileri.html>.
<https://www.tarim.com.tr/Nukleer-Felaketin-Ardindan-Fukusima-da-Yetisen-21-Mutant-Bitki,1838fg?Sayfa=4>
- Ito, N., Hasegawa, R., Imaida, K., Kurata, Y., Hagiwara, A., Shirai, T. (1995). Effect of ingestion of 20 pesticides in combination at acceptable daily intake levels on rat liver carcinogenesis. *Food and chemical toxicology*, 33(2), 159-163.
- İnci, O. Gülyaşar T. Yolal M. Çakına S. Süt N. Akdere H. ve Atakan İ. H. (2013b). Ergene Nehri Çevresinde ve Diğer Yerleşimlerde Yaşayan Böbrek Tümörlü Olguların Kan ve Böbreğin Normal ve Tümörlü Dokularında Bazı Ağır Metallerin Araştırılması, Nehir Kirliliği ile ilişkisinin Değerlendirilmesi. 11. Üroonkoloji Kongresi Özet Kitabı, Antalya.
- İnci, O. Gülyaşar T. Yolal M. Çakına S. ve Süt N. (2013a). Atıklarla Ağır Derecede Kirlenen Ergene Nehri Çevresinde Yaşayan Ürogenital Tümörlü Olguların Tırnaklarında Bazı Ağır Metallerin Araştırılması, 11. Üroonkoloji Kongresi, Özet Kitabı, Antalya.
- Jelski, W., Szmítkowski, M. (2008). Alcohol dehydrogenase (ADH) and aldehyde dehydrogenase (ALDH) in the cancer diseases. *Clinica chimica acta*, 395(1-2), 1-5.
- Kara, P. Ö., Günay, E. C. (2013). Çernobil kazası ve etkileri. *Mersin Üniversitesi Tıp Fakültesi Lokman Hekim Tıp Tarihi ve Folklorik Tıp Dergisi*, 3(2).
- Kaygusuz S., Tolunay T., Keskinlik B., Özsarı S., Gökler E., Hamavioğlu E.İ.O., Dündar S., Ergün A.K., Sevinç A., ve Tütüncü S. (2018). Türkiye Kanser İstatistikleri. Halk Sağlığı Genel Müdürlüğü, Sağlık Bakanlığı, Ankara.
- Kaymak, S., Özdem, A., Karahan, A., Özercan, B., Aksu, P., Aydar, A., Güler, Y. (2015). Ülkemizde zirai mücadele girdilerinin değerlendirilmesi. *Zirai Mücadele Merkez Araştırma Enstitüsü Müdürlüğü*, Ankara.
- Klug, W. S. Cummings, M. R. Spencer, C. A. Öner, C. (2009). *Genetik kavramlar*. Palme Yayıncılık.
- Knippers, R. (2006). *Molekular genetik*. Georg Thieme Verlag.
- Knudson, A. G. (1971). Mutation and cancer: statistical study of retinoblastoma. *Proceedings of the National Academy of Sciences of the United States of America*.
- Korkusuz, M.T. (2019). 2004-2013 yılları arasında Trakya Üniversitesi Sağlık Uygulama ve Araştırma Merkezi Tıbbi Onkoloji Kliniğine başvuran jinekolojik kanser vakalarının yaşam analizi (Master's thesis, Trakya Üniversitesi, Sağlık Bilimleri Enstitüsü).
- Köse, S., Ölez Ş. (2018). Kanser biyolojisi tümör tetikleyiciler ve tümör baskılayıcılar. <https://evrimagaci.org/kanser-biyolojisi-tumor-tetikleyiciler-ve-tumor-baskilayicilar-7516>
- Krutmann, J., Bouloc, A., Sore, G., Bernard, B. A., Passeron, T. (2017). The skin aging exposome. *Journal of dermatological science*, 85(3), 152-161.
- Kulaksız, Ç., Akgün, A. (2020). Meriç Nehri (Edirne) Boyunca Nehir Suyuyla Sulanan Çeltiklerde Pestisit Kalıntıları. *Akademik Gıda*, 18(1), 36-44.
- Kurutaş, E. B., Kılınç M. (2003). Pestisitlerin biyolojik sistemler üzerine etkisi. *Arşiv Kaynak Tarama Dergisi*, 12(3).
- Lee, H. C., Lee, H. S., Jung, S. H., Yi, S. Y., Jung, H. K., Yoon, J. H., Kim, C. Y. (2001). Association between polymorphisms of ethanol-metabolizing enzymes and susceptibility to alcoholic cirrhosis in a Korean male population. *Journal of Korean medical science*, 16(6), 745-750.
- McKusick, V. A. (2006). Online Mendelian inheritance in man, OMIM. <http://www.ncbi.nlm.nih.gov/omim/>.
- Narayanan, D. L., Saladi, R. N., Fox, J. L. (2010). Ultraviolet radiation and skin cancer. *International journal of dermatology*, 49(9), 978-986.

- Newsham I. F. Hadjistilianou T. Cavenee W. K. (1998). Retinoblastoma & The genetic basis of human cancer. New York.
- Özdoğan, M. (2017). UV ışınları ile kanser ilişkisi. <https://www.drozdogan.com/uv-isininlari-ile-kanser-iliskisi/>
- Özdoğan, M. (2021a). Kanser nedir, neden ve nasıl oluşur? <https://www.mutluvesaglikli.com/kanser-nedir-nasil-olusur/>
- Özdoğan, M. (2021b). Kanser tedavisi ve araştırmalarında yeni bir ufuk. <https://www.drozdogan.com/kanser-tedavisi-ve-arastirmalarinda-yeni-bir-ufuk-metagenomik-bakteri-ve-virus-gibi-mikroorganizmalar-kansere-nasil-yol-acar/>
- Özdoğan, M. (2021c). Genlerimiz bencil olabilir mi, kalıtsal kanserler ve genleri. <https://www.drozdogan.com/genlerimiz-bencil-olabilir-mi-kalitsal-kanserler-ve-genleri/#:~:text=BRCA1%20ve%20BRCA2%3A%20DNA%20tamirinde,ve%20BRCA2%20genlerinde%20meydana%20gelir>
- Özdoğan, M. (2021d). Mlh1 mutasyonu nedir hangi kanserlerin riskini artırır. <https://www.drozdogan.com/mlh1-mutasyonu-nedir-hangi-kanserlerin-riskini-artirir/>
- Özdoğan, M. (2023). Alkolün DNA'ya nasıl hasar vererek kansere sebep olduğu gösterildi. <https://www.drozdogan.com/alkolun-nasil-dnaya-hasar-vererek-kansere-sebep-oldugu-gosterildi/>
- Pazarbaşı, A., Kasap, M. (2003). Kanser genetiği. Arşiv Kaynak Tarama Dergisi, 12(4).
- Perincek, S. D., Duran, K., Körlü, A. E., Bahtiyari, M. İ. (2007). Ultraviolet technology. Textile and Apparel, 17(4), 219-223.
- Saito, L. (1999). Interdisciplinary modeling at Shasta Lake, Dissertation, Colorado State University, Fort Collins.
- Saraçoğlu, G. V. (2006). Son Yirmi Yılda Çernobil Kazası Sonrası Dünyada Yaşananlar. Türk Tabipler Birliği içinde. Çernobil Nükleer Kazası Sonrası Türkiye'de Kanser, 11-43.
- Schutze, M., Boeing, H., Pischon, T., Rehm, J., Kehoe, T., Gmel, G., Bergmann, M. M. (2011). Alcohol attributable burden of incidence of cancer in eight European countries based on results from prospective cohort study. Bmj, 342.
- T. T. B. (Türk Tabipler Birliği) Merkez Konseyi (2006). Çernobil Nükleer Kazası Sonrası Türkiye'de Kanser. Türk Tabipler Birliği Yayınları, Ankara.
- Tudi, M., Li, H., Li, H., Wang, L., Lyu, J., Yang, L., Connell, D. (2022). Exposure routes and health risks associated with pesticide application. Toxics, 10(6), 335.
- TÜİK (Türkiye İstatistik Kurumu), 2022. İstatistiklerle Yaşlılar, 2022. <https://data.tuik.gov.tr/Bulten/>
- Urhan, M., & Akbulut, G. (2017). Obezite ve Kanser İlişkisi: Leptin Kanserojen bir Adipokin midir? İzmir Kâtip Çelebi Üniversitesi Sağlık Bilimleri Fakültesi Dergisi, 2(3), 35-43.
- Vural, N. (2005). Toksikoloji, Ankara Üniversitesi, Eczacılık Fakültesi, Farmasötik Toksikoloji Anabilim Dalı, Ankara.
- WHO (Dünya Sağlık Örgütü) ve Uluslararası Kanser Araştırma Ajansı (IACR) (2021). DSÖ Kanser Verileri Tablo Çevirisi <https://www.losante.com.tr/Content/brosur/DSÖ%20Kanser%20Verileri%20Tablo%20Çevirisi.pdf>
- World Health Organization (WHO), (2002). The human consequences of the Chernobyl nuclear accident. A strategy for recovery. A report commissioned by UNDP and UNICEF with the support of UN-OCHA and WHO. Final-25.01. 02 (No. INIS-XU--019). United Nations Development Programme (UNDP).
- Yiğit, Ş., Ece, A. R. I., Meriç, A. B., Kurt, M. F., Kürşat, A. R. A. S., Erkasap, N. (2019). Obezite ve Kanser Mekanizması. Türk Tıp Öğrencileri Araştırma Dergisi, 1(2), 34-37.

- Yokuş, B., Çakır, D. Ü. (2012). Kanser biyokimyası. Dicle Üniversitesi Veteriner Fakültesi Dergisi, (1), 7-18.
- Yolal, M. (2014). Ergene Nehri Çevresinde ve Trakya'da Yaşayan Ürotelyal Tümörlü Olguların Tümörlü ve Normal Epitelinde Kanda Ağır Metallerin İncelenmesi ve Nehir Kirliliği ile İlişkinin Araştırılması, Trakya Üniversitesi, Tıp Fakültesi, Üroloji Ana Bilim Dalı, Edirne.

CRISPR/CAS9 BASED GENOME EDITING STRATEGIES IN HONEY BEES

Berkant Ismail YILDIZ¹, Kemal KARABAG²

¹*Akdeniz University, Graduate School of Natural and Applied Sciences, Antalya, Turkey*

²*Akdeniz University, Faculty of Agriculture, Department of Agricultural Biotechnology, Antalya, Turkey*

Corresponding author e-mail: berkantyardiz@gmail.com

ABSTRACT

Honey bees (*Apis mellifera*) are scientifically important model organisms in terms of haplodiploid sex system, social order in the hive, learning and memory studies, as well as pollinating a large part of flowering plants to ensure the continuity of both industrial agriculture and wild flora. Continuously developing molecular genetic methods and technologies are applied in the examination of honey bee behavior, determination of breeds and subspecies and disease and pest control giving successful results. Recently, studies based on the CRISPR/Cas9 (clustered regularly interspaced short palindromic repeats/CRISPR associated nuclease 9) system have been carried out for genome editing in honey bees. As a genome editing technique, CRISPR technology is a highly effective and relatively economical method for the analysis of gene functions. From this point of view, CRISPR/Cas9-based gene editing strategies and current studies in honey bees were compiled in this study.

Keywords: Honey bee, biotechnology, CRISPR/Cas9, genome editing

INTRODUCTION

Humanity has been using traditional breeding techniques for many years to carry out manipulations in the genomes of plants and animals. Artificial selection carried out for specific traits has resulted in a variety of plants and animals, ranging from sweet corn to hairless cats. However, this artificial selection process is limited by naturally occurring variations (Phillips, 2008).

The discovery of the transferability of genetic material between different species has led to the initiation of modern genetic modification's initial steps (Raman, 2017). In 1973, Cohen and his team conducted a groundbreaking experiment involving the use of restriction endonucleases and DNA ligase as molecular “scissors” and “paste”, respectively, enabling the cutting and pasting of DNA between different species. These experiments resulted in the successful design of the world's first genetically modified organism (Cohen et al., 1973). The integration of genetic engineering and biotechnological advancements into agricultural practices has ushered in a new era in agriculture. As a result of this integration, agriculture has been presented with sustainable solutions that reduce the harmful effects of climate change, require less cost, and are more environmentally friendly.

For many years, scientists have been searching for effective ways to manipulate the DNA and RNA of organisms. With the recent development of more specific and easily applicable CRISPR technology, the use of programmable gene editing techniques in agriculture has become a focal point of interest (Zhang et al., 2018). Economical solutions are successfully applied, particularly in livestock, to address the issues encountered, resulting in the successful production of animals with improved traits.

One of the most up-to-date molecular techniques used in honey bees (*Apis mellifera*), which is one of the most beneficial farm animal species due to their role as pollinators in the healthy and balanced functioning of ecosystem and their production of valuable bee products such as honey, beeswax, pollen, royal jelly, and propolis, is genome editing technology through CRISPR/Cas9 (Clustered Regularly Interspaced Short Palindromic Repeats-CRISPR-associated nuclease 9). The CRISPR/Cas9 system is an RNA-guided DNA endonuclease system consisting of Cas9 nuclease and a customizable single guide RNA (sgRNA). The sgRNA can be programmed to contain a complementary 18-20 nucleotide sequence to a target sequence, immediately preceding a protospacer adjacent motif (PAM) (Tian et al, 2017). The Cas9-sgRNA complex guided by sgRNA searches along the genome and creates a blunt-ended double-strand break approximately 3 base pairs upstream of the protospacer adjacent motif (PAM) region (Jinek et al., 2012). The subsequent DNA repair results in either non-homologous end joining or homologous recombination-based repair (Symington and Gautier, 2011), leading to the silencing (knockout) of the target gene or the introduction of the desired mutation.

In this study, CRISPR/Cas9-based genome editing strategies and potential, which is one of the most recent molecular methods in honey bees, were evaluated.

CLUSTERED REGULARLY INTERSPACED SHORT PALINDROMIC REPEATS (CRISPR)

Genome engineering utilizing CRISPR-Cas technology has made significant progress in a short period. In the late 1980s, regularly clustered regularly interspaced short palindromic repeats (CRISPR) were detected in DNA from *Escherichia coli*. In the early 1990s, CRISPR-associated systems (CAS) were found to be common in prokaryotes. For nearly two decades, their role in bacterial antiviral defense has been studied. A little over five years ago, the system was named 2015's invention of the year by Science, successfully designed as a highly adaptable, targetable tool for cleaving and rewriting DNA sequences (SurrIDGE, 2018). With this technology, many of the limitations of other gene editing techniques are left behind. ZFN and TALEN are expensive and less versatile than CRISPR, largely due to the need to design new proteins for each new target site (Doudna and Charpentier, 2014).

CRISPR is an RNA-mediated DNA endonuclease system consisting of Cas nuclease and customizable single-guided RNA (sgRNA). The sgRNA can be programmed to contain an 18-20 nucleotide sequence complementary to a target sequence just before a protospacer adjacent motif (PAM) (Tian et al., 2017). The sgRNA-guided Cas-sgRNA complex seeks out the target throughout the genome and generates a blunt-ended double-stranded break about 3 base pair upstream of the PAM region (Jinek et al., 2012). The created broken DNA stimulates the repair pathway. DNA repair, non-homologous end joining or repair based on homologous recombination results in knockout of the target gene or insertion of the desired mutation (Symington and Gautier, 2011) (Şekil 1).

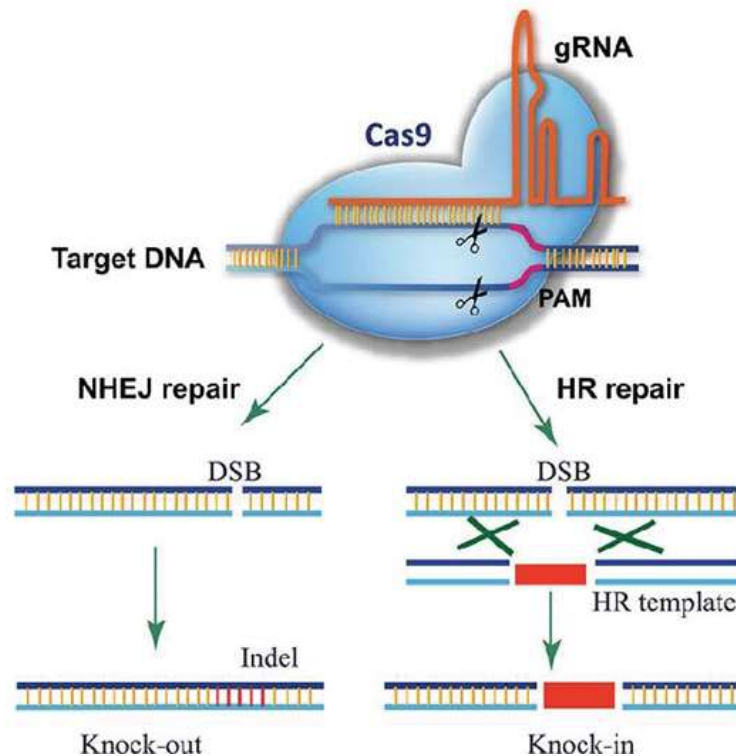

Figure 1. The working mechanism of the CRISPR system (Razzaq and Masood 2018)

According to the Cas protein structure and functions, CRISPR systems are divided into two classes, class I and class II, and they are divided into six types, type I–VI (Makarova et al., 2015). Class I, type I, III and IV; class II includes types II, V and VI (Mohanraju, et al., 2016). Type I, II and V systems target DNA, type VI RNA and type III both DNA and RNA. The effect of the type IV system is not yet known. In particular, type II (Cas9) systems are the most widely used in gene editing (Wang et al., 2019).

The most studied protein for programmable endonuclease activity is Cas9. Cas9 can also be programmed to target single-stranded DNA (ssDNA) or single-stranded RNA (ssRNA) with its PAM-presenting oligonucleotide (PAMmer) sequence. The PAMmer is typically designed to fuse with the target strand and form a pseudo-PAM site to activate Cas9 (Feng, 2021). In addition, many variants of Cas9 naturally target RNA without the need for a PAM sequence (Sampson et al., 2013; Dugar et al., 2018; Rousseau et al., 2018; Strutt et al., 2018).

It is also possible to increase targeting specificity by inducing manipulations of Cas9 protein domains. Mutations in one of Cas9's RuvC nuclease domains targeting the DNA strand and an HNH nuclease domain targeting the complementary strand convert Cas9 to a DNA nickase (Ren et al., 2014). Cas9 nickase (Cas9n), a mutant version of Cas9, creates single-stranded nicks in DNA. Paired nickases, which effectively form double strand breaks (DSBs) by generating two single-strand breaks at a short distance at a targeted site, have been developed to reduce off-target activity (Gopalappa et al., 2018).

The most important step for successful genome engineering is the efficient delivery of CRISPR/Cas9 components to the cell nucleus. CRISPR/Cas9 components can be delivered to cells in the form of plasmid DNA (pDNA), messenger RNA (mRNA), or ribonucleoprotein (RNP; Cas9 protein complex with sgRNA) (Wang et al., 2017). However, DNA and RNA based methods have some disadvantages.

After the DNA plasmid is transfected into a cell, must enter the nucleus for transcription of Cas9 mRNA and gRNA. The Cas9 protein is translated from the processed mRNA and finally the Cas9/gRNA complex cuts the chromosomal DNA after nuclear translocation.

However, this method is inefficient due to the many steps required for mature Cas9/gRNA ribonucleoprotein expression and proper localization. In addition, there is a risk of off-target mutations due to the continued expression of the CRISPR system even after target gene editing is finished (Sioson et al., 2021). Another consideration is that the transfection of plasmids encoding Cas9 and sgRNA can lead to undesired integrations in the host genome. Random integrations can produce insertional mutagenesis at critical genomic regions, resulting in gene disruption or oncogenesis (Bloomer et al., 2022).

mRNA delivery can be a useful method compared to plasmid delivery since DNA transcription is not required. This method is also advantageous as the CRISPR components do not need to cross the nuclear membrane; Only direct delivery to the cytoplasm is sufficient for the ribosomes to express the delivered mRNA. However, due to the unstable nature of mRNA to RNases in the physiological environment, safe delivery and rapid translation of mRNA are essential. In fact, mRNA stability compromises gene editing efficiency (Sioson et al., 2021).

Cas9-sgRNA RNP complexes with preformed CRISPR-Cas components can be delivered in the simplest and most efficient manner. In this way, it offers a technique by which barriers associated with pDNA or mRNA delivery can be overcome (Kim et al., 2014). The sgRNA is protected from the cutting enzymes by the RNP complex and the complex that reduces the chance of off-target mutations in the cell is preferred in many studies because of its advantages (Shalaby et al., 2020).

CRISPR/Cas9 APPLICATIONS IN HONEY BEES

CRISPR/Cas9 study in honey bees was first performed by Takeo Kubo and his team in 2016 (Kohno et al., 2016). Kohno et al. (2016) established a basic genome editing protocol in honey bees to perform in vivo gene function analysis. To test the viability of the protocol, the researchers targeted a gene that was unlikely to affect honeybee development. Researchers who successfully knocked out the major royal jelly protein 1 (mrjp1) gene with CRISPR/Cas9 reported that this gene is indispensable for normal drone development, at least until the pupal stage. In another study, the same team knocked out the mKast gene (middle-type Kenyon cell-preferential arrestin-related protein) in drones with the CRISPR/Cas9 approach. In their results, they reported that the mKast gene is indispensable for normal development and sexual maturation in drones (Kohno and Kubo, 2018). In their study targeting the Mrjp1 gene and the transcription factor Pax6 involved in developmental processes, Hu et al. (2019) successfully achieved a CRISPR/Cas9 gene editing efficiency of over 70%. The editing efficiency obtained by Kohno et al. (2016) was only 40%.

In the study where the first morphological mutant worker bees were obtained using CRISPR, Roth et al. (2019) investigated whether feeding is the sole factor directing size polyphenism and whether more genetic instructions are required beyond the sex determination pathway, utilizing CRISPR/Cas9. They reported that the response of the mutants obtained through CRISPR/Cas9 to nutrition is based on a genetic program activated by the fem (feminizer) gene. In another study, Sinakevitch et al. (2020) used CRISPR/Cas9 to verify the specificity of antibodies developed against the insect GABAA receptor subunit Resistance to Dieldrin (RDL) and the metabotropic glutamate receptor mGlutR1 in honey bees. For this purpose, the Rdl and mGlutR1 genes were knocked out by injecting CRISPR/Cas9 into the brains of adult honey bees through the ocellar system. The distribution of receptors was analyzed in honey bee brains 48 hours after the injection. When both mGlutR1 CRISPR/Cas9 and RDL CRISPR/Cas9 were successfully delivered, a significant reduction in the corresponding antibody staining levels was observed. This also demonstrated the successful knockout procedure in adult bees.

Recently, the targets of CRISPR studies have been sensory receptor genes. Değirmenci

et al. (2020) achieved measurable behavioral changes in honey bees using nonsense mutations obtained through CRISPR/Cas9. Honey bees' main carbohydrate source, nectar, is composed of three primary components: Sucrose, glucose, and fructose. Honey bees express three different receptors (AmGr1, AmGr2, and AmGr3) capable of detecting these sugars. When researchers created nonsense mutations in the AmGr3 gene in worker bee eggs using CRISPR/Cas9, the resulting mutants showed a loss of response to fructose but had normal responses to sucrose. Chen et al. (2021) investigated whether mutations in orco (odorant receptor (OR) co-receptor) affect the development of the honey bee brain, a model organism for social behavior and chemical communication. They found that CRISPR-edited mutant bees had significantly fewer glomeruli in the antennal lobes compared to wild-type bees. However, the volume of each glomerulus was larger on average. RNA-Sequencing (RNA-Seq) has revealed that orco knockout results in differential expression of hundreds of genes in the antennae, including genes related to neural development and odorant receptor genes, indicating a specific knockout effect on olfaction.

In 2021, for the first time, visually distinguishable homozygous mutant male bees were produced by Nie et al. (2021). Nie et al. (2021) used CRISPR/Cas9 technology to knockout the Amyellow-y gene in honey bees to understand its functional role in pigmentation. They reported a reduction in black pigment in the cuticles of the edited mosaic workers and mutant male bees.

Geng (2022) investigated the functions of opsins genes in honey bees using a combination of CRISPR/Cas9 and visual conditioning experiments. Through CRISPR/Cas9, Geng (2022) successfully created adult mutant bees with Amlop1 and Amlop2 gene modifications. The mutant bees were tested using a conditioning protocol based on electric shock punishment to assess their ability to learn to inhibit phototaxis towards blue light. Amlop2 mutants learned to inhibit phototaxis towards blue light, whereas Amlop1 mutants failed to do so.

In honey bees, many genes including mrjp1, mKast, pax6, fem, Rdl, mGlutR1, Amgr3, orco, Amyellow-y, Amlop1, and Amlop2 have been knocked out using CRISPR/Cas9 technology, demonstrating its suitability for investigating gene functions.

CONCLUSIONS

CRISPR/Cas9 has emerged as a revolutionary breakthrough in biotechnology in recent years. This technology is derived from the fundamental mechanisms of an adaptive bacterial immune system and is described as a groundbreaking method in the field of gene editing. The use of CRISPR/Cas9 technology in social insects like honeybees presents a significant opportunity to understand important features that influence their behavior, social organization, and colony health. Thanks to this technology, the functions and interactions of genes in honeybees can be examined in greater detail, thereby contributing to the understanding of various biological processes and enhancing productivity and sustainability in agricultural applications. However, CRISPR/Cas9 studies in honey bees are not sufficient yet. In particular, there is a lack of studies on different characters. Therefore, more comprehensive and diverse studies are needed to fully evaluate the potential of CRISPR/Cas9 technology in honey bees. The realization of these studies will contribute significantly to better understanding the genetic mechanisms in honey bees and developing innovative solutions to cope with future agricultural and environmental challenges.

REFERENCES

- Bloomer, H., J. Khirallah, Y. Li, Q. Xu. 2022. CRISPR/Cas9 ribonucleoprotein-mediated genome and epigenome editing in mammalian cells. *Advanced Drug Delivery Reviews*, 181: 114087.
- Chen, Z., I.M. Traniello, S. Rana, A. C. Cash-Ahmed, A.L. Sankey, C. Yang, G.E. Robinson. 2021. Neurodevelopmental and transcriptomic effects of CRISPR/Cas9-induced somatic orco mutation in honey bees. *Journal of Neurogenetics*, 35(3): 320-332.
- Cohen, S.N., A.C. Chang, H.W. Boyer, R.B. Helling. 1973. Construction of biologically functional bacterial plasmids in vitro. *Proceedings of the National Academy of Sciences*, 70(11): 3240-3244.
- Değirmenci, L., D. Geiger, F.L. Rogé Ferreira, A. Keller, B. Krischke, M. Beye, I. Steffan-Dewenter, R. Scheiner. 2020. CRISPR/Cas 9-mediated mutations as a new tool for studying taste in honeybees. *Chemical Senses*, 45(8): 655-666.
- Doudna, J.A., E. Charpentier. 2014. The new frontier of genome engineering with CRISPR-Cas9. *Science*, 346(6213).
- Dugar, G., Leenay, R.T., S.K. Eisenbart, T. Bischler, B.U. Aul, C.L. Beisel, C.M Sharma. 2018. CRISPR RNA-Dependent Binding and Cleavage of Endogenous RNAs by the *Campylobacter jejuni* Cas9. *Molecular cell*, 69(5): 893-905. DOI: 10.1016/j.molcel.2018.01.032.
- Feng, W., A.M. Newbigging, J. Tao, Y. Cao, H. Peng, C. Le, J. Wu, B. Pang, J. Li, D.L. Tyrrell, H. Zhang, X.C. Le. 2021. CRISPR technology incorporating amplification strategies: molecular assays for nucleic acids, proteins, and small molecules. *Chemical Science*, 12(13): 4683-4698.
- Geng, H. 2022. Molecular analyses of visual processing and learning in honey bees. Doctoral dissertation, Université Paul Sabatier, Toulouse.
- Gopalappa, R., Suresh, B., Ramakrishna, S. and Kim, H. 2018. Paired D10A Cas9 nickases are sometimes more efficient than individual nucleases for gene disruption. *Nucleic Acids Research*, 46(12): e71-e71.
- Hu, X.F., B. Zhang, C.H. Liao, Z.J. Zeng. 2019. High-Efficiency CRISPR/Cas9-mediated gene editing in honeybee (*Apis mellifera*) embryos. *G3 Genes|Genomes|Genetics*, 9: 1759-1766. DOI: 10.1534/g3.119.400130.
- Jinek, M., K. Chylinski, I. Fonfara, M. Hauer, J.A. Doudna, E. Charpentier. 2012. A programmable dual-RNA-guided DNA endonuclease in adaptive bacterial immunity. *Science*, 337: 816-821.
- Kim, S., D. Kim, S.W. Cho, J. Kim, J.S. Kim. 2014. Highly efficient RNA-guided genome editing in human cells via delivery of purified Cas9 ribonucleoproteins. *Genome Research*, 24: 1012-1019.
- Kohno, H., T. Kubo. 2018. mKast is dispensable for normal development and sexual maturation of the male European honeybee. *Scientific Reports*, 8(1): 1-10.
- Kohno, H., S. Suenami, H. Takeuchi, T. Sasaki, T. Kubo. 2016. Production of knockout mutants by CRISPR/Cas9 in the European honeybee, *Apis mellifera* L. *Zoological Science*, 33(5): 505-512.
- Makarova, K.S., Y.I. Wolf, O.S. Alkhnbashi, F. Costa, S.A. Shah, S.J. Saunders, E.V. Koonin. 2015. An updated evolutionary classification of CRISPR-Cas systems. *Nature Reviews Microbiology*, 13(11): 722-36.
- Mohanraju. P., K.S. Makarova, B. Zetsche, F. Zhang, E.V. Koonin, J. Van der Oost. 2016. Diverse evolutionary roots and mechanistic variations of the CRISPR-Cas systems. *Science*, 353(6299).

- Nie, H.Y., L.Q. Liang, Q.F. Li, Y.N. Zhu, Y.K. Guo, Q.L. Zheng, Y. Lin, D. Yang, Z. Li, S.K. Su. 2021. CRISPR/Cas9 mediated knockout of Amyyellow-y gene results in melanization defect of the cuticle in adult *Apis mellifera*. *Journal of Insect Physiology*, 132: 104264.
- Phillips, T. 2008. Genetically modified organisms (GMOs): Transgenic crops and recombinant DNA technology. *Nature Education*, 1(1): 213.
- Raman, R. 2017. The impact of Genetically Modified (GM) crops in modern agriculture: A review. *GM Crops & Food*, 8(4): 195-208.
- Ren, X., Z. Yang, D. Mao, Z. Chang, H.H. Qiao, X. Wang, J. Sun, Q. Hu, Y. Cui, L.P. Liu, J.Y. Ji, J. Xu, J.Q. Ni. 2014. Performance of the Cas9 nickase system in *Drosophila melanogaster*. *G3: Genes, Genomes, Genetics*, 4(10): 1955-1962.
- Roth, A., C. Vleurinck, O. Netschitailo, V. Bauer, M. Otte, O. Kaftanoglu, R.E. Page, M. Beye. 2019. A genetic switch for worker nutrition-mediated traits in honeybees. *PLoS Biology*, 17(3): e3000171.
- Rousseau B.A., Z. Hou, M.J. Gramelspacher, Y. Zhang. 2018. Programmable RNA Cleavage and Recognition by a Natural CRISPR-Cas9 System from *Neisseria meningitidis*. *Molecular Cell*, 69: 906-914. DOI: 10.1016/j.molcel.2018.01.025.
- Sampson T.R., S.D. Saroj, A.C. Llewellyn, Y.L. Tzeng, D.S. Weiss. 2013. A CRISPR/Cas system mediates bacterial innate immune evasion and virulence. *Nature*, 497: 254-257. DOI: 10.1038/nature12048.
- Shalaby, K., M. Aouida, O. El-Agnaf. 2020. Tissue-specific delivery of CRISPR therapeutics: strategies and mechanisms of non-viral vectors. *International Journal of Molecular Sciences*, 21: 7353. DOI: 10.3390/ijms21197353.
- Sinakevitch, I., Z. Kurtzman. H.G. Choi, D.A.R. Pardo, R.A. Dahan, N. Klein, B. Bugarija, E. Wendlandt, B.H. Smith. 2020. Anti-RDL and Anti-mGlutR1 Receptors Antibody Testing in Honeybee Brain Sections using CRISPR-Cas9. *JoVE (Journal of Visualized Experiments)*, e59993.
- Sioson, V.A., M. Kim, J. Joo. 2021. Challenges in delivery systems for CRISPR-based genome editing and opportunities of nanomedicine. *Biomedical Engineering Letters*, 11, 217-233.
- Strutt S.C., R.M. Torrez, E. Kaya, O.A. Negrete, J.A. Doudna. 2018. RNA-dependent RNA targeting by CRISPR-Cas9. *Elife*, 7: e32724. DOI: 10.7554/eLife.32724.
- Surridge, C. 2018. A crispr definition of genetic modification. *Nature Plants*, 4: 233.
- Symington, L.S. J. Gautier. 2011. Double-strand break end resection and repair pathway choice. *Annual Review of Genetics*, 45: 247-271.
- Tian, S., L. Jiang, Q. Gao, J. Zhang, M. Zong, H. Zhang, Y. Ren, S. Guo, G. Gong, F. Liu, Y. Xu. 2017. Efficient CRISPR/Cas9-based gene knockout in watermelon. *Plant Cell Reports*, 36(3): 399-406.
- Wang, F., L. Wang, X. Zou, S. Duan, Z. Li, Z. Deng, J. Luo, S.Y. Lee, S. Chen. 2019. Advances in CRISPR-Cas systems for RNA targeting, tracking and editing. *Biotechnology Advances*, 37(5): 708-729.
- Wang, M., Z.A. Glass, Q. Xu. 2017. Non-viral delivery of genome-editing nucleases for gene therapy. *Gene Therapy*, 24(3): 144-150.
- Zhang, Y., K. Massel, I.D. Godwin, C. Gao. 2018. Applications and potential of genome editing in crop improvement. *Genome Biology*, 19(1): 1-11.

STRUCTURAL CHARACTERISTICS OF ZEEN OAK (*QUERCUS CANARIENSIS*) (NORTHEASTERN ALGERIA)

Norhane Chouiter, Lilia Redjaimia, Malika Rached-Kanouni¹, Boutheyna Touafchia, Alia Zerrouki, Ouarda El Wahida Boucif, Rabah Arhab

¹Laboratory Of Natural Substances, Biomolecules & Biotechnological Applications, Algeria

²Department of Natural and Life Sciences, Faculty of Exact Sciences and Natural and Life Sciences, Larbi Ben M'Hidi University, Oum El Bouaghi, Algeria.

³Conservation of Forests in Mila, Algeria

ABSTRACT

Our research focuses on describing the demographic structure of Algerian zéen oak (*Quercus canariensis* L.) in Zouagha forest (Mila, Algeria). Data were collected through random sampling in four plots of 0.09 hectares (30m x 30m). Dendrometric parameters measured included diameter at 1.3 m above the ground, total tree height, and diameter of young plants \leq 10 cm. Diameter and height structures were fitted to the theoretical Weibull distribution using Minitab19 software. The main results reveal significant differences in mean height, mean diameter, and basal area among the selected study plots. The mean height of zéen oak trees is 8.855 m, the diameter is 49.72 cm, and the basal area is 83.59 m² per hectare. The analysis of diameter and height demographic structures shows a predominance of mature individuals with large diameters and tall heights. These results provide important data and contribute to the enhancement and sustainable management of zéen oak in Zouagha forest.

Keywords: Zouagha, *Quercus canariensis*, demographic structure.

INTRODUCTION

Mediterranean forests cover approximately 81 million hectares (9.4% of the world's forest area) and consist of a mosaic of forest species, mainly deciduous (about 60%) (Mugnossa et al. 2001). Some of these forests hold fundamental ecological importance. Algeria possesses a forest resource characterized by a wide variety of Mediterranean bioclimates, ranging from humid to Saharan climates. Despite this diversity, Algerian forests are dominated by a limited number of species, some of which are highly endemic (Rached-Kanouni et al.2012). Oaks are particularly abundant in Mediterranean landscapes, with deciduous oaks in wet areas and sclerophyllos oaks in subhumid zones. They represent nearly 40% of Algeria's forests and play a crucial role ecologically, economically, and socially (Sarir et al. 2017). Research on the structural and ecological characteristics of forests is essential for sustainable management and provides a foundation for planning decisions. Indeed, the spatial structure of a forest stand describes the arrangement of trees in space. The spatial distribution of a species provides insights into its spatial occupation and can inform about seed dispersal mechanisms and habitat preferences (Comita et al. 2017). It also sheds light on the biology of the species and its use of forest resources. It particularly determines the local environment around each tree and thus the

growth conditions. Hence, the analysis of spatial structure emerges as a significant approach, as a preliminary step to the study, description, and modeling of forest stand (dynamics Nishimura et al. 2008). The primary objective of this study is to analyze the demographic structure and spatial distribution of *Quercus canariensis* populations in Zouagha forest, a crucial step in the process of sustainable management.

MATERIALS AND METHODS

Dendrometric Measurements Four plots of *Quercus canariensis* were randomly selected, each with an equivalent area of 900m² (30m x 30m) (Rached-Kanouni et al.2020) exhaustive inventory was conducted, which involved counting all stems within diameter classes. This type of inventory is commonly used; it does not require advanced technical skills and can be performed using a GPS.

The description of the populations was based on data from individuals with dbh (diameter at breast height) ≥ 10 cm. The parameters considered are :

Density : It represents the average number of trees per plot and is expressed in stems/ha. It is given by the formula $N = n/s$, where n is the total number of trees with dbh ≥ 10 cm, and s is the plot area (s = 0.09 ha).

Basal Area : It is the sum of the basal areas of all trees with dbh ≥ 10 cm found in the plot and is expressed in m²/ha:

$$G = \frac{\pi}{4s} \sum_{i=1}^n d_i^2$$

where n is the total number of trees with dbh ≥ 10 cm in the plot, d_i is the diameter of tree i (m), and s is the plot area.

Average Diameter of Trees in Basal Area : It is the diameter of the tree that has a basal area equal to the average basal area and is expressed in centimeters.

n: total number of trees with dbh ≥ 10 cm in the plot, G: basal area of the plot (m²/ha).

Mean Lorey height: the average height of all trees in the plot weighted by their respective basal areas, expressed in meters.

The diameter and height structures of the *Q. canariensis* population were established for the Zouagha forest. These structures were fitted to the theoretical Weibull distribution using the maximum likelihood method. The three-parameter Weibull distribution (a, b, and c) is characterized by a probability density function, f(x), which is given by the following equation (Rondeux J., 1999)

Where x is the diameter or height of the trees, "a" is the location parameter, "b" is the scale or size parameter, and "c" is the shape parameter related to the observed structure. To test the fit of the observed structure to the theoretical Weibull distribution, a log-linear analysis, a method of variance analysis performed on the logarithm of class densities, was conducted using MiniTab 19 software.

Table 1: Shape of the Weibull distribution according to the values of the parameter “c”.

« c »	Shape of the Weibull distribution
$c < 1$	Inverted "J" distribution, characteristic of multi-species or uneven-aged stand.
$c = 1$	Exponentially decreasing distribution, characteristic of populations in extinction.
$1 < c < 3.6$	Positive asymmetric or right asymmetric distribution, characteristic of monospecific stands with a predominance of young or small diameter individuals.
$c = 3.6$	Symmetrical distribution ; normal structure, characteristic of even-aged or monospecific stands even-aged or monospecific stands of the same cohort.
$c > 3.6$	Negative or left-skewed distribution, characteristic of monospecific stands with a predominance of older individuals.

RESULTS AND DISCUSSION

Table 1 presents the dendrometric characteristics of *Quercus canariensis* in the Zouagha forest. The analysis of this table reveals that the values of the different parameters obtained vary among the studied plots. Dendrometric characteristics are significant indicators for measuring the qualitative and quantitative evolution of forest stands (Kotz et al.1970). Surface terrière is a criterion used to assess the condition of a species within a stand. For all stands, the average surface terrière is 83.59 m²/ha (Table 2). As surface terrière is closely related to diameter, land units containing many individuals with small diameters have low surface terrière values. Consequently, the highest surface terrière values are observed in stands of plot 3 (110.96 m²/ha), followed by stands of plot 2 (96.27 m²/ha). The lowest values are observed in plots 1 and 4. The average density of *Q. canariensis* in the Zouagha forest is approximately 339 individuals/ha. This density varies from 256 individuals/ha in plot 3 to 389 individuals/ha in plot 4. The highest values of total tree height are 9.84 m and 9.19 m for plots 4 and 2, respectively, while the lowest height is obtained in plot 3 (7.79 m). Our results reveal that trees with small diameters are observed in plots 1, 3, and 4, which is explained by the predominance of young individuals in these stands. The highest mean diameter values are obtained in plot 2.

Table 2. Dendrometric parameters of the study plot

	Plots	N	H _l (m)	D _q (cm)	G (m ² /ha)
Zouagha forest	P1	356	8.60	46.47	60.26
	P2	356	9.19	58.73	96.27
	P3	256	7.79	46.87	110.96
	P4	389	9.84	46.81	66.90
Average		339	8.855	49.72	83.59

The diameter of trees is considered an integrative parameter to describe the structural and demographic properties of a forest stand. Indeed, the distribution of tree diameters indirectly reflects the age distribution and allows us to appreciate the structure and dynamics of the stands.

According to demographic models in population ecology, age distributions help identify different states in plant populations based on succession and reproductive strategy (Ostertag et al., 2008). Interpreting diameter distributions provides insights into stand dynamics, which may correspond to different states: stable, declining, or degraded. In this regard, fitting the diameter distribution to the theoretical Weibull distribution helps to better characterize the structure of forest stands. It is worth noting that the diameter structure of the *Q. canariensis* population in the forest shows a left-skewed or negatively skewed distribution in parcels 1, 2, 3, and 4. The shape parameter "c" is greater than 3.6 (Figure 2). This indicates a predominance of older and larger diameter individuals within monospecific stands. This can be explained by the ecological and climatic characteristics of this area.

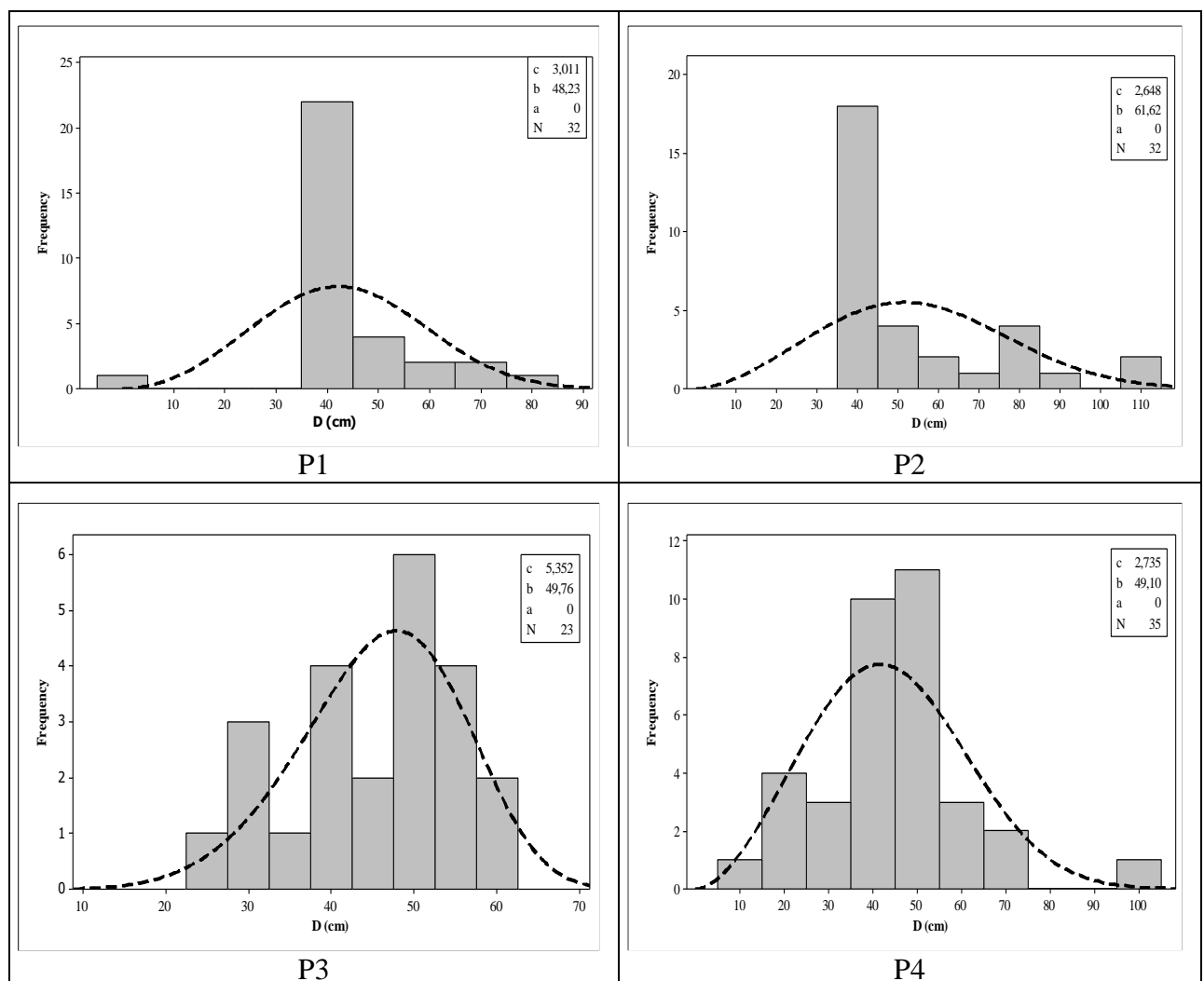

Figure 1: Diameter structure of *Q. canariensis* in the Zouagha forest.

The results of the height structures of natural populations of *Q. canariensis* in the Zouagha forest are illustrated in Figure 3. The values of "c" are greater than 3.6, indicating a predominance of individuals with tall heights (5 to 10 m). Individuals with heights greater than 15 m are poorly represented or almost absent in the Zouagha forest.

The distribution by diameter and height classes shows variations according to ecological parameters. According to the literature, adaptations to ecological conditions, competition for resources, anthropogenic activities, and exploitation may underlie this structural variability (Ajbilou et al .2008). The diameter and height structures of natural populations of *Quercus canariensis* in the forest reveal a predominance of individuals with large diameters and varying heights. This structure generally indicates a high representation of older individuals with large diameters and raises concerns about the future of their populations. In natural stands, when the frequency of small diameter stems (young individuals) is lower than that of large diameter individuals (older individuals), the future of the population cannot be guaranteed (Feeley et al. 2007).

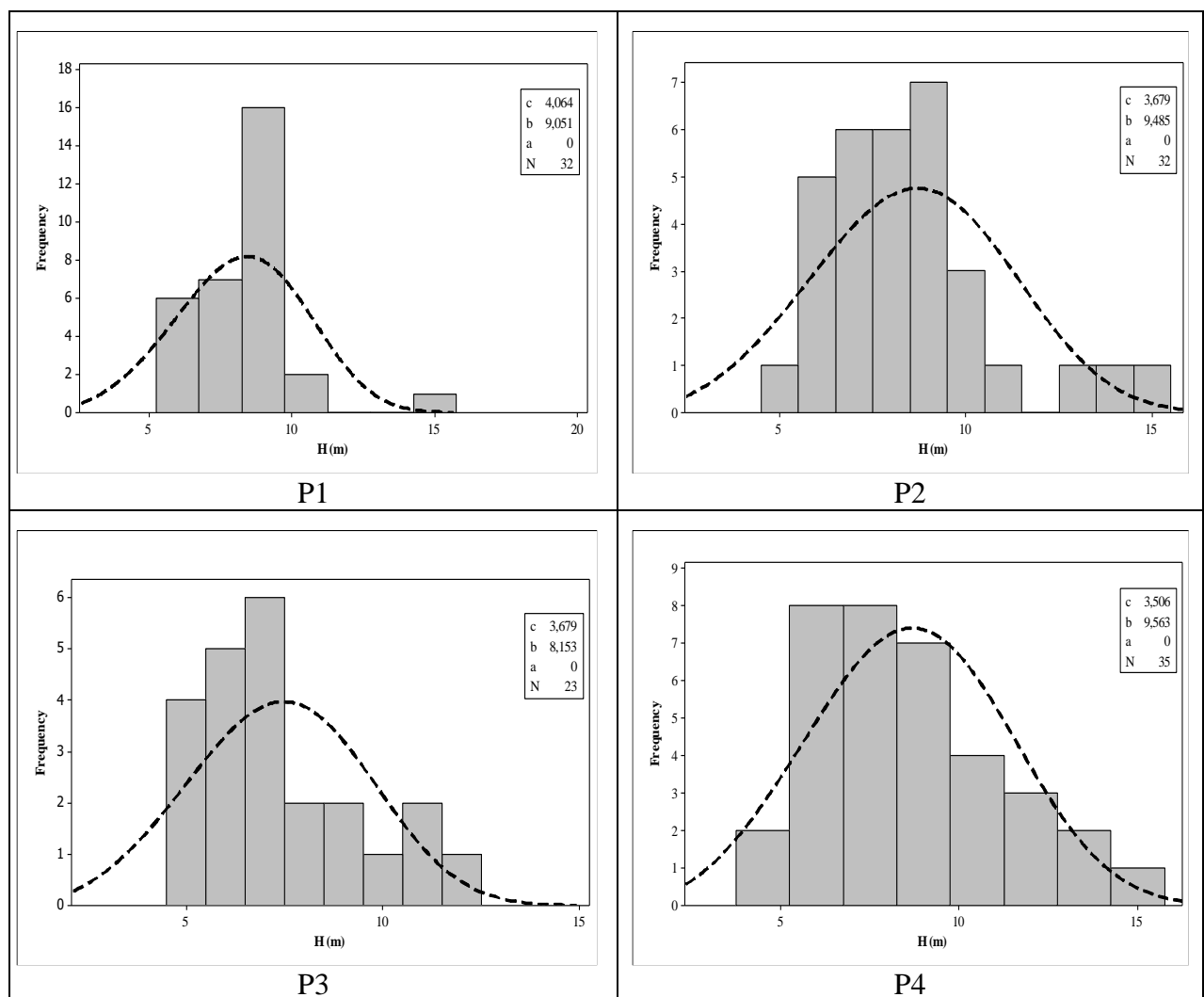

Figure 2: Height structure of *Q. canariensis* in the Zouagha forest.

CONCLUSION

This study compared the dendrometric and structural parameters of *Q. canariensis* in the Zouagha forest. The results of the structure of this species and its regeneration contribute to a better understanding of its viability. Such a study is a fundamental prerequisite for developing

conservation and sustainable management strategies. The dendrometric characteristics showed highly significant variations, which are related to stand density, ecological conditions, and habitat disturbance intensity. According to the Weibull adjustment test, this forest is characterized by a *Q. canariensis* population dominated by individuals with large diameters, indicating a moderate level of regeneration for the species. While there are individuals with small diameters, these young saplings do not always reach maturity due to their vulnerability to anthropogenic activities. Ultimately, this state will provide a database for monitoring and conserving this species.

REFERENCES

- Ajbilou, R., Marañón, T., Arroyo, J., Ater, M., 2008. Structure et diversité des subéraies du Nord-Ouest du Maroc. *Annales de la recherche forestière au Maroc*. 39 : 36-42.
- Comita, L., S., Condit, R., Hubbell, S., P., 2007. Developmental changes in habitat associations of tropical trees. *Journal of Ecology*. 95: 482-492.
- Feeley, J. K., Davies, S. J., Noor, M. N. S., Kassim, A. R., Tan, S., 2007. Do current stem size distributions predict future population changes? An empirical test of intraspecific patterns in tropical trees at two spatial scales. *Journal of Tropical Ecology*. 23: 191-198.
- Givnish, T.J. 1999. On the causes of gradients in tropical tree species diversity. *J. Ecol.* 87: 193-210.
- Kotz, S., Johnson, N.L., 1970. *Distributions in Statistics: Continuous Univariate Distributions*. John Wiley & Sons, New York.
- Mugnossa, G. Scarascia, Oswald, H., Piussi, P., Radaglou, K., 2000. Forests of the Mediterranean region: Gaps in knowledge and research needs. *For. Ecol. Manag.* 132:
- Nishimura, S., Yoneda, T., Fujii, S., Mukhtar, E., Kanzaki, M., 2008. Spatial patterns and habitat associations of Fagaceae in a hill dipterocarp forest in Ulu Gadut, West Sumatra. *Journal of Tropical Ecology*. 24: 535-550.
- Ostertag, R., Inman-Narahari, F., Cordell, S., Giardina, C.P., Sack L., 2014. Forest structure in low-diversity tropical forests: a study of Hawaiian wet and dry forests. *PLoS One*, 9: 1-18.
- Rached-Kanouni, M., Kara, K., Khammar, H., Ababsa L., 2020. Floristic diversity and demographic structure of the Sidi R'Ghies forest, north-eastern of Algeria. *Biodiversitas* 21(3): 1980-1988. doi: 10.13057/biodiv/d21030.
- Rached-Kanouni, M., Sakr, S., Alatou, D., 2012. Morphological and physiological responses of seedlings of cork oak to high temperature. *International journal of advanced scientific and technical research*. 2(4): 742-749.
- Rondeux, J., 1999. *La mesure des arbres et des peuplements forestiers*. Gembloux, Belgique, Presses agronomiques de Gembloux, 522 p.
- Sarir, R., Benmahioul, B., 2017. Etude comparative de la croissance végétative et du développement de jeunes semis de trois espèces de chênes (chêne vert, chêne liège et chêne zéen) cultivés en pépinière. *Agriculture and Forestry Journal*. 1(1): 42-48.

STRUCTURE OF CORK OAK (*QUERCUS SUBER*) STANDS IN THE ZOUAGHA FOREST (NORTHEAST ALGERIA)

Norhane Chouiter, Malika Rached-Kanoun¹, Lilia Redjaimia, Alia Zerrouki, Boutheyne Touafchia, Ouarda El Wahida Boucif, Rabah Arhab

¹Laboratory of Natural Substances, Biomolecules And Biotechnological Applications. Algeria

²Department of Natural and Life Sciences, Faculty of Exact Sciences and Natural and Life Sciences, Larbi Ben M'Hidi University, Oum El Bouaghi, Algeria.

³Conservation of forests in Mila, Algeria.

ABSTRACT

The theme of our research is to describe the structural characteristics and natural regeneration of cork oak (*Quercus suber*) in the Zouagha Forest (Mila, Algeria). The data was collected through random sampling on 6 squares plots of 0.09 hectares. The dendrometric parameters measured include the diameter at 1.3 meters above ground level, total tree height, and seedlings with a diameter ≤ 10 cm. The average density of cork oak trees in the Zouagha forest is 155.66 individuals/ha with a basal area of 33.65 ± 5.53 m²/ha, and the average natural regeneration is 449.51%. The analysis of diameter and height structures shows a predominance of older individuals with large diameters and tall heights. These results constitute a database and contribute to the improvement and sustainable management of cork oak in the Zouagha forest.

Keywords: Zouagha, *Quercus suber*, regeneration, structures.

INTRODUCTION

Cork oak (*Quercus suber* L.) is an evergreen plant species belonging to the family Fagaceae. It exhibits a very long lifespan (over 200 years). Its outer bark is characterized by cork, forming a compact, elastic, waterproof, and thermally insulating layer, which can reach up to 30 cm thick (Natividade, J., 1956). It is also the only plant species capable of renewing cork production (Gil et al., 2009).

Cork oak forests represent a characteristic component of the Mediterranean ecosystem. They are found in the warmest areas of the humid and sub-humid biogeographical regions and cover the western Mediterranean region, including Portugal, Spain, Morocco, and northern Algeria and Tunisia. Additionally, they cover smaller areas in southern France and along the western coast of Italy, including Sicily and Sardinia (Pereira et al., 2008). The cork oak stands cover nearly 1.5 million hectares in Europe and approximately 700,000 hectares in North Africa (Anonyme., 2013).

The cork oak forests in Algeria originally covered an area ranging from 429,000 to 480,000 hectares (ranking third after Portugal and Spain) and are currently estimated at 357,231 hectares, with 68% being old-growth stands. The majority of the best and vast woodlands are located in the eastern part of the country, primarily in humid and sub-humid zones. Outside of this region, cork oak extends more sporadically in the form of isolated and less significant masses.

Cork oak holds significant ecological (Macarthur., 1967), socio-economic, and cultural importance, offering numerous opportunities for developing rural leisure activities (ecotourism) (Kotz et al.1967). Despite the strong impact of human interventions in this emblematic ecosystem, cork oak forests remain an important genetic reservoir and are highly diverse, hosting around 700 plant species and a fauna comprising approximately 70 bird species and 252 mammal species (Damerji J., 2011). However, in Algeria, cork oak forests are threatened by multiple factors, such as agricultural expansion, infrastructure development (settlements and roads), overgrazing, and wildfires (Nasralah B., 2007) .These pressures have led to substantial degradation of plant resources, resulting in modifications to demographic structures and declines in density and floristic diversity of woody species (Sarir, R., 2017). Research on the structural and ecological characteristics of forests is, therefore, essential for sustainable management and serves as a prerequisite for all planning decisions. Indeed, characterizing the structure of a stand entails describing all its structural attributes, such as tree density (Acker et al., 1988) and basal area (Speces et al., 1991).The spatial structure of an ecosystem, which refers to how individuals within it are organized in space, plays a crucial role in its functioning. It relates to both the vertical and horizontal use of space by ecosystem elements (Delvaux, 2012). The structure of a population of forest species is generally defined by the diameter distribution of its individuals (Herrero-Jáuregui et al., 2012).

The objective of this study is to describe the structural and demographic characteristics under consideration (height, diameter, basal area, etc.) and the effect of this structure on the natural regeneration of the cork oak population in this forest. This is to derive silvicultural norms useful for managing this population in the future.

MATERIAL AND METHODS

Study Area Description

The Zouagha forest is located in the North of Algeria. Its geographic coordinates are $Y=6^{\circ}9'15.52''E$ and $X=36^{\circ}34'38.90''N$. It covers an area of 3915.52 hectares (Figure 1).

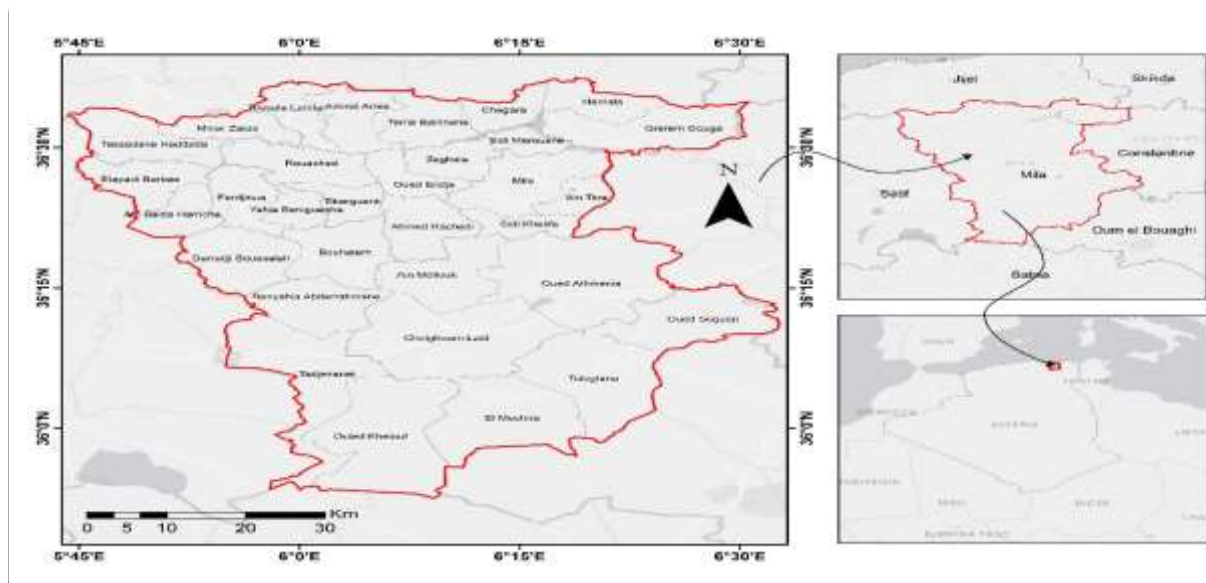

Figure 1 : Geographic presentation of the study area.

Selection of Study Plots

Six cork oak (*Quercus suber*) plots are randomly chosen, each having a rectangular shape with an equivalent area of 900m² (30m x 30m). Within each plot, all individuals of this species are inventoried. Since the study focuses on the 900m² plots, it is preferable to conduct a full inventory. This involves a comprehensive counting of stems by diameter class (Kemadjou M., 2011). This type of inventory is the most common (Rached-Kanouni et al. 2020), and is considered sufficiently accurate for the main dendrometric variables. In each plot, the following parameters are taken into consideration: tree diameter measured on bark at breast height (1.30m) above the ground, total height (Ht) defined as the length of the straight line connecting the base of the tree (ground level) to the tip of the terminal bud of the stem. The geographic coordinates (longitude and latitude) of each plot were obtained using a Global Positioning System.

Structural Characteristics of the Cork Oak Stand

The structural parameters selected for the study of the cork oak stand are total height, diameter, density, and basal area. The following formulas were used to calculate these dendrometric parameters. Density (N, in individuals/ha): It represents the average number of standing trees per hectare. It is given by the following formula :

Density (N) = n / s
n: number of trees in the plot

s: plot area (in hectares)

Basal Area (G) in m²/ha, is the sum of the cross-sectional areas at 1.30 m above the ground of all trees in the plot.

$$G = 4s * \sum_{i=1} (d_i^2)$$

d_i: diameter (in cm) of tree i in the plot

s: plot area (in hectares)

Regeneration Study

Measuring the regeneration stems allows evaluating the future of forest stands. In each plot, the number of regeneration individuals with a diameter at breast height (dbh) < 10 cm is considered as juveniles (Maazou et al.2017), Regeneration is defined by the relative density of regeneration per valuable species: it is the average number of regeneration shoots of the species per hectare. Regeneration densities are calculated per plot and then extrapolated to the hectare.

Cork Oak Structure

The cork oak structure was analyzed based on the distribution of woody individuals in diameter and height classes.

RESULTS

Dendrometric characteristics are major indicators to measure the qualitative and quantitative evolution of forest stands (Hamidou et al., 2017). Basal area is a criterion to assess the status of a species in a stand. For all stands, it is 33.65 ± 8.33 m²/ha (Table 1). Basal area is closely related to diameter; land units with many individuals of small diameter have low basal areas. Thus, the largest basal areas are observed in stands of plot 6 (60.05 ± 2.01 m²/ha), followed by stands of plot 2 (40.67 ± 1.40 m²/ha). Low values are observed in plot 4 (6.88 ± 0.24 m²/ha).

Table 1 : Dendrometric parameters of the study plots.

Plots	H (m)	D (cm)	G (m ² /ha)
P1	14.19 ±5.10	68.71±15.46	34.40± 2.02
P2	11.21±2.49	50.39± 14.69	40.67± 1.40
P3	19.12± 3.42	54.46± 13.50	32.79± 1.41
P4	6.32±1.73	24.14±5.13	6.88±0.24
P5	16.34±2.59	48.89±14.30	27.15±1.22
P6	15.37±3.69	61.36±17.38	60.05±2.01

The average diameter values range from 68.71±15.4 cm for plot 1 to 60.33±7.34 cm for plot 6. The highest values of total tree height are observed in plot 3 (19.12±3.42 m), while plot 4 records the lowest average height (6.32±1.73 m). Our results reveal that large-diameter trees are observed in all plots, which can be attributed to the predominance of mature individuals in these stands.

Regeneration is the foundation of silviculture, and cork oak regenerates through natural seeding, stump sprouts, suckers, and assisted regeneration (Messaoudene, M., 1989). Mature cork oak stands ensure their natural regeneration through their own seeds. As for assisted regeneration, it involves selecting elite trees with intrinsic and extrinsic criteria and good adaptation to the environment. The corresponding natural regeneration stage refers to the seedling stage when young plants have not yet surpassed the herbaceous layer and have a height of 20 to 30 cm. The individuals in this stratum were counted in the 6 plots of the Zouagha Forest. The regeneration density varies between 700 to 544 individuals/ha in the 6 plots presented in Table 2.

Table 2 : Regeneration rates in the studied plots.

Plots	(Na/ha)	(na/ha)	TR (%)
P1	89	666	74.15
P2	189	544	287.83
P3	133	611	459.39
P4	144	633	439.58
P5	189	700	370.37
P6	190	744	391.57

However, we note a high density (700 seedlings/ha) in plot P5. This difference in density may be due to the influence of pedological characteristics on the dynamics of cork oak. In general, natural regeneration in the Zouagha forest area is moderate, with a density of 459.39% seedlings/ha. The observed difference in density between plots could be related to the lack of light, which hampers the survival of the species in the understory (Gourlet-Fleury., 2019). Additionally, the species has a low ability to sprout, so the destruction of the aerial part (by fires or animals) leads to the death of most individuals of the species [20].

Diameter Structure

The diameter of trees is considered an integrating parameter to describe the structural and demographic properties of a forest stand. Indeed, the distribution of tree diameters indirectly reflects the distribution of ages and allows us to assess the structure and dynamics of the stands. The diameter structure of the sampled cork oak trees is presented in Figure 2. The majority of cork oak individuals belong to classes 3 (40-60cm) and 2 (20-40cm), with percentages of 40.13% and 31.57% respectively, while class 4 (>60cm) represents a rate of 3.28%. There is a predominance of older individuals with large diameters within mono-specific stands. This can be explained by the ecological and climatic characteristics of this area.

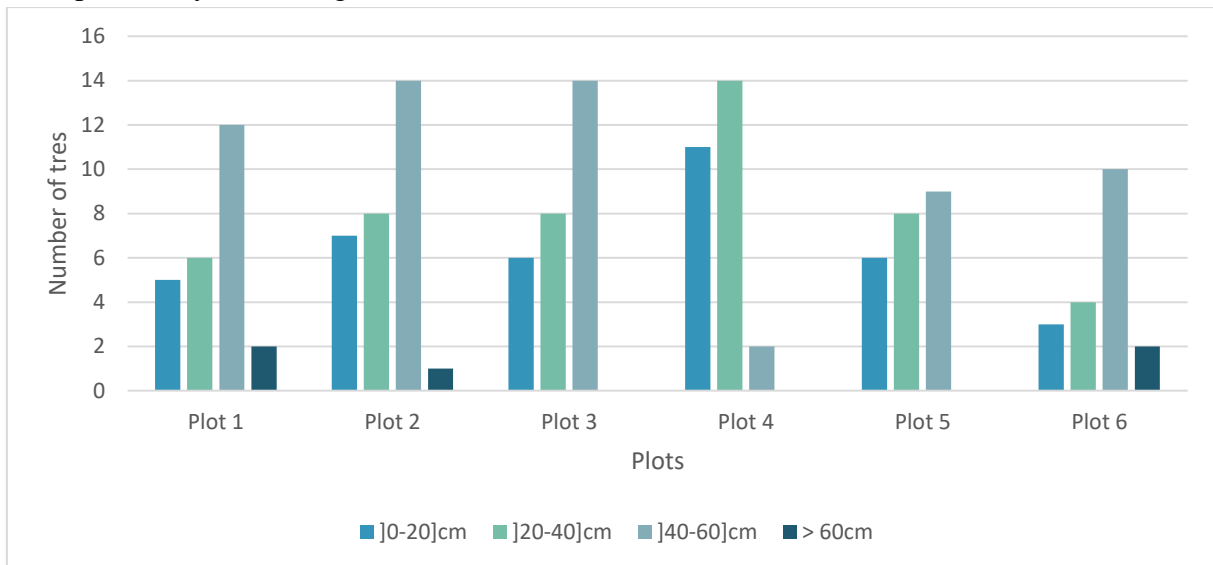

Figure 2 : Diameter structure of cork oak.

Height structure The height distribution of the cork oak population in the different study plots of Zouagha Forest is illustrated in Figure 3. The majority of heights belong to classes 3 and 2 with percentages of 41.44% and 31.57% respectively. Finally, class 4 is found with a percentage of 6.57%.

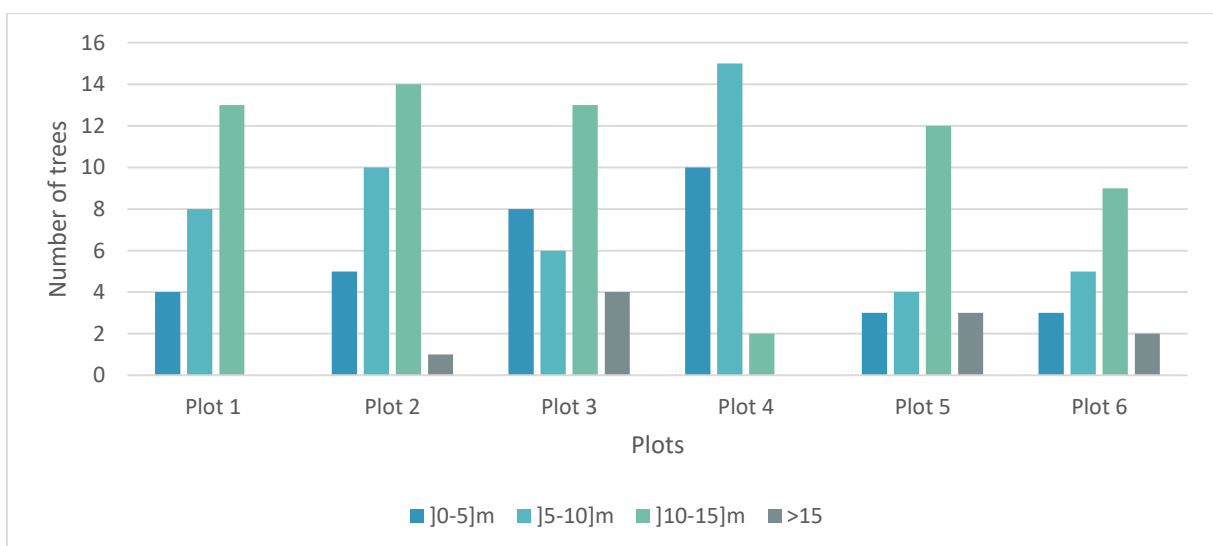

Figure 3: Height structure of cork oak.

The distribution by diameter and height classes shows variations according to altitudes. According to the literature, adaptations to ecological conditions, competition for resources, anthropogenic activities, and exploitation are the basis for this structural variability (Bationo., 2001).

CONCLUSION

This study allowed for the comparison of dendrometric and structural parameters of cork oak in the natural forest of Zouagha. The cork oak's structure and regeneration contribute to a better understanding of its viability in this forest massif. Such a study is a fundamental prerequisite for the development of conservation and sustainable management strategies. The results of this study reveal highly significant variations in dendrometric characteristics. These variations are related to the stand density, ecological conditions, and the intensity of habitat disturbances. This forest is characterized by a cork oak population with a predominance of large-diameter individuals, indicating moderate regeneration of the species. Small-diameter individuals also exist, but these young shoots do not always reach maturity as they are highly vulnerable to anthropogenic activities. Ultimately, this state will serve as a database for monitoring and conserving this species.

REFERENCES

- Acker, S.A., Sabin, T. E., Ganio, L. M., McKee, W. A., 1998. Development of old-growth structure and timber volume growth trends in maturing Douglas-fir stands. *Forest Ecology and Management*. 104: 265-280.
- Anonyme, 11. 2013. Direction Générale des Forêts (DGF). Evaluation économique des biens et services de la forêt tunisienne.
- Bationo, BA, Ouédraogo, SJ, Guinko, S., 2001. Stratégies de régénération naturelle de *Detarium microcarpum* Guill. Et Perr. Dans la forêt classée de Nazinon (Burkina Faso), *Fruits*. 56 : 271-285.
- Damergi, J., 2011. Vulnérabilité de la subéraie tunisienne. *Tunisie news*, le 28/04/2011 : <http://www.tuess.com/fr/lexpert/5505>.
- Delvaux, J., 2012. Différenciation sociale. *Journal de Foresterie, Suisse*. 132: 733-749.
- éen) cultivés en pépinière. *Agriculture and Forestry Journal*. 1(1) : 42-48.
- Gil, L., Varela, M.C., 2009. Euforgen technical guidelines for genetic conservation and use for cork oak (*Quercus suber*). *Biodiversity International*, Rome, Italy. 6p.
- Gourlet-Fleury, S., 1998. Indices de compétition en forêt dense tropicale humide : étude de cas sur le dispositif sylvicole expérimental de Paracou (Guyane française). *Annales des Sciences Forestières*. 55 : 623-654.
- Hamidou, A., Habou, R., Abdoulaye, D., Boube, M., Ali, M., Ronald, B., 2017. Structure démographique et répartition spatiale des populations de *Sclerocarya birrea* (A. Rich.) Hochst du secteur sahélien du Niger. *Population structure and spatial distribution of Sclerocarya birrea*. *Bois et forêts des tropiques*. 333 (3) : 55-65.

- Herrero-Jáuregui, C., García-Fernández, C., Sist, P.L., Casado, M.A. 2012. Recruitment dynamics of two low-density neotropical multiple-use tree species. *Plant Ecology*. 212 (9): 1501-1512.
- Kemadjou M., 2011. Dynamique forestière post-exploitation industrielle : Cas de la forêt dense semi- décidue de Mbalmayo au sud Cameroun. Université de Yaoundé I, p10-13.
- Kotz S., Johnson, N.L., 1970. *Distributions in Statistics: Continuous Univariate Distributions*. John Wiley & Sons, New York.
- Maazou, R., Rabiou, H., Issiaka, Y., Abdou, L., Saidou, S.I., Mahamane A., 2017. Influence de l'occupation des terres sur la dynamique des communautés végétales en zone Sahélienne : cas de la commune rurale de Dantchandou (Niger). *Int. J. Biol. Chem.* 11(1) : 79-92.
- Macarthur R. H., Wilson E. O., 1967. *The theory of island biogeography*. Princeton, NJ, USA, Princeton University Press. 224 p.
- Messaoudene, M., 1989. Étude dendroécologique et productivité de *Q. canariensis* Willd. et de *Q. afares* Pomel dans les massifs de l'Akfadou et de Beni-Ghobri en Algérie. Thèse de doctorat en sciences, université Aix-Marseille III, France. 124p.
- Nasralah, B., 2007. Les champignons et pseudo-champignons pathogènes des plantes cultivées : Biologie, Nouvelle systématique, Interaction Pathologique. Publication de l'INAT. 180 p.
- Natividade, J.V., 1956. *Subericulture*. Edition Ecole Nationale des Eaux et Forêts. Nancy, France, 302 p.
- Pereira, J.S., Bugalho, M.N., Caldeira, M.C., 2008. From the Cork Oak to cork - A sustainable system. APCOR, Portuguese Cork Association, Litografia Coimbra, S.A., 40 p.
- Rached-Kanouni, M., Kara, K., Khammar, H., Ababsa, L., 2020. Floristic diversity and demographic structure of the Sidi Rghies forest, north-eastern of Algeria. *Biodiversitas* 21(3): 1980-1988. doi: 10.13057/biodiv/d21030.
- Sarir, R., Benmahioul B. 2017. Etude comparative de la croissance végétative et du développement de jeunes semis de trois espèces de chênes (chêne vert, chêne liège et chênez.
- Spies, T. A., Franklin J. F. 1991. The structure of natural young, mature, and old-growth Douglas-Fir forests in Oregon and Washington. *Wildlife and Vegetation of Unmanaged Douglas-Fir Forests*. 91-109.

ECOTOXICOLOGICAL RISK ASSESSMENT OF POTENTIALLY TOXIC ELEMENTS IN WATER OF FLUVIAL HABITATS LOCATED IN GELIBOLU PENINSULA (TÜRKIYE)

Cem Tokatlı¹, Memet Varol²

¹Trakya University, Evrenos Gazi Campus, İpsala Vocational School, Department of Laboratory Technology, Edirne / Türkiye

²Malatya Turgut Özal University, Doğanşehir Vahap Küçük Vocational School, Department of Aquaculture, Malatya / Türkiye

Corresponding author e-mail: cemtokatli@trakya.edu.tr

ABSTRACT

Water management, which is a significant global problem, is essential to protect human health and the environment. Potentially toxic elements (PTEs) are among the most hazardous chemical contaminants and amounts of these significant pollutants rises day by day in especially fluvial habitats. The Gelibolu Peninsula that is located in the northwest part of the Anatolia has a great agricultural, industrial and touristic potential. In this research, concentrations of 8 PTEs including arsenic (As), barium (Ba), boron (B), cadmium (Cd), mercury (Hg), nickel (Ni), selenium (Se) and antimony (Sb) were investigated in the water of Munipbey, Bağlar and Kayaaltı Creeks located in the Gelibolu Peninsula of Türkiye. Heavy Metal Pollution Index (HPI) and Heavy Metal Evaluation Index (HEI) were used to evaluate the water qualities in terms of PTEs contamination. According to detected data, the average order of levels of investigated PTEs in water of 3 fluvial ecosystems were as follows: Hg < Sb < Se < Cd < Ni < As < Ba < B. Also, the ecological risk assessment indices showed that all the investigated fluvial ecosystems were unpolluted by toxic metals (<100 for HPI; <10 for HEI).

Keywords: Gelibolu Peninsula, Creeks, Toxic elements, Ecotoxicological risk assessment

INTRODUCTION

Potentially toxic elements (PTEs) are significant pollutants that can be harmful to human health and the environment. They can be found in various sources such as air, water, soil, and food. Exposure to these hazardous chemicals can cause serious health problems such as cancer, neurological disorders, and developmental delays (Arslan et al., 2012; Çiçek et al., 2014; Tokatlı et al., 2020; Köse et al., 2020; Ustaoglu et al., 2022; Varol et al., 2022).

Toxic metal risk assessment indices are used to evaluate the risk of toxic metal contamination in water. Some commonly used indices include the Heavy Metal Pollution Index (HPI) and Heavy Metal Evaluation Index (HEI). These indices are used to assess water quality and determine the potential ecological and human health risks associated with toxic metal contamination (Tokatlı and Varol, 2021; Varol and Tokatlı, 2022; Jannat et al., 2022; Mutlu et al., 2023; Mia et al., 2023; Tokatlı et al., 2023a; 2023b).

The Gelibolu peninsula is located in the southern part of East Thrace, the European part of Türkiye, with the Aegean Sea to the west and the Çanakkale Strait to the east. The region has a significant agricultural and touristic potential. An agriculture-based economy dominates in the

peninsula. Also, as a result of the development of agricultural activities in the region, there are many industrial facilities engaged in agriculture-based production. Fishing activities are also very intense in the region and there are many facilities based on fish canning in the Gelibolu District (Anonymous, 2021; <https://www.gelibolu.bel.tr/>; <http://www.gelibolu.gov.tr/>).

In this research, concentrations of 8 significant PTEs were investigated in the water of Munipbey (GS1), Bağlar (GS2) and Kayaaltı (GS3) Creeks located in the Gelibolu Peninsula of Türkiye and Heavy Metal Pollution Index (HPI) and Heavy Metal Evaluation Index (HEI) were used to evaluate the water qualities in terms of toxic metal contamination.

MATERIALS AND METHODS

Study Area and Collection of Samples

Water samples were collected 0.5 m below the water surface in 1 L pre-cleaned glass bottles in the dry season of 2022 (end of summer) from 3 stations (GS1 – GS3) located on the downstream regions of the Munipbey, Bağlar and Kayaaltı Creeks, which are the main lotic ecosystems of the Gelibolu Peninsula. The map of study area and selected stations are given in Figure 1.



Figure 1. Study area and selected stations

Chemical Analysis

For determination of arsenic (As), barium (Ba), boron (B), cadmium (Cd), mercury (Hg), nickel (Ni), selenium (Se) and antimony (Sb) concentrations in water, water samples of one liter were adjusted to pH 2 by adding 2 ml of HNO₃ into each. Afterwards, all the samples were filtered (cellulose nitrate, 0.45 µm) in such a way as to make their volumes to 50 ml with ultra-pure water. The element levels in water samples were determined by using the "Agilent 7700 xx" branded Inductively Coupled Plasma – Mass Spectrometer (ICP-MS) device in Trakya University Technology Research and Development Application and Research Center (TÜTAGEM). The center has an international accreditation certificate within the scope of TS EN / ISO IEC 17025 issued by TÜRKAK (representative of the World Accreditation Authority in Turkey). The element analyses were recorded as means triplicate measurements (APHA, 1992; EPA, 2001).

Calculation of Risk Assessment Indices

Heavy Metal Pollution Index (HPI) (formulas 1 and 2) (Mohan et al., 1996) and Heavy Metal Evaluation Index (HEI) (formula 3) (Edet and Offiong, 2002) are being calculated according to the following formulas:

$$HPI = \frac{\sum_{i=1}^n W_i Q_i}{\sum_{i=1}^n W_i} \quad (1)$$

$$Q_i = \sum_{i=1}^n \frac{M_i}{S_i} \times 100 \quad (2)$$

$$HEI = \sum_{i=1}^n \frac{H_c}{H_{MAC}} \quad (3)$$

“Q_i” is the sub – index of the toxic element, “W_i” is the unit weight of the *i*th parameter, “M_i” is the monitored values of toxic metals, “S_i” is the standard values of the parameter and *n* is the number of parameters considered (WHO, 2011). Water quality ratings for applied HPI are given in Table 1.

"H_c" is value observed for each parameter and "H_{MAC}" indicates the value of maximum admissible concentration (MAC) for each parameter (WHO, 2011). Water quality ratings for applied HEI are given in Table 1.

Table 1. Water quality ratings for indices

Value	Rating of Water Quality	Usage Possibilities
Heavy metal pollution index (HPI)		
< 100	Low heavy metal contamination	Suitable
> 100	High heavy metal contamination	Not suitable
Heavy Metal Evaluation Index (HEI)		
< 10	Low contamination	Suitable
10 – 20	Medium contamination	Not suitable
> 20	High contamination	Not suitable

RESULTS AND DISCUSSION

In this research, Heavy Metal Pollution Index (HPI) and Heavy Metal Evaluation Index (HEI), which are among of the most widely used toxic metal risk assessment tools, are applied to detected elemental data in order to evaluate the water quality of fluvial ecosystems located in the Gelibolu Peninsula of Türkiye in terms of the contamination of PTEs. The results of accumulation levels of PTEs in water of streams are given in Table 2 and the results of applied toxic metal risk assessment indices are given in Figure 2.

According to detected data, the average order of investigated PTEs in water of 3 fluvial ecosystems were as follows: Hg (0.077 ppb) < Sb (0.139 ppb) < Se (0.155 ppb) < Cd (0.486 ppb) < Ni (0.675 ppb) < As (1.293 ppb) < Ba (45.579 ppb) < B (312.082 ppb). Ecological risk assessment indices showed that all the investigated fluvial ecosystems were unpolluted by heavy metals (<100 for HPI; <10 for HEI). The water qualities of the investigated rivers were determined as follows: GS1 > GS2 > GS3 in terms of HPI; and GS3 > GS1 > GS2 in terms of HEI.

Many touristic facilities are located near the Munipbey Stream downstream region and the detected relatively high HPI values in this location is thought to be due to pollutants originating from touristic activities. It is also thought that the industrial facilities that make production based on agriculture in the Kayaaltı Stream basin and the agricultural practices carried out in the region are the main reasons for the detected relatively high HEI value in this location.

Table 2. Accumulation levels of PTEs in water of investigated streams (ppb)

	B	Ni	As	Se	Cd	Sb	Ba	Hg
GS1	90.081	1.109	0.960	0.247	1.253	0.066	62.108	0.075
GS2	67.747	0.602	2.079	0.219	0.201	0.263	59.963	0.083
GS3	778.418	0.316	0.840	0.000	0.003	0.089	14.668	0.073

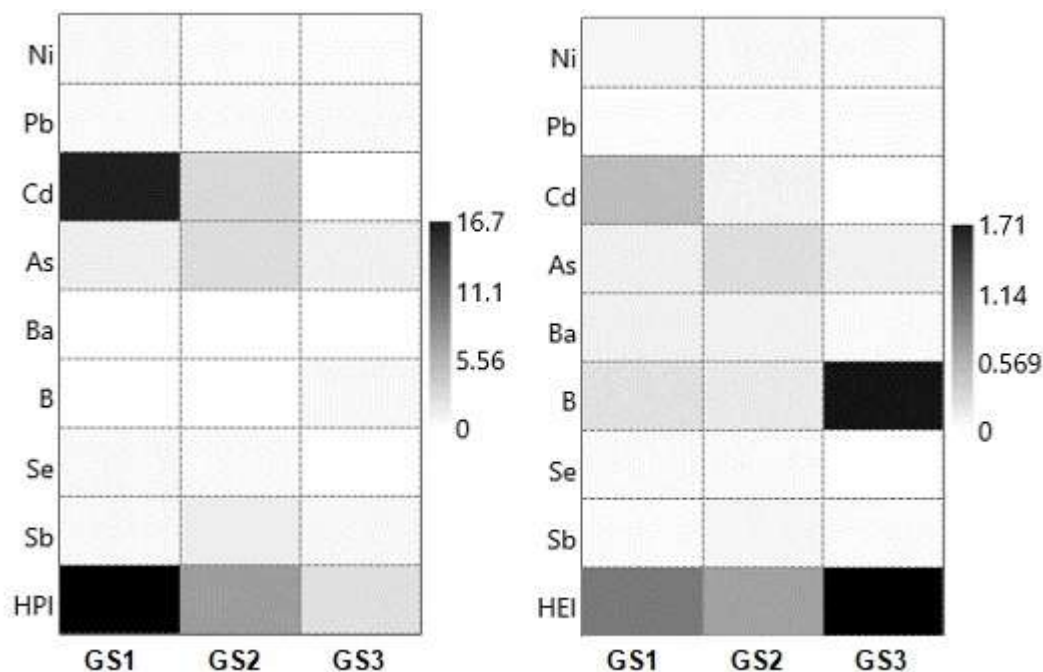

Figure 2. Results of applied HPI (left) and HEI (right)

CONCLUSIONS

In this study, water qualities of the main riverine habitats located in the Gelibolu Peninsula were evaluated in terms of PTEs contamination by using HPI and HEI. According to the results of applied toxic metal risk assessment indices, Munipbey Creek was found as the riskiest habitat among the investigated fluvial ecosystems in terms of applied HPI and Kayaaltı Creek was found as the riskiest habitat among the investigated fluvial ecosystems in terms of applied HEI. The data of the present research also reflects the importance, applicability and necessity of the use of different toxic metal risk assessment indices together on evaluation of surface water ecosystems.

ACKNOWLEDGEMENTS

This research was supported by Trakya University Scientific Research Projects (2022/168).

REFERENCES

- Anonymous, 2021. Çanakkale Provincial Environmental Report for the Year 2021. Republic of Türkiye Çanakkale Governorship Provincial Directorate of Environment, Urbanization and Climate Change.
- APHA (American Public Health Association). 1992. Standard methods for the examination of water and wastewater. In A.E. Greenberg, A.E., Clesceri, L.S. and Eato, A.D. (eds.) American Public Health Association, 18th ed., Washington, U.S.A.
- Arslan, N., Köse, E., Tokatlı, C., Emiroğlu, Ö., Çiçek, A., 2012. Ecotoxicological effects of solid waste storage areas on aquatic systems: example of Yedigöller, Kütahya. *Karaelmas Science and Engineering Journal*, 2 (1): 20-26.
- Çiçek, A., Köse, E., Emiroğlu, Ö., Tokatlı, C., Başkurt, S., Sülün, Ş., 2014. Boron and arsenic levels in water, sediment and tissues of *Carassius gibelio* (Bloch, 1782) in a dam lake. *Polish Journal of Environmental Studies*, 23 (5): 1843-1848.
- Edet, A.E., Offiong, O.E., 2002. Evaluation of Water Quality Pollution Indices for Heavy Metal Contamination Monitoring. A Study Case from Akpabuyo-Odukpani Area, Lower Cross River Basin (Southeastern Nigeria). *GeoJournal*, 57, 295–304.
- Environmental Protection Agency (EPA) METHOD 200.7. 2001. Determination of Metals and Trace Elements in Water and Wastes by Inductively Coupled Plasma-Atomic Emission Spectrometry.
- Jannat, J. N., İslam, K. M. S., İslam, H. M. T., İslam, M. S., Khan, R., Bakar, S. M. A., Varol, M., Tokatlı, C., Chandra, P. S., İslam, A., İdris, A. M., Malafaia, G., Islam, A. R. T., 2022. Hydrochemical assessment of fluoride and nitrate in groundwater from east and west coasts of Bangladesh and India. *Journal of Cleaner Production*, <https://doi.org/10.1016/j.jclepro.2022.133675>.
- <https://www.gelibolu.bel.tr/>
- <http://www.gelibolu.gov.tr/>
- Köse, E., Emiroğlu, Ö., Çiçek, A., Aksu, S., Başkurt, S., Tokatlı, C., Şahin, M., Uğurluoğlu, A., 2020. Assessment of ecologic quality in terms of heavy metal concentrations in sediment and fish on Sakarya River and dam lakes, Turkey. *Soil and Sediment Contamination: An International Journal*, 29:3, 292-303.
- Mia, Y., İslam, A. R. T., Jannat, J. N., Jion, M. M. F., Sarker, A., Tokatlı, C., Siddique, A. B., İbrahim, S. M., Senapathi, V., 2023. Identifying factors affecting irrigation metrics in the Haor Basin using integrated Shannon's Entropy, fuzzy logic and automatic linear model. *Environmental Research*, 226: 115688.

- Mohan, S.V., Nithila, P., Reddy, S.J. 1996. Estimation of Heavy Metal in Drinking Water and Development of Heavy Metal Pollution Index. *Journal of Environmental Science and Health, Part A*, 31 (2), 283–289.
- Mutlu, E., Tokatlı, C., İslam, A. R. T., İslam, S., Muhammad, S., 2023. Water quality assessment of Şehriban Stream (Kastamonu, Türkiye) from a multi-statistical perspective. *International Journal of Environmental Analytical Chemistry*, <https://doi.org/10.1080/03067319.2023.2197114>.
- Tokatlı, C., Köse, E., Çiçek, A., Emiroğlu, Ö., 2020. Pesticide accumulation in Turkey's Meriç River basinwater and sediment. *Polish Journal of Environmental Studies*, 29 (1): 1-6.
- Tokatlı, C., Onur, Ş. G., Dindar, M. B., Malafaia, G., İslam, A. R. T., Muhammad, S., 2023a. Spatial-temporal variability and probabilistic health risk assessment of fluoride from lentic ecosystem, Türkiye. *International Journal of Environmental Analytical Chemistry*, <https://doi.org/10.1080/03067319.2023.2198645>.
- Tokatlı, C., Varol, M., Ustaoglu, F., 2023b. Ecological and health risk assessment and quantitative source apportionment of dissolved metals in ponds used for drinking and irrigation purposes. *Environmental Science and Pollution Research*, <https://doi.org/10.1007/s11356-023-26078-2>.
- Tokatlı, C., Varol, M., 2021. Variations, health risks, pollution status and possible sources of dissolved toxic metal(loid)s in stagnant water bodies located in an intensive agricultural region of Turkey. *Environmental Research*, 201: 111571.
- Ustaoglu, F., İslam, S., Tokatlı, C., 2022. Ecological and probabilistic human health hazard assessment of heavy metal in sera lake nature park sediments (Trabzon, Turkey). *Arabian Journal of Geosciences*, 15: 597.
- Varol, M., Tokatlı, C., 2022. Seasonal variations of toxic metal(loid)s in groundwater collected from an intensive agricultural area in northwestern turkey and associated health risk assessment. *Environmental Research*, 204, Part A: 111922.
- Varol, M., Ustaoglu, F., Tokatlı, C., 2022. Ecological risk assessment of metals in sediments from three stagnant water bodies in northern Turkey. *Current Pollution Reports*, <https://doi.org/10.1007/s40726-022-00239-2>.
- World Health Organization (WHO), 2011. Guidelines for Drinking-water Quality. World Health Organization Library Cataloguing-in-Publication Data, NLM classification: WA 675.

LEVELS OF POTENTIALLY TOXIC ELEMENTS AND ECOTOXICOLOGICAL WATER QUALITY ASSESSMENT OF RIVERINE ECOSYSTEMS IN BIGA PENINSULA, TÜRKIYE

Cem Tokatlı¹, Memet Varol²

¹Trakya University, Evrenos Gazi Campus, İpsala Vocational School, Department of Laboratory Technology, Edirne / Türkiye

²Malatya Turgut Özal University, Doğanşehir Vahap Küçük Vocational School, Department of Aquaculture, Malatya / Türkiye

Corresponding author e-mail: cemtokatli@trakya.edu.tr

ABSTRACT

Contamination of freshwater ecosystems is a significant environmental problem today for the whole world and the levels of potentially toxic elements (PTEs) in especially riverine habitats rises day by day. The Biga Peninsula that is located in the northwest part of the Anatolia has a great agricultural, industrial and touristic potential. In this research, concentrations of 8 PTEs including arsenic (As), barium (Ba), boron (B), cadmium (Cd), mercury (Hg), nickel (Ni), selenium (Se) and antimony (Sb) were investigated in the water of Umurbey, Çanakkale, Kepez, Hamamlık and Küçük Menderes Streams located in the Biga Peninsula of Türkiye. Heavy Metal Pollution Index (HPI) and Heavy Metal Evaluation Index (HEI) were used to evaluate the water qualities in terms of PTEs contamination. According to detected data, the average order of levels of investigated PTEs in water of 5 fluvial ecosystems were as follows: Cd < Hg < Sb < Se < Ni < As < Ba < B. As a result of applied heavy toxic metal risk assessment indices, although significant spatial differences were detected, water of all the investigated lotic habitats were unpolluted by toxic metals (<100 for HPI; <10 for HEI).

Keywords: Biga Peninsula, Fluvial habitats, Potentially toxic elements, Ecotoxicological evaluation

INTRODUCTION

Water pollution that means the contamination of water bodies such as lakes, rivers, oceans, aquifers, and groundwater a global concern today. It occurs when harmful substances such as chemicals contaminate a water habitat, degrading water quality and making it unsafe for human use and aquatic ecosystems and can have serious consequences on human health and the environment (Tokatlı and Varol, 2021; Varol and Tokatlı, 2022; Jannat et al., 2022; Mutlu et al., 2023; Mia et al., 2023; Tokatlı et al., 2023).

Potentially toxic elements (PTEs) are hazardous chemical contaminants that can be harmful to human health and the environment. They can be found in various sources such as air, water, soil, and food. Exposure to these PTEs can cause serious health problems such as cancer, neurological disorders, and developmental delays (Arslan et al., 2012; Çiçek et al., 2014; Tokatlı et al., 2020; Köse et al., 2020; Ustaoglu et al., 2022; Varol et al., 2022).

The Biga Peninsula, which is known as the western extension of Anatolia, is the eastern part of the Anatolian and Rumelian connection divided by the Çanakkale Strait. The region has a significant agricultural, industrial and touristic potential. An agriculture-based economy dominates in the peninsula. Also, as a result of the development of agricultural activities in the

region, there are many industrial facilities engaged in agriculture-based production (Anonymous, 2021; <https://www.biga.bel.tr/>; <http://www.biga.gov.tr/>).

In this research, concentrations of 8 significant PTEs were investigated in the water of Umurbey (BS1), Çanakkale (BS2), Kepez (BS3), Hamamlık (BS4) and Küçük Menderes (BS5) Streams located in the Biga Peninsula of Türkiye and Heavy Metal Pollution Index (HPI) and Heavy Metal Evaluation Index (HEI) were used to evaluate the water qualities in terms of toxic metal contamination.

MATERIALS AND METHODS

Study Area and Collection of Samples

Water samples were collected 0.5 m below the water surface in 1 L pre-cleaned glass bottles in the dry season of 2022 (end of summer) from 5 stations (BS1 – BS5) located on the downstream regions of the Umurbey, Çanakkale, Kepez, Hamamlık and Küçük Menderes Streams, which are the main lotic ecosystems of the Biga Peninsula. The map of study area and selected stations are given in Figure 1.

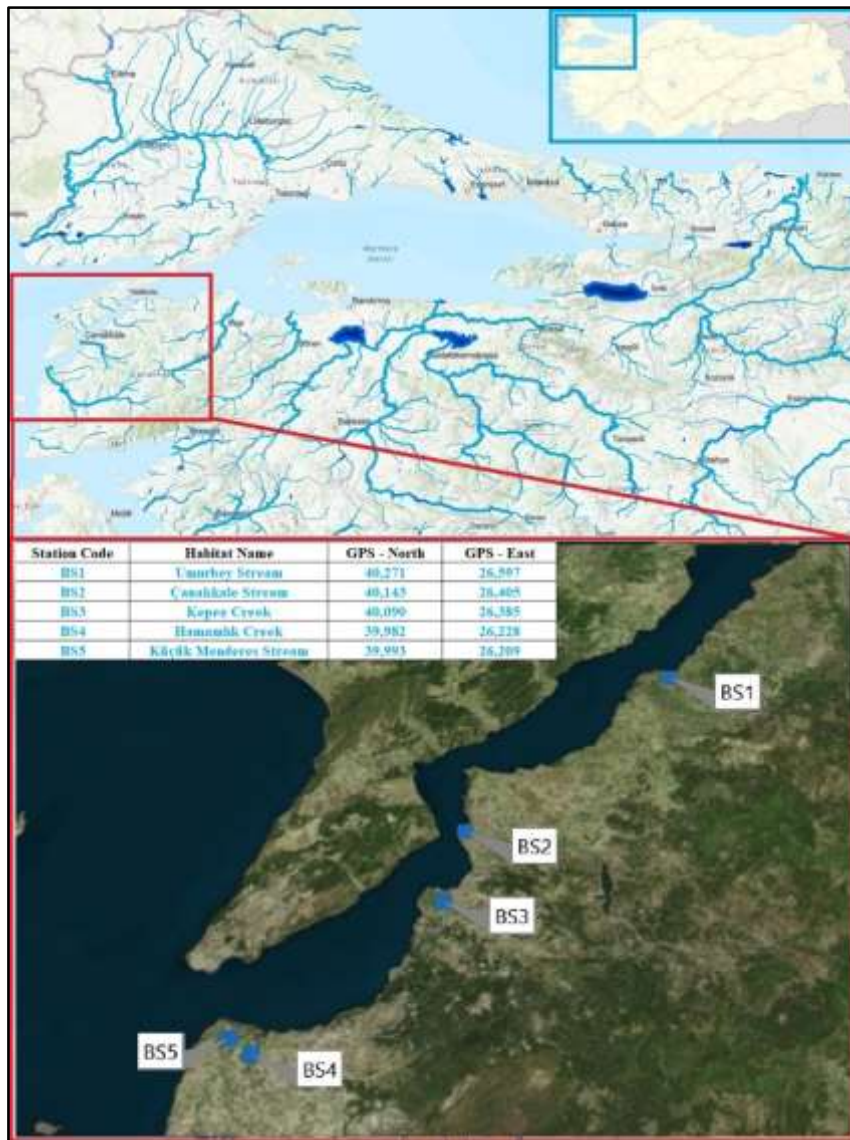

Figure 1. Study area and selected stations

Chemical Analysis

For determination of arsenic (As), barium (Ba), boron (B), cadmium (Cd), mercury (Hg), nickel (Ni), selenium (Se) and antimony (Sb) concentrations in water, water samples of one liter were adjusted to pH 2 by adding 2 ml of HNO₃ into each. Afterwards, all the samples were filtered (cellulose nitrate, 0.45 µm) in such a way as to make their volumes to 50 ml with ultra-pure water. The element levels in water samples were determined by using the "Agilent 7700 xx" branded Inductively Coupled Plasma – Mass Spectrometer (ICP-MS) device in Trakya University Technology Research and Development Application and Research Center (TÜTAGEM). The center has an international accreditation certificate within the scope of TS EN / ISO IEC 17025 issued by TÜRKAK (representative of the World Accreditation Authority in Turkey). The element analyses were recorded as means triplicate measurements (APHA, 1992; EPA, 2001).

Calculation of Risk Assessment Indices

Heavy Metal Pollution Index (HPI) (formulas 1 and 2) (Mohan et al., 1996) and Heavy Metal Evaluation Index (HEI) (formula 3) (Edet and Offiong, 2002) are being calculated according to the following formulas:

$$HPI = \frac{\sum_{i=1}^n W_i Q_i}{\sum_{i=1}^n W_i} \quad (1)$$

$$Q_i = \sum_{i=1}^n \frac{M_i}{S_i} \times 100 \quad (2)$$

$$HEI = \sum_{i=1}^n \frac{H_c}{H_{MAC}} \quad (3)$$

“Qi” is the sub – index of the toxic element, “Wi” is the unit weight of the ith parameter, “Mi” is the monitored values of toxic metals, “Si” is the standard values of the parameter and n is the number of parameters considered (WHO, 2011). Water quality ratings for applied HPI are given in Table 1.

"Hc" is value observed for each parameter and "Hmac" indicates the value of maximum admissible concentration (MAC) for each parameter (WHO, 2011). Water quality ratings for applied HEI are given in Table 1.

Table 1. Water quality ratings for indices

Value	Rating of Water Quality	Usage Possibilities
Heavy metal pollution index (HPI)		
< 100	Low heavy metal contamination	Suitable
> 100	High heavy metal contamination	Not suitable
Heavy Metal Evaluation Index (HEI)		
< 10	Low contamination	Suitable
10 – 20	Medium contamination	Not suitable
> 20	High contamination	Not suitable

RESULTS AND DISCUSSION

In the present research, Heavy Metal Pollution Index (HPI) and Heavy Metal Evaluation Index (HEI), which are among of the most widely used toxic metal risk assessment tools, are applied to detected elemental data in order to evaluate the water quality of fluvial ecosystems located in the Biga Peninsula of Türkiye in terms of the contamination of PTEs. The results of accumulation levels of PTEs in water of streams are given in Table 2 and the results of applied toxic metal risk assessment indices are given in Figure 2.

According to detected data, the average order of investigated PTEs in water of 5 fluvial ecosystems were as follows: Cd (0.010 ppb) < Hg (0.050 ppb) < Sb (0.153 ppb) < Se (0.417 ppb) < Ni (1.419 ppb) < As (8.181 ppb) < Ba (136.744 ppb) < B (223.652 ppb). As a result of applied heavy toxic metal risk assessment indices, although significant spatial differences were detected, water of all the investigated lotic habitats were unpolluted by toxic metals (<100 for HPI; <10 for HEI). The water qualities of the investigated rivers were determined as follows: BS3 > BS5 > BS4 > BS1 > BS2 in terms of HPI and HEI.

Table 2. Accumulation levels of PTEs in water of investigated streams (ppb)

	B	Ni	As	Se	Cd	Sb	Ba	Hg
BS1	87.104	0.431	2.812	0.466	0.049	0.138	79.445	0.046
BS2	656.679	0.398	1.290	0.000	0.000	0.155	17.121	0.072
BS3	286.630	4.423	22.717	1.563	0.001	0.170	416.692	0.050
BS4	30.523	0.981	5.874	0.055	0.000	0.203	74.357	0.054
BS5	57.324	0.863	8.214	0.000	0.000	0.101	96.103	0.029

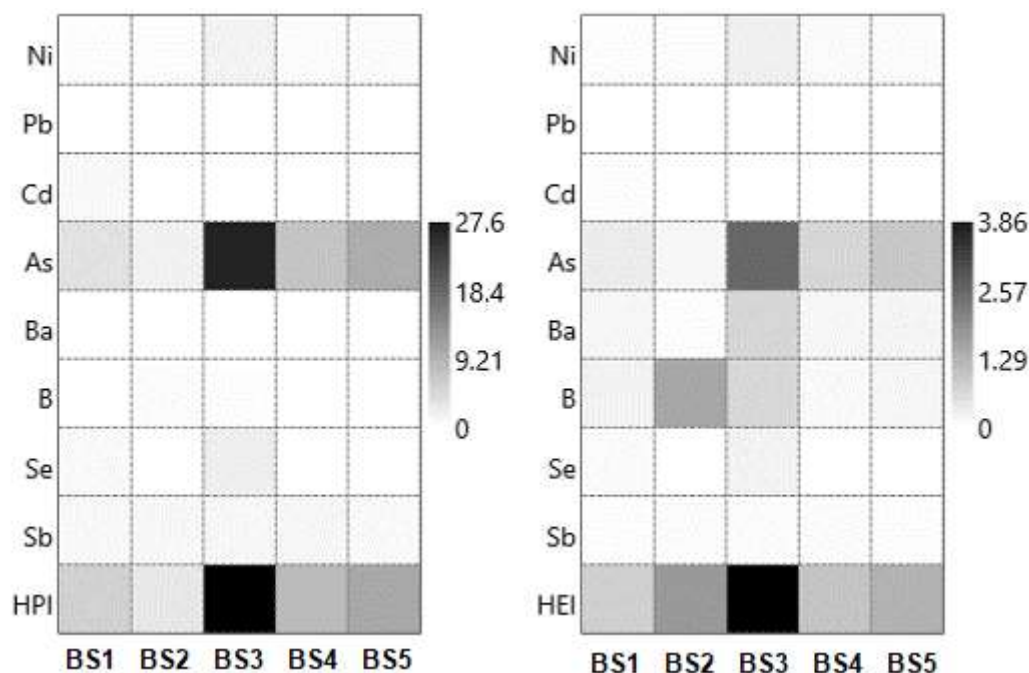

Figure 2. Results of applied HPI (left) and HEI (right)

Kepez Stream that flows into the Çanakkale Strait has a much smaller drainage area and flow compared to the other Çanakkale Strait basin components. Also, it is known that anthropogenically induced pollution in the mouth of Kepez Stream has reached a significant level where urban waste, agricultural activities, maritime traffic and vacation homes put great

pressure on the stream ecosystem. (Enginal et al., 2002; Anonymous, 2021; Çavuş et al., 2023). According to the results of toxic metal risk assessment indices applied in the current research, it was determined that the riskiest river ecosystem is Kepez Stream among the investigated freshwater bodies.

CONCLUSIONS

In this study, water qualities of the main riverine habitats located in the Biga Peninsula were evaluated in terms of PTEs contamination by using HPI and HEI. According to the results of applied toxic metal risk assessment indices, Kepez Stream was found as the riskiest habitat among the investigated fluvial ecosystems, in general. The data of the present research also reflects the importance, applicability and necessity of the use of different toxic metal risk assessment indices together on evaluation of surface water ecosystems.

ACKNOWLEDGEMENTS

This research was supported by Trakya University Scientific Research Projects (2022/168).

REFERENCES

- Anonymous, 2021. Çanakkale Provincial Environmental Report for the Year 2021. Republic of Türkiye Çanakkale Governorship Provincial Directorate of Environment, Urbanization and Climate Change.
- APHA (American Public Health Association). 1992. Standard methods for the examination of water and wastewater. In A.E. Greenberg, A.E., Clesceri, L.S. and Eato, A.D. (eds.) American Public Health Association, 18th ed., Washington, U.S.A.
- Arslan, N., Köse, E., Tokatlı, C., Emiroğlu, Ö., Çiçek, A., 2012. Ecotoxicological effects of solid waste storage areas on aquatic systems: example of Yedigöller, Kütahya. *Karaelmas Science and Engineering Journal*, 2 (1): 20-26.
- Çavuş, H., Kükrer, S., Sağlam, M., Erginal, A. E., 2023. Analysis of Toxic Metal-Induced Ecological Risk in Kepez Stream, Çanakkale. *International Journal of Environment and Geoinformatics*, 10 (2): 24-32.
- Çiçek, A., Köse, E., Emiroğlu, Ö., Tokatlı, C., Başkurt, S., Sülün, Ş., 2014. Boron and arsenic levels in water, sediment and tissues of *Carassius gibelio* (Bloch, 1782) in a dam lake. *Polish Journal of Environmental Studies*, 23 (5): 1843-1848.
- Edet, A.E., Offiong, O.E., 2002. Evaluation of Water Quality Pollution Indices for Heavy Metal Contamination Monitoring. A Study Case from Akpabuyo-Odukpani Area, Lower Cross River Basin (Southeastern Nigeria). *GeoJournal*, 57, 295–304.
- Erginal, A. E., Öztürk, B., Cürebal, İ., 2002. Kepez Deresi havzasının jeomorfolojik özelliklerinin morfometrik açıdan incelenmesi. *Türk Coğrafya Dergisi*, 39, 23-43.
- Environmental Protection Agency (EPA) METHOD 200.7. 2001. Determination of Metals and Trace Elements in Water and Wastes by Inductively Coupled Plasma-Atomic Emission Spectrometry.
- Jannat, J. N., İslam, K. M. S., İslam, H. M. T., İslam, M. S., Khan, R., Bakar, S. M. A., Varol, M., Tokatlı, C., Chandra, P. S., İslam, A., İdris, A. M., Malafaia, G., Islam, A. R. T., 2022. Hydrochemical assessment of fluoride and nitrate in groundwater from east and west coasts of Bangladesh and India. *Journal of Cleaner Production*, <https://doi.org/10.1016/j.jclepro.2022.133675>.

<https://www.bigabel.tr/>

<http://www.bigagov.tr/>

- Köse, E., Emiroğlu, Ö., Çiçek, A., Aksu, S., Başkurt, S., Tokatlı, C., Şahin, M., Uğurluoğlu, A., 2020. Assessment of ecologic quality in terms of heavy metal concentrations in sediment and fish on Sakarya River and dam lakes, Turkey. *Soil and Sediment Contamination: An International Journal*, 29:3, 292-303.
- Mia, Y., İslam, A. R. T., Jannat, J. N., Jion, M. M. F., Sarker, A., Tokatlı, C., Siddique, A. B., İbrahim, S. M., Senapathi, V., 2023. Identifying factors affecting irrigation metrics in the Haor Basin using integrated Shannon's Entropy, fuzzy logic and automatic linear model. *Environmental Research*, 226: 115688.
- Mohan, S.V., Nithila, P., Reddy, S.J. 1996. Estimation of Heavy Metal in Drinking Water and Development of Heavy Metal Pollution Index. *Journal of Environmental Science and Health, Part A*, 31 (2), 283–289.
- Mutlu, E., Tokatlı, C., İslam, A. R. T., İslam, S., Muhammad, S., 2023. Water quality assessment of Şehriban Stream (Kastamonu, Türkiye) from a multi-statistical perspective. *International Journal of Environmental Analytical Chemistry*, <https://doi.org/10.1080/03067319.2023.2197114>.
- Tokatlı, C., Köse, E., Çiçek, A., Emiroğlu, Ö., 2020. Pesticide accumulation in Turkey's Meriç River basin water and sediment. *Polish Journal of Environmental Studies*, 29 (1): 1-6.
- Tokatlı, C., Onur, Ş. G., Dindar, M. B., Malafaia, G., İslam, A. R. T., Muhammad, S., 2023. Spatial-temporal variability and probabilistic health risk assessment of fluoride from lentic ecosystem, Türkiye. *International Journal of Environmental Analytical Chemistry*, <https://doi.org/10.1080/03067319.2023.2198645>.
- Tokatlı, C., Varol, M., 2021. Variations, health risks, pollution status and possible sources of dissolved toxic metal(loid)s in stagnant water bodies located in an intensive agricultural region of Turkey. *Environmental Research*, 201: 111571.
- Ustaoğlu, F., İslam, S., Tokatlı, C., 2022. Ecological and probabilistic human health hazard assessment of heavy metal in sera lake nature park sediments (Trabzon, Turkey). *Arabian Journal of Geosciences*, 15: 597.
- Varol, M., Tokatlı, C., 2022. Seasonal variations of toxic metal(loid)s in groundwater collected from an intensive agricultural area in northwestern turkey and associated health risk assessment. *Environmental Research*, 204, Part A: 111922.
- Varol, M., Ustaoğlu, F., Tokatlı, C., 2022. Ecological risk assessment of metals in sediments from three stagnant water bodies in northern Turkey. *Current Pollution Reports*, <https://doi.org/10.1007/s40726-022-00239-2>.
- World Health Organization (WHO), 2011. Guidelines for Drinking-water Quality. World Health Organization Library Cataloguing-in-Publication Data, NLM classification: WA 675.

TREND ANALYSIS OF PRECIPITATION PARAMETERS IN EDIRNE PROVINCE USING MANN-KENDALL AND SEN'S SLOPE ESTIMATOR TESTS (1982-2021)

Zinnur Yılmaz^{1*}, Mustafa Bünyamin Karagözoğlu²

^{1,2} Sivas Cumhuriyet University, Faculty of Engineering, Department of Environmental Engineering, 58140, SIVAS

* Corresponding Writer E-mail: zinnuryilmaz@cumhuriyet.edu.tr

ABSTRACT

Climate change is currently one of the most prominent and increasingly significant environmental issues on a global scale. In this context, precipitation data is crucial for assessing climate change, as precipitation plays a critical role in influencing the climate system and ecosystems. The quantity, distribution, and characteristics of precipitation are vital for monitoring and understanding climate change processes, such as water cycles, droughts, floods, soil fertility, agriculture, water resources, water management, sea level rise, and ocean currents. This study aimed to establish a comprehensive framework for investigating the variability and trends in daily, seasonal, and annual precipitation using parametric and non-parametric tests. The primary aim was to focus on the analysis of annual precipitation trends in Edirne province, located in the northwestern part of Turkey (Western Thrace), over a period of 40 years (1982-2021) using statistical tools. The study demonstrates the monthly, seasonal, and annual trend models in the temporal precipitation data series, along with the magnitude of the trend slope. This study employed the Mann-Kendall test to determine the temporal trend of precipitation parameters in Edirne, and the Sen's slope estimator test to evaluate the magnitude and significance of the trend in precipitation data. A detailed statistical analysis applied to the precipitation time series for all indicators reveals that precipitation is highly variable over time, and there is an increase in the annual precipitation amount during the studied period. The results revealed a statistically significant increasing trend ($p < 0.05$) in precipitation parameters in Edirne, indicating an annual increase of $0.015 \text{ mm day}^{-1}$. This increase provides essential insights into potential climate change impacts and plays a significant role in updating regional climate models and developing strategies to mitigate climate change. Furthermore, this study opens the possibility for future similar analyses on other climate parameters.

Keywords: Climate Change, Edirne, Mann-Kendall, Precipitation, Trend, Sen's Slope

INTRODUCTION

The trend changes in the climate have been one of the most significant topics in climate research over the past few decades and remain a primary challenge today. Climate change on a global scale does not have the same impact in different regions. Precipitation is a vital meteorological element related to climate change. Global warming and, consequently, changes in annual precipitation have attracted the attention of researchers in various regions around the world. One of the most significant consequences of the defined global warming is the possibility of an increase or decrease in the magnitude and frequency of annual precipitation (Croitoru vd., 2013; Santos & de Morais, 2013). In numerous studies conducted at the local, regional, or global scale, annual precipitation changes have been detected (da Silva vd., 2015; Gocic & Trajkovic, 2013; Hamlaoui-Moulai vd., 2013).

Climate variability is directly related to water resources, which hold significant socioeconomic and environmental importance. To optimize hydraulic structures, understanding

the climatic behavior of the relevant region, which plays a crucial role in water resource management in the short, medium, and long term, is essential. Climate change is a pressing global issue that has far-reaching implications for various aspects of the Earth's systems, including precipitation patterns.

Environmental changes and anthropogenic adverse factors consistently affect the hydro-meteorological process. One of the most significant outcomes of environmental change is the alteration in the quantity, type, spatial, and temporal distribution of precipitation, which is becoming increasingly severe in specific regions worldwide (Ali & Abubaker, 2019; Zamani vd., 2018). Precipitation plays a crucial role in the Earth's water cycle and has significant impacts on ecosystems, agriculture, water resources, and human societies. Precipitation is one of the vital climate factors that can indicate climate change. Changes in precipitation affect hydrological and soil properties. The spatial and temporal variations in precipitation will influence surface runoff, soil moisture, and groundwater reserves. Analyzing precipitation trends is essential for examining the impacts of climate change on water resources planning and management (Mani & Kottiswaran, 2016).

Understanding the relationship between climate change and precipitation is essential for predicting future climate scenarios and developing effective adaptation and mitigation strategies. Researchers have developed some trend analysis calculations to better understand and predict this relationship. Overall, the Mann-Kendall (MK) and Sen's Slope (SS) estimator test is a valuable tool for analyzing the relationship between climate change and precipitation, providing insights into the long-term trends and changes in precipitation patterns.

The adopted procedures for determining the presence of trends are the MK (Mann-Kendall) and SS (Sen's Slope) statistical estimators performed at a 95% confidence level. Precipitation data from month to month has been utilized to process annual and regular time arrangements. Correction in the scope for a periodic arrangement is resolved using a non-parametric technique, SS, and the significance of the factual relevance is disrupted with the MK test (Agarwal vd., 2021).

Trend analysis of precipitation parameters using the MK and SS tests has been widely applied in various studies. The MK test is a nonparametric test suitable for data sets with seasonality, missing values, or values reported as less than a limit (Hirsch vd., 1982). On the other hand, SS estimator is an unbiased estimator of the slope of a linear trend and has higher precision than a regression estimator, especially for skewed data (Amarouche & Akpınar, 2021; Hirsch vd., 1982). In addition to the MK test, SS estimator is often used to quantify the magnitude of the trend in precipitation data. It is an unbiased estimator of the slope of a linear trend and provides a measure of the trend's magnitude (Hirsch vd., 1982).

These tests have been used in studies analyzing precipitation trends in different regions. For example, in the Western Mediterranean, the MK and SS tests were used to assess the increasing trend in storm wave intensity (Amarouche & Akpınar, 2021). In the Jemma sub-basin of the Upper Blue Nile Basin in Ethiopia, the Modified MK trend test, which is essentially developed from the MK trend test, was used to detect the change in precipitation, average temperature, and streamflow (Lebeza vd., 2023). Similarly, in Jagtial District of Telangana State, India, SS was used to detect negative trends in rainfall (Navatha vd., 2021).

This study aims to investigate the trend analysis of precipitation data in Edirne Province, located in the northwestern part of Turkey, from 1982 to 2021. Edirne is situated in the Thrace Region and holds strategic importance as a border province of Turkey. Edirne, a province located in northwestern Turkey, experiences a transitional climate influenced by both the Mediterranean and Black Sea climates. The Mediterranean climate is characterized by hot, dry summers and mild, wet winters (García-García vd., 2022). The Black Sea climate, on the other hand, is characterized by relatively mild summers and cool, wet winters (Lima vd., 2021). The

proximity of Edirne to both the Mediterranean Sea and the Black Sea contributes to the variability in its climate patterns.

The primary objective of this study is to determine the trends in precipitation parameters in Edirne Province from 1982 to 2021, thereby providing valuable insights into the regional climate change processes. The period from 1982 to 2021 was chosen as the analysis period due to the increasing visibility of the effects of climate change during this time frame and the availability of reliable meteorological data from observation stations in Turkey. The trend analysis of monthly average flows is essential for better water resources management and planning. In this regard, non-parametric Mann-Kendall and Sen's methods were used to determine whether there is a positive or negative trend in precipitation data, along with their statistical significances, aiming to assess water resources more effectively. The findings will contribute to the understanding of potential impacts of climate change on water resources, agriculture, ecosystems, and the environment in Edirne Province.

MATERIAL AND METHOD

Study Area

Edirne province is located in northwestern Turkey, bordering Greece and Bulgaria (Figure 1) (Kazel, 2022). A significant portion of the province's territory consists of plains, while the valley of the Maritsa River shapes the region's geographical features. The Thrace Plain stands out as an area where agriculture is concentrated, becoming the center of economic activities (Uncu & Karakoca, 2022).

Edirne province is situated in a temperate climate zone (Koçman, 1993). It exhibits a climate pattern shaped by the humid influence from the Black Sea and the warm-dry influence from the Aegean Sea. Winters tend to be mild, while summers can follow a hot and arid course. These climatic characteristics hold significance in terms of agricultural activities and the management of water resources (Trakya Kalkınma Ajansı, t.y.).

The population of Edirne province has been shaped by geographical and economic factors. As of the year 2022, it has an approximate population of 414,714. Population density is generally higher in central areas and regions close to agricultural areas (TUİK, 2022). The city center is one of the regions where the population is concentrated, owing to its economic and social opportunities.

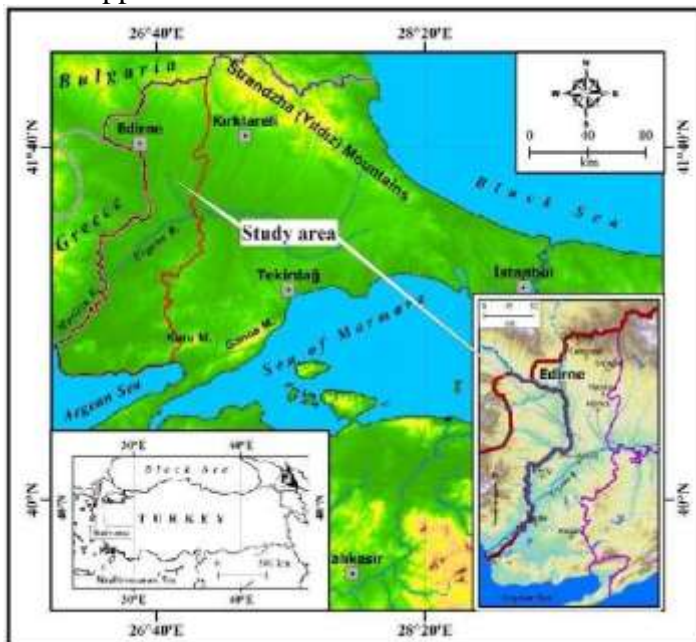

Figure 1. Location Map of Edirne Province (Özşahin & Eroğlu, 2017)

Data Collection

Meteorological data used in this study were obtained from NASA POWER site for Edirne Province (NASA, 2023). The primary variables of interest were precipitation records spanning the period from 1982 to 2021.

Data quality checks were performed to ensure the accuracy and consistency of the precipitation records. Any missing or inconsistent data points were appropriately addressed, and a high level of data completeness was maintained to enhance the reliability of the analysis.

In this study, four seasons were defined as follows: spring (March to May), summer (June to August), autumn (September to November) and winter (December to February).

Methodology

To determine the trends in temperature and precipitation during the period of 1982-2021, two popular trend analysis methods, SS estimator analysis, and the MK test were used. Additionally, to strengthen the results obtained from the MK and SS analyses conducted in the study area, they were compared with the values from Theil-Sen analysis and Kendall Tau correlation analysis.

Mann-Kendall Test

The MK test is a non-parametric statistical test used to assess trends in data based on their relative rankings within a given time range. One of the main advantages of this test is that it does not require the data to meet normality assumptions. It is particularly useful when dealing with data that may not follow a normal distribution or when the sample size is small. The test is robust and widely used for trend analysis in various fields (Sa'adi vd., 2019). The MK test is a widely used statistical method for trend analysis in precipitation data (Doukoro vd., 2022; Hirsch vd., 1982; Khatiwada & Curtis, 2021; Repel vd., 2021). In this analysis, the MK test was applied to identify significant trends in precipitation parameters over the study period. The test works by comparing the ranks of the data points in the time series to assess whether there is a systematic upward or downward trend. The significance of the trend is evaluated based on the computed test statistic and its associated p-value. The mathematical calculation of the MK test is as follows:

$$S = \sum_{i=1}^{n-1} \sum_{j=i+1}^n \text{sgn}(x_j - x_i) \tag{1}$$

where n represent the total count of data points, where x_i and x_j denote data values in time series i and j (where $j>i$), respectively. Additionally, $\text{sgn}(x_j-x_i)$ refers to the sign function defined as follows:

$$\text{sgn}(x_j - x_i) \begin{cases} +1, & \text{if } x_j - x_i > 0 \\ 0, & \text{if } x_j - x_i = 0 \\ -1, & \text{if } x_j - x_i < 0 \end{cases} \tag{2}$$

The MK test is applicable to time series of elements x_i taken from $i=1,2,\dots,n-1$, and elements x_j taken from classes $j=i+1,2,\dots,n$ in such a manner that...

The variance is calculated as:

$$\text{Var}(S) = \frac{n(n-1)(2n+5) - \sum_{i=1}^m t_i(t_i-1)(2t_i+5)}{18} \tag{3}$$

where n represents the total count of data points, m represents the number of connected groups, and t_i indicates the number of connections within group i. For situations where the sample size exceeds 10 ($n>10$), the standard normal test statistic is computed using the ZS Equation (4):

$$Z_S \begin{cases} \frac{S-1}{\sqrt{\text{Var}(S)}}, & \text{if } S > 0 \\ 0, & \text{if } S = 0 \\ \frac{S-1}{\sqrt{\text{Var}(S)}}, & \text{if } S < 0 \end{cases} \quad (4)$$

When Z_S has a positive value, it signifies increasing trends, whereas a negative Z_S value indicates decreasing trends. To assess the trends, a specific level of α significance is employed. The p-value (probability) is used to evaluate the statistical significance and the level of evidence for any difference (Dawson & Trapp, 2004). The MK analysis examines k years of precipitation data for a particular location to determine if there is a trend between years.

The analysis was indeed conducted at the $\alpha=0.05$ significance level, implying that trends with p-values less than 0.05 were considered statistically significant ($|Z_S|>1.96$). Consequently, it indicates that there was a significant trend among precipitation data across the years.

Sen's Slope Estimator Test

While the MK test is effective in detecting linear trends, it may not capture non-linear trends that could be present in the precipitation data. To address this limitation, SS Estimator test was employed in this study. SS test provides a robust and flexible approach for estimating the magnitude and direction of trends, even when non-linear trends are present. The combination of SS test with other statistical methods, such as the MK trend test, provides a comprehensive approach to trend analysis in climate data (Dwevedi vd., 2022; Jiqin vd., 2023; Toma vd., 2022). These tests help researchers identify and quantify long-term trends, detect changes in trends over time, and assess the significance of these trends. The SS Estimator calculates the median of all possible slopes between data points, providing a resistant estimator that is less influenced by outliers (Sen, 1968).

The equation for SS concerning a set of N data sample pairs can be expressed in the following manner:

$$Q_i = \frac{X_j - X_k}{j - k} \quad (5)$$

Considering X_j and X_k as the data values at times j and k (where $j > k$) respectively, if there is only one data point per time period, the total number of data sample pairs N can be computed using $N = n(n - 1)/2$, where n is the number of time periods. However, if there are multiple observations in one or more time periods, N is less than $n(n - 1)/2$. The values of Q_i are arranged in ascending order, and the average of the n values or the slope of SS estimator is subsequently determined as follows:

$$Q_{med} = \begin{cases} Q_{[(n+1)/2]}, & \text{if } n \text{ is odd} \\ \frac{Q_{[\frac{n}{2}]} + Q_{[\frac{n+2}{2}]}}{2}, & \text{if } n \text{ is even} \end{cases} \quad (6)$$

The symbol Q_{med} captures the data trend, while its value signifies the steepness of the trend. In order to assess whether the median slope significantly deviates from zero, it is necessary to compute a confidence interval for Q_{med} with a predetermined probability. The confidence interval for the time slope can be determined using the following method (Gilbert, 1987):

$$C_\alpha = Z_{1-\alpha/2} \sqrt{\text{Var}(S)} \quad (7)$$

In this context, $\text{Var}(S)$ is defined as specified in Equation (3), and $Z_{1-\alpha/2}$ is obtained from the standard normal distribution table. Next, two values are computed, $M1=(N-C_\alpha)/2$ and

$M2=(N+C\alpha)/2$, where N is the total number of slope estimates Q_i . To determine the lower and upper limits of the confidence interval, denoted as Q_{min} and Q_{max} , respectively, we look for the $M1$ -th largest and $(M2+1)$ -th largest slope estimates among the N ordered slope estimates Q_i . If $M1$ is not an integer, the lower limit Q_{min} is interpolated accordingly. Similarly, if $M2$ is not an integer, the upper limit Q_{max} is interpolated. This process ensures that we obtain a reliable confidence interval for the time slope estimate.

Creating Theil-Sen graphs allowed for observing how the data changed over the years, and the regression r^2 values were determined to assess the strength of the trends. The Theil-Sen graph is a powerful graphical representation of the Theil-Sen estimator, a nonparametric method used to estimate the slope of a trend line in a dataset. This approach is widely employed in trend analysis to identify and quantify trends across various domains, including climate change research. The Theil-Sen estimator calculates the median of all possible pairwise slopes between data points, making it a robust measure that is less affected by outliers compared to other methods. Its usage in assessing the direction and magnitude of trends in climate variables provides valuable insights into the long-term changes in these variables (Ikiel, 2022). Overall, the Theil-Sen graph serves as a valuable tool for trend analysis in climate change research and other relevant fields, enabling researchers to gain a deeper understanding of trends and variations in the data over time. It contributes to a more comprehensive and accurate assessment of how various factors evolve and impact our environment.

The combination of both the MK and SS tests allows for a comprehensive assessment of the temporal trends in precipitation parameters, enabling a more robust analysis of the climate trends in Edirne Province.

RESULTS AND DISCUSSION

The statistical analysis results of precipitation data for the period 1982 - 2021 are discussed in this section, as presented in Table 1. Table 1 also displays the magnitudes of the annual precipitation models obtained from the Mann-Kendall test and Sen's slope estimator analyses. The 40-year average monthly precipitation amount for Edirne, obtained from NASA POWER, ranges from 0.620 to 2.274 mm/day. The daily average precipitation amount analysis revealed that the highest rainfall occurred during the Winter season in the year 2021 (4.96 mm/day), whereas the lowest rainfall was recorded during the Summer season in the year 2012 (0.16 mm/day). The highest monthly precipitation occurs in December (2.274 mm day⁻¹ (95% CI: 1.740-2.484 mm day⁻¹)), followed by November (2.112 mm day⁻¹ (95% CI: 1.740-2.484 mm day⁻¹)) and January (1.907 mm day⁻¹ (95% CI: 1.436-2.378 mm day⁻¹)). On the other hand, the lowest monthly precipitation is observed in August (0.620 mm day⁻¹ (95% CI: 0.482-0.758 mm day⁻¹)), followed by July (1.002 mm day⁻¹ (95% CI: 0.754-1.249 mm day⁻¹)) and September (1.157 002 mm day⁻¹ (95% CI: 0.818-1.497 mm day⁻¹)). Positive trend values indicate an increasing trend in the annual precipitation amount. On the other hand, a decrease in precipitation amounts suggests that the respective locations will become drier in the future for the given time unit. According to MK Test results of precipitation data for Edirne province, there is a statistically significant trend at 95% significance level in January and October and annual average data, and this trend has been determined to increase ($p_{value}<0.05$). In addition, it has been calculated that there is a statistically significant trend at the 95% significance level in the winter season, and this trend is also in the direction of increase ($p_{value}<0.05$). No trend could be detected at the 95% significance level in the time units other than these months and seasons ($p>0.05$). According to the SS analysis based on the precipitation data in Edirne Province, the highest increase by years was observed in January with 0.065 mm/day and in October with 0.047 mm/day. On the other hand, the most significant decrease was found in November with -0.018 mm/day and in August with -0.006 mm/day.

In this study, Kendall Tau correlation coefficients were calculated in order to examine the relationships between precipitation data for each month and the corresponding years in Edirne Province. The analysis revealed varying degrees of correlation between annual precipitation and calendar months. When the SS slope estimator and Kendall Tau values listed in Table 1, along with the Mann Kendall ZS values found in Figure 1, are positive, they indicate that the data exhibits an increasing trend on a monthly basis. Conversely, negative values suggest a decreasing trend. A low positive correlation (Kendall Tau = 0.357) was observed for January with the highest correlation coefficient, indicating a slight upward trend in precipitation over the years during this month. Similarly, October showed a low positive correlation (Kendall Tau = 0.329), indicating a slight upward trend in precipitation. Conversely, November and August showed low negative correlations (Kendall Tau = -0.130 and -0.089, respectively), indicating a minor declining trend in precipitation for these months. The remaining months showed either very low or low positive correlations, implying limited or minimal changes in precipitation patterns over the years. Overall, the Kendall Tau analysis provides valuable insights into the temporal variations in monthly precipitation, allowing for a comprehensive assessment of the climate trends in the region (Table 1).

Table 1. Results of statistical and trend analysis of precipitation data of Edirne province

Month	Mean Precipitation (mm day ⁻¹)	95% CI (mm day ⁻¹)		MK p value	SS	Kendall Tau	Trend	Direction of increase/decrease
		Lower Bound	Upper Bound					
Jan	1.907	1.436	2.378	0.001*	0.065	0.357	YES	+
Feb	1.755	1.356	2.154	0.159	0.020	0.157	NO	+
Mar	1.581	1.237	1.925	0.608	0.005	0.058	NO	+
Apr	1.426	1.205	1.646	0.641	0.004	0.053	NO	+
May	1.550	1.262	1.838	0.091	0.017	0.187	NO	+
Jun	1.513	1.216	1.806	0.395	0.016	0.095	NO	+
Jul	1.002	0.754	1.249	0.807	0.003	0.028	NO	+
Aug	0.620	0.482	0.758	0.428	-0.006	-0.089	NO	-
Sep	1.157	0.818	1.497	0.145	0.014	0.162	NO	+
Oct	1.702	1.346	2.058	0.003*	0.047	0.329	YES	+
Nov	2.112	1.740	2.484	0.244	-0.018	-0.130	NO	-
Dec	2.274	1.850	2.698	0.334	0.018	0.108	NO	+
Ann	1.548	1.429	1.666	0.001*	0.015	0.356	YES	+
Win	1.979	1.704	2.252	0.003*	0.029	0.323	YES	+
Spr	1.519	1.389	1.648	0.098	0.010	0.183	NO	+
Sum	1.045	0.892	1.199	0.284	0.007	0.117	NO	+
Aut	1.657	1.451	1.864	0.081	0.016	0.190	NO	+

CI: confidence interval for the mean at the significance level. * p<0.05

Moving z values calculated in MK test according to precipitation data in Edirne province are shown in Figure 2. The dashed lines in this figure represent z-values at the ±95% (1.96) significance level for significant decreasing/ascending trends. Moving z-values vary in all months. There is a significant upward trend ($z \geq 1.96$ and $P < 0.05$) in January and October. Although there was an increase and decrease in the other months, no trend was found at the 95% significance level ($p > 0.05$).

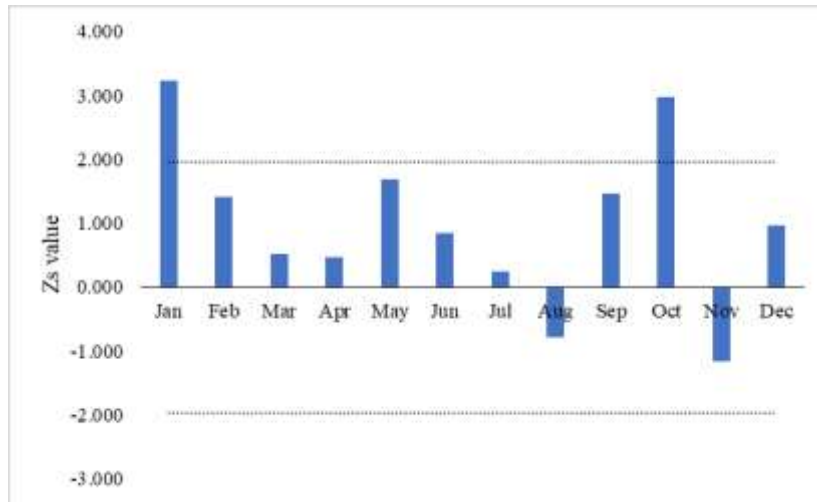

Figure 2. Moving z values of precipitation data in Edirne province

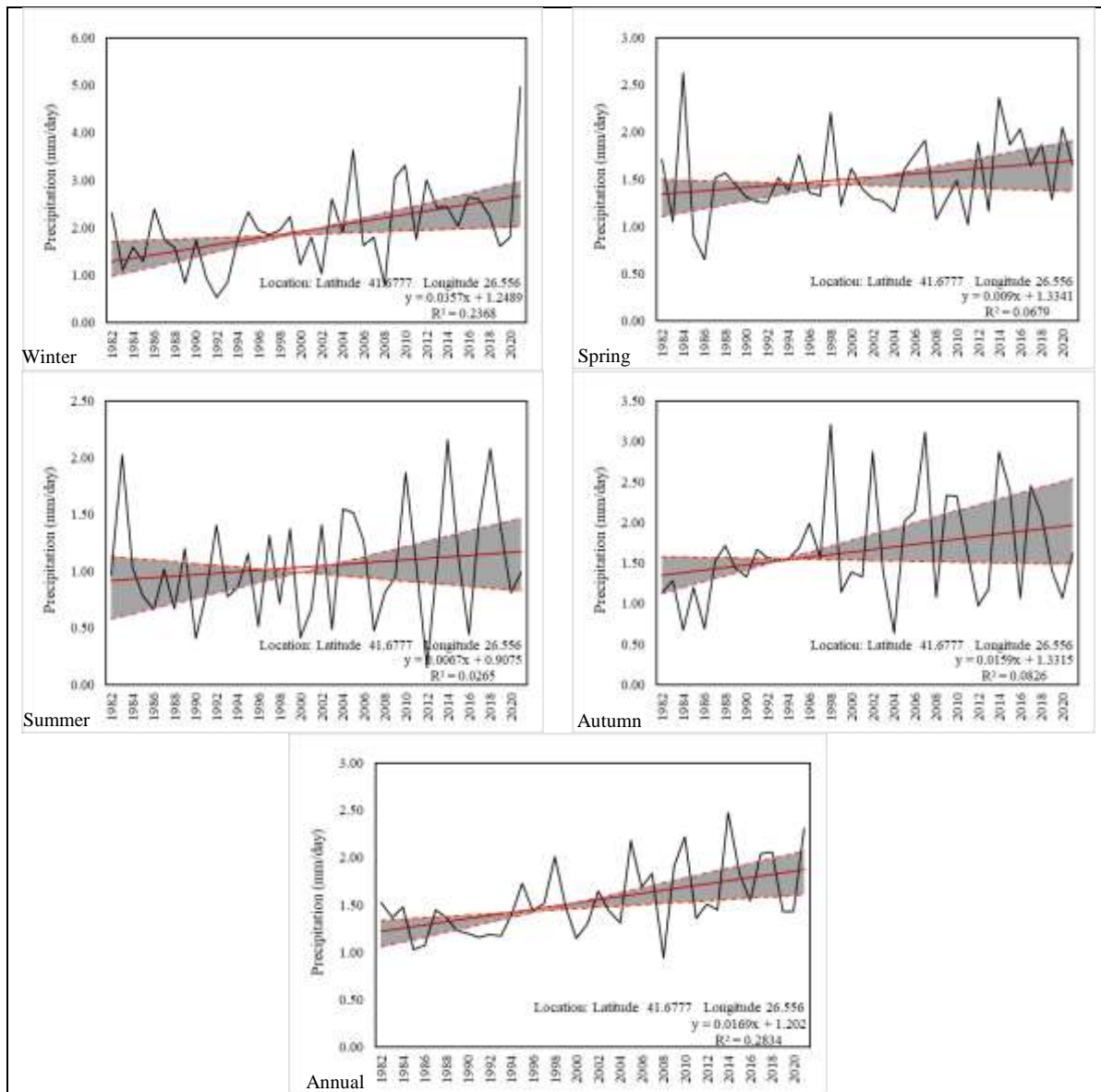

Figure 3. Theil-Sen graph of the changes in precipitation data of Edirne province according to years

As a result of Theil-Sen trend analysis, the graph presented in Figure 3, which facilitates the analysis of monthly data, shows the red straight lines representing the average precipitation predictions for the 40-year period, while the dashed red lines indicate the 95% confidence intervals for the predicted values. Additionally, the graphs provide the R^2 values, which represent the relationship between the precipitation amounts and the regression equation for each year. According to this graph, the highest positive correlation between precipitation amounts and years was found in the annual and winter season data. From this figure, the analysis of the slope of linear regression was positive, with values of 0.0357, 0.009, 0.0067, and 0.0159 mm/day for the Winter, Spring, Summer, and Autumn seasons, respectively. The linear regression trend test results were nearly similar to the monthly precipitation trends found by the Mann-Kendall test and Sen's slope estimator. Based on Theil-Sen trend analysis, if no different parameters are introduced into the system, and if this trend continues as observed, it is projected that by the year 2030 in Edirne, the average annual precipitation will exhibit an increasing tendency in the range of 1.671 to 2.305 mm day⁻¹. For the winter season, this rate is estimated to be in the range of 2.062 to 3.427 mm day⁻¹.

CONCLUSIONS

In this study, monthly, annual, and seasonal average precipitation, based on precipitation data, have been analyzed for the period between 1982 and 2021 in Edirne province. Two types of trend analysis, MK and SS, were used in the study. When the precipitation data of Edirne province are examined, the average for the first 30 years (1982-2011) is 1.461 mm day⁻¹, while the average for the last 10 years (2012-2021) is calculated as 1.808 mm day⁻¹. In other words, it was determined that the amount of precipitation in the last 10 years increased by 25.75% compared to the first 30 years. When the monthly precipitation pattern is examined, it has been determined that January has the highest tendency to increase in precipitation, while November has the highest decrease in precipitation, but there is no trend. In addition, when the precipitation trend in the seasons is examined, it is concluded that there is an increase in the winter season only in the winter season and there is an increase in terms of precipitation in other seasons, but the trend cannot be determined.

The results obtained in this study are promising and can assist engineers in designing water resource structures and decision-makers in the agricultural sector in Edirne. Given the significant impact of climate variability, especially precipitation variability, and the fact that rainfall is a key driving force for agricultural growth in the examined region, accurately determining precipitation trends across the region can create awareness among various sectors (such as agriculture and industry) directly affecting the country's economic growth and help mitigate the risks these sectors face.

Therefore, relevant stakeholders should consider precipitation variability, and overall temperature variability in particular, in their climate change adaptation strategies, and the implementation of precise and innovative policies and programs appears to be necessary. Despite the significant positive trend indicating an increasing tendency in rainfall, it is urgently essential to transform available water resources into additional storage structures to meet the challenges of water scarcity. A better understanding of changing precipitation patterns will contribute to enhanced water management strategies for agricultural production, irrigation, industrial, and domestic uses, and will also aid in better designing and managing irrigation infrastructure, flood and drought management planning.

Overall, the study underscores the need for urgent actions to cope with water scarcity challenges and highlights the importance of converting available water resources into more storage facilities. Improved understanding of changing rainfall patterns will facilitate the development of advanced water management strategies for agricultural production, irrigation,

industrial, and domestic usage, as well as more effective planning and management of irrigation infrastructure, flood, and drought management.

REFERENCES

- Agarwal, S., Suchithra, A. S., & Gurjar, S. P. (2021). Analysis and Interpretation of Rainfall Trend using Mann- Kendall's and Sen's Slope Method. *Indian Journal of Ecology*, 48, 453-457.
- Ali, R., & Abubaker, S. (2019). *Trend analysis using mann-kendall, sen's slope estimator test and innovative trend analysis method in Yangtze river basin, china: Review*. <https://doi.org/10.14419/ijet.v7i4.29591>
- Amarouche, K., & Akpınar, A. (2021). Increasing Trend on Storm Wave Intensity in the Western Mediterranean. *Climate*, 9(1), Article 1. <https://doi.org/10.3390/cli9010011>
- Croitoru, A.-E., Chiotoroiu, B.-C., Ivanova Todorova, V., & Torică, V. (2013). Changes in precipitation extremes on the Black Sea Western Coast. *Global and Planetary Change*, 102, 10-19. <https://doi.org/10.1016/j.gloplacha.2013.01.004>
- da Silva, R. M., Santos, C. A. G., Moreira, M., Corte-Real, J., Silva, V. C. L., & Medeiros, I. C. (2015). Rainfall and river flow trends using Mann–Kendall and Sen's slope estimator statistical tests in the Cobres River basin. *Natural Hazards*, 77(2), 1205-1221. <https://doi.org/10.1007/s11069-015-1644-7>
- Dawson, B., & Trapp, R. G. (2004). *Basic & Clinical Biostatistics*. McGraw Hill Professional.
- Doukoro, D., Abbey, G. A., & Kalifa, T. (2022). Drought Monitoring and Assessment of Climate Parameters Variability in Koutiala and San Districts, Mali. *American Journal of Climate Change*, 11(3), Article 3. <https://doi.org/10.4236/ajcc.2022.113011>
- Dwevedi, R., Gupta, R., & Sethy, J. (2022). A comparative study of regional climate trends in the Keoladeo and Bhitarkanika wetlands, India. *Journal of Applied and Natural Science*, 14(2), Article 2. <https://doi.org/10.31018/jans.v14i2.3381>
- García-García, D., Vigo, M. I., Trottini, M., Vargas-Alemañy, J. A., & Sayol, J.-M. (2022). Hydrological cycle of the Mediterranean-Black Sea system. *Climate Dynamics*, 59(7), 1919-1938. <https://doi.org/10.1007/s00382-022-06188-2>
- Gilbert, R. O. (1987). *Statistical Methods for Environmental Pollution Monitoring*. John Wiley & Sons.
- Gocic, M., & Trajkovic, S. (2013). Analysis of changes in meteorological variables using Mann-Kendall and Sen's slope estimator statistical tests in Serbia. *Global and Planetary Change*, 100, 172-182. <https://doi.org/10.1016/j.gloplacha.2012.10.014>
- Hamlaoui-Moulai, L., Mesbah, M., Souag-Gamane, D., & Medjerab, A. (2013). Detecting hydro-climatic change using spatiotemporal analysis of rainfall time series in Western Algeria. *Natural Hazards*, 65(3), 1293-1311. <https://doi.org/10.1007/s11069-012-0411-2>
- Hirsch, R. M., Slack, J. R., & Smith, R. A. (1982). Techniques of trend analysis for monthly water quality data. *Water Resources Research*, 18(1), 107-121. <https://doi.org/10.1029/WR018i001p00107>

- Ikiel, C. (2022). Erosion risk analysis in Sapanca Lake Basin: Sapanca Gölü Havzası'nda erozyon risk analizi. *Journal of Human Sciences*, 19(4), 625-640. <https://doi.org/10.14687/jhs.v19i4.6340>
- Jiqin, H., Gelata, F. T., & Chaka Gameda, S. (2023). Application of MK trend and test of Sen's slope estimator to measure impact of climate change on the adoption of conservation agriculture in Ethiopia. *Journal of Water and Climate Change*, 14(3), 977-988. <https://doi.org/10.2166/wcc.2023.508>
- Kazel, E. (2022). Türkiye'nin Siyasi Sınırları ve Uluslararası Sınır Değeri Açısından Edirne'nin Önemi. İçinde *Edirne İlinin Coğrafyası* (ss. 1-22). Türk Coğrafya Kurumu. <https://www.tck.org.tr/publics/1673564920.pdf>
- Khatiwada, M., & Curtis, S. (2021). Precipitation Trends in the Ganges-Brahmaputra-Meghna River Basin, South Asia: Inconsistency in Satellite-Based Products. *Atmosphere*, 12(9), Article 9. <https://doi.org/10.3390/atmos12091155>
- Koçman, A. (1993). *Türkiye iklimi*. Ege Üniversitesi Edebiyat Fakültesi, Coğrafya Bölümü.
- Lebeza, T. M., Gashaw, T., Tefera, G. W., & Mohammed, J. A. (2023). Trend analysis of hydro-climate variables in the Jemma sub-basin of Upper Blue Nile (Abbay) Basin, Ethiopia. *SN Applied Sciences*, 5(5), 129. <https://doi.org/10.1007/s42452-023-05345-4>
- Lima, L., Ciliberti, S. A., Aydoğdu, A., Masina, S., Escudier, R., Cipollone, A., Azevedo, D., Causio, S., Peneva, E., Lecci, R., Clementi, E., Jansen, E., Ilicak, M., Creti, S., Stefanizzi, L., Palermo, F., & Coppini, G. (2021). Climate Signals in the Black Sea From a Multidecadal Eddy-Resolving Reanalysis. *Frontiers in Marine Science*, 8. <https://www.frontiersin.org/articles/10.3389/fmars.2021.710973>
- Mani, T., & Kottiswaran, S. (2016). *Analysis Of Rainfall Trend Using Mann-Kendall Test And The Sen's Slope Estimator In Udumalpet Of Tirupur District In Tamil Nadu*.
- NASA Langley Research Center. (t.y.). *Prediction Of Worldwide Energy Resource (POWER) Project: Monthly 2.0.0 version [Data set]*. NASA Power. Geliş tarihi 18 Haziran 2023, gönderen <https://power.larc.nasa.gov/>
- Navatha, N., Sreenivas, G., & Umareddy, R. (2021). Rainfall and Temperature Trends in Jagtial District of Telangana State. *International Journal of Environment and Climate Change*, 47-59. <https://doi.org/10.9734/ijecc/2021/v11i1130515>
- Özşahin, E., & Eroğlu, İ. (2017). *Spatiotemporal change of land use in the Edirne Province (NW Turkey)*.
- Repel, A., Zelenáková, M., Jothiprakash, V., Hlavatá, H., Blišťan, P., Gargar, I., & Purcz, P. (2021). Long-Term Analysis of Precipitation in Slovakia. *Water*, 13(7), Article 7. <https://doi.org/10.3390/w13070952>
- Sa'adi, Z., Shahid, S., Ismail, T., Chung, E.-S., & Wang, X.-J. (2019). Trends analysis of rainfall and rainfall extremes in Sarawak, Malaysia using modified Mann-Kendall test. *Meteorology and Atmospheric Physics*, 131(3), 263-277. <https://doi.org/10.1007/s00703-017-0564-3>
- Santos, C. A. G., & de Morais, B. S. (2013). Identification of precipitation zones within São Francisco River basin (Brazil) by global wavelet power spectra. *Hydrological Sciences Journal*, 58(4), 789-796. <https://doi.org/10.1080/02626667.2013.778412>

- Sen, P. K. (1968). Estimates of the Regression Coefficient Based on Kendall's Tau. *Journal of the American Statistical Association*, 63(324), 1379-1389. <https://doi.org/10.2307/2285891>
- Toma, M. B., Belete, M. D., & Ulsido, M. D. (2022). Trends in climatic and hydrological parameters in the Ajora-Woybo watershed, Omo-Gibe River basin, Ethiopia. *SN Applied Sciences*, 5(1), 45. <https://doi.org/10.1007/s42452-022-05270-y>
- Trakya Kalkınma Ajansı. (t.y.). *Trakya Bölgesi Turizm Master Planı Mevcut Durum Raporu*. Geliş tarihi 31 Ağustos 2023, gönderen <https://www.kalkinmakutuphanesi.gov.tr/dokuman/trakya-bolgesi-turizm-master-plani-mevcut-durum-raporu/978>
- TUİK. (2022). *Adrese Dayalı Nüfus Kayıt İstatistikleri*. <https://data.tuik.gov.tr/Kategori/GetKategori?p=Nufus-ve-Demografi-109>
- Uncu, L., & Karakoca, E. (2022). Edirne İli'nin Konumu, Jeolojisi ve Jeomorfolojisi. İçinde *Edirne İlinin Coğrafyası* (ss. 23-45). Türk Coğrafya Kurumu. <https://www.tck.org.tr/publics/1673564920.pdf>
- Zamani, R., Mirabbasi, R., Nazeri, M., Meshram, S. G., & Ahmadi, F. (2018). Spatio-temporal analysis of daily, seasonal and annual precipitation concentration in Jharkhand state, India. *Stochastic Environmental Research and Risk Assessment*, 32(4), 1085-1097. <https://doi.org/10.1007/s00477-017-1447-3>

ADAPTATION OF GREEN OAK TO ENVIRONMENTAL CONDITIONS IN ALGERIA

Lilia Redjaimia¹, Malika Rached-Kanouni², Norhane Chouter², Boutheyne Touafchia², Alia Zerrouki², Rabah Arhab².

¹Functional Ecology and Environment Laboratory (L. E. F. E), Department of Natural and Life Sciences, Faculty of Exact Sciences and Natural and Life Sciences, Larbi Ben M'Hidi University, Oum El Bouaghi, Algeria

²Laboratory of natural substances, biomolecules and biotechnological applications, Department of Natural and Life Sciences, Faculty of Exact Sciences and Natural and Life Sciences, Larbi Ben M'Hidi University, Oum El Bouaghi, Algeria
Corresponding author e-mail : liliaredjaimia84@gmail.com

ABSTRACT

The climatic changes experienced by the Mediterranean region are at the origin of the physiognomic variations of forest ecosystems. This pathology is manifested by environmental constraints that trees undergo in their natural range, affecting their growth and productivity. The most disastrous consequences are manifested by a risk of displacement of their biogeographical areas. This work focuses on the adaptability of holm oak (*Quercus ilex*) to environmental variations. The determinations of proline and soluble sugars are carried out in the leaves of seedlings of three varieties of holm oak (Batna, Tébessa and Souk Ahras). The determinations of proline and soluble sugars are carried out in the leaves of seedlings of three varieties of holm oak (Batna, Tébessa and Souk Ahras). Seedlings come from acorns without pericarps. The results obtained show a significant accumulation of proline in the leaves of seedlings from acorns with pericarps (Controls) compared to those without pericarps; this accumulation is also important in the leaves of seedlings having undergone an ablation of the pericarps (without pericarp) of the variety of Tébessa. Contrary to the previous results, the contents of total soluble sugars are higher in the leaves of the control seedlings. Regarding the varieties, the highest content is also obtained in the leaves of Tébessa seedlings (acorns without pericarps). The amounts accumulated could be linked to the level of tolerance to environmental variations, contributing to the maintenance of cell turgor, created by the osmotic adjustment for which proline and total sugars are responsible.

Keywords: varieties, *Quercus ilex*, proline, total sugars, adaptation.

INTRODUCTION

The "Quercus" oak forest in Algeria is mainly established from the center to the east thanks to the very favorable climatic conditions (altitude, rainfall, temperature). This forest has suffered serious damage since Roman colonization. Algeria has seen several civilizations succeed each other; these frequent invasions have ravaged a good part of its forest.

Various representatives of the genus *Quercus* play a more or less important role in the constitution of Mediterranean forests and although their precise taxonomic interpretation is

often tricky, around twenty species are mentioned. Among these, we generally distinguish between evergreen oaks or sclerophyllous oaks, deciduous oaks and also semi-deciduous oaks. Although this classification hardly responds to systematic criteria, it nevertheless corresponds fairly generally to bioclimatic types. Thus, sclerophyllous oaks selectively characterize the “eu-Mediterranean” vegetation level, especially in a subhumid bioclimatic environment, while deciduous oaks are found mainly in the “supra-Mediterranean” level and in a humid bioclimatic environment. Semi-deciduous oaks, on the other hand, are found in the southern Mediterranean and also in a humid bioclimatic environment (Quezel, 1974).

Several metabolic changes are related to the plant environment including modification of the synthesis and/or accumulation of osmoprotectants such as soluble sugars, amino acids, proteins, phospholipids and fatty acids. Among the amino acids that have been studied in relation to different stresses, the accumulation of proline. In plants exposed to water stress, cold or hot temperatures (Rached-Kanouni et al., 2013), proline has been extensively investigated over the past forty years (Hare et al., 1999).

Our work consists in analyzing the tolerance capacity of holm oak seedlings from acorns of three varieties located in eastern Algeria on the accumulation of some important metabolites in the resistance of plants to different biotic and abiotic attacks; the latter are proline and soluble sugars.

MATERIAL AND METHODS

Plant material

The holm oak plants (*Quercus ilex* L.) come from acorns harvested from adult trees in the regions of Batna, Tébessa and Souk Ahras (Eastern Algeria) in November 2021. In the laboratory, the acorns are soaked for a few minutes in the water, in order to eliminate the acorns in bad condition or parasitized. They are then left to dry in the open air for 48 hours. The experiment is carried out on intact acorns (Controls) and acorns without pericarps of three varieties (Batna, Tébessa and Souk Ahras). These acorns are germinated in vermiculite saturated with water at an ambient temperature of $20^{\circ}\text{C} \pm 2^{\circ}\text{C}$.

The selected seedlings (hypocotyl 6 to 14 cm and an epicotyl 1 to 2 cm long) are transferred into pots 50 cm in diameter and 60 cm deep, filled with peat (organic matter 2%, dry matter 3 %, water retention 30%, pH=6.5). The pots are placed in semi-controlled conditions, under an illumination of 6000 lux at the base of the plants, a temperature of $25^{\circ}\text{C} \pm 2^{\circ}\text{C}$ and a photoperiod of 16 hours and watered regularly with water.

Proline dosage

The method used is that of Troll and Lindsley (1955). Each sample collected (100 mg of the vegetal substance), is immediately weighed and then put in a test tube. A 2 ml volume of methanol at 40% is added to the sample, and then the whole is heated at 85°C in a double boiler for 1h at 85°C . After cooling 1 ml of the extraction solution is added to 2 ml of acetic acid, 25 mg of ninhydrine and 1 ml of mixture distilled water- acetic acid- orthophosphoric acid of density 1.7 (120,300, 80: v/v/v). The whole is heated up to boiling point during 30mn in a double boiler at 100°C , then let to cool down and added 5 ml of toluene. After agitation in Vortex, a pinch of sodium sulphates (Na_2SO_4) is added in each tube. The reading of the optic density is done at 528 nm after 48 hours (specifically for the cork oak).

Dosage of total sugars

The sugar content in the extracts normally was analyzed by a phenol-sulfuric acid method (Dubois et al., 1956). This colorimetric method determines only the amount of total sugars. This is the most widely used colorimetric method to date for determination of carbohydrate concentration in aqueous solutions. The basic principle of this method is that carbohydrates,

when dehydrated by reaction with concentrated sulfuric acid, produce furfural derivatives. Further reaction between furfural derivatives and phenol develops detectable color. The standard procedure of this method is as follows. A 2 ml aliquot of a carbohydrate solution is mixed with 1 ml of 5% aqueous solution of phenol in a test tube. Subsequently, 5 ml of concentrated sulfuric acid is added rapidly to the mixture. After allowing the test tubes to stand for 10 min, they are vortexed for 30 s and placed for 20 min in a water bath at room temperature for color development. Then, light absorption at 490 nm is recorded on a spectrophotometer. Reference solutions are prepared in identical manner as above, except that the 2 ml aliquot of carbohydrate is replaced by DDI water. The phenol used in this procedure was redistilled and 5% phenol in water (w/w) was prepared immediately before the measurements.

RESULTS AND DISCUSSION

In response to environmental conditions, many species simulate significant morphological and metabolic changes. Among these species, *Quercus ilex*. It is in this context, that our study aims at the same time the knowledge of this species and its eco-physiological reaction vis-à-vis the environmental conditions and the treatments applied, while trying to understand its capacity of adaptation. by biochemical markers such as proline and total sugars.

In general, the results obtained vary remarkably between the different varieties (Batna, Tebéssa and Souk Ahras) on the one hand and between the different treatments applied on the other hand (Figure 1).

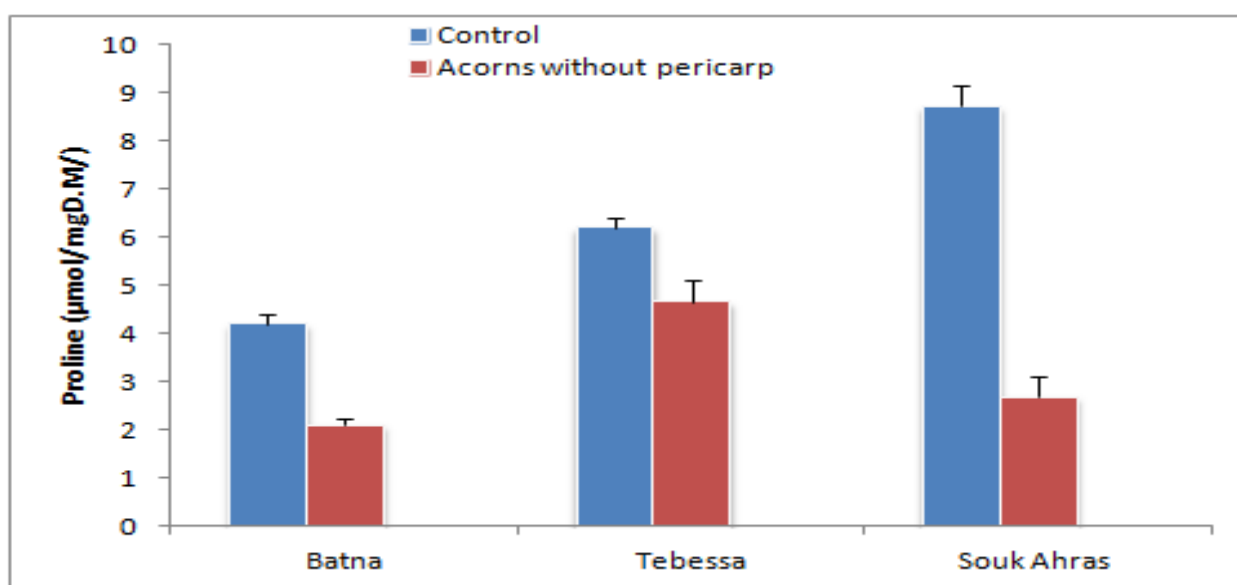

Figure 1. Proline content in the different organs of cork oak seedlings. Bars represent means values (n= 4).

The highest proline content was found in the leaves of seedlings that had come from intact acorns, while the lowest was found in those of seedlings whose acorns had undergone pericarp removal.

The comparison of the amounts of proline in the leaves of holm oak seedlings from acorns having undergone physical treatment of three varieties (Batna, Tebéssa and Souk Ahras), reveals that the highest amounts are found in the leaves of the seedlings of the Souk Ahras variety from control acorns and from Tebéssa for the leaves of seedlings that came from acorns without pericarp, while the low levels are those of the Batna variety.

Proline accumulation may contribute to osmoprotection in natural accumulators; however, the latter seems to be responsible for the tolerance to the abiotic stresses of the environment. Early in vitro studies showed that proline can be a ROS scavenger (Smirnoff and Cumbes 1989). It has also been proposed to function as a structurally stabilizing molecular chaperone of proteins, and its accumulation may provide a means to buffer cytosolic pH and balance the redox status of cells. Finally, proline accumulation may be part of the stress signal influencing adaptive responses (Maggio et al. 2002).

The accumulation of soluble sugars could contribute to osmoprotection under natural conditions; however, the latter seems to be responsible for the tolerance to the abiotic stresses of the environment. The comparison of the amounts of soluble sugars in the leaves of holm oak seedlings from acorns having undergone some physical treatment of three varieties (Batna, Tébéssa and Souk Ahras) reveals that the highest amounts are found in the leaves of seedlings of the varieties of Tébéssa and Souk Ahras coming from acorns without pericarps, whereas the weak ones those of the variety of Batna. For the witnesses, the great value is recorded in the leaves of the Souk Ahras seedlings; while the weakest is obtained at the level of the leaves of Batna seedlings.

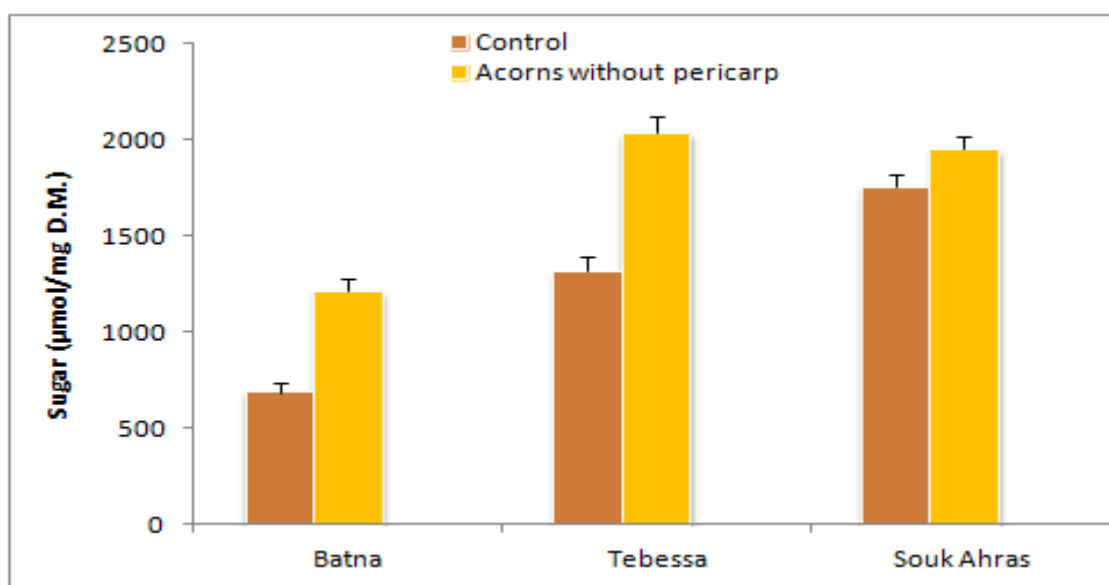

Figure 2. Proline content in the different organs of cork oak seedlings. Bars represent means values (n= 4).

Under water stress, soluble sugars and more particularly glucose contribute the most to osmotic adjustment. According to Dib et al. (1992), the accumulation of carbohydrates in the leaves varies from one species to another and from one variety to another, depending on the level of tolerance and the intensity of stress. Ben Abdellah and Ben Salem (1992), show that the strong relationship between the content of soluble sugars in the stems and the damage suffered by the cell membranes, resulting from a relatively high accumulation of carbohydrate reserves, in the stems constitutes a preservation of the maintenance of high cellular integrity.

One of the major consequences of this imbalance is the accumulation of solutes, a good number of woody species such as *Eucalyptus microtheca* (Chunyang, 1998) and *Quercus ilex* (Pesoli et al., 2003) have shown a significant increase in soluble sugar concentrations. The presence of soluble sugars in periods of heat and drought would protect the thylakoids from irreversible

damage to the membranes and would exert a favorable action on protoplasmic resistance to drought (Munns et al., 1975).

The content of soluble sugars is higher in the leaves than the content begins to decrease in the other organs (stems and roots), this shows that the sugars are synthesized at the level of the "source" leaves and are transported to the other organs (Aissani and Bousba, 1992).

The holm oak can present two vegetative growths, one takes place in the spring, it takes place systematically and is the most important in terms of the biomass produced. The second takes place in the fall, but it is not systematic. It strongly depends on the abundance of precipitation, which must be high enough to replenish the water reserve after the summer drought. Cases have been noted where several spring shoots could take place on the same young individual, in the same year (Vivat, 1995).

CONCLUSION

The climatic changes experienced by the Mediterranean region are at the origin of the physiognomic variations of forest ecosystems. This pathology is manifested by abiotic and biotic stresses, which trees undergo in their natural range, affecting their growth and productivity. The most disastrous consequences are manifested by a risk of displacement of their biogeographical areas. The adaptation capacities of holm oak using biochemical markers (proline and soluble sugars) are the problem of this research. The seedlings, raised in semi-natural conditions, undergo a few physical treatments before their germination. The results obtained from the proline and soluble sugar contents indicate that a significant accumulation in the leaves of the varieties of Tébessa and Souk Ahras; while a decrease in its content is noticed in the leaves of the Batna variety. The accumulated quantities of these metabolites could be linked to the level of tolerance to the climatic and soil conditions of the environment, contributing to the maintenance of cell turgor, created by the osmotic adjustment for which proline is responsible. Holm oak is characterized by its better adaptation to the semi-arid climate and to the conditions of three study regions.

REFERENCES

- Achhal, A. (1979). Le chêne vert dans le haut Atlas Central: Et de phytoécologique. Problèmes posés par les Aménagements de la chênaie. Thèse Doct. 3^{ème}. Cycle, Univ. Aix. Marseille. 116 p.
- Anket, S., Babar S., Vinod, K., Sukhmeen, K.K., Gagan, P., Singh, S., Aditi Shreeya, B., Neha, H., Dhriti, K., Renu, B., Bingsong, Z. (2019). Phytohormones Regulate Accumulation of Osmolytes Under Abiotic Stress. *Biomolecules*, 9(7): 271-285. doi: 10.3390/biom9070285. PMID: 31319576; PMCID: PMC6680914.
- Chu, T.M., Jusaitis, M., Aspinall, D., Paleg, L.G. 1978. Accumulation of free proline at low temperatures. *Physiol Plant*, 43: 254-260.
- Li, C. 2000. RAPD analysis of genetic variation in *Eucalyptus microtheca* F. Muell. populations. *Hereditas*, 132: 151-156.
- Dubois, M., Gilles, K.A., Hamilton, J.K., Rebers, P.A. and Smith, F. 1956. Colorimetric Method for Determination of Sugars and Related Substances. *Analytical Chemistry*, 28: 350-356. Doi: <http://dx.doi.org/10.1021/ac60111a017>.
- Gratani, L., Meneghini, M., Pesoli, P.; Crescente M.F. 2003. Structural and functional plasticity of *Quercus ilex* seedlings of different provenances in Italy. *Trees*, 17: 515-521 doi: <https://doi.org/10.1007/s00468-003-0269-8>.
- Hare, P.D., Cress, W.A., Van Staden, J. 1999. Proline synthesis and degradation: a model system for elucidating stress-related signal transduction. *J. Exp. Bot.*, 50: 413-434.

- Kavi Kishor, P.B., Hong, Z., Miao, G.H., Hu, C.A.A., Verma, D.P.S. 1995. "Overexpression of pyroline - 5 - carboxylate synthetase increases proline production and confers osmotolerance in transgenic plants". *Physiol.*, 108: 1387-1394.
- Khan, M.I.R., Fatma, M., Per, T.S., Anjum, N.A., Khan, N.A. 2015. Salicylic acid-induced abiotic stress tolerance and underlying mechanisms in plants. *Front. Plant Sci.*, 6:462. doi: 10.3389/fpls.00462. - DOI - PMC - PubMed.
- Maggio, A., Miyazaki, S., Veronese, P., Fujita, T., Ibeas, J.I., Damsz, B., Narasimhan, M.L., Hasegawa, P.M., Joly, R.J., Bressan, R.A. 2002. Does proline accumulation play an active role in stress-induced growth reduction? *Plant J.*, 31: 699-712.
- Munns, R. 1975. Comparative Physiology of Salt and Water Stress. *Plant Cell Environ.*, 28: 239-250.
- Quezel, P. 1974. Les forêts du pourtour méditerranéen. In : Forêts et maquis méditerranéens : écologie, conservation et aménagement. Note techn. MAB, 2. 158p.
- Rached-Kanouni, M., Alatou, D., Sakr, S. 2012. Effets des hautes températures sur le chêne liège. *European Journal of Scientific Research*, 74(3): 370-380.
- Rached-Kanouni, M., Alatou, D., Sakr S. 2012. "Responses of cork oak seedlings to short-term exposures to low temperatures". *American Journal of Scientific Research*, 59, 28-41.
- Smirnoff, N., Cumbes, Q.J. (1989). Hydroxyl radical scavenging activity of compatible solutes. *Phytochemistry*, 28: 1057-1060.
- Troll, W., Lindsley, J. 1955. "A photometric method for the determination of proline". *J Biol.Chem*, 215: 655-660.

SEASONAL EFFECT ON ALEPPO PINE PHYSIOLOGY

Lilia Redjaimia¹, Malika Rached-Kanouni², Norhane Chouiter², Alia Zerrouki², Boutheyne Touafchia², Rabah Arhab².

¹Functional Ecology and Environment Laboratory (L. E. F. E), Department of Natural and Life Sciences, Faculty of Exact Sciences and Natural and Life Sciences, Larbi Ben M'Hidi University, Oum El Bouaghi, Algeria.

²Laboratory of natural substances, biomolecules and biotechnological applications, Department of Natural and Life Sciences, Faculty of Exact Sciences and Natural and Life Sciences, Larbi Ben M'Hidi University, Oum El Bouaghi, Algeria.

Corresponding author e-mail: liliaredjaimia84@gmail.com

ABSTRACT

Our work consists in quantifying the contents of soluble sugars and total proteins in the different organs of the Aleppo pine (*Pinus halepensis* Mill.) during the four seasons of the year 2022. The contents of total soluble sugars and proteins are higher in the needles than the other organs. Regarding the seasons, the highest content of soluble sugars is obtained for the summer, while the content of total proteins is higher for the winter. One of the main reasons explaining the success of adaptation of the Aleppo pine in the Mediterranean area lies in its remarkable resistance to ecological constraints.

Keywords: *Pinus halepensis*, soluble sugars, total proteins, adaptation.

INTRODUCTION

Forests and maquis cover 4.1 million hectares, i.e. an afforestation rate of 16.4% for northern Algeria and only 1.7% if the arid Saharan regions are also taken into consideration. These afforestation rates are obviously very insufficient to ensure the physical and biological balance. The Aleppo pine (*Pinus halepensis* Mill.) is considered as a main and essential component of the Mediterranean forest and represents a forest capital of great value by the majority of the countries around the Mediterranean and more particularly in Algeria (Boudy, 1950; Nahal, 1962). The Aleppo pine is among the most commonly planted tree species because of their rapid growth, their resistance to the most xeric conditions, their ability to restore degraded areas and to occupy bare land (Zavala and Zea, 2004).

In Algeria, the Aleppo pine covers 35% of the wooded areas in the north, i.e. around 850 000 ha. It forms important forests whose ecological values are variable (Bentouati, 2006; Guit, 2015). It is largely located in its natural state in the eastern and central regions of the country, mainly on the Atlas, Tellian and Saharan mountains. This species, which is present in all bioclimatic stages, from the coast to the Saharan Atlas, finds its optimum growth mainly in semi-arid zones (Kadik, 2005; Djerrad, 2016). Its great plasticity and robust temperament have made it a pioneer species for major reforestation (Quézel, 2002; Kadik, 2005; Guit, 2015; Djerrad, 2016).

For several decades, the Aleppo pine in arid and semi-arid zones has suffered severe degradation due to the effects of increasing anthropogenic pressures (illegal cutting, overgrazing, fires) and climatic (successive and prolonged droughts) thus causing the regression of this forest species (Bentouati, 2006; Rached-Kanouni et al., 2020).

In order to better understand the effect of climate on the behavior of Aleppo pine and to quantify their degree of adaptation to their environment, biochemical analyzes were carried out on some metabolites such as total proteins and soluble sugar on their various organs.

MATERIAL AND METHOD

Our study was carried out on adult subjects of Aleppo pine from the forest of Sidi R'Ghies (East-Algerian). Biochemical analyzes are carried out on the different organs (needles, stems and roots).

Extraction and estimation of soluble proteins

Protein was determined by method described by Bradford (1976), using bovine serum albumin as standard. Leaf, stems and roots samples (100 mg) were homogenized with 3ml extraction buffer (50mM Tris-HCl (pH: 7.5), 2mM EDTA, 1mM 2-Mercaptoethanol, 1mM DTT). Samples then were centrifuged at 14000 rpm for 25 min at 4°C and supernatants were isolated and used for protein assay.

Dosage of total sugars

The sugar content in the extracts normally was analyzed by a phenol-sulfuric acid method (Dubois et al., 1956). This colorimetric method determines only the amount of total sugars. This is the most widely used colorimetric method to date for determination of carbohydrate concentration in aqueous solutions. The basic principle of this method is that carbohydrates, when dehydrated by reaction with concentrated sulfuric acid, produce furfural derivatives. Further reaction between furfural derivatives and phenol develops detectible color. The standard procedure of this method is as follows. A 2 ml aliquot of a carbohydrate solution is mixed with 1 ml of 5% aqueous solution of phenol in a test tube. Subsequently, 5 ml of concentrated sulfuric acid is added rapidly to the mixture. After allowing the test tubes to stand for 10 min, they are vortexed for 30 s and placed for 20 min in a water bath at room temperature for color development. Then, light absorption at 490 nm is recorded on a spectrophotometer. Reference solutions are prepared in identical manner as above, except that the 2 ml aliquot of carbohydrate is replaced by DDI water. The phenol used in this procedure was redistilled and 5% phenol in water (w/w) was prepared immediately before the measurements.

RESULTS AND DISCUSSION

With regard to the seasons, Table 1 shows that high temperatures summer and winter cause the greatest accumulations of total soluble sugars. On the other hand, the autumn and spring seasons present low accumulation rates at the level of the different organs. The accumulation of sugars represents very significant variations during the seasons. During the spring and autumn season, it is the roots that accumulate the most sugars, while in the summer season the needles present the highest values.

Table 1. Newman-Keuls test at 5%.

Organs	Averages	Saisons	Averages
Needles	296.75a	Summer	257.33a
Stems	215b	Winter	254.33a
Roots	201.5c	Autumn	226.67b
		Spring	212.67b

Cold acclimation is a complex process involving physiological and metabolic changes under genetic control. Plants that remain active through the winter must maintain their essential primary metabolism to maintain minimal growth. They have to fight against the cold, which reduces the speed of enzymatic reactions, which has consequences for most biological processes (Stitt and Hurry, 2002). Compounds can act as osmoprotectors. These are soluble proteins, proline, glycine betaine, sorbitol or polyamides but also soluble sugars. These constituents are highly soluble and non-toxic to the body. Osmoprotectants serve to increase osmotic pressure in the cytoplasm and can also stabilize proteins and membranes when temperatures are unfavorable (Breton et al., 2000).

Our results on Aleppo pine trees show that the action of low temperatures results in variations in soluble sugar levels. Moreover, these variations differ depending on the organ considered, probably reflecting different tolerance mechanisms. The presence of these soluble sugars in periods of heat and drought would protect the thylakoids from the irreversible alteration of the membranes and would exert a favorable action on protoplasmic resistance to drought. Marguery (1992) states that temperature, associated with insolation and could be a determining factor for the accumulation of sugars.

Sugars can also serve as compatible soluble compounds for osmotic adjustment, like many other molecules (proline, glycine-betaine or pinitol). Thus, enzymes related to sugar metabolism seem to have a major importance in stress tolerance. Many studies have shown the accumulation of soluble sugars during desiccation. A main idea emerges: different soluble sugars can be present in well hydrated tissues, but sucrose is preferentially accumulated in dehydrated tissues.

Finally, sugars can have an impact on the regulation of gene expression. Indeed, some genes are directly regulated by the level of glucose in the cell. Mention may be made, for example, of the gene coding for the protein GRR1 (glucose regulated repressor) isolated from *S. cerevisiae* which is involved in the transduction cascades which involve glucose. There GRR1 protein also plays a role in protein degradation. Finally, GRR1 is involved in cell cycle regulation via the degradation of the G1 phase-specific cyclins Cln1 and Cln2 (Liu et al., 1998; Shinozaki, 1998).

Table 2 shows that the most accumulative season for proteins in the different organs is the winter season. On the other hand, the lowest levels are recorded during the summer and autumn. At the organ level, it is the needles that accumulate the highest levels compared to the other organs (stems and roots). During the fall season, the needles indicate the lowest levels and the roots the highest levels.

Table 2. Newman-Keuls test at 5%.

Organs	Averages	Saisons	Averages
Needles	2,5875a	Winter	3.87a
Stems	1,5875c	Spring	3.73a
Roots	2,53b	Summer	0.28b
		Autumn	0.28b

It can be seen that the protein content in the needles is higher than that of the stems and roots. It can be concluded that low temperatures induced an increase in protein in holm oak trees. These results are in accordance with the research of several authors including Davis and Gilbert (1970); Mckenzie et al., (1988). Among the proteins that are involved in cold tolerance, the CBFs which are isolated from more than 50 genera of dicots and monocots.

Thus, several proteins induced by the gel have no known function and are only attributed to potential roles (Thomashow, 1999). During cold acclimatization, an increase in the rate of unsaturation of the fatty acids that make up membrane lipids and an increase in the phospholipid to protein ratio are observed in the membranes. The statistical analysis reveals that the first group corresponds to the needles which characterize the highest average, the second group corresponds to the roots and the last corresponds to the stems with the lowest averages. The growth of the aerial part, and especially that of the leaves, is generally more sensitive than that of the roots. The latter are not important storage tissues; their continuous growth and the low levels of protein concentration may indicate that the roots are permanent absorbers with constant needs during the period of growth of the aerial parts in waves (Alaoui-Sossé et al., 1994) and explains the low protein content at their levels. However, it seems that the synthesis of specific proteins is necessary for hardening.

Proteins also experienced a variation in their concentration after thermal stress (high temperatures). Therefore, proteins accumulate as a result of heat stress. This increase is due to an activation of a set of genes allowing the synthesis of specific proteins associated with stresses such as the "LEA" proteins which ensure protection of the vital set of cellular proteins (David and Grongnet, 2001) and the heat shock proteins which maintain the protein and membrane structures of the plant cell (Baker et al., 1988). The involvement of HSPs in the phenomenon called "thermotolerance" has been demonstrated. The HSPs thus synthesized allow the "renaturation" of proteins and the recovery of enzymatic activity (Souren et al., 1999). The duration of heat stress negatively affects the protein content. The cells, which were subjected to a pre-thermal shock before being subjected to another stress, show increased resistance during the second stress. Depending on the organs, the accumulation of proteins is greater in the leaves than in the stems and roots.

CONCLUSION

This research is used to analyze the influence of environmental factors on the behavior of the Aleppo pine is characterized by a semi-arid climate. Biochemical analyzes of soluble sugars and total proteins are carried out on the different organs of Aleppo pine trees. The results obtained indicate that the levels of soluble sugars and total proteins vary between seasons and organs. The contents of total soluble sugars and total proteins are higher in the needles compared to the other organs. For the seasons, summer and winter are the most accumulators of soluble sugars and proteins respectively. One of the main reasons explaining the success of adaptation of the Aleppo pine in the Mediterranean area lies in its remarkable resistance to ecological constraints and in particular thermal.

REFERENCES

- Alaoui-Sossé, B., Parmentier, C., Dizengremel, P., Barnola P. 1994. Rhythmic growth and carbon allocation in *Quercus robur* starch and sucrose. *Plant Physiology and Biochemistry*, 32: 331-339.
- Baker, S.S., Wilhelm, K.S., Thomashow, M.F. 1994. The 5'-Region of *Arabidopsis-Thaliana* Cor15a Has Cis-Acting Elements That Confer Cold-Regulated, Drought-Regulated and Aba-Regulated Gene-Expression. *Plant Mol.Biol.*, 24: 701-713.
- Bentouati, A., Bariteau, M. 2006. Réflexion sur le dépérissement du Cèdre de l'Atlas des Aurès (Algérie). *Forêt Méditerranéenne*, XXVII (4): 317-322.
- Boudy, P. 1950. *Economie forestière Nord-Africaine*, tome 2 (Monographie et traitement des essences forestières). Edit. Larose, Paris, France, 619p.

- Bradford, M. 1976. A rapid and sensitive method for the quantitation of microgram quantities of protein utilizing the principle of protein-dye binding. *Analytical Biochemistry*, 72(1-2): 248-254. [https://doi.org/10.1016/0003-2697\(76\)90527-3](https://doi.org/10.1016/0003-2697(76)90527-3).
- Breton, G., Ouellet, F., Danyluk, I., Sarhan, F. 2000. Biotechnological applications of plant freezing associated proteins. *Biotechnology Annual Review.*, 6: 57-100
- David, J.C., Grongnet J.F. 2001. Les protéines de stress. *INRA Prod. Anim.*, 14(1): 29-40.
- Davis, D.L., Gilbert W.B. 1970. Winter hardiness and changes in soluble protein fractions of bermudagrass. *Crop Sci.*, 10: 7-9
- Dionne J. (2001). Protection hivernale et tolérance au froid du Pâturin Annuel *Pea ann. Plant J.*, 4: 215-223.
- Djerrad, Z. 2016. Etude phytoécologique des provenances de pin d'Alep (*Pinus halepensis* Mill.) de la partie centrale de l'atlas Saharien, comparaison de la variabilité morphologique et chimique avec les pinèdes du semi-arides est algérien. Thèse doctorat en sciences de la nature. USTHB, Fac. Sc. Biol., Alger. 182p.
- Dubois, M., Gilles, K.A., Hamilton, J.K., Rebers, P.A. and Smith, F. 1956. Colorimetric Method for Determination of Sugars and Related Substances. *Analytical Chemistry*, 28: 350-356. Doi: <http://dx.doi.org/10.1021/ac60111a017>.
- Guit, B., Nedjimi, B., Chakali, G., Guibal, F. 2016. État sanitaire des peuplements de pin d'Alep (*Pinus halepensis* Mill.) dans le massif forestier de Senalba (Djelfa, Algérie). *Revue d'écologie. (Terre et Vie)*, 71 (2) : 156-167. <http://hdl.handle.net/2042/59913>.
- Kadik, B. 2005. Etude phytosociologique et phytoécologique des formations à pin d'Alep (*Pinus halepensis* mill) de l'étage bioclimatique semi-aride algérien. Thèse doctorat en sciences de la nature. USTHB. Alger. 350p.
- Liu, Q., Kasuga, M., Sakuma, Y., Abe, H., Miura, S., Yamaguchi-Shinozaki, K., Shinozaki K. 1998. Two transcription factors, DREB1 and DREB2, with an EREBP/AP2 DNA binding domain separate two cellular signal transduction pathways in drought- and low-temperature responsive gene expression, respectively, in *Arabidopsis*. *Plant Cell*, 10: 1391-1406.
- Marguery, P. 1992. Contribution à l'étude et à l'amélioration de la croissance du fruit chez le pommier (*Malus domestica* Dork. cv Golden delicious).Thèse de doctorat, Université d'Amiens, 177 p.
- McKenzie, J.S.R., Paquin, R., Duke, S.H. 1988. Cold and heat tolerance. In : Hanson, A.A., Barnes, D.K., and Hill, R.R. , Jr eds *Alfafa and alfafa irnprovement*. Agronomy monograph., 29: 259.302.
- Nahal, I. 1962. Le pin d'Alep, Etude taxonomique, phytogéographique, écologique et Sylvicole. *Annales de l'Ecole Nationale des Eaux et Forêts*, 19 (4): 533-627 ; 487-554.
- Quèzel, P. 2000. Taxonomy and biogeography of Mediterranean pines (*Pinus halepensis* and *P. brutia*). In: Ne'eman G, Trabaud L, editors. *Ecology, Biogeography and Management of Pinus halepensis and P. brutia Forest Ecosystems in the Mediterranean Basin* Backhuys, Leiden, The Netherlands: 1-12.
- Rached-Kanouni, M., Hani, I., Bousba, R., Beldjazia, A., Khammar, H. 2020. Structural variability of Aleppo pine stands in two forests in northeastern Algeria. *Biodiversitas* 21(6): 2848- 2853. <https://doi.org/10.13057/biodiv/d210663>.
- Souren, J.E., Wiegant, F.A., Van wijk, R. 1999. The role of hsp70 in protection and repair of luciferase activity in vivo; experimental data and mathematical modelling. *Cell Mol. Life Sci.*, 55: 799-811
- Stitt, M. Hurry, V. 2002. A plant for all seasons: alterations in photosynthetic carbon metabolism during cold acclimation in *Arabidopsis*". *Current Opinion in Plant Biology*, 5: 199-206.

- Thomashow, M.F. 1999. Plant cold acclimation: freezing tolerance genes and regulatory mechanisms. *Annual Review of Plant Physiology and Plant Molecular Biology*, 50: 571-599.
- Zavala, M., Zea, E. 2004. Mechanisms maintaining biodiversity in Mediterranean pine-oak forests: insights from a spatial simulation model. *Plant Ecol.* 171: 197-207.
<https://doi.org/10.1023/B:VEGE.0000029387.15947.b7>

DETERMINATION OF HEAT STRESS BY TEMPERATURE-HUMIDITY INDEX IN ENRICHED CAGE SYSTEM LAYING HENS: A BURSA CASE STUDY

Busra Yayli¹, Ilker Kilic¹

¹ *Bursa Uludag University, Agriculture Faculty, Biosystem Engineering Department, Bursa, Turkey*

Corresponding author e-mail: busrayayli@uludag.edu.tr

ABSTRACT

Providing optimum indoor conditions in livestock farms is critical regarding animal health, production efficiency, and secure food production. Poultry animals are more sensitive to indoor environmental conditions than other farm animals. They are affected more quickly by changes in environmental conditions—especially high temperatures and relative humidity, causing heat stress in animals, reducing productivity and causing vital effects. The temperature-humidity index is an important indicator to evaluate the heat stress caused by high temperature and humidity. This study aimed to determine the impact on laying hens by calculating the temperature-humidity index (THI) values for a poultry house with an enriched cage system operating in Bursa. According to the results of the study, it was determined that THI values were at the critical limit in which heat stress started to be seen in July and August and within the normal range in other months. The highest THI values were calculated as 20,8, 24,7, and 24,4 for June, July, and August, respectively. It has been observed that the high index values, especially in the summer months, are inversely proportional to egg production and are effective in the decrease in production. In other months, it is in the comfort zone of birds.

Keywords: Bursa, Heat stress, Humidity, Temperature, Laying hen

INTRODUCTION

Global warming has increased the pressure and intensity on animals in the poultry farming sector. Especially in the summer, when the temperature increases, heat stress on laying hens affects yield and productivity (Gencoglan, 2023). When the ambient temperature rises, laying hens breathe excessively and try to remove excess heat from their bodies. Since chickens do not have sweat glands, the temperature difference between the ambient and animal body temperatures will decrease as the air temperature increases. Hens will try to remove excess heat from their bodies by increasing respiration.

The optimum temperature range (thermoneutral zone) for optimal performance of laying hens is 19°C-22°C. Heat stress occurs at temperatures above the thermoneutral zone, triggering physiological defense mechanisms in hens (Kim et al., 2020). While there is a significant decrease in body weight and feed consumption in chickens exposed to heat stress, decreases are also observed in quality characteristics such as egg weight, shell weight, and shell thickness (Mashaly et al., 2004; Koyuncu and Nageye, 2020).

This study aimed to calculate heat stress in laying hens by temperature-humidity index and to evaluate its correlation with egg production.

MATERIAL AND METHOD

This study aimed to determine the heat stress by calculating the temperature-humidity index values in the laying hen house operating in the Bursa region.

The monitored poultry house has an enriched cage system, and the number of chickens throughout the year is given in Table 1 according to the months. There was a decrease in the number of hens in March, so animals were added the following month to maintain the same productivity. Production started to be completed from September onwards as the hens aged and deaths occurred.

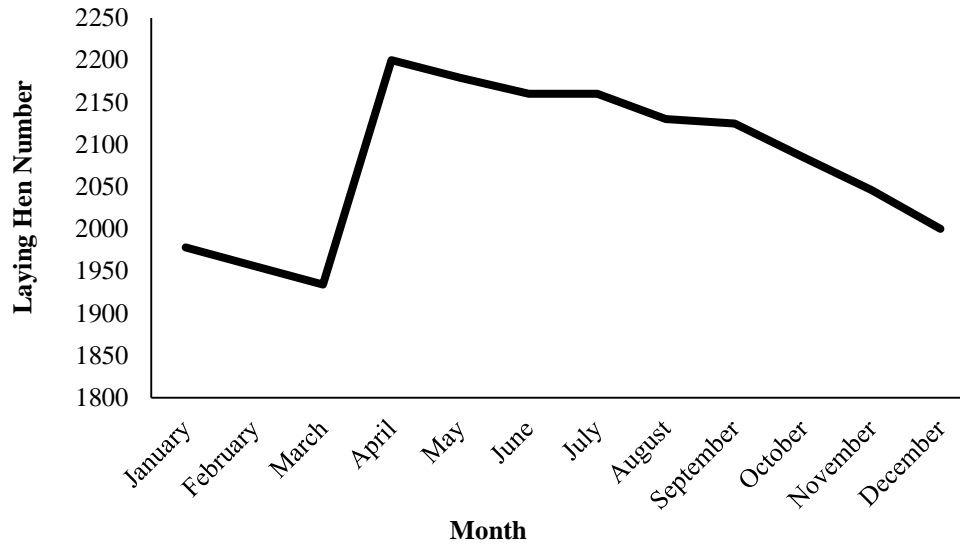

Figure 1. Number of hens in the hen house in this study according to the month

Equation (1) was used to calculate the temperature-humidity index values (Zulovich and DeShazer, 1990):

$$THI_{layers} = 0,6 T_{db} + 0,4 T_{wb} \quad (1)$$

THI_{layers} : Temperature-humidity index for laying hens

T_{db} = Dry-bulb temperature in °C

T_{wb} = Wet-bulb temperature in °C

The chart in Figure 2 was used for THI values (NFACC, 2013). In this chart, the white zone represents the region where heat stress does not occur in animals, the comfort zone. The yellow zone, corresponding to the value of 24-25,5, indicates the alarm condition in which the symptoms of heat stress begin to be seen in birds. The zone in the range 26-28 constitutes a dangerous situation for chickens, and serious measures should be taken in the poultry house, and the birds should be carefully monitored. >29 is an emergency and is considered a hazard category.

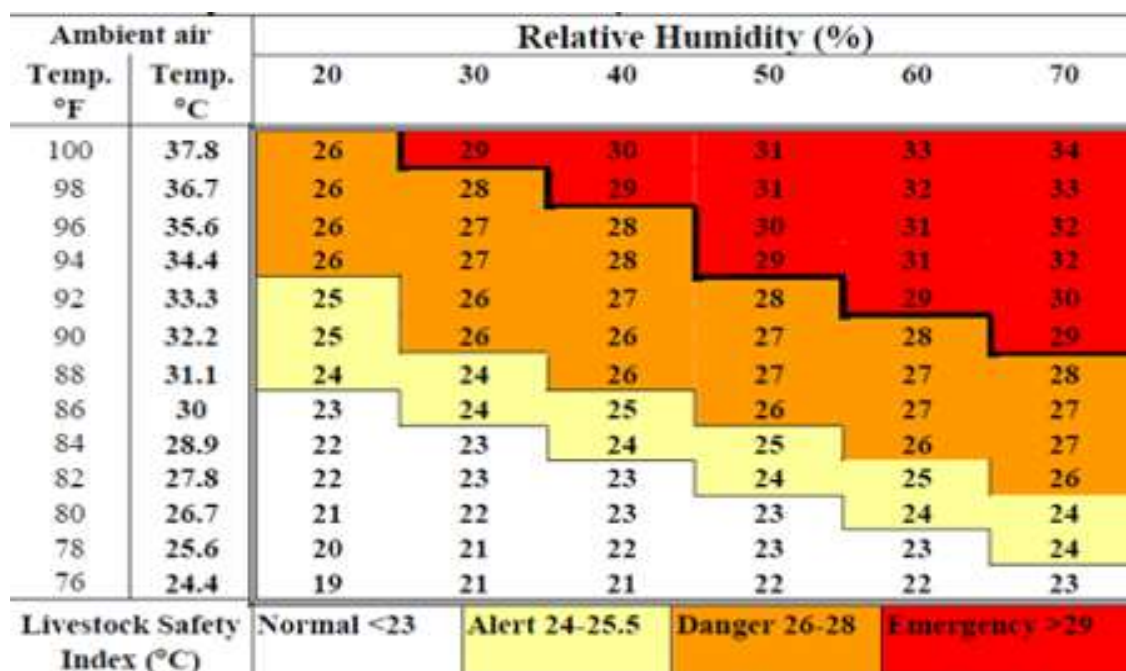

Figure 1. Livestock Temperature-Humidity Index (THI)

RESULTS AND DISCUSSION

In the study, temperature and humidity values were measured throughout the study. Dry and wet bulb temperatures were used to calculate THI values (Table 2). When the THI values were analyzed, the highest values were found in the summer months and were calculated as 20,8, 24,7, and 24,4 for June, July, and August, respectively. When these values are evaluated in the heat stress graph for laying hens (Figure 2), it indicates that it is in the comfort zone for June and the alarm status for July and August. When hens are in their comfort zone, they lose controlled heat, so heat stress does not occur. When the ambient temperature is high in the summer, egg yield decreases, and eggshell quality decreases (Konca and Yazgan, 2002).

Table 2. The hen house where the study was conducted ambient conditions and the calculated THI data

Month	Dry-bulb temperature (°C)	Wet-bulb temperature (°C)	Humidity (%)	Temperature-Humidity Index
January	14,7	9,7	55,3	12,7
February	12,0	7,7	58,7	10,3
March	12,5	8,3	60,0	10,8
April	16,7	11,8	58,3	14,7
May	23,2	16,9	53,3	20,7
June	22,6	18,1	65,1	20,8
July	27,1	21,0	57,4	24,7
August	27,1	20,4	53,5	24,4
September	21,9	16,4	57,3	19,7
October	17,5	12,7	59,9	15,6
November	16,0	12,2	67,0	14,5
December	15,7	11,0	59,14	13,8

When heat stress and egg production were correlated, it was observed that egg production and heat stress were inversely proportional. It is seen that the high index values in the summer season are effective in the decrease in egg production. Since the beginning of autumn, the animals have been sent to slaughter because the production has been completed. After all, the animals are getting old. Therefore, production is finished before the end of the season.

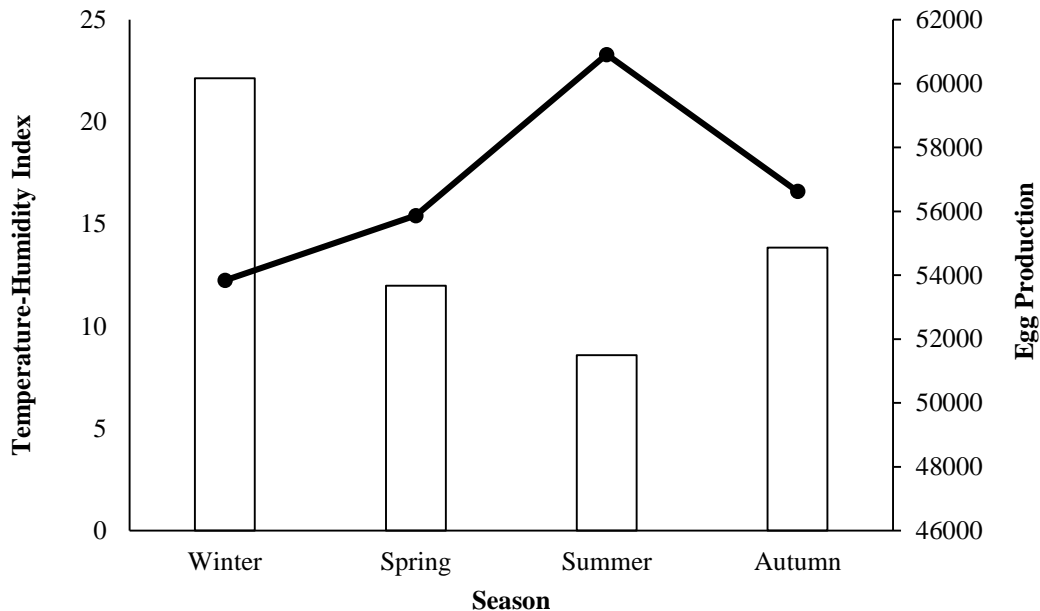

Figure 2. Egg production and temperature-humidity index correlate according to seasons

CONCLUSIONS

This study evaluated heat stress with the temperature-humidity index in a layer hen with an enriched cage system operating in the Bursa region. According to the results, it was seen that the index values were above 20 in the summer season. In July and August, it shows the alert status for hens.

Environmental factors are essential in laying hen activities, so the temperature-humidity index is the most crucial factor to consider. It is felt in our lives with serious effects that the effect of global warming increases every year. It is an inevitable fact that heat stress will emerge as a more critical problem in animal production in the future. Therefore, it is necessary to address the situations where heat stress will occur and to produce practical solutions to ensure the continuity of production, not to affect productivity, and to provide a social welfare environment for animals.

REFERENCES

- Gencoglan, S. 2023. The Effects of Heat Stress on Yield and Fertility of Laying Hens and Precautions to be Taken. *Turkish Journal of Agriculture - Food Science and Technology*, 11(1): 140–150.
- Kim, D. H., Y. K. Lee, S. H. Kim, K. W. Lee. 2020. The Impact of Temperature and Humidity on the Performance and Physiology of Laying Hens. *Animals*, 11(1): 56.
- Konca, Y., O. Yazgan. 2002. Heat Stress and Vitamin C in Laying Hens. *Journal of Animal Production*, 43(2).
- Koyuncu, M., F. Nageye. 2020. Effects of Climate Change on Sustainable Livestock System. *Journal of Animal Production*, 61(2): 157-167.

- Mashaly, M. M., G. L. Hendricks, M. A. Kalama, A. E. Gehad, A. O. Abbas, P. H. Patterson. 2004. Effect of heat stress on production parameters and immune responses of commercial laying hens. *Poultry Science*, 83 (6): 889–894.
- NFACC, 2013. The National Farm Animal Care Council, Code of Practice for the Care and Handling of Sheep. <https://www.nfacc.ca/codes-of-practice/sheep> (Accessed on 14 July 2023).
- Zulovich, J. M., DeShazer, J. A. 1990. Estimating egg production declines at high environmental temperatures and humidity. ASAE Paper No. 90-4021, St. Joseph, MI.

ENVIRONMENTAL EFFECTS OF OFFSHORE AND ONSHORE WIND POWER PLANTS AND THE CAPACITY OF WIND ENERGY IN TURKEY

Heval DAYAN¹, Ebru ÇOKAY¹

¹ Dokuz Eylül University, Engineering Faculty, Environmental Engineering Department, Izmir, Turkey

Corresponding author: ebru.cokay@deu.edu.tr

ABSTRACT

Wind energy, which is one of the most important renewable energy sources, has minimal environmental impact and high energy production potential because its source is a type of energy that comes from nature. One way to make the most of this potential is with offshore wind energy systems. There are many factors affecting the prevalence of offshore wind energy systems; cost, installation and operating difficulties, and lack of appropriate regulation/legislation. This study was conducted to determine the wind energy potential in Turkey, to examine the applicability of offshore wind energy systems in Turkey, and to evaluate its possible environmental effects. Based on the study results, the implementation of offshore wind energy systems in Turkey will be a big step in reducing the use of fossil fuels and switching to the use of renewable energy sources, as well as providing economic benefits. In addition, offshore wind power plants (OWPPs) will be an important step toward reducing Turkey's dependence on foreign energy and achieving sustainable development goals.

Keywords: Renewable energy, offshore wind energy, onshore wind energy, environmental impact assessment of wind energy

INTRODUCTION

Wind energy is the energy resulting from the displacement of warm and cold air in the atmosphere, which converts the kinetic energy of the wind first into mechanical energy and subsequently into electrical energy. Wind energy sourced from the sun, is a natural, renewable, clean, and infinite source of power. It has been determined that approximately 2% of the energy sent to the Earth by the sun is converted into wind energy. This energy transformed into wind is converted into electrical energy through turbine technology.

Wind energy, besides being a renewable source, has a relatively low negative impact on the environment. Wind turbines, which utilize wind as their fuel, do not release toxic gasses into the atmosphere like fossil fuels such as natural gas, coal, or oil do when burned. Consequently, wind energy is recognized as a green and environmentally friendly energy source. In summary, it plays an important role in an economically, environmentally, and socially sustainable future.

In recent years, the use of wind energy in energy production has been steadily increasing in Turkey. Approximately 10% of the electricity consumed in 2020 was generated from wind energy, and this proportion is expected to increase further in the upcoming years. Turkey has a considerably high wind energy potential; consequently, it is planning to activate a wind energy capacity of 16,000 MW by 2027. As of June's end 2022, our wind energy-based electricity-installed capacity is 10,976 MW (ETKB, 2022).

KIND OF WIND ENERGY

Wind energy being sourced from nature, is one of the renewable energy sources with the lowest impact on the environment. Owing to its geographical positioning, Turkey has a rich wind energy potential. To obtain maximum wind energy, we should choose useful areas and important parameters. Therefore, the selection of wind turbine areas is a very important criterion.

Onshore wind energy

Onshore wind energy refers to the production of electricity by wind turbines located on land. Wind turbines capture the kinetic energy of the wind and convert it into electrical energy that can be used for various purposes, including powering homes, businesses, and industries.

Table 1. Advantages and disadvantages of onshore wind energy

Advantages	Disadvantages
It is renewable because it is a natural resource. It is clean because it produces no greenhouse gas emissions or air pollutants during operation.	Some people think that it causes visual pollution and can create noise pollution for those living nearby.
It is an unlimited source of energy because it takes its energy from nature.	Sometimes it needs the kind of space that would affect agriculture or habitat protection areas. There can also be environmental impacts related to bird and bat collisions and habitat disruption.
After the initial investment, the operating cost is lower than that of fossil fuel power plants.	The upfront costs of building and installing wind turbines can be high.
It reduces a country's reliance on imported fossil fuels, enhancing energy security.	

The convenient area selection for onshore wind power projects involve a combination of technical, environmental, economic, and regulatory factors. These criteria help determine the feasibility of installing wind turbines at a particular location. These criteria:

- **Geotechnical and topographical analysis:** The geological characteristics of the site, including soil type and stability, as well as the topography of the land, are important in determining the feasibility of installing wind turbines and their foundations.
- **Wind resource assessment:** The primary criterion is the availability of sufficient and consistent wind resources. Wind speed and direction data were collected over a period to analyze the energy potential at a site. Sites with higher average wind speeds are favorable for onshore wind projects.
- **Land availability:** Choosing a suitable area for wind energy production is one of the most important criteria. The basis of the offshore wind power plant (WPP) investment lies at this point. For this purpose, it is necessary to determine the regions with high wind potential. Sufficient land area is required for wind turbine installation and associated infrastructure. Flat lands are preferred, away from residential areas, agricultural areas, and animal husbandry areas. The proximity to existing roads, transmission lines, and other infrastructure is also important.

- Environmental impact: Environmental assessments are conducted to evaluate potential impacts on wildlife, habitats, and ecosystems. This includes considering the potential effects on bird and bat populations and the disruption of local ecosystems and landscapes.
- Noise and visual impact: The visual and noise impacts of wind turbines on nearby residential areas and lands should be assessed. The permissible noise levels and distances to residential areas are determined by the regulations.
- Meteorological conditions: In addition to wind speed, other meteorological factors, such as turbulence, shear, and temperature gradients, can affect turbine performance and stability.
- Infrastructure and logistics: Access to the site for construction, equipment transportation, and ongoing maintenance is crucial. Sites that are easily accessible can help reduce project costs and complications.
- Grid connection: The proximity to the electrical grid and the capacity to connect the generated electricity to the grid are crucial factors. Grid connection costs, capacity, and compatibility must be considered.
- Wind turbine technology: The choice of wind turbine technology and design can affect the suitability of a site. Factors such as turbine size, tower height, and rotor diameter are considered in relation to the site's wind conditions.

Offshore wind energy

Offshore wind energy refers to the generation of electricity using wind turbines situated in bodies of water, typically in oceans or seas. These wind turbines operate similarly to onshore wind turbines, but they are located in offshore locations where the wind is often stronger and more consistent than that in onshore locations.

Table 2. Advantages and disadvantages of offshore wind energy

Advantages	Disadvantages
It has higher and more consistent wind speeds than onshore locations. This means more reliable power generation and higher power capacity.	Building and installing offshore wind turbines is generally more expensive than onshore installations. The cost of constructing and maintaining the necessary infrastructure, such as foundations, substructures, and cabling, can be substantial.
Because it has extensive marine environments, it can build larger turbines. These larger turbines can generate more electricity per unit, thus contributing to higher overall energy use.	Operating in a marine environment can be challenging. Installation and maintenance activities require specialized vessels, equipment, and skilled personnel, which can increase costs and complexity.
It is typically placed away from densely populated areas, thereby reducing the visual and noise effects that can be associated with WPPs.	It can have environmental impacts, including disturbance to marine ecosystems during construction and potential risks to marine life from turbine operations and underwater noise.
Unlike WPPs, which require large areas of land, OWPPs use bodies of water where land use conflicts are minimized.	It is exposed to harsh weather conditions, including storms, saltwater corrosion, and extreme temperatures, which can increase maintenance requirements and affect the overall lifespan of the equipment.

OWPPs can be installed both on land and at sea; these projects include different processes and criteria from design to production. These criteria:

- Location selection: One of the most crucial stages of OWPPs is the selection of a suitable location. In this process, professionals from various disciplines, such as engineers, meteorologists, geologists, oceanographers, and ornithologists play roles. Wind measurements are taken, marine conditions are examined, and criteria such as water depth are calculated. Alongside these factors, environmental considerations, ship traffic, fishing activities, and other factors are also considered.
- Wind energy potential assessment: Conducting wind energy potential assessments is highly important in OWPPs. These studies were conducted to select suitable wind turbines and enhance their energy efficiency.
- Ocean observations: Detailed ocean observations are carried out for OWPPs. Designs and engineering calculations are made based on the results of these observations. Notably, currents and wave heights are among the key observations. In addition, interactions with marine life and seabed geotechnics must be well-understood (Durak et al., 2020).
- Geophysical and geotechnical studies: Geophysical and geotechnical surveys involve bathymetric measurements and studies of seabed geotechnics. These studies were conducted using purpose-built research vessels (Durak et al., 2020).
- Engineering: The design of OWPPs is accomplished through engineering studies. In this phase, technical details such as wind turbine design, material selection, laying underwater cables and preparing the seabed for appropriate foundation are determined.
- Permits: Permits required for OWPPs are obtained from sectors including environment, maritime, energy, agriculture, and other relevant fields. This stage is highly significant for the project execution. The permit and approval process may vary by country, but environmental impact assessments (EIAs) are mandatory in all countries (Durak et al., 2020).
- Financing: Financing OWPPs can be quite costly. Therefore, before project financing, costs should be calculated and evaluated if it is possible.
- Construction: The construction phase of OWPP projects can be quite lengthy. During this stage, wind turbines are constructed, underwater cables are placed, and other technical operations are conducted. Moreover, environmental protection measures are taken to avoid damage to environmental factors and natural habitats.
- Operation and Maintenance: Because OWPP projects are structures that need to operate for many years, the operation and maintenance process is crucial. The regular maintenance of wind turbines, underwater cables, and other technical equipment is necessary. In addition, energy production and efficiency should be monitored during the operation phase.

In addition to all these stages, port infrastructure is also a crucial aspect of OWPP projects. This is because all equipment is transported from the port, which must meet certain standards. When examining major OWPP projects with high installed capacity in Europe, project sites are located near major ports. Furthermore, because OWPP projects are present in the North Sea, having major ports of European countries located in the North Sea is a significant advantage (Durak et al., 2020).

CURRENT STATUS IN TURKEY

Onshore wind

The regions with the highest wind energy potential in Turkey are the Marmara, Aegean coastal areas, and the Southeastern Anatolia region. These regions also exhibit significantly high annual average wind speeds and wind densities. In the Marmara region, the annual average wind speed is 3.29 m/s and the wind density is 51.91 W/m², whereas for the Southeastern Anatolia region, these values are 2.69 m/s and 29.33 W/m², and for the Aegean region, they are 2.65 m/s and 23.47 W/ (Kaya, 2021).

Owing to its substantial wind energy potential, Turkey has become one of the largest wind energy globally. The increase in wind energy use will contribute to both environmentally friendly energy usage and energy independence. Therefore, efforts to enhance Turkey's wind energy capacity should continue swiftly.

According to the report dated January 2020 by the Turkish Wind Energy Association (TWEA), there are 198 wind energy power plants in Turkey. The combined installed capacity (electrical power) of these plants is 8,288-MW (Figure 1). According to the data provided in the report, there are 45 power plants in the province of Izmir, with a combined installed capacity of 1,549.50 MW. The wind power plant with the highest installed capacity in Izmir is the Karaburun Wind Power Plant, with a capacity of 224 MW. The province of Balıkesir comes in second with a total installed capacity of 1,163.50-MW from 26 power plants. The wind power plant with the highest installed capacity in Balıkesir is the Balıkesir WPP, with a capacity of 143 MW. In third place, the province of Manisa holds a position with 9 power plants, accounting for a total installed capacity of 689.95 MW and a percentage share of 8.56%. The wind power plant with the highest installed capacity in Manisa is the Soma WPP, with a capacity of 284.10 MW. Based on these data, the provinces of Izmir, Balıkesir, and Manisa are among the provinces with the highest wind energy capacity in Turkey.

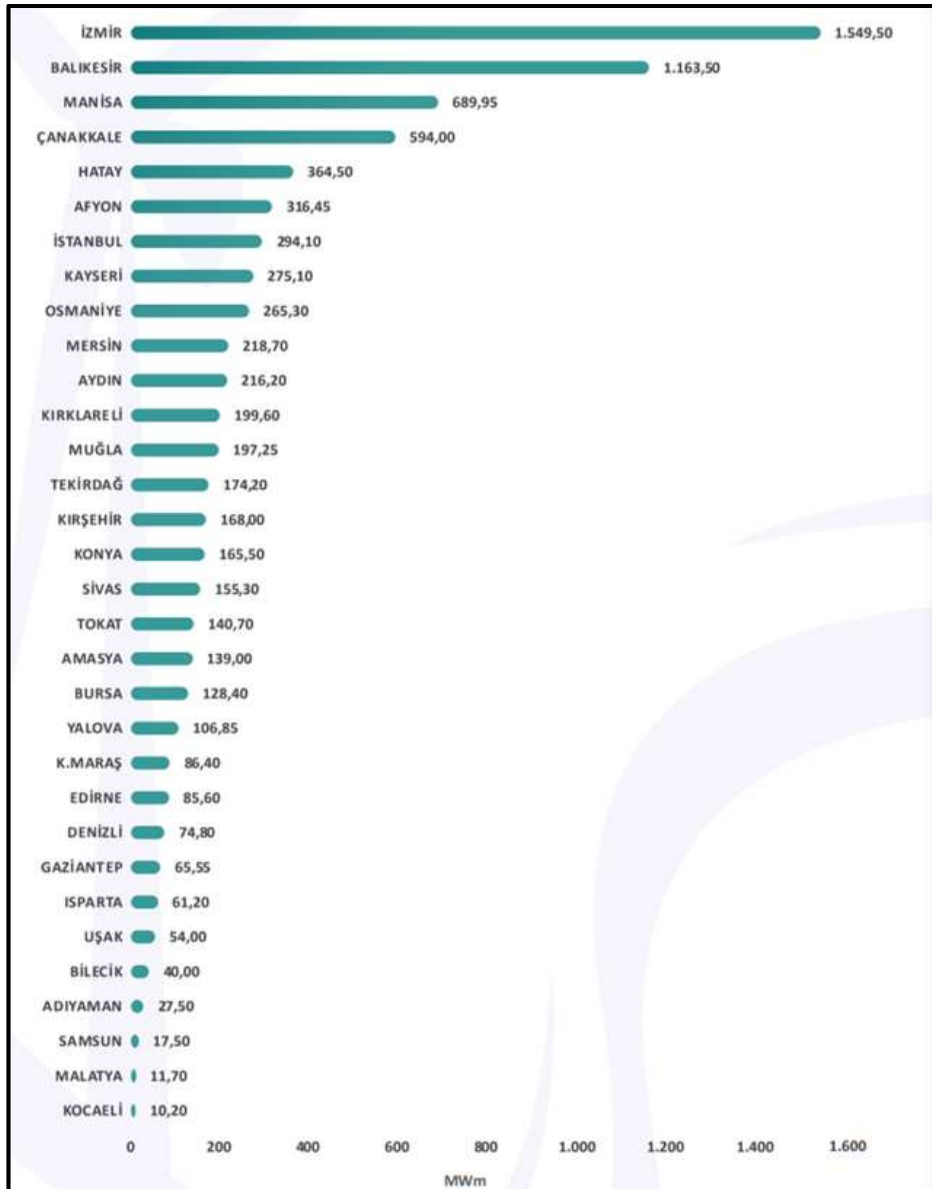

Figure 1. The distribution of WPPs in operation by province (TWEA, 2020)

Offshore wind

According to the statements of Durak, Chairman of the Offshore Wind Energy Association, Turkey's installed power in energy has exceeded 104 GW as of the end of May 2023. According to a report published by the World Bank in October 2019, the offshore wind energy potential is 75 GW. The area where this potential is highest in Turkey is northwest of the Aegean region. This region has a total wind energy potential of 25 GW, of which 6 GW is fixed and 19 GW is floating. The next highest capacity of the Aegean Sea is the Marmara Sea. In these seas, there is both high wind intensity and it is located around the provinces where we need high energy. We can easily talk about the energy potential of 50 GW in these regions, which is approximately half of the installed power of our country (Temiz Enerji, 2023).

There is no offshore wind project that has been implemented yet in Turkey. However, because of years of studies on this subject, the Ministry of Energy and Natural Resources announced the candidate Renewable Energy Resource Areas for the first offshore wind power plant on July 4, 2023.

According to the statement made by the Ministry, renewable energy areas for the first offshore wind power plant were determined as Bandırma, Bozcaada, Gelibolu, and Karabiga offshore (Figure 2).



Figure 2. Renewable energy fields for the first offshore wind farms (TWEA, 2023)

ENVIRONMENTAL EFFECTS OF WIND ENERGY

Onshore wind

Due to their environmental impacts on ecosystem, WPP projects should be carefully planned, installed, and operated. Many factors should be considered during the planning, installation, and operation phases of these projects. The possible environmental impacts of WPPs may vary depending on the size and location of WPP projects and environmental factors. It is possible to list some possible environmental effects as follows:

- May cause changes in vegetation during construction and operation. Preparation of the plant site may lead to the destruction or alteration of local vegetation. This, in turn, can affect the structure of local ecosystems.
- It may cause noise and vibrations during operation. This can affect the quality of life of surrounding people and the behavior of nearby wildlife.
- May have environmental effects on birds and local wildlife. The rotational motion of wind turbines can affect the flight paths of birds and create a collision risk. It can also cause visual pollution.
- Large land areas are required for its construction and operation. This can result in changes in the use of farmland and natural habitats. In addition, new roads and infrastructure needs may arise for the deployment of wind turbines and related infrastructure.

Offshore wind

OWPPs are environmentally friendly energy production systems as renewable energy sources. However, as with any power generation system, the environmental impact of OWPP

should be evaluated. There is no OWPP project implemented or is about to be implemented in our country. However, it is possible to examine the environmental effects of OWPP through existing projects around the world. While examining the environmental impacts of OWPPs, planning, installation, and operation phases should be taken into account, just as in WPPs. Since the environmental effects of OWPP are seen mostly in the marine environment, they differ from the environmental effects of WPP. It is possible to list some possible environmental effects as follows:

- Its construction and operation may affect the marine ecosystem. During the construction process, excavations on the seafloor and foundation building can result in the destruction or alteration of marine habitats. In addition, anchoring wind turbines to the seafloor or placing them on floating platforms can alter the seafloor substrate and affect benthic (lowest aquatic ecoregion) habitats.
- Acoustic noise and electromagnetic fields can also affect marine life.
- It may cause visual pollution on the shoreline. This may affect tourism activities and have a potential impact on economic activity in coastal areas.
- Its construction and operation may affect maritime traffic. Wind turbines and submarine cables can become obstacles to marine traffic and fishing activities and affect navigation safety.

Necessary measures should be taken to manage and mitigate these effects. Thus, environmental sustainability can be achieved while achieving the goal of clean energy production.

RESULTS AND DISCUSSION

The important differences between onshore and offshore wind energy can be seen in the Table 3 as a short summary.

Table 3. Comparison of offshore and onshore wind energy systems

Offshore wind turbines are more difficult and costly to install than land turbines.
Offshore wind turbines have higher transportation and maintenance costs because they are installed in offshore environments.
Offshore wind turbines provide higher energy efficiency because they have higher wind speeds. This indicates that it will be a more economical choice eventually.
Offshore wind turbines have wider installation locations. In this way, more and larger turbines can be installed, resulting in more energy production.
The environmental impacts of offshore turbines are less than onshore turbines.

The energy capacities of offshore wind energy systems are considerably higher than all other renewable energy systems. Emphasis should be focus on OWPP projects to evaluate this potential to the maximum extent and exhibit an environmentally sensitive approach to energy production.

While the costs of OWPPs exceed those of WPPs, they have a greater energy generation capacity. If comprehensive efforts are undertaken for OWPP projects in Turkey, it will understand more obvious that the country is well suited for OWPPs, resulting in significant increases in energy production. Implementation of necessary incentives and policies is crucial for the success of these projects.

OWPP projects will reduce dependence on fossil fuels and minimize environmental impacts. By promoting clean energy production, they will decrease carbon emissions and contribute to decrease climate change. Additionally, OWPPs, being constructed in marine environments, will eliminate some issues such as noise pollution, visual pollution, and potentially bird mortality (although monitoring this in a marine environment might be challenging).

Effective implementation of OWPP projects requires careful selection of appropriate technology. Wind turbines resistant to marine conditions should be utilized, and infrastructure compatible with the seabed should be constructed. Moreover, considerations must encompass wave movements, currents, and other environmental factors.

The extension of OWPP projects in Turkey will also produce economic benefits. New job opportunities going to be occurred to support indigenous industry and technology development. Furthermore, OWPPs will serve as a significant step toward reducing Turkey's energy dependence and achieving sustainable development goals.

CONCLUSIONS

The environmental impact of wind energy systems (offshore/onshore both) is minimal, but the energy capacity is high. When maximum energy efficiency from energy source is desired, it is necessary to focus on offshore wind energy systems. Turkey's wind energy potential is high, and it is possible to switch from onshore wind energy systems to offshore wind energy systems in the light of appropriate regulations/laws+regulation/law.

REFERENCES

- Durak, Dr. Murat ve Güçlüer Küpeli, Dolunay. 2020. Deniz Üstü Rüzgâr Elektrik Santralleri. Kaya, E. 2021. A'dan Z'ye Rüzgâr Santrali. Nordex Enerji, İzmir. 274 pages.
- MENR (Ministry of Energy and Natural Resources of Türkiye). 2022. <https://enerji.gov.tr/bilgi-merkezi-enerji-ruzgar>, Date of Access: 15 June 2023.
- MENR (Ministry of Energy and Natural Resources of Türkiye). 2023. <https://enerji.gov.tr/duyuru-detay?id=20382>, Date of Access: 5 July 2023.
- Temiz Enerji, 2023. Türkiye'de Yüzer Temelli Deniz Üstü Rüzgâr Enerjisi İçin Ar-Ge Çalışmaları Devam Ediyor. <https://temizenerji.org/2023/06/23/turkiyede-yuzer-temelli-deniz-ustu-ruzgar-enerjisi-icin-ar-ge-calismalari-devam-ediyor/>, Date of Access: 25 June 2023.
- TWEA (Turkish Wind Energy Association). 2020. Turkish Wind Energy Statistics Report. Ankara. 49 pages.

ASSESSMENT OF METHANE EMISSIONS FROM BALAKHANI LANDFILL USING LANDGEM MODEL

Fakhraddin Mammadli¹, Serkan Eker¹

¹ *Dokuz Eylül University, Department of Environmental Engineering, İzmir, Turkey*

Corresponding author e-mail: serkan.eker@deu.edu.tr

ABSTRACT

Landfill sites are significant anthropocentric sources of pollutants, encompassing various forms such as litter, dust, odor, and emissions of landfill gas (LFG). This research focuses on evaluating the methane emissions originating from the Balakhani municipal solid waste sanitary landfill located in Baku, Azerbaijan. The estimation of methane emissions was conducted using the Landfill Gas Emissions Model (LandGEM). The quantity and rate of LFG are subject to variation based on the organic composition of the waste material that is deposited within the landfill site. The study's framework encompassed an evaluation of several key factors, including the quantity of waste deposited in landfills, the characteristics of these landfills, the composition of the waste materials, and the current climate in the area.

Keywords: Municipal solid waste, Methane, Sanitary landfill

INTRODUCTION

In an era marked by burgeoning populations and the consequent surge in waste generation, the role of landfills in exacerbating atmospheric methane levels has gained substantial attention. The correlation between increasing population, waste production, and the potential for landfills to become significant contributors to atmospheric methane is becoming more pronounced. Methane, with its current atmospheric concentration of 1.7 parts per million (ppm), holds a noteworthy position, contributing approximately 15% to the anthropogenic greenhouse effect. Moreover, its concentration shows a discernible upward trajectory. Projections indicate a global annual increase of around 30 million tons in methane emissions from landfills. Particularly notable is the prevalence of landfill methane emissions in industrialized nations characterized by high per capita waste output rates. In fact, a prominent source—accounting for approximately 80%—of atmospheric methane emissions stems from the disposal of solid waste in landfills (Tsatsarelis and Karagiannidis, 2009; Kalantarifard et al., 2012).

Amid the complex interplay of environmental factors, the release of landfill gas, a byproduct of solid waste decomposition at landfill sites, emerges as a notable environmental concern within the framework of global warming. Central to this concern is the substantial presence of methane—a compound possessing considerable calorific value—within landfill gas. Notably, methane's heat-retention capability within the atmosphere surpasses that of carbon dioxide by about 20-fold. This elevated efficiency renders methane a potent greenhouse gas, exerting discernible influence over the Earth's climate system. Recognizing the urgency of the situation, the implementation of strategies designed to curtail methane emissions, coupled with the conversion of landfill gas into usable energy, offers a dual advantage encompassing both economic and environmental facets. This confluence of factors propels the notion of landfill sites as prospective energy sources (Fourie and Morris, 2004; Kumar et al., 2004; Nickolas and Ulloa, 2007; Vasudevan et al, 2011; Barros et al, 2014).

Navigating this landscape, the present and future applications of landfill gas can be succinctly categorized into three principal domains: electricity generation, direct deployment as heating-boiler fuel, and utilization as a fuel source for vehicles, among other innovative avenues. By exploring and harnessing these applications, society stands to not only address the pressing issue of methane emissions but also to unlock potential energy resources that can effectively steer us toward a more sustainable future (Nickolas and Ulloa, 2004; Vasudevan et al, 2011; Rodrigue et al, 2018).

Nonetheless, landfills stand out as non-point sources of methane emissions, contributing to spatial variability that complicates the measurement of this pervasive gas. The quantification of methane emissions from landfill sites holds paramount importance in the pursuit of reducing greenhouse gas (GHG) emissions emanating from both source and non-source points. While several studies have endeavored to assess methane emission rates from landfills (Kumar et al, 2004, Nickolas et al., 2007; Couth et al, 2011; Kalantarifard et al, 2012; Fallahizadeh et al, 2019), a noticeable research gap remains in determining methane emission rates, overall greenhouse gas volumes, and emissions per capita for each gas specifically in Azerbaijan.

The task of estimating methane emissions for national greenhouse gas inventories has traditionally relied on waste quantity and composition considerations (Kumar et al., 2004). Prior investigations have indicated that the generation of greenhouse gases from a metric ton of waste ranges from 40 to 250 m³. Over recent years, a spectrum of mathematical models has evolved to predict landfill gas emissions, employing approaches of varying orders (zero, first, or second). Numerous models have been developed to approximate landfill gas emissions from sites dedicated to municipal solid waste disposal. However, these methodologies are not devoid of limitations, including incomplete emission coverage, limited spatial scope, sensitivity to irregular topographies, complexity, uncertainty in source area delineation, and high-cost implications. Among these alternatives, LandGEM stands out as the most widely employed model for estimating landfill gas emissions. Its popularity is attributed to its straightforwardness and resistance to atmospheric instability effects. Nonetheless, as the field of emissions estimation evolves, it becomes evident that an integrated approach, possibly harnessing the strengths of multiple methods, holds the key to a more comprehensive understanding of landfill gas emissions and their potential impact on the environment (Alexander et al, 2005; Couth et al, 2011; Kalantarifard et al, 2012; Sadeghi et al, 2015; Fallahizadeh et al, 2019)

The process of urbanization and the subsequent shifts in the lifestyle patterns of urban dwellers have led to the emergence of solid waste creation. During that period, Azerbaijan saw a significant economic revival as a result of its oil resources, which laid the groundwork for enhancing living standards. Concurrently, the nation experienced a swift expansion of urban areas due to a substantial influx of individuals migrating to the city of Baku. The quantity of municipal waste generated in Azerbaijan exhibits a positive correlation with the growth of the country's Gross Domestic Product (GDP). The improvement of the socio-economic conditions has resulted in a significant increase in population, as evidenced by the growth rate of Baku city's population (2.341 million), which has experienced a substantial rise of around 34.8 percent during the period spanning from 1991 to 2018, as reported by the State Statistics Committee of the Republic of Azerbaijan.

This study aims to bridge these research gaps and offer insights into refining emissions estimation techniques for landfill sites, thereby contributing to more accurate greenhouse gas inventories and informed mitigation strategies.

MATERIAL AND METHOD

The research focuses on the Balakhani landfill, situated along the northeastern shoreline of Boyuk Shor Lake within the Sabunchu district of Baku City. This location, approximately 15 km distant from Baku, encompasses a total expanse of 120 hectares, of which around 45 hectares are actively utilized for waste disposal. Geographically, the Balakhani landfill is positioned within the Absheron region, characterized by a prevailing continental climate. This climate features a modest annual rainfall of 200–250 mm and an average yearly air temperature of approximately 14.2° Celsius. Notably, the highest temperatures manifest in August, reaching peaks of 37-42°C, while the lowest values (-8-12°C) are observed during January (National Hydrometeorology Department).



Figure 1. The geographical location of the area under study

Presently, the Balakhani landfill lacks a landfill gas (LFG) collection and leachate treatment system, resulting in the emission of LFG into the atmosphere. The greenhouse gas methane constitutes a significant component of LFG, thereby posing a noteworthy contribution to global warming.

The composition of solid waste exerts a notable influence on the rate of landfill gas production. The outcomes pertaining to solid waste composition in the study area are elucidated in Table 1. The results underscore that organic and food-related waste constitute the most substantial portions within the solid waste stream, exceeding 40%. Given their propensity for swift decomposition and subsequent gas generation, the imperative nature of effective solid waste management becomes evident in this context. It is noteworthy that the composition of waste profoundly impacts the types of gases generated within the landfill. The prevalence of organic and food waste, owing to their rapid decomposition, contributes to an accelerated emission of gases from the landfill. Moreover, the presence of plastic emerges as a noteworthy component within the solid waste fractions.

Furthermore, the cumulative quantity of solid waste disposed of at the Balakhani Landfill Site is presented in Table 1.

Table 1. Waste composition at the Balakhani Landfill Site (2011-2012)

Waste Type	Content (%)
organic	40.0%
paper and cardboard	18.4%
textile	4.6%
wood	1.5%
plastic	10.9%
baby diaper	7.6%
glass	6.6%
other	3.1%
metal	1.6%
composit	1.3%
bulk waste	1.1%
shoes	0.8%
small hazardous wastes	2.2%
ceramic	0.6%

Table 2. The amount of waste deposited at Balakhani Landfill Site

Year	Waste Accepted (Mg/year)	Year	Waste Accepted (Mg/year)
2009	130,411	2017	219,000
2010	140,700	2018	235,000
2011	146,665	2019	147,000
2012	150,700	2020	157,000
2013	181,383	2021	170,000
2014	191,282	2022	170,000
2015	387,000		
2016	472,500		

The Landfill Gas Emissions Model (LandGEM) stands as a computerized estimation tool seamlessly integrated with a Microsoft Excel interface. It serves the pivotal purpose of estimating emission rates encompassing total landfill gas, methane, carbon dioxide, nonmethane organic compounds, and specific air pollutants originating from municipal solid waste landfills. This modeling practice emerges as a critical stride within project development, as it furnishes insights into the projected recoverable LFG volumes anticipated over time. Fundamentally, LandGEM operates on the foundation of a first-order decomposition rate equation, orchestrating the quantification of emissions ensuing from the decomposition of landfill-bound waste within MSW landfills (Alexander, A et al., 2005; Kalantarifard, et al, 2012; Chandra et al, 2023.).

The equation employed for the estimation of methane generation is formulated as follows:

$$Q_{CH_4} = \sum_{i=1}^n \sum_{j=0.1}^1 kL_0 \left(\frac{M_i}{10} \right) e^{-kt_{ij}}$$

Where:

- Q_{CH_4} represents the annual methane generation in the year of calculation ($m^3/year$).
- i corresponds to the yearly time increment, ranging from the initial year of waste acceptance to the year of calculation.
- n stands for the total number of years encompassed by the calculation (year of calculation - initial year of waste acceptance).
- j signifies the 0.1-year time increment.
- k denotes the methane generation rate ($year^{-1}$).
- L_0 signifies the potential methane generation capacity (m^3/Mg).
- M_i refers to the mass of waste accepted in the (i)th year (Mg).
- t_{ij} denotes the age of the j th segment of waste mass M_i accepted in the i th year.

This equation serves as the cornerstone for assessing methane generation rates within the studied landfill site. It amalgamates variables capturing waste mass, time increments, potential generation capacity, and methane generation rates, orchestrating a comprehensive understanding of methane production trends.

Regarding emissions composition, LandGEM estimates the composition of municipal solid waste (MSW) landfill emissions, attributing approximately 50% each to methane (CH₄) and carbon dioxide (CO₂), accompanied by trace nonmethane organic compounds (NMOCs). However, these default percentages can be tailored to specific scenarios. LandGEM affords the flexibility to estimate concentrations of total and speciated NMOCs, allowing for default or site-specific concentrations. The CH₄ generation rate constant (k) is a pivotal parameter dictating the rate of CH₄ generation across landfill waste segments. It is influenced by waste moisture content, nutrient availability for methanogens, pH, and temperature. (k) values span 0.003 to 0.21, obtained from field test data and theoretical models. LandGEM utilizes default (k) values if not user-specified, with the model's default value at 0.05 year⁻¹ for conventional landfills under the Clean Air Act (CAA) option. In this study, the determination of the k value for the Balakhani landfill site involved consideration of two crucial factors: the average annual precipitation in the Absheron peninsula and the typical composition of waste found within the landfill. Given the dynamics of waste degradation and separation within this particular landfill environment, coupled with the influence of annual rainfall on the site, an estimation of k = 0.017 yr⁻¹ was derived. This calculated k value, signifying the methane generation rate (yr⁻¹) for the Balakhani landfill, stands as a pivotal parameter driving the modeling and estimation of methane emissions within this distinctive landfill context. The potential CH₄ generation capacity of waste (L_o) is a factor determined solely by the waste type. The theoretical and attainable range for (L_o) spans 6.2 to 270 m³/Mg of waste. LandGEM accommodates both user-specified and default (L_o) values, with the model's default (L_o) set at 170 m³/Mg of waste for the CAA conventional landfills option. The L_o value of 116.7 m³/Mg for the Balakhani landfill was determined using the equation provided in the LandGEM User's Guide. The concentration of nonmethane organic compounds (NMOCs) in landfill gas is contingent on waste types and decomposition reactions. NMOC concentration data were sourced from emission test reports, yielding a range of 240 to 14,300 ppm from 23 landfills. LandGEM deploys suggested default NMOC concentrations, varying between CAA and inventory default options.

RESULTS AND DISCUSSION

Upon executing the LandGEM model with the dataset provided in Table 1 and 2, the investigation yielded valuable insights into the potential methane production rate and total landfill gas emissions stemming from the Balakhani landfill site (Figure 2). The commencement year for MSW disposal at the Balakhani landfill was set as 2005, as depicted in Figure 2. Through the LandGEM model outcomes, it became evident that the initial twenty-five years of landfilling exhibited substantial total gas and methane production rates. Figure 2 effectively showcases the projected trends, with estimations pointing to peak quantities of total emissions, carbon dioxide, and methane from the Balakhani landfill. The model's projections indicate a gradual decline in methane emission rates post the initial twenty-five years. This phenomenon could be attributed to a decrease in emission rates following the initial five years, primarily driven by the substantial degradation of the organic solid waste fractions during this timeframe. Organic waste constituents can be broadly classified into rapidly degradable and slowly degradable compounds. Rapidly degradable compounds typically break down within a span of three months to five years, whereas their slow-degrading counterparts decompose over periods surpassing fifty years. Swiftly degradable elements encompass food waste, putrescence, fines,

and certain segments of garden waste, while slowly degradable components encompass rubber, textiles, leathers, woody garden waste, and others.

The comprehensive analysis and meticulous estimations surrounding Municipal Solid Waste (MSW) characteristics have enabled the determination of the total volumes of biogas, methane (CH₄), carbon dioxide (CO₂), and nonmethane organic compounds (NMOC) emissions, all measured in cubic meters per year (m³/year). Considering these calculations, the trajectory of gas production within the Balakhani landfill has been projected. Remarkably, the estimates indicate that the pinnacle of total biogas emissions from the Balakhani landfill will be attained in the year 2024, reaching the level of 76,982.177 m³/year. Following this zenith, a subsequent exponential decline in biogas emissions is anticipated. This decline can be attributed to the gradual depletion of organic matter, a key factor contributing to biogas generation, over time.

This projection unveils the dynamic nature of gas emissions within the Balakhani landfill, underscoring the importance of anticipating both peak emission periods and the subsequent decrease. Such insights into the trajectory of landfill gas production facilitate informed decision-making processes concerning gas collection, emissions mitigation, and waste management practices for optimizing environmental sustainability.

The temporal dynamics of methane emissions from landfills were also highlighted in the study. Typically, methane emissions commence around six to twelve months after waste deposition, reaching a peak shortly after landfill closure. Subsequently, emissions exhibit a gradual decline over a span of 60-80 years, before entering another period of diminishing emissions over 40-70 years. This consistent pattern underscores the common lifecycle of methane generation in landfills, with emissions initiating shortly after waste deposition, peaking post-closure, and gradually receding over decades.

In summary, the LandGEM model simulations, informed by the specific characteristics of the Balakhani landfill site, present an anticipated trajectory of landfill gas emissions, with methane generation following distinct phases over time. These insights provide valuable guidance for landfill management and emissions mitigation strategies within the context of Balakhani's unique waste disposal environment.

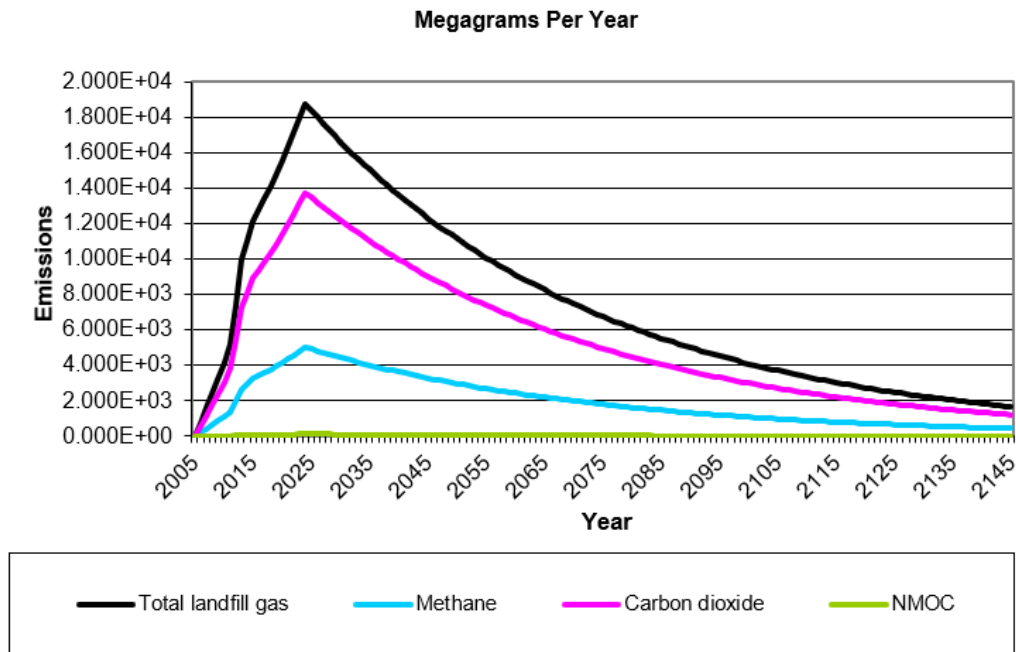

Figure 2. The amount of gas emissions originating from the Balakhani landfill site.

CONCLUSIONS

The LandGEM simulations, fueled by the distinct attributes of the Balakhani landfill site, offer a projected trajectory of landfill gas emissions. This predictive framework, revealing phases of methane generation across time, stands as a valuable resource for landfill management tactics, emissions control, and the pursuit of sustainable waste disposal practices tailored to the unique context of Balakhani's environment.

REFERENCES

- Alexander, A., Burklin, C., & Singleton, A. 2005. Landfill Gas Emissions Model (LandGEM) Version 3.02 User's Guide. U.S. Environmental Protection Agency, Office of Research and Development.
- Barros, R. M., Tiago Filho, G. L., & da Silva, T. R. 2014. The electric energy potential of landfill biogas in Brazil. *Energy Policy*, 65, 150-164.
- Couth, R. C. Trois, S. Vaughan Jones, 2011. Modelling of greenhouse gas emissions from municipals olid waste disposal in Africa. *International Journal of Greenhouse Gas Control*. 5, 6, pp 1443– 1453.
- Chandra S, Ganguly R. 2023. Assessment of landfill gases by LandGEM and energy recovery potential from municipal solid waste of Kanpur city, India. *Heliyon*. 5;9(4):e15187.
- Fallahizadeh, S., Rahmatinia, M., Mohammadi, Z., Vaezzadeh, M., Tajamiri, A., & Soleimani, H. (2019). Estimation of methane gas by LandGEM model from Yasuj municipal solid waste landfill, Iran. *MethodsX*, 6, 391-398.
- Fourie AB and Morris JW. 2004. Measured gas emissions from four landfills in south africa and some implications for landfill design and methane recovery in semi-arid climates. *Waste Manag Res.*;22(6):440-53
- Kalantarifard, A., & Yang, G. S. 2012. Estimation of Methane Production by LANDGEM Simulation Model from Tanjung Langsat Municipal Solid Waste Landfill, Malaysia. *International Journal of Science and Technology*, 1(9), 481–487.

- Kumar, S., Mondal, A. N., Gaikwad, S. A., Devotta, S., & Singh, R. N. 2004. Qualitative Assessment of Methane Emission Inventory from Municipal Solid Waste Disposal Sites: A Case Study. *Atmospheric Environment*, 38, 4921–4929.
- Nickolas, J. T., & Ulloa, P. A. 2007. Methane Generation in Landfills. *Renewable Energy*, 32(7), 1243-1257.
- Rodrigue, K., Essi, K., Cyril, K., & Albert, T. 2018. Estimation of Methane Emission from Kossihouen Sanitary Landfill and Its Electricity Generation Potential (Côte d'Ivoire). *Journal of Power and Energy Engineering*, 6, 22–31.
- Sadeghi, S., & Shahmoradi, B. (2015). Estimating Methane Gas Generation Rate from Sanandaj City Landfill Using LANDGEM Software. *Research Journal of Environmental Sciences*, 9, 280.
- Tsatsarelis, T., and Karagiannidis, A. 2009. Estimation of Future Methane Production from Hellenic Landfills. *Global NEST Journal*, 11(2), 162-171.
- Xiaoli, C., Ziyang, L., Shimaoka, T., Nakayama, H., Ying, Z., Xiaoyan, C., ... & Inoue, T. (2010). Characteristics of environmental factors and their effects on CH₄ and CO₂ emissions from a closed landfill: an ecological case study of Shanghai. *Waste Management*, 30(3), 446-451.
- Vasudevan Rajaram, Faisal Zia Siddiqui, M. Emran Khan. 2011. *From Landfill Gas to Energy: Technologies and Challenges*. CRC Press. Pages 107-108.

INFLUENCE OF ROOT RESTRICTION ON YIELD AND FRUIT QUALITY IN 'HAFIF ÇUKURGOBEK' LOQUAT TREES

A. Aytekin POLAT¹

¹Hatay Mustafa Kemal University, Faculty of Agriculture, Department of Horticulture,
Antakya, 31034 Hatay, Turkey

Corresponding author e-mail: aapolat@mku.edu.tr

ABSTRACT

In the study, the effect of root restriction treatment on fruit yield and quality of loquat (*Eriobotrya japonica* Lindl) trees was investigated. 'Hafif Çukurgöbek' loquat trees budded on seedling rootstock were planted within root restrictive plastic containers buried in the soil and compared with trees planted without containers(control). Yields per tree, per unit trunk cross-sectional area and per unit area, and pomological characteristics of fruits were determined according to the treatments. Root restriction treatment had no effect on the maturity period of the fruits. In trees with restricted root growth, yield per plant and yield per unit area were lower, while yield per trunk cross-sectional area was higher than the control trees. In terms of fruit weight, fruit size and seed weight, higher values were obtained from root-restricted trees compared to control ones. There was no significant difference between the treatments in terms of other fruit characteristics. As a result, positive effects of root restriction treatment were determined in loquat trees compared to control ones.

Key words: Root restriction, fruit set, vegetative growth, yield, loquat.

INTRODUCTION

Achieving the proper balance between vegetative and reproductive growth is necessary to enhance early orchard production and to maximise yields during the life of the orchard (Williamson and Coston, 1990). To achieve these aims, the control of vigour has long been viewed as a major consideration in the successful management of fruit trees.

The majority of research directed at controlling tree growth has focused on either genetic means or on cultural practices aimed at the above-ground portions of the tree (Ferree et al., 1992). The genetic approach has met with some success with the selection of dwarfing cultivars (Scorza et al., 1984; Hansche et al., 1986) and rootstocks to control fruit tree size. However, the development of size controlling rootstocks for species other than apple and pear and the selection of dwarfing cultivars has been limited (Martin, 1989; Ferree et al., 1992).

Therefore, cultural practices such as pruning, plant growth regulators, girdling, and root restriction have also been used to control tree size, flowering and fruit yield with varying degrees of success. The existence of a close coordination between root and shoot growth opens up possibilities that above-ground growth can be altered by belowground manipulation. One approach of below-ground manipulation to control tree size is root pruning and root restriction. Many studies have shown that shoot growth is related to the strength of the root system and that it is possible to change the root growth of the plant with belowground manipulation. Reductions in shoot growth rates following root pruning have been shown for apple (Schupp and Ferree, 1987; Schupp and Ferree, 1988a; Ferree, 1989; Schupp and Ferree, 1990) and peach (Richards and Rowe, 1977a). There are limited reports on use of root pruning to control growth of plants other than apple (Ferree et al., 1992).

Root restriction is another approach of below-ground manipulation to control tree size. Unlike root pruning, new root growth is limited as the root system is restricted to a confined space. Reductions in shoot growth of fruit trees has been shown where root volume was restricted by root containers (Richards, 1986; Williamson and Coston, 1990; Myers, 1992; Williamson et al., 1992). Nonetheless in these studies, the effect of restricted root volume translated into a increase in yield efficiency (yield per tree/trunk cross-sectional area). There is no study in the literature reporting the effects of root restriction on loquat (*Eriobotrya japonica* Lindl) trees.

Loquat seedlings are generally used as rootstock in loquat cultivation in Turkey. On this rootstock, loquats form large crowned trees 5-10 m tall. Since the cultivation cost of such trees forming a large crown is high, it is necessary to control the vegetative growth of loquat trees in order to reduce these costs (Polat, 2022a,b). In this context, while studies on the determination of suitable dwarf rootstocks for loquat (Polat, 2021, 2022a,b,c; Akkuş and Polat, 2020, 2021, 2022) are carried out, on the other hand, the effects of root restriction on various vegetative and generative parameters of the loquat trees are tried to be determined. The aim of this study is to determine the effect of root restriction on fruit yield and quality of HCG loquat variety.

MATERIAL AND METHODS

The experiment was carried out in the loquat orchard in the research area of Hatay Mustafa Kemal University, Faculty of Agriculture, Department of Horticulture, Hatay, Turkey in 2019 and 2020. The research area is located at 36° 52' N latitude, 36° 12' E longitude, with an elevation of 80 m. In the study, Hafif Çukurgöbek cultivar budded onto the seedling rootstock were used. All experimental plants were grown in cylindrical plastic containers with 25 litre volume on seedling rootstocks. In the establishment stage of the experiment, the root restricted plants were planted without removing the plastic containers, while the control plants were removed from the plastic tubes with their soil and planted in the experimental area.

The trial material, one-year-old plants, were planted in the experiment area in a single row at 1.0 x 1.0 meter intervals on 26 April, 2018. The experiment was arranged according to a completely randomized design with 5 replications and 2 plants were used in each replicate. To determine fruit quality, 50 fruits (10 fruits from each replicate) were randomly sampled from each treatment and physical and chemical measurements and analyzes were made according to Polat et al. (2004 and 2005) and Akkuş (2020), including fruit weight (g), fruit dimensions (mm), seed weight (g), number of seeds (pieces), flesh/seed ratio (%), total soluble solids (TSS) (%), titratable total acidity (TA) (%), pH.

To assess yield efficiency, the total yield per tree (kg fruit per tree), the total yield per plot (tone fruit per plot), and the total yield per trunk cross-sectional area (TCSA) (g fruit per TCSA) were calculated. To calculate fruit yield per trunk cross-sectional area (g fruit per mm² TCSA), the total fruit yield per tree was divided by TCSA measured at 5 cm above the graft union at harvesting time. Considering the planting distances in the experiment, the yield for area-basis was calculated by multiplying yield per tree by the number of plants.

The variance analyzes of the data obtained from the experiment were performed in the SPSS computer package program, according to the "Completely Randomised Design" (Bek and Efe, 1987). The differences between the treatments means were compared with the LSD test.

RESULTS AND DISCUSSION

Pomological Analyses

Higher values were obtained from root restricted plants compared to control plants in terms of fruit weight, fruit width and length, and seed weight. These differences between

treatments were found to be statistically significant. Seed number, flesh/seed ratio, acidity and pH values were also measured higher in plants with root restriction, but the differences between treatments were not found to be statistically significant. SÇKM was found to be slightly higher in the control treatment (Table 1)

Table 1. The effects of root restriction on fruit quality of Hafif Çukurgöbek loquat cultivar (2020)

Treatments	Fruit weight (g)	Fruit width (mm)	Fruit length (mm)	Seed weight (g)	Seed number per fruit	Flesh/seed ratio	Soluble solids (%)	Acidity (%)	pH
Control	18.32 b ^x	31.73 b	33.67 b	5.25 b	4.02	2.52	11.30	0.45	3.16
root restriction	23.88 a	34.66 a	37.27 a	6.39 a	4.14	2.75	10.80	0.50	3.20
LSD	**	**	*	**	NS ^y	NS	NS	NS	NS

^x Different letters within columns indicate significant difference by LSD test at $P < 0.05$ or $P < 0.01$.

** : Significant at $P < 0.01$; * : Significant at $P < 0.05$; ^y NS: Not significant

The influence of root restriction on fruit size is less clear. Myers (1992) found no difference in mean fruit weight between restricted and unconfined plants. In contrast, Williamson and Coston (1990) reported a small reduction in fruit diameter in response to root restriction. Similarly, Richards (1986) found root restriction reduced fruit weight in one year but not in the subsequent year. Webster et al. (2000) reported that root restrictive membranes reduced fruit size in apple.

Yield

In the study, slightly lower values were obtained from root restricted plants compared to control plants in terms of yield per plant and yield per unit area, but these partial differences between the treatments were not found to be statistically significant. On the other hand, in terms of yield per unit trunk cross-sectional area, higher yield values were obtained in plants with root restricted than in control plants, and the difference between the treatments was found to be statistically significant (Table 2).

Table 2. The effects of root restriction on fruit yield of Hafif Çukurgöbek loquat cultivar(2020).

Treatments	Yield (g plant ⁻¹)	Yield per unit trunk cross-sectional area (g mm ² ⁻¹)	Yield (kg da ⁻¹)
Control	1051.75	0.81 b ^x	1051.75
Root restriction	1007.41	1.19 a	1007.41
LSD	NS ^y	**	NS

^x Different letters within columns indicate significant difference by LSD test at $P < 0.01$.

** : Significant at $P < 0.01$; ^y NS: Not significant

The findings of our study were found to be compatible with the findings of studies conducted on different fruit types. Indeed, Richards (1986) determined that despite final fruit yields were slightly lower for trees grown in small root volumes, the effect of restricted root volume translated into a increase in yield efficiency (yield per tree/trunk cross-sectional area). Webster et al. (2000) reported that root restriction reduced annual yield and cumulative yield in apples. In another study conducted on apple (White, 1995), it was determined that trees with

root restriction had lower yields than control trees, but the cumulative yield per unit trunk cross-sectional area and productivity efficiency were higher.

CONCLUSION

Although the physiological basis for the effects of root restriction is still not clear, the above studies indicate that restricting the root volume of fruit trees is a promising technique to control vegetative vigour and improve orchard efficiency.

Root restricting bags are used to control tree size, encourage early flowering and fruitfulness, and increase fruit productivity. In our study, it was determined that root restriction had different levels of effects on fruit yield and quality of the HCG loquat cultivar. In the study, in terms of yield per unit trunk cross-sectional area, higher yield values were obtained in plants with restricted root growth than in control plants, and the difference between the treatments was found to be statistically significant. These findings were found hopeful that it is possible to get more product from the unit area by planting densely with small-crowned trees. The findings of our study are very important and valuable as they are new findings in terms of the using of root restriction in loquat specie. When the findings of our study are evaluated in general, it is seen that trees with restricted root growth give superior results compared to control trees. However, since these findings are not sufficient to make a definitive conclusion, the study needs to be continued for a few more years.

REFERENCES

- Akkuş, S. (2020). Bazı ayva anaçlarının sık dikilen Hafif Çukurgöbek yenidoğruya çeşidinde vegetatif büyüme ve meyve kalitesi üzerine etkileri [Yüksek Lisans Tezi]. Hatay Mustafa Kemal Üniversitesi, Hatay.
- Akkuş, S., Polat A. A. 2020. Effects of quince rootstocks on phenological properties and fruit set rates in Hafif Çukurgöbek loquat cultivar. II. International Agricultural, Biological Life Science Conference, p.1120-1123.
- Akkuş, S., Polat, A.A. 2021. Investigation of vegetative growth, yield and fruit quality characteristics of 'Hafif Çukurgöbek' loquat cultivar grafted on different quince rootstocks. *Harran Tarım ve Gıda Bilimleri Dergisi*, 25(3): 279-286.
- Akkuş, S., Polat, A.A. 2022. Effect of some Quince rootstocks on inflorescence properties, flowering and fruit set in loquat (*Eriobotrya japonica* Lindl.). *KSU J. Agric Nat* 25 (2): 253-257.
- Bek, Y. ve Efe, E. 1998. *Araştırma ve Deneme Metodları*. ÇÜZF. Ders Kitabı. No:71, Adana, 395s.
- Ferree, D.C., Schupp, J.R., Myers, S.C. 1992. Root pruning and root restriction of fruit trees - current review. *Acta Horticulturae* 322: 153-167.
- Hansche, P.E., Beres, W., Darnell, R. 1986. Yield potential of peach trees dwarfed by the dw gene. *HortScience* 21(6): 1452-1453.
- Martin, G.C. 1989. Control of vegetative growth. In: *Manipulation offruiting*. (ed) C.J. Wright. London: Butterworth and Co Ltd. p 363-376.
- Myers, S. C. 1992. Root restriction of apple and peach with in-ground fabric containers. *Acta Horticulturae* 322: 215-219.
- Polat, A.A., Durgaç, C., Çalışkan, O. 2004. Effects of different planting space on the vegetative growth, yield and fruit quality of loquat. *Acta Horticulturae*, 632:189-195.
- Polat, A.A., Durgaç, C. and O. Caliskan, 2005. Effect of Protected Cultivation on the Precocity, Yield and Fruit Quality in Loquat. *Scientia Horticulturae*, 104(2):189-198.

- Polat, A.A. 2021. Investigation on the usage of hawthorn (*Crataegus* spp) as rootstock for loquat (*Eriobotrya japonica* Lindl.). *Harran Tarım ve Gıda Bilimleri Dergisi*, 25(1): 86-91.
- Polat, A.A. 2022a. Bazı anaçların Hafif Çukurgöbek yenidoğru çeşidinin makro ve mikro besin elementleri alımına etkileri. *Harran Tarım ve Gıda Bilimleri Dergisi*, 26(1): 92-100.
- Polat, A. A. 2022b. Effect of hawthorn(*Crataegus* spp) rootstock on fruit quality in loquat (*Eriobotrya japonica* Lindl.) Proceedings of IV. Balkan Agriculture Congress, Edirne, Türkiye. p.250-254.
- Polat A.A. 2022c. Effects of hawthorn (*Crataegus* spp) rootstock on vegetative growth in loquat (*Eriobotrya japonica* Lindl). Proceedings of IV. International Agricultural, Biological & Life Science Conference, Agbiol, 511-514.
- Richards, D. 1986. Tree growth and productivity - the role of roots. *Acta Horticulturae* 175:27-35.
- Richards, D. and Rowe, R.N. 1977a. Effects of root restriction, root pruning and 6-Benzylaminopurine on the growth of peach seedlings. *Annals of Botany* 41:729-740.
- Scorza, R. Lightner, G.W. Gilreath, L.E. Wolf, S.J. 1984. Reduced-stature peach tree growth types: pruning and light penetration. *Acta Horticulturae* 146: 159-164.
- Schupp, J.R. and Ferree, D.C. 1987. Effect of root pruning at different growth stages on growth and fruiting of apple trees. *HortScience* 22(3):387-390.
- Schupp, J.R. and Ferree, D.C. 1988a. Effects of root pruning at four levels of severity on growth and yield of 'Melrose'/M26 apple trees. *Journal of the American Society for Horticultural Science* 113(2): 194-198.
- Shupp, J.R. and Ferree, D.C. 1990. Influence of time of root pruning on growth, mineral nutrition, net photosynthesis and transpiration of young apple trees. *Scientia Horticulturae* 42:299-306.
- Webster, A.D., Altkinson, C.J., Lucas, A.S., Vaughan, S.P. and Taylor, L. 2000. Interactions between root restriction, irrigation and rootstock treatments on the growth and cropping of 'Queen Cox' apple trees: Effects on orchard growth and cropping, *The Journal of Horticultural Science and Biotechnology*, 75:2, 181-189.
- White, M.D. 1995. The effects of root growth control using root restricting bags on the growth, fruitfulness, and fruit calcium concentrations and contents of apple (*Malus x domestica* Borkh. cv. 'Fuji'). Lincoln University, Master Thesis.
- Williamson, J.G. and Coston, D.C. 1990. Planting method and irrigation rate influence vegetative and reproductive growth of peach planted at high density. *Journal of the American Society for Horticultural Science* 115(2):207-212.
- Williamson, J. G., Coston, D. C. and Cornell, J. A. 1992. Root restriction affects shoot development of peach in a high-density orchard. *Journal of the American Society for Horticultural Science*. 17:362-367.

EFFECTS OF ROOT RESTRICTION ON VEGETATIVE GROWTH AND PHENOLOGICAL CHARACTERISTICS IN LOQUAT (*Eriobotrya japonica* Lindl.) TREES

A. Aytekin POLAT¹

¹*Hatay Mustafa Kemal University, Faculty of Agriculture, Department of Horticulture, Antakya, 31034 Hatay, Turkey*

Corresponding author e-mail: aapolat@mku.edu.tr

ABSTRACT

The aim of the study is to determine the effect of root restriction on vegetative growth and phenological characteristics in loquat trees. 'Hafif Çukurgöbek' loquat trees grafted on seedling were planted within root restrictive plastic pots buried in the soil and compared with trees planted without pots. Vegetative growth, flowering periods, inflorescence characteristics and fruit set rates of these trees were investigated. In addition, yields per tree, per unit trunk cross-sectional area and per unit area, and pomological characteristics of fruits were determined according to the applications. Although the flowering stages of the cultivar differed partially according to the applications, it was completed in the period between December 5 and February 10. The first flowering was took place on 5 December in the root restriction application and on 9 December in the control. The full bloom and the end of flowering phases occurred on January 18 and February 5, respectively, in root restraint application, and on January 29 and February 10, respectively, in control. Root restriction had no effect on the maturity period of the fruits. While there was no significant difference between the applications in terms of the length of the inflorescence and the number of panicle in the cluster; Statistically significant differences were determined between the treatments in terms of the numbers of flower buds, blooming flowers and initial fruit set in the cluster. Applications were not significant effect on the number of the small fruit and the number of fruits harvested in the cluster. In terms of annual shoot length, scion and rootstock diameter and other vegetative parameters, lower values were obtained in plants with restricted root growth compared to the control plants. As a result, it was determined that root restriction reduces vegetative growth in loquat trees.

Key words: Root restriction, fruit set, vegetative growth, loquat.

INTRODUCTION

Control of fruit tree vigour and cropping is vital to the profitability of modern commercial orchards. Tree size is controlled primarily by using rootstocks or interstocks, together with shoot pruning and training techniques. Unfortunately, dwarfing rootstocks are not fully suited to all soil conditions, and other methods are sometimes needed to control growth. The most common alternative method of growth control relies on plant growth regulators. Foliar sprays of the gibberellin biosynthesis inhibitor paclobutrazol (Cultar) are applied to many UK apple orchards to control excessive shoot vigour. However, these plant growth regulator treatments are not permitted in many countries and the use of such chemicals is not an option for growers wishing to adopt organic or Integrated Fruit Production methods. Alternative supplementary methods of growth control are needed which meet current environmental concerns (Webster et al., 2000).

Shoot growth of an apple tree usually develops in close balance with the tree's root growth (Brouwer, 1963); mature apple trees of the same cultivar/rootstock combination that are managed similarly and are growing in the same environment have very similar ratios of root to shoot length. Few studies have reported the effects of long-term root restriction in the field. Myers (1992) reported that flower cluster and fruit number per limb in apples in the first year of fruiting increased linearly with decreasing container size. Research in Australia showed that restricting the growth of the roots of peach seedlings growing in hydroponic culture reduced shoot growth (Richards and Rowe, 1977a & b). Subsequent research in Georgia, USA showed that limiting the root growth of peach trees by planting them within root restrictive membranes also reduced the growth of scion shoots (Williamson et al., 1992). In some other studies where root growth was limited by root barriers, reductions in tree vigour have been shown to be accompanied by increases in flower density in peach (Richards, 1986; Williamson and Coston, 1990). As a result of increases in flower density, Williamson and Coston (1990) found no difference in fruit number or yield per tree between root restriction and several other conventional planting systems, despite the smaller tree size of root restricted trees. Webster et al. (2000) reported that root restrictive membranes that restricted most roots to within a known soil volume greatly reduced extension shoot growth, increased the numbers of floral buds. There is no study in the literature reporting the effects of root restriction on loquat (*Eriobotrya japonica* Lindl) trees. The experiment reported here was used to assess the effects on the vegetative growth and phenological characteristics of the loquat cv. Hafif Çukurgöbek of planting trees within root restrictive membranes.

MATERIAL AND METHODS

The experiment was carried out in the loquat orchard in the research area of Hatay Mustafa Kemal University, Faculty of Agriculture, Department of Horticulture, Hatay, Turkey in 2019 and 2020. The research area is located at 36° 52' N latitude, 36° 12'E longitude, with an elevation of 80 m.

Material

In the study, Hafif Çukurgöbek cultivar budded onto the seedling rootstock were used. All experimental plants were grown in cylindrical plastic containers with 25 litre volume on seedling rootstocks. In the establishment stage of the experiment, the root restricted plants were planted without removing the plastic containers, while the control plants were removed from the plastic tubes with their soil and planted in the experimental area. The trial material, one-year-old plants, were planted in the experiment area in a single row at 1.0 x 1.0 meter intervals on 26 April, 2018. The experiment was arranged according to a completely randomized design with 5 replications and 2 plants were used in each replicate.

Methods

Phenological observations

Phenological observations in the experiment were made according to Polat (2015 and 2018).

Observations on flowering and fruit development

Observations about flowering were made at 3 days' intervals since the first bud swelling began to appear. We considered the beginning of flowering as the date when 5% of the flowers were open; 70% as full bloom and 70% petal drop as the end of blossoming. The period when 70% of the flowers turned into fruits after they shed their petals was considered as fruit set, and

the period when the fruits reached the size of hazelnuts was considered as the small fruit period. The stage when the fruits reached the color and size specific to the variety and the total soluble solids increased to 10% was accepted as the maturity stage.

Observations on inflorescences

Observations were made at an intervals of 3 days on average after the clusters of the branches were seen. Inflorescence characteristics such as peduncle numbers in cluster, number of flower buds in cluster, number of flowers in cluster, the number of fruits set in cluster, and the number of harvested fruits. These observations were made according to Polat (2007).

Observations on flowering and fruit set ratios

Percent blossom ratios, initial fruit set (%), small and final fruit set (%) were recorded under each of the treatment during the experimental period. These observations were made the methods suggested by Westwood (1995) and Polat (2007 and 2015).

Vegetative growth

Vegetative growth of plants were measured according to Polat et al. (2004) and Polat (2018). In order to determine the vegetative growth of the experimental plants, the following parameters were measured at three-month intervals as of February 2019 during the study, but only February-May measurements are given in the article.

Annual shoot length (cm): Four shoots from each plant were measured from 4 sides of the plants.

Trunk diameter (mm): Scion and rootstock trunk diameters (5 cm below and above of bud union) were measured in all plants with a digital caliper sensitive to 0.01 mm.

Bud union-first branching (cm): The distance between the bud union and the first branching on the scion trunk was measured.

First branching - longest shoot (cm): The distance between the first branching and the top of the longest shoot on the scion trunk was measured.

Bud union-longest shoot (cm): The distance between the bud union and the top of the longest shoot on the scion trunk was measured.

Evaluation of the data

The variance analysis of the data obtained from the experiment was performed according to the 'Completely Randomized Factorial Design' with SPSS statistical software. The means of significant variation sources were compared according to the "LSD Test" at the 0.01 or 0.05 level (Steel and Torrie, 1980).

RESULTS AND DISCUSSION

Flowering Periods

Although the flowering stages of the cultivar varied slightly depending on the applications, they were completed in the period between 5 December and 10 February. The first flowering occurred on December 5 in root-restricted trees and on December 9 in control trees. Full bloom and end-bloom phases occurred on 18 January-5 February, respectively, in the root restriction application, while they occurred on 29 January-10 February, respectively, in the control. Trees with restricted root growth reached the fruit setting stage on February 17, while control trees reached the fruit setting stage on February 21. However, root restriction was not have a significant effect on the maturity period of the fruits. Since no studies on this subject could be found in the literature, it was not possible to compare the data. However, in a study conducted by Akkuş and Polat (2022), the first flowering date of the HCG loquat variety grafted onto Quince-A, Quince-C and BA-29 rootstocks was 14-15-11 December, respectively, and full

flowering was 18-10-11 January, respectively, and the end of flowering were determined as 31-23-25 January, respectively. In another study by Polat (2015), the first flowering of the HÇG loquat variety grafted onto the loquat rootstock was determined as 27 November, full flowering as 9 December and the end of flowering as 24 December. While the data we obtained in our study were partially similar to the data obtained by Akkuş and Polat (2022), they were found to be significantly different from the data obtained by Polat (2015). This difference may be due to the effect of climatic differences in the years when the studies were conducted, as well as the difference in the trial areas and plant ages.

Inflorescences Properties

According to two-year averages, the effect of the application on inflorescence length was not found to be significant. In terms of the number of flower buds and blooming flowers in the cluster and the first fruit set in the cluster, higher values were obtained from the root restriction application compared to the control, and this difference between the applications was found to be statistically significant at the 1% level. In terms of other parameters examined, the difference between the applications was not significant (Table 1).

Table 1. Effects of root restriction on cluster characteristics of Hafif Çukurgöbek loquat cultivar(2019-2020 average)

Treatments	Lenght of cluster (cm)	No. of peduncle per cluster	No. of flower buds per cluster	No. of flowers per cluster	No. of initial fruits	No. of small fruits
Control	18.46	15.84	155.73 b	145.05 b	17.53 b	11.34
Root restriction	17.96	15.83	165.26 a	154.91 a	19.37 a	11.74
LSD	NS ^y	NS	**	**	**	NS

^x Different letters within columns indicate significant difference by LSD test at $P < 0.05$ or $P < 0.01$.

** : Significant at $P < 0.01$; ^y NS: Not significant

Although there are no studies on this subject in loquat, the findings of studies conducted on some other fruit species are compatible with our research findings. As a matter of fact, in studies conducted on peach (Richards, 1986; Williamson and Coston, 1990; Williamson et al., 1992) and apple (Myers, 1992), it was determined that root restriction reduced the strength of the tree and increased flower density. Myers (1992) reported that flower cluster and fruit number per limb in apples in the first year of fruiting increased linearly with decreasing container size. The same researcher determined that root restriction with fabric bags resulted in smaller tree size, higher number of flower buds, and an increase in fruit set in both apple and peach trees. Webster et al. (2000) reported that root-restricting materials, which confine most roots within a given soil volume, greatly reduced shoot growth, increasing the number of flower buds.

Flowering and Fruit set rates

The effect of root restriction application on the flowering, small fruit and harvested fruit rates of the HCG loquat variety was not found to be significant. However, the rate of first fruit set in the cluster was determined to be higher in the root restriction application than in the control, and this difference between the applications was found to be statistically significant (Table 2).

Table 2. Effects of root restriction on flowering and fruit set in Hafif Çukurgöbek loquat cultivar (2019-2020 average).

Treatments	Flowering (%)	Initial fruit set (%)	Small fruit (%)	Harvested fruit (%)
Control	93.16	11.25 b ^x	7.34	5.89
Root restriction	94.01	11.93 a	7.18	5.80
LSD	NS ^y	*	NS	NS

^x Different letters within columns indicate significant difference by LSD test at $P < 0.05$. ^y NS: Not significant

Although there is no study on this subject in loquat, Ross et al., (2008) determined that root restriction suppressed tree growth in apples and increased tree flowering. Myers (1992) determined that root restriction in apple and peach trees increased fruit set while reducing the size of the tree.

Vegetative Growth

In terms of annual shoot length, scion and rootstock diameter and other vegetative parameters, lower values were obtained in plants with restricted root growth compared to the control plants. As a result, it was determined that root restriction reduces vegetative growth in loquat trees (Table 3). There are few studies in the literature reporting the effects of long-term root restriction. Our findings are consistent with the findings of studies conducted on some fruit species, especially apples and peaches. As a matter of fact, studies on peach (Richards, 1986; Williamson and Coston, 1990; Williamson et al., 1992) and apple (Myers, 1992) have shown that root restriction reduces tree vigour. Ross et al., (2008) compared the effects of different root restrictor bag types on the vegetative growth and pruning of the apple tree and determined that root restriction suppressed the growth of the tree and reduced the need for pruning. Webster et al. (2000) report that root growth restrictive membranes greatly reduce shoot growth.

Table 3. Effect of root restriction on various vegetative growth parameters in Hafif Çukurgöbek loquat cultivar (2019-2020 averages)

Treatments	Annual shoot length(cm)	Rootstock diameter (mm)	Scion diameter (mm)	Bud union-first branching (cm)	First branching-shoot tip (cm)	Bud union-main axis tip (cm)
Control	61.32 a ^x	33.24 a	30.63 a	12.03 b	108.27a	119.40 a
Root restriction	55.88 b	28.43 b	25.88 b	14.32 a	91.16 b	105.18 b
LSD	**	**	**	**	**	**

^x Different letters within columns indicate significant difference by LSD test at $P < 0.01$.

CONCLUSION

Studies show that restricting the root volume of fruit trees is a promising technique for controlling vegetative vigor. Root restrictor bags are used to control tree size and encourage early flowering and yield. In our study, it was determined that root restriction had different effects on the vegetative growth, phenological characteristics, flowering and fruit set rates of the HCG loquat variety. In terms of annual shoot length, scion and rootstock diameter and other vegetative parameters, lower values were obtained in root restricted plants compared to the control. The findings of our study are very important and valuable as they are new findings in terms of the use of root restriction in loquat trees. When the findings of our study are evaluated

in general, it is seen that trees with restricted root growth give superior results compared to control trees. However, since these findings are not sufficient to make a definitive conclusion, the study needs to be continued for a few more years.

REFERENCES

- Akkuş, S., Polat, A.A. 2022. Effect of some Quince rootstocks on inflorescence properties, flowering and fruit set in loquat (*Eriobotrya japonica* Lindl.). *KSU J. Agric Nat* 25 (2): 253-257.
- Brouwer, R. (1963). Some aspects of the equilibrium between overground and underground plant parts. *Jaarboek Instituut voor Biologische en Scheikundig Onderzoek van Landbouwge-wassen*, 11,31-9
- Myers, S. C. 1992. Root restriction of apple and peach with in-ground fabric containers. *Acta Horticulturae* 322: 215-219.
- Polat, A.A., Durgaç, C., Çalışkan, O. 2004. Effects of different planting space on the vegetative growth, yield and fruit quality of loquat. *Acta Horticulturae*, 632:189-195.
- Polat AA 2007. Determination of Productivity and Fruit Set Ratios of Various Loquat (*Eriobotrya japonica*) Cultivars under Mediterranean Conditions. *New Zealand Journal of Crop and Horticultural Science.*, 35: 101-105.
- Polat AA 2015. Effect of canopy orientation on flowering time and fruit set in loquat. *Acta Horticulturae*, 1092: 205-210.
- Polat, A.A., 2018. Effects of some Quince rootstocks on phenological properties and fruit set rates in Hafif Çukurgöbek loquat cultivar. The 9th International Scientific Agriculture Symposium “AGROSYM 2018” , Jahorina, Bosnia and Herzegovina, 4-7 October 2018. pp: 488-492.
- Richards, D. 1986. Tree growth and productivity - the role of roots. *Acta Horticulturae* 175:27-35.
- Richards, D. and Rowe, R.N. 1977a. Effects of root restriction, root pruning and 6-Benzylaminopurine on the growth of peach seedlings. *Annals of Botany* 41:729-740.
- Richards, D. and Rowe, R. N. (1977b). Root shoot interactions in peach: The function of root. *Annals of Botany*, 41, 1211-1216.
- Ross, E. Byers, David H. C and Leon D.C.2004. Root restriction, an alternative to rootstocks, for control of flowering, fruiting, tree growth, yield efficiency, and fruit quality of apple. *Journal of Tree Fruit Production*, 3 (2):11-31.
- Steel R, Torrie J.H. 1980. Principles and Procedures of Statistics. 2nd ed. New York, McGraw-Hill.
- Webster, A.D.,Altkinson,C.J.,Lucas,A.S.,Vaughan,S.P. and Taylor, L.2000. Interactions between root restriction, irrigation and rootstock treatments on the growth and cropping of ‘Queen Cox’ apple trees: Effects on orchard growth and cropping, *The Journal of Horticultural Science and Biotechnology*, 75:2, 181-189.
- Westwood MN 1995. Temperate-Zone Pomology: Physiology and Culture. United States, Timber Press, Inc. 523 p
- Williamson, J.G. and Coston, D.C. 1990. Planting method and irrigation rate influence vegetative and reproductive growth of peach planted at high density. *Journal of the American Society for Horticultural Science* 115(2):207-212.
- Williamson, J. G., Coston, D. C. and Cornell, J. A.1992. Root restriction affects shoot development of peach in a high-density orchard. *Journal of the American Society for Horticultural Science.* 17:362-367.

THE EFFECT OF ACIDIFIED BIOCHAR APPLICATIONS ON SOME MACRO-ELEMENT CONTENTS OF A CALCAREOUS SOIL

Salih DEMİRKAYA, Coşkun GÜLSER

Ondokuz Mayıs University, Faculty of Agriculture, Department of Soil Science and Plant Nutrition, Samsun, TÜRKİYE

Corresponding author e-mail: salih.demirkaya@omu.edu.tr

ABSTRACT

Biochar has recently been widely used as a soil conditioner that improves soil's physical, chemical, and biological properties. This study aims to investigate the effect of acidified biochar on some macronutrients in calcareous soil. For this purpose, the biochar obtained by the gasification process was acidified with H₂SO₄. Four doses (0, 1, 2, and 4%) of original (non-acidified) and acidified biochar were tested in a 90-day incubation study conducted under laboratory conditions. At the end of the experiment, all treatments increased the exchangeable K content while decreasing the exc. Ca content compared to the control treatment. Besides some treatments, Mg and P contents also increased according to the control. The highest increment in the exc. K, Mg, and plant-available P were 95%, 31%, and 67%, respectively, in the AB4.0 treatment. As a result, it has been shown that applying acidified biochar can effectively increase the fertility of calcareous soils.

Keywords: Soil fertility, biochar, acidification, lime soil

INTRODUCTION

Biochar is a product obtained by thermochemically degrading organic materials at different temperatures under oxygen-limited conditions (Lehmann et al. [2011](#)). The addition of biochar to the soil as an organic conditioner due to its long-term residence in the soil has received increasing attention in recent years thanks to its beneficial effects on soil chemical productivity and quality and climate change mitigation (Oliveira et al. [2017](#)).

In recent years, many studies have been carried out to improve the physicochemical properties of soils, increase fertility, and reduce nutrient losses by applying biochar to calcareous and coarse soils (Demirkaya et al., 2021; Demirkaya and Gulser, 2023). It has been reported that the addition of biochar to sandy soils increases water storage in the soil by reducing hydraulic conductivity (Barnes et al., 2014; Glab et al., 2016), ensures the retention of nutrients in the soil (Sohi et al., 2010; Novak et al., 2012) and increases aggregate stability (Baiamonte et al., 2019).

The fact that the biochars produced at high temperatures usually have an alkaline character makes it difficult to apply to these calcareous and high pH soils. The addition of organic regulators such as acid character biochar to these soils can improve the nutrient status of soils and microbial functions (Karimi et al., 2020; Demirkaya and Gulser, 2023).

In this study, the applications of acidified biochar the effect of some macroelements on a calcareous soil has been investigated.

MATERIAL AND METHOD

Soil sample used in the study was taken from a depth of 0- 20 cm from the Ondokuz Mayıs University, Faculty of Agriculture, Bafra experiment area. The soil sample was dried and sieved through a 2 mm sieve to be used in the incubation experiment. Soil has a sandy loam texture, neutral pH, non-saline, moderate lime, very low organic carbon and low iron content (Hazleton & Murphy, 2006). The biochar material obtained by gasification process from the tree waste. The incubation experiment was conducted under laboratory conditions (20-24 °C) between 06.01.2021 and 06.03.2021.

Details of the acidification process are available in our previous study (Demirkaya ve Gülser, 2023). Briefly, the biochar and H₂SO₄ were mixed in a 1:1 ratio and dried before being used in the study.

The original and acidified biochars were applied to the soil in three doses (1, 2, and 4 %). Biochar was not applied to the control soil. The experiment was set up in a completely randomized design with 3 replications. During the incubation, the soils were weighed at intervals of 2 days and irrigated to be in field capacity. The experiment was ended at 90 days. The exchangeable cations (Ca, Mg, K, Na) and plant available phosphorus were determined by 1 N ammonium acetate extraction method (Kacar, 1994). The collected data were analysed with one-way ANOVA and LSD test at ($p > 0.05$)

RESULTS AND DISCUSSION

Some characteristics of soil, original and acidified biochar samples are given in Table 1. After acidification, the electrical conductivity and nutrient content of the biochar significantly increased.

Table 1. Some properties of soil, original and acidified biochar samples

Properties	Unit	Soil	Original biochar	Acidified Biochar
pH	-	7,5	9,4	3,6
EC	dS m ⁻¹	0,2	0,3	4,3
Exc. Ca	g kg ⁻¹	21,4	7,5	17,8
Exc. Mg	g kg ⁻¹	7,1	1,5	2,1
Exc. K	g kg ⁻¹	0,3	0,9	1,4
Olsen's P	g kg ⁻¹	10,6	0,2	0,5

At the end of the 90-day incubation period, statistically significant differences ($p < 0.05$) were observed in the effects of the treatments on all measured parameters.

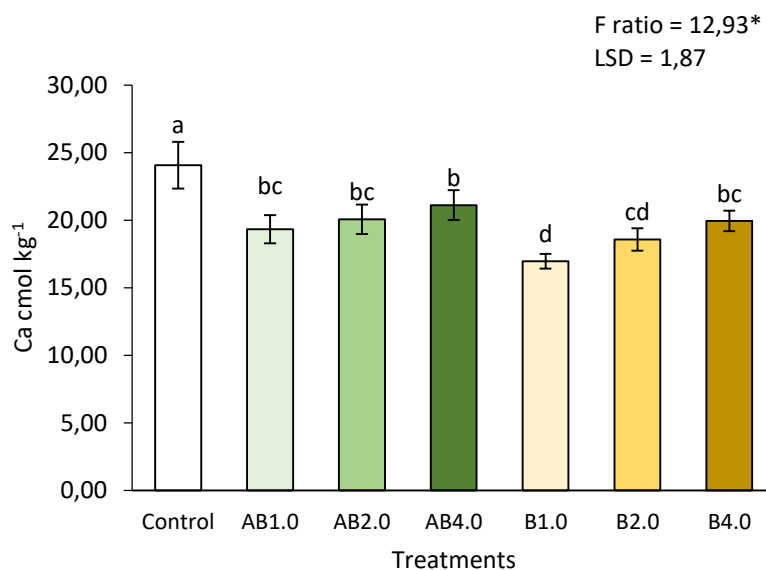

Figure 1. Exchangeable Ca contents of the treatments

All treatments decreased the exchangeable Ca contents according to the control treatment. The highest decrement was observed in the B1.0 treatment as 29%. Hailegnaw et al. (2019) examined the application of biochar to 10 different soil samples. They reported that the impact of biochar on the exchangeable calcium content of these soils exhibited variations.

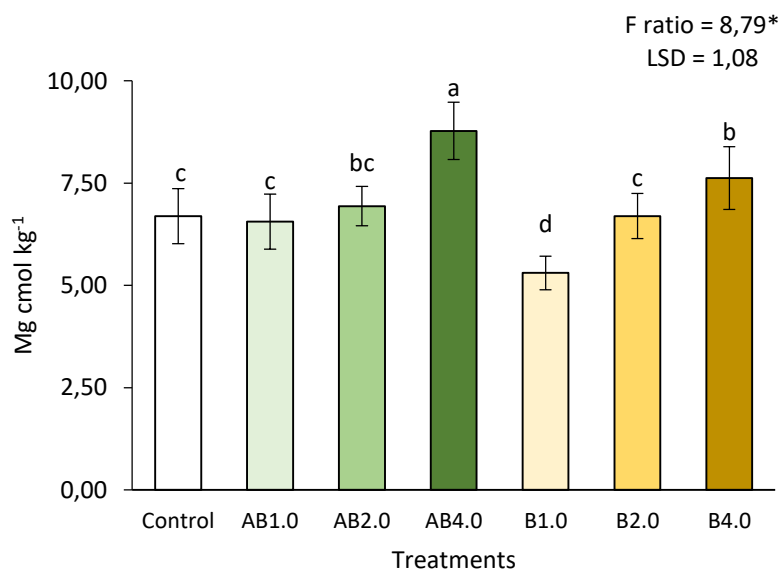

Figure 2. Exchangeable Mg contents of the treatments

The impact of treatments on exchangeable Mg content exhibited variability. The AB (4.0%) treatment demonstrated the most substantial increase, at 31%, compared to the control treatment. Wang et al. (2014) noted that the addition of biochar resulted in notable increases, ranging from 60% to as high as 670%, in the levels of extractable K, Ca, Na, and Mg in the soil.

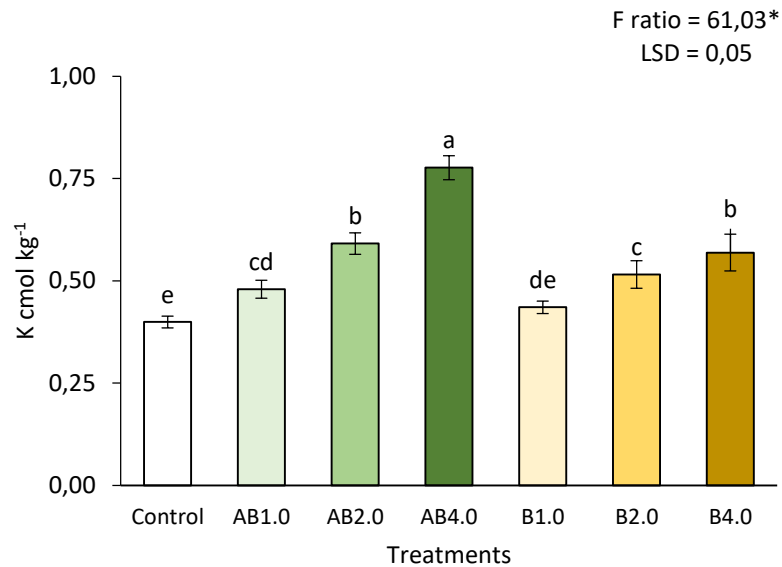

Figure 3. Exchangeable K contents of the treatments

All treatments resulted in increased exchangeable potassium (K) content compared to the control treatment, with a linear relationship between the applied doses and the increment. The highest increase, at 95%, was observed in the AB (4.0%) treatment. Abd El-Mageed et al. (2021) cultivated *Vicia faba* plants and applied acidified biochar at three different doses. Their findings indicated that the application of acidified biochar led to an increase in soil exchangeable K content.

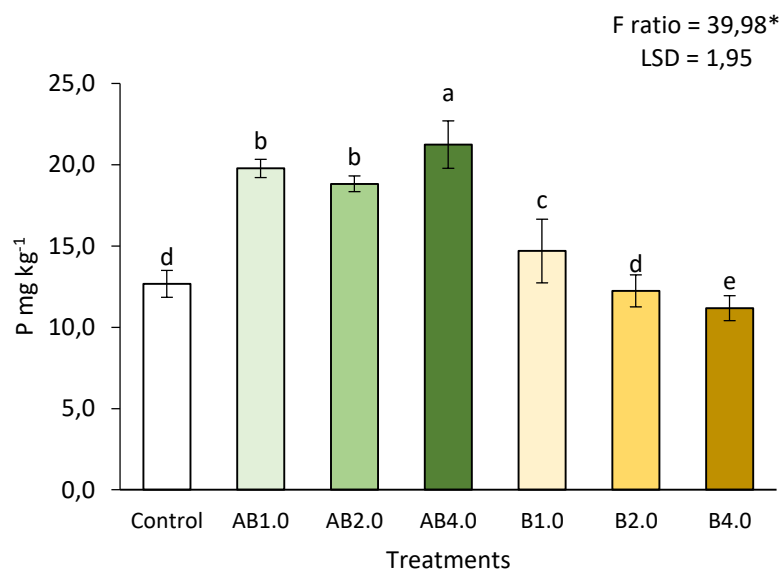

Figure 4. Plant available P contents of the treatments

Except for the B (2.0% and 4.0%) treatments, all treatments enhanced plant-available phosphorus (P) content compared to the control. The AB (4.0%) treatment showed the most significant increment, at 67%. Similar to our result, there are studies showing that the application of biochar increases the availability of phosphorus in soil (Lehmann et al., 2003; Uzoma et al., 2011)

CONCLUSIONS

The acidification process appears to be a suitable method for applying biochar to soils with high pH, as it also enhances the solubility of the nutrients present in the biochar. Acidified biochar applications had positive effects on all macronutrients except for exchangeable calcium. Considering the phosphorus deficiency in calcareous soils, it is expected that acidified biochar application will positively affect plant development. According to the findings obtained at the end of this study, acidified biochar applications were found to be more effective than the original biochar applications.

REFERENCES

- Lehmann, J., da Silva Jr, J.P., Steiner, C., Nehls, T., Zech, W. & Glaser, B. 2003. Nutrient availability and leaching in an archaeological Anthrosol and a Ferralsol of the Central Amazon basin: fertilizer, manure and charcoal amendments. *Plant and Soil*, 249, 343–357.
- Uzoma, K. C., Inoue, M., Andry, H., Fujimaki, H., Zahoor, A., & Nishihara, E. (2011). Effect of cow manure biochar on maize productivity under sandy soil condition. *Soil use and management*, 27(2), 205-212.
- Kacar, B. (1994). *Bitki ve toprağın kimyasal analizleri*. Ankara Üniversitesi Ziraat Fakültesi Eğitim, Araştırma ve Geliştirme Vakfı.
- Karimi A, Moezzi A, Chorom M, Enayatizamir N. 2020. Application of biochar changed the status of nutrients and biological activity in a calcareous soil. *Journal of Soil Science and Plant Nutrition*, 20, 450-459.
- Lehmann J, Rillig MC, Thies J, Masiello CA, Hockaday WC, Crowley D (2011) Biochar effects on soil biota-A review. *Soil Biol Biochem* 43:1812–1836
- Oliveira FR, Patel AK, Jaisi DP, Adhikari S, Lu H, Khanal SK (2017) Environmental application of biochar: Current status and perspectives. *Bioresour Technol* 246:110–122
- Głąb T, Palmowska J, Zaleski T, Gondek K. 2016. Effect of biochar application on soil hydrological properties and physical quality of sandy soil. *Geoderma*, 281, 11-20.
- Barnes R T, Gallagher M E, Masiello C A, Liu Z, Dugan B. 2014. Biochar-induced changes in soil hydraulic conductivity and dissolved nutrient fluxes constrained by laboratory experiments. *PloS one*, 9(9), e108340
- Sohi S P, Krull E, Lopez-Capel E, Bol R. 2010. A review of biochar and its use and function in soil. *Advances in agronomy*, 105, 47-82
- Novak J M, Busscher W J, Watts D W, Amonette J E, Ippolito J A, Lima I M, Gaskin J, Das K C, Steiner C, Ahmedna M, Rehrh D, Schomberg H. 2012 Biochars impact on soil-moisture storage in an ultisol and two aridisols. *Soil Sci* 177:310–320. <https://doi.org/10.1097/ss.0b013e31824e5593>
- Baiamonte G, Crescimanno G, Parrino F, De Pasquale C. 2019. Effect of biochar on the physical and structural properties of a sandy soil. *Catena*, 175, 294-303
- Demirkaya, S., and Gülser, C. (2023). Asitleştirilmiş biyoçar uygulamalarının kaba bünyeli bir toprakta DTPA ile ekstrakte edilebilir mikro element içeriğine etkisi. *Toprak Bilimi ve Bitki Besleme Dergisi*, 11(1), 47-53.

- Demirkaya, S., Gülser, C., and Ay, A. (2021). The effect of iron enriched acidified and non-acidified biochars on DTPA extractable iron content of a calcareous soil. In *Int. Symposium on" Soil Sci. Plant Nutr* (pp. 197-201).
- Wang Y, Yin R, Liu R (2014) Characterization of biochar from fast pyrolysis and its effect on chemical properties of the tea garden soil. *J Anal Appl Pyrol* 110:375–381. doi:[10.1016/j.jaap.2014.10.006](https://doi.org/10.1016/j.jaap.2014.10.006)
- Abd El-Mageed, T. A., Belal, E. E., Rady, M. O., Abd El-Mageed, S. A., Mansour, E., Awad, M. F., & Semida, W. M. (2021). Acidified biochar as a soil amendment to drought stressed (*Vicia faba* L.) plants: Influences on growth and productivity, nutrient status, and water use efficiency. *Agronomy*, *11*(7), 1290.
- Hailegnaw, N. S., Mercl, F., Pračke, K., Száková, J., & Tlustoš, P. (2019). Mutual relationships of biochar and soil pH, CEC, and exchangeable base cations in a model laboratory experiment. *Journal of Soils and Sediments*, *19*, 2405-2416.

EFFECTS OF MANURE ON STRUCTURAL STABILITY OF A SANDY CLAY LOAM SOIL

Coşkun GÜLSER

*Ondokuz Mayıs University, Faculty of Agriculture, Soil Science & Plant Nutrition
Department, Samsun, Türkiye*

Corresponding author email: cgulser@omu.edu.tr

ABSTRACT

In this study, the effect of manure application on structural stability of a sandy clay loam (SCL) soil was investigated. After incorporating 0, 2, 4 and 6% of manure into a SCL soil in a randomized plot design with three replicates, the soil samples were incubated 6 months under field capacity moisture content in a greenhouse condition. After the incubation period wet aggregate stability (AS) and structural stability index (SSI) in the soil samples were determined as soil structural stability indexes. The manure application significantly increased AS and SSI values of the soil over the control treatment. The highest AS value (33.65%) was determined by the 6% doses of manure treatment over the control (19.31%). Although SSI values increased with manure application, increasing the application doses from 2% to 6% reduced the SSI values. But these decreases in SSI values were not significant statistically. The highest SSI value (20.55%) was determined by the 2% doses of manure treatment over the control (15.95%). It was found that manure is a good soil conditioner material to improve structural stability of SCL soil to prevent degradation.

Keywords: Manure, aggregate stability, structural stability index, coarse textural soil.

INTRODUCTION

Soil organic matter is one of the most important soil properties and loss of it causes soil structural degradation resulting soil compaction and root growth (Usowics and Lipiec, 2009; Busscher and Bauer, 2003). Organic waste applications affect soil structural properties due to mineralization of organic matter in soil (Gülser and Candemir, 2015) and change aggregate stability and size distribution with increasing pore and aggregate sizes in bulk soil (Gülser et al. 2015). In a study, hazelnut husk treatment in a sandy clay loam soil increased organic C content, basal soil respiration, saturated hydraulic conductivity and aggregate stability of soil (Gülser et al., 2017). Increasing soil aeration due to improved aggregation by the organic waste application increases in basal soil respiration or microbial activity in clay soil (Candemir and Gülser, 2011). Organic matter in soil increases soil water holding capacity and stabilization of aggregates containing an abundance of pores that hold water under moderate tensions (Weil and Magdoff, 2004). Aggregate stability is known as a main factor improving agronomic productivity, controlling topsoil hydrology, crustability and erodibility (De Ploey and Poesen, 1985; Bronick and Lal, 2005). Soil degradation involves destruction of soil structure due to loss of soil organic matter by intensive agricultural practices. Most studies showed that the amelioration of soil physical properties is largely based on increases of organic carbon in the soils with using organic wastes (Gülser and Candemir, 2012; Demir and Gülser 2021). Manure is one of the most important agricultural wastes in farmyards. Therefore, the objective of this study was to determine the effect of manure application on structural stability parameters of a sandy clay loam soil.

MATERIAL AND METHODS

Manure was incorporated to the soil at 0, 2, 4 and 6 % by weight. 500 g mixtures in the pots were moistened near the field capacity and incubated for 6 months $25\pm 5^\circ\text{C}$ in a laboratory condition for aggregate stability (AS) and structural stability index (SSI) measurements. The physical and chemical properties of soil sample and manure used in this study were determined using standard methods (Day, 1965; Kacar, 1994). Aggregate stability and structural stability index were determined according to Kemper and Rosenau (1986) and Tüzüner (1990), respectively. Statistical analysis of experimental data was accomplished in a completely randomized plot design with three replicates using the SPSS 17.

RESULTS AND DISCUSSION

According to the soil physical and chemical properties of soil sample used in this study, soil has sandy clay loam texture, acid in pH (1:1), low in organic matter content and non-saline according to EC value (Soil Survey Staff., 1993). Some chemical properties of the farmyard manure are given in Table 2.

Table 1. Some physical and chemical properties of the soil.

Sand, %	65,40	pH (1:1, w/v)	4,80
Clay, %	21,40	EC ₂₅ (1:1, w/v), dSm ⁻¹	0,143
Silt, %	13,20	CaCO ₃ , %	0,26
Texture class	SCL	Organic matter, %	0,35

Table 2. Properties of the farmyard manure used in this study.

Org. Matter %	Ash %	Ca %	Mg %	N %	P %	K %	Cu ppm	Mn ppm	Zn ppm	Fe ppm
4,60	58,40	8,52	0,89	2,20	1,32	2,68	50,0	435,0	258,8	8642,0

Aggregate stability (AS) and structure stability (SSI) values after the 6-month incubation period are given in Table 3 for the sandy clay loam soil. The aggregate stability of soil was significantly increased by the manure applications ($P < 0.01$). While the lowest AS (19,31%) was found in the control, the highest AS (33,65%) was determined in the 6% dose of manure application (Figure 1). According to the control treatment, percentage increases in AS by the 2%, 4% and 6% doses of manure were determined as 13,0, 30,0 and 74,3%, respectively.

Table 3. Effect of manure application on structural parameters of sandy clay loam soil.

Application doses, %	Aggregate Stability, %	Structural Stability Index, %
0	19,31 c	15,95
2	21,82 bc	20,55
4	25,11 b	19,93
6	33,65 a	18,85

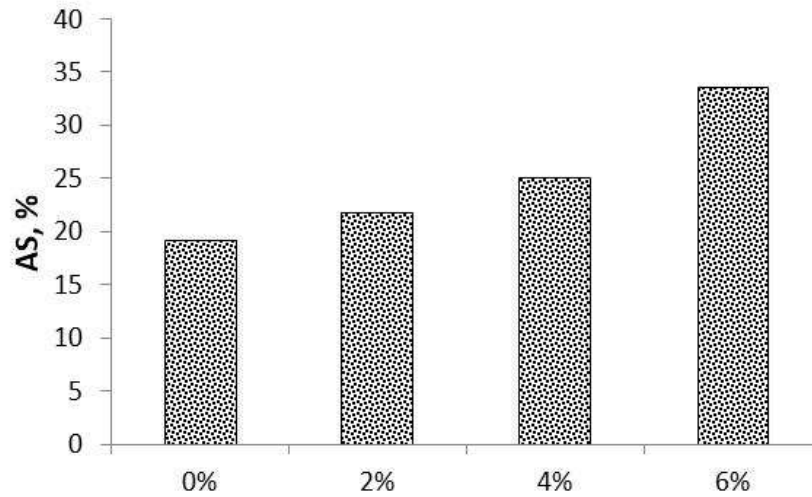

Figure 1. Effect of application doses of manure on soil aggregate stability.

All manure treatments had higher SSI than control treatment (Table 3). Although the SSI values of soil was reduced from 2% to 6% dose of manure application, there was no statistically significant difference among the mean SSI values. While the lowest SSI (15,95%) was found in the control, the highest SSI (20,55%) was determined in the 2% dose of manure application (Figure 2). According to the control treatment, percentage increases in SSI by the 2%, 4% and 6% doses of manure were determined as 28,8, 25,0 and 18,2%, respectively.

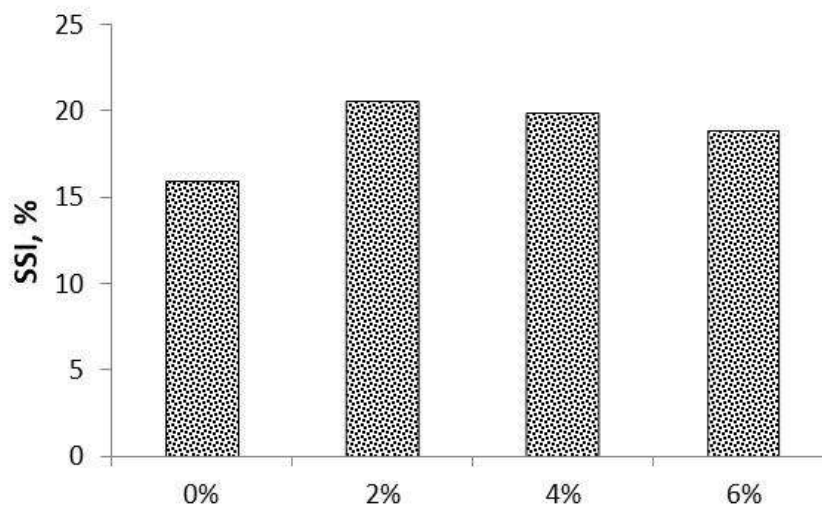

Figure 2. Effect of application doses of manure on soil structural stability index.

The improved structural parameters such as AS and SSI by adding manure to soil is a result of decomposition of manure components and increasing microbial activity due to carbohydrates metabolisms. Gülser (2006) reported that the increments in soil organic C content significantly reduced the bulk density and increased the total porosity and the proportion of larger aggregates, and also there was a significant positive correlation between OM and AS. In a study by Demir and Gülser (2021), the compost applications in field and greenhouse conditions had positive effects on soil properties with increasing organic matter content, electrical conductivity, field capacity, permanent wilting point, available water content and reducing soil pH and soil bulk density over the control. Gülser and Candemir (2012) reported that bulk density, relative

saturation and penetration resistance decreased while mean weight diameter, total porosity, gravimetric water and organic matter contents of a clay soil increased with increasing application rates of agricultural wastes.

CONCLUSION

It can be concluded that manure application had positive effects on improving soil structural properties of the sandy clay loam soil. AS and SSI values of coarse textured soil increased over the control treatment by manure treatment as an organic matter source. While the highest AS value was determined by the 6% doses of manure treatment, the highest SSI value was determined by the 2% doze of manure application. Farmyard manure is a good soil conditioner to improve physical properties and prevent degradation of coarse textured soils.

REFERENCES

- Anikwe, M.A.N. (2000). Amelioration of a Heavy Clay Loam Soil with Rice Husk Dust and its Effect on Soil Physical Properties and Maize Yield. *Bioresource Technology* 74, 169-173.
- Bronick, C.J., Lal, R. (2005). Soil structure and management: a review. *Geoderma*, 124, 3-22.
- Busscher, W.J., Bauer, P.J. (2003). Soil strength, cotton root growth and lint yield in a southeastern USA coastal loamy sand. *Soil and Tillage Research* 74, 151–159.
- Candemir, F., Gülser, C. (2011). Effects of different agricultural wastes on some soil quality indexes at clay and loamy sand fields. *Communications in Soil Science and Plant Analysis* 42(1): 13-28.
- De Ploey, J., Poesen, J. (1985). Aggregate stability, runoff generation and interrill erosion. In: Richards, K., Arnett, R., Ellis, S. (Eds.), *Geomorphology and Soils*. London, 99-120.
- Demir, Z. and Gülser, C. (2021). Effects of Rice Husk Compost on Some Soil Properties, Water Use Efficiency and Tomato (*Solanum lycopersicum* L.) Yield under Greenhouse and Field Conditions. *Communications in Soil Science and Plant Analysis*, pp.1-18.
- Demir, Z., Gülser, C. (2015). Effects of rice husk compost application on soil quality parameters in greenhouse conditions. *Eurasian Journal of Soil Science* 4(3):185-190.
- Demiralay, I. (1993). Soil physical analysis. Ataturk Univ. Agric. Fac. Pub. No:143, Erzurum.
- Dexter, A.R. (2004). Soil physical quality Part I. Theory, effects of soil texture, density, and organic matter, and effects on root growth. *Geoderma* 120(3-4): 201-214.
- Gülser, C. and Candemir, F. (2012). Changes in penetration resistance of a clay field with organic waste applications. *Eurasian Journal of Soil Science*, 1(1), pp.16-21.
- Gülser, C. (2004). A Comparision of some physical and chemical soil quality indicators influenced by different crop species. *Pakistan Journal of Biological Sciences* 7(6): 905-911.
- Gülser, C. (2006). Effect of forage cropping treatments on soil structure and relationships with fractal dimensions. *Geoderma* 131(1-2): 33-44.
- Gülser, C., Candemir, F. (2015). Effects of agricultural wastes on the hydraulic properties of a loamy sand cropland in Turkey. *Soil Science and Plant Nutrition*, 61(3), 384-391.
- Gülser, C., Candemir, F., Kanel, Y., Demirkaya, S. (2015). Effect of manure on organic carbon content and fractal dimensions of aggregates. *Eurasian Journal of Soil Science*, 4(1), 1.
- Gülser, C., Ekberli, I., Candemir, F., Demir, Z. (2016). Spatial variability of soil physical properties in a cultivated field. *Eurasian Journal of Soil Science* 5(3): 192-200.
- Gülser, C., Minkina, T., Sushkova, S. and Kızılkaya, R. (2017). Changes of soil hydraulic properties during the decomposition of organic waste in a coarse textured soil. *Journal of Geochemical Exploration*, 174, pp.66-69.

- Gülser, C., Minkina, T., Sushkova, S., and Kızılkaya, R. (2017). Changes of soil hydraulic properties during the decomposition of organic waste in a coarse textured soil. *Journal of Geochemical Exploration*, 174, 66-69.
- Gülser, F , Salem, S , Gülser, C. (2020). Changes in some soil properties of wheat fields under conventional and reduced tillage systems in Northern Iraq . *Eurasian Journal of Soil Science* , 9 (4) , 314-320 .
- Gupta, S.C., Dowdy, R.H. and Larson, W.E. (1977). Hydraulic and Thermal Properties of a Sandy Soil as Influenced by Incorporation of Sewage Sludge. *Soil Science Society America Journal* 41, 601-605.
- Iqbal, J., Thomasson, J.A., Jenkins, J.N., Owens, P.R., Whisler, F.D. (2005). Spatial variability analysis of soil physical properties of alluvial soils. *Soil Science Society of America Journal*, 69: 1338– 1350.
- Kacar, B. (1994). Chemical analysis of plant and soil analysis. Ankara Univ. Faculty of Agriculture Publication No. 3 Ankara.
- Mamedov, A., I. Ekberli, I., I. Gülser, C., I. Gümüş, I., I. Çetin, U., I. Levy, G.J. (2016). Relationship between soil water retention model parameters and structure stability. *Eurasian Journal of Soil Science*, 5(4): 314 - 321.
- Marinari, S., Masciandar, G., Ceccanti, B. and Grego, S. (2000). Influence of Organic and Mineral Fertilizers on Soil Biological and Physical Properties. *Bioresource Technology* 72, 9-17.
- Miller, R.W., Donahue, R.L. (1995). *Soils in Our Environment*, Seventh Edition. Prudence Hall, Englewood, Cliffs, NJ. p. 323.
- Selvi, K.C., Gülser, C., Beyhan, M.A. (2019). Short Term Effects of Different Tillage Methods on Nitrate Content in Soil and Corn Yield. *Malaysian Journal of Soil Science* 23: 55-68.
- Soil Survey Staff, (1993). *Soil Survey Manuel*. United States Department of Agriculture (USDA) Handbook No:18, Government Printing Office, Washington, D.C. USA.
- Usowics, B., Lipiec, J. (2009). Spatial distribution of soil penetration resistance as affected by soil compaction: The fractal approach. *Ecological Complexity* 6, 263-271.
- Weil RR, Magdoff, F. (2004). Significance of soil organic matter to soil quality and health. In: Weil RR, Magdoff F (eds) *Soil organic matter in sustainable agriculture*. CRC press, Florida, pp 1–43.

EVALUATING THE PERFORMANCE OF LOGISTIC REGRESSION MODEL IN PREDICTING SOIL QUALITY INDEX FOR PADDY FIELDS

Nursaç Serda KAYA¹, Orhan DENGİZ¹

¹ Ondokuz Mayıs University, Faculty of Agriculture, Department of Soil Science and Plant Nutrition, Samsun, Turkey

Corresponding author e-mail: nursackaya@gmail.com

ABSTRACT

The growing human population generates an increasing need for land. This population growth not only leads to the expansion of urban and industrial areas but also contributes to the gradual exhaustion of soil, which is the fundamental and non-renewable resource. This unsustainable situation persists in our country, resulting in a continuous reduction in available agricultural land. Consequently, agricultural practices, driven by the rising population and the utilization of less productive lands, aim to achieve higher yields per unit area but ultimately contribute to soil degradation. There are several approaches aimed at developing and expanding methods to identify and evaluate changes in soil functions through soil management practices. One of these approaches is the Soil Quality Index (SQI) model. The present study aims to utilize the Neutrosophic Fuzzy-AHP (NF-AHP) and Standard Scoring Function (SSF) approaches to determine the SQI and assess the predictive accuracy of the Logistic Regression (LR) model specifically for paddy fields in the agricultural farmlands of Yesil Kure. The SQI model incorporates 28 parameters associated with soil quality, identified as crucial indicators for rice production, categorized into four main aspects: physical, chemical, fertility, and biological indicators. According to the research findings, the LR model exhibits a strong accuracy rate of 0.88.

Keywords: Logistic regression, Neutrosophic Fuzzy-AHP, Paddy fields, Rice production, Soil quality index, Standard scoring function

INTRODUCTION

Soil is a dynamic living system that supports agricultural productivity and ecosystem function (Doran and Jones, 1996). The excessive and unsustainable use of soil in today's world leads to significant and irreparable problems. Utilizing agricultural lands in accordance with their capacities plays a crucial role in determining our country's future prosperity. In recent years, the concept of soil quality has been developed as a solution to these issues.

Soil quality is defined as the capacity of soil in a natural or managed ecosystem to sustain plant and animal production, improve water and air quality, and create a suitable living environment for human health (Doran, 2002). Due to its complex nature, the quality of soil cannot be directly measured either in the field or in the laboratory. However, soil quality is assessed based on measurable indicators such as a range of physical, chemical, productivity, and biological qualities of the soil (Çelik et al., 2011). For this purpose, methods such as Analytic Hierarchy Process (AHP), Multi-Criteria Decision Making (MCDM), Fuzzy Logic, Standard Scoring Function (SSF) and Neutrosophic Fuzzy-AHP (NF-AHP) are preferred for evaluating multiple and heterogeneous soil quality parameters (Rezaee et al., 2020).

Machine learning techniques have gained significant interest in predicting soil quality. Various models, including decision trees, support vector machines, random forest regressions (Were et al., 2015), and logistic regressions, are used for accurate forecasts. The main goal of

machine learning is to improve computer functionality through data analysis without explicit programming.

Our objective is to identify the SQI by employing the NF-AHP and linear SSF techniques. Furthermore, we seek to assess the logistic regression model's capacity to precisely forecast the SQI in paddy fields situated within the Yeşil Küre farmlands.

MATERIAL AND METHOD

Located at the 40th kilometer on the Samsun-Bafra highway, Yeşil Küre Agricultural Enterprise (Headquarters) is situated between the coordinates of 249000-254000 D and 4599200-4602400 K (WGS84, Zone 37, UTM-m). The total land area of the enterprise is 92398 hectares. To the east lies the Black Sea, to the south is Bünyan Mountain, and to the west and north is the Düden section of the enterprise's land, which is part of the Bafra Plain and neighbors the western shore of Balık Lake in the Kızılırmak Delta.

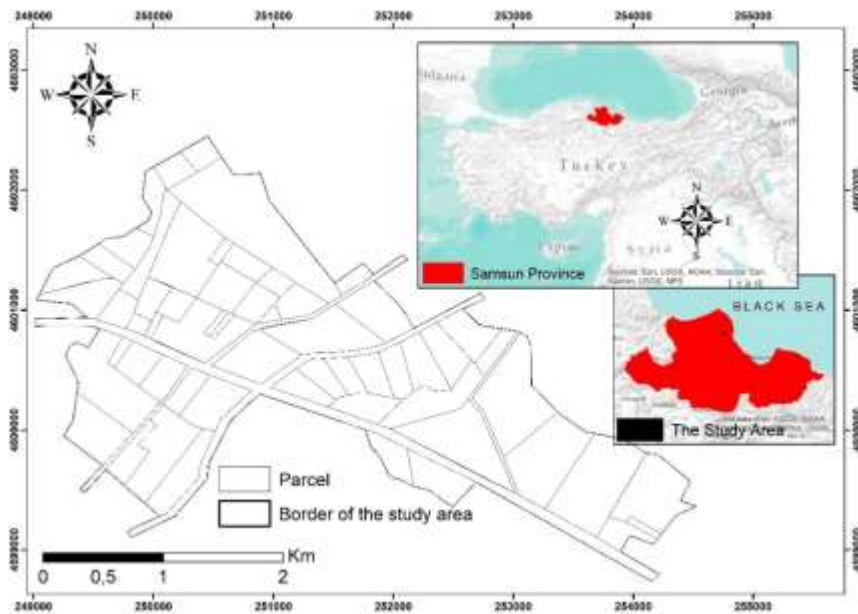

Figure 1. Location map of the study area

The elevation of the enterprise lands between 5 and 74 meters above sea level. The northwestern and southeastern parts of the area exhibit areas with moderate to steep slopes, while the central and northwestern sections generally consist of flat to gently sloping areas ranging from 0 to 4 percent (Figure 2).

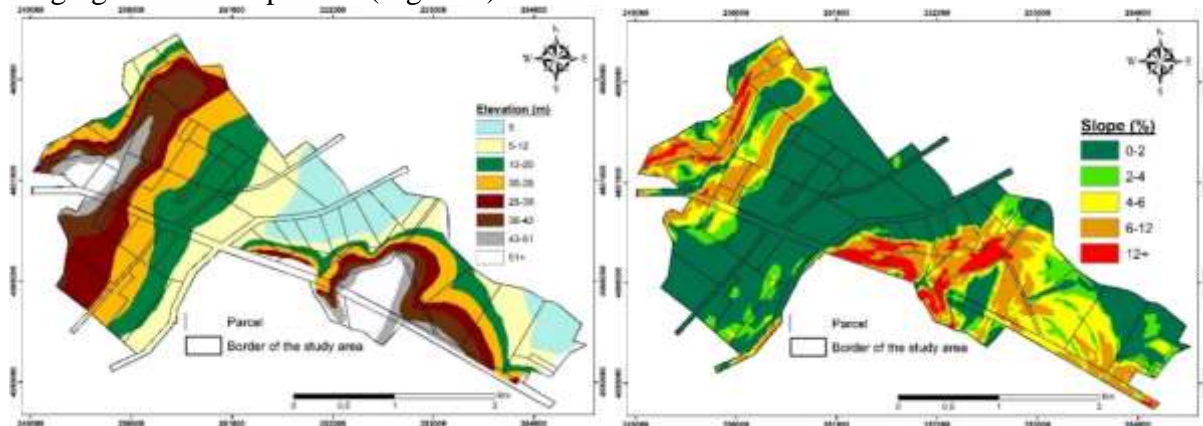

Figure 2. Elevation and slope maps of the study area

In order to evaluate the influence of indicators of soil quality for paddy fields, the utilization of the SQI was employed. The identified properties are transformed into dimensionless scores ranging from 0 to 1, allowing for comparison using linear SSFs (Andrews et al., 2002). In this study, the scoring functions "more is better" and "less is better" were employed (Masto et al., 2008). Once the properties of the soil were converted into a dimensionless format using a SSF, NF-AHP developed by Radwan et al., (2016) is used to perform pairwise comparisons of soil quality parameters, determining their weights and priorities. In this study, detailed implementation steps of NF-AHP were not provided. However, Radwan et al., (2016) conducted a study where these steps can be readily observed. The equation for the SQI (Eq. 1) is provided below.

$$SQI = \sum_{i=1}^n Wi.Xi \tag{1}$$

Where, SQI defines soil quality index, *Wi* is weighting of criterion *i* and *Xi* is sub-criteria value.

In this research, the min-max normalization method was employed to ensures that quantitative column values are scaled to a common range while maintaining their relative differences, ensuring they fall within the range of 0 to 1 (Yapraklı and Erdal, 2016). Normalization is a commonly used technique in machine learning to prepare data. The LR analysis was applied as the final analysis method in the study in the binary form due to the nature of the dependent variable (0 and 1). LR generally employs the sigmoid function to determine binary responses, depending on one or more variables. It identifies the most suitable parameters through this function. The value of the sigmoid function (σ) and the input to the sigmoid function (*x*) have been provided in Eq. 2 (Awoyemi et al., 2017). In the estimated model, a value of 0 was assigned to SQI with a low level of SQI (low and very low levels of SQI are evaluated as low SQI), while a value of 1 was assigned to SQI with a moderate level of SQI. The soil quality classes used in this study, adapted from Moebius-Clune et al., (2011), are presented in Table 1.

Table 1. SQI classes for rice

Class	Definition	SQI _R value
I	Very low	< 0.40
II	Low	0.40 - 0.50
III	Moderate	0.50 - 0.65
IV	High	0.65 – 0.85
V	Very high	> 0.85

The SQI was defined as the dependent variable. The LR model in the research was developed and evaluated (with a testing size of 0.3) using Python 3.8 as the programming language, Anaconda3 as the development environment, and Spyder 5.2.2 as the code editor.

$$\sigma(x) = \frac{1}{(1+1^{-x})} \tag{2}$$

The Receiver Operating Characteristic (ROC) curve, along with sensitivity and specificity, is used to calculate the model's success rate through the area under the curve (AUC). The AUC value indicates how well the model predicts future events. Performance evaluation based on AUC is categorized as weak (< 0.6), average (0.6 - 0.7), good (0.7 - 0.8), very good (0.8 - 0.9), and excellent (> 0.9) according to Hanley and McNail (1982).

RESULTS AND DISCUSSION

In the study, weight values were assigned to different parameters, with physical parameters having the highest weight (0.4045) and biological parameters having the lowest weight (0.1888). The most crucial criteria for physical, chemical, productivity, and biological parameters were identified as slope (0.0746), organic matter (0.0595), nitrogen (0.0327), and microbial biomass carbon (0.0787), respectively. The significance of physical, chemical, productivity, and biological parameters for SQI evaluation in paddy fields is emphasized by factors such as steep slopes impacting water retention (Salazar et al., 2002), the positive effects of organic matter on nutrient storage, water and air balance regulation, and plant root uptake (Brady and Weil, 2007), the vital role of nitrogen as an essential plant nutrient found in organic compounds, and the role of microbial biomass carbon in soil aggregation (Zhang et al., 2017).

Various performance metrics are used to measure the success of the LR model created. In the LR model applied, the accuracy rate of the test dataset was found to be 88%. Another criterion used to compare the performance of LR is the area under the ROC curve, denoted as AUC. In the graph shown in Figure 3, the area under the ROC curve (AUC) has a value of 0.901, which indicates that the test's performance can be classified as excellent (Xu et al., 2022). LR is a specific type of generalized linear model that commonly employs the sigmoid function to predict binary outcomes based on one or more variables (Robles-Velasco et al., 2020). The success of the LR model in this study can be attributed to the use of SQI calculated using linear scoring functions.

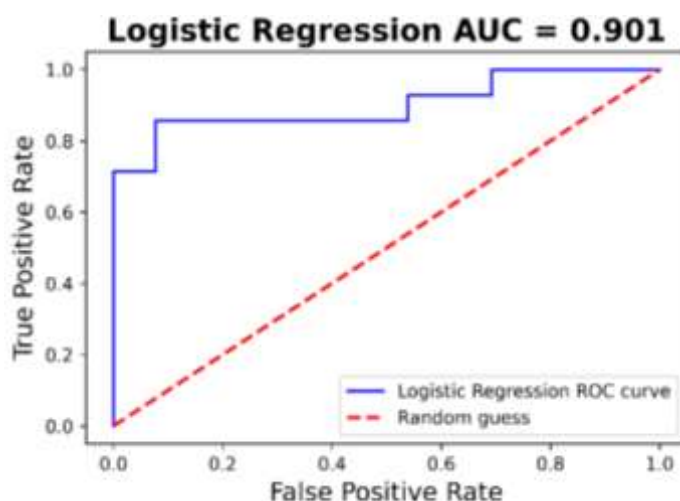

Figure 3. ROC curve of LR model for SQI

The diagonal line signifies a random guess and is deemed meaningless by the model. As the curve approaches the top-left corner, the model's performance improves significantly. Any curve below the diagonal line indicates performance worse than a random guess.

The confusion matrix is another method employed to assess the performance of LR model. The confusion matrix is a table that summarizes the success of the LR model in predicting examples belonging to different classes. It shows the predicted labels on one axis and the actual labels on the other axis (Figure 4). L1-regularization, also known as Lasso Regression, was used in this study to tackle the issue of overfitting (Kumar et al., 2019). Overfitting occurs when a machine learning algorithm performs well on training data but poorly on test data due to memorization. In this research, optimizing the 'C' parameter was crucial for managing the model's performance, and we set the algorithm to 'C=0.05' to prevent overfitting. Higher 'C' values result in a close fit to the training data, while lower 'C' values encourage better generalization to new data.

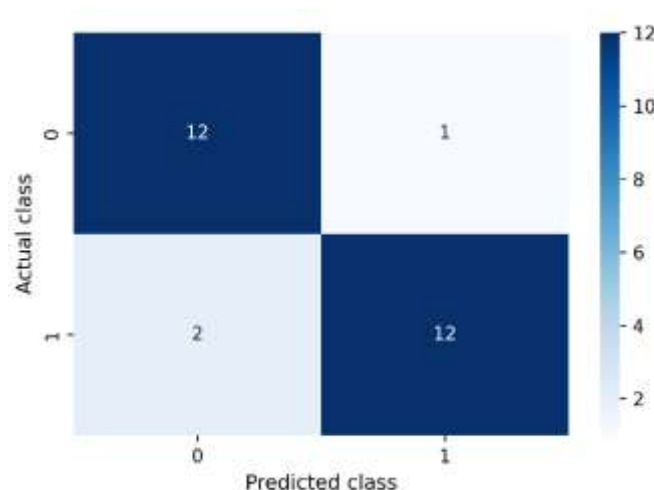

Figure 4. Confusion Matrix for the Testing Set using Logistic Regression

CONCLUSIONS

The research introduced a hybrid model, NF-AHP, to calculate the SQI for paddy fields. In this study, the LR model utilized for SQI prediction achieved an accuracy rate of 0.88 and an ROC curve value of 0.901, indicating excellent performance. The utilization of linear scoring function in calculating the SQI for paddy fields and the concept of LR being a general version of linear regression played a crucial role in achieving these successful results. These findings can be valuable for future research in areas with comparable environmental conditions. The model's effectiveness may be influenced by the dataset size and variations in recorded soil quality-related factors. To ensure reliable predictions, high-quality datasets and rigorous validation are essential.

REFERENCES

- Andrews, S.S., Karlen, D.L. & Mitchell, J.P. (2002). A Comparison of Soil Quality Indexing Methods for Vegetable Production Systems in Northern California. *Agric. Ecosyst. Environ.*, 90:, 25-45.
- Brady, N. C., and R. R. Weil (2007), *The Nature and Properties of Soils*, 14th ed., Pearson Prentice Hall, Upper Saddle River, N. J.
- Celik, I., Barut, Z.B., Ortas, I., Gok, M., Demirbas, A., Tulun, Y., Akpınar, C., 2011. Impacts of different tillage practices on some soil microbiological properties and crop yield under semi-arid Mediterranean conditions. *International Journal of Plant Production* 5 (3), 237–254.
- Doran, J.W., 2002. Soil health and global sustainability: translating science into practice. *Agric. Ecosys. Environ.* 88, 119–127.
- Hanley J.A., McNeil B.J., (1982), The meaning and use of the area under a receiver operating characteristic (ROC) curve, *Radiology*, 143(1), 29-36.
- J. O. Awoyemi, A. O. Adetunmbi, and S. A. Oluwadare, “Credit card fraud detection using machine learning techniques: A comparative analysis,” *Proc. IEEE Int. Conf. Comput. Netw. Informatics, ICCNI 2017*, vol. 2017-Janua, pp. 1–9, 2017.
- Kumar, S., Attri, S. D., & Singh, K. K. (2019). Comparison of Lasso and stepwise regression technique for wheat yield prediction. *Journal of Agrometeorology*, 21(2), 188-192.

- Masto, R.E, Chhonkar, P.K., Purakayastha, T.J., Patra, A.K. & Singh, D. (2008). Soil Quality Indices for Evaluation of Long-Term Land Use and Soil Management Practices Semi-Arid Sub-Tropical India. *Land Degradation and Development*, 19 (5), 516-529.
- Moebius-Clune BN, Idowu OJ, Schindelbeck RR, Van Es HM, Wolfe DW, Abawi GS, Gugino BK. 2011. Developing standard protocols for soil quality monitoring and assessment. In: Bationo A, Waswa B, Okeyo JM, Maina F, editors. *Innovations as key to the green revolution in Africa: exploring the scientific facts*. Springer, Netherlands, p. 833–842.
- Radwan NM, Senousy MB, Riad AEDM (2016) Neutrosophic AHP multi criteria decision making method applied on the selection of learning management system. *Int J Adv Comput Technol* 8:95–105.
- Rezaee, L., Moosavi, A. A., Davatgar, N., & Sepaskhah, A. R. (2020). Soil quality indices of paddy soils in Guilan province of northern Iran: Spatial variability and their influential parameters. *Ecological Indicators*, 117, 106566.
- Robles-Velasco, A., Cortés, P., Muñuzuri, J., & Onieva, L. (2020). Prediction of pipe failures in water supply networks using logistic regression and support vector classification. *Reliability Engineering & System Safety*, 196, 106754.
- Salazar, M., Poch, R. M., & Bosch, A. D. (2002). Reclamation of steeply sloping coal spoil banks under Mediterranean semi-arid climate. *Soil Research*, 40(5), 827-845.
- Were, K., Bui, D.T., Dick, Ø.B., & Singh, B.R., 2015. A comparative assessment of support vector regression, artificial neural networks, and random forests for predicting and mapping soil organic carbon stocks across an Afromontane landscape. *Ecological Indicators*, 52, 394-403.
- Xu, X., Xiong, F., & An, Z. (2022). Using machine learning to predict corporate fraud: evidence based on the gone framework. *Journal of Business Ethics*, 1-22.
- Yaprakli, T.S., & Erdal, H., 2016. Firm failure prediction: A case study based on machine learning. *International Journal of Informatics Technologies*, 9(1), 21-31.
- Zhang, Q., Miao, F., Wang, Z., Shen, Y., & Wang, G. (2017). Effects of long-term fertilization management practices on soil microbial biomass in China's cropland: A meta-analysis. *Agronomy Journal*, 109(4), 1183-1195.

THE COMMUNICATION LEVEL WITH THE SOURCES OF AGRICULTURAL TECHNOLOGY INFORMATION BY FARMERS IN ZOMMAR REGION / NINEVEH GOVERNORATE / IRAQ

Ahmed Awad Talb Altalb⁽¹⁾ Luma Monther Idress⁽²⁾
Mehmood Ali Noor⁽³⁾

^(1,2) Department of agricultural extension and technologies transfer, College of Agriculture & forestry, University of Mosul, Iraq

⁽³⁾ Institute of Crop Science, Chinese Academy of Agricultural Science – Ministry of Agriculture, Beijing, China

Email: ahmed_altalb@uomosul.edu.iq

ABSTRACT

Aim of the current research is to know level of connection with sources of agricultural technological information and farmers of Zommar district / governorate of Nineveh in general, define level of connection for farmers with agricultural technological information in every resource of connection in research, know the correlation between level of connection with agricultural technical information and independent variables of research. Place of research Zommar district – governorate of Nineveh. Limits: All (500) farmers of Zommar, (50) of which were simply randomly chosen as the sample to represent (10%). Tool: a two-section questionnaire, first section included personal and social information about farmers (age, academic achievement, willingness to be farmer, area of cultivated land, nature of estate, and social life). The second included (20) sources of agricultural information and knowledge, specially connection with sources of agricultural technical information level of farmers with resources of agricultural technical information in Zommar district, generally speaking, is moderate with bias towards low. researcher concluded that farmers need to promote their connection level with their sources of agricultural information. Variables of (age, academic achievement, willingness to be a farmer) play role in increasing communication of respondents with their sources of agricultural technical information.

Keywords: Sources, Technologies, information, communication, agriculture

INTRODUCTION

Communication is a science that plays huge role of lives for individuals, communities, states. It got importance in social, economic, political and cultural aspects (Al-mashakba, 2011). Communication is one of the most human activities in modern times, represents an invaluable branch of human and social sciences at the era of data flow where knowledge is multiplied in gigantic unprecedented level in human history. (Nasr 2008); (. Shaarawey, 2014). Importance of communication multiplies to become an academic expertise that worth studying due to its importance in economic, cultural and social development (Al-Sardi 2011). Communication system is one of the basic and mst important social constructions. Communication connects groups, cultures and countries with each other (Al-Jumaeli et al, 2016); (Al-Hafidh, 2019). Communication comes in various contexts with various connotations. Basically it means exchanging ideas and information and messages and in general refers to means that states communicate (Al- Salhe, 2016).

Communication plays a great role in rural society. It is one of most important sources to deliver knowledge and information. Thus agricultural development depends on quality of resources providing farmer with knowledge and information (Abdel- Waheed, 2015); (Abd Alfaraje, 2019). delivering information needs to document types and levels of communicative ability that join workers in agricultural guidance with farmers (Swanson, 2010); (Al-Saidi, 2009). Efficiency in agricultural guides in communication is an important factor that establish efficiency of agricultural guidance. Thus guidance faculties works on improving information and skills of guides and farmers by providing necessary training programs to enhance their communicative skills (Ahmed and Ghothaib 2010); (Sultan 2019); (Murad, 2020). As well as urging agricultural extension to deliver their message to farmers via agricultural communicative means and resources. Agricultural Extension aims to deliver all modern inventions and information to farmers via different guidance ways and communication means (Al-Salihi, 2010);(Al-Khashab, 2014). There are many goals, and functions for agricultural communication, and the goals of educations connections for both of extension worker and farmer different according to the planning of extension programs and it is usefulness to farmers in the target area (Ajele, 2020); (Al-Shabriqi, 2017). The goals of communication of extension such as (transfer the technologies and ideas to the farmers in the simple ways, and exchange the experiences between the change gent and farmers, and the important goal is creating the interaction and touching between farmer and worker in extension through participation in actively (Abu Esba, 2017); (Al-Zaede, 2016). The aims of agricultural guidance of communications operation is transfer the new knowledge's and experiences to the respondents (farmers) and persuasion farmers to reach for the best (Al-Khazeraje, 2014).

Generally speaking, in Iraq and Nineveh governorate and Zommar district in particular there are innumerable information sources provide farmers with agricultural knowledge and information, it became important to lay a hand on the most important sources of agricultural information and knowledge of farmers regarding agricultural processes. Thus researchers wanted to do this research to know level of communication of farmers with their agricultural and technical resources.

AIMS OF RESEARCH

- 1- Know level of communication with agricultural technical information by Zommar farmers / Nineveh governorate in general
- 2- Define level of communication of farmers with agricultural technological information in every source of communication mentioned in research.
- 3- Know the correlation between level of connection with agricultural technical information and independent variables of research (age, academic achievement, willingness to work in agriculture, area of cultivated land, nature of land estate, social participate).

MATERIALS AND METHODOLOGY OF RESEARCH

Zommar district of Nineveh governorate was chosen to be place of research. Society of research was all its (500) farmers. A simple random sample representing (10%) was chosen, so the sample was (50) farmers.

To collect data, a questionnaire was made as a tool of two sections, first part included social and personal information of farmers: age , academic achievement , willingness to be a farmer , area of cultivated land nature of estate and social life . The second included (20) sources of agricultural technical information regarding connection with sources of these information.

After putting the blue print of tool of research, it passed a panel of experts in agricultural guidance to extract surface validity and reliability of content of scale to ascertain academic and linguistic safety of research items. Data were collected during January 2023

A pre-test was applied on a pilot researches not within the sample they were (30). Stability was found using half division to find stability of half skill. Using spearman – Brown equation. Total stability of scale was found reaching (0,93) After having the final form of questionnaire final data of research were gathered in February 2023.

- Measuring dependent variable

Level of connection with sources of agricultural technical information was found via the following alternatives (highly connected, moderately connected, rarely connected, no connection) and graded (4,3,2,1) respectively. Through collecting farmers' answers on all items to get degree of connection with sources of agricultural technical information. After completing the draft of questionnaire, it underwent a panel of specialists in agricultural guidance to verify its surface reliability of items as well as academic safety of items. data were collected on January 2023.

- Measuring independent variables were measured as follows:

- 1- Age:** measured through years of farmers while collecting data each year was given 1 point
- 2- academic achievement:** measured through these levels: graduate of primary study, graduate of middle study, graduate of secondary study, graduate of college study, and graded (4,3,2,1) respectively
- 3- Willingness to working in agriculture:** measured through alternatives: (i willing, i don't walling) and graded (2,1) respectively.
- 4- Area of cultivated land:** measured using donams.
- 5- Type of agriculture land:** through the following levels (property, contract, rent) and graded (3,2,1) respectively
- 6- Social participate:** measured through (participation of high social, participate of moderately social, participation of rarely social) and graded (3,2,1) respectively.

- Statistical means

- 1- Ratio:** To describe farmers according to their distribution on categories of research variables.
- 2- Mathematical means:** To describe research variables, level of connection of agricultural technical information according to the following law:

$$\bar{X} = \frac{\sum X}{n}$$

Where x mathematical means:

X = Average

$\sum x$ = sum of vectors

n= number of sample

- 3- Pearson conjunction factor:** Used to calculate person conjunction factor when finding stability of scale and indicators of independent research variables using half division method as shown in the following law:

$$roe = \frac{\sum XY - \frac{(\sum X)(\sum Y)}{n}}{\sqrt{(\sum X^2 - \frac{(\sum X)^2}{n})(\sum Y^2 - \frac{(\sum Y)^2}{n})}}$$

R= conjunction value (stability).

X= values of individual items

Y= values of binary items

N= number of farmers

4- Spearman – Brown equation: used to correct stability of scale values of independent variables calculated using half division according to the following law:

$$\frac{2r_{oe}}{1+r_{oe}}$$

r_{xx}= value of estimated stability

r_{oe} = value of correlation between individual and marital items.

Results and discussion

1- Set connection level with sources of agricultural technical information by farmers of Zommar district / Nineveh Governorate in general:

Results showed, that highest degree of farmers in Zommar region about their connection with information sources of agricultural technical information in general, was (71), the lowest was (25), it takes average (48). Zommar farmers, were distributed to the (3 categories), as show in Table (1).

Table (1) Categorizing of farmers according for their connection with sources of agricultural technical information in general.

Categories	Number	%
Low (33-40)	16	32
Middle (41-56)	22	44
High (57-72)	12	24
Sum	50	100

Table (1) shows that the highest number for farmers in middle category (41-56) representing (44%) it is meaning that the level of connection with sources of agricultural technical information for Zommar farmers is moderate with trend toward low. The reason maybe lead that those farmers use communication means in agriculture in moderately tending to be low and they need to enforce their desire to be connected to sources of agricultural technical information.

2- Set level of connection to resources of agricultural technical information of farmers in every connection channel mentioned in research.

Table (2) shows that sources of technical information that came in first place were (agricultural unit in the region, agricultural guide, friends and neighborhood) is meaning that farmers use these sources of information more heavily than other sources and rely on them to solve their agricultural problems because of their trust in these resources, while these sources that came in last places were (mobile, meetings and e-magazines) meaning that farmers don't trust these resources to get agricultural information.

Table (2) Arrangement of information sources according to the answer of farmers (average of answer) on sources.

Item	Average	No.
Agricultural unit in region	3,55	1
Agricultural guide	3,45	2
Friends and neighbors	3,40	3
brochures	3,30	4
College of agriculture	3,09	5
viber	3,07	6
Whats app	305	7
Agricultural groups via internet	3	8
telegram	2,90	9
e-mail	2,80	10
Visits to research centers	2,74	11
Mobile text messages	2,72	12
Administrate of agriculture	2,40	13
Participation in executed agricultural guidance programs	2,22	14
Participation in executed agricultural training courses	2	15
Participation in agricultural seminars and workshops	1,95	16
You tube	1,90	17
e- magazines	1,88	18
Zoom and Google meets	1,82	19
Mobile	1,80	20

3- Know the correlation between level of connection with sources of agricultural technical information and independent variables: age, academic achievement, willingness to work in agriculture, area of cultivated land, Type of agriculture land and social participate:

Age: results showed that highest age rank in this sample was (25 year) and the least age was (22 year), with an average of (45 years). Respondents farmers, were categorized according to their age into three types shown in the Table (3).

Table (3) categorizing farmers according to their age and its relationship with their connection with sources of agricultural technical information

Categories	Number	%	Value of Pearson conjunction
Low (22-36)	14	28	*0.03
Middle (37-51)	28	56	
High (52-66)	8	16	
Sum	50	100	

Table (3) shows, that the category with highest ratio of farmers was in middle category (37-51) reaching (56%). The category of least farmers was (52-66) with an average of (16%). Results showed there is significant correlation between connection level between sources of agricultural technical information and age. Simple Pearson conjunction factor was (*0,03) moral at (0,05) level, it is meaning that age of farmers related to his level of connection with sources of agricultural technical information, meaning that the older farmer has the higher awareness, he

got it in his connection with sources of agricultural information as results of number of years in working in agriculture.

- **Academic achievement:** Zommar farmers were categorized according, to their academic achievement as show in Table (4).

Table (4) categorizing farmers according to academic achievement and, relation with their connection with sources of agricultural technical information.

Categories	number	%	Value of spearman conjunction
graduate of primary study	7	14	0,04
graduate of middle study	22	44	
graduate of secondary study	13	26	
graduate of college study	8	16	
Sum	50	100	

Table (4) shows that highest number of farmers was in (graduated of middle study) reaching (44%) and the category of graduate of primary study got to less percent than, is (14%). Results showed a strong moral correlation between level of connection of farmers with sources of agricultural technical information and academic achievement, were spearman rank conjunction factor was (0,04) moral at (0,05), meaning that level of connection of farmers with sources of agricultural technical information depends on academic achievement due to the knowledge he got during school.

- **Willingness to work in agriculture:**

Farmers were categorized according to variable of willingness to be a farmer to categories, as shown in Table (5).

Table (5) categorizing farmers according to willingness to work in agriculture and its relation to connection with sources of information

Categories	number	%	Value of Spearman conjunction
I willing	35	70	0,420
I don't willing	15	30	
sum	50	100	

Table (5) shows that highest number of farmers was in (I don't want to be a farmer) representing (70%), while the (I don't willing) was (30%). Results also showed there is moral correlation between level of connection between farmers and their resources of agricultural technical information and willingness to work in agriculture. Spearman rank conjunction factor was (0,420) moral at (0,01) meaning that desire to be a farmer encourage him to communicate and look for sources of agricultural information to develop his knowledge and information about agriculture.

- **Area of cultivated land:**

Results showed that highest area in Zommar region was (6) donams, and the least area was (1 donams), with an average of (3,5) donams. Farmers were categorized according to area cultivated into categories, as shown in table (6).

Table (6) shows categorizing farmers to categories according to their connection with sources of agricultural technical information and its relationship with area of cultivated land.

Categories	number	%	Value of Pearson simple conjunction
Low (1-2)	40	80	*0,312
Middle (3-4)	6	12	
High (5-6)	4	8	
Sum	100	50	

Table (6) shown that highest number of farmers was in low category (1-2) representing (80%), while the high category got the least ratio farmers (8%). Results showed a moral correlation between level of relationship of farmers with their sources of agricultural technical information and Area of cultivated land. Pearson simple conjunction factor was (*0,312) moral at (0,05), it is meaning the more cultivated area of farmers lead to, the bigger motive and increase his connection with sources of agricultural information to enhance his agricultural knowledge.

- Type of agriculture land:

Farmers respondents were categorized according to type of agriculture land, as shown in table (7).

Table (7) Categorizing farmers according to type of agriculture land and its relationship with connection with agricultural information.

Categories	number	%	spearman conjunction value
Property	15	30	0,953
Contract	16	32	
Rent	19	38	
Sum	50	100	

Table (7) shows that highest number of farmers was in category of rental representing, with (38%), while the category of (property) was (30%). Results, showed also there is no correlation between level of connection with agricultural technical sources and type of agriculture land, the spearman rank conjunction factor was (0,953), meaning that type of agriculture land, isn't related with level of connection with sources of agricultural technical information and seeking information in cultivating land.

- Social participate:

Farmers were categorized according to their social life as shown in table (8).

Table (8) categorizing farmers regarding sources of agricultural technical information and participation in social participation.

Categories	Number	%	Pearson conjunction value
High participate	22	44	0,621
moderate participate	18	36	
Low participate	10	20	
Sum	50	100	

Table (8) explain that the highest category was in moderate participate, with (36%), and the low participate (20%). Also, the results showed there is no correlation between connection of respondents with sources of agricultural technical information and social participate, the simple

Pearson conjunction factor is (0,621), this meaning that participate of social for farmers doesn't affect on their connection with sources of agricultural technical information in their work.

CONCLUSIONS

According to results of research, we can conclude:

1- Connection of farmers with their sources of agricultural technical information of Zommar district in general is moderate tends to be low. It is concluded that farmers need to develop their communication level with their sources of agricultural information.

2- The variables (Age, academic achievement, cultivated land area, willingness to working in agriculture) these variables play role in enhancing connection level of farmers with their information sources.

3- Farmers respondents have high connection with these sources (agricultural unit in the region, agricultural guide, friends and neighbors), thus they come in first place, we conclude that these sources provide the information to farmers in the research area.

REFERENCES:

- Al-Mashakba, Bassam abdulrahman (2011). Communication theories. Dar Asma publications, Amman Jordan, 1st edition.
- Al-Sardi, Mohammed Al-Dibs (2011). Connection and public relations in running libraries and information centers. Al-Balkaa applied university. Jordan. Ithraa for publication and distribution. Jordan.
- Al-Saidi, Haidar Abas Abdullah (2009). Connection skills for agricultural guides in planting of vegetables crops in some governorates of middle region and its relation to some sources and factors. M.A. Thesis in agricultural extension and generalization. College of agriculture. University of Baghdad.
- Ahmed, Abas Ali and Ali Ahmed Ghotheeb (2010). General view of trainees about training programs executed by guidance center in Salahuldeen. Magazine of Tikrit university of agricultural sciences, vol.10 no.3.
- Al-Salihi, Ahmed Thwaini (2010), Communicative skills for administrators of agricultural guidance in agricultural administrates of middle region from the perspective of agricultural guides M. A. Thesis, College of agriculture, university of Baghdad.
- Al-Hafidh. A. Z. Y. (2019). Farmers Knowledge Level of Potato Crop Cultivation in Rabia Sub- district / Nineveh Governorate. Mesopotamia J. of Agric. Vol. (47) No. (1).
- Al-Kashab, Radwan T. (2014). Knowledge needs for vegetable cultivators in Rabeaa District Neneveh Governorate in the field of high ant bush leaves and its relation with som factors, Mesopotamia J. of Agric., Vol. (42), No. (1).
- Abd Alfaraje (2019). Dhoha Mostafa. Attitudes of rural women towards participation in extensional activities in the District of Sharqat/Salah.
- Al-Din Province. Mesopotamia Journal of Agriculture Vol. (47), Supplement II, 2019 Proceedings of the 3rd International Agri. Conference College of Agri. and Forestry, Univ. of Mosul and College of Agri. Engineering Sciences, Univ. of Duhok 2-3 .
- Abdel- Waheed, Manisour Ahmed Mohammed Hanefe, (2015), The use of agricultural extension workers for ICT in extension work, in the Sohage Governorate, Faculty of Agriculture, Sohage University, Egypt.

- Al-Ajele, Rayan Raid Kadim, 2020, The Extension Knowledge Needs for Agricultural Employees in the Field of Conservation Agriculture in Nineveh Province, Master Thesis, Faculty of Agriculture, University of Tikrit.
- Abu Esba, Ahmed Ibin Fahd Moqbeel (2017). Factors of affecting farmers' for adoption of recommended use tags for Agricultural Pesticides in Yemen, PhD thesis, University of Khartoum, Sudan.
- Al-Jumaeli, Mahmmoud Hades Jasim and Ghosan Najaah Mahde Al-Samarrae (2016). Obstacles of extension communication in the agricultural techniques transfer from the point of view of workers in agricultural extension in Samarra District and its Relationship to some factors, Journal of University of Tikrit for Agricultural Sciences, 16 (4).
- Al-Khazeraje, Raed Musliem Ismaail (2014). Knowledge of the employees in the extension organization of some standards that related to the development of extension programs planning, Journal of Anbar for Agricultural Sciences, 12 (2). Al-Zaede, Mohammed Jassem Mutasher and Ashwaiq Abdul Razzieq Naje (2016). Planning extension programs under total quality standards in some governorates of the central region of Iraq, Journal of Iraqi Agricultural Sciences, 47(5), University of Baghdad.
- Al-Shabriqi, Magda Rezik (2017). Expectations of agricultural extension workers from the agricultural extension apparatus in the Regions of Al-Bayeda and Garnada - Green Mountiain - Libya, Faculty of Agriculture, Omar Al-Mukhtair University.
- Al- Salhe, Ahmed Thewaine Haddoum (2016). Communication sources that used by the agricultural extension in the transfer of agricultural information to the farmers of sheelp in the Abbasiya District of Najaf Governorate, Iraqi Journal of Agricultural Sciences, 47(3), College of Agriculture, University of Baghdad.
- Swanson Burton. E., Riika Rajalahti (2010). Strengthening Agricultural Extension and advisory systems: Procedures for assessing, Transforming and Evaluating Extension systems, The World Bank.
- Sultan, Zahraa meiser (2019). Extension Needs For Agricultural Staff In The Directorate Of agriculture/ Nineveh Governorate in the field using Extension Aids, Mesopotamia Journal of Agriculture Vol. (47), Supplement II, 2019 Proceedings of the 3rd International Agri. Conference, College of Agri. and Forestry, Univ. of Mosul and College of Agri. Engineering Sciences, Univ. of Duhok 2-3.
- Nasr, Hussein Mohammed (2008). Introduction in mass communication, Introduction and means. Al-Falah library for printing and publication. 1st edition. College of media, University of Cairo.
- Murad, Hashim S., (2020). Knowledge Level of Agricultural Employees In Duhok Directorate On Integrated Pest Management, Mesopotamia J. of Agric., Vol. (48) No. (2).
- Shaaraway, Ejlal (2014). Extension Programs, Administration of Central for Agricultural Extension & Environment, Online of Kenana gates. <http://www.caaes.org/posts/591170>.

DESIGN OF A SELF BALANCING SINGLE WHEEL ROBOT

*Ahmet VATANSEVER**

*Hilmi KUSCU***

**Computer Programming Department in Vocational College of Technical Sciences, Trakya University, TURKEY*

***Mechanical Engineering Department in Faculty of Engineering, Trakya University, TURKEY*

ahmetvatansever@trakya.edu.tr

ABSTRACT

Self-balancing single-wheeled robots have been an important research topic in the fields of robotics, dynamic balance, control theory, and mechatronic systems. Single-wheeled mobile robots are inherently unstable and non-linear, which makes balancing difficult. In this study, a PID controller is used to control the balance of the single-wheeled robot. In addition, the balancing mechanism is designed separately, assuming that both roll and pitch dynamics are separated in the study. The self-balancing single-wheeled robot consists of a reaction wheel and a wheel for balancing and forward/backward movement, and also pitch and roll angles are measured by the IMU sensor and used for balancing by applying a complementary filter algorithm to these measured data. The reaction wheel pendulum method is used to balance the roll axis, while the inverted pendulum method is used to balance the pitch axis. As for balancing control, the motor control on the reaction wheel and wheel is based on the feedback of the measured pitching and rolling angles from the IMU sensors. The prototype of the single-wheeled robot is designed, produced, and controlled.

Keywords: Self-balance, Single-wheeled robot, Complementary Filter, PID Control, Arduino.

1. INTRODUCTION

This study focuses on single-wheeled robots, which are included in the subcategory of unmanned robots. Single-wheeled robots are a special type of robot that performs its movements on only one wheel. Compared to mobile robots with two, four, or more wheels, single-wheeled robots have significant advantages.

Single-wheeled robots provide superior maneuverability in limited spaces and are more energy efficient due to their lighter structures. Additionally, they are more cost-effective than other types of mobile robots as they operate with only one wheel (1).

This study focuses on the balancing control of single-wheeled robots, presenting fundamental principles and methods to optimize the performance and stability of this type of robot. The balancing control of a single-wheeled robot consists of two main components: the inverted pendulum method for pitch control and the reaction wheel pendulum method for roll control. The angular data of the robot is measured using an Inertial Measurement Unit (IMU) sensor. For balancing control, a complementary filter algorithm is applied to the pitch and roll angle feedbacks from the IMU sensors, which is used to control the motors on the reaction wheel and wheel.

The interaction between robotics and control theory has a rich history spanning over half a century. Research on single-wheeled robots has been ongoing in the US, Europe, and Japan since the 1980s. Various single-wheeled robots have been developed and different control systems have been proposed for these robots in the studies (2)(3).

In 1980, Ozaka et al. invented a single-wheeled robot with a long arm that extends to the right and left. In this robot, they achieved rolling balance by moving a mass along the arm. Although the approved experimental results could not be reached, this robot is the first self-balancing single-wheeled robot (4)(5).

In 1987, A. Schoonwinkel from Stanford University wrote a doctoral thesis on the dynamic analysis of a humanoid unicycle robot. In this work, he designed a self-balancing unicycle robot based on the control methods of a person riding a wheeled circus bicycle. He achieved the stabilization of a unicycle using active feedback control. He built a unicycle robot with mass and inertial properties similar to that of a small child and used it as an experimental platform to test various control algorithms. He obtained a linearized model and designed and simulated the most appropriate control systems to balance the robot. (6)

Prof. Yamafujii from the University of Tokyo proposed an approach that considers the dynamic model of the robot as an upper rotating wheel and a lower rolling wheel. In addition, in 1997, Prof. Yamafujii applied PI motion control to the robot. It was proven that the dynamic model of the robot was too complex to be applied in real-time (7). Therefore, in this study, we aim to maintain the balance of the single-wheeled robot using a PID controller that can control a system based on a specific controller gain without system modeling.

PID controller is widely preferred in industry because of its simplicity and easy applicability. This controller has the ability to effectively maintain control performance in various environments (8).

The most critical step in designing a PID controller is determining the appropriate proportional (P), integral (I), and derivative (D) gains. In this study, these gains were obtained through careful and repeated experiments.

1.1 System Design

In Figure 1, two DC motors are used in the mechanical design of the robot, which is viewed from the front and the side. One of these motors is used to turn the wheel and the other to turn the reaction wheel. The motor that drives the wheel is located on the upper left side of the wheel and is connected via a timing belt mechanism. The motor that rotates the reaction wheel is positioned on the top of the robot.

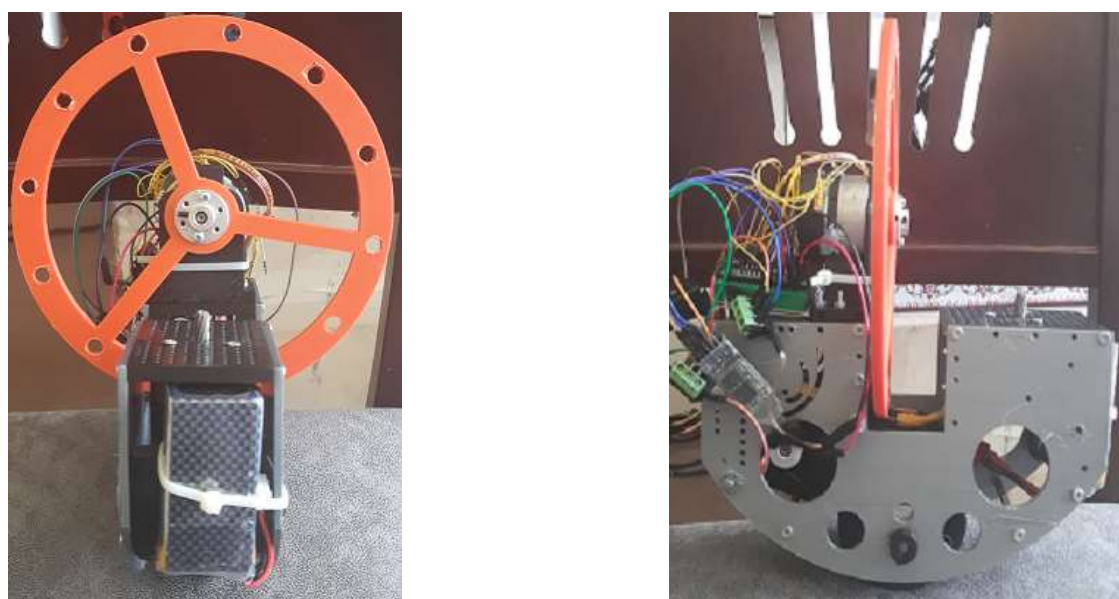

Figure 1: Front and Side View of the Single Wheeled Robot

Figure 2 shows the general system configuration of the single-wheeled robot. The microcontroller unit (MCU) takes the angle of the robot from the IMU sensor and uses it as input for the controller. The controller converts this angle into a PWM signal and transmits it to the DC motors on the roll and pitch axes, thereby controlling the torque and rotational speed. Data from all sensors is processed by the Arduino Nano microcontroller to control the rotation of the reaction wheel motor and the wheel motor. The robot is powered by a 3-cell LiPo battery (11.1 V) with a capacity of 1100 mAh.

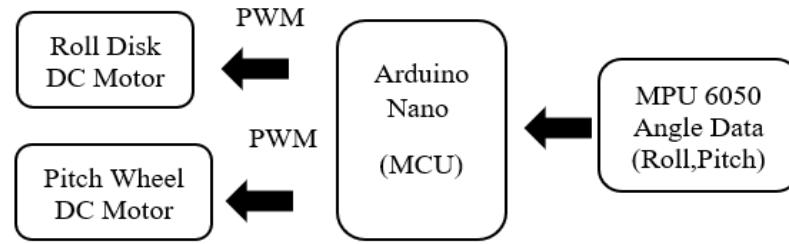

Figure 2: General System Structure of the Single Wheeled Robot

1.1.1 Arduino Nano Specification

In this study, Arduino Nano is used as the microcontroller board. The Arduino Nano is the same as Arduino Uno in terms of basic features but much smaller in size. It also has the ATmega328 microcontroller like Arduino Uno. This board has 14 digital input/output pins, 8 analog inputs, a 16 MHz crystal oscillator, a USB socket, an ICSP connector, and a reset button. The physical appearance of the Arduino Nano is shown in Figure 3 (9).



Figure 3: Arduino Nano

1.1.2 Control Unit

In roll and pitch control, we use a DC motor to rotate the reaction disc mounted at the top and the wheel placed at the bottom. DC motors are driven by a motor driver module with an H-bridge circuit structure. The input of the motor driver is called pulse width modulation (PWM). The torque and rotation speed of the motor are adjusted by the PWM width given as input.

At intervals of 10 ms, the microcontroller unit (MCU) sends a control signal to the motor driver to maintain balance in accordance with the designed controller. The control signal generated by the MCU is in the form of PWM, and the motor driver provides the necessary power to rotate the DC motor according to the input signal.

1.1.3 Inertial Measurement Unit (IMU)

An IMU is a sensor used to measure and track the motion and orientation of an object. IMUs often contain a combination of multiple sensors such as accelerometers and gyroscopes. Accelerometers measure the effect of gravity on objects, while gyroscopes measure angular

velocities. IMUs are commonly used in airplanes, drones, robots, and electronic devices (e.g., smartphones and game controllers).

In this study, MPU-6050 was used as the IMU sensor board. MPU-6050 includes a 3-axis gyroscope, a 3-axis accelerometer, and a Digital Motion Processor (DMP) that processes complex 6-axis Motion Fusion algorithms on the same silicon chip. MPU-6050 can be easily connected to microcontrollers or other systems via the I²C (Inter-Integrated Circuit) protocol. To digitize the accelerometer and gyroscope outputs, the DMP has built-in 16-bit ADCs.

MPU-6050 has a programmable ± 250 , ± 500 , ± 1000 , and $\pm 2000^\circ/\text{s}$ (degrees per second) range to provide precise tracking of fast and slow movements. Additionally, these components have a programmable $\pm 2g$, $\pm 4g$, $\pm 8g$, and $\pm 16g$ accelerometer range. The orientation of the sensor axes is shown in Figure 4.

In summary, the MPU-6050 IMU sensor board provides a powerful and effective solution for tracking the motion and orientation of objects, offering precise motion measurements and fast communication.

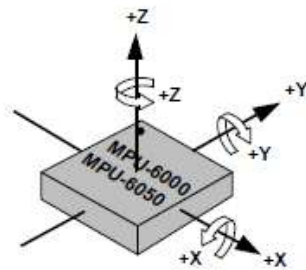

Figure 4: Orientation of the sensor's axes (10)



Figure 5: MPU-6050 6-Axis MEMS

1.2 Angle Measurement

To measure the tilt angle, data obtained from two sensors, such as an accelerometer and a gyroscope, is used. The accelerometer measures in three axes (A_x , A_y , and A_z) to determine the tilt angle of the object under the influence of gravity. In a two-dimensional situation, the tilt angle can be calculated using the following formula:

$$\theta = \arctan(A_y / A_x) \quad (1)$$

In the three-dimensional case, the general formulas are as follows:

$$\text{Roll } (\varphi): \arctan(A_y / \sqrt{A_x^2 + A_z^2}) \quad (2)$$

$$\text{Pitch } (\theta): \arctan(-A_x / \sqrt{A_y^2 + A_z^2}) \quad (3)$$

The gyroscope measures the angular velocity (ω) of the object. We can calculate the object's angle (θ) by integrating this value over a given time interval using the following formula:

$$\theta(t) = \theta(t-1) + \omega(t) * dt \tag{4}$$

Here, "dt" represents the time step. However, gyroscopic readings are not reliable for long-term measurements due to accumulated errors and deviations over time. Accelerometer readings may also be insufficient in terms of accuracy for short-term measurements. Therefore, sensor fusion algorithms that combine accelerometer and gyroscope data are used to provide more accurate and stable angle estimates. In this study, complementary filter algorithm is used for sensor fusion.

1.3 Complementary Filter

The complementary filter is a simple and effective sensor fusion algorithm that combines accelerometer and gyroscope data. The accelerometer provides accurate angle measurements for low-frequency movements but is noisy for high-frequency movements, while the gyroscope provides more accurate angle measurements for high-frequency movements but accumulates errors over time. The complementary filter combines the data from these two sensors using low-pass and high-pass filters and provides more accurate and stable angle estimates. The filter's workflow is shown in Figure 6.

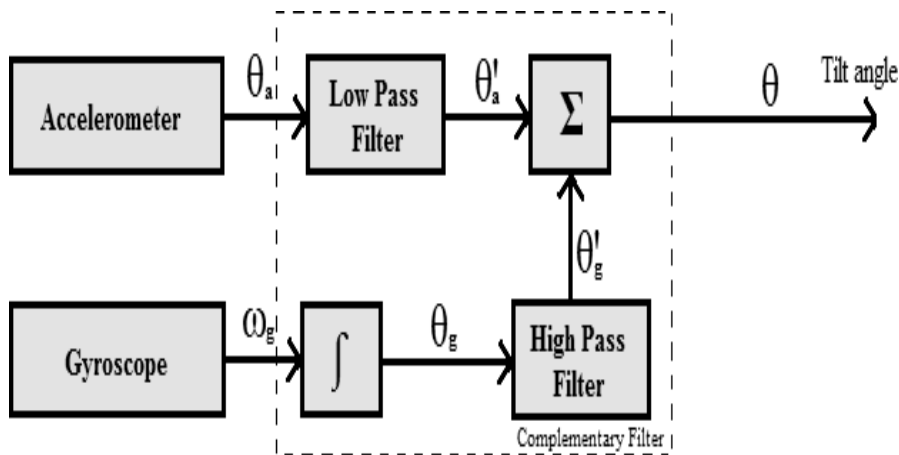

Figure 6: Flow of Complementary Filter

Essentially, the complementary filter works by processing the accelerometer readings with a low-pass filter and the gyroscope readings with a high-pass filter. This allows us to use the strengths of both sensors to obtain more accurate and stable angle estimates. First, the accelerometer readings are converted to angles using the relevant formulas. Then, the gyroscope data is integrated over time and combined with the accelerometer angles using the following equation:

$$\theta = (1-\alpha)* \theta_g' + \alpha* \theta_a' \tag{5}$$

Here, θ_g is the angle calculated from gyroscope readings, θ_a is the angle calculated from accelerometer readings, θ corrected steering angle, and α is the filter coefficient. The α value varies between 0 and 1 and is adjusted to provide the best combination of sensor data (12). In this study, the α values used to calculate the orientation in the x and y axis are 0.996.

The complementary filter provides accurate and stable angle estimations of low and high frequency movements, increasing the efficiency of both sensors and making it possible to obtain more reliable results.

1.4 PID Control of the Motor

PID control is a feedback controller commonly used in automatic control systems. PID is the initials of the words proportional (P), integral (I) and derivative (D), and these three components are brought together to reduce errors in the system and provide the desired performance. The PID controller calculates the difference between a measured process variable and a desired reference value as the "error" value. The controller tries to adjust the process control inputs to minimize the error.

$$u(t) = K_p * e(t) + K_i \int_0^t e(t) * dt + K_d \frac{de(t)}{dt} \quad (6)$$

Figure 7 shows the PID controller design for this control system. We use the PID equation to obtain the control signal for the DC motor. In equation 6, $e(t)$ represents the position error value between the desired angle and the measured output angle (actual angle), $u(t)$ denotes the PWM signal for the DC motor, and $y(t)$ represents the actual angle. K_p , K_i , and K_d are the proportional, integral, and derivative coefficient values, respectively.

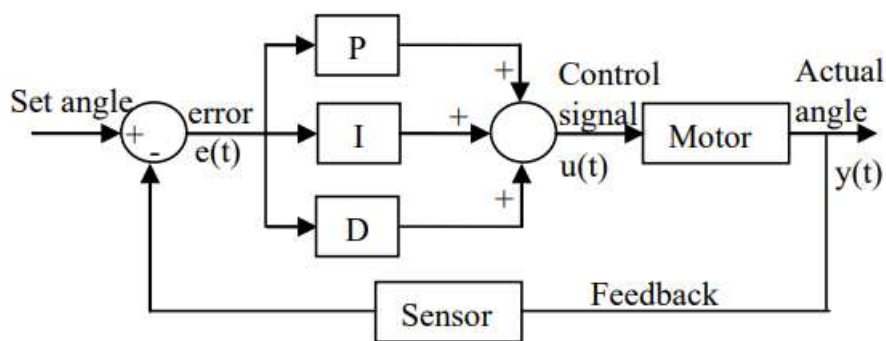

Figure 7: Closed Loop Position Control of DC Motor Using PID Controller

Proportional gain (K_p) applies correction in proportion to the magnitude of errors. A high K_p value provides faster response and more overshoot, while reducing steady-state error but not completely eliminating it.

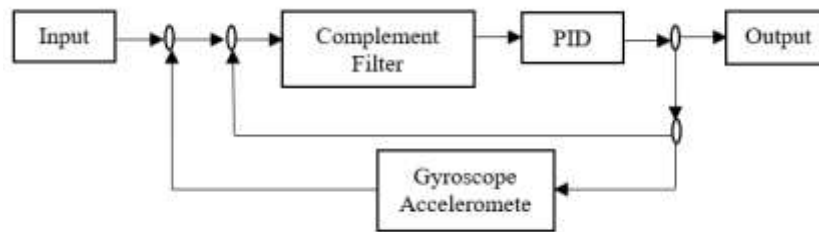

Figure 8: Control Diagram

The derivative gain (K_d) provides correction by taking into account the rate of change of the error. This adjusts the control effort based on the rate of change of the error. Derivative control responds quickly to sudden changes in the system, improves system stability, but is sensitive to noise.

The integral gain (K_i) provides correction by taking into account the accumulation of errors. It calculates the sum of errors over time and applies correction based on this value. Integral control eliminates continuous errors and improves system stability, but can cause the response to slow down over time.

These three control components are combined in a PID controller, and the weight of each component is determined by the K_p , K_i , and K_d gains set to optimize controller performance. Properly setting these gains ensures that the system reaches the desired state quickly and steadily.

There are various techniques available to determine the PID gains for optimizing system performance, including manual tuning, Ziegler-Nichols method, and automatic tuning. In this study, these gains were determined manually through careful and repeated experiments.

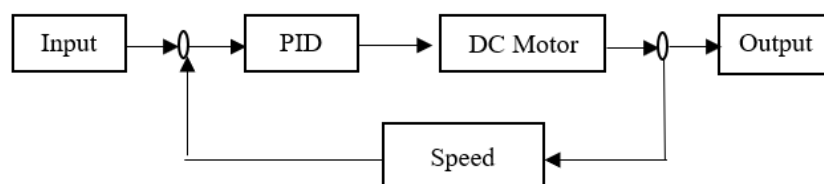

Figure 9: Block Diagram of the Feedback Mechanism of the PID Controller.

1.5 Controller Design

Assuming that the roll and pitch axes of the single wheeled robot are separated from each other, the controllers are designed separately. The angle of the robot body is used as the controller input and the center of the robot is considered as zero degrees.

1.5.1 Pitch Axis Controller

In pitch control, we balance the robot using only the pitch angle. Pitch control is the same as the balancing control of a two-wheeled inverted pendulum. As mentioned earlier, PID gains are obtained through repeated experiments.

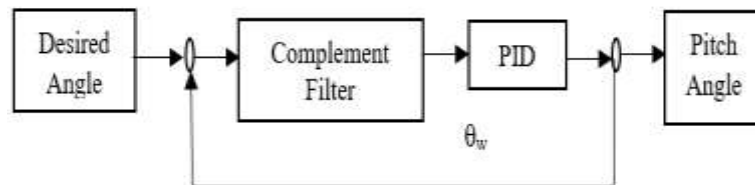

Figure 10: Pitch Controller

Figure 10 shows the Pitch controller. Here, θ_w represents the pitch angle. The input to the controller is the error between the current pitch angle and the desired angle.

1.5.2 Roll Axis Controller

The concept of roll balance control is similar to the method used for balancing gyroscopes or spacecraft using the law of conservation of angular momentum.

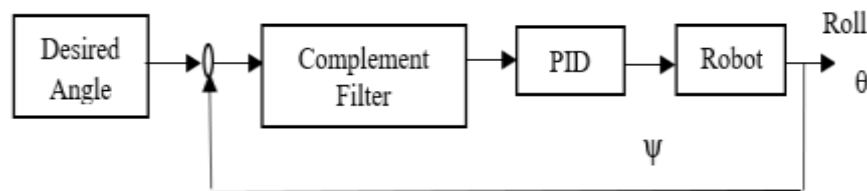

Figure 11: Roll Controller

Figure 11 shows the controller structure for the roll axis of the single-wheeled robot. Here, θ represents the roll axis angle of the robot body, while ψ represents the rotation speed of the disk. The controller is designed based on the PID controller. The reaction wheel pendulum method uses the instantaneous acceleration of the disk to provide balance control for the robot.

1.6 CONCLUSION

In this study, research has been conducted on the design, production, and control of a self-balancing single-wheeled robot. A PID controller has been used to maintain the balance of the robot, and balancing mechanisms have been designed separately for pitch and roll dynamics. The reaction wheel pendulum method has been effective in balancing the roll axis, while the inverted pendulum method has been used to balance the pitch axis.

Using a complementary filter on the feedback of pitch and roll angles obtained from IMU sensors, the control of the reaction wheel and the motor on the wheel were regulated to

maintain the balance of the robot. In this way, the robot stabilized and moved in a stable manner.

At the core of the study, the design, production and control of the prototype of the one-wheeled robot offers a solution to the balancing problems in the field of robotics and mechatronics systems. This study provides a foundation for future similar projects and also presents ideas for single-wheeled robots with more complex balancing and movement capabilities.

In the future, by adding a rotating wheel at the front of the robot, it will be possible for the robot to move sideways. Additionally, voice-controlled remote control for the robot can also be implemented. While focusing on balance control, further research is needed to improve driving control in more challenging conditions such as sloped and curved roads.

REFERENCES

1. Jae-Won An, Min-Gyu Kim, & Jangmyung Lee. (2014) Control of a Unicycle Robot using a Non-model based Controller. *Journal of Institute of Control, Robotics and Systems* 20(5):537-542 <http://dx.doi.org/10.5302/J.ICROS.2014.13.0003> ISSN:1976-5622 eISSN:2233-4335.
2. Lee, J., Han, S., & Lee, J., (2013). Decoupled Dynamic Control for Pitch and Roll Axes of the Unicycle Robot. *IEEETransaction on Industrial Electronics*, Vol 60, No 9, 3814-3822.
3. Mohan, S., Nandagopal, J. L., & Amritha, S. (2016). Decoupled Dynamic Control of Unicycle Robot Using Integral Linear Quadratic Regulator and Sliding Mode Controller. *Global Colloquium in Recent Advancement and Effectual Researches in Engineering, Scien.*
4. Daoxiong, G., Qi, P., Guoyu, Z., & Xinghui, L.(2012). LQR Control for a Self-Balancing Unicycle Robot on Inclined Plane, *Article in Journal of System Design and Dynamics*, Vol. 6, No. 5, 685-699.
5. Ozaka, C., Kano, H., & Masubuchi, M. (1980). Stabilization of unicycle. *System and Control*, vol.25, no.3, 159-166.
6. Schoonwinkel, A. (1987). Design and Test of a Computer Stabilized Unicycle. Stanford University, USA.

7. Lim, H., Hwang, J.-M., Ahn, B.-H., Lee, J.-M. (2009). Robust yaw Motion Control of Unicycle Robot. *Journal of Institute of Control, Robotics and Systems* 15(11), 1130–1136
8. M.-Y. Lee, D.-G. Koo, and J.-M. Lee.(1997). Optimal design and real application of nonlinear PID controllers, *Journal of Control, Automation and Systems Engineering*, vol. 3, no.
9. <https://www.robotistan.com/arduino-nano-328-usb-kablolu>.
10. MPU 6050 datasheet, weblink:
<https://www.invensense.com/wp-content/uploads/2015/02/MPU-6000-Datasheet1.pdf>
11. MPU 6050 register map (for programming purpose, available:
<https://www.invensense.com/wp-content/uploads/2015/02/MPU-6000-Register-Map1.pdf>
12. Vinayak Tripathi, Richa Gupta. (April 2019) Self-Stabilizing Platform Using Mpu 6050 - a Boon for The Society To Reduce Accidental Death. *International Journal of Engineering and Advanced Technology* (IJEAT) ISSN: 2249-8958 (Online), Volume-8 Issue-4.
13. Myo Maung Maung, Maung Maung Latt, Chaw Myat Nwe. (November 2018). DC Motor Angular Position Control using PID Controller with Friction Compensation. *International Journal of Scientific and Research Publications*, Volume 8, Issue 11, 149 ISSN 2250-3153.

DESIGN OF A TWO-WHEELED SELF-BALANCING ROBOT CONTROLLED BY VOICE

*Ahmet VATANSEVER**

*Hilmi KUSCU***

**Computer Programming Department in Vocational College of Technical Sciences, Trakya University, TURKEY*

***Mechanical Engineering Department in Faculty of Engineering, Trakya University, TURKEY*

ahmetvatansever@trakya.edu.tr

ABSTRACT

This study encompasses the design, construction, balancing, and voice command-based control of a two-wheeled self-balancing robot. The robot, statically unstable but dynamically stable, is based on the inverse pendulum system. The PID control method was used to maintain the robot's balance and control its movements. The PID controller corrects the error between the actual tilt angle and the desired set point by regulating the speed of the DC motor, thus maintaining the robot's balance. Additionally, an Inertial Measurement Unit (IMU), which combines accelerometer and gyroscope measurements to determine and measure the robot's tilt angle, was used. The IMU measures angular acceleration and angular velocity via accelerometers and gyroscopes, and the necessary calculations are made by applying a Kalman filter to these values. Four commands were used in the control of the robot. These commands were defined to the EasyVR voice recognition card through a throat microphone. EasyVR Commander, the graphical interface program of the EasyVR voice recognition card, was used to define these commands. After the voice commands are converted into digital signals by the voice module, they are transmitted to the robot via the Bluetooth module.

Keywords: Balance Control, Inverted Pendulum, PID Controller, Kalman Filter, Voice Recognition.

1. INTRODUCTION

The rapid advancement of technology and increasing industrial needs have constantly triggered new quests for understanding and controlling complex systems. This situation has increased interest in two-wheeled balance robots and has popularized their use on a commercial and industrial scale. Since the beginning of the 21st century, the interest in two-wheeled balance robots has increased, especially in response to the needs such as energy efficiency, space saving

and ease of use. These robots are widely used in places that require high maneuverability in narrow and crowded areas such as large shopping malls, car parks and hospitals [1].

A two-wheeled self-balancing robot (Two Wheel Balancing Robot - TWBR) is a type of robot that can move by continuously maintaining its balance on two wheels. These wheels, positioned vertically on the same axis, continuously adjust the robot's balance and prevent it from tipping over. In this process, the robot maintains a steady position by making adjustments such as moving forward or backward [2].

The initial examples of this robot model were developed in the 1980s by Japanese Professor Kazuo Yamafuji with the aim of simulating an inverted pendulum behavior [3]. Since then, various prototypes have been produced by many researchers.

The study by Juang and Lum involves the comparative use of PID and PI-PD controllers. In this study, it has been observed that better balance was achieved with the PI-PD controller compared to the PID control method, and also the center of gravity (C.G.) shift could be compensated [4].

Rasoul and Mehdi's study presents a series of dynamic models and control strategies for a two-wheeled self-balancing robot. Researches have calculated the dynamic model of the robot according to the Newton method and developed various control strategies based on this calculated dynamic model. In the study, three different controllers, namely PD, PID, and Fuzzy-PID, were applied to the robot. The effectiveness of these controllers has shown different results in maintaining the robot's balance and resisting external forces. As a result of the implementation of the PD controller, a slight vibration has been observed in the body of the robot, and the robot has tended to fall within a few seconds. In addition, the use of the PID controller has improved the overall stability of the robot, but the robot still tended to fall when an external force was applied to its body. Finally, after the Fuzzy-PID controller was applied to the robot, the robot's resistance to external forces and overall stability have improved impressively. This result was obtained thanks to various parameters set using Fuzzy logic. This study demonstrates the significant impact of control strategies on the performance and stability of self-balancing robots [5].

The study conducted by Zimit and his colleagues addresses the design and implementation of a PID controller on a two-wheeled self-balancing (TWSB) robot. The dynamic model of the robot was developed with the Lagrangian method. The robot can automatically maintain the vertical stability of the body and can follow the specified trajectory by successfully receiving signals through Bluetooth. The PID controller was designed and developed in real-time. It has been shown experimentally that the application of different PID

values brings about various results and how PID gains affect the performance of the controller [6].

In the study carried out by Unluturk and colleagues, a two-wheeled autonomous mobile robot system has been designed and implemented. The system has been created using a Qt-Creator based computer interface, allowing for the easy application of various control algorithms. The robot was aimed to maintain a vertical position, and in this regard, feedback controllers such as P, PI, PID were used. The effects of the controllers on the robot have been examined. In their work, it has been observed that the P-controller alone is insufficient to maintain the balance of the robot. However, when the PI controller was used, the robot can balance itself even for a short period of time and maintain its balance in a certain area. Also, when appropriate K_p , K_i , and K_d values were chosen, it was found that with the PID controller, the robot can stand upright for longer periods [7].

In the work of Zeng et al., a two-wheeled self-balancing robot system was designed using Arduino UNO R3 microcontroller board. The system is designed to enable the two-wheeled robot to sense its motion status and balance itself. DC motors as actuators, PID control loop as a controller, and Kalman filter to combine sensor data were used. Moreover, a Bluetooth module has been included in the system for the robot to receive signals through a mobile application [8].

The study by Velazquez et al. provides information on how a self-balancing robot can provide balancing, speed and motion control. A cascaded controller application has been offered for both balancing control and angular speed control [9].

Principles derived from balancing robots have been used in transportation applications. The most recognized example of these applications is the Segway PT, which was designed by Dean Kamen and commercialized as a personal transportation vehicle. Segway has the features of a two-wheeled, personal, and simply self-balancing robot. Segway applies the same principles as balancing robots, but motion is based on the user's body movements. To move forward or backward, the user needs to lean in the desired direction. Turns are controlled via steering. Segway, with the capacity to carry the weight of a single person, is a suitable vehicle for short-distance outdoor transportation, indoor transportation, tourism, and medical purposes [10-11].

Another commercial vehicle carrying the principles of a balancing robot is the Hoverboard, also known as an electric skateboard. Also referred to as a "hoverboard scooter" and a "self-balancing scooter", the Hoverboard, described as a self-balancing personal vehicle, runs on a rechargeable battery. The platform where the driver stands is integrated with an

internal balancing mechanism. Wheels and sensors allow the vehicle to balance itself, so the user can focus solely on steering. This feature provides ease of use for the Hoverboard [12].

Two-wheeled balancing robots generally require a control strategy similar to the inverted pendulum problem. The equations of motion of these robots are defined as nonlinear complex equations. These equations have been obtained using dynamic approaches such as the Newton's laws of motion or the Lagrange energy method [1]. In many studies, these kinds of balancing robots have been used to test control theory and control methods.

In addition, these robots collect orientation and motion data through sensors such as Inertial Measurement Units (IMUs). The collected data are processed by a control algorithm applied on an embedded microcontroller like Arduino, and adjustments to be made in the robot's movements are determined. This data collection and processing process allows the robot to maintain its balance and prevent it from falling over [2].

In recent years, thanks to advancing technology, control of these robots can be achieved through applications that can be remotely controlled with a Bluetooth connection. This situation has made the use of devices easier and allowed them to be used in a wider area.

The design and applications of self-balancing robots have required the development and use of different types of controllers. This has led researchers to focus on different controller techniques and to develop new methodologies in this field. This study focuses on the design of a two-wheeled balancing robot, how it is controlled with voice commands, and the control method used. This information will be presented in the context of modeling, applied techniques, and obtained results. The main goal of this study is to encourage more work on this subject and to show that balancing robots can be controlled with voice commands.

2. System Design

2.1. General System Design

In Figure 1, our self-balancing robot, visible from the front and side, is controlled by two Arduino electronic boards. These boards contain the ATmega328 microcontroller. For wireless communication, two HC-05 Bluetooth modules are used. MPU-6050 is preferred as IMU sensor board. In addition, a TB6612FNG motor driver board is used to drive two motors with DC 12V and encoder. Voice recognition processes are performed with the EasyVR module and a throat microphone is used for voice transmission.

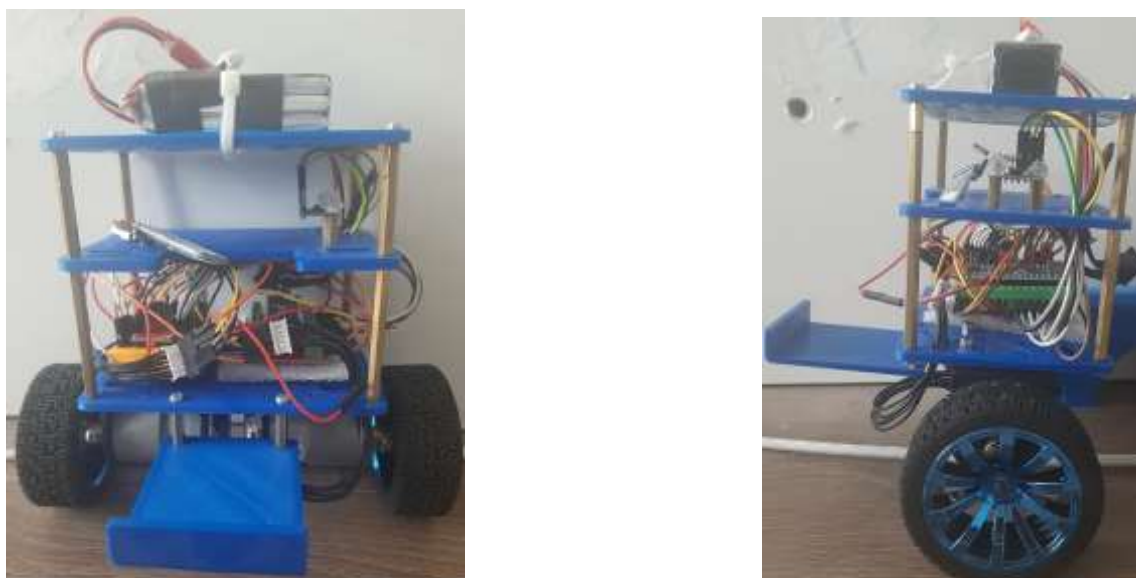

Figure 1: Front and Side View of Self Balancing Robot

According to the block diagram shown in Figure 2, two main processes are required for a self-balancing robot to maintain its upright position. The first is to measure the tilt angle of the robot; the second is to control the robot's motors to maintain a 0° angle. The robot is placed vertically on a horizontal surface and the power button is activated to apply the voltage required for each device from the power supply. This supply is provided by a battery, and this energy goes to both the Arduino Nano and the MPU 6050 sensor, which has the robot's two main sensors, the gyroscope and accelerometer. The accelerometer is used to measure the tilt angle. This angle is measured by the gyroscope and the information of angular velocity is transmitted to the wheels of the robot through Arduino. This information allows the motor driver to control the robot's wheels. The motion of the robot's wheels is arranged to be in the direction of fall, thereby preventing it from falling. The direction of the robot's movement is provided by the Bluetooth control mechanism, which can be controlled by voice commands. This mechanism allows control of all movement of the robot.

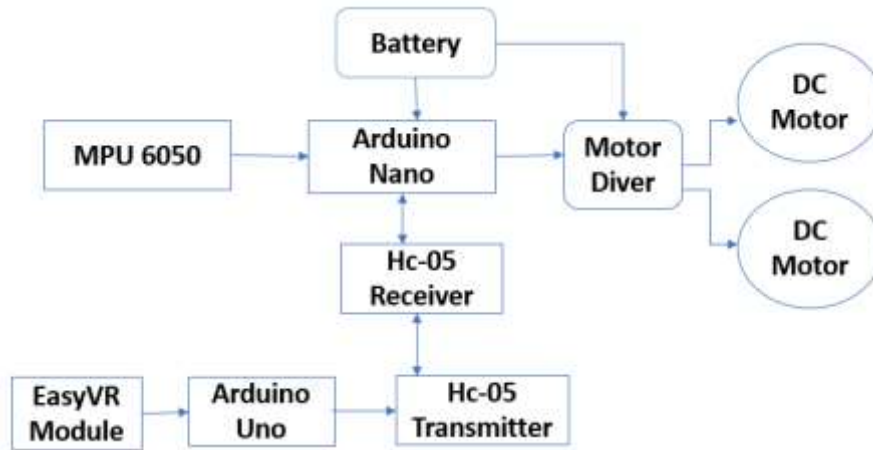

Figure 2: Block Diagram of Self Balancing Robot

Voice commands are transmitted to the EasyVR module via a throat microphone. The EasyVR module receives these voice commands and converts these commands into digital signals with its internal analog-to-digital converter (ADC). After the conversion process is completed, these signals are compared with predefined voice commands (for example: forward, backward, right, and left). If a match occurs, a binary value represented as a letter value for each command is sent. This binary information is received in the next stage by the ATmega328 microcontroller. After all comparisons are made, an information signal is sent to the transmitter Hc-05 Bluetooth. These digital signals are received by the receiver Bluetooth and the binary values are sent to the ATmega328 microcontroller. The microcontroller compares these values and according to the result of the comparison, the DC motors perform the necessary actions. The voice-controlled operation principle of the system is shown in detail in the block diagram in Figure 3.

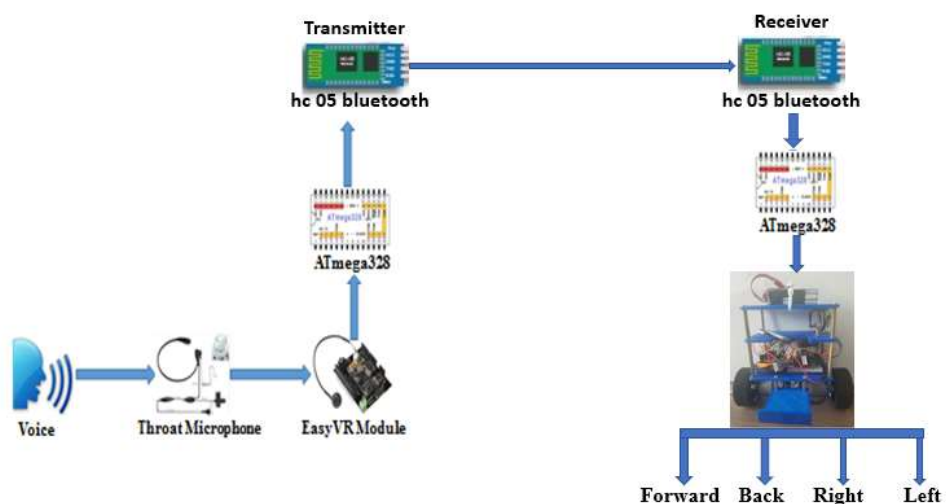

Figure 3: Voice Control General Structure of the System

The EasyVR module used for voice control is first connected to the Arduino Uno. After this connection is established, a Bluetooth connection is established between the Arduino Uno and the HC-05 module. After these connections are successfully completed, four different commands can be given for the control of the robot. After each command is transmitted vocally through a throat microphone, and each is represented by a different character, so they can be recognized by the microcontroller.

For example, the "forward" command corresponds to the "I" character, the "back" command to the "G" character, the "left" command to the "L" character, and the "right" command to the "R" character. These voice commands given through the throat microphone are used to control the movement of the robot. The flowchart showing the process of controlling the movement of the robot with these voice commands is given in Figure 4. In addition, the flowchart showing the process of the microcontroller controlling the movements of the robot is shown in Figure 5.

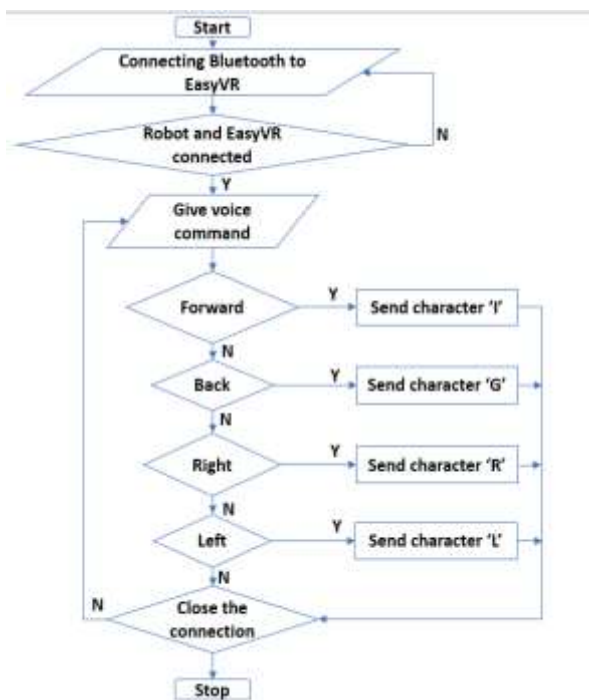

Figure 4: Flowchart to Control the Robot's Motion With Voice Commands

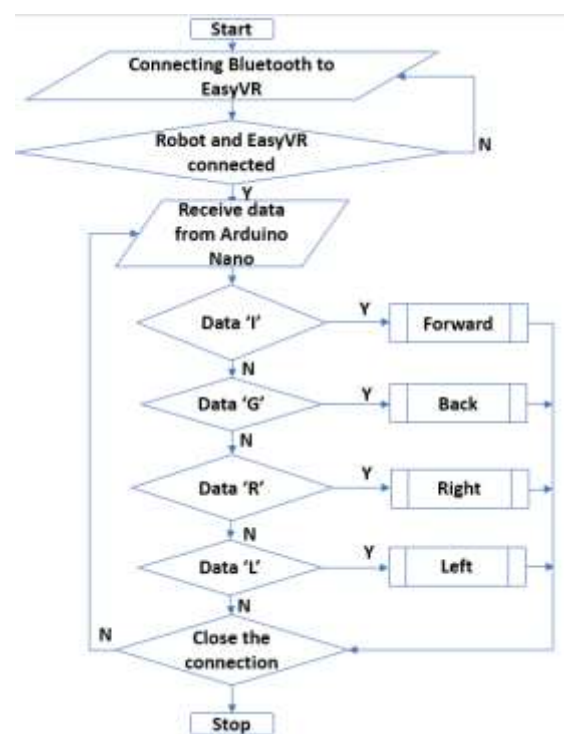

Figure 5: Flowchart Program From the Microcontroller

2.1.1. Arduino Nano

In this study, Arduino Nano was used as a microcontroller on the robot. The Arduino Nano, the smallest member of the Arduino series, is based on the ATmega328. It supports the

I2C communication protocol and works compatibly with the selected IMU thanks to this feature. Furthermore, it provides compatible operation with various types of actuators (DC motors, servo motors, stepper motors, etc.).

Arduino Nano offers the same functionality as Arduino UNO in most projects; but its smaller size makes it an ideal option. There are very small differences between UNO and Nano. Nano's architecture is different from UNO, and while Nano has 8 analog pins, UNO has only 6 analog pins. Also, Nano uses a Mini-B USB cable for power input [13]. An image of Arduino Nano is presented in Figure 6.



Figure 6: Arduino Nano

2.1.2. Arduino Uno

In this study, an Arduino Uno, along with an EasyVR voice recognition module, is used to enable our robot to process voice commands. The Arduino Uno is a microcontroller board with an ATmega328 processor. It has a total of 14 digital input/output pins, six of which can optionally be used for PWM output. In addition, it has 6 analog input pins. On the Arduino Uno, there is also a 16 MHz crystal oscillator, a USB connection port, a power input, an ICSP header, and a reset button. The Arduino Uno can be powered either via a USB connection or an external power source (such as a 2.1mm AC-DC adapter or battery power). Power source selection is made automatically [14-16]. The front and back view of the Arduino Uno microcontroller board is shown in Figure 7.



Figure 7: Arduino Uno Microprocessor Board (Front and Back)

2.1.3. EasyVR Shield 2.0 Voice Recognition Card

The EasyVR Shield 2.0 is a voice recognition module designed for Arduino. This card has been developed for various voice recognition applications in order to provide low-cost

solutions. Especially in home automation systems, it can be used in applications such as voice command control of lights, curtains, or kitchen appliances [17]. The image of the EasyVR Shield 2.0 voice recognition card is in Figure 8.



Figure 8: EasyVR Shield 2.0

The features of EasyVR Shield 2.0 can be listed as follows:

- Supports 28 different speaker-independent (SI) command words.
- Supports English, Italian, Japanese, German, Spanish, French, and Korean languages.
- Supports 32 speaker-dependent (SD) user-defined triggers or commands and voice passwords.
- User-specific commands can be created in any language.
- EasyVR 2.0 has SonicNet technology for wireless communication between modules or other sound sources (Audio CD, DVD, MP3 Player).
- Includes a DTMF tone generator.
- Can be used on any host via a UART interface.
- May be compatible with Arduino cards with a 3.3V-5V power range and cards like PIC.
- Serial communication protocol for programming on the host card is available.
- PWM audio output directly supports an 8-ohm speaker.
- Inputs are available for headphone and microphone connection [17].

2.1.4. Throat Microphone

Throat microphones transmit sound through vibrations in the throat. In this way, they can transmit sound clearly even in high noise environments. To transmit voice commands to the EasyVR voice recognition card, a two-sensor throat microphone, as shown in Figure 9, was used. The idea that using two sensors would bring the sound quality to a higher and clearer level influenced this choice [18].



Figure 9: Throat Microphone with Two Sensors

The features of the microphone can be listed as follows:

- Sensitivity $37.5 \pm 2 \text{ dB}$ & 1 kHz $2.2 \text{ k}\Omega$ 3 V $0 \text{ dB} = 1 \text{ v/pa}$
- Impedance Max. $2.20 \text{ k}\Omega$ & 1 kHz
- Directionality: Omnidirectional frequency: $100 \text{ Hz} - 16000 \text{ Hz}$
- Max. Working voltage 10 V
- Standard operating voltage 3 V
- Current consumption max. 0.5 mA
- S/N ratio Min. -56 dB & 1.1 kHz

2.1.5. MPU-6050

The MPU-6050 is a motion tracking device. This device hosts a Digital Motion Processor (DMP) capable of processing six-axis Motion Fusion algorithms and a gyroscope and accelerometer on three axes on the same silicon chip. The MPU-6050 can easily connect to microcontrollers or other systems via the I2C (Inter-Integrated Circuit) protocol. To convert gyroscope and accelerometer outputs into a digital format, 16-bit built-in ADCs have been added to the DMP [19].

2.1.6. HC-05 Bluetooth

In this study, two HC-05 Bluetooth modules are used for wireless control of our two-wheeled self-balancing robot. The HC-05 module on the robot is set to work in slave mode, and the HC-05 module on the voice recognition card is set to work in master mode. The HC-05 allows wireless serial communication applications with Bluetooth SSP (Serial Port Standard).

It supports Bluetooth 2.0 technology and communicates at a frequency of 2.4GHz. It offers a communication distance of up to approximately 10 meters in open areas [20].

2.1.7. Motor driver circuit

In this study, the TB6612FNG module is used as a motor driver circuit. The TB6612FNG is a DC motor driver with a high current MOSFET-H bridge structure and dual-channel circuit output. There are two input pins (IN1 and IN2) for the motor's four different operation modes (clockwise rotation, counterclockwise rotation, short brake, and stop). The PWM signal supports frequencies up to 100kHz, which gives it a significant advantage over other similar chips. The logic power supply (VCC) can operate in the range of 2.7-5.5VCC, while the motor power supply is 15VCC maximum. Each channel can provide 3.2A instantaneously while providing 1.2A continuous current [21].

3. Kalman Filter

The Kalman filter is generally known as a linear estimator that has the ability to minimize the error covariance [22]. Basically, the Kalman filter acts like an optimal estimate corrector and aims to minimize the estimated error covariance [23]. The Kalman filter has a mechanism for estimating a process in the form of feedback control: it estimates the state of the process at a certain time point and then receives (noisy) measurement data as feedback [23].

The Kalman Filter was introduced in a paper titled "A New Approach to Linear Filtering and Prediction Problems" by Rudolf Emil Kalman in 1960. Kalman developed a method to estimate the motion state of an object using previous state information. In addition, the Kalman Filter is also used to deal with data uncertainty caused by noise or noise interference [24].

The Kalman filter is based on a system of (1) and (2) linear equations [23].

$$\mathbf{x}_k = A\mathbf{x}_{k-1} + B\mathbf{u}_{k-1} + \mathbf{w}_{k-1} \quad (1)$$

$$\mathbf{y}_k = H\mathbf{x}_k + \mathbf{z}_k \quad (2)$$

In equations (1) and (2) above, A, B, and H represent the state transition matrix, input matrix, and measurement matrices, respectively. x is the state vector of the system and u is the inputs to the system. y represents a measurable output. w stands for process noise and z stands for measurement noise. The state vector x estimates the system state based on measurements in v and inputs in vector u . However, obtaining the x vector is complex because the information obtained from v is not completely reliable, as v is noisy [25].

The Kalman filter assumes that the process noise and measurement noise are uncorrelated with each other and their mean values are zero [26]. In order to meet the assumptions mentioned above, the covariance matrices for the process noise (Q) and measurement noise (R) are defined with formulas (3) and (4).

$$Q = E(w_k w_k^T) \quad (3)$$

$$R = E(z_k z_k^T) \quad (4)$$

Kalman filter equations are generally divided into two parts: prediction state and state correction. The prediction state represents a refresh time. In this case, a new state is estimated based on the current state and error covariance estimate. State correction is the process where feedback is received to form the next measurement from the obtained predictions.

<i>Predictions state:</i>	<i>Correction state:</i>
<ul style="list-style-type: none"> ▪ Estimation of state ahead $x_k'^- = Ax_{k-1}'^- + Bu_k$ ▪ Estimation of Error Covariance ahead $P_k^- = AP_{k-1}A^T + Q$ 	<ul style="list-style-type: none"> ▪ Kalman Gain calculation $K_k = P_k^- H^T (HP_k^- H^T + R)^{-1}$ ▪ Measurement estimation $x_k' = x_k'^- + K_k(z_k - Hx_k'^-)$ ▪ Error covariance update $P_k = (I - K_k H)P_k^-$

Figure 10: Kalman Filter Process [22].

In Figure 10, $x_k'^-$ represents the raw estimate before the measurement correction update is made. In other words, this value is the prediction value before the correction of the measurement. Similarly, P_k^- represents the previous error covariance. These two values are used as input to the measurement update stage, i.e., they are considered as previous values in the next stage [27].

The equations in the measurement update stage help us find the actual x_k' value. This is the value of the x vector at the k moment and this is actually the value we want to find. We also calculate the P_k value at this stage. We predict these two values for the next step, the (k+1) stage. The Kalman gain, called K_k , is important for the next stage, but we do not calculate this value. Although this value is somewhat hidden, mysterious, it is the most important component of these equations. These values in the measurement update stage are known as "posterior" or "next" values [27].

4. PID Controller

Proportional-integral-derivative (PID) controllers are widely used in various engineering applications. These controllers consist of proportional (P), integral (I), and derivative (D) components brought together to minimize errors in systems and ensure targeted performance. They are used to improve both transient and permanent situation responses. PID controllers play an important role in process control, they stand out with their simple structure as well as their robustness. Moreover, they are often preferred when a certain output needs to be directed to a predetermined target point [28].

In the 21st century, the rapid development of microcomputer and microelectronic technology has had a decisive effect on the development of PID controllers [29]. These technological advancements have allowed for controllers to be used more effectively and efficiently.

$$u(t) = K_p * e(t) + K_i \int_0^t e(t) * dt + K_d \frac{de(t)}{dt} \quad (6)$$

Equation 6 describes a continuous time PID control device that determines the initial setting of the control signal and control error. In this equation, $u(t)$ represents the output control signal, that is the PWM signal for the DC motor, while $e(t)$ denotes the position error between the targeted angle and the real output angle (actual angle). k_p , k_i and k_d are the proportional, integral, and derivative coefficients, respectively.

Figure 11 shows a closed loop control system enabling a robot to balance itself. In this system, the PID equation is used to obtain the control signal for the DC motor. The system output represents the real position of the robot. To detect this position, the MPU-6050 sensor is used. The detected position, compared to the ideal posture of the robot (90° vertical position relative to the ground), creates an error that should be reduced to zero for balancing purposes. A fast controller is required for this error correction operation, and a PID controller is used for this purpose. The PID controller precisely controls the motion of the DC motors by sending commands to the motor driver. This way, the balance state of the robot is constantly adjusted and controlled [30]. There are various techniques to determine PID gains, used to optimize system performance. These techniques include manual tuning, the Ziegler-Nichols method, and automatic tuning. In this study, these gains were manually determined as a result of careful and repeated experiments. Figure 12 provides a block diagram related to the feedback mechanism of the PID controller. This diagram provides a detailed view of how the control system operates.

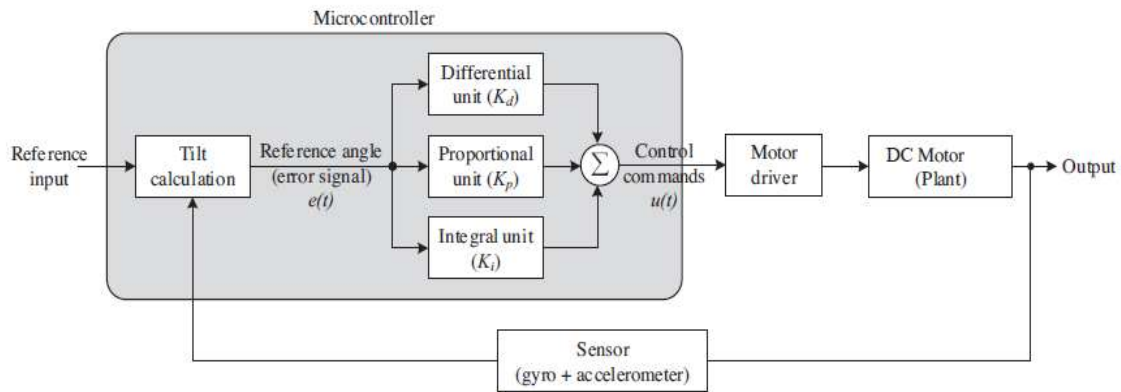

Figure 11: Closed Loop Control System of Self Balancing Robot [30].

There are various techniques to determine PID gains, used to optimize system performance. These techniques include manual tuning, the Ziegler-Nichols method, and automatic tuning. In this study, these gains were manually determined as a result of careful and repeated experiments.

Figure 12 provides a block diagram related to the feedback mechanism of the PID controller. This diagram provides a detailed view of how the control system operates.

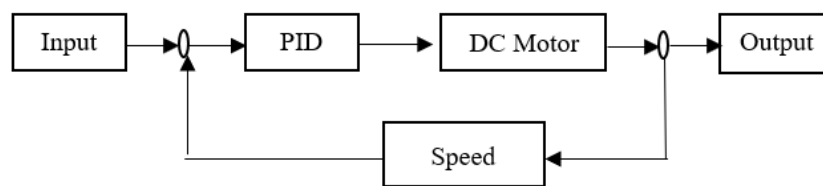

Figure 12: Block Diagram of the Feedback Mechanism of the PID Controller.

5. CONCLUSION

In this study, the research was conducted on the design, construction, balancing process, and user control with specific voice commands of a two-wheeled self-balancing robot. A PID controller was used to maintain the robot's balance. The PID controller corrected the error between the desired set point and the actual tilt angle by adjusting the speed of the dc motor, thereby maintaining the robot's balance. Also, an inertial measurement unit (IMU) combining accelerometer and gyroscope measurements was used to predict and measure the robot's tilt angle. The IMU measures angular acceleration and angular velocity through accelerometers and gyroscopes, and these values were calculated using the Kalman filter method. In this way, the robot maintained its balance stably, and its direction was controlled via voice commands

through Bluetooth connection. The robot's orient according to given commands and ability to self-balance has been experimentally verified.

By adding additional sensors and features to this robot, it can be used in many areas and can be an excellent learning tool. For example, a standard line-following robot, an obstacle-avoiding robot, or a maze-solving robot could be built using this balance robot. Such applications will make the learning process more intriguing and provide a different experience than four-wheeled special robots.

In conclusion, it can be summarized that a learning platform has been developed through the design and development of an optimally performing self-balancing robot.

REFERENCES

1. G. Taşhalan, O. E. Akay, "İki tekerlekli denge robotunun PID ile kontrolü", NÖHÜ Müh. Bilim. Derg. / NOHU J. Eng. Sci., 2022; 11(2), 393-403.
2. S. E. Arefin, "Simple Two-wheel Self-Balancing Robot Implementation", Texas Tech University Lubbock, Texas, USA, <https://arxiv.org/ftp/arxiv/papers/2303/2303.12067.pdf>.
3. K. Yamafuji and A. Koshiyama, "Postural and Driving Control of a Variable-Configuration-Type Parallel Bicycle," J. Robotics Mechatronics, vol. 3, no. 5, pp. 365-372, 1991.
4. H. S. Juang, K. Y. Lum, "Design and control of a two-wheel self-balancing robot using the arduino microcontroller board". In: Control and Automation (ICCA), 2013 10th IEEE International Conference, 2013; pp. 634-639.
5. R. Sadeghian, M., T. Masoule, "An experimental study on the PID and Fuzzy-PID controllers on a designed two-wheeled self-balancing autonomous robot". In: Control, Instrumentation, and Automation (ICCIA), 2016 4th International Conference, 2016; pp. 313-318.
6. A.Y. Zimit, H.J. Yap, M.F. Hamza, I. Siradjuddin, B. Hendrik, T. Herawan, "Modelling and Experimental Analysis Two-Wheeled Self Balance Robot Using PID Controller". In: International Conference on Computational Science and Its Applications, Melbourne, Australia, 2-5 July, 2018, pp. 683-698.
7. A. Unluturk, O. Aydogdu, U. Guner, "Design and PID control of two wheeled autonomous balance robot". In: Electronics, Computer and Computation (ICECCO), 2013 International Conference, 7 Nov 2013; pp. 260-264.

8. B. Zeng, J. Zhang, L. Chen, Y. Wang, "Self-balancing car based on ARDUINO UNO R3". In: 2018 IEEE 3rd Advanced Information Technology, Electronic and Automation Control Conference (IAEAC), 2018; pp. 1939-1943.
9. M. Velazquez, D. Cruz, Garcia S and Bandala M, "Velocity and motion control of a self-balancing vehicle based on a cascade control strategy". INT J ADV ROBOT SYST 13 1-1, 2016.
10. "Segway PT." Wikipedia. Wikimedia Foundation. <https://en.wikipedia.org/wiki/Segway>.
11. "Segway PT." Wikipedia. <https://tr.wikipedia.org/wiki/Segway>.
12. <https://www.makaleler.com/hoverboard-nedir-ozellikleri-nelerdir>.
13. <https://www.direnc.net/arduino-nano-klon-usb-kablo-dahil>
14. <http://arduino.cc/en/Main/ArduinoBoardUno>.
15. <http://arduino.cc/en/Guide/Windows>.
16. <http://arduino.cc/en/Reference/HomePage>.
17. http://www.veear.eu/files/easyvr_user_manual_3.6.7.pdf.
18. <http://tr.aliexpress.com/item/Clear-Transmission-Throat-Microphone-Air-Tube-Headset-with-2-Sensors-for-Yaesu-Portable-Radio-FT-10R/32276708707.html#extend>.
19. MPU 6050 datasheet, weblink:
https://www.invensense.com/wp_content/uploads/2015/02/MPU-6000-Datasheet1.pdf
20. <https://www.robotistan.com/hc05-bluetooth-serial-modul-karti-hc05-bluetooth-to-serial-port-module-br>.
21. <https://www.robotistan.com/tb6612fng-step-motor-surucu-dc-motor-sucuru>.
22. G. Welch and G. Bishop, "Kalman Filter. An Introduction to the Kalman Filter", University of North Carolina at Chapel Hill Department of Computer Science Chapel Hill, NC 27599-3175, February 2009.
23. G. Welch and G. Bishop, "An Introduction to the Kalman Filter", SIGGRAPH 2001 Course Note, University of North Carolina, Chapel Hill, U.S, 2001.
24. S. Rudi, T., Hendri Himawan, F., Muhammad, " Gesture Control Using IMU MPU 6050 Kalman Filter Method for Quadcopter Control" Prosiding Seminar Nasional Sains Teknologi dan Inovasi Indonesia, Akademi Angkatan Udara | Yogyakarta, 24-25 November 2021, Volume 3, Tahun 2021, hlm. 411-422. DOI:10.54706/senastindo.v3.2021.133
25. Y. Bar-Shalom, X. Rong Li, T. Kirubarajan, "Estimation with Applications to Tracking and Navigation", John Wiley & Sons, 2001.
26. R. Sławomir, G. Zdzisław, "Kalman Filter Realization for Orientation and Position Estimation on Dedicated Processor", Acta Mechanica et Automatica, vol.8 no.2 (2014).

27. İ.Çayıroğlu, “ Kalman Filtresi ve Programlama”, Fen ve Teknoloji Bilgi Paylaşımı, 2012-1. Article Web Page: www.ibrahimcayiroglu.com.
28. B. Sumantri, E. Binugroho, I. Putra and R .Rokhana, “Fuzzy-PID ontroller for an energy efficient personal vehicle: Two-wheel electric skateboard”.2019, Int. J. Electr. Comput. Eng 9 5304- 5311.
29. J. Kang, W. Meng A. Abraham and H. Liu , “An adaptive PID neural network for complex nonlinear system”, 2014 , *Neurocomputing* **135** 79-85.
30. S. Anmol Singh, R. Yogesh, “Design and Control of Two-wheeled Self-Balancing Robot using Arduino”, Proceedings of the International Conference on Smart Electronics and Communication (ICOSEC 2020) IEEE Xplore Part Number: CFP20V90-ART; ISBN: 978-1-7281-5461-9

DETERMINATION OF THE PROPERTIES OF A POLYMERIC GEL AS A DRUG CARRIER MATERIAL VIA MOLECULAR SIMULATIONS

Ceyda KIMIL¹, Gokhan KACAR²

1 Genetics and Bioengineering, Institute of Natural Sciences, Trakya University, Edirne, Turkey

2 Genetics and Bioengineering, Faculty of Engineering, Trakya University, Edirne, Turkey

Corresponding author e-mail: ceydakimil06@trakya.edu.tr

ABSTRACT

The purpose of this thesis is to use molecular modeling and simulations to study a Pluronic®-based polymeric gel in order to create a novel drug carrier. First, the mechanical properties of the polymeric gels will be computed in accordance with the thesis's goal. Drug release and encapsulation efficiency at various temperatures will be examined by incorporating drug molecules into the gels. One of the coarse-grained simulation techniques, the MARTINI force field, will be used for the simulations in this thesis. Furthermore, as a consequence of the simulations, an investigation into the drug's distribution, dynamic features, and interactions in the carrier system is planned. Molecular simulations will also be used to study the drug's release characteristics and mechanisms. By introducing drug molecules to these gels in a modeling environment, the results of this thesis study will yield important insights into the structures of polymeric gels, drug transport capabilities, and gel properties.

Keywords: Polymeric gels, Cross-linked polymers, Smart drug delivery systems, Pluronic®, Molecular dynamic simulations, MARTINI force field

INTRODUCTION

Gel-like structures formed by combining polymer chains with different long chains are known as polymeric gels. These gels are formed when polymer chains are linked together by physical or chemical bonds. Gels made from polymers such as Pluronic® are also known as hydrogels because they contain high amounts of water. Hydrogels can swell and grow in volume due to their ability to absorb water. Due to these properties, they are used in medical applications, drug delivery systems, tissue engineering and contact lenses (Gudeman & Peppas, 1995).

Polymeric gels have been particularly useful in drug delivery systems in recent years, allowing for the controlled release and transportation of medications to specific locations. These systems preserve the stability of the medication while shielding it from negative physiological effects. Simultaneously, they have the potential to enhance medication effectiveness and extend the period of administration.

As an example of Pluronic®-based gels, a physical cross-linked gel using hyaluronic acid and Pluronic® F-127 was developed in the literature. Hyaluronic acid and Pluronic® F-127 molecules have injectable properties that can form gels under thermal stimuli (Jung et al., 2017). Hyaluronic acid has several benefits, including high water retention capacity, biocompatibility, biodegradability, biofunctionality, and viscoelastic characteristics. Different HA molecular weights are possible. These benefits, along with the fact that hyaluronic acid can physically crosslink with Pluronic® molecules, led to its use as a crosslinker.

Drugs like those used to treat cancer, microbial infections, or pain relief are incorporated into Pluronic®-based gels for controlled drug release applications. Since Pluronic® micelles contain hydrophobic groups, they can increase the absorption of hydrophobic drugs and offer the potential for effective treatment by transporting various drugs such as hormones, antibiotics, cancer treatment drugs and gene therapy to targeted areas (Basak & Bandyopadhyay, 2013). One of these drug classes, painkillers, has several benefits when delivered in Pluronic® micelles. By making them water soluble, Pluronic® micelles can improve the absorption and effectiveness of painkillers with low water solubility. Drugs can be concentrated at the desired location with the help of targeted delivery, resulting in efficient treatment and a reduction in side effects. With its controlled release and long-lasting effects, it can also help with effective pain management. These benefits highlight the possibility for more efficient, secure, and patient-centered pain management through the administration of painkillers in Pluronic® micelles.

In this study, lidocaine was chosen as the drug to be placed inside the box. A medication used as a local anesthetic is lidocaine hydrochloride, or lidocaine. It is typically offered as injectables, gels, sprays, and creams that numb the skin. When undergoing surgery, dental work, or other medical procedures, lidocaine is used to minimize pain and discomfort. In certain situations, it can also be used to control heart rhythm (Lui, 2016). The fact that lidocaine is a hydrophobic medication is one of the main factors in the decision. Precipitation or aggregation between the hydrophobic moieties of Pluronic® molecules can happen when hydrophobic medications, like lidocaine, interact with the hydrophobic moieties of a block copolymer, like Pluronic® L-64. The hydrophobic moieties come together and form the basis of this interaction. Pluronic® may facilitate the better solubilization and transportation of a hydrophobic medication like lidocaine. It is common practice to employ this kind of interaction to enhance drug solubility or transport.

MATERIALS AND METHOD

CG-MARTINI, a coarse-grained molecular dynamics simulation method, was used for the simulations conducted in this study. Coarse-grained molecular dynamics simulations facilitate the modeling of relatively crowded and complex systems such as polymers by reducing atomic-level details and modeling a series of atoms as a single bead. The MARTINI method presented by Marrink et al. is recognized as an effective model for coarse-grained structures (Marrink et al., 2007). This method is suitable for simulating various components such as lipids, proteins, carbohydrates, DNA, polymers, coatings, surfactants. In addition, optimizing drug transport and release systems through the MARTINI method can enable drugs to reach the targeted site more effectively and increase their therapeutic effect (Kjølbye et al., 2022).

Hyaluronic acid and Pluronic® L-64 molecules were physically cross-linked in the system to create a polymeric gel structure, and the MARTINI method was used in a computer environment to create a physical gel. The drug encapsulation efficiency of the resulting structures was first assessed after various concentrations of lidocaine drug were added. The mechanical characteristics of the gel will be computed in the next section of the investigation.

The chemical structure and coarse graining procedure are schematically shown in Fig. 1.

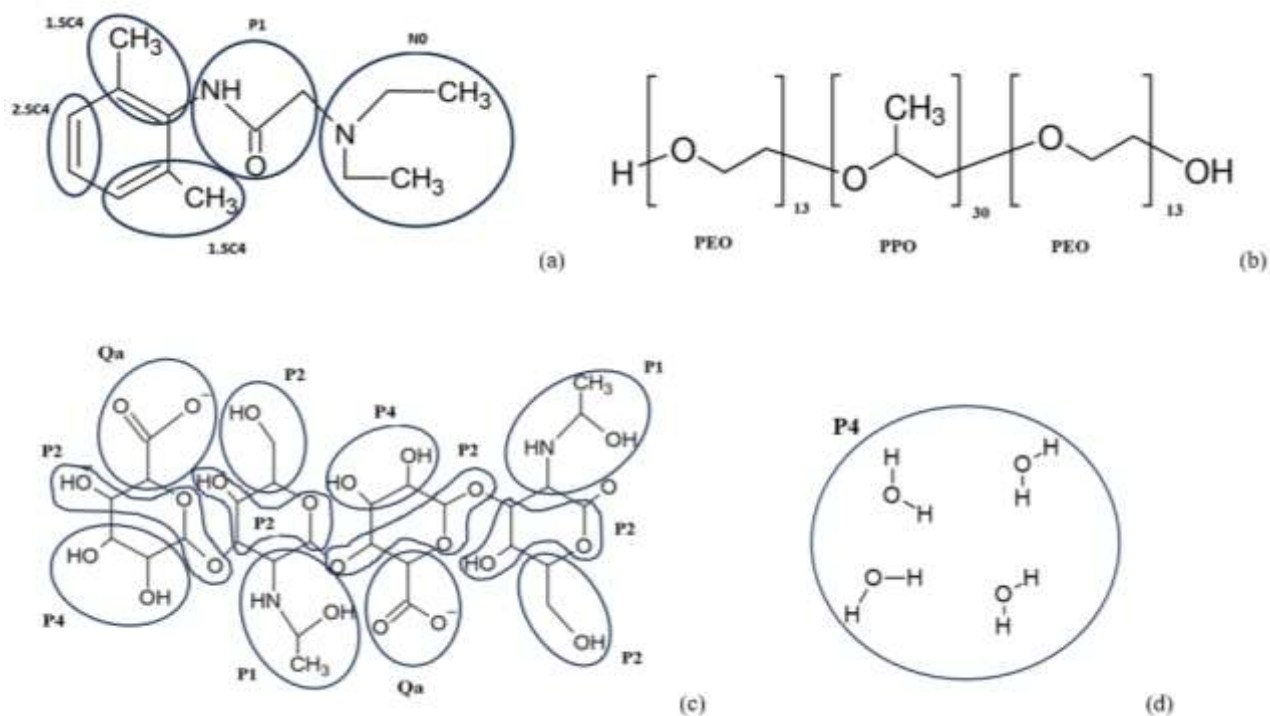

Figure 1. Schematic representation of the coarse-graining and the beads of (a) Lidocaine, (b) Pluronic® L-64, (c) Hyaluronic acid and (d) water.

The concentrations of the molecules in the non-drug systems in this study are given in table 1.

Table 1. Concentrations of molecules for the bulk systems in the study.

Concentration number	Hyaluronic acid 26 units $m_w=1000$ g/mol			Hyaluronic acid 51 units $m_w=2000$ g/mol			Hyaluronic acid 77 units $m_w=3000$ g/mol		
	1%	3%	5%	1%	3%	5%	1%	3%	5%
Hyaluronic acid $m_w=393.3$ g/mol (per 1 unit)	6	16	28	3	8	14	2	5	9
Pluronic® L-64 $m_w=2900$ g/mol	25%	25%	25%	25%	25%	25%	25%	25%	25%
	458	470	485	457	470	482	457	467	480
Water $m_w=72$ g/mol	74%	72%	70%	74%	72%	70%	74%	72%	70%
	54321	54299	54272	54325	54307	54289	54326	54313	54296

The concentrations of the molecules in the drug-loaded systems in this study are given in Table 2.

Table 2. Concentrations of molecules for the drug-loaded bulk systems in the study.

Concentration number	Hyaluronic acid 26 units <i>m_w</i> =1000 g/mol						Hyaluronic acid 51 units <i>m_w</i> =2000 g/mol						Hyaluronic acid 77 units <i>m_w</i> =3000 g/mol					
	1%	1%	3%	3%	5%	5%	1%	1%	3%	3%	5%	5%	1%	1%	3%	3%	5%	5%
Hyaluronic acid <i>m_w</i> =393.3 g/mol (per 1 unit)	6	6	47	16	28	28	3	3	8	8	14	14	2	2	5	5	9	9
Pluronic® L-64 <i>m_w</i> =2900 g/mol	459	459	470	475	485	487	459	459	470	475	485	487	458	458	470	475	485	487
Lidocaine <i>m_w</i> =234.3 g/mol	46	230	47	235	48	28	46	230	47	235	48	242	46	230	47	235	48	242
Water <i>m_w</i> =72 g/mol	73.8 % 54274	73% 54090	71.8 % 54252	71% 54059	69.8 % 54224	69% 54028	73.8 % 54277	73% 54093	71.8 % 54260	71% 54067	69.8 % 54238	69% 54042	73.8 % 54279	73% 54095	71.8 % 54263	71% 54070	69.8 % 54243	69% 54047

RESULTS AND DISCUSSION

The starting bin for each molecule was chosen at random at the start of the simulation. The hydrophobics gathered and clumped on top of one another during the simulation. At the tip, the hydrophilic portions of the molecule were still free. In addition to physically cross-linking with pluronic, the hyaluronic acid that has been added to the system also seems to interact and organize with the hydrophobic ends.

While the concentration of pluronic L64 remained constant, systems with a molecular weight of 2000 hyaluronic acid exhibited increased aggregation based on the simulations' hyaluronic acid concentration and weight. Furthermore, it was noted that the higher concentration of hyaluronic acid in the systems resulted in its being more ordered and regular.

Images of the boxes obtained as a result of the simulation without water beads are shown in Figure 2.

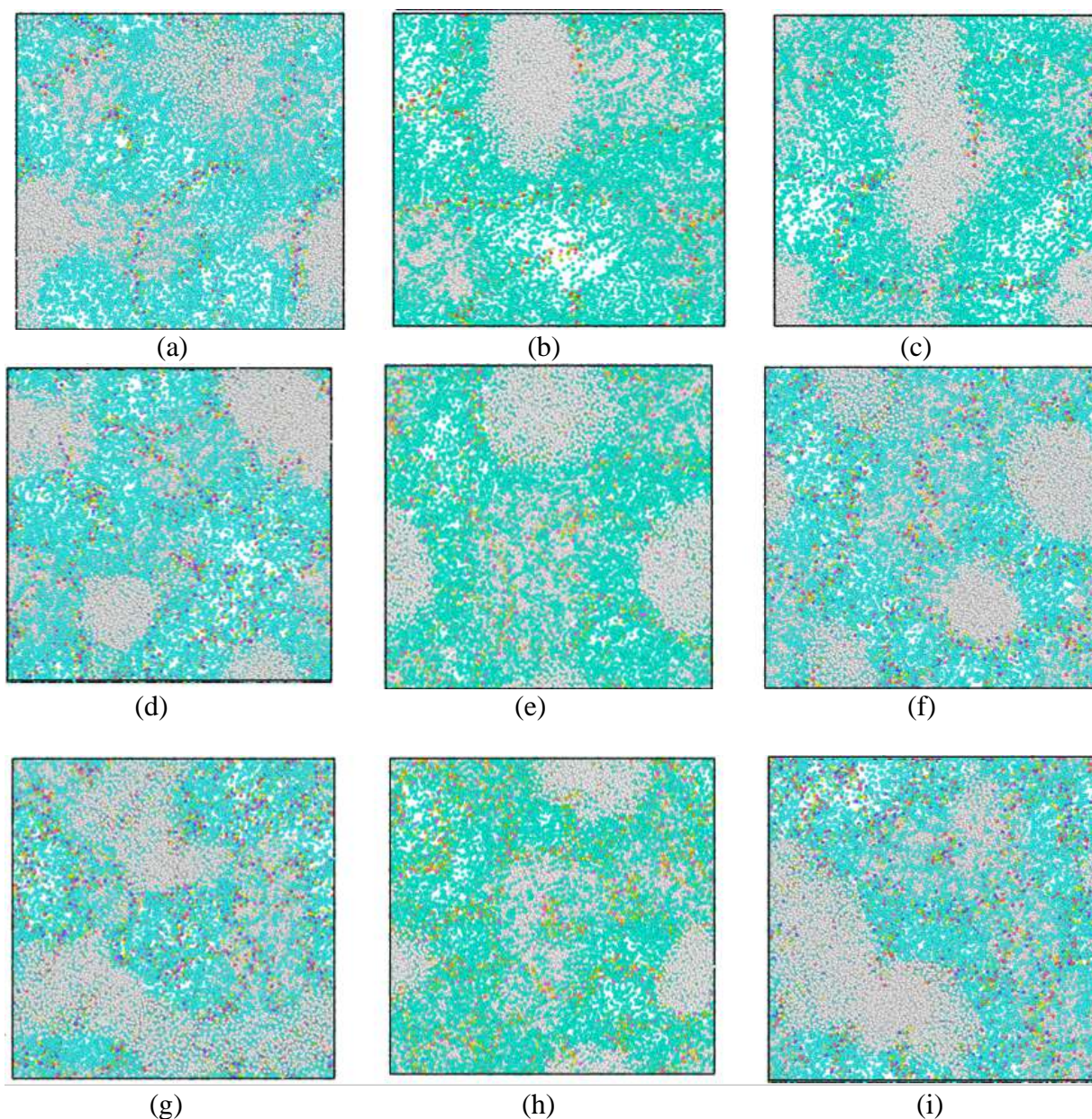
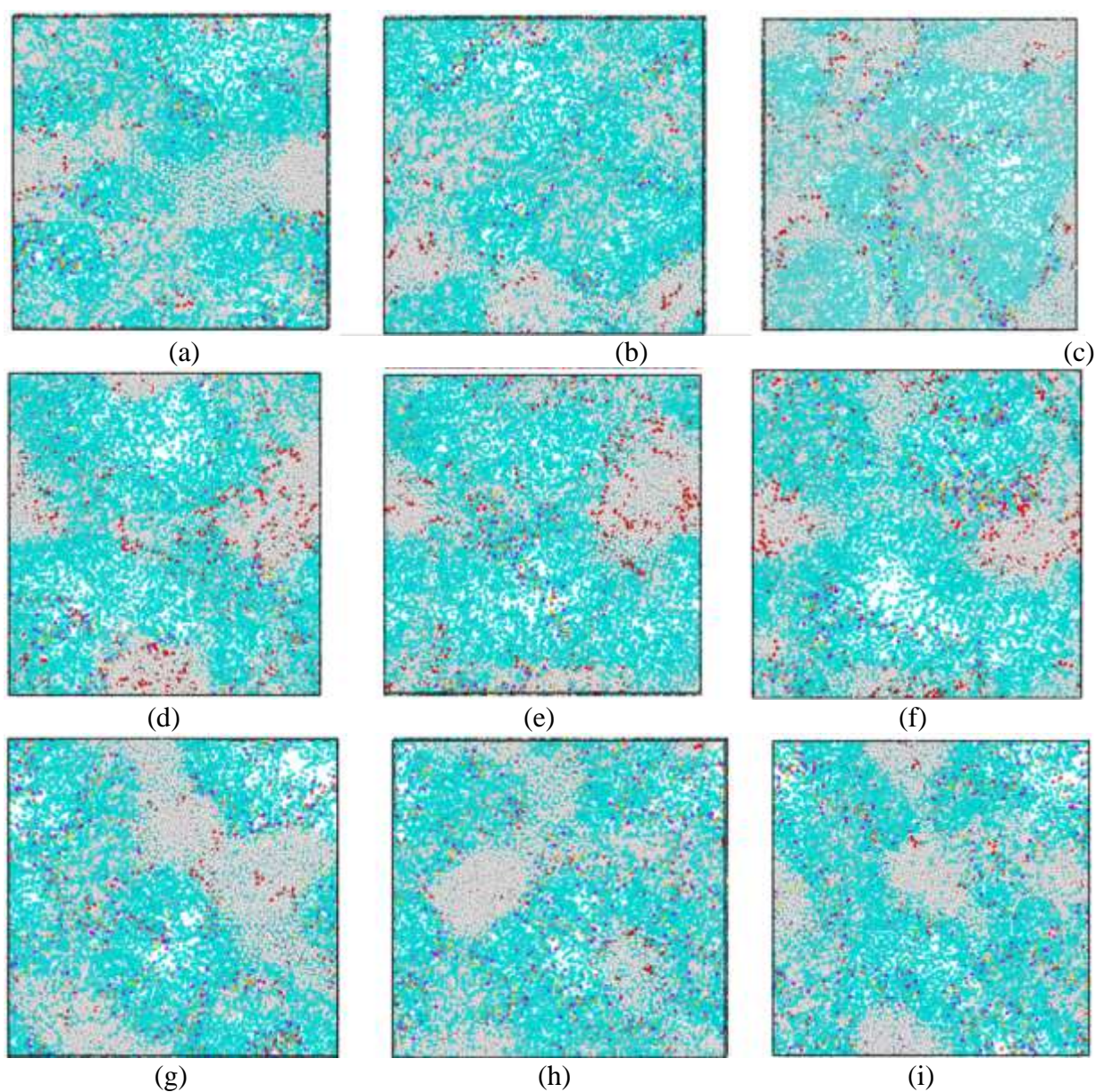

Figure 2. Images of the boxes obtained as a result of the simulation without water beads. Pluronic L64's hydrophilic and hydrophobic parts are represented by light blue and white beads, respectively. Hyaluronic acid is present in other colored beads. (a) 1% hyaluronic acid with a molecular weight of 1000 and Pluronic® L-64, (b) 1% hyaluronic acid with a molecular weight

of 2000 and Pluronic® L-64, (c) 1% hyaluronic acid with a molecular weight of 3000 and Pluronic® L-64, (d) 3% hyaluronic acid with a molecular weight of 1000 and Pluronic® L-64, (e) 3% hyaluronic acid with a molecular weight of 2000 and Pluronic® L-64, (f) 3% hyaluronic acid with a molecular weight of 3000 and Pluronic® L-64, (g) 5% hyaluronic acid with a molecular weight of 1000 and Pluronic® L-64, (h) 1% hyaluronic acid with a molecular weight of 2000 and Pluronic® L-64, (i) 1% hyaluronic acid with a molecular weight of 3000 and Pluronic® L-64.

Precipitation or aggregation between the hydrophobic segments of the Pluronic molecules can happen when a hydrophobic medication, like lidocaine, interacts with the hydrophobic portion of a block copolymer, like Pluronic L64. The hydrophobic moieties come together as a result of this interaction, which is based on hydrophobic interactions.

Images of the simulation boxes consisting of hydrogel and drug molecules without water beads are shown in Figure 3.



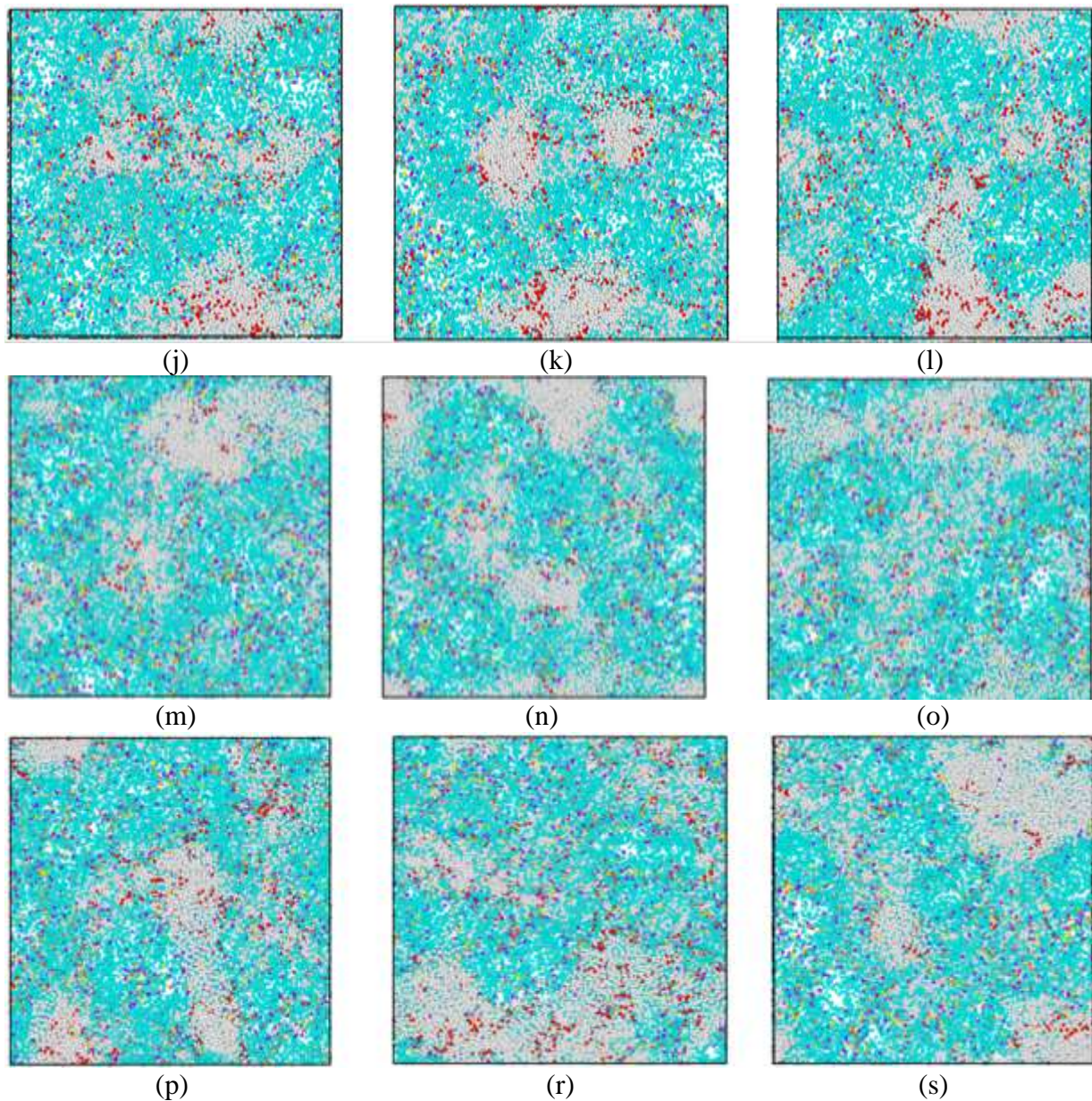

Figure 3. The hydrophilic parts of pluronic L64 are represented by light blue beads, and the hydrophobic parts by white beads. Hyaluronic acid is present in other colored beads. Lidocaine is found in red beads. (a) 1% hyaluronic acid with a molecular weight of 1000, Pluronic® L-64 and 0.2% Lidocaine, (b) 1% hyaluronic acid with a molecular weight of 2000 and Pluronic® L-64 and 0.2% Lidocaine, (c) 1% hyaluronic acid with a molecular weight of 3000 and Pluronic® L-64 and 0.2% Lidocaine, (d) 1% hyaluronic acid with a molecular weight of 1000, Pluronic® L-64 and 1% Lidocaine, (e) 1% hyaluronic acid with a molecular weight of 2000 and Pluronic® L-64 and 1% Lidocaine, (f) 1% hyaluronic acid with a molecular weight of 3000 and Pluronic® L-64 and 1% Lidocaine, (g) 3% hyaluronic acid with a molecular weight of 1000, Pluronic® L-64 and 0.2% Lidocaine, (h) 3% hyaluronic acid with a molecular weight of 2000 and Pluronic® L-64 and 0.2% Lidocaine, (i) 3% hyaluronic acid with a molecular weight of 3000 and Pluronic® L-64 and 0.2% Lidocaine, (j) 3% hyaluronic acid with a molecular weight of 1000, Pluronic® L-64 and 1% Lidocaine, (k) 3% hyaluronic acid with a molecular weight of 2000 and Pluronic® L-64 and 1% Lidocaine, (l) 3% hyaluronic acid with a molecular weight of 3000 and Pluronic® L-64 and 1% Lidocaine, (m) 5% hyaluronic acid with a molecular weight of 1000, Pluronic® L-64 and 0.2% Lidocaine, (n) 5% hyaluronic acid with a molecular weight of 2000 and Pluronic® L-64 and 0.2% Lidocaine, (o) 5% hyaluronic acid with a molecular weight of 3000 and Pluronic® L-64 and 0.2% Lidocaine, (p) 5% hyaluronic acid with a molecular weight of

1000, Pluronic® L-64 and 1% Lidocaine, (r) 5% hyaluronic acid with a molecular weight of 2000 and Pluronic® L-64 and 1% Lidocaine, (s) 5% hyaluronic acid with a molecular weight of 3000 and Pluronic® L-64 and 1% Lidocaine.

CONCLUSIONS

The study found that the structure of hydrogels made with pluronic acid is influenced by hyaluronic acid at varying molecular weights and concentrations. A polymeric gel containing pluronic and hyaluronic acid showed precipitation between the drug and the hydrophobics in the gel structure at varying concentrations of lidocaine added. The hydrophobic outer layer created by the pluronic molecule gradually filled with drug molecules as the concentration of the drug rose.

REFERENCES

Basak, R., & Bandyopadhyay, R. (2013). Encapsulation of Hydrophobic Drugs in Pluronic F127 Micelles: Effects of Drug Hydrophobicity, Solution Temperature, and pH. *Langmuir*, 29, 4350–4356.

Gudeman, L.F. & Peppas, N.A. (1995). Preparation and characterization of pH-sensitive, interpenetrating networks of poly(vinyl alcohol) and poly(acrylic acid). *Journal of Applied Polymer Science*, 55(6), 919-928.

Jung, Y.-S., Park, W., Park, H., Lee, D.-K., & Na, K. (2017, 20 Jan). Thermo-sensitive injectable hydrogel based on the physical mixing of hyaluronic acid and Pluronic F-127 for sustained NSAID delivery, *Carbohydrate Polymers*, 156, 403-408.

Kjølbjerg, Lisbeth R.; Pereira, Gilberto P.; Bartocci, Alessio; Pannuzzo, Martina; Albani, Simone; ve diğerleri (2022). Towards design of drugs and delivery systems with the Martini coarse-grained model. *QRB Discovery*; Cambridge, 3.

Marrink, S.J., Risselada, H. J., Yefimov, S., Tieleman, D. P. & de Vries, A. H. (2007). The MARTINI force field: coarse grained model for biomolecular simulations. *J. Phys. Chem. B* 111, 7812-7824.

T.H. Lui, (2016). Arthroscopic interpositional arthroplasty of the second metatarsophalangeal joint, *Arthrosc. Tech.* 5 1333–1338

MECHANICAL PROPERTIES AND PROTEIN ADSORPTION OF POLYURETHANE COATINGS WITH DUAL HYDROPHILIC/HYDROPHOBIC DANGLING CHAINS

Aysu Erdim¹, Deniz Kizilkaya¹, Gokhan Kacar¹

¹ *Genetics and Bioengineering, Institute of Natural Sciences, Trakya University, Edirne, Turkey*

² *Genetics and Bioengineering, Faculty of Engineering, Trakya University, Edirne, Turkey*

Corresponding author e-mail: gokhankacar@trakya.edu.tr

ABSTRACT

In this study, we present the results of a molecular dynamics (MD) simulation investigation on the mechanical, thermal properties, and protein-surface interactions of hydrophilic and amphiphilic functional polyurethane (PU) coating systems. By examining the surface behavior of polyurethane systems containing both hydrophilic and hydrophobic dangling chains, we aim to explore whether these systems selectively exhibit hydrophilic or hydrophobic functionality depending on the environment. We will investigate the mechanical properties and protein-surface interactions of polyurethane systems with two different dangling chain structures. Additionally, we will examine how protein-surface interactions in marine environments affect these coatings. The results obtained will reveal potential new developments in material design, surface coating technologies, and applications. The outcomes of this study aim to contribute to supporting innovative approaches and solutions in the field of materials science and engineering.

Keywords: Functional Polymer Surfaces, Polyurethane, Molecular Modeling and Simulation, Protein Adsorption, Mechanical Properties

INTRODUCTION

Polyurethane materials find a wide range of applications in the commercial and industrial sectors due to their excellent mechanical strength, durability, good wear resistance, corrosion resistance, and processability. The two blocks that make up the structure of PU materials are isocyanate, which is a component that makes up the hard parts of the polyurethane, and long, flexible polyol chains, which form the soft segments of the polyurethane polymer (Akindoyo & Beg, 2016). Functional groups are frequently added to PU networks or backbones in PU materials to give them functional features (Tian, 2020). This enables PU materials to exhibit both their intrinsic qualities and the attributes of the functional groups that have been added.

PU is generally a polymer that exhibits hydrophobic characteristics. In this study, the developed functional PU coating, with the addition of hydrophilic and amphiphilic dangling chains, exhibits hydrophilic properties when in contact with water, as the dangling chains migrate to the surface. However, it shows hydrophobic properties when not in contact with water. This behavior implies that the developed material possesses anti-biofouling properties.

This study investigated atomistic functional PU systems with two different dangling chains possessing distinct properties. In this PU coating, the polyol molecule responsible for forming the soft and hard segments is polycarbonate (PC), and the cross-linking agent tris(isocyanatohexyl)biuret (HDI-BT) was used, along with n-butyl acetate (nBAC) and methyl ethyl ketone (MEK) solvent molecules to provide the appropriate reaction environment. To explore the hydrophilic and hydrophobic surface behavior of dangling chains, an amphiphilic system was created in the literature by Kizilkaya and other members using only hydrophilic mPEG

dangling chains and a combination of hydrophilic (mPEG) and hydrophobic (oDEC) chains (Kizilkaya & Ghermezcheshme, 2023).

Within the scope of this study, the mechanical properties of these two systems were calculated. Initially, tensile tests were conducted using simulation methods to calculate the systems' elastic modulus and Poisson ratios. In the step of applying tensile tests using simulation methods, different strain rates were also used to reveal the differences in results. Additionally, in this study, the protein-surface interactions of the created amphiphilic PU systems containing hydrophilic and hydrophilic-hydrophobic dangling chains will be investigated in a marine environment. In the literature, hydrophilic polymer coatings are commonly used for anti-fouling applications in marine settings. However, as some studies have indicated, hydrophilic coatings can exhibit swelling behavior or may not entirely prevent biofouling. The protein adsorption tendencies of the amphiphilic PU system with hydrophilic-hydrophobic dangling chains and the hydrophilic PU system have not been thoroughly researched in the literature. In the later stages of the study, the protein adsorption tendencies of two differently featured PU materials will be investigated using simulation methods.

MATERIALS

The chemical structure of functional PU models is shown schematically in Figure 1.

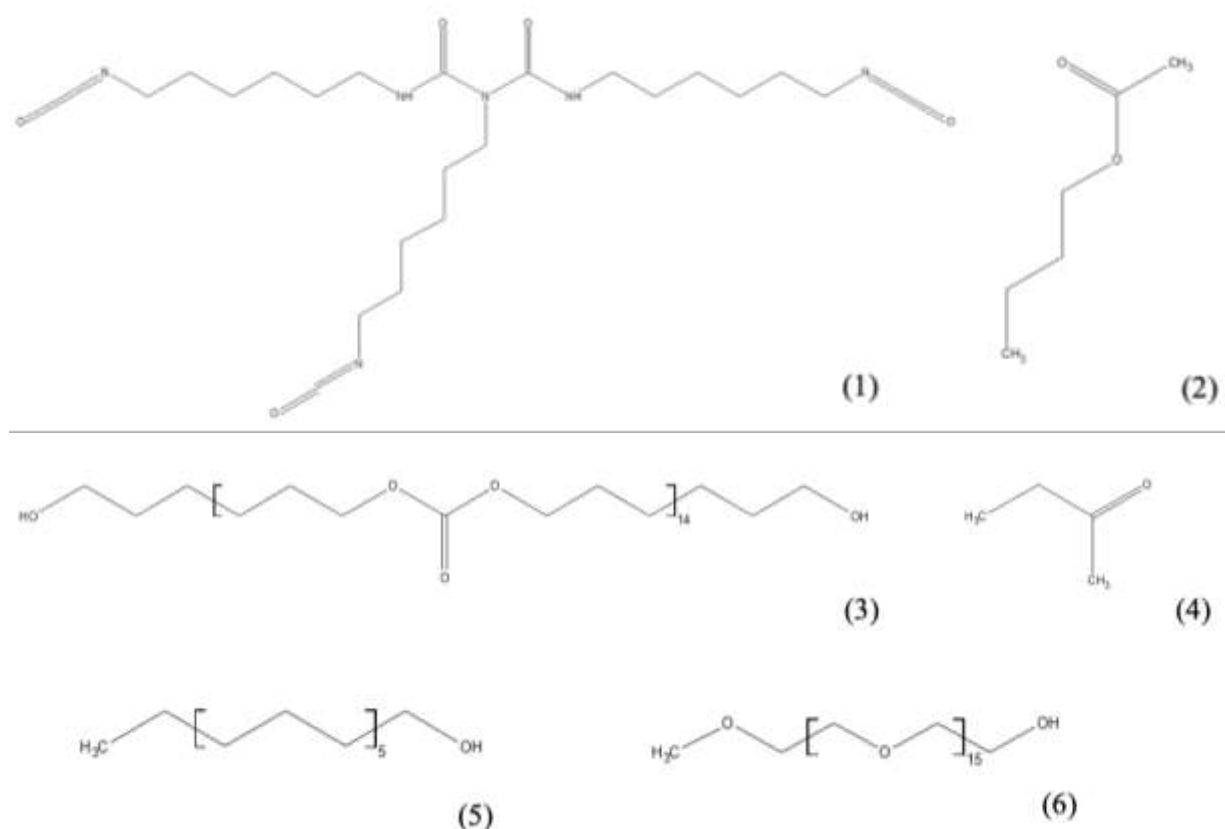

Figure 1. Chemical structures of molecules used in the systems; (1) HDI-BT, (2) nBAC, (3) PC, (4) MEK, (5) oDEC, (6) mPEG.

These systems include PC as the macrodiol, HDI-BT as the crosslinker, MEK as the solvent, and n-BAc as the binder. The hydrophilic mPEG system features hydrophilic mPEG as the dangling chain, while the hydrophilic-hydrophobic, amphiphilic mix system includes the hydrophobic oDEC and mPEG as dangling chains. Figure 2 shows the atomistic pictures of the mixed PU systems with hydrophilic and hydrophobic dangling chains, as well as the hydrophilic dangling chains containing mPEG.

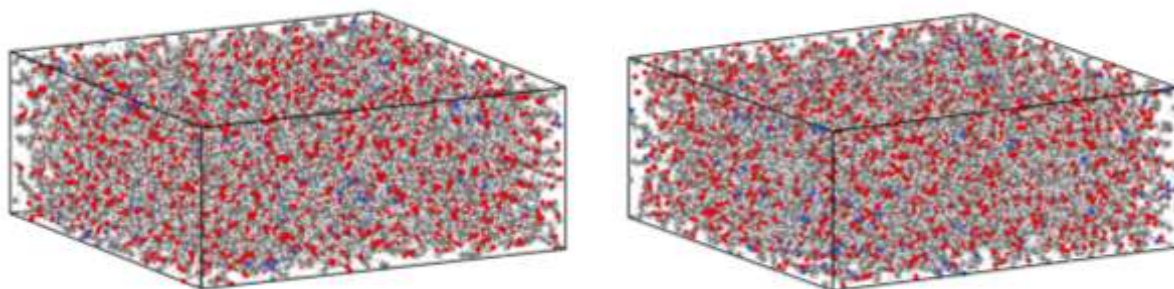

Figure 2. Atomistic images of the mPEG and mix systems, respectively.

METHODS

In our study, we utilized atomistic molecular dynamics simulation methods as the fundamental simulation technique. Atomistic MD simulations investigate the physical movements of atoms and molecules based on their interactions with one another. They provide insights into the dynamics of the components comprising a system over a specific period. These simulations reveal the positions of all atoms at the nanosecond scale. When considering the positions of all atoms in a biomolecular system, it becomes possible to calculate the forces applied by all other atoms to each atom in the system. Therefore, in MD simulations, Newton's laws of motion are employed to predict the spatial position of each atom as a function of time (Hansson & Oestenbrink, 2002). After establishing the initial coordinates and velocities of the system, Newton's second law of motion is used to calculate changes in the positions and momenta of particles. These calculations are carried out through the system's potential energy and forces.

In our atomistic MD simulations, we first conducted energy minimization, followed by simulations under NVT conditions to relax the mPEG and mix systems. For the calculation part of mechanical and thermal properties, different input files were employed for each property, which included applying tensile tests to the system and inducing changes in system temperature and pressure.

RESULTS

In the step of investigating the mechanical and thermal properties of two different functional PU systems with distinct characteristics, a tensile test will be initially applied to these systems in the simulation environment to calculate their elastic modulus. Using commands specified in the simulation input, the box will be stretched in the -x direction at a constant velocity while keeping the pressure in the -y and -z directions at zero (Moeini & Isfahani, 2020) (Yuan & Zhang, 2022). Figure 3 shows the tensile test results of the systems.



Figure 3. Atomistic images of the mPEG and mix systems after the tensile test.

With the output obtained from the simulation, stress-strain curves were plotted, and the slope of the elastic region was used to determine the elastic modulus. Simultaneously, in this step, the systems were deformed at different strain rates to reveal the differences in results. When compared to experimental studies, it was determined that the optimal strain rate for PU systems is 10^{-7} 1/fs.

Table 1. The calculated elastic modulus of the mPEG and mix systems based on the tensile test results with different dragging strain rates.

mPEG E Modulus		mix E Modulus	
Strain Rate (1/fs)	Stress (GPa)	Strain Rate (1/fs)	Stress (GPa)
10^{-5}	1.6175	10^{-5}	1.1192
10^{-6}	1.4186	10^{-6}	0.9654
10^{-7}	0.6789	10^{-7}	0.6237
10^{-9}	0.0522	10^{-9}	0.0482

Furthermore, in order to assess the isotropic properties of the hydrophilic dangling chain mPEG system, tensile tests were conducted on the materials in different directions and at different strain rates to calculate their elastic modulus. Consequently, since an isotropic material should exhibit similar mechanical properties in different directions, we can say that our mPEG system shows isotropic characteristics, even though there are significant differences in the results obtained from different directions.

Poisson's ratio, which is the ratio of the change in width per unit width of a material to the change in length per unit length resulting from deformation, was calculated using Equation (1) as a result of the tensile test (Kacar & Peters, 2015). The results are provided in Table 4 for both mPEG and mix systems. As a result, the Poisson ratio of the mPEG system was found to be 0.2929, and the mixing system was 0.3349. As expected, the Poisson's ratio of the less complex mPEG system is lower than that of the mix system.

Table 2. The calculated elastic modulus of the mPEG system in different directions and at different dragging strain rates in the tensile test.

mPEG E Modulus			
Strain Rate (1/fs)	Drag-x	Drag-y	Drag-z
10^{-5}	1.6175	2.4643	1.7195
10^{-6}	1.4186	1.2077	1.2538
10^{-7}	0.6789	0.6321	0.8328

$$\nu = -\frac{d\varepsilon_{\text{trans}}}{d\varepsilon_{\text{axial}}} = -\frac{d\varepsilon_y}{d\varepsilon_x} = -\frac{d\varepsilon_z}{d\varepsilon_x} \quad \text{Equation (1)}$$

The glass transition temperature (T_g), which signifies the transition of a material from a solid state to an amorphous (glassy) state, has been calculated for both the mPEG and mix systems. The calculation of the glass transition temperature (T_g) involves increasing the pressure of a system with NPT and NVT ensembles to raise the density and gradually reduce the pressure to prevent a sudden density drop. These commands have been included in the simulation input file. Subsequently, the output data obtained from the simulation is calculated from density and temperature data based on the intersection of two linear fits of high and low-temperature T_g data. (Batyrowab & Dericiler 2023). The results are presented in Figure 4. When studying experimental and computational studies in the literature for polyurethane systems, our results have been found to be consistent.

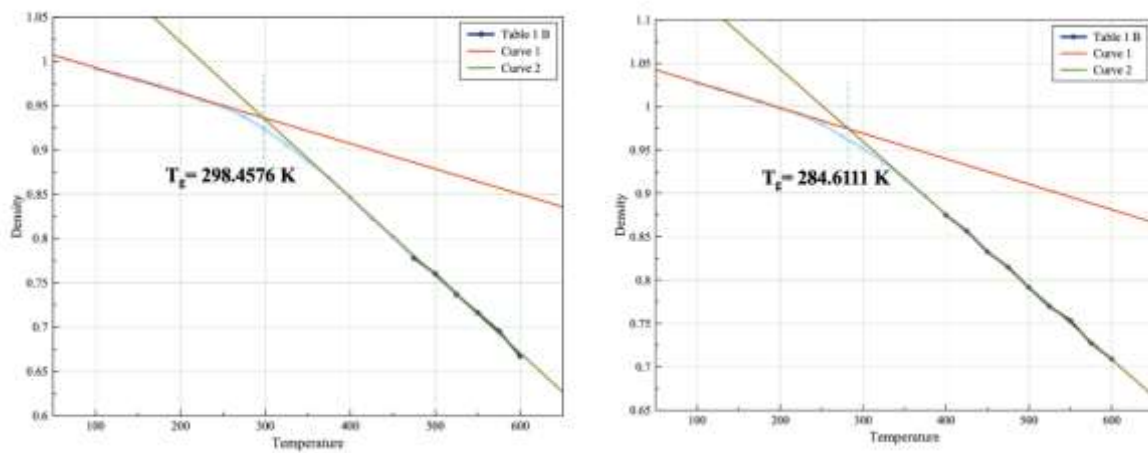

Figure 4. Density-temperature graphs and glass transition temperatures of the mPEG and mix systems.

In this study, the selective functionalities of amphiphilic and hydrophilic chains in widely used PU coatings in marine environments will be investigated for their anti-biofouling properties, along with an examination of protein adsorption tendencies. For this research, one of the primary proteins that make up the adhesive cement in *Megabalanus rosa*, a commonly studied mussel species in the context of this work, the mussel cement protein MrCP20 (PDB: 6LEK), has been selected (Sarker & Chen, 2022). A seawater environment has been created through simulation methods, and interactions will be examined in the later stages of the study by adding the protein to the material surface.

CONCLUSIONS

In this study, we investigated the mechanical and thermal properties of polyurethane-based systems with hydrophilic and hydrophilic-hydrophobic dangling chains using atomistic molecular dynamics simulation methods. The data we obtained confirmed that our functional PU systems exhibited favorable mechanical and thermal properties. The next steps in our research involve assessing the protein adsorption efficiency of our PU systems in the marine environment created through atomistic MD simulation and characterizing the wettability properties of these systems using water contact angle measurements.

REFERENCES

- Akindoyo, J. O., Beg, M. D. H., Ghazali, S., Islam, M. R., Jeyaratnam, N., Yuvaraj, A. R. (2016). "Polyurethane types, synthesis and applications – a review". *Rsc Advances*, 115.
- Batyrowa, M., Dericiler, K., Erucar, İ., Palabiyika, B. A., Okanc, B. S., Ztürka, H. O., (2023). "Combining tensile test results with atomistic predictions of elastic modulus of graphene/polyamide-6,6 nanocomposites". *Materials Today Communications*, 35 (105636).
- Hansson, T., Oostenbrink, C., Gunsteren, W. V. (2002). "Molecular dynamics simulations". *Current Opinion In Structural Biology*, 12(2), 190-196.
- Kacar, G., Peters, E. A., With, G. D. (2015). "Multi-scale simulations for predicting material Properties of a cross-linked polymer". *Computational Materials Science*, 102, 68-77.
- Kizilkaya, D., Ghermezcheshme, G., Sabzevar, S. E., Makkı, H., Kacar, G. (2023). "Modeling surface segregation of smart pu coatings at hydrophilic and hydrophobic interfaces via coarse-grained molecular dynamics and mesoscopic simulations". *Progress In Organic Coatings*, 174, 107279.
- Moeini, M., Isfahani, R. B., Samandari, S.S., Aghdam, M.M. (2020). "Molecular dynamics simulations of the effect of temperature and strain rate on mechanical properties of graphene– epoxy nanocomposites". *Molecular Simulation*, 46(6), 476–486.
- Sarker, P., Chen, G. T., Sajib, M. S. J., Jones, N. W., Wei, T. (2022). "Hydration and antibiofouling of tmao- derived zwitterionic polymers surfaces studied with atomistic molecular dynamics simulations". *Colloids and Surfaces A: Physicochemical And Engineering Aspects*, 653, 129943.
- Yuan, L., Zhang, C., Wang, C., Wei, N., Wan, J., Zhu, C., Fang, H., M. S. (2022). "Effect of the crosslinking degree on the microstructure and thermomechanical properties of a polymer grouting material". *Polymer*, 259, 125342.

MOLLUSCS FROM HIMARA COAST, IONIAN SEA, ALBANIA

¹*Stela Ruci, ²Denada Kasemi, ²Ina Nasto, ¹Anisa Toska, ¹Sajmir Beqiraj,

¹Department of Biology, Faculty of Natural Sciences, University of Tirana, Albania

²Department of Biology, Faculty of Technical and Natural Sciences, University "Ismail Qemali", Vlora, Albania

*Corresponding author e-mail: stela.ruci@fshn.edu.al

ABSTRACT

Himara is part of the Ionian coast in southern Albania. Data on molluscs of the shallow coast of Himara are limited, while there are more detailed data for the deeper waters of the infralittoral of this area. This study was carried out in four sites of this area: Guma, Llaman, Porto Palermo, and Qeparo.

Molluscs were collected on shallow rocky shores in supralittoral, midlittoral and the upper part of the infralittoral, in October 2022. This study provides data on species composition and abundance of the mollusc populations. The mollusc groups with the highest presence and abundance were gastropods of the families Patellidae, Trochidae, Cerithiidae, Littorinidae, Risoiidae, and bivalves of the Family Mytilidae. Among the species found in this study are threatened and alien species for the Mediterranean Sea. Data on the species composition and abundance of the molluscs populations were analyzed in comparison between the four sites of the study. Considerations on possible factors affecting the mollusc populations in the studied area are also presented.

Key words: marine malacofauna, threatened species, alien species, algal cover.

INTRODUCTION

Himara lies along the Ionian coast of Albania. It is situated in the southwestern part of the country, from the extreme south of Llogara Pass to Qeparo Mountain in southeast, with a straight length of 22 km. The total length of coastline, rocky coast and clefts is about 26 km (Pano, 2015). Southern Coast is crucial for marine biodiversity as flora and fauna include species of various origin.

Existing studies on malacofauna of the Himara coast are scarce and related to deep infralittoral and circalittoral, mainly focused on the evaluation of areas proposed as marine protected areas (Beqiraj et al., 2008; Beqiraj & Kashta, 2013; Beqiraj, 2014; Beqiraj & Ballesteros, 2018; Fraschetti et al., 2011; Kashta et al., 2005; Kashta et al., 2007; Kashta & Beqiraj, 2009; Pititto et al., 2009). Also, there are few studies on marine alien species of Albania, including the coast of Himara (Beqiraj & Zenetos, 2021; Katsanevakis et al., 2011; Zenetos et al., 2016). Meanwhile, there are no studies on the rocky shore communities of the Himara coast. This is the first study on malacofauna of the rocky shores of this area. The marine and coastal environment of this area has high-value economic, social and ecological recourses for the country, but, on the other hand, it represents one of the most vulnerable territory from tourism development.

The area from Porto Palermo bay, to Llamani Bay, has been proclaimed a Marine and Coastal Protected Area in July 2022.

MATERIAL AND METHOD

Sampling was carried out in autumn season, October 2022, according to standard methods for benthic sampling in hard bottoms, after Bianchi et al. 2004, Salomidi 2003, and Zenetos et al. 2000. Sampling was carried out in shallow waters at a depth of up to 1m in four sites, from north to south of the coast of Himara: Guma, Llamani Bay, Porto Palermo Bay and Qeparo. The sampling aimed at collecting molluscs sheltered in algae as well as on the bare rocks. Algal cover samples were also taken, in order to get a more complete knowledge of the biocenoses.

For each site, it was sampled in 3 transects, at a linear distance of 50-100 m from each other. For each transect, 3 samples were taken. A total of 9 samples were taken for each site, and a total of 36 samples were taken for all (4) sites. Samples were taken quantitatively by collecting and evaluating the malacofauna within a 50 cm x 50 cm frame. This frame was divided into 16 small squares in order to facilitate quantitative assessment of the molluscs. Within these squares, the number of individuals or the cover in percentage for colonial animals, such as *Melarhaphe*, *Mytilaster*, *Vermetus*, etc., was evaluated. On bare rocks the collection of the molluscs was done by hand and forceps. On rocks covered by macroalgae, the whole algal cover with all included invertebrates has been collected within the sampling frame. After sampling, the collected material was stored in 4% formaldehyde and transported to the laboratory.

The taxonomic identifications of molluscs were mainly based on existing literature from the Mediterranean, as well as larger databases: Cossignani 1992, Clemam checklist, D'Angello & Gargiullo 1991, Gianuzzi-Savelli 1994, 1997, 1999, 2001, 2003, Pope & Goto 1991, 1993, Riedl 1991, Millard 2001. The systematic position of molluscs was referred to WoRMS (World Register of Marine Species).

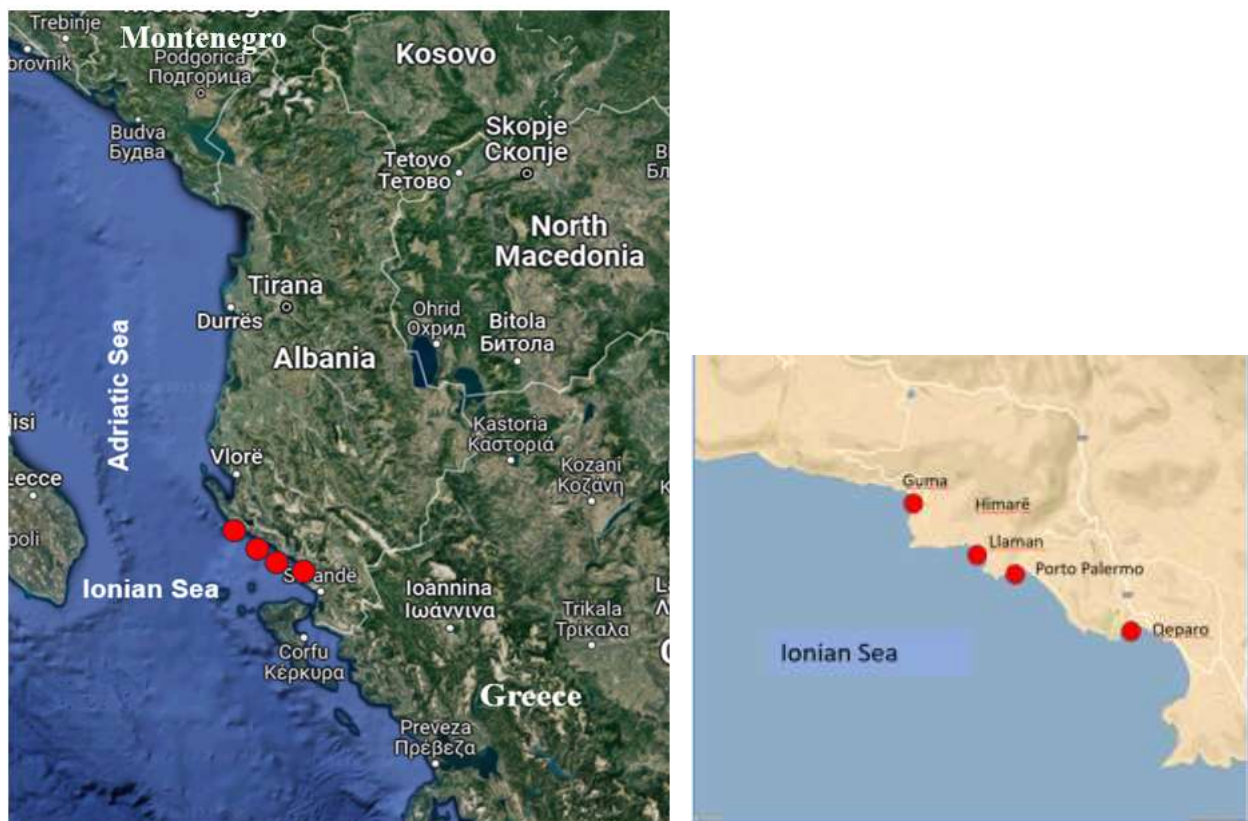

Figure 1. Map of the Himara coast, with the sampling sites indicated in red color.



Figure 2. Photos from the four sampling sites, a) Guma, b) Lllaman, c) Porto Palermo, d) Qeparo.

Total abundance and average abundance for each species and for each sampling site have been evaluated. The following indexes and coefficients have been evaluated:

1. Constancy: $C = a / p * 100$ where: C – Constancy
a – the number of samples where the assessed species is present
p – Total number of samples.

According to Blanc et al. 1976, based on the value of the costancy, the following classification of species has been done:

- Constant species ($K > 50\%$);
- Accompanying species ($25\% \leq K \leq 50\%$);
- Occasional species ($K < 25\%$)

2. The species similarity coefficient Sokal & Sneath (after Blanc et al., 1976) has been evaluated, according to the formula in the following:

$i = a / a + 2 * (b + c)$ where:

a – the number of common species for both sites;

b – the number of species present only in the first site;

c – number of species present only in the second site.

3. In order to evaluate the degree of diversity, the following indexes were calculated and evaluated according to Begon et al., 2006, for each season and sampling station:

a) Shannon-Weaver $H' = -\sum p_i \ln(p_i)$

b) Pielou: $J = H' / \ln S$

c) Margalef: $M = (S - 1) / \ln N$

d) Simpson $(1/D) = 1 / \sum (p_i^2)$,

where:

$p = n/N$

n = number of individuals of one particular species

N = total number of individuals

S = number of species.

RESULTS AND DISCUSSION

The total number of taxa recorded in the four studied areas was 60, and belong to three classes of molluscs: Polyplacophora, Gastropoda and Bivalvia, with the highest number of species recorded from gastropods, with 40 species (see Appendix 1).

The total number of taxa recorded for each site was: Guma 31, Llanan 20, Porto Palemo 24 and Qeparo 32. As shown in Appendix 1, the number of species that were found in only one site were 9 in Guma, 4 in Llanan, 6 in Porto Palermo, and 13 in Qeparo. The largest number of gastropods was found in Guma and the lowest number in Llanan, while the largest number of bivalves was found in Qeparo, followed by Llanan, while the lowest number of bivalves was found in Guma (Appendix 1). The species with the highest average abundance for each site were respectively, in Guma: *Pisania striata* (4.4), *Phorcus (Monodonta) turbinatus* (3.28), *Columbella rustica* (6.28) and *Patella caerulea* (5.71); in Llanan: *Musculus costulatus* (9), *Modiolus adriaticus* (9.83), *Mytilus galloprovincialis* (4.16), *Patella caerulea* (3.16); in Porto Palermo: *Musculus costulatus* (40.33), *Pisania striata* (9.32), *Phorcus (Monodonta) turbinatus* (8.88), *Bittium reticulatum* (9.66), *Patella ulyssiponensis* (5.11), *Patella rustica* (4.88); in Qeparo: *Musculus costulatus* (55.8), *Modiolus adriaticus* (22.6), *Bittium reticulatum* (21.4), *Musculus discors* (14.2), *Patella caerulea* (10.2).

Two alien mollusk species for the Mediterranean has been recorded: the gastropod *Cellana rota* and the bivalve *Brachidontes pharaonis*. The relatively high species number and the presence of alien species show the importance of the studied area at national and regional level. Polyplacophorans were found only in Llanan with two species *Acanthochitona fascicularis* and *Rhyssoplax olivacea*.

The families with the highest abundance were the gastropods Trochidae, Patellidae, Buccinidae, Pissaniidae, Columbellidae and Cerithiidae, and the bivalves of the Family Mytilidae (Table 1). The highest abundance among the whole collected molluscs has been recorded for the mytilids, followed by the patellids, which show an evident difference compared to the other groups in all sampling sites. The site with the highest abundance of these two families was Qeparo. Comparing the four sampling sites, the lowest number for the most abundant families has been recorded in Guma. The family with the largest number of species in all sites was Mytilidae.

The largest number of mollusc species in Qeparo may be related to the diversity of microhabitats, caused by freshwater inputs, as surface water and ground water, pouring from karstic coastal rocks in this area. Consequently, brackish water conditions are also present there.

The large number of species in Guma maybe related with the algal cover. From the field observations during sampling, in this site it was noticed a high cover and a large number of macroalgae species, mainly of the class Phaeophyceae with predominance of *Ericaria amentacea* and *Cystoseira compressa*, which serve as shelter and food for most of the mollusc species found in this site.

Some of the recorded species have been considered as species with a high level of threat (VU and CR) at a national scale (table 2), referring to the Red List of Threatened Species of Albania, after the Ministry of Environment (2013), where most of them are gastropods 6 species and 3 bivalves. Some of them are threatened from direct collection for trading in markets and restaurants mainly local, while many others, although they are not the object of trade, are threatened from degradation of coastal habitats, and from water pollution, as a result of human impacts. *Lithophaga lithophaga* is a species threatened at international scale, and it belongs to Annex II of the Barcelona Convention (Convention for the Protection of the Mediterranean Sea from Pollution). During the last three decades, this species has been collected intensively throughout the rocky Albanian coast, mainly on the Ionian coast, and currently it became very rare already. Although it is a protected species, it is served in restaurants in Albania, and illegally exported abroad.

Table 1. The average abundance for the most abundant families for each sampling site.

Families	Guma	Llaman	Porto Palermo	Qeparo
<i>Trochidae</i>	4.57	1.83	8.88	3.33
<i>Patellidae</i>	11	6.33	11.11	14.33
<i>Pissanidae</i>	4.57	0.16	9.22	1.22
<i>Cerithiidae</i>	3.14	-	10.11	21.77
<i>Columbellidae</i>	8.28	0.16	1.44	0.11
<i>Mytiliidae</i>	5.28	33.8	47.11	93.6

Table 2. List of species threatened at national scale.

Gastropoda	Threat level at national scale
1. <i>Patella caerulea</i> (Linnaeus, 1758)	VUA1c
2. <i>Patella rustica</i> Linnaeus, 1758	VUA1c
3. <i>Patella ulyssiponensis</i> Gmelin, 1791	VUA1c
4. <i>Osilinus</i> (<i>Monodonta</i>) <i>turbinatus</i> (Born, 1778)	VUA2b
5. <i>Diodora graeca</i> (Linnaeus, 1758)	VUA2b
6. <i>Bittium reticulatum</i> (da Costa, 1778)	VUD2
Bivalvia	
7. <i>Lithophaga lithophaga</i> (Linnaeus, 1758)	VUA1a
8. <i>Mytilus galloprovincialis</i> Lamarck 1819	VUA1c
9. <i>Mytilaster minimus</i> (Poli 1795)	CRD1

As can be seen from Table 3, in general, species similarity is of medium scale (according to Blanc et al., 1976) between sites.

Porto Palermo had the highest species similarity with the other sites. Qeparo had the lowest species similarity with the other sites, and this may be related to the special salinity conditions in this area, due to freshwater inputs, as already mentioned here above.

Table 3. Species similarity coefficient (Sokal & Sneath) between sampling sites.

Sites	Guma	Llaman	Porto Palermo	Qeparo
<i>Guma</i>		20.63%	28.81%	20.51%
<i>Llaman</i>	20.63%		23.07%	23.33%

<i>Porto Palermo</i>	28.81%	23.07%		20%
<i>Qeparo</i>	20.51%	23.33%	20%	

Referring to the evaluated diversity indexes (Shannon & Weaver (H'), Pielou (J), Margalef (M) and Simpson (D)) (table 4), it is noted that for Guma and Llanan, the diversity of the molluscs community is of a good degree, while for Porto Palermo and Qeparo, the diversity is of an average degree. In general, the indexes present the highest values for Guma and Llanan, and the lowest values for Porto Palermo and Qeparo, with the exception of the Margalef index, which presents the highest values for Guma and Qeparo, and the lowest values for Llanan and Porto Palermo.

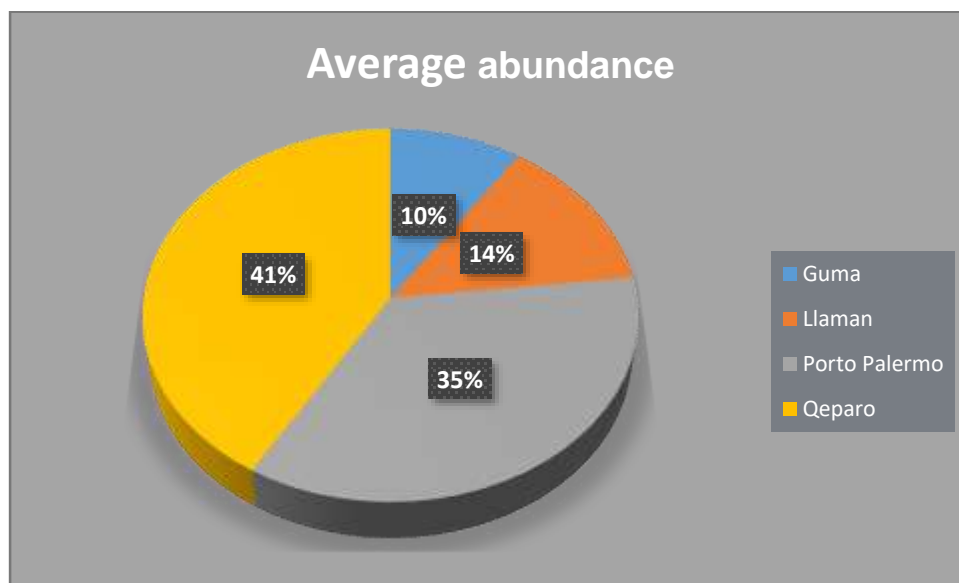

Figure 3. The total average abundance of molluscs for each site: Guma, Llanan, Porto Palermo and Qeparo.

Table 4. Diversity indexes in each sampling site.

Sites	<i>Guma</i>	<i>Llanan</i>	<i>Porto Palermo</i>	<i>Qeparo</i>
<i>Indexes</i>				
<i>Shannon & Weaver (H')</i>	2.679	2.446	1.922	1.905
<i>Pielou (J)</i>	0.795	0.791	0.613	0.555
<i>Margalef (M)</i>	7.771	5.520	4.901	6.072
<i>Simpson (D)</i>	0.094	0.120	0.246	0.225

Table 5. Percentage of species according to the values of constancy for each sampling site.

Sites	Constant species	Accompanying species	Occasional species
Guma	17%	24%	59%
Llanan	20%	40%	40%
Porto Palermo	30%	22%	48%

Qeparo	19%	7%	74%
--------	-----	----	-----

In Qeparo it was recorded the lowest degree of stability of the molluscs community, referring to the values of the constancy (table 5), according to the assessment based on Blanc et al. 1976. While in Porto Palermo and Llanan, based on the constancy values the degree of stability of the molluscs community is considered as average.

Considering the results and findings in this study, the main factors that affect molluscs populations at the shallow rocky coast of Himara are related to macroalgal cover, diversity of microhabitats, and human impacts, mainly from tourism development.

REFERENCES

- Beqiraj, S., Kashta, L., Kuci, M., Kasemi, D., Mato, Xh, Gace. A. (2008). Benthic macrofauna of *Posidonia oceanica* meadows in the Albanian coast. *Natura Montenegrina* 2008/7(2): 55 – 69.
- Beqiraj, S., Kashta, L. (2013). Assessment of marine natural values and rationale for the proposed MPA of Porto Palermo. Technical Report. GEF / UNDP. Tirana, 56 pp.
- Beqiraj, S. (2014). Overview on marine and coastal ecosystems of Albania. Technical Report. MedReact. Rome, 40 pp.
- Beqiraj, S., Ballesteros, E. (2018). Assessment of the state of marine biodiversity in the Albanian littoral. Albanian Conference on Biology and Environment (KShBM - ACBE). 28 – 30 September 2018. Prishtina.
- Beqiraj, S., Zenetos, A. (2021). Non-indigenous species. – In “Integrated Monitoring Programme – Albania”. Eds: PAP/RAC, GEF Adriatic project. pp140 + Annexes.
- Bianchi, C. N., Pronzato, R., Cattaneo-Vietti, R., Benedetti Cecchi, L., Morri, C., Pansini, M., Chemello, R., Milazzo, M., Frascetti, S., Terlizzi, A., Peirano, A., Salvati, E., Benzoni, F., Calcinai, B., Cerrano, C., Bavestrello, G. (2004). Bianchi et al. 2003, Hard bottoms. In: *Mediterranean marine benthos: a manual of methods for its sampling and study*. *Biologia Marina Mediterranea* (2004), 11, (suppl.1): 185 – 215.
- Blanc, F., Chardy, P., Laurec, A., Reys, J. P. (1976). Choix des métriques qualitatives en analyse d’ inertie. Implications en ecologie marine benthique. *Marine Biology*. Springer Verlag. 35: 49-67.
- CLEMAM, Check List of European Marine Mollusca, [h://www.mnhn.fr/base/malaco.html](http://www.mnhn.fr/base/malaco.html).
- Cossignani, T. (1992). Atlante delle conchiglie Del Medio Adriatico. L’informatore Piceno Ed. Ancona: 11 – 40. 17.
- D’Angello, G. & Gargiullo, S. (1991). Guida alle Conchiglie Mediterranee. Fabbri S.p.A. Milano: 224 pp. 18.
- Frascetti, S., Beqiraj, S., Gačić, M., Mascle, J., Odorico, R. (2011). Scientific rationale for the proposed CIESM North Ionian Sea Marine Peace Park. CIESM Workshop Monographs. Nr. 87-96.
- Giannuzzi-Savelli, R., Pusateri, F., Palmeri, A., Ebreo, C. (1999). Atlante delle conchiglie Del Mediterraneo. “Evolver” srl. Roma. Vol. 3: 7 – 18. 28.
- Giannuzzi-Savelli, R., Pusateri, F., Palmeri, A., Ebreo, C. (2001). Atlante delle conchiglie Del Mediterraneo. “Evolver” srl. Roma. Vol. 7: 42 - 240. 29.
- Giannuzzi-Savelli, R., Pusateri, F., Palmeri, A., Ebreo, C. (2003). Atlante delle conchiglie Del Mediterraneo. “Evolver” srl. Roma. Vol. 4: 22 - 290
- Hazarika, L. P. (2013). Diversity indices of macroinvertebrates. *Annals of Biological Research*, 4 (8): 68 – 72.

- Kashta, L., Beqiraj, S., Mato, Xh., Xhulaj, M., Gaçe, A., Mullaj, A. (2005). The inventory of habitats with *Posidonia oceanica* and littoral habitats in Albania. Technical Report. APAWA, Tirana. 86 pp.
- Kashta, L., Xhulaj, M., Mato, Xh., Beqiraj, S., Gace, A. (2007). The state of *Posidonia meadows* along the Albanian coast: general evaluation. 3-d Mediterranean Symposium on Marine Vegetation. Marseilles, France: 121 – 125.
- Kashta, L., Beqiraj, S. (2009). Analysis of the proposed potential Marine Protected Areas. Protected Areas Gap Assessment and Marine Protected Areas Development in Albania, (UNDP, GEF, MEFWA). Technical report, 81 pp.
- Katsanevakis, S., Poursanidis, D., Yokes, B., Mačić, V., Beqiraj, S., Kashta, L., Sghaier, Y. R., Zakhama-Sraieb, R., Benamer, I., Bitar, G., Bouzaza, Z., Magni, P., Nike Bianchi, C., Zenetos, A. (2011). Twelve years after the introduction of the Sally Lightfoot Crab *Percnon gibbesi* (H. Milne Edwards, 1853) in the Mediterranean: current distribution and invasion rates. *Journal of Biological Research. Thessaloniki* (16): 224 - 236.
- Katsanevakis S., Zenetos A., Mačić V. Beqiraj S., Poursanidis D. & Kashta L. (2011): Invading the Adriatic: spatial patterns of marine alien species across the Ionian-Adriatic boundary. *Aquatic Biology* (13): 107 - 118.
- Millard, V. (2001). Clasification of Mollusca. Vol.2 & Vol. 3. V. Millard. South Africa: 36 – 128, 144 – 189.
- Nybakken, j. W (1997). *Marine Biology – an ecological approach*. Addison-Wesley Educational Publishers Inc. 145 – 151, 304 – 335.
- Pano, N. (2015). Pasuritë ujore të Shqipërisë. Akademia e Shkencave të Shqipërisë. Tiranë. 549 – 562.
- Pititto, F., Greci, S., Dedej, Z., Gace, A., Kashta, L., Beqiraj, S., Acunto, S., Bulgheri, G., Cinelli, F., Sivini, N., Greco, R., Torchia, G. (2009): Cartography and protection of the *Posidonia oceanica* meadows along the Albanian coast. [Cartografia e protezione delle praterie di *Posidonia oceanica* lungo la costa albanese]. *Biologia Marina Mediterranea*. 16 (1): 324 – 325.
- Poppe, G. T. & Goto, Y. (1991). *European Seashells*. Verlag Christa Hemmen. Wiesbaden. Vol. 1: 11 – 300. 68.
- Poppe, G. T. & Goto, Y. (1993). *European Seashells*. Verlag Christa Hemmen. Wiesbaden. Vol. 2: 12 – 188. 69.
- Riedl, R. (1991). *Fauna e Flora Del Mediterraneo*. Franco Muzzio Editore. Padova: 105 – 472.
- Salomidi. M. (2003). *Hard Bottom Benthic Communities: Towards A New Concept In Assessing And Monitoring Marine Biodiversity* https://www.coastalwiki.org/wiki/Sampling_tools_for_the_marine_environment
- Trainito E. *Atlante di Flora e Fauna Del Mediterraneo*. Il Castello srl. Milano; 2004: 10 – 241.
- WoRMS (World Register of Marine Species) (www.marinespecies.org)
- Zenetos, A., Revkov, N. K., Konsulova, T., Sergeeva, N., Simboura, N., Todorova, V. R., Zaika, V. E. (2000). Coastal benthic diversity in the Black and Aegean Seas. *Mediterranean Marine Science*. Athens. Vol.1/2: 105 – 117.
- Zenetos, A., Mačić, V., Jaklin, A., Lipej, L., Poursanidis, D., Cattaneo-Vietti, R., Beqiraj, S., Betti, F., Poloniato, D., Kashta, L., Katsanevakis, S., Crocetta, F. (2016). Adriatic Opisthobranchs (Gastropoda, Heterobranchia): Shedding light on biodiversity issues. *Marine Ecology*, Vol. 37, Issue 6: 1239 – 1255.

Appendix 1.

Table 6. Total list of species recorded in the four sampling sites: Guma, Llaman, Porto Palermo and Qeparo, in Himara Coast.

Taxa	Guma	Llaman	Porto Palermo	Qeparo
Mollusca				
Polyplacophora				
1. <i>Rhyssoplax olivacea</i> (Spengler, 1797)		+		
2. <i>Acanthochitona fascicularis</i> (Linnaeus, 1767)		+		
Gastropoda				
3. <i>Patella caerulea</i> Linnaeus, 1758	+	+	+	+
4. <i>Patella rustica</i> Linnaeus, 1758	+	+	+	+
5. <i>Patella ulyssiponensis</i> Gmelin, 1791	+	+	+	+
6. <i>Cymbula safiana</i> (Lamarck, 1819)	+			
7. <i>Cellana rota</i> (Gmelin, 1791)				+
8. <i>Iothia fulva</i> (Müller O.F., 1776)				+
9. <i>Diodora gibberula</i> (Lamarck, 1822)	+		+	
10. <i>Diodora dorsata</i> (Monterosato, 1878)	+			
11. <i>Clanculus corallinus</i> (Gmelin, 1791)	+			
12. <i>Jujubinus exasperatus</i> (Pennant, 1777)	+			
13. <i>Gibbula ardens</i> (Von Salis, 1793)	+	+		
14. <i>Gibbula umbilicaris</i> (Linnaeus, 1758)	+			
15. <i>Gibbula varia</i> (Linnaeus, 1758)	+			+
16. <i>Phorcus (Monodonta) articulatus</i> (Lamarck 1822)				+
17. <i>Phorcus (Monodonta) mutabilis</i> (Philippi, 1846)				+
18. <i>Phorcus (Monodonta) turbinatus</i> (Born, 1778)	+	+	+	+
19. <i>Cerithium vulgatum</i> Bruguière, 1792	+		+	+
20. <i>Bittium reticulatum</i> (da Costa, 1778)	+		+	+
21. <i>Cerithidium perparvulum</i> (Watson, 1886)				
22. <i>Melarhaphe (Littorina) neritoides</i> (Linnaeus, 1758)	+		+	
23. <i>Rissoa similis</i> Scacchi, 1836				+
24. <i>Rissoa variabilis</i> (Von Mühlfeldt, 1824)				
25. <i>Alvania lineata</i> Risso, 1826				+
26. <i>Alvania discors</i> (Allan, 1818)				+
27. <i>Alvania cimex</i> (Linnaeus, 1758)	+		+	
28. <i>Circulus striatus</i> (Philippi, 1836)			+	
29. <i>Vermetus triquetrus</i> <u>Bivona Ant. 1832</u>	+			
30. <i>Vermetus</i> sp. Daudin, 1800	+			+
31. <i>Hexaplex (Trunculariopsis) trunculus</i> (Linnaeus, 1758)				+
32. <i>Ocinebrina edwardsii</i> (Payraudeau, 1826)			+	
33. <i>Ocinebrina hispidula</i> (Pallary, 1904)			+	
34. <i>Ocenebra ingloria</i> (Crosse, 1865)			+	
35. <i>Pisania striata</i> (Gmelin, 1791)	+	+	+	+
36. <i>Aplus scacchianus</i> (R. A. Philippi, 1844)	+			
37. <i>Tritia incrassata</i> (Strøm, 1768)	+			+
38. <i>Columbella rustica</i> (Linnaeus, 1758)	+	+	+	+
39. <i>Enginella leucozona</i> (Philippi, 1844)				+
40. <i>Tarantinaea (Fasciolaria) lignaria</i> (Linnaeus, 1758)	+			

41. <i>Conus mediterraneus</i> Hwass in Bruguière, 1792			+	
42. <i>Aplysia fasciata</i> Poiret, 1789	+			
Bivalvia				
43. <i>Arca noae</i> Linnaeus, 1758				+
44. <i>Mytilus galloprovincialis</i> Lamarck, 1819	+	+	+	+
45. <i>Mytilus edulis</i> Linnaeus, 1758	+	+	+	+
46. <i>Mytilaster minimus</i> (Poli, 1795)	+	+	+	+
47. <i>Mytilaster lineatus</i> (Gmelin, 1791)		+		
48. <i>Mytilaster sp.</i> Monterosato, 1884				
49. <i>Musculus costulatus</i> (Risso, 1826)	+	+	+	+
50. <i>Musculus discors</i> (Linnaeus, 1767)		+	+	+
51. <i>Lithophaga lithophaga</i> (Linnaeus, 1758)			+	
52. <i>Modiolus adriaticus</i> Lamarck, 1819	+	+	+	+
53. <i>Modiolus barbatus</i> (Linnaeus, 1758)		+		+
54. <i>Brachidontes pharaonis</i> (P. Fischer, 1870)	+	+		
55. <i>Modiolula phaseolina</i> (Philippi, 1844)		+		
56. <i>Anomia ephippium</i> Linnaeus, 1758	+		+	
57. <i>Ostrea edulis</i> Linnaeus, 1758		+		+
58. <i>Ostrea stentina</i> Payraudeau, 1826				+
59. <i>Chama gryphoides</i> Linnaeus, 1758				+
60. <i>Pododesmus (Monia) patelliformis</i> (Linnaeus, 1761)				+
Total	31	20	24	32

ALGAL COENOSES OF SHALLOW ROCKY COASTS OF THE ADRIATIC SEA IN ALBANIA

¹*Stela Ruci, ²Denada Kasemi, ¹Sajmir Beqiraj, ¹Lefter Kashta

¹Department of Biology, Faculty of Natural Sciences, University of Tirana, Albania

²Department of Biology, Faculty of Technical and Natural Sciences, University "Ismael Qemali", Vlora, Albania

*Corresponding author e-mail: stela.ruci@fshn.edu.al

ABSTRACT

Studies on algae of shallow rocky coasts in Albania are limited and so are the existing data. The aim of this study is to know species composition and algal cover in the rocky coasts of the Adriatic Sea in Albania, as well as their seasonal differences between the study areas. The study was carried out in the all rocky areas of the Albanian Adriatic coastline, namely Cape Rodoni, Kallm, Spille, and Triport in the spring, summer, and autumn seasons. The study presents the list of species composition of macroalgae for each studied area and the percentage of algal cover. Comparisons of these data were made between the four studied areas and between the three seasons. The dominant classes of algae were: Cyanophyceae; Florideophyceae with families Rodomelaceae, Corallinaceae, Rhodymeniaceae, Callithamniaceae; Phaeophyceae with families Sargassaceae, Dictyotaceae, Stypocaulaceae; Ulvophyceae with families Ulvaceae, Caulerpaceae, Cladophoraceae. Kallmi and Triport areas had the highest algal cover in the spring and autumn seasons, while Kallmi and Spille had the highest algal cover in the summer season. In the Spille area it was recorded a large number of algal species, which were not found in the other three areas. In this paper are also given considerations on possible natural and anthropogenic factors that affect the algal coenoses of the studied areas.

Key words: marine macroalgae, algal cover, species composition, natural and anthropogenic impacts.

INTRODUCTION

The macroalgae of the rocky shores of the Albanian coast of the Adriatic Sea have been poorly studied. The existing data on macroalgae coenoses are very few and sporadic.

Some important studies on the macroalgae of the Albanian Adriatic coast have been published in Anonymus, 2002; Ercegovic A., 1952; Ercegovic A., 1960; Kashta L., 1987, 1992-93; Kashta L. & Pizzuto, F., 1995; Kashta L., 1995-1996; Kashta L., 1995-1996, 1999, 2006; Xhulaj M. & Kashta L., 2007. Most of the existing data are from deep infralittoral and circalittoral, while the shallower parts, including midlittoral and upper infralittoral have been poorly investigated. Most recent data belong to assessments mainly related to proclamation of marine protected areas in the Adriatic coast of Albania, and they are mainly presented in technical projects reports and rare in scientific papers, such as Beqiraj et al. (2011), Beqiraj & Kashta (2014), Beqiraj et al. (2014), Blanfuné et al. (2016), Gogo & Kashta (2013), Kashta et al. (2005), Kashta & Beqiraj (2009), Kashta et al. (2010), Frascetti et al. (2011), Maiorano et al. (2011). Some data have also been presented in students' master theses and PhD theses, but not presented in scientific publications, like journals, conferences, or other scientific events.

Rocky areas in the Albanian part of Adriatic Sea are very short segments and very sensitive in ecological and environmental point of view. During the three last decades, the environmental

impact is considerably influenced by the urban and touristic development of the country (Fraschetti et al. 2011).

MATERIALS AND METHODS

Benthic samples have been taken during three seasons: spring, summer and autumn, in four rocky coastal areas along the Adriatic coast of Albania: Rodoni Cape, Kallm, Spille and Triport (Figure 1). Samples of macroalgae were taken in shallow water, including the supralittoral, midlittoral and upper limit of infralittoral. The samples were taken through standard methods for benthic sampling in hard bottoms, after the methods of Bianchi et al. 2004, Salomidi 2003, and Zenetos et al. 2000. In each site the sampling was done along three transects, distanced 50 m from each other.

Total algal cover in percentage has been evaluated in all sampling sites. It has been evaluated the species composition in each site, cover in percentage of each species in each sample, and the average cover of each species in each site. A comparison between sampling sites has been conducted regarding the differences in macroalgal cover and species number. Identification of macroalgae was based on atlases, identification keys, monographs and other relevant publications, referring to Cerrano et al. (2004), Mojetta & Ghisotti (1994), Riedl (2010), Trainito (2011). Taxonomic classification of macroalgae has followed the system of WoRMS (World Register of Marine Species).

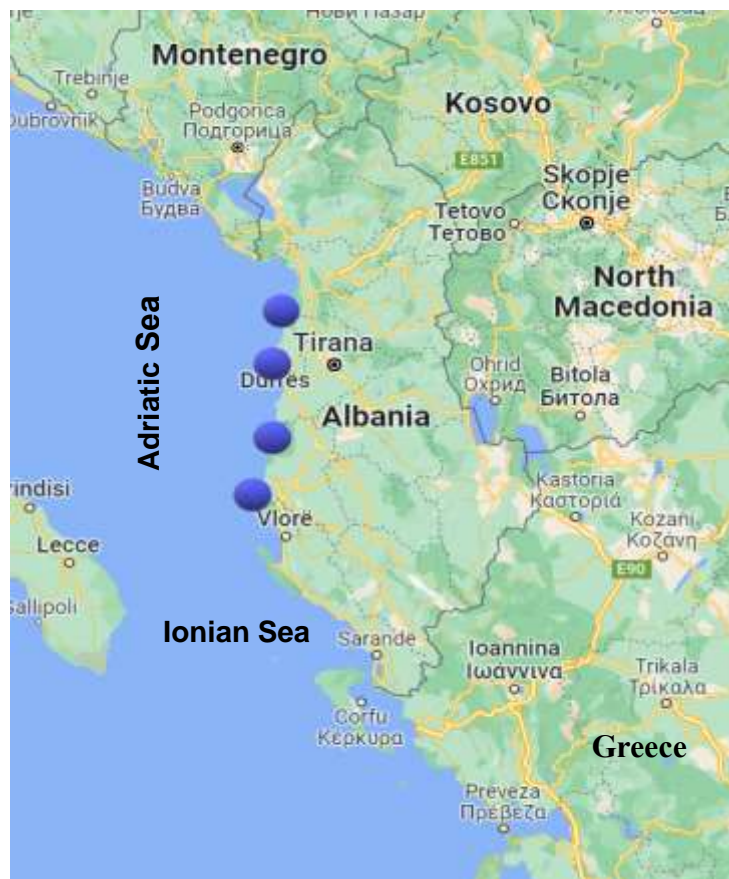

Figure 1. Map of Albania with the sampling sites: 1. Rodoni Cape; 2. Kallm; 3. Spille, 4. Triport



Figure 2. Photos of the sampling sites, a) Rodoni Cape, b) Kallm, c) Spille, d) Triport.

RESULTS AND DISCUSSIONS

The total number of macroalgae taxa recorded in the three seasons in the four studied areas was 50 (Appendix 1), of which 43 taxa were found in spring, 41 in summer and 25 taxa in autumn. The highest number of taxa was recorded in Kallm (41) and the lowest number of taxa was recorded in Rodoni Cape (21). The low number of taxa in Rodoni Cape maybe related to the exposure of the coast, under direct impact of the waves. The impact of pollution from beach tourism can be considerable at this site, taking into consideration the fact that the sea currents in this area have a south-north direction (according to Pano 2015). About 1 km in south of this site lies the beach of Saint Peter (Shën Pjetër), which is quite populated during the summer.

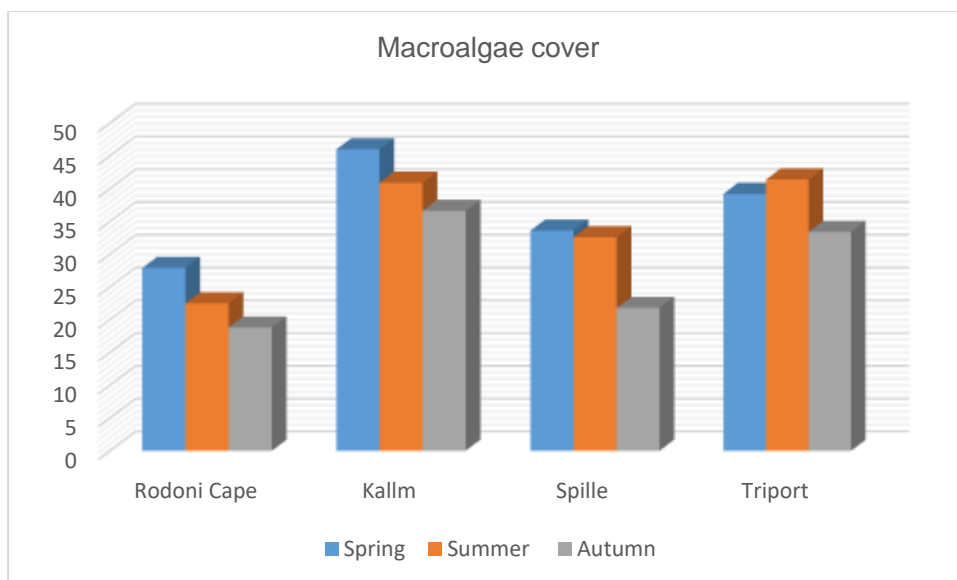

Figure 3. Macroalgae cover in percentage for each sampling site in each season.

As it is shown in figure 3, Kallm was the site with the highest macroalgae cover in the three seasons followed by Triport, which in summer had the highest cover from all sites. The lowest macroalgae cover was found in Rodoni Cape. The lowest algal cover in Rodoni Cape, also corresponds to the lowest number of species found in this site compare to the other sites.

A difference in algal cover and also in species composition has been evident between seasons, too. The highest number of species and the highest algal cover has been recorded in spring season in all sampling sites (Fig. 4). Kallm represents the site with the highest macroalgae cover and number of species in three seasons, with the exception of Triport, which in summer presents the highest algal cover compared to the other sites.

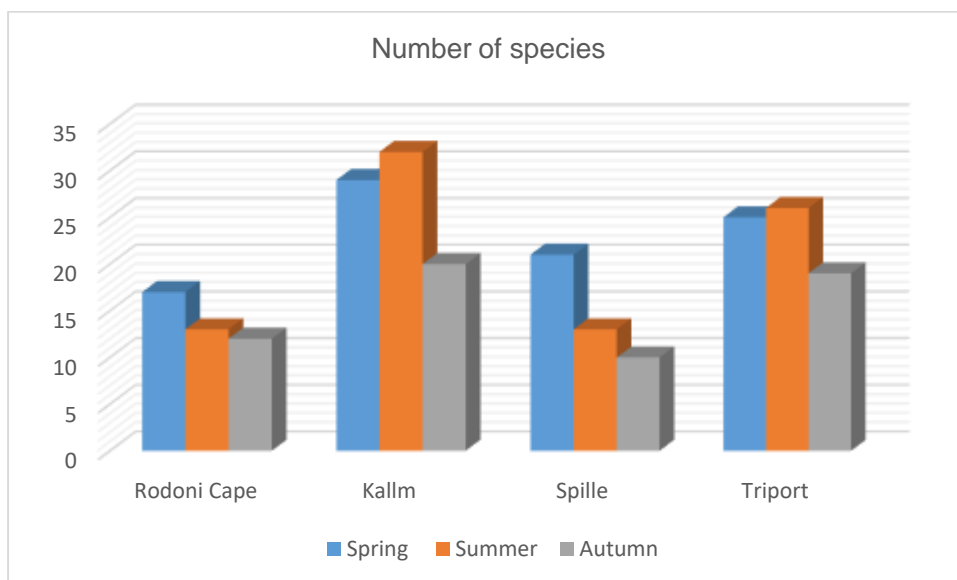

Figure 4. Number of macroalgae species found in each sampling site in each season.

From the **Chromista** kingdom there were recorded 16 taxa belonging to: Phylum Ochrophyta, part of Class Phaeophyceae represented by Fam. Sargassaceae (7 species), Fam. Dictyotaceae with 6 species, Fam. Stypocaulaceae with 2 species, and Fam. Fucaceae with only one species. From the **Plantae** kingdom there were recorded 34 taxa belonging to Phylum Rhodophyta and

Phylum Chlorophyta. Rhodophyta was recorded with 21 species, distributed in 2 classes and 11 families as below: Class Floridophyceae represented by Fam. Rhodomelaceae with 6 species, Fam. Corallinaceae (4 species), Fam. Callithamniaceae with 2 species, Fam. Delesseriaceae with 2 species and families Ceramiaceae, Phyllophoraceae, Cystocloniaceae, Sphaerococcaceae, Rhodymeniaceae, Peyssonneliaceae with 1 species recorded; Class Bangiophyceae with Fam. Bangiaceae with 1 species recorded. Rhodophyta represented the largest number of species during the whole period of this study. Phylum Chlorophyta was recorded with 13 species distributed in 7 families, part of Ulvophyceae. Ulvophyceae was represented by Fam. Ulvaceae (4 species), Fam. Cladophoraceae (3 species), Fam. Halimedaceae (2 species), and families Valoniaceae, Caulerpaceae, Dasycladaceae, and Polyphysaceae with 1 species recorded. The most represented families in species number were Sargassaceae (7 species), followed by Dictyotaceae and Rhodomelaceae with 6 species and afterwards Corallinaceae and Ulvaceae with 4 species each. Number of species of each class was as following: Floridophyceae with 20 species, Phaeophyceae with 16 species, Ulvophyceae with 13 species, Bangiophyceae and Cyanophyceae with 1 species. Class Floridophyceae was the class with the highest species diversity, while the class with the highest cover was Phaeophyceae.

In this study, an invasive alien macroalgae species was found, *Caulerpa racemosa* (Forsskål) J. Agardh, 1873 of the family Caulerpaceae, known as native to Australia. This species was found in Kallm and Triport sites. Also, another important species found in this study was *Fucus virsoides* J. Agardh, 1868 of the family Fucaceae that is an endemic species in the Adriatic Sea. This species was found in Rodoni Cape, Kallm and Spille sites. In most of existing databases, Albania has not been mentioned as a distribution site of *Fucus virsoides*, although its presence in the Albanian coast has been published since many years already, in Kashta, 1995-1996. Albania should be considered as the most southern distribution of this species in the Adriatic Sea.

LITERATURE

Anonymus, 2002: National Report on Marine and Coastal Biodiversity. Tirana.

Beqiraj, S., Frascetti, S., Gačić, M., Joksimovic, A., Mackelworth, P., Mascle, J., Notarbartolo di Sciara, G., Odorico, R. (2011). Scientific rationale for the proposed CIESM South Adriatic Sea Marine Peace Park. CIESM Workshop Monographs, N. 41, 128 p., Monaco.

Beqiraj, S., Kashta, L. (2014). Assessment and preparation of documents for the new proposed MPA Cape of Rodoni. "Improving the coverage and management effectiveness of marine and coastal protected areas in Albania" (UNDP, GEF, MoE). Technical report, 61 p.

Beqiraj, S., Kashta, L., Gaçe, A., Mato, Xh. (2014). Ecological study in the Porto Palermo Bay and surrounding areas. Regional Project for the Development of a Mediterranean Marine and Coastal Protected Areas (MPAs) Network through the boosting of MPA creation and management. Ed. RAC/SPA, Tunis. 45p + Appendices.

Bianchi, C. N., Pronzato, R., Cattaneo-Vietti, R., Benedetti Cecchi, L., Morri, C., Pansini, M., Chemello, R., Milazzo, M., Frascetti, S., Terlizzi, A., Peirano, A., Salvati, E., Benzioni, F., Calcinai, B., Cerrano, C., Bavestrello, G. (2004). Bianchi et al. 2003, Hard bottoms. In: Mediterranean marine benthos: a manual of methods for its sampling and study. *Biologia Marina Mediterranea* (2004), 11, (suppl.1): 185 – 215.

Blanfuné A., Boudouresque Ch- F., Verlaque M., Beqiraj S., Kashta L., Nasto I., Ruci S., Thibaut Th. (2016). Response of rocky shore communities to anthropogenic pressures in Albania (Mediterranean Sea): Ecological status assessment through the CARLIT method. *Marine Pollution Bulletin*, Elsevier. vol. 109, 1: 409–418

Cerrano, C., Ponti, M., Silvestri, S. (2004). Guida alla biologia marina Del Mediterraneo. Editore Ananke. 320 p.

- Ercegovic A., 1952: Jadranske cistozire. Njihova morfologija, ekologija I razvitk. Fauna ET Flora Adriatika. Split, 2:1-212.
- Ercegovic A., 1960: La vegetation des algues sur les fonds pechereux de l'Adriatique. "Hvar"-Rap. 6(4): 1-32. Inst. Oceanogr. Ribar. Split. Izvjeska 6(4): 1-32.
- Fraschetti S., Terlizzi A., Guarnieri G., Pizzolante F., D'Ambrosio P., Maiorano P., Beqiraj S., Boero F. (2011). Effects of unplanned development on marine biodiversity: A lesson from Albania (central Mediterranean Sea). Journal of Coastal Research, Special Issue No. 58, pp. 106–115. West Palm Beach (Florida).
- Gogo, S., Kashta, L. (2013). Macroalgae biodiversity and anthropogenic impact on Albanian rocky shore. Preliminary results. Proceedings of 2nd International Conference "Research and Education in Natural Sciences" November 15-16, Shkodër, Albania.
- Kashta L., 1987: Alga makrofite të brigjeve të Shqipërisë [The macrophyte algae of Albanian coast]. Dissertation. Tiranë: 1-187.
- Kashta L., 1992-93: Rezultate të studimit të florës detare të brigjeve shqiptare të Adriatikut. [Results of the study of marine flora of the Albanian Adriatic shore]. *Buletini i Shkencave Natyrore*, Tiranë, seria B, Kimi-Biologji, n. 1-4.
- Kashta L. & Pizzuto, F., 1995. Sulla presenza di *Halophyla Stipulacea* (Forskaal) Ascherson nelle coste dell'Albania. - *Boll. Acc. Gioenia Sci. Nat.* Catania: 161-166.
- Kashta L., 1995-1996: Rreth përhapjes dhe ekologjisë së *Fucus virsoides* J. Agardh ne brigjet e Shqipërisë. [About the distribution and ecology of *Fucus virsoides* J. Agardh along the Albanian coast]. *Universiteti i Shkodres 'Luigj Gurakuqi', Bul. Shk. Ser. Shk. Nat.*, nr. (48)1: 60-65.
- Kashta L., 1996. Dati sulla distribuzione floristica di alghe rosse (Corallinales) lungo le coste dell'Albania. – *Atti. Mus. Civ. Stor. Nat.* Trieste (47): 137-141.
- Kashta L., 1999. Albania, Country Report. In: *UNEP: Proceedings of the workshop on Invasive Caulerpa Species in the Mediterranean, Herakleon, Crete, Greece, 18-20 March 1998. MTS No. 125, UNEP*, Athens: 225-226.
- Kashta L., Mato Xh., Beqiraj S., Mullaj A., Gaçe A., Xhulaj M. (2005). Inventarizimi i habitateve me *Posidonia oceanica* dhe atyre bregdetare. Shoqata e Mbrojtjes së Gjallesave Ujore të Shqipërisë & Ministria e Mjedisit. Technical report: 84p.
- Kashta L., 2006: Flora detare. Në: Libri i Kuq i Florës së Shqipërisë [Marine Flora. In: Red Book of Albanian Flora] – electronic version.
- Kashta, L., Beqiraj, S. (2009). Analysis of the proposed Marine Protected Areas in Albania. Protected Areas Gap Assessment and Marine Protected Areas Development Project. (UNDP, GEF, MEFWA). Technical report, 81p.
- Kashta L., Beqiraj S., Tilot V., Zuna V., Dodbiba E. (2010). The first MPA in Albania, Sazani Island-Karaburuni Peninsula, as a regional priority conservation area for marine biodiversity. *Varstvo narave-Ljubljana*, Supl. 1: 139-157.
- Maiorano P., Mastrototaro F., Beqiraj S., Costantino G., Kashta L., Gherardi M., Sion L., D'ambrosio P., Tursi A. Bioecological study of the benthic communities on soft bottom of the Vlora gulf (Albania). Journal of Coastal Research, Special Issue No. 58, pp. 95–105. West Palm Beach (Florida).
- Mojetta, A., Ghisotti, A. (1994). Flora e Fauna Del Mediterraneo. Mondadori. 318 p. [30]. Panneta, P., Mastrototaro, F., Beqiraj, S., Matarrese, A. (2009): Molluscs of soft bottoms in Valona Bay. *Biologia Marina Mediterranea* (16 (1): 328 – 329. [31].

Pano, N. (2015). Pasuritë ujore të Shqipërisë. Akademia e Shkencave të Shqipërisë. Tiranë. 447 – 469.

Riedl, R. (2010). Fauna e Flora Del Mediterraneo. Franco Muzzio Editore. 806 p. [32]. Schlieper, C. (1976). Research methods in marine biology. Sidgwick & Jackson. London: 104 – 116. [33].

Salomidi. M. (2003). Hard Bottom Benthic Communities: Towards a New Concept in Assessing and Monitoring Marine Biodiversity https://www.coastalwiki.org/wiki/Sampling_tools_for_the_marine_environment

Trainito, E. (2011). Atlante di Flora e Fauna del Mediterraneo. Editore “Il Castello”. 336 p. [34].

Zenetos, A., Revkov, N. K., Konsulova, T., Sergeeva, N., Simbura, N., Todorova, V. R., Zaika, V. E. (2000). Coastal benthic diversity in the Black and Aegean Seas. Mediterranean Marine Science. Athens. Vol.1/2: 105 – 117 [35].

Xhulaj M. & Kashta L., 2007: *Halophila stipulacea* (Forsskål) Ascherson and *Culerpa racemose* (Forsskål) J. Agardh in Albania. Poster In: *Third Mediterranean Symposium on Marine Vegetation Marseilles*, March 2007.

WoRMS. World Register of Marine Species. Http: www. marinespecies.org

Appendix 1. The list of macroalgae species and their systematic position

Taxa	Rodoni Cape	Kallm	Spille	Triport
Chromista				
Ochrophyta				
Phaeophyceae				
Fucales				
Sargassaceae				
1. <i>Treptacantha barbata</i> (Stackhouse) Orellana & Sansón, 2019	+	+	+	+
2. <i>Cystoseira crinita</i> Duby, 1830		+	+	+
3. <i>Cystoseira compressa</i> (Esper) Gerloff & Nizamuddin, 1975	+	+	+	+
4. <i>Ericaria amentacea</i> (C.Agardh) Molinari & Guiry, 2020	+	+	+	+
5. <i>Cystoseira foeniculacea</i> (Linnaeus) Greville, 1830		+	+	+
6. <i>Cystoseira</i> C.Agardh, 1820			+	+
7. <i>Sargassum vulgare</i> C.Agardh, 1820		+	+	+
Fucaceae				
8. <i>Fucus virsoides</i> J.Agardh, 1868	+	+	+	
Dictyotales				
Dictyotaceae				
9. <i>Dictyopteris polypodioides</i> (A.P.De Candolle) J.V.Lamouroux, 1809	+	+	+	+
10. <i>Dictyota dichotoma</i> (Hudson) J.V.Lamouroux, 1809	+	+		+
11. <i>Dictyota fasciola</i> (Roth) J.V.Lamouroux, 1809		+		
12. <i>Dictyota</i> J.V.Lamouroux, 1809	+	+		+
13. <i>Padina pavonica</i> (Linnaeus) Thivy, 1960	+	+	+	+

14. <i>Taonia atomaria</i> (Woodward) J.Agardh, 1848			+	
Sphacelariales				
Stypocaulaceae				
15. <i>Halopteris scoparia</i> (Linnaeus) Sauvageau, 1904	+	+	+	+
16. <i>Halopteris filicina</i> (Grateloup) Kützing, 1843		+		+
Plantae				
Rhodophyta				
Florideophyceae				
Ceramiales				
Ceramiaceae				
17. <i>Ceramium virgatum</i> Roth, 1797		+	+	+
Rhodomelaceae				
18. <i>Laurencia obtusa</i> (Hudson) J.V.Lamouroux, 1813	+	+		+
19. <i>Palisada perforata</i> (Bory) K.W.Nam, 2007		+		
20. <i>Laurencia</i> J.V.Lamouroux, 1813	+	+	+	
21. <i>Rytiphlaea tinctoria</i> (Clemente) C.Agardh, 1824		+	+	+
22. <i>Alsidium corallinum</i> C.Agardh, 1827				+
23. <i>Halopithys incurve</i> (Hudson) Batters, 1902	+	+		+
Callithamniaceae				
24. <i>Callithamnion granulatum</i> (Ducluzeau) C.Agardh, 1828			+	
25. <i>Spyridia filamentosa</i> (Wulfen) Harvey, 1833		+		
Delesseriaceae				
26. <i>Dasya baillouvia</i> (S.G.Gmelin) Montagne, 1841			+	
27. <i>Dasya</i> C.Agardh, 1824		+		
Corallinales				
Corallinaceae				
28. <i>Jania virgata</i> (Zanardini) Montagne, 1846	+	+	+	+
29. <i>Ellisolandia elongata</i> (J.Ellis & Solander) K.R.Hind & G.W.Saunders, 2013		+	+	+
30. <i>Corallina</i> Linnaeus, 1758	+	+	+	+
31. <i>Jania rubens</i> (Linnaeus) J.V.Lamouroux, 1816		+		
Gigartinales				
Phylloporaceae				
32. <i>Phyllophora crispa</i> (Hudson) P.S.Dixon, 1964			+	
Cystocloniaceae				
33. <i>Hypnea musciformis</i> (Wulfen) J.V.Lamouroux, 1813	+	+	+	+
Sphaerococcaceae				
34. <i>Sphaerococcus coronopifolius</i> Stackhouse, 1797		+		
Rhodymeniales				
Rhodymeniaceae				
35. <i>Botryocladia botryoides</i> (Wulfen) Feldmann, 1941	+	+		
Peyssonneliales				
Peyssonneliaceae				
36. <i>Peyssonnelia heteromorpha</i> (Zanardini) Athanasiadis, 2016				+
Bangiophyceae				
Bangiales				
Bangiaceae				

37. <i>Bangia fuscopurpurea</i> (Dillwyn) Lyngbye, 1819		+		
Chlorophyta				
Ulvophyceae				
Ulvales				
Ulvaceae				
38. <i>Ulva linza</i> Linnaeus, 1753		+		
39. <i>Ulva lactuca</i> f. <i>rigida</i> (C.Agardh) Hylmö		+	+	+
40. <i>Ulva intestinalis</i> Linnaeus, 1753		+		
41. <i>Ulva</i> Linnaeus, 1753	+	+	+	+
Cladophorales				
Cladophoraceae				
42. <i>Cladophora fracta</i> f. <i>prolifera</i> (C.Agardh) Rabenhorst	+	+	+	+
43. <i>Cladophora</i> Kützing, 1843		+	+	
44. <i>Chaetomorpha aerea</i> (Dillwyn) Kützing, 1849				+
Valoniaceae				
45. <i>Valonia utricularis</i> (Roth) C.Agardh, 1823		+		
Bryopsidales				
Halimedaceae				
46. <i>Halimeda tuna</i> (J.Ellis & Solander) J.V.Lamouroux, 1816	+	+		+
47. <i>Flabellia petiolata</i> (Turra) Nizamuddin, 1987				+
Caulerpanceae				
48. <i>Caulerpa racemosa</i> (Forsskål) J.Agardh, 1873		+		+
Dasycladales				
Dasycladaceae				
49. <i>Dasycladus vermicularis</i> (Scopoli) Krasser, 1898	+	+		+
Polyphysaceae				
50. <i>Acetabularia acetabulum</i> (Linnaeus) P.C.Silva, 1952	+	+		+
Total	21	41	26	32

SOME ENDANGERED ENDEMIC PLANTS IN THRACE REGION: A REMOTE SENSING APPROACH WITH UAV IMAGERY

Selçuk KAYA^{1}, Hilmi KUSCU¹*

*¹ Trakya University, Engineering Faculty, Mechanical Engineering Department,
Edirne, Turkey*

Corresponding author e-mail: selcukkaya@trakya.edu.tr

ABSTRACT

Endemic plants need protection due to their rarity. This protection should be more serious if these rare species are in endangered status due to various reasons. Some of the endemic plants in Thrace Region also have big potential for pharmaceutical and medical science, This is another important reason to protect them besides protecting the regions flora due to extinction threat. Therefore, a remote sensing with uav imagery can be a solution firstly for identifying fastly then taking precautions effectivly against the danger. Until now, endemic plants in Turkiye's Thrace Region were only detected by eye during field trips. Since these plants have small size, its nearly impossible to identify them from satellite imagery. A high resolution UAV imagery can be a solution for detecting these plants. These imagery also can be used for mapping and this map can involve statistical data such as the coordinates of the endemic plants and the number of them in a certain area. In this way, important inferences such as the endemic plant density in the region and the change in the number of plants according to time can be collected. These collected statistical data can show the state of endangered endemic plants in Thrace Region.

Keywords: Remote Sensing, Endemic Plants in Thrace Region, UAV Imagery, Mapping

INTRODUCTION

Plant detection in the world is done in two ways. Plants are detected in the area where the plants are located as a result of visual observation or by remote sensing methods. While remote sensing methods used to be done using satellite images and aerial photography, now higher resolution and less costly UAVs have begun to be preferred. The reason for this is the difficulty in detecting small plants. Disease detection with remote sensing using UAV (Albetis et al., 2017; Görlich et al., 2021; Wang, Thomasson, Isakeit, Yang & Nichol, 2020), weed detection (Şin & Kadioğlu, 2019; Mohidem et al., 2021; Che'Ya, Dunwoody & Gupta, 2021; Sa, et al. 2018; Deng et al., 2020), missing plant detection (Primicerio et al., 2017), plant counting (Wu, Shen, Cao, Wang & Cao, 2019), and Vegetation analysis (Song & Park, 2020) is carried out. Detection methods for endemic plant species that are difficult to find consume a lot of time and effort. In general, satellite images and visual detection method are used to find it. Once identified, it is difficult to obtain statistical data about the coordinates and number of plants. Using remote detection with UAV's can give highly accurate data and detection rate. In order to detect some of endemic plants, a detection mechanism would be needed. Using an algorithm would be a solution.

MATERIAL AND METHOD

4 individual endemic plants located in Thrace Region are the main materials in this research. These endemic plants are particularly selected due to their rarity rate and endangered status. The endemic plants are *Tripleurospermum baytopianum*, *Verbascum degenii*, *Centaurea kilaea* and *Dianthus ingoldbyi*.

Tripleurospermum baytopianum is biennial or perennial. Has a morphology of stems being single or numerous, unbranched or rarely branched at the top. 0.8-1 cm except capitulum radiate and ligules. Ligules 3-5 mm. Flowering period is from April to May. It is listed as EN (Endangered) in the threat category of IUCN (World Union for Conservation of Nature and Natural Resources) because of herding and farming. There is a picture of plant located at between Keşan and Evreşe road (Figure 1).



Figure 1. Close view of *Tripleurospermum baytopianum*

Verbascum degenii is biennial has morphology of corolla being 1.5-2 cm in diameter (Figure 2). Flowering period is from May to August. It has been determined that the methanol and ethanol extracts the plant contains can be an alternative to some synthetic antibiotics in the treatment of diseases (Avşar et al., 2016). Also it is in the IUCN threat category CR (Highly Endangered) and it is a plant protected by the Bern Convention. (Kırklareli 2021 Environmental Status Report). Its in the danger category because of tourism activities. It has been located from Kırklareli beaches to Kilyos beaches.

Centaurea kilaea is a perennial endemic plant with morphology of its papi being 3-5 mm (Figure 3). Flowering period is from June to August. It has been found to be effective against breast, cervical, prostate (Şen et al., 2017) and liver cancers (Şekerler et al., 2020) and has been recommended as a strong candidate for anti-cancer drugs. It is included in the EN (Endangered) category on the IUCN Red list due to tourism activities in its habitat. The endemic plant has been found at Kumluk on the Kasatura coast (Baytop 1967, Özhatay 1994), Kastros Creek edge (Dökmeci 1973), İğneada Langozu and beach sands close to Saka Lake (Byfield 1993).



Figure 2. *Verbascum degenii*



Figure 3. Close view of *Centaurea kilaea*

Dianthus ingoldbyi is a perennial plant having petal length 17.48-19.4 mm as morphological data (Figure 4). Flowering period is from June 2nd week to October 3rd week. It is classified as CR (Highly Endangered) according to the IUCN threat category. Since this plant grows on limestone it is heavily threatened by mining activities.



Figure 4. *Dianthus ingoldbyi* on a limestone

In order to detect these selected endemic plants, remote sensing with UAV imagery selected as method. Each plant will be photographed from air in a certain altitude at seen locations that are found in literature research and expert opinion. The altitude is determined according to Ground spacing/sample distance (GSD). GSD ratio refers to the size of a pixel in a photo taken from a certain height. In order to distinguish an endemic plant from surrounding objects, at least a part of that plant must be included in one pixel. Maximum required flight altitudes for UAV photography for each plant according to the logic that has been stated previously are shown at Table 1.

Table 1. Maximum required flight altitudes for UAV photography

Name of Endemic Plant	Maximum Flight Altitude
<i>Centaurea kilea</i>	7 Meter – 0,3 cm/px
<i>Tripleurospermum baytopianum</i>	35 Meter – 1,5 cm/px
<i>Verbascum degenii</i>	35 Meter – 1,5 cm/px
<i>Dianthus ingoldbyi</i>	7 Meter – 0,3 cm/px

RESULTS AND DISCUSSION

The endemic plants that are selected in this research found and photographed using a DJI Phantom 3 Advanced UAV in the locations that are determined based on the expert opinions and literature research (Figure 5,6,7 and 8).

From the pictures, it can be seen that at certain altitudes of UAV images the plants can be distinguished from other plants and identified in the region. Lower altitudes will give more detail about the endemic plant such as shape of petal or leaves. This may be a crucial information that can allow differentiate very similar plants that look like the endemic plant.

Using the GPS data while photographing with UAV can be helpful locating the plants afterwards in order to visual check if it's the correct endemic plant or not.



Figure 5. UAV image of *Tripleurospermum baytopianum*



Figure 6. UAV image of *Verbascum degenii*



Figure 7. UAV image of *Centaurea kilaea*



Figure 8. UAV image of *Dianthus ingoldbyi*

CONCLUSIONS

Based on the study, UAV imagery allows much more detailed photographs for identification, cheaper operation than remote sensing approaches (satellite imagery, ariel imagery with airplane or helicopter) and removes geographical barriers such as rough and thorny areas that makes visual inspection methods very hard to work.

An orthophoto can be created using the UAV images. Using the orthophoto, protected areas can be increased, statistical information of plants (depending on the year and month) can be

obtained, data such as plant density and number can be created, and finally, it can be an important study to create an infrastructure for the discovery of new species. It is aimed that institutions and organizations working on endemic plants in the Thrace region can do their work much faster and more reliable.

Some of the endemic plants can be very small and can have same similarities with near plants. For example, in *Tripleurospermum baytopianum* habitat very similar plants like *Anthemis austriaca*, *Bellis perennis*, *Matricaria chamomilla* can be located. Just looking at an UAV image it may be difficult to distinguish these plants from each other. That's why a visual inspection can be needed.

REFERENCES

- Albetis J., Duthoit S., Guttler F., Jacquin A., Goulard M., Poilvé H., Féret J-B & Dedieu G. (2017). Detection of Flavescence dorée Grapevine Disease Using Unmanned Aerial Vehicle (UAV) Multispectral Imagery. *Remote Sensing*. 9(4):308.
- Avşar C., Keskin H. & Berber İ. (2016). Antimicrobial Activity of Some Plant Extracts against Microorganisms Isolated from Hospital Infections.; *Int. J. Pure Appl. Sci.* 2(1): 22-29 11(7):1435.
- Che'Ya NN, Dunwoody E & Gupta M. (2021). Assessment of Weed Classification Using Hyperspectral Reflectance and Optimal Multispectral UAV Imagery. *Agronomy*.; 11(7):1435.
- Deng J., Zhong Z., Huang H., Lan Y., Han Y. & Zhang Y. (2020). Lightweight Semantic Segmentation Network for Real-Time Weed Mapping Using Unmanned Aerial Vehicles. *Applied Sciences*. 10(20):7132.
- Görllich F., Marks E., Mahlein A-K., König K., Lottes P. & Stachniss C. (2021). UAV-Based Classification of Cercospora Leaf Spot Using RGB Images. *Drones*. 5(2):34
- Mohidem, N.A., Che'Ya, N.N., Juraimi, A.S., Fazlil Ilahi, W.F., Mohd Roslim, M.H.; Sulaiman, N., Saberioon, M. & Mohd Noor, N. (2021), How Can Unmanned Aerial Vehicles Be Used for Detecting Weeds in Agricultural Fields? *Agriculture*, 11, 1004
- Primicerio J., Caruso G., Comba L., Crisci A., Gay P., Guidoni S., Genesio L., Aimonino D. R. & Vaccari F. P. (2017). Individual plant definition and missing plant characterization in vineyards from high-resolution UAV imagery, *European Journal of Remote Sensing*, 50 (1), 179-186,
- Sa I., Popović M., Khanna R., Chen Z., Lottes P., Liebisch F., Nieto J., Stachniss C., Walter A. & Siegwart R. (2018). WeedMap: A Large-Scale Semantic Weed Mapping Framework Using Aerial Multispectral Imaging and Deep Neural Network for Precision Farming. *Remote Sensing*. 10(9):1423.
- Song B. & Park K. (2020). "Detection of Aquatic Plants Using Multispectral UAV Imagery and Vegetation Index" *Remote Sensing* 12, no. 3: 387
- Şen A., Turan S.A. & Bitiş L. (2017) Bioactivity-guided isolation of anti-proliferative compounds from endemic *Centaurea kilaea*, *Pharmaceutical Biology*, 55:1, 541-546
- Şekerler T, Şen A, Bitiş L, Şener A. (2020) Antihepatocellular carcinoma activity of secondary metabolites of *Centaurea kilaea* Boiss. *J Res Pharm.*; 24(4): 479-486.
- Şin B. & Kadioğlu İ. (2019). İnsansız Hava Aracı (İHA) ve Görüntü İşleme Teknikleri Kullanılarak Yabancı Ot Tespitinin Yapılması. *Turkish Journal of Weed Science*, 22(2): 211-217.
- Wang T., Thomasson JA., Isakeit T., Yang C. & Nichols RL. (2020). A Plant-by-Plant Method to Identify and Treat Cotton Root Rot Based on UAV Remote Sensing. *Remote Sensing*. 12(15):2453.
- Wu X., Shen X., Cao L., Wang G. & Cao F. (2019). Assessment of Individual Tree Detection

and Canopy Cover Estimation using Unmanned Aerial Vehicle based Light Detection and Ranging (UAV-LiDAR) Data in Planted Forests" *Remote Sensing 11*, no. 8: 908.

CONTRIBUTIONS TO *BLACINAE* (*HYMENOPTERA: BRACONIDAE*) FAUNA OF CENTRAL ANATOLIA REGION IN TURKEY

Özlem ÇETİN ERDOĞAN¹

¹ Trakya University, Science Faculty, Biology Department, Edirne, Turkey

Corresponding author e-mail: ozlemerdogan@trakya.edu.tr

ABSTRACT

This study provides information about Blacinae fauna in the Central Anatolia Region, in Turkey, during the years of 2004-2008. As a result of this study, six species were identified. Those were *Blacus* (*Blacus*) *nigricornis* Haselbarth, 1973 *Blacus* (*Ganychorus*) *conformis* Wesmael, 1835, *Blacus* (*G.*) *diversicornis* (Nees, 1834), *B. (G.) maculipes* Wesmael, 1835, *B. (G.) ruficornis* (Nees, 1812), *B. (G.) tripudians* Haliday, 1812. Although all identified species were recorded before Turkey, they are new records for the research area. The distributions and detailed locality records of the identified species are given.

Keywords: Blacinae, Braconidae, Central Anatolia Region, Fauna, Türkiye

INTRODUCTION

This small Braconidae subfamily of about 229 described species worldwide. The great majority, including just over 20 recorded from Turkey, belong to the genus *Blacus*. Blacinae are endoparasites of the larvae of phytophagous insects, especially from the families Anobiidae, Cerambycidae, Cryptophagidae, Curculionidae, Melyridae, Nitidulidae, Scolytidae and Staphylinidae (van Achterberg, 1988).

The subfamily Blacinae is represented in Turkey by genus *Blacus*. Up to now 21 species have been recorded from Turkey. (Çetin Erdoğan and Beyarslan, 2005, Çetin Erdoğan, 2010, Güçlü, 2011).

There is a considerable amount of study concerning the Braconidae fauna of Turkey; however, the Blacinae fauna of the Central Anatolia Region is a rather newly studied subject. The research region, is the second largest region of Turkey. The 13 provinces in this region are Aksaray, Ankara, Çankırı, Eskişehir, Karaman, Kayseri, Kırıkkale, Kırşehir, Konya, Nevşehir, Niğde, Sivas and Yozgat.

The present study is to contribute to the knowledge on the species composition of Blacinae of the Central Anatolia Region.

MATERIALS AND METHODS

This study was carried out during 2004 and 2008 in various habitats in Central Anatolia Region. Specimens were collected with sweeping net. Collected samples were transferred in the 70% ethanol and brought to Trakya University, Science Faculty, Biology Department.

Distributional information provided here for each species comes from Yu et al. (2016). The works of van Achterberg (1976, 1988) were used for taxonomical examination and identification of the materials. The distributions and detailed locality records of the identified species are given. The material of the study is deposited in Entomological Museum of Trakya University (EMTU), Edirne, Turkey.

RESULTS

BLACINAE

Blacus Nees, 1819

Blacus (Blacus) nigricornis Haselbarth, 1973

Material examined: Sivas: Yıldızeli, 30.05.2007, 1 ♀.

General distribution: Palaearctic

Blacus (Ganychorus) conformis Wesmael, 1835

Material examined: Ankara: Beypazarı-Akkavak, 8.6.2007, 1 ♀, **Eskişehir:** Sündiken-Asarlık, 9.7.2007, 1 ♀, **Niğde:** Çiftlik, 18.07.2007, 1 ♀.

General distribution: Palaearctic

Blacus (Ganychorus) diversicornis (Nees, 1834)

Material examined: Eskişehir: Kaymaz, 10.7.2007, 1 ♀; **Kayseri:** Bünyan-Ekrek, 2 ♀♀, **Sivas:** Koyulhisar, 1.7.2004, 1 ♀.

General distribution: Palaearctic

Blacus (Ganychorus) maculipes Wesmael, 1835

Material examined: Eskişehir: Sündiken-Asarlık, 9.7.2007, 3 ♀♀; **Kayseri:** Bünyan-Ekrek, 2 ♀♀; **Nevşehir:** Avanos-Saruhan, 6.6.2007, 7 ♀♀; **Gülşehir:** Aşıksaray, 12.9.2006, 1 ♀; **Sivas:** Gürün-Gökpinar, 13.7.2007, 1 ♀.

General distribution: Palaearctic

Blacus (Ganychorus) ruficornis (Nees, 1812)

Material examined: Ankara: Beypazarı-Akkavak, 8.6.2007, 1 ♂; Haymana-Balçıkhisar, 10.7.2007, 5 ♀♀, 1 ♂; Temelli-Elagöz, 10.7.2007, 11 ♀♀; Gölbaşı-Oğulbey, 11.7.2007, 1 ♀; Nallıhan-Sabran, 8.6.2007, 2 ♀♀; **Eskişehir:** Anadolu Üniversitesi-Hatıra Ormanı, 10.7.2007, 1 ♀; Bilecik Yolu, 7.7.2007, 17 ♀♀, 12 ♂♂; Sündiken-Asarlık, 9.7.2007, 5 ♀♀; Sivrihar-Babatat, 10.07.2007, 2 ♀♀; Türkmendağı-Çamlıca, 8.7.2007, 5 ♀♀; Yemliha, 8.7.2007, 1 ♂; Yörükhırka, 8.7.2007, 2 ♀♀; **Kayseri:** Bünyan-Ekrek, 12.7.2007, 4 ♀♀, 5 ♂♂; İncesu-Güzelşehir, 14.9.2006, 1 ♀; Kalkancık, 12.07.2007, 2 ♀♀; Pınarbaşı-Aşağıkızılçevlik, 13.7.2007, 2 ♀♀; Talas-Başakpınar, 6.6.2007, 1 ♀, 1 ♂; Yeşilhisar-Kuşçu, 15.09.2006, 1 ♂; **Kırşehir:** Kaman, 10.7.2007, 6 ♀♀; **Konya:** Beyşehir, Çukurgöl, 9.9.2006, 2 ♀♀; **Nevşehir:** Avanos-Saruhan, 6.6.2007, 1 ♀, 3 ♂♂; Ürgüp-Üzengi, 13.9.2006, 1 ♀; Çiftlik, 18.07.2007, 1 ♀; Sultanpınarı, 18.7.2007, 3 ♀♀, 1 ♂; **Sivas:** Gürün-Gökpinar, 13.7.2007, 3 ♂♂; Gürün-İncesu, 13.7.2007, 4 ♀♀; Hafik-Durulmuş, 31.5.2007, 1 ♀; Koyulhisar, 1.7.2004, 1 ♀; **Sivas:** Sincan, 31.05.2007, 1 ♀; **Sivas:** Yıldızeli-31.08.2008, 3 ♀♀; **Sivas:** Yıldızeli-Ekecek, 30.05.2007, 1 ♀.

General distribution: Palaearctic

**Blacus (Ganychorus) tripudians* Haliday, 1835

Material examined: Eskişehir: Kaymaz, 10.07.2007, 1♀; Nevşehir: Avanos-Saruhan, 6.6.2007, 1♀; Gülşehir-Gümüşkent, 07.06.2007, 1♀; Ürgüp, 13.09.2006, 4♀♀; Ürgüp-Üzengi, 13.09.2006, 20 ♀♀.

General distribution: Palaearctic

CONCLUSIONS

In this study, 6 species of the genus *Blacus* were reported from Central Anatolia Region of Turkey. All species are new records for the area. *Blacus (Ganychorus) ruficornis* is the most common species in the study areas in all provinces where the study was conducted in the Central Anatolia Region of Turkey. The largest number of specimens (118 females and 12 males) belongs to *Blacus (Ganychorus) ruficornis*. The highest species diversity was found in Eskişehir.

Blacinae species are endoparasitoids of plant pests, especially Coleoptera species, and therefore these insects are important in the natural regulation of pests in agricultural and forest areas. Therefore, determining species diversity, habitats and host complexes is of great importance to understand and protect the populations of the beneficial insects in nature. It was concluded that the detection of Blacinae species will contribute to the fauna of Turkey.

ACKNOWLEDGMENTS

Thanks are due to the Scientific Research Fund of Trakya University (TÜBAP-740) for financial support.

REFERENCES

- Çetin Erdogan, O. A., Beyarslan. 2005. Contributions to the Blacinae of Turkey. Entomofauna 26: 1–8.
- Çetin Erdogan, O. 2010. Further addition to the Blacinae (Hymenoptera: Braconidae) of Turkey and Coleoptera species as hosts. Egyptian Journal of Biological Pest Control, 20: 105–109.
- Güçlü, C. 2011. A contribution to the knowledge of Blacinae (Hymenoptera: Braconidae) from Turkey. Sci Res Essays 6: 575–579
- van Achterberg, C. 1976. A revision of the Tribus Blacini (Hym., Braconidae, Helconinae). Tijdschrift voor entomologie 118: 159-322.
- van Achterberg, C. 1988. Revision of the subfamily Blacinae Foerster (Hymenoptera, Braconidae). Zoologische Verhandlungen 249: 324 pp
- Yu, D.S., C., van Achterberg, K. Horstmann. 2016. Home of Ichneumonoidea. Ottawa, Canada. Available online at www.taxapad.com.

A REVIEW OF AGATHIDINAE PARASITOIDS ASSOCIATED WITH LEPIDOPTERA (HYMENOPTERA: BRACONIDAE) IN TURKEY WITH A SUMMARY OF HOST BUTTERFLY FAMILIES AND THEIR HOST PLANTS

Özlem ÇETİN ERDOĞAN¹

¹ Trakya University, Science Faculty, Biology Department, Edirne, Turkey

Corresponding author e-mail: ozlemerdogan@trakya.edu.tr

ABSTRACT

This study presents available data in Turkey about the members of the subfamily Agathidinae (Braconidae: Hymenoptera) determined as natural enemies of Lepidoptera in the country, the related Lepidoptera species and the host plants the butterflies damage. A total published literature search revealed of 19 Lepidoptera families as hosts of Agathidinae species found in Turkey (Arctiidae, Blastobasidae, Elachistidae, Coleophoridae, Depressariidae, Epermeniidae, Gelechiidae, Geometridae, Gracillariidae, Heliodinidae, Momphidae, Noctuidae, Psychidae, Pterophoridae, Pyralidae, Sesiidae, Tineidae, Tortricidae, Yponomeutidae). Among the families, Tortricidae is the most diverse one with 35% number of host species. The survey also revealed that the determined butterfly species belonged to 87 genera. Among these genera, *Coleophora* was represented with 31 species, *Cydia* with 10 species while the other genera were represented with 4 or less species. There are a total of 7 genus and 41 Agathidinae species in Turkey. The investigation of faunal, taxonomic, plant protection or plant-host-parasitoid based studies showed that 24 Agathidinae species recorded in Turkey as parasitoids of Lepidoptera. Among these, *Agathis* was represented with 13 species, *Therophilus* with 7 species while the *Bassus*, *Camptothlips*, *Cremonops* and *Earinus* were represented with 1 species. There is no Lepidoptera host record of the known species from Turkey belonging to the genus *Disophrys*. It has been revealed that the number of plant families hosted by butterfly species, whose parasitoid is Agathidinae, is 12. Compositae is the most common preferred family followed by Fabaceae, Lamiaceae, Juncaceae and Amaranthaceae. Determination of butterflies with their hosts, parasitoids and habitats and revealing data about their ecology and biology is concluded to be helpful to contribute required data in natural and agricultural ecosystems.

Keywords: Parasitoid, Turkey, Agathidinae, host butterflies, host plants

INTRODUCTION

Agathidinae Haliday, 1833 is one of the largest subfamilies of the Braconidae, containing 1,213 described valid species worldwide (Yu et al. 2016).

Agathidinae are koinobiont endoparasitoids of larval Lepidoptera. Most host larvae are leaf rollers, or stem borers, though about 20% of the hosts are free living foragers that are often crepuscular or nocturnal (Sharkey, 1996).

Many members of the Agathidinae are important in the natural control of pest species of Lepidoptera (Sharkey, 1996).

Based on their economic importance in biological control of pest butterflies, extensive studies have been performed on their systematic and trophic associations (Telenga, 1955; Tobias, 1986, Sharkey, 1996, Balevski, 1999; Simbolotti and van Achterberg, 1999, Ohshima et al., 2015 etc.)

The early evidences on fauna of Agathidinae in Turkey have been summarized in Zettel and Beyarslan (1992) which includes 21 species belonging to 5 genera. Since then, many other attempts have been done on systematics of the agathidin parasitoids in different parts of Turkey Çetin Erdoğan (2005, 2010, 2013, 2014, 2018), Çetin Erdoğan and Beyarslan (2001, 2004, 2006, 2009, 2016), Çetin Erdoğan et al. (2009) and Güçlü and Özbek (2002).

In addition, many studies have also directly contributed to biology of the important butterfly parasitoid species in Turkey (Güçlü and Özbek 2007, Özsemerci et al. 2016, Turanlı, 2017, Avcı, 2000, Efe, 2022, Öztemiz, 2012). Turkey, as the Anatolian biogeographic region is

the westernmost part of the Irano-Turanian phytogeographical region and western Asian elements constitute a major proportion of its species diversity. However, elements from the Mediterranean, Euro-Siberia (including the Black Sea) and North Africa are also present where topographical and climatic conditions provide suitable habitats. This leads to the establishment of many different habitats which pest butterflies and their parasitoids (European Environment Agency, 2002)

The faunistic research on Agathidinae, jointed with the data on their trophic associations, is an important background for the subsequent ecological and biological studies. Here we present the review of all Agathidinae species that have been recorded from Turkey from 1957 to 2013, as well as their host butterfly associations and distribution.

With this evaluation, it is aimed to summarize the Agathidinae (Hymenoptera: Braconidae) species registered in Turkey, to contribute to the Turkish Braconidae fauna and to list Agathidinae species that may be effective in the biological control of harmful butterflies and to obtain data that will form the basis for biological control studies.

MATERIAL AND METHOD

The major part of the data has been extracted from literatures which refer to taxonomy, faunal diversity and biology of Agathidinae parasitoids in various provinces of Turkey (Çetin and Beyarslan (2001), Çetin Erdoğan (2005, 2010, 2013, 2014, 2018), Çetin Erdoğan and Beyarslan (2004, 2006, 2009, 2016), Çetin Erdoğan et al. (2009), and Güçlü and Özbek (2002). Agathidinae and Lepidoptera nomenclature follows Yu et al. (2016). For each parasitoid species, general distribution in the world the data on the recorded host butterflies and the host plants the butterflies damage are presented. The species names are presented alphabetically, both for parasitoids and their host butterflies.

RESULTS

Agathidinae

Agathis anglica Marshall, 1885

Turkey distribution of reared parasitoid: Adana, Afyon, Amasya, Antakya, Artvin, Bartın, Bayburt, Bolu, Bursa, Çankırı, Edirne, Ege Bölgesi, Elazığ, Erzincan, Erzurum, Gaziantep, Gümüşhane, Hakkari, İçel, Isparta, Kahramanmaraş, Karaman, Kayseri, Kırklareli, Konya, Malatya, Nevşehir, Niğde, Ordu, Rize, Şanlıurfa, Samsun, Sivas, Tokat, Yozgat, Zonguldak

HOST:

Depressariidae: *Agonopterix nervosa*; *Agonopterix pallarella*;

Gelechiidae: *Aproaerema anthyllidella*; *Nothris verbascella*; *Pexicopia malvella*; *Syncopacma taeniolella*; *Teleiodes saltuum*

Coleophoridae: *Coleophora adjunctella*; *Coleophora albitarsella*; *Coleophora argentula*; *Coleophora discordella*; *Coleophora laricella*; *Coleophora lusciniapennella*;

Tortricidae: *Epinotia mercuriana*

Pyralidae: *Loxostege sticticalis*; *Pyrausta aurata*

HOST FOOD:

Asteraceae: *Achillea collina*; *Centaurea scabiosa*

Fabaceae: *Anthyllis vulneraria*; *Lotus corniculatus*

Juncaceae: *Juncus compressus*

***Agathis assimilis* Kokujev, 1895**

Turkey distribution of reared parasitoid: Kırklareli

HOST:

Coleophoridae: *Coleophora astragalella*

HOST FOOD: ----

***Agathis breviseta* Nees, 1812**

Turkey distribution of reared parasitoid: Edirne, Rize, Balıkesir, Erzurum

HOST:

Tortricidae: *Aethes rutilana*; *Spilonota ocellana*; *Stictea mygindiana*

Depressariidae: *Agonopterix kaekeritziana*

Gelechiidae: *Chrysoesthia hermannella*; *Monochroa cytisella*; *Monochroa striatella*

Coleophoridae: *Coleophora albitarsella*; *Coleophora conyzae*; *Coleophora follicularis*;
Coleophora inulae; *Coleophora lutipennella*; *Coleophora trochilella*

Pyralidae: *Pyrausta purpuralis*

HOST FOOD:

Betulaceae: *Carpinus betulus*

***Agathis fuscipennis* (Zetterstedt, 1838)**

Turkey distribution of reared parasitoid: Gümüşhane, İçel, Kırklareli, Erzurum, Tekirdağ, Bilecik, Bursa, Kırklareli, Ege Bölgesi, Afyon, Bozcaada, Kütahya, Amasya, Bolu, Çankırı, Ordu, Kayseri

HOST:

Gelechiidae: *Aproaerema anthyllidella*; *Caryocolum saginella*; *Chrysoesthia hermannella*;
Chrysoesthia sexguttella; *Scrobipalpa atriplicella*; *Scrobipalpa gallicella*; *Scrobipalpa ocellatella*; *Scrobipalpula absoluta*; *Thiotricha subocellea*

Coleophoridae: *Coleophora albicostella*; *Coleophora albitarsella*; *Coleophora artemisiae*;
Coleophora artemisicolella; *Coleophora chamaedriella*; *Coleophora conspicuella*;
Coleophora conyzae; *Coleophora cracella*; *Coleophora dianthi*; *Coleophora follicularis*;
Coleophora granulata; *Coleophora inulae*; *Coleophora laripennella*; *Coleophora linosyridella*;
Coleophora meridonella; *Coleophora salicorniae*; *Coleophora salinella*.

Heliodinidae: *Heliodines roesella*

Epermeniidae: *Ochromolopis ictella*;

Tortricidae: *Olethreutes arbutella*; *Spilonota ocellana*;

HOST FOOD:

Fabaceae: *Anthyllis* sp.

Asteraceae: *Aster linosyris*; *Pulicaria dysenterica*

Amaranthaceae: *Chenopodium album*

Fabaceae: *Medicago sativa*

Lamiaceae: *Origanum vulgare*

Solanaceae: *Solanum nigrum*

***Agathis griseifrons* Thomson, 1895**

Turkey distribution of reared parasitoid: Rize

HOST:

Pyralidae: *Pyrausta aurata*

***Agathis lugubris* (Förster,1863)**

Turkey distribution of reared parasitoid: Antalya, Bursa, Ege, Bozcaada, Erzurum, Kütahya, Bolu, Çankırı, Kastamonu, Ordu, Zonguldak, Eskişehir, Kayseri, Niğde, Sivas, Yozgat

HOST:

Coleophoridae: *Coleophora alticolella*; *Coleophora glaucicolella*

HOST FOOD

Juncaceae: *Juncus inflexus*

***Agathis malvacearum* Latreille, 1805**

Turkey distribution of reared parasitoid: Mersin, Adıyaman, Edirne, Ege Bölgesi, Kırklareli, Amasya, Samsun, Ordu, Tokat, Bolu, Zonguldak, Elazığ, Tunceli, Malatya, Ankara, Konya, Niğde, Sivas, Yozgat.

HOST:

Coleophoridae: *Coleophora galbulipennella*; *Coleophora graminicolella*

Pterophoridae: *Hellinsia didactylites*

Gelechiidae: *Metzneria aestivella*; *Metzneria lappella*; *Pexicopia malvella*;

Tortricidae: *Rhyacionia resinella*

HOST FOOD:

Asteraceae: *Arctium minus*

***Agathis montana* Shestakov, 1932**

Turkey distribution of reared parasitoid: Isparta, Ege Bölgesi, Erzurum, Amasya

HOST:

Tortricidae: *Pandemis cerasana*

Pyralidae: *Pyrausta aurata*

***Agathis nigra* Nees, 1812**

Turkey distribution of reared parasitoid: Edirne, Isparta, Antakya, Silifke, İçel, Elazığ, Edirne, Kırklareli, Ege Bölgesi, Erzurum, Tekirdağ, Aksaray, Tokat, Sinop, Zonguldak, Aksaray

HOST:

Tortricidae: *Acleris quercinana*

Gelechiidae: *Apodia bifractella*; *Isophrictis striatella*; *Metzneria lappella*
Metzneria metzneriella; *Monochroa striatella*

Coleophoridae: *Coleophora argentula*; *Coleophora laripennella*; *Coleophora meridionella*;
Coleophora vestianella

Tortricidae: *Eupoecilia roseana*; *Ptycholoma lecheana*

Pyralidae: *Ortholepis betulae*; *Phlyctaenia coronata*; *Pyrausta aurata*

Gelechiidae: *Scrobipalpa atriplicella*

HOST FOOD:

Asteraceae: *Tanacetum vulgare*

Oleaceae: *Ligustrum vulgare*

***Agathis rufipalpis* Nees, 1812**

Turkey distribution of reared parasitoid: Edirne, Kırklareli, Isparta, Burdur, Antalya, Antakya, Erzurum, Kırklareli, Edirne, Bilecik, Bursa, Ege Bölgesi, Bozcaada, Isparta, Amasya, Tokat, Bolu, Çankırı, Elazığ, Malatya, Artvin

HOST:

Depressariidae: *Agonopterix kaekeritziana*

Gelechiidae: *Chrysoesthia hermannella*

Coleophoridae: *Coleophora alcyonipennella*

Pyralidae: *Pyrausta aurata*

HOST FOOD:

Fabaceae: *Trifolium repens*

Lamiaceae: *Mentha aquatica*

***Agathis tibialis* Nees, 1812**

Turkey distribution of reared parasitoid: Bolu, Kayseri

HOST:

Gelechiidae: *Apodia bifractella*; *Ptocheuusa paupella*;

Coleophoridae: *Coleophora astragalella*; *Coleophora cracella*; *Metzneria lappella*;

HOST FOOD:

Asteraceae: *Inula spiraeifolia*; *Pulicaria dysenterica*

***Agathis umbellatarum* Nees, 1812**

Turkey distribution of reared parasitoid: Ankara, Niğde, İstanbul, Edirne, İçel, Kahramanmaraş, Antakya, Erzurum, Kırklareli, Bursa, Ege Bölgesi, Bozcaada, Gökçeada, Artvin, Sivas, Amasya, Tokat, Aksaray, Ankara, Çankırı, Kayseri Nevşehir, Niğde, Sivas, Yozgat

HOST:

Depressariidae: *Depressaria* sp.

Gelechiidae: *Metzneria*; *Metzneria aestivella*; *Metzneria lappella*

HOST FOOD:

Apiaceae: *Pimpinella anisum*

***Agathis varipes* Thomson, 1895**

Turkey distribution of reared parasitoid: Isparta, Ege Bölgesi, Samsun, Bolu, Tokat, Sivas

HOST:

Gelechiidae: *Apodia bifractella*; *Metzneria lappella*

Pyralidae: *Myelois cirrigerella*

HOST FOOD:

Asteraceae: *Arctium lappa*; *Arctium majus*; *Pulicaria dysenterica*

***Bassus calculator* (Fabricius,1798)**

Turkey distribution of reared parasitoid: Bartın

HOST:

Tineidae: *Archinemapogon yildizae*; *Morophaga choragella*; *Scardia boletella*; *Triaxomera parasitella*

HOST FOOD: *Ganoderma applanatum*; *Trametes gibbosa*

***Camptothlipsis armeniaca* (Telenga,1955)**

Turkey distribution of reared parasitoid: Ankara, Kırklareli

HOST:

Gelechiidae: *Anarsia eleagnella*; *Anarsia lineatella*; *Recurvaria leucatella*; *Recurvaria nanella*

Tortricidae: *Cydia funebrana*

***Cremnops desertor* (Linnaeus,1758)**

Turkey distribution of reared parasitoid: Artvin

HOST:

Pyralidae: *Anania hortulata*; *Ostrinia nubilalis*; *Palpita machaeralis*

Psychidae: *Carchesiopsyche muscella*

Tortricidae: *Cydia pomonella*

Noctuidae: *Euxoa triaena*

Sesiidae: *Synanthedon spheciformis*

HOST FOOD:

Lamiaceae: *Tectona grandis*

***Earinus elator* (Fabricius,1804)**

Turkey distribution of reared parasitoid: Erzurum

HOST:

Noctuidae: *Acontia lucida*; *Agrochola circellaris*; *Agrochola lota*; *Atethmia ambusta*; *Atethmia centrago*; *Conistra vaccinii*; *Dichonia convergens*; *Lithophane ornitopus*; *Orthosia stabilis*

Geometridae: *Alsophila aescularia*

Gracillariidae: *Gracillaria syringella*

Geometridae: *Lycia hirtaria*

HOST FOOD:

Salicaceae: *Salix caprea*

***Therophilus cingulipes* (Nees,1812)**

Turkey distribution of reared parasitoid: Bolu

HOST:

Tortricidae: *Aethes francillana*; *Cydia laricana*; *Exapate duratella*; *Phalonidia curvistrigana*; *Spilonota laricana*; *Spilonota ocellana*; *Tortrix viridana*; *Zeiraphera griseana*

Gelechiidae: *Approaerema anthyllidella*; *Caryocolum fraternella*; *Metzneria aestivella*; *Teleiodes saltuum*

Coleophoridae: *Coleophora follicularis*; *Coleophora frischella*

Geometridae: *Eupithecia intricata*

HOST FOOD:

Pinaceae: *Abies grandis*; *Larix decidua*; *Pinus*;

Rosaceae: *Malus domestica*

***Therophilus conspicuus* (Wesmael,1837)**

Turkey distribution of reared parasitoid: Bolu, Uşak

HOST:

Tortricidae: *Cydia pomonella*; *Grapholita molesta*; *Gypsonoma nitidulana*; *Pammene regiana*; *Phalonidia manniana*; *Rhopobota ustomaculana*

Pyralidae: *Scoparia crataegella*;

HOST FOOD:

Rosaceae: *Malus domestica*;

***Therophilus dimidiator* (Nees,1834)**

Turkey distribution of reared parasitoid: Samsun, Erzurum

HOST:

Tortricidae: *Acleris forsskaleana*; *Acleris variana*; *Aleimma loeflingiana*; *Archips cerasivorana*; *Archips crataegana*; *Archips rosana*; *Archips xylosteana*; *Argyrotaenia velutinana*; *Choristoneura rosaceana*; *Croesia bergmanniana*; *Cydia latiferreana*; *Epiblema scutulana*; *Epinotia tetraquetra*; *Grapholita interstinctana*; *Grapholita molesta*; *Hedya nubiferana*; *Pandemis cerasana*; *Pandemis heparana*; *Spilonota ocellana*; *Tortrix viridana*

Elachistidae: *Blastodacna atra*

Coleophoridae: *Coleophora spinella*

Gelechiidae: *Recurvaria leucatella*; *Recurvaria nanella*

Yponomeutidae: *Yponomeuta malinella*

HOST FOOD:

Rosaceae: *Malus domestica*; *Malus sylvestris*; *Pyrus communis*

Fagaceae: *Quercus trojana*

***Therophilus linguarius* (Nees,1812)**

Turkey distribution of reared parasitoid: Kayseri, Bilecik

HOST:

Coleophoridae: *Coleophora sp.*

***Therophilus nugax* (Reinhard,1867)**

Turkey distribution of reared parasitoid: Gökçeada

HOST:

Tortricidae: *Eupoecilia roseana*

***Therophilus rugulosus* (Nees,1834)**

Turkey distribution of reared parasitoid: Van

HOST:

Blastobasidae: *Blastobasis lignea*

Coleophoridae: *Coleophora meridionella*

Tineidae: *Nemapogon cloacella*; *Nemaxera betulinella*; *Triaxomera parasitella*

Gelechiidae: *Recurvaria nanella*

HOST FOOD: *Bjerkandera adusta*; *Schizopora paradoxa*; *Stereum hirsutum*; *Stereum rugosum*

***Therophilus tumidulus* (Nees,1812)**

Turkey distribution of reared parasitoid: Konya, Sivas

HOST:

Depressariidae: *Agonopterix atomella*

Tortricidae: *Cydia compositella*; *Cydia delineana*; *Cydia pallifrontana*; *Cydia splendana*; *Cydia tenebrosana*; *Dichrorampha acuminatana*; *Epiblema cirsiana*; *Epiblema scutulana*; *Gypsonoma aceriana*; *Gypsonoma minutana*; *Lathronympha strigana*; *Lobesia botrana*; *Lobesia euphorbianus*; *Rhopobota ustomaculana*; *Sparganothis pilleriana*

Momphidae: *Mompha epilobiella*

Gelechiidae: *Ptocheuusa inopella*

Arctiidae: *Utetheisa jacobaeae*;

HOST FOOD:

Asteraceae: *Chrysanthemum leucanthemum*

Salicaceae: *Populus alba*; *Populus tremula*; *Populus canadensis*

Table 1. Number of species of Agathidinae subfamily according to genera in Turkey.

GENUS	Number of species
<i>Agathis</i>	25
<i>Bassus</i>	2
<i>Camptothlipsis</i>	1
<i>Cretnops</i>	1
<i>Disophrys</i>	1
<i>Earinus</i>	1
<i>Therophilus</i>	10

When the species known as Lepidoptera parasitoids are examined according to genus; *Agathis* 13, *Therophilus* with 7 species *Bassus*, *Camptothlips*, *Cretnops* and *Earinus* were represented by 1 species. There is no Lepidoptera host record of the known species from Turkey belonging to the genus *Disophrys*.

Table 2. Number of species of Agathidinae genus found in Turkey that use the Lepidoptera order as hosts.

GENUS	Number of species of Agathidinae genus found in Turkey that use the Lepidoptera order as hosts
<i>Agathis</i>	13
<i>Bassus</i>	1
<i>Camptothlipsis</i>	1
<i>Cretnops</i>	1
<i>Disophrys</i>	-
<i>Earinus</i>	1
<i>Therophilus</i>	7

CONCLUSIONS

The investigation of faunal, taxonomic, plant protection or plant-host-parasitoid based studies showed that 7 genus and 41 Agathidinae species recorded in Turkey (Table 1). Among them, 24 Agathidinae species were recorded as Lepidoptera parasitoids. A total published literature search revealed of 19 Lepidoptera families as hosts of Agathidinae species found in Turkey. Among the

families, Tortricidae is the most diverse one with 35% number of host species. The survey also revealed that the determined butterfly species belonged to 87 genera. Among these genera, *Coleophora* was represented with 31 species, *Cydia* with 10 species while the other genera were represented with 4 or less species.

When the species known as Lepidoptera parasitoids are examined according to genus; *Agathis* 13, *Therophilus* with 7 species *Bassus*, *Camptothrips*, *Cremnops* and *Earinus* were represented by 1 species. There is no Lepidoptera host record of the known species from Turkey belonging to the genus *Disophrys* (Table 2)

In the study, it has been revealed that the number of plant families hosted by butterfly species, whose parasitoid is Agathidinae, is 12. The number of plant families determined to be harmful to butterflies used by agathidine species distributed in Turkey is 12 (Juncaceae, Rosaceae, Lamiaceae, Fabaceae, Asteraceae, Apiaceae, Amaranthaceae, Solanaceae, Oleaceae, Fagaceae, Salicaceae, Pinaceae, Betulaceae) Among these families, the families most preferred by butterflies were Compositae, Fabaceae, Lamiaceae, Juncaceae and Amaranthaceae, respectively.

Determination of butterflies with their hosts, parasitoids and habitats and revealing data about their ecology and biology is concluded to be helpful to contribute required data in natural and agricultural ecosystems.

REFERENCES

- Avcı M. 2000. Türkiye’de Yeni Bir Sedir Zararlısı *Dichelia cedricola* (Diakonoff) 1974 (Lep.: Tortricidae)’nın Biyolojisi, Zararı ve Doğal Düşmanları. Türkiye IV. Entomoloji Kongresi, Aydın, Türkiye. 447-454.
- Balevski, N. A., 1999. Catalogue of the Braconid Parasitoids (Hym.; Braconidae) Isolated From Various Phytophagous Insect Hosts in Bulgaria. Pensoft Publishers, Sofia, 126 pp.
- Çetin Ö, Beyarslan A. 2001. The Agathidinae (Hymenoptera: Braconidae) fauna of the Marmara Region. *Turkish Journal of Zoology*, 25 (3): 257-268.
- Çetin Erdoğan Ö, Beyarslan A. 2016. Faunistic survey on the Agathidinae (Hymenoptera: Braconidae) in the Central Anatolia Region with a new record for the Turkish fauna: *Bassus tegularis* (Thomson, 1895). *Turk. J. Zool.* 40 (3): 448-453.
- Çetin Erdoğan Ö. 2014. A contribution on the subfamily Agathidinae (Hymenoptera: Braconidae) in Diyarbakır, Mardin, and Şanlıurfa provinces of Turkey. *Turk. J. Zool.* 38 (1): 102-103.
- Çetin Erdoğan Ö. 2013. Contributions to the knowledge of Agathidinae fauna of the Eastern Anatolia Region of Turkey. *Turk. J. Zool.* 37(2): 195-199.
- Çetin Erdoğan Ö. 2010. A new species, *Agathis berkei* sp. n., from Eastern Anatolia, Turkey (Hymenoptera, Braconidae, Agathidinae). *Turk. J. Zool.* 34 (2): 177-180.
- Çetin Erdoğan Ö, Beyarslan A. 2009. Doğu Karadeniz Bölgesi Agathidinae Haliday, 1833 (Braconidae: Hymenoptera) türleri üzerine bir araştırma. *Türk Entomol. Derg.* 33(1): 73-80.
- Çetin Erdoğan Ö, van Achterberg C, Beyarslan A. 2009. On the Zoogeographical Distribution of the Genus *Agathis* Latreille, 1804 (Hymenoptera: Braconidae: Agathidinae) in Turkey. *J Entomol Res Soc.* 11 (1): 17-25
- Çetin Erdoğan Ö, Beyarslan A. 2006. New records of endoparasitoid *Bassus* Fabricius, 1804 (Hymenoptera: Braconidae: Agathidinae) Species from Turkey. *Phytoparasitica* 34(4): 353-356.
- Çetin Erdoğan Ö. 2005. *Bassus beyarslani* sp.n. (Hymenoptera, Braconidae, Agathidinae) from Turkey. *Biologia* 60 (2):129-132.
- Çetin Erdoğan Ö, Beyarslan A. 2004. First record of *Agathis Tobias* from Turkey (Hymenoptera: Braconidae: Agathidinae). *Acta Entomol. Serbica* 12 (2): 75-76.
- Çetin Erdoğan Ö, Beyarslan A. 2001. The Agathidinae (Hymenoptera: Braconidae) Fauna of the Marmara Region. *Doga Tr. J. Zoology* 25 (3): 257-268.

- Efe R. 2022. Coragen®'In *Archips rosana* (Linnaeus, 1758) (Lepidoptera: Tortricidae) Üzerine Toksik Etkileri Yüksek Lisans Tezi
- European Environment Agency 2002. Europe's biodiversity — biogeographical regions and seas Biogeographical regions in Europe The Anatolian region, 1-16. https://www.eea.europa.eu/publications/report_2002_0524_154909
- Güçlü C, Özbek H. 2007. *Agathis montana* Shestakov (Hymenoptera: Braconidae), a new parasitoid of *Pandemis cerasana* Hübner (Lepidoptera: Tortricidae) in Turkey. *Entomological News* 118(5): 534.
- Ohshima I, Watanabe K, Kawamura T. 2015. Distinct parasitoid communities associated with host races of the leaf-mining moth *Acrocercops transecta* on distantly related host plants (Juglandaceae and Ericaceae), *J. Nat. Hist.*, 49(13-14):815-828.
- Ozsemerci F, Altindisli FO, Koclu T, Karsavuran Y. 2016. Manisa ve İzmir ili Bağ Alanlarında Salkım güvesi (*Lobesia botrana* Den. Schiff. (Lepidoptera:Tortricidae)'nin Larva Parazitleri ve Doğal Parazitlenme Oranları. Uluslararası katılımlı Türkiye VI. Bitki Koruma Kongresi 5-8 Eylül 2016, Konya Bildiri özetleri s:132.
- Öztemiz S. 2012 The tomato leafminer [*Tuta absoluta* Meyrick (Lepidoptera: Gelechiidae)] and it's biological control. *KSU J Nat Sci*, 15 (4): 47-57.
- Sharkey MJ (1996) The Agathidinae (Hymenoptera: Braconidae) of Japan. *Bull. of the Nat. Inst. of Agro-Env.Sci.* 13: 1-100.
- Simbolotti G, van Achterberg C. 1999. Revision of the West Palearctic species of the genus *Agathis* Latreille (Hymenoptera: Braconidae). *Zool. Verh. Leiden*, 325: 1-167.
- Telenga NA. 1955. Fauna of the U.S.S.R., Microgastrinae and Agathinae (Hymenoptera: Braconidae), Zoological Institute of the Academy of Sciences of the U.S.S.R., 5 (4): 217 - 283.
- Tobias VI. 1986. Gnaptodontinae, Braconinae, Telengainae, pp. 85–149. In: Medvedev G.S. (ed.), *Opredelitel' nasekomykh Evropejskoj chasti SSSR 3, Pereponchatokrylye 4, Opr. Faune SSSR, Nauka, Leningrad.*
- Turanlı F. 2017. Bağ Zararlıları ve Mücadeleleri. *Nevşehir Bilim ve Teknoloji Dergisi* Cilt 6n (Kapadokya Ulusal Bağcılık Çalıştayı Özel Sayı) 112-121.
- Yu DS, van Achterberg C, Horstmann K. 2016. Interactive Catalogue of World Ichneumonoidea Taxonomy, Biology, Morphology and Distribution, Compact Disc (Master Version), Taxapad.

CYTOLOGICAL EVALUATIONS AND A METHODOLOGICAL APPROACH TO OBSERVE APOPTOTIC EFFECT OF NiSO₄ ON *Allium cepa* L. ROOT GERMINATION BY USING EB/AO FLUORESCENCE STAINING

Fulya Dilek Gökalp^{*1}, Didar Güzey¹, Mihriban Abis¹, Özgür Mert¹

^{*1}Trakya University, Science Faculty, Biology Department, 22030 Edirne, TURKIYE

^{*}Corresponding author, e-mail: fulyadilek@trakya.edu.tr

ABSTRACT

Ethidium Bromide-Acridine Orange (EB/AO) is one of the fast, economical and valid methods that allows to separate living and dead cells in plant root tips. In the present study, it was aimed to investigate the apoptotic effect, nuclear abnormalities, cell division index by using *Allium cepa* test assay by using EB/AO staining and ImageJ program. NiSO₄ concentrations (1.75, 3.5, 7, 14 ppm) were exposed on root germination of *A. cepa* for 48 and 72 h for to observe mitotic abnormalities/cytotoxic effect and 5-day exposure for apoptotic effect. It was observed that amorphous nuclei, vacuolisation and C-mitosis were mostly observed abnormalities and were increased at 14 ppm NiSO₄ exposure after 48 and 72 hours. Total nuclear abnormalities were significantly increased at all concentration and exposure periods. ImageJ program was used to determine apoptosis rates. The data obtained showed that high concentrations of NiSO₄ caused significant cell death in root tips compared to control group resulted as root growth inhibition that apoptosis were increased with the increase of concentration and exposure period. NiSO₄ caused toxic activity on root growth determined as apoptosis especially at cortex and vascular region in root tips. The results of the study indicated that affected damaged/apoptotic areas on root tips were demonstrated by using EB/AO staining method, can be used as a marker of damaged tissue areas.

Key Words: Nickel, *Allium cepa*, apoptosis, nuclear abnormalities, ethidium bromide, acridine orange

INTRODUCTION

Acridine orange [3,6-bis(dimethyl) acridinium chloride hemi(zinc chloride salt)] (AO), Ethidium bromide [(3,8-diamino-5-ethyl-6-phenyl phenanthridinium bromide)] (EB) are used as fluorescent dyes and known as intercalating agents bind DNA and RNA between base pairs (LePecq and Paoletti, 1967; Bugs and Cornelio, 2001). EB and AO are used to differentiate dead and live cells both in plant and animal cells. AO can penetrate every cell even if it is alive or dead and emit green fluorescence, EB can penetrate only dead cells emits red fluorescence. At apoptosis stage the cell nuclear membrane permeability changes, EB penetrate the cell undergoing apoptosis fluoresces in colours ranging from yellow/orange to red. Although AO has penetrated the dead cells, the colour of EB suppresses the AO colour, making it distinguishable under fluorescence microscopy. The degree of fluorescence intensity can show live and dead cells, and the stage of apoptotic cells (Byczkowska et al., 2013). Another indicator that living, dead and necrotic cells are separated from each other is cell morphology. Condensation of chromatin material in the nucleus, fragmentation of nuclear DNA, shrinkage of cells and nucleus, cytoplasm vacuolization, cytoplasm fragmentation are morphological changes in apoptotic cells (Vanyushin et al., 2004). In apoptotic cells, the membrane integrity of the cell begins to deteriorate in the early stages of apoptosis, so EB can penetrate the cell membrane and be observed in fluorescence microscopy from its morphological characters and colour differences, in the early and/or late stages of

apoptosis. Necrotic cells, on the other hand, have normal cell morphology and emit an orange/red colour.

EB/AO dual staining is fast and useful method for to assess apoptotic effect of some chemicals on plant and animal cells. This method is used to investigate apoptotic effect of some plant extracts on cancer cell lines (Manosroi et al., 2015; Khursheed and Jain, 2021; Bozali et al., 2022) also effect of some chemicals on healthy tissues (L. Wang and Lu, 2007; AlKahtani et al., 2014). Although this staining has been used more frequently in animal cells, it is known that disintegration and chromatin condensation of apoptosis in plants are similar to animals (O'brien et al., 1998). Petriccione et al. (2013) have used EB/AO to distinguish apoptotic/necrotic cells in root cells of *A. cepa* (Petriccione et al., 2013). Kazmierczak (2008), Kazmierczak (2010) also studied cell atrophy on gametophytes by using EB/AO (Kazmierczak, 2008; Kazmierczak, 2010). Yassin et al (2019) also detected morphological and molecular evidence of apoptosis (Yassin et al., 2019), Kunikowska (2013) demonstrated kinetin-induced cell death on *Vicia faba* ssp. Minor seedlings by using EB/AO dual fluorescence staining method (Kunikowska et al., 2013).

Dual staining method is a preferred method in the evaluation of apoptotic effects in plants due to its cheapness and ease of application (Ciniglia et al., 2010). However, it can take time to examine the cells separately under the microscope. Vertical sections of root tips of plant tissue can provide information about the intensity of apoptosis and the detection of apoptotic regions. Apoptosis evaluations can also be made by preparing and examination of tissue sections. As a result of fluorescent staining, the amount of apoptosis can be determined quickly by using software that detects different wavelengths of live and dead cells in the tissue. It can also provide information about the size change of plant root tips.

Nickel accumulation in environment is increased as a result of industrial and agricultural drainage (Yan et al., 2018). Although Nickel is an essential element for plants on biological pathways (Eskew et al., 1983, Rahman et al., 2005) and functioning as a metalloenzyme, increased accumulation of Nickel in soil causes oxidative damage, DNA damage, production of reactive oxygen specieses and resulted as toxic effect on cells (Wang et al., 2012). It is shown that Ni disrupts DNA strands, crosslinks and DNA repair (Klaunig and Kamendulis, 2004; Valko et al., 2006). Also in previous studies it has been indicated that Ni leads impaired plant growth and development. The reason of this inhibition is due to metabolic downregulation (Murch et al., 2003), impaired cell division and elongation (Demchenko et al., 2005), nuclear abnormalities (Liu et al., 1995; Sresty and Rao, 1999). High concentrations of Ni leads to toxic effects; reduced root growth (Rahman et al., 2005), inhibition of germination (Aggarwal et al., 1990), mitotic root tip abnormalities (Mcilveen and Negusanti, 1994). It has been determined that nickel is effective on plant growth and metabolism, reduces growth, causes senescence, chlorosis in leaves and meristems, changes N metabolism, and decreases Fe intake (Ahmad and Ashraf, 2011).

In the present study, it was aimed to study apoptotic and cytogenetic effects of NiSO₄ on *A. cepa* roots at germination stage to investigate apoptotic areas, apoptosis ratio, mitotic abnormalities, mitotic inhibition by using EB/AO fluorescence staining and ImageJ program.

MATERIAL AND METHOD

Preliminary Study

The aim of the preliminary study is to determine the test concentrations of NiSO₄ to be used in the experiment. In the preliminary study, the growth inhibition of the *A. cepa* root meristematic tissue was determined after exposed with 5, 10, 20, 40 and 50 ppm NiSO₄ .6H₂O concentrations. Root lengths of germinated onions were measured after 5th, 6th and 7th days of exposure and the IC₅₀ concentrations were calculated according to the probit analysis. 5 day IC₅₀ concentration and its decreasing concentrations were used as test concentrations.

Treatment and analyse procedure for to estimate cell death

Clean and healthy bulbs of *Allium cepa* L. were chosen for the experiments and five bulbs were used in each of the exposure groups and control group. Before starting to the experiments dry scales of bulbs were removed and the roots were exposed with different concentrations of NiSO₄.6H₂O (1.75 ppm, 3.5 ppm, 7 ppm and 14 ppm) for 5 days. Control group was exposed with distilled water. Detection of cell death in the root tips of *A. cepa* seedlings induced by NiSO₄ was carried out according to the following procedure: Apical fragments of roots were cut off washed with 0.01 M phosphate buffer, pH 7.4(PBS); after roots were stained in EB/AO fluorescence staining mixture (containing 100 µgml⁻¹ acridine orange (AO) (Sigma Cas No:260-94-6) and 100 µgml⁻¹ Ethidium Bromide (EB) (Sigma Cas No:1239-45-8 in PHB) for 3 min, washed with PBS and fixed with 1.0% glutaraldehyde (Merck Cas No 111-30-8) in PBS for 15 min. After fixation the roots were cut along axis with a razor blade, after washing with PBS, the root tips immediately analysed using fluorescence microscopy with a blue filter (Byczkowska et al., 2013).

Analysis of apoptosis by using ImageJ program

At the root tips, green areas show viable cells and are stained with AO. Red areas show apoptotic cells and they are stained with EB. For to analyse apoptosis in root tips after exposure, fluorescent images were taken by using Fluorescence Olympus BX51 Microscope. Fluorescence intensity of root tip images were measured by ImageJ program. The fluorescence intensities of two different stains were determined in pixel size on equal size of selected root tip photograph images by using the program. Green and red areas were determined by the program and apoptotic cell percentages were calculated in percentage as; Apoptosis Index %=(a/b) *100 where a; is pixel size of dead cells in b and b; Pixel size of live and dead cells.

Use of ImageJ program is as follows:

- 1-In the menu of imageJ program open the image by using file and open tabs.
- 2-It is important to select all the images at the same regions. So, for to measure the scale, mark a line from the tip of the root to the elongation and maturation zones of the root. That was the length of area near vascular system of roots. This program will give us the length of selected line in pixels. In our study the distance in pixel is calculated as 578 pixels. And this number was used for further selections of the root tips while choosing the affected root tip areas as the dimensions varies among root tips. For this step use straight button, select the length of the root tip. Analyse > set scale remark the distance in pixels.
- 3-Use the Polygon selection button for to select root tip area. Delimit the edges of the area to be measured. Use the tab to clear outside. Use the image button to adjust colour threshold. In the threshold colour window select threshold colour red, colour space HSB and adjust brightness in red colour. Colour all the selected area in red colour by using brightness selection button to measure all the selected region in pixel form. Use select button before analyse and measure tabs.
- 4-Use threshold colour brightness to differentiate red and green areas which means apoptotic areas. In this study it is at 110 decrease on the bar. Tab the select button and analyse and measure. Take the measurement in pixel forms from window>Results. The first measurement will be the width of all the selected area of the root tip, the second measurement will be the width of apoptotic area.

The ratio of red coloured area to all the selected area has given us apoptotic ratio.

Treatment and analyse procedure for to observe cytogenetic abnormalities

1.75, 3.5, 7, 14 ppm concentrations of NiSO₄ were exposed on root germination of *Allium cepa* for 48 and 72 h for to observe mitotic abnormalities and cytotoxic effect. For the microscopic analyses root tips were hydrolysed with 1N HCl + 2% Aceto orcein (1:9) for 5 min followed by preparation of crushed material with Aceto orcein dying method. 5000 cells for each group were evaluated for cytogenetic abnormalities. Mitotic index (MI) was determined by examination of 3000 cells and mitotic stages of cells were determined for to calculate mitotic index.

Statistical Analyses

IC₅₀ concentration was determined with probit analysis using SPSS Statistics according to results of preliminary study. The analysis was performed by comparing the apoptotic values of control with exposure groups values using T-test. Cytogenetic abnormalities and Mitotic index analysis were performed using Fisher's exact X² test (P=0.05). Pearson correlation was used for dose response relations.

RESULTS

Apoptotic Effect Results

IC₅₀ concentration was determined with probit analysis of growth inhibition measurements obtained on the 5th day of exposure of NiSO₄ on *Allium cepa* root tip germination. Preliminary study results were given in Table 1. After 5-day exposure, IC₅₀ concentration was calculated as 13,99 ppm and decreasing concentrations of IC₅₀ value in multiples were determined as test concentrations.

Table 1: Growth inhibition ratios of *A. cepa* root tips after exposed with NiSO₄ concentrations between 0-50 ppm after 5, 6 and 7 days.

Concentration	Growth inhibition (%) 5 th day	Growth inhibition (%) 6 th day	Growth inhibition (%) 7 th day
Control (-)	100/0	100/0	100/0
5 ppm	21,87	42,25	44,65
10 ppm	45,98	48,67	61,83
20 ppm	59,81	57,11	72,08
40 ppm	69,77	76,4	80,97
50 ppm	83,93	83,33	92,07
IC ₅₀	IC ₅₀ =13,99	IC ₅₀ =9,46	IC ₅₀ =6,36

In the present study, the apoptotic effect was observed by EB/AO dual staining method, that the green areas are accepted as live cells are stained with acridine orange, the orange/red areas show the cells that have undergone apoptosis and are stained with EB in Figure 1. Although root cap and epidermal regions of *A. cepa* root tips were affected at lower concentrations of NiSO₄ exposure, meristematic region, vascular cylinder, pericycle, endodermis and cortex were more affected after 7 and 14 ppm NiSO₄ exposure (Figure 1-2).

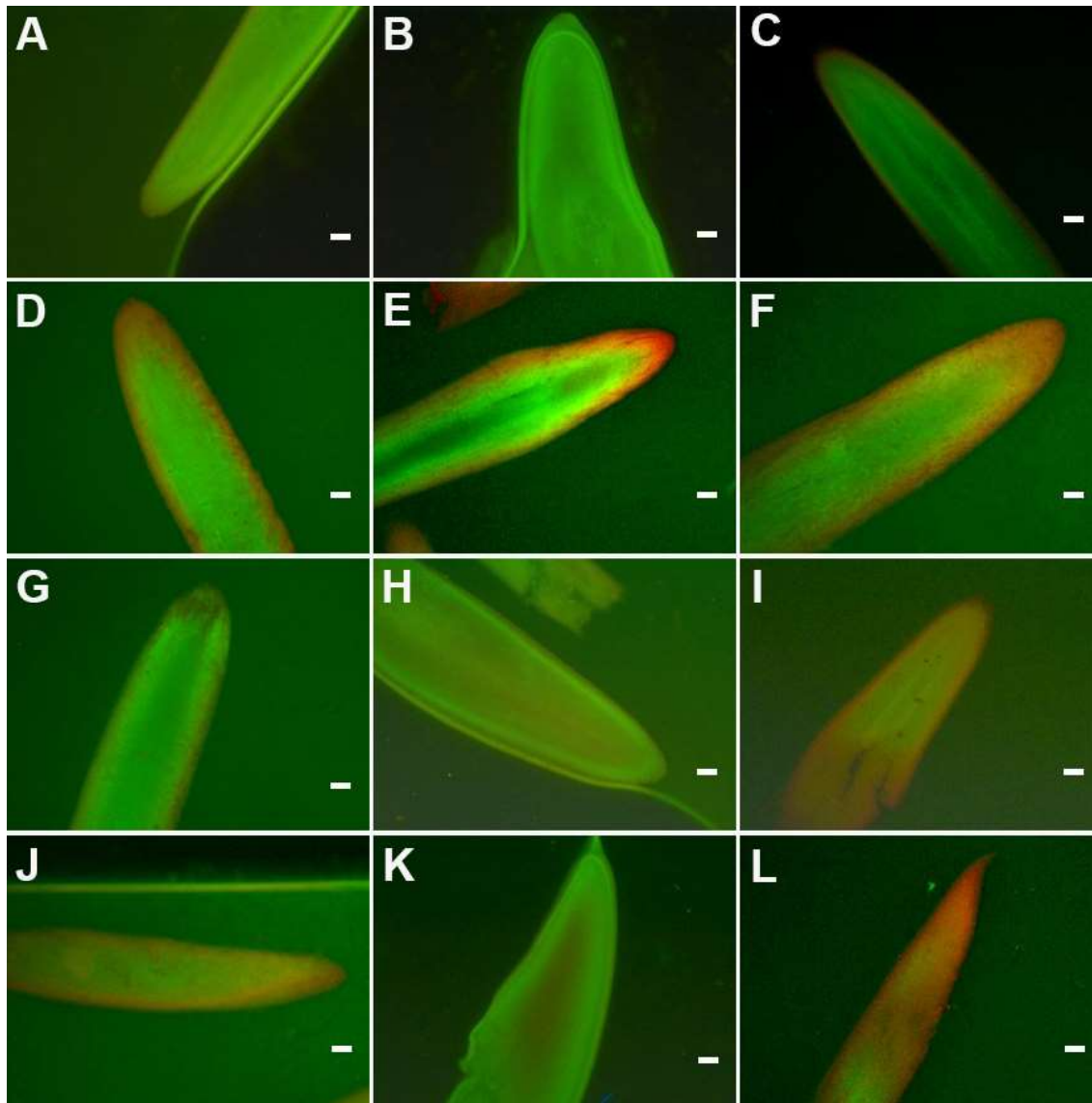

Figure 1. Fluorescence microscope images of *A. cepa* root tips at 5th day of root germination after exposed with different concentrations of NiSO_4 by using EB/AO staining method. Root tips show green and red colour with dual staining. Green coloured areas are the viable cells with normal cell morphology and orange-red coloured areas are the apoptotic cells. (A,B,C) control groups, (D,E,F) 3.5 ppm, (G,H,I) 7 ppm, (J,K,L) 14 ppm NiSO_4 exposure groups. Scale bar = 100 μm .

A. cepa root tips were germinated at 1.75, 3.5, 7, 14 ppm concentrations of NiSO_4 for 5 days. Apoptosis ratios were determined by using imageJ program by measuring fluorescence intensities. It was found out that all the tested concentrations induced apoptosis in root tips ($p \leq 0.001$) (Table 2). Significant cell death at root tips was observed at high concentrations of NiSO_4 compared to the control group, resulted as growth inhibition at plant root tips. It has been found that the apoptosis observed at the root tips increased as the exposure of NiSO_4 concentration increase (Pearson korelasyon ,867 * $P=0.028$) (Figure 3).

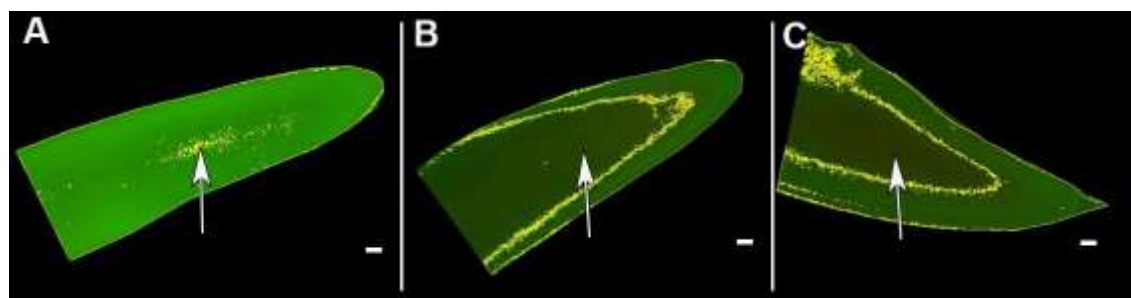

Figure 2. Viable and dead cell areas on the root tips were determined by ImageJ program distinguishes red and green colour areas and measured in pixel sizes. Apoptotic areas were near vascular system of roots in general. The calculation was done by calculating the ratio of apoptotic area to all the measured area. (A) Control group sample and (B,C) 7 and 14 ppm exposure groups. Arrow shows apoptotic regions. Scale bar = 100 μ m.

Table 2. Apoptosis frequency observed on the 5th day of *A. cepa* root tips germinated at different concentrations of NiSO₄ (***)P<0,001)

Concentration	Apoptosis Mean (%)±Std D.
Control (-)	15,86±5,1
1,75 ppm	***35,19±3,28
3,5 ppm	***43,39±9,55
7 ppm	***48,28±11,41
14 ppm	***56,68±3,11

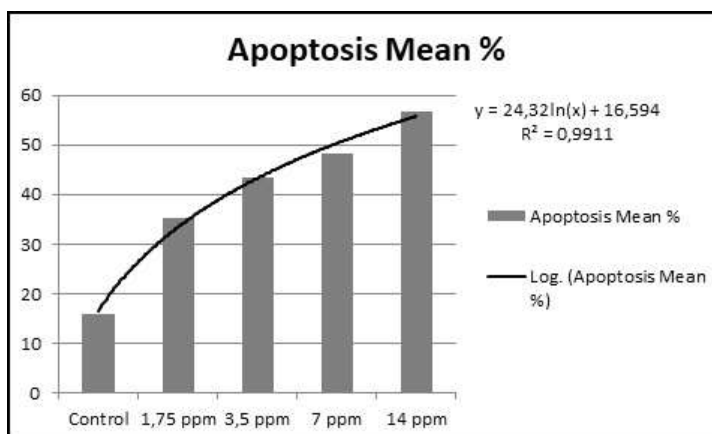

Figure 3. Apoptosis ratio was increased as the concentration increase. (Pearson correlation + ,867 *P=0.028)

The results of the present study showed that the increased concentration of NiSO₄ leads to significant cell death on the root tips compared to the control group and showed that low concentrations of NiSO₄ lead to growth inhibition.

Mitotic abnormalities and cytogenetic effect on meristematic tissue of *A. cepa* root tips were investigated after exposed with 1.75, 3.5, 7 ve 14 ppm NiSO₄ for 48 and 72 hours by using *A. cepa* test assay (Table 3). It was observed that amorphous nuclei, vacuolisation and C-mitosis were mostly observed abnormalities and were increased at 14 ppm NiSO₄ exposure after 48 and 72 hours (P<0.001) (Table 3). Total nuclear abnormalities were significantly increased at all concentration and exposure periods. On the other hand, the results showed that the abnormalities were less after 72 h exposure than 48 h exposure period. The results showed a positive correlation between Nuclear Abnormalities (NA) increase and concentration increase after 48 hours exposure (Pearson correlation +,921, P=0.026) (Figure 4).

Table 3. Mitotic abnormalities on meristematic tissue of *A. cepa* root tips after exposed with 1.75, 3.5, 7 ve 14 ppm NiSO₄ for 48 and 72 hours.

	TNA (%)±S.D.	C-Mitosis	Stickiness	Bridge	MDMA	Vagrant	Fragment	AN	Vacuole
48 h									
Control	0.12±0.02	0.02±0.01	0.02±0.01	0.0±0.0	0.08±0.031	0.0±0.0	0.0±0.0	0.0±0.0	0.0±0.0
1.75 ppm	^c 0.62±0.05	^c 0.14±0.06	^c 0.24±0.07	0.0±0.0	0.12±0.04	0.12±0.05	0.0±0.0	0.0±0.0	0.0±0.0
3.5 ppm	^c 1.18±0.14	^c 0.38±0.09	^c 0.3±0.1	0.02±0.01	^a 0.30±0.16	0.089±0.05	0.0±0.0	0.0±0.0	0.0±0.0
7 ppm	^c 1.42±0.08	^c 0.74±0.1	^a 0.16±0.07	0.02±0.01	0.176±0.09	^c 0.32±0.11	0.0±0.0	0.0±0.0	0.0±0.0
14 ppm	^c 1.86±0.19	^c 0.78±0.14	0.14±0.06	^c 0.4±0.22	^a 0.28±0.14	^c 0.26±0.1	0.0±0.0	^c 1.2±0.45	^c 1.8±0.7
72 h									
Control	0.22±0.025	0.06±0.022	0.04±0.02	0.0±0.0	0.12±0.05	0.0±0.0	0.0±0.0	0.0±0.0	0.0±0.0
1.75 ppm	^c 0.92±0.15	^b 0.26±0.12	^c 0.36±0.12	^c 0.06±0.02	0.176±0.1	0.0±0.0	^c 0.06±0.0	0.0±0.0	0.0±0.0
3.5 ppm	^c 0.6±0.01	^b 0.24±0.1	^b 0.2±0.08	^a 0.02±0.01	0.12±0.03	0.0±0.0	0.02±0.0	0.0±0.0	0.0±0.0
7 ppm	^c 0.54±0.05	^c 0.30±0.08	0.06±0.03	^a 0.02±0.01	0.12±0.06	0.02±0.01	0.0±0.0	0.0±0.0	0.0±0.0
14 ppm	^c 1.4±0.16	^c 0.88±0.07	0.14±0.05	^c 0.04±0.02	0.1±0.04	^c 0.18±0.08	0.0±0.0	^c 5±0.79	^c 2±0.41

TNA; Total nuclear abnormalities, MDMA; Multipolar and disoriented metaphase and anaphase, AN; Amorphous nuclei. Mean values with superscripted letters of values are significantly different (^aP<0.05; ^bP<0.01; ^cP<0.001) based on Fisher's exact X² test significant difference comparisons.

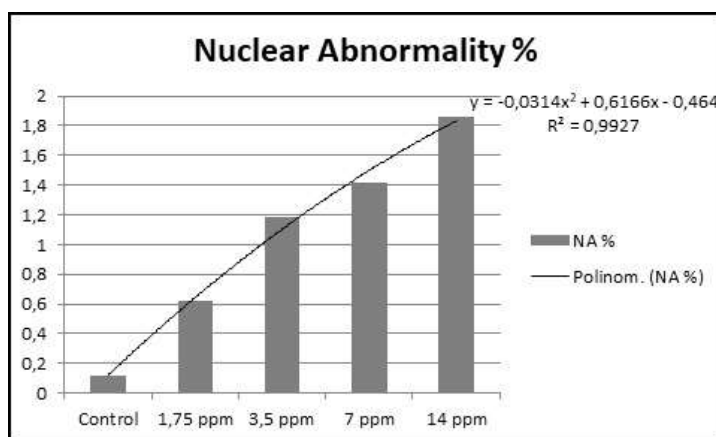

Figure 4. Positive correlation was found between concentration and nuclear abnormalities after 48 hours' exposure period. (Pearson correlation; +,921 *P=0,026)

Mitotic index and each of mitotic phases were investigated and found to decrease significantly at all the tested concentrations for 48 and 72 hours exposure periods (Table 4). There

was a negative correlation between mitotic index decrease and concentration increase after 72-hour exposure period (P=0.03) (Figure 5).

Table 4. Mitotic index inhibition and mitotic phases observed on meristematic tissue of *A.cepa* root tips after exposed with 1.75, 3.5, 7 ve 14 ppm NiSO₄ for 48 and 72 hours. (*P<0.05; **P<0.01; ***P<0.001)

Exp. period	Conc.	Mitotic Index (%)±S.D.	Prophase (%)±S.D.	Metaphase (%)±S.D.	Anaphase (%)±S.D.	Telophase (%)±S.D.
48 h	Control(-)	6.68±0.84	2.48±0.19	2.02±0.38	1.04±0.25	1.16±0.22
	1.75 ppm	4.02±0.79***	1.62±0.22***	0.96±0.16***	0.78±0.14***	0.66±0.18***
	3.5 ppm	3.82±0.62***	1.92±0.29**	0.94±0.158***	0.5±0.13***	0.46±0.22***
	7 ppm	2.87±0.63***	1.46±0.22***	0.66±0.08***	0.36±0.07***	0.4±0.16***
	14 ppm	2.9±0.74***	1.34±0.15***	0.75±0.15***	0.32±0.12***	0.56±0.45***
72 h	Control(-)	6.32±0.43	2.96±0.35	1.24±0.14	1.16±0.22	1,18±0.14
	1.75 ppm	3.84±0.26***	1.88±0.19***	0.82±0.07***	0.6±0.24***	0.54±0.14***
	3.5 ppm	3.4±0.57***	1.67±0.64***	0.86±0.12***	0.64±0.17***	0.34±0.08***
	7 ppm	2.58±0.45***	1.32±0.16***	0.56±0.12***	0.3±0.079***	0.4±0.16***
	14 ppm	0.98±0.35***	0.62±0.22***	0.08±0.02***	0.1±0.03***	0.18±0.09***

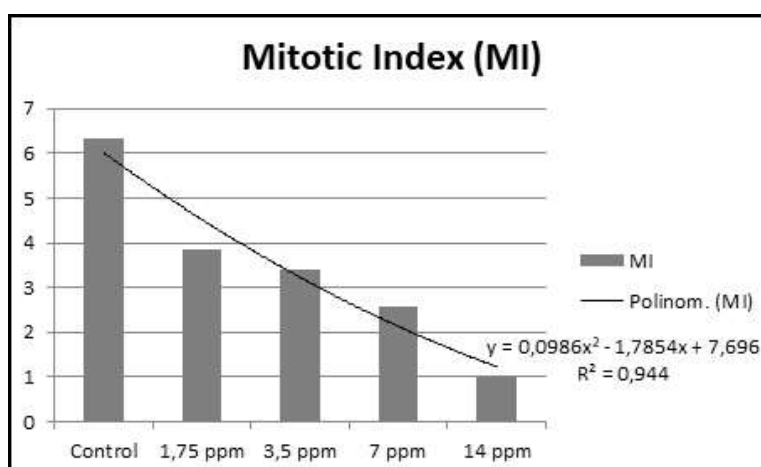

Figure 5. Negative correlation was found between mitotic index decrease and concentration increase after 72-hour exposure period (Pearson correlation -,915, P=0.03).

DISCUSSION

Nickel, a phytotoxic metal, is easily taken up by plant root tips. It has been determined that Nickel, which may be found in large amounts in soil, cause programmed cell death in root tips (Samadi, 2005; Samadi and Behboodi, 2005). Previous studies revealed that Nickel inhibited root and stem growth as the concentration and duration period increase, and also induced abnormal root tip mitosis (Liu et al., 1994). Also Samadi et al. 2005, demonstrated that Nickel induced cell death at root tips, showed a different cell morphology, and apoptotic bodies have been identified in apoptotic stages of cells (Samadi and Behboodi, 2005). In the study of Cortes-Eslava et al. 2018, it was indicated that Ni activated Caspase-3-like proteins and increased release of Cyt-C that resulted as apoptosis in *A. cepa* root tips (Cortes-Eslava et al., 2018). It has been indicated in most of the studies apoptosis is induced as a result of DNA damage (Caicedo et al., 2008, Jia and Chen 2008). In the present study, it was observed that NiSO₄ significantly increased cell death in root tips as the concentration increase (Pearson correlation (p = 0.000), resulted as root growth inhibition. All the tested concentrations induced apoptosis depending on concentration increase in

root tips ($p \leq 0.001$). Although 1.75 ppm NiSO_4 exposure induced cell death at epidermal region of root tips, over 3.75 ppm concentration exposure vascular region of the roots was more affected. It was probably as a result of containing high percentage of Ni (over 80%) in root vascular cylinder, less than (20%) in cortical region (Page and Feller, 2005; Riesen and Feller, 2005). In this vascular region; pericycle, endodermis and cortex of root tips were affected at higher concentrations. Live and apoptotic cells were observed in root tips and these regions were differentiated by using EB/AO dual staining method. Ni accumulation in affected cells, might impair cell division and proliferation rate and resulted as cell dead. Our results were in accordance with other studies that Ni penetrate endodermal barrier and accumulate in the pericycle cells (Seregin and Kozhevnikova, 2006).

In the present study, mitotic abnormalities were studied that amorphous nuclei, vacuolisation and C-mitosis were mostly observed abnormalities and were increased at 14 ppm NiSO_4 exposure after 48 and 72 hours ($P < 0.001$). Total nuclear abnormalities were significantly increased at all concentration and exposure periods. Similar results were also obtained by other researchers. Nickel nitrate induced several types of chromosomal aberrations at concentrations of 50, 150 and 450 ppm for 72 hours by use of *Allium* indicates the aneugenic effects of nickel nitrate (Sarac et al., 2019). Nickel has been reported to cause nucleus abnormalities in onion root cells due to the toxic effect of high concentrations (Liu et al., 1994) and nuclear morphological alterations; irregular nuclei, chromosomal breaks, bridges, laggards, micronuclei 20 to 100 μM concentrations of nickel ions (Ni) (Gantayat et al., 2018). Nickel nitrate has an aneugenic effect as a result of chromosome aberration increase in all treatment variants in meristematic cells of *A. sativum* (Sarac et al., 2019). Oxygen radical generation which was induced by metals, attack on DNA and also other cellular components that are sensitive to oxidation (Valiko et al., 2006). The reason of generation of chromosome abnormalities is increase of ROS induced DNA damage, base alterations (Doreswamy et al., 2004). Chronic Nickel exposure increase ROS generation involved in the cytotoxicity of in vitro and in vivo models (Kargacin et al., 1993, Kang et al., 2005). Induction of oxidative damage as a result of heavy metal exposure showed significant reduction in root length, mitotic index on *A. cepa* root tips (Gantayat et al., 2018), Nickel sulphate also induce genetic and chromosomal aberrations on V79 Chinese hamster cell (Maehle et al., 1992). It is known that disorganization of nuclear structures resulted as cell division inhibition. Root tips of *Cajanus cajan* grown in 1.5 mM concentration $\text{NiSO}_4 \cdot 6\text{H}_2\text{O}$ showed condensed chromatin, nuclear membrane disruption, two nucleoli development in the nucleus exposure of (Sresty and Rao 1999). High concentrations of Nickel known to induce nuclear abnormalities in root tips of *A. cepa* because of its toxic effect (Liu et al., 1994, Gantayat et al., 2018). In previous studies, it was also reported that Nickel inhibited root and stem growth by concentration increase and duration of treatment and induced abnormal root tip mitosis (Liu et al., 1994, Akbas et al., 2016, Gantayat et al., 2018) and known has a significant mitotic inhibitor effect in the meristematic cells of *A. sativum* (Sarac et al., 2019). Cytotoxic results showed that vacuolisation is the most observed effect in cells. It is known that Ni distribution is higher in the cytoplasmic fluid and in vacuoles (over 87%) than other organelles (Brooks et al., 1981). Nickel compounds are phagocytized in vacuoles (Cameron et al., 2011). That might be the reason of higher vacuolisation observed in the present study.

In our preliminary study, root germination inhibition was obvious after high concentration, exposure and long exposure period. Also, mitotic index inhibition showed the same result although at lower concentrations (3.5, 7, 14 ppm) and duration periods (48 and 72 h). In the present study, this inhibition was also supported with the significant decrease of mitotic phase ratios compared to control group at all the tested concentrations for both 48 and 72 h exposure periods. This germination and growth inhibition was also demonstrated by other studies that increasing concentrations of Ni inhibited seed germination and seedling growth (Espen L 1997, Leon et al., 2005), because of downregulation of protein synthesis and enzyme systems (C D Foy 1978, Bishnoi et al., 1993). The roots which was directly exposed Ni, resulted as reduced growth and

proliferation (Wong and Bradshaw 1982, Kopittke et al., 2007, Gantayat et al., 2018) that supports our results. MI inhibition/arrest was also indicated after NiCl₂ and NiSO₄ exposure on *Vicia faba* and *Triticum aestivum* roots (Demchenko et al., 2005). The presence of a toxic effect of Ni on the cell and nucleus explains the cause of mitotic inhibition observed in our study. The cells affected by the toxic effect of nickel do not enter mitosis, which was observed as mitotic inhibition.

In the present study it was found out that, there was a positive correlation between concentration and nuclear abnormalities after 48-hour exposure, but no correlation was found after 72-hour exposure as the aberrations were decreased. Also, negative correlation was determined between concentration and MI after 72 h exposure. In this case, it is thought that as the duration of exposure increases, the abnormalities were not observed as the mitotic index decreases. So the nuclear abnormalities couldn't be observed because of MI decrease. The reason why the abnormalities were not observed at a higher frequency is long exposure time, due to the fact that it could not be detected because of cell death. After 72 hours of treatment, the cytological indications are; the increase of amorphous nucleus and cell shape, and increase of cellular vacuolization, that might be resulted due to increase of affected cells, inhibition of growth that leads to cell death. Therefore, the frequency of NA's after 72 h exposure were less than 48 h exposure period.

CONCLUSIONS

In our study, different concentrations of Nickel were exposed on *Allium cepa* root tips to investigate cell death, mitotic inhibition and nuclear abnormalities. Affected areas on root tips demonstrated by using EB/AO staining method/ImageJ program can be used as a marker of affected areas. The results of the study indicated that Nickel causes apoptosis in the root tips of plants depending on concentration, Nickel caused toxic activity on root growth determined as apoptosis especially at cortex and vascular region in root tips. Cell division might be inhibited due to NiSO₄ toxic effect resulted as nuclear and cytological abnormalities. As a result of the present study, Ni related stress induced mitotic abnormalities, cytotoxic abnormalities and consequently increased apoptosis in root tips. NiSO₄ has an inhibitor effect on cell viability and affects growth inhibition due to cytotoxic and apoptotic effects on *A. cepa* root tips, depending on concentration and germination period. Further studies with different application methods will determine the toxic effects of NiSO₄ on plants and ensure to avoid significant effects on ecosystem functions and animal and human health through food chains.

Declaration of interest statement: There is no conflict of interest.

REFERENCES

- Aggarwal, N., Laura, J.S., Sheoran, I.S. 1990. Effect of Cadmium and Nickel on Germination, Early Seedling Growth and Photosynthesis of Wheat and Pigeonpea. *International Journal of Tropical Agriculture*. 8(2): 141-147.
- Ahmad, M.S.A. Ashraf, M. 2011. Essential Roles and Hazardous Effects of Nickel in Plants. *Reviews of Environmental Contamination and Toxicology*. Vol 214, 214: 125-167.
- Akbas, H., Dane, F., Meric, C. 2016. A comparative study on the significance of lead, nickel and cadmium on root growth, the kinetics of metal ion transport and pH changes in onion (*Allium cepa*) root. *Fresenius Environmental Bulletin*. 25(5): 1623-1629.
- AlKahtani, A., Alkahtany, S.M., Mahmood, A., Elsafadi, M.A., Aldahmash, A.M., Anil, S. 2014. Cytotoxicity of QMix (TM) endodontic irrigating solution on human bone marrow mesenchymal stem cells. *Bmc Oral Health*. 14.

- Bishnoi, N.R., Sheoran, I.S., Singh, R. 1993. Effect of Cadmium and Nickel on Mobilization of Food Reserves and Activities of Hydrolytic Enzymes in Germinating Pigeon Pea-Seeds. *Biologia Plantarum*. 35(4): 583-589.
- Bozali, K., Guler, E.M., Celikten, M. 2022. Investigation of the Effect of Curcumin on Cytotoxicity, Genotoxicity, and Apoptosis on Breast Cancer Cells. *World Cancer Research Journal*. 9: 1-8.
- Brooks, R.R., Shaw, S., Marfil, A.A. 1981. The Chemical Form and Physiological-Function of Nickel in Some Iberian Alyssum Species. *Physiologia Plantarum*, 51(2): 167-170.
- Bugs, M., Cornelio, M. 2001. Analysis of the Ethidium Bromide Bound to DNA by Photoacoustic and FTIR Spectroscopy. *Photochemistry and Photobiology*. 74(4): 512-520.
- Byczkowska, A., Kunikowska, A., Kaźmierczak, A. 2013. Determination of ACC-induced cell-programmed death in roots of *Vicia faba* ssp. minor seedlings by acridine orange and ethidium bromide staining. *Protoplasma*. 250(1): 121-128.
- C D Foy, R.L.C., M C White. 1978. The Physiology of Metal Toxicity in Plants Annual Review of Plant Physiology. 29: 511-566
- Caicedo, M., Jacobs, J.J., Reddy, A., Hallab, N.J. 2008. Analysis of metal ion-induced DNA damage, apoptosis, and necrosis in human (Jurkat) T-cells demonstrates Ni²⁺ and V³⁺ are more toxic than other metals: Al³⁺, Be²⁺, Co²⁺, Cr³⁺, Cu²⁺, Fe³⁺, Mo⁵⁺, Nb⁵⁺, Zr²⁺. *J Biomed Mater Res A*. 86(4): 905-913.
- Cameron, K.S., Buchner, V., Tchounwou, P.B. 2011. Exploring the molecular mechanisms of nickel-induced genotoxicity and carcinogenicity: a literature review. *Rev Environ Health*. 26(2): 81-92.
- Ciniglia, C., Pinto, G., Sansone, C., Pollio, A. 2010. Acridine orange/Ethidium bromide double staining test: A simple In-vitro assay to detect apoptosis induced by phenolic compounds in plant cells. *Allelopathy Journal*. 26(2): 301-308.
- Cortes-Eslava, J., Gomez-Arroyo, S., Risueno, M.C., Testillano, P.S. 2018. The effects of organophosphorus insecticides and heavy metals on DNA damage and programmed cell death in two plant models. *Environ Pollut*. 240: 77-86.
- Demchenko, N.P., Kalimova, I.B., Demchenko, K.N. 2005. Effect of nickel on growth, proliferation, and differentiation of root cells in *Triticum aestivum* seedlings. *Russian Journal of Plant Physiology*, 52(2): 220-228.
- Doreswamy, K., Shrilatha, B., Rajeshkumar, T., Muralidhara. 2004. Nickel-induced oxidative stress in testis of mice: evidence of DNA damage and genotoxic effects. *J Androl*. 25(6): 996-1003.
- Eskew, D.L., Welch, R.M., Cary, E.E. 1983. Nickel - an Essential Micronutrient for Legumes and Possibly All Higher-Plants. *Science*. 222(4624): 621-623.
- Espen L, P.L., Cocucci SM. 1997. Effects of Ni²⁺ during the early phases of radish (*Raphanus sativus*) seed germination. *Environmental and Experimental Botany*. 38(2): 187-197.
- Gantayat, S., Mania, S., Pradhan, C., Das, A.B. 2018. Ionic Stress Induced Cytotoxic Effect of Cadmium and Nickel Ions on Roots of *Allium cepa* L. *Cytologia*. 83(2): 143-148.
- Jia, J. and Chen, J. 2008. Chronic nickel-induced DNA damage and cell death: the protection role of ascorbic acid. *Environ Toxicol*. 23(3): 401-406.
- Kang, J.H., Zhang, D.W., Chen, J., Liu, Q., Lin, C.J. 2005. Antioxidants and trichostatin A synergistically protect against in vitro cytotoxicity of Ni²⁺ in human hepatoma cells. *Toxicology in Vitro*. 19(2): 173-182.
- Kargacin, B., Klein, C.B., Costa, M. 1993. Mutagenic Responses of Nickel Oxides and Nickel Sulfides in Chinese-Hamster V79 Cell-Lines at the Xanthine Guanine Phosphoribosyl Transferase Locus. *Mutation Research*. 300(1): 63-72.
- Kazmierczak, A. 2010. Endoreplication in *Anemia phyllitidis* coincides with the development of gametophytes and male sex. *Physiologia Plantarum*. 138(3): 321-328.

- Kaźmierczak, A. 2008. Cell number, cell growth, antheridiogenesis, and callose amount is reduced and atrophy induced by deoxyglucose in *Anemia phyllitidis* gametophytes. *Plant cell reports*. 27(5): 813-821.
- Khursheed, A., Jain, V. 2021. Oxidative stress-mediated caspase-dependent intrinsic apoptosis and proautophagic therapeutic potential of *Salvia moorcroftiana* Wall. ex Benth. growing in the Kashmir Valley, India. *Biomedical Research and Therapy*. 8(11).
- Klaunig, J.E., Kamendulis, L.M. 2004. The role of oxidative stress in carcinogenesis. *Annu Rev Pharmacol Toxicol*. 44: 239-267.
- Kopittke, P.M., Asher, C.J., Menzies, N.W. 2007. Toxic effects of Ni²⁺ on growth of cowpea (*Vigna unguiculata*). *Plant and Soil*. 292(1-2): 283-289.
- Kunikowska, A., Byczkowska, A., Kazmierczak, A. 2013. Kinetin induces cell death in root cortex cells of *Vicia faba* ssp *minor* seedlings. *Protoplasma*, 250(4): 851-861.
- L. Samadi, B.S.B. 2005. Detection of apoptotic bodies in nickel-treated root apical cells of *Allium cepa*. *Russian Journal of Plant Physiology*. 52: 131-133.
- Leon, V., Rabier, J., Notonier, R., Barthelemy, R., Moreau, X., Bouraima-Madjebi, S., Viano, J., Pineau, R. 2005. Effects of three nickel salts on germinating seeds of *Grevillea exul* var. *rubiginosa*, an endemic serpentine proteaceae. *Annals of Botany*, 95(4): 609-618.
- LePecq, J.-B., Paoletti, C. 1967. A fluorescent complex between ethidium bromide and nucleic acids: physical—chemical characterization. *Journal of Molecular Biology*. 27(1): 87-106.
- Liu, D.H., Jiang, W.H., Guo, L., Hao, Y.Q., Lu, C., Zhao, F.M. 1994. Effects of Nickel Sulfate on Root-Growth and Nucleoli in Root-Tip Cells of *Allium-Cepa*. *Israel Journal of Plant Sciences*. 42(2): 143-148.
- Liu, D.H., Jiang, W.S., Wang, W., Zhai, L. 1995. Evaluation of Metal-Ion Toxicity on Root-Tip Cells by the *Allium* Test. *Israel Journal of Plant Sciences*, 43(2): 125-133.
- Maehle, L., Metcalf, R.A., Ryberg, D., Bennett, W.P., Harris, C.C., Haugen, A. 1992. Altered p53 gene structure and expression in human epithelial cells after exposure to nickel. *Cancer Res*. 52(1): 218-221.
- Manosroi, A., Akazawa, H., Akihisa, T., Jantrawut, P., Kitdamrongtham, W., Manosroi, W., Manosroi, J. 2015. In vitro anti-proliferative activity on colon cancer cell line (HT-29) of Thai medicinal plants selected from Thai/Lanna medicinal plant recipe database "MANOSROI III". *Journal of Ethnopharmacology*. 161: 11-17.
- Mcilveen, W.D., Negusanti, J.J. 1994. Nickel in the Terrestrial Environment. *Science of the Total Environment*. 148(2-3): 109-138.
- Murch, S.J., Haq, K., Rupasinghe, H.P.V., Saxena, P.K. 2003. Nickel contamination affects growth and secondary metabolite composition of St. John's wort (*Hypericum perforatum* L.). *Environmental and Experimental Botany*. 49(3): 251-257.
- O'brien, I.E., Baguley, B.C., Murray, B.G., Morris, B.A., Ferguson, I.B. 1998. Early stages of the apoptotic pathway in plant cells are reversible. *The Plant Journal*. 13(6): 803-814.
- Page, V., Feller, U. 2005. Selective transport of zinc, manganese, nickel, cobalt and cadmium in the root system and transfer to the leaves in young wheat plants. *Annals of Botany*. 96(3): 425-434.
- Petriccione, M., Forte, V., Valente, D., Ciniglia, C. 2013. DNA integrity of onion root cells under catechol influence. *Environmental Science and Pollution Research*. 20(7): 4859-4871.
- Rahman, H., Sabreen, S., Alam, S., Kawai, S. 2005. Effects of nickel on growth and composition of metal micronutrients in barley plants grown in nutrient solution. *Journal of Plant Nutrition*. 28(3): 393-404.
- Riesen, O., Feller, U. 2005. Redistribution of nickel, cobalt, manganese, zinc, and cadmium via the phloem in young and maturing wheat. *Journal of Plant Nutrition*. 28(3): 421-430.
- Samadi, L., Behboodi, B.S. 2005. Detection of apoptotic bodies in nickel-treated root apical cells of *Allium cepa*. *Russian Journal of Plant Physiology*. 52(1): 131-133.

- Sarac, I., Bonciu, E., Butnariu, M., Petrescu, I., Madosa, E. 2019. Evaluation of the cytotoxic and genotoxic potential of some heavy metals by use of *Allium* test. *Caryologia*. 72(2): 37-43.
- Seregin, I.V., Kozhevnikova, A.D. 2006. Physiological role of nickel and its toxic effects on higher plants. *Russian Journal of Plant Physiology*. 53(2): 257-277.
- Sresty, T.V.S., Rao, K.V.M. 1999. Ultrastructural alterations in response to zinc and nickel stress in the root cells of pigeonpea. *Environmental and Experimental Botany*. 41(1): 3-13.
- Valko, M., Rhodes, C.J., Moncol, J., Izakovic, M., Mazur, M. 2006. Free radicals, metals and antioxidants in oxidative stress-induced cancer. *Chem Biol Interact*, 160(1): 1-40.
- Vanyushin, B.F., Bakeeva, L.E., Zamyatnina, V.A., Aleksandrushkina, N.I. 2004. Apoptosis in plants: Specific features of plant apoptotic cells and effect of various factors and agents. *International Review of Cytology - a Survey of Cell Biology*. Vol. 233, 233: 135-179.
- Wang, L., Lu, L. 2007. Pathway-specific effect of caffeine on protection against UV irradiation-induced apoptosis in corneal epithelial cells. *Investigative Ophthalmology & Visual Science*. 48(2): 652-660.
- Wang, Y.F., Shyu, H.W., Chang, Y.C., Tseng, W.C., Huang, Y.L., Lin, K.H., Chou, M.C., Liu, H.L., Chen, C.Y. 2012. Nickel (II)-induced cytotoxicity and apoptosis in human proximal tubule cells through a ROS- and mitochondria-mediated pathway. *Toxicology and Applied Pharmacology*. 259(2): 177-186.
- Wong, M.H., Bradshaw, A.D. 1982. A Comparison of the Toxicity of Heavy-Metals, Using Root Elongation of Rye Grass, *Lolium-Perenne*. *New Phytologist*, 91(2): 255-261.
- Yan, X.L., Liu, M., Zhong, J.Q., Guo, J.T., Wu, W. 2018. How Human Activities Affect Heavy Metal Contamination of Soil and Sediment in a Long-Term Reclaimed Area of the Liaohe River Delta, North China. *Sustainability*. 10(2).
- Yassin, A.M., El-Deeb, N.M., Elsaid, F.G., Shati, A.A., Cioca, G., Tit, D.M., Bungau, S., Popa, A., Hafez, E.E. 2019. Lectin from *Pisum fulvum* Seeds as in vitro Anticancer and Apoptotic Gene Regulator. *Revista De Chimie*. 70(4): 1490-1495.

SEISMIC ISOLATION OF A MECHANICAL FIRE INSTALLATION FOR DIFFERENT STANDARDS

Fatih KARAÇAM, Kaan ENSER

Trakya University, Engineering Faculty, Mechanical Engineering Department, Edirne, Turkey

Corresponding author e-mail: fatihkar@trakya.edu.tr

ABSTRACT

Depending on the recent developments in technology, the buildings and structures should be constructed with higher earthquake resistance. However, even if the structures can withstand the earthquake, neglected measures in mechanical installations may cause casualties. In order to prevent possible damages, the seismic isolation of mechanical installations must be developed in accordance with the relevant standards. In the seismic isolation of mechanical installations, cost analysis is the other major parameter to be considered. For this reason, it is crucial to project and implement the seismic isolation with the lowest possible cost. In this paper, a mechanical fire installation has been designed according to two different standards, and the cost analysis has been developed.

Keywords: Seismic isolation, Earthquake, Seismic standards, Seismic load.

INTRODUCTION

Vibrational motion may occur on surfaces and structures due to the dynamic loading. Dynamic loads may result various types of vibrations such as harmonic, periodic, random, and temporary vibrations. Fractures in the earth's crust may cause vibrations to occur. These vibrations, which move in waves on the earth's crust, are called earthquakes. The earthquakes create random vibrations on the surface. In such cases, mechanical installation and its equipment should be able to move simultaneously and together with the structure. The amplitude of acceleration, velocity, displacement, frequency, and time must be taken into consideration in the analysis of surface and structural problems. Modeling the motion of the surface with the only consideration of the maximum acceleration value may not give accurate results in the dynamic analysis. For example, an earthquake with a higher amplitude of acceleration may not cause as much damage as expected, while an earthquake with a lower amplitude may cause more damage. Resonance is the other major parameter in the seismic isolation. When the natural frequency of the structure and the excitation frequency of the earthquake coincide, the resonance occurs. For this reason, it is very important to determine the exact natural frequency and excitation frequency of the system. Today, even if the buildings can withstand the earthquakes, the precautions not taken into account in the mechanical installation may cause serious problems. In order to prevent these problems, the seismic measures in mechanical installations should be implemented by certain standards. Dikmen and Dülger examined the seismic protection methods for different earthquake standards and the advantages of seismic isolation in mechanical installations (Dikmen and Dülger, 2017). Kalafat searched the most common problems in seismic isolation projects of mechanical installations, determined the damage caused by earthquakes on mechanical systems and seismic loads that affect the components of the mechanical installation and examined the principles of preparing the technical specifications used in seismic isolation projects (Kalafat, 2007, 2011, 2013). Kalafat and Yücelman examined the design and seismic life of mechanical installation components under different operating conditions (Kalafat and Yücelman, 2011). In this study, seismic loads used in the seismic isolation of a mechanical installation were obtained

for two different standards. According to the results, seismic isolation and cost analysis of mechanical installation were performed.

SEISMIC ISOLATION

The main purpose of the seismic isolation in mechanical installations is the safety of the system. However, the system anchor and functionality should also be taken into account. The anchor prevents the system from being damaged after the earthquake. System functionality ensures that the mechanical systems of the building after the earthquake are fully operating. After being accepted, the building regulations represent minimum seismic requirements for the design and installation. There are many participants of architects and engineers in ensuring the compliance with relevant regulations. The design of the mechanical installation under the influence of seismic loads and the selection of the equipment to be used in the design are based on international standards. The designs should be made in accordance with the standards and the application areas should be inspected regularly. The basis for seismic resistance calculation of installations and equipment is to determine the seismic loads acting on these elements (Tauby and Lloyd, 2012). Equipment, installation, and elements connecting these elements to the structure are selected depending on these loads. Dynamic and static analysis are generally used to determine the seismic loads acting on the installation. The design of the system is based on these analyses.

STANDARDS USED IN SEISMIC ISOLATION

In many building regulations, NFPA-13 and ASCE 7-10 are taken as the reference standards. In the seismic isolation of the mechanical installations of the buildings, the determination of seismic load should be taken into account in accordance with these standards.

Seismic Load Based on NFPA-13

The seismic load values may not be determined exactly. Empirical formulas based on the theoretical studies associated with the recent earthquakes can be used to calculate these loads. For NFPA-13 standard, following equation is used to determine the seismic load where “ F_{pw} ” is the seismic horizontal load for NFPA-13, “ C_p ” is the seismic coefficient and “ W_p ” is the weight of the operating component which will be taken 15% higher as the safety factor.

$$F_{pw} = C_p W_p \quad (1)$$

“ S_s ” is the short period response coefficient and obtained from the authority having jurisdiction or seismic hazard maps. The appropriate value of the seismic coefficient in Eq. 1 is chosen depending on this value. The cable load “ F_c ” acting on the mechanical installation is given in Eq. 2. The “ α ” value in the equation corresponds to the cable orientation angle. In the mechanical installations, cables are generally oriented at $45^\circ \pm 15^\circ$ on both axes. As for the worst-case scenario, the cable orientation angle was accepted as 60° in the study.

$$F_c = \frac{F_{pw}}{\cos(\alpha)} \quad (2)$$

In Table 1, short period response and corresponding seismic coefficient values are presented. Linear interpolation can be used for the values of short period response coefficients that are not included in the table. In cases where the data are not sufficient, the seismic coefficient on seismic suspensions can be accepted as $C_p = 0.5$.

Table 1. Short period response and corresponding seismic coefficient values

S_S	C_p
0.33 or less	0.35
0.40	0.38
0.50	0.40
0.60	0.42
0.70	0.42
0.80	0.44
0.90	0.48
1.00	0.51
1.10	0.54

Seismic Load Based on ASCE 7-10

According to ASCE 7-10, the horizontal seismic load “ F_p ” is applied to the center of gravity of the mechanical installation component [8], and is defined as follows:

$$F_p = (0.4 \alpha_p S_{DS} W_p) \frac{I_p}{R_p} \left(1 + 2 \frac{z}{h}\right) \quad (3)$$

“ α_p ” is the amplification factor that varies from 1.00 to 2.50, “ S_{DS} ” is the spectral acceleration, “ W_p ” is the weight of the operating component, “ I_p ” is the importance factor that varies from 1.00 to 1.50, “ R_p ” is the response modification factor that varies from 1.00 to 12, “ z ” is the height in structure of point of installation of component with respect to the base, and “ h ” is the average roof height of structure with respect to the base. The horizontal seismic load obtained from ASCE 7-10 is expected to be within the range of minimum and maximum seismic loads given in Eq. 4-5, respectively.

$$(F_p)_{max} = 1.6 S_{DS} W_p I_p \quad (4)$$

$$(F_p)_{min} = 0.3 S_{DS} W_p I_p \quad (5)$$

The seismic load should neither be higher than the maximum value, nor less than the minimum value. If the seismic load obtained is more than the maximum, the value obtained from Eq. 3 is considered to be the new horizontal seismic load. On the other hand, If the seismic load obtained is lower than the minimum value, the new horizontal seismic load again will be the one obtained from Eq. 3.

FUNDAMENTALS OF SEISMIC DESIGN

Seismic isolation and planning must be done in accordance with the appropriate regulations or standards. After the standards are decided, the necessary coefficients are calculated using the relevant formulas and then the process is started. Seismic suspension points are marked on the floor plan used in the seismic isolation of the mechanical installation of the relevant standards. The total weight of the installation is determined by multiplying the pipe weights at the seismic suspension points by the suspension distances. By determining the weight of the installation, all the unknowns in the formula are completed, thus, the seismic load can be calculated according to the NFPA-13 or ASCE 7-10 standards.

The seismic isolation points on the project are determined by considering the following parameters:

- In order to limit the horizontal and vertical deformation that may occur in the pipes, transverse and longitudinal seismic suspension should be adopted in the system.
- All the pipes above DN65, including the branch and all mainline pipes that are independent of diameter, should be seismically isolated.
- For the branches of 2" and below, the branch limiter application should be applied.
- At the beginning and end of each line, a transverse seismic confinement should be made within a maximum of 1.8 m and a longitudinal seismic confinement within 12 m.
- The maximum distance between two transverse seismic applications on a straight line should be 12 m and this value should not be exceeded.
- The maximum distance between two longitudinal seismic applications on a straight line should be 24 m and this value should not be exceeded.
- There must be a 4-way seismic application in every column line longer than 1 m, and within the first 610 mm from the bend where the vertical line turns to horizontal.
- A transverse seismic suspension within 610 mm after one bend serves as a longitudinal seismic suspension for the other line, and a longitudinal seismic suspension serves as a transverse seismic suspension for the other line. However, the diameter of the pipe before the return should not be less than the diameter of the pipe after the return.
- Seismic suspension may not be applied at points where the distance between the pipe top level and ceiling is less than 15 cm and on the straight lines shorter than 3.66 m.

EQUIPMENTS USED IN SEISMIC ISOLATION

In the seismic isolation of mechanical installations, a seismic cable set with high tensile strength, resistant to horizontal seismic loads, with pre-tensioned flexibility, galvanized coating, suitable for connecting with ferrules, and containing steel-based material corner pieces for ceiling and system connections, should be used. The equipment used in the seismic cable set are presented in Figure 1-3. The set includes a steel cable, two brackets and two ferrules. In Figure 4, the ferrule crimping apparatus that connects the steel cable with the ferrule is given.



Figure 1. Galvanized steel cable



Figure 2. Bracket used in the connection of ceiling and installation of a seismic cable



Figure 3. Ferrule used in the connection of cable and bracket



Figure 4. Ferrule crimping apparatus

MECHANICAL INSTALLATION DESIGN AND SEISMIC LOAD CALCULATION

In this study, the design of a mechanical fire installation of a sample project is performed, and the seismic load is obtained for NFPA-13 and ASCE 7-10 standards. For both standards, “ W_p ” is chosen as 9.16 kg/m, 12.15 kg/m and 27.12 kg/m for DN65, DN80 and DN125 pipes, respectively. “ F_c ” is calculated from Eq. 2 so as to obtain the required cable load for bracing.

In NFPA-13 standard, the seismic load is determined for $S_s = 0.704$ and corresponding value of $C_p = 0.42$. In ASCE 7-10 standard, the seismic load is determined for $\alpha_p = 2.5$, $S_{DS} = 0.871$, $I_p = 1.5$, and $R_p = 4.5$. In the design process, the second floor of a building with three floors and 3.10 m floor height is considered. “ z ” and “ h ” values are chosen as 7.20 m and 10 m, respectively. Installation pipes with transverse and longitudinal seismic isolation are presented in Figure 5(a) and 5(b).



(a)



(b)

Figure 5. Installation pipes with transverse (a) and longitudinal (b) seismic isolation

In Table 2, the horizontal seismic and cable loads for different pipe diameters are presented for NFPA-13. Depending on the seismic and cable loads obtained for the relevant standards, the appropriate type of pipes and seismic cables are determined. Tensile strength values for SF11, SF12, SF13 and SF15 steel cables marked on the project are 180 kgf, 360 kgf, 670 kgf and 1500 kgf, respectively.

Table 2. The horizontal seismic and cable loads and corresponding pipe and seismic cable types for NFPA-13 standard

F_{pw} (kgf)	F_C (kgf)	Max. Bracing (m)	Pipe Type	Seismic Cable Type
53.09	106.18	12	DN65	SF11
106.18	212.37	24	DN65	SF12
70.42	140.84	12	DN80	SF11
140.84	281.69	24	DN80	SF12
157.19	314.38	12	DN125	SF12
314.38	628.75	24	DN125	SF13

In Figure 7, the seismic isolation project designed according to the NFPA-13 standard is presented. Depending on the seismic loads in accordance with the relevant standard and design criteria, the seismic isolation application points are specified on the project, the seismic cable types are determined with respect to the cable loads. The components numbered as 2 in the figure represent the transverse seismic isolation applications, whereas the components numbered as 3 represent the longitudinal seismic isolation applications.

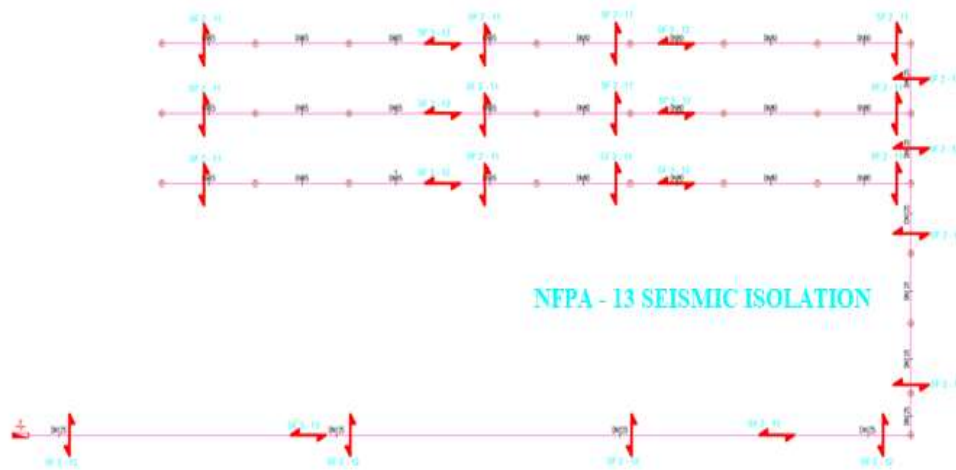

Figure 7. Seismic isolation project in accordance with NFPA-13

In Table 3, the horizontal seismic and cable loads and corresponding pipe and seismic cable types of the mechanical installation are presented for ASCE 7-10 standard.

Table 3. The horizontal seismic and cable loads and corresponding pipe and seismic cable types for ASCE 7-10 standard

F_p	F_C	Max. Bracing (m)	Pipe	Seismic Cable
-------	-------	------------------	------	---------------

(kgf)	(kgf)		Type	Type
77.08	154.16	12	DN65	SF11
154.18	308.36	24	DN65	SF12
102.25	204.50	12	DN80	SF12
204.50	409.00	24	DN80	SF13
230.55	461.09	12	DN125	SF13
461.09	922.18	24	DN125	SF15

In Figure 8, the seismic isolation project designed according to the ASCE 7-13 standard is presented. The application points of the seismic isolation are shown on the project. As in the previous figure, the components of the mechanical installation numbered as 2 and 3 indicate the transverse and longitudinal seismic isolation applications respectively.

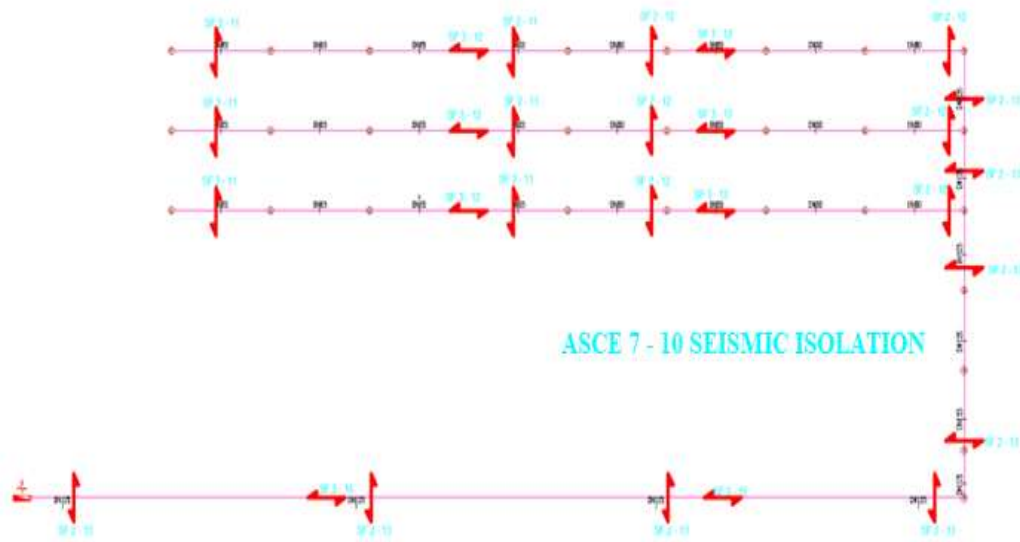

Figure 8. Seismic isolation 1197project in accordance with ASCE 7-10

COST ANALYSIS

The type, unit price, quantity and total prices of seismic cables used in the seismic isolation project based on NFPA-13 and ASCE 7-10 standards are given in Table 4-5 respectively. Since the seismic load calculated due to ASCE 7-10 is higher, seismic cables with higher tensile strength are used in the design. When the total costs of both cases are compared, it is seen that the mechanical installation cost according to NFPA-13 is 18% less than ASCE 7-10.

Table 4. The type, unit price, quantity and total price of seismic cables for NFPA-13 and ASCE 7-10 standards

NFPA-13	ASCE 7-10
---------	-----------

Cable Type	Unit Price (\$)	Quantity	Total Price (\$)	Cable Type	Unit Price (\$)	Quantity	Total Price (\$)
SF11	3.60	12	43.20	SF11	3.60	6	21.60
SF12	4.20	14	58.80	SF12	4.20	9	37.80
SF13	5.10	2	10.20	SF13	5.10	11	56.10
SF15	8.40	0	-	SF15	8.40	2	16.80
Total Price			112.20	Total Price			132.30

RESULTS AND DISCUSSION

In this study, the seismic effects on mechanical installations were discussed, the equipment used in the seismic isolation of mechanical installations was introduced, and then the seismic and cable loads acting on the mechanical fire installation were calculated based on NFPA-13 and ASCE 7-10 standards.

Depending on the seismic design criteria and loads obtained, the seismic isolation equipment has been selected and application points have been determined. It has been observed that the seismic loads on the seismic ropes obtained from the NFPA-13 standard are 45% smaller than those obtained from the ASCE 7-10 standard.

Based on these values, the seismic ropes with lower ultimate strength values were selected for NFPA-13, while seismic ropes with higher ultimate strength were selected for ASCE 7-10. Although the design made according to the NFPA-13 standard is more advantageous in terms of cost, it will be safer to use the ASCE 7-10 standard in order to keep the mechanical installations still in operating condition after the earthquake and to prevent possible losses.

REFERENCES

- Dikmen, V., Dülger, Ö. 2017. Seismic protection of electromechanical systems. Proceedings of TESKON 2017, 13. Ulusal Tesisat Mühendisliği Kongresi, 19-22 April, İzmir, Türkiye, 2121-2134.
- Kalafat, E. 2007. Seismic protection of fire sprinkler and other mechanical systems: Best practices from Turkey. Proceedings of Clima 2007 WellBeing Indoors, Helsinki, Finland, 1-8.
- Kalafat, E. 2011. Tesisatlarda deprem korumasının uygulamalı mühendislik esasları. HVAC, Refrigeration, Fire Fighting and Sanitary Journal, 74, 1-11.
- Kalafat, E. 2013. Common misconceptions about seismic restraint of installations. HVAC, Refrigeration, Fire Fighting and Sanitary Journal, 86, 17-23.
- Kalafat, E., Yücerman, E.A. 2011. Hastane Tesisatlarında Sismik Hasarların Azaltılması-FEMA 150 Standardı. Proceedings of TESKON 2011, 10. Ulusal Tesisat Mühendisliği Kongresi, 13-16 April, İzmir, Türkiye, 563-575.
- Minimum Design Loads for Buildings and Other Structures. 2010. ISBN 978-0-7844-1085-1, American Society of Civil Engineers, Virginia, USA.

NFPA 13 Standard for the Installation of Sprinkler Systems. 2021. ISBN-13: 978-1-4559-2781-4, National Fire Protection Association, Massachusetts, USA.

Tauby, J.R., Lloyd, R. 2012. Practical Guide to Seismic Restraint, ISBN-13: 978-1-9365-0418-3, American Society of Heating, Refrigerating and Air-Conditioning Engineers; 2nd edition, Atlanta, USA.

CURRENT BIOTECHNOLOGICAL BREEDING METHODS AND APPLICATIONS IN HEMP (*Cannabis sativa* L.)

Mert ARSLANBAYRAK¹, Ali Kemal AYAN¹, Büşra TİK¹, Hossem HAJIABAE¹

¹Ondokuz Mayıs University, Faculty of Agriculture, Department of Field Crops, Samsun, Turkey

Corresponding author e-mail: Mert.arslanbayrak@hotmail.com

ABSTRACT

Cannabis sativa is an industrial plant with a long history and extensive application areas. Thanks to biotechnology, the synthesis and extraction of active chemicals from hemp has been developed, providing a wide variety of treatment opportunities in the field of health. In addition, hemp is utilized in about 60 different industries, including cosmetics, textiles, food, paper, bioenergy and biocomposites. Using these methods, purposes such as micropropagation, optimization, material conservation, production, and breeding are served in hemp. In this study, biotechnological research conducted with hemp in recent years has been examined from a broad perspective.

Keywords: Hemp, Genotype, In vitro culture, Biotechnological methods

INTRODUCTION

Hemp is a versatile industrial plant that has numerous applications. Its secondary metabolites, known as hemp cannabinoids, including THC (Δ^9 -tetrahydrocannabinol) and CBD (Cannabidiol), are utilized in the medical and pharmaceutical industries. Moreover, hemp is utilized in around 60 different industries, including cosmetics, textiles, food, paper, bioenergy, bio-composites, and biodegradable product manufacturing, as well as the automotive and construction sectors where petroleum and petro-chemistry are used.

Hemp synthesizes chemical compounds in terpenophenolic structures called cannabinoids. When hemp is mentioned, the perception it creates in people is usually related to the narcotic part. THC (Δ^9 -tetrahydrocannabinol) in the content of hemp is the only psychoactive compound. In this sense, hemp has been used as an arbitrary plant (addictive). For this reason, cultivation of the plant has recently been banned. For many years, hemp cultivation has not been done globally, and the industry, which developed based on hemp, had to change its production direction and techniques. Later, scientists carried out breeding studies and developed hemp varieties with low THC content by using cultural and biotechnological methods. In this way, it has been made possible to make hemp farming worldwide again with permission. Over time, industrial hemp varieties with low THC ratios have begun to be developed in many countries. For Turkey, two hemp varieties were registered by Samsun Ondokuz Mayıs University Faculty of Agriculture and Samsun Karadeniz Agricultural Research Institute in 2021. These varieties are essential for being Turkey's first and local varieties (Aytaç., 2022), and protecting genetically created varieties and using them as breeding material is vital. It may be inevitable that cross-pollinated plants such as hemp show genetic expansion. For this reason, it is crucial to use biotechnological methods to ensure the continuity of the obtained varieties.

Botanical Characteristics of Hemp

hemp (*Cannabis sativa*) is a one-year cultivar with $2n=20$ chromosomes belonging to the Cannabinaceae family. The homeland of hemp is known as Asia. Since cannabis is a foreign pollinated plant, it creates a difficult situation for the breeder to collect the desired genes in a plant in breeding studies. For this reason, clonal studies are important especially in dioecious plants such as hemp. In this sense, effective results can be obtained by applying biotechnological methods and principles (Yaman., 2020).

Biotechnological Methods

Tissue culture applications are a method that allows micro-propagation in an aseptic environment and in cultures specially prepared for the plant, and in which plant growth and regulators are used in the prepared environment, the desired material is the same or plants with different gene structures according as the technique used (Kodym et al., 2019). This method is free from diseases, allows rapid reproduction, and is used to protect rootstock plants and in gene transfer. Although it has been reported recently that the success rate of these techniques on hemp is low, significant progress has been made now thanks to optimization studies.

Hemp is a traditionally grown crop and is propagated from its seed. Nevertheless, reproduction is usually done using clonal methods in hemp produced for medical purposes. In this way, the desired product level can be produced without expanding the population. Hemp can be grown under diode-led lamps in clonal propagation, culture vessels, and culture rooms. In this way, many plantlets can be grown in a small area. In this way, in plants grown in these environments, Insect, pathogen, or virus-free plants can be obtained (Monthony et al., 2021).

B5 vitamins and MS salts have been developed to support the culture of hemp, callus induction, and suspension (Mandolino and Ranalli, 1999). Researchers have reported that hemp responds positively to the MS environment and B5 vitamins (Braemer and Paris., 1987).

In a study, the effects of different combinations of plant growth regulators on plant regeneration were investigated. For this purpose, three different monoic hemp cultivars (Bialobrzeskie, Beniko, Silesia) were studied. Cotyledon, stem, and root parts were used as explant sources. Sterilized for 10 seconds in 70% ethanol and 20 minutes in 1% sodium hypochlorite. Prepared explants were kept in the dark for 4 to 7 days at 24°C innocent of plant growth regulators in Knopp medium “(KNO₃ 200 mg/L, Ca(NO₃)₂ 4H₂O 500 mg/L, MgSO₄ 7H₂O 200 mg/L)”. The cotyledon, stem, and root explants (1 mg/L kinetin and 0.05 Naphthalene Acetic Acid (NAA) mg/l) were transferred to the medium with plant growth regulators. It was incubated in a 24–26°C growth chamber under a 16-hour photoperiod. Three weeks later, the explants were supplemented with plant growth regulators 0.2 mg/L BAP and 0.03 mg/L NAA for callus development. Explants were moved to a medium containing 2.0 mg/L Indole-3-acetic acid (IAA) for root formation. It has been reported that the calluses formed are of the same efficiency in the three cultivars, but there are some characteristic differences. It was reported that differences were observed in terms of water content and callus color, and the best callus induction was obtained from stem explants. Researchers have reported that the root explanatory callus color is white and brown and unsuitable for morphogenesis. In addition, it has been reported that they differ in regeneration. It was reported that the highest regeneration was observed in the cotyledon parts of the Beniko variety (Wielgus., 2008). For this reason, the genotypes studied on success have a direct relationship with the protocol applied.

Anther and pollen culture is an essential protocol for obtaining haploid plants. It is also a vital breeding method applied in breeding studies. In this context, in a study conducted in 2009, anthers collected from seven hemp cultivars (Finola, Jermakowskie, Silistrenskie, W1, Juso11, Bialobrzeskie, Zenit) were cultured for callus induction from anthers grown in vitro to determine the optimal condition in hemp anther culture. Plant regeneration has been studied. It is embedded in the Medium PYL (Medium Pylon Protocol) environment. MS medium modifiers: Plantlet growth was supported with 6-Benzylaminopurine (BAP) (1 mg/L) and NAA (0.5 mg/L), and after

culturing, they were placed in a dark environment for two weeks. The cultures were then kept in a photoperiod of 23°C, 16/8 hours light. While the Jermakowskie cultivar showed the maximum (42%) callus induction rate, it was reported that no callus production was observed in Finola, Juso11, and Silistrenskie cultivars (Luwanska and Wielgus., 2009).

Seed germination, which is the initial physiological stage of plant life, is significant in examining the factors affecting growth conditions and obtaining juvenile tissue as a potency explant for various in vitro procedures. In other words, in vitro seed germination is a variable biological stage that can be affected by environmental and genetic factors (media composition and environmental conditions). In in vitro production, the success rate may decrease due to contaminations. For this purpose, hydrogen peroxide (H₂O₂) applications have been frequently used in tissue environments in recent years. At the same time, since hydrogen peroxide allows the cells in the tissue environment to develop faster, the cells in the medium provide callus formation in a much shorter time. A study conducted in 2022 was carried out to stabilize production, and infrastructure was created with algorithms and artificial neural network technology. The study was designed to explore possible responses to hydrogen peroxide ratios. Five different algorithms were used to predict germination and morphological characteristics of cannabis grown in vitro. These algorithms; Gaussian Process (GP), Extreme Gradient Boosting (XGBoost), Vector Classifier (SVC), Random Forest (RF) models and Multilayer Perceptron (MLP) system. In this study, the Narlisaray hemp variety was studied. The development of seeds in vitro was estimated using five different algorithms. In the study, for the sterilization of plant seeds, they were subjected to surface sterilization with 70% ethanol for 3 minutes, followed by 0.10% HgCl₂ (Civachloride) for 10 minutes, then washed three times with distilled water for 5-7 minutes. Seeds were treated with different concentrations of hydrogen peroxide (0.5%, 1.0%, 2.0% and 3.0% v/v) for 24 hours and transferred to MS medium. The medium for in vitro germination was prepared using 0.44% MS, 3.0% sucrose. The medium was gelled with 0.65% agar. The pH of the medium was adjusted to 5.8 with HCl (hydrogen chloride) and NaOH (sodium hydroxide). The medium was autoclaved at 121 °C and a pressure of 1.5 atm for 15 minutes. In addition, 200 mg/L “Sulcid” antibiotic was added to the medium to prevent bacterial formation. All culture media were grown in the growth chamber at 24 °C under white light diode lamps and 16/8 h illumination. Established in eight replicates with ten seeds per replicate. Fresh and dry weight measurements were taken from the plantlets formed after 21 days. Morphological characteristics (seedling fresh weight, seedling dry weight, shoot length and root length) along with germination (%) and plantlet (%) were recorded and the algorithm (RF) giving these values was reported to be the Random Forest model. The most realistic result in estimation. When the seeds were exposed to different concentrations of hydrogen peroxide compared to the control seeds, it was reported that high hydrogen peroxide concentration had positive effects on average germination as well like over germination, shoot length, fresh weight and dry weight (Aasim et al., 2022).

In another study, plantlets were obtained from seed and treated in different concentrations of hydrogen peroxide solutions (0, 1, 3, 5, and 10%) for one day. Surface sterilization was performed with 70% ethanol for 3 minutes and 6% sodium hypochlorite for 5 minutes. The sterilized seeds were then washed with distilled water. For hydrogen peroxide applications, the seeds were directly treated with the indicated concentrations of the solutions. Hydrogen peroxide solution gave the fastest and most successful germination results for hemp seeds, while at higher concentrations, the germination rate decreased, and contamination was observed (Ahsan et al., 2022).

In a study conducted in 2022, a study was conducted on the evaluation of genetic transformation in in vitro reproductions. In this study, cultivars with high cannabinoid (CBD) and cannabigerol (CBG) levels were studied. Simple Sequence Repeat (SSR) technology was used to evaluate genetic stability. Callus was obtained by culturing in MS basal medium with various concentrations of 6-benzyl adenine (BA) or tidiazuron (TDZ) for shoot regeneration. Then, 1-Naphthaleneacetic acid (NAA) was supplemented with 2,4-Dichlorophenoxyacetic acid (2,4-D)

or kinetin (KIN), and stem explants were used. For rooting of the formed plantlets, they were transferred to a semi-strong MS medium supplemented with Indole-3-butyric acid (IBA), and rooting was achieved. No somacloning variation was observed in clones propagated by SSR technology. It has been reported that genetic homogeneity is achieved in clones in this culture production. It has been shown that culture protocols developed for in vitro propagation are suitable and applicable for clonal mass dissemination (Ioannidis et al., 2022). The absence of somacloning variation for hemp provides an opportunity for mass production and quickly obtaining a homogeneous population.

An alternative in vitro method has been developed for medicinal hemp production from plant nodes. This method made it possible to obtain new plantlets. The study used ground Stagnum Peat Moss containing sponges in semi-strength MS medium in different hemp varieties. Supplemented with indole-3-butyric acid (IBA) (0, 4.92, 2.46, and 9.84 μM) as growth hormones, Explantations were sterilized with 0.05% Tween-20 and 1% NaOCl, 70% ethanol for 12 minutes. It was then rinsed three times with deionized water. Two culture forms were created with and without aeration. The most effective result was obtained in the IBA (2.46 μM) solution, where the highest rooting was achieved in the environment without aeration, while the maximum growth was obtained in IBA (4.92 μM) in the ventilated containers. It was determined that the presence of IBA and reducing MS to half strength were more effective regarding rooting properties. This result supports the claim of Lata et al., (2010) that it is the most effective hormone in the development of hemp cultures under IBA. In addition, it has been reported by researchers that there is a significant correlation between genotype, culture vessel, and IBA (Ioannidis et al., 2022).

A study in 2021 was conducted on optimizing the in vitro seed germination of cannabis of the Finola cannabis cultivar. To sterilize the hemp seeds, they were treated with 70% ethanol for 60 seconds and rinsed under tap water for 15 minutes and washed with deionized water for 5 minutes in a laminar air flow cabinet. Seeds were sterilized using 12% (v/v) commercial bleach for 12 minutes, then rinsed with deionized water for 3-5 minutes. Then, different concentrations of DKW (Driver and Kuniyuki, 1984) medium (tenth, half and whole), glucose (5% and 2%) were added to the seeds. The pH was adjusted to 5.8 and 30 ml of GA7 (Gibberic Acid) was added for each treatment. As a result of the study, the best root length (8.68 cm) and number of leaves (6.67) were obtained as DKW+5% sucrose, DKW+2% sucrose and 1/2, respectively. Maximum seedling fresh weight (0.37 g) and shoot length (13.99 cm) were observed in semi-strength mMS medium containing 5% glucose. In general, seedling fresh weight and shoot length decreased in full power environments (DKW and mMS). According to the results of the correlation coefficient, all morphological features were significantly related; The highest correlation was between plant weight and shoot length, and the lowest correlation was between root length and number of leaves (Hesami et al., 2021).

Another study was conducted on developing hemp varieties containing high CBD and CBG in vitro. Plant particles containing axillary buds were taken from the plant and transferred to an MS medium after sterilization. The shoots of the resulting plant were then subcultured in complete and semi-strength MS medium supplemented with various concentrations of 6-benzyl-aminopurine BA (4.0, 8.0 μM) or tiazuron TDZ (2.0, 4.0 μM). The researchers reported that the highest average shoot number and length were obtained and rooted in adding 4.0 μM BA hormone in complete and half-strength MS mediums. In the same study, after enrichment with different concentrations of IBA (indole-3-butyric acid) 2.0 or 4.0 μM or NAA (α -Naphthalene Acetic Acid) 4.0 μM , it resulted in optimum rooting rates, Average root number and length yield per shoot, 4.0 μM IBA (indole-3-butyric acid) and NAA (Naphthalene Acetic Acid) in the culture medium, which successfully formed approximately 92% of the plant hormone Naphthalene Acetic Acid It has been reported that it is adapted to the conditions (Ioannidis et al., 2020).

In another study on the evaluation of the efficacy of growth regulators, a study was conducted in 2020 to obtain plantlets from hemp shoot tip and node segment tissues under in vitro conditions. This study investigated callus development in environments containing different

growth regulators by utilizing cytokinin activities. The cultivar used in the study is the CBD-rich monoecious Eplison68 cultivar. For the sterilization process of the seed, it was kept in 75% ethanol for 1 minute and then in 5% active sodium chloride for 15 minutes. Then it was rinsed five times with deionized water and transferred to an MS medium. It was kept dark ($25 \pm 1^\circ\text{C}$) for seven days. Explants were taken from shoot tip and node segment tissues obtained from the seed, while plantlets were in vitro. Explanations were cultured on complete and half-strength MS medium. Daylight was maintained with fluorescents for a photoperiod of 16 hours at $25 \pm 1^\circ\text{C}$ under a photosynthetic photon flux density of $120 \mu\text{mol}$. It was then transferred to a semi-strength MS medium containing 2% sucrose supplemented with 0.5 mg/L indole-3-acetic acid (IAA). Measurements were taken after 21-28 days. Shoots were examined in 3 different parameters: well-growing, weak-growing, and non-growing. Visual observations determined the shooting status, and IAA and IBA (0.5 mg/L concentration in $\frac{1}{2}$ MS medium) were tested in the rooting status of explants. However, no statistical difference was observed between the two hormones regarding rooting. Different concentrations of tidiazuron (TDZ 0.1–0.5 mg/L), 6-Benzylaminopurine (BAP 0.5–2.0 mg/L), and meta-topolin (mT 0.1–1 mg/L) were used in the MS medium. The explants obtained from plants grown in this medium were compared regarding their ability to form new shoots. The regeneration rate decreased proportionally regarding shoot formation features in subcultured plants. The most effective hormone in MS basal medium for shoot induction has been reported as TDZ (0.5 mg/L). Success has been achieved in obtaining plants from shoots compared to nodal segments (Wróbel et al., 2022).

In a 2021 study to evaluate the regenerative ability on the Yumna7 hemp cultivar, hemp was cultured in MS medium to investigate the effects on embryo, cotyledon hypocotyl and leaf regeneration. Calli formed 10 days, 15 days, 20 days and 25 days after callus formation were collected and transferred to a callus induction medium. During the 4-week incubation, the highest callus yield was observed in explant specimens transplanted after 15 days. Induction frequencies of 5.97% in leaves, 7.65% in cotyledons, and 5.31% in hypocotyls were observed. The tissues grown here were transferred a regeneration medium at 26°C and uninterrupted light for five weeks. About 6.12% produced shoots, and less than 3% of calli-developed shoots proliferating from the other three explants were reported by investigators. In addition, the study was repeated on 1000 different hemp varieties, and as a result, it was reported that the most effective explant sample was from cotyledons. In addition, it was reported that the success rate of the variety used was statistically significant. The most productive regeneration is reported to be a hemp hybrid, DMG278, with the F2 strain obtained from crossing Red Cherry Berry and Yunma7. This line gave the highest cotyledon regeneration rate at 7.09% (Zhang et al., 2021).

CONCLUSION

Hemp is an industrial plant that can be used in many areas with its history and agriculture dating back to ancient times. On 12/06/1933, hemp farming was banned in Turkey due to its illegal use. It is banned not only in Türkiye but also in many countries. World scientists have reduced the effectiveness of cannabinoids that cause neuropathic effects, such as THC, which is one of the most important reasons for the ban on hemp, allowing its agriculture to continue in a permitted way. In this process, this success has been achieved by using biotechnological methods and principles. It can be difficult to provide genetic stability with cultural methods, especially when working in a plant that is usually dioecious, such as hemp. It may be necessary to use the possibilities of biotechnology in a plant such as hemp. This is important in saving both work and time. In recent years, the scientific world has come a long way in the functionality and usefulness of biotechnological methods in studies with hemp and has achieved successful results. For this

purpose, they discovered protocols that serve different purposes by using different media, different plant growth hormones and doses, different sugars and different sterilization methods. As a result of all studies, it was stated that different theories and unique methods should be developed for each genotype, and it was determined that the most important difference in success was due to the genotype.

REFERENCES

- Aytaç, S., Kenevir; çiftçi eğitimleri söyleşi. Samsun Vezirköprü. (2022).
- Aasim, M., Katırcı, R., Akgur, O., Yildirim, B., Mustafa, Z., Nadeem, M. A., ... & Yılmaz, G. (2022). Machine learning (ML) algorithms and artificial neural network for optimizing in vitro germination and growth indices of industrial hemp (*Cannabis sativa* L.). *Industrial Crops and Products*, 181, 114801.
- Ahsan, S. M., Shin, J. H., & Choi, H. W. (2022). Availability of Hydrogen Peroxide Solutions as a Germination Liquid Medium for Contamination-free in vitro Seedling Development of *Cannabis sativa*. *Horticultural Science and Technology*, 40(6), 605-613.
- Braemer, R., & Paris, M. (1987). Biotransformation of cannabinoids by a cell suspension culture of *Cannabis sativa* L. *Plant cell reports*, 6(2), 150-152.
- Classic Murashige, T., & Skoog, F. (1962). A revised medium for rapid growth and bioassays with tobacco tissue cultures. *Physiol Plant*, 15, 473-497.
- Driver, J. A., & Kuniyuki, A. H. (1984). In vitro propagation of Paradox walnut rootstock. *HortScience*, 19(4), 507-509.
- Hesami, M., Pepe, M., Monthony, A. S., Baiton, A., & Jones, A. M. P. (2021). Modeling and optimizing in vitro seed germination of industrial hemp (*Cannabis sativa* L.). *Industrial Crops and Products*, 170, 113753.
- Kodym, A., & Leeb, C. J. (2019). Back to the roots: protocol for the photoautotrophic micropropagation of medicinal *Cannabis*. *Plant Cell, Tissue and Organ Culture (PCTOC)*, 138, 399-402.
- Lata, H., Chandra, S., Khan, I. A., & ElSohly, M. A. (2010). High frequency plant regeneration from leaf derived callus of high Δ^9 -tetrahydrocannabinol yielding *Cannabis sativa* L. *Planta medica*, 76(14), 1629-1633.
- Ioannidis, K., Dadiotis, E., Mitsis, V., Melliou, E., & Magiatis, P. (2020). Biotechnological approaches on two high CBD and CBG *Cannabis sativa* L.(Cannabaceae) varieties: In vitro regeneration and phytochemical consistency evaluation of micropropagated plants using quantitative ¹H-NMR. *Molecules*, 25(24), 5928.
- Ioannidis, K., Tomprou, I., Mitsis, V., & Koropouli, P. (2022). Genetic evaluation of in vitro micropropagated and regenerated plants of *Cannabis sativa* L. using SSR molecular markers. *Plants*, 11(19), 2569.
- Mandolino, G., & Ranalli, P. (1999). Advances in Biotechnological Approaches for Hemp Breeding. *Advances in hemp research*, 185.
- Luwanska, A., & Wielgus, K. (2009). Anther culture and callus induction in *Cannabis sativa* L. *New Biotechnology*, 25, S302.
- Monthony, A. S., Page, S. R., Hesami, M., & Jones, A. M. P. (2021). The past, present and future of *Cannabis*
- YAMAN, C. (2020). *Cannabis Sativa* L.(Kenevir)'de İn Vitro Mikroçoğaltım. *Sürdürülebilir Mühendislik Uygulamaları ve Teknolojik Gelişmeler Dergisi*, 3(2), 54-62.
- Richez-Dumanois, C., Braut-Boucher, F., Cosson, L., & Paris, M. (1986). Multiplication végétative in vitro du chanvre (*Cannabis sativa* L.). Application à la conservation des clones sélectionnés. *Agronomie*, 6(5), 487-495.

- Wielgus, K., Luwanska, A., Lassocinski, W., & Kaczmarek, Z. (2008). Estimation of Cannabis sativa L. tissue culture conditions essential for callus induction and plant regeneration. *Journal of Natural Fibers*, 5(3), 199-207.
- Wróbel, T., Dreger, M., Wielgus, K., & Słomski, R. (2022). Modified nodal cuttings and shoot tips protocol for rapid regeneration of Cannabis sativa L. *Journal of Natural Fibers*, 19(2), 536-545.
- Zhang, X., Xu, G., Cheng, C., Lei, L., Sun, J., Xu, Y., ... & Su, J. (2021). Establishment of an Agrobacterium-mediated genetic transformation and CRISPR/Cas9-mediated targeted mutagenesis in Hemp (Cannabis Sativa L.). *Plant biotechnology journal*, 19(10), 1979-1987.

GERMINATION METHODS AND APPLICATIONS IN GIANT NETTLE (*Girardinia diversifolia*)

Mert ARSLANBAYRAK¹, Ali Kemal AYAN¹, Büşra TİK¹

¹Ondokuz Mayıs University, Faculty of Agriculture, Department of Field Crops, Samsun, Turkey

Corresponding author e-mail: mert.arslanbayrak@hotmail.com

ABSTRACT

The origin of the plant *Girardinia diversifolia* L., known as the giant nettle, is in Asia and the Himalayas. Giant nettle is a plant species belonging to the Urticaceae family. Also this plant is also known as "Himalayan nettle" or "Nepalese nettle". It is found naturally in the Himalayan Mountains, parts of Nepal, Bhutan, India, China and Tibet. In addition to the quality fibers that the plant has, at the same time the leaves of the plant are used for medicinal purposes. The chemical components contained in its leaves are known to have anti-inflammatory, analgesic and antipyretic (antipyretic) effects. Traditionally, its leaves are dried and powdered and used in teas, dishes and ointments. The height of the plant can be around 2-3m. Although the seeds are quite small, the success rate in germination is quite low. At this point, it is planned to increase the yield and the success rate in germination optimization with pre-germination applications in the planned study. Factors used in the study; By applying different salt (NaCl) concentrations, temperature applications, Hydrochloric acid (HCl) and Ethyl alcohol (C₂H₅OH) pre-applications, the effect on germination, hypocotyl and epicotile growth in giant nettle and the correlation between the parameters were examined. The best germination percentage was obtained from the salt concentration of 12.5 mM of salt (NaCl) with the highest hypocotyl length +20°C. Significant and very important correlation was identified between the parameters.

Keywords: *Girardinia diversifolia*, Germination, Fibre crops, Giant nettle

INTRODUCTION

Botany of the plant

Giant stinging nettle *Girardinia diversifolia* L. is a perennial plant from the Urticaceae family that can grow up to 1.5-3.5m tall. It has needles like nettles on its body, but more prominent. The leaves are 5-lobed and saw-toothed. The stem is covered with thin spines. The width of the leaf is on average 24-26 cm. It is named as giant nettle because of its burning. Its flowers continue from July to September and its seeds mature like November. It grows in high altitude and humid areas in Nepal and the Himalayas. It is also found in Bhutan, Sri Lanka, northern India, eastern China, Myanmar, Indonesia, Malaysia, and Africa (Sharan Shrestha., 2020). The plant has 5-angled stems and branches from the bottom (Annette Sethmann., 2004). The seeds of the plant are quite small and many seeds can be obtained from one plant. The seeds are rich in unsaturated fatty acids and contain 12% oil.

The main usage area of the plant consists of fiber feature. The bast fibers obtained from the stems are among the highest quality natural fibers in the world. In terms of chemical content of fiber, it is 85.93% cellulose, 6.8% hemicellulose, 5.49% lignin (Annette Sethmann., 2004). The plant likes

shaded areas and when exposed to the sun, the fiber quality decreases and the stripping process becomes difficult and the fiber turns dark (S.Blackburn, 2016).

It has been stated that the fibers of giant nettle have a flatter and oval lumen when compared to other fiber plants. At the same time, the stretch curve of giant stinging nettle (0.3) is higher than that of stinging nettle (*Urtica dioica*) (0.2) (S.Blackburn, 2016). Since the fibers of giant stinging nettle have a hollow structure, it has the potential to be a good source of insulation for the construction industry. However, there are deficiencies in the literature about fibers, so more studies are needed on the quality of the fiber.



Figure 1. The journey of the Giant Nettle (*G. Diversifolia*) from seed to mature seedling.

Medical Content

Giant nettle (*Girardinia diversifolia*) is a plant used in many places for fiber purposes as well as the treatment of many ailments in traditional medicine. Although there is a lack of information in the literature due to the small number of studies on the plant, detailed phytochemical analyzes have been performed showing the presence of phytosterols, fatty acids, carotenoids, polyphenols and saponins, secondary metabolites β - and γ -sitosterol (11% and 9% respectively) and trans syringin (0.5 mg/g) are the most abundant compounds. There are also plenty of unsaturated fatty acid derivatives. It also has antioxidant properties

Showing that the ovary has been reported to be cytotoxic against pancreatic cancers. These data show potential for applications of this species in the pharmaceutical, nutraceutical, and cosmetic fields (Sharan Shrestha., 2020).

G. diversifolia is used in traditional medicine for stomach disorders, chest pain (Kumar Rana et al., 2015), rheumatism, tuberculosis (Nath et al., 2011), headache, joint pains (Kunwar., 2012), diabetes (Gurung., 2012), asthma, gastritis, headache, joint pain (Subedee., 2020), birth problems. It is also used for diseases and requirements such as bone fracture, internal injury and blood thinning etc. (Rokaya., 2010).

MATERIAL AND METHOD

The study was conducted in the laboratory of Samsun Ondokuz Mayıs University Hemp Research Institute. The supply of seeds was obtained from the 2022 harvests from the giant nettle (*Girardinia diversifolia*) plant grown in the trial area of the Faculty of Agriculture of the same university. The seeds of the plant are quite small (Figure 2). Seed color varies from black to brown. In this research, the effect of 8 different germination processes applied to plant seeds on seeds was examined in line with different parameters.



Figure 2. Image of Giant Nettle (*Girardinia diversifolia*) seeds.

Factors used in the study; Pre-treatments of treatment at different salt (NaCl) concentrations (12.5, 25, 37.5mM), +20° and -20°C, Hydrochloric acid (HCl) 1% and Ethyl alcohol (C₂H₅OH) at 70% for 5 minutes were investigated for the effect on germination success in giant nettle. Each application was applied in 11 cm petri dishes (Figure 3). In each petry, 50 seeds were placed according to the UPOV criterion. Petries were stored in the air conditioning chamber at 22°C under Philips TL-D36W fluorescent white light for 16 hours and dark photoperiods for 8 hours.

The effectiveness of the processes used; Hydrochloric acid (HCl) is an acidic substance and has a low pH level. This low pH allows some of the components present in the seed coat to dissolve and germinate more easily. Some types of seeds, in particular, may experience difficulties in the germination process due to their naturally high-resistance shells. HCl can then be used to improve the germination success of seeds. Ethyl alcohol (C₂H₅OH) can be used for sterilization purposes in germination tests. It helps to remove microorganisms on the outer surface of the seeds. It is used in germination works. Different salt concentrations can exert different levels of stress on seeds, which can have different effects on germination. Low salt concentrations can promote germination, while high salt concentrations can reduce or inhibit the germination capacity of seeds. It varies depending on the ability of plant seeds to tolerate salt. For this reason, the most appropriate dose should be determined by conducting dose studies. Hot and cold applications are among the frequently used applications and can give successful results.



Figure 3. Placing the seeds into the climate chamber after the treatments.

Germination Rate (%): Calculated using the formula (Number of germinated seeds in a petri dish / Total number of seeds in a petri dish) x 100 (Senel, 2005). Since there were "0" values in the analysis, the values were analyzed using the arcsine square root transformed values.

The results obtained from the experiment were analyzed using the "MSTATC" statistical program. Differences between the values obtained from the Giant Nettle applications were subjected to LSD (Least Significant Difference) test.

RESULTS

In the study, giant nettle (*Girardinia diversifolia* L.) Intake of statistical data for the purpose of examining the effect of different germination practices of seeds on germination (Table 1) count 8. day.

Table 1. Germination treatments and doses used

Application No	Application Dosages and Durations	
1	Control	-
2	NaCl	12.5mM
3	NaCl	25mM
4	NaCl	37.5 mM
5	+20°C	5min.
6	-20°C	5min.
7	HCl	%1-5min.
8	C ₂ H ₅ OH	%70-5min.

The table of analysis of variance of germination applications used in this study is indicated in Table 2. The means are given in (Table 3) and (Figure 5). As a result of the analysis, it was determined that there are important and very important differences between the applications.



Figure 4. Germinated Giant Nettle (*Girardinia diversifolia*) seeds.

Table 2. Variance Analysis Table for Germination Treatments of *Girardinia diversifolia* Seeds: Mean squares and significance levels*

Sources of Variance	Degrees of Freedom	MS		
		Germination Rate	Hypocotyl Length	Epicotyl Length

Repeat	2	84.230*	1.0929	0.8070
Operation	7	245.141**	2.6420*	1.5976
Error	14			

(* The difference is statistically significant

** The difference is highly statistically significant)

When the effect of the applications used in the study on germination was examined, it was found that there were significant differences between the applications. The classification made (Table 3) is shown. The application with the best germination at 28% was due to the salt concentration of 12.5mM, but no significant difference was found with the control. However, compared to the control, it was found that the remaining applications had a very significant negative effect on the success rate of germination. The averages (%) are given (Figure 5).

Table 3. Germination Averages (%)*

Operations	Germination (%)**
NaCl 12.5 mM	28 A
Control	17.33 AB
Ethyl Alcohol	17.33 AB
+20°C	14 BC
NaCl 37.5 mM	8 BCD
NaCl 25 mM	4,66 CDE
HCl	2 DE
-20°C	0 E
LSDGermination, 0.01=9.465	

Differences among means indicated by the same letter are not statistically significant at the P<0.01 level.

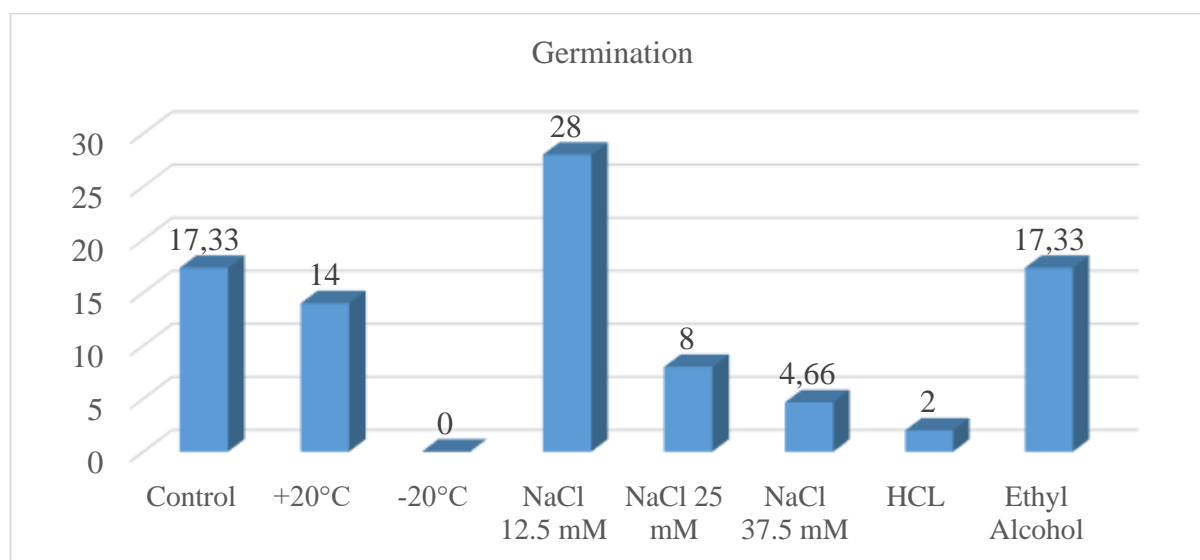

Figure 5. Germination Percentage Average

In terms of hypocotyl length, although +20°C 5min, there was no significant difference between the procedure and the control group, although it was between the applications that increased the hypocotyl length. Doses of salt (25, 37.5 mM), -20°C and HCl hypocotyl length were adversely affected by control. The classification made (Table 4) is given. The mean of hypocotyl length is given (Figure 6).

Table 4. Hypocotyl Length (cm)**

Operations	Hypocotyl Length (cm)**
+20°C	0.71 A
Control	0.44 AB
NaCl 12.5 mM	0.65 ABC
Ethyl Alcohol	0.65 ABC
NaCl 25 mM	0.26 BC
NaCl 37.5 mM	0.23 BC
-20°C	0 C
HCl	0 C
LSDHypocotyl, 0.01=0.2878	

Differences among means indicated by the same letter are not statistically significant at the $P < 0.05$ level.

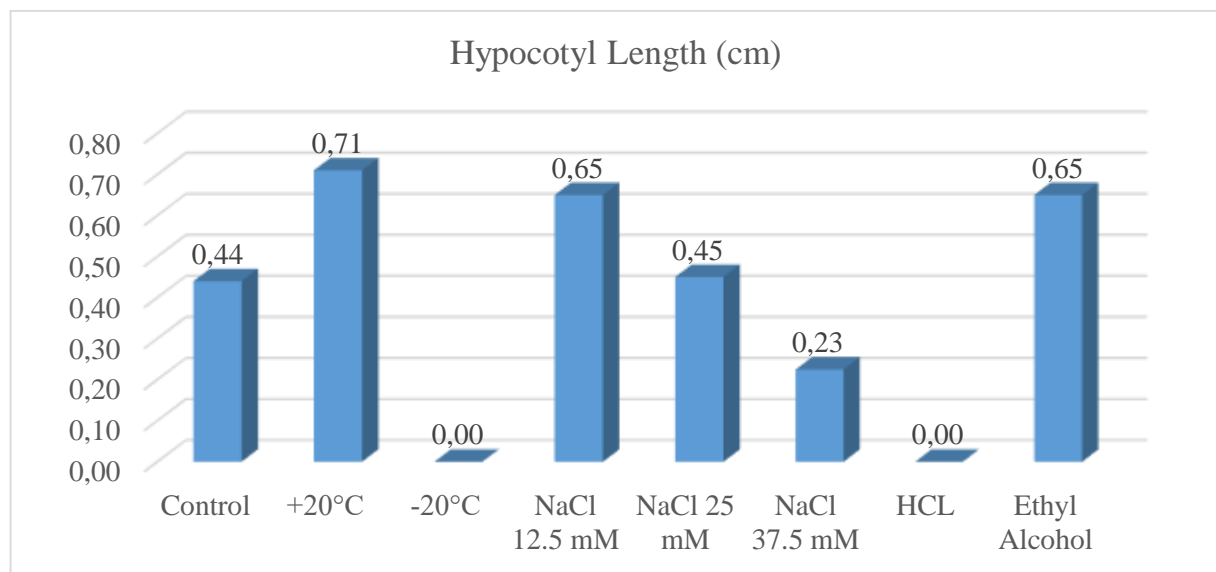

Figure 6. Average Hypocotyl Lengths

In the study, the averages of each parameter (Figure 7) as a result of germination processes were also given comparatively. Since the best germination rate (%) was due to 12.5mM salt concentration, the best application in terms of hypocotyl length (cm) was due to +20°C 5min application, no application in terms of epicotile length (cm) gave a more effective result than control.

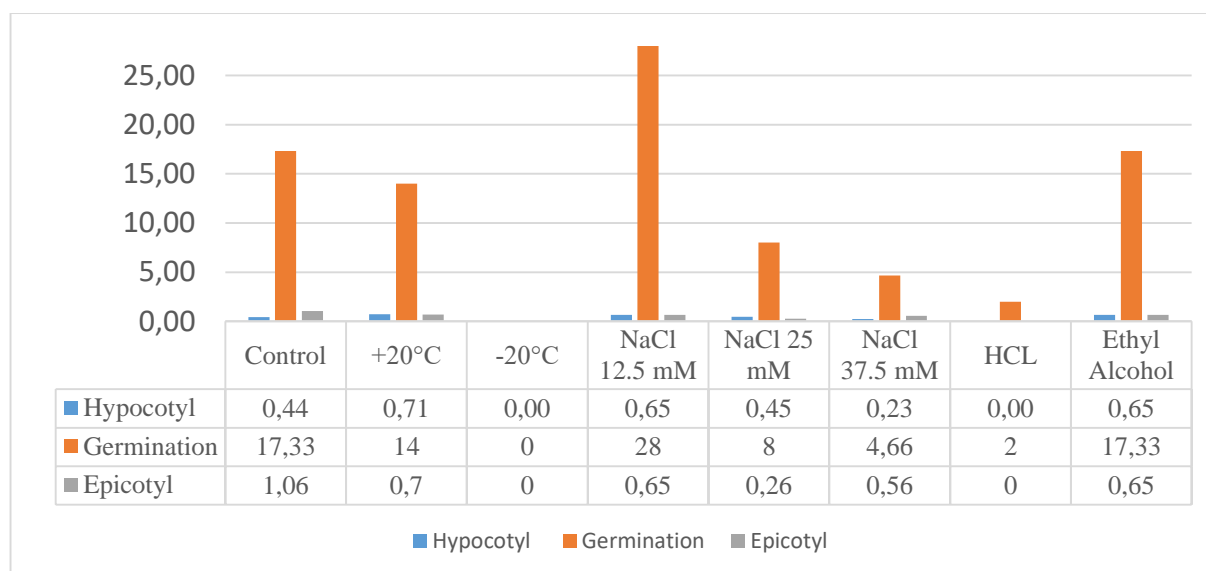

Figure 7. Average values of the parameters

The correlation values between the treatments are presented in Table 5. A significant positive correlation (0.394*) was found between germination and epicotyl length, indicating a meaningful relationship. Furthermore, a highly significant positive correlation (0.648**) was observed between germination and hypocotyl length.

Table 5. Correlation Table

Average	Germination	Hypocotyl Length (cm)	Epicotyl Length (cm)
Germination	-	0.648**	0.394*
Hypocotyl		-	
Epicotyl		0.117	-

*p<0.05 and **P<0.01

RESULTS AND DISCUSSION

As a result of the data obtained in this study, 12.5mM concentration of salt was the most efficient application in terms of its effect on germination rate and epicotyl among the germination pre-treatments. In terms of hypocotyl length, the best application is due to the temperature application of +20°C for 5 minutes. However, no application was found to be superior to the control group in terms of classification. Salt significantly reduces the water requirement of the seeds thanks to the osmotic pressure it creates. Thus, the seed can increase the germination rate with less water (Kabar., 1987). Increasing salt concentration in *G. diversifolia* caused a decrease in germination rate. This situation gives results consistent with the information in the literature (Tekin and Bozcuk., 1997). In the study, the lowest salt concentration was more successful than all other applications. Temperature treatments were highly effective on *Girardinia diversifolia* L. seeds. Although the success rate of germination and other parameters increased in the +20°C 5 min application and even the best hypocotyl length was obtained, the -20°C 5 min application caused the seeds to enter dormancy and prevent germination. For this reason, even the slightest sign of vitality was not observed in all petri dishes at -20°C for 5 minutes. Cesur et al. In their germination study with pitrak (*Xanthium strumarium* L.) in 2017, they reported that temperature applications with different doses and times are important for optimizing germination, and that temperature applications are effective on germination, and they reported that increasing temperatures cause negative effects on germination. Hayta and Arabacı (2011) reported that the

best germination in different thyme seeds among different germination applications is provided by temperature. In our study, although the temperature was effective, it was not found to be statistically significant compared to the control. However, the application of +20°C for 5 minutes gave positive results. It is necessary to carry out new studies focusing on increasing doses of temperature. Thus, it is thought that temperature may have positive effects on giant nettle seeds.

Differences between applications in germination studies may cause different results on different seeds. While any pre-treatment may encourage the germination of some plants, it may prevent or delay the germination of some plants (Kenanoğlu et al., 2007). One of the pre-germination applications, 1.5 minutes. HCl (hydrochloric acid) application is among the applications frequently used in germination studies. It caused changes in color and death of *G. diversifolia* seeds, resulting in inability to obtain data from petri dishes.

CONCLUSION

In this study, the effect of different applications on the germination of nettle (*Girardinia diversifolia*) seeds was investigated. The effects on germination rate, hypocotyl and epicotyl length were investigated by applying various salt concentrations, temperatures and chemical pretreatments. According to the findings, it was determined that 12.5 mM salt concentration gave the best germination rates. In addition, temperature application at +20°C for 5 minutes increased the hypocotyl length. However, no treatment was statistically superior to the control group. 1% HCl application caused seed mortality.

Based on the results, it was seen that the most appropriate treatment to improve the germination performance of Giant Nettle seeds was 12.5 mM salt concentration, and +20°C temperature application had a positive effect on germination. It is also necessary to investigate the effects of different temperatures and concentrations of ethyl alcohol, indicating positive results. For this, larger scale studies should be done. In addition, it has been shown that 1% HCl acid has toxic properties and more research is needed for lower concentrations such as 0.1%.

REFERENCES

- Blackburn S.R., Lanzilo G., Goswami, P.,(2016). Study of the morphological characteristics and physical properties of Himalayan giant nettle (*Girardinia diversifolia* L.) fibre in comparison with European nettle (*Urtica dioica* L.) fibre. *elsevier*, 200-203.
- Cesur, C., Coşge Şenkal, B., Uskutoğlu, T., Yaman, C., & Yurteri, T. (2017). Pıtrak (*Xanthium strumarium* L.) tohumlarının en uygun çimlendirme metotlarının belirlenmesi üzerine bir araştırma. *Türkiye Tarımsal Araştırmalar Dergisi*, 4(2), 124-130.
- Gurung, A.; Flanigan, H.; Ghimeray, A.K.; Karki, R.; Bista, R.; Gurung, O.P. Traditional knowledge of processing and use of the Himalayan giant nettle (*Girardinia diversifolia* (Link) Friis) among the Gurungs of Sikles, Nepal. *Ethnobot. Res. Appl.* 2012, 10, 167–174.
- Hayta, E., & Arabacı, O. (2011). Kekik olarak adlandırılan bazı bitki cinslerinin tohumlarında farklı çimlendirme yöntemlerinin belirlenmesi. *Adnan Menderes Üniversitesi Ziraat Fakültesi Dergisi*, 8(1), 91-101.
- Kabar, K., Alleviation of salinity stress by plant growth regulators on seed germination, *J. Plant Physiol.* 128, 179-183 (1987).
- Kenanoğlu, B.B., Demir, I., Mavi, K., Yetişir, H., 2007. *Lagenaria siceraria* genotiplerinin düşük sıcaklıkta çimlenmesi üzerine ekim öncesi uygulamaların etkisi. *Tarım Bilimleri Dergisi*, 13(3): 169-175.
- Kumar Rana, S.; Sen Oli, P.; Kala Rana, H. Traditional botanical knowledge (TBK) on the use of medicinal plants in Sikles area, Nepal. *Asian J. Plant Sci. Res.* 2015, 5, 8–15.

- Kunwar, R.M.; Mahat, L.; Sharma, L.N.; Shrestha, K.P.; Kominee, H.; Bussmann, R.W. Underutilized plant species in Far West Nepal. *J. Mt. Sci.* 2012, *9*, 589–600.
- Nath, K.K.; Deka, P.; Borthakur, S.K. Traditional remedies of joint diseases in Assam. *Indian J. Tradit. Knowl.* 2011, *10*, 568–571.
- Rokaya, M.B.; Münzbergová, Z.; Timsina, B. Ethnobotanical study of medicinal plants from the Humla district of western Nepal. *J. Ethnopharmacol.* 2010, *130*, 485–504.
- Sethmann, A. (2004). *Girardinia diversifolia* (LINK) FRIIS (Urticaceae)-eine neue Faserpflanze-Untersuchungen zu den morphologischen und mechanischen Fasercharakteristika (Doctoral dissertation, Staats-und Universitätsbibliothek Hamburg Carl von Ossietzky).
- Sharan Shrestha, S., Sut, S., Ferrarese, I., Barbon Di Marco, S., Zengin, G., De Franco, M., ... & Rajbhandary, S. (2020). Himalayan nettle *Girardinia diversifolia* as a candidate ingredient for pharmaceutical and nutraceutical applications—phytochemical analysis and in vitro bioassays. *Molecules*, *25*(7), 1563.
- Subedee, B.R.; Chaudhary, R.P.; Uprety, Y.; Dorji, T. Socio-ecological perspectives of Himalayan Giant Nettle (*Girardinia diversifolia* (Link) Friis) in Nepal. *J. Nat. Fibers* 2020, *17*, 9–17.
- Senel, E. 2005. Bazı endemik bitki tohumlarının çimlenme şartlarının ve toplam fenolik madde içeriklerinin belirlenmesi üzerine araştırma. Ondokuz Mayıs Üniversitesi, Fen Bilimleri Enstitüsü Yüksek Lisans Tezi, 52 s., Samsun.
- Tekin, F., & Bozcuk, S. (1998). *Helianthus annuus* L. var. *santafe* (Ayçiçeği) tohumlarının çimlenmesi ve erken büyüme üzerine tuz ve dışsal putresinin etkileri. *Turkish Journal of Biology*, *22*(3), 331-340.

REVERSIBLE HEMATOLOGICAL AND BIOCHEMICAL TOXIC EFFECTS OF AZOXYSTROBIN AND DIFENCONAZOLE MIXTURE EXPOSURES IN OREOCHROMIS NILOTICUS UNDER INCREASED HEAT STRESS

*Elif ORUC**, *Askin Baris KAYA*

**The University of Cukurova, Department of Biology 01330 Balcali, Adana, Turkey*

**Corresponding author: eozean@cu.edu.tr, eliforuc@gmail.com*

ABSTRACT

As one of the fastest growing sectors, aquaculture contributes to global food security. While pesticides play an important role in improving land productivity and food quality for a growing world population, especially in developing countries, their presence in agricultural drainage is a serious risk to all components of aquatic ecosystems. Additionally, there is a high risk that environmental contaminants will enter the human food chain and threaten public health. Therefore, there is an increasing need to find reliable approaches to rapidly determine the conditions of aquaculture ecosystems exposed to agricultural runoff and assess fish health and welfare. In addition to increases in pollutant inputs, increasing surface water temperatures due to climate change are affecting the physical condition of the aquatic system and coastal systems worldwide. Difenconazole is a typical triazole fungicide used for the control of fungal disease in vegetables, grains and other field crops. Azoxystrobin is the most widely used fungicide worldwide. Although temperature is an important factor in toxicity, there are not enough studies to elucidate the metabolism related to the effects of temperature on pesticide toxicity. Therefore, the effects of pesticide exposures to azoxystrobin and difenconazole mixture (0.5ppb, 5 ppb, 10 ppb) under heat stress (22°C and 30°C) on defense mechanisms in *Oreochromis niloticus* blood tissue and the reversibility of these effects was examined in order to evaluate the health status of aquatic creatures and determine water quality. In this study, it was determined that hematological, enzymatic and metabolic responses occurred in *O. niloticus* against exposure to the pesticide mixture azoxystrobin and difenconazole.

Keywords: Pesticides, Fish, Enzyme, Blood, Heat stress

INTRODUCTION

Climate change is a global concern in response to anthropogenic activities. Due to climate change, extreme weather events are experienced with increasing frequency and intensity around the world (Shahjahann et al., 2022). While global warming may have horizontal negative perturbations by expanding temperatures (synergistic effect) of other anthropogenic stressors (Verberk et al. 2016), warming is allowed to track antagonistically with other stress characteristics, which appears to be a pattern of pressure in freshwater ecosystems (Jackson et al. 2016). In addition to global warming, other anthropogenic stressors that threaten freshwater biodiversity include pesticides. Environmental factors such as temperature caused by natural (seasonal changes) or anthropogenic (thermal pollution) factors affect pesticide toxicity in aquatic organisms, and temperature changes cause changes in homeostasis and physiological parameters in fish (Gandar et al., 2017). Although temperature is an important factor in toxicity, there are not enough studies to elucidate the metabolism regarding the effects of temperature on pesticide toxicity. It has been reported that there is an increase in the toxicity of pesticides at high temperatures. It has been reported that fish are sensitive to environmental pollutants and respond quickly to contamination (Fiorino et al., 2018). Therefore, fish are considered a good model to evaluate the toxicity of water-based chemicals (Sehonova et al., 2017).

Fish are sensitive organisms to environmental changes (Rudneva et al., 2012; Shahjahan et al., 2017). Therefore, it can be measured the physiological responses of fish to the environmental stressors. Using more comprehensive testing methods to understand the effects of environmental conditions has the potential to improve our ability to unravel the possible causes and dynamics of perturbations and even detrimental confounding factors, allowing the use of more appropriate diagnostic biomarkers for fish health (Shahjahan et al., 2022). Because they have biochemical responses similar to those found in mammals, teleost fish, including tilapia, can be good indicators of contamination by a wide range of pollutants. Tilapia (*Oreochromis niloticus*) is a species of fish widely grown and consumed worldwide.

Difenoconazole provides protection against fungi in vegetables, grains and other field crops. Azoxystrobin is a typical triazole fungicide used to control the disease. Its concentration in agricultural runoff and surface water was found to be 1-50 µg/L.

However, except for a few studies on species and pesticides, the data collected on the effects of global warming on the toxicity of pesticides are not comprehensive enough for environmental risk assessments. Therefore, more studies are needed to better understand the interactions of global warming and pesticides.

In this present study, we wanted to determine the potential harmful effects of environmentally realistic concentrations of the Azoxystrobin/Difenoconazole mixture, which is widely used all over the world, and heat stress on biochemical and hematological biomarkers in *Oreochromis niloticus* under different temperature conditions.

MATERIALS AND METHODS

Fish (*O. niloticus*) were obtained from the Cukurova University Fish Culture Pools. They were acclimated to the new conditions in glass aquariums containing 100 L of tap water (40x40x100 cm) at least two weeks before the experiments.

Prior to the pesticide exposure, fish were gradually acclimatized during 15 days to the experimental temperatures of 22 and 30°C. For that, the temperature was increased by 1°C every 24 h until reaching the experimental temperature. Water was heated to the respective temperature with external heating units. Fish were kept 15 d to acclimate to each temperature regime. In the final 96 h (4 d) of the temperature exposure, fish were also simultaneously coexposed to azoxystrobin/Difenoconazole mixture in concentrations of 5, and 50 µg/L. Pesticide concentrations were chosen from a range of reported measured concentrations during runoff events. Semi-static toxicity test was performed.

Following the adaptation period, fish were individually exposed to different temperatures alone (22°C and 30°C) and combination of temperature and azoxystrobin/difenoconazole mixture commercial formulation (200g/L Azoxystrobin+125 g/L Difenoconazole, Quadris Maxx, Sygenta) at environmentally relevant concentrations of 5 µg/L and 50 µg/L at 22°C and at the elevated water temperatures (30°C) for acute exposure (96 hours). Each exposure concentration and control contained 6 fish which the length (40.38±2.20 cm) and weight (17.18±1.39 g) were similar ($P>0.05$) among exposure groups. Aquaria media were changed every day to keep pesticide concentrations close to the nominal values and clean the exposure media. During adaptation and experiments, animals received fish feed purchased from Pinar Company (Izmir, Turkey). Feeding was done just 1 h before water renewal.

At the end of experiments, six fish per each experimental group (n=6) were sampled. The blood samples were collected via severing the caudal peduncle of fish. To avoid coagulation, EDTA (1.26 mg/0,6 ml) was used. Blood sample were centrifuged at 3000 rpm at 4°C for 10 min and the plasma was removed and stored at -80°C for the biochemical analysis. The hematological parameters including hemoglobin (Hb), hematocrit (Hct) and hematological indices like mean cell hemoglobin (MCH), mean cell volume (MCV) and mean cell hemoglobin

concentration (MCHC) were determined by Sysmexpoc H100i. Anticoagulant was not added to the blood samples for serum biochemical analysis. The blood sample was kept on ice for an hour, followed by centrifugation (3000 rpm, for 10 min) for serum isolation. The samples were stored (-80 °C) for further analysis of different biochemical parameters. Biochemical parameters including glucose and triglyceride amount were determined by Roche Cobas Integra 800.

All data were analyzed using analysis of variance (ANOVA) with SPSS 22.0 software (version 22, SPSS Inc., Armonk, NY, USA) and are shown as means \pm standard deviation (SD) at $p < 0.05$. If the variance homogeneity threshold could be met, the data were analyzed with SNK's test.

RESULTS AND DISCUSSION

Blood assessment is an important technique to determine the physiological health of fish. Hematological indices such as hemoglobin (Hb), mean cell hemoglobin (MCH), mean cell volume (MCV) and mean cell hemoglobin concentration (MCHC), as well as biochemical parameters such as plasma glucose and triglyceride are widely used in the evaluation of toxic stress (Ismail et al., 2017). Enzyme activities, another category of sensitive indicators, have also been used to determine tissue damage in fish exposed to various groups of water pollutants (Saravanan et al., 2011).

Effects of various concentrations of Azoxystrobin/Difenconazole mixture and heat stress on hematological parameters of fish are shown in Figures 1-2.

Figure 1. Changes in hematological parameters of freshwater fish *O. niloticus* after exposure to sublethal concentrations of azoxystrobin/difenconazole mixtures and heat stress; HGB (Hemoglobin), HCT (Hematocrit) and hematological indices like mean cell hemoglobin (MCH), mean cell volume (MCV) and mean cell hemoglobin concentration (MCHC).

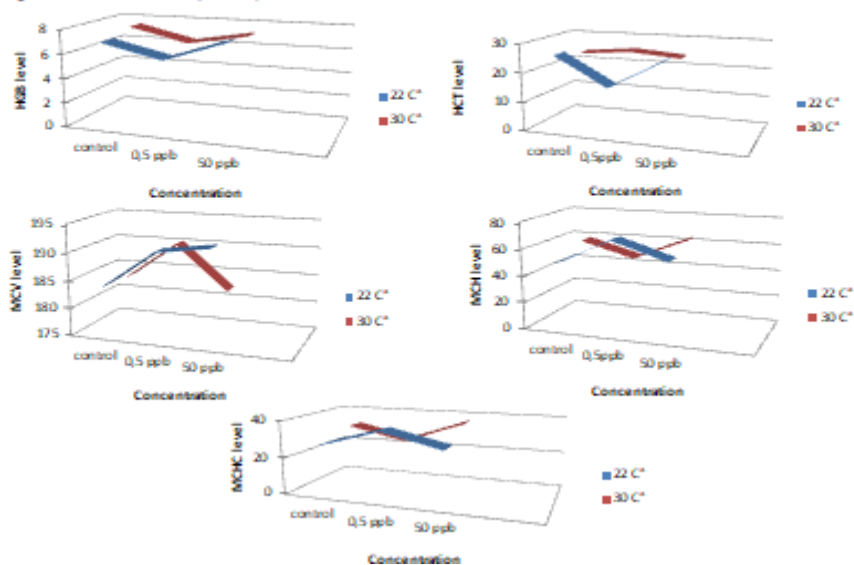
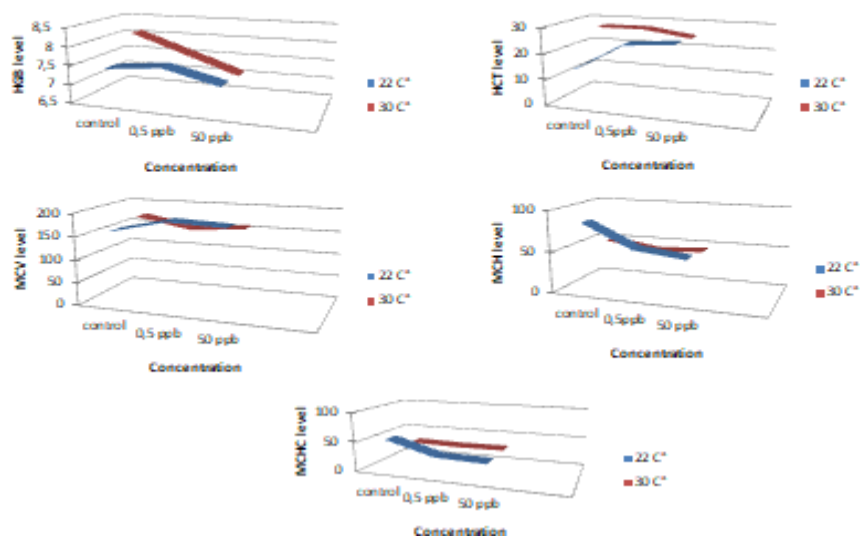
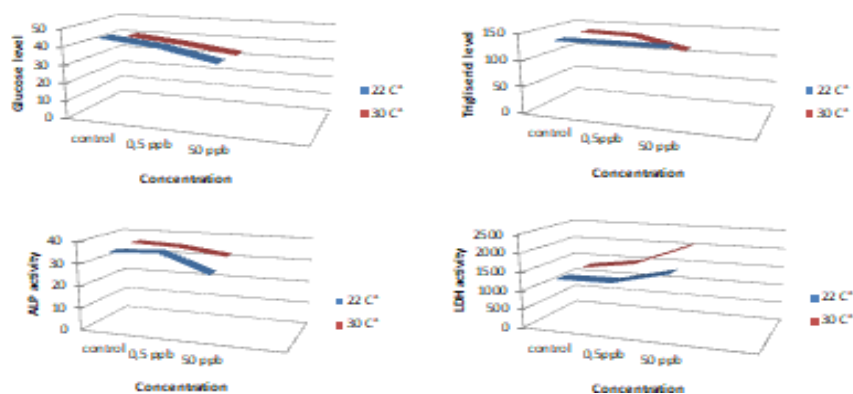

Figure 2. Changes in hematological parameters of freshwater fish *O. niloticus* exposed to sublethal concentrations of azoxystrobin/difenoconazole mixtures and heat stress after depuration period for 7 days; HGB (Hemoglobin), HCT (Hematocrit) and hematological indices like mean cell hemoglobin (MCH), mean cell volume (MCV) and mean cell hemoglobin concentration (MCHC).



Pesticide exposure caused significant changes in Hct and Hb in *O. niloticus*. Jenkins et al. stated that the decrease in hematological parameters may be related to a decrease in the rate of erythrocyte production, destruction and/or anemia resulting from pesticide toxicity in fish (Jenkins et al., 2003). The pesticide caused a significant decrease in Hct, Hb, HCM and MCHC, indicating an anemic state. At the other hand, at low dose exposure, an increase which may be attributed to the release of new red blood cells into the circulation in response to stress (Pereira et al., 2013).

Figure 3. Changes in biochemical parameters of freshwater fish *O. niloticus* after exposure to sublethal concentrations of azoxystrobin/difenoconazole mixtures and heat stress



Temperature also affects glucose and triglyceride levels in fish (Figure 3-4). It was found that glucose and triglyceride content increased during high temperature exposure, while serum glucose and triglyceride tended to decrease at some exposure concentrations (Islam et al., 2020). Alterations in metabolites in fish exposed to extreme temperatures can be used as an indicator of increasing energy demands to metabolically adapt.

Figure 4. Changes in biochemical parameters of freshwater fish *O. niloticus* exposed to sublethal concentrations of azoxystrobin/difenoconazole mixtures and heat stress after depuration period for 7 days.

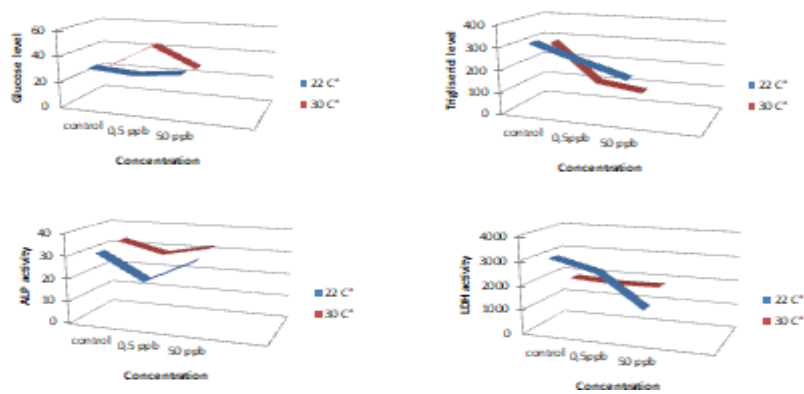

Differences in hematobiochemical parameters serve as indicators of physiological changes associated with environmental changes in response to environmental pollution. Hemoglobin (Hb), hematocrit (Hct), red blood cell (RBC) and some hematological parameters such as mean corpuscular volume (MCV), mean corpuscular hemoglobin (MCH) and mean corpuscular hemoglobin concentration (MCHC) contribute significantly to the environmental risk assesment's studies. Hematological changes are also used to evaluate the health of fish (Ismail et al., 2017). The results of hematological assessments in fish are affected by several factors, such as stress levels and duration. Moreover, blood biochemical parameters related to metabolism such as glucose (Glu), triglyceride (TG) can be viewed as important indicators of fish health and physiology. These parameters can be used to monitor fish physiology in response to varying diets, disease states, and environmental environments to monitor changes in fish health (Ashaf-Ud-Doulah et al., 2019). Plasma glucose is one of the stress indicators in fish; Low glucose levels indicate a state of high stress (Hossain et al., 2015). Hyperglycemia has been stated in various fish species exposed to a stressor through stimulation of glycogenolysis and gluconeogenesis in response to changes in temperature (Islam et al., 2020).

The induction of alkaline phosphatase and lactate dehydrogenase activities is a result of the anaerobic activity of tissues at the effect of stress conditions and, appear to be as reliable biomarker by which tissue damage caused by toxic substances can be recognized (Nemcsok and Benedeczky, 1990). Biochemical biomarkers are often evaluated as primary diagnostic tools when an organism is exposed to pollutants (Gholami-Seyedkolaei et al., 2013). Moreover, because biomarkers represent early warning of environmental contamination and thermal stress, they are useful for the development of public policies focused on finding alternatives that can minimize the effects of pollutants on a specific population (Freitas et al., 2017).

CONCLUSIONS

We showed that temperature has an important effect on the hematological and biochemical parameters of *O. niloticus* exposed to pesticides. Because the activities of ALP and LDH enzymes were significantly changed in the blood of pesticide exposed tilapia, the alterations of these parameters can be successfully used as valuable biomarkers to determine health of fish and aquatic environment.

ACKNOWLEDGEMENTS:

This study was supported by a grant from Cukurova University (FBA- 2021-14166).

REFERENCES

- Ashaf-Ud-Douh, M., Shahjahan, M., Islam, S.M.M., Al-Emran, M., Rahman, M.S., Hossain, M.A.R., 2019. Thermal stress causes nuclear and cellular abnormalities of peripheral erythrocytes in Indian major carp, rohu *Labeo rohita*. J. Therm. Biol. 86: 102450.
- Cox, P.M., Huntingford, C., Williamson, M.S., 2018. Emergent constraint on equilibrium climate sensitivity from global temperature variability. Nature 553: 319.
- Fiorino E., Sehonova P., Plhalova L., Blahova J., Svobodova Z., Faggio C., 2018. Effect of glyphosate on early life stages: comparison between *Cyprinus carpio* and *Danio rerio*. Environ Sci Poll Res <https://doi.org/10.1007/s11356-017-1141-5>.
- Freitas, J.S., Felício, A.A., Teresa, F.B., Almeida, E.A., 2017. Combined effects of temperature and clomazone (Gamit®) on oxidative stress responses and B-esterase activity of *Physalaemus nattereri* (Leiuperidae) and *Rhinella schneideri* (Bufonidae) tadpoles. Chemosphere 185:548-562.
- Gandar, A., Laffaille, P., Marty-Gasset, N., Viala, D., Molette, C., Jean, S., 2017. Proteome Response of Fish under Multiple Stress Exposure: Effects of Pesticide Mixture and Temperature Increase. Aquatic Toxicol. 184:61-77.
- Gholami-Seyedkolaei, S.J., Mirvaghefi, A., Farahmand, H., Kosari, A.A., 2013. Effect of a glyphosate-based herbicide in *Cyprinus carpio*: Assessment of acetylcholinesterase activity, hematological responses and serum biochemical parameters, Ecotoxicol. Environ. Safe. 98:135-141
- Hossain, S., Khatun, M., Rahman, M., Sukhan, Z., 2015. Impacts of sumithion on blood glucose and some hematological parameters in common carp. Int. J. Environ. 5: 8–13.
- Ismail M., Ali R., Shahid M., Khan A.S., Zubair M., Ali T., Mahmood Khan Q. 2017. Genotoxic and hematological effects of chlorpyrifos exposure on freshwater fish *Labeo Rohita*. Drug and Chem. Toxicol., doi.org/10.1080/01480545.2017.1280047
- Islam, M.J., Slater, M.J., Bögner, M., Zeytin, S., Kunzmann, A. 2020. Extreme ambient temperature effects in European seabass, *Dicentrarchus labrax*: growth performance and hemato-biochemical parameters. Aquaculture 522: 735093.

- Imada, Y., Shiogama, H., Takahashi, C., Watanabe, M., Mori, M., Kamae, Y., Maeda, S., 2018. Climate change increased the likelihood of the 2016. heat extremes in Asia. Bull. Am. Meteorol. Soc. 99, S97–S101.
- Jackson, M.C., Loewen, C.J., Vinebrooke, R.D. & Chimimba, C.T. 2016. Net effects of multiple stressors in freshwater ecosystems: a meta-analysis. Global Change Biol. 22:, 180–189
- Jenkins, F., Smith, J., Rajanna, B., Shameem, U., Umadevi, K., Sandhya, V., Madhavi, R., 2003. Effect of sub-lethal concentrations of endosulfan on hematological and serum biochemical parameters in the carp *Cyprinus carpio*. Bull. Environ. Contam. Toxicol. 70: 993–997.
- Nemcsok, J., Benedeczky, I., 1990. Effect of sublethal concentrations of phenol on some enzymatic activities and blood sugar level of carp, *Cyprinus carpio* (L.). Environ. Monit. Assess. 14:377–383.
- Noyes, P.D., Mc Elwee, M.K., Miller, H.D., Clark, B.W., Van Tiem, L.A., Walcott, K.C., Erwin, K.N., Levin, E.D., 2009. The toxicology of climate change: environmental contaminants in a warming world. Environ. Int. 35: 971.
- Oruc, E., 2010. Oxidative stress, steroid hormone concentrations and acetylcholinesterase activity in *Oreochromis niloticus* exposed to chlorpyrifos. Pest. Biochem. Physiol. 96:160–166
- Pereira, L., Fernandes, M.N., Martinez, C.B.R. 2013. Hematological and biochemical alterations in the fish *Prochilodus lineatus* caused by the herbicide clomazone. Environ. Toxicol. Pharmacol. 36: 1–8.
- Rudneva, I.I., Skuratovskaya, E.N., Dorohova, I.I., Kovyreshina, T.B., 2012. Use of fish blood biomarkers for evaluating of marine environment health. World J. Sci. Technol. 2, 19–25.
- Saravanan, M., Prabhu Kumar, K., Ramesh, M. 2011. Haematological and biochemical responses of freshwater teleost fish *Cyprinus carpio* (Actinopterygii: Cypriniformes) during acute and chronic sublethal exposure to lindane. Pestic. Biochem. Physiol. 100: 206–211.
- Sehonova P, Plhalova L, Blahova J, Doubkova V, Marsalek P, Prokes M, Tichy F., 2017. Effects of selected tricyclic antidepressants on early-life stages of common carp (*Cyprinus carpio*). Chemosphere 185:1072–1080
- Shahjahan M., Jakiul Islam M., Tahmeed Hossain M., Alam Mishu M, Hasan J, Brown C. 2022. Blood biomarkers as diagnostic tools: An overview of climate-driven stress responses in fish. Science of the Total Environ. 843: 156910
- Verberk, W.C., Durance, I., Vaughan, I.P. & Ormerod, S.J. (2016) Field and laboratory studies reveal interacting effects of stream oxygenation and warming on aquatic ectotherms. Global Change Biology 22: 1769–1778.

THE USE OF WIND ENERGY IN PROVIDING CLIMATIC ENVIRONMENTAL CONDITIONS OF BARNs FOR SMALL CATTLE

Elif Türkboyları^{1}, Ahmet Nedim Yüksel²*

¹Vocational School of Technical Sciences, Department of Plant and Animal Production, Tekirdağ Namık Kemal University, Tekirdağ, Turkey

²Faculty of Agriculture, Department of Biosystem Engineering, Tekirdağ Namık Kemal University, Tekirdağ, Turkey

**Corresponding author's e-mail: eyuksel@nku.edu.tr*

ABSTRACT

In our country, as in the world, the vast majority of energy needs are met with fossil fuels. However, the use of fossil fuels causes alarming environmental problems all around the world. Although our country is insufficient in terms of the fossil energy resources, it is very advantageous in terms of wind power and solar energy which are renewable energy sources. The Marmara Region is quite good in terms of its wind power potential. Therefore, the electrical energy can be obtained and used with a wind turbine system in the agricultural enterprises located in rural areas of Tekirdağ Province. A possibility to provide mechanical ventilation and cooling in the barns emerges by meeting the electrical energy needs of animal barns. Bringing the air inside the barn to optimum conditions by utilizing green energy increases the yield and quality of the products obtained from animals. By utilizing the wind turbine system, a ventilation and cooling system was designed for a sheep barn with a floor area of 490 m² (14x35 m) and designed to house 400 animals. For this system, 4 aspirators with a power of 0.75 kWh and a pad system with a circulation pump with a power of 0.2 kWh are needed. Although the energy requirement of this system is 3.2 kWh, due to the intermittent and fluctuating nature of the wind power, a 4-5 kWh wind turbine is suitable for the system. The approximate price of the proposed wind turbine ventilation and cooling system is \$18830. The excess energy to be generated with the wind turbine system can be stored in batteries and used for other purposes in the barn.

Keywords: Sheep-goat barn, Wind energy system, Fossil energy, Fan-pad system

INTRODUCTION

The renewable energy resources have an important position in terms of reducing our country's dependence on the fossil energy resources. Although Turkey's geography is not sufficient in terms of the fossil fuels, it is a country with high energy potential in terms of the renewable energy resources. However, most of the energy needed by the Turkish economy is met by imported fossil fuels such as oil, coal and natural gas. This situation causes dependence on foreign countries in order to meet the energy needs. In addition, dependence on foreign resources increases the current account deficit in the government budget. Accordingly, Turkey

should use renewable energy resources efficiently in order to meet its ever-increasing energy needs (Demircan and Bayraktar, 2020).

The need for energy is increasing day by day for many reasons. This widens the gap between energy production and consumption. The main reasons are population growth, technological developments, industrialization and the increase in people's comfort of life. Today, the energy problem has become a global problem rather than an independent problem experienced by each country (Karaca, 2012).

A significant number of environmental problems are caused by the consumption of fossil resources. Harmful gases that emerge as a result of this process both cause environmental pollution and harm human, animal and plant health. Apart from these effects, its impacts such as global warming, pollution of water and soil, damage to vegetation, acid rains, desertification and decreases in biodiversity are also common (Karaca, 2012).

Despite all these, while various energy resources are used around the world, 85.5% of these resources include fossil resources such as oil, natural gas and coal (Koç et al., 2018).

The initial installation costs of facilities operated with renewable energy sources are high. However, the low maintenance and operating costs of these facilities and the absence of raw material costs make these resources attractive. The order of importance in renewable energy is solar and wind power and these sources are more dominant than others (Özen et al., 2015).

Wind Power Potential in Turkey

Due to its geographical location, Turkey is much more advantageous than many countries in terms of wind and solar energy. The use of these resources will help to reduce dependence on foreign energy. In addition, it will support the reduction of the current deficit caused by energy expenditures in the state budget. Studies have shown that renewable energy resources can be used economically in the agricultural enterprises (Küsek et al., 2016; Yüksel and Yüksel-Türkboyları, 2018).

Besides diversifying the country's energy resources by using clean energy sources, we might also reduce the negative impact on the environment (Koçarlan, 2010). Wind is the air movements caused by the effect of low and high pressures resulting from the unequal heating and cooling of the earth's surface by solar radiation. The wind power is the motion energy of the air flow that creates the wind. Wind is represented by two different parameters: direction and speed. The wind speed increases with altitude and its theoretical power changes in proportion to the cube of its speed (MENR, 2023).

In Turkey, there are continuous low- and high-pressure centers between the cold Black Sea and North Asian Steppe and the warm Aegean and Mediterranean. These pressure center differences create strong and continuous winds in the coastal areas of Thrace, South Marmara, Aegean and Mediterranean (Koçarlan, 2010).

Seasonal averages show that the wind speed reaches the highest levels in December, January, February and March around the coastlines and the Marmara Sea (Tunus, 2019).

Wind speeds start to increase with the fall season, starting from September. The strongest wind speeds are observed in January and February. The decline starts in March and continues in April and May. The wind speed reaches its lowest level in June and this continues throughout the summer months until September (Tunus, 2019).

Importance of Small Cattle Breeding in Turkey

Sufficient and balanced nutrition is one of the most important problems currently challenging the world. This emerges more and more with each passing day. Agricultural policies should be environmentally, socially and economically sustainable and ensure sufficient nutrition for the people in the country (Özkan, 2020).

Turkey's natural resources, especially its meadows and pastures, have the first place in terms of their importance in bringing meat, one of the sources of protein, to our tables (Özkan, 2020). Factors such as the fact that meadows and pastures are more suitable for sheep and goats and the consumption habits of families in rural areas create a suitable environment for small cattle breeding. Due to the ease of management of small cattle in herds and reduced manpower needs, small cattle breeding is more common than cattle breeding (Amak, 2018).

In order for people to have a healthy diet; it is necessary to take the calories, proteins, fats and carbohydrates that the body needs in a balanced way (Karacan, 2017). Our red meat production, which is a source of animal protein of great importance in nutrition, is not sufficient. Meat consumption in our country has followed a curved course over the years. Per capita consumption is decreasing due to the population growth. Although our country's meat consumption is low compared to the developed countries, the average meat consumption in recent years is 36.1 kg (sheep 1.5, cattle 13.6, poultry 21.0 kg) (BESD-BİR, 2023). It is believed that small cattle products will have a great impact in closing this gap in animal products.

Environmental Conditions in Small Cattle Barns

In our country, it is a common practice to keep small cattle in barns during rainy and cold weather. The barns should provide the animals with the best living comfort. For this purpose, small cattle barns to be built should provide suitable environmental conditions for animals. They should also meet their care and feeding needs and protect them from negative external environmental factors (Amak, 2018).

In our country, sheep breeding is widely practiced using the traditional (extensive) method. Recently, the rate of housing in modern barns has been increasing. In the traditional housing, the structures of the sheep barns cannot provide the desired conditions for the sheep sufficiently. In our country, this type of housing is seen in small family-type businesses. In order to obtain high efficiency in intensive housing, the sheep should be housed to provide appropriate environmental conditions and animal welfare. The intensive housing method is applied by the commercial and large capacity businesses established in our country in recent years (Koyuncu, 2005; Taşkın et al., 2015).

Barns that are easy, cost effective and simple to construct and that provide the sheep with the desired environmental conditions are preferred in intensive housing. In recent years, tunnel and greenhouse type barns have been constructed for the housing of the sheep and goats. These barns are built in a short period of time. They can also be dismantled and transported to other places. These closed barns are preferred in the high and cold regions of our country (Ünal and Yılmaz, 2009).

During the production in animal barns, we do not encounter great technical challenges in meeting the nutritional and health needs of the animals. However, it is known that there are important problems in regulating the climatic environmental conditions inside the barn (Barnwell, 1997; Karaca et al., 2016).

Ventilation of the barns plays an important role in ensuring the appropriate environmental conditions and comfort of life in the animal barns. Climatic and chemical environmental conditions inside the barn are kept at an optimum level for animals through adequate ventilation. Climatic environmental conditions in the barn are provided by balancing air temperature and humidity and air movement. The chemical environmental conditions and the rates of dust, harmful microorganisms and gases in the barn can also be kept at the desired level with ventilation (Yüksel and Şişman, 2015).

Natural and forced (mechanical) ventilation systems are used in the barns. Stables that are traditionally planned have natural ventilation. In the modern systems, mechanical systems are preferred more. On days when there is little air movement outside and the air temperature is high, the natural ventilation cannot provide the desired effect. In such cases, forced ventilation should be activated. Ensuring sufficient ventilation and cooling in the barns at all times can be achieved through the use of forced ventilation systems.

Animal barns are usually located far away from the residential areas. In addition, according to the environmental protection law, the animal barns have to be built 1000 meters away from the residential areas. The fact that city electricity networks are not extended outside the residential areas may cause problems in accessing electrical energy in the barns.

The need for electrical energy in rural areas for agricultural purposes can be met by utilizing green energy. For this purpose, electrical energy can be generated and used with a wind turbine system by utilizing green energy when the electricity grid and electricity are not available, when there is a power outage or in order to save on energy costs.

MATERIAL AND METHOD

General Characteristics of the Research Location

Tekirdag province, the research location, is located in the Thrace Region located in the northwest of Turkey. It is located in the southeast of Europe is the smaller of Turkey's two peninsulas. Located on the European side of Turkey, Tekirdağ lies between 26°41'-28°10' eastern longitudes and 40°35'-41°35' northern latitudes. The terrain is slightly hilly and the geological structure of Tekirdag is young and emerged during the fifth geological time. The climate type is semi-humid, dry in summer, rainy in fall, winter and spring. In other words, it is similar to the Mediterranean rainfall regime. It is windy in all seasons, although more in winter (MCT, 2023).

According to the Wind Power Potential Atlas, Tekirdağ and the southern and northern coasts of Marmara have high wind speed (Karık et al., 2017; Tunus, 2019). Therefore, Tekirdağ has a significant advantage in terms of generating electrical energy from the wind with a wind turbine energy system.

Wind Power Potential of Tekirdağ Province

The wind power potential data of Tekirdağ, which is located in the Marmara Region where wind speed is high, is given in Table 1. These wind speeds are measured at a height of 2 m above the ground.

Table 1. Long-term average monthly prevailing wind direction and wind speed data for Tekirdağ-Merkez district (1940-2018) (MoEU, 2020)

Months	January	February	March	April	May	June	July	August	September	October	November	December	Annual Average
Wind Direction	NW (% 15.40)	NW (%12.81)	NE (% 11.56)	WNNW (% 10.49)	WNNW (% 10.89)	WNNW (% 13.90)	NE (% 12.60)	NE (% 15.80)	NE (% 12.69)	NW (% 14.29)	NW (% 14.77)	NW (% 15.98)	NW (% 13.36)
Wind Speed (ms ⁻¹)	3.1	3.0	2.9	2.3	2.2	2.3	2.7	2.9	2.7	2.8	2.7	3.0	2.7

Wind speed increases as the altitude increases. In a study conducted in Ağlasun district of Burdur, the wind speed, which was measured as 1.05 ms⁻¹ at a height of 2 m, was calculated with different methods at a height of 60 m and was found to be 3.0 ms⁻¹ with an increase of 2.86 times. Also, the wind speed measured as 3.0 ms⁻¹ increased 2.4 times at 60 m and was calculated as 7.21 ms⁻¹ (Dikmen and Örgen, 2018). The reason for taking the wind speed at a height of 60 m into consideration in the calculation is that the hub (rotor hub) height of wind turbines is usually located at this height.

It is also worth noting that the values given for Tekirdağ in Table 1 will increase significantly as the altitude increases.

According to the data on wind power plant potential, Tekirdağ province is at the forefront (7th place) in Turkey in terms of wind power plant installation. The theoretical potential of Tekirdağ wind power plant is 4627 MWe, with 183 wind turbine systems in operation and 96 under construction (Anonymous, 2023a).

The aim of this study is to meet the electrical energy need of forced ventilation in animal barns with a wind turbine energy system. Generally, there is no electricity network in rural areas where animal barns are located. With the electrical energy to be generated from the wind turbine system to be installed in animal barns, ventilation and cooling of the barn can be provided by using the fan and wet pad system.

Method

This study was conducted to determine the possibility of using green energy in animal barns for agriculture. The climatic environmental conditions should be provided in the barns, which are small cattle barns, in order to increase the yield and quality of the products obtained. Ventilation systems are used to provide environmental conditions in the barns. The electrical energy requirement of the ventilation system is met by the wind turbine system. In order to ensure climatic environmental conditions and comfort of life in the barns, a ventilation system

project was designed for the barn. In addition, a pad system was also designed to cool the animals during hot weather. Mechanical ventilation is needed to provide ventilation and cooling (Türkboyları and Yüksel, 2020).

The barn where a ventilation and cooling system will be installed is large enough to house 400 animals and the dimensions of the barn are around 490 m² (14x35 m) (Karaman et al., 2012).

To reduce heat losses in animal barns, the barns should have insulation. So that heating and cooling systems can be designed with a more cost-effective capacity. As a result, it is possible to design a fan pad and wind turbine system with less cost and capacity.

Design of Wind Turbine and Ventilation System

Electric energy generated with the renewable energy sources, i.e., wind and solar energy systems, can be used for different purposes in agriculture. In agricultural production, these resources can be used for disinfection of soil in greenhouses, ventilation of greenhouses, and ventilation and cooling in animal barns (Türkboyları and Yüksel, 2020; Türkboyları and Yüksel, 2021).

The wind turbines are the main structural element of wind power plants. Turbines are machines that convert the kinetic energy of circulating air first into mechanical energy and then into electrical energy. Depending on the application, the structure of the wind turbine system includes a wind turbine, accumulator, battery charge control unit (charge regulator), inverter, various electronic circuits and a command center (Toprak 2011; Şenel and Koç, 2015). In this system, the energy requirement is met by wind turbines having the required power. It is obligatory to use batteries in the system. Batteries store electrical energy by converting it into chemical energy. When needed, they convert chemical energy into electrical energy and enable its use. The necessity of using batteries in wind energy systems is due to the supply-demand imbalance in wind power. In other words, it means that energy production cannot be done when needed. Furthermore, the batteries also provide energy to the system when there is no wind. Overcharging or discharging the batteries shortens their service life and increases the amortization cost. A charge regulator should be added to the system to prevent overcharging or discharging the batteries. Thus, the service life of the batteries will be extended and their costs will be reduced. Depending on the condition of the battery, the charge regulator cuts the electric current coming from the wind turbine or from the load. If there is a battery in the system and 220 V alternating (fluctuating) current will be used or current will be supplied to the city grid, an inverter should be used in the system (Toprak, 2011; Şenel and Koç, 2015).

The green energy systems to be used in animal barns are similar to each other in terms of structure. The fan, and wet cushion (pad) mechanism that will provide ventilation and cooling in these systems is shown in Figure 1 (Yüksel and Yüksel-Türkboyları, 2018).

Water can be used for cooling in animal barns with a fan-pad system. In order to use wet pads in animal barns, fans and mechanical ventilation are needed. To provide mechanical ventilation, aspirators are placed on the wall opposite the wall of the barn where the wet pads are installed. The system is usually located on walls along the length of the barn. When the aspirators start working, the used and contaminated air inside the barn is removed to the outside of the barn. Due to the low pressure created inside the barn, the air passing through the wet pads, which is loaded with humidity and whose temperature decreases, begins to fill the barn (Yüksel and Şişman, 2015; Yüksel and Yüksel-Türkboyları, 2019; Boyacı et al., 2012).

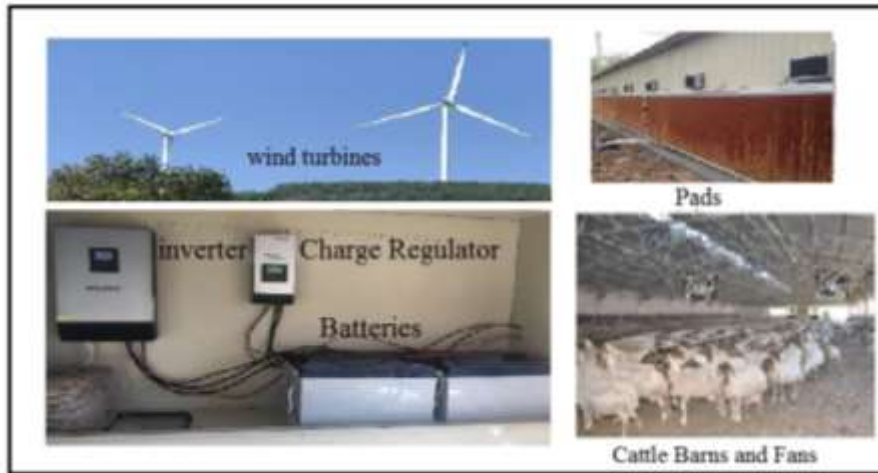

Figure 1. Elements of ventilation and cooling systems used in animal barns with a wind turbine system

Water can be used in many different ways in agriculture. The primary purpose is to meet the drinking and usage needs of the plants and animals. Apart from this, water can also be used in agriculture for frost protection and cooling. Water receives or releases heat from the environment during a phase change, i.e., freezing-thawing or evaporation-condensation. Plants can be protected from frost by some methods using the heat (80 cal) that one gram of water releases to the environment when freezing.

The use of water for cooling in animal barns can be done in different ways (Yağcıoğlu, 2005; Yüksel and Şişman, 2015; Yüksel and Yüksel-Türkboyları, 2018). These are sprinkler irrigation, fogging or pad system. In sprinkling and fogging methods, water particles fall on the animals, on the barn's structural elements and on the floor of the barn and then evaporate from these. In the fan-pad system, water is evaporated inside the pad. As one gram of water evaporates, it takes 598 cal (2500 J) of heat from the environment. This reduces the temperature of the environment. Almost all of the latent heat of evaporation required for the evaporation of water is taken from the sensible heat of the air. Thus, the temperature of the air, which passes through the pad and enters the barn and loses energy in the pad, is also lowered. With the wet pads, the temperature inside the barn can vary between 6°C and 16°C depending on the climate of the region where the measurement is made and the seasons (Abdalla and Narendran, 1991; Barnwell, 1997; Karaca et al., 2016).

Cooling Systems in Sheep Barns

As with all farm animals, sheep are sensitive to the climatic environment, care and feeding conditions. Temperatures below and above the welfare and comfort level, sudden temperature changes, high barn humidity and air currents may especially cause respiratory system disorders. At the same time, since it adversely affects the material changes in the animal metabolism, lamb and goat development slows down and productivity decreases (Kaymakçı and Taşkın, 1995).

In order to prevent these adverse effects, it is important to provide a certain degree of cooling of the indoor air in the barns during hot seasons to minimize the heat stress on animals. In this way, it would be possible to maintain a healthy and efficient production.

Under the conditions of Tekirdag, there are months when ventilation, heating and cooling of the barn are necessary to ensure the comfort of animals kept in the sheep barns. It may be necessary to heat the barn in December, January, February and March when the outside air temperature falls below 7°C -8°C due to the decrease in temperature and increase in humidity. Ventilation is needed in April, May, September, October and November when the outside temperature is between 7°C - 8°C and 22°C -24°C. Forced ventilation should be supported with wet pads on hot and windless days when the outside temperature exceeds 22°C - 24°C (Yüksel and Şişman, 2015; Türkboyları and Yüksel, 2020). If sheep and goats are kept in the barns at all times, cooling should be done during the summer season, in June, July and August.

It is reported that the relative humidity, which is another climatic environmental condition, should be between 50-60% in the barns (Ekmekyapar, 1991; Olgun, 2011). This relative humidity in animal barns increases too much especially in winter months when the outside air temperature decreases and it may disturb the animals. For this purpose, heating might be required to reduce the humidity level in the barn down to the desired levels.

Designing a Fan-Pad System for Sheep Barns

Dimensions of the sheep barn where the fan-pad project will be implemented are needed. The barn will house 400 sheep and has a width of 14 m, length of 35 m, height of 3 m and floor area of 490 m² (14x35) (Karaman et al., 2012).

For every 25 m² floor area of the animal barns, 1 m² wet pad area is needed (Yüksel and Şişman, 2015). Accordingly, the wet cushion area that is sufficient for a barn with a floor area of 490 m² is as follows:

$$490/25 = 19.6m^2$$

The water requirement of the pad is 30-40 liters per 1 m² wet pad area on hot days (Bucklin and Hendley, 1993). The daily water requirement of the pad is 600-800 liters of water. In order to wet the pad in the barn, the water must be carried to the top of the pad. For this purpose, the system needs a 0.2 kWh circulation pump.

The amount of ventilation in the animal barns can be calculated using different methods. Since the number of animals in the barns might be less or more, the need for ventilation in an animal barn might be more or less. Animals require ventilation the most during the summer months. The project should be designed accordingly. The amount of ventilation required for 1 kg sheep weight is 0.7 m³ h⁻¹ kg⁻¹ in summer. Although the weights of sheep and goats vary between 40-60 kg, the average weight can be considered as 55-60 kg (Olgun, 2011). In addition, sheep and goat weights start from 40 kg and go up to 90-100 kg depending on whether the animals are male or female and depending on their breeds (TAGEM, 2009).

Since the number of animals in the projected barn is 400 and their average weight is 60 kg, the amount of ventilation required in the barn can be calculated as follows:

$$400 \times 60 \times 0.7 = 16800 m^3 h^{-1}$$

The fans to be used in the barn should be capable of being operated separately or collectively according to the climatic conditions and the needs of the animals. The fans to be used in the system should not be too large in diameter. The diameter of the fans to be used in animal barns should not be more than 60 cm. Any larger fan diameter can increase the noise of the fans and disturb the animals. Fans with a diameter of 60 cm have a flow rate of $9500 \text{ m}^3 \text{ h}^{-1}$, power of 0.75 kWh, cycle speed of 1400 rpm (dd^{-1}) and a single phase of 220 V (Anonymous, 2023b). Since the ventilation requirement is $16800 \text{ m}^3 \text{ h}^{-1}$, 2 fans can provide air exchange from inside the barn to the outside. However, since the length of the projected barn exceeds 25-30 m, fans placed on one side of the barn cannot provide sufficient ventilation inside the barn. In order to ensure that there are no unventilated areas in the barn and to ensure adequate air circulation, 2 more aspirators should be placed in the center of the barn (Yüksel and Yüksel-Türkboyları, 2018).

The energy requirement of the projected ventilation and fan-pad system can be calculated as follows. The installation design of the system includes 4 fans with a power of 0.75 kWh and a circulation pump with a power of 0.2 kWh that consume energy. Accordingly, the energy requirement of the system can be calculated as follows:

$$0.75 \times 4 + 0.2 = 3.2 \text{ kWh}$$

RESULTS AND DISCUSSION

The wind turbine system to be erected for using green energy in the sheep barns leads to a non-continuous activity in the generation of electricity from wind due to the irregularity of the wind (Şenel and Koç, 2015). To ensure continuity in energy, a battery group should be added to the system. Batteries can meet the need for a certain period of time. If the period without wind is longer, it is more appropriate to use a hybrid system. A hybrid system means integrating wind turbines and solar panels or a diesel generator group and operating them all together.

Electric energy to be generated with wind turbines will be used for ventilation and cooling in the sheep barns. In the system, the pad area is around 19.6 m^2 , the ventilation amount is $16800 \text{ m}^3 \text{ h}^{-1}$, the number of fans is 4 and the energy requirement of the system is 3.2 kWh.

A wind turbine system, which will meet the approximate energy requirement of 3.2 kWh of the projected closed sheep barn housing 400 animals, is needed. However, negative factors such as the irregularity of the winds and insufficient winds in some seasons prevent the wind turbine system from providing the desired energy. Due to these reasons, a system of 4-5 kWh, which is 25-30% more than the calculated value of 3.2 kWh, should be installed in order for the wind turbine system to operate efficiently.

The system generates excess energy when it operates at full capacity when the weather conditions are favorable. This excess energy is stored in batteries. The excess energy can also be used when there is no wind and for tools and equipment used in the barns such as milking, cleaning and automatic feeding equipment.

Cost Analysis of Ventilation and Cooling System

Among renewable energy sources, wind turbine system has the most affordable unit energy cost and is one of the most suitable systems. Wind turbine energy systems vary depending on the brand and the countries where they are produced. However, the cost of wind turbine systems is high and the installation cost per kWh is around \$ 2500 (Erkoç, 2019; Türkdoğan et al., 2020). The wind turbine system is 5 kWh and it is worth \$12500. The transportation and installation cost of this system is around \$2500. The total cost of the turbine used in the system is \$ 15000. The unit cost of transportation and installation of the aspirators used in ventilation in the system is \$500 and the total cost for 4 aspirators is \$2000 (Anonymous, 2023b).

The price per square meter of the pad used for cooling the air entering the barn is \$20 and 20 m² pad costs \$400 (Anonymous, 2023c). If transportation and installation are included, the pad system costs \$480. The pump that supplies water to the pad costs \$50 (Anonymous, 2023d).

The unit cost of the 150 Ah gel battery to be used in the system is \$278. The total cost of 4 batteries with transportation and installation is 1300 \$ (Anonymous, 2023e).

In total, the cost of the ventilation and cooling system reaches 18830 \$.

CONCLUSION

Our red meat production, which is of great importance in nutrition and a source of animal protein, cannot meet the needs of our country. In parallel with the population growth, our per capita meat consumption is decreasing. Small cattle breeding may contribute to closing this protein deficit. The major factor in this is that meadows and pastures, which are among Turkey's natural resources, are more suitable for sheep and goat breeding. In addition, other factors such as the consumption habits of families living in rural areas lead to significant increases in the number of animals.

Another important problem in animal production is access to energy. The necessity of building animal barns at least 1000 meters away from residential areas creates problems in access to energy. In addition, another important challenge in animal production is the increasing energy prices.

Renewable energy sources could be used to meet the energy needs in agriculture and to avoid the increase in energy prices. Use of wind power, a renewable energy source, in Tekirdağ region may help to solve the energy problem.

The primary objective of animal production is to obtain high quality and high yield. For this, optimum environmental conditions must be provided in the barn. Heating in winter, ventilation in spring, and ventilation and cooling in summer could be done in the barns. Fans and pads are used for ventilation and cooling. In order to use systems such as fans and pads, the necessary electrical energy could be generated by using wind turbine systems.

However, the fact that wind energy is not continuous, it fluctuates and sometimes it is not available at all can cause problems in its use. Short-term problems can be solved with the help of batteries to be added to the system. For extended periods without wind, it is useful to use hybrid systems such as solar panels.

REFERENCES

- Abdalla AM., R. Narendran (1991). Fog emitters as evaporative cooling devices for dairy cow sheeds. *Agricultural Mechanization in Asia, Africa and Latin America (AMA)*, 22(1): 73-76.
- Amak, A. (2018). Güneydoğu Anadolu bölgesi Şanlıurfa yöresindeki küçükbaş hayvan barınaklarının yapısal yönden araştırılması ve geliştirilmesi. *Harran Üniversitesi Fen Bilimleri Enstitüsü Yüksek Lisans Tezi*, 150s., Şanlıurfa.
- Anonymous (2023a). <https://www.enerjiatlas.com/ruzgar-enerjisi-haritasi/turkiye> (Accessed date: 02.09.2023)
- Anonymous (2023b). <https://www.fansanmarket.com/urun/sanayi-aspiratoru-harici-motorlu-kare-kasa-9500-m3h-cap-60-cm/146/> (Accessed date: 01.09.2023)
- Anonymous (2023c). <https://turkish.alibaba.com/p-detail/Agriculture-60708802282.html?spm=a2700.7724857.%200.0.332a4dd40GozfY> (Accessed date: 01.09.2023)
- Anonymous (2023d). <https://www.hepsiburada.com/klpro-klpsp256-100watt-sirkulasyon-pompa-pm-HBC00000E6SPM> (Accessed date: 01.09.2023)
- Anonymous (2023e). <https://www.acdc.com.tr/tr/jel-aku-hakkinda.htm?id=121507150> (Accessed date: 01.09.2023)
- Barnwell, R. (1997). Evaporative cooling systems. *Technical news. Quarterly Publication of Cobb-Wantres*, 5(2).
- BESD-BİR (2023). <https://besd-bir.org/assets/uploaded/Tr-kisi-basina-turlere-gore-et-tuketimi.pdf> (Accessed date: 17.08.2023)
- Boyacı S., A. Akyüz, S. Gençođlan, Ş. Baydar (2012). Etlik piliç kümeslerinin fan ped sistemiyle serinletilmesi. 2. Ulusal Sulama ve Tarımsal Yapılar Sempozyumu, 24-25 Mayıs 2012, İzmir:949-954.
- Bucklin R.A., R.A. Hendley (1993). McConnel DB. Fan and pad greenhouse evaporative cooling systems. University of Florida, Florida Cooperative Extension Service, Circular 1135.
- Demircan, N., B. Bayraktar (2020). Rüzgar enerjisi ve Balıkesir Bölgesindeki potansiyeli. *Balıkesir Üniversitesi İktisadi ve İdari Bilimler Fakültesi Dergisi*, 1(2):84-105.
- Dikmen, E., F.K. Örgen (2018). Ağlasun bölgesi için rüzgar hızı tahmini ve en uygun türbin tespiti. *Niğde Ömer Halisdemir Üniversitesi Mühendislik Bilimleri Dergisi*, 7(2):871-879.
- Ekmekyapar, T. (1991). Hayvan Barınaklarında Çevre Koşullarının Düzenlenmesi. *Atatürk Üniversitesi Ziraat Fakültesi Yayınları No:698*, pp.65-95.
- Erkoç, R. (2019). Güneş enerjisi santrallerinin modellenmesi, ekonomik analizi ve değerlendirme: Almanya ve Türkiye uygulamaları. *Ordu Üniversitesi Fen Bilimleri Enstitüsü Yüksek Lisans Tezi*, 106s., Ordu.
- Karaca, C. (2012). Güneş ve rüzgar enerjisinden elektrik enerjisi üretimi sistemi tasarımı. *Selçuk Üniversitesi Fen Bilimleri Enstitüsü Yüksek Lisans Tezi*, 114s., Konya.
- Karaca, C., Y. Yıldız, M. Dağtekin, Z. Gümüş (2016). Effect water flow rate and cooling effectiveness and air temperature change in evaporative cooling pad systems. *Environmental Engineering and Management Journal*, 15(2):823-827.

- Karacan, R. (2017). Türkiye’de kırmızı et talebinin beyaz et tüketimi ve gelir dağılımı açısından değerlendirilmesi. *Finans Politik ve Ekonomik Yorumlar*, 54(630):67-73.
- Karaman, S., Z. Ulutaş, E. Şirin, Y. Aksoy (2012). Tokat yöresindeki ağıkların yapısal ve çevre koşulları yönünden durumu ve geliştirme olanakları üzerine bir araştırma. *GOÜ Ziraat Fakültesi Dergisi*, 29(2):29-41.
- Karık, F., A. Sözen, M.M. İzgeç (2017). Rüzgar gücü tahminlerinin önemi: Türkiye elektrik piyasasında bir uygulama. *Politeknik Dergisi*, 20(4):851-861.
- Kaymakçı, M., T. Taşkın (1995). Kuzey Kıbrıs Türk Cumhuriyeti koyun yetiştiriciliğinin yapısal özellikleri ve verimliliği (1. Döl verimi ve gelişme özellikleri). *Ege Üniversitesi Ziraat Fakültesi Dergisi*, 36(1-2-3): 125-132.
- Koç, A., H. Yağlı, Y. Koç, İ. Uğurlu (2018). Dünyada ve Türkiye’de enerji görünümünün genel değerlendirilmesi. *Mühendis ve Makina*, 59(692):86-114.
- Koçarlan, G. (2010). Sürdürülebilir kalkınma hedefi çerçevesinde Türkiye’nin rüzgar enerjisi potansiyelinin yeri ve önemi. *Sosyal Bilimler Dergisi*, 4:53-61.
- Koyuncu, M. (2005). Keçi yetiştiriciliğinin dünya ve Türkiye stratejileri. *Süt Keçiciliği Ulusal Kongresi, Bildiriler*, 25-27 May 2005, İzmir:59-65.
- Küsek, G., H.H. Öztürk, Ş. Akdemir (2016). Tarım işletmelerinde güneş enerjisinden elektrik üretiminin tekno-ekonomik uygulanabilirliği. 13. Ulusal Kültürteknik Kongresi, 12-15 Nisan 2016, Antalya:127-136.
- MCT (Republic of Türkiye Ministry of Culture and Tourism) (2023). <https://tekirdag.ktb.gov.tr/TR-75726/genel-bilgiler.html> (Accessed date: 15.06.2023)
- MENR (Republic of Türkiye Ministry of Energy and Natural Resources) (2023). <https://enerji.gov.tr/eigm-resources-en> (Accessed date: 28.07.2023)
- MoEU (Ministry of Environment and Urbanisation) (2020). https://webdosya.csb.gov.tr/db/tekirdag/menu/temiz-hava-eylem-plani-2020-2024-s_20201016045422.pdf
- Olgun, M. (2011). *Tarımsal Yapılar*. Ankara Üniversitesi Ziraat Fakültesi Yayın No: 1577, Ders Kitabı:529, Ankara.
- Özen, A., M.Ü. Şaşmaz, E. Bahtiyar (2015). Türkiye’de yeşil ekonomi açısından yenilenebilir bir enerji kaynağı: Rüzgar enerjisi. *Karamanoğlu Mehmetbey Üniversitesi Sosyal ve Ekonomik Araştırmalar Dergisi*, 17(28):85-93.
- Özkan, U. (2020). Türkiye yem bitkileri tarımına karşılaştırmalı genel bakış ve değerlendirme. *Turkish Journal of Agricultural Engineering Research (TURKAGER) (Türk Ziraat Mühendisliği Araştırmaları Dergisi)*, 1(1):29-43.
- Şenel, M.C., E. Koç (2015). Dünyada ve Türkiye’de rüzgar enerjisi durumu-genel değerlendirme. *Mühendis ve Makina*, 56(663):46-56.
- TAGEM (Agricultural Research and Policy General Directorate) (2009). *Introductory catalogue for domesticated animals genetical resources of Turkey*, Ankara, 24-83.
- Taşkın, T., H.B. Ünal, Ö. Canbolat (2015). *Koyuncululuğun Temel Esasları*. Hasad Yayıncılık, s.106-125, İstanbul.
- Toprak, A. (2011). Elektrik üretimi için düşük güçlü rüzgar enerji sistemi tasarımı. Selçuk Üniversitesi Fen Bilimleri Enstitüsü Yüksek Lisans Tezi, 82s., Konya.
- Tunus, O. (2019). Bursa'da yenilenebilir enerji kaynakları ile elektrik üretim potansiyelinin ekonomik analizi. Bursa Uludağ Üniversitesi Sosyal Bilimler Enstitüsü Yayınlanmamış Yüksek Lisans Tezi, 141s., Bursa.

- Türkboyları, E., A.N. Yüksel (2020). Possibilities of using solar panels in small ruminant barns. 2. International Agricultural, Biological and Life Science Conference, 1-3 September 2020, Edirne:867-877.
- Türkboyları, E., A.N. Yüksel (2021). Possibilities of using wind turbines in disinfection of greenhouse soils. 3. International Agricultural, Biological and Life Science Conference, 1-3 September 2021, Edirne:660-666.
- Türkdoğan S., M.T. Mercan, T. Çatal (2020). Şebekeden bağımsız hibrit enerji sistemleri kullanılarak 40 hanelik bir topluluğun elektrik ve termal yük ihtiyacının karşılanması: Teknik ve ekonomik analizleri. *Avrupa Bilim ve Teknoloji Dergisi*, 18: 476-485.
- Ünal, H.B., H.İ. Yılmaz (2009). Koyun ağıllarında konstrüksiyon özellikleri ve yeni uygulamalar. *Hasad-Hayvancılık*, 24(285):34-37.
- Yağcıoğlu, A. (2005). Sera Mekanizasyonu. Ege Üniversitesi Yayınları Ziraat Fakültesi Yayın No: 562, İzmir.
- Yüksel, A.N., C.B. Şişman (2015). Hayvan Barınaklarının Planlanması. *Hasad Yayıncılık*, s.123-128, İstanbul.
- Yüksel, A.N., E. Yüksel-Türkboyları (2018). Using the photovoltaic cells for ventilation and cooling of the animal barns. 1st International 14th National Congress of Agricultural Structures and Irrigation (ICASI-2018), 26-28 September 2018, Antalya:49-55.
- Yüksel, A.N., E. Yüksel-Türkboyları (2019). Ensuring the ventilation and cooling of poultry houses with zero energy. 1st International Congress on Biosystem Engineering (ICOBEN 2019), 24-27 September 2019, Hatay:148-154.

POSSIBILITIES OF USING WIND ENERGY FROM RENEWABLE ENERGY SOURCES FOR AGRICULTURAL PURPOSES IN WATER BUFFALO BARN AND ENVIRONMENTAL EFFECTS

Elif Türkboyları^{1}, Ahmet Nedim Yüksel²*

¹Vocational School of Technical Sciences, Department of Plant and Animal Production, Tekirdağ Namık Kemal University, Tekirdağ, Turkey

²Faculty of Agriculture, Department of Biosystem Engineering, Tekirdağ Namık Kemal University, Tekirdağ, Turkey

**Corresponding author's e-mail: eyuksel@nku.edu.tr*

ABSTRACT

The continuous increase in the prices of fossil energy sources, which cause various environmental problems, has led humanity to turn to the renewable energy sources, which are clean and sustainable energy sources. Since the agricultural businesses are located far away from electricity networks, it is more appropriate to turn to the renewable energy sources. In places with high wind power potential, such as the Marmara Region, the electricity need of water buffalo barns can be met with a wind turbine system. This study focuses on the use of electrical energy generated by a wind turbine in the water buffalo barns. Since the water buffaloes have few sweat glands in their skin and their skin is thick, it is difficult for them to balance their body temperature. On the other hand, the water buffaloes need water to cool down. Ventilation and cooling of the buffalo barns can be provided by a fan-pad system. In a buffalo barn with a floor area of 540 m² (11.1x48.6 m), a pad area of 21.6 m² is needed for the cooling system. The system should have a 0.2 kWh circulation pump for water circulation. For mechanical ventilation, 10 aspirators with a flow rate of 9500 m³h⁻¹ should be used in the buffalo barn. The highest energy required by the fan-pad system is 7.7 kWh. Due to the random variability of the wind power, depending on the climatic conditions, a wind turbine system of 10 kWh should be used, which is 25 to 30% more than the required 7.7 kWh. By leveraging the wind power potential in Turkey, the country will considerably avoid oil imports and reduce its current account deficit. The use of the wind turbine system as a renewable energy source in agriculture for the generation of electrical energy will significantly reduce CO₂ emissions to nature. In Tekirdağ province, a 10-kWh wind turbine system can generate 18250 kWh of electrical energy per year. Thanks to environment-friendly energy generation, 17155 kg of CO₂ emissions, which is equivalent to the annual electricity generation value, would be prevented. In addition to the fact that the wind turbine energy system is suitable for use in agriculture, preventing CO₂ emission is also a great advantage. The excess energy coming from the wind turbine system can be stored in batteries and used when there is no wind.

Keywords: Anatolian water buffalo, Wind turbine, Water buffalo barn, Ventilation, Cooling

INTRODUCTION

Since the world's population increases rapidly day by day; people's nutrition, shelter and energy problems continue to emerge. Limited natural resources, combined with the rapidly growing population and improving living standards, have also increased the need for energy. While all these energy needs are met with fossil fuels, they have negative impacts on the natural

environment. Emissions of harmful gases into the atmosphere and their negative effects are also very common during the processes of energy generation and use.

At the same time, the fossil energy-poor countries have problems in ensuring their energy supply security due to the climate change and possibility of depletion of fossil fuels within next 50 years as well as the increasing energy demand. For these reasons, studies on the use of renewable energy sources have accelerated. The renewable energy sources can be listed as solar, wind, geothermal, hydraulic, biomass, wave and sea current. The renewable energy sources are energy resources that renewed in nature at a faster rate than they are consumed (Bayraktar and Kaya, 2016).

Thanks to the renewable energy sources, it is possible to meet the need for electrical energy at a certain rate and in a way that does not harm nature and people. The use of renewable energy sources does not only meet the need for electricity, but also help to prevent climate change globally. In this context, energy generation from wind is of great importance due to the high potential of wind power in the northwest of Turkey, ease of use and being environment-friendly (Taktak and Ili, 2018). Turkey has more advantages in terms of renewable energy resources potential, compared to fossil energy resources (Tunus, 2019).

The wind power, which causes very little environmental damage unlike the fossil fuels, is very important for all economies focused on sustainable development. As a country with a very high dependence on foreign energy, Turkey must definitely convert its static energy into kinetic energy. Among the static energies it has, the solar and wind powers are extremely important for the economy (Özen et al., 2015).

In addition to the economic reasons, the need to protect the nature in the light of the environmental awareness created in the recent years as well as the negative effects of global warming, and elimination of greenhouse gas emissions have underlined the importance of renewable energy (Tunus, 2019). The use of renewable energy sources does not only meet the need for electricity but also helps to prevent climate change globally (Taktak and Ili, 2018).

Wind Energy and Economic Value of Turkey's Wind Energy Potential

Wind energy is the fastest developing and most invested source of energy among all renewable energy sources in the world. Wind is caused by the differential heating of the earth due to solar radiation. Air temperature and humidity will be different in places heated differently. As a result, anticyclones and cyclones are formed. The movement of air is from the anticyclone to the cyclone. The wind changes based on time and location due to local geographical differences and inhomogeneity of the earth. Since this air movement is combined with the earth's rotation around itself, air movements carrying high levels of kinetic energy occur. The wind power is the result of the conversion of the kinetic energy in the air mass into mechanical energy. Wind is evaluated with two data: direction and speed. The wind speed increases with height and its theoretical power changes as the cube of its speed (MENR, 2023).

In Turkey, winds are generated by the differences between the anticyclones and cyclones, constantly seen between the cold Black Sea and North Asian Steppe and the warm Aegean and Mediterranean Regions. These pressure differences cause strong and continuous winds in the Thrace, South Marmara, Aegean and Mediterranean coasts (Koçarslan, 2010). Tekirdağ province, where the study was carried out, is located in the northern Marmara Region and, therefore, has a significant wind potential.

Turkey has significant potential in terms of wind energy. As a matter of fact, it is accepted that a wind power plant with a power of 5 MW per square kilometer can be established at location which are 50 m above ground level and have wind speeds above 7.5 ms^{-1} . According to these assumptions, the Wind Power Potential Atlas (REPA) was prepared using a medium-scale numerical weather forecast model and a micro-scale wind flow model. Accordingly, Turkey's wind energy potential is determined as 48000 MW. The total area corresponding to this

potential is 1.3% of Turkey's surface area (MENR, 2023). This potential can be portrayed in economic terms as follows. Since a barrel of oil produces 775 kWh (0.775 MWh) of energy, 48000 MW of wind energy (48000 MW/0.775=61935) is equivalent to 61935 barrels of oil. In September 2022, 1 barrel of oil was around 95 dollars and the economic value of wind energy potential was equal to 5.88 billion dollars (Özen et al., 2015). Thus, we, as a country, might save up to 5.88 billion dollars in a year if we use the wind power effectively. This will both reduce our foreign dependence in terms of energy and significantly contribute to our economy in terms of closing the current account deficit of our country.

Wind Turbine

It is possible to use wind power as electrical energy in remote settlements, islands, rural areas, agricultural operations, forest and mountain areas where the electricity network is not available. Household type small wind turbines are highly suitable for personal use in areas with high wind efficiency and far from the network (Toprak, 2011).

Wind turbines are the main structural component of the wind power plants. When the kinetic energy of the moving air hits the blades of the wind turbines, it is transformed into mechanical energy and eventually into electrical energy. The wind turbines can only start generating electricity at a certain wind speed. A wind turbine produces energy between the cut-in and cut-out speeds. Modern wind turbines have cut-in speeds between 2 to 4 ms⁻¹, nominal speeds between 10 to 15 ms⁻¹ and cut-out speeds between 25 to 35 ms⁻¹. At a wind speed specified for each wind turbine, the power generated from the system reaches the highest value. The maximum power is reached at the nominal wind speed. The wind turbines automatically stop at the cut-out wind speed, which is the maximum wind speed, to prevent damages to the system (MENR, 2023).

When the wind hits the blades of the turbine, it activates the blades. The rotating blades transmit the rotational motion to the generator through the shaft. In order to make this rotational movement faster, the movement is accelerated by means of a gearbox. This kinetic energy of the wind is converted into mechanical energy and finally into electrical energy by the generator. The electrical energy transferred to the power converter unit is adapted to the network or consumer criteria and then transferred to the user (Yaylacı and Yazıcı, 2019). The wind turbine system includes the wind turbine, charge control unit, braking system, battery (storage battery) group, turbine tower (mast), cables and control panel (Tunus, 2019).

Water Buffalo Barns and Use of Wind Turbine System

Water plays an important role in the life of a water buffalo and this animal is known as a water buffalo all around the world and as an Anatolian water buffalo in our country. The water buffaloes are divided into two main classes: swamp and river water buffaloes. Swamp buffaloes are common in China, Thailand, the Philippines and Southeast Asia. The river buffaloes are common in the Western India, Egypt and Europe (Subasinghe et al., 1998). In the Asian countries where buffaloes can be seen quite a lot; buffalo milk, meat and its draught power are also used (Yüksel and Türkboyları, 2021).

There is not sufficient information about the water buffaloes and water buffalo barns in Europe and in our country (Yüksel and Şişman, 2015). Therefore, in determining the dimensions of the buffalo barns, standards recommended for cattle might be used based on water buffaloes' body surface areas (Hurnik and Lewis, 1991).

Ventilation of the barns ensures that excess heat, humidity, harmful gases, dust and foul odors are removed from the animal barns. This assures availability of suitable environmental conditions and comfortable living conditions in a barn. Climatic and chemical environmental conditions inside a barn are kept at an appropriate level through ventilation (Yüksel and Şişman, 2015).

Inadequate ventilation causes unfavorable environmental conditions for the animals. The productivity of animals living in poorly ventilated barns decreases, their development slows down, and the risk of contracting diseases increases (Yüksel and Yüksel-Türkboyları, 2018). If there is not enough ventilation in the barn, these foul odors in the barn's air might pass into the milk and reduce the quality of the milk.

It is known that air pollutant gas emissions from the water buffalo barns sometimes reach to an extent that can adversely affect animal, environmental and human health (Kocaman et al., 2018a). Therefore, the water buffalo barns should be adequately ventilated.

Ventilation in animal barns can be done naturally and mechanically. The natural ventilation does not provide the desired effect on hot days when the number of animals is high and air movement outside is low. In such cases, the adequate ventilation and cooling in animal barns can only be provided with mechanical ventilation. If ventilation for heat balance in the water buffalo barns is supported by fogging method, the capacity of the ventilation system may be slightly lower (Kocaman et al., 2018b).

The Animal barns must be located in rural areas. According to the environmental protection law, they must be located at least 1000 m away from the residential areas. As a result of this obligation, they are generally far from the city networks and may have difficulty in accessing electrical energy. In rural areas, electrical energy can be generated with the renewable energy sources in agricultural buildings when there is no electrical energy, when there is a power blackout, or in order to reduce energy costs (Yüksel and Yüksel-Türkboyları, 2018).

The use of renewable energy sources in agriculture is possible with photovoltaic cells and wind turbines. The electrical energy obtained from the wind turbines can be used for ventilation of greenhouses and animal barns. Here, the most important factor is that Thrace, where the study was conducted, is the center of the country with its significant wind power potential (Bilgili et al., 2010).

The aim of this study is to study the use of wind turbines to meet the electrical energy requirement for mechanical ventilation of the animal barns because electricity network is generally scarce in the rural areas where animal barns are located. The fan and pad system will be operated with the electricity generated from the wind turbine system to be installed in the animal barns. In this way, ventilation and cooling of the barn can be assured.

MATERIALS AND METHOD

Turkey consists of two large peninsulas. The larger of these two peninsulas, namely the Anatolian peninsula, is located in west of the Asian continent. The smaller peninsula, namely the Thracian peninsula, is located in the southeast of Europe.

Tekirdağ province is the research area and it is located between 26°41' -28°10' east longitudes and 40°35' -41°35' north latitudes on the Thracian peninsula. Located in the north of the Marmara Sea, Tekirdağ has a surface area of 6313 km². Tekirdağ is slightly undulating in terms of surface features. The area does not have any high mountains, steep slopes and deep valleys. Based on its general humidity levels, Tekirdağ falls into the semi-humid climate type. Tekirdağ region is windy in summer and winter seasons (MCT, 2023).

According to the wind power potential atlas, Tekirdağ and Marmara coasts of our country have high wind speed (Tunus, 2019). Therefore, Tekirdağ has an important advantage in terms of generating electrical energy from wind with wind turbines.

There are large water buffalo barns in and around Tekirdağ province. These producers supply products such as water buffalo milk, clotted cream and butter to dessert and pastry producers in Istanbul. A project will be designed to for ventilating and cooling the water buffalo barns based on the conditions of Tekirdağ province. In order to ensure adequate ventilation and cooling in the water buffalo barns in all seasons, mechanical ventilation is required. There are 60 buffaloes

in the tie-stall barn where the project will be implemented and the dimensions of the barn are approximately 540 m² (11.1x48.6=539.5) (Avcı, 2015).

Method

Water is used to balance the body temperature in the water buffalo barns. Effective use of water in the water buffalo barns can be done with a fan-pad system. Water evaporation is utilized for cooling and using fan-pads in the animal barns. The cooling effect of water is achieved by using a wet pad. As 1 gram of water passing through the pad evaporates, 598 cal (2500 J) of sensible heat is removed from the air. With the effect of aspirators, the air inside the barn is removed. Instead of this, the air entering into the barn is charged with water vapor as it passes through the wet pads. All of the latent heat of vaporization required for the evaporation of water in the pad is taken from the sensible heat of the air. Thus, the temperature of the air entering into the barn and charged with humidity is also reduced. In case of the wet pads, the temperature inside the barn varies between 6 °C to 16 °C depending on the climatic conditions of that particular location and the season (Abdalla and Narendran, 1991; Karaca et al., 2016).

For a barn housing 60 water buffaloes with the dimensions previously mentioned; a project, including ventilation fans, pads for cooling (wet pads) and wind turbines to generate electricity for them, should be designed.

Use of Fan-Pad System in Water Buffalo Barns

Data on the water buffaloes are created by comparing them with cattle. The sizes are recorded slightly larger. However, the water buffaloes are physiologically different from the cattle. The sweat glands in their bodies are much less than those of cattle and their skin is thicker. Therefore, the air temperature inside the barn is very important. Since they cannot sweat enough, they have difficulty in balancing their body temperature. The indoor air temperature of the barn has a great effect on milk yield and prolongation of lactation period (Kocaman and Kurç, 2018).

Meat and milk yields are negatively affected as the environmental conditions in the barn rapidly deviate from the comfort zone and stress out the animals (Avcı, 2015; Kocaman and Kurç, 2014).

Water can be used for cooling in the water buffalo barns with a fan-pad system. In order to use the wet pads in the water buffalo barns, fans and mechanical ventilation are needed. To provide mechanical ventilation, aspirators are placed on the wall opposite the barn wall where the wet pads are located (Figure 1). The system is generally installed on the walls along the length of the barn. When the aspirators start working, the used and contaminated air inside the barn is exhausted from the barn. Due to the low pressure inside the barn, the air passing through the wet pads, which is charged with moisture and has decreasing temperature, starts to fill up the barn (Yüksel and Şişman, 2015; Yüksel and Yüksel-Türkboyları, 2019; Boyacı et al., 2012).



Figure 1. Water buffalo barns, wind turbine system and elements of ventilation and cooling systems

Designing a Fan-Pad Project to be Used in Water Buffalo Barns

For the design of a fan-pad project to be used for ventilation and cooling in water buffalo barns, specific data is needed. These are the dimensions of the barn and the number of animals in that barn. There are 60 water buffaloes in the stall barn to be used in the project. The width of the water buffalo barn is 11.1 m, length is 48.6 m, height is 3 m, and floor area is 540 m² (Avcı, 2015).

For every 25 m² floor area of the animal barn, 1 m² pad area is needed and 21.6 m² pad area will be sufficient for this barn (Yüksel and Yüksel-Türkboyları, 2018). In order to cool down the pad, it must be constantly wetted. A 0.2 kWh circulation pump must be operated to transfer the water to the top of the pad.

Data about the number of animals and amount of ventilation should be available when designing the ventilation system in the water buffalo barns. Living conditions will be significantly improved by ventilation in the barn environment. In order to remove the excess heat and humidity accumulated in the environment by operating the fans, ventilation between 0.35 and 3.5 m³ h⁻¹ kg⁻¹ should be done for ruminant cattle, depending on the seasons and live weight. The average value of this can be considered as 1.925 m³ h⁻¹ kg⁻¹ (Wathes and Charles, 1994). The average weight of the Anatolian water buffaloes is around 500 kg (TAGEM, 2009). According to the average weights of the water buffaloes, the amount of ventilation in the Anatolian water buffalo barn can be calculated as follows in this project.

$$1.925 \times 60 \times 500 = 57750 \text{ m}^3 \text{ h}^{-1}$$

The fans to be used in the system should preferably have a diameter of 60 cm for quieter operation. Fans with a diameter of 60 cm have a flow rate of 9500 m³ h⁻¹, power of 0.75 kWh; cycles are 1400 rpm (dd⁻¹) and monophase is 230 V (Anonymous, 2022). The number of fans that will provide air exchange in the barn can be calculated as follows:

$$57750 \text{ m}^3 \text{ h}^{-1} / 9500 \text{ m}^3 \text{ h}^{-1} = 6.07 \sim 6 \text{ pcs}$$

The aspirators cannot be effective in ventilation over long distances. For this reason, fans should be placed at certain intervals such as 15 to 20 m in barns with a longer length. Thus, the mechanical ventilation of the barn will be more effective (Yüksel and Yüksel-Türkboyları, 2018). Therefore, in a 48.6-meter-long water buffalo barn, 2 more fans should be placed at 17-

18 m and 36-38 m to ensure efficient ventilation. The number of fans to be used in the system will be 10. Accordingly, 10 fans with a power of 0.75 kWh and a circulation pump with a power of 0.2 kWh are needed for the ventilation and cooling system in a water buffalo barn housing 60 water buffaloes. The total energy requirement of the system can be calculated as follows:

$$10 \text{ pcs} \times 0.75 \text{ kWh} + 0.2 \text{ kWh} = 7.7 \text{ kWh}$$

RESULTS AND DISCUSSION

A wind turbine ventilation and cooling system has been designed for a specific type of animal barn: a closed type barn housing 60 Anatolian water buffaloes. A 7.7 kWh wind turbine system is needed to provide the desired environmental conditions in the water buffalo barn. The system to be installed for this purpose should provide an air flow of $57750 \text{ m}^3 \text{ h}^{-1}$ with 10 fans. The pad system requires an area of 21.6 m^2 for cooling and a 0.2 kWh circulation pump for water supply. This system needs a wind turbine larger than the calculated 7.7 kWh, such as 10 kWh, in order to work efficiently because there is a time mismatch in the wind power. In other words, energy cannot be generated when energy is needed (Tunus, 2019). In addition, the wind, which blows constantly but at a regular speed or does not blow at all, prevents generation of the required energy. For these reasons, a system larger than the needed system should be preferred. The wind turbine system will work more efficiently if it is supported by solar panels or a diesel generator, as hybrid energy options.

The excess energy generated when the system runs at full capacity is stored in batteries to be used when there is no wind. At the same time, the excess energy can be used for the hydrophore used in animal barns, milking and manure stripping machines or for interior lighting.

Environmental Impact of Wind Turbine Energy System

In Turkey, a significant portion (21%) of the installed electrical energy capacity is generated from thermal power plants, i.e., coal (Orhan and Şahin, 2022). Coal-fired thermal power plants emit a significant amount of CO₂ gas into the atmosphere to generate electrical energy. According to the Carbon Neutral Charitable Fund (CNCF), the amount of CO₂ emitted to the atmosphere by thermal power plants to generate 1 kWh of electrical energy is 0.94 kg CO₂ gas (CNCF, 2023). Taking this figure into account, the amount of CO₂ prevented from being emitted into the atmosphere is calculated in kilograms by multiplying 0.94 with the amount of energy generated in kWh per year by a facility producing with renewable energy sources. This shows the importance of switching to renewable energy sources for protecting the environment. A 10.0 kWh wind turbine system will be used in the planned study. This means that the system will generate 8 kW of electric energy per hour. The turbine system might run for a shorter duration on some days and for a longer duration on others. When it runs longer, the batteries are activated to store the excess energy. On days when it works for a shorter period of time, the batteries feed the system. Since the power of the wind turbine system is 10 kWh and it will operate 5 hours per day, the amount of energy it will generate in a year (365 days) will be

$$10 \text{ kWh} \times 5 \text{ hour} \times 365 \text{ day} = 18250 \text{ kWh}$$

With this generated electrical energy, 17155 kg ($18250 \times 0.94 = 17155 \text{ kg}$) CO₂ emission would be prevented. Switching to renewable energy sources is the best solution to reduce the high amount of CO₂ to be emitted to the atmosphere while generating energy with fossil fuels.

CONCLUSION

The use of wind energy, one of the renewable energy sources, is possible for agricultural purposes in very windy regions such as the Thrace region. The electrical energy generated with the wind turbines helps to solve the energy problem in rural areas and meets the electricity needs of mechanical ventilation. However, natural ventilation system is widely used in animal barns in our country. Natural ventilation cannot provide the desired environmental conditions in barns during hot seasons.

In the water buffalo barns; excess heat, humidity, harmful gases, dust and foul smells can be removed from the barn with mechanical ventilation in order to provide suitable environmental conditions and comfortable living conditions. The primary purpose in animal production is to ensure comfortable living conditions through the indoor environmental conditions of a barn for assuring quality and high yield. This also accelerates the development of animals and reduces the risk of disease.

Adequate ventilation and cooling of the water buffalo barns can be done with fan pad systems. Electrical energy is needed for the operation of the fan pad system. However, the fact that animal barns are located in rural areas may limit the use of electrical energy. This problem can be overcome with the use of wind turbines along the coasts of the Marmara Sea, which has sufficient wind power potential, and with the electrical energy to be generated in this way. In regions where the wind power is sufficient in our country, it is possible to use wind energy systems for agricultural purposes.

REFERENCES

- Abdalla AM., R. Narendran (1991). Fog emitters as evaporative cooling devices for dairy cow sheeds. *Agricultural Mechanization in Asia, Africa and Latin America (AMA)*, 22(1): 73-76.
- Anonymous (2022). <https://www.hvacturk.com/urun/ayas-60-cm-7-kanatli-sanayi-tipi-aspirator> (Accessed date: 26.10.2022)
- Avcı, H. (2015). İstanbul İli Avrupa Yakasındaki Manda İşletmelerinin Yapısal ve Mekansal Özelliklerinin Belirlenmesi Üzerine Bir Çalışma. Namık Kemal Üniversitesi Fen Bilimleri Enstitüsü Biyosistem Mühendisliği Anabilim Dalı, Yüksek Lisans Tezi, 69s., Tekirdağ.
- Bayraktar, Y., H.İ. Kaya (2016). Yenilenebilir Enerji Politikaları ve Rüzgâr Enerjisi Açısından Bir Karşılaştırma: Çin, Almanya ve Türkiye Örneği. *Uluslararası Ekonomik Araştırmalar Dergisi*, 2(4):1-18.
- Bilgili, M., B. Şahin, E. Şimşek (2010). Türkiye'nin Güney, Güneybatı ve Batı Bölgelerindeki Rüzgar Enerjisi Potansiyeli. *Isı Bilimi ve Tekniği Dergisi*, 30(1):1-12.
- Boyacı S., A. Akyüz, S. Gençoğlan, Ş. Baydar (2012). Etlik piliç kümeslerinin fan ped sistemiyle serinletilmesi. 2. Ulusal Sulama ve Tarımsal Yapılar Sempozyumu, 24-25 Mayıs 2012, İzmir:949-954.
- CNCF (Carbon Neutral Charitable Fund) (2023). <https://carbonpositiveaustralia.org.au/calculate/> (Accessed date: 01.08.2023)
- Hurnik, C.F., N.J. Lewis (1991). Use of body surface area to set minimum space allowances for confined pigs and cattle. *Canadian Journal of Animal Science*, 71(2):577-580.
- Karaca, C., Y. Yıldız, M. Dağtekin, Z. Gümüş (2016). Effect of water flow rate on cooling effectiveness and air temperature change in evaporative cooling pad systems. *Environmental Engineering and Management Journal*, 15:823-827.

- Kocaman, İ., B.C. Şişman, H.C. Kurç, E. Gezer (2018a). A study on gas emissions and environmental impacts from traditional water buffalo barns in Turkey. *Fresenius Environmental Bulletin*, 27(4):2173-2179.
- Kocaman, İ., B.C. Şişman, H.C. Kurç (2018b). A research on determination of ventilation capacity for heat-humidity and CO₂ balance in closed type water buffalo barn. *Journal of Scientific and Engineering Research*, 5(10):66-71.
- Kocaman, İ., H.C. Kurç (2018). A research on the determination of lactation length and milk yield of Anatolian water buffaloes under different environmental conditions. *Journal of Scientific and Engineering Research (JSER)*, 5(8):39-44.
- Kocaman, İ., H.C. Kurç (2014). Climatic environmental conditions of water buffalo barns. *The Journal of Association of İstanbul Water Buffaloes Breeders*, 2(1):43-48.
- Koçarslan, G. (2010). Sürdürülebilir Kalkınma hedefi çerçevesinde Türkiye'nin rüzgar enerjisi potansiyelinin yeri ve önemi. *Sosyal Bilimler Dergisi*, 4:53-61.
- MCT (Republic of Türkiye Ministry of Culture and Tourism) (2023). <https://tekirdag.ktb.gov.tr/TR-75726/genel-bilgiler.html> (Accessed date: 15.06.2023)
- MENR (Republic of Türkiye Ministry of Energy and Natural Resources) (2023). <https://enerji.gov.tr/eigm-resources-en> (Accessed date: 28.07.2023)
- Orhan, N., S. Şahin (2022). Bir Besi Çiftliğinde Güneş Enerji Sisteminin Uygulanması ve Ekonomik Analizi, *Türk Tarım ve Doğa Bilimleri Dergisi*. 9(1):33-40. <https://doi.org/10.30910/turkjans.1013347>
- Özen, A., M.Ü. Şaşmaz, E. Bahtiyar (2015). Türkiye'de yeşil ekonomi açısından yenilenebilir bir enerji kaynağı: Rüzgar enerjisi. *Karamanoğlu Mehmetbey Üniversitesi Sosyal ve Ekonomik Araştırmalar Dergisi*, 17(28):85-93.
- Subasinghe, D.H.A., N.U. Horadogoda, H. Abeygunawardena, J.A.S. Siriwardene (1998). Water buffalo–improved utilisation through new technologies. *National Science Foundation, Sri Lanka*.
- TAGEM (Agricultural Research and Policy General Directorate) (2009). Introductory catalogue for domesticated animals genetical resources of Turkey. Ankara, 22-23p.
- Taktak, F., M. İli (2018). Güneş Enerji Santrali (GES) Geliştirme: Uşak Örneği, *Geomatik Dergisi*, 3(1):1-21.
- Toprak, A. (2011). Elektrik üretimi için düşük güçlü rüzgar enerji sistemi tasarımı. Selçuk Üniversitesi Fen Bilimleri Enstitüsü Yüksek Lisans Tezi, 82s., Konya.
- Tunus, O. (2019). Bursa'da yenilenebilir enerji kaynakları ile elektrik üretim potansiyelinin ekonomik analizi. Bursa Uludağ Üniversitesi Sosyal Bilimler Enstitüsü Yayınlanmamış Yüksek Lisans Tezi, 141s., Bursa.
- Wathes, C.M., D.R. Charles (1994). *Livestock Housing*. CAB International, ISBN 085198 774 5 [book review], Wallingford, Oxon, UK.
- Yaylacı, E.K., İ. Yazıcı (2019). Otonom bir Rüzgâr Enerji Sistemi için Örnek Test Düzenine Gerçekleşmesi. *Gazi Üniversitesi Fen Bilimleri Dergisi, Part C*, 7(1):175-183.
- Yüksel, A.N., C.B. Şişman (2015). Hayvan barınaklarının planlanması. *Hasad Yayıncılık*, s.123-128, İstanbul.
- Yüksel, A.N., E. Türkboyları (2021). Use of solar panels in water buffalo barns for providing climatic environmental conditions. *Iğdır International Applied Sciences Congress*, 14-15 April 2021, Iğdır:301-310.
- Yüksel, A.N., E. Yüksel-Türkboyları (2019). Ensuring the ventilation and cooling of poultry houses with zero energy. *1st International Congress on Biosystem Engineering (ICOBEN 2019)*, 24-27 September 2019, Hatay:148-154.
- Yüksel, A.N., E. Yüksel-Türkboyları (2018). Using the photovoltaic cells for ventilation and cooling of the animal barns. *1st International 14th National Congress on Agricultural Structures and Irrigation*, 26-28 September 2018 (ICASI-2018), Antalya:49-55.

PARTICIPANT LIST

#	<u>NAME</u>	<u>SURNAME</u>	<u>E MAIL</u>	<u>COUNTRY</u>
1	Alma	Imeri	aimer@ubt.edu.al	Albania
2	Arben	Haziri	arben.haziri@uni-pr.edu	Albania
3	Dhimiter	Peci	dhimiter.peci@fshn.edu.al	Albania
4	Ina	Nasto	ina.nasto@yahoo.com	Albania
5	Julian	Karauli	jkarauli@ubt.edu.al	Albania
6	Marjol	Meço	mariol.meco@yahoo.com	Albania
7	Marsida	Bllaca	mblaca@ubt.edu.al	Albania
8	Stela	Ruci	stela.ruci@fshn.edu.al	Albania
9	Rana	Khankishiyeva	renanamazova0@gmail.com	Azerbaijan
10	Zəminə	Bünyatzadə	zbunyatade@gmail.com	Azerbaijan
11	Katica	Arar	katica.arar@gmail.com	Bosnia Herzegovina
12	Sonja	Umićević	sonja.raseta@igr.unibl.org	Bosnia Herzegovina
13	Velida	Bakić	velida.durmic@yahoo.com	Bosnia Herzegovina
14	Angel	Sarov	angel.sarov@gmail.com	Bulgaria
15	Ani	Georgieva	georgieva_any@abv.bg	Bulgaria
16	Emil	Vasilev	vasilev_642@abv.bg	Bulgaria
17	Evgeniya N.	Ivanova	geneiv@uni-plovdiv.bg	Bulgaria
18	Georgi	Bonchev	georgi.bonchev71@gmail.com	Bulgaria
19	Inna	Sulikovska	inna_sulikovska@ukr.net	Bulgaria
20	Irina	Moskova	irinamoskova@yahoo.com	Bulgaria
21	Krasimira	Tasheva	krasitasheva@abv.bg	Bulgaria
22	Maria	Lazarova	m.lazarova@gmail.com	Bulgaria
23	Mariana	Petkova	mpetkova@au-plovdiv.bg	Bulgaria
24	Milen	Chaney	mchaney@space.bas.bg	Bulgaria
25	Nikolaya	Velcheva	nikolaya_velcheva@abv.bg	Bulgaria
26	Penka	Vasileva	pvasileva@uni-plovdiv.bg	Bulgaria
27	Vasil	Georgiev	vasgeorgiev@gmail.com	Bulgaria
28	Vasilissa	Manova	manovavasilissa@gmail.com	Bulgaria
29	Vesela	Yancheva	vyancheva@uni-plovdiv.bg	Bulgaria
30	Viliana	Vasileva	viliana.vasileva@gmail.com	Bulgaria
31	Yana	Koycheva	yana.koicheva@gmail.com	Bulgaria
32	Elena	Petkova	asiliana@abv.bg	Bulgaria
33	M. Mansi	Joseph	mansibas@gmail.com	Congo
34	Mbah Alma	Andoh	mbah.alma@aiesec.net	Camerun
35	Abbaci	Sameh	sameh.abbaci@yahoo.com	Algeria
36	Abdelfettah	Gherib	a.gherib@crbt.dz	Algeria
37	Abdelkrim	Kameli	abdelkrim.kameli@g.ens-kouba.dz	Algeria
38	Abdelmalek	Oulmi	oulmi@yahoo.fr	Algeria
39	Abdelouahab	Belhadj	abdelouahab.belhadj@g.ens-kouba.dz	Algeria
40	Abdenacer	Mouffok	mouffok_adel@univ-setif.dz	Algeria
41	Abderrezak	Kennas	kennas-a@univ-boumerdes.dz	Algeria
42	Abed	Aicha	a.abed@univ-dbkm.dz	Algeria
43	Adjlane	Noureddine	adjanenoureddine@hotmail.com	Algeria
44	Ahmed	Kabouche	ahmedkabouche6@gmail.com	Algeria

45	Aicha	Fetati	a.fetati@univ-mascara.dz	Algeria
46	Oudahmane	Samira	s_akdader@yahoo.fr	Algeria
47	Ali	Aouabed	aouabed@hotmail.com	Algeria
48	Ali	Guendouz	guendouz.ali@gmail.com	Algeria
49	Alia	Telli	alia.telli5618@gmail.com	Algeria
50	Allaoua	Silini	siliniallaoua@univ-setif.dz	Algeria
51	Allaoua	Nouri	allaoua03@hotmail.fr	Algeria
52	Amer	Fenchouch	fenchouchamer@yahoo.com	Algeria
53	Amina	Hammoudi	aminahammoudi14@gmail.com	Algeria
54	Ammar	Kalem	ammam.kalem@gmail.com	Algeria
55	Amrani	Ahlem	ahlem.amrani@edu.ensa.dz	Algeria
56	Amrani	Amina	amrani81@yahoo.fr	Algeria
57	Aouacheri	Ouassila	aouacheriwa@yahoo.fr	Algeria
58	Aribi	Djihad	djihad.aribi@edu.ensa.dz	Algeria
59	Asmaa	Guessab	guessab71@gmail.com	Algeria
60	Asselah	Amel	asselah.amel@yahoo.fr	Algeria
61	Assia	Belguet	assiasetif@gmail.com	Algeria
62	Ayad Loucif	Wahida	wahloucif@yahoo.fr	Algeria
63	Ayadi	Ouarda	ayadioird@yahoo.com	Algeria
64	Azri	Naima	naima.azri@univ-biskra.dz	Algeria
65	Badreddine	Attir	attir.badreddine@gmail.com	Algeria
66	Bechiri	Loubna	loubnainata@yahoo.fr	Algeria
67	Behar	A. A. Abdellah	faslawafaadjamila@gmail.com	Algeria
68	Bellebcir	Leila	leila.bellebcir@univ-biskra.dz	Algeria
69	Belmeskine	Hayet	hbelmeskine69@gmail.com	Algeria
70	Benabid	Hamida	h.benabid@umc.edu.dz	Algeria
71	Benahmed	Fatiha	biochimie88@gmail.com	Algeria
72	Benchaaâne	Samia	benchaabanesamia@yahoo.com	Algeria
73	Bencheikh	Amor	Benchomar@univ-setif.dz	Algeria
74	Benlaksira	Bouchra	benlaksira25@gmail.com	Algeria
75	Benmeslem	Karima	ka.benmeslem@gmail.com	Algeria
76	Bennadja	Salima	salimabennadja0@gmail.com	Algeria
77	Benoussaid	Nacera	nacerabenoussaid@yahoo.fr	Algeria
78	Bensoltane	Samira	bensoltane_samira@yahoo.fr	Algeria
79	Bergal	Amira	amourabergal@yahoo.fr	Algeria
80	Berghiche	Hinda	hindabentoubal@hotmail.ca	Algeria
81	Berrai	Hassiba	hassiba.berrai@edu.ensa.dz	Algeria
82	Bicha	Sabrina	bichasabrina2016@gmail.com	Algeria
83	Bouchareb	Mokhradhya	radia.bouchareb@umc.edu.dz	Algeria
84	Boucif	Ouarda El Wahida	fatibiosnv@gmail.com	Algeria
85	Boudeffa	Khaled	k.boudeffa@univ-skikda.dz	Algeria
86	Bouderbala	Djazia	Nourhane_hyd@hotmail.fr	Algeria
87	Boudraa	Loubna	loubna.boudraa@univ-biskra.dz	Algeria
88	Boufermes	Radia	boufermes@yahoo.fr	Algeria
89	Bougherra	Fateh	bougherra_f@yahoo.fr	Algeria
90	Boukhari	Ibtissem	basma131@live.fr	Algeria
91	Boumaza	Ouahiba	ouahibaboumaza@yahoo.fr	Algeria
92	Bounechada	Mustapha	bounechadam@yahoo.fr	Algeria
93	Bourahla	Amel	amel.bourahla@univ-bba.dz	Algeria
94	B. Bouhafis	Naziha	bourenanenaziha@yahoo.fr	Algeria

95	Boussaïd	Linda	linda.boussaïd@hotmail.fr	Algeria
96	Boutabia	Lamia	b_lamiadz94@yahoo.fr	Algeria
97	Brahim	Amina Cherifa	aminacherifa.brahim@univ-usto.dz	Algeria
98	Chahera	Hamane	hamane.chahera@edu.univ-oran1.dz	Algeria
99	Charchar	Nabil	n.charchar@crbt.dz	Algeria
100	Chebaani	Meriem	meriem.chebaani@g.ens-kouba.dz	Algeria
101	Chebbi	Rachid	r.chebbi@univ-biskra.dz	Algeria
102	Cheniti	Khalissa	khalissacheniti@gmail.com	Algeria
103	Chergui	Achour	biochimie.labo15@gmail.com	Algeria
104	Chetouh	Zineb	zineb.chetouh@univ-ueb.dz	Algeria
105	Chiali	Fatima Zohra	lm_biochimie_07@yahoo.fr	Algeria
106	Chouabia	Amel	amelchouabia@gmail.com	Algeria
107	Chouahda	Salima	chouahda_s@yahoo.fr	Algeria
108	Chouari	Zhor	chouarizhor33@gmail.com	Algeria
109	Chouitah	Ourida	chouitah_o@yahoo.fr	Algeria
110	Dahel	Amina Tania	dahel-amina@univ-eltarf.dz	Algeria
111	Dakhouché	Soumia	dakhouchesoumia90@gmail.com	Algeria
112	Dalila	Bereksi Reguig	dalilabereksi13@gmail.com	Algeria
113	Debabeche	Nedjla	nadjela.debabeche@univ-biskra.dz	Algeria
114	Derardja	Imene	imene.derardja@univ-biskra.dz	Algeria
115	Derbane	Said	derbane_said@yahoo.fr	Algeria
116	Derouiche	Meriem	derouichemeriem11@gmail.com	Algeria
117	Dib	Loubna	dib.loubna@univ-eltarf.dz	Algeria
118	Djabourabi	Aïcha	djabourabiaïcha@yahoo.fr	Algeria
119	Djafer	Rachid	djafertox@yahoo.fr	Algeria
120	Djalel Eddine	Gherissi	biotech.zootech@gmail.com	Algeria
121	Djamila	Deffairi	tahadjam@yahoo.fr	Algeria
122	Djamila	Cherfaoui-Yami	djamila.cherfaoui@ummto.dz	Algeria
123	Djihed	Hamdani	hamdani.djihed@edu.univ-oran1.dz	Algeria
124	El Hassasna	Souhir	souhir.elhassasna@univ-tebessa.dz	Algeria
125	Elkolli	Meriem	elkolli@yahoo.fr	Algeria
126	Fadel	Amar	am.fadel@univ-biskra.dz	Algeria
127	Fadhela	M. Mahmoud	m-fadhela@netcourier.com	Algeria
128	Fadhila	Mansour	fadhila.mansour@univ-tebessa.dz	Algeria
129	Farhi	Kamilia	k.farhi@univ-biskra.dz	Algeria
130	Farida	Kadri	fakad74@gmail.com	Algeria
131	Fateh	Chouia	fateh.chouia@univ-biskra.dz	Algeria
132	Fayçal	Meziri	meziri_faycal@yahoo.fr	Algeria
133	Fekrache	Fadila	fadilafekrache@yahoo.fr	Algeria
134	Fella	Chergui-Hamaidi	hamaidifella@yahoo.fr	Algeria
135	Fenghour	Fenghour	asma.fenghour@gmail.com	Algeria
136	Filali	Mira	m.filali@univ-dbk.m.dz	Algeria
137	Fizazi	Anissa	anissa.fizazi@gmail.com	Algeria
138	Gacem	Habiba	ritadjbiba7@gmail.com	Algeria
139	Ghadbane	Mouloud	mouloud.ghadbane@univ-msila.dz	Algeria
140	Gharabi	Dhia	gharabidhia@yahoo.fr	Algeria
141	G. Amara	Djilani	djilani-ghemamamara@univ-eloued.dz	Algeria
142	Hacene	Laouedj	laouedj-hacene@univ-eloued.dz	Algeria
143	Hacib	Hinda	h.hacib12@gmail.com	Algeria
144	Hadia	Rizi	h.rizi@univ-eltarf.dz	Algeria

145	Hadj Mostefa Khelladi	hadjmostefa.khelladi@univ-mascara.dz	Algeria
146	Hafsa Cherif-Silini	cherifhafsa@univ-setif.dz	Algeria
147	Hajira Berredjem	h_berjem@yahoo.fr	Algeria
148	Halmi Sihem	halmi.sihem@umc.edu.dz	Algeria
149	Hamdani Sarra	hamdanisarra13@gmail.com	Algeria
150	Hamdani Amel	a_hamdaniamel@yahoo.fr	Algeria
151	Hamdi Leila	leila_hamdi07@yahoo.fr	Algeria
152	Haou Abir	haouabir85@gmail.com	Algeria
153	H. Hafida Boukhalifa	h.boukhalifa@univ-biskra.dz	Algeria
154	Heni Sonia	heni.sonia@yahoo.com	Algeria
155	Hicham Boughendjioua	boughendjioua.hicham@yahoo.com	Algeria
156	Houneida Benbouzid	benbouzid_h@yahoo.com	Algeria
157	Houria Mataoui	houria.mataoui@univ-dbk.m.dz	Algeria
158	Idir Moualek	moualek_idir@yahoo.fr	Algeria
159	Imane Ghouri	imaneghouri@yahoo.fr	Algeria
160	Isma Merad	meradisma@hotmail.fr	Algeria
161	Kaci Zakia	z.kaci@univ-dbk.m.dz	Algeria
162	Kadi Hanane	hanane.kadi@umc.edu.dz	Algeria
163	Kahalerras Labiba	labiba.kahalerras@gmail.com	Algeria
164	Kamel Assia	assia.kamel_fsb@usthb.edu.dz	Algeria
165	Kazi Tani Nessrine	kazinessrine@yahoo.fr	Algeria
166	Khaoula Bouznada	khaoula.bouznada@g.ens-kouba.dz	Algeria
167	Khedidja Zerouti	zeroutikhadidja@hotmail.fr	Algeria
168	Khedidja Amira	amira_khedidja@yahoo.com	Algeria
169	Khelfaoui Mohamed Sabri	sabkhe@hotmail.fr	Algeria
170	Kohl Karima	kohl-8@hotmail.com	Algeria
171	Koudri Amel	amkoudri@gmail.com	Algeria
172	Ladaci Hadjer	hadjerladaci41@gmail.com	Algeria
173	Lakache Zineb	lakache.zineb@gmail.com	Algeria
174	Lamari Lynda	lynda.lamari@g.ens-kouba.dz	Algeria
175	Laradj Zazou Khalida	k-zazou@hotmail.fr	Algeria
176	Lardjane Nadia	nadiaalar@yahoo.fr	Algeria
177	Latoui Rayenne	rayenne.latoui@doctorant1.enp-constantine.dz	Algeria
178	Lazreg Fatiha	fatiha_lazrag@yahoo.fr	Algeria
179	Leila Mallem	mallemlleila04@gmail.com	Algeria
180	Loudjani Farida	loudjanifarida@yahoo.fr	Algeria
181	Lynda Abdellaoui	lyndabdellaoui5@gmail.com	Algeria
182	Lynda Mediani	lyndamediani_27@hotmail.com	Algeria
183	Madi Aicha	maicha_bio@yahoo.fr	Algeria
184	Mahi Zineb	z.mahiman@gmail.com	Algeria
185	Malika Chenna	malikatizi76@yahoo.fr	Algeria
186	Manel Bencheikh	bencheikh.manel@univ-ouargla.dz	Algeria
187	Mardja Tahri	tahri-mardja@univ-eltarf.dz	Algeria
188	Matmoura Amina	amina190280@gmail.com	Algeria
189	Meddour Salim	salimeddour@gmail.com	Algeria
190	Merchela Widad	merchela.widad@gmx.fr	Algeria
191	Merdaci Latifa	l.merdaci@univ-eltarf.dz	Algeria
192	Meriem Slama	meriemsalama95@gmail.com	Algeria
193	Meriem Hamoudi	meryoumamm2009@hotmail.fr	Algeria

194	Merzoug	Aoumria	aoumria.merzoug@univ-mascara.dz	Algeria
195	Merzoug	Aoumria	aoumria.merzoug@univ-mascara.dz	Algeria
196	Messaoudi	Mohammed	mohammed35401@gmail.com	Algeria
197	Mezani	Samir	samir.mezani@ummo.dz	Algeria
198	Mohamed	Khiari	mohamedkhiari@yahoo.fr	Algeria
199	M. Nadjib	Kaarar	kmpnh23000@gmail.com	Algeria
200	Mohammed	Messaoudi	messoudi-mohammed@univ-eloued.dz	Algeria
201	Mokaddem	Habiba	habiba.mokaddem@yahoo.com	Algeria
202	Morsli	Seloua Mounira	morsliseloua@univ-eltarf.dz	Algeria
203	Mostapha	Ferrouk	ferrouk_mostapha@yahoo.fr	Algeria
204	Moulai	Djilali	modj204p@yahoo.fr	Algeria
205	Moulay	Belkhodja	belkhodja1947@gmail.com	Algeria
206	Nada	Boukelkal	nadaboukelkal@gmail.com	Algeria
207	Nadia	Chergui	n_chergui@univ-blida.dz	Algeria
208	Nadia	Ziane	ziane23@yahoo.fr	Algeria
209	Nadjim	Semcheddine	semcheddinenadjim@gmail.com	Algeria
210	Nadjiha	Djellel	n.djellel18@gmail.com	Algeria
211	Nedjoua	Sekhri-Arafa	arafa.nedjoua@umc.edu.dz	Algeria
212	Nesrine	Zaouadi	nesrine.zaouadi@univ-dbk.dz	Algeria
213	Norhane	Chouiter	chouiter.norhane@univ-ueb.dz	Algeria
214	Noueddine	Chetouh	nourchetouh2010@univ-tebessa.dz	Algeria
215	Nouha Halim	Bendekhis	bendekhisnouahalima@gmail.com	Algeria
216	Nouioua	Wafa	nouioua.wafa@yahoo.fr	Algeria
217	N. El-Houda	Djehader	djehader_nour@yahoo.fr	Algeria
218	Nouria	Boukenaoui	nouria09@yahoo.fr	Algeria
219	Ouarda	Mansouri	souadmansouri2003@yahoo.fr	Algeria
220	Oulamara	Hayet	houlamara@gmail.com	Algeria
221	Ouldyerou	Karima	ouldyeroukarima@gmail.com	Algeria
222	Oulmi	Abdelmalek	Benchomar@yahoo.co.uk	Algeria
223	Ounaissia	Karima	ounaissia_k@yahoo.fr	Algeria
224	Racha	Abed	abedracha3@gmail.com	Algeria
225	Rached	Wahiba	rachedwahiba@yahoo.fr	Algeria
226	Rachid	Sahraoui	rachid_sahra@univ-setif.dz	Algeria
227	Ramdane	Seghiri	seghiri25000@yahoo.fr	Algeria
228	Redjaimia	Lilia	liliredjaimia84@gmail.com	Algeria
229	Rouag	Noureddine	n.rouag@univ-setif.dz	Algeria
230	Sabrina	Baaziz	s.baaziz@univ-eltarf.dz	Algeria
231	Sadi	Fadhila	fadilienne@yahoo.fr	Algeria
232	Safa	Abderrahmani	safa.abderrahmani@univ-biskra.dz	Algeria
233	Sahraoui	Ouafa	ouafa.saharaoui@univ-annaba.dz	Algeria
234	Saim	Souhila	saim.souhila@univ-mascara.dz	Algeria
235	Saliha	Dermeche	salydermeche@gmail.com	Algeria
236	Samir	Medjekal	samir.medjekal@univ-msila.dz	Algeria
237	Samira	Ghedjati	sghedjati10@gmail.com	Algeria
238	Saouli	Nacira	nacirasaouli@gmail.com	Algeria
239	Sara	Mokhtari	sarabio113@yahoo.fr	Algeria
240	Sara	Bouzenzana	sara.bouzenzana@univ-tebessa.dz	Algeria
241	Sarah	Benchabane	sarah_benchabane@yahoo.fr	Algeria
242	Siboukeur	Abdellah	siboukeur.abd@gmail.com	Algeria
243	Sihem	Ziouche	sihem.ziouche@univ-bba.dz	Algeria

244	Souad	Bessila	amelamirouche182@yahoo.fr	Algeria
245	Soudani	Asma	asma.soudani@univ-tebessa.dz	Algeria
246	Taib	Nadjat	nadjat.taib.dr@gmail.com	Algeria
247	Tata	Samira	samira.tata@g.ens-kouba.dz	Algeria
248	Tebbanı	Fouzia	fouziatebani@yahoo.fr	Algeria
249	Thoraya	Dahmane	thoraya.dahmane@univ-dbkm.dz	Algeria
250	Tine-Djebbar	Fouzia	fouzia.djebbar@univ-tebessa.dz	Algeria
251	Tirchi	Nadia	n.tirchi@univ-dbkm.dz	Algeria
252	Tirchi	Nadia	n.tirchi@univ-dbkm.dz	Algeria
253	Tiah	Yasmine	yasminetiah558@gmail.com	Algeria
254	Yamina	Tahri	tahriamina76@gmail.com	Algeria
255	Yezli-Touker	Samira	yezlitouikersamira@yahoo.fr	Algeria
256	Zahia	Kabouche	zahiakabouche@gmail.com	Algeria
257	Zahia	Dorbane	zahiadorbane@hotmail.fr	Algeria
258	Zaidı	Nedjoua	znedjoua@yahoo.fr	Algeria
259	Zaoui	Lilia	lilia_zaoui@yahoo.fr	Algeria
260	Zıdane	Ouiza	ouizazid@gmail.com	Algeria
261	Zineb	Hamanı	hamaniz972@gmail.com	Algeria
262	Zoheir	Amrouche	zoheir.amrouche@yahoo.fr	Algeria
263	Meskel Desta	Godana	meskelnati@gmail.com	Egypt
264	Liana	Koiava	liaka555@yahoo.com	Germany
265	Rusudan	Dumbadze	rusudandumbadze6@gmail.com	Germany
266	Slavica	Dudaš	sdudas@veleri.hr	Croatia
267	Zvonimir	Zdunic	zvonimir.zdunic@poljinos.hr	Croatia
268	Mwafaq	Ibdah	mwafaq@volcani.agri.gov.il	Israel
269	Anshuman	Roy	anshubaap7047@gmail.com	India
270	Nikhil	Kawatra	nikhilkawatra29@gmail.com	India
271	Shubha	Singh	Shubhasingh51@gmail.com	India
272	Swati	Jaiswal	swatijaiswal8082@gmail.com	India
273	A. A. Talb	Altalb	ahmed_altalb@uomosul.edu.iq	Iraq
274	Samir	Al-Badri	samir.albadri@coagri.uobaghdad.edu.iq	Iraq
275	Alireza	Allameh	a.allameh@areeo.ac.ir	Iran
276	Jafar	Pejuhan	mahyarpejuhan@gmail.com	Iran
277	Keyvan	Shams	keyvansh3@gmail.com	Iran
278	Majid	Shouri	majidshoori@ymail.com	Iran
279	Mousa	Torabi Giglou	mtorabi@uma.ac.ir	Iran
280	Giacomo	Di Giacinto	giacomo.dg17@gmail.com	IT
281	Arjeta	Simitciu	arjetasimitciu@gmail.com	Kosovo
282	Astrit	Bilalli	astrit.bilalli@unhz.eu	Kosovo
283	Flamur	Mehmeti	flamur.m92@gmail.com	Kosovo
284	Mimoza	Basholli	mimoza.basholli@uni-pr.edu	Kosovo
285	Teuta	Bajra -Brahimaj	teuta.bajra@student.uni-pr.edu	Kosovo
286	Toske	Kryeziu	toskekryeziu@gmail.com	Kosovo
287	Balzhan	Akhylbekova	ahilbekova@mail.ru	Kazakhstan
288	Pamodya	Kmarasingha	pamodya13430@gmail.com	Sri Lanka
289	Sasini	Wickramanayaka	sasiniwickramanayaka@gmail.com	Sri Lanka
290	Vaidas	Bivainis	vaidas.bivainis@vdu.lt	Latvia
291	Alaoui	Asmae	asmae98@gmail.com	Maroc
292	Chbel	Faiza	cfaiza75@gmail.com	Maroc
293	Doha	Naji	naji.doha@uit.ac.ma	Maroc

294	Doha	Mazigh	dohamazigh22@gmail.com	Maroc
295	Ezzouine	Nirmine	nirmine.ezzouine@gmail.com	Maroc
296	Fatima	Abdou-Allah	fati.abdouallah@gmail.com	Maroc
297	Ikhlas Hanı	Chennoufi	ikhlashani86@gmail.com	Maroc
298	Ilham	Barakat	barakat.iavcha@gmail.Com	Maroc
299	Intissar	Loughlaimı	i.loughlaimi@uhp.ac.ma	Maroc
300	Jamila	Zouhri	jamila.zouhri@usms.ma	Maroc
301	Karima	Hbyaj	karima.hbyaj@uit.ac.ma	Maroc
302	K. Meftah	Khadija Meftah	khadija.meftah.mef@gmail.com	Maroc
303	Lamiaa	Aıt Sı	lamiaaaiti28@gmail.com	Maroc
304	Mazri	Mouaad Amine	m.a.mazri@gmail.com	Maroc
305	Mehdi	El Mellouki	mehdielmellouki7@gmail.com	Maroc
306	Meriem	Rafya	meriemrafya1996@gmail.com	Maroc
307	Meryem	Souidek	meriem.swidak@gmail.com	Maroc
308	Mohammed	Ajdig	ajdig988@gmail.com	Maroc
309	Mounia	Ennamı	ennami.mounia@yahoo.fr	Maroc
310	Nadia	Elidrissi El Yallouln	elidrissielyallouli@gmail.com	Maroc
311	Ouabou	Mbarek	ouaboumbarek@gmail.com	Maroc
312	Oumaima	Ouala	oumaima.ouala@ced.uca.ma	Maroc
313	Sahar	Dahbı	saharenam69@gmail.com	Maroc
314	Saliha	Gharbı	saliha.gharbi@etu.uae.ac.ma	Maroc
315	Souad	Amghar	eamghar@gmail.com	Maroc
316	Soukaina	Mıtro	mitrosoukaina@gmail.com	Maroc
317	Youness	Moukhliiss	y.moukhliiss@edu.umi.ac.ma	Maroc
318	Clapco	Steliana	steliana.clapco@imb.utm.md	Moldova
319	Biljana	Trajkovska	biljana.trajkovska@uklo.edu.mk	Macedonia
320	Jane	Aleksoski	anakorubin@yahoo.com	Macedonia
321	Monika	Stojanova	stojanova.monika@yahoo.com	Macedonia
322	Suzana	Jordanovska	suzana.jordanovska@unt.edu.mk	Macedonia
323	Lawal	Garba	lagarpak@gsu.edu.ng	Nigeria
324	Michael	Oke	talentupgradeglobalconcept@gmail.com	Nigeria
325	Victor	Olowe	oloweio@funaab.edu.ng	Nigeria
326	Yahaya	Mustapha	ymustapha116@gmail.com	Nigeria
327	Abdul	Sattar	abdulsattar04@gmail.com	Pakistan
328	Abdul	Qayyum	aqayyum@uoh.edu.pk	Pakistan
329	Abid Hussain	Dr	abidhussain@must.edu.pk	Pakistan
330	Ahmad	Sher	ahmad.sher@bzu.edu.pk	Pakistan
331	Ammara	Asif	ammara.asif106@gmail.com	Pakistan
332	Anila	Afzal	anilaafzal@gmail.com	Pakistan
333	Anwaar	Ahmed	anwaarft@uuar.edu.pk	Pakistan
334	Bilal Saeed	Khan	bilalentomologyuaf@gmail.com	Pakistan
335	B. Masaud	M. Ahmad Khan	bushra.bm36@gmail.com	Pakistan
336	Ghazalah	Yasmin	ghazalahrizwan@gmail.com	Pakistan
337	Ishrat	Jamil	ishratjamil.kibge@gmail.com	Pakistan
338	Jan	Muhammad	janmarree@gmail.com	Pakistan
339	Kashif	Ahmed	kashifahm@neduet.edu.pk	Pakistan
340	Muhammad	Arshad	muhammad.arshad@uvas.edu.pk	Pakistan
341	M. Kashif	Maan	kashif.maan@uvas.edu.pk	Pakistan
342	M. Umar	Farid	umar.farid@uvas.edu.pk	Pakistan
343	Noshia	Arshad	noshia@uog.edu.pk	Pakistan

344	Rifat Ullah	Khan	rukhan@aup.edu.pk	Pakistan
345	Saqib	Bashir	sbashir@gudgk.edu.pk	Pakistan
346	Shabana	Naz	drshabananz@gcuf.edu.pk	Pakistan
347	Sher	Ali	sher.ali@uvas.edu.pk	Pakistan
348	Sobia	Kanwal	sobia.kanwal@aious.edu.pk	Pakistan
349	Sumaira	Sahreen	sumairasahreen@gmail.com	Pakistan
350	Yamin	Bibi	dryaminbib@uuar.edu.pk	Pakistan
351	Zia Ud Din	Sindhu	ziasandhu@hotmail.com	Pakistan
352	Ivan	Pavlovic	dripavlovic58@gmail.com	Serbia
353	Marija	Pavlovic	majaspavlovic@gmail.com	Serbia
354	Sandra	Vuković	sandra.vukovic@agrif.bg.ac.rs	Serbia
355	Teodora	Cvanić	teodora.cvanic@uns.ac.rs	Serbia
356	Alaa El-Din	Omar	omaradks2@yahoo.com	Saudi Arabia
357	Munir	Ahmad	munirksu@gmail.com	Saudi Arabia
358	Nada Salah	Al Naffae	jnon1975@hotmail.com	Saudi Arabia
359	Abir	Haddada	abir.haddada@etudiant-fst.utm.tn	Tunisia
360	Amel	Najjar	amelnajarbenmatoug@gmail.com	Tunisia
361	Anouar	Bouali	bouali.anwaar@gmail.com	Tunisia
362	Dalila	Haouas	dalila_haouas@yahoo.fr	Tunisia
363	Imen	Fguiri	imen.fguiri@yahoo.com	Tunisia
364	Jihen	Arroussi	jihen041088@gmail.com	Tunisia
365	Kahlaoui	Samih	sameh_kahlaoui@yahoo.fr	Tunisia
366	Ksouri	Riadh	ksouri.riadh@gmail.com	Tunisia
367	Mnari Bhour	Amira	amiramnari2@gmail.com	Tunisia
368	Nourhen	Hammami	nourhen.hammami@etudiant-fst.utm.tn	Tunisia
369	Sarra	Jribi	sarra.jribi@gmail.com	Tunisia
370	Wissal	Saadellaoui	wissal.saadellaoui@etudiant-fst.utm.tn	Tunisia
371	A. Aytakin	Polat	aapolat@mku.edu.tr	Türkiye
372	Abdullah	Yazıcı	abdullahyazici11@gmail.com	Türkiye
373	Adem	Yılmaz	ademylmz6572@gmail.com	Türkiye
374	Adile	Akpınar	akpinaradile8@gmail.com	Türkiye
375	Ahmet	Uludag	ahuludag@yahoo.com	Türkiye
376	Ahmet	Vatansever	ahmetvatansever@trakya.edu.tr	Türkiye
377	Ahmet	Çetinkaya	ahmet_cetinkayaaa@hotmail.com	Türkiye
378	Ahmet Ismail	Özkan	aiozkan@artvin.edu.tr	Türkiye
379	Ahmet Nedim	Yüksel	anyuksel@nku.edu.tr	Türkiye
380	Ahmet Tansel	Serim	ahmettansel.serim@bilecik.edu.tr	Türkiye
381	Ali	Sağlam	saglamali801@gmail.com	Türkiye
382	Ali Osman	Karataavuk	aosmankarataavuk@trakya.edu.tr	Türkiye
383	Alican	Güvenç	alicanguvenc@trakya.edu.tr	Türkiye
384	Alper Gun	Ozturna	alpergun.ozturna@iuc.edu.tr	Türkiye
385	Armağan	Kaya	armagan-kaya@hotmail.com	Türkiye
386	Asuman	Karadeniz-Pekgöz	asumankaradeniz@gmail.com	Türkiye
387	Aybegün	Ton	aybeguntoncu@gmail.com	Türkiye
388	Aysu	Erdim	aysuerdim@gmail.com	Türkiye
389	Ayşe Övgü	Şen	ayseovgusen@gmail.com	Türkiye
390	Ayşegül	Ertinmaz Özkan	aysegulozkan@yahoo.com	Türkiye
391	Ayşenur	Bayrak	abayrak2018@gtu.edu.tr	Türkiye
392	Ayten Kubra	Yagız	aytenkubraturkmen@gmail.com	Türkiye
393	Azime	Gökçe	azimegokce@gmail.com	Türkiye

394	Banu	Orta Yılmaz	banu.yilmaz@istanbul.edu.tr	Türkiye
395	Barış	Uz	uzb20@itu.edu.tr	Türkiye
396	Barışcan	Curabay	bcurabay@hotmail.com	Türkiye
397	Behiye Banu	Bilgen	bbilgen@nku.edu.tr	Türkiye
398	Berat	Çınar Acar	beratcinar@gazi.edu.tr	Türkiye
399	Beray	Kızılkaya	kizilkayaberay@gmail.com	Türkiye
400	Berk	Benlioğlu	benliogluberk@hotmail.com	Türkiye
401	B. Ismail	Yıldız	berkantyildiz@gmail.com	Türkiye
402	Berrin	Kurşun	berrin.kursun@marmara.edu.tr	Türkiye
403	Beste	Turanlı	beste.turanli@marmara.edu.tr	Türkiye
404	Betül	Çukadar	cukadar.btl@gmail.com	Türkiye
405	B A Gathot	Subrata	bhaskara.anggarda@mail.ugm.ac.id	Türkiye
406	Bilge Kağan	Koçak	bilgekkocak@gmail.com	Türkiye
407	Buket	Askin	buketaskin@klu.edu.tr	Türkiye
408	Burak	Dilemek	burakveyunus@hotmail.com	Türkiye
409	Burak	Koçak	burakkocak@gmx.com	Türkiye
410	Burcu	Kartal Sural	burcu.kartal8@gmail.com	Türkiye
411	Büşra	Yaylı	busrayayli@uludag.edu.tr	Türkiye
412	Büşra	Tik	btik952@gmail.com	Türkiye
413	Büşra	Sevgi	bsevgig28@gmail.com	Türkiye
414	Caner	Solar	canersolar54@trakya.edu.tr	Türkiye
415	Cavit Meriç	Bozdağ	bozdagcmeric@gmail.com	Türkiye
416	Cem	Tokatlı	cemtokatli@trakya.edu.tr	Türkiye
417	Cemal	Budağ	cbudag@yyu.edu.tr	Türkiye
418	Cenk	Atlig	cenk.atlig@gmail.com	Türkiye
419	Ceyda	Kımıl	ceydakimil06@trakya.edu.tr	Türkiye
420	Ceyhun	Bereketoğlu	ceyhun.bereketoglu@marmara.edu.tr	Türkiye
421	Coşkun	Gülser	cgulser@omu.edu.tr	Türkiye
422	Çağatay	Altinkök	caltinkok@itu.edu.tr	Türkiye
423	Çağatay	Oltulu	cagatayo@trakya.edu.tr	Türkiye
424	Deniz	Yüksel	denizyuksel@trakya.edu.tr	Türkiye
425	Deniz	Yuzbasioglu	deniz@gazi.edu.tr	Türkiye
426	Deniz	Dölgen	deniz.dolgen@deu.edu.tr	Türkiye
427	Deniz	Şumnulu	denizsumnulu@trakya.edu.tr	Türkiye
428	Deniz Levent	Koç	leventk@cu.edu.tr	Türkiye
429	Derya	Çetintürk	deryacetinturk@gmail.com	Türkiye
430	Dilara	Yalmancı	dilara.yalmanci@akgida.com.tr	Türkiye
431	Dilara	Kaya Öztürk	dilara.kaya55@gmail.com	Türkiye
432	Dilara	Kızılkaya	kizilkayadilara@icloud.com	Türkiye
433	Dilek	Güney	dilek_gney@yahoo.de	Türkiye
434	Dinçer	Akal	dincerakal@trakya.edu.tr	Türkiye
435	Dinçer	Akal	dincerakal@trakya.edu.tr	Türkiye
436	Zafer	Karavaşahin	zaferkarasahin@gmail.com	Türkiye
437	Dursun	Kısa	drsn57@hotmail.com	Türkiye
438	Duygu	Keser	dukeser@gmail.com	Türkiye
439	Duygu	Ozhan Turhan	duygu.turhan@inonu.edu.tr	Türkiye
440	Ebru	Çokay	ebru.cokay@deu.edu.tr	Türkiye
441	Ece	Avuloglu Yılmaz	ece.yilmaz@amasya.edu.tr	Türkiye
442	Efe	Dallı	efedalli96@gmail.com	Türkiye
443	Elif	Türkboyları	eyuksel@nku.edu.tr	Türkiye

444	Elif Nur	Sarı	elifnur.sari@iuc.edu.tr	Türkiye
445	Elif Özlem	Günçaldı	eoguncaldi2018@gtu.edu.tr	Türkiye
446	Elvan	Bakar	elvanbakar@trakya.edu.tr	Türkiye
447	Emine	Durmaz	eminedurmaz1999@gmail.com	Türkiye
448	Emine	Açar	acaremine01@gmail.com	Türkiye
449	Emine	Orhan	eorhan@atauni.edu.tr	Türkiye
450	Emine Erdem	Cingöz	ehyurur@gmail.com	Türkiye
451	Emir	Özsoy	ecemirozsoy@gmail.com	Türkiye
452	Emrah	Güngör	emrah.gungor@omu.edu.tr	Türkiye
453	Emrah	Özdemir	eoazdemir@iuc.edu.tr	Türkiye
454	Emre	Karakaya	emrekarakaya@erciyes.edu.tr	Türkiye
455	Emre	Akdogan	emreakdogan@eskisehir.edu.tr	Türkiye
456	Emrullah	Culpan	eculpan@nku.edu.tr	Türkiye
457	Ender	Makineci	emak@iuc.edu.tr	Türkiye
458	E. Kuopuobe	Naawe	eric.naawe@gmail.com	Türkiye
459	Esin	Hazneci	esin.hazneci@omu.edu.tr	Türkiye
460	Esra	Özyiğit	esra.ozyigit@cbu.edu.tr	Türkiye
461	Esra Tuğçe	Gül	esra.gul@selcuk.edu.tr	Türkiye
462	Evrım	Sönmez	esonmez@sinop.edu.tr	Türkiye
463	Evrım	Unal	unalev@itu.edu.tr	Türkiye
464	E. Mürüvvet	Akbaş	akbasezgim@gmail.com	Türkiye
465	Fadime	Eryılmaz Pehlivan	eryilmazfadime@gmail.com	Türkiye
466	Fatma	Özdemir	ozkardes_f@ibu.edu.tr	Türkiye
467	Fatma	Okus	fatma.okus@gazi.edu.tr	Türkiye
468	Fatma	Özdemir	ozkardes_f@ibu.edu.tr	Türkiye
469	Fatmagül	Halıcı Demir	fatmagulhalici@trakya.edu.tr	Türkiye
470	Fatmagül	Kavut	sekenay@gmail.com	Türkiye
471	Fazlı Engin	Tombuş	fengintombus@hitit.edu.tr	Türkiye
472	Ferhat	Büyükdeveci	ferhat.bykdeveci@gmail.com	Türkiye
473	Feride	Öncan Sümer	fsumer@adu.edu.tr	Türkiye
474	Fulya Dilek	Gökalp	fulyadilek@trakya.edu.tr	Türkiye
475	Furkan	Baş	furkanbas@ohu.edu.tr	Türkiye
476	Gamze	Tan	gamzetan2003@yahoo.com	Türkiye
477	Gizem	Yıldırım Baştemur	gizemyildirimbastemur@istanbul.edu.tr	Türkiye
478	Gizem	Moğol	gizem.mogol@drt.com.tr	Türkiye
479	Gizem	Çufaoğlu	gizemcufaoğlu@kku.edu.tr	Türkiye
480	Gizem	Başer	gizem_baser@outlook.com	Türkiye
481	Gülay	Karahan	gkarahan03@gmail.com	Türkiye
482	Gülçin Ece	Aslan	ecebacalan@akdeniz.edu.tr	Türkiye
483	Güliden	Aynacı	guldenaynaci@hotmail.com	Türkiye
484	Gülru	Yücel	gulru.yucel@omu.edu.tr	Türkiye
485	Gürkan	Diken	gurkandiken@isparta.edu.tr	Türkiye
486	Hacer	Akhan	hacera@trakya.edu.tr	Türkiye
487	Hafize	Özcan	hafizeozcan@trakya.edu.tr	Türkiye
488	Hafizenur	Şengül Binat	hafizenur.sengul@hotmail.com	Türkiye
489	Halide	Karabıyık	halideaydogdu@trakya.edu.tr	Türkiye
490	Hande	Mutlu Durak	hndemutlu@gmail.com	Türkiye
491	Hasan	Can	hasan.can@erbakan.edu.tr	Türkiye
492	Hatice	Bozoğlu	hbozoglu@omu.edu.tr	Türkiye
493	Hilal	Ural	hilalural0@gmail.com	Türkiye

494	Hilal	Arslan Bayrakcı	hilalbayrakci@gmail.com	Türkiye
495	Hilal	Taşbaşı	hhilaltasbasi@gmail.com	Türkiye
496	Hilal	Arslan Bayrakcı	hilalbayrakci@gmail.com	Türkiye
497	Hilal	Taşbaşı	hhilaltasbasi@gmail.com	Türkiye
498	Hüseyin	Çetin	drhcetin@gmail.com	Türkiye
499	Ibrahim Mura	Ozulu	imuratozulu@hitit.edu.tr	Türkiye
500	Ilham	Eröz Poyraz	ieroz@anadolu.edu.tr	Türkiye
501	Inji	Shikhaliyeva	inci.shikhaliyeva@gmail.com	Türkiye
502	Ismail	Yıldız	iyildiz@yyu.edu.tr	Türkiye
503	Ismail Emrah	Tavali	emrahtavali@gmail.com	Türkiye
504	İrem	Çelik	iremceelkk@gmail.com	Türkiye
505	İrfan	Öztürk	ozturkifan62@yahoo.com	Türkiye
506	Kaan	Kaltalioglu	kaan.kaltalioglu@gmail.com	Türkiye
507	Kadir	Akar	kadirakar@yyu.edu.tr	Türkiye
508	Koray	Özşeker	ozseker.koray@gmail.com	Türkiye
509	Kuzey	Kılıç	kuzeykilic@icloud.com	Türkiye
510	Lamia	Yakkou	yakkou.lam@gmail.com	Türkiye
511	Lira	Usakbek Kyzy	lira199322@gmail.com	Türkiye
512	Mehmet	Yabas	mehmet.yabas@ozal.edu.tr	Türkiye
513	Mehmet Akif	Gültekin	makif89@gmail.com	Türkiye
514	M. Ali Turan	Koçer	matkocer@hotmail.com	Türkiye
515	Mehmet Ugur	Yıldırım	ugur.yildirim@usak.edu.tr	Türkiye
516	Melike	Oğuz	oguz.melike0902@gmail.com	Türkiye
517	Melike Kübra	Ekiz Bozdemir	melike.ekiz@kocaeli.edu.tr	Türkiye
518	Melike Kübra	Ekiz Bozdemir	melike.ekiz@kocaeli.edu.tr	Türkiye
519	Menekşe	Taş Divrik	menekse.tas@cumhuriyet.edu.tr	Türkiye
520	Mert	Arslanbayrak	mert.arslanbayrak@hotmail.com	Türkiye
521	Merve	Akman Gezer	mrv_akm92@hotmail.com	Türkiye
522	Merve	Şekerli	mervesekerli@gmail.com	Türkiye
523	Merve	Tekinsoy	mervetekinsoy10@gmail.com	Türkiye
524	Merve	Yilmazer	merve.yilmazer@istanbul.edu.tr	Türkiye
525	Mete	Soysal	metesoysal@odu.edu.tr	Türkiye
526	Mine	Aslan	mineaslan_90@hotmail.com	Türkiye
527	Mine	Aslan	mineaslan_90@hotmail.com	Türkiye
528	Mizgin	Ermanoğlu	mizginerm@hotmail.com	Türkiye
529	Mohammed	Salim	mohammedabdalrahman.ahmedsalim@mail.ohu.edu.tr	Türkiye
530	Moin	Qureshi	moin.qureshi8@gmail.com	Türkiye
531	Muhammad	Amjid	amjidhorti@gmail.com	Türkiye
532	Murat	Abay	mabay@erciyes.edu.tr	Türkiye
533	Musa	Kırışık	musa_0007@hotmail.com	Türkiye
534	Mustafa	Kaplan	mustafakaplan44@hotmail.com	Türkiye
535	Mustafa	Tan	mustafatan@trakya.edu.tr	Türkiye
536	M Kemalettin	Büyükakin	mkbuyukakin@trakya.edu.tr	Türkiye
537	Müge	Erkan Can	merkan@cu.edu.tr	Türkiye
538	Nahdhoit	Ahamada Rachid	nahdhoit7@gmail.com	Türkiye
539	Nazli	Turkten	nazli.turkten@yahoo.com	Türkiye
540	Nazli	Turkten	nazli.turkten@yahoo.com	Türkiye
541	Necla	Birgül	birgul@boun.edu.tr	Türkiye
542	Necmettin	Güler	nguler@trakya.edu.tr	Türkiye

543	Nilüfer	Aksu Uslu	nsaksu@hotmail.com	Türkiye
544	Nour	Awad	awadnur5@gmail.com	Türkiye
545	Nur	Koc Koyun	nurkoc@selcuk.edu.tr	Türkiye
546	Nurcan	Özkan	nurcanozkan@hotmail.com	Türkiye
547	Nurcan	Vardar Yel	nurcan.vardar@altinbas.edu.tr	Türkiye
548	Nurhayat	Özkan Sevencan	dr_nurhayat@hotmail.com	Türkiye
549	Nursaç Serda	Kaya	nursackaya@gmail.com	Türkiye
550	Nursel	Çöl Keskin	nurselcol@gmail.com	Türkiye
551	Ogün	Demir	ogundemir8@gmail.com	Türkiye
552	Oğuzhan	Noğay	oguzhannogay@klu.edu.tr	Türkiye
553	Okan	Ertosluk	okan.ertosluk@adu.edu.tr	Türkiye
554	Orhan Onur	Aşkın	oaskin82@gmail.com	Türkiye
555	Ousseini	Kiemde	kiemdeousseini@gmail.com	Türkiye
556	Ozum	Ozoglu	ozoglu@uludag.edu.tr	Türkiye
557	Ömer Faruk	Coşkun	omerfaruk.coskun@mku.edu.tr	Türkiye
558	Özgür	Anuk	ozgur.anuk@kerevitas.com.tr	Türkiye
559	Özgür	Ateş	ozgurates@windowslive.com	Türkiye
560	Özlem	Çetin Erdoğan	ozlemerdogan@trakya.edu.tr	Türkiye
561	Öznur	Eymir	oznureymir@gmail.com	Türkiye
562	Pakize Özlem	Kurt Polat	ozlemkurt@uludag.edu.tr	Türkiye
563	Pelin	Özkaya	pelin.ozkaya@cbu.edu.tr	Türkiye
564	Reyhan	Akpınar	reyhanakpnr1@gmail.com	Türkiye
565	S. Melike	Sülü	serapmelike.icoz@tarimorman.gov.tr	Türkiye
566	Sabriye	Belgüzar	sabriye.yazici@gop.edu.tr	Türkiye
567	Salih	Demirkaya	salih.demirkaya@omu.edu.tr	Türkiye
568	Sami	Bulut	samibulut@trakya.edu.tr	Türkiye
569	Seçil	Acar	secilkolsal@comu.edu.tr	Türkiye
570	Selcuk	Kaya	sk5nove@gmail.com	Türkiye
571	Selen	Yatkin	selenyatkin@nku.edu.tr	Türkiye
572	Selen	Avcı Azkeskin	selen.avci@kocaeli.edu.tr	Türkiye
573	Selim	Bayraktar	sbayraktar@iuc.edu.tr	Türkiye
574	Sema	Aydın	semaydin@gelisim.edu.tr	Türkiye
575	Semih	Kale	semihkale@comu.edu.tr	Türkiye
576	Semra	Çiçek	semra.cicek@atauni.edu.tr	Türkiye
577	Senem	Cabiroğlu	cabiroglu.senem@gmail.com	Türkiye
578	Seren	Sargın	serensargn@gmail.com	Türkiye
579	Sergun	Dayan	sergundayan@trakya.edu.tr	Türkiye
580	Serkan	Eker	serkan.eker@deu.edu.tr	Türkiye
581	Serkan	Uzun	serkan.uzun28@hotmail.com	Türkiye
582	Sermet	Beylikçi	sermetcan.beylikci@cbu.edu.tr	Türkiye
583	Seval	Cing Yildirim	seval.cing@inonu.edu.tr	Türkiye
584	Sıddıka Yusra	Özkılıç	Yusraydn@gmail.com	Türkiye
585	Simay	Elmacı	simayelmaci@live.com	Türkiye
586	Simge	Çolak	simge.colak1661@gmail.com	Türkiye
587	Sine	Kaya	sinekayaa@gmail.com	Türkiye
588	Süleyman	Kök	koks@trakya.edu.tr	Türkiye
589	Şaika Gül	İliksiz	saikaguliliksiz@gmail.com	Türkiye
590	Şakir	Yılmaz	sakiryilmaz@yyu.edu.tr	Türkiye
591	Şeyma	Sarı	seymasari4646@gmail.com	Türkiye
592	Tekmile	Cankurtaran	tekmilecankurtaran@gmail.com	Türkiye

593	Tuba Nur	Sürkaç	tsurkac@gmail.com	Türkiye
594	Tugce	Ozsan	tugceozsan@akdeniz.edu.tr	Türkiye
595	Tuğba	Tarakcı	tugba.tarakci@tarimorman.gov.tr	Türkiye
596	Tuğba	Şahin	tugbaashnn@gmail.com	Türkiye
597	Tuğçe	Akman	akmantugce0@gmail.com	Türkiye
598	Tunahan	Pamukçu	tunahanpamukcu64@trakya.edu.tr	Türkiye
599	Turkan	Keceli	turkankecelimutlu@gmail.com	Türkiye
600	Ufuk	Bağcı	ufukbagci@trakya.edu.tr	Türkiye
601	Utku	Güner	uguner@trakya.edu.tr	Türkiye
602	Ülkü Zeynep	Üreyen Esertaş	biyolog_ulku@hotmail.com	Türkiye
603	Vahit Umut	Filik	umutfilik@gmail.com	Türkiye
604	Volkan	Atav	volk.atav@gmail.com	Türkiye
605	Yağmur	Arıkan	yagmurarkn@gmail.com	Türkiye
606	Yasemin	Aydın	yastun@istanbul.edu.tr	Türkiye
607	Yeliz	Akpınar	yeliz.akpinar@ahievran.edu.tr	Türkiye
608	Yılmaz	Çamlıtepe	yilmazc@trakya.edu.tr	Türkiye
609	Zehra Nur	Soyunmez	znursoyunmez@trakya.edu.tr	Türkiye
610	Zehranur	Yuksekdag	zehranur@gazi.edu.tr	Türkiye
611	Zeynep	Gül	zdumlu@atauni.edu.tr	Türkiye
612	Zinnur	Yılmaz	zinnuryilmaz@cumhuriyet.edu.tr	Türkiye
613	Ziya	Binat	ziyabinat@gmail.com	Türkiye
614	Zülal	Akba	zulalakba@gmail.com	Türkiye
615	Deniz	Inci	inci@ucdavis.edu	USA
616	Rasim	Unan	rasimunan@hotmail.com	USA
617	Dien	Tran Thi	tranthidien1979@gmail.com	Vietnam

AGBIOL 2023 CONFERENCE STUDENT ORGANIZING TEAM

NAME

1. Emrah Akpınar
2. Metin Burak Tatlıses
3. Deniz Kızılkaya
4. Selçuk Kaya
5. Hüseyin Gökberk Düşova
6. Mislina Işık
7. Mutlu Şen
8. Aysu Erdim
9. Ceyda Kıymıl
10. Yaren Akpınar
11. Selinay Demir
12. İlayda Küçük
13. Gülce Tuğba Gözel
14. Neslihan Yılmaz
15. Begüm Kurt
16. Ahmet Refi Yüce
17. Serhat Kayan
18. Muhammet Doğan
19. Ece Zeren

OUR SPONSORS

**PLATINUM SPONSOR
TSÜAB**



<https://www.tsuab.org.tr/>

**GOLDEN SPONSORSHIP
TÜRKTÖB**



<https://www.turktob.org.tr/>

TRAKYA BİRLİK



**TRAKYA
BİRLİK**

<https://www.trakyabirlik.com.tr/>

TRAGEN RD CO Ltd



www.tragen.gen.tr

BRONZE SPONSORS

TEKCAN TOHUMCULUK



tekcan
tarım

<https://www.tekcantohum.com/>

BASTAK GRUP



BASTAK
instruments

<https://www.bastak.com.tr/>

İÇDAŞ TARIM



İÇDAŞ

Tarım

<https://icdastarim.com/>

GENESIS AGRO TRADE



