

GOLDEN TREE LIVE[®]

USER MANUAL

Version 09/06

Deluxe **Dedicated**



Deluxe **Retrofit Kit**



Standard **Online Kit**



Basic **Offline Kit**



WARNINGS AND NOTICES

NOTICE

This game is intended to be operated for amusement purposes only. It is not to be operated in violation of any federal, state, or local laws or regulations. As the owner and/or operator of this game you are responsible for its operation in compliance with such laws and regulations. The factory settings for this game may require adjustment in order to comply with the laws and/or regulations in the jurisdiction where the game is located. It is the sole responsibility of the operator to determine what laws and/or regulations are applicable and to make any adjustments to the game before operating it for its intended purpose.

NOTICE

This manual and the information contained within is subject to change without notice.

WARNING

Use of unauthorized parts or making any unauthorized modifications will void the warranty and may result in the game operating in an unsafe or incorrect manner.

WARRANTY, REPAIR, AND RETURN POLICY

- 90-day warranty on all electronic components. All warranty periods begin on the date of purchase from Incredible Technologies, Inc.
- There is a minimum \$75.00 service charge for all non-warranty repairs or returns.
- For all servicing, return to Incredible Technologies, Inc.
- ANY non-factory repair or attempted repair voids warranty.

RETURN MERCHANDISE AUTHORIZATION

- All returned merchandise must have a Return Merchandise Authorization (RMA) number marked clearly on the outside of the package.
- You must obtain all RMA numbers from Incredible Technologies. Please have the product's Cabinet Identification Device number available when calling for an RMA number.
- Merchandise returned without an RMA number will not be accepted.
- Warranty may be void if serial number or security labels are tampered with or removed. **Opening the Nighthawk Chassis system will void your warranty.**
- Advance replacement hardware will be shipped to the customer address on file unless specified otherwise.
- Advance replacement hardware will be billed to the customer until Incredible Technologies, Inc. receives the returned merchandise, at which time a credit will be issued.
- All repairs and/or replacements will ship as soon as possible after receipt or request (subject to availability).

If the original purchaser discovers any physical defect in the media (disk, EPROM, tape) on which the software is distributed or in the documentation, which in the opinion of Incredible Technologies, Inc. (IT) prevents the product from being used as reasonably intended, IT will replace the media or documentation at no charge. The purchaser must return the item to be replaced, with proof of purchase, to IT within 90 days after taking delivery of the software.

IT warrants to the original purchaser that the hardware product is in good working condition for a period of 90 days from taking delivery of the product. Should this product, in IT's opinion, malfunction within the warranty period because of a defect in design, materials, or workmanship, IT will repair or replace this product without charge under the terms as follows. Replacement of either the hardware product or its component parts will be only on an exchange basis. Any replaced parts or components become the property of IT. This warranty does not apply to those products that have been damaged due to accident, abuse, improper installation, natural disaster, or unauthorized repairs or modifications.

IT excludes any and all implied warranties, including warranties of merchantability and fitness for a particular purpose, and limits the purchaser's remedy to returning the software, hardware, or documentation to IT for replacement.

IT makes no warranty or representation, either express or implied, with respect to this software, hardware, or documentation, their quality, performance, merchantability, or fitness for a particular purpose. This software, hardware, and documentation are licensed "as is," and the purchaser/licensee assumes the entire risk as to their quality and performance.

In no event will IT be liable for direct, indirect, special, incidental, or consequential damages arising out of the use or inability to use the software, hardware, or documentation, even if advised of the possibility of such damages. The warranty and remedies set forth above are exclusive and in lieu of all others, oral or written, express or implied. No person, seller, dealer, agent, or employee is authorized to make any modification or addition to this limited warranty.

Some states do not allow the exclusion of implied warranties or liability for incidental or consequential damages, so the above limitation or exclusion may not apply to you. This warranty gives you specific legal rights, and you may also have other rights that vary from state to state.

- INCREDIBLE TECHNOLOGIES, INC



Golden Tee LIVE USER MANUAL

TABLE OF CONTENTS

TABLE OF CONTENTS	1
DEDICATED CABINET	5
Step 1: Dedicated Cabinet Contents	5
Step 2: Marquee Header.....	5
Step 3: Leg Leveler Installation and Adjustment	5
Step 4: Apply Power	6
Step 5: ITNet® Registration.....	7
Dedicated Cabinet Repair Procedures.....	8
System Chassis Box.....	8
I/O Board.....	9
Antenna	9
Cabinet Identification Device (CID)	10
Cash Vault.....	10
Card Reader.....	11
Control Panel.....	12
Cabinet Bezel.....	13
Lighted Marquee.....	14
Fluorescent Light Fixture	14
Speakers.....	14
27" Monitor	15
LCD Monitor.....	16
I/O Dip Switch Settings	16
General Cabinet Maintenance	17
General Cabinet Maintenance	17
Care and Cleaning of Rubber Bumper	17
Nighthawk Air Filter	17
Trackball Maintenance.....	17
Care and Cleaning of Cooling Fans and Vents.....	17
LCD Monitor Care and Cleaning	17
RETROFIT KIT INSTALLATION.....	19
Step 1: Retrofit Kit Contents.....	19
Step 2: Recommended Tools.....	20
Step 3: Installation Preparation.....	20
Step 4: Preparing the Cabinet for Installation.....	21
Step 5: Retrofit Kit Component Installation.....	24
Step 6: Apply Power	31
Step 7: ITNet® Registration.....	32
General Cabinet Maintenance	33
General Cabinet Maintenance	33
Trackball Maintenance.....	33
Care and Cleaning of Cooling Fans and Vents.....	33
Nighthawk Air Filter	33
LCD Monitor Care and Cleaning	33
Antenna Adjustment	33

STANDARD ONLINE AND BASIC OFFLINE Kit Contents.....	35
Kit Installation.....	36
Recommended Tools.....	36
Installation Preparation.....	36
Preparing The Cabinet.....	37
Cabinet Selection.....	37
Preparing the Cabinet for Installation.....	37
Check JAMMA Harness and Wiring.....	37
Check Coin Mechs and Bill Acceptor.....	37
Check Coin Door Connections.....	37
Check Monitor.....	38
Remove Cabinet Graphics.....	38
Remove Existing Card Reader (If applicable).....	38
CUT Hole for Card Reader (Online Kit Only).....	39
Bore Hole for Fan.....	39
Vacuum Cabinet Thoroughly.....	39
Electronics Installation.....	39
Install Cooling Fan.....	39
Install Card Reader (Online Kit Only).....	39
Install Nighthawk Chassis.....	40
Install Cabinet Identification Device (CID).....	40
Install I/O Board.....	41
Install Antenna (Online Kit Only).....	41
Control Panel Installation.....	41
Install Optional Control Panel for Golden Tee Fore! Cabinets.....	41
Trackball and Button Preparation (For Most Kits).....	42
Control Panel Overlay Installation.....	43
Finishing The Control Panel.....	44
Complete Nighthawk Chassis Connections.....	45
Attach I/O Power, Audio, and USB cables.....	45
Attach Main Video Cable.....	45
Attach Power Cable.....	45
Soft Power / Fan Cable.....	45
Complete I/O Board Connections.....	46
Connect JAMMA Harness.....	46
Connect the Control Panel Switches and Cable.....	46
Connect New Buttons.....	46
Connect Coin Door Lamps.....	46
Connect the Trackball.....	46
Connect Antenna.....	46
Connect Audio Cables.....	46
Connect the USB Cable.....	46
Connect Medium or Low Resolution Monitor.....	46
Connect VGA or SVGA Monitor.....	46
Connect I/O Power Cable.....	46
Check All Connections.....	46
Cabinet Graphics Installation.....	47
Side Decal Installation.....	47
Marquee Installation.....	47
Coin Doors, Test Switch, and Volume Controls.....	48
Initial Power-Up.....	48
GOLDEN TEE LIVE SYSTEM SETUP MENUS.....	49
Navigating The Menu System.....	49
Entering System Setup Mode.....	49
Selecting a Menu.....	49
Choosing a Menu/Option.....	49
Changing a Value.....	49
Main Menu.....	49
Collections & Earnings Menu.....	50
Do Collection.....	50

General Settings	51
Operator Adjustables.....	52
General Adjustments.....	52
Money Slot Adjustments.....	53
Sound Adjustments.....	53
Collection Settings.....	54
Reset to Factory Settings.....	55
System Tests.....	56
Video Tests.....	56
Color Adjustments.....	57
Contrast Adjustments.....	57
Screen Size Adjustment.....	58
Sound Tests.....	58
Player Control Tests.....	58
Mechanical Meter Test.....	59
Hardware Tests.....	59
Hardware/Software.....	59
System Info.....	60
USB Info.....	60
Version Info.....	60
Check Hard Drive.....	61
Check Cooling.....	61
Check Card Reader (online only).....	61
Troubleshooting Shortcuts	62
Golden Tee Settings & Audits	62
Golden Tee Settings.....	63
Golden Tee Audits.....	63
Player Cost Schedule.....	64
ITNet Settings (online only)	65
Change Location.....	65
Communication Settings.....	66
Configure Ethernet Settings.....	66
Connection Tests.....	67
Re-Activate Modem.....	67
GOLDEN TEE LIVE TROUBLESHOOTING & REFERENCE	69
Appendix A Troubleshooting Guide	69
Appendix B JAMMA, Trackball, and I/O Power Connections	74
Appendix C Replacement Part Numbers	75
Appendix D System Diagrams	78
Appendix E GNU General Public License	87
Appendix F Informational Guides	89
Wireless Signal Strength and Antenna Guide.....	89
Collections Guide.....	90
Income Split Guide.....	91
Player Accounts Guide.....	92
Golden Tee LIVE Revenue Guide.....	93
Accounting for the Various Revenue Types.....	93
Golden Tee LIVE Fees.....	94
Accounting for Fees.....	95
Collections.....	95
Collection Worksheet.....	96
GT LIVE Collection Procedure.....	97
Menu Navigation Shortcuts.....	100
Appendix G ITNet Registration Forms	101
ITNet DEBIT ACCOUNT FORM.....	101
ITNet GAME REGISTRATION FORM.....	103
ITNet OPERATOR AGREEMENT.....	105

APPENDIX H Mounting Templates.....	109
Trackball Orientation Diagram	109
Trackball Mounting Template.....	111
Button Templates	113
Card Reader Mounting Template A.....	117
Card Reader Mounting Template B.....	118
Fan Hole Template.....	118

NOTE
PLEASE RETAIN ORIGINAL SHIPPING BOX FOR SERVICE AND REPAIR.

NOTE:
This kit is designed for use in cabinets with a JAMMA cable and wiring installed.
If you do not have a JAMMA harness already installed in the cabinet you have selected and are wiring the cabinet yourself, refer to the JAMMA Wiring Diagram in Appendix B.

NOTE:
Do NOT install this kit when the cabinet is powered on. Make sure the cabinet is unplugged from all power sources before and during installation.

Deluxe Dedicated



DEDICATED CABINET

STEP 1: DEDICATED CABINET CONTENTS

Dedicated Parts List

(1) Golden Tee LIVE Dedicated Cabinet

Shipped inside a separate box labeled *Parts – Do Not Discard* within the cabinet packaging.

(1) Marquee Header

Shipped inside the coin tray:

(1) Power Cord

(2) Rear Leg Levelers, shipped inside the coin tray.

Shipped inside the vinyl pocket attached to the inside of the back door:

(1) Golden Tee LIVE Manual

(1) Monitor Manual

(1) DBV/Coin Door Manual and Extra Parts

(1) T-15 Torx Tamper-Resistant Wrench

(1) T-20 Torx Tamper-Resistant Wrench

(1) T-25 Torx Tamper-Resistant Wrench

(2) ¼-20 Bolts for Marquee Header

If any parts to your dedicated cabinet are missing/damaged please contact Incredible Technologies Technical Support at 847-870-7027 x121.

STEP 2: MARQUEE HEADER

Your dedicated cabinet requires some simple assembly before it is ready to be placed on location. Please follow these steps to install the marquee header. The header is shipped inside a separate box labeled *Parts – Do Not Discard* within the cabinet packaging. The box is located outside of the cabinet directly under the cash vault.

Marquee Header Installation

First, remove the two center Phillips head screws that secure the access/mounting plate for the marquee fluorescent light fixture, and loosen the four outside Phillips head screws, but do not remove them. Remove the plate and light fixture and set-aside for now. Remove the bolts from the holes in the top of the cabinet. Place the marquee header on top of the cabinet and align it with the mounting holes located at the top of the cabinet. Secure to the top of the cabinet with the bolts. Once secure, connect the power cable from the header to the mating connector located at the access hole on the cabinet. Reinstall the access/mounting plate by placing it over the outside four screws. Reinstall the two center screws, and tighten all six screws.

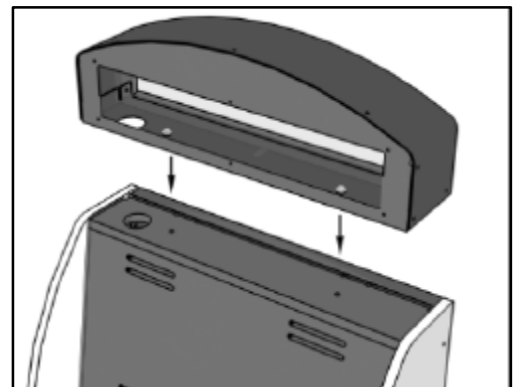

STEP 3: LEG LEVELER INSTALLATION AND ADJUSTMENT

Once your game is in position at the location, it is necessary to install and adjust the leg levelers. The leg levelers will help stabilize the game on an uneven floor, and help it from moving or shifting during game play. The game is shipped with the two front leg levelers installed. You will need 2 people to install the rear leg levelers. One person must carefully tip the game either forward or to one side to expose the threaded inserts located on the bottom rear of the cabinet. While tipped up, carefully thread the leg levelers into place. Adjust the levelers as necessary to level and stabilize the game.

STEP 4: APPLY POWER

Locate the power cord, shipped inside a small box inside the cardboard carton. Connect the power cable to the plug on the back of the cabinet. Then plug the cable into a 3-pronged, grounded wall socket. Locate the power switch on the back of the cabinet and turn it on.

Watch the game carefully when you first turn it on. Look and smell for smoke (TURN IT OFF IMMEDIATELY IF ANY IS NOTICED). Make sure the fan inside the chassis is running and the LED's on the I/O board in back are flashing. If not, something is wrong, turn off the game.

Check the Cabinet ID Device (CID) Number

Watch the screen during boot-up and wait for an orange verification screen to appear. Note the Cabinet ID Number (CID) that appears on this screen, and verify that it matches the CID number printed on the back of the cabinet. The screen will automatically time out and boot-up will continue.

Check the Coin Switch and Bill Validator

Try the coin switch. Drop quarters or tokens through to check the coin mech. Insert a dollar bill into the bill validator and listen for the credits to ring up. Make sure the game is adding credits and the correct quantity. You can use the PLAYER CONTROL TEST by pressing the System Setup button inside the coin door and entering the SYSTEM TESTS MENU. Make sure all of the controls work.

Checking the Wireless Connection Signal Strength

There are two ways to check the signal strength of your Golden Tee LIVE test machine. First, you can power the game off and on. A signal meter will appear in the lower right corner of the game's boot-up screen. The number of bars that are displayed indicate the signal strength. Additionally, you can enter Operator Mode by pressing the System Setup button inside the coin vault door. Once at the main Operator Mode menu, use the trackball and Start button to select *ITNet Settings*, then *Communication Settings* to view more information.



Cabinet Temperature

The state of the art Nighthawk hardware is extremely powerful, and therefore generates a substantial amount of heat. Measures have been taken to keep the various components cool during normal use. If overheating occurs, game play and hardware longevity may be affected. Use the Check Cooling menu in the System Setup menus to monitor the temperature within your cabinet. Enter System Setup by pressing the System Setup button inside the outer door of the coin vault. Once at the main System Setup menu, use the trackball and Start button to select *Troubleshooting/Info*, then *Check Cooling*.



Custom Adjustments

Upon initial power-up, the game will initialize to factory default settings. These settings affect game elements such as number of credits per coin, volume settings, etc. The System Setup section will describe how to alter these settings and view the system audits or run system tests.

STEP 5:

ITNET® REGISTRATION

Golden Tee LIVE is an online only game, and must be properly registered to ITNet for all of the game features to be available. First you must register with ITNet as an ITNet Operator. Once you are established as an ITNet Operator, you can register your game to receive the online features.

ITNet® Operator Registration

Follow these simple instructions to become eligible for ITNet® online features.

1. Fill out the ITNet® Debit Account Form, found in Appendix G, and open a Debit Account at your local bank.
2. Read and sign the ITNet® Operator Agreement, found in Appendix G at the back of this manual.
3. Fax or mail these two forms to Incredible Technologies, Inc. at **(847) 454-9156** to become an authorized ITNet® Operator.
4. Once these forms are processed, you will receive your ITNet® Operator ID Card in the mail.

The Operator ID Card allows you to:

Register your games for online play right on-site.

Activate games, add and change location information, and de-activate games at the location.

Gain access to the personalized IT Operator Services web site.

Check audits, bookkeeping and game play statistics and make game adjustments from your home or office.

NOTE:

If you are a brand new ITNet® operator and can't wait for your Operator ID card to arrive in the mail, you can fax the GAME REGISTRATION FORM, found in Appendix G, to Incredible Technologies. The ITNet® staff will then enter your machine's location data for you. Please allow 2 to 5 business days for processing. When your machine connects with ITNet, it will automatically register to your account and activate the online features.

ITNet® Game Registration

Follow these simple instructions for game and ITNet setup.

Follow the instructions above to become an ITNet operator and receive your Operator ID card. You can use the card to register your games on site, or you can submit a Game Registration Form to complete game registration.

Game Registration Form

1. Fill out the Game Registration Form found in Appendix G. Be sure all of the information is correct and legible. Make sure to include the Cabinet Identification Device (CID) number.
2. Fax or mail the Game Registration Form to Incredible Technologies for processing. Forms are usually processed within 3 days, but please allow up to 10 business days for complete registration.
3. Your game will be automatically registered once the form has been processed, and should enable online features automatically. Online features may take up to four hours to appear on the game.

On-Site Registration

1. Turn on the game. You may have to wait a few seconds for hard drive access. If the game is not registered a screen will appear asking you to swipe your operator card to start the registration process. If you do not have your card, or do not have it ready, the screen will time out after 4 or 5 minutes.
2. Enter all of the necessary location information carefully and accurately. When completed, the game will automatically attempt to connect to ITNet.
3. If registration is successful, the game will switch directly to the attract mode. If there was any trouble with the connection to ITNet, an error message will appear. Select Yes to try to connect again. If your first few attempts to connect are unsuccessful, refer to the troubleshooting guide in Appendix A of this manual or call IT tech service at 847-870-7027 x121.
4. The game is now connected to the ITNet System and ready for public play! Online features will be automatically activated by Incredible Technologies, and some may take up to four hours to be received.

DEDICATED CABINET REPAIR PROCEDURES

SYSTEM CHASSIS BOX

The Nighthawk Chassis houses most of the game electronics and hardware in one box that can be easily installed. As with all electronic equipment, the Chassis box should be handled with extreme care. Shock, severe temperature, or sudden impacts can damage the internal components that require costly repair.

Note!

Turn off power to the cabinet when performing any of the following.

System Chassis Removal

1. Disconnect all connections to the system box. Be sure all wires and connectors are clear and out of the way. Label the connectors for easy reconnection.
2. Remove the lower 4 wood screws that secure the system box to the cabinet's mounting panel.
3. Support the system box against the mounting panel. Remove the 2 3/8" nuts from the mounting studs and lift the system box out of the cabinet.

System Chassis Installation

1. Align the system box onto the top two mounting studs of the panel. The connection ports face up. Install and secure the two 3/8" nuts to the mounting studs first. Next install and secure the 4 lower wood screws.
2. Connect the required connections. See the Connections Diagram in Appendix D for more details.

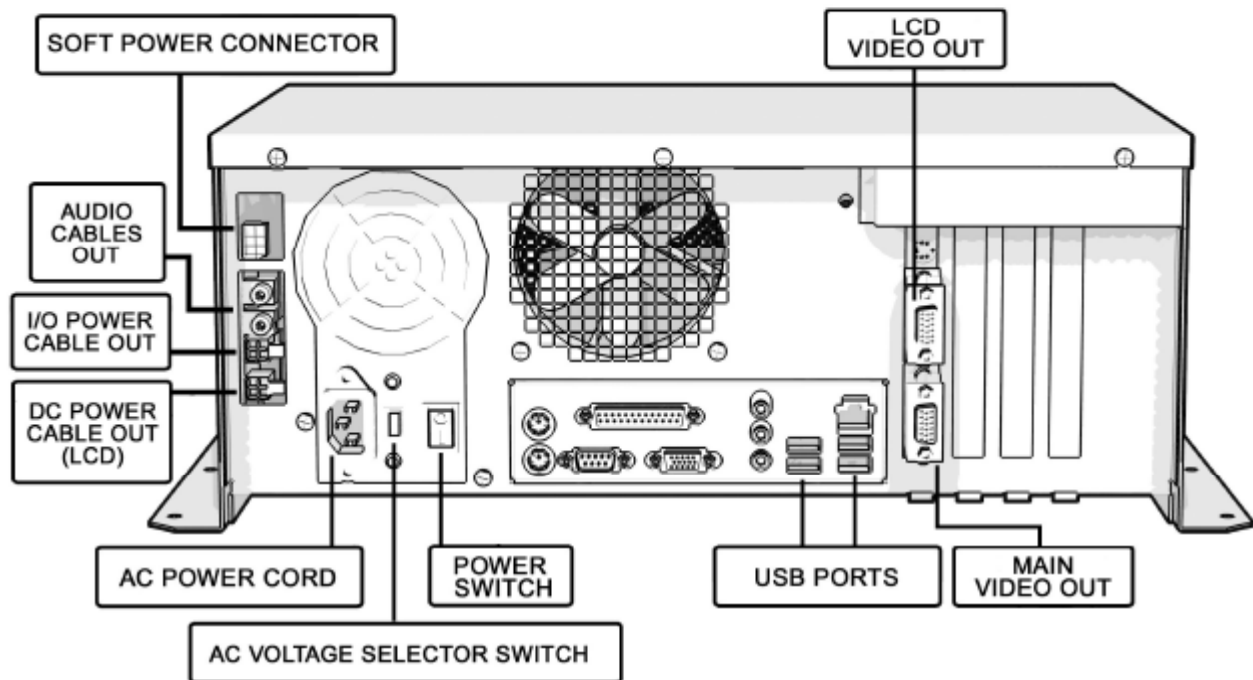

I/O BOARD

NOTE!

The I/O board is game title specific and is not interchangeable with other game titles produced by Incredible Technologies on this system. Dedicated and Retrofit Kit I/O boards are different and are not interchangeable.

Dedicated I/O Board Removal

First, disconnect all connections from the I/O board. Refer to the I/O board connections diagram below. Label the connectors for easy reconnection and move them safely out of the way. Next, remove the four 1/4" wood screws that secure the board to the left inside wall of the cabinet. Carefully remove the I/O board from the cabinet.

Dedicated I/O Board Installation

Place the I/O board in the proper location inside the cabinet. Be sure it is oriented properly so the cables reach the board. Secure the I/O board to the side of the cabinet with the four 1/4" wood screws. Use the same mounting holes if at all possible. Be sure the board does not "bow" or is not stressed in any way. Once mounted, connect the appropriate connectors. Refer to the Dedicated I/O board connection diagram below.

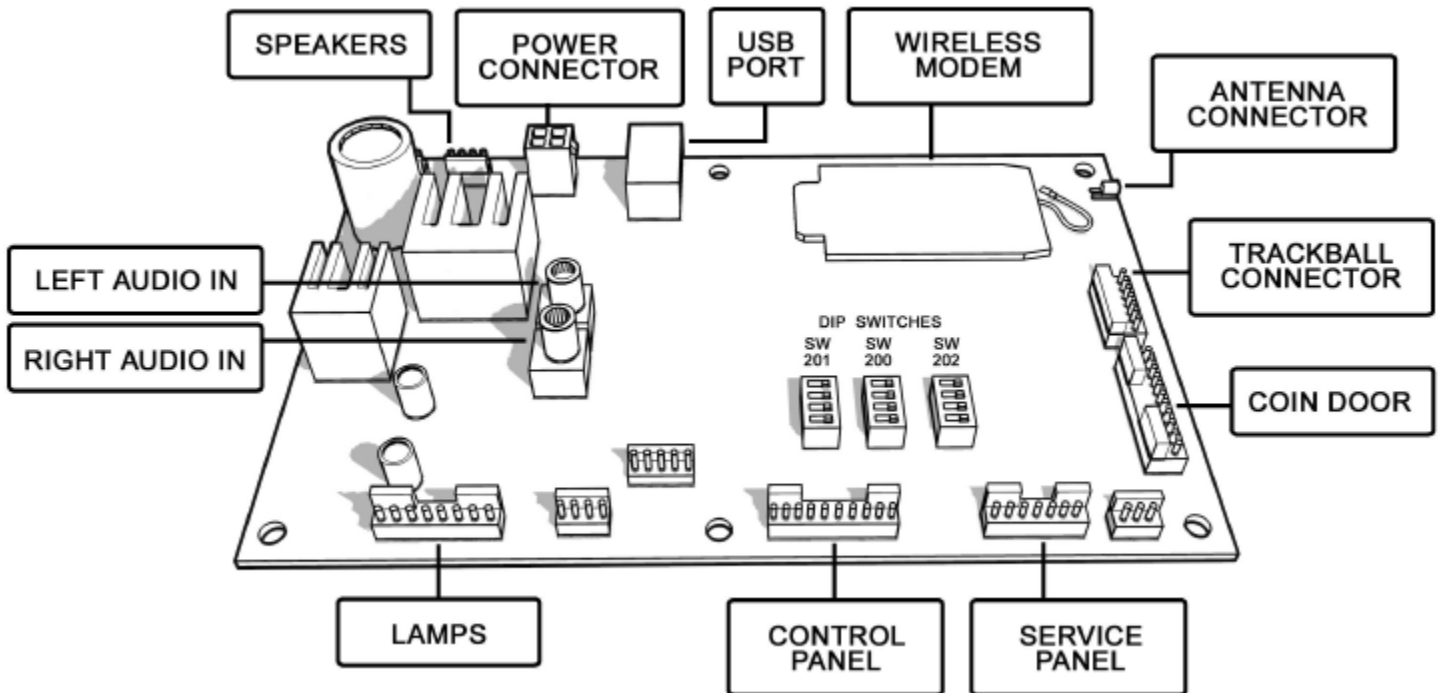
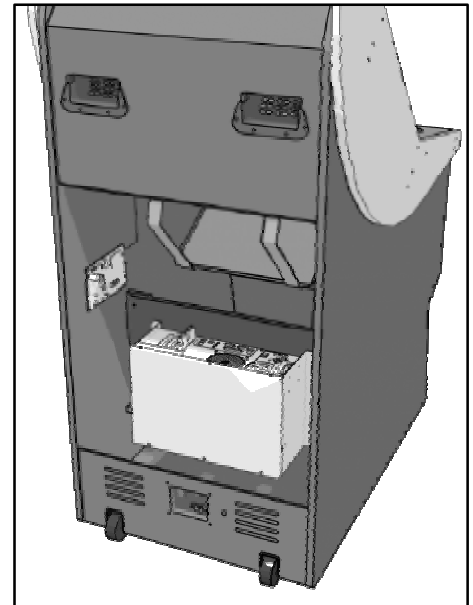

ANTENNA

The antenna connects to the I/O Board and is mounted in a housing on the back of the cabinet. A strong wireless signal is very important to getting the most out of your game. Depending on the positioning of the game in the location, you may need to adjust the antenna's position to achieve the best signal. The antenna's housing allows for a variety of positions within, and the housing itself can be easily moved to a different location using tape or screws. See the Wireless Signal Strength and Antenna Guide found in Appendix F for more information on getting the best possible wireless signal strength for your game.

CABINET IDENTIFICATION DEVICE (CID)

This device contains a specific ID number that identifies your cabinet. The CID is a permanent number and must be connected to the main system box via the USB cable and working properly in order for the game to operate.

CID Removal and Replacement

If for some reason you must replace the CID, disconnect the USB cable from the CID. This is the only connection to the CID. Next, remove the two 1/4" wood screws that secure the CID to the right inside of the cabinet.

To install a CID, reverse the order above.

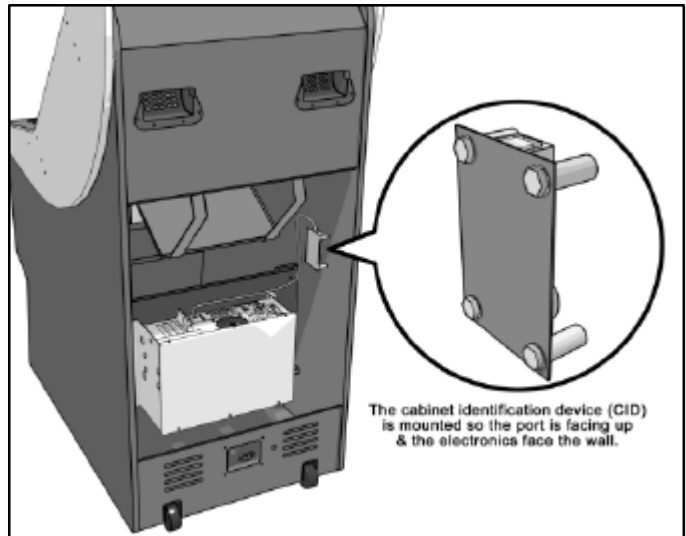

Note!

The Cabinet Identification Device should **NEVER** be removed from the cabinet, even when replacing any of the other components. The CID is the cabinet's PERMANENT Identifier, regardless of any other components.

CASH VAULT

The Cash Vault has been designed for optimal security. With the double-locking doors, service technicians can read meters and enter System Setup mode with no access to the cash box.

Cash Vault Removal and Replacement

- 1) Unlock and open the outer door of the Cash Vault.
- 2) Using a T-15 Torx wrench, unscrew the card reader/button plate located on the right side by removing the four #8-32 screws located at the top and bottom of the plate.
- 3) Unplug the cable from the card reader, and disconnect the connectors for the coin meter and buttons.
- 4) Remove the plate and set it aside.
- 5) Remove the coin bin and the bill validator magazine to make it easier to work inside the vault.
- 6) Unplug the bill validator cables, and push the cables for the bill validator, card reader, buttons, and coin meter through the 2 holes located in the back of the vault.
- 7) The Cash Vault is attached by upper and lower locking brackets. These are each attached with two socket-head screws located within the vault.
- 8) Locate the socket-head screws on the top and bottom locking brackets. Remove the two bottom screws using a 9/64" hex key and remove the bottom locking bracket. Make sure to note how it was installed.
- 9) Remove the two top screws and remove the top locking bracket, again noting how it was installed.
- 10) You can now pull the entire vault assembly out from the front of the cabinet. The vault is attached with foam tape, so it will need to be pried out or pushed from behind to loosen the adhesive.
- 11) Reverse the procedure to install the new door.

Locks

The outer lock is a secure T-handle lock, commonly used in vending. To open, insert the key and turn it clockwise until the lock-handle pops out. Next, rotate the lock-handle clockwise 90 degrees to open the outer door.

The inner door has a lock installed above the System Setup button. This lock is unlocked by turning the key 90 degrees clockwise.

Volume and Service Buttons

Mounted inside the outer door are controls for Volume and System Setup. Press the Volume Up button to increase the loudness of the sounds on the game, and press the Volume Down button to make your game quieter. Press the System Setup button to access the game's software menu system. The System Setup menus cover a variety of important areas including collections, tests, game adjustments, and optional settings. System Setup is covered in detail starting on page 49.

Bill Acceptor

The dedicated cabinet ships with a MARS AE2681 D5 bill acceptor and is mounted on the cash vault door. The default dipswitch settings for this acceptor are ON = 1,2,4-7 and OFF = 3,8.

Bill Acceptor Removal

Disconnect the cable to the bill acceptor. Remove the four 11/32" sized nuts from the mounting studs. Disconnect the ground wire from the one lower stud. Then gently pull the acceptor off the studs from the back side of the coin door.

Bill Acceptor Installation

From the back side of the coin door, place the bill acceptor onto the four mounting studs. The faceplate will protrude out the front of the coin door. Place the field ground wire on a lower stud, and install the four 11/32" sized nuts on the mounting studs and tighten. Next, connect the bill acceptor cable in the cabinet to the mating cable on the bill acceptor itself.

Stacker Removal

A blue slide switch is located at the bottom of the stacker. Engaging it allows the stacker to be removed.

Coin Mech

Coin Mech Removal

Loosen the two finger screws to release the securing braces. Slide the upper brace upward, and the lower brace downward. The mechanism should pull straight out.

Meter

This 5-volt device is mounted behind the card reader plate next to the inner door of the coin vault. One lead of the meter is connected to a +5 volt source and the other lead is connected to the appropriate signal wire. See wiring diagram on page 81. An additional opening is available just below the meter, if a second meter is desired.

CARD READER

The Card Reader is a very important aspect to Golden Tee LIVE, and is very important to keep in good working condition. Players are required to use a card to identify themselves for most of the online features. If the card reader is not working properly, these features will not be available.

Card Reader Removal

Access the card reader through the coin door opening. To remove the card reader, disconnect the USB connector from the Card Reader. Then remove the 4 T-15 security screws that secure the mounting panel that holds the card reader, coin counter and buttons. Next, remove the two Phillips head screws holding the card reader to the mounting panel. Once loose, pull the card reader out through the front of the panel.

Card Reader Installation

Open the coin door to access the card reader mounting. Place the back end of the card reader through the opening on the mounting panel. The larger portion of the card reader bezel should be in the up position. From the backside of the panel, secure the card reader to the panel with the 2 Phillips head screws. Once in place, reconnect the USB cable to the card reader. Attach the mounting panel to the coin door with the 4 T-15 security screws. Power the game back on and test the card reader using the Card Reader Test located in the Troubleshooting/Info Menu in System Setup.

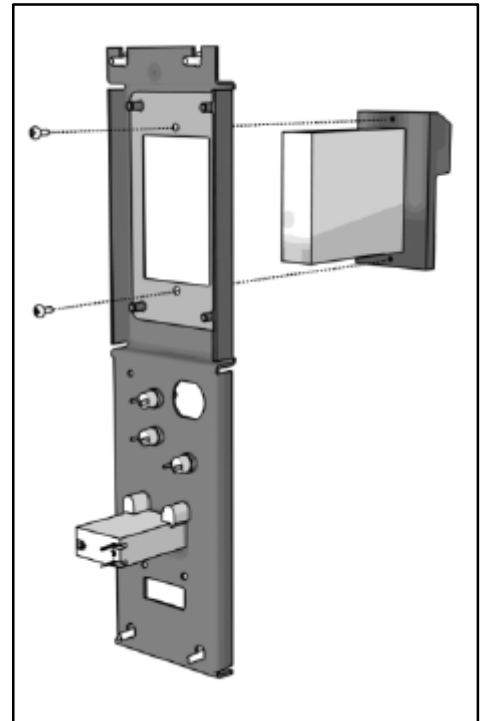

CONTROL PANEL

Opening the control panel provides access to the trackball and buttons, as well as the controls for adjusting both color monitors. To open the control panel, locate and remove the two T-25 security screws on either side of the cabinet. A T-25 Torx wrench has been provided in the vinyl pocket on the back door. Remove the screws completely before opening the control panel. Once the screws have been removed, store them in a safe place and then lift the hinged control panel from the top, where the control panel meets the plastic bezel.

Monitor Adjustments (LCD and 27" CRT)

There are two small boards located beneath the control panel that are used to adjust your monitors. These controls are placed here so you can view both monitors when making corrections to color, brightness or size. Use the Monitor Test screens in System Setup for best results.

Software Update Connections

A power cord and USB connector are supplied under the control panel, in anticipation of software updates via a DVD drive. When a software update is available, you can conveniently connect your compatible DVD drive with no additional equipment needed.

Note!

Some DVD drives do not have a mating AC power connector and will require an alternative AC power source.

Soft Power Switch

A "soft power" switch has been added beneath the control panel, to assist in the update process. This switch will turn off power to the cabinet so you don't have to reach around to the main power switch located on the back of the cabinet.

Note!

If you turn power off using the Soft Power Switch, you **must** use this same switch when turning power back on.

Trackball Replacement

To replace a trackball, open the control panel and remove the 4 long screws holding the trackball in place. Be careful not to lose any of the screws, washers and lock washers. Disconnect the wire harness and ground wire and remove the old trackball. Position the new trackball in the proper orientation over the existing standoffs. Make sure that the arrow on the trackball that points to the monitor is pointing up. Replace the 4 long screws and washers. Do not over tighten! Screw in until the lock washer is fully compressed. Reconnect the wiring connector and ground wire.

Note!

The field ground wire is critical to avoid electrical problems and assure optimal performance.

Button Replacement

All of the buttons on the control panel require a 1 1/8th inch hole, and are pre-drilled on the dedicated control panel. To remove a button, disconnect the wires from the button assembly by sliding the wires off of the micro switch posts. Next carefully twist the micro-switch assembly off of the button posts. Finally, unscrew the nut to remove the button from the control panel.

Place the new button assembly into the hole and position the smaller side of the micro-switch housing to face the rubber bumper, angled towards the middle. Tighten the supplied nut using a pushbutton wrench. Do not over tighten. Install the micro-switch by snapping it onto the pushbutton assembly by hand. Position the assembly so the micro switch posts face the rubber bumper, angling towards the middle. Reconnect the wires by sliding the wire assembly onto the contact posts of the appropriate micro switch. See the wiring diagrams in the back of this manual.

L.E.D. Lighted Buttons

The Help and Options buttons on Golden Tee LIVE are Light Emitting Diode buttons. The housing for the L.E.D. snaps into the back of the button assembly. The L.E.D. must be installed properly for the light to function properly. The Anode/positive side of the L.E.D. is connected to the +5 volts, and the Cathode/negative side of the L.E.D. is connected to the appropriate signal wire. The L.E.D. slides into the housing and the housing is marked Positive and Negative. See the lamps connector J202 in the cabinet wiring diagram in Appendix D.



Control Panel Removal

To remove the control panel from its hinge, Disconnect the trackball cable, field-ground wire, and the control panel interconnect connector to the I/O board. Remove the screw that attaches the safety cable to the control panel. Remove the four 1/4" screws holding the panel to the hinge.

Control Panel Graphics Removal

The control panel artwork has been screened onto a solid sheet of polycarbonate, which is resistant to scratches and burns. Unfortunately long exposure to excessive situations may damage the surface over time. To remove and replace this piece, the pushbutton assemblies must first be removed. Next, remove the 4 T-20 security screws from the four corners of the panel. A T-20 Torx wrench has been included and ships inside the pocket on the back door. Separate the polycarbonate piece from the wood portion of the panel by starting at one corner and slowly peeling the two apart. The overlay has adhesive on the entire surface and will take some force to separate the pieces due to the adhesive. Once removed, the graphic overlay will not be able to be used again.

Control Panel Graphics Installation

To install a new polycarbonate Graphics overlay, make sure the wood control panel surface is clean, smooth, and free from dirt and debris. Remove the paper protecting the adhesive from the new artwork/cover panel. Carefully place it on the wood panel, aligning it properly. Press and smooth firmly to assure that it is secure. Install the 4 security screws in each corner of the panel. Be sure they are flush or below the surface to prevent injury. Replace the buttons in the correct orientation.

CABINET BEZEL

The molded bezel on the front of the Golden Tee LIVE cabinet is used to mount and secure a number of components. This bezel will need to be removed to gain access to the speakers, 27" monitor, and LCD monitor.

Bezel Removal

First, remove the two security screws on either side of the cabinet that lock down the control panel. The bezel is held in place with 6 T-25 security screws, 3 on each side of the cabinet. Remove these screws. A T-25 Torx wrench has been provided in the pocket on the back door. Once all of the screws have been removed, lift the hinged control panel from the top, where the control panel meets the plastic bezel. Carefully loosen the bezel and pull it out slightly to allow access to the speaker connectors. Unplug both connectors. Carefully remove the bezel from the cabinet. Be careful not to pull on or excessively stress the plastic.

Bezel Installation

With the control panel open, place the bottom of the plastic bezel into position. Pivot it back far enough so the speaker connectors can be plugged back in, and do so. Push the bezel the rest of the way in, being careful not to pinch the speaker wires. The holes to secure the panel to the cabinet will align themselves if the bezel is properly placed into position. Install the 6 security screws, 3 on each side of the cabinet, to secure the bezel into place. Once the bezel is installed, close and secure the control panel with the 2 security screws.

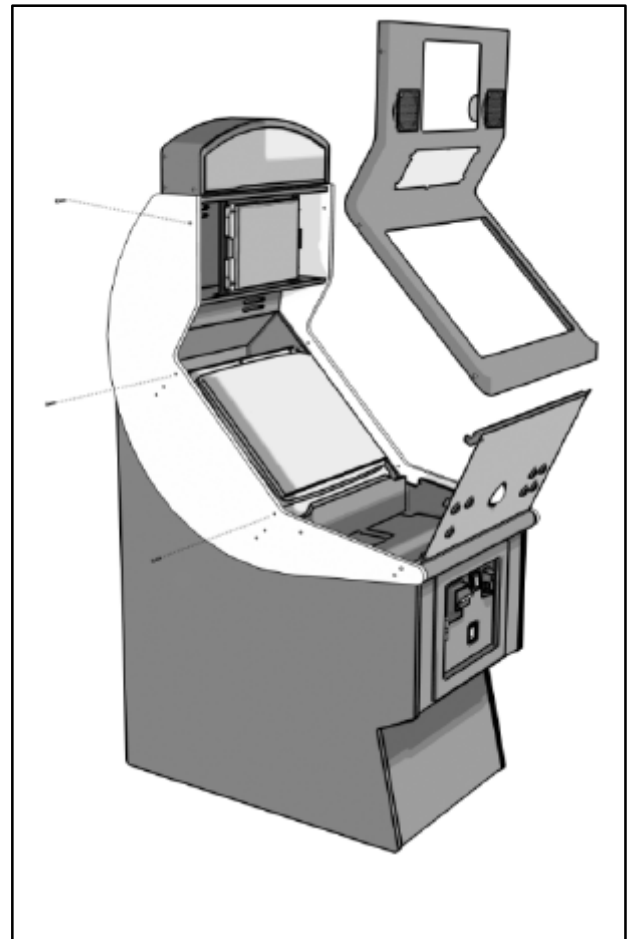

LIGHTED MARQUEE

Periodically a new version or update for Golden Tee will become available, requiring a new game marquee to be installed. Follow these directions for removing the existing marquee and replacing it with a new one.

Marquee Installation

First, remove the two center Phillips head screws that secure the access/mounting plate for the marquee fluorescent light fixture, and loosen the outside four Phillips head screws, but do not remove them. Next remove the plate and light fixture. Be sure to disconnect the power connector to the light and set it aside. A strong adhesive on the outer edges of the marquee artwork secures it in place. Carefully peel off the old marquee artwork.

Marquee Installation

To install the new marquee, first make sure the area where the adhesive is to go is clean and smooth, and free of dirt and debris. Remove the strips of protective paper on the outer edges to expose the adhesive on the new marquee. Through the access opening in the back, line up the artwork appropriately and press on the outer edges to secure the marquee in place. Next, connect the power cable to the mating connector located at the access hole. Place the plate assembly back over the four Phillips head screws and slide it downward. Reinstall the two center screws and then tighten all six screws.

FLUORESCENT LIGHT FIXTURE

The Golden Tee LIVE cabinet uses a Happ Controls fixture. The ballast is a clamped core that works with a T8 Lamp - Happ Controls P/N 91-1228-00. The starter is FS2 Deluxe - Happ Controls P/N 91-2000-00. The Fluorescent bulb is an F15 T8 CW and is easily replaced once the back plate on the marquee header has been removed. As with all electrical devices, do not work on this component when the power is on.

SPEAKERS

The speakers are mounted on either side of the LCD monitor, so players can best hear the audio. Sounds and speech are important aspects to the play experience and should be adjusted and maintained for optimal results. Make sure your speakers are in good working condition, are wired correctly, and are grounded properly to avoid buzz or hiss.

Speaker Access

In order to reach the speakers, the cabinet bezel must first be removed. Refer to the Bezel Removal section above. The speakers are located on the back of the bezel. Remove the 4 nuts with an 11/32" nut driver to remove the speakers from their mounting.

Note:

Both speakers must be identically wired to work properly. For optimal sounds, both speakers must be in phase with one another. Be sure the positive wire is connected to the positive terminal of each speaker and the negative speaker wire is connected to the negative terminal of each speaker. See the diagrams in Appendix D.

27" MONITOR

Your Golden Tee LIVE cabinet comes equipped with a digital monitor set to SVGA resolution. Golden Tee LIVE dedicated cabinets support high-res monitors, offering superb graphics and brilliant colors. Additionally, Golden Tee LIVE supports low-res, mid-res, VGA and SVGA monitors. Make sure the I/O Board and monitor are set properly for best game play results. The bank of dip switches marked SW201 on the I/O board control video settings. Refer to the diagram on page 16 for the proper setting for your monitor. Your monitor may require additional adjustments to set it to the best resolution. Check your monitor's manual for more information.

Adjustments for color, brightness, contrast and image size are located under the control panel. Refer to the Control Panel section on page 12 for information on how to access these controls. Monitors are delicate and can lose color or clarity if not treated properly. Never move a cabinet when the monitor is on. A game with a clear, bright monitor will attract more players and earn more money than a dim or poorly adjusted monitor.

27" Monitor Removal

To remove the monitor, you first need to open the control panel and remove the cabinet bezel. Refer to those sections above for the proper removal procedures.

1. Once the monitor is exposed, disconnect the power cable and video connection at the back of the monitor.
2. The Remote controller board should be re-routed from under the control panel to the back of the monitor and placed in the electronics area.
3. Be sure all wires that are not attached to the monitor are free and clear of the frame. Be sure that none of the cabinet wires are attached to the monitor by a connector or wire ties.
4. From the front, remove the 4 nuts from the studs of the monitor mounting brackets. Two of the nuts are located on the top and two are on the bottom. Do not remove the bolts holding the tube to the monitor frame.
5. It is best to have two people remove the monitor from the cabinet. Start with one person in the back to lift the monitor off the mounting studs. The second person should be positioned in front to guide the monitor out. The person in the back can then join the person in front to completely remove the monitor from the cabinet.

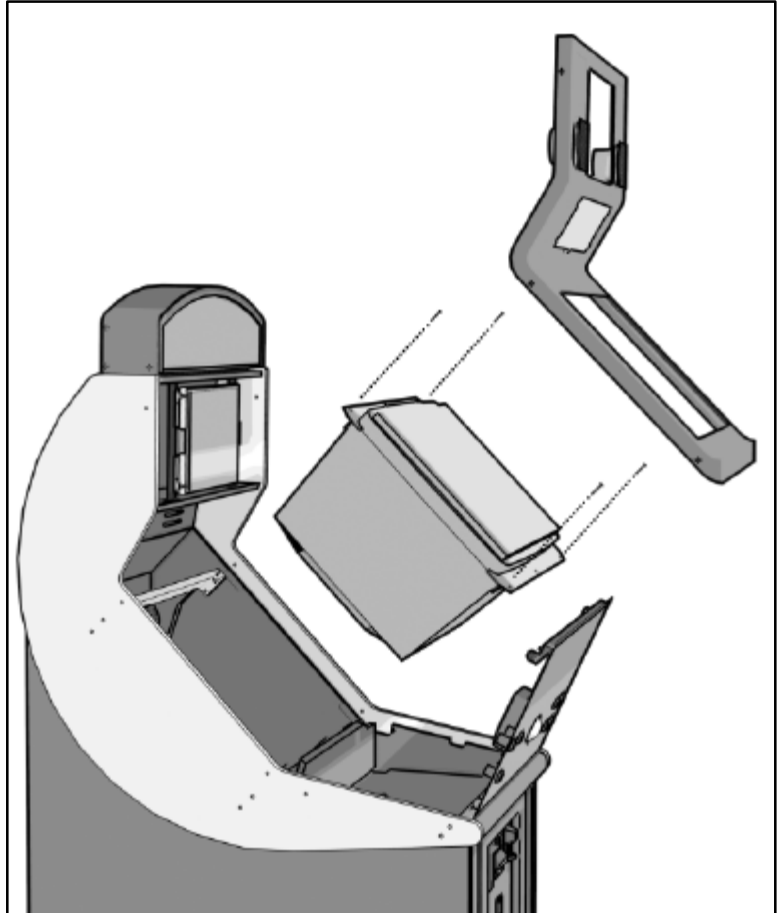

27" Monitor Installation

To replace the monitor into the cabinet, make sure all power is off, then open the control panel and remove the cabinet bezel. Refer to those sections above for the proper removal procedures.

1. Place the monitor into the monitor opening from the front of the cabinet. The electronics on the monitor should face into the cabinet. It is best to use two people to guide the monitor onto the mounting studs, located on the mounting brackets inside the cabinet.
2. Install the 4 nuts to secure the monitor to the mounting studs.
3. Route the controller board through the back of the control panel, and to the right side. Secure it with Velcro.
4. Attach the main monitor video cable from the LIVE system box to the video input of the monitor.
5. Attach the power cable to the power input cable of the monitor.
6. Dress cables with wire ties as needed to assure proper routing and reliability.
7. Turn the cabinet on to test the monitor. Adjustments are likely needed. Be sure the dip switches on the I/O board match the desired resolution. See the monitor's manual for more details.

LCD MONITOR

The LCD monitor is mounted in such a way so that players view the best possible image. Game software controls the displayed images so they appear in the correct orientation. You may see some text displayed upside down during the boot-up process. This is normal.

In order to reach the LCD Monitor, the cabinet bezel must first be removed. Refer to the Bezel Removal section on page 13. Once the bezel has been removed, the LCD monitor is exposed.

LCD Monitor Removal

The remote control board should be pulled from under the control panel back to the LCD. Remove the 4 nuts holding the LCD to the mounting brackets with an 11/32" nut driver. Gently pull the LCD from the mounting studs. Support the LCD carefully while you disconnect the video and power input cables from the back.

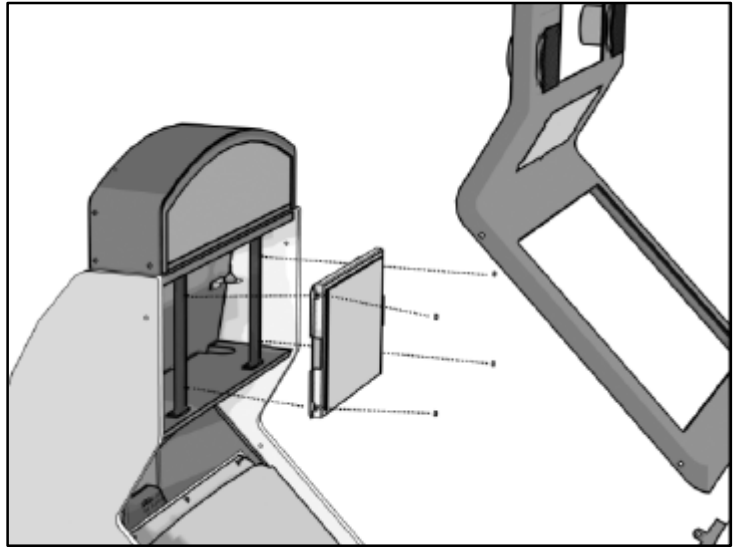

Note:

Handle the LCD monitor with care. Do not press on the display or allow anything to lie on top of it. Permanent damage can occur.

LCD Monitor Installation

To install a new LCD monitor, remove the cabinet bezel and carefully connect the video input and power cables to the LCD monitor. Once connected, set the LCD monitor onto the mounting studs. Fasten the monitor securely with the 4 nuts. Route the remote adjustment board down through the mouse hole and beside the main monitor, and finally through the right access hole under the control panel. Secure the remote adjustment board with Velcro. Be sure the cables are secure. It is best to strain relief the cables with wire ties. Turn on power to the game and test the monitor to make adjustments as needed.

Note:

Use a soft cloth with an ammonia free glass cleaner to clean the LCD Monitor. Ammonia can ruin the display. Do not press hard on the display surface. Permanent damage may occur.

I/O DIP SWITCH SETTINGS

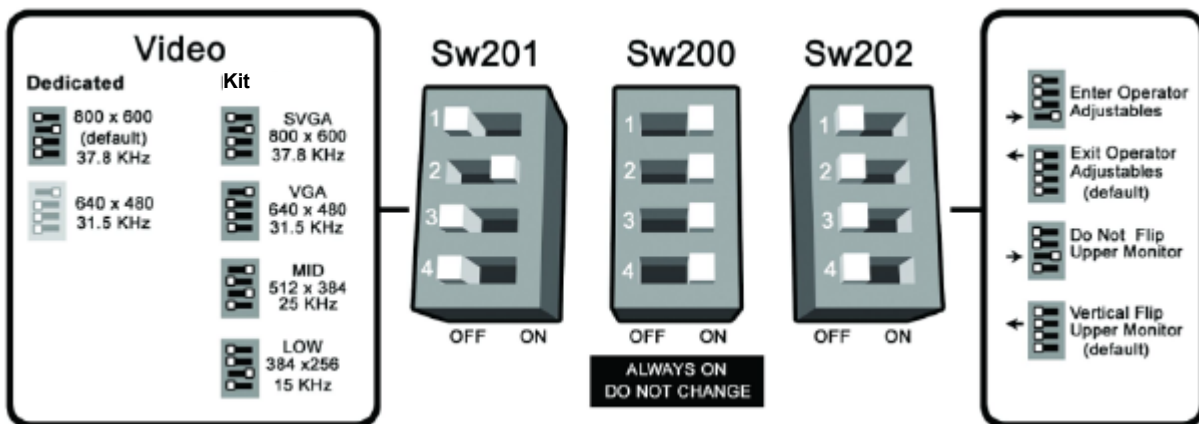

GENERAL CABINET MAINTENANCE

GENERAL CABINET MAINTENANCE

Games that are in good working condition, with clear monitors, clean control panels and working trackballs will make more money than a machine in poor condition. It is definitely worth your time and attention to protect your investment with a little common care. Each week, clean the 27" monitor and wipe down the control panel to bring back that new game look. Test the trackball and buttons regularly to make sure they are playing properly. And perhaps most important, make sure the coin mechs and bill acceptors are in good working order.

CARE AND CLEANING OF RUBBER BUMPER

The rubber bumper on the front of the cabinet's control panel is made from durable nitrile rubber. Clean it using a mild soap and water solution or blue window cleaner.

NIGHTHAWK AIR FILTER

The Nighthawk Chassis comes equipped with an external electrostatic air filter. This filter is held in place by a metal bracket, attached to the chassis. The filter prevents debris from entering the chassis and damaging the electronic components. A clogged filter will impede airflow, thus building up unwanted heat which can cause damage to your hardware. Be sure to check this filter at least once a month. Remove the filter by sliding it out of its housing. Shake off excess dirt and if necessary clean it with soap and water. Be sure the filter is completely dry before reinstalling the filter.

TRACKBALL MAINTENANCE

The trackball will require periodic maintenance to assure optimum performance. In most cases the inside of the trackball simply needs to be cleaned of any accumulated dust and debris.

To access the inside of the trackball, remove the 6 Phillips head screws that hold the trackball together and remove the top cover. Clean out any dust and debris inside the trackball. Polish the rollers and remove any foreign material that may be on the rollers. Do not lubricate the bearings, as this will only attract more dust. If the bearings do not spin freely it is best to replace the bearing assembly. Inspect the rollers for any nicks that may cause poor performance and replace if needed. Inspect the ball for any nicks and replace if needed. Parts can be obtained from Happ Controls and is an economical option rather than replacing the entire trackball assembly.

It is critical that the green field ground wire be properly connected to field ground. This prevents the trackball from building a static charge that can cause the game to lock up or reset. A static discharge can also damage the trackball's electronic components, as well as the main system.

CARE AND CLEANING OF COOLING FANS AND VENTS

The hardware that runs Golden Tee LIVE is quite sophisticated, and many of the chips and processors will get hot very quickly. Like your desktop PC, the Golden Tee LIVE hardware needs adequate ventilation to work properly. Dust and dirt can be a major cause to overheating and will lead to costly repairs. At least once a month, check to make sure the cabinet and chassis fans are working and free of dust and debris. Use a vacuum to clear all the ventilation holes on the cabinet at this time as well.

LCD MONITOR CARE AND CLEANING

Never use ammonia-based products on the upper LCD monitor. Instead clean the LCD with a mild soap or plain water, or an alcohol-based cleaner. Handle the screen with great care. Do not press down anywhere on the screen and do not place any heavy objects on the screen as irreparable damage can occur.

Clean the screen with a glass cleaner that is ammonia free. Alcohol-based cleaners are best.

Deluxe Retrofit Kit











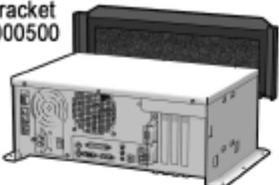
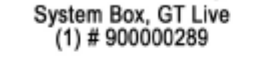
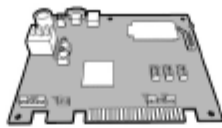
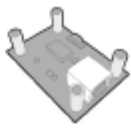



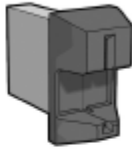

RETROFIT KIT INSTALLATION

STEP 1: RETROFIT KIT CONTENTS

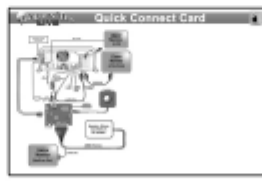
Please refer to these IT part numbers when placing orders.

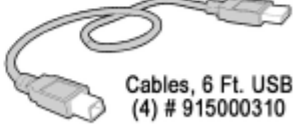
Included in the Golden Tee LIVE Retrofit Kit (Part # 903000250) should be the following:

Chassis & Filter		I/O Board		CID		Antenna			
 Filter & Bracket (1) # 753000500  System Box, GT Live (1) # 900000289		 I/O Board Assembly (1) # 900145001		 Cabinet Identification Device (CID) Assembly (1) # 900145003		 Antenna, GT Live (1) # 510000900			
Header Assembly		Fan Kit (#900000755)		Card Reader					
 Header, GT Live (1) # 900100903		 Fan, GT Live (1) # 755000915		 Fan Grill, GT Live (1) # 755000220		 Cable, Fan/Soft Power (1) # 915250203		 Card Reader, GT Live (1) # 760007104	
		Hardware Cables		Misc. Cables					
 Cable, LCD Power (Installed in Header)		 Cable, I/O Board Power (1) # 915250204		 VGA Adaptor (2) # 630000600		 Cable, 6 Ft. Male/Male SVGA (1) # 915000315			
 Bracket, Header, GT Live		 GT Manual (1) # 815000289		 Quick Connect Guide (1) # 840250903		 Cable, Audio 6 Ft. (1) # 915000285			
 10 Ft. Male/Male SVGA Cable (1) # 915010315						 Cables, 6 Ft. USB (4) # 915000310			
Control Panel & Decals									
 Control Panel Assembly (1) # 900250903		 Decals, GT Live (1) # 830000250				 AC Power Cord Cable for System Box (1) # 915000745			

NOTE: PLEASE RETAIN ORIGINAL SHIPPING BOX FOR SERVICE AND REPAIR.

STEP 2: RECOMMENDED TOOLS

Have the following tools ready before you begin to install this kit:

- ¼" and 11/32" Socket Drivers
- Phillips Head #2 Screw Driver
- Drill with 3/32" and 7/32" Bits
- T-15 Torx Bit - Tamperproof
- Small Flat Blade Screwdriver
- Awl
- 3 ½" Hole Saw
- Wire Cutters
- Tape Measure
- Decal Roller/Squeegee
- Liquid Window Cleaner & Cleaning Cloth
- Vacuum Cleaner
- Any tools needed to remove parts from your existing cabinet not listed above.

Many operators notice their earnings increase with touches as simple as a fresh coat of paint and a clean cabinet. If you will be painting, you'll need these supplies:

- Air Brush or Paint Sprayer
- Paint Brush, Paint Roller, and Pan
- Paint (and Primer)
- Sandpaper

STEP 3: INSTALLATION PREPARATION

Before You Start:

Before you install the Golden Tee LIVE Retrofit Kit into your cabinet there are a few things you should check first:

1. Make sure you are installing the Retrofit Kit into an existing IT cabinet.
 - This Retrofit Kit will only work with Golden Tee Fore! dedicated cabinets created by IT.
2. Check to make sure your existing cabinet's monitor, speakers, and AC power cord all work properly.
 - Replace or repair where necessary.
3. Check to make sure all the necessary parts are included in your kit.
 - If any are missing/damaged please contact IT's Technical Support at 847-870-7027 x121.
4. Check to make sure cabinet is wired with standard earth grounded A.C. plug compatible with local building codes and/or safety requirements.
 - If not, have a qualified electrician install one (not provided).
5. Have all the necessary tools available to install this kit.
 - Refer to the recommended tools list above to make sure you are prepared before you start.
6. Make sure the cabinet is unplugged.
 - Working with any part of the system plugged in or powered on can be dangerous.
7. Keep in mind that it's been proven that the higher quality of work put into a kit installation results in a higher earning game.
 - Make sure you have plenty of space, time, and concentration to put into this installation.

NOTE! This Retrofit Kit is designed for use on Incredible Technologies cabinets ONLY.

Many components of this Retrofit Kit will only work on cabinets produced for Golden Tee Fore! by Incredible Technologies.

STEP 4:

PREPARING THE CABINET FOR INSTALLATION

Follow these steps to prepare your cabinet before installation. Be sure the cabinet is unplugged before proceeding.

1. Remove LED Sign
2. Remove PCB
3. Remove Hard Drive
4. Remove Power Supply
5. Remove Marquee
6. Remove Light Fixture
7. Remove Control Panel
8. Remove Card Reader
9. Check JAMMA Wiring
10. Check Monitor
11. Check Coin Mechs
12. Check Bill Acceptor
13. Bore Fan Hole
14. Remove Cabinet Graphics
15. Vacuum & Clean Cabinet

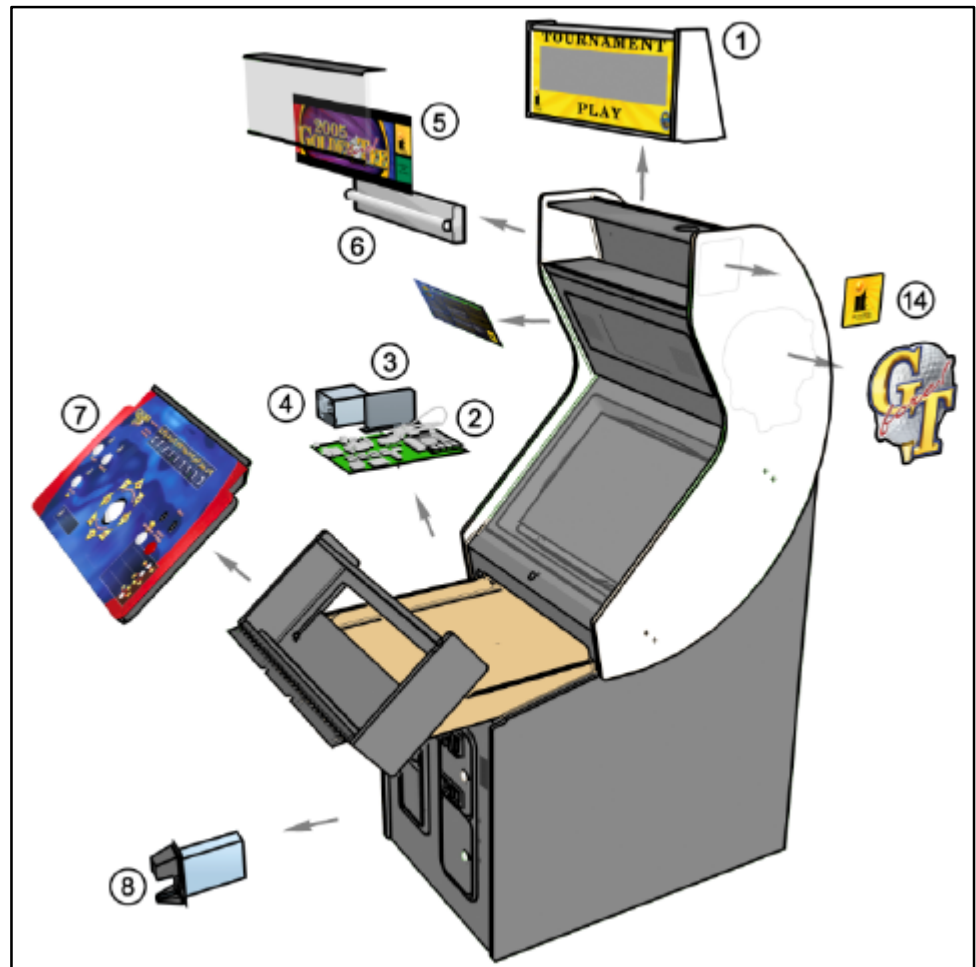

Remove LED Sign

The scrolling LED sign on top of your cabinet must be removed. Remove the screws holding the metal brackets from the sign and rotate them so they are clear of the LED sign. Leave the brackets attached to the cabinet, as they will be used with the new Golden Tee LIVE header. Fold the sign back and disconnect the wiring connector. Pull the excess wire up through the hole in the top of the cabinet. Remove the screws from the hinge that secures the sign to the cabinet.

Remove PCB, Hard Drive and Power Supply

From the coin door, reach in and disengage the clamps that lock the control panel drawer in place. Once the clamps are released, pull the control panel drawer out so the electronic components are exposed. Disconnect all of the connectors from the motherboard and hard drive. Use a 1/4" nut driver to remove the screws holding these components in place. Once free, remove the main PCB, the hard drive and the power supply, and set them aside.

Note!

Be sure to keep the existing AC power cord that was connected to the power supply. This AC line cord will be used to connect the new Golden Tee LIVE System Chassis to power.

Remove Marquee and Light Fixture

The current cabinet marquee must be removed so the new LCD monitor and header can be installed. Remove the top and bottom plastic braces by removing the T15 security Torx screws. This allows the marquee cover and marquee to be removed to expose the fluorescent light fixture.

From the back of the cabinet, disconnect the A.C. power source to the light fixture located on the left wall as you face the back of the cabinet. Route the cable back to the fixture. Remove the 2 ¼ inch hex head screws on either side of the fixture to remove the assembly.

Remove Control Panel

The Golden Tee LIVE Retrofit Kit comes with a new control panel, complete with new controls already mounted. You will need to remove your existing control panel from the hinge, and replace it with the new one. Remove the 4 screws that attach the control panel top to the hinge, and set the control panel top aside. Leave the hinge on the cabinet, as it will be used for the new control panel.

Remove Card Reader

Golden Tee LIVE requires a new card reader, to take advantage of new credit card technology. To remove your current card reader, open the coin door to access the card reader. Reach inside and disconnect the ribbon cable from the Card Reader. Then from inside remove the four 11/32" nuts that hold the card reader to the inside of the cabinet. Once loose, pull the card reader out through the front of the cabinet.

Check JAMMA Harness and Wiring

The Golden Tee LIVE Retrofit Kit comes with a special I/O Board that uses the existing JAMMA wiring harness. Make sure your existing wires and connectors are in good working order. Replacement Part Number 910000250.

Check Monitor

Golden Tee LIVE has been designed to operate with SVGA (800 x 600), VGA (640 x 480), medium resolution (512 x 384) and low resolution (384 x 256) monitor systems. The factory monitors in all Golden Tee Fore! cabinets are compatible with Golden Tee LIVE. However, to take advantage of the best and most current quality available, it is recommended to upgrade to an SVGA compatible monitor.

Operating Golden Tee LIVE at the highest possible resolution will give your game the best results (and revenue). Your Golden Tee Fore! cabinet should contain a medium-res. or VGA monitor already. If you have a low-res. monitor, it may be possible to switch it to a higher resolution. Check your monitor's manual for capabilities.

Also check your monitor for a DB15 VGA connector. If your current monitor has a DB15 VGA connector, it is capable of VGA or SVGA resolutions. Check your monitor's manual on how to switch the monitor to VGA mode. Make sure the video dip switches on the I/O board match the resolution that the monitor is expecting. Plug the video cable from the Nighthawk Chassis directly into the monitor. Be sure to disconnect the old composite sync video cable from the monitor.

When operating with an SVGA or VGA monitor, Golden Tee LIVE uses the standard VGA sync timing and signals. When operating with medium resolution or low resolution monitors, which are common in Golden Tee Fore! dedicated cabinets, Golden Tee LIVE operates with composite negative serrated sync.

NOTE: In all cases a horizontal mount raster scan monitor is required.

NOTE: ALWAYS disconnect the power to the cabinet before working on or around the monitor.

CAUTION! Monitors are extremely dangerous and can result in severe injury. Make sure you follow and observe all safety precautions as outlined in your monitor's manual.

Now is a great time to clean both sides of the monitor viewing glass and monitor screen to ensure a clear view of the game. Once you have done so reinstall the monitor viewing glass back in place.

Check Coin Mechs and Bill Acceptor

Make sure your coin mechs and bill acceptor are functioning properly, and your coin box and stacker are in good condition. You want to make sure your game will accept money when players are ready to play.

Check Coin Door Connections

Your Golden Tee Fore! cabinet should already be wired correctly through the JAMMA connector. Now is a good time to make sure your game can accept money. Check the JAMMA pinout chart in Appendix B for the correct wire colors and pins. Trace the wiring to their sources and make sure they are connected properly and securely. Be sure the wires are away from the coin door where they can be pinched or crimped.

Bore Hole for Fan

The sophisticated Nighthawk hardware requires more ventilation than what is currently in your Golden Tee Fore! cabinet. You need to bore a 3.5 inch hole in the back of the cabinet for the supplied cooling fan. Use the supplied template found in Appendix H for proper placement of the fan. Align the template to the lower right corner on the back of the cabinet and tape into place. Be sure the right edge of the template aligns with the right edge of the cabinet, and the bottom of the template aligns with the bottom of the cabinet. Use an awl to mark the center of each hole, and remove the template. Drill holes for the mounting screws and fan opening.

Remove Cabinet Graphics

Remove any decals from the cabinet. Make sure that the sides of the cabinet are as smooth and flat as possible to allow for a higher quality finish when applying the new side decals.

For a fresh look and best earnings painting is highly recommended. Spray painting gives a better finish, but if an air brush or paint sprayer is unavailable a roller is second best. Remember to cover all exposed surfaces not to be painted.

Vacuum Cabinet Thoroughly

The "new game look" should always apply to the inside of your game as well. A few wire ties and shrink tubing on your harness, some fastening hardware on your subassemblies, and a thorough sweep with the vacuum cleaner will help ensure that glitches do not occur.

Dust and dirt can damage your hardware and cause problems with game play. Be sure that your cabinet is clean inside and out. It is highly recommended to vacuum your cabinet at least once a month, especially near the fans and vents, to avoid overheating and costly repairs.

STEP 5: RETROFIT KIT COMPONENT INSTALLATION

You are now ready to install your Retrofit Kit. It is recommended that the installation take place in the following order. Take your time and follow each section carefully, checking your work often as you progress. A good, clean and safe installation will bring you better earnings in the long run.

1. Install Fan
2. Install Nighthawk Chassis
3. Install I/O Board
4. Install CID
5. Install Antenna
6. Install LCD Header
7. Install Control Panel
8. Install Card Reader
9. Connect Coin Door
10. Connect I/O Board
11. Connect Nighthawk
12. Install Graphics



Install Cooling Fan

Align the supplied cooling fan with the hole you bored earlier in the bottom right corner of the back of the cabinet. Place the fan so that the arrow on the fan is facing into the cabinet, so the fan will pull air inward. Cover the hole with the fan grill, and use the 4 mounting screws to secure the assembly into place. The fan cable will plug into the Soft Power cable, which is connected to the Nighthawk Chassis above the RCA audio jacks.

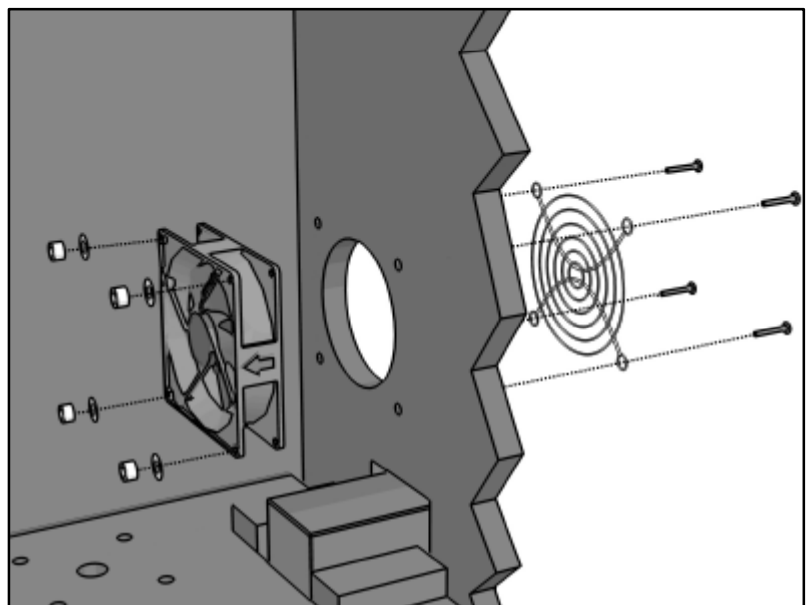

Install Nighthawk Chassis

The Nighthawk Chassis houses most of the game electronics and hardware into one box that can be easily installed. **Verify that the Nighthawk Chassis Power Switch is in the "ON" position.**

1. Locate the area on the floor where the chassis will be placed. Make sure there is enough clearance to plug in cables.
 - The Nighthawk Chassis measures 19" W x 7" H x 11" D.
2. Relocate and secure any wires to make room for the chassis.
3. Place the chassis so it sits flat on the floor and does not pinch wires. Be sure there will be sufficient air flow to the chassis. Overheating can damage your system.
4. Mount the chassis with 6 - #6 x 3/4" Hex Washer Head Sheet Metal Screws.

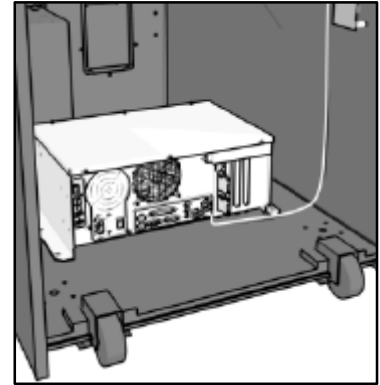

NOTE: The Nighthawk Chassis comes equipped with an external air filter to help keep dust, smoke and debris from collecting on the electronic components. Check and clean this filter regularly to avoid costly repairs.

Install I/O Board

NOTE: Before installing any electronics make sure cabinet power switch is in the OFF position and the cabinet power is unplugged from the wall.

Golden Tee LIVE comes with a specially designed I/O board that works with your cabinet's already installed JAMMA harness. The I/O board is used as a connection interface between the JAMMA and the Nighthawk Chassis.

Mount the I/O board onto the drawer of the cabinet using 4 of the 6 x 3/4" Hex Washer Head Sheet Metal Screws, 1 in each corner. The existing JAMMA harness edge connector will attach to this board. Do not attach cables at this time.

NOTE: Route all cables AWAY from the I/O Board. Laying cables on top of or below the I/O Board will result in unwanted noise or static during the game.

Install Cabinet Identification Device (CID)

The Cabinet Identification Device or C.I.D. is an innovative and important component. This device permanently identifies your cabinet as Golden Tee LIVE. It should remain even if another component such as the I/O board or chassis is replaced. The C.I.D. has a unique number to individualize the cabinet and is referred to as the Cabinet Identification Number.

1. Attach the C.I.D. to the inside side of the cabinet using the 2 - #6 X 1" Hex Washer Head Sheet Metal Screws. Mount so the port is facing up and the electronics faces the wall.
2. Attach the USB cable from the Nighthawk Chassis.
 - Place the included Cabinet Identification Number on the back of the cabinet for future reference. **Refer to this number to track your equipment and whenever you are calling in for service.**
 - The Cabinet Identification Number is displayed in the operator menus in the lower right hand corner, and is labeled as Game ID. It is also displayed on the last line of the initial boot-up screen.

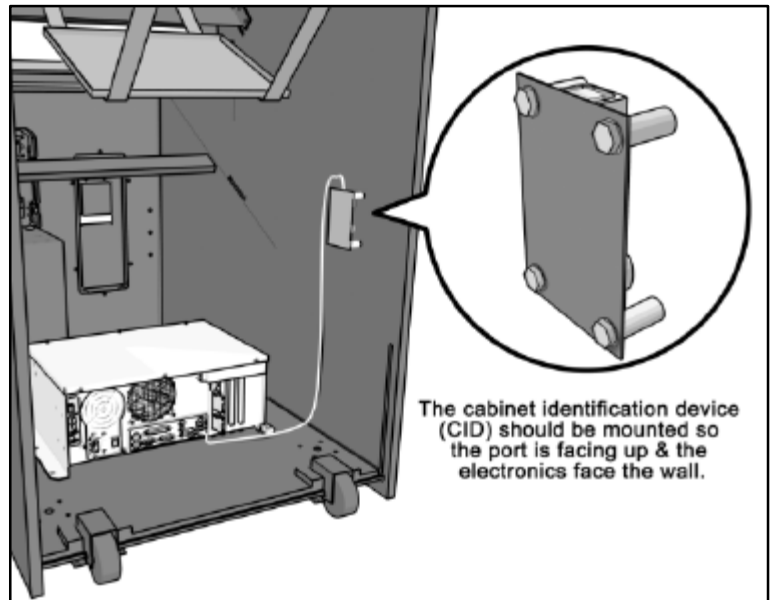

Install Antenna

Mount the supplied antenna to the inside left back wing of the cabinet. When mounted vertically, the antenna is omni-directional, so be sure it is as straight as possible to get the widest signal area. Feed the cable through the vent hole on the cabinet, and route it to the I/O board.

Note!

Take care not to bundle the antenna wire with other cables in the cabinet.

Install LCD Monitor and Header

This procedure is best performed with two people. Before you begin, find someone who can assist you.

- 1) Install the video and power cables for the header. The cables should be routed through the access hole on the top of the cabinet and down the inner side wall. The 3-pin AC male connector will plug into the existing 3-pin female connector, located about mid way down the cabinet's right side, which used to power the marquee lamp. The Video Cable and DC Power Cable will connect to the Nighthawk Chassis. When finished, the 6-pin Power Cable and one end of the Video Cable should be secured in the old marquee cavity.
- 2) Using a T-15 Torx wrench, remove the (2) #8 security screws and washers from the bottom of the Header assembly.
- 3) Have someone assist you in lifting the Header up onto the top of the cabinet into its final location.
- 4) Have someone hold the left side of the Header as you carefully rotate the right side toward you, making sure that the left side stays up on the top of the cabinet.
- 5) Reach behind the Header into the old marquee area and locate the Video cable and Header power cable.
- 6) Plug the video cable into the video connector on the lower back of the Header, and tighten the 2 finger screws.
- 7) Plug the Header Power Cable into the connector located below the video connector. Push it until it snaps in.
- 8) Slide the Header back to its final position.
- 9) Locate the Header Front Mounting Bracket and position it under the header.
- 10) Insert (2) #8 security screws through the holes in the top side of the bracket and into the holes in the bottom of the Header and tighten them with the T-15 Torx wrench.
- 11) Make sure the Header is pushed all the way back, and drill (3) 3/32" pilot holes in the wood centered in the 3 holes in the bracket.
- 12) Insert the (3) #8 wood screws into the bracket holes and drive them into the wood.
- 13) Go to the back of the cabinet, and rotate the black brackets that were originally used to install the LED Tournament Sign back upward and secure them using the 1" #8 security screws and the T-15 Torx wrench.

NOTE: If you are installing this kit into a Non-Tournament Dedicated cabinet, you most likely will need to order the black brackets that secure the header in place. Call Incredible Technologies to order these parts. Refer to P/N 999000187.

Install Control Panel

Attach the new control panel to the existing hinge on the control panel drawer. Drive the 4 Phillips screws into the holes in the bottom of the control panel. The control panel comes equipped with trackball and buttons in place. Snap the switches onto the buttons. Refer to the JAMMA wiring diagram to match up the correct wire to the correct button. The following buttons need to be connected: Start, Spin, Flyby, Turn Left, Turn Right. Connect to the normally open post. Be sure common ground is connected to each common post.

Help and Options are new buttons and come with the cable installed to the buttons on the new control panel. Connect the 8-pin connector to the Lamps connector J202 on the I/O board. Connect the 10-pin connector to the Control Panel connector J203 on the I/O board. Finally, connect the Trackball to the trackball connector J208 on the I/O board.

Install New Card Reader

Place the back end of the card reader through the opening on the cabinet. The large part of the front of the card reader faces up. Insert the four carriage bolts into the mounting holes of the metal bezel. Reach through the coin door to secure the 11/32" nuts to the carriage bolts, and secure the card reader in place. Connect the USB cable to the card reader and feed the rest of the cable to the back of the cabinet. The other end of the cable will connect to the System Chassis.

Complete Nighthawk Chassis Connections

Follow these procedures to correctly connect the various electronic components. Be sure the cables are connected securely and in working order. Use cable clamps, with appropriate tension, where necessary to ensure all cables stay in place during operation. Dress all cables with additional clamps and wire tie wraps where needed. Avoid loose wires or disconnected cables, as they can cause an unneeded service call.

Attach I/O power, Audio, and USB cables.

- ◆ **I/O board power cable.** Connect from the I/O board to one of the two 4-pin power output connectors on the chassis.
- ◆ **Audio cables.** Connect to the audio output jacks of the chassis. Match the appropriate colors.
- ◆ **USB cable #1.** Connect from the I/O board to any USB port on the chassis.
- ◆ **USB cable #2** for future updates. Attach to any USB port on the chassis. Route the other end to the control panel for easy access when updating.
- ◆ **USB cable #3** for Cabinet Identification Device (CID). Refer to the CID Installation Section for proper orientation and placement of the CID.
- ◆ **USB cable #4** for Card Reader. Connect to any USB port on the chassis. The other end connects to the card reader.

Attach Main Video Cable

If your cabinet has a VGA or SVGA monitor, connect the video cable from the Nighthawk Chassis directly to the VGA or SVGA monitor input.

If your cabinet has Medium or Low Resolution monitor, connect the video cable from the Nighthawk Chassis to the I/O board.

Be sure to adjust your Dip Switch settings to match your monitor's resolution.

Attach LCD Video Cable

Locate the video cable from the LCD monitor and connect it to the Nighthawk Chassis.

Attach Power Cable

Use the AC power cord that is currently in your cabinet. The cord plugs into the Chassis. Have a qualified electrician do the wiring. Verify A.C. main voltage selector switch is in the proper position. In North America the setting is 115 volts AC. In some countries this should be set at 230 VAC.

Soft Power / Fan Cable

There is a "soft power" switch to turn your game on or off without reaching to the back of the cabinet. This switch is mounted on the back of the control panel, and comes in handy when performing any DVD updates. Connect one end of the Soft Power Cable to the Nighthawk Chassis. Route the other end to the switch located in control panel. Locate the 3-Pin connector and plug it in to the Fan Cable.

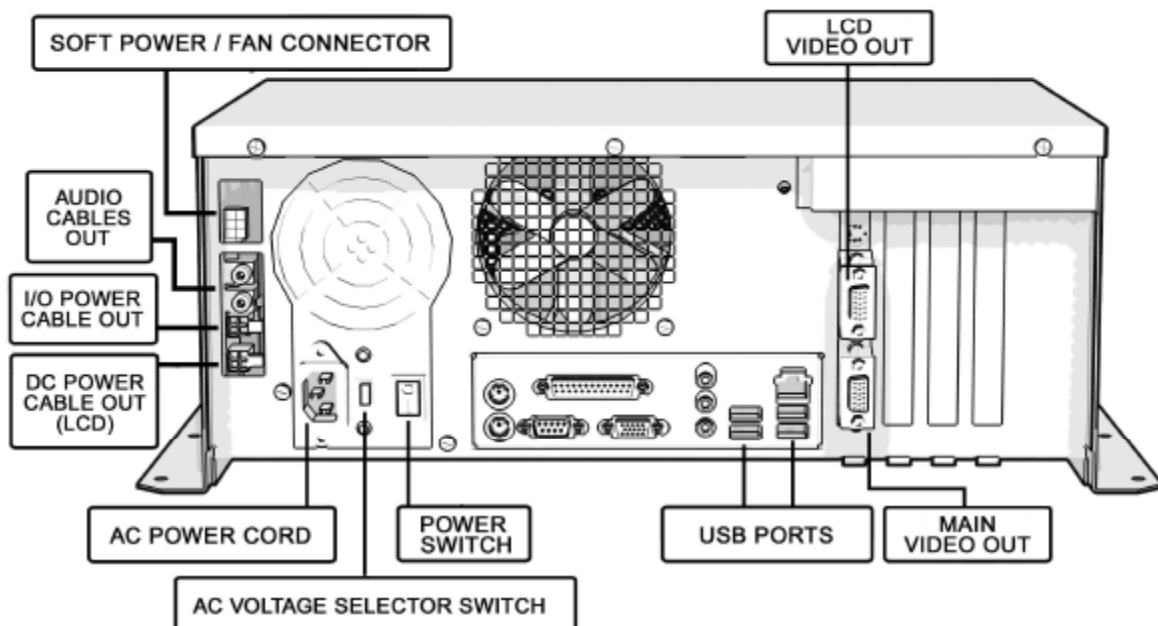

Complete I/O Board Connections

Connect JAMMA Harness

Connect the JAMMA Connector to the I/O Board. Be sure it fits tightly and is oriented correctly.

Connect the Control Panel Switches and Cable

Snap the switches onto the buttons. Connect the Control Panel wiring harness using the JAMMA wiring chart.

Connect New Buttons

Golden Tee LIVE has two additional buttons, Help and Options. Locate the cable from the control panel and connect it to the connector labeled Control Panel on the I/O board.

Connect Coin Door Lamps

Connect the coin door lamp cable to the pigtail off the I/O Power cable. If your game had a GT Fore! green PCB, then use the 9 pin connector. If your game had a GT Fore! red PCB, then use the 4 pin connector. Find the mating connector leading to the coin door to make your connection.

Connect the Trackball

Locate the Trackball Cable and connect it to the connector labeled Trackball on the I/O board. The other end will connect to the trackball. Connect the green earth ground wire to the trackball plate.

Connect Antenna

Locate the antenna cable and attach to the connector on the I/O board. A click should be heard if installed properly. Be sure the antenna is mounted vertically to achieve the widest signal.

Connect Audio Cables

Locate the Audio Cables already connected to the Nighthawk Chassis, and connect them to the I/O board audio inputs. Inputs are color coded, so be sure to connect red to red, etc.

Connect the USB Cable

Locate the 6 ft. USB Cable from the Nighthawk Chassis and connect it to the USB port on the I/O board.

Connect Medium or Low Resolution Monitor

If your cabinet has a Medium or Low Resolution monitor, you need to connect the video to the I/O board. Connect the SVGA Video cable from Nighthawk Chassis to the J501 connector on the I/O Board. Connect the Red, Green, Blue video outputs, the composite sync, and video ground from the JAMMA connector to the appropriate monitor inputs. To find the correct JAMMA pin outs refer to the diagram in Appendix B. Be sure to set the Dip Switches on the I/O Board to match your resolution.

Connect VGA or SVGA Monitor

VGA or SVGA monitors are connected directly to the Nighthawk Chassis video output. Do not connect a video cable to the I/O Board if you are using these resolutions.

Connect I/O Power Cable

Connect the I/O Power cable to the power input connector. Use the end with the pigtail. The other end connects to the Nighthawk Chassis.

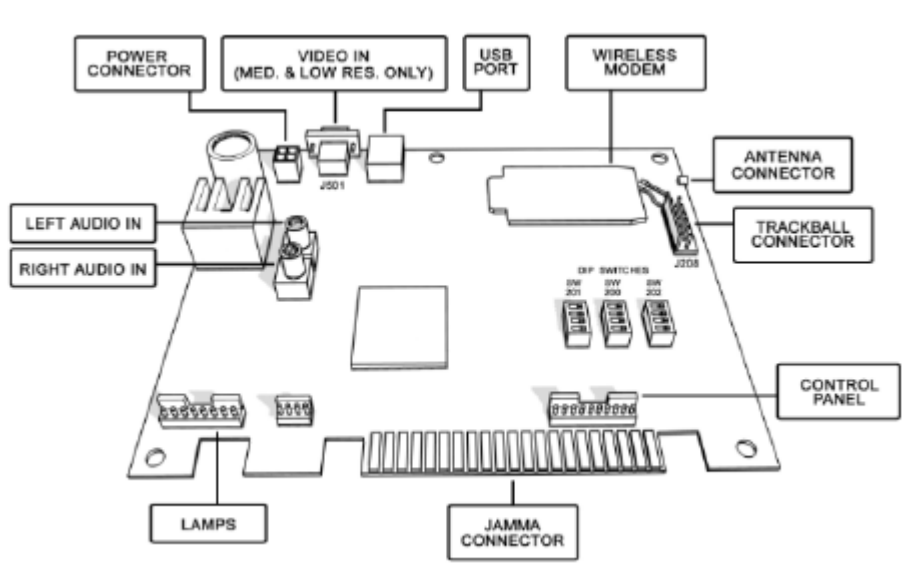

Check All Connections

Go over your entire cabinet again and double-check all of the connections. Make sure that all connectors are tight and secure and in their proper place. Look for frayed, broken or exposed wiring and repair as needed. Bundle and wire-tie your wiring and secure it to the inside of the cabinet. A thorough and neat job now will save you a lot of time and trouble in the future.

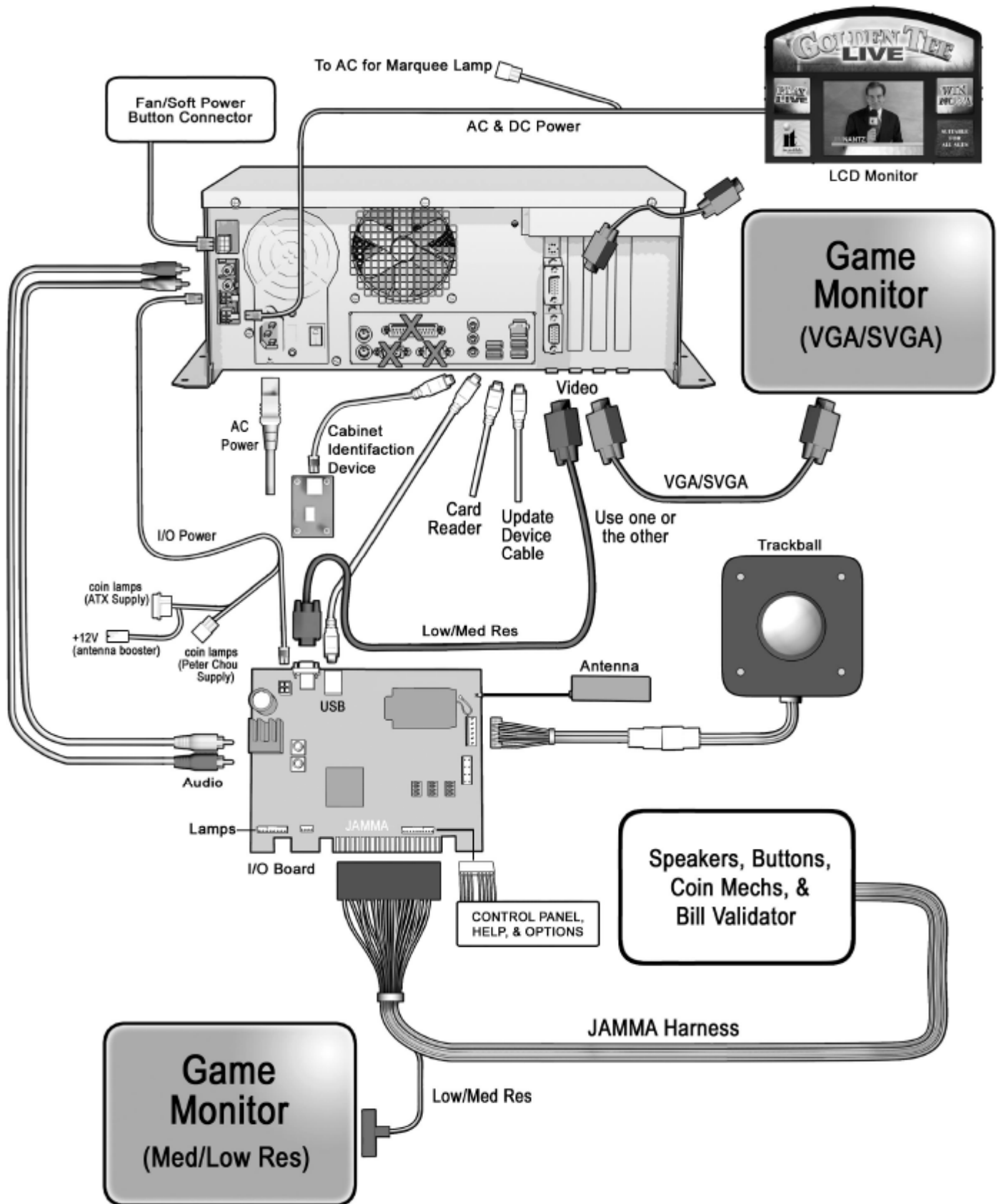

Install Cabinet Decals

Included with your Golden Tee LIVE kit is a set of decals to place on the side of your cabinet and a brand new marquee. This will help identify your new game as Golden Tee LIVE. By placing and installing these correctly it can help give players instant recognition, even from a distance.

Side Decal Installation

The following are the instructions on placing your side decals correctly on to the cabinet:

1. Refer to the diagram included on the decal sheet and to the right of these instructions for optimal placement of each decal.

NOTE: Make sure to have the sides of the cabinet as smooth and flat as possible, removing all previous residue from prior decals, to allow for a higher quality finish.

TIP: Liquid window cleaner can be sprayed onto the sides of the cabinet before placing the decals. The window cleaner will allow the decal to be removed and re-installed without damaging the decal or adhesive. The decal roller or squeegee forces the cleaner out, leaving just the adhesive.

2. Remove the first of the new cabinet decals from the backing.
3. Center the first decal on the location selected for your cabinet.
4. Using your hands (or a decal roller/squeegee), press down firmly starting from the center and smooth the side decal outward. Make sure all bubbles have been pressed out for a clean, flat surface.
5. Repeat for each of the remaining decals. Do not forget the decal for the card reader.

Dip Switch Sticker

Install the Dip Switch Settings sticker near the I/O board for easy reference. Orient the sticker to match the dip switches on the board.



Congratulations!
Your Retrofit Kit installation is complete.

STEP 6: APPLY POWER

Connect the power cable to a 3-pronged, grounded wall socket. Locate the power switch on the back of the cabinet and turn it on.

Watch the game carefully when you first turn it on. Look and smell for smoke (TURN IT OFF IMMEDIATELY IF ANY IS NOTICED). Make sure the fans inside the chassis are running and the LED's on the I/O board and CID are flashing. If not, something is wrong, turn off the game.

Check the Cabinet ID Device (CID) Number

Watch the screen during boot-up and wait for an orange verification screen to appear. Note the Cabinet ID Number (CID) that appears on this screen, and verify that it matches the CID number printed on the back of the cabinet. The screen will automatically time out and boot-up will continue.

Check the Coin Switch and Bill Validator

Try the coin switch. Drop quarters or tokens through to check the coin mech. Insert a dollar bill into the bill validator and listen for the credits to ring up. Make sure the game is adding credits and the correct quantity. You can use the PLAYER CONTROL TEST by pressing the Test button inside the coin door and entering the SYSTEM TESTS MENU. Make sure all of the controls work.

Checking the Wireless Connection Signal Strength

There are two ways to check the signal strength of your Golden Tee LIVE test machine. First, you can power the game off and on. A signal meter will appear in the lower right corner of the game's boot-up screen. The number of bars that are displayed indicate the signal strength. Additionally, you can enter Operator Mode by pressing the System Setup button inside the coin door. Once at the main Operator Mode menu, use the trackball and Start button to select *ITNet Settings*, then *Communication Settings* to view more information.



Cabinet Temperature

The state of the art Nighthawk hardware is extremely powerful, and therefore generates a substantial amount of heat. Measures have been taken to keep the various components cool during normal use. If overheating occurs, game play and hardware longevity may be affected. Use the Check Cooling menu in the System Setup menus to monitor the temperature within your cabinet. Enter System Setup by pressing the Test button inside the door. Once at the main System Setup menu, use the trackball and Start button to select *Troubleshooting/Info*, then *Check Cooling*.

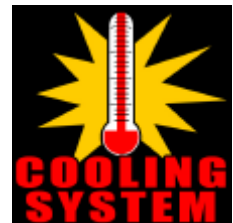

Custom Adjustments

Upon initial power-up, the game will initialize to factory default settings. These settings affect game elements such as number of credits per coin, volume settings, etc. The System Setup section will describe how to alter these settings and view the system audits or run system tests.

STEP 7:

ITNET® REGISTRATION

Golden Tee LIVE is an online only game, and must be properly registered to ITNet for all of the game features to be available. First you must register with ITNet as an ITNet Operator. Once you are established as an ITNet Operator, you can register your game to receive the online features.

ITNet® Operator Registration

Follow these simple instructions to become eligible for ITNet® online features.

1. Fill out the ITNet® Debit Account Form, found in Appendix G, and open a Debit Account at your local bank.
2. Read and sign the ITNet® Operator Agreement, found in Appendix G at the back of this manual.
3. Fax or mail these two forms to Incredible Technologies, Inc. at **(847) 454-9156** to become an authorized ITNet® Operator.
4. Once these forms are processed, you will receive your ITNet® Operator ID Card in the mail.

The Operator ID Card allows you to:

Register your games for online play right on-site.

Activate games, add and change location information, and de-activate games at the location.

Gain access to the personalized IT Operator Services web site.

Check audits, bookkeeping and game play statistics and make game adjustments from your home or office.

NOTE:

If you are a brand new ITNet® operator and can't wait for your Operator ID card to arrive in the mail, you can fax the GAME REGISTRATION FORM, found in Appendix G, to Incredible Technologies. The ITNet® staff will then enter your machine's location data for you. Please allow 2 to 5 business days for processing. When your machine connects with ITNet, it will automatically register to your account and activate the online features.

ITNet® Game Registration

Follow these simple instructions for game and ITNet setup.

Follow the instructions above to become an ITNet operator and receive your Operator ID card. You can use the card to register your games on site, or you can submit a Game Registration Form to complete game registration.

Game Registration Form

1. Fill out the Game Registration Form found in Appendix G. Be sure all of the information is correct and legible. Make sure to include the Cabinet Identification Device (CID) number.
2. Fax or mail the Game Registration Form to Incredible Technologies for processing. Allow up to 10 business days for complete registration.
3. Your game will be automatically registered once the form has been processed, and should enable online features automatically. Online features may take up to four hours to appear on the game.

On-Site Registration

1. Turn on the game. You may have to wait a few seconds for hard drive access. If the game is not registered a screen will appear asking you to swipe your operator card to start the registration process. If you do not have your card, or do not have it ready, the screen will time out after 4 to 5 minutes.
2. Enter all of the necessary location information carefully and accurately. When completed, the game will automatically attempt to connect to ITNet.
3. If registration is successful, the game will switch directly to the attract mode. If there was any trouble with the connection to ITNet, an error message will appear. Select Yes to try to connect again. If your first few attempts to connect are unsuccessful, refer to the troubleshooting guide in Appendix A of this manual or call IT tech service at 847-870-7027 x121.
4. The game is now connected to the ITNet System and ready for public play! Online features will be automatically activated by Incredible Technologies, and some may take up to four hours to be received.

GENERAL CABINET MAINTENANCE

GENERAL CABINET MAINTENANCE

Games that are in good working condition, with clear monitors, clean control panels and working trackballs will make more money than a machine in poor condition. It is definitely worth your time and attention to protect your investment with a little common care. Each week, clean the glass and wipe down the control panel to bring back that new game look. Test the trackball and buttons regularly to make sure they are playing properly. And perhaps most important, make sure the coin mechs and bill acceptors are in good working order.

TRACKBALL MAINTENANCE

The trackball will require periodic maintenance to assure optimum performance. In most cases the inside of the trackball simply needs to be cleaned of any accumulated dust and debris.

To access the inside of the trackball, remove the 6 Phillips head screws that hold the trackball together and remove the top cover. Clean out any dust and debris inside the trackball. Polish the rollers and remove any foreign material that may be on the rollers. Do not lubricate the bearings, as this will only attract more dust. If the bearings do not spin freely it is best to replace the bearing assembly. Inspect the rollers for any nicks that may cause poor performance and replace if needed. Inspect the ball for any nicks and replace if needed. Parts can be obtained from Happ Controls and is an economical option rather than replacing the entire trackball assembly.

It is critical that the green field ground wire be properly connected to field ground. This prevents the trackball from building a static charge that can cause the game to lock up or reset. A static discharge can also damage the trackball's electronic components, as well as the main system.

CARE AND CLEANING OF COOLING FANS AND VENTS

The hardware that runs Golden Tee LIVE is quite sophisticated, and many of the chips and processors will get hot very quickly. Like your desktop PC, the Golden Tee LIVE hardware needs adequate ventilation to work properly. Dust and dirt can be a major cause to overheating and will lead to costly repairs. At least once a month, check to make sure the cabinet and chassis fans are working and free of dust and debris. Use a vacuum to clear all the ventilation holes on the cabinet at this time as well.

NIGHTHAWK AIR FILTER

The Nighthawk Chassis comes equipped with an external electrostatic air filter. This filter is held in place by a metal bracket, attached to the chassis. The filter prevents debris from entering the chassis and damaging the electronic components. A clogged filter will impede airflow, thus building up unwanted heat which can cause damage to your hardware. Be sure to check this filter at least once a month. Remove the filter by sliding it out of its housing. Shake off excess dirt and if necessary clean it with soap and water. Be sure the filter is completely dry before reinstalling the filter.

LCD MONITOR CARE AND CLEANING

Never use ammonia-based products on the upper LCD monitor. Instead clean the LCD with a mild soap or plain water, or an alcohol-based cleaner. Handle the screen with great care. Do not press down anywhere on the screen and do not place any heavy objects on the screen as irreparable damage can occur.

Clean the screen with a glass cleaner that is ammonia free. Alcohol-based cleaners are best.

ANTENNA ADJUSTMENT

The antenna connects to the I/O Board and is mounted in a housing to the back of your cabinet. A strong wireless signal is very important to getting the most out of you game. Depending on the positioning of the game in the location, you may need to adjust the antenna's position to achieve the best signal. The antenna's housing allows for a variety of positions within, and the housing itself can be easily moved to a different location using tape or screws. See the Wireless Signal Strength and Antenna Guide found in Appendix F for more information on getting the best possible wireless signal strength for your game.

Standard **Online** Kit













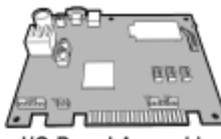

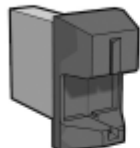
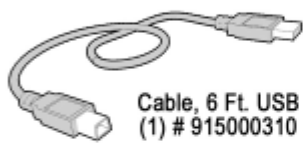





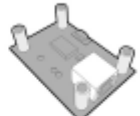
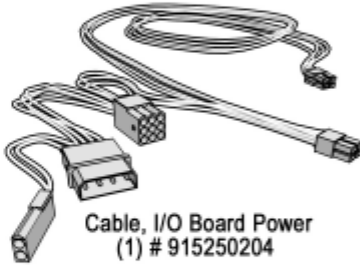

Basic **Offline** Kit

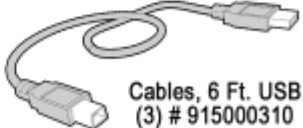

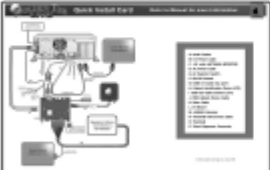
STANDARD ONLINE AND BASIC OFFLINE KIT CONTENTS

Please refer to these IT part numbers when placing orders. See Appendix C for more information.
Note the Basic Offline Kit does not include the Online Components.

Chassis & Filter		I/O Board		Marquee	
 Filter (1) # 753000500  System Box & Filter Bracket (1) # 900000289		 I/O Board Assembly (1) # 900145001 (Standard Online) # 900000014 (Basic Offline)		 Marquee (1) # 820000289 (Standard Online) # 820289100 (Basic Offline)	
Online Components		Fan Kit (#900000755)		CID	
 Card Reader (1) # 760007104  Cable, 6 Ft. USB (1) # 915000310  Antenna (1) # 510000900  Antenna Cover (1) # 750250201		 Fan (1) # 755000915  Fan Grill (1) # 755000220  Cable, Fan/Soft Power (1) # 915250203		 Cabinet Identification Device (CID) Assembly (1) # 900145003	
Hardware Cables		Misc. Cables			
 Cable, I/O Board Power (1) # 915250204  VGA Adaptor (2) # 630000600		 Cable, 6 Ft. Male/Male SVGA (1) # 915000315  Cable, Audio 6 Ft. (1) # 915000285  Cables, 6 Ft. USB (3) # 915000310			
Manual & Guide					
 Manual (1) # 815000289  Quick Connect Guide (1) # 840250100					
Control Panel Overlay & Decals					
 Control Panel Overlay (1) # 825100250  Decals, GT LIVE (1) # 830000250  Promo Card (1) # 840000250  AC Power Cord Cable for System Box (1) # 915000745					

Hardware for component installation is also included.

KIT INSTALLATION

RECOMMENDED TOOLS

Have the following tools ready before you begin to install this kit:

- ¼", 11/32" and 7/16" Sockets or Nut Drivers
- Phillips Head #2 Screw Driver
- 3/16", 7/32" and 9/32", or 5/16", 3/8", and ¾" Drill Bits
- 1 1/8" and 3 1/2" Hole Saw or Drill Bit
- Small Flat Blade Screwdriver
- Jig/Sabre Saw
- Router
- Push Button Nut Socket or Large Adjustable Pliers
- X-acto® Knife or other Sharp Knife/Razor Blade
- Wire Cutters
- Scissors
- Tape Measure
- Putty Knife
- Decal Roller/Squeegee
- Liquid Window Cleaner & Cleaning Cloth
- Vacuum Cleaner
- Any tools needed to remove parts from your existing cabinet not listed above.

Many operators notice their earnings increase with touches as simple as a fresh coat of paint and a clean cabinet.

If you will be painting, you'll need these supplies:

- Air Brush or Paint Sprayer
- Paint Brush, Paint Roller, and Pan
- Paint (and Primer) **--We recommend black as a cabinet color choice.**
- Sandpaper

INSTALLATION PREPARATION

BEFORE YOU START...

Before you install the Golden Tee LIVE kit into your cabinet there are a few things you should check first:

1. Check to make sure your existing cabinet's monitor, speakers, AC power cord, lights, bill acceptor and coin mechs work.
 - Replace or repair where necessary.
2. Check to make sure all the necessary parts are included in your kit.
 - If any are missing/damaged please contact IT's Technical Support at 847-870-7027 x121.
3. Check to make sure cabinet is wired with standard earth grounded A.C. plug compatible with local building codes and/or safety requirements.
 - If not, have a qualified electrician install one (not provided).
4. Have all the necessary tools available to install this kit.
 - Refer to the recommended tools list above to make sure you are prepared before you start.
5. Make sure any parts of the system (lights, monitor, etc.) are not plugged in.
 - Working with any part of the system plugged in or powered on can be dangerous.
6. Keep in mind that it's been proven that the higher quality of work put into a kit installation results in a higher earning game.
 - Make sure you have plenty of space, time, and focus to put into this kit installation.

PREPARING THE CABINET

CABINET SELECTION

You can choose either a new cabinet or a used cabinet for your Golden Tee LIVE game. Reusing a cabinet is by far the most cost-effective way to maximize the return on your initial investment. In either case, all you need to provide is the cabinet with a monitor, JAMMA harness, coin and bill acceptors, working fluorescent/marquee lights, and speakers.

When selecting a cabinet, keep in mind that a larger control panel allows you to mount the trackball farther from the monitor. This prevents players' hands from hitting the monitor glass when rolling the trackball forward, and will earn better than a smaller control panel closer to the monitor. An older-model Golden Tee dedicated cabinet is ideal for this purpose.

If using a Golden Tee cabinet for this installation, consider ordering a new Control Panel from Incredible Technologies. These control panels come pre-installed with controls and graphics, and can save you considerable time and money through easy installation.

PREPARING THE CABINET FOR INSTALLATION

Follow these steps to prepare your cabinet before installation:

1. Remove the following from the cabinet: Main Logic Board(s) (and hard drive if present), Control Panel, Monitor Viewing Glass, Marquee, and Power Supply. Now is a great time to clean both sides of the monitor viewing glass and monitor screen to ensure a clear view of the game.
2. Thoroughly clean out your cabinet. Remove all of the old buttons, joysticks, etc. **DO NOT** remove monitor and speaker wires or the wires that were previously hooked up to the control panel.
3. Remove the old graphics and adhesive from the cabinet including the control panel.
4. For a fresh look and best earnings, painting is highly recommended. Spray painting gives a better finish, but if an air brush or paint sprayer is unavailable a roller is second best. Remember to cover all exposed surfaces not to be painted. When not installing into an old Golden Tee® dedicated cabinet, the recommended color choice is black.
5. Make sure to have the sides of the cabinet and the control panel as smooth and flat as possible to allow for a higher quality finish when applying the control panel background, labels, and side decals.
6. The "new game look" should always apply to the inside of your game as well. A few wire ties and shrink tubing on your harness, some fastening hardware on your subassemblies, and a sweep with the vacuum cleaner will help ensure that glitches do not occur.

CHECK JAMMA HARNESS AND WIRING

The Golden Tee LIVE Kit comes with a special I/O Board that uses your cabinet's existing JAMMA wiring harness. Make sure your existing wires and connectors are in good working order. Check the JAMMA wiring diagram in Appendix B.

CHECK COIN MECHS AND BILL ACCEPTOR

Make sure your coin mechs and bill acceptor are functioning properly, and your coin box and stacker are in good condition. You want to make sure your game will accept money when players are ready to play.

CHECK COIN DOOR CONNECTIONS

Your Golden Tee Fore! cabinet should already be wired correctly through the JAMMA connector. Now is a good time to make sure your game can accept money. Check the JAMMA pinout chart in Appendix B for the correct wire colors and pins. Trace the wiring to their sources and make sure they are connected properly and securely. Be sure the wires are away from the coin door where they can be pinched or crimped.

CHECK MONITOR

Golden Tee LIVE has been designed to operate with SVGA (800 x 600), VGA (640 x 480), medium resolution (512 x 384) and low resolution (384 x 256) monitor systems. The factory monitors in all Golden Tee Fore! cabinets are compatible with Golden Tee LIVE. However, to take advantage of the best and most current quality available, it is recommended to upgrade to an SVGA compatible monitor.

Operating Golden Tee LIVE at the highest possible resolution will give your game the best results (and revenue). Many standard cabinets contain a medium-res. or VGA monitor already. If you have a low-res monitor, it may be possible to switch it to a higher resolution. Check your monitor's manual for capabilities. If not, you should consider upgrading to a newer monitor.

Also check your monitor for a DB15 VGA connector. If your current monitor has a DB15 VGA connector, it is capable of VGA or SVGA resolutions. Check your monitor's manual on how to switch the monitor to VGA mode. Make sure the video dip switches on the I/O board match the resolution that the monitor is expecting. Plug the video cable from the Nighthawk Chassis directly into the monitor. Be sure to disconnect the old composite sync video cable from the monitor.

When operating with an SVGA or VGA monitor, Golden Tee LIVE uses the standard VGA sync timing and signals. When operating with medium resolution or low resolution monitors, which are common in Golden Tee Fore! dedicated cabinets, Golden Tee LIVE operates with composite negative serrated sync.

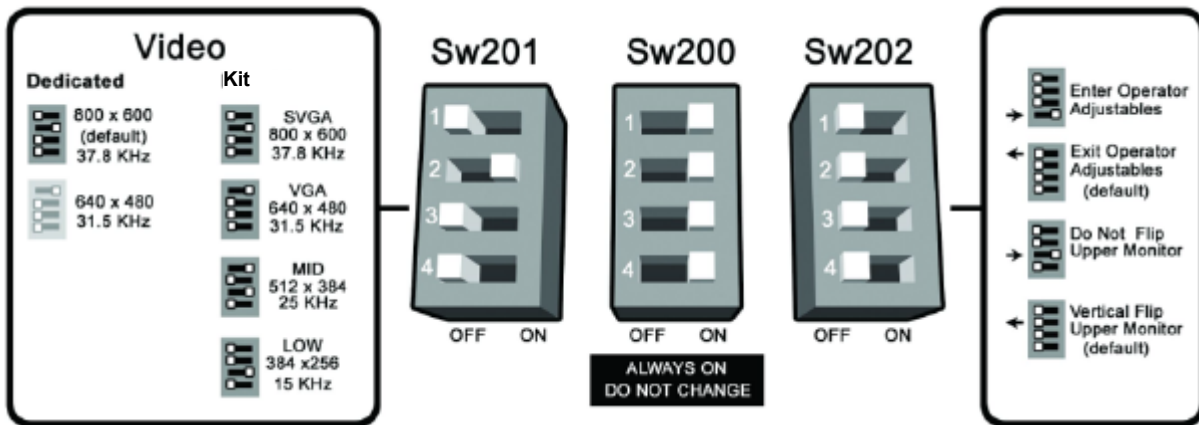

NOTE: In all cases a horizontal mount raster scan monitor is required.

CAUTION! Monitors are extremely dangerous and can result in severe injury. Make sure you follow and observe all safety precautions as outlined in your monitor's manual. **ALWAYS** disconnect the power to the cabinet before working on or around the monitor.

REMOVE CABINET GRAPHICS

Remove any decals from the cabinet. Make sure that the sides of the cabinet are as smooth and flat as possible to allow for a higher quality finish when applying the new side decals.

For a fresh look and best earnings painting is highly recommended. Spray painting gives a better finish, but if an air brush or paint sprayer is unavailable a roller is second best. Remember to cover all exposed surfaces not to be painted.

REMOVE EXISTING CARD READER (IF APPLICABLE)

If you are using a Golden Tee Fore! cabinet, the existing card reader must be removed. Golden Tee LIVE requires a new card reader, to take advantage of new credit card technology. To remove your current card reader, open the coin door to access the card reader. Reach inside and disconnect the ribbon cable from the Card Reader. Then from inside remove the four 11/32" nuts that hold the card reader to the inside of the cabinet. Once loose, pull the card reader out through the front of the cabinet. If you are installing an Offline kit, install the supplied card reader plate to cover this opening.

CUT HOLE FOR CARD READER (ONLINE KIT ONLY)

If your cabinet does not have a card reader installed, you must cut a hole to mount the supplied card reader. The card reader is a very important aspect to Golden Tee LIVE, and is very important to keep in good working condition. Players are required to use a card to identify themselves for most of the online features. If the card reader is not working properly, these features will not be available.

Position the Card Reader Hole template found in Appendix H on the front of the cabinet, and as high up as possible so players won't have to stoop over to insert their cards. Use an awl to mark the center of the four bolt-holes and drill them to size. Use an electric handsaw to cut the rectangular opening to house the card reader.

BORE HOLE FOR FAN

The sophisticated Nighthawk hardware requires more ventilation than what is currently in most cabinets, including Golden Tee Fore! cabinets. You need to bore a 3.5 inch hole in the back of the cabinet for the supplied cooling fan. Use the supplied template found in Appendix H for proper placement of the fan. Follow the instructions on the template when creating the cutout.

VACUUM CABINET THOROUGHLY

The "new game look" should always apply to the inside of your game as well. A few wire ties and shrink tubing on your harness, some fastening hardware on your subassemblies, and a thorough sweep with the vacuum cleaner will help ensure that glitches do not occur.

Dust and dirt can damage your hardware and cause problems with game play. Be sure that your cabinet is clean inside and out. It is highly recommended to vacuum your cabinet at least once a month, especially near the fans and vents, to avoid overheating and costly repairs.

ELECTRONICS INSTALLATION

INSTALL COOLING FAN

Align the supplied cooling fan with the hole you bored earlier in the bottom right corner of the back of the cabinet. Place the fan so that the arrow on the fan is facing into the cabinet, so the fan will pull air inward. Cover the hole with the fan grill, and use the 4 mounting screws to secure the assembly into place. The fan cable will plug into the Soft Power cable, which is connected to the Nighthawk Chassis above the RCA audio jacks.

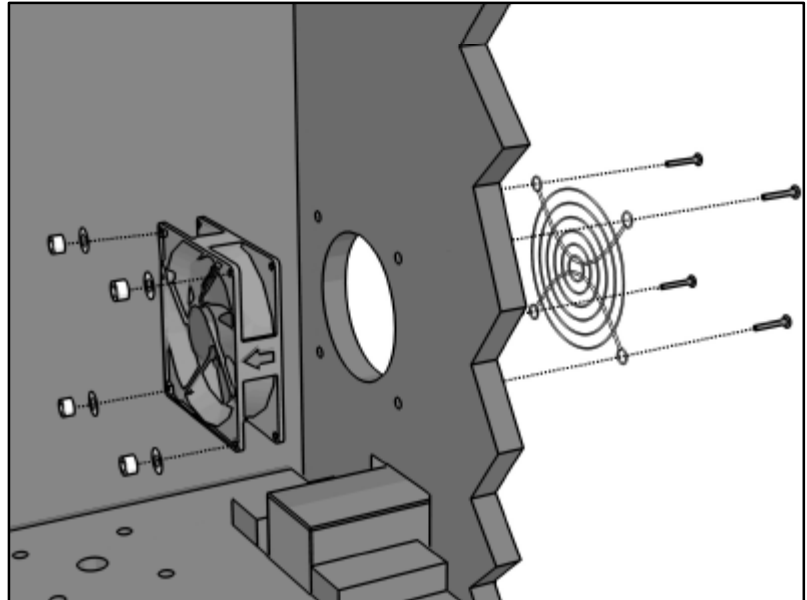

INSTALL CARD READER (ONLINE KIT ONLY)

Place the back end of the card reader through the opening on the cabinet. The large part of the front of the card reader faces up. Insert the four carriage bolts into the mounting holes of the metal bezel. Reach through the coin door to secure the 11/32" nuts to the carriage bolts, and secure the card reader in place. Connect the USB cable to the card reader and feed the rest of the cable to the back of the cabinet. The other end of the cable will connect to the System Chassis. Power the game back on and test the card reader using the Card Reader Test located in the Troubleshooting/Info Menu in System Setup.

INSTALL NIGHTHAWK CHASSIS

The Nighthawk Chassis houses most of the game electronics and hardware into one box that can be easily installed. **Verify that the Nighthawk Chassis Power Switch is in the "ON" position.**

1. Locate the area on the floor where the chassis will be placed. Make sure there is enough clearance to plug in cables.
 - The Nighthawk Chassis measures 19" W x 7" H x 11" D.
2. Relocate and secure any wires to make room for the chassis.
3. Place the chassis so it sits flat on the floor and does not pinch wires. Be sure there will be sufficient air flow to the chassis. Overheating can damage your system.
4. Mount the chassis with 6 - #6 x 3/4" Hex Washer Head Sheet Metal Screws.

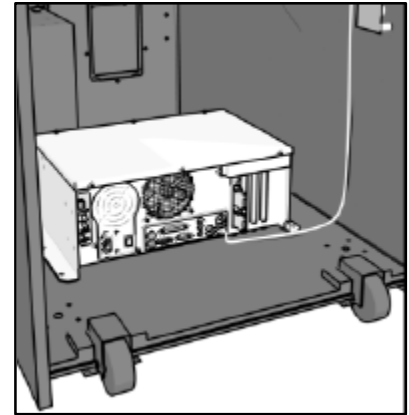

NOTE: The Nighthawk Chassis comes equipped with an external air filter to help keep dust, smoke and debris from collecting on the electronic components. Check and clean this filter regularly to avoid costly repairs.

INSTALL CABINET IDENTIFICATION DEVICE (CID)

The Cabinet Identification Device or C.I.D. is an innovative and important component. This device permanently identifies your cabinet as Golden Tee LIVE. It should remain even if another component such as the I/O board or chassis is replaced. The C.I.D. has a unique number to individualize the cabinet and is referred to as the Cabinet Identification Number.

1. Attach the C.I.D. to the inside side of the cabinet using the 2 - #6 X 1" Hex Washer Head Sheet Metal Screws. Mount so the port is facing up and the electronics face the wall.
2. Attach the USB cable from the Nighthawk Chassis.
 - Place the included Cabinet Identification Number on the back of the cabinet for future reference. **Refer to this number to track your equipment and whenever you are calling in for service.**
 - The Cabinet Identification Number is displayed in the operator menus in the lower right hand corner, and is labeled as Game ID. It is also displayed on the last line of the initial boot-up screen.

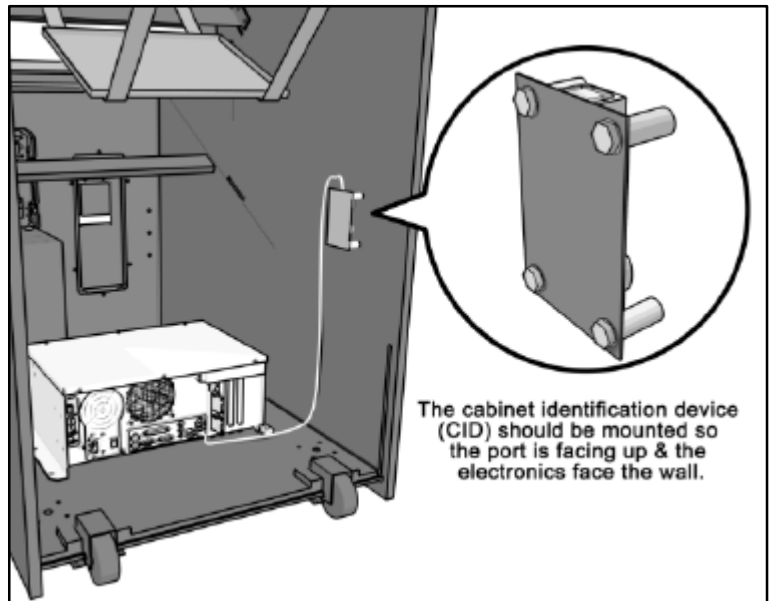

INSTALL I/O BOARD

NOTE: Before installing any electronics make sure cabinet power switch is in the OFF position and the cabinet power is unplugged from the wall.

Golden Tee LIVE comes with a specially designed I/O board that works with your cabinet's already installed JAMMA harness. The I/O board is used as a connection interface between the JAMMA and the Nighthawk Chassis.

Mount the I/O board inside the cabinet using 4 of the 6 x 3/4" Hex Washer Head Sheet Metal Screws, 1 in each corner. The existing JAMMA harness edge connector will attach to this board. Do not attach cables at this time.

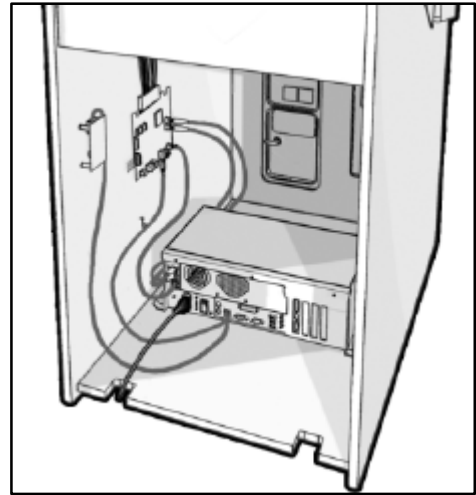

NOTE: Route all cables AWAY from the I/O Board. Laying cables on top of or below the I/O Board will result in unwanted noise or static during the game.

INSTALL ANTENNA (ONLINE KIT ONLY)

Mount the supplied antenna to the upper back of the cabinet. When mounted vertically, the antenna is omnidirectional, so be sure it is as straight as possible to get the widest signal area. Drill a 9/32" or 5/16" hole behind the antenna cover. Feed the cable through the hole and route the cable to the I/O board. Attach the antenna cover to the back of the cabinet using two 6x3/4" Hex screws.

NOTE: Take care not to bundle the antenna wire with other cables in the cabinet.

Careful placement of the antenna is important for good wireless communication. Sometimes relocating a wire or moving the antenna within the housing will deliver a more reliable signal. Once the installation is complete, be sure to use the Signal Strength test in the game's System Setup menus. Refer to Appendix F for more details on how to achieve the best signal strength.

CONTROL PANEL INSTALLATION

INSTALL OPTIONAL CONTROL PANEL FOR GOLDEN TEE FORE! CABINETS

If you are installing your kit into an existing Golden Tee Fore! cabinet manufactured by IT, you can purchase a new, fully outfitted control panel. This will not only make your installation easier, it will make your game look and play better too. Use this section to install this control panel. For all other cabinet types, refer to the next section.

Attach the new control panel to the existing hinge on the control panel drawer. Drive the 4 Phillips screws into the holes in the bottom of the control panel. The control panel comes equipped with trackball and buttons in place. Snap the switches onto the buttons. Refer to the JAMMA wiring diagram to match up the correct wire to the correct button. The following buttons need to be connected: Start, Spin, Flyby, Turn Left, Turn Right.

Connect to the normally open post. Be sure common ground is connected to each common post.

Help and Options are new buttons and come with the cable installed to the buttons on the new control panel. Connect the 8-pin connector to the Lamps connector J202 on the I/O board. Connect the 10-pin connector to the Control Panel connector J203 on the I/O board. Finally, connect the Trackball to the trackball connector J208 on the I/O board.

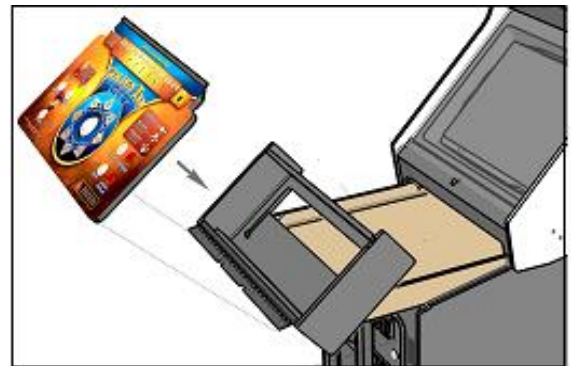

TRACKBALL AND BUTTON PREPARATION (FOR MOST KITS)

Mounting the trackball and buttons correctly and securely is very important for the profitability and safety of your new game. This kit is designed for use in cabinets with $\frac{3}{4}$ " thick wood control panels where proper routing of the control panel is used to create a safe playing experience. If you do not have a $\frac{3}{4}$ " thick wood control panel, please replace your control panel or choose a cabinet with a $\frac{3}{4}$ " thick wood control panel installed. Keep in mind that if your current control panel has many old holes in it from previous buttons, joysticks, etc. that it may be easier to start with a new solid control panel. This will give your game a better look and feel and help it to earn better.

NOTE: If the cabinet already has a trackball plate installed, discard and replace with the new trackball plate. The metal trackball mounting plate and trackball mounting procedure have been designed to remove all bolts from the playing surface. Routing the wood control panel is required so the metal mounting plate is flush with the panel surface. An uneven playing surface or exposed edges will affect game play and could impact your earnings.

TIP: Trackball and button templates can be found in Appendix H of this manual. They include:

- ❑ Trackball Template to install the trackball plate and make the appropriate routing.
- ❑ Trackball Orientation Diagram to orient your trackball correctly when installing.
- ❑ Button Set Templates to position and install control panel buttons.

Trackball Preparation

Install the metal trackball plate by following these steps:

1. Cut out the template from Appendix H with a pair of scissors along the noted line. Tape this template to the top of the control panel as far away from the monitor as possible, making sure that the trackball will clear the cabinet beneath it. **NOTE:** Installing the trackball as far away from the monitor as possible will prevent players' hands from hitting the monitor glass when rolling the trackball forward.
2. Using a sharp object, mark the eight points shown on the template on the control panel. Using a pencil, trace the outside of the template. Remove the template.
3. Drill Holes 1-4 with a $\frac{9}{32}$ " or $\frac{5}{16}$ " drill bit.
4. Drill Holes 5-8 with a $\frac{3}{4}$ " drill bit.
5. Route the crosshatched region to a depth of about .075" (about the thickness of a nickel).
6. Using a sabre saw cut out the center portion by cutting between holes 5-8.
7. Once you have cleaned up the routed area, install the trackball plate into the control panel using the $\frac{1}{4}$ " Flat Washers and $\frac{1}{4}$ -20 Nylon Hex Nuts. Be sure the mounting plate is flush with the top of the control panel.

NOTE: At this time you are only installing the trackball plate, do not install the trackball yet.

Button Preparation

The following are the steps you should take to prepare your control panel for the installation of the button assemblies:

1. Cut out the template(s) (see Appendix H).
2. Using a tape measure, measure the specified distances from the center of the trackball hole in the trackball plate and make a mark for both the left and right button reference points.
3. Lay each template over the appropriate reference marking point. Mark the centers of the remaining holes using a sharp object.
4. Drill a 1 $\frac{1}{8}$ " hole at each marked point.

NOTE: Do NOT install the trackball or buttons until the control panel graphics have been applied.

Once the installation is complete, be sure to use the System Controls test in the game's System Setup menus to ensure proper functionality of all the player controls.

CONTROL PANEL OVERLAY INSTALLATION

Golden Tee LIVE comes with an oversized control panel overlay that will accommodate a variety of existing game cabinets, but works best on Golden Tee® Fore!, NFL® Blitz™ and EA Sports™ PGA Tour® Golf cabinets. Follow these instructions to correctly install the control panel overlay on one of these cabinets:

1. Make sure that the newly drilled control panel has a smooth, clean surface. Sand where necessary to make sure the graphics are installed on an even surface.
2. Clean the control panel to make sure it is free from dust, grease, metal filings, etc. Make sure that all residues (adhesive, overlay material, etc.) from the previous control panel graphics are removed. This will ensure a clean, easy, and beautiful application of the control panel graphics.
3. **It is very important that the trackball and control panel graphics be mounted perfectly straight.** Find the center of your trackball template and lightly draw vertical and horizontal guidelines on the control panel, marking out your centering lines.
4. Remove a small section of the protective backing from the overlay. Carefully center the overlay over the control panel by lining up the die-cut hole with the trackball template. **Be sure the graphic is positioned perfectly straight.** Line up your pencil guidelines with the lines incorporated into the art. Once in position, gently press down on the section with exposed adhesive, affixing the overlay into place. Once affixed, the overlay cannot be removed.
5. While holding down the overlay over the attached area, very carefully turn over one side and remove the exposed backing. Gently lay down the exposed overlay from the center outward, smoothing with your hands or a roller as you go. **Be sure the overlay remains straight and square.** Repeat the process with the other side of the overlay, so the entire surface is affixed to the control panel. Make sure all bubbles have been pressed out for a clean, flat surface.
TIP: Liquid window cleaner can be sprayed onto the control panel before placing the overlay onto the control panel. The window cleaner will allow the overlay to be positioned with less risk of damage to the overlay or adhesive. Once in position, use a decal roller or squeegee to force any excess cleaner out. Be sure to add additional time for the liquid to evaporate.
6. Using a razor knife (or other sharp instrument) carefully cut around the edges of your control panel, trimming any excess material.
7. Find the center of each hole you've drilled out for the buttons and use the knife to poke a hole into the overlay. Make a vertical and horizontal line (like a plus sign) from the center of the hole to the edges. You should be able to place your button in later with no edges showing.

CAUTION: If you choose to install a Plexiglas® cover over your control panel (not recommended), to ensure the safety of your players and the quality of your game make sure that all surfaces, edges and bolts that a player may come in contact with are smooth, safe and secure.

FINISHING THE CONTROL PANEL

1. Reattach the control panel to your cabinet adjusting any hinges or chains where necessary. Make sure not to pinch or crimp any wires while re-attaching the control panel.
2. Install the trackball into the trackball plate. The trackball must be oriented correctly in order to function properly. Refer to the diagram located in Appendix H for correct orientation. You will need the following parts in order to install the trackball correctly to the plate: 4 - 10/32 x 2½" Phillips Head Machine Screws, 4 - #10 Flat Washers and 4 - #10 Split Lock Washers **NOTE:** Do not over-tighten the trackball. It will warp and cause the trackball to not operate correctly.
IMPORTANT! Be sure to install your trackball securely, and maintain it regularly. Loose, worn, or incorrectly mounted trackballs can result in decreased earnings and possible injury to players.
3. Secure the trackball ground wire to the trackball plate at the 8-32 stud on one end with an 8-32 KEPS nut and the other end to the cabinet ground stud (usually located near the AC power cord inlet) using an 8-32 KEPS nut.
4. Install the buttons in the holes located on your control panel. Make sure you use the red button assembly for the Start button, the lighted blue button assembly for the Help button, and the lighted yellow button assembly for the Options button.
5. Attach the micro switches to your newly installed buttons and connect the wires up to the correct pins on the JAMMA harness.

NOTE: The post on the switch labeled COM should connect to the ground wire and the post labeled NO should connect to the signal wire. See the JAMMA pin out chart in Appendix B.



IMPORTANT! Trackball and trackball plate **MUST BE GROUNDED** to Earth Ground to prevent damage to the trackball or game electronics.

COMPLETE NIGHTHAWK CHASSIS CONNECTIONS

Follow these procedures to correctly connect the various electronic components. Be sure the cables are connected securely and in working order. Use cable clamps, with appropriate tension, where necessary to ensure all cables stay in place during operation. Dress all cables with additional clamps and wire tie wraps where needed. Avoid loose wires or disconnected cables, as they can cause an unneeded service call.

ATTACH I/O POWER, AUDIO, AND USB CABLES.

- ◆ **I/O board power cable.** Connect from the I/O board to one of the two 4-pin power output connectors on the chassis.
- ◆ **Audio cables.** Connect to the audio output jacks of the chassis. Match the appropriate colors.
- ◆ **USB cable #1.** Connect from the I/O board to any USB port on the chassis.
- ◆ **USB cable #2** for future updates. Attach to any USB port on the chassis. Route the other end to the control panel for easy access when updating.
- ◆ **USB cable #3** for Cabinet Identification Device (CID). Refer to the CID Installation Section for proper orientation and placement of the CID.
- ◆ **USB cable #4** for Card Reader (online option only). Connect to any USB port on the chassis. The other end connects to the card reader.

ATTACH MAIN VIDEO CABLE

If your cabinet has a VGA or SVGA monitor, connect the video cable from the Nighthawk Chassis directly to the VGA or SVGA monitor input.

If your cabinet has Medium or Low Resolution monitor, connect the video cable from the Nighthawk Chassis to the I/O board.

Be sure to adjust your Dip Switch settings to match your monitor's resolution. Refer to Appendix D.

ATTACH POWER CABLE

Use the AC power cord that is currently in your cabinet. The cord plugs into the Chassis. Have a qualified electrician do the wiring. Verify A.C. main voltage selector switch is in the proper position. In North America the setting is 115 volts AC. In some countries this should be set at 230 VAC.

SOFT POWER / FAN CABLE

There is a "soft power" switch to turn your game on or off without reaching to the back of the cabinet. This switch is mounted on the back of the control panel, and comes in handy when performing any DVD updates. Connect one end of the Soft Power Cable to the Nighthawk Chassis. Route the other end to the switch located under the control panel. Locate the 3-Pin connector and plug it in to the Fan Cable.

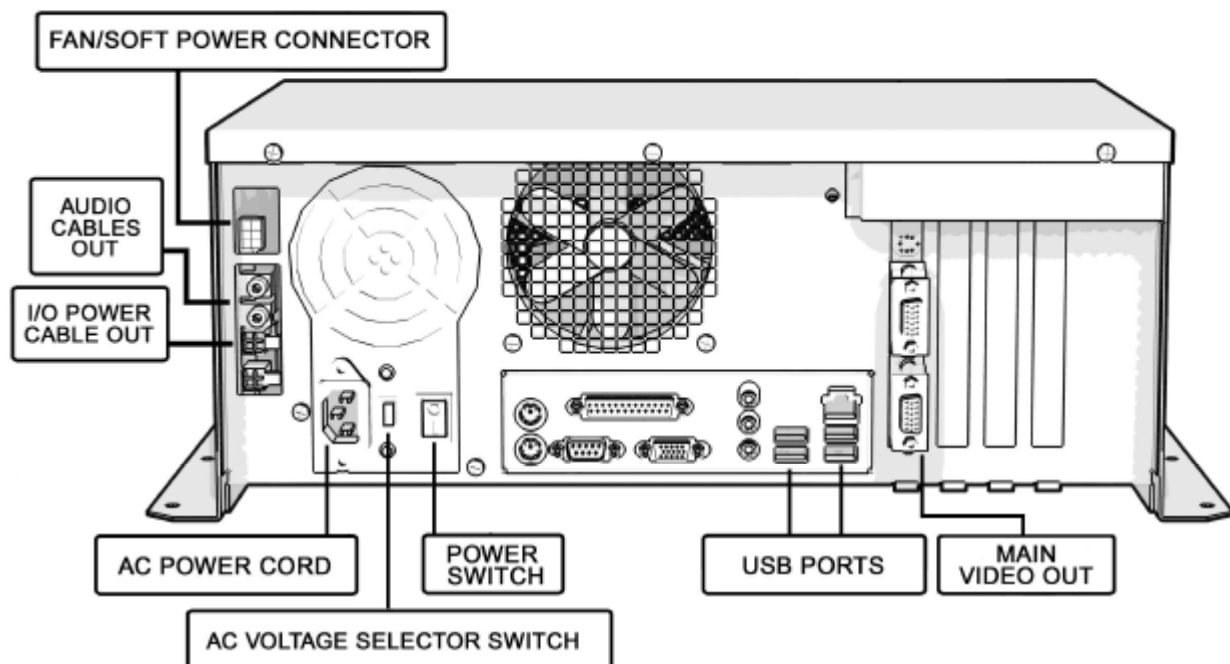

COMPLETE I/O BOARD CONNECTIONS

CONNECT JAMMA HARNESS

Connect the JAMMA Connector to the I/O Board. Be sure it fits tightly and is oriented correctly.

CONNECT THE CONTROL PANEL SWITCHES AND CABLE

Snap the switches onto the buttons. Connect the Control Panel wiring harness using the JAMMA wiring chart found in Appendix B.

CONNECT NEW BUTTONS

Golden Tee LIVE has two additional buttons, Help and Options. Locate the cable from the control panel and connect it to the connectors labeled Control Panel and Lamps on the I/O board.

CONNECT COIN DOOR LAMPS

Connect the coin door lamp cable to the pigtail off the I/O Power cable. If your game had a GT Fore! green PCB, then use the 9 pin connector. If your game has a GT Fore! red PCB, then use the 4 pin connector. Find the mating connector leading to the coin door to make your connection.

CONNECT THE TRACKBALL

Locate the Trackball Cable and connect it to the connector labeled Trackball on the I/O board. The other end will connect to the trackball. Connect the green earth ground wire to the trackball plate.

CONNECT ANTENNA

Locate the antenna cable and attach to the connector on the I/O board. A click should be heard if installed properly. Be sure the antenna is mounted vertically to achieve the widest signal.

Note: Use extreme care with this connector, as it is very delicate and can be damaged easily.

CONNECT AUDIO CABLES

Locate the Audio Cables already connected to the Nighthawk Chassis, and connect them to the I/O board audio inputs. Inputs are color coded, so be sure to connect red to red, etc.

CONNECT THE USB CABLE

Locate the 6 ft. USB Cable from the Nighthawk Chassis and connect it to the USB port on the I/O board.

CONNECT MEDIUM OR LOW RESOLUTION MONITOR

If your cabinet has a Medium or Low Resolution monitor, you need to connect the video to the I/O board. Connect the SVGA Video cable from Nighthawk Chassis to the J501 connector on the I/O Board. Connect the Red, Green, Blue video outputs, the composite sync, and video ground from the JAMMA connector to the appropriate monitor inputs. To find the correct JAMMA pin outs refer to the diagram in Appendix B. Be sure to set the Video Dip Switches on the I/O Board to match your resolution. Refer to the diagram in Appendix D.

CONNECT VGA OR SVGA MONITOR

VGA or SVGA monitors are connected directly to the Nighthawk Chassis video output. Do not connect a video cable to the I/O Board if you are using these resolutions.

CONNECT I/O POWER CABLE

Connect the I/O Power cable to the power input connector. Use the end with the pigtail. The other end connects to the Nighthawk Chassis.

CHECK ALL CONNECTIONS

Go over your entire cabinet again and double-check all of the connections. Make sure that all connectors are tight and secure and in their proper place. Look for frayed, broken or exposed wiring and repair as needed. Bundle and wire-tie your wiring and secure it to the inside of the cabinet. A thorough and neat job now will save you a lot of time and trouble in the future.

CABINET GRAPHICS INSTALLATION

Included with your Golden Tee LIVE kit is a set of decals to place on the side of your cabinet and a brand new marquee. This will help identify your new game as Golden Tee LIVE. By placing and installing these correctly it can help give players instant recognition, even from a distance.

SIDE DECAL INSTALLATION

The following are the instructions on placing your side decals correctly on to the cabinet:

1. Locate the place where the side decals will be viewed best on your cabinet. Refer to the diagram included on the decal sheet and to the right of these instructions for optimal placement.

NOTE: Make sure to have the sides of the cabinet as smooth and flat as possible, removing all previous residue from prior decals, to allow for a higher quality finish.

TIP: Liquid window cleaner can be sprayed onto the sides of the cabinet before placing the decals. The window cleaner will allow the decal to be removed and re-installed without damaging the decal or adhesive. The decal roller or squeegee forces the cleaner out, leaving just the adhesive.

2. Remove the first of the new cabinet side decals from the backing.
3. Center the first decal on the location selected for your cabinet.
4. Using your hands (or a decal roller/squeegee), press down firmly starting from the center and smooth the side decal outward. Make sure all bubbles have been pressed out for a clean, flat surface.
5. Repeat for each of the remaining side decals.

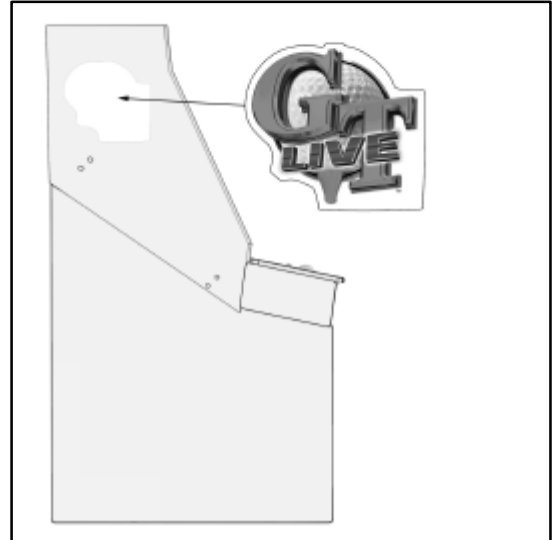

MARQUEE INSTALLATION

The following are the instructions for placing the new marquee in your cabinet:

1. Using the old marquee glass as a template, center the glass on top of your new marquee. Make sure that all the printed images are visible.
2. Using an X-acto® knife or other sharp blade, score the new marquee deeply by following the edges of the old glass as a guide.

CAUTION: Do not cut on table or counter top. Use a cutting board or a disposable surface.

3. Carefully break off any excess material you have cut off.
4. Be sure the light behind the marquee works.
5. Clean the glass on both sides to give players a clear view of the new marquee.
6. Install the marquee graphics and glass securely.

COIN DOORS, TEST SWITCH, AND VOLUME CONTROLS

Wire the coin doors as per the JAMMA Harness Connection table in Appendix B. Connect the door lamps to the appropriate (+12Vdc or +5Vdc) supply. Some games have separate power supply outputs for the lamps. Install a test switch somewhere convenient inside the coin door area. This switch allows you to enter adjustables, run diagnostics, and see or clear audits. Make it readily accessible through the coin door. Wire it to the Test wire on the JAMMA Harness. Golden Tee LIVE has the ability to adjust volume at any time during a game. Install two push button switches (not included) inside the coin door for easy access. Connect the switches to the JAMMA harness. Refer to the JAMMA Harness Connection table in Appendix B.

INITIAL POWER-UP

There are several steps you should take when powering up your Golden Tee LIVE for the first time. This is a quick checklist for you to follow when doing your first initial power-up:

- ❑ Plug in the game and turn it ON; be sure the game powers up correctly into the attract mode.
- ❑ Adjust volume levels to desired settings.
- ❑ Adjust monitor settings for best picture.
NOTE: Sound and Video Tests are available through the System Tests Menu. They are beneficial when making any adjustments. Proper monitor and sound adjustment is very important.
- ❑ Try all money slots. Drop quarters or tokens through to check the coin mechs and insert a bill into the bill acceptor. Make sure the game is adding credits.
NOTE: Golden Tee LIVE supports most bill acceptors. Installing a bill acceptor is highly recommended and will increase your earnings. Refer to your bill acceptor's manual for installation specifications. The bill acceptor can be wired to coin door 3 on the JAMMA.
- ❑ Test all of the player input controls. You can use the PLAYER CONTROL TESTS in the SYSTEM SETUP MENU.
- ❑ Upon initial power-up the game is set to factory default settings. These settings affect game elements such as number of credits per coin, difficulty settings, etc. The OPERATOR MENUS section (see page 49) will describe how to alter these settings for your location.

Congratulations! You have finished installing Golden Tee LIVE!



SYSTEM SETUP MENUS

GOLDEN TEE LIVE SYSTEM SETUP MENUS

NAVIGATING THE MENU SYSTEM

The System Setup menus cover a variety of important areas including collections, tests, game adjustments, and optional settings. You should familiarize yourself with these menus, as they are designed to optimize your game for your location and your business. Pay particular attention to the Collection menus, as they will detail how much money to give to your location, and how much money to set aside for ITNet. There are also menus that allow you to adjust various split percentages for a variety of different charges. These screens can help you maximize your investment and involve your location in the costs associated with your equipment.

ENTERING SYSTEM SETUP MODE

There are two ways to enter System Setup. Open the coin door and press the Test button to access the game's System Setup software menu system. Or, from the I/O board, move the dip switch SW202 position 4 to the ON position. This switch needs to be moved back to OFF to exit the System Setup menus. Refer to the diagram in Appendix D for all dip switch settings.

SELECTING A MENU

A menu option can be selected at any time by rolling the trackball up or down or by pressing the Left or Right buttons.

CHOOSING A MENU/OPTION

A menu option can be chosen at any time by pressing the Start Button.

CHANGING A VALUE

A value can be changed at any time by rolling the trackball left or right.

NOTE: Some menus are not available on the Basic Offline Kit. Menus available on the Standard Online Kit only are marked accordingly.

MAIN MENU

The Main Menu displays five main areas that make up System Setup mode. Please familiarize yourself with these areas, as they will help you maximize your earnings potential.

Collections & Earnings

This section displays your machine's monetary activity, and details the various areas for income and expenses. This section should be reviewed during every collection, to make sure you manage your split correctly.

General Settings

This area allows you to adjust operator adjustables, perform system tests, and reset your game back to factory settings.

Troubleshooting Shortcuts

This section presents a variety of tests and menus that will help you troubleshoot any problems you may be having with your game. The available sections are also accessible through the other main sections.

Golden Tee Settings & Audits

This area allows you to adjust settings specific to Golden Tee LIVE including the player cost schedule, game features, and game audits.

ITNet Settings (online only)

This section details various ITNet settings, such as game registration and connection settings with ITNet.

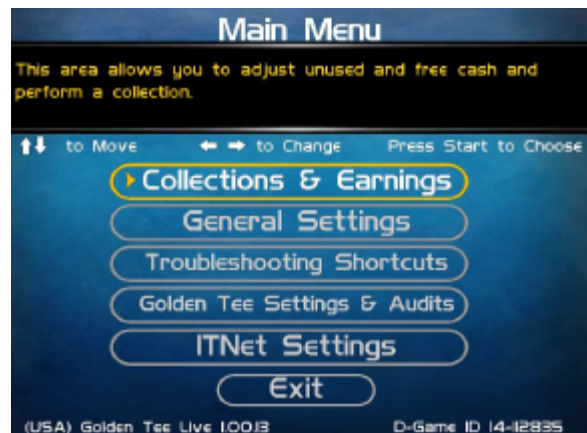

Exit

This will exit the System Setup menus and take you back into the game's attract mode.

COLLECTIONS & EARNINGS MENU

This menu allows you to perform a collection or view various earnings and fees.

Do Collection

This section is used when making a collection. The various screens will detail the cost breakdowns and show you how much of the cash box is to be paid to the location. Please take some time to familiarize yourself with this section. Using it wisely can save you money.

Clear Unused Cash

Sometimes when you go to make your collection, there is money in the game that has not been played yet. Use this setting to clear the unused cash from the screen, so your future collections will reconcile with game play.

Add Free Cash

Use this setting if you wish to add money to the game for free plays that do not advance the hard meter.

Back

This will take you back to the **Main Menu**.

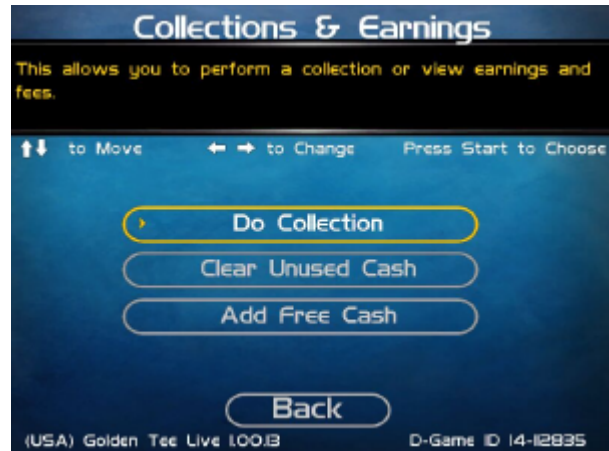

DO COLLECTION

This screen is the main collection screen. There is a lot of helpful information displayed that will help you with your collection. It is highly recommended that you view this screen with every collection, and reset it when your collection is complete.

This screen displays the following helpful information:

Collection Date Range

The displayed dates are from your last collection until today.

Days In Operation

The number of days the machine was active and available for play since the last collection.

Reset

Highlight this to reset the number of days in operation field.

Total Income

The total income your machine made for this time period.

More Details

Select More Details to display a breakdown of Total Income, including income from Cash, Player Accounts, Credit Card purchases, and various promotional or Gift Cards.

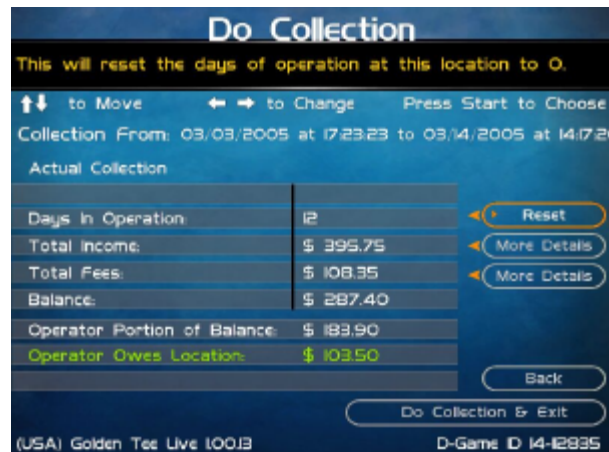

Total Fees

The total of the various fees that need to be set aside before making your split.

More Details

Select this to display a breakdown of the various fees, including the ITNet fees, money for the Prize Fund, Communication fees, Credit Card fees, Software Update fees and Hardware Upgrade fees.

Note! Software Update Fees and Hardware Update Fees are included for your convenience, to help you cover the costs of owning and operating your equipment. These two line items are NOT included on your monthly ITNet statement.

Balance

The total income minus the total fees.

Operator Portion of Balance

The amount of the collection that the operator keeps.

Operator Owes Location

The amount of the collection that you pay your location.

Back

If you do NOT wish to perform a collection and reset the audits, highlight Back to exit this screen and return to the **Collections & Earnings** menu.

Do Collection and Exit

If you wish to perform a collection and reset the audits (recommended), highlight Do Collection and Exit and press Start. This will set all the fields in the Do Collection screen to zero. Be sure to empty your cash box at the same time, so these screens will match the money at your next collection.

GENERAL SETTINGS

The General Settings menu houses various adjustable settings relating to the cabinet, and is divided into three sections.

Operator Adjustables

This area allows you to adjust options like volume, attract mode sounds, and money slot settings.

System Tests

This area allows you to perform diagnostics including video adjustments, input tests, and sound tests.

Advertisements

This area allows you to manage various graphic and text advertisements on your machine. This section is currently unavailable but is planned for a future update.

Back

This will take you back to the **Main Menu**.

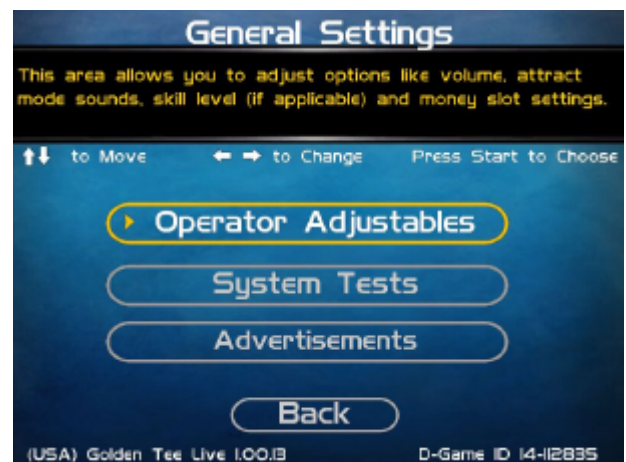

OPERATOR ADJUSTABLES

This menu contains adjustable settings that pertain to you and your business. Please familiarize yourself with this section, as it can help you maximize the game's earning potential.

General Adjustments

This area allows you to adjust options like coin message, skill level, and money modes.

Money Slot Adjustments

This area allows you to adjust the settings of your various money slots on your cabinet.

Sound Adjustments

This area allows you to adjust the various sound settings including attract mode sounds, game volume, and stereo setup.

Collection Settings

This important area allows you to adjust various fees and splits for your collections.

Reset To Factory Settings

This option allows you to reset all the settings found in the Operator Adjustables section to factory defaults.

Back

This will take you back to the **General Settings** menu.

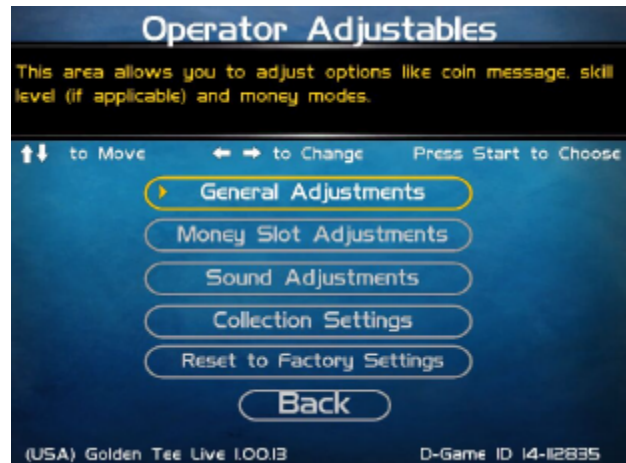

GENERAL ADJUSTMENTS

Coin Message

The default is set to Insert \$.

Accept Credit Cards (online only)

This yes/no choice lets you decide to allow game purchases with credit cards. **The default is set to Yes.**

Game Mode

This lets you toggle between money/free play. **The default is set to Money Play.**

2nd Monitor Mode

You can add an external monitor to your dedicated or kit game by connecting it to the USB port for the upper monitor on the Nighthawk Chassis. Use this setting to select from SVGA and S-Video signals. Note that the upper LCD monitor on dedicated and retrofit kit cabinets will be shut off when an external monitor is added.

2nd Monitor Output

Use this setting to select which image you prefer to display on your external monitor. The display on your second monitor can either be the main game screen, or the upper LCD monitor.

Reset Values

This resets all values to their default value located on this page.

Back

This will take you back to the **Operator Adjustables** menu.



MONEY SLOT ADJUSTMENTS

Money Slot 1 (all machines)

This adjusts how much one pulse equals for Money Slot 1. **The default is set to \$0.25.**

Money Slot 2 (kits only)

This adjusts how much one pulse equals for Money Slot 2. **The default is set to \$0.25.**

Money Slot 3

This adjusts how much one pulse equals for Money Slot 3. **The default is set to \$0.25.**

Credit Card (online only)

See the General Adjustments screen.

Reset Values

This resets all values to their default value located on this page.

No

This will not perform the reset and take you back to the previous menu.

Yes

This will perform the reset and take you back to the previous menu.

Back

This will take you back to the Operator Adjustables menu.



SOUND ADJUSTMENTS

In Game Volume

This option lets you adjust the In Game volume from OFF to 100%. **The default is set to 30%.**

Attract Volume

This option lets you adjust the Attract Volume from OFF to 100%. **The default is set to 30%.**

Attract Mode Sounds

This adjusts how often sounds are played in the attract mode: Never, Rarely (every 10th time), Sometimes (every 5th time), Often (every other time), and Always. **The default is set to On - Sometimes.**

Stereo/Mono

This option is where you select stereo or mono setup. **The default is set to Stereo.**

Reset Values

This resets all values to their default value located on this page.

Back

This will take you back to the **Operator Adjustables** menu.

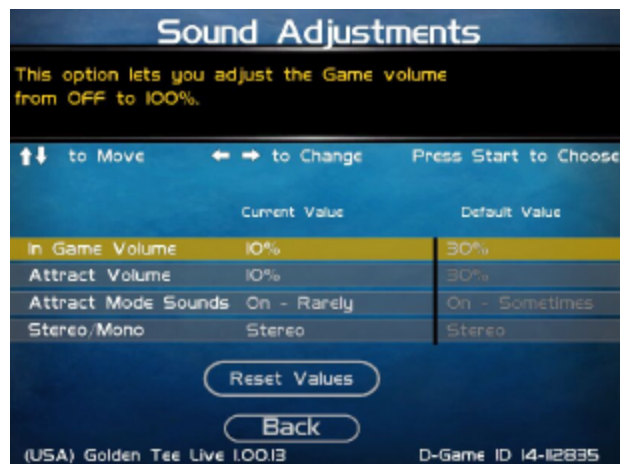

COLLECTION SETTINGS

Golden Tee LIVE allows you to adjust costs and percentages for the various income types that are received. Use this menu to determine how much you want your location to help you pay for these charges and services.

Set Hardware Update Fee

This menu allows you to adjust the Hardware Update Fee. This fee is included for your convenience, as a method to have the location pay for part of your equipment. The default value for 2007 machines is \$0.00 per week. Adjust this value to an appropriate amount for your location.

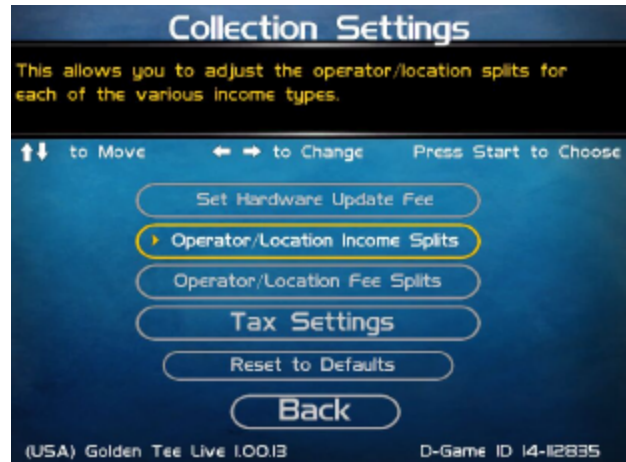

Note! Hardware Update Fees are included for your convenience, and are NOT included on your monthly ITNet statement.

Operator/Location Income Splits

Use this menu to fine-tune your splits for any generated income. Since there may be times when you have to pay the location before you actually have the cash in hand, you may want to adjust the split in your favor to cover the waiting period. The default settings are displayed on the accompanying screen.

The adjustable settings refer to income generated from:

Cash

Player Account (online only)

Credit Card (online only)

ITNet Money Card (online only)

Operator Money Card (online only)

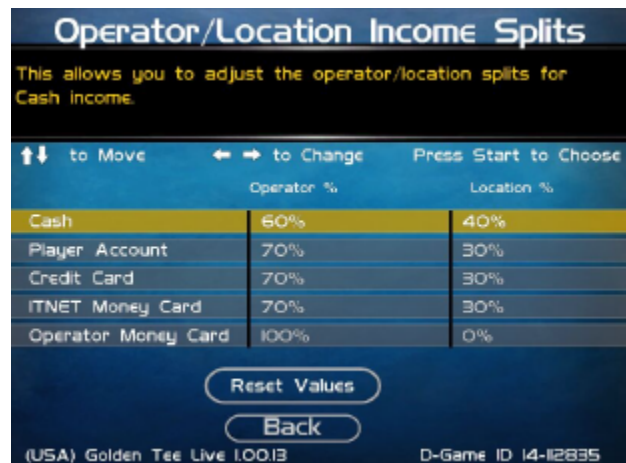

Operator/Location Fee Splits

Use this menu to determine how you wish to split the various fees with your location. For example, since there is a fee associated with credit card usage, you may want to adjust the split in your favor to help cover the costs of the transaction fees.

ITNet Fees (online only)

Prize Fund Fees (online only)

Credit Card Fees (online only)

Communication Fees (online only)

Software Update Fees

Hardware Update Fees

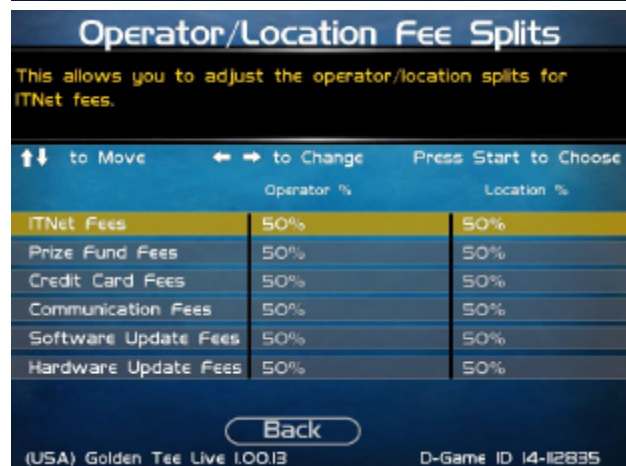

Note!

Software Update Fees and Hardware Update Fees are included for your convenience, and are NOT included on your monthly ITNet statement.

Tax Settings

Many states require special taxes or license fees that affect your bottom line. Use this menu to separate these costs from your collection before making your normal split.

Set Tax Rate

This menu allows you to adjust your current tax rate percentage.

Set Tax Type

This menu helps you determine what part of the collection is taxed, and who pays for these taxes.

Set Tax Split

This menu allows you to split the tax fees with the location.

Reset to Defaults

This menu will set all of the collection settings to their factory default values. A verification screen will display to make sure you agree to the change.

Back

This will take you back to the **Collection Settings** menu.

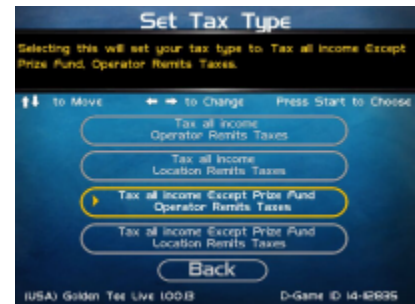
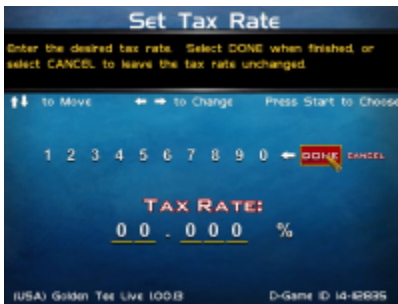
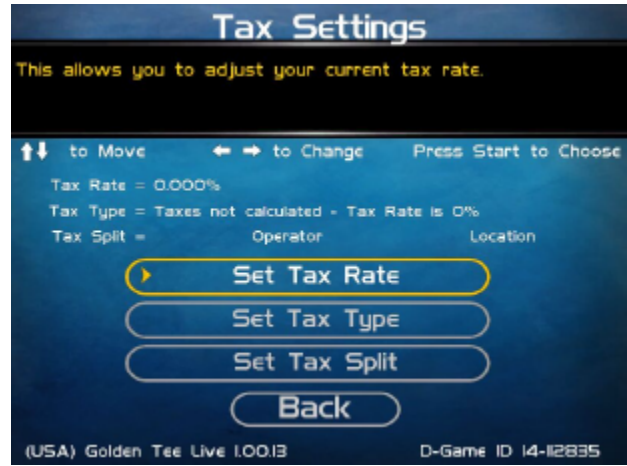

RESET TO FACTORY SETTINGS

This menu will reset ALL settings in the Operator Adjustments section to their default values. A verification screen will display to make sure you agree to the change.

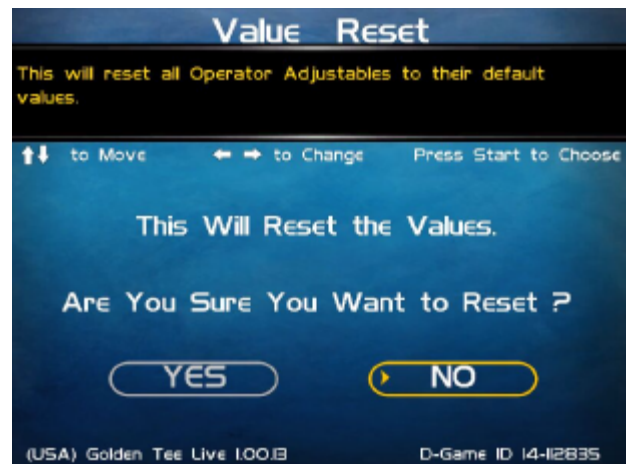

SYSTEM TESTS

This area allows you to perform diagnostics including video adjustments, input tests, and sound tests.

Video Tests

This area has tests that will help you to adjust your game's color, contrast, and screen size.

Sound Tests

This area has tests that will help you adjust your game's audio setup by playing a stored sound, a streaming sound, and testing the speaker(s).

Player Control Tests

This option allows you to test all inputs including trackball, buttons, and money slots.

Mechanical Meter Test

This test makes the hard meter adjust by one to make sure it is functioning properly.

Hardware Tests

This area includes a series of diagnostic screens and tests to help you make sure your game is functioning correctly.

Back

This will take you back to the **General Settings** menu.



VIDEO TESTS

The Video Tests section has a variety of tests that will help you adjust your monitor.

Color Adjustments

This area will take you to a series of tests to adjust your monitor's RGB settings to have each color display properly.

Contrast Adjustments

This area will take you to a series of tests to adjust your monitor's brightness/contrast so the game displays properly.

Screen Size Adjustment

Use this screen to align your monitor so that all the circles appear as circles and the boundary line appears on the edge of each side of the screen.

Back

This will take you back to the **System Tests** menu.

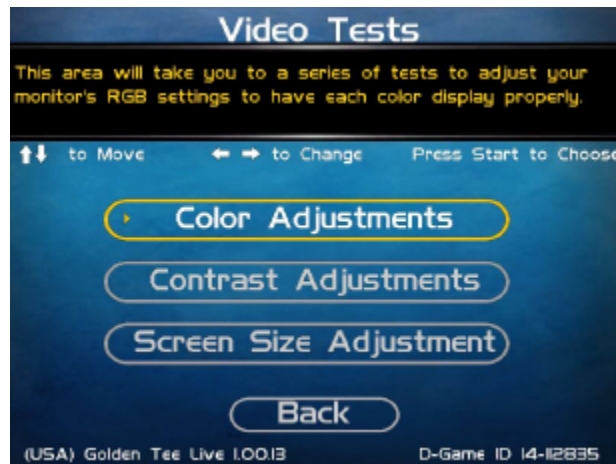

COLOR ADJUSTMENTS

Color Grid Adjustment

Adjust your monitor to have each colored box display properly.

Red Screen

Adjust your monitor to have red display properly.

Green Screen

Adjust your monitor to have green display properly.

Blue Screen

Adjust your monitor to have blue display properly.

Back

This will take you back to the **Video Tests** menu.



CONTRAST ADJUSTMENTS

White Screen

Adjust your monitor to have white display properly.

50% White Screen

Adjust your monitor to have 50% white display properly.

25% White Screen

Adjust your monitor to have 25% white display properly.

Black Screen

Adjust your monitor to have black display properly.

Contrast Screen

This option is a test you can use to adjust your monitor's contrast and brightness settings to have the boxes displayed properly.

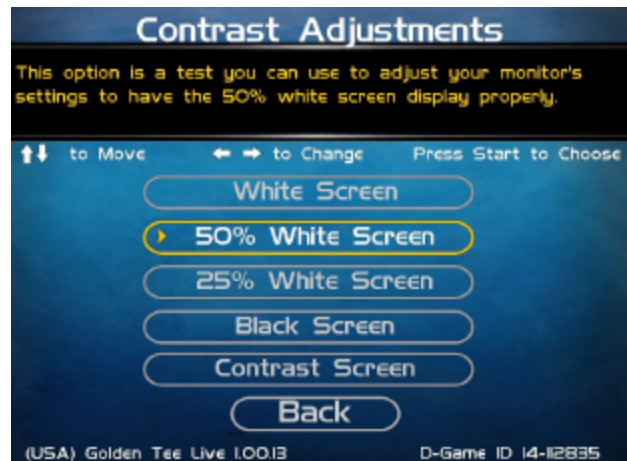

Note: May not work on older or often used monitors. If you have a monitor that's old or has been used often you may not be able to adjust the contrast and/or brightness levels accordingly. In this case adjust the monitor for best performance while getting close to the recommended settings.

Back

This will take you back to the **Video Tests** menu.

SCREEN SIZE ADJUSTMENT

Use this screen to adjust the size and aspect ratio of your picture. Press the Start button to exit.

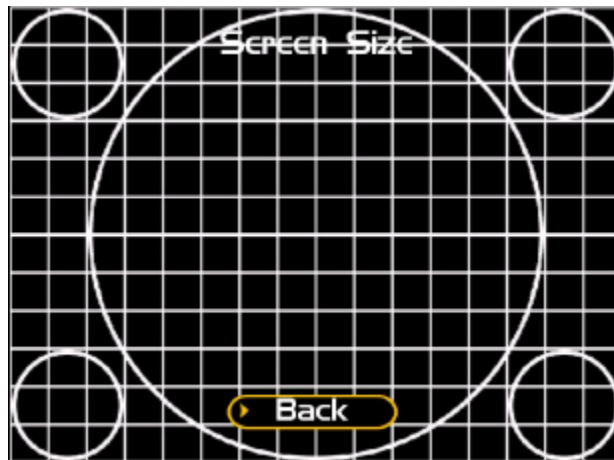

SOUND TESTS

Stored Sound

This will play a stored sound so you can make sure your audio setup is functioning properly.

Streaming Sound

This will play a streaming sound so you can make sure your audio setup is functioning properly.

Speaker Test

This test will say MONO if you have your game set to Mono or LEFT and RIGHT if you have it set to stereo so you can make sure your audio setup is functioning properly.

Back

This will take you back to the **System Tests** menu.

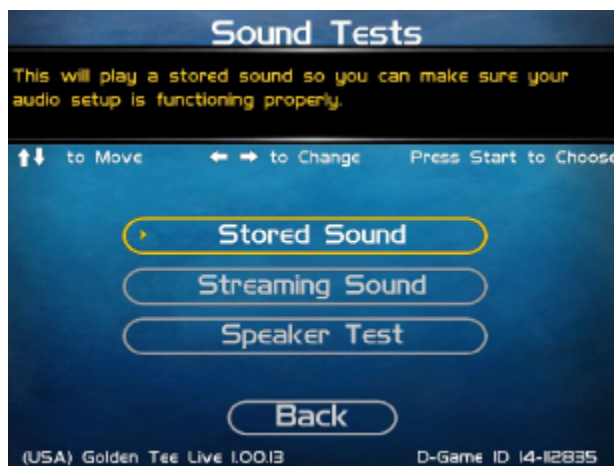

PLAYER CONTROL TESTS

Use this screen to test all of the inputs, including the trackball, buttons, money slots and card reader. When an input is active the appropriate graphic image will light. Press the Left, Right and Start buttons simultaneously to exit this test screen.

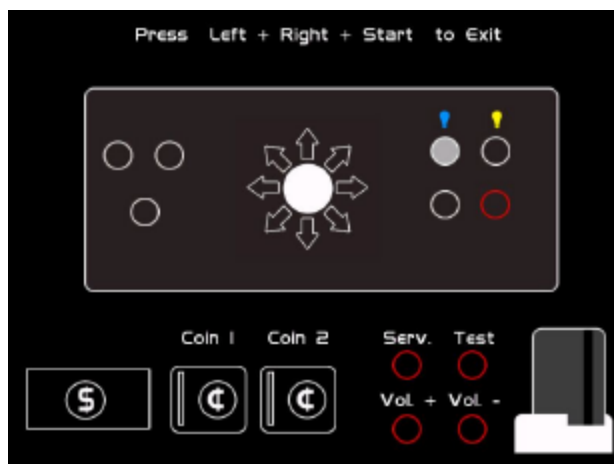

MECHANICAL METER TEST

Click Meter

This test makes the hard meter adjust by one to make sure it is functioning properly.

Back

This will take you back to the **System Tests** menu.

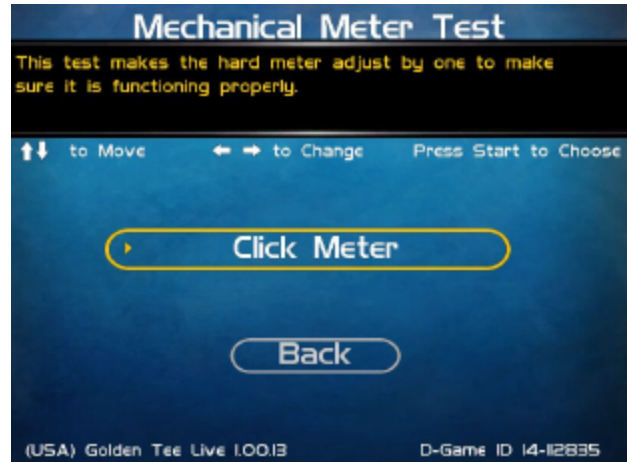

HARDWARE TESTS

This area includes a series of diagnostic screens and tests to help you make sure your game is functioning correctly.

Hardware/Software

This area has options to view your system and USB info.

Check Hard Drive

This test checks the integrity of your hard drive's data.

Note: This test can take several minutes.

Check Cooling

This test helps you make sure your game is functioning at the proper temperature and all fans are working.

Check Card Reader

This test will test the functionality of the card reader, and display some details on the card that is tested.

Back

This will take you back to the **System Tests** menu.



HARDWARE/SOFTWARE

System Info

This is a list of your game's current basic system info.

USB Info

This is a list of your game's current USB devices.

Version Info

This is a list of your game's software version.

Back

This will take you back to the **Hardware Tests** menu.



SYSTEM INFO

This is a list of your game's current basic system information, including Hard Drive, CPU and Video Card.

Back

The Back button takes you back to the **Hardware/Software** menu.

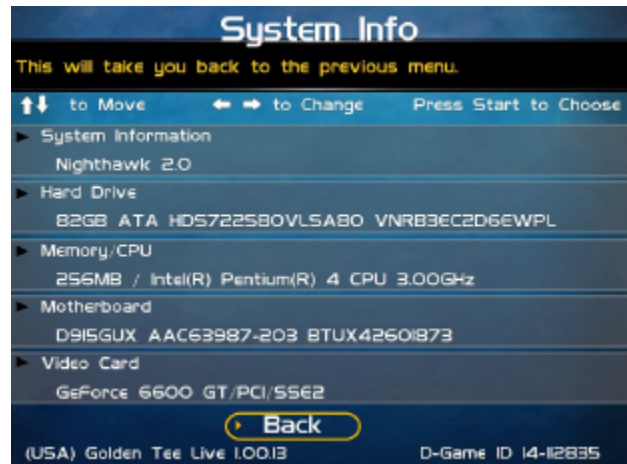

USB INFO

This is a list of your game's current USB devices.

Back

The Back button takes you back to the **Hardware/Software** menu.



VERSION INFO

This is a list of your machine's software version.

Back

The Back button takes you back to the **Hardware/Software** menu.

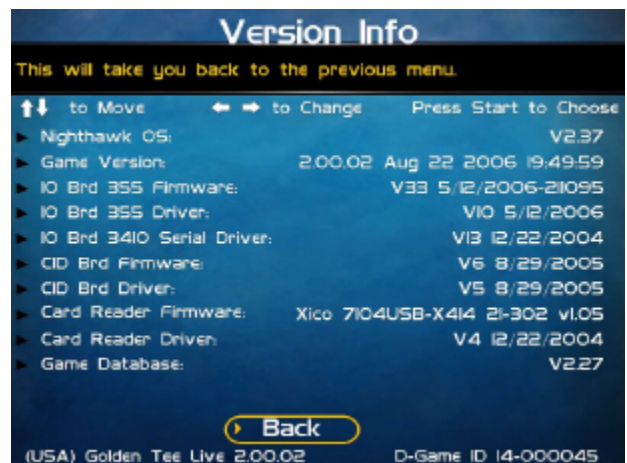

CHECK HARD DRIVE

Check File Data

This test checks the integrity of your hard drive's data.

Select **Begin Test** to initiate the process.

Note: This test can take up to 3 hours to complete.

If this test succeeds you will see the message: **Status: Hard Drive Functioning Properly.** If this test fails, you will see the message: **Hard Drive Error (#)**

Select **Back** to skip the test and return to the **Hardware Tests** menu.

Check File System

This test REBOOTS YOUR GAME and performs a low level systems check of the integrity of your hard drive.

Note: This can take several minutes.

Back

This will take you back to the **Hardware Tests** menu.

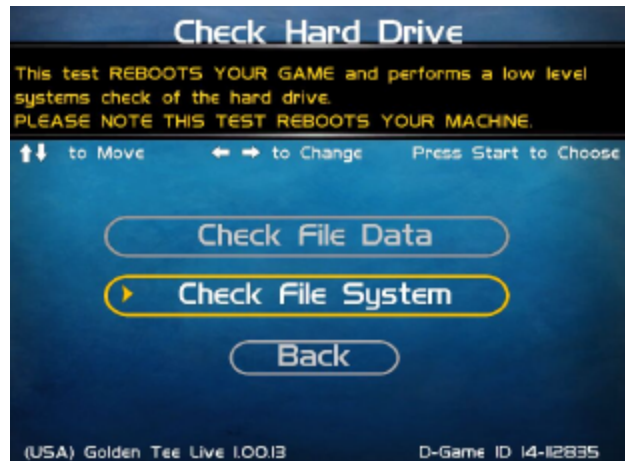

CHECK COOLING

This checks that your game is functioning at the proper temperature and all fans are working. The current status is color-coded for easy viewing. If the results are displayed in green, your cabinet is at normal settings.

Back

The Back button takes you back to the **Hardware Tests** menu.

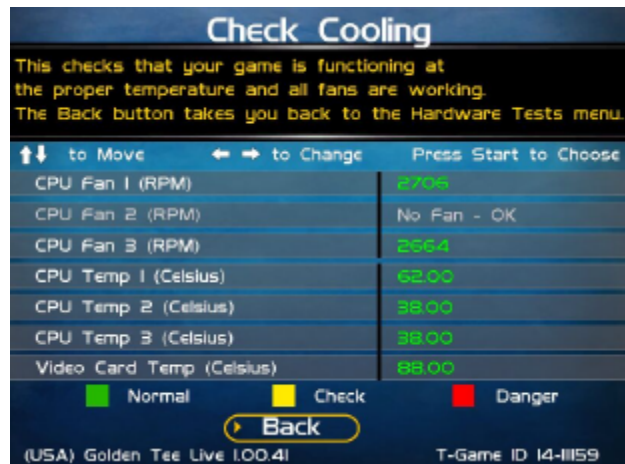

CHECK CARD READER (ONLINE ONLY)

This test will check to see if your card reader can read and recognize properly encoded IT and credit cards.

From this screen, insert a card into the card reader. If the card can be read, a message will appear on the screen.

Back

The Back button takes you back to the **Hardware Tests** menu.

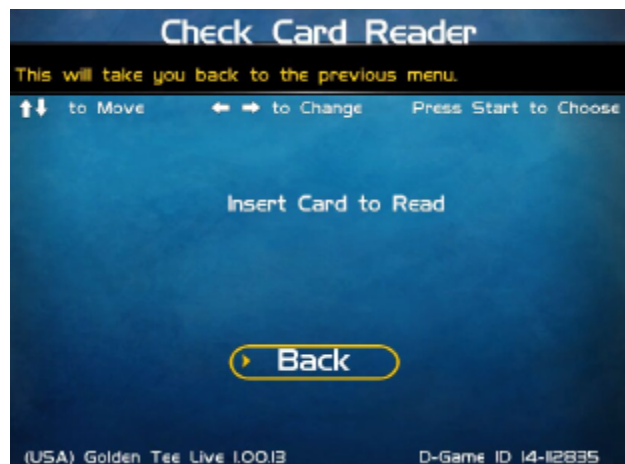

TROUBLESHOOTING SHORTCUTS

This section gathers many of the commonly used tests and menus into one convenient area. Check here first when troubleshooting problems or questions about the integrity of your machine.

The tests that are available in this section are:

- Check Card Reader** (online only)
- Check Cooling**
- Check Hard Drive**
- Hardware & Software**
- Communications Settings** (online only)
- Player Control Tests**
- System Tests**

Descriptions of each of these tests and sections can be found elsewhere in this manual.

Back

This will take you back to the **Main Menu**.



GOLDEN TEE SETTINGS & AUDITS

Golden Tee Settings

This section allows you to make custom adjustments to certain features on your machine, including Prize Play, Practice Mode, Closest to the Pin, and Hole-N-Win.

Golden Tee Audits

This area allows you to view your money audits, game purchase audits, and reset your collections and audits.

Player Cost Schedule

This option allows you to adjust the amount of money it costs a player to play various game types.

Back

This will take you back to the **Main Menu**.



GOLDEN TEE SETTINGS

LIVE Prizes (online only)

Turn the ability to play for prizes off or on.

Delay of Game Timeout

Adjust the timer that senses activity between shots.

Balls in Practice Mode

Adjust the number of balls awarded for a Practice Facility game.

Operator CTP

Activate the ability for the game to enter Closest to the Pin (CTP) mode. This version of CTP does not display any sponsored or branded game elements.

Activate Sponsored CTP

Activate the ability for the game to enter a branded Closest to the Pin (CTP) mode. This version of CTP will display sponsored or branded game elements, if available. The sponsor may be able to activate this mode using a specially encoded card, which requires a machine rental fee to activate.

Hole-N-Win

Activate the ability for the game to offer special Hole-N-Win opportunities on some holes where allowed. Check your local regulations to determine if this feature is allowed in your area.

Allow Locked Conditions

Activate the ability for the game to allow for special contests where course conditions are the same for each player. This is generally used during live events and promotions, and requires a special activation card. Contact your IT representative for more information.

Reset Values

Select this to reset all of the options on this screen to their factory default settings.

Back

Select this to return to the **Golden Tee Settings & Audits** menu.



GOLDEN TEE AUDITS

This section displays various counts and totals for a variety of areas of interest. The following values are based on the last reset, the date of which is shown at the top of the screen.

Total Number of 18-Hole Games

Total Number of 9-Hole Games

Number of 18-Hole Games With Prizes

Number of 9-Hole Games With Prizes

Number of Sampler Purchases

Number of Practices Purchased

Coin Slot 1 (All Machines)

Coin Slot 2 (Kits only)

Bill Acceptor

Lifetime Money In

This field shows how much total money your machine has made since its initial registration with ITNet. This field is cumulative and is not affected by resetting the audits on this screen.

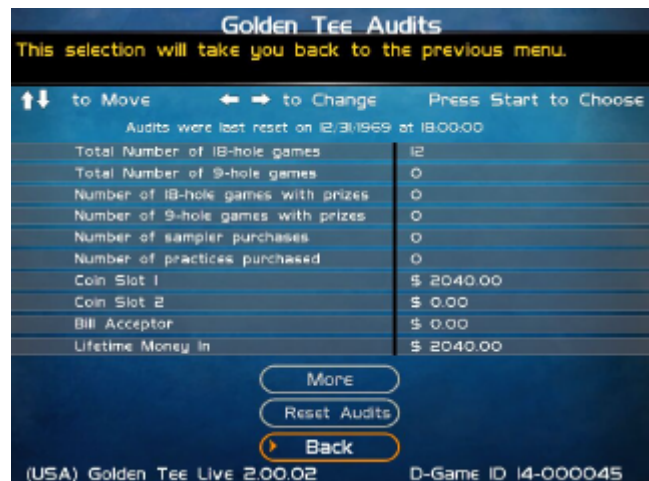

More

Selecting More brings you to a second page of even more audit information.

Boxes of Balls Purchased

Sets of Clubs Purchased

18-Hole Unregistered Contest Games

9-Hole Unregistered Contest Games

Gold Cards Purchased

Hole-N-Win Par 3 Plays (online only)

Hole-N-Win Par 4 Plays (online only)

Reset Audits

This will reset the fields on this screen to zero, and update the date of the last audit reset. The Lifetime Money In field will not be affected by this function.

Back

Select this to return to the **Golden Tee Settings & Audits** menu.

Item	Value
Boxes of balls purchased	0
Sets of clubs purchased	0
18-hole unregistered contest games	0
9-hole unregistered contest games	0
Gold cards purchased	0
Hole-N-Win par 3 plays	0
Hole-N-Win par 4 plays	0

PLAYER COST SCHEDULE

This screen details the costs of various play selections. The player cost is shown as a total, with the Operator Portion and the ITNet Portion broken out.

18 Holes LIVE (or 18 Holes Basic)

This option lets you adjust how much it costs a player to play an 18-hole game. **The default is set to \$4.00.**

9 Holes LIVE (or 9 Holes Basic)

This option lets you adjust how much it costs a player to play an 9-hole game. **The default is set to \$3.00.**

Sampler

This option lets you adjust how much it costs a player to play the Sampler mode, which offers a fee for play on a random, single hole. **The default is set to \$0.25.**

Practice

This option lets you adjust how much it costs a player to play the Practice Facility, which offers a bucket of 25 balls on various practice courses. **The default is set to \$1.00.**

View Fixed Costs

Selecting View Fixed Costs displays payment settings and splits for some items that are not adjustable.

Play for Prizes (online only)

Golf Club Sets

Dozen Golf Balls

Gold Card Purchase (online only)

Hole-N-Win Par 3 (online only)

Hole-N-Win Par 4 (online only)

Reset Values

This resets all values to their default value located on this page.

Back

Select this to return to the **Golden Tee Settings & Audits** menu.

Adjustable Costs	Operator Portion	ITNET Portion	Total To Player	Default Value
18 Holes LIVE	\$ 3.90	\$ 0.35	\$ 4.25	\$ 4.00
9 Holes LIVE	\$ 2.65	\$ 0.35	\$ 3.00	\$ 3.00
Sampler	\$ 0.25	\$ 0.00	\$ 0.25	\$ 0.25
Practice (25 balls)	\$ 1.00	\$ 0.00	\$ 1.00	\$ 1.00

Fixed Costs	Operator Portion	ITNET Portion	Cost To Player
Play for Prizes 18	\$ 0.00	\$ 1.00	\$ 1.00
Play for Prizes 9	\$ 0.00	\$ 1.00	\$ 1.00
Golf Club Sets	\$ 1.00	\$ 1.00	\$ 2.00
Dozen Golf Balls	\$ 0.25	\$ 0.25	\$ 0.50
Gold Card Purchase	\$ 0.25	\$ 1.75	\$ 2.00
Hole-N-Win Par 3	\$ 0.00	\$ 0.50	\$ 0.50
Hole-N-Win Par 4	\$ 0.00	\$ 1.00	\$ 1.00

ITNET SETTINGS (ONLINE ONLY)

This section details various ITNet settings, such as game registration and connection settings with ITNet.

Change Location/Register Game

This section lets you update the information for the location that your game is currently in and send it to ITNet.

If your machine is unregistered, the screen will display **Register Game**. If your machine is already registered, the screen will display **Change Location**.

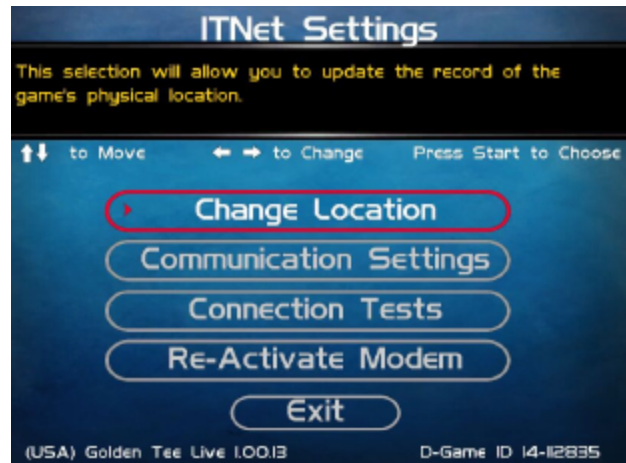

Note: These sections require an Operator ID Card to activate.

Note: These sections require a working connection to ITNet.

Communication Settings

This section lets you select and adjust various communication options.

Connection Tests

This section tests your communication connections for integrity and reliability.

Re-Activate Modem

This section gives you the ability to use a special Modem Reactivation Card if your modem is currently unregistered.

Exit

Select this to return to the **Main Menu**.

CHANGE LOCATION

Select this option and insert your Operator ID Card into the Card Reader. If the machine is properly registered, you will be asked to enter the zip code of the location the machine is placed in. The zip code is very important and is used to find the most optimal wireless service available. Once the zip code is entered, the machine will contact ITNet for a list of available cities. Verify that the city and zip code are accurate.

Next enter the name and phone number of the location. This information will be used to identify the game and will be posted on the Golden Tee website, so players can find and play on your machines. Verify that all information is accurate. Once complete, exit the screen to complete the location change process.

COMMUNICATION SETTINGS

This screen shows the type of communication device that is currently in use, and its status and signal strength. In most cases, the wireless modem will be in use and active. If your machine is in a location with low signal strength, check the Troubleshooting section of the manual for ways to help boost your signal.

Configure Ethernet Settings

If your machine is in a location with low signal strength, and none of the suggestions on boosting your signal help, you may need to connect to ITNet using a broadband connection through Ethernet.

Back

Select this to return to the **ITNet Settings** menu.

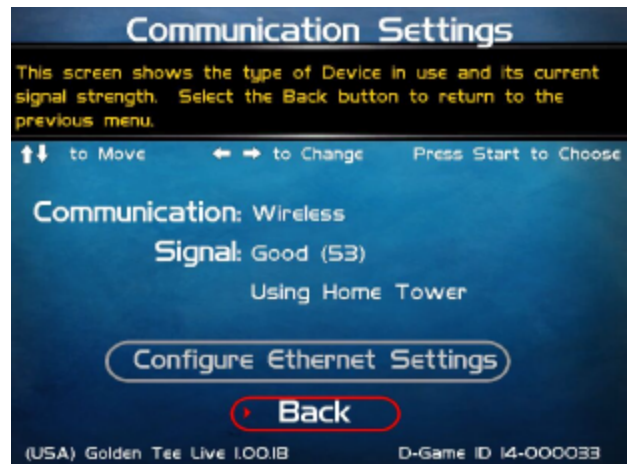

CONFIGURE ETHERNET SETTINGS

Depending on your system setup, you may need to manually set specific settings for Ethernet to work. Use this menu to enter these settings.

Enable DHCP

Set this to Yes if your service provider or your router hardware has DHCP enabled. DHCP automatically sets the IP, Gateway and Net Mask.

If you edit the IP below to anything other than 0.0.0.0, it automatically changes Enable DHCP to No.

If No DHCP, Static IP

Set this to the IP that your service provider issued, or an IP from your router's subnet that is not already being used.

If the IP is set to 0.0.0.0, it automatically changes Enable DHCP to Yes.

Gateway

Set this to the Gateway that your service provider issued, or the IP address of your router. Example: 192.168.1.1

Net Mask

Set this to the Net Mask that your service provider issued, or if you are using a router it is typically 255.255.255.0. Example: 255.255.255.0

Test Ethernet

Selecting this will initiate a network connection using your entered network settings for DHCP or Static IP, Gateway and Net Mask. If the connection succeeds, a latency time check is also performed. Results are displayed at the end of the tests. It is a good idea to perform this test anytime you make changes to any of these settings to make sure everything works.

Back

Select this to return to the **Communication Settings** menu.

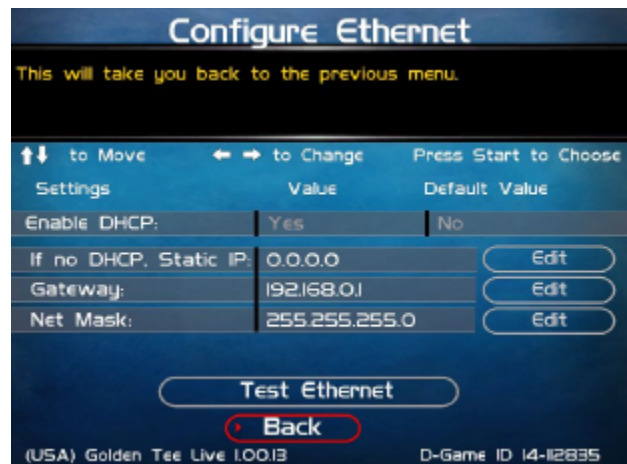

CONNECTION TESTS

Use this section to test the connection to ITNet.

Check Latency Time

This test will measure the time it takes for your game to communicate with ITNet. If successful, the delay time in seconds will be displayed.

Force Call to ITNet

This test will initiate a connection with the ITNet system and give a result status.

Back

Select this to return to the **Communication Settings** menu.

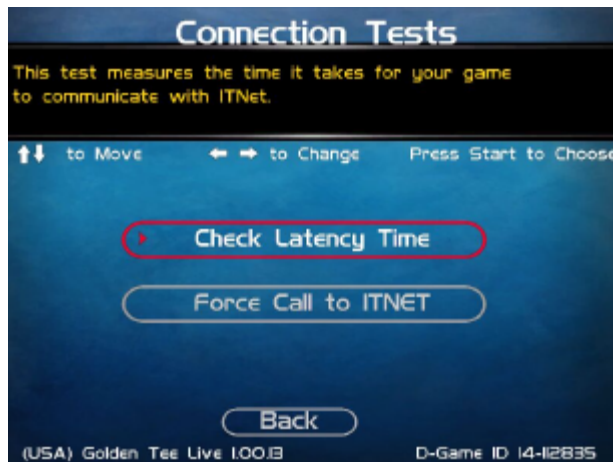

RE-ACTIVATE MODEM

Once your machine is registered, your wireless service is active regardless of how much play or activity is on the machine. If you must un-register your machine to avoid wireless modem service charges, the wireless modem will be made inactive.

When you wish to once again register the machine, you will need a special Modem Reactivation Card to make your modem viable again. These special, one-time-use cards are encoded specifically for a machine and are created by IT on an as-needed basis. Allow 2 weeks to receive your card from Incredible Technologies.

Once you receive your Modem Reactivation Card, access this menu and insert the card into the card reader. Be sure the number on the card matches the number on the screen.

The process can take several minutes and is sensitive to signal strength. Watch the progress bar as the reactivation process takes place. Once complete, a status message will appear. If the reactivation was unsuccessful, try again. If subsequent attempts are unsuccessful, write down the error code and contact the IT tech department for assistance.





APPENDICES

GOLDEN TEE LIVE TROUBLESHOOTING & REFERENCE

APPENDIX A TROUBLESHOOTING GUIDE

Video Problems		
Symptom	Probable Cause	Solution
No picture on 27" Monitor	I/O Board Dip Switch settings are wrong.	Adjust Dip Switch settings to match the resolution of the monitor you are using. Refer to I/O Dip Switch Settings in Appendix D.
	Incorrect video connection configuration.	Be sure the video connections are correct according to the type of monitor you are using. Refer to the diagrams in Appendix D.
	Monitor does not have a proper A.C. voltage input.	Verify A.C. power to the Nighthawk Chassis. Verify monitor is working on a known good system.
	Monitor is defective.	Repair or replace.
	Nighthawk Chassis is defective	Go to Nighthawk Chassis troubleshooting section.
No picture but game sounds are heard	Incorrect video connection configuration.	Verify video is connected to the system correctly. Refer to the diagrams in Appendix D.
	Since you hear game sounds the system is working.	Review no picture troubleshooting section above.
Scrambled Picture	I/O board Dip Switch settings are set wrong.	Adjust Dip Switch settings to match the resolution of the monitor you are using. Refer to Dip Switch Settings in Appendix D.
	Incorrect video connection configuration.	Be sure the video connections are correct according to the type of monitor you are using. Refer to the diagrams in Appendix D.
Entire picture is not seen on the screen or it does not fill the entire screen	Misadjusted monitor.	Adjust the monitor width and height. Use video screen adjustment in system tests. Refer to the monitor manual.
Missing or washed out colors	Bad Video connections	Verify continuity from the monitor to the video out on the I/O board. Red, Green, Blue video signal. <i>Mid. and Low resolution monitors only.</i>
	Contrast and brightness on the monitor needs to be adjusted.	Refer to the monitor manual to make adjustments.
	Defective Monitor.	Verify by connecting a known good monitor to the system.

Wireless Connection Problems

<i>Symptom</i>	<i>Probable Cause</i>	<i>Solution</i>
Low Signal Strength See Appendix F for more information.	Placement in location is impeding the signal.	Place the game near a window or doorway to yield a better signal.
	Antenna needs to be repositioned for best signal strength.	Adjust the orientation of the Antenna within the cabinet. Be sure the antenna is vertical(straight up and down) Sometimes a slight tilt in one direction will help. Rotate the Antenna 180 degrees. Reposition the Antenna to the opposite side of the cabinet. See Appendix F for hints on methods for optimal signal strength.
	Signal strength in location is weak.	Add a signal booster. In rare instances a booster can be added for an additional charge. Please call customer service for more information. P/N 900100510

Sound Problems

<i>Symptom</i>	<i>Probable Cause</i>	<i>Solution</i>
No Sound	Audio Cable between the I/O board and the Nighthawk Chassis are not connected.	Verify audio cables are connected. Refer to Appendix D.
	Speakers are not connected properly.	Verify continuity from the I/O board speaker output pins to the speakers. Refer to Appendix D.
	Volume is set to the lowest level.	Adjust the volume to an audible level.
	Attract mode sounds may be set to all off. You will have sounds when playing the game.	Choose one of the 5 Attract Mode sound options in Sound Adjustments.
	Defective I/O board.	Verify on a known working system. Replace if necessary.
	Defective Nighthawk Chassis.	Be certain all other possibilities are explored before replacing the Nighthawk Chassis.
Distorted or scratchy game sounds	Bad speaker.	Replace blown speaker.
	Loose speaker or grill cover is causing vibration.	Verify all components are installed properly and securely.
	Loose/defective audio cables from the Nighthawk Chassis to the I/O board.	Check the audio cable connections. Replace cable.
	Defective I/O board.	Verify on a known working system. Replace if necessary.
	Defective Nighthawk Chassis.	Be certain all other possibilities are explored before replacing the Nighthawk Chassis.

Nighthawk Chassis Problems

<i>Symptom</i>	<i>Probable Cause</i>	<i>Solution</i>
No video and no green lights on the I/O board. Fans are not heard on the Nighthawk Chassis.	No A.C. power to the Nighthawk Chassis.	Verify A.C. voltage is connected to the Nighthawk Chassis.
	Power switch on the Nighthawk Chassis is off.	Flip the Nighthawk Chassis power switch to on.
	Main cabinet power switch is off.	Be certain the main cabinet switch is set to on.
	Defective Nighthawk Chassis.	Be certain all other possibilities are explored before replacing the Nighthawk Chassis.
No video and no green lights on the I/O board. Fans are heard on the Nighthawk Chassis.	DC power cord not connected from Nighthawk Chassis to I/O board.	Connect the DC power cord from the Nighthawk Chassis to the I/O board.
	Defective I/O board.	Try it on a known good system. Verify by disconnecting all cables from the I/O board except the DC power and USB cable to the Nighthawk Chassis. No green lights, replace the I/O board.

Control Problems

<i>Symptom</i>	<i>Probable Cause</i>	<i>Solution</i>
Button does not work.	Switches Common post is not connected to digital ground.	Verify continuity to digital/power supply ground.
	Signal wire is not connected to the Normally Open post of the switch.	Verify continuity from the I/O board to the Normally Open post of the switch.
	Switch is defective.	Replace defective switch.
Button always indicates closed in the player control test. Pressing it will show it is not depressed.	Signal wire is connected to the Normally Closed post of the switch.	Connect signal wire to the Normally Open post of the switch.
Button always indicates closed in player control test even with the switch disconnected entirely.	Defective I/O board.	Test on a known good system. Replace if necessary.
Trackball is not functioning in any direction.	Trackball is not connected to the I/O board properly.	Verify the trackball is connected to J208 labeled trackball on the I/O board.
	Defective trackball Interconnect cable.	Verify continuity on the trackball Interconnect cable.
	Trackball is defective.	Replace trackball.
	I/O board is defective	Replace I/O board. Try it on a known good system.
Trackball does not work in a certain direction.	Trackball cable is defective.	Verify continuity on the trackball cable. Repair or replace if needed.
	Trackball is defective.	Repair or replace the trackball. Try it on a known working system.
	I/O board is defective.	Repair or replace the I/O board. Try it on a known working system.
Trackball works intermittently.	Inside of the trackball is dirty.	Clean the inside of the trackball.
	Rollers are worn.	Replace the rollers and bearings.
	Trackball is over-tightened.	Do not over-tighten the trackball. Tighten just enough to flatten the lock washers.

Error Messages		
Symptom	Probable Cause	Solution
Most on screen error messages explain themselves.	Multiple	Follow the onscreen instructions. Many times turning the game off for ten seconds and then turning it back on will solve the error.
Flash code 6 on I/O board Diode D102	CID is not connected or is defective	Check the USB cable connection. Swap with a known good cable. Call I.T. Service for further assistance.
Please turn game off, then connect Cabinet Identification Device (CID) then turn game back on.	CID is not connected	Connect CID to the Nighthawk Chassis via USB cable.
	CID cable is defective	Try or swap with a known good USB cable.
	If LED is not flashing - Call I.T. Service	I.T. service will instruct you what to do.
Flash code 1 on I/O board diode D102	This indicates to USB connection fail from Chassis to I/O board.	Connect USB Cable.
Please turn game off, Then connect USB I/O board and then turn game back on.	USB cable is not connected	Connect the USB cable.
	USB cable is Defective	Try with a known good USB cable.
	I/O board has no power connection.	Verify power to the I/O board.
	I/O board is defective	Swap with a known good I/O board. Possibly bad. Cal I.T. service.

Flash Code Messages		
Flash Code (I/O Diode D102)	Code Description	Solution
Flash code 2	This indicates to USB connection fail from Chassis to I/O board.	Connect USB Cable.
Flash Code 3	INFO: Last reboot due to Watchdog time out.	Turn off game, wait 10 seconds, turn game on. If the problem persists call IT tech support.
Flash Code 4	Error when updating USB CID to latest version.	Turn off game, wait 10 seconds, turn game on. If the problem persists call IT tech support.
Flash Code 5	Updated USB CID was detected.	Turn off game, wait 10 seconds, turn game on. If the problem persists call IT tech support.
Flash code 6	CID is not connected or is defective	Check the USB cable connection. Swap with a known good cable. Call I.T. Service for further assistance.
Flash Code 7	CID Malfunction.	Make sure all connections are in place. Turn off game, wait 10 seconds, turn game on.
Flash Code 10	Error when updating USB I/O Board to latest version.	Turn off game, wait 10 seconds, turn game on. If the problem persists call IT tech support.
Flash Code 11	Updated USB I/O Board was detected.	Turn off game, wait 10 seconds, turn game on. If the problem persists call IT tech support.
Flash Code 12	I/O Board is disconnected.	Make sure all connections are in place. Turn off game, wait 10 seconds, turn game on.
Flash Code 13	I/O Board malfunction.	Make sure all connections are in place. Turn off game, wait 10 seconds, turn game on.
Flash Code 14	Incompatible I/O Board.	Make sure all connections are in place. Turn off game, wait 10 seconds, turn game on.

Miscellaneous Problems

<i>Symptom</i>	<i>Probable Cause</i>	<i>Solution</i>
Unable to exit Operator Menus.	Dipswitch SW202 position 4 is in the on position.	Set position 4 of SW202 to off. Press start to exit.
	Test switch wired from the I/O board is closed.	Verify satellite test switch is not closed.
No fluorescent light	No 120 volts A.C. power going to the light fixture.	Verify A.C. voltage to the light fixture.
	Defective fluorescent light.	Replace fluorescent light.
	Defective starter	Replace the starter.
	Defective ballast.	Replace the ballast.
Coin Meter is not working	Defective Coin Meter	Replace with a known good one.
	Not wired properly	Connect one lead to +5 or +12 volts depending on device. The other lead to count 1 on the JAMMA connector.
	Defective I/O board	Replace with a known good board.

APPENDIX B

JAMMA, TRACKBALL, AND I/O POWER CONNECTIONS

For Standard Online Kit, Basic Offline Kit, and Deluxe Retrofit Kit.

JAMMA Harness Connection

SOLDER SIDE			PARTS SIDE		
WIRE COLOR	FUNCTION		FUNCTION	WIRE COLOR	
	*	2	1	*	
	*	4	3	*	
	*	6	5	*	
	*	8	7	*	
		10	9		
	*	12	11	*	e
KEY		14	13	KEY	
		16	15	Coin Counter 1	Red-Green
		18	17		
Yellow-Green	Left Speaker (-)	20	19	Left Speaker (+)	Yellow-Red
White-Green	Right Speaker (-)	22	21	Right Speaker (+)	White-Red
Green-Black	Video Green	24	23	Video Red	Red-Black
White	Video Sync	26	25	Video Blue	Blue-Black
Orange-Black	Service Button	28	27	Video GND	White-Black
		30	29	System Setup Button	Blue
Green-Red	Coin 2	32	31	Coin1	Red-Blue
		34	33	Start 1	Red-White
		36	35	Options Button	Green-White
		38	37	Help Button	Blue-White
		40	39	Spin Button	Black-White
		42	41	Flyby Button	Violet-White
		44	43	Turn Left Button	Brown-White
		46	45	Turn Right Button	Yellow-White
Orange-Yellow	Volume Down	48	47	Volume Up	Orange-White
		50	49	Coin 3 (Bill)	Gray-White
		52	51		
Black	GND	54	53	GND	Black
Black	GND	56	55	GND	Black

***NOTE: Power is NOT routed through the JAMMA connector.**

Trackball Harness Connector Pin Outs

I/O Board Connector	Trackball Connector
PIN WIRE #6 - Black	PIN WIRE #1 - Black
PIN WIRE #1 - Red	PIN WIRE #2 - Red
PIN WIRE #2 - Yellow	PIN WIRE #3 - Yellow
PIN WIRE #3 - Green	PIN WIRE #4 - Green
PIN WIRE #5 - Blue	PIN WIRE #5 - Blue
PIN WIRE #4 - Purple	PIN WIRE #6 - Purple

I/O Power Cable Pin Outs

Pin Number	Wire Color	Function
1	Yellow	+ 12 Volts DC
2	Black	Ground
3	Red	+ 5 Volts DC
4	Black	Ground

Control Panel XJ203 Connector Pin Outs

Pin	Color	Function
1	Green-White	Options
8	Blue-White	Help
10	Black	GND

Lamps J202 Connector Pin Outs

Pin	Color	Function
1	Red-Black	Lamp Power
5	Red-Yellow	Help Lamp
6	Red-Green	Options Lamp

APPENDIX C REPLACEMENT PART NUMBERS

Please refer to these IT part numbers when placing orders.

Deluxe Dedicated Cabinet Part Numbers

QTY	Description	Part Number
1	MANUAL, GOLF LIVE 2007	815000289
1	SYSTEM BOX, GOLF LIVE 2007	900000289
1	CABINET IDENTIFICATION DEVICE, GOLF LIVE C.I.D. (DONGLE)	900145003
1	IO BOARD ASSY, GOLF LIVE, DEDICATED WITH WIRELESS MODEM	900145002
2	ADAPTER, DVI TO VGA FOR VIDEO CARD	630000600
1	ANTENNA W/CABLE FOR WIRELESS SOCKET MODEM	510000900
1	BEZEL FOR GOLF LIVE, BLACK MOLDED FRONT PIECE	750250002
1	BILL VALIDATOR, MARS AE 2681	999000250
1	BUMPER, RUBBER, FOR CONTROL PANEL GOLF LIVE CAB.	753000250
1	BUTTON, PUSH, BLUE ROUND ILLUMINATED	861000022
1	BUTTON, PUSH, RED	850000001
4	BUTTON, PUSH, WHITE	850000003
1	BUTTON, PUSH, YELLOW ROUND ILLUMINATED	861000025
1	CABLE ASSY, AUDIO CABLE, 3 FT 2RCA PLUG TO 2RCA PLUG	915003285
1	CABLE ASSY, SVGA, 6 FT. DB15HD M-M	915000315
1	CABLE ASSY, TRACKBALL	915000173
2	CABLE ASSY, USB CABLE, 3 FT.	915003310
2	CABLE ASSY, USB CABLE, 6 FT.	915000310
1	CARD READER, USB	760007104
1	CASH VAULT ASSEMBLY, CASH VAULT ONLY	999000715
1	CASH VAULT SUB-ASSY, GT LIVE SECURITY DOOR W/CARD RDR & DBA	900938715
1	CONTROL PANEL PLEXI W/ART (GOLF LIVE)	845000250
1	DECAL SET, BEZEL, GOLF LIVE (IT/AAMA/GOLDEN TEE LOGOS)	830100250
1	DECAL SIDE, GOLF LIVE (SIDE LOGOS, CARD RDR STICKER)	830000250
1	LCD FLAT PANEL MONITOR, 15"	938000150
4	LEG LEVELER PLATE	999000110
4	LEG LEVELER WITH STOP NUT	999000120
1	MARQUEE, DIE CUT, GOLF LIVE 2007 FOR DEDICATED CABINET	820100289
	MONITOR CHASSIS, NEOTEC, 27" FLAT FOR GT LIVE	900270250
	MONITOR CHASSIS, WG/RCA, 27" FLAT FOR GT LIVE	900270500R
	MONITOR CHASSIS, WG/PHILLIPS, 27" FLAT FOR GT LIVE	900270500P
	MONITOR CHASSIS, KORTEK, 27" FLAT FOR GT LIVE	900270100
	MONITOR CHASSIS, MAKVISION, 27" FLAT FOR GT LIVE	900270200
1	PLATE MOUNTING FOR TRACKBALL	885000030
1	TOPPER, MOLDED MARQUEE HOUSING FOR DEDICATED GOLF LIVE	750250003
1	TOPPER, COMPLETE MARQUEE ASSEMBLY FOR DED. GOLF LIVE	900500250
1	TRACKBALL ASSY, 3" WHITE	880000030

Retrofit Kit Part Numbers

Please refer to these IT part numbers when placing orders.

Part Description	Part Number
Adapter, DVI to VGA	630000600
Antenna for wireless modem	510000900
Board assy., IO, GT LIVE Retrofit Kit, with wireless modem	900145001
Button assembly, Blue Round Illuminated, Push	861000022
Button assembly, Red, Push	850000001
Button assembly, White, Push	850000003
Button assembly, Yellow Round, Illuminated, Push	861000025
Cabinet Identification Device (C.I.D.) Assembly	900145003
Cable, Audio, 6 Ft.	915000285
Cable, Fan/Soft Power	915250203
Cable, IO board power	915250204
Cable, SVGA, 10Ft. Male/Male For LCD	915010310
Cable, SVGA, 6 Ft.Male/Male for monitor main	915000315
Cable, SVGA, Assembly, 18" M/F with Jack Screws	915000180
Cable, Trackball interconnect	915000173
Cable, USB, 6 FT	915000310
Card Reader	760007104
Control Panel Assembly, complete	900250903
Decals, Bezel set, GT LIVE	830100250
Decals, Side, GT LIVE	830000250
Fan Assembly	900000755
Fan Only	755000915
Fan Guard	755000220
Header with LCD sub-assembly, GT LIVE Retrofit kit	900100903
Header only for GT LIVE Retrofit kit, molded plastic	750250101
LCD, 15", GT LIVE	938000150
Leg Leveler Plate	999000110
Leg Leveler with stop nut	999000120
Manual, Golden Tee LIVE 2007	815000289
Marquee, GT LIVE	820100289
Quick Install Guide, Retrofit, GT LIVE	840250903
Retrofit Kit, Complete	903000289
System box, GT LIVE	900000289
Trackball Assembly, 3" white	880000030
Trackball Plate for 3" trackball assembly	885000030

Standard Online and Basic Offline Kit Part Numbers

Please refer to these IT part numbers when placing orders.

Part Number	Description
925000289	KIT – STANDARD ONLINE GOLF LIVE U.S.
925000289CP	KIT – STANDARD ONLINE GOLF LIVE U.S. W/ CONTROL PANEL
925100289	KIT - BASIC OFFLINE G-LIVE U.S.
925100289CP	KIT - BASIC OFFLINE G-LIVE U.S. W/ CONTROL PANEL
630000600	ADAPTER, DVI TO VGA
750250201	ANTENNA COVER W/VELCRO
510000900	ANTENNA W/CABLE FOR WIRELESS SOCKET MODEM
900910050	BAG SUB-ASSEMBLY, ANTENNA KIT
900000755	BAG SUB-ASSY, COOLING FAN KIT
900250040	BAG SUB-ASSY, GOLF LIVE KIT
900250030	BAG SUB ASSY, GOLF LIVE KIT W/ CONTROL PANEL
900145003	BOARD ASSY, C.I.D., GOLF LIVE
900000014	BOARD ASSY, I/O, KIT GOLF LIVE, OFFLINE
900145001	BOARD ASSY, I/O, KIT GOLF LIVE U.S.WITH WIRELESS MODEM MODULE
980000265	BOX, SYSTEM BOX KIT
752259500	BRACKET, CHASSIS FILTER W/3M
915250302	CABLE ASSEMBLY, HELP OPTION CONTROL PANEL SWITCH CABLE
915250203	CABLE ASSY, FAN/SOFT POWER
915250204	CABLE ASSY, I/O PWR/KIT,G-LIVE
915000315	CABLE ASSY, SVGA, 6 FT.
915000173	CABLE ASSY, TRACKBALL/GUN INTERFACE
900265050	CABLE BAG SUB-ASSY/SYSTEM BOX
999000060	CARD READER BLANKING PLATE
900007104	CARD READER SUB-ASSEMBLY, USB WITH BEZEL AND HARDWARE
825100250	CONTROL PNL, GOLF LIVE, DIECUT WITH CONTROL LABELS/TB HOLE
755000220	FAN GUARD FOR 92mm CABINET FAN
755000915	FAN, COOLING – CABINET FAN
753000500	FILTER FOR SYSTEM BOX
915000234	GROUND WIRE ASSEMBLY
815000289	MANUAL, GOLF LIVE 2007
820000289	MARQUEE, GOLF LIVE 2007
820100289	MARQUEE, GOLF LIVE BASIC OFFLINE
840000250	PROMO INSERT GRAPHIC, GOLDENTEE.COM
850000001	PUSHBUTTON ASSY, RED WITH VERTICAL MOUNTED SWITCH
850000003	PUSHBUTTON ASSY, WHITE WITH VERTICAL MOUNTED SWITCH
861000022	PUSHBUTTON, BLUE ROUND ILLUM. W/SWITCH AND LED
861000025	PUSHBUTTON, YELLOW ROUND ILLUM W/SWITCH AND LED
840250100	QUICK INSTALL, GOLF LIVE KIT
830000250	SIDE DECAL, GOLF LIVE (SIDE LOGOS, CARD READER STICKER)
900000289	SYSTEM BOX, GOLF LIVE 2007
880000030	TRACKBALL ASSY, 3" WHITE
885000030	TRACKBALL PLATE FOR 3" TRACKBL (WITH STANDOFFS)

APPENDIX D SYSTEM DIAGRAMS

Nighthawk Chassis Diagram

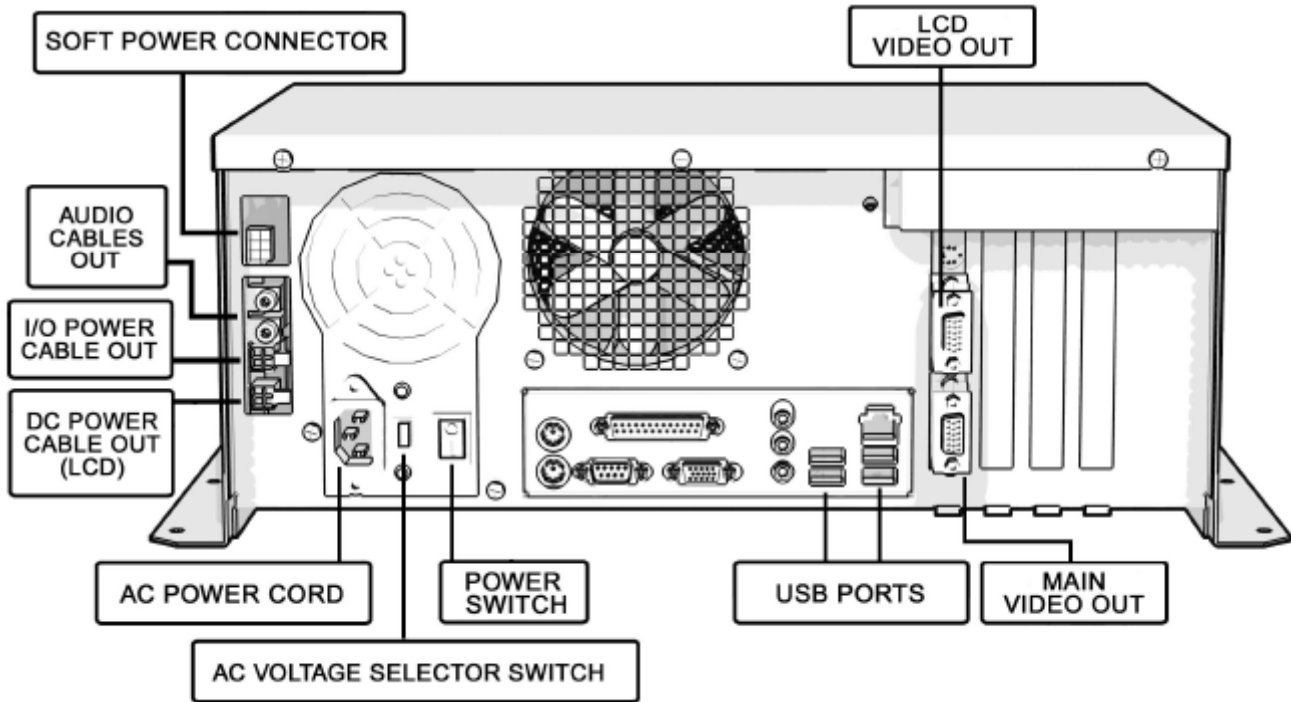

Video and I/O Dip Switch Settings

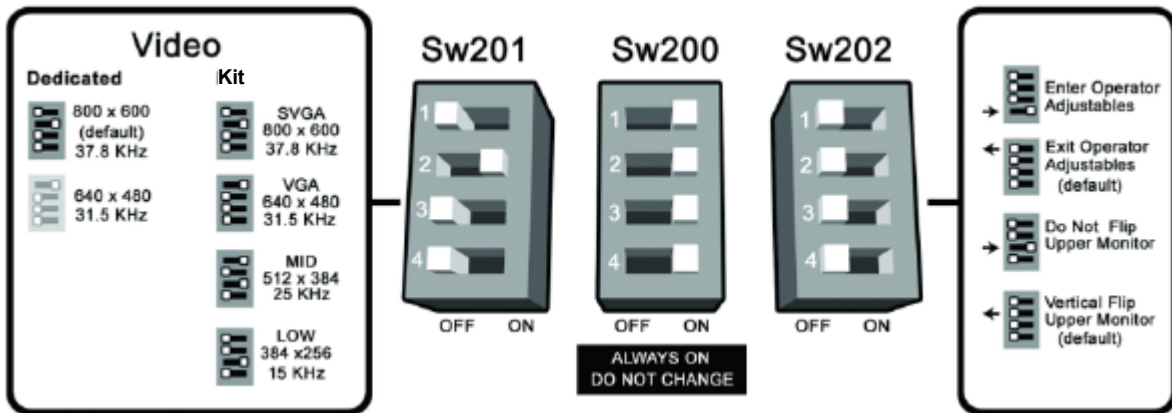

Deluxe Dedicated I/O Board Diagram

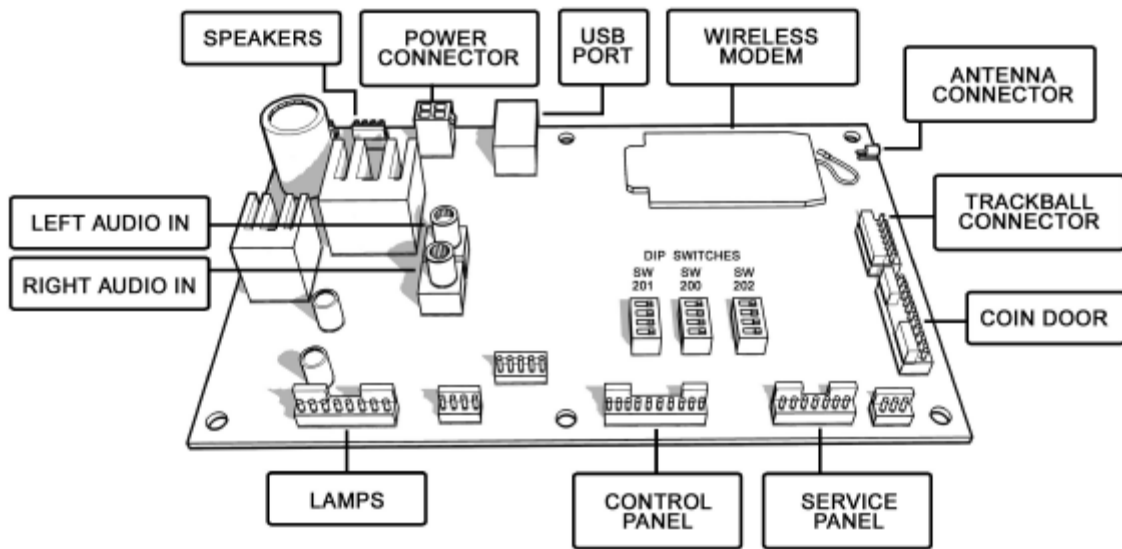

Deluxe Retrofit Kit, Standard Online Kit and Basic Offline Kit I/O Board Diagram

Note: Some elements are not available on I/O boards for Basic Offline Kits.

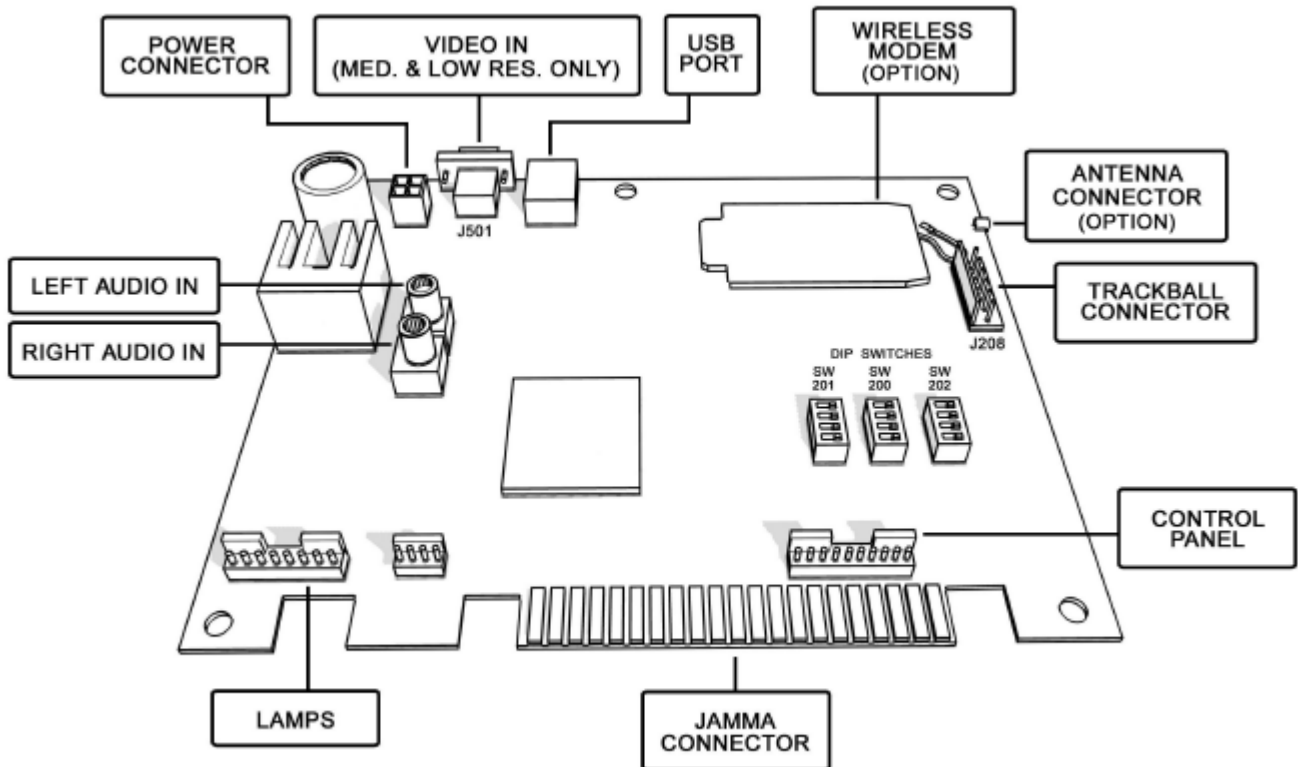

Detailed Cable Connection Diagram

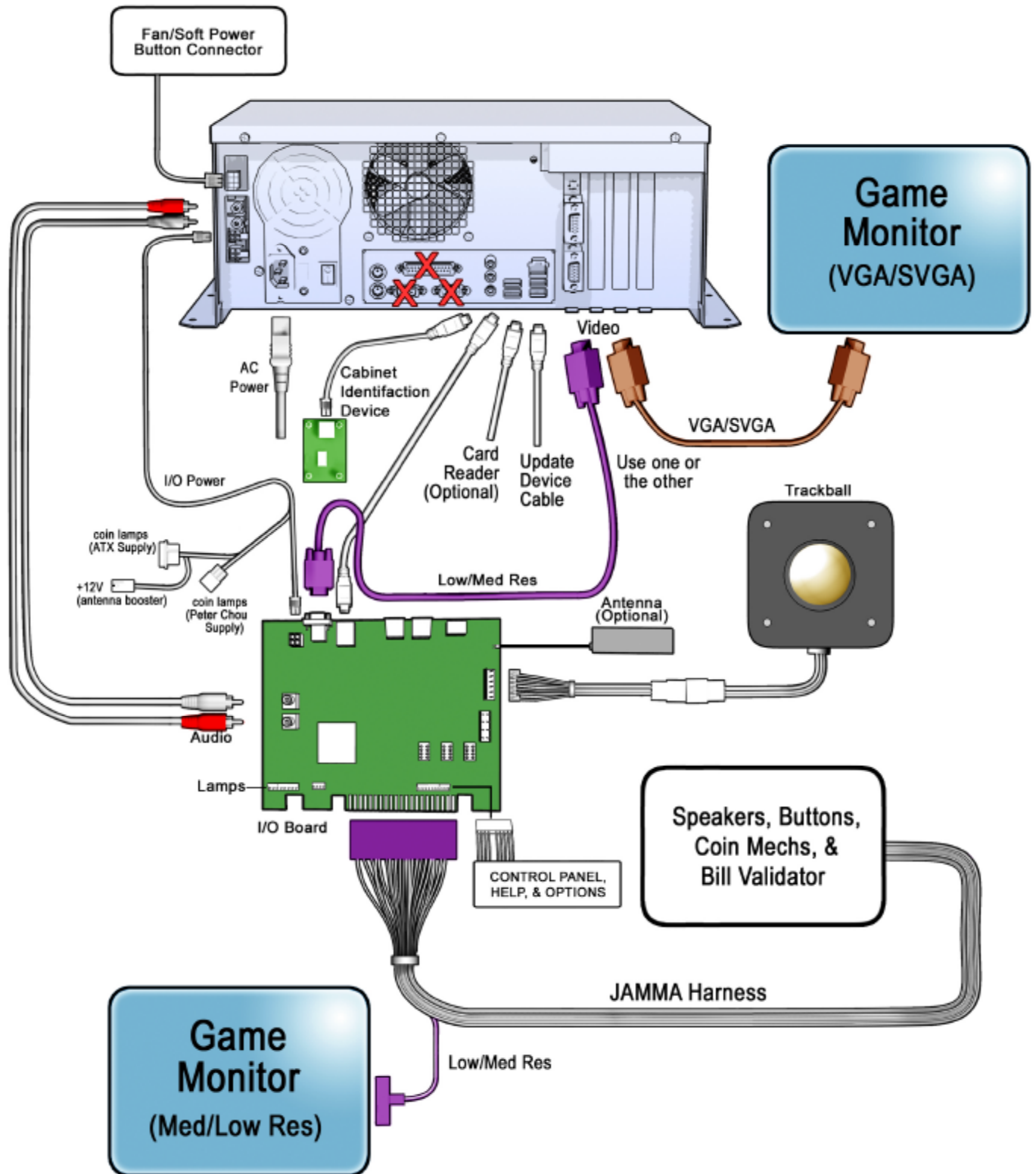

Deluxe Dedicated Cabinet Wiring Diagram

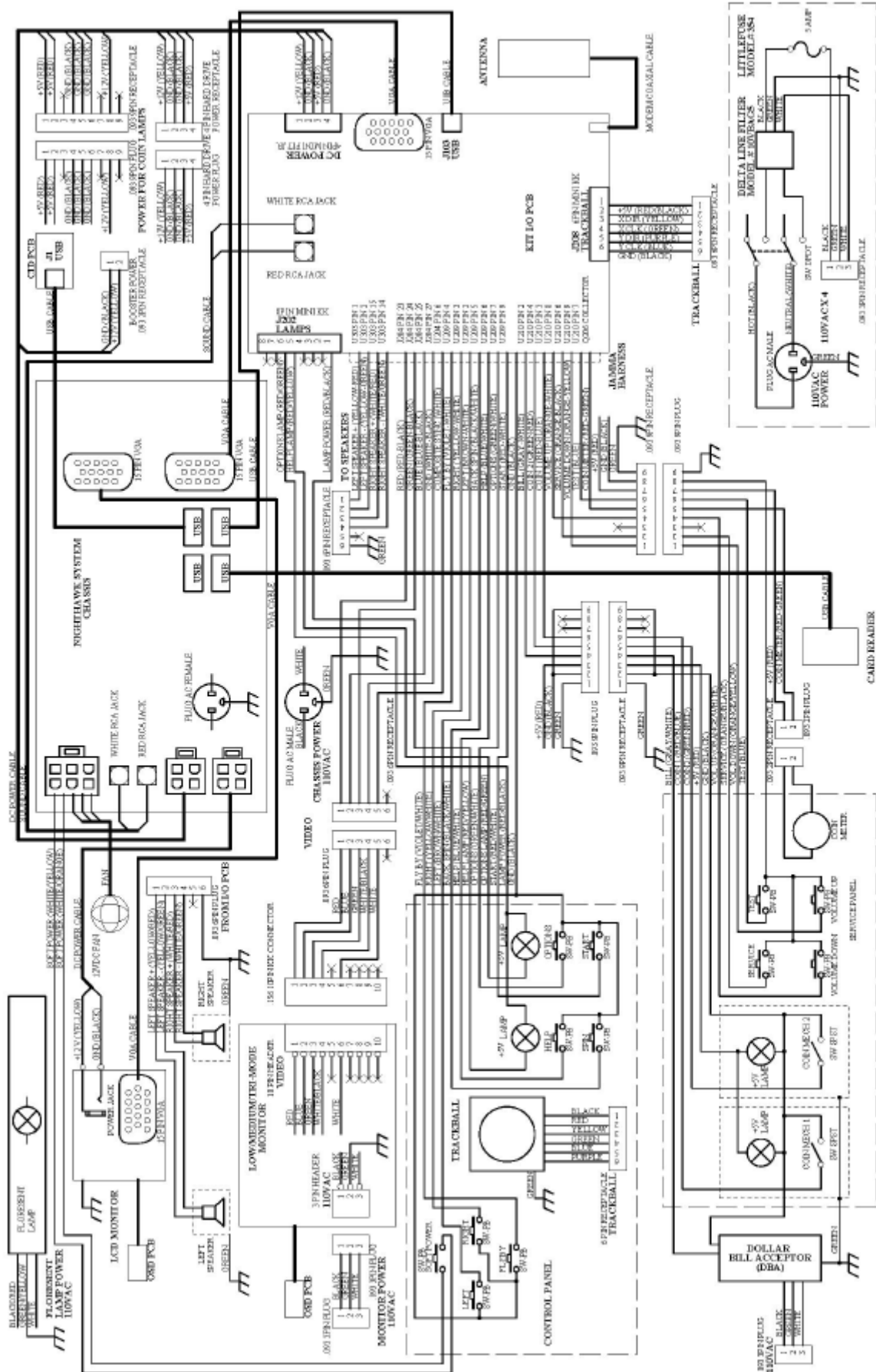

Golder

Deluxe Retrofit Kit Wiring Diagram

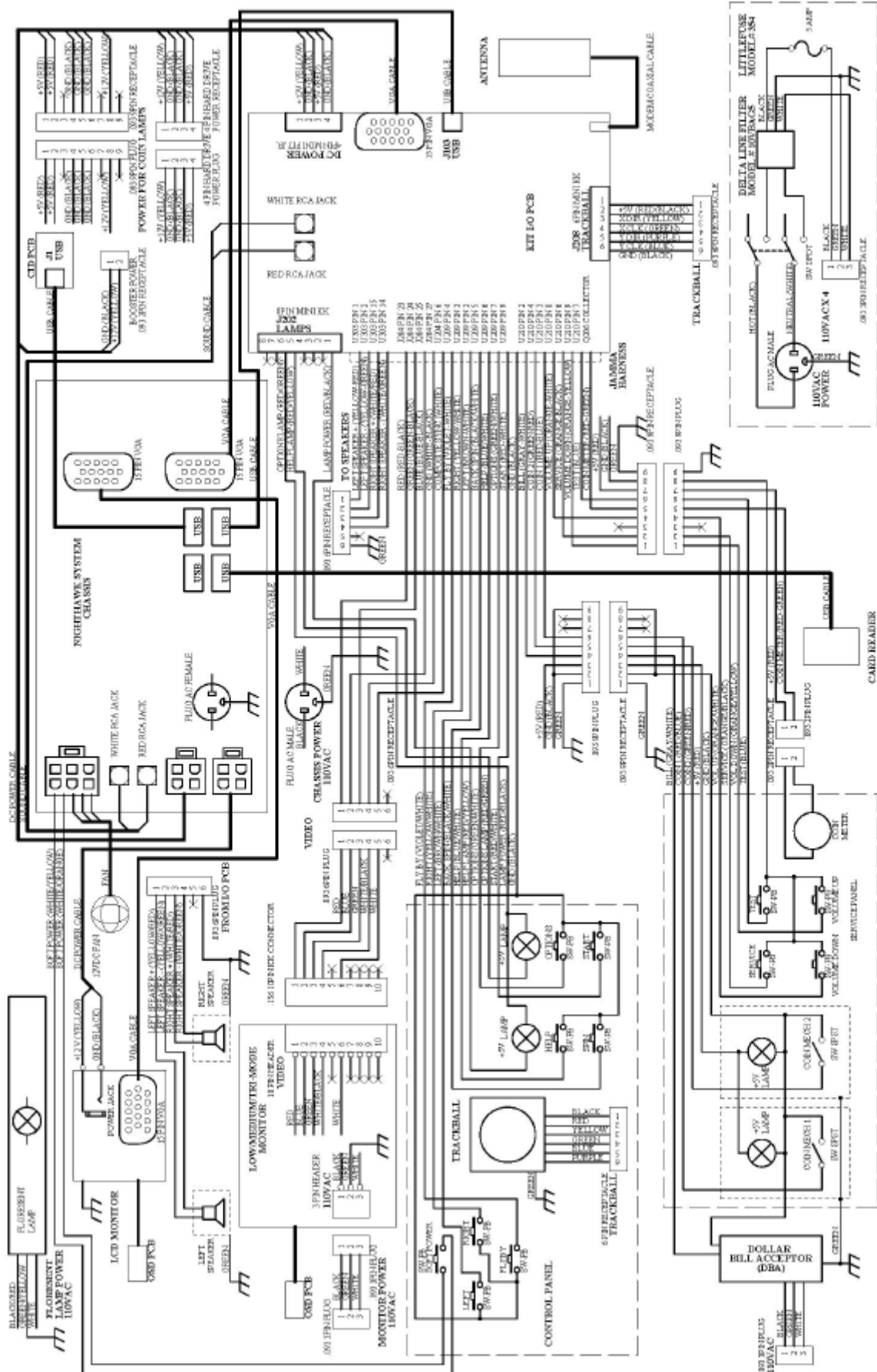

Standard Online and Basic Offline Kit Wiring Diagram

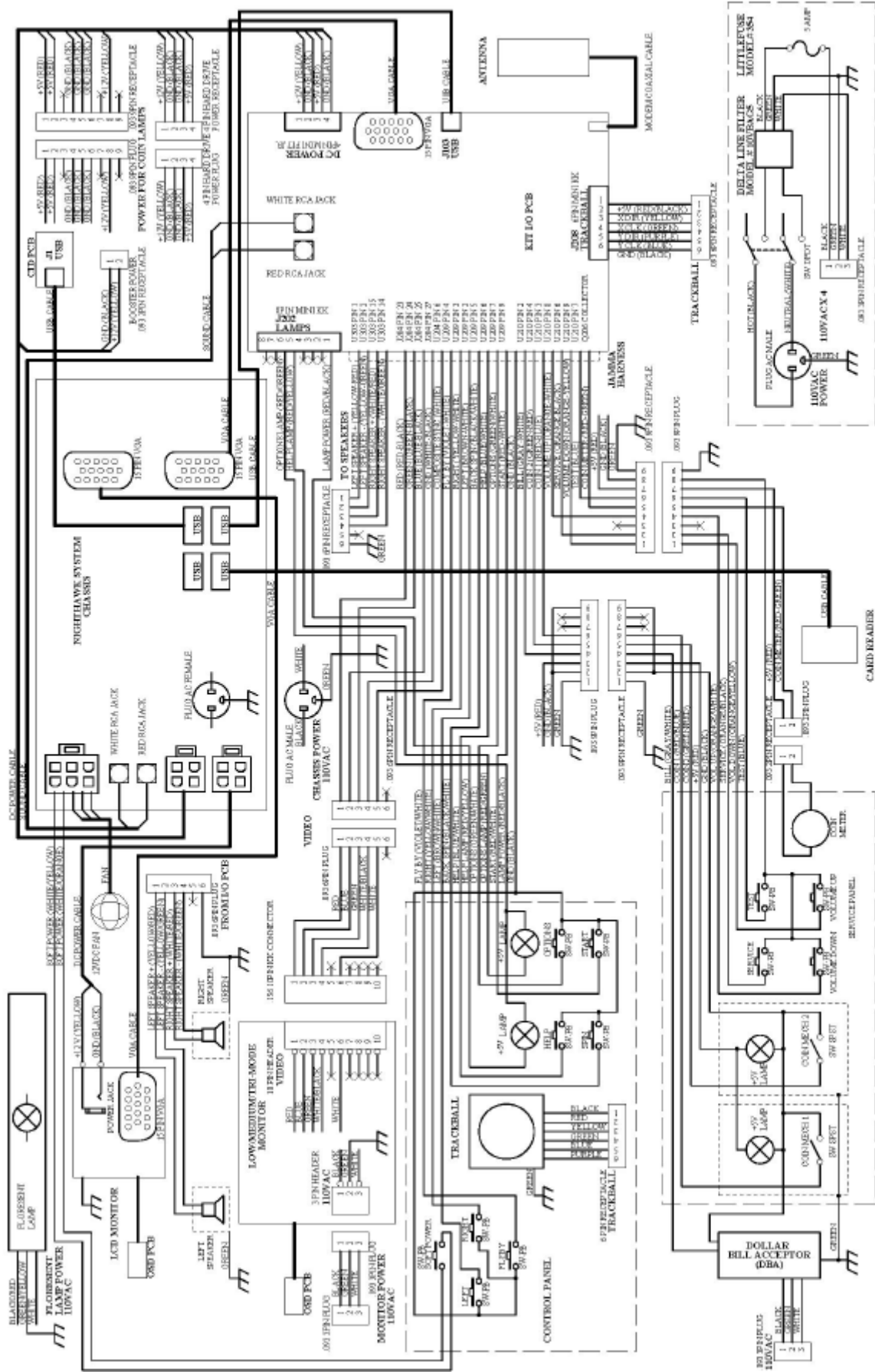

APPENDIX E

GNU GENERAL PUBLIC LICENSE

TERMS AND CONDITIONS FOR COPYING, DISTRIBUTION AND MODIFICATION

0. This License applies to any program or other work which contains a notice placed by the copyright holder saying it may be distributed under the terms of this General Public License. The "Program", below, refers to any such program or work, and a "work based on the Program" means either the Program or any derivative work under copyright law: that is to say, a work containing the Program or a portion of it, either verbatim or with modifications and/or translated into another language. (Hereinafter, translation is included without limitation in the term "modification".) Each licensee is addressed as "you".

Activities other than copying, distribution and modification are not covered by this License; they are outside its scope. The act of running the Program is not restricted, and the output from the Program is covered only if its contents constitute a work based on the Program (independent of having been made by running the Program). Whether that is true depends on what the Program does.

1. You may copy and distribute verbatim copies of the Program's source code as you receive it, in any medium, provided that you conspicuously and appropriately publish on each copy an appropriate copyright notice and disclaimer of warranty; keep intact all the notices that refer to this License and to the absence of any warranty; and give any other recipients of the Program a copy of this License along with the Program.

You may charge a fee for the physical act of transferring a copy, and you may at your option offer warranty protection in exchange for a fee.

2. You may modify your copy or copies of the Program or any portion of it, thus forming a work based on the Program, and copy and distribute such modifications or work under the terms of Section 1 above, provided that you also meet all of these conditions:

a) You must cause the modified files to carry prominent notices stating that you changed the files and the date of any change.

b) You must cause any work that you distribute or publish, that in whole or in part contains or is derived from the Program or any part thereof, to be licensed as a whole at no charge to all third parties under the terms of this License.

c) If the modified program normally reads commands interactively when run, you must cause it, when started running for such interactive use in the most ordinary way, to print or display an announcement including an appropriate copyright notice and a notice that there is no warranty (or else, saying that you provide a warranty) and that users may redistribute the program under these conditions, and telling the user how to view a copy of this License. (Exception: if the Program itself is interactive but does not normally print such an announcement, your work based on the Program is not required to print an announcement.) These requirements apply to the modified work as a whole. If identifiable sections of that work are not derived from the Program, and can be reasonably considered independent and separate works in themselves, then this License, and its terms, do not apply to those sections when you distribute them as separate works. But when you distribute the same sections as part of a whole which is a work based on the Program, the distribution of the whole must be on the terms of this License, whose permissions for other licensees extend to the entire whole, and thus to each and every part regardless of who wrote it.

Thus, it is not the intent of this section to claim rights or contest your rights to work written entirely by you; rather, the intent is to exercise the right to control the distribution of derivative or collective works based on the Program.

In addition, mere aggregation of another work not based on the Program with the Program (or with a work based on the Program) on a volume of a storage or distribution medium does not bring the other work under the scope of this License.

3. You may copy and distribute the Program (or a work based on it, under Section 2) in object code or executable form under the terms of Sections 1 and 2 above provided that you also do one of the following:

a) Accompany it with the complete corresponding machine-readable source code, which must be distributed under the terms of Sections 1 and 2 above on a medium customarily used for software interchange; or,

b) Accompany it with a written offer, valid for at least three years, to give any third party, for a charge no more than your cost of physically performing source distribution, a complete machine-readable copy of the corresponding source code, to be distributed under the terms of Sections 1 and 2 above on a medium customarily used for software interchange; or,

c) Accompany it with the information you received as to the offer to distribute corresponding source code. (This alternative is allowed only for noncommercial distribution and only if you received the program in object code or executable form with such an offer, in accord with Subsection b above.)

The source code for a work means the preferred form of the work for making modifications to it. For an executable work, complete source code means all the source code for all modules it contains, plus any associated interface definition files, plus the scripts used to control compilation and installation of the executable. However, as a special exception, the source code distributed need not include anything that is normally distributed (in either source or binary form) with the major components (compiler, kernel, and so on) of the operating system on which the executable runs, unless that component itself accompanies the executable.

If distribution of executable or object code is made by offering access to copy from a designated place, then offering equivalent access to copy the source code from the same place counts as distribution of the source code, even though third parties are not compelled to copy the source along with the object code.

4. You may not copy, modify, sublicense, or distribute the Program except as expressly provided under this License. Any attempt otherwise to copy, modify, sublicense or distribute the Program is void, and will automatically terminate your rights under this License. However, parties who have received copies, or rights, from you under this License will not have their licenses terminated so long as such parties remain in full compliance.

5. You are not required to accept this License, since you have not signed it. However, nothing else grants you permission to modify or distribute the Program or its derivative works. These actions are prohibited by law if you do not accept this License. Therefore, by modifying or distributing the Program (or any work based on the Program), you indicate your acceptance of this License to do so, and all its terms and conditions for copying, distributing or modifying the Program or works based on it.

6. Each time you redistribute the Program (or any work based on the Program), the recipient automatically receives a license from the original licensor to copy, distribute or modify the Program subject to these terms and conditions. You may not impose any further restrictions on the recipients' exercise of the rights granted herein. You are not responsible for enforcing compliance by third parties to this License.

7. If, as a consequence of a court judgment or allegation of patent infringement or for any other reason (not limited to patent issues), conditions are imposed on you (whether by court order, agreement or otherwise) that contradict the conditions of this License, they do not excuse you from the conditions of this License. If you cannot distribute so as to satisfy simultaneously your obligations under this License and any other pertinent obligations, then as a consequence you may not distribute the Program at all. For example, if a patent license would not

permit royalty-free redistribution of the Program by all those who receive copies directly or indirectly through you, then the only way you could satisfy both it and this License would be to refrain entirely from distribution of the Program.

If any portion of this section is held invalid or unenforceable under any particular circumstance, the balance of the section is intended to apply and the section as a whole is intended to apply in other circumstances.

It is not the purpose of this section to induce you to infringe any patents or other property right claims or to contest validity of any such claims; this section has the sole purpose of protecting the integrity of the free software distribution system, which is implemented by public license practices. Many people have made generous contributions to the wide range of software distributed through that system in reliance on consistent application of that system; it is up to the author/donor to decide if he or she is willing to distribute software through any other system and a licensee cannot impose that choice.

This section is intended to make thoroughly clear what is believed to be a consequence of the rest of this License.

8. If the distribution and/or use of the Program is restricted in certain countries either by patents or by copyrighted interfaces, the original copyright holder who places the Program under this License may add an explicit geographical distribution limitation excluding those countries, so that distribution is permitted only in or among countries not thus excluded.

In such case, this License incorporates the limitation as if written in the body of this License.

9. The Free Software Foundation may publish revised and/or new versions of the General Public License from time to time. Such new versions will be similar in spirit to the present version, but may differ in detail to address new problems or concerns.

Each version is given a distinguishing version number. If the Program specifies a version number of this License which applies to it and "any later version", you have the option of following the terms and conditions either of that version or of any later version published by the Free Software Foundation. If the Program does not specify a version number of this License, you may choose any version ever published by the Free Software Foundation.

10. If you wish to incorporate parts of the Program into other free programs whose distribution conditions are different, write to the author to ask for permission. For software which is copyrighted by the Free Software Foundation, write to the Free Software Foundation; we sometimes make exceptions for this. Our decision will be guided by the two goals of preserving the free status of all derivatives of our free software and of promoting the sharing and reuse of software generally.

NO WARRANTY

11. BECAUSE THE PROGRAM IS LICENSED FREE OF CHARGE; THERE IS NO WARRANTY FOR THE PROGRAM, TO THE EXTENT PERMITTED BY APPLICABLE LAW. EXCEPT WHEN OTHERWISE STATED IN WRITING THE COPYRIGHT HOLDERS AND/OR OTHER PARTIES PROVIDE THE PROGRAM "AS IS" WITHOUT WARRANTY OF ANY KIND, EITHER EXPRESSED OR IMPLIED, INCLUDING, BUT NOT LIMITED TO, THE IMPLIED WARRANTIES OF MERCHANTABILITY AND FITNESS FOR A PARTICULAR PURPOSE. THE ENTIRE RISK AS TO THE QUALITY AND PERFORMANCE OF THE PROGRAM IS WITH YOU. SHOULD THE PROGRAM PROVE DEFECTIVE, YOU ASSUME THE COST OF ALL NECESSARY SERVICING, REPAIR OR CORRECTION.

12. IN NO EVENT UNLESS REQUIRED BY APPLICABLE LAW OR AGREED TO IN WRITING WILL ANY COPYRIGHT HOLDER, OR ANY OTHER PARTY WHO MAY MODIFY AND/OR REDISTRIBUTE THE PROGRAM AS PERMITTED ABOVE, BE LIABLE TO YOU FOR DAMAGES, INCLUDING ANY GENERAL, SPECIAL, INCIDENTAL OR CONSEQUENTIAL DAMAGES ARISING OUT OF THE USE OR INABILITY TO USE THE PROGRAM (INCLUDING BUT NOT LIMITED TO LOSS OF DATA OR DATA BEING RENDERED INACCURATE OR LOSSES SUSTAINED BY YOU OR THIRD PARTIES OR A FAILURE OF THE PROGRAM TO OPERATE WITH ANY OTHER PROGRAMS), EVEN IF SUCH HOLDER OR OTHER PARTY HAS BEEN ADVISED OF THE POSSIBILITY OF SUCH DAMAGES.

How to Apply These Terms to Your New Programs If you develop a new program, and you want it to be of the greatest possible use to the public, the best way to achieve this is to make it free software which everyone can redistribute and change under these terms.

To do so, attach the following notices to the program. It is safest to attach them to the start of each source file to most effectively convey the exclusion of warranty; and each file should have at least the "copyright"

line and a pointer to where the full notice is found.

One line to give the program's name and an idea of what it does.

Copyright (C) yyyy name of author

This program is free software; you can redistribute it and/or modify it under the terms of the GNU General Public License as published by the Free Software Foundation; either version 2 of the License, or (at your option) any later version.

This program is distributed in the hope that it will be useful, but WITHOUT ANY WARRANTY; without even the implied warranty of MERCHANTABILITY or FITNESS FOR A PARTICULAR PURPOSE. See the GNU General Public License for more details.

You should have received a copy of the GNU General Public License along with this program; if not, write to the Free Software Foundation, Inc., 59 Temple Place - Suite 330, Boston, MA 02111-1307, USA.

Copyright 2004 Incredible Technologies, Inc. (IT). Certain programs, identified at IT's Website are free software subject to an associated license.

1. Because certain programs are licensed free of charge, see it's website, there is no warranty for such programs to the extent permitted by applicable law. Except when otherwise stated in writing the copyright holders and/or other parties provide those programs "as is" without warranty of any kind, either expressed or implied, including, but not limited to, the implied warranties of merchantability and fitness for a particular purpose. The entire risk as to the quality and performance of those programs is with you. Should the programs prove defective, you assume the cost of all necessary servicing, repair or correction.

2. In no event unless required by applicable law or agreed to in writing will any copyright holder, or any other party who may modify and/or redistribute those programs be liable to you for damages including any general, special, incidental or consequential damages arising out of the use or inability to use those programs (including but not limited to loss of data or data being rendered inaccurate or losses sustained by you or third parties or a failure of those programs to operate with any other programs), even if such holder or other party has been advised of the possibility of such damages.

A complete machine-readable copy of the source code of those programs and associated license is available to any third party, at the it website.

APPENDIX F INFORMATIONAL GUIDES

WIRELESS SIGNAL STRENGTH AND ANTENNA GUIDE

Understanding the basics of wireless antennas and the wireless frequency can help to improve your game's signal strength and reliability.

In a perfect world the tower antenna and the machine's antenna are in perfect phase with one another, and close enough in proximity that the strength is very good. In the real world the environment will change the phase of the signal and reduce its strength. Buildings, walls, metal or concrete, and even cars outside can affect the wireless signal. Basically, everything between the tower and the game will have some sort of affect.

The Antenna in Golden Tee LIVE is designed to "see" the wireless signal equally from any direction. However, because objects in the machine's surroundings can affect the signal, the antenna may accept a better signal if it is positioned a few inches from where it originally was, or possibly even rotated 180 degrees. There is no exact science to finding the optimal signal, so some locations may require some testing to get the best possible results.

When testing the wireless signal strength, go to *ITNet Settings/Communication Settings* in the System Setup menus. Use tape or Velcro to temporarily position the antenna into a new location, and let it settle for at least 30 seconds. Note the antenna's current position, and signal strength reading on the screen. Then try another location or orientation and note the results. The best location for the antenna can usually be found using this procedure. Once you find the optimal spot, affix the antenna using the supplied mounting bracket so it stays in place. Remember that fewer obstacles between the antenna and the tower is your goal, and often that means that height is not always better.

A signal reading of 20 is good as long as there are not large or noticeable shifts in the signal strength. A signal reading of 25 to 50 is very good. A great signal is anything above 50. Each location is different, and these characteristics can often change if the surroundings change. It is a very good idea to check the signal strength test with every collection, to see if you are continuing to get the optimal signal position.

An Antenna signal booster can easily be installed if good signal strength can't be obtained. The Incredible Technologies part number is 900100510, "Booster Kit for Antenna". Call Technical Support for more information.

COLLECTIONS GUIDE

Golden Tee LIVE is a revolutionary product that requires some special handling when making a collection. Follow these steps every time you make a collection to make sure your profits and payments are managed properly.

Step 1: Collect your Cash Box

Open the coin vault and collect the cash and bills. Count it carefully and note the total.

Step 2: Review the Collection Screen

Remember that there are various fees and charges associated with some Golden Tee LIVE features, so it is important to compare the total cash you collect to the Collection Screen in the game. Open the outer door of the cash vault and press the System Setup button to enter the System Setup Menus. Select **Collections and Earnings**, and then **Do Collection**. The machine will attempt to contact ITNet for complete and updated data.

If an error occurs, back out of the collection menus and try the process again. If the machine is unable to contact ITNet, an estimated collection will be presented. This estimate will be close to accurate, and should allow you to complete the collection. Any discrepancies will be reconciled once the machine is able to connect properly.

This process takes you to the main collection screen. You should familiarize yourself with this screen, and how the information is displayed. These figures will help you determine how much to give to the location.

Note the date range and number of days in operation. If used properly, these fields should match with your collection dates. They are also important for calculating some of the various monthly fees.

Actual Collection	
Days In Operation:	12
Total Income:	\$ 395.75
Total Fees:	\$ 108.35
Balance:	\$ 287.40
Operator Portion of Balance:	\$ 183.90
Operator Owes Location:	\$ 103.50

Review the **Total Income** and **Total Fees** columns to see how much money your machine made for this time period, and how much is owed for various fees for this time period.

Total Income includes income from Cash, Player Accounts, Credit Card purchases, and various Promotional or Gift Cards. Note that games paid by anything other than cash will NOT be in your cashbox, and will instead be credited to you on your ITNet statement. **THIS MEANS THAT YOUR CASHBOX WILL NOT MATCH YOUR TOTAL INCOME.** Select **More Details** to view a breakdown of cash, player account, and credit card income.

To verify the Operator and Location portions, first divide Total Income by the correct split percentage to get the operator and location portions of income. Then divide Total Fees by its split percentage to get both portions of the fees. Then subtract each fee portion from the income portion to get the final operator and location portions.

Total Fees include ITNet fees, money for the Prize Fund, Communication fees, Credit Card fees, Software Update fees and Hardware Upgrade fees. Note that Software Update Fees and Hardware Update Fees are included for your convenience, to help you cover the costs of owning and operating your equipment. These two line items are NOT included on your monthly ITNet statement, but give you a great opportunity to split some of these costs with the location. The **Balance** column displays the Total Income minus the Total Fees, giving you a realistic total of income for this time period.

Step 3: Pay the Location

Operator Portion of Balance is the amount of the collection that you keep. Operator Owes Location is the amount of the collection that you pay your location. These amounts are determined by the split percentages set in the Collection Settings menus. See the reverse side for details on reviewing and adjusting these settings. In some extreme cases, there may not be enough money in the cash box to cover the location portion. **It is highly recommended that you do your best to pay the location at the time of the collection, as any missing funds will be reconciled during the monthly ITNet billing.**

Step 4: Reset the Collection Screen

It is highly recommended that you reset these audit screens after every collection. When you have finished reviewing the information, highlight **Do Collection and Exit** and press Start. This will set all of the fields in the **Do Collection** screen to zero. Be sure to empty your cash box at the same time, so these screens will match the money at your next collection.

INCOME SPLIT GUIDE

Golden Tee LIVE is a revolutionary product that offers a variety of ways to pay for game play, including credit cards, player accounts and gift cards. There are also some fees associated with the operation of Golden Tee LIVE. The operator/location split on many of these income and fee settings can be individually adjusted, allowing you to fine tune your costs and maximize your profits.

To access the Collection Settings menus, open the outer door of the cash vault and press the System Setup button to enter the System Setup Menus. Select **General Settings**, then **Operator Adjustables**, then **Collection Settings**. The four available categories are: Hardware Update Fee, Income Splits, Fee Splits, and Tax Settings.

Hardware Update Fee

This menu allows you to adjust the Hardware Update Fee. This fee is included for your convenience, as a method to have the location pay for part of your equipment. As of version 2.00, the default value is \$0.00 per week. Use this menu to adjust this value up or down. The weekly amount will be calculated on a per day basis, and added in to the **Total Fees** field on the **Do Collection** screen. Note that the Hardware Update Fee is included for your convenience, and is NOT included on your monthly ITNet statement.

Operator/Location Income Splits

Use this menu to fine-tune your splits for income generated from Cash, Player Account, Credit Card, ITNet Money Card, and Operator Money Card payments. Since there may be times when you have to pay the location before you actually have the cash in hand, you may want to adjust the split in your favor to cover the waiting period. The default settings are displayed on the accompanying screen.

	Operator %	Location %
Cash	60%	40%
Player Account	70%	30%
Credit Card	70%	30%
ITNET Money Card	70%	30%
Operator Money Card	100%	0%

Operator/Location Fee Splits

Use this menu to determine how you wish to split the various fees associated with Golden Tee LIVE, including ITNet Fees, Prize Fund Fees, Credit Card Fees, Communication Fees, Software Update Fees and Hardware Update Fees. The location is benefiting from your game by increasing food and beverage sales and creating loyal patrons. Setting some of these splits in your favor will help you to cover your costs in a fair and equitable manner. The default settings are displayed on the accompanying screen.

	Operator %	Location %
ITNet Fees	50%	50%
Prize Fund Fees	50%	50%
Credit Card Fees	50%	50%
Communication Fees	50%	50%
Software Update Fees	50%	50%
Hardware Update Fees	50%	50%

Tax Settings

Many states require special taxes or license fees that affect your bottom line. Use this menu to account for these costs in your collection.

In these menus, you can set the **Tax Rate** percentage, the **Tax Type**, meaning what part of the collection is taxed and who pays for these taxes, and the **Tax Split** for how to share these fees with your location.

Incredible Technologies hopes that you will take advantage of these menu to maximize your earnings potential.

PLAYER ACCOUNTS GUIDE

Golden Tee LIVE offers a revolutionary Play for Prizes contest format that allows players from all over the world to compete for cash with every game they play. In most cases, prizes are awarded immediately following the completion of each contest, via a credit to special ITNet Player Accounts.

These Player Accounts are available to the individual players right on a Golden Tee LIVE machine. That means that the players can easily use their winnings to play more games of Golden Tee LIVE. Now, instead of getting a check in the mail and spending the winnings away from the game or location, the majority of players are using their winnings to play more Golden Tee LIVE games, thus putting their winnings right back into the machine. This is a huge benefit to both the location and operator, because it keeps people in their seats, eating and drinking and playing Golden Tee. Operators can look at this reinvestment as found money, and a brand new source of revenue.

When a player pays for his game using his Player Account, he is not putting cash directly into the coin box. This means that the game revenue in a normal collection cycle will typically exceed the actual cash in the game. Therefore it is very important to familiarize yourself with the Golden Tee LIVE collection menus and procedures, and your monthly ITNet billing statement.

When the player uses this Player Account money to play more Golden Tee, ITNet credits the full amount to the appropriate operator. These credits will appear on your regular monthly ITNet statement, and will mean a lower ITNet bill, or sometimes even a credit to your bank account!

You are encouraged to pay the location portion in full at each collection, to avoid additional accounting on your part. While there might be a delay before you get your money back from ITNet, it will simplify the process immensely if you can manage the location up front. The operator/location split percentage has been set in your favor at 70/30 for Player Account income, since you must wait for your portion. Use this as a selling tool to adjust the collection in your favor.

The Collection Menu on Golden Tee LIVE details the various income sources for your review. You are encouraged to spend some time with these screens so you understand where your revenue is being generated. You should also log in regularly to your Operator Services account on itsgames.com, to check on the performance of your equipment and check to see if the cash in the cash box will be enough to cover the split with your location.

- ◆ Skill based Play for Prizes adds an additional revenue source with huge potential
- ◆ Winners are encouraged to reinvest their winnings back to Golden Tee LIVE
- ◆ Entry Fees and Player Account Play must be collected and distributed by ITNet first
- ◆ The Player Account default split percentage is factory set to the operator's advantage
- ◆ Use the Collection Screen to set aside the various game fees, including Prize Pool money, and determine the location split
- ◆ Pay the location portion at the time of collection if at all possible
- ◆ Each month ITNet will issue a credit to your bill for Player Account activity on your machines.
- ◆ In some cases this additional revenue and resulting credit will cover or surpass your fees, in which case ITNet will credit your bank account.

GOLDEN TEE LIVE REVENUE GUIDE

Revenue Types –With GT LIVE, cash is now not your only source of income. You can't just count up the cash, deduct the fees and split the rest. Players can now play games with cash as well as 5 other revenue types. The different types of revenue are:

- Cash
- Player Account
- Credit Cards
- IT Gift cards
- Operator gift cards
- Operator free cash

Cash – Is just that; coin and currency. This is the only revenue that will appear on your hard meter, since it is counting physical pulses from the coin mechs and bill validator.

Player Account – This is the revenue earned when a player plays games with their “Play for Prizes” winnings. Players can still request a check for their winnings on the IT website, but most are rolling it right back into your game.

Credit Cards – This is revenue earned when a player pays by credit or debit card. GT LIVE currently accepts Visa and MasterCard.

IT Gift Cards – This is revenue earned when a player swipes his gift card to pay for a game. IT Gift cards are purchased through us directly and shipped either to the purchaser or the recipient of the gift. This is similar to a Wal-Mart or Best Buy gift card.

Operator gift cards – These are cards you can purchase for the cost of the plastic. You request whatever denomination you want. We will print the cards with your logo and artwork. You can give these out for promotions or refunds. Players will only be able to use them on machines registered to your account.

Operator free cash – This is the dollar value of games played using Operator free cash. These are credits you can put on your game for free play. This is intended for use if you want to test a game or set up a certain dollar amount of free play for promotional purposes, such as an open house.

ACCOUNTING FOR THE VARIOUS REVENUE TYPES

Cash – The GT Live machines are factory set to give you 60% and the location 40% of the cash.

Player account, Credit card and IT Gift revenue - Since this is revenue to you, but you do not have the cash in hand at the point of collection, you will get your money on your ITNet billing statement as a credit in a column titled “Due from IT.” You'll need to pay your location on collection day and wait to receive this revenue until your next statement, so you are basically fronting this revenue type to your locations. Because of this, the machines are factory set to give you 70% of this revenue and the location 30%. That extra 10% of the cash split that you're taking will help cover the 30% you're fronting.

Operator gift cards and Operator free cash – Operator gift cards and Operator free cash are a way to promote your GT Live without splitting this “Revenue” with your locations. This is accounted like non-revenue or free play. This revenue is set to give you 100% and the location 0%. Please note that any fees incurred from this revenue still apply.

Please note all the revenue and fee settings can be changed to whatever split percentage you want, for each type of revenue source.

GOLDEN TEE LIVE FEES

Fee Types – The 6 different fee types are as follows:

- ITNet Fees
- Credit Card fees
- Communication fees
- Prize pool
- Software Update fees (operator benefit)
- Hardware Update fees (operator benefit)

ITNet fees – This is what is paid to IT for the administering of a “Live” game or virtual balls & equipment. For every “Live” game the ITNet portion is \$0.35; whether it be a 9-hole game, 18-hole game, 9-hole for prizes, or 18-hole for prizes. IT is also paid half of the cost when a player purchases premium balls or clubs. See the player cost schedule below that breaks out these fees.

Play Choice	Total To Player	Operator Portion	ITNet Portion	Prize Fund
Sampler (18 holes)	\$4.50	\$4.50	0	0
Practice Facility	\$1.00	\$1.00	0	0
9-Hole for Glory	\$3.00	\$2.65	\$0.35	0
18-Hole for Glory	\$4.00	\$3.65	\$0.35	0
9-Hole for Prizes	\$4.00	\$2.65	\$0.35	\$1.00
18-Hole for Prizes	\$5.00	\$3.65	\$0.35	\$1.00
Virtual Golf Clubs	\$2.00	\$1.00	\$1.00	0
Virtual Golf Balls	\$0.50	\$0.25	\$0.25	0

Credit Card fees – When a player opts to pay by a credit card, there will be a merchant fee associated with this charge. The fee comes to just under 2% plus a per-transaction fee. When this transaction fee is rolled back in with the 2% fee, your actual percentage rate ends up being around 7.2%. This may look high, but for a micro transaction this is low.

For example a normal purchase of \$100.00 is made on a credit card. Add the 2% plus a \$0.30 per transaction fee. It comes to \$2.30 or 2.3%. Do this same transaction with a \$4.00 purchase. You would add the 2% (\$0.08) to the per transaction fee of \$0.30 and you get \$0.38. This works out to 9.5%.

Communication fees – There is a communication fee for the use of the Sprint wireless service on the game. On the GT Fore! platform, data was stored onto a hard drive and phoned in every other day. With LIVE, the players are continuously connected for their entire game. The Sprint charge is \$0.36 per day or \$10 per month whichever is cheaper. It does not matter if your game uses 500 or 5000 minutes per month, the rate stays the same. Please note that if you have Ethernet capability at your location, simply plug it in and your modem will automatically be disabled. You will also no longer be billed for communication fees.

Prize Pool– When a player enters a LIVE game, they are asked if they want to play for prizes. This will not occur if your game is in a state that does not allow Live for Prize Play or if you disable Live for Prize Play on your machine. If the player opts to play for prizes (money), they are asked to pay an additional dollar. All of this revenue is given right back to the winners of that tournament, making the tournaments 100% player funded. The prize fund money can be accounted as pass-thru money. This fee will appear on your ITNet statement. IT collects these entry fees from you, and disperses them to the winners through their player accounts.

Software Update fees – Down the road when you purchase new courses for your live game this will give you the opportunity to split the cost of your new courses with your location. It is handled much like the Hardware Update fee, described next.

Hardware Update fee – This Hardware Update fee is for you and you alone. You will NEVER BE BILLED for this fee. Operators have been asking for a place where they could recoup extra costs (should they so desire) from their locations. As of software version 2.00, the default weekly fee is set to \$0.00. If you were to change the default setting to \$29 per week on your machine, you will have recouped half the cost of your LIVE game from your location in 4 years time. Many operators use this feature for other purposes. It can be used in certain locations where a weekly minimum is required. It can also be used for a weekly contest participation fee. The dollar amount of this fee can be changed to whatever dollar amount you want. The percentage split may also be adjusted.

ACCOUNTING FOR FEES

All of the fees above are factory set to split 50/50. The collection will take the different revenue types and calculate the different percentage splits, then take the different fees and calculate their split percentages. The fees will be deducted from the revenue and a dollar value is given to you and to your location. These values are shown on the collection screens in System Setup mode.

COLLECTIONS

GT Live Collection Screen – The first thing you will see is the collection from and to dates. Just below that you will either see “Estimated Collection” or “Actual Collection.” If you see “Estimated Collection” there was a problem getting a connection to our servers. We strongly suggest you back out without collecting and then go right back in to try to connect again. Nine times out of ten you should get an actual reading.

In the gray boxes, you will see the line item “days of operation.” This is the number of days since your last collection screen was cleared. You will see the total income, total fees, balance, operator portion of balance and operator owes location numbers. Since cash is no longer your only source of revenue, it is very important to view the details of the total income. To get these numbers, simply move the trackball up to the “More Details” blue box located directly to the right of the total income dollar value. Click your start button and you will be into the revenue breakdown page.

This screen shows a line item for each type of revenue source. This is where you can compare your cash on screen to your cash in hand. You can then go back to the main collection screen and do the same for your total fees. When you are done viewing all your numbers, click on the “Do Collection and Exit” button. The game will then send the collection data to your secure operator services web page for viewing at your office.

The next page is a sample GT LIVE collection sheet, showing the different revenue and income. This also shows the default percentages of the various split settings. You may want to take this form with you to your collections until you are comfortable with the system.



GOLDEN TEE LIVE

COLLECTION WORKSHEET

Location _____ CID _____

From ___/___/___ to ___/___/___

Collector _____

Total Income \$ _____

Cash _____ (Default 60% Operator/40% Location)

Player Account (Due from IT) _____ (Default 70%/30%)

IT Gift Cards _____ (Default 70%/30%)

Credit Cards _____ (Default 70%/30%)

Operator Free Cash _____ (Default 100%/0%)

Operator Gift Cards _____ (Default 100%/0%)

Total Fees \$ _____

ITNet Fees _____ (\$0.35 p/ Live game; 50% of balls & clubs, Hole-N-Win)

Prize Fund _____ (\$1.00, 100% player funded tournament)

Communication Fee _____ (\$0.36 per day; or \$10 per month)

Hardware Update Fee _____ (adjustable by the operator; not charged by IT)

Credit Card Fees _____ (7.2%)

Software Update Fees _____ (will activate with new courses)

Net to Split \$ _____ / _____ Operator portion / Location Portion

GT LIVE COLLECTION PROCEDURE

Follow this step-by-step visual guide to aid in proper collections on your machines. Refer to the Collections Guide in your manual for more helpful information.

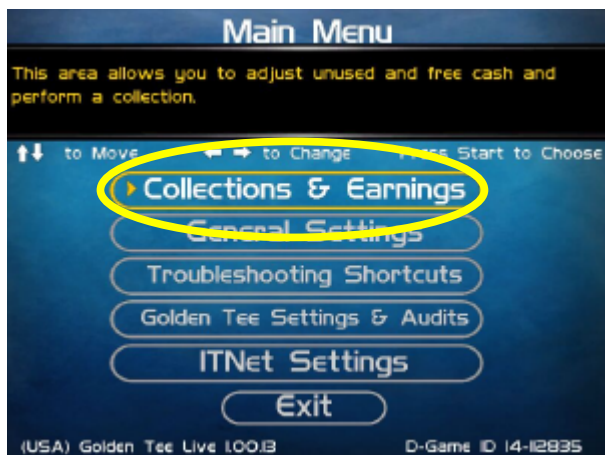

Press the System Setup button inside the coin door to access the System menus.

Use the trackball to highlight **Collections & Earnings** and press the Start button.

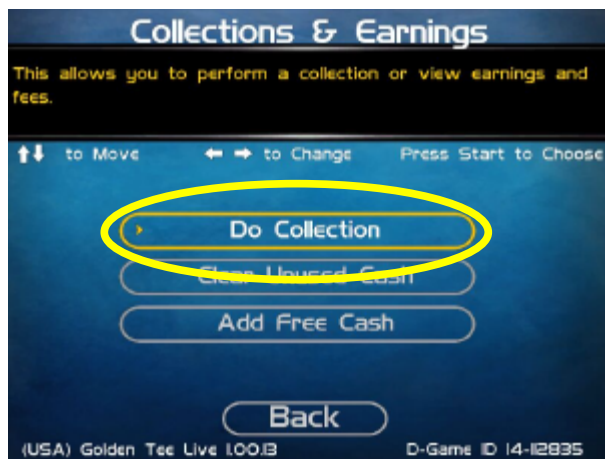

From the Collections & Earnings Menu, highlight **Do Collection** and press the Start Button. The game will connect with ITNet and gather the most current financial data.

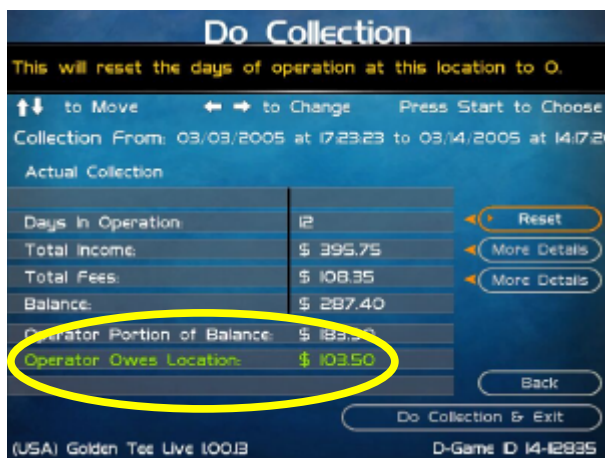

Look at the number printed in green. This is the location portion that should be paid at the time of the collection. This number will NOT match the cash in the coinbox, due to the various alternative payment options. However, you should pay the location his share now. Any money owed to you will be credited to you on your monthly ITNet statement.

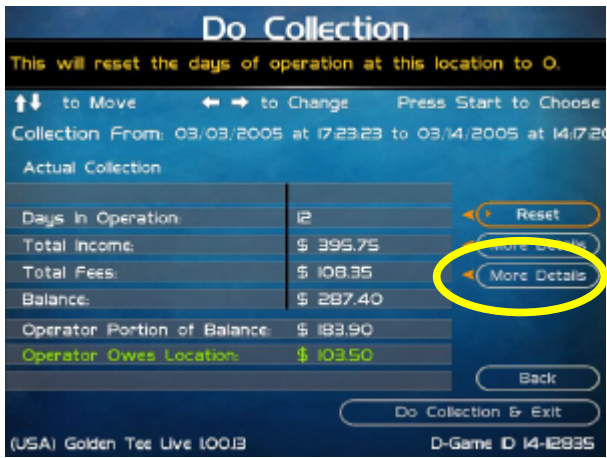

Once the location is paid, your collection is effectively complete. However, if you wish to view a more detailed breakdown of the various income and fee categories, use the trackball to highlight More Details and press the Start button.

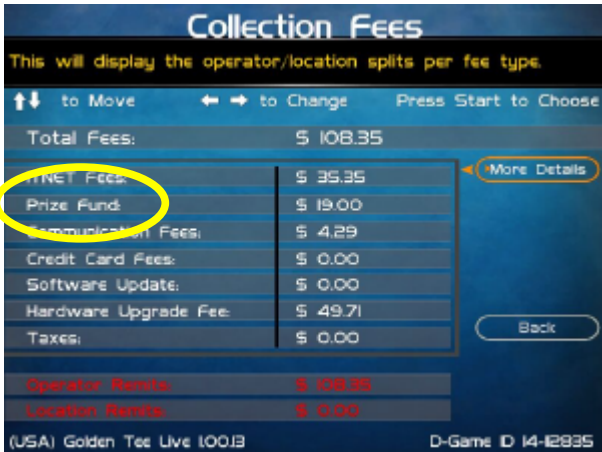

The Collection Fees menu displays the various fees associated with the current collection.

Note that 100% of the prize fund is redistributed to Prize Play winners, and IT does not keep this money. Nearly 90% of these winnings are being spent back in machines as more game play.

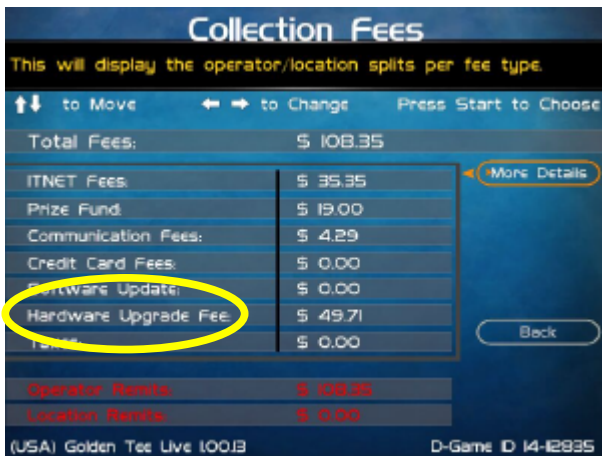

Note that the Hardware Update Fee is included as a means for you to have the location help pay for the cost of the game, and IT does not collect or keep any portion of this fee. This fee is completely adjustable and can be set to zero if desired.

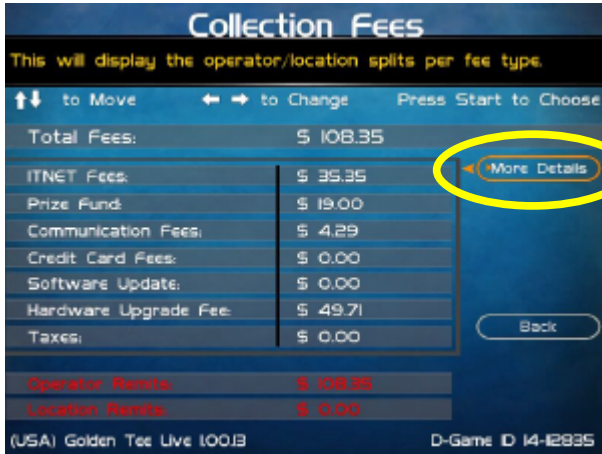

If you wish to view the operator and location portions of these various fee categories, highlight More Details and press the Start button.

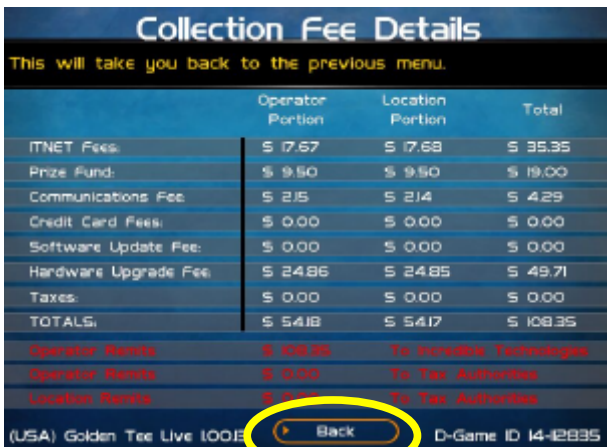

This screen further details the operator and location portions for the various fees, based on the adjustable split settings. See the GT LIVE manual for more information on how to set up your splits.

To exit this menu, highlight Back and press the Start button.

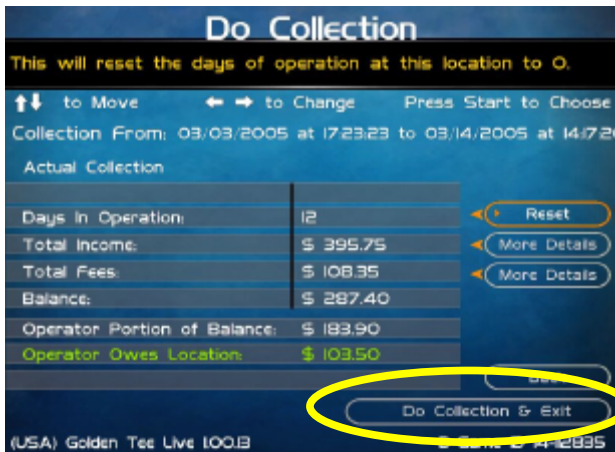

To complete your collection, get back to the Do Collection menu. Once there, use the trackball to highlight **Do Collection & Exit**, and press the Start button.

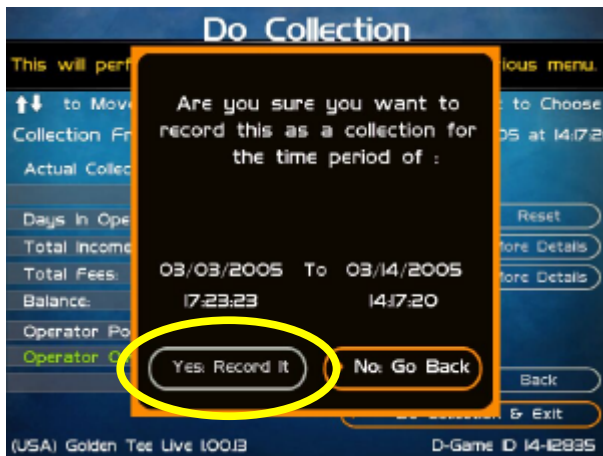

Check the dates in the window to make sure they match your time period. To complete the collection, highlight Yes: Record It and press the Start button.

This will reset all the income and fees to zero, so your next collection will be accurate for that time period.



Continue to select Back on the various screens until you get to the Main Menu. Highlight Exit and press the Start button to exit System Setup mode and return to the game.

MENU NAVIGATION SHORTCUTS

Force a Call

- Push the red system setup button inside the coin door
- Select the **ITNet Settings** menu
- Select the **Connection Tests** menu
- Select **Force Call**
- Exit all the way out when complete

Change Collection Settings

- Push the red System Setup button inside the coin door
- Select **General Settings** menu
- Select **Operator Adjustables** menu
- Select **Collection Settings** menu
- Select the menu that you want changed

Disable Credit Cards

- Push the red system setup button inside the coin door
- Select **General Settings**
- Select **Operator Adjustables**
- Select **General Adjustments**
- Go to the **Accept Credit Card** line and change to a "Yes" or "No"

Add Operator Free Cash

- Push the red System Setup button inside the coin door
- Select **Collection and Earnings**
- Select **Add Free Cash**
- Move the trackball to select the desired dollar amount

APPENDIX G ITNET REGISTRATION FORMS



ITNET DEBIT ACCOUNT FORM

You **MUST** have this form on file at Incredible Technologies, Inc.
or your games will not be activated for online play.

After processing of the ITNet® forms, a personalized Operator Identification Card will be mailed to you.
The Operator Identification Card allows you to immediately register your games on-site.
Billing Information for Automatic Debit Payments

Authorization Agreement for Pre-authorized Payments For participation in ITNet®

I (we) authorize Incredible Technologies, Inc., hereafter called COMPANY, to initiate debit entries to my (our) bank account indicated below. I (we) authorize the financial institution named below, hereafter called INSTITUTION, to credit the amount of such entries to my (our) account to correct any errors, and the Institution to deposit any such corrections to my (our) account. I have attached an unsigned and voided check for the account I wish to be debited from time to time and in varying amounts.

Please Print Clearly and Legibly to Insure Accuracy.

_____	<input type="checkbox"/> Checking Account	<input type="checkbox"/> Savings Account
Company Name	_____	
_____	Bank Account Number	
Address	_____	
_____	Bank Routing Number (VERY IMPORTANT)	
City, State, Zip	_____	
_____	Bank Name	
Company Contact	_____	
() _____	() _____	() _____
Phone Number	Fax Number	Bank Phone Number

To assist in verifying data, please attach an unsigned voided blank check from your account.

The authority is to remain in full force and effect until I (we) revoke the agreement in writing as hereafter provided. Any revocation is effective only after COMPANY has received written notice from me (us) to terminate this agreement in such time and manner to afford a reasonable opportunity to act upon the notice. I (we) have the right to stop payment of a debit entry by notification to the Institution in such time and manner to afford a reasonable opportunity to act prior to charging the account. A copy of this authorization will be provided at your request.

Email Addresses

Incredible Technologies® can alert you to a variety of information through email.
Please fill in the name and email address of the parties responsible for the following areas:

Main _____	_____
Main Contact Name	Main Contact Email Address
Billing _____	_____
Billing Contact Name	Billing Contact Email Address
Technical _____	_____
Technical Contact Name	Technical Contact Email Address
Promotions _____	_____
Promotions Contact Name	Promotions Contact Email Address

Authorized Signature _____ Date _____
Signature MUST accompany this form.



Fill out this form completely and mail or fax to:
Incredible Technologies, Inc.
3333 N. Kennicott Ave. Arlington Heights, IL 60004
(847) 870-7027 Phone (847) 454-9156 ITNet Registration Fax
Allow up to 10 Business Days for Processing.



ITNET GAME REGISTRATION FORM

USE THIS FORM ONLY IF YOU CANNOT REGISTER YOUR GAME ON-SITE.

For faster service, Use Your ITNet® Operator Identification Card
and Register Your Game Right at the Location!

Company Name: _____	Contact: _____
Address: _____	
Phone: _____	Date: _____
Fax: _____	Email: _____
ITNet® Operator ID Number: _____	
Debit Account On File: <input type="checkbox"/> Yes <input type="checkbox"/> No If No, include ITS® Debit Account Form.	

Game Type: <input type="checkbox"/> Golden Tee LIVE <input type="checkbox"/> Silver Strike Bowling <input type="checkbox"/> Golden Tee Fore! <input type="checkbox"/> Big Buck Hunter
Game ID Number/CID: _____
Location Name: _____
Location Address: _____
City/State: _____ Zip Code: _____ <small>Be sure the Zip Code is accurate.</small>
Location Phone Number: (_____) _____ <small>To avoid excessive phone charges, please enter the phone number of the jack that the machine is connected to.</small>
Preferred Call-In Time: _____ <input type="checkbox"/> am <input type="checkbox"/> pm

Please Select One of the Following:
<input type="checkbox"/> Please REGISTER this Game.
<input type="checkbox"/> Please UNREGISTER This Game.
<input type="checkbox"/> This Game is in a NEW LOCATION. Old Location Name: _____

Authorized Signature _____ Date _____
Signature MUST accompany this form.



Fill out this form completely and mail or fax to:
Incredible Technologies, Inc.
 3333 N. Kennicott Ave. Arlington Heights, IL 60004
 (847) 870-7027 Phone (847) 454-9156 ITNet Registration Fax
 Allow up to Business Days for Processing.



ITNET OPERATOR AGREEMENT

Page 1 of 3

This AGREEMENT is made and entered into this _____ day of _____, 200__, by and between Incredible Technologies, Inc. ("IT"), an Illinois corporation, whose address is 3333 North Kennicott Avenue, Arlington Heights, Illinois, 60004, and, _____ ("OPERATOR"), whose address is _____

WHEREAS, IT is skilled in the design of computer hardware and software relating to coin-operated video games, and;

WHEREAS, OPERATOR is skilled in the operation and management of coin-operated amusement equipment and represents that it is in the business of operating and managing the same.

NOW THEREFORE, for and in consideration of the mutual promises herein and other valuable consideration, the parties agree as follows:

1. APPLICATION.

This Agreement shall apply to the operation of all games ("TGAMES") that are capable of connecting to IT's International Tournament System ("ITS") that Operator elects to register with the ITS for the purpose of obtaining additional services and/or enabling additional game play features.

2. IT OBLIGATIONS.

IT agrees to do the following:

- A. Administer the ITS and offer contests on a regular and periodic basis throughout the year, and allow OPERATOR'S TGAMES to be included in such contests provided that OPERATOR has complied with all ITS rules and regulations, which are subject to change at IT's sole discretion without notice, and this Agreement;
- B. Be responsible for payment and distribution of all IT sponsored contest prizes;
- C. Provide technical support to technical representatives of OPERATOR in the installation and maintenance of TGAMES and in the connection to the ITS;
- D. Fax, mail, email or otherwise make available billing statements to OPERATOR at least 4 business days prior to the date of automatic debiting of amounts owed to IT for ITS related fees;
- E. Provide usual and customary accounting and related services for ITS fees, prizes, IRS 1099 reporting, and the like;
- F. Warrant TGAMES for 90 day replacement for defects in materials and workmanship;
- G. Pay all money, if any, owed to OPERATOR timely when due, as determined by IT in its sole discretion;
- H. Use its best reasonable efforts to positively promote the ITS program.

3. OPERATOR OBLIGATIONS.

OPERATOR agrees to the following:

- A. Operate all TGAMES approved by IT for inclusion in the ITS;
- B. Fill out and submit Game Initialization Forms, Game Registration Forms, Debit Account Forms, and such other forms as IT may require from time to time;
- C. Comply with the rules and regulations of the ITS, which are subject to change at IT's sole discretion without notice, and report non-compliance or cheating on ITS rules should this become known to OPERATOR;
- D. Provide prompt and courteous technical support and service to locations where the TGAMES have been placed in service;
- E. Pay all money owed to IT, including but not limited to any and all ITS fees incurred on games registered to Operator's account, by depositing such amounts in the account that OPERATOR sets up under the Debit Account Form prior to the date that the account will be automatically debited;



ITNet[®] OPERATOR AGREEMENT

Page 2 of 3

- F. Only operate TGAMES at locations where OPERATOR has used its best, good-faith efforts to determine that the operation of TGAMES and related game play features are in compliance with all local, state, and other governmental body laws and regulations;
- G. Only operate TGAMES in a traditional coin-operated environment as determined solely by IT, unless otherwise approved by IT;
- H. Hold IT harmless for any losses due to theft or machine setting tampering.
- I. Use its best reasonable efforts to positively promote the ITS program;

4. TAXES.

OPERATOR agrees to pay all taxes, fees, and assessments of any kind which may be assessed by any governmental body on the fees generated by the TGAMES, including, but not limited to any gross receipts taxes. OPERATOR is not responsible for any income tax or related assessments that are directly attributable to the business of IT.

5. ASSIGNMENT.

Neither party to this Agreement may sell, assign, transfer, pledge, or encumber, with or without consideration, all or any part of their interest in this Agreement without first obtaining the written consent of the other party.

6. EXPIRATION AND TERMINATION.

This Agreement shall continue in force for a period of one year from the date hereof, and shall automatically renew for successive one-year periods upon the anniversary date, and annually thereafter, unless sooner terminated in writing. Notwithstanding the forgoing, either party may terminate this agreement immediately upon notice to the other party.

7. EFFECT OF TERMINATION.

No termination shall affect any right, liability, or obligation, which accrues prior to such termination. Additionally, termination shall not affect either party's obligations to the other which by the nature thereof are intended to survive any such termination, including, but not limited to, the obligations of maintaining confidentiality as well as the obligations for payment of any outstanding monies that may be owed by one party to another.

8. CONFIDENTIALITY.

Each party agrees that the trade secrets, technological information, marketing plans, game play data, location and game revenue data, and any other confidential business information disclosed in the course of performance under this Agreement, including the terms of this Agreement, shall be held in strict confidence and not disclosed to anyone without the written consent of the other party. Notwithstanding the forgoing, OPERATOR may share such financial information relating to TGAMES as OPERATOR deems appropriate with the locations in which the TGAMES are operated, and IT may list or otherwise publish such non-financial information regarding OPERATOR and the locations at which the TGAMES are operated on its website(s). This provision shall survive the termination or expiration of this agreement for a period of two years from the date thereof.

9. GOVERNING LAW AND JURISDICTION.

The validity and construction of this Agreement and of the rights and obligations herein shall be determined and governed by the laws of the State of Illinois. The parties hereby submit to the Jurisdiction of any state or federal court in Cook County Illinois.

10. SEVERABILITY.

If any provision of this Agreement shall be held by a court of competent jurisdiction to be illegal, invalid or unenforceable, the parties nevertheless agree that the court should endeavor to give effect to the parties' intentions as reflected in the provision, and the remaining provisions shall remain in full force and effect.



ITNet® OPERATOR AGREEMENT

11. HEADINGS.

The headings in this Agreement are inserted for convenience and reference only, and are not intended to be part of or to affect the meaning or interpretation of this Agreement.

12. ENTIRE AGREEMENT, MODIFICATION AND MERGER.

This Agreement, including the Exhibits attached hereto, if any, states the entire Agreement between the parties with respect to the subject matter hereof, and supersedes and cancels all previous agreements, negotiations, commitments and representations regarding the subject matter of hereof which may have previously been made between the parties, whether orally or in writing. This Agreement may not be modified or altered except by written instrument duly executed by both parties.

13. ADDITIONAL DOCUMENTS.

The parties shall execute any and all documents, agreements, contracts, or other writings, which may be necessary or appropriate to carry out the terms, spirit and intent of this Agreement.

14. COUNTERPARTS.

This Agreement may be executed in any number of counterparts, each of which will be deemed an original, but all of which together shall constitute one and the same instrument.

15. INDEPENDENT CONTRACTORS.

Each of the parties to this Agreement shall be deemed to have the status of independent contractors, and nothing contained herein shall be deemed or construed as creating a joint venture, partnership, agency, or employer/employee relationship between the parties.

In Witness Whereof, the parties hereto have duly executed this Agreement on the day and year first written above.

INCREDIBLE TECHNOLOGIES, INC.

OPERATOR

By: _____

By: _____

Its: _____

Its: _____

(Printed name and title)

(Printed name and title)



This form must be on file with Incredible Technologies in order for your games to receive ITNet features.

Fill out this form completely and mail or fax to:

Incredible Technologies, Inc.

3333 N. Kennicott Ave. Arlington Heights, IL 60004

(847) 870-7027 Phone (847) 454-9156 ITNet Registration Fax

Allow up to 10 Business Days for Processing.

APPENDIX H MOUNTING TEMPLATES



MONITOR
DIRECTION

TRACKBALL ORIENTATION DIAGRAM

(VIEWED FROM UNDERSIDE OF CONTROL PANEL)

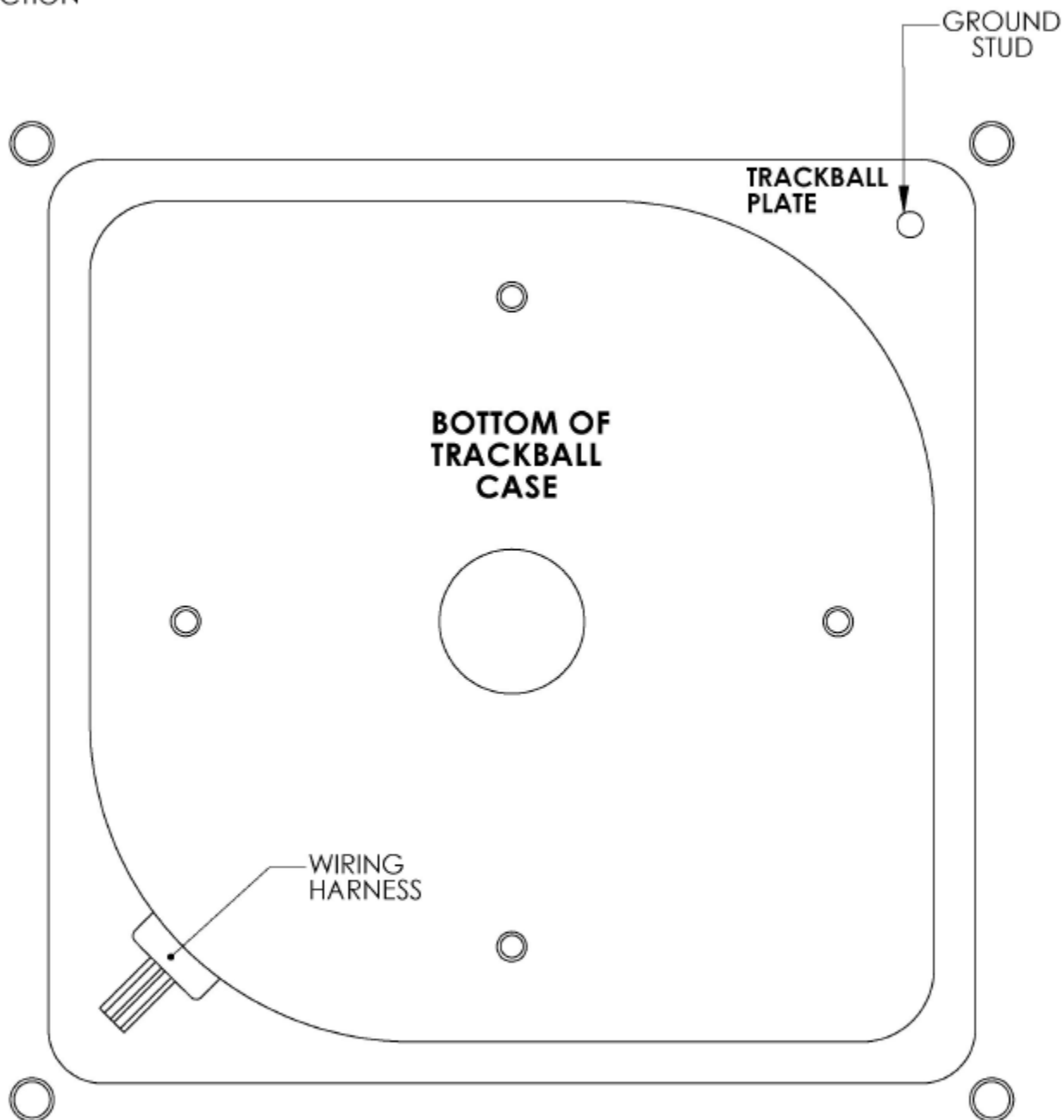

INSTALLATION NOTES:

- 1) THE WIRING HARNESS SHOULD POINT AWAY FROM THE MONITOR AND TO THE LEFT.
- 2) GROUND PIN SHOULD BE TOWARD THE MONITOR AND ON THE RIGHT SIDE.

TRACKBALL MOUNTING TEMPLATE

TOOLS REQUIRED:

DRILL, 9/32" OR 5/16" & 3/4" DRILL BITS, SABRE SAW, SCISSORS, & ROUTER

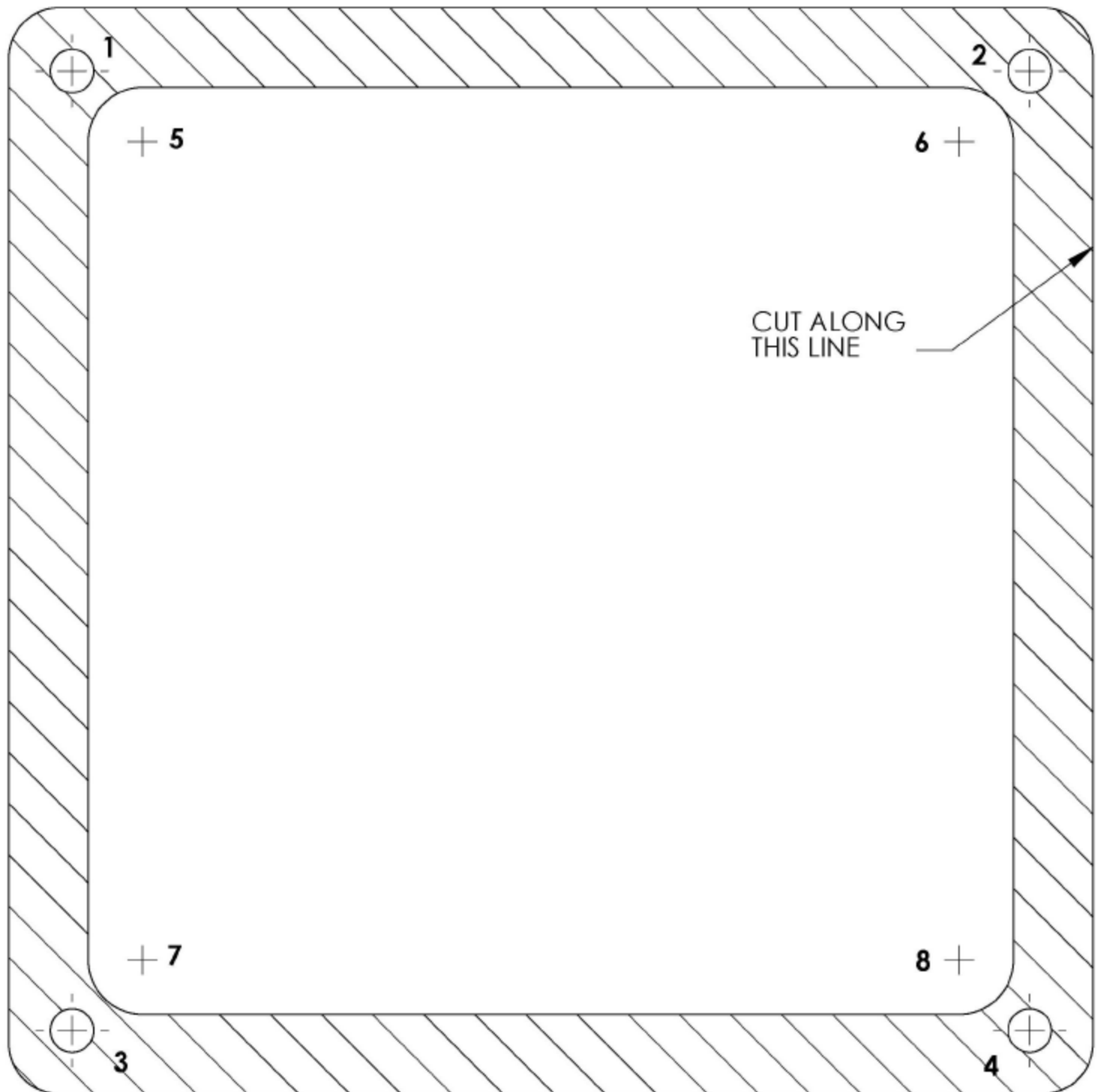

INSTRUCTIONS:

- 1) CUT THE TEMPLATE OUT WITH A PAIR OF SCISSORS ALONG THE NOTED LINE. TAPE THIS TEMPLATE TO THE TOP OF THE CONTROL PANEL AS FAR AWAY FROM THE MONITOR AS POSSIBLE, MAKING SURE THAT THE TRACKBALL WILL CLEAR THE CABINET BENEATH IT.
- 2) USING A SHARP OBJECT, MARK THE (8) POINTS SHOWN HERE ON THE CONTROL PANEL. USING A PENCIL, TRACE THE OUTSIDE OF THE TEMPLATE. REMOVE THE TEMPLATE.
- 3) DRILL HOLES 1-4 WITH THE 9/32" OR 5/16" DRILL BIT.
- 4) DRILL HOLES 5-8 WITH THE 3/4" DRILL BIT.
- 5) ROUTE THE CROSSHATCHED REGION TO A DEPTH OF ABOUT .075" (ABOUT THE THICKNESS OF A NICKEL).
- 6) USING THE SABRE SAW CUT OUT THE CENTER PORTION BY CUTTING BETWEEN HOLES 5-8.

LEFT BUTTON DRILL TEMPLATE

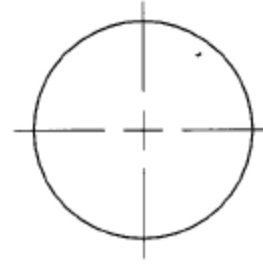
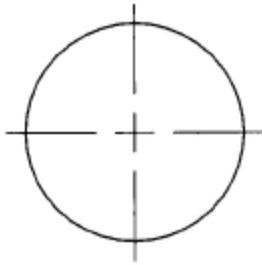

2

THE CENTER OF
BUTTON #2 SHOULD
BE LOCATED 2.75"
ABOVE, AND 9" TO
THE LEFT OF THE
CENTER OF THE
TRACKBALL.

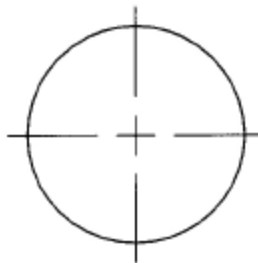

RIGHT BUTTON DRILL TEMPLATE

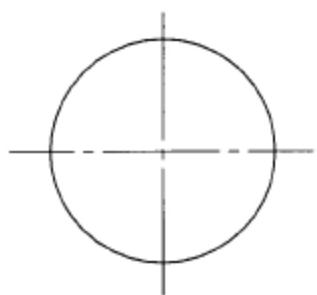

1

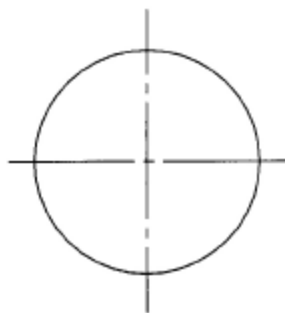
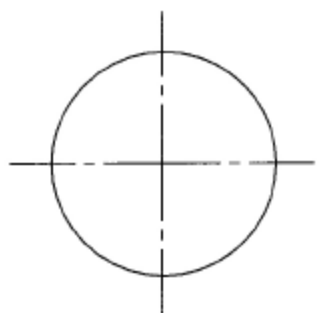
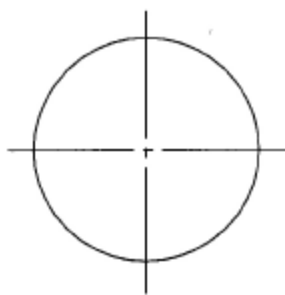

- 1) THE CENTER OF BUTTON #1 SHOULD BE LOCATED APPROX. 8" TO THE RIGHT OF THE CENTER OF THE TRACKBALL WITH THE BUTTONS CENTERED ABOUT THE TRACKBALL VERTICALLY.
- 2) FOR GOLDEN TEE FORE CABINETS THE #1 BUTTON HOLE SHOULD BE ALIGNED WITH THE EXISTING BACKSPIN BUTTON HOLE.

CARD READER MOUNTING TEMPLATE - SHEET A

FOR MODIFICATION OF INCREDIBLE TECHNOLOGIES' CABINET

1. CUT OUT AND POSITION TEMPLATE AGAINST COIN DOOR FLANGE AND AGAINST THE INSIDE CABINET WALL.
2. WHILE HOLDING TEMPLATE IN POSITION:
USING AN AWL, MAKE 4 MARKS FOR EACH OF THE PLATE MOUNTING HOLES AND MARK THE CENTER POINTS OF THE CUT OUT.
3. DRILL THE FOUR PLATE MOUNTING HOLES (3/16 DIA).
4. NEXT, DRILL A 3/8" DIA HOLE IN EACH OF THE FOUR CENTER MARKS FOR THE CUT OUT.
5. USING A SMALL SAW, CUT OUT THE AREA BETWEEN DRILLED HOLES.
6. MOUNT CARD READER TO PLATE AND ENTIRE ASSY. TO CABINET.

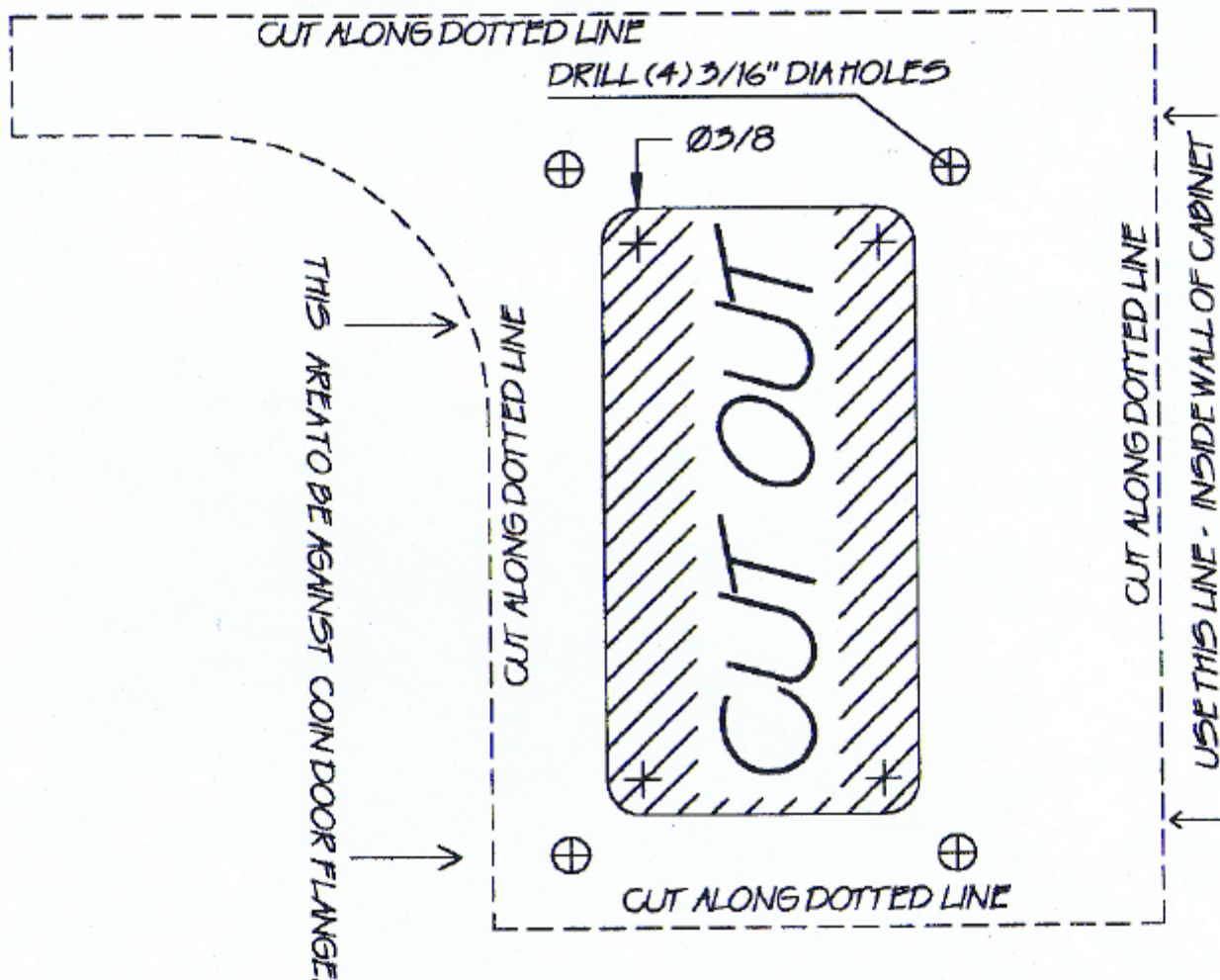

CARD READER MOUNTING TEMPLATE - SHEET B

CARD READER POSITIONING FOR MOST GAME CABINETS

1. CUT OUT TEMPLATE AS SHOWN (along dotted lines).
2. USING A TAPE MEASURE, LOCATE TOP OF CUTOUT TEMPLATE AT $25 \frac{5}{16}$ " FROM THE BOTTOM OF THE CABINET AND $\frac{3}{4}$ " FROM THE RIGHT SIDE OF THE CABINET.
3. WHILE HOLDING TEMPLATE IN POSITION:
USING AN AWL, MAKE 4 MARKS FOR EACH OF THE PLATE MOUNTING HOLES AND MARK THE CENTER POINTS OF THE CUT OUT.
4. DRILL THE FOUR PLATE MOUNTING HOLES ($\frac{3}{16}$ " DIA).
5. NEXT, DRILL A $\frac{3}{8}$ " DIA HOLE IN EACH OF THE FOUR CENTER MARKS FOR THE CUT OUT.
USING A SMALL SAW, CUT OUT THE AREA BETWEEN DRILLED HOLES.
6. MOUNT CARD READER TO PLATE AND ENTIRE ASSEMBLY TO CABINET.

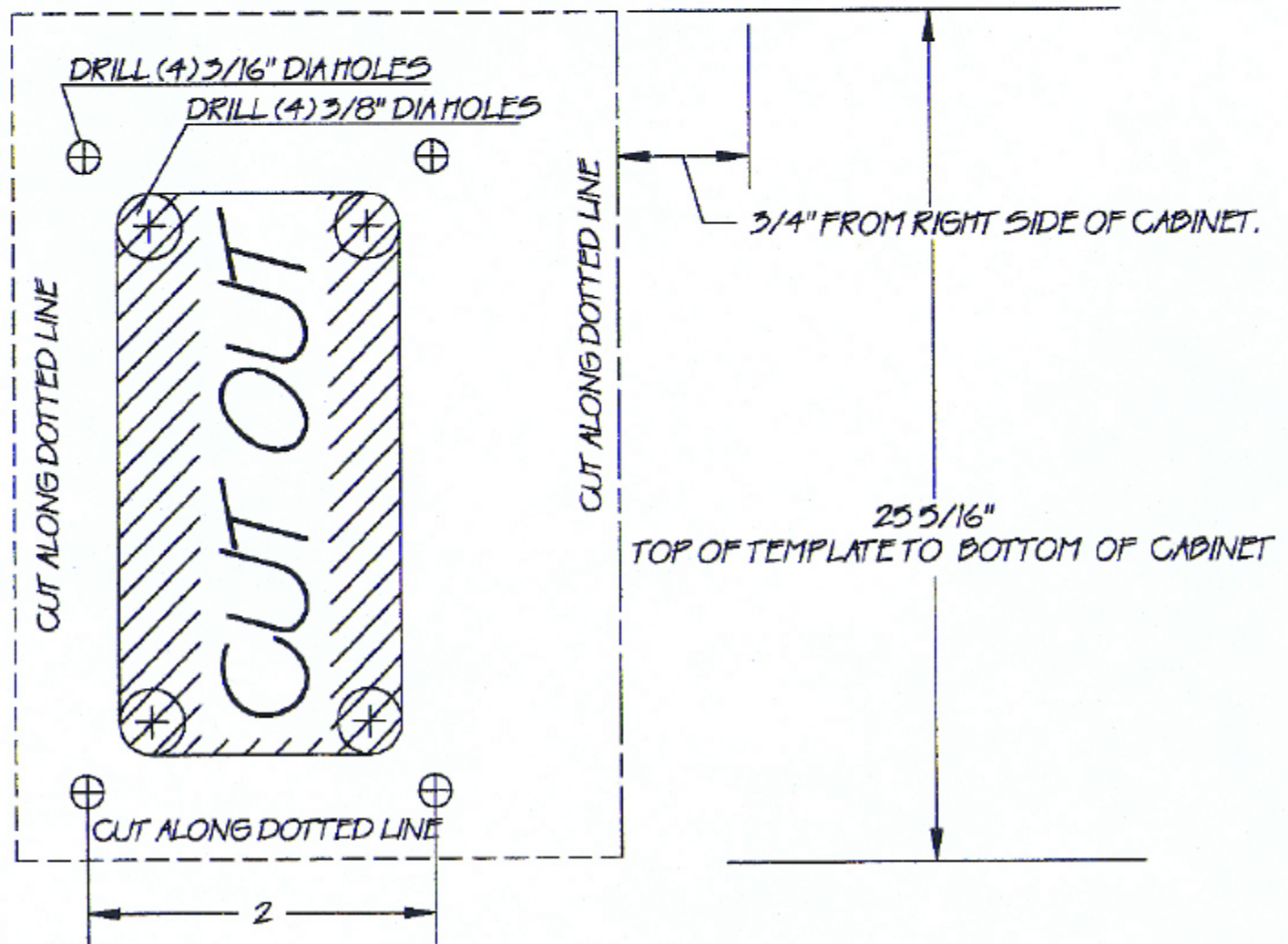

FAN INSTALLATION TEMPLATE - GENERIC CABINET

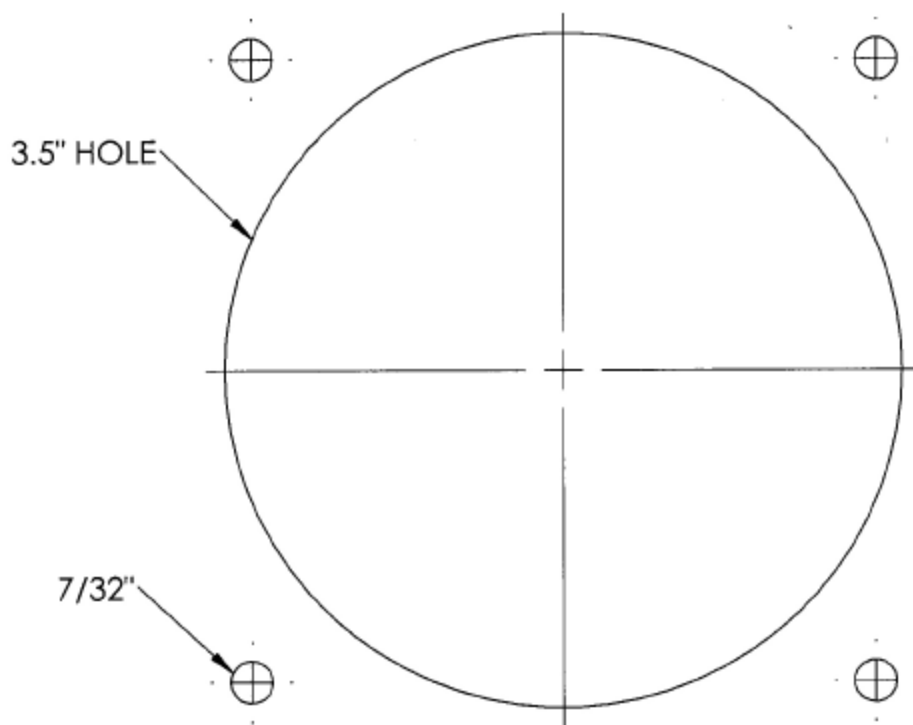

- 1) PLACE THIS TEMPLATE IN THE LOWER RIGHT BACK SIDE OF THE CABINET AND TAPE IT IN PLACE.
- 2) MARK THE CENTERS OF THE FOUR OUTSIDE HOLES AND THE LARGE CENTER HOLE USING AN AWL, NAIL, OR OTHER SHARP OBJECT. REMOVE THE TEMPLATE.
- 3) DRILL THE FOUR 7/32" HOLES CENTERED ON THE FOUR OUTSIDE MARKS.
- 4) DRILL THE CENTER HOLE USING A 3.5" HOLE SAW.

FAN INSTALLATION TEMPLATE - G14

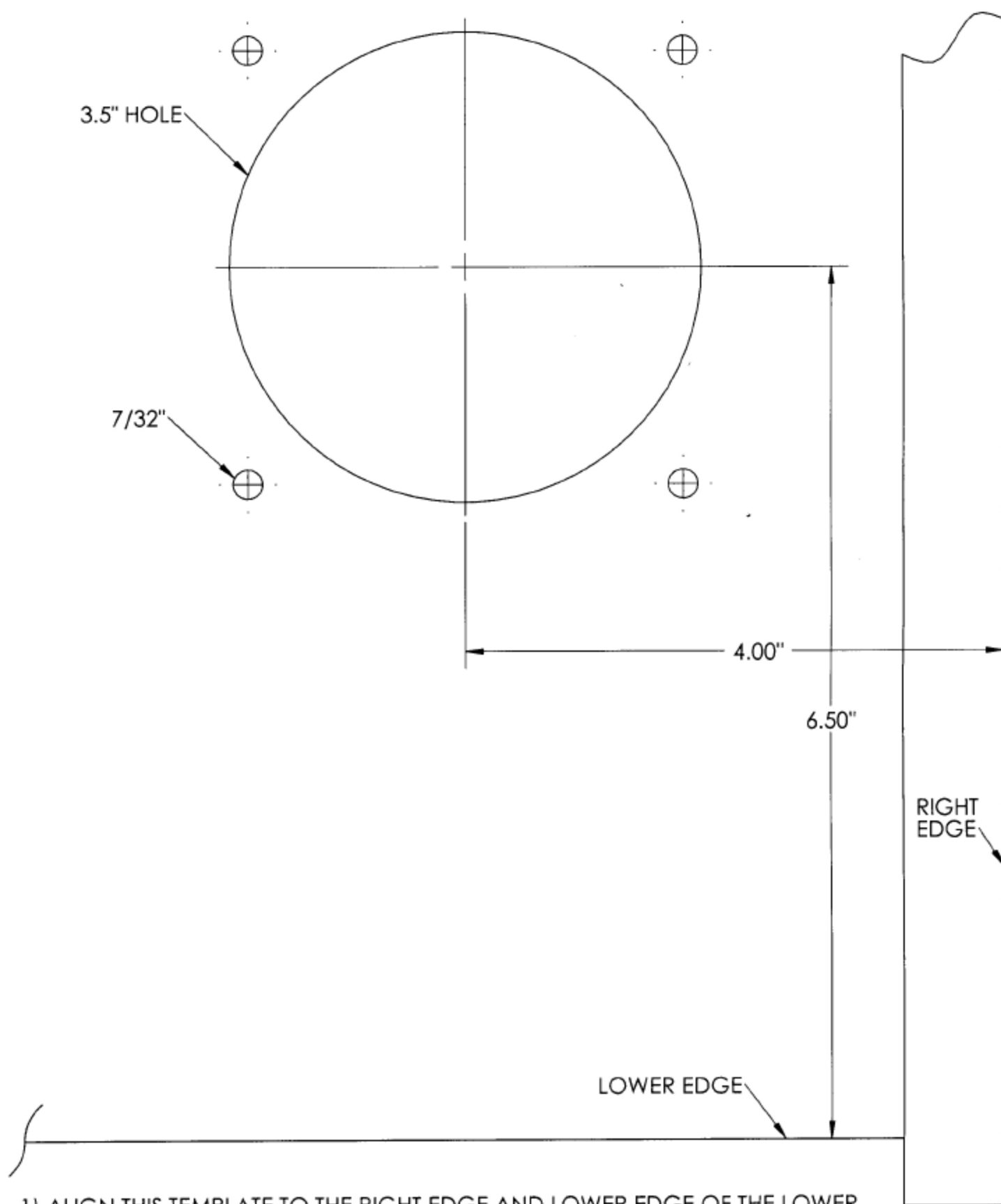

- 1) ALIGN THIS TEMPLATE TO THE RIGHT EDGE AND LOWER EDGE OF THE LOWER BACK SIDE OF THE CABINET AND TAPE IT IN PLACE.
- 2) MARK THE CENTERS OF THE FOUR OUTSIDE HOLES AND THE LARGE CENTER HOLE USING AN AWL, NAIL, OR OTHER SHARP OBJECT. REMOVE THE TEMPLATE.
- 3) DRILL THE FOUR 7/32" HOLES CENTERED ON THE FOUR OUTSIDE MARKS.
- 4) DRILL THE CENTER HOLE USING A 3.5" HOLE SAW.

Contact Information

IT Sales and Service

To purchase additional Golden Tee LIVE machines or any of IT's other fine products please visit IT's website at www.itsgames.com and click on PRODUCTS!

General Numbers

IT Sales Hotline:

800-262-0323 x106

847-870-7027 x106

Technical Support, Warranty, & Repair:

Incredible Technologies, Inc.

800-262-0323 x121

847-870-7027 x121

Parts, Customer Service, & Operator Services:

Incredible Technologies, Inc.

800-262-0323 x118

847-870-7027 x 118

IT Mailing Address:

Incredible Technologies, Inc.
3333 North Kennicott Avenue
Arlington Heights, IL 60004-0129

ITNet Registration/Sales Fax Number 847-454-9156

General/Tech Services Fax Number

847-870-0120

IT Vendor Information

Wells-Gardner:

Phone: 800-336-6630

Fax: 773-252-8299

Mars Technical Service:

Phone: 800-345-8172

NeoTec

Phone: 909-626-9889

Fax: 909-626-0990

Happ Controls:

Phone: 866-BUY-HAPP

(866-289 -4277)

In our replacement part numbers section is a list of parts you can get from these vendors including the vendor's part numbers.



Incredible Technologies, Inc.
3333 N. Kennicott Ave.
Arlington Heights, IL 60004
Phone (847) 870-7027 (800) 262-0323
www.itsgames.com