



case study - casa del fascio

modernism, rationalism & nationalism

Giuseppe Terragni's Casa del Fascio was built in Como, Italy between 1936 and 1939. Commissioned by the Partito Nazionale Fascista (PNF, or National Fascist Party) under the power of dictator Benito Mussolini, the building is one of many Case del Fascio erected after the party's rise to power in 1922.

Terragni was a follower of the International Style and the Modernist school of thought, agreeing with the ideas of architects such as Le Corbusier, Gropius, and Mies van der Rohe: he became leader of the Gruppo 7, a group of young architects known as the "Italian Rationalists."

Once completed, the Casa del Fascio was largely hailed as the successful culmination of a battle for the affirmation of modernist architecture, and "Terragni's intention was to employ a newly elaborated notion of modern classicism to express Fascist spatial practice" (Storchi 232). However, as Eisenman argues, the Casa del Fascio resists identification as either Fascist or Rationalist, and is not easily categorized as such.



the glass house of fascism



casa del fascio (storchi)

terragni and the casa del fascio: introduction

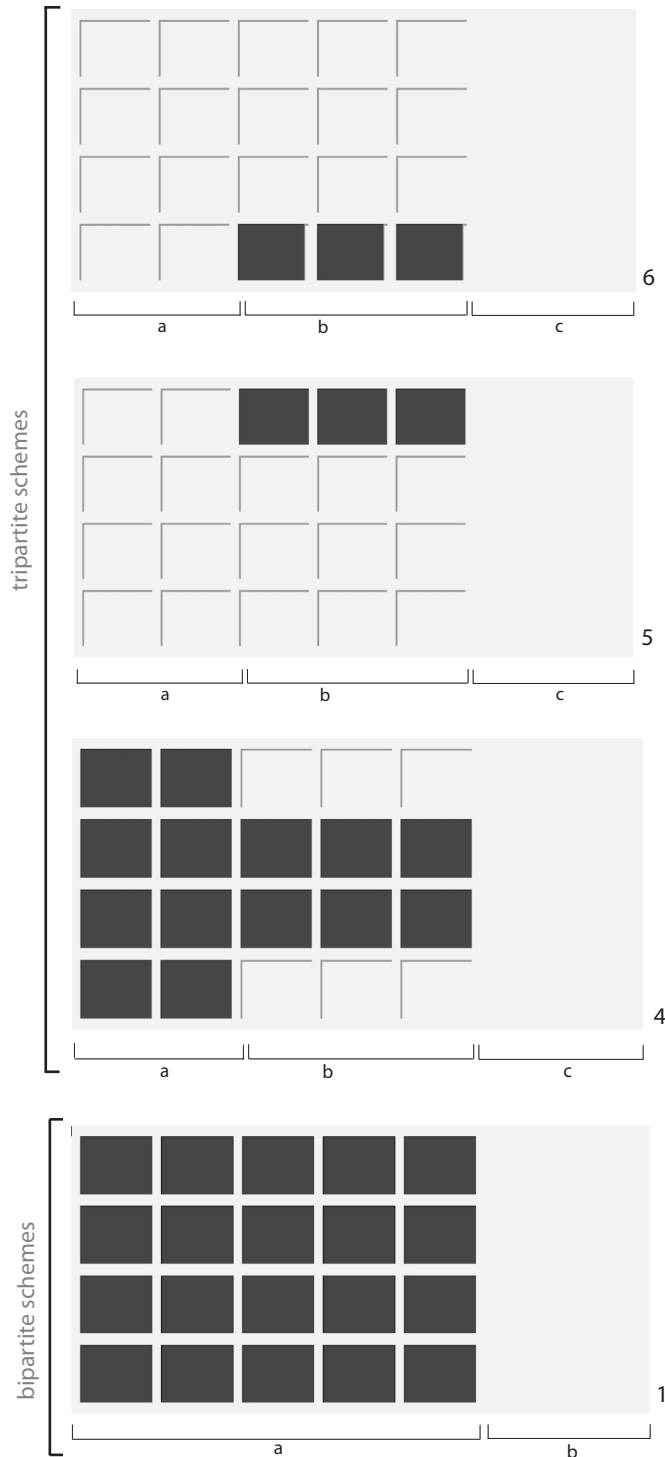

facade

The four facades of the building appear to be composed in a simple and straightforward way, but there are layers of contextual and symbolic information at work in the formal strategies used by Terragni. Indeed, "in its role as the 'glass house of Fascism,' it was logical that the interior of the Casa del Fascio be expressed on the exterior. But the Casa is a building with an intricate set of interior spaces, requirements, orientations, and exterior spaces. The exterior facades could project and express numerous ideas about the building, and the problem for Terragni was how to express this diversity without losing harmonic unity" (Shumacher 167).

The entry (south-west) facade is the most simple and most monumental: "it is the official face to the city, rendered as a multi-storied colonnade, recalling the colonnades of antiquity and the Renaissance" (Schumacher167). Originally, the entry facade held a photomontage acting as a political billboard: "the panels were nostalgic and patriotic rather than radical, summoning up an interest in the past historic moments of Fascism, recalling triumphs, lives touched, and the role of the Duce above that of all others. The design explicitly projected the most salient feature of Fascism: the gigantic head of Mussolini hovered above the smaller figures in the other panels much as a marble head of Constantine on the Capitoline Hill symbolically loomed over the city of Rome" (Ghirardo 470). The rear facade recalls those facing gardens in certain Palladian villas, while the two side facades are equally subtle and complex.

visual dominance: south-west (entry) facade

- 1: caged void as object
- 2: gridded colonnade as object
- 3: front cage enclosing central void
- 4: closed surfaces on grid as object
- 5: upper open void as object
- 6: entry void as object

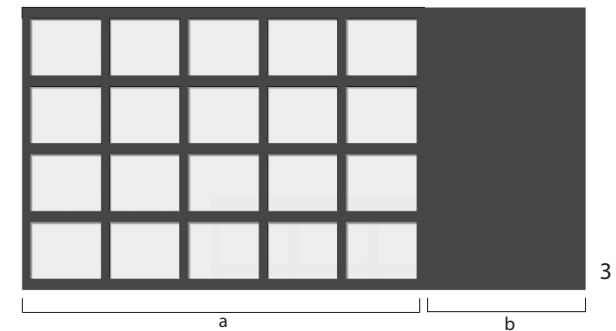
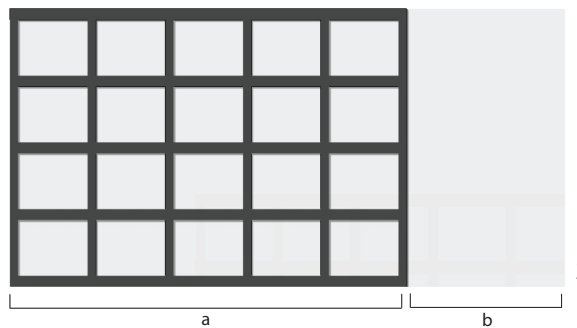

exterior: facade & elevation

interaction of four levels

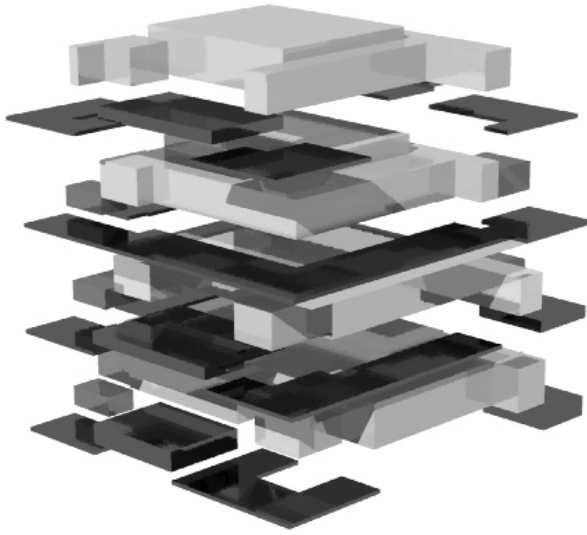

levels in plan

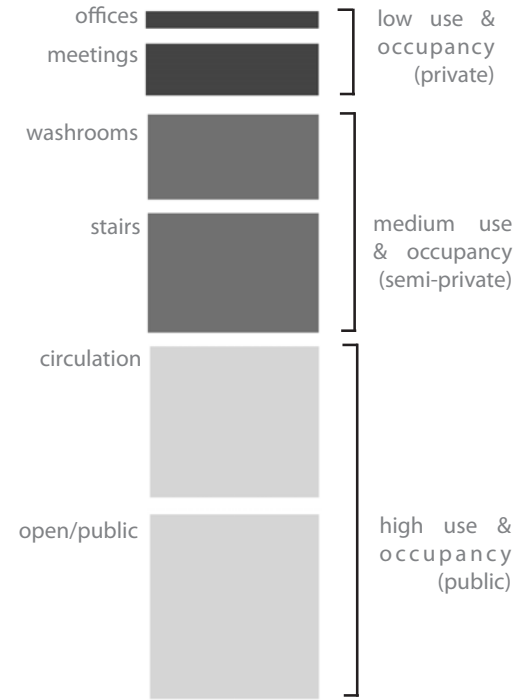
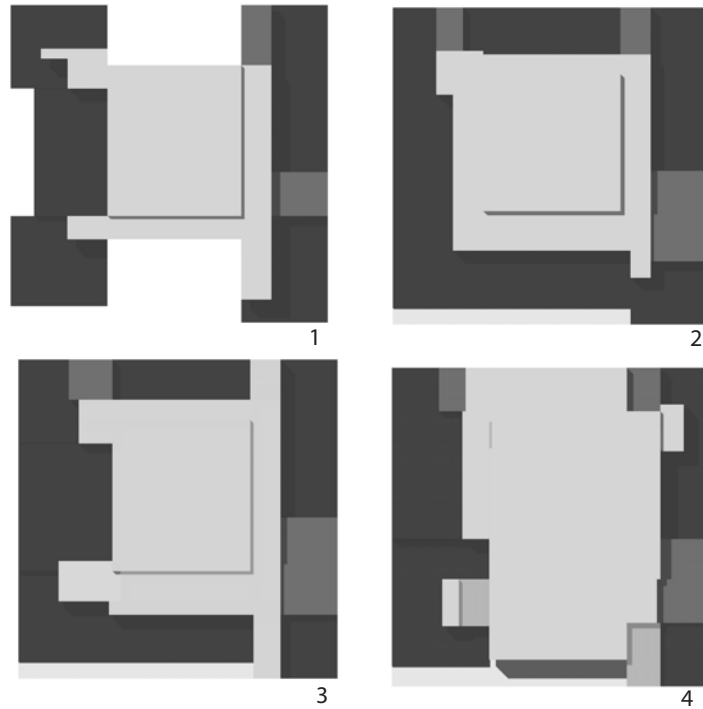

context: politics and history

The Casa del Fascio functions as a state institution: it is not a place for dwelling. The open interior space and the front courtyard areas are meant to function as public gathering spaces for the people of the city. As a rule, the Casa del Fascio were generally the only physical manifestations of the presence of the Fascist state within any given community, so the structures were given important symbolic significance.

Paul Rudolph suggests one of the determinants of architectural form is the "peculiar psychological demands of the space," and that "such necessities are met primarily through the manipulation of space and the use of symbols" (214). The spaces in the Casa del Fascio range from public to semi-private, and each is laid out in a logical manner regarding circulation and spatial sequence. The town hall configuration also symbolically gathers the "fragmented village and provincial loyalties under the umbrella of a supreme power, each small community having direct if not always immediate access to the national state through the offices of the Casa del Fascio" (Ghirardo 468-9).

hierarchy of use:
4 levels, 6 uses

levels in perspective



interior form: context & use

casa del fascio elevation



type (1): renaissance palazzo

villa pisani - plan and front elevation (palladio)

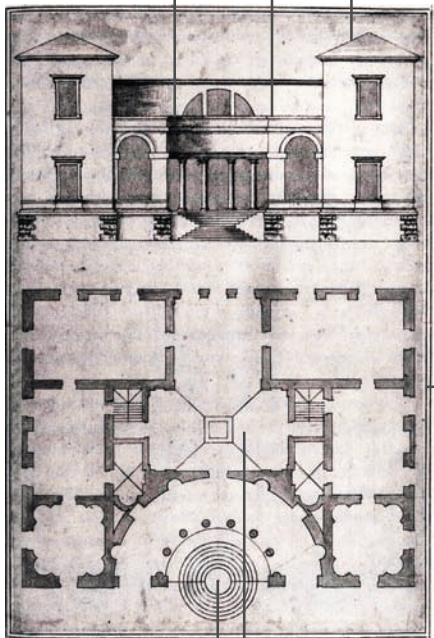

centered entry

tower form

central atrium/courtyard

forecourt

axiality symmetry of uses centralized plan

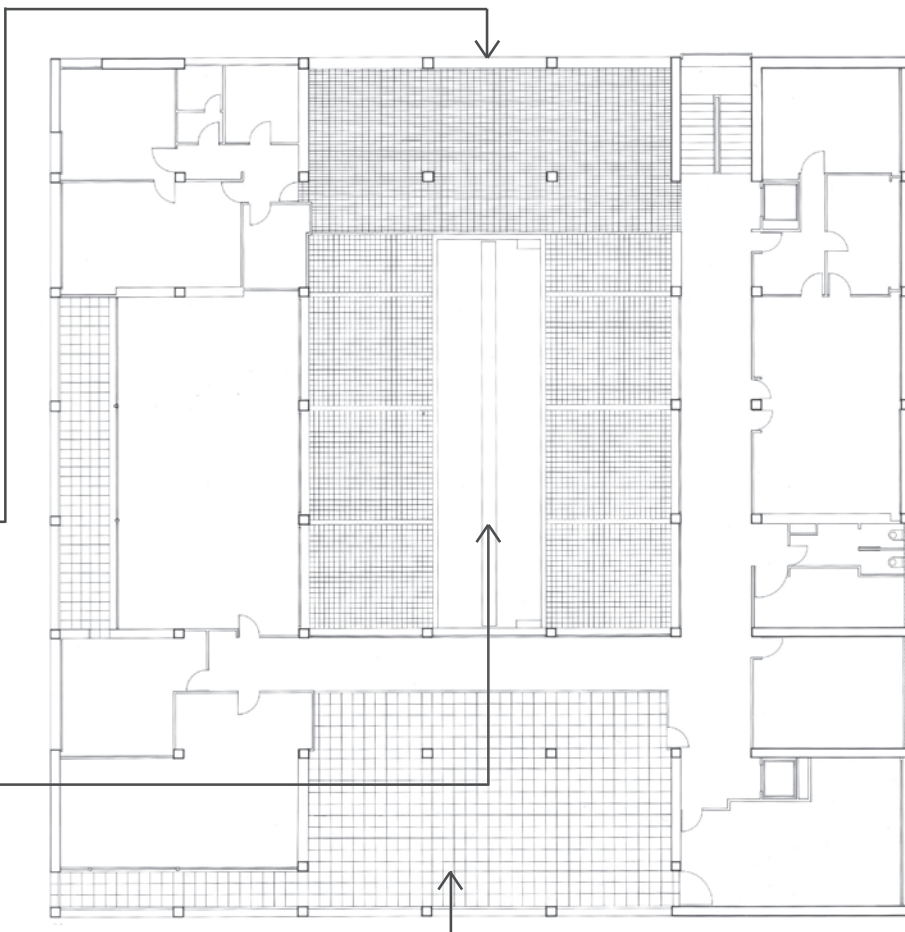

ground floor plan, casa del fascio (eisenman)

terragni's typologies

The Casa del Fascio makes use of a number of typologies. Collectively, the Case del Fascio were meant to be the centers of the political and social life of the Fascist populace, and as such many of the Case utilized the typology of the town hall. Use of this model was intended to be "an identifiable and reassuring standard that held out a promise to restore a glorious past" (Storchi 235). In a sense, the building also functions as a monument to Fascism and national pride, and "the monument in the classical age is the center, it is the imago Dei, the figuration of a transcendent divinity that guarantees the consistency of time" (Morales 622-3).

In addition, Terragni drew from the typology of the Renaissance palazzo, referencing Italian architects such as Michelangelo and Palladio (see plan, above left) in a further attempt by the Fascists to connect to a glorious past. Indeed, in early drawings of the Casa del Fascio, Terragni includes a "rusticated base with rusticated pilasters around the entry, a low, hipped roof, and a secondary articulation, in the front and side facades, of the four volumetric corners typical of a Renaissance palazzo" (Eisenman 43). However, as Eisenman argues, the final scheme for the Casa "simultaneously [reinforces] these relationships between historical archetypes and Fascism and to disengage the work from them" (Eisenman 9). Truly, the Casa del Fascio is a unique artifact in Italian architectural history, borrowing from both classicism and modernism, but refusing to be defined by either.

typology: town hall/palazzo

body: spheres of influence

como, pre-1930s - area surrounding duomo

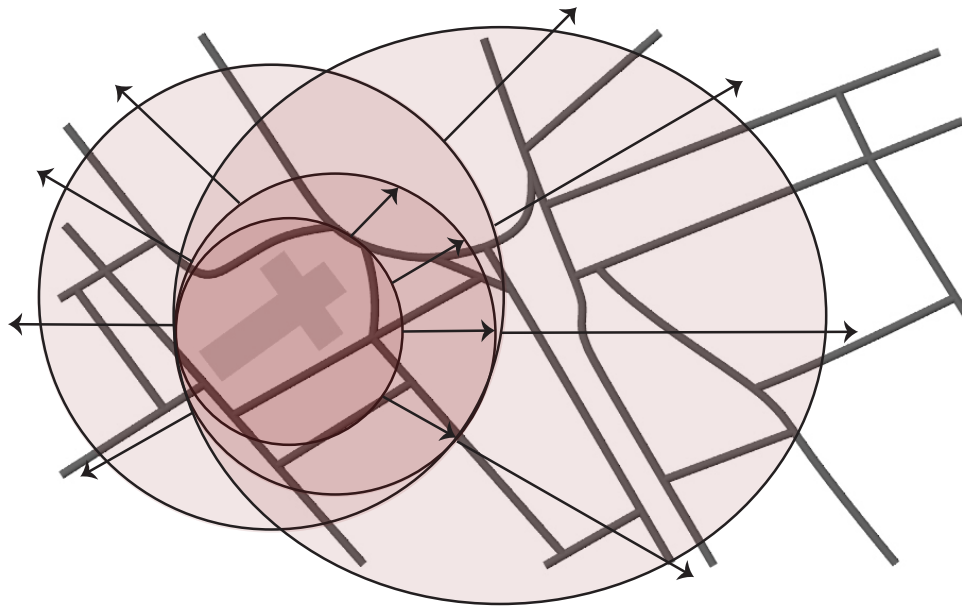

como during the 1930s: church overtaken by fascism/state via the casa del fascio

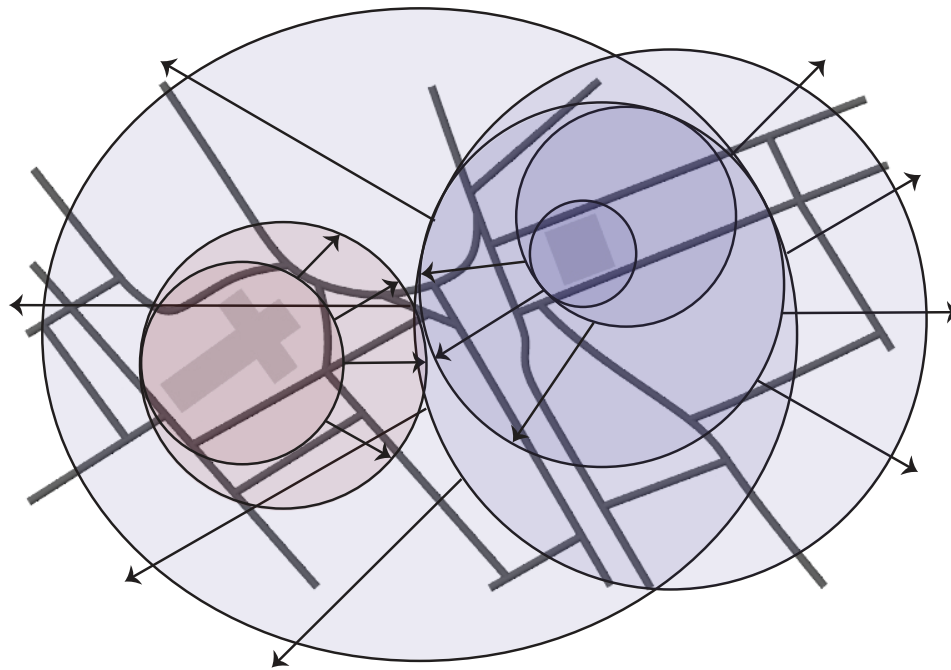

● catholic church (como duomo) ● influence of fascism (casa del fascio)

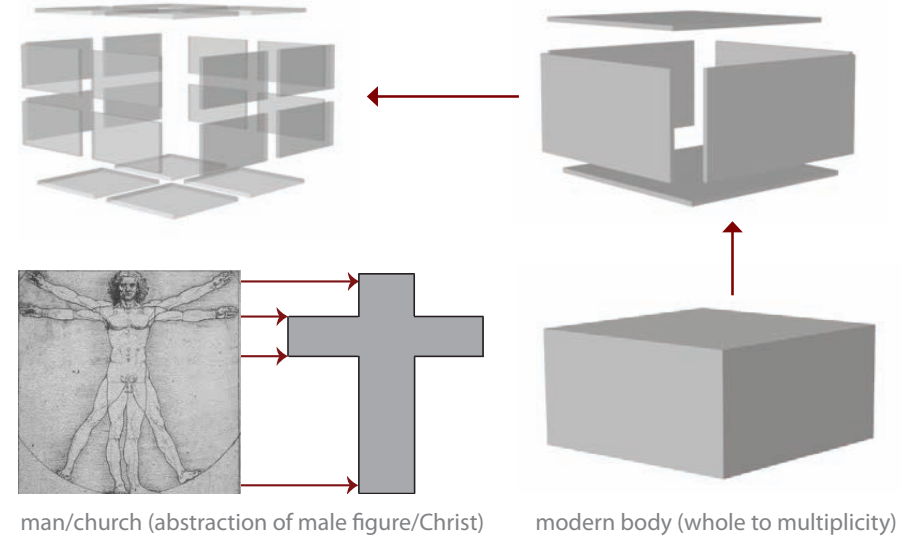

whole/unified vs. fractured/fragmented body

Italian Renaissance architecture frequently featured an anthropomorphic abstraction of the human form, specifically the male form, which was thought to embody the perfection and harmony found in nature. Como's cathedral or Duomo represents this use of the body in architecture, as well as the primary sphere of influence in the town before the rise of Fascism: the Catholic Church.

The erection of the Casa del Fascio in the 1930s signified a shift in the spheres of influence in Como, as in all of Italy. The building was intended to be the party seat, as well as "the physical setting of the totally new propaganda, and the locus of the diffusion of the revolutionary idea" (Ghirardo 471). However, the utilization of the International Style, influenced by the modern movement and the Rationalists, produced a generally typical modern structure. However, the "modern body housed by modern architecture was not a single body but a multiplicity of bodies. The body was no longer a stable point of reference around which an architecture could be built" (Colomina 235). The modern body is fragmented and disjointed and the multiplicity of bodies is echoed in the multiplicity of formal influences in the Casa del Fascio.

the body in architecture

body - casa del fascio

object/subject and interior/exterior

Arguably, the mere presence of construction, be it walls, columns, beams, or planes, defines and implies a sense of space. In addition, individuals' experience of architecture has primarily been defined by their perception through vision. In fact, the "interiority of architecture more than any other discourse [defines] a hierarchy of vision articulated by inside and outside" (Eisenman 558). Interior and exterior are clearly defined in the Casa del Fascio, but the separation and/or inversion of these concepts allows for a different perspective and analysis to become possible. For instance, tracing the paths of movement of dwellers (both horizontal and vertical), as well as the path through which light enters the building, one may begin to reveal a new body; a new structure.

new body/interior: skeleton from light & movement

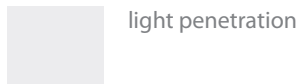

light penetration

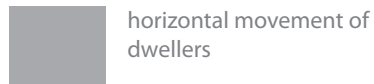

horizontal movement of dwellers

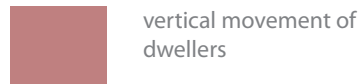

vertical movement of dwellers

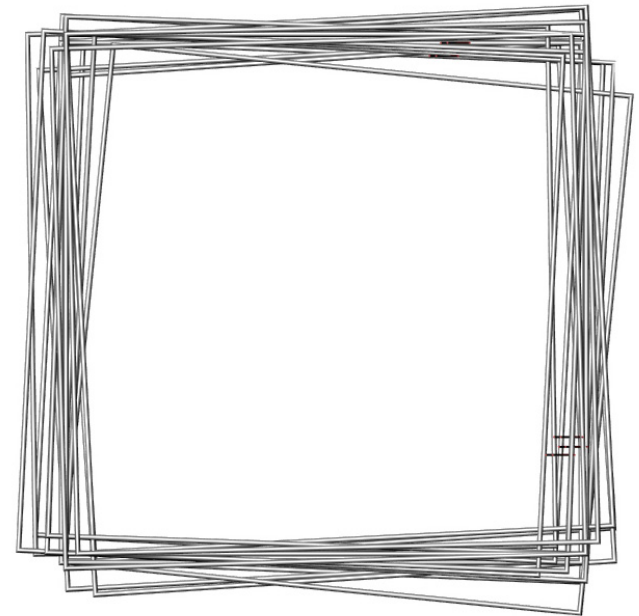

plan view of interior body

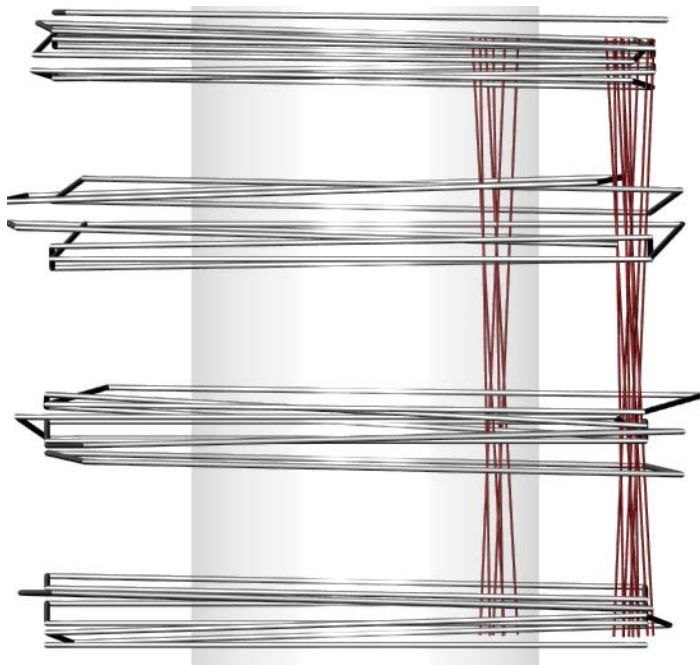

front view of interior body

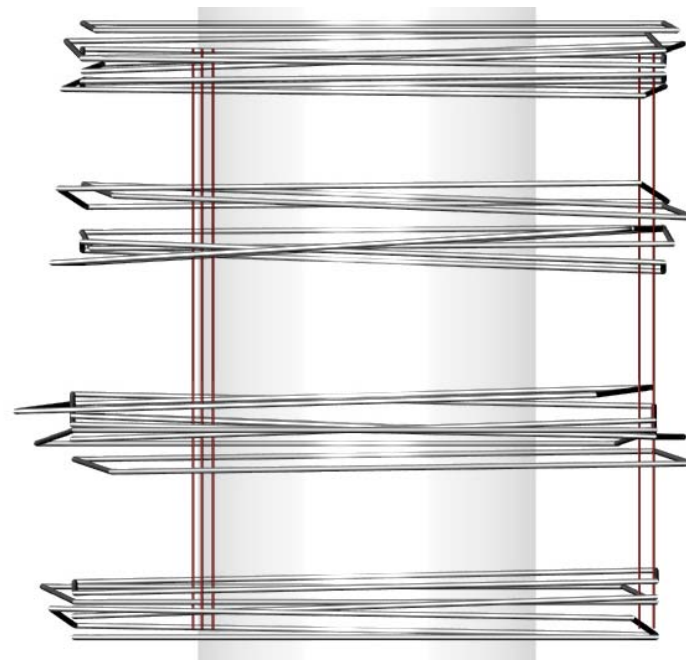

side view of interior body

vision & interior/exterior

il Duce: absence & presence

In one of the conference rooms of the Casa del Fascio, the figure of Benito Mussolini presided over every meeting. He was not necessarily present in the flesh, but rather a cut-out image of il Duce was situated at the head of the conference table, allowing his figure to be present despite his absence. This figure represented the unsleeping eye of the Fascist government in Italy: a constant reminder that Mussolini was capable of knowing what was happening at all times and in all places, especially in the Casa del Fascio.

After the fall of the regime, and to the present day, the place where Mussolini's figure stood and presided over all meetings is covered with a wooden board which still bears the shape of the outline of a man (right). This is mirrored by the continued presence of the Casa del Fascio in Como, despite the fall of the Fascist regime, which remains present and in use, albeit in a different capacity. However, the building is falling into disrepair and its power, the power of the Fascists, is no longer tangible in the urban fabric: the building represents instead a moment within the modern movement. The situation is reminiscent of the modern body, which cannot be made "healthy" or whole - "it has finally recognized itself as an object whose finitude is ever in question, and whose powers are in doubtful play, always to be tested by the infiltration of other objects" (Vidler 8). Indeed, the building can be reduced to its bare elements, fractured and fragmented and never to be made whole (below).

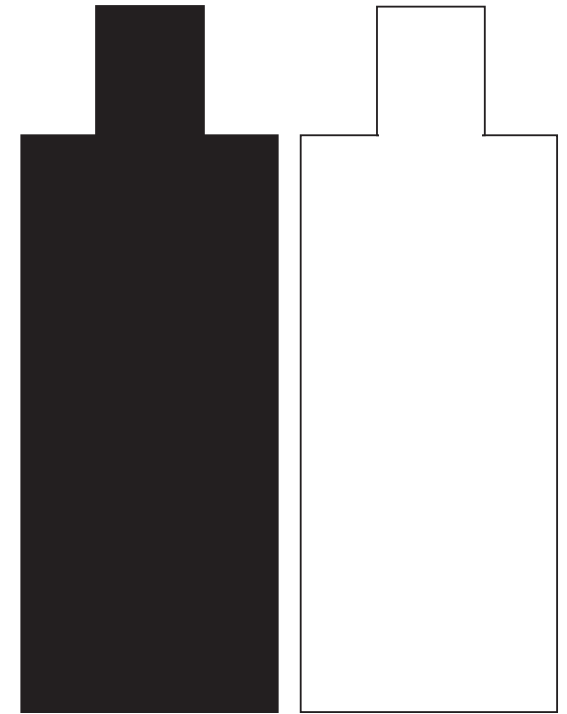

figure/body left behind (presence in absence)

deconstruction/decay: fragmentation of the modern body

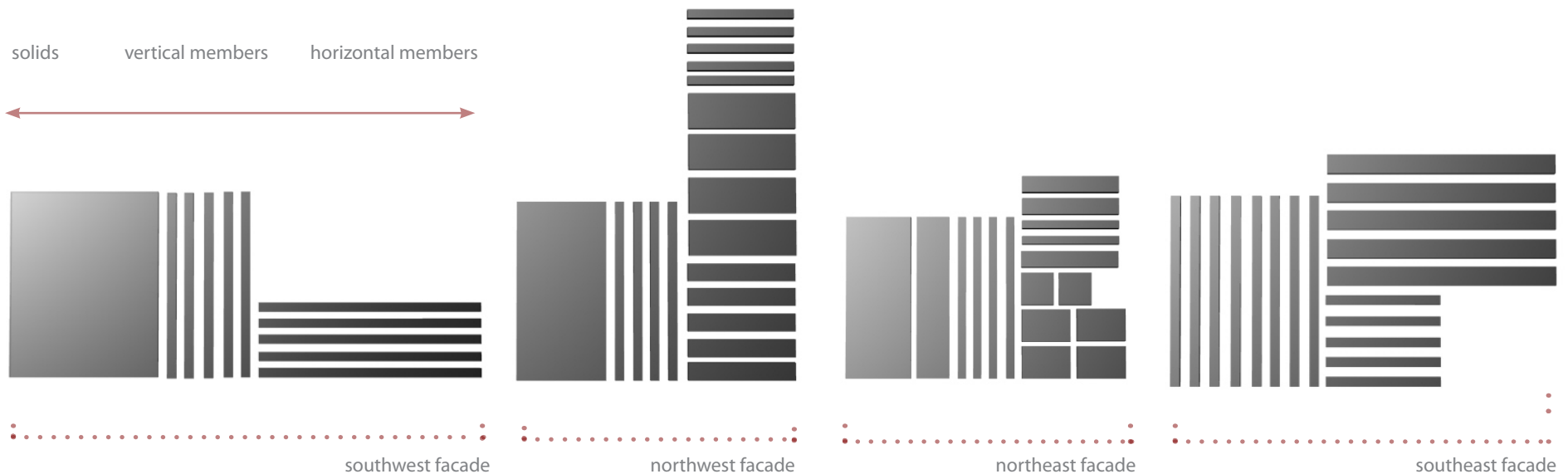

the body: space, signifiers & fragmentation

[argument 1]: Terragni's Casa del Fascio seeks to connect the Fascist regime to the myth and history of the Roman Empire through the formal influences of Classical and Renaissance architecture.

The Fascist Party in Italy was desperate to associate itself with the rich history of power, creativity and genius of the Classical and Renaissance periods in the Mediterranean, and with the Roman Empire in particular. Terragni himself was educated in Italy and studied the Classical and Renaissance masters, including Vitruvius and Michelangelo. His "particular classicism manifests itself in the use of proportion, in figurative motifs, parti-forms, compositional regularity and cubic stereometry, and in the use of classic detail forms," (Schumacher 53).

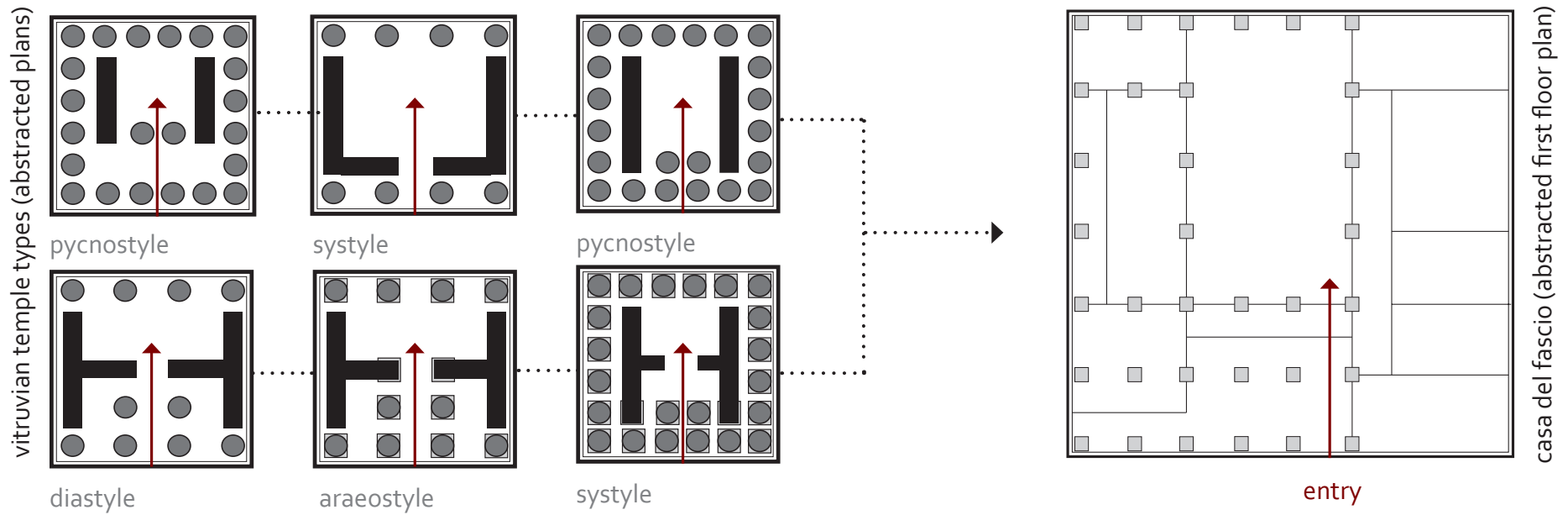

Terragni references Classical forms in the layout of his floor plans, such as the temple layouts from Vitruvius' "Ten Books on Architecture" (above). He modifies these forms to suit the purposes of his program, as well as to incorporate Modernist principles relating to the works of Le Corbusier and others. He deviates from the Classical form in a number of ways, such as the fact that the entry to the Casa del Fascio is not centered, in contrast to the central temple entries of Vitruvius. However, the regularity of the structural grid in the overall scheme is in keeping with Classical values. Indeed, even the half-cube shape of the building references the square, which was part of the "sacred geometry" of Classical architecture.

In addition, the Italian Rationalists in general sought to uphold the high historical standards of Italian architecture and distinguish themselves as superior to modernists from other parts of Europe. Terragni himself wrote: "There is a clear and serene rationalism, most *Mediterranean*, of certain Hellenized buildings, and barbaric rationalism, irritating, of certain typically northern architects: there is a rationalism that gives rise to houses and villas built for a life in the sun, amongst the trees, with flowers, overlooking the waters: and a rationalism that gives an inhuman vision of squalor and nightmares," (Schumacher 54). In essence, Terragni wished to associate the new Fascist architecture with Mediterranean ideals, history and superiority, and he utilized Classical forms in order to achieve this end.

technique [1] - connecting to a mythic past

[argument 2]: The body of the Casa del Fascio is fragmented - a multiplicity of bodies - due to its diverse formal and ideological references and influences, including Modern, Classical, Rationalist, and Fascist.

As has been mentioned, Terragni drew from diverse influences in his design for the Casa del Fascio. In his attempt to incorporate his many motivations, influences and desires into his design, Terragni created a structure that is difficult to categorize. Upon first glance, the half-cube ("square doughnut") shape, rectilinear layout and white exterior seem to suggest that the building is strictly Modernist, but further exploration uncovers many layers of meaning in the spatial layout and facade arrangement. Arguably, the body presented by the Casa del Fascio is fragmented, with conflicting ideologies and motivations at play in its design and execution.

Terragni utilizes typologies and conventions from Renaissance architects, desiring to emulate the harmony and grandeur of Renaissance humanist architecture. However, "during the Renaissance, [architectural] theory was not merely a series of technical precepts but was underlined by metaphysical preoccupations often implicit in the mathematical rules themselves. The mythical, ancient world embodied in the writings of Vitruvius and the visible ruins was never lost sight of. In this Aristotelian world, there could be no split between architectural theory and practice," (Perez-Gomez 470). Trying to marry these ideas with Modernist sensibilities in a Fascist atmosphere, however, there is a disconnect between theory and practice, and between vision/intent and the final product (diagrams, right).

The Casa del Fascio at once reinforces historical references and breaks from them, the conflicting stylistic and ideological systems creating a multiplicity of bodies. In fact, Eisenman categorizes the building as a critical text, in which "facades, plans, and sections can be read as displacements from an architecture of origin, hierarchy, unity, sequence, progression, and continuity to one of fragmentation, disjunction, contingency, alternation, slippage, and oscillation" (298). The diagrams (right) represent the fractured nature of the formal content of Casa del Fascio: the blending of diverse influences, including Vitruvius, has resulted in a fragmented body.

fragmented body: midway point between vitruvius & terragni (plans)

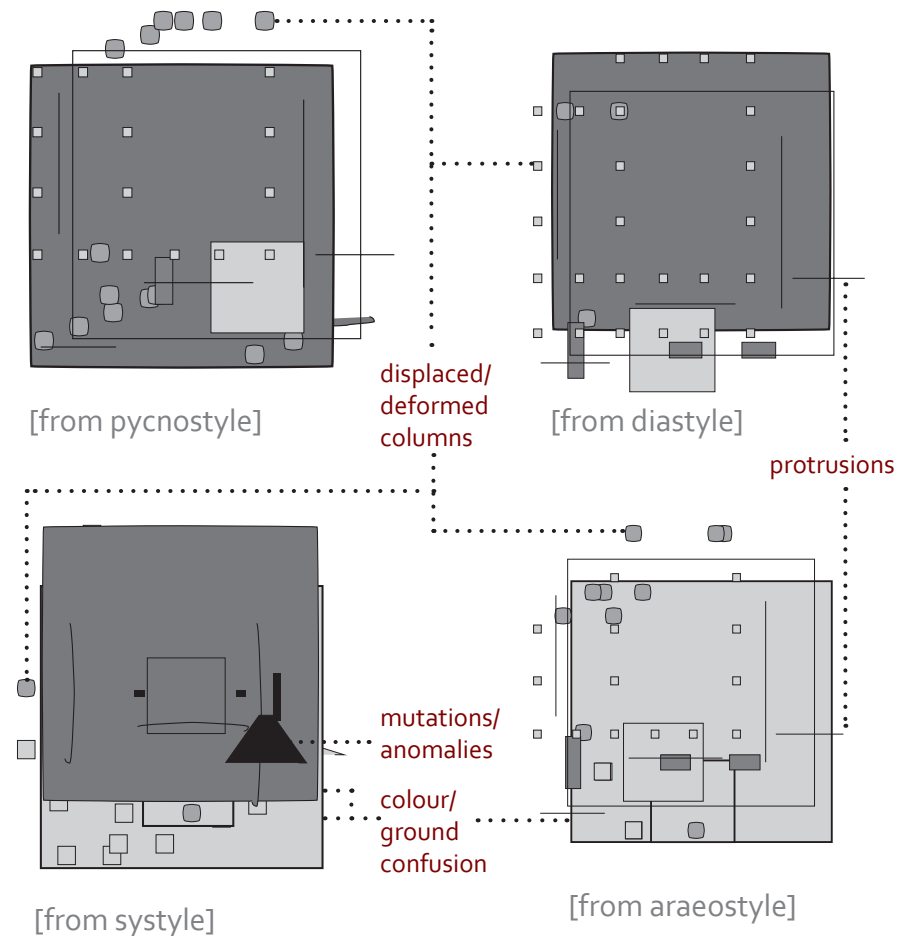

technique [2] - fragmented body

[argument 3]: The form of Casa del Fascio is defined by a hierarchy of access/uses, with the public spaces being interior and the private spaces surrounding them, creating a power dialectic between public/private, interior/exterior and watched/watching.

The Casa del Fascio were meant to provide an indication of political presence within the cities and towns in Italy, reinforcing the power structure that was in place during Fascist rule. They were intended to provide a model for the new Fascist architecture, and as Michel Foucault argues, "disciplinary normalization consists first of all in positing a model, an optimal model that is constructed in terms of a certain result, and the operation of disciplinary normalization consists in trying to get people, movements, and actions to conform to this model, the normal being precisely that which can conform to this norm, and the abnormal that which is incapable of conforming to the norm," (57). In other words, then, the Casa del Fascio were a means by which the Fascist party could control the populace by creating a normative condition. To further Foucault's ideas, then, Terragni's Casa del Fascio helped to establish the new relationship between sovereign (the state/Fascists) and subject (the populace).

power dialectic: hierarchies of power within casa del fascio

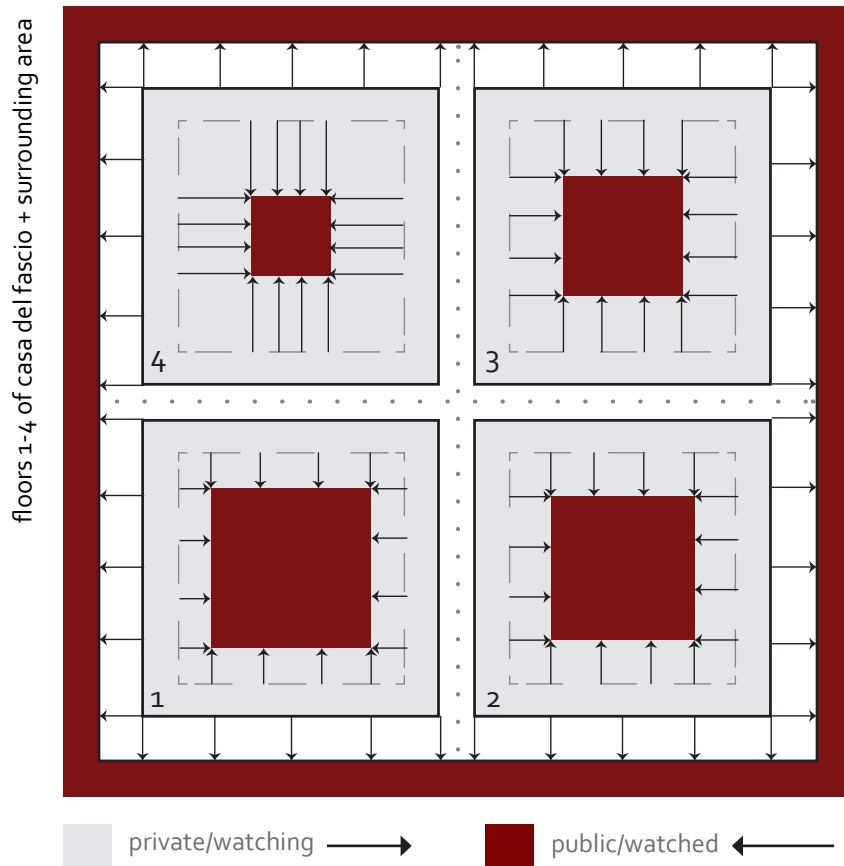

Furthermore, the location and form of the Casa del Fascio sets up a clear boundary between public and private, as well as watched and watching. Located in the centre of Como, the building signifies the Fascist presence at the heart of the city. Within the building itself, however, the public space is in the centre of the building, surrounded by private spaces occupied by Fascist officials: the public space is constantly under watch by the private space.

Terragni himself writes about the participation of the masses in Fascist rallies and activities at the Casa del Fascio: "attendance will not be a philanthropic or charitable activity but a social duty. And the way the organizations, and therefore the departments, are distributed in the building will have to reflect the party statute, which determines, to the smallest detail, the complex political activity, the hierarchy of values and ranks of the members of the Fasci di Combattimento," (Eisenman 266). In other words, the general population was encouraged (or forced) to participate in civic events under the guise of sharing in power, when in reality the power structure was impenetrable and separate from the lives of everyday people.

1



historical influence/precedent [vitruvius] + existing condition + symbols/representations + entry condition

2

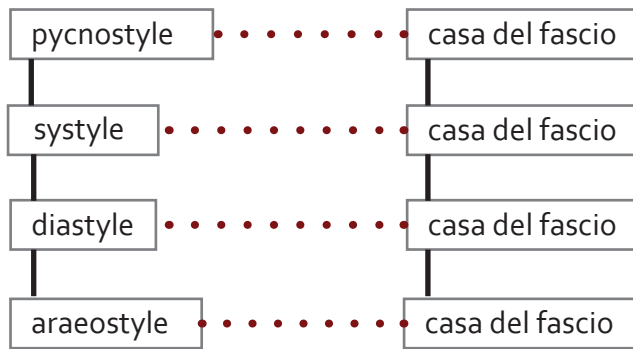

diagrams from part 1 [temple types] + existing condition [casa del fascio]

understanding diagrammatic techniques

The first set of diagrams allows for a comparison between the design of Terragni and the work of one of his influences, Vitruvius. Temple plans and the plan of Casa del Fascio are laid out diagrammatically in order to recognize similar and dissimilar elements within their layouts.

The second set of diagrams takes the first diagrams and finds the midpoint in a transformation between the temple plans and the Casa del Fascio plan. The resulting images partially indicate the fractured body of Terragni's design, as it attempts to incorporate diverse and conflicting historical influences.

The final diagram describes visually the complex power relationships at play in the Casa del Fascio, revealing the dialectic between state/sovereign and subject (as well as watching/watched).

3

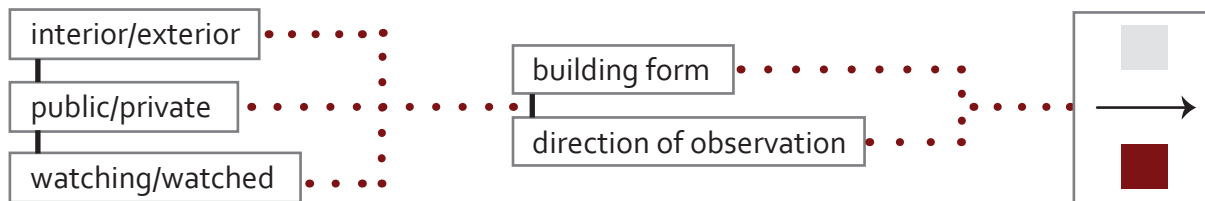

values to be expressed + form of diagrams + symbols/representations

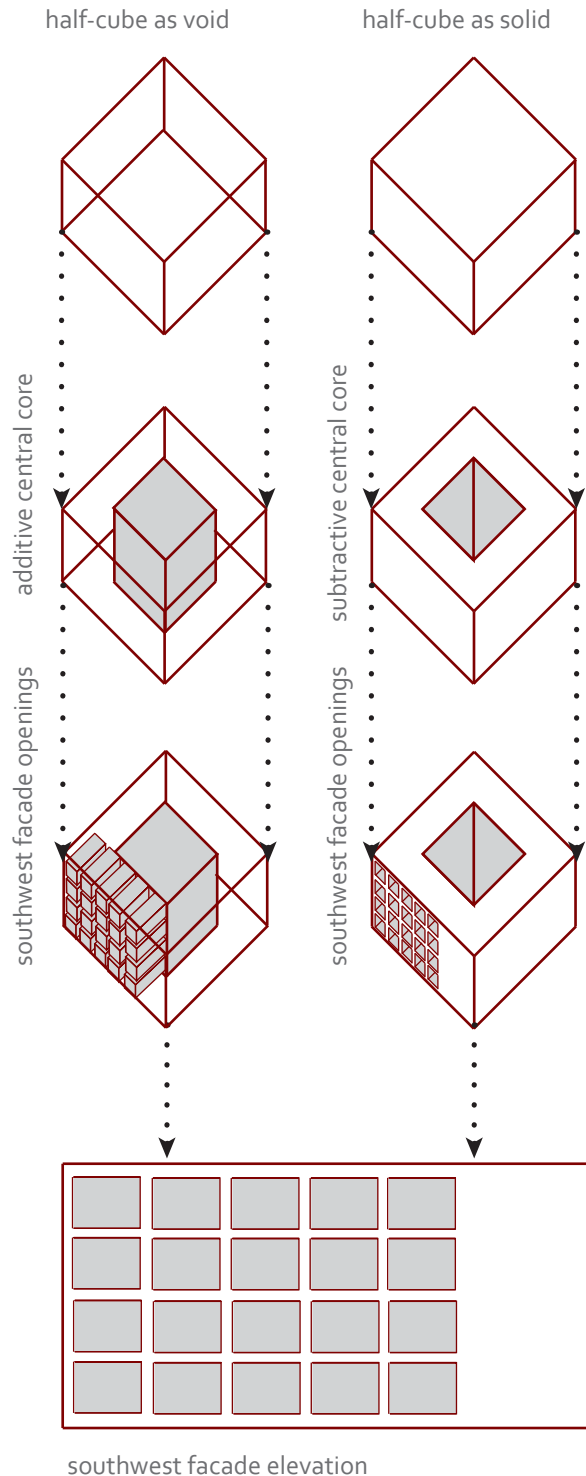

additive/subtractive space

The basic space of the Casa del Fascio has the potential to be read as either a solid or a void. The overall form of the structure is a half-cube, and this volume may be interpreted as having an initial condition that is either solid, allowing interior/interstitial spaces to be subtractive; or void, allowing interstitial spaces to be additive, as is demonstrated in the diagrams (right).

In addition, Eisenman suggests, "both the solid and void cubes imply a center, either as a result of the intersection of four planes or as the result of the relationship between void and solid. Since the Casa del Fascio, in its final dimension, is half a cube, a vertical compression or cutting is implied in the transformation from what was originally a whole cube" (121). Thus, the space of the Casa del Fascio is complex even at its most basic level, allowing multiple readings and experiences of its raw spatial qualities.

spatial implications of plan & facade

In modernist thought, the plan assumed a high level of importance in relation to the construction and shaping of spaces. The plan becomes a "map" marking the procession of the sequence of spaces within a building or enclosure. Eisenman notes that the plan is the sum of "single instances of perception," and the "plan can be seen as a mechanism that generates space as a kinetic and open field, suggesting a new relationship between time and experience" (115). The plans of the Casa del Fascio reference historical typologies, including the Renaissance palazzo, but the movement within these plans differs markedly from that which occurred in their predecessors. For the general public, the "sequence" of spaces is nonexistent, as there is only one place in which they are free to move: the central atrium/courtyard.

Conversely, the façade largely disappeared in modernist spatial thinking. As Lefebvre notes, however, Fascism "placed an increased emphasis on facades, thus opting for total 'spectacularization'" (179). In fact, the Casa del Fascio appears to embody Lefebvre's notion of abstract space; it has homogeneity as its goal, but is multiform. It reduces the 'real' to a plan, "existing in a void and endowed with no other qualities," like "the flatness of a mirror, of an image, of pure spectacle under and absolutely cold gaze" (187). As such, the spatial logic of the building has a complex and disjointed relationship with the plan and the façade, causing the sequence of interior spaces to function outside the expected, normative logic generally dictated by the plan and façade.

formal logic of space - solid/void cube

militarized space: fascist control

As a state building, the Casa del Fascio may be considered a rhetorical gesture of the ruling government. In particular, the structure as a rhetorical exercise in power and control is particularly appropriate in an analysis of the Casa and its connotations. The modernist/rationalist style that Terragni utilized in his design was a relatively new development in architectural theory and practice, and as "Fascism offered itself as an entirely new and modern phenomenon, it could readily align itself with modern architecture, amply buttressed by references to the '*romanita*' and '*mediterraneita*' that these constructions presumably projected" (Ghirardo 468). The Fascist government sought to construct spaces that were uniquely Fascist, while still allowing for references to Italy's storied history. This deliberate pairing of classical and modern allowed the Casa del Fascio to subtly establish the Fascist government in Como as the sole ruling entity and the sole link to the larger Fascist body politic.

The Casa del Fascio were physical manifestations of power within Italian communities, and were meant to be used as public spaces for the general public under Fascist control. Indeed, "Terragni's aim was to create a building that was the spatial representation of a specific aesthetic, ideology and view of history, but also it intended to redefine, through a poetics of spatial experience, the notion of public space under Fascism, in terms of the visualization of the spatial relationship between power and people" (Storchi 233). In his writings about Casa del Fascio, Terragni spoke of the 'disciplined masses' that would gather in the forecourt and atrium of the building, as demonstrated in the diagrams below. Specifically, "in his description of the assembly hall, he had already envisaged an orderly crowd, both inside and outside his Casa del Fascio, intent on listening to party officials or to the voice of the '*Capo*'. His concept of the mass was orderly, as it was given an order through space" (Storchi 242). Henri Lefebvre referred to this concept as the space of social order being hidden in the order of space (242). Truly, the spatiality of the Casa del Fascio left no doubt how the hierarchy of power and influence was constructed and maintained.

[dis]orderly masses: order through space

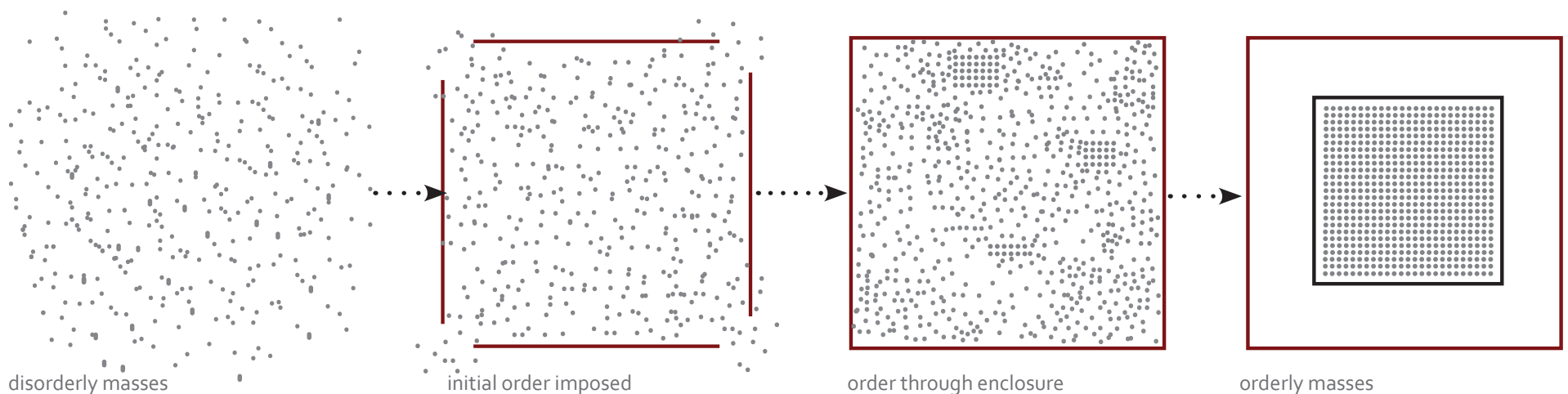

governance of space - structure of control

monumentality & tradition

In addition to its functional status as a state building, the Casa del Fascio fulfilled an important propagandic role for il Duce and the Fascists. The façade and spatiality of the building immediately draw comparisons to monumental structures, and the monumentality of the interior and exterior spaces is carefully constructed and controlled. This poses an interesting dialectic of style and thought as the Rationalists, in spite of their dream of an architectural fresh start and an antimemorial turn of mind, regularly found themselves “summoned to find new ways to commemorate the past” (Schnapp 8). Schnapp further argues that Terragni sought to create a monumentality without style, referring to an archaic vocabulary of funerary monoliths, cubes, crosses and walls founded upon an aesthetic of emotional restraint (9).



delusions of grandeur: house for il duce & the fascists

To expand on the idea of the monumental, Storchi suggests that monumental space constitutes a collective mirror for the members of a society (233). The aim of such spaces is to have “visitors take part in an ideologization of space, contemplate and decipher symbols, and on the basis of their own bodies, experience a total being in a total space” (233). In the Casa del Fascio, the symbols presented in the space mostly include images of Mussolini and the glories of the PNF. Individuals may contemplate these symbols and their own bodies functioning in the space, but the overwhelming control of the Fascist Party leaves little room for interpretation. The Casa del Fascio functions as a monument to Fascism (above).

house of fascism: “casa mia”

In Italian, *casa* means “house;” *la mia casa* means “my house,” while “home” is idiomatically referred to as *casa mia*. In theory, the Casa del Fascio were meant to provide a “home” for the Fascist populace, providing a public space for gathering, socializing and celebrations. Sometimes, the “Case contained the only theater, cinema, or radio in town, as well as a reading room with books and the latest newspapers from all over Italy,” and often “the Case del Fascio served as the only link not just with the world, or even Italy, but with the rest of the local province” (Ghirardo 468). The Fascist populace was meant to dwell within the collective, with the houses of Fascism providing spaces for their dwelling.

Martin Heidegger defines the essence of building as letting dwell; “building accomplishes its essential process in the raising of locales by the joining of their spaces” (361). He further argues that we may only build once we are capable of dwelling (361). The building that Terragni designed and executed was, on the surface, meant to provide a communal dwelling place for the general public. However, the resulting structure was a state building that embodied a space of control, leaving little to no opportunity for dwelling to occur. According to J. Macgregor Wise, “home is not an originary place from which identity arises. It is not the place we ‘come from’; it is a place we are” (297). The Casa del Fascio cannot be a home – a space for dwelling – because it does not allow development of identity, but attempts to impose identity on its “dwellers.” The Casa del Fascio is not *casa mia*, but a house of power and control: it is a house for and a monument to il Duce and the Fascists.

sensations produced by space - the monumental & the idea of home

- Argan, Giulio Carlo. "On the Typology of Architecture," in Kate Nesbitt, Ed. *Theorizing a New Agenda for Architecture*, 1996, 242-246. Print.
- Colomina, Beatriz. "The Medical Body in Modern Architecture," in *Anybody*, 1997, 228-239. Print.
- Eisenman, Peter. "From Object to Relationship II: Casa Giuliani Frigerio: Giuseppe Terragni Casa del Fascio." *Perspecta* 13/14 (1971): 37-65. Print.
- Eisenman, Peter. *Giuseppe Terragni: Transformations, Decompositions, Critiques*. New York: The Monacelli Press Inc., 2003. Print.
- Eisenman, Peter. "Visions' Unfolding: Architecture in the Age of Electronic Media," in Kate Nesbitt, Ed. *Theorizing a New Agenda for Architecture*, 1996, 556-561. Print.
- Foucault, Michel. "25 January 1978," in M. Senellart, Ed. *Security, Territory, Population: Lectures at the College de France 1977-1978*, 2007, 55-86.
- Ghirardo, Diane. "Politics of a Masterpiece: The Vicenda of the Decoration of the Facade of the Casa del Fascio, Como, 1936-39." *The Art Bulletin* 62.3 (1980): 466-478. Print.
- Heidegger, Martin. "Building, Dwelling, Thinking," in D.F. Krell, Ed. *Martin Heidegger Basic Writings*, 1992, 344-363. Print.
- Lefebvre, Henri. "The Production of Space," in K.M. Hays, Ed. *Architecture Theory Since 1968*, 2000, 178-188. Print.
- Morales, Ignasi de Sola. "Weak Architecture," in K.M. Hays, Ed. *Architecture Theory Since 1968*, 2000, 616-623. Print.
- Perez-Gomez, Alberto. Introduction to "Architecture and the Crisis of Modern Science," in K.M. Hays, Ed. *Architecture Theory since 1968*, 2000, 466-475. Print.
- Palladio, Andrea. "Villa Pisani." 1542. Minnesota State University. Web. 5 October 2010.
- Rudolph, Paul. "The Six Determinants of Architectural Form," in C. Jencks and K. Kropf, Eds., *Theories and Manifestoes of Contemporary Architecture*, Wiley-Academy, 2006, p. 213-215. Print.
- Schnapp, Jeffrey. "The Monument without Style (On the Hundredth Anniversary of Giuseppe Terragni's Birth." *Grey Room* 18 (2004): 5-25. Print.

Schumacher, Thomas L. *Surface and Symbol: Giuseppe Terragni and the Architecture of Italian Rationalism*. New York: Princeton Architectural Press, 1991. Print.

Storchi, Simona. " 'Il Fascismo E Una Casa Di Vetro': Giuseppe Terrangi and the Politics of Space in Fascist Italy." *Italian Studies* 62. 2 (2007): 231-245. Print.

Vidler, Anthony. "The Building in Pain: The Body and Architecture in Post-Modern Culture," in *AA Files* 19, 3-10. Print.

Wise, J. Macgregor. "Home: Territory and Identity," in *Cultural Studies*, 2000, 295-310. Print.