

SIEMENS

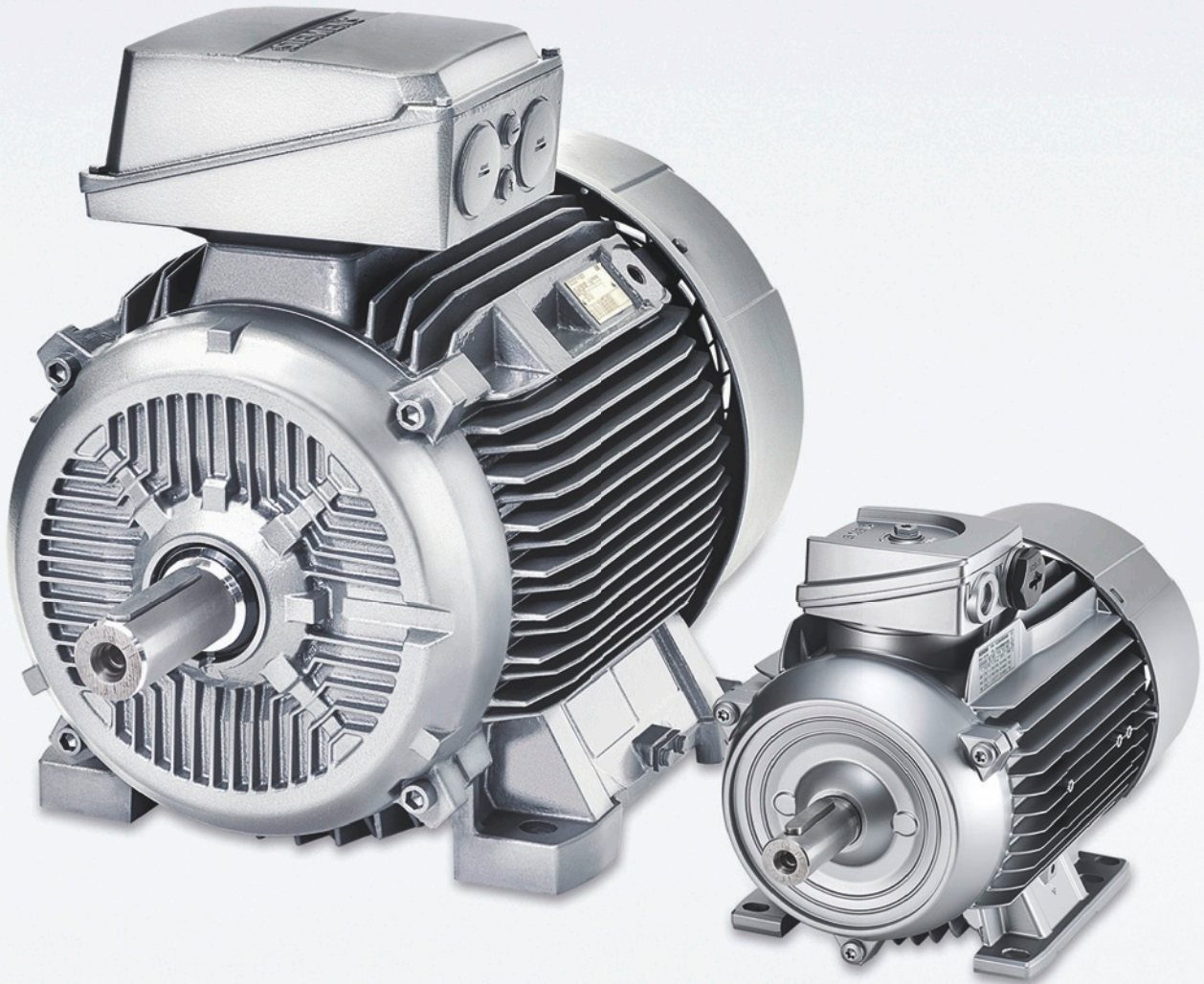

SIMOTICS Motors

SIMOTICS GP, SD, XP, DP Low-Voltage Motors

Type series 1FP1, 1LE1, 1LE5, 1MB1, 1MB5 and 1PC1

Frame sizes 63 to 450 · Power range 0.09 to 1000 kW

Catalog
D 81.1

Edition
12/2021

[siemens.com/drives](https://www.siemens.com/drives)

Related catalogs

SIMOTICS FD D 81.8
Low-Voltage Motors
 Frame sizes 315 to 450
 Power range 200 to 1800 kW
 PDF (E86060-K5581-A181-A5-7600)



SIMOTICS NEMA Motors D 81.2
 Low Voltage AC Motors
 Selection and Pricing Guide
 Further details available on the Internet at:
www.usa.siemens.com/motors

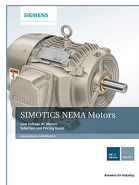

SINAMICS G130 D 11
 Drive Converter Chassis Units
SINAMICS G150
 Drive Converter Cabinet Units
 E86060-K5511-A101-A6-7600



Motion Control Drives D 21.4
 SINAMICS S120 and SIMOTICS
 E86060-K5521-A141-A1-7600



SINAMICS S120 D 21.3
 Chassis Format Converter Units
 Chassis-2 Format Converter Units
 Cabinet Modules, Cabinet Modules-2
SINAMICS S150
 Converter Cabinet Units
 E86060-K5521-A131-A7-7600



Motion Control Drives D 31.1
 SINAMICS Inverters for Single-Axis Drives
 Built-In Units
 E86060-K5531-A111-A1-7600



Industrial Controls IC 10
 SIRIUS
 E86060-K1010-A101-B1-7600



Industry Mall
 Information and Ordering Platform
 on the Internet:
www.siemens.com/industrymall



All catalogs and other information material, such as brochures, manuals and operating instructions for standard drive systems are available up-to-date on the Internet at the following address:

www.siemens.com/drives/catalogs

The listed documentation can be ordered here or it is available in commonly used file formats (PDF, ZIP) for downloading.

SinaSave energy saving/energy efficiency tool

Further information on the subject of energy saving and the SinaSave energy efficiency tool is available at the following address:

www.sinasave.siemens.com

Drive Technology Configurator

The DT Configurator can be used on the Internet without requiring any installation.

The DT Configurator can be found in the Industry Mall at the following address:

www.siemens.com/dt-configurator

The Drive Technology Configurator for gear units, motors, mechanical components, converters, connection systems, control and licenses and system configuration can be found in the Industry Mall main menu, under drive systems, selection and engineering tools.

- Data sheets in up to 7 languages in PDF or RTF format
- 2D/3D dimensional drawings in various formats
- Terminal box drawing and terminal connection diagram
- Operating instructions
- Certificates
- Start-up calculation for SIMOTICS motors
- EPLAN macros

Copper surcharges

The metal factors that are applicable for the copper surcharges are specified in the headers of the current Price List D 81.1 P. Further information about "Metal surcharges" can be found in the appendix to this catalog.



SIEMENS

SIMOTICS GP, SD, XP, DP Low-Voltage Motors

Type series 1FP1, 1LE1, 1LE5, 1MB1, 1MB5 and 1PC1
Frame sizes 63 to 450, power range 0.09 to 1000 kW

Catalog D 81.1 · 12/2021

Dear Customer,

We are pleased to present you with the new Catalog D 81.1 · 12/2021.
The new catalog replaces the old Catalog D 81.1 · 06/2020:

In the catalog, numerous new products have been included, which are marked with "▲" to indicate a brand new listing.

- New chapter „Digitalisation of motors“
 - SIMOTICS CONNECT 400 / SIDRIVE IQ Fleet
- For the SIMOTICS GP/SD standard motors:
 - Expansion of aluminum- and cast-iron series 1LE1 with IE3 Premium Efficiency, 2- to 8-pole, frame sizes 80 to 280
 - Inclusion of 1LE10 aluminum series with IE2 High Efficiency, 6- and 8-pole, frame sizes 63 and 71
- For the SIMOTICS XP explosion-protected motors:
zone 21, 22 and 2 with types of protection Ex tb, Ex tc, Ex ec (Efficiency IE4 bis IE2)
 - Expansion of cast-iron series 1MB15.3, 1MB55.4, 1MB55.3
 - Expansion of aluminum series 1MB10.3, 1MB10.1
 - Inclusion of the 1MB15.7, 1MB55.7, 1MB55.6, 1MB18.3, 1MB58.3

By clicking on the article numbers in each chapter of the catalog PDF, you can go directly to our "Industry Mall".

The products listed in this catalog are also included in the "Industry Mall".

The "Drive Technology Configurator" is updated daily in the Internet at
www.siemens.com/dt-configurator

Up-to-date information about low-voltage motors is available online at:
www.siemens.com/lowvoltagegmotors

You can access our "Industry Mall" online at
www.siemens.com/industrymall

Your personal contact will be glad to receive your suggestions and recommendations for improvement. You can find your representative in our contact person database at www.siemens.com/automation-contact

We hope that you will often enjoy using Catalog D 81.1 · 12/2021 as a selection and ordering reference document and wish you every success with our products and solutions.

With kind regards,



Christoph Nöth
Head of Product Portfolio Management
Siemens AG, Motion Control, Low Voltage Motors, Europe

SIMOTICS GP, SD, XP, DP Low-Voltage Motors

Type series 1FP1, 1LE1, 1LE5, 1MB1, 1MB5 and 1PC1

Motors

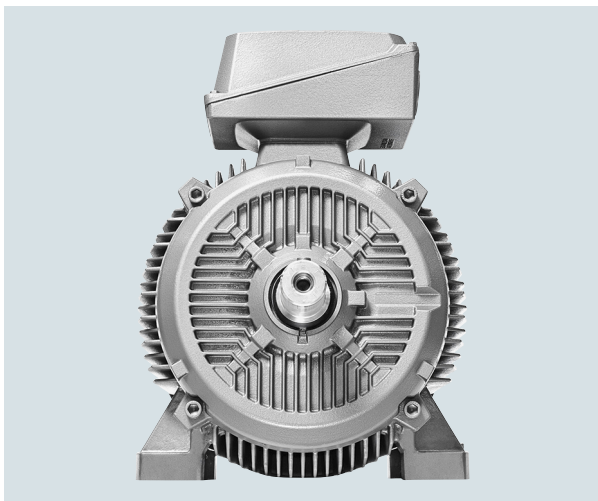

Catalog D 81.1 · 12/2021

Supersedes:
Catalog D 81.1 · 06/2020

Refer to the Industry Mall for current updates of
this catalog:

www.siemens.com/industrymall

Please contact your local Siemens branch.

© Siemens 2021

NEW

By clicking on an Article No., you can access the DT
Configurator to complete the configuration and then you
can get product information and order in the Industry Mall.

Article No.

1LE1504-1AB4

1LE1504-1AB5

Or directly on the Internet in the Industry Mall, e.g. by entering
www.siemens.com/product?1LE1504-1AB4



The products and systems described in
this catalog are manufactured/distributed
under application of a certified quality
management system in accordance with
EN ISO 9001 (04-31-1267 Certified Regis-
tration No. DE-000357 QM). The certificate
is recognized by all IQNet countries.

Introduction

Information regarding efficiency in accordance with
International Efficiency,
Guide to selecting and ordering the motors,
General information, Electrical design, Mechanical version,
Mounting technology

1

Digitalisation of motors

SIMOTICS CONNECT 400
SIDRIVE IQ Fleet

2

SIMOTICS GP and SIMOTICS SD standard motors

3

SIMOTICS SD standard motors next generation

4

SIMOTICS VSD motors for converter operation

5

SIMOTICS XP explosion-protected motors

6

SIMOTICS DP application-specific motors

- Marine motors

7

Appendix

NEMA motors, Industry Services, Partner at Siemens,
Tools and engineering, Index of order codes,
Conversion tables, Metal surcharges,
Conditions of sale and delivery

8

Digital Enterprise

The building blocks that ensure everything works together perfectly in the digital enterprise

Digitalization is already changing all areas of life and existing business models. It is placing greater pressure on industry while at the same time creating new business opportunities. Today, thanks to scalable solutions from Siemens, companies can already become a digital enterprise and ensure their competitiveness.



Industry faces tremendous challenges



Reduce time-to-market

Today manufacturers have to bring products to market at an ever-increasing pace despite the growing complexity of these products. In the past, a major manufacturer would push aside a small one, but now it is a fast manufacturer that overtakes a slow one.



Boost flexibility

Consumers want customized products, but at a price they would pay for a mass-produced item. That only works if production is more flexible than ever before.



Improve quality

To ensure a high level of quality while meeting legal requirements, companies have to establish closed quality loops and enable the traceability of products.



Boost efficiency

Today the product itself needs to be sustainable and environmentally friendly, while energy efficiency in production has become a competitive advantage.



Increase security

Increasing networking escalates the threat to production facilities of cyberattacks. Today more than ever, companies need suitable security measures.



The digital enterprise has already become a reality

To fully benefit from all the advantages of digitalization, companies first have to achieve complete consistency of their data. Fully digitally integrated business processes, including those of suppliers, can help to create a digital representation of the entire value chain. This requires

- the integration of industrial software and automation,
- expansion of the communication networks,
- security in automation,
- and the use of business-specific industrial services.

MindSphere

The cloud-based open IoT operating system from Siemens

With MindSphere, Siemens offers a cost-effective and scalable cloud platform as a service (PaaS) for the development of applications. The platform, designed as an open operating system for the Internet of Things, makes it possible to improve the efficiency of plants by collecting and analyzing large volumes of production data.

Totally Integrated Automation (TIA) Where digitalization becomes reality

Totally Integrated Automation (TIA) ensures the seamless transition from the virtual to the real world. It already encompasses all the necessary conditions for transforming the benefits of digitalization into true added value. The data that will form the digital twin for actual production is generated from a common base.

Digital Plant

Learn more about the digital enterprise for the process industry
www.siemens.com/digitalplant

Digital Enterprise Suite

Learn more about the digital enterprise for the discrete industry
www.siemens.com/digital-enterprise-suite

Integrated Drive Systems

Faster on the market and in the black with Integrated Drive Systems

Integrated Drive Systems are Siemens' trendsetting answer to the high degree of complexity that characterizes drive and automation technology today. The world's only true one-stop solution for entire drive systems is characterized in particular by its threefold integration: Horizontal, vertical, and lifecycle integration ensure that every drive system component fits seamlessly into the whole system, into any automation environment, and even into the entire lifecycle of a plant.

The outcome is an optimal workflow – from engineering all the way to service that entails more productivity, increased efficiency, and better availability. That's how Integrated Drive Systems reduce time to market and time to profit.

Horizontal integration

Integrated drive portfolio: The core elements of a fully integrated drive portfolio are frequency converters, motors, couplings, and gear units. At Siemens, they're all available from a single source. Perfectly integrated, perfectly interacting. For all power and performance classes. As standard solutions or fully customized. No other player in the market can offer a comparable portfolio. Moreover, all Siemens drive components are perfectly matched, so they are optimally interacting.

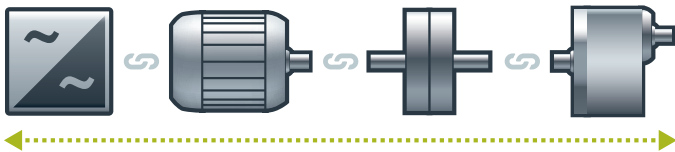

You can boost the availability of your application or plant to up to

99%*
*e.g., conveyor application

Vertical integration

Thanks to **vertical integration**, the complete drive train is seamlessly integrated in the entire automation environment – an important prerequisite for production with maximum value added. Integrated Drive Systems are part of Totally Integrated Automation (TIA), which means that they are perfectly embedded into the system architecture of the entire industrial production process. This enables optimal processes through maximum communication and control.

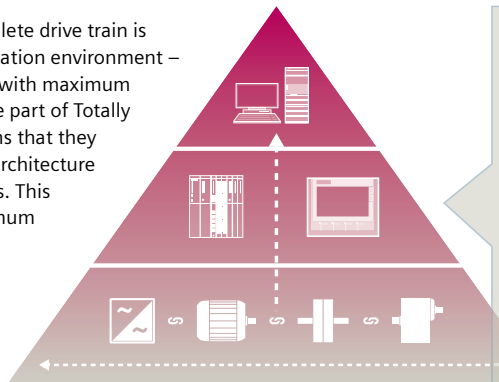

With TIA Portal you can cut your engineering time by up to

30%

Lifecycle integration

Lifecycle integration adds the factor of time: Software and service are available for the entire lifecycle of an Integrated Drive System. That way, important optimization potential for maximum productivity, increased efficiency, and highest availability can be leveraged throughout the system's lifecycle – from planning, design, and engineering to operation, maintenance, and all the way even to modernization.

With Integrated Drive Systems, assets become important success factors. They ensure shorter time to market, maximum productivity and efficiency in operation, and shorter time to profit.

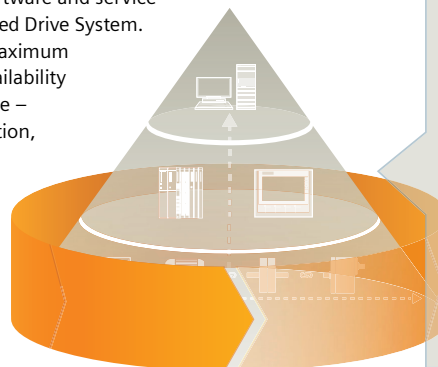

With Integrated Drive Systems you can reduce your maintenance costs by up to

15%

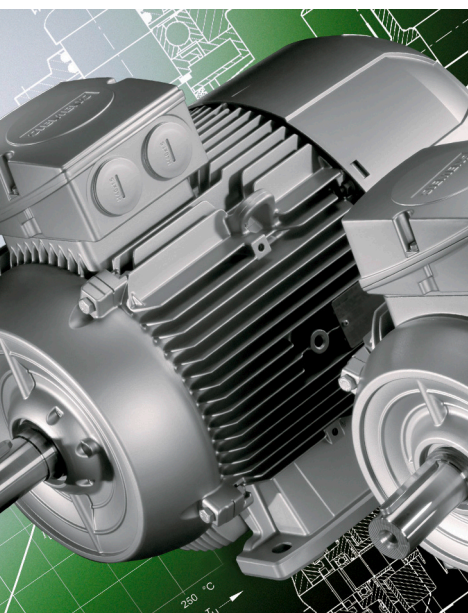

1/2	SIMOTICS motors	1/46	Mechanical version
1/2	Innovative drive technology for all industries, applications and power classes	1/46	Types of construction
1/4	SIMOTICS Digital Data App	1/48	Flange dimensions
1/5	Information regarding efficiency in accordance with International Efficiency	1/49	Shaft and rotor
1/5	Efficiency classes and efficiencies according to IEC 60034-30-1	1/51	Measures for gear mounting
1/7	Guide to selecting and ordering the motors	1/52	Balance and vibration severity
1/7	Catalog orientation and drive selection	1/53	Noise levels for line operation
1/13	General information	1/54	Bearings and lubrication
1/13	Cut-away diagram of a low-voltage motor	1/77	T-Drain – adjustable drainage of condensed water
1/14	Colors and paint finish	1/78	Lifting eyes and transport
1/17	Packaging and dispatch	1/79	Mounting technology
1/17	Safety notes and documentation	1/79	Preparation for mountings
1/17	Test certificates	1/80	Modular technology
1/18	Extension of the liability for defects	1/80	• Separately driven fan
1/19	Versions in accordance with standards and specifications	1/81	• Brakes
1/23	CHEMSTAR	1/82	• BFK458 spring-operated disk brake
1/24	Electrical design	1/86	• KFB spring-operated brake
1/24	Voltages, currents and frequencies	1/89	• SFB-SH solenoid double-disk spring-operated brake
1/24	Powers	1/92	• Configuration of motors with brakes
1/25	Rating plate and additional rating plates	1/93	• FDW/FDX spring-operated brake
1/26	Efficiency and power factor	1/99	Special technology
1/26	Rated speed and direction of rotation, rated torque	1/99	• LL 861 900 220 rotary pulse encoder
1/27	Converter operation	1/100	• HOG 9 DN 1024 I rotary pulse encoder
1/28	Windings and insulation	1/101	• POG 9 rotary pulse encoder
1/30	Coolant temperature and installation altitude	1/102	• POG 10 DN 1024 I rotary pulse encoder
1/31	Heating and ventilation	1/103	• HOG 10 D 1024 I rotary pulse encoder
1/33	Motor protection	1/104	• Sendix 5020 rotary pulse encoder
1/36	Connection, circuit and terminal boxes	1/105	• Rotary pulse encoders for SIL2, SIL3 safety applications
1/45	Degrees of protection	1/105	- Sendix 5834 FS2/FS3 rotary pulse encoder
		1/106	- HOGS 100 S rotary pulse encoder
		1/106	- FSI 862 rotary pulse encoder
		1/107	• XSI 850 rotary pulse encoder
		1/107	• XHI 861 rotary pulse encoder
		1/108	• Backstop, protective cover
		1/109	Dimensions and weights of the mountings

Introduction

SIMOTICS motors

Innovative drive technology for all industries, applications and power classes

Overview

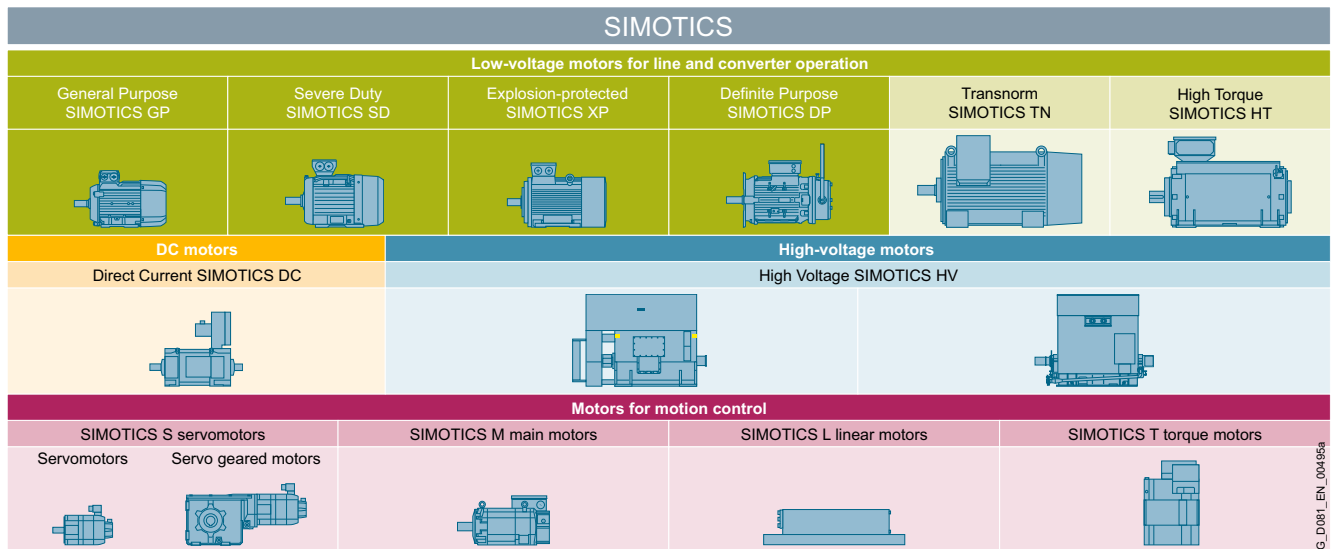

G_D081_EN_004956

SIMOTICS motors

With SIMOTICS, Siemens has the most comprehensive portfolio of electric motors worldwide. From energy-efficient, low-voltage motors through servomotors with high dynamic performance up to well-proven DC motors and powerful high-voltage motors. Innovative drive technology for all industries, applications and power classes.

Outstanding performance, quality, efficiency, and compactness.

The SIMOTICS motor portfolio:

- SIMOTICS Low-Voltage Motors for line and converter operation:
For standard applications with low to high motor power ratings
- SIMOTICS Motion Control motors:
For highly dynamic and extremely precise applications in mechanical engineering
- SIMOTICS DC motors:
For DC applications
- SIMOTICS High-Voltage Motors:
For line and converter operation in standard applications with high to very high motor power ratings.

SIMOTICS Low-Voltage Motors for line and converter operation

SIMOTICS Low-Voltage Motors are the right choice for solving drive tasks efficiently and reliably. In contrast to Motion Control motors, which are additionally characterized by very high dynamic response and precision, the more favorably priced low-voltage motors are predestined for continuous or periodic, as well as powerful motions with fixed or variable speed, such as in pumps, fans, compressors, conveyor belts, lifts, hoisting and traversing gear, winders, mixers, kneaders and centrifuges.

SIMOTICS Low-Voltage Motors are characterized by very high reliability, ruggedness, and efficiency in operation.

They are available in diverse series and versions, which means that the appropriate motor can always be found for any application in an industrial or commercial environment, as well as in building management systems, shipbuilding and infrastructure.

SIMOTICS Low-Voltage Motors comply with the most important relevant standards and guidelines and are available in IEC, NEMA, and APAC versions. They can be used all over the world, and have a global, long-term spare parts service. For these reasons, they provide a sustainable basis for export-oriented, globally operating companies to enable them to conduct their international business efficiently.

Overview

SIMOTICS GP – General Purpose motors are the most economical solution for use under standard environmental conditions. Typically, these motors have an aluminum housing and are characterized by their low weight. SIMOTICS GP motors are available in the power range from 0.09 to 45 kW.

Available motor variants:

- Induction motors, optimized for line operation
 - in efficiency classes IE4, IE3, IE2, IE1
 - as a standards-compliant version or compact version with increased power (IE3, IE2, IE1)
 - as a 2-, 4-, 6-, 8-pole version
 - as pole-changing motors
 - as an APAC version for use in the ASEAN Pacific region (IE3, IE2)
 - as a NEMA version for use in the NAFTA area
 - electrically (mechanically acc. to IEC): Eagle Line
 - electrically and mechanically
 - can optionally be run on a converter
- Motors optimized for operation on frequency converters
 - as a SIMOTICS GP – VSD10 line induction motor
 - as a SIMOTICS GP – VSD4000 line synchronous reluctance motor for particularly efficient operation in conjunction with SINAMICS converters.
- Different types of construction, voltage versions, and a wide variety of options/add-ons for precise adaptation of the motors to application and customer-specific requirements.

SIMOTICS SD – Severe Duty motors have a rugged cast-iron housing, which means that they are also suitable for use in harsh to very harsh environments. With a wide power range from 0.09 to 1000 kW, SIMOTICS SD motors are the basis for machine and plant builders and owners who require a universal motor for flexible requirements and conditions of use.

Available motor variants:

- Induction motors, optimized for line operation
 - in efficiency classes IE4, IE3, IE2, IE1
 - standards-compliant version or compact version with increased power (IE3, IE2, IE1)
 - as a 2-, 4-, 6-, 8-pole version
 - as an APAC version for use in the ASEAN Pacific region (IE3, IE2)
 - as a NEMA version for use in the NAFTA area
 - electrically (mechanically acc. to IEC): Eagle Line
 - electrically and mechanically
 - can optionally be run on a converter
- Motors optimized for operation on frequency converters
 - as a SIMOTICS SD – VSD10 line induction motor
 - as a SIMOTICS SD – VSD4000 line synchronous reluctance motor for particularly efficient operation in conjunction with SINAMICS converters.
- Basic Line and particularly rugged Performance Line
- Different types of construction, voltage versions, and a very wide variety of options/add-ons for precise adaptation of the motors to application and customer-specific requirements.

SIMOTICS SD – next generation is the next innovation step in low-voltage motors.

In particular, these motors offer the following advantages for customers:

- More efficiency in the engineering process due to the Digital Twin Concept.
- Further increase in availability due to the Smart Motor Concept.

SIMOTICS XP – Explosion Proof motors are designed for use in hazardous environments. For all conditions of use and hazard zones, e.g. in explosive gas atmospheres of the chemical/petrochemical sector or in explosive dust atmospheres in the mining or food and beverage sectors, there are suitable motor versions in aluminum and cast iron that ensure maximum safety and satisfy the relevant standards and regulations.

SIMOTICS XP motors are available in the power range from 0.09 to 460 kW.

Available motor variants:

- Motors for use in Zones 1, 2, 21 and 22
- Induction motors optimized for line operation
 - in efficiency classes IE3, IE2, IE1
 - as a 2-, 4-, 6-, 8-pole version
 - as a NEMA version for use in the NAFTA area
- For motors suitable for line and converter operation
- Basic Line and particularly rugged Performance Line in a cast-iron housing
- Different types of construction, voltage versions, and a wide variety of options/add-ons for precise adaptation of the motors to application and customer-specific requirements.

SIMOTICS DP – Definite Purpose motors are low-voltage motors for application-specific, customized and industry-specific use.

They have the required respective industry-specific properties and certificates.

SIMOTICS DP motors:

- Crane motors for use in cranes (primarily for hoisting gear)
- Marine motors for use on ships
- Steel plant motors for use in the steel industry
- Roller table motors for roller table applications in the steel industry

SIMOTICS TN – Transnorm motors are low-voltage motors for line and converter operation in a cast-iron housing with higher power ratings up to 5000 kW from shaft height 315. In non-standard (Transnorm) motors, the assignment of the power rating and shaft extensions to frame size is not standardized.

SIMOTICS HT – High Torque motors are permanent-magnet synchronous motors and are used in applications that require extremely powerful drives without gear units, even at low speeds.

Introduction

SIMOTICS motors

1

SIMOTICS Digital Data App

Overview

The SIMOTICS Digital Data App provides access to technical data, spare part information, and operating instructions for SIMOTICS GP/SD motors any time any place. This gives our customers quick access to important contents of the digital twin. This simplifies our customers' processes.

By scanning the data matrix code on the additional rating plate of the motor, the relevant electrical and mechanical data can be displayed for this motor.

- Electronic and mechanical rating plate data
- Additional motor data
- Service information, e.g. display of the spare part list
- Display of the ordering options installed
- Documentation and manuals

The SIMOTICS Digital Data App is available for Apple and Android devices and can be installed from the respective stores. To do this, please scan the appropriate QR code.

Benefits

- Shorter commissioning and service times
- Fast access to relevant service information
- Online availability of the motor data for integration into ERP systems



Overview

Harmonization of the efficiency classes

Various energy efficiency standards exist worldwide for induction motors. To promote global standardization, the international standard IEC 60034-30-1:2014 (Rotating electrical machines – Part 30-1: Efficiency classes of single-speed, three-phase, cage-induction motors (IE code) were defined and are used as the basis for local standards in most countries. Only the NAFTA countries USA, Canada, and Mexico¹⁾ use the differing standards of NEMA MG1. Standard IEC 60034-30-1:2014 divides low-voltage induction motors into efficiency classes IE1 to IE4.

Applicability (excerpt)

- Low-voltage motors up to 1000 V (50/60 Hz in line operation)
- Power rating: 0.12 to 1000 kW; with 2, 4, 6, or 8 poles
- Operating mode: S1

The efficiencies in IEC 60034-30-1 are based on the method for determining losses according to IEC 60034-2-1:2014.

IE efficiency classes

The efficiency classes are grouped according to the following nomenclature (IE = International Efficiency):

- IE1 (Standard Efficiency)
- IE2 (High Efficiency)
- IE3 (Premium Efficiency)
- IE4 (Super Premium Efficiency)

IEC 60034-30-1 EU and other countries	NEMA MG1 NAFTA (USA, Canada, Mexico ¹⁾)	GB 18613-2020 China
IE4		Grade 2 (IE4)
IE3	Premium Efficient (60 Hz)	Grade 3 (IE3)
IE2	Energy Efficient (60 Hz)	

Comparison of IE efficiency classes

Note:

All efficiency classes are stated with reference to 50 Hz data (unless specified otherwise).

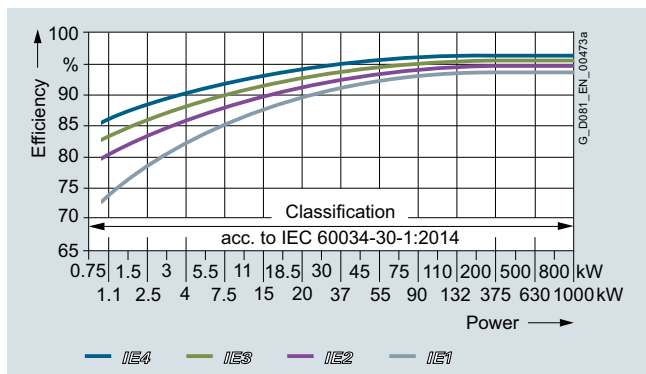

IE1-IE4 efficiencies, 4-pole, 50 Hz, depending on the power

Minimum efficiencies according to IEC 60034-30-1:2014

Rated power $P_{rated, 50 Hz}$ kW	Efficiency η in %							
	IEC IE class							
	IE1 – Standard Efficiency				IE2 – High Efficiency			
	2-pole	4-pole	6-pole	8-pole	2-pole	4-pole	6-pole	8-pole
0.18	52.8	57.0	45.5	38.0	60.4	64.7	56.6	45.9
0.20	54.6	58.5	47.6	39.7	61.9	65.9	58.2	47.4
0.25	58.2	61.5	52.1	43.4	64.8	68.5	61.6	50.6
0.37	63.9	66.0	59.7	49.7	69.5	72.7	67.6	56.1
0.40	64.9	66.8	61.1	50.9	70.4	73.5	68.8	57.2
0.55	69.0	70.0	65.8	56.1	74.1	77.1	73.1	61.7
0.75	72.1	72.1	70.0	61.2	77.4	79.6	75.9	66.2
1.1	75.0	75.0	72.9	66.5	79.6	81.4	78.1	70.8
1.5	77.2	77.2	75.2	70.2	81.3	82.8	79.8	74.1
2.2	79.7	79.7	77.7	74.2	83.2	84.3	81.8	77.6
3	81.5	81.5	79.7	77.0	84.6	85.5	83.3	80.0
4	83.1	83.1	81.4	79.2	85.8	86.6	84.6	81.9
5.5	84.7	84.7	83.1	81.4	87.0	87.7	86.0	83.8
7.5	86.0	86.0	84.7	83.1	88.1	88.7	87.2	85.3
11	87.6	87.6	86.4	85.0	89.4	89.8	88.7	86.9
15	88.7	88.7	87.7	86.2	90.3	90.6	89.7	88.0
18.5	89.3	89.3	88.6	86.9	90.9	91.2	90.4	88.6
22	89.9	89.9	89.2	87.4	91.3	91.6	90.9	89.1
30	90.7	90.7	90.2	88.3	92.0	92.3	91.7	89.8
37	91.2	91.2	90.8	88.8	92.5	92.7	92.2	90.3
45	91.7	91.7	91.4	89.2	92.9	93.1	92.7	90.7
55	92.1	92.1	91.9	89.7	93.2	93.5	93.1	91.0
75	92.7	92.7	92.6	90.3	93.8	94.0	93.7	91.6
90	93.0	93.0	92.9	90.7	94.1	94.2	94.0	91.9
110	93.3	93.3	93.3	91.1	94.3	94.5	94.3	92.3
132	93.5	93.5	93.5	91.5	94.6	94.7	94.6	92.6
160	93.8	93.8	93.8	91.9	94.8	94.9	94.8	93.0
200 ... 1000	94.0	94.0	94.0	92.5	95.0	95.1	95.0	93.5

Rated power $P_{rated, 50 Hz}$ kW	Efficiency η in %							
	IEC IE class							
	IE3 – Premium Efficiency				IE4 – Super Premium Efficiency			
	2-pole	4-pole	6-pole	8-pole	2-pole	4-pole	6-pole	8-pole
0.18	65.9	69.9	63.9	58.7	70.8	74.7	70.1	67.2
0.20	67.2	71.1	65.4	60.6	71.9	75.8	71.4	68.4
0.25	69.7	73.5	68.6	64.1	74.3	77.9	74.1	70.8
0.37	73.8	77.3	73.5	69.3	78.1	81.1	78.0	74.3
0.40	74.6	78.0	74.4	70.1	78.9	81.7	78.7	74.9
0.55	77.8	80.8	77.2	73.0	81.5	83.9	80.9	77.0
0.75	80.7	82.5	78.9	75.0	83.5	85.7	82.7	78.4
1.1	82.7	84.1	81.0	77.7	85.2	87.2	84.5	80.8
1.5	84.2	85.3	82.5	79.7	86.5	88.2	85.9	82.6
2.2	85.9	86.7	84.3	81.9	88.0	89.5	87.4	84.5
3	87.1	87.7	85.6	83.5	89.1	90.4	88.6	85.9
4	88.1	88.6	86.8	84.8	90.0	91.1	89.5	87.1
5.5	89.2	89.6	88.0	86.2	90.9	91.9	90.5	88.3
7.5	90.1	90.4	89.1	87.3	91.7	92.6	91.3	89.3
11	91.2	91.4	90.3	88.6	92.6	93.3	92.3	90.4
15	91.9	92.1	91.2	89.6	93.3	93.9	92.9	91.2
18.5	92.4	92.6	91.7	90.1	93.7	94.2	93.4	91.7
22	92.7	93.0	92.2	90.6	94.0	94.5	93.7	92.1
30	93.3	93.6	92.9	91.3	94.5	94.9	94.2	92.7
37	93.7	93.9	93.3	91.8	94.8	95.2	94.5	93.1
45	94.0	94.2	93.7	92.2	95.0	95.4	94.8	93.4
55	94.3	94.6	94.1	92.5	95.3	95.7	95.1	93.7
75	94.7	95.0	94.6	93.1	95.6	96.0	95.4	94.2
90	95.0	95.2	94.9	93.4	95.8	96.1	95.6	94.4
110	95.2	95.4	95.1	93.7	96.0	96.3	95.8	94.7
132	95.4	95.6	95.4	94.0	96.2	96.4	96.0	94.9
160	95.6	95.8	95.6	94.3	96.3	96.6	96.2	95.1
200	95.8	96.0	95.8	94.6	96.5	96.7	96.3	95.4
250	95.8	96.0	95.8	94.6	96.5	96.7	96.5	95.4
315 ... 1000	95.8	96.0	95.8	94.6	96.5	96.7	96.6	95.4

¹⁾ Additionally required NOM certification.

Introduction

Information regarding efficiency in accordance with International Efficiency

Efficiency classes and efficiencies according to IEC 60034-30-1

1

Overview

Background information

Comprehensive laws have been introduced in the European Union with the objective of reducing energy consumption and therefore CO₂ emissions. EU Regulations 640/2009 and 2019/1781 concern the energy consumption or efficiency of induction motors in the industrial environment. This regulation is in force in every country of the European Economic Area until June 30, 2021.

Effective July 1, 2021, the new regulation (EU) 2019/1781 will come into force. The main contents of and exceptions to both regulations are explained below.

Motor exclusively for use in transportation equipment for passenger and freight transportation corresponding to EVPG §1

To ensure that a "marine" motor (with "marine" option Exx and re-ally use in a ship) will be considered as an exception from EU regulation it's necessary to add option D23 (Motor exclusively for use in transportation equipment for passenger and freight transportation corresponding to EVPG §1 dated February 27, 2008).

Train motors (with option code I90, L91 and L92) are totally designed for use only in a rail vehicle, and therefore option code D23 is not needed.

For more information on internationally applicable standards and legal requirements, visit:

www.siemens.com/international-efficiency

Regulation (EC) 640/2009

Exceptions

- Motors that are designed to be operated totally submerged in a liquid;
- Motors fully integrated into a product (e.g. a gear unit, pump, fan or compressor) whose energy efficiency cannot be measured independently of the product;
- Motors that are specially designed for operation under the following conditions:
 - At altitudes greater than 4000 meters above sea level;
 - At ambient temperatures above 60 °C;
 - At maximum operating temperatures above 400 °C;
 - At ambient temperatures below -30 °C
 - With cooling liquid temperatures at the product intake of below 0 °C or above 32 °C;
 - In hazardous areas in the context of Directive 2014/34/EU of the European Parliament and Council;
- Brake motors

The following motors are not affected:

- Pole-changing motors
- Synchronous motors
- Motors for intermittent duty S2 to S9
- Single-phase motors
- Motors specially developed for converter operation in accordance with IEC 60034-25

The following changes came into effect on the dates below:

From January 1, 2015:

Compliance with the legally required minimum efficiency class IE3 for a power range from 7.5 to 375 kW (2-, 4-, 6-pole) or, as an alternative, IE2 motor plus frequency converter.

From January 1, 2017:

Compliance with the legally required minimum efficiency class IE3 for a power range from 0.75 to 375 kW (2-, 4-, 6-pole) or, as an alternative, IE2 motor plus frequency converter.

From July 1, 2021:

Compliance with the legally required minimum efficiency class IE2 for a power range from 0.12 to 0.75 kW (2-, 4-, 6-, and 8-pole), exception: Ex eb motors

Compliance with the legally required minimum efficiency class IE3 for a power range from 0.75 to 1000 kW (2-, 4-, 6- and 8-pole), exception: Ex eb motors

From July 1, 2023:

Compliance with the legally required minimum efficiency class IE2 for a power range from 0.12 to 1000 kW (2-, 4-, 6- and 8-pole) of Ex eb motors with increased safety and of single-phase motors with a rated output power of at least 0.12 kW.

Compliance with the legally required minimum efficiency class IE4 for a power range of 75 kW to 200 kW (2-, 4-, 6-pole). Exception: Motors with a brake, Ex eb motors with increased safety or other explosion-protected motors.

Changes according to EU motor regulation 640/2009 Motor series SIMOTICS VSD10 (1LE1092/1LE1592) and VSD4000 (1FP10/1FP15) are the preferred motor types for converter operation.

New regulation (EU) 2019/1781

Exceptions

- Motors that are designed to be operated totally submerged in a liquid
- Motors fully integrated into a product (e.g. a gear unit, pump, fan or compressor) whose energy efficiency cannot be measured independently of the product
- Motors that are specially designed for operation under the following conditions:
 - At altitudes greater than 4000 meters above sea level
 - Where ambient temperatures exceed 60 °C
 - At maximum operating temperatures above 400 °C
 - At ambient temperatures below -30 °C
 - With cooling liquid temperatures at the product intake of below 0 °C or above 32 °C
 - In hazardous areas as defined in Directive 2014/34/EU of the European Parliament and Council that are designed and certified for underground mining applications
 - Motors with an integrated brake that is an integral part of the interior motor structure and can neither be removed or powered from a separate source during motor efficiency testing.
 - Motors with an integrated speed control (compact drives), whose energy efficiency cannot be tested independently of the speed control

The following motors are not affected:

- Pole-changing motors
- Synchronous motors
- Totally enclosed, naturally ventilated motors (TENV motors);
- Motors specially developed for converter operation in accordance with IEC 60034-25

Other potential restrictions as described in the technical documentation may apply to converter operation and must be taken into account!

The following are generally recommended for converter operation:

- Motor temperature detection by embedded temperature sensor
- Bearing insulation with frame size 225 and larger

Note:

Different minimum efficiency class requirements apply in China, Korea, and Australia. Other countries will be available soon.

Motors for the North American market

The Energy Policy Act (EPAAct) was superseded in December 2010 by the Energy Independence Security Act (EISA). The following motors must fulfill the NEMA Premium Efficient Level:

- 1 hp (0.75 kW) ... 500 hp (373 kW): 2-, 4-pole
- 1 hp (0.75 kW) ... 350 hp (261 kW): 6-pole
- 1 hp (0.75 kW) ... 250 hp (186 kW): 8-pole
- 2-, 4-, 6- and 8-pole
- ≤ 600 V
- NEMA Design A, B, or C. IEC Design N or H

For details, see NEMA MG1, Table 12-11 and Table 12-12.

Abbreviations

NEMA: National Electrical Manufacturers Association

IEC: International Electrotechnical Commission

EEA: European Economic Area

Overview

Steps for drive selection

Step 1	Orientation and general technical information	
Technical requirements for the motor	Rated frequency and rated voltage	3 AC 50/60 Hz, 400, 500 or 690 V
	Operating mode	Standard duty (continuous duty S1 according to EN 60034-1)
	Degree of protection or type of explosion protection required	IP..
	Rated speed (No. of poles)	$n = \dots\dots\dots$ rpm
	Rated power	$P = \dots\dots\dots$ kW
	Rated torque	$T = P \cdot 9550/n = \dots\dots\dots$ Nm
	Type of construction	IM..
Step 2	Preselection in accordance with the application	
Determination of the installation conditions and definition of the application, if necessary	Ambient temperature	≤ 40 °C
	Installation altitude	≤ 1000 m
	Factors for derating	None
		Determine the factor for derating (for reduction factor, see "Coolant temperature and installation altitude" on page 1/30)
Cross-reference to other motors	These include motors for special requirements in the area of explosion protection and applications or motors according to the NEMA standard.	
Step 3	Preliminary selection of the motor	
Determination of the range of possible motors	Select the frame size and therefore the possible motors on the basis of the following parameters: efficiency class, cooling method, degree of protection, rated power, rated speed and rated torque range. <u>Note:</u> The standard temperature range of the motors is from -20 to +40 °C.	

Layout of the selection and ordering tables and description of the columns of the table headers

Power, frame size, temperature class													Operating values at rated power		Article No., add. data					
Table header – Meaning																				
P_{rated} 50 Hz	P_{rated} 60 Hz	P_{rated} 60 Hz	Frame size	n_{rated} 50 Hz	T_{rated} 50 Hz	Different IE class	CC No. CC032A	η_{rated} 50 Hz, 4/4	η_{rated} 50 Hz, 3/4	η_{rated} 50 Hz, 2/4	$\cos\phi_{\text{rated}}$ 50 Hz, 4/4	I_{rated} 50 Hz, 400 V	$T_{\text{LR}}/T_{\text{rated}}$	$I_{\text{LR}}/I_{\text{rated}}$	T_B/T_{rated}	L_{pFA} 50 Hz	L_{WA} 50 Hz	Article No.	m IM B3	J
kW	kW	hp	FS	rpm	Nm			%	%	%		A				dB (A)	dB (A)		kg	kgm ²
Rated power at 50 Hz	Rated power at 60 Hz	Rated power at 60 Hz	Frame size	Rated speed at 50 Hz	Rated torque at 50 Hz	Efficiency class according to IEC 60034-30-1	CC No. CC032A	Efficiency at 50 Hz, 4/4-load	Efficiency at 50 Hz, 3/4-load	Efficiency at 50 Hz, 2/4-load	Power factor at 50 Hz, 4/4-load	Rated current at 400 V, 50 Hz	Locked-rotor torque on direct switch-on as a multiple of the rated torque	Locked-rotor current on direct switch-on as a multiple of the rated current	Breakdown torque on direct switch-on as a multiple of the rated torque	Measuring-surface sound pressure level at 50 Hz	Sound power level at 50 Hz	Article number	Weight for type of construction IM B3, approx.	Moment of inertia

Legend:

Primary key
Standard values for all motors
Specially for NEMA Energy Efficient MG1 motors, Table 12-11 or NEMA Premium Efficient MG1 motors, Table 12-12

Note on pole-changing motors:

The operating values are specified here for the rated power for the two different pole numbers.

Step 4	Detailed selection of the motor in the selection and ordering data tables	
Determination of the basic Article No. of the motor	Determine the motor Article No. according to the following parameters: rated power, rated speed, rated torque and rated current from the "Selection and ordering data" for the motors that have already been identified as possibilities.	
Step 5	Selection of the special versions or options	
Completing the motor Article No.	Determine special versions and the associated order codes (e.g. special voltages and types of construction, motor protection and degrees of protection, windings and insulation, colors and paint finish, mountings and mounting technology, etc.).	
Step 6	Additional information for motor selection	
Checking the required dimensions	The dimensions are specified in each catalog section under the heading of "Dimensions".	
Selection of the frequency converter, if required	Article No. of the converter as well as its selection, see Catalogs D 11, D 18.1, D 21.3, D 31.1, D 31.2 and D 31.5.	

Introduction

Guide to selecting and ordering the motors

Catalog orientation and drive selection

1

Overview

Steps for drive selection in the catalog

Step 1	Step 2	Step 3	Step 4	Step 5	Step 6	Catalog section/ page
Introduction						1
SIMOTICS CONNECT 400 / SIDRIVE IQ Fleet						3
SIMOTICS GP and SIMOTICS SD standard motors						3
Orientation						3/2
IE4 Super Premium Efficiency						3/2
• Aluminum series SIMOTICS GP 1LE1004 – self-ventilated or forced-air cooled						3/8
• Cast-iron series SIMOTICS SD 1LE1504 Basic Line – self-ventilated or forced-air cooled						3/9
• Cast-iron series SIMOTICS SD 1LE1604 Performance Line – self-ventilated or forced-air cooled						3/11
IE3 Premium Efficiency						3/13
• Aluminum series SIMOTICS GP 1LE1003 – self-ventilated						3/13
• Aluminum series SIMOTICS GP 1LE1003 with increased power – self-ventilated						3/16
• Aluminum series SIMOTICS GP 1LE1083 – self-ventilated						3/17
• Cast-iron series SIMOTICS SD 1LE1503 Basic Line – self-ventilated or forced-air cooled						3/18
• Cast-iron series SIMOTICS SD 1LE1603 Performance Line – self-ventilated or forced-air cooled						3/22
• Cast-iron series SIMOTICS SD 1LE1503 Basic Line with increased power – self-ventilated						3/26
• Cast-iron series SIMOTICS SD 1LE1603 Performance Line with increased power – self-ventilated						3/28
• Cast-iron series SIMOTICS SD 1LE1583 – self-ventilated						3/29
IE2 High Efficiency						3/32
• Aluminum series SIMOTICS GP 1LE1001 – self-ventilated or forced-air cooled						3/32
• Aluminum series SIMOTICS GP 1LE1001 with increased power – self-ventilated						3/36
• Cast-iron series SIMOTICS SD 1LE1501 Basic Line – self-ventilated or forced-air cooled						3/38
• Cast-iron series SIMOTICS SD 1LE1601 Performance Line – self-ventilated or forced-air cooled						3/42
• Cast-iron series SIMOTICS SD 1LE1501 Basic Line with increased power – self-ventilated						3/46
• Cast-iron series SIMOTICS SD 1LE1601 Performance Line with increased power – self-ventilated						3/48
IE1 Standard Efficiency						3/50
• Aluminum series SIMOTICS GP 1LE1002 – self-ventilated or forced-air cooled						3/50
• Aluminum series SIMOTICS GP 1LE1002 with increased power – self-ventilated						3/53
• Cast-iron series SIMOTICS SD 1LE1502 Basic Line – self-ventilated or forced-air cooled						3/54
• Cast-iron series SIMOTICS SD 1LE1502 Basic Line with increased power – self-ventilated or forced-air cooled						3/58
APAC Line - IE3 Premium Efficiency						3/60
• Aluminum series SIMOTICS GP 1LE1043 – self-ventilated or forced-air cooled						3/60
• Aluminum series SIMOTICS GP 1LE1043 with increased power – self-ventilated or forced-air cooled						3/62
• Cast-iron series SIMOTICS SD 1LE1543 Basic Line – self-ventilated or forced-air cooled						3/63
• Cast-iron series SIMOTICS SD 1LE1643 Performance Line – self-ventilated or forced-air cooled						3/66
• Cast-iron series SIMOTICS SD 1LE1543 Basic Line with increased power – self-ventilated						3/69
• Cast-iron series SIMOTICS SD 1LE1643 Performance Line with increased power – self-ventilated						3/71
APAC Line - IE2 High Efficiency						3/72
• Aluminum series SIMOTICS GP 1LE1041 – self-ventilated or forced-air cooled						3/72
• Aluminum series SIMOTICS GP 1LE1041 with increased power – self-ventilated or forced-air cooled						3/74
• Cast-iron series SIMOTICS SD 1LE1541 Basic Line – self-ventilated or forced-air cooled						3/75
• Cast-iron series SIMOTICS SD 1LE1541 Basic Line with increased power – self-ventilated or forced-air cooled						3/77
ABNT Line - IR3 Rendimento Premium						3/78
• Aluminum series SIMOTICS GP 1LE1073 – self-ventilated or forced-air cooled						3/78
• Cast-iron series SIMOTICS SD 1LE1573, 1LE5773 – self-ventilated or forced-air cooled						3/80
Eagle Line - NEMA Premium Efficient MG1 Table 12-12						3/82
• Aluminum series SIMOTICS GP 1LE1023 – self-ventilated or forced-air cooled						3/82
• Cast-iron series SIMOTICS SD 1LE1523 Basic Line – self-ventilated or forced-air cooled						3/84
• Cast-iron series SIMOTICS SD 1LE1623 Performance Line – self-ventilated or forced-air cooled						3/88
Eagle Line - NEMA Energy Efficient MG1 Table 12-11						3/92
• Aluminum series SIMOTICS GP 1LE1021 – self-ventilated or forced-air cooled						3/92
• Cast-iron series SIMOTICS SD 1LE1521 Basic Line – self-ventilated or forced-air cooled						3/93
Pole-changing						3/94
• Aluminum series SIMOTICS GP 1LE1011 for constant load torque – self-ventilated						3/94
• Aluminum series SIMOTICS GP 1LE1011/1LE1012 for square-law load torque – self-ventilated						3/95
Article No. supplements and special versions						3/97
Dimensions						3/146
SIMOTICS SD standard motors next generation						4
Orientation						4/2
IE4 Super Premium Efficiency						4/8
• Cast-iron series SIMOTICS SD 1LE5504 Basic Line – self-ventilated or forced-air cooled						4/8
• Cast-iron series SIMOTICS SD 1LE5604 Performance Line – self-ventilated or forced-air cooled						4/9
• Cast-iron series SIMOTICS SD Add 1LE5534 Basic Line – self-ventilated or forced-air cooled						4/10
• Cast-iron series SIMOTICS SD Add 1LE5634 Performance Line – self-ventilated or forced-air cooled						4/12
IE3 Premium Efficiency						4/13
• Cast-iron series SIMOTICS SD 1LE5503 Basic Line – self-ventilated or forced-air cooled						4/13
• Cast-iron series SIMOTICS SD 1LE5603 Performance Line – self-ventilated or forced-air cooled						4/14
• Cast-iron series SIMOTICS SD Add 1LE5533 Basic Line – self-ventilated or forced-air cooled						4/15
• Cast-iron series SIMOTICS SD Add 1LE5633 Performance Line – self-ventilated or forced-air cooled						4/17
• Cast-iron series SIMOTICS SD Pro 1LE5583 Basic Line – self-ventilated or forced-air cooled						4/18
• Cast-iron series SIMOTICS SD Pro 1LE5683 Performance Line – self-ventilated or forced-air cooled						4/19
Article No. supplements and special versions						4/20
Dimensions						4/38

Overview

Step 1	Step 2	Step 3	Step 4	Step 5	Step 6	Catalog section/ page
Introduction						1
SIMOTICS VSD motors for converter operation · Introduction						5
Synchronous reluctance motors for SINAMICS converters – VSD4000 line · Orientation						5/2
Super Premium Efficiency						5/46
• Aluminum series SIMOTICS GP 1FP1014, line voltage 400 V, 50 Hz/480 V, 60 Hz/400 V, 87 Hz – self-ventilated, enclosed						5/46
• Cast-iron series SIMOTICS SD 1FP1514, line voltage 400 V, 50 Hz/460 V, 60 Hz/400 V, 87 Hz – self-ventilated, enclosed						5/48
Article No. supplements and special versions						5/52
Dimensions						5/76
Standard induction motors optimized for converter operation – VSD10 line · Orientation						5/82
Standard Efficiency						5/92
• Aluminum series SIMOTICS GP 1LE1092, line voltage 400 V, 50 Hz/460 V, 60 Hz/400 V, 87 Hz – self-ventilated, enclosed						5/92
• Aluminum series SIMOTICS GP 1LE1092, line voltage 500 V, 50 Hz/575 V, 60 Hz/500 V, 87 Hz – self-ventilated, enclosed						5/94
• Aluminum series SIMOTICS GP 1LE1092, line voltage 690 V, 50 Hz/690 V, 87 Hz – self-ventilated, enclosed						5/96
• Cast-iron series SIMOTICS SD 1LE1592, line voltage 400 V, 50 Hz/460 V, 60 Hz/400 V, 87 Hz – self-ventilated, enclosed						5/98
• Cast-iron series SIMOTICS SD 1LE1592, line voltage 500 V, 50 Hz/575 V, 60 Hz/500 V, 87 Hz – self-ventilated, enclosed						5/102
• Cast-iron series SIMOTICS SD 1LE1592, line voltage 690 V, 50 Hz/690 V, 87 Hz – self-ventilated, enclosed						5/106
Article No. supplements and special versions						5/108
Dimensions						5/134
SIMOTICS XP explosion-protected motors						6
Orientation						6/2
Zones 21, 22, and 2 with types of protection Ex tb, Ex tc, Ex ec · IE4 Super Premium Efficiency						6/27
• Cast-iron series 1MB55 – self-ventilated						6/27
Zones 21, 22, and 2 with types of protection Ex tb, Ex tc, Ex ec · IE3 Premium Efficiency						6/29
• Aluminum series 1MB10 – self-ventilated						6/29
• Cast-iron series 1MB15, 1MB16 – self-ventilated						6/31
• Cast-iron series 1MB55, 1MB58 – self-ventilated						6/35
Zones 21, 22, and 2 with types of protection Ex tb, Ex tc, Ex ec · IE2 High Efficiency						6/38
• Aluminum series 1MB10 – self-ventilated						6/38
• Cast-iron series 1MB15, 1MB16 – self-ventilated						6/40
Zones 21, 22, and 2 with types of protection Ex tb, Ex tc, Ex ec · with IE1 Standard Efficiency						6/44
• Aluminum series 1MB10 – self-ventilated						6/44
Zone 1 with type of protection Ex eb · IE3 Premium Efficiency						6/46
• Cast-iron series 1MB1543, 1MB1643, 1MB5543, 1MB5643 – self-ventilated						6/46
Zone 1 with types of protection Ex db, Ex db eb · IE3 Premium Efficiency						6/52
• Cast-iron series 1MB15/1MB55 – self-ventilated						6/52
• Cast-iron series 1MB18/1MB58 – self-ventilated						6/62
Article No. supplements and special versions						6/66
Dimensions						6/120
SIMOTICS DP application-specific motors · Introduction						7
SIMOTICS DP application-specific motors – Marine motors · Orientation						7/2
Special designs · Options						7/9
• Aluminum series 1LE10						7/9
• Cast-iron series 1LE15/1LE16 Basic/Performance Line						7/10
• Cast-iron series 1LE55/1LE56 Basic/Performance Line						7/11
• Aluminum series 1MB10, cast-iron series 1MB15/1MB16/1MB5						7/12

Introduction

Guide to selecting and ordering the motors

Catalog orientation and drive selection

1

Overview

SIMOTICS GP/SD 1LE1 standard motors

Motor version	Efficiency class	Rated power at 50 Hz (values in kW) or 60 Hz (values in hp)	Frame size – motor type														Page	
			63	71	80	90	100	112	132	160	180	200	225	250	280	315		
SIMOTICS GP aluminum housing																		
IEC	IE4 Super Premium Efficiency	2.2 ... 37 kW															1LE1004	3/8
	IE3 Premium Efficiency	0.37 ... 45 kW															1LE1003	3/13
		2.2 ... 37 kW															1LE1083	3/17
	IE2 High Efficiency	0.12 ... 45 kW															1LE1001	3/32
	IE1 Standard Efficiency	0.09 ... 37 kW															1LE1002	3/50
APAC Line	IE3 Premium Efficiency	0.75 ... 45 kW															1LE1043	3/60
	IE2 High Efficiency	0.75 ... 22 kW															1LE1041	3/72
ABNT Line	IR3 Rendimento Premium	0.25 ... 22 kW															1LE1073	3/78
Eagle Line	NEMA Premium Efficient	0.37 ... 37 kW 0.5 ... 50 hp															1LE1023	3/82
	NEMA Energy Efficient	0.37 ... 0.55 kW 0.5 ... 0.75 hp															1LE1021	3/92
Pole-changing	– For a constant load torque	0.55 ... 16 kW															1LE1011 4/2-pole, 8/4-pole	3/94
		0.5 ... 28 kW															1LE1011 4/2-pole, 8/4-pole	3/95
		0.6 ... 26 kW															1LE1012 6/4-pole	3/95
SIMOTICS SD cast-iron housing																		
IEC	IE4 Super Premium Efficiency	– Basic Line	2.2 ... 200 kW														1LE1504	3/9
		– Performance Line	2.2 ... 200 kW														1LE1604	3/11
	IE3 Premium Efficiency	– Basic Line	0.18 ... 200 kW														1LE1503	3/18
		– Performance Line	1.5 ... 200 kW														1LE1603	3/22
			2.2 ... 200 kW														1LE1583	3/29
	IE2 High Efficiency	– Basic Line	0.09 ... 200 kW														1LE1501	3/38
		– Performance Line	0.75 ... 200 kW														1LE1601	3/42
	IE1 Standard Efficiency	– Basic Line	0.75 ... 200 kW														1LE1502	3/54
		– Performance Line	0.75 ... 200 kW														1LE1543	3/63
APAC Line	IE3 Premium Efficiency	– Basic Line	0.75 ... 200 kW														1LE1643	3/66
		– Performance Line	0.75 ... 200 kW														1LE1541	3/75
	IE2 High Efficiency	– Basic Line	15 ... 200 kW														1LE1541	3/75
ABNT Line	IR3 Rendimento Premium	– Basic Line	9.2 ... 300 kW														1LE1573	3/80
Eagle Line	NEMA Premium Efficient	– Basic Line	0.18 ... 185 kW 0.25 ... 250 hp														1LE1523	3/84
		– Performance Line	2.2 ... 185 kW 3 ... 250 hp														1LE1623	3/88
	NEMA Energy Efficient	– Basic Line	0.09 ... 0.55 kW 0.12 ... 0.75 hp														1LE1521	3/93

SIMOTICS SD 1LE5 standard motors – next generation

Motor version	Efficiency class	Rated power at 50 Hz	Frame size – motor type														Page		
			63	71	80	90	100	112	132	160	180	200	225	250	280	315		355	400
SIMOTICS SD cast-iron housing																			
IEC	IE4 Super Premium Efficiency	– Basic Line	55 ... 315 kW															1LE5504	4/8
		– Performance Line	160 ... 500 kW															1LE5604	4/9
	IE3 Premium Efficiency	– Basic Line	160 ... 315 kW															1LE5503	4/13
		– Performance Line	160 ... 500 kW															1LE5603	4/14
SIMOTICS SD Add cast-iron housing																			
IEC	IE4 Super Premium Efficiency	– Basic Line	55 ... 315 kW															1LE5534	4/10
		– Performance Line	160 ... 1000 kW															1LE5634	4/12
	IE3 Premium Efficiency	– Basic Line	160 ... 315 kW															1LE5533	4/15
		– Performance Line	160 ... 1000 kW															1LE5633	4/17
SIMOTICS SD Pro cast iron housing																			
IEC	IE3 Premium Efficiency	– Basic Line	200 ... 980 kW															1LE5583	4/18
		– Performance Line	200 ... 500 kW															1LE5683	4/19

Overview

SIMOTICS VSD motors for converter operation

SIMOTICS GP/SD VSD4000 line reluctance motors for SINAMICS converters,
SIMOTICS GP/SD VSD10 line standard motors for converter operation

Motor version	Efficiency class	Rated power	Frame size – motor type													Page
			63	71	80	90	100	112	132	160	180	200	225	250	280	
SIMOTICS GP aluminum housing																
VSD4000 line	Super Premium Efficiency	0.55 ... 30 kW														5/46
VSD10 line	Standard Efficiency	2.2 ... 18.5 kW														5/92
SIMOTICS SD cast-iron housing																
VSD4000 line	Super Premium Efficiency	0.55 ... 45 kW														5/48
VSD10 line	Standard Efficiency	2.2 ... 200 kW														5/98

SIMOTICS XP explosion-protected motors

Motor version	Efficiency class	Rated power	Frame size – motor type													Page
			63	71	80	90	100	112	132	160	180	200	225	250	280	
Motors for Zones 21, 22, and 2 with types of protection Ex tb, Ex tc, Ex ec - aluminum housing SIMOTICS XP																
IEC	IE3 Premium Efficiency	0.37 ... 18.5 kW														6/29
	IE2 High Efficiency	0.37 ... 18.5 kW														6/38
	IE1 Standard Efficiency	0.75 ... 18.5 kW														6/44
Motors for Zones 21, 22, and 2 with types of protection Ex tb, Ex tc, Ex ec - cast-iron housing SIMOTICS XP																
IEC	IE4 Super Premium Efficiency	355 ... 1000 kW														6/27
	IE3 Premium Efficiency	– Basic Line 0.18 ... 200 kW														6/31
		– Performance Line 1.5 ... 200 kW														6/31
		– Advanced insulation system 355 ... 1000 kW														6/35
		– Premium insulation system 335 ... 980 kW														6/35
	IE2 High Efficiency	– Basic Line 0.09 ... 200 kW														6/40
		– Performance Line 0.75 ... 200 kW														6/40
Motors for Zone 1 with type of protection Ex eb - cast-iron housing SIMOTICS XP																
IEC	IE3 Premium Efficiency	– Basic Line 0.25 ... 80 kW														6/46
		– Performance Line 1.3 ... 80 kW														6/46
		– Basic Line 64 ... 165 kW														6/46
		– Performance Line 64 ... 165 kW														6/46
Motors for Zone 1 with types of protection Ex db, Ex db eb - cast-iron housing SIMOTICS XP																
IEC	IE3 Premium Efficiency	0.09 ... 90 kW														6/52
		55 ... 460 kW														6/52

Introduction

Guide to selecting and ordering the motors

Catalog orientation and drive selection

1

Overview

SIMOTICS DP application-specific motors

Motor version	Efficiency class	Rated power at 50 Hz (values in kW) or 60 Hz (values in hp)	Frame size – motor type													Page	
			63	71	80	90	100	112	132	160	180	200	225	250	280		315
Marine motors – aluminum housing																	
IEC	IE4 Super Premium Efficiency	2.2 ... 37 kW								1LE1004							7/9
	IE3 Premium Efficiency	0.37 ... 45 kW							1LE1003								7/9
	IE2 High Efficiency	0.12 ... 45 kW							1LE1001								7/9
	IE1 Standard Efficiency	0.09 ... 37 kW							1LE1002								7/9
IEC – with explosion protection	IE3 Premium Efficiency	0.37 ... 18.5 kW							1MB10.3								7/12
	IE2 High Efficiency	0.37 ... 18.5 kW							1MB10.1								7/12
	IE1 Standard Efficiency	0.75 ... 18.5 kW							1MB10.2								7/12
Eagle Line	NEMA Premium Efficient	0.37 ... 37 kW 0.5 ... 50 hp							1LE1023								7/9
	NEMA Energy Efficient	0.37 ... 0.55 kW 0.5 ... 0.75 hp							1LE1021								7/9
Pole-changing	–	0.5 ... 28 kW							1LE1011								7/9
	–	0.6 ... 26 kW							1LE1012								7/9
Marine motors – cast-iron housing																	
IEC	IE4 Super Premium Efficiency	– Basic Line	2.2 ... 200 kW						1LE1504								7/10
			160 ... 315 kW												1LE55.4		7/11
	– Performance Line	2.2 ... 200 kW							1LE1604								7/10
			160 ... 500 kW													1LE56.4	7/11
	IE3 Premium Efficiency	– Basic Line	0.18 ... 200 kW						1LE1503								7/10
			160 ... 315 kW												1LE55.3		7/11
	– Performance Line	1.5 ... 200 kW							1LE1603								7/10
			160 ... 500 kW													1LE56.3	7/11
	IE2 High Efficiency	– Basic Line	0.09 ... 200 kW						1LE1501								7/10
		– Performance Line	0.75 ... 200 kW						1LE1601								7/10
IEC – with explosion protection	IE3 Premium Efficiency	– Basic Line	0.18 ... 200 kW						1MB15.3								7/12
		– Performance Line	1.5 ... 200 kW							1MB16.3							7/12
			0.09 ... 90 kW						1MB1553								7/12
			55 ... 460 kW													1LE5553	7/11
	IE2 High Efficiency	– Basic Line	0.09 ... 200 kW						1MB15.1								7/12
		– Performance Line	0.75 ... 200 kW							1MB16.1							7/12
Eagle Line	NEMA Premium Efficient	– Basic Line	0.18 ... 185 kW 0.25 ... 250 hp						1LE1523								7/10
		– Performance Line	2.2 ... 185 kW 3 ... 250 hp							1LE1623							7/10
	NEMA Energy Efficient	– Basic Line	0.09 ... 0.55 kW 0.12 ... 0.75 hp						1LE1521								7/10

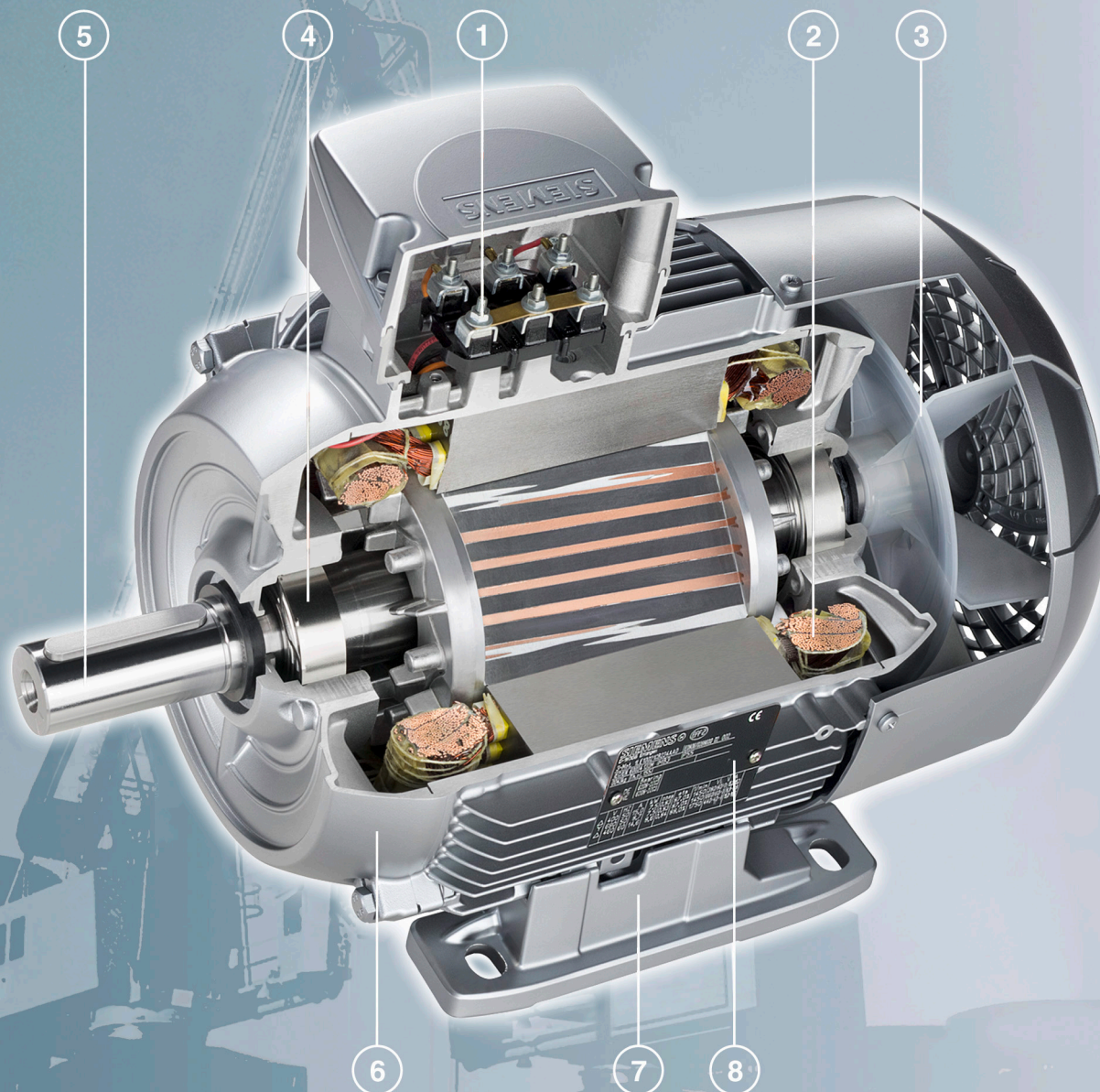
Overview

- ① Motor protection page 1/33
 Motor connection and terminal box page 1/36
 Voltages, currents and frequencies page 1/24
- ② Windings and insulation page 1/28
 Coolant temperature and installation altitude page 1/30
- ③ Heating and ventilation page 1/31
 Mechanical version page 1/46
 Degrees of protection page 1/45
 Modular technology page 1/80
 Special technology page 1/99

- ④ Bearings and lubrication page 1/54
- ⑤ Shaft and rotor page 1/49
 Balance and vibration severity page 1/52
- ⑥ Colors and paint finish page 1/14
- ⑦ Types of construction page 1/46
- ⑧ Rating plate and additional rating plates page 1/25

Introduction

General information









Colors and paint finish

1

Overview

To protect the drives against corrosion and external influences, high-quality paint systems are available in various colors.

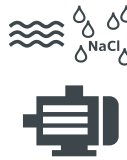
Additional identification code -Z with order code							
S00 ⁷⁾	S01	Standard version ⁶⁾	S02 ⁶⁾	S03 ^{6) 8)}	S04 ⁶⁾	S08 ⁹⁾	S09 ⁹⁾
Paint systems, suitability for atmospheric-corrosivity categories in accordance with EN ISO 12944-2:2017							
Unpainted, but unfinished cast-iron surfaces are primed	Unpainted, motor primed	C2 Standard paint system	C3 Special paint system	C4 Special paint system "sea air resistant"	C5 Special paint system "offshore"	C5mid Special paint system with durability "medium"	CX Special paint system for offshore with durability "high"
Use							

							
The motors can be supplied unpainted on request.	The motors can be supplied with just a primer coat on request.	Indoor unheated spaces with varying temperature and relative humidity, low frequency of condensation and low pollution. Outdoor in dry and cold zones with a short time of wetness, low pollution.	Moderate frequency of condensation and medium pollution (SO ₂ or chlorides), urban areas, subtropical and tropical zone with low pollution. Standard paint system for VIK design (C02).	High frequency of condensation and high pollution, industrial processing plants, polluted urban areas, coastal areas without spray of salt water or exposure to strong effect of de-icing salts.	ISpaces with very high pollution from production process, outdoor installations exposed to direct weather conditions, significant effect of SO ₂ or chlorides, offshore maritime climate.	Industrial areas with high frequency of condensation, humidity, pollution, and aggressive atmosphere. Coastal areas with high salinity, sheltered positions on coastlines, unventilated buildings in subtropical and tropical zone.	Offshore areas with high salinity, spaces with almost permanent condensation or extensive periods of exposure to extreme humidity effects. Industrial areas with extreme aggressive atmosphere with high pollution. Unventilated buildings in humid tropical zones exposed to outdoor factors to an extent that is particularly corrosion-stimulating.

Durability according to EN ISO 12944-1:2017							
–	–	C2 low	C3 low	C4 low	C5 low	C5 medium	C5 high
Erfüllt auch Anforderungen von Kategorien							
–	–	–	C2 medium	C2 high C3 medium	C3 high C4 medium	C4 high	C5 very high
Total film thickness for outer surface - nominal film thickness in µm - aluminum / cast iron ^{2) 3)}							
0 / 30 ^{4) 5)}	30 / 60	30 / 60	60 / 90	120 / 150	– / 170	– / 230	– / 400

¹⁾ Machined laminated rotor core, shaft, inner diameter of cast-iron housing, interior surfaces of cast-iron bearing plates.

²⁾ Total film thickness:

- The specified film thickness represents average values for the external motor surfaces.
- The film thickness may differ at inaccessible locations (pockets/recesses or bases of ribs).

³⁾ The paint coat can become electrostatically charged where there is a thick film. Electrostatic discharges can occur. There is a risk of explosion if potentially explosive mixtures are also present at this moment. This can result in death, serious injury or material damage. When painted surfaces are recoated, one of the following conditions must be fulfilled:

- Limit the total paint film thickness according to the explosion protection group:
 - IIA, IIB: Total paint film thickness „≤ 2 mm
 - IIC: Total paint film thickness „≤ 0.2 mm for motors of group II (gas)
- Limit the surface resistance of the paint used:
 - Surface resistance „≤ 1 GfÇ for motors of groups II and III (gas and dust)
- Charge transfer limit:
 - 60 nC for group I or group IIA devices
 - 25 nC for group IIB devices
 - 10 nC for group IIC devices
 - 200 nC for group III devices

- Breakdown voltage „T 4 kV for explosion group III (dust only)

Note:

Paints for IIC with film thickness exceeding 200 µm are optionally available. Paints with film thickness exceeding 200 µm have been tested for electrostatic charging. Motors with a coating thickness exceeding 200 µm may only be painted over if the conditions mentioned above are complied with.

- ⁴⁾ Aluminum motors/components without a paint finish already meet the requirements for corrosivity class C2. It is not therefore necessary to apply paint to components that are not visible. The paint finish is therefore applied only for the purpose of coloring.
- ⁵⁾ Aluminum motors with cast-iron components (e.g. DE bearing plate) have a primer coat of > 30 µm on cast-iron components.
- ⁶⁾ SIMOTICS XP cast-iron motors suitable for dust hazardous areas (zone 21/22) are used conductive paint systems with color shades available.
- ⁷⁾ Not possible for SIMOTICS XP cast-iron motors suitable for dust hazardous areas (zone 21/22).
- ⁸⁾ SIMOTICS XP aluminum motors suitable for dust hazardous areas (zone 21/22) are used conductive paint systems with color shades available.
- ⁹⁾ Conductive paint systems with color shades available according to tables in the page 1/16.

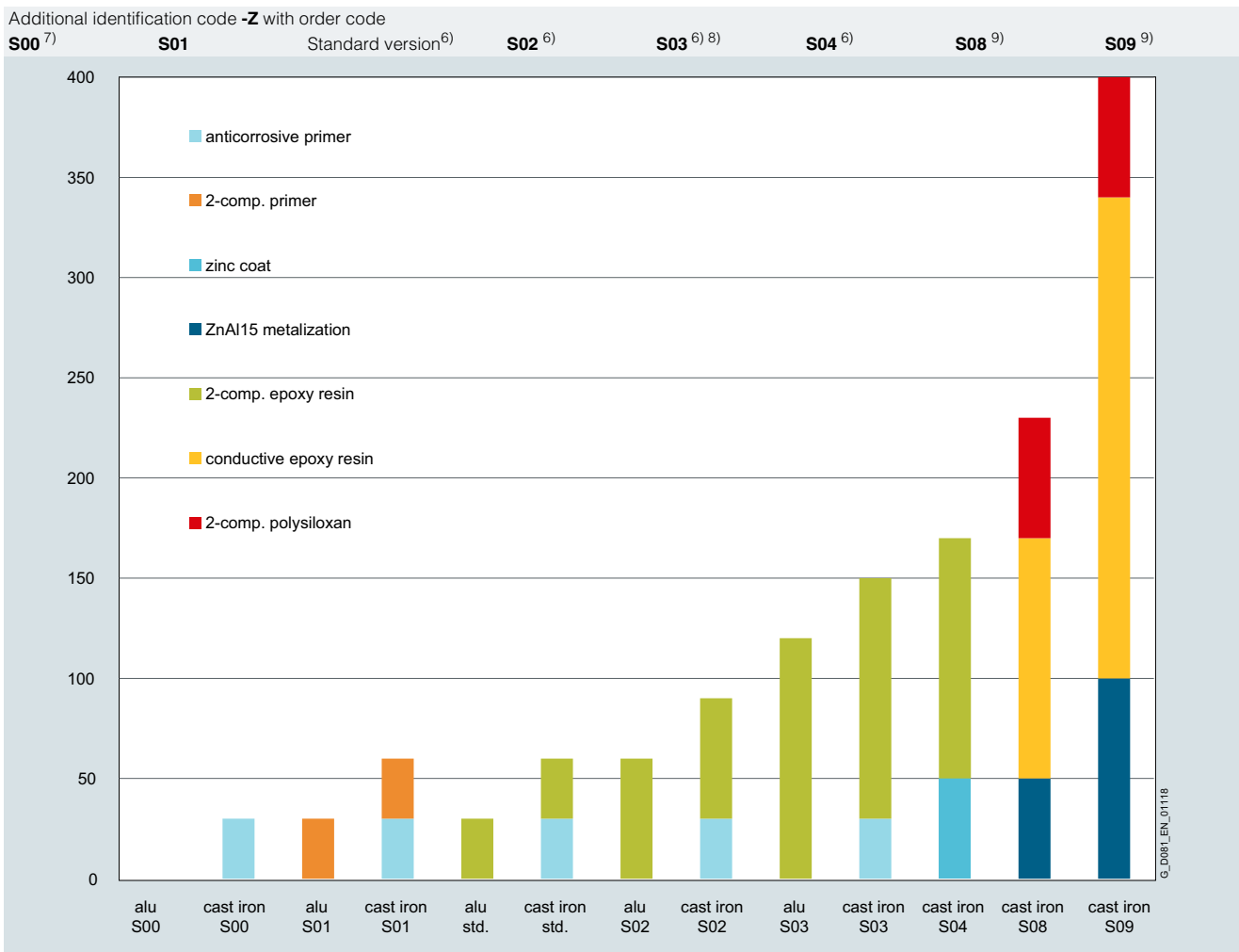

Other available option codes

S05¹⁾ **Interior paint -finish**, all bare internal components primed with rust inhibitor. The motors can be supplied with internal paint finish on request. Recommended when there is a risk of heavy condensate formation.

S06^{6) 8)} **Polyurethane-based top coat**, can only be ordered with **S03** and **S04** (with **S08** and **S09** included as standard with Polysiloxan). Exposure to direct sunlight (UV light) may cause a change in color. When color stability is a requirement, a polyurethane-based paint system is recommended for the top coat (RAL 7030). Colors other than RAL 7030 are available on request.

Top coat colors

Standard version: RAL 7030 (stone grey)

Available colors: Alternative standard and special RAL colors must be ordered with order code Y53, Y56 or Y66 and specification in plain text of the required RAL number (or another number when not RAL). (See tables for order codes Y53, Y56 and Y66 on the following page for selection of available numbers/colors). S06 is available only in standard RAL 7030..

Treatment of bare metal areas of shaft extensions and flanges

Coated with anti-corrosion agent that repels water and palm sweat.

Motors in frame sizes 400 and 450 - here the paint procedure is different

S00	S01	Standard version	S02	S03	S04	S08	S09
Paint systems, suitability for atmospheric-corrosivity categories in accordance with EN ISO 12944-2:2017 (frame sizes 400 and 450)							
Unpainted, but unfinished cast-iron surfaces are primed	Unpainted, motor primed	C2 Standard paint system	C3 Special paint system	C4 Special paint system "sea air resistant"	SC5 Special paint system "offshore"	-	-
Synth. resin	Water-based 2-comp. polyurethane primer	Water-based 2-comp. polyurethane	Water-based 2-comp. polyurethane	Water-based 2-comp. polyurethane	Water-based 2-comp. polyurethane	-	-
Durability according to EN ISO 12944-1:2017 (frame sizes 400 and 450)							
-	-	C2 medium	C3 medium	C4 medium	C5 medium	-	-
Total film thickness for outer surface - nominal film thickness in µm^{2) 3)} (frame sizes 400 and 450)							
60	120	120	180	240	320	-	-

Table continues on the next page.

Note: For transport, the bare parts are coated with anti-corrosion paint which will last for a limited amount of time.

Introduction

General information

Colors and paint finish

1

Overview

Paint finish in other standard RAL colors –

Order code Y53

(RAL number is required in plain text)

RAL-No.	Color name	RAL-No.	Color name
1015	Light ivory	7011	Iron grey
3000	Flame red	7016	Anthracite grey
5002	Ultramarine blue	7031	Blue grey
5009	Azure blue	7032	Pebble grey
5010	Gentian blue	7035	Light grey
5012	Light blue	7037	Dusty grey
5015	Sky blue	8012	Red brown
6011	Reseda green	9005	Jet black
7001	Silver grey	9010	Pure white

Paint finish in special RAL colors -

Order code Y56

(RAL number is required in plain text)

RAL-No.	Color name	RAL-No.	Color name
1013	Oyster white	6020	Chrome green
2004	Pure orange	6021	Pale green
3002	Carmine red	6032	Signal green
3012	Beige red	7005	Mouse grey
3020	Traffic red	7012	Basalt grey
5000	Violet blue	7021	Black grey
5003	Sapphire blue	7022	Umbra grey
5005	Signal blue	7024	Graphite grey
5007	Brilliant blue	7038	Agate grey
5014	Pigeon blue	7042	Traffic grey A
5017	Traffic blue	7045	Telegrey 1
5018	Turquoise blue	9001	Cream
5019	Capri blue	9002	Grey white
5021	Water blue	9003	Signal white
5024	Pastel blue	9006	White aluminum
6000	Patine green	9007	Grey aluminum
6002	Leaf green	9016	Traffic white
6010	Grass green	9018	Papyruswhite
6018	Yellow green	9023	Pearl dark grey

Paint finish in non-standard colors –

Order code Y66 - rarely ordered RAL-colors, weakly opaque colors, non-RAL-colors

(color shade is required in plain text)

RAL-No.	Farbname	RAL-No.	Color name
1001	Beige	6016	Turquoise green
1002	Sand yellow	6017	May green
1003	Signal yellow	6019	Pastel green
1004	Golden yellow	6024	Traffic green
1005	Honey yellow	6025	Fern green
1006	Maize yellow	6026	Opal green
1007	Daffodil yellow	6027	Light green
1011	Brown beige	6029	Mint green
1012	Lemon yellow	6033	Mint turquoise
1014	Ivory	6034	Pastel turquoise
1018	Zinc yellow	7000	Squirrel grey
1019	Grey beige	7004	Signal grey
1021	Colza yellow	7009	Green grey
1023	Traffic yellow	7010	Tarpaulin grey
1028	Melon yellow	7013	Brown grey
1033	Dahlia yellow	7015	Slate grey
1036	Pearl gold	7023	Concrete grey
2000	Yellow orange	7026	Granite grey
2001	Red orange	7033	Cement grey
2002	Vermilio	7034	Yellow grey
2003	Pastel orange	7036	Platinum grey
2008	Bright red orange	7039	Quartz grey
2009	Traffic orange	7040	Window gre
2010	Signal orange	7043	Traffic grey B
2011	Deep orange	7044	Silk grey
2012	Salmon orange	7046	Telegrey 2
3001	Signal red	7047	Telegrey 4
3003	Ruby red	7048	Pearl mouse grey
3004	Purple red	8001	Ockerbraun
3005	Wine red	8002	Signal brown
3007	Black red	8003	Clay brown
3011	Brown red	8008	Olive brown
3013	Tomato red	9004	Signal black
3015	Light pink	9011	Graphite black
3016	Coral red	9017	Traffic black
4005	Blue lilac	AS2700_N52	
4006	Traffic purple	BS06_C39	
5001	Green blue	BS381C_637	
5011	Steel blue	BS381C_355	
5013	Cobalt blue	BS4800_00E55	
5020	Ocean blue	BS4800_06E51	
5022	Night blue	BS4800_14E53	
5023	Distant blue	MAERSK 30070	
6001	Emeral green	MUN10B6/6	
6003	Olive green	MUN10GY8/4	
6004	Blue green	MUN10R5/16	
6005	Moos green	MUN7,5BG7/2	
6007	Bottle green	NCS_S1000_N	
6009	Fir green	NCS_S_1502_B	
6012	Black green	NCS_S7500_N	
6013	Reed green	PROROT	

Coating structure and colors not specified in the catalog are available on request.

Overview

Connected in star for dispatch – Order code M01

The terminal board of the motor is connected in star for dispatch.

Connected in delta for dispatch – Order code M02

The terminal board of the motor is connected in delta for dispatch.

Packing weights

For motors Frame size	Type 1LE1...- 1PC1...- 1MB1...-	For land transport			Types of construction IM B5, IM V1				
		Type of construction IM B3			in	in	on ISPM wooden	on	in
		in box Tare	on ISPM wooden base board with telescopic box Tare	on pallet Tare	crate Tare	box Tare	on ISPM wooden base board with telescopic box Tare	on pallet Tare	crate Tare
		kg	kg	kg	kg	kg	kg	kg	kg
63 M	0B.2	0.65	–	–	–	0.65	–	–	–
71 M	0C.2	0.65	–	–	–	0.65	–	–	–
80 M	0D.2	0.65	–	–	–	0.65	–	–	–
90 S	0E.0	0.65	–	–	–	0.65	–	–	–
100 L	1A.4	–	5.0	–	–	–	5.0	–	–
	1A.5	–	5.0	–	–	–	5.0	–	–
	1A.6	–	5.0	–	–	–	5.0	–	–
112 M	1B.2	–	5.0	–	–	–	5.0	–	–
	1B.6	–	5.0	–	–	–	5.0	–	–
132 S	1C.0	4.7	–	–	–	5.2	–	–	–
	1C.1	4.7	–	–	–	5.2	–	–	–
132 M	1C.2	4.7	–	–	–	5.2	–	–	–
	1C.3	4.7	–	–	–	5.2	–	–	–
	1C.6	8.7	–	–	–	9.2	–	–	–
	1D.2	4.8	–	–	–	5.7	–	–	–
160 M	1D.3	4.8	–	–	–	5.7	–	–	–
	1D.4	4.8	–	–	–	5.7	–	–	–
160 L	1D.6	8.8	–	–	–	9.7	–	–	
180		–	–	8.0	–	–	–	10.0	–
200		–	–	11.0	–	–	–	13.0	–
225		–	–	14.0	–	–	–	17.0	–
250		–	–	22.0	–	–	–	25.0	–
280		–	–	24.0	–	–	–	27.0	–
315		–	–	28.0	–	–	–	32.0	–
315	1LE5, 1MB5	–	–	32.0	–	–	–	46.0	–
355	1LE5, 1MB5	–	–	58.0	–	–	–	78.0	–
315	1LE5, 1MB5	–	–	50.0	–	–	–	40.0	–
355	1LE5, 1MB5	–	–	60.0	–	–	–	50.0	–

Data apply for individual packaging. Wire-lattice pallets can be used, order code **B99**.

Safety notes

Printed safety notes in German/English and safety notes in the language of the country of use are supplied as standard with each motor

Operating instructions

Operating instructions for all official EU languages as well as Norwegian, Russian, Turkish, and Chinese are provided in PDF format only at

<https://support.automation.siemens.com/WWW/view/en/10803948/13330>

Test certificates

Inspection certificate 3.1 in accordance with **EN 10204** – Order code **B02**

An inspection certificate 3.1 in accordance with EN 10204 can be supplied for most motors.

Type test with temperature-rise run for horizontal motors

- **With acceptance** – Order code **B83**
- **Without acceptance** – Order code **B82**

During the type test, a temperature-rise test is performed; no-load, short-circuit, and load characteristics are recorded; the iron losses and friction losses are determined and the efficiency is calculated from the summed losses. This option is only applicable to motors with a horizontal type of construction. Acceptance testing is performed by an external representative (e.g. customer, classification society). No acceptance test is performed when order code **B82** is stated.

Introduction

General information

Period of liability for defects

1

Overview

Standard warranty and extension of liability for defects

The standard warranty period is quoted in the standard conditions of supply and delivery and is 12 months.

This is valid if nothing else is stated. It is possible to obtain an extension of the liability for defects beyond the standard liability period.

Motors	Series	Standard warranty	Extension of the liability for defects
SIMOTICS GP	1LE10	12 months	Not available
SIMOTICS SD	1LE15 / 1LE55 Basic Line	12 months	1LE1 see page 3/129 1LE5 see page 4/20
SIMOTICS SD	1LE16 / 1LE56 Performance Line	36 months	1LE1 not available 1LE5 see page 4/20
SIMOTICS GP VSD4000	1FP10	36 months	Not available
SIMOTICS SD VSD4000	1FP15	36 months	Not available
SIMOTICS GP VSD10	1LE109	12 months	Not available
SIMOTICS SD VSD10	1LE159	12 months	see page 5/126
SIMOTICS XP	1MB10	12 months	Not available
SIMOTICS XP	1MB151 / 1MB551 / 1MB581 Basic Line (Ex tb), 1MB152 / 1MB552 / 1MB582 Basic Line (Ex tc), 1MB153 / 1MB553 / 1MB583 Basic Line (Ex ec)	12 months	1MB1 not available 1MB5 see page 6/113
SIMOTICS XP	1MB161 / 1MB561 Performance Line (Ex tb), 1MB162 / 1MB562 Performance Line (Ex tc), 1MB163 / 1MB563 Performance Line (Ex ec)	36 months	1MB1 not available 1MB5 see page 6/113
SIMOTICS XP	1MB154 / 1MB554 Basic Line (Ex eb)	12 months	see page 6/107
SIMOTICS XP	1MB164 / 1MB564 Performance Line (Ex eb)	36 months	Not available
SIMOTICS XP	1MB155 / 1MB555 (Ex db, Ex db eb)	12 months	see page 6/107

For the case of a new product order

With the following optional order suffixes listed in the table, extension of the liability for defects beyond the standard liability period is possible in conjunction with a new order for a product.

The markup on the product price is graded according to the duration of the extension.

Extension of the liability for defects for 1LE15, 1MB15, 1LE5, and 1MB5 motors	
Additional identification code -Z with order code	Description
Q80	Extension of the liability for defects period by 12 months to a total of 24 months (2 years) from delivery
Q81	Extension of the liability for defects period by 18 months to a total of 30 months (2.5 years) from delivery
Q82	Extension of the liability for defects period by 24 months to a total of 36 months (3 years) from delivery
Q83	Extension of the liability for defects period by 30 months to a total of 42 months (3.5 years) from delivery
Q84	Extension of the liability for defects period by 36 months to a total of 48 months (4 years) from delivery
Q85	Extension of the liability for defects period by 48 months to a total of 60 months (5 years) from delivery

Overview**Applicable standards and specifications**

The 1LE motors comply with the IEC 60034 series of international product standards for rotating electrical machines and, in particular, those parts that are listed in the table below.

Title	IEC/EN	DIN EN
General specifications for rotating electrical machines	IEC 60034-1, IEC 60085	EN 60034-1
Specification of the losses and efficiency of rotating electrical machines	IEC 60034-2-1	EN 60034-2-1
General-purpose three-phase induction motors having standard dimensions and powers	IEC 60072 Mounting dimensions and power series only (no assignment of frame size to power)	EN 50347 Mounting dimensions according to IEC 60072 and power assignment for Europe
Starting performance of rotating electrical machines	IEC 60034-12	EN 60034-12
Terminal designations and direction of rotation for electrical machines	IEC 60034-8	EN 60034-8
Designation for types of construction, mounting, and terminal box position (IM code)	IEC 60034-7	EN 60034-7
Terminal box cable entries	–	DIN 42925
Built-in thermal protection	IEC 60034-11	EN 60034-11
Noise limits of rotating electrical machines	IEC 60034-9	EN 60034-9
IEC standard voltages	IEC 60038	IEC 60038
Cooling methods of rotating electrical machines (IC code)	IEC 60034-6	EN 60034-6
Vibration severity of rotating electrical machines	IEC 60034-14	EN 60034-14
Vibration limits	–	ISO 10816
Degrees of protection for rotating electrical machines (IP code)	IEC 60034-5	EN 60034-5
International efficiency classes for rotating electrical machines (IE code)	IEC 60034-30-1	EN 60034-30
In addition, the following applies to Ex motors:		
General provisions	IEC/EN 60079-0	EN 60034-30-1
Flameproof enclosure "d"	IEC/EN 60079-1	EN 60079-1
Increased safety "e"	IEC/EN 60079-7	EN 60079-7
Type of protection "n" (non-sparking)	IEC/EN 60079-15	EN 60079-15
Areas containing flammable dust	IEC/EN 60079-31	EN 60079-31

The following applies to explosion-protected motors:

Since the requirements of explosion-protected motors comply with the European standards EN 60079-0, EN 60079-1, EN 60079-7, EN 60079-15, EN 60079-31 and Directive 2014/34/EU (ATEX 95), the certificates issued by authorized testing agencies (PTB, FTZU, etc.) are accepted by all member states of the EU. The remaining members of CENELEC, Switzerland in particular, also accept the certificates.

Tolerances for electrical data

According to EN 60034, the following tolerances are permitted: Motors that comply with EN 60034-1 must have a voltage tolerance according to Area A (see diagram on page 1/24). If this is fully utilized, the admissible limit temperature of the temperature class may be exceeded by 10 K.

Efficiency η at

$$P_{\text{rated}} \leq 150 \text{ kW: } -0.15 \cdot (1 - \eta)$$

$$P_{\text{rated}} > 150 \text{ kW: } -0.1 \cdot (1 - \eta)$$

Where η is a decimal number.

$$\text{Power factor} = \frac{1 - \cos \phi}{6}$$

- Minimum absolute value: 0.02
- Maximum absolute value: 0.07

Slip $\pm 20\%$ (for motors $< 1 \text{ kW}$ $\pm 30\%$ is admissible)

Locked-rotor current $+20\%$

Locked-rotor torque -15% to $+25\%$

Breakdown torque -10%

Moment of inertia $\pm 10\%$

For more details, see section "Voltages, currents and frequencies" on page 1/24.

Certifications

Product certifications are differentiated in terms of safety-related certificates and efficiency certificates.

Since 2011, it has been obligatory for low-voltage motors with power ratings in the range of 0.75 to 375 kW (2-, 4-, and 6-pole) to be classified in accordance with the IEC 60034-30-1 efficiency standard and to be marked with the corresponding IE code (International Efficiency IE1, IE2, or IE3). The efficiency is determined using the summed losses method in accordance with IEC 60034-2-1.

Introduction

General information

Versions in accordance with standards and specifications

1

Overview

Energy-saving motors for the European Economic Area in accordance with EU Regulation 640/2009 – valid until June 30, 2021 (from July 1, 2021, EU Regulation 2019/1781 comes into force)

Since January 2017, all low-voltage motors that fall within the scope of the EU Regulation must fulfill the specifications of international efficiency class IE3 or IE2.

- Line voltage ≤ 1000 V
- Line frequency 50 or 50/60 Hz and 60 Hz
- Power range 0.12 to 0.74 IE2
Power range 0.75 to 1000 kW IE3
- Pole number 2-, 4-, 6- and 8-pole
- Continuous duty S1, S3 > 80 % and S6 > 80 %

Energy-saving motors for the North-American economic area in accordance with EISA

In accordance with EISA, modified conditions have been in effect since June 1, 2016.

This law stipulates that all motors must comply with the requirements stated in NEMA MG1 Table 12-12 (NPE = Nema Premium Efficient).

From this date onwards, therefore, motors previously covered by the EPA act must also comply with NPE. The NPE requirements apply to motors with the following characteristics / operating conditions:

- Line voltage ≤ 600 V
- Line frequency 60 Hz
- Power range 1 hp to 500 hp
- Number of poles: 2-, 4-, 6-, 8-pole motors and geared motors
- Continuous duty S1

Explosion-protected motors are also included.

Exclusions from the EISA efficiency requirements:

- Brake motors
- Converter motors

Note:

Option **D30**: el. acc. to NEMA

Option **D31**: UL version

These options can be ordered for motors that are not subject to the EISA specifications (e.g. for use outside North America).

Options **D30** and **D31** do not authorize operation within North America.



The logo NEMA Premium is a registered trademark. It is only permitted to be used by companies that voluntarily submit to the control of the NEMA organization.

Approval for the USA: UL safety and DoE listing

For the USA, the motor series with following motor types are listed and marked with the certification number **CC032A**:

1AV3/1CV3 (1LE1.23, 1LE5.33, 1LE5.83)

1AV4/1CV4 (1LE1.24, 1LE5.34, 1LE5.84)

Additional specifications to NEMA MG1: Nominal efficiency acc. to NEMA MG1 Table 12-12, design letter, code letter, CONT, CC No. CC 032A (Siemens) and service factor SF 1.15.

Motor series 1LE1.21 and 1LE1.23 remain certified up to a rated voltage of 600 V from Underwriters Laboratories Inc. and are marked accordingly ("Recognition Mark" = R/C).



UL approval does not apply to motors for Zones 1, 2, 21, 22 or marine motors.

Approval for Canada: CSA safety and CSA Energy Efficiency Verification

In April 2012, the EISA requirements were implemented in Canada; in this case, all powers are subject to certification without the restrictions applicable to the NEMA frame sizes. Motor series 1LE1.21 and 1LE1.23 are certified for Canada through the Canadian Standard Association (CSA), listed by the Office of Energy Efficiency (OEE) and marked with both the CSA safety logo and the CSA efficiency label. These motors comply with the efficiency requirements of the new CSA standard C390-10. The efficiency is determined in the same manner as with IEC 60034-2-1.



Externally or internally mounted components which are used are listed by CSA or are used by manufacturers in accordance with regulations. Suitability in the final application must be verified. Approval does not apply to 1MB1 motors for Zones 1, 2, 21 and 22 or marine motors.

Korea certification – Order code **D33**

Minimum efficiencies required by law

According to a legislative amendment with reference to the MKE-2015-28 (Ministry of Knowledge Economy Korea) dated February 12, 2015, Minimum Efficiency IE3 became obligatory in Korea on the following dates:

- October 1, 2015 for motors ranging from 37 to 200 kW
- October 1, 2016 for motors ranging from 200 to 375 kW
- October 1, 2018 for motors ranging from 0.75 to 37 kW

For this reason, the SIMOTICS GP/SD APAC series (Asia/Pacific) with efficiency class IE3, which complies with the IE3 energy efficiency requirements for line frequencies 50 Hz and 60 Hz (P50), was launched onto the market:

- SIMOTICS GP, 2-, 4-, and 6-pole motors of the 1LE1043 motor series
- SIMOTICS SD, 2-, 4-, and 6-pole motors of the 1LE1543 and 1LE1643 motor series

Scope of Korean standard KS C 60034-2-1

This Korean standard is applicable to three-phase asynchronous motors with the following parameters:

- Voltage: ≤ 600 V
- Power supply: 60 Hz three-phase
- Rated power: 0.75 ... 375 kW
- Number of poles: 2, 4, 6 and 8
- Speed: Constant
- Coolant temperature: ≤ 40 °C
- Mounting method: Foot or flange-mounted

Overview

Korea Energy Label

Option **D33** KEMCO (Korea Energy Management Cooperation KEMCO) Korea Energy Efficiency Label can be ordered only for those motors which comply with Korean efficiency requirements. Confirmation that the motor efficiency and power factor comply with KS C 60034-2-1 is provided by certification.

The Korea Energy Label includes the following information:

- Full-load efficiency
- Motor Type (MT)
- Rated output power
- No. of poles
- CO₂ emissions per hour
- Energy costs per annum



Rating plate

KEMCO-certified motors with option code **D33** are fitted with a modified rating plate that indicates the admissible minimum energy efficiency value (P50 for 60 Hz) in accordance with the Korean Energy Efficiency Ordinance with reference to Korean Standard KS C 60034-2-1.

The energy efficiency values stipulated by KS C 60034 are identical to the international efficiency values IE (IEC 60034-30).

SIEMENS		IE3		CE			
Made in Czech. Rep. D-90441 Nürnberg		3-Mot. 1CV3314B		1LE15433AB434AA4-Z UC 1701/1234567 001 001			
IEC/EN 60034 315L IMB3		IP55					
990kg	Th.Cl. 155(F)	-20°C ≤ TAMB ≤ 40°C					
Bearing		UNIREX-N3					
DE	6319-C3	40g	INTERVAL: 6000h				
NE	6319-C3	40g					
KS C 60034-2-1							
V	Hz	A	kW	cosφ	NOM.EFF	1/min	IE-CL
400 Δ	50	275	160	0.87	95.8	1490	IE3
690 Y	50	161	160	0.87	95.8	1490	IE3
460 Δ	60	275	184	0.88	96.2	1788	IE3
460 Δ	60	240	160	0.87	96.2	1791	IE3

You will find a complete list of KEMCO-certified motors (APAC Line) on the selection tables in Chapter 2.

1PC3 motors: 1PC3 motors are also covered by certification provided that the electrical design complies with local requirements as stipulated in standard KS C 60034-2-1. Please contact QC for further clarification if required.

Motors from the APAC Line can be ordered with or without option **D33** depending on the final destination region.

Energy-saving motors for China: China Energy Label

In 2012, the directive for the China Energy Label was redefined. Applicability was extended to explosion-protected motors.

- Line voltage ≤ 1000 V
- Line frequency 50 Hz
- Power range 0.75 kW to 375 kW
- Number of poles: 2-, 4-, 6-, 8-pole
- Continuous duty S1

The minimum requirements for the efficiency classes previously defined in the Chinese standard GB 18613-2012 were classified in the new standard GB 18613-2020 (Minimum Allowable Values of Energy Efficiency and Energy Efficiency Grades for Small and Medium Three-Phase Asynchronous Motors) in accordance with International Efficiency IE3-5.



IEC IE class	GB 18613-2020
IE5	Grade 1
IE4	Grade 2
IE3	Grade 3

The 1LE1/5 motor series for IE3 and IE4, plus order code **D34** were previously certified for China Energy Label 20124421.

CCC safety certification is also required for motors with lower powers.

CCC – China Compulsory Certification – Order code **D01**

Motors with small powers (small power motors) that are exported to China must be certified up to a rated power of:

- 2-pole: ≤ 2.2 kW
- 4-pole: ≤ 1.1 kW
- 6-pole: ≤ 0.75 kW
- 8-pole: ≤ 0.55 kW

Notes:

Chinese customs checks the need for certification of imported products by means of the commodity code.

The following do not need to be certified:

- Explosion-protected motors
- Multi-voltage motors
- Multi-speed motors with powers higher than those listed above
- Repair parts

Introduction

General information

Versions in accordance with standards and specifications

Overview

VIK version

VIK – .German Association of the Energy and Power Supply Industry

- **VIK standard version** – 1LE1, 1LE5 frame sizes 400 and 450 + order code **C02**
"VIK" identification on rating plate.
→ Product range in Catalog Section 2.
- **VIK-Ex ec version** – 1MB1.3, 1MB5.3 + order code **C02**
"VIK" and "Ex ec IIC T3 Gc" marking on the rating plate according to Directive 2014/34/EU (ATEX).
→ Product range in catalog section 5.

Both versions include technology for Zone 2 with type of protection Ex ec IIC T3 Gc. Motors up to frame size 355 can be supplied in accordance with the technical requirements of the VIK recommendation.

Design features for VIK version:

- Rating plate made of stainless steel
- Fan cover made of sheet steel
- Vertical motors with protective cover (order code H00 must be ordered)
- Terminal box with silicone seal
- Certified connection system in the terminal box
- Terminal box with certified sealing plugs
- External grounding
- Painting according to corrosivity category C3
- Second rating plate supplied loose

Minimum efficiency class:

- VIK standard version:
IE3 in accordance with legal specifications.
- VIK-Ex ec version:
At least IE3 according to the VIK recommendation of January 2018.

Notes:

- Motors in VIK version with mounted technology (brake, rotary pulse encoder and separately driven fan) are not compatible with Zone 2. Versions for Zone 21/22 are not possible.
- Standard motors (e.g. 1LE.) in VIK standard version with externally mounted components (brake, rotary pulse encoder and separately driven fan) are not suitable for use in Zone 2. Versions for Zone 21/22 are not possible.
- Before using 1LE. motors in VIK version in Zone 2, a rating plate with type of protection and valid certificate number must be attached to the motor.

TR CU product safety certificate EAC for the Eurasian Customs Union (Russia, Belarus, Kazakhstan, Armenia, Kyrgyzstan)

TR CU = Technical Regulation Customs Union
EAC = Eurasian Conformity

The TR CU product safety certificate is required in order to import motors into the Eurasian Customs Union area.

"TR CU product safety certificate EAC for Eurasian Customs Union" – order code **D47**

When motors are ordered with order code **D47**, the motor rating plate and packaging are marked with the logo "EAC".

The motor must have a "TR CU product safety certificate EAC", although the certificate does not generally have to be shipped with the motor. The customs authorities use the motor article number to check the motor certification.

The following are available in the SIOS (Siemens Industry Online Support)

<https://support.industry.siemens.com/cs/ww/en/>
and the Drive Technology Configurator
www.siemens.com/dt-configurator

- TR CU product safety certificate in accordance with the Low-Voltage Directive
- Additional TR CU product certificate in accordance with the EMC Directive.

Train-compatible version

Train-compatible version IC418, EN IEC 60349, acc. to EN 45545, with external fan and fan cover (1LE10 aluminum motors in frame sizes 80 to 200) – Order code **L92** for cooling method IC418

- Electrical design in accordance with EN IEC 60349;
 $U_{rated} \leq 500$ V AC.
- DC-link voltage: $U_{dc} \leq 700$ V; $du/dt \leq 5$ kV/ μ s
- Vibration resistance to Class 3M4 according to IEC 60721-3-3
- Metal cable gland
- Including external grounding depending on construction type (corresponds to order code **H04**).
- Standard paint finish certified according to EN 45545 (Polyurethane-based paint, order code **S06**, not possible as not certified)

Train-compatible version IC411, EN IEC 60349, with EN 45545, with external fan and fan cover in metal – order code **L91** for cooling method IC411

- 1LE10 aluminum motors in frame sizes 80 to 200
- Electrical design in accordance with EN IEC 60349;
 $U_{rated} \leq 500$ V AC.
- DC-link voltage: $U_{dc} \leq 700$ V; $du/dt \leq 5$ kV/ μ s
- Vibration resistance to Class 3M4 according to IEC 60721-3-3
- Metal cable gland
- Including external grounding depending on construction type (corresponds to order code **H04**).
- Standard paint finish certified according to EN 45545 (Polyurethane-based paint, order code **S06**, not possible as not certified)
- Including metal fan cover

Train-compatible version IC411, EN IEC 60349, without EN 45545, with external fan and fan cover in plastic – Order code **L90** for cooling method IC411

- 1LE10 aluminum motors in frame sizes 80 to 200
- Electrical design in accordance with EN IEC 60349;
 $U_{rated} \leq 500$ V AC
- DC-link voltage: $U_{dc} \leq 700$ V; $du/dt \leq 5$ kV/ μ s
- Vibration resistance to Class 3M4 according to IEC 60721-3-3
- Metal cable gland
- Including external grounding depending on construction type (corresponds to order code **H04**).
- Standard paint finish, without EN 45545 (Polyurethane-based paint, order code **S06**, not possible as not certified)
- Including plastic fan cover

Recommended supplementary options:

- Located bearing DE (order code **L20**)
- Temperature class 155 (F), utilized according to 130 (B), coolant temperature 55 C, derating approx. 13 % (order code **N07**)
- Coolant temperature –30 to +40 °C (order code **D04**)
- Coolant temperature –40 to +40 °C (order code **D03**)

Overview

SIMOTICS XP CHEMSTAR & SIMOTICS SD CHEMSTAR - The industry-specific motor solution for the Chemical, Petrochemical, and Oil & Gas sectors

The proven industry-specific CHEMSTAR range has been setting standards for decades in terms of motor technology for the extreme operating conditions prevailing in the chemical industry as well as in the plants producing, transporting and processing oil and gas raw materials. The combination of these many years of experience and expertise on the one hand and the technology of the SIMOTICS motor platform on the other ensures maximum reliability, safety, high efficiency and simple project handling in these industries.

In the often complex processes and procedures of the chemical industry, many, though not all plant components are subject to explosion hazards due to flammable gases, liquids and dusts. The motor used must therefore function permanently and smoothly, even in chemically aggressive atmospheres.

The situation is similar in the application fields of the Oil & Gas sector. These are characterized by extreme demands placed on the drive technology used. This applies not only to the high explosion risk inherent in both commodities, but also to the place of deployment, whether it be offshore on the high seas, in the Arctic or in the Arabian desert.

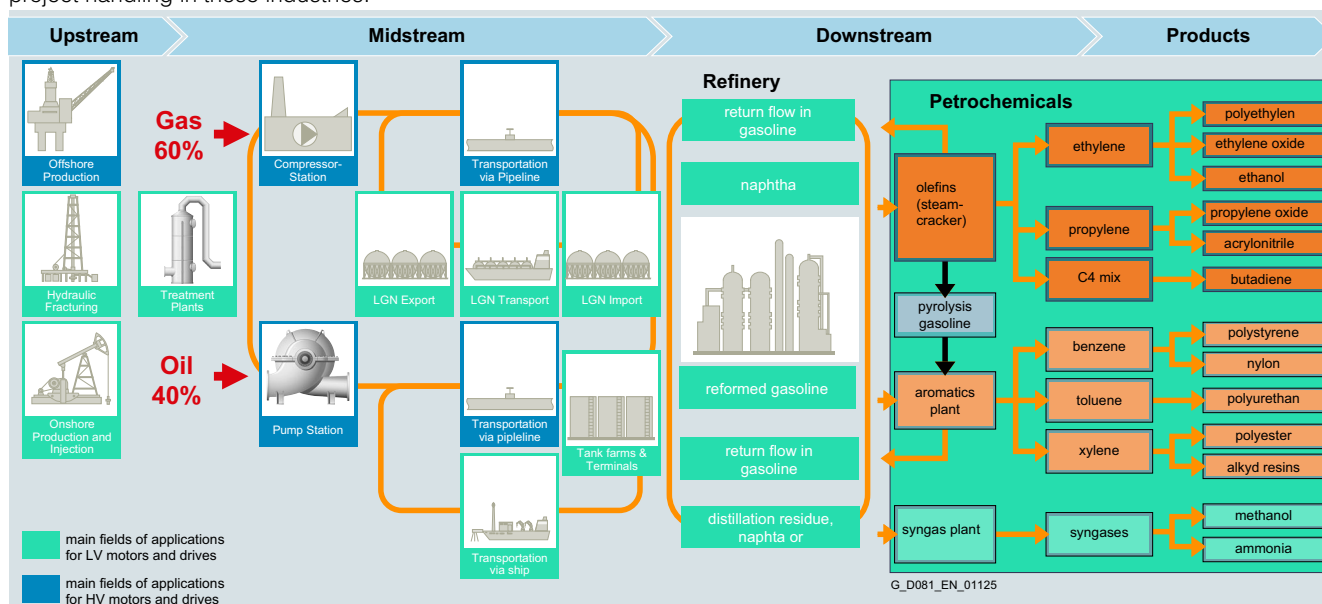

With this in mind, we offer the explosion-protected SIMOTICS XP and SIMOTICS SD motors for harsh environments without the risk of explosion in the CHEMSTAR version. And this again in two industry-specific variants: One variant for the chemical industry and one for the Oil & Gas sector. The CHEMSTAR basic features are combined with chemical-specific or oil & gas-specific additional features

In the case of the "CHEMSTAR for Chemical Industry" variant, this ensures that the motor is precisely tailored to the specific ambient conditions of this industry, thus ensuring maximum reliability and safety in chemical processes.

With the "CHEMSTAR for Oil & Gas" version, the basic and additional features are combined in such a way that the motors ensure maximum safety and plant availability while simultaneously reducing lifecycle costs, even under the extreme conditions of oil and gas production and transport.

SIMOTICS motors for oil and gas applications in CHEMSTAR design meet the new standard of the IOGP specification.



The following overview shows the basic features and the industry-specific features of the two variants.

Variant	Chemice industry	Oil & gas
Sector options	C03	C04
Options included in the package		
Paint system	Special paint finish "sea air resistant" category C4	Special paint finish for use offshore with high durability category CX
Plate material	Plates made of stainless steel QR code plate made of stainless steel	
Screws	Standard version	Stainless steel screws
Fan cover	Fan cover made of sheet steel	
Grounding	External grounding	
Housing	IP66 Increased air humidity 40-60 g per m ³ of air ¹⁾	
Condensation drainage holes	Sealed ²⁾	
Bearings	Bearings reinforced at both ends for DE and NDE, bearing size 63 from frame size 100	
Warranty	36 months from delivery	
Inspection certificate	Inspection certificate 3.1	
Included standard	VIK version	-
Recommended options		
Documentation	Documentation package "Advanced"	Documentation package "Projects"
Additional rating plate	Additional rating plate with customer specifications	

¹⁾ C04 in conjunction with corrosivity category C3 or higher

²⁾ Ex db motors without drainage holes

Introduction

Electrical design

1

Voltages, currents and frequencies · Powers

Overview

Voltages, currents and frequencies

Standard voltages

EN 60034-1 differentiates between Category A (combination of voltage deviation $\pm 5\%$ and frequency deviation $\pm 2\%$) and Category B (combination of voltage deviation $\pm 10\%$ and frequency deviation $+3/-5\%$) for voltage and frequency fluctuations. The motors can supply their rated torque in both Category A and Category B. In Category A, the temperature rise is approx. 10 K higher than during rated operation.

Standard	Category	Category
IEC 60034-1	A	B
Voltage deviation	$\pm 5\%$	$\pm 10\%$
Frequency deviation	$\pm 2\%$	$+3\%/-5\%$
Rating plate data stamped with rated voltage a (e.g. a=400 V)	a $\pm 5\%$ (e.g. 400 V $\pm 5\%$)	a $\pm 10\%$ (e.g. 400 $\pm 10\%$)
Rating plate data stamped with rated voltage ranges b to c (e.g. b=380 V to c=420 V)	b -5% to c $+5\%$ (e.g. 380 -5% to 420 $+5\%$)	b -10% to c $+10\%$ (e.g. 380 -10% to 420 $+10\%$)

For further details, see EN 60034-1.

According to the standard, longer operation is not recommended for Category B. See "Rating plates and additional rating plates" for details of the rating plate inscriptions and corresponding examples. The selection and ordering data give the rated current at 460 V, 60 Hz. The IEC 60038 standard specifies a tolerance of $\pm 10\%$ for line voltages of 230 V, 400 V, and 690 V.

Line voltages	Voltage code
1LE1 motors	
230 VΔ/400 VY, 50 Hz	22
460 VY, 60 Hz	
400 VΔ/690 VY, 50 Hz	34
460 VΔ, 60 Hz	
500 VY, 50 Hz	27
575 VY, 60 Hz	
500 VΔ, 50 Hz	40
575 VΔ, 60 Hz	

Non-standard voltages and/or frequencies

The tolerance laid down by EN 60034-1 applies to all non-standard voltages.

For some non-standard voltages at 50 or 60 Hz, order codes are specified. They are ordered by specifying the code digit **9** for voltage in the 12th position of the Article No. as well as the code digit **0** in the 13th position of the Article No. and the corresponding order code.

The lowest rated voltage for **M1Y** that can be delivered depends on factors including the circuit (delta connection 200 V/star (wye) connection 250 V) and frame size. The defined order codes for further rated voltages provide an indication of the lowest rated voltage for **M1Y**.

Order codes for other rated voltages are listed under "Order suffixes" in the "Selection and ordering data" as well as "Special versions" under "Voltages".

Line voltages according to NEMA

Assignment of rated voltage of the motor to that of the line:

Line voltage	Motor voltage
208 V	200 V
240 V	230 V
480 V	460 V
600 V	575 V

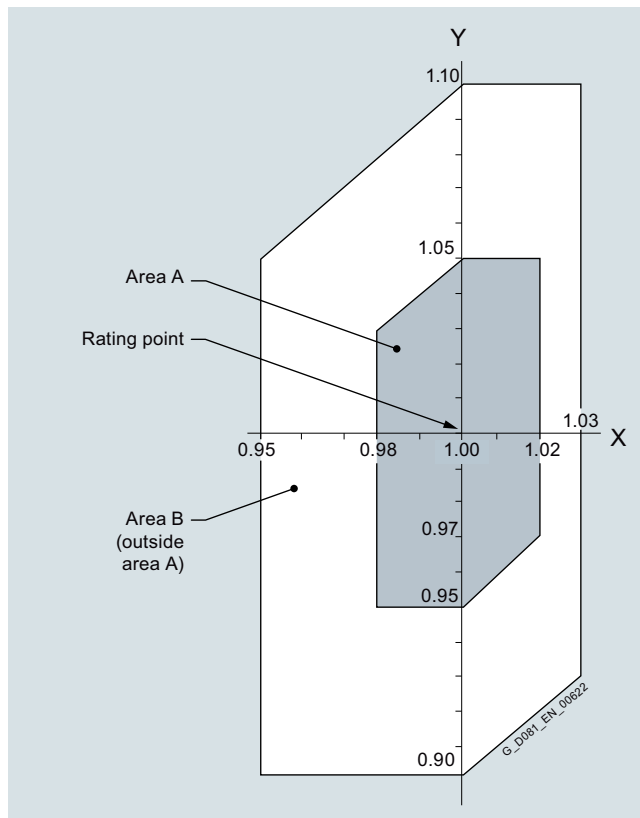

Y-axis: Voltage tolerance
X-axis: Frequency tolerance

Powers

The powers or rated powers are listed in the selection tables for both 50 Hz and 60 Hz. For 60 Hz, the rated power values must, in some cases, be increased, e.g. for pole-changing motors.

Assignment of standard powers kW-hp in accordance with IEC 60072-1

The values specified for kW and hp are not precise conversion values. They are the approximate relationship between the values generally applied in the countries in which both units are used.

P_{rated} kW	P_{rated} hp	P_{rated} kW	P_{rated} hp	P_{rated} kW	P_{rated} hp	P_{rated} kW	P_{rated} hp	P_{rated} kW	P_{rated} hp	P_{rated} kW	P_{rated} hp
0.06	0.08	2.2	3	37	50	200	270	450	603	800	1072
0.09	0.12	3	3.7	45	60	220	300	475	637	850	1139
0.12	0.16	4	5	55	75	250	350	500	670	900	1206
0.18	0.25	5.5	7.5	75	100	280	375	530	710	950	1273
0.25	0.33	7.5	10	90	125	300	402	560	750	1000	1340
0.37	0.5	11	15	110	150	315	422	600	804		
0.55	0.75	15	20	132	175	335	476	630	845		
0.75	1	18.5	25	150	200	375	503	670	898		
1.1	1.5	22	30	160	220	400	536	710	952		
1.5	2	30	40	185	250	425	570	750	1005		

Overview

In accordance with EN 60034-1, the approximate total weight is specified on the rating plate for all motors.

Supplementary data (maximum of 20 characters) can be indicated on the rating plate or additional rating plate and on the packaging label.
Order code **Y84**

An additional rating plate for customer specifications is also possible, additional text: 9 lines of 40 characters each.
Order code **Y82**

An adhesive label can also be supplied loose.
Order code **Y85**

An additional rating plate for customer specifications is also possible, additional text: 9 lines of 40 characters each.
Order code **Y82**

An additional rating plate with deviating rating plate data can also be ordered (only for ratings such as voltage, power, speed).
Order code **Y80**.

An "additional rating plate for voltage tolerance" can also be ordered.

Can be ordered for 230 VΔ/400 VY or 400 VΔ/690 VY (voltage code "22" or "34"). Not possible for pole-changing motors, naturally cooled 1PC1 motors, 8-pole motors and in combination with order code D34.
Order code **B07**
(voltage range plate is always provided in the form of an adhesive label)

The number of rating plates and/or the material quality of the rating plate including additional rating plates can be ordered using order codes Y82, Y84 and Y80. Does not apply to order code B07, rotational direction arrows, PTC thermistor plates, other notices.

- Extra (rating) plate(s) – Order code **M10**
- Plate(s) with resistance to scratches, heat, cold and acid – Order code **M11**

As standard, the normal version of the rating plate is international (in English).

Other languages on request.

Examples of rating plates

SIEMENS		Made in Germany		CE				
3-MOT 1AV2092A 1LE10010EA422AA0		IEC/EN 60034		TH.CL.155(F) IP55				
F no E1701/1234567 01 001		FS 90L		IMB3 WT 13kg				
V	Hz	kW	A	PF	RPM	EFF-CL	ETA %	IE2 (H)
230 Δ	50	2.2	7.8	0.85	2890	IE2	83.2	
400 Y	50	2.2	4.50	0.85	2890	IE2	83.2	
460 Y	60	2.55	4.35	0.86	3485	IE2	85.5	

Adhesive rating plate up to frame size 90

SIEMENS		Made in Czech Rep.		D-90441 Nürnberg		IE3		CE	
3-Mot. 1AV3314B 1LE15433AB434AA0-Z		UC 1701/1234567 001 001							
IEC/EN 60034 315L IMB3		IP55							
990kg	Th.Cl. 155(F)	-20°C ≤ TAMB ≤ 40°C							
	Bearing	UNIREX-N3							
DE	6319-C3	40g		INTERVAL: 6000h					
NE	6319-C3	40g							
		KS C 60034-2-1							
V	Hz	A	kW	cosφ	NOM.EFF	1/min	IE-CL		
400 Δ	50	275	160	0.87	95.8	1490	IE3		
690 Y	50	161	160	0.87	95.8	1490	IE3		
460 Δ	60	275	184	0.88	96.2	1788	IE3		
460 Δ	60	240	160	0.87	96.2	1791	IE3		

Rating plate for motor with KEMCO certification

SIEMENS		Made in Germany		D-90441 Nürnberg		IE3		CE	
3-Mot. 1AV3164A 1LE10431DA434AA0-Z		E 1701/1410842 001 001							
IEC/EN 60034 160L IMB3		IP10=FAN COVER/IP55		Brake:					
94kg	Th.Cl. 155(F)	-20°C ≤ TAMB ≤ 45°C		2000M		2LM8040-5NA10		230V AC 50/60Hz 1.25A	
	Bearing	UNIREX-N3				TH.Cl. 155(F) 40Nm			
DE	6209-2ZC3	20g		INTERVAL: 2000h					
NE	6209-2ZC3	20g							
		Vibration B		SF 1.1 CONT		KS C 60034-2-1			
V	Hz	A	kW	cosφ	NOM.EFF	1/min	IE-CL		
400 Δ	50	32.0	18.5	0.90	92.4	2955	IE3		
690 Y	50	18.6	18.5	0.90	92.4	2955	IE3		
460 Δ	60	32.0	21.3	0.91	91.7	3550	IE3		
460 Δ	60	28.0	18.5	0.90	91.7	3560	IE3		
KDNNo. 12345678999111		MATNo. 12345678		Space Heater 230V					

Rating plate (metal) for IEC motors (APAC Line) – maximum characteristics

SIEMENS		Made in Germany		D-90441 Nürnberg		IE3		CE	
3-Mot. 1AV3164A 1LE10231DA434AA0-Z		E 1701/1410842 001 001							
IEC/EN 60034 160L IMB3		IP55		Brake:					
94kg	Th.Cl. 155(F)	-20°C ≤ TAMB ≤ 45°C		2000M		2LM8040-5NA10		230V AC 50/60Hz 1.25A	
	Bearing	UNIREX-N3				TH.Cl. 155(F) 40Nm			
DE	6209-2ZC3	20g		INTERVAL: 2000h					
NE	6209-2ZC3	20g							
		Vibration B		60Hz: SF 1.1 CONT		NEMA MG1 12-12		TEFC DES A 25.0 HP	
V	Hz	A	kW	PF	NOM.EFF	rpm	IE-CL	CL	
400 Δ	50	32.0	18.5	0.90	92.4	2955	IE3	M	
690 Y	50	18.6	18.5	0.90	92.4	2955	IE3	M	
460 Δ	60	32.0	21.3	0.91	91.7	3550	IE3	M	
460 Δ	60	28.0	18.5	0.90	91.7	3560	IE3	N	
KDNNo. 12345678999111		MATNo. 12345678		Space Heater 230V					

Standard rating plate (metal) for NEMA motors – maximum characteristics

Introduction

Electrical design

Rating plate and additional rating plates

1

Overview

1	Machine type: Three-phase low-voltage motor	20	Installation altitude (only when higher than 1000 m)								
2	Article No.	21	Customer data (optional)								
3	Factory serial number (Ident.-no., serial number)	22	Date of manufacture YYYYMM								
4	Type of construction	23	Half-key balancing								
5	Degree of protection	24	Code letter "CL"								
6	Rated voltage [V] and winding connections	25	Motor type number (MT)								
7	Frequency [Hz]	26	IEC standard series, power 50 Hz (P50/50 Hz) 400 Δ								
8	Rated current [A]	27	IEC standard series, power 50 Hz (P50/50 Hz) 690 Δ								
9	Rated power [kW]	28	Equivalent power 60 Hz at the same utilization as IEC standard series 50 Hz								
10	Power factor (cos φ)	29	IEC standard series power 60 Hz (P50/60 Hz)								
11	Efficiency	30	Manufacturer's address								
12	Rated speed [rpm]	31	Marine certificates								
13	IE efficiency class	32	Optional information								
14	Standards and specifications	33	Bearing size								
15	Weight of machine [kg]	34	Relubrication data optional								
16	Temperature class										
17	Frame size										
18	Supplementary data (optional)										
19	Operating temperature range (only if it deviates from standard)										

Explanation of the standard rating plate

Efficiency, power factor, rated speed, direction of rotation, rated torque

Overview

Efficiency and power factor

The efficiency η for 4/4, 3/4 and 1/2 load and the power factor $\cos \varphi$ for each rated power are listed in the selection tables in the individual sections of this catalog. See page 1/5 for minimum efficiencies.

Rated speed and direction of rotation

The rated speeds are applicable for the rated data. The synchronous speed changes proportionally with the line frequency. The motors are suitable for clockwise and counterclockwise rotation.

When U1, V1, W1 are connected to L1, L2, L3 the motor rotates clockwise when viewing the drive shaft extension. Counterclockwise rotation is achieved by swapping two phases (see also "Heating and ventilation" on page 1/31).

Rated torque

The rated torque T in Nm delivered at the motor shaft is

$$T = \frac{9.55 \cdot P \cdot 1000}{n}$$

P Rated power in kW
 n Speed in rpm

Note:

If the voltage deviates from its rated value within the admissible limits, the locked-rotor torque, the pull-up torque and the breakdown torque vary with the approximate square of the value, but the locked-rotor current varies approximately linearly.

In the case of squirrel-cage motors, the locked-rotor torque and breakdown torque are listed in the selection tables as multiples of the rated torque.

Preferred practice is to start squirrel-cage motors directly on line. The torque class indicates that with direct-on-line starting, even if there is an undervoltage of -5 %, it is possible to start up the motor against a load torque of

- 160 % for CL 16
- 130 % for CL 13
- 100 % for CL 10
- 70 % for CL 7
- 50 % for CL 5

of the rated torque.

Overview

All motors in the SIMOTICS generation are equipped with innovative insulation systems, consisting of high-quality enamel wires and insulating sheet materials in conjunction with highly temperature-resistant impregnations.

The motors can be operated with SINAMICS G and SINAMICS S converters (controlled and uncontrolled infeed) while adhering to the admissible voltage peaks in accordance with the adjacent table.

Continuous operation while fully utilizing the admissible voltage tolerances must be avoided and is not recommended in accordance with IEC 60034-1 2011 Chapter 7.3.

The preferred supply system configurations are TT systems and TN systems with neutral-point grounding. We do not recommend operation in TN systems because of the higher voltage load.

Operation on non-grounded IT systems is also possible. However, in a ground fault, the insulation is excessively stressed. In the case of a ground fault, the process should be terminated as quickly as possible ($t < 2$ h), and the fault resolved.

For motors with protruding connection cables (order codes **R20**, **R21**, **R22**, **R23**, and **R24**), please inquire in the case of converter operation.

Impulse Voltage Insulation Class (IVIC) – category C (strong)

The insulation system of SIMOTICS motors significantly exceeds the requirements of stress category C (IVIC C = high stress). If voltage peaks higher than those specified according to IVIC C can occur, observe the data in the following table.

- For a line voltage (converter input voltage) up to 500 V and operation connected to a SINAMICS G/SINAMICS S converter with uncontrolled infeed (BLM, SLM), the relevant guidelines for the motor and converter configuration must be observed.
- For a line voltage (converter input voltage) up to max. 480 V and operation connected to a SINAMICS S converter with controlled infeed (ALM), the relevant guidelines for the motor and converter configuration must be observed.
- For line voltages (converter input voltages) higher than those stated above (max. 690 V), motors that are ordered for converter operation must have a suitable insulation system.
- For operation of a converter of another manufacturer, the permissible voltage peaks according to IEC 60034-18-41 in accordance with stress category C (see table below) must be observed, depending on the particular line voltage (converter input voltage) and the motor insulation system.

	Line voltage U_{rated}					
	400 V		480 V		500 V	
Standard	IVIC C	Siemens	IVIC C	Siemens	IVIC C	Siemens ¹⁾
U_{phase}	1680	2200	2016	2200	2100	2800
$U_{phase-to-ground}$	840	1100	1008	1100	1050	1400
$U_{phase-to-phase}$	2360	3000	2832	3000	2950	3200
$U_{phase-to-phase}$	1180	1500	1416	1500	1475	1600

	Line voltage U_{rated}			
	500 V		690 V	
PREMIUM	IVIC C	Siemens	IVIC C	Siemens
U_{phase}	2100	3000	2898	3000
$U_{phase-to-ground}$	1050	1500	1499	1500
$U_{phase-to-phase}$	2950	4400	4070	4400
$U_{phase-to-phase}$	1475	2200	2035	2200

The following applies for the voltage rise time: $T_a > 0.3$ μ s.

The voltages according to EN 60034-18-41/IVIC C are specified as peak-to-peak values ($V_{pk/pk}$). For information, the conventional peak values (V_{pk}) are also stated.

¹⁾ Only for motors with voltage code 27 or 40.

Insulation systems for converter operation > 480 V/500 V

The SIMOTICS motors can be operated in their standard version on SINAMICS converters without an additional filter up to a maximum converter input voltage of 480 V 3 AC on uncontrolled infeeds (SINAMICS G/S/N, BLM/SLM) and up to 480 V 3 AC on controlled infeeds (SINAMICS S, ALM). The specific configuration guidelines for motors and converters must be observed.

For higher converter input voltages, > 480 V/500 V 3 AC (max. 690 V), a special insulation system of the motor (PREMIUM) is required.

This is available for converter motors, such as SIMOTICS GP/SD VSD10, SIMOTICS DP crane motors, SIMOTICS FD, and the converter-capable SIMOTICS SD Pro motors.

For IE3 standard motors, the PREMIUM insulation system is available depending on the type.

Bearing insulation/shaft grounding brushes

To avoid damage to bearings due to bearing currents, we recommend bearing insulation at the non-drive end (NDE) for frame size 225 and larger (order code **L51**).

For converter operation and for frame size 315 and larger, bearing insulation at the non-drive end (NDE) is always provided (order code **L51**).

When rotary encoders are used, it must be ensured that these do not bypass the bearing insulation. The rotary encoders in this catalog meet this requirement except for type 1XP8.

In most cases, NDE bearing insulation provides sufficient protection against damage to bearings due to bearing currents.

In rare cases, depending on the application and system, it may be necessary to take further measures on the converter or motor. On the motor side, bearing insulation is provided on the drive end (DE) (order code **L50** on frame size 225 and larger) and shaft grounding brushes (order code **L52** as of frame size 280).

When NDE bearing insulation is used together with DE bearing insulation, the "shaft grounding brush" option (order code **L52**) must also be selected to maintain the shaft at a defined potential. In this constellation, to avoid damage to the bearings of the driven machine due to bearing currents, it is also necessary to insulate the coupling between the motor and the driven machine.

When DE or NDE bearing insulation (order codes L50 or L51) is used together with shaft grounding brushes (order code L52), care must be taken - to avoid damage to the bearings of the driven machine - that the shaft grounding brushes are not mounted on the same side as the insulated bearing.

The EMC guidelines must always be complied with when the drive system is installed.

Thermal utilization of the motor

When motors are operated on a converter, additional losses occur due to the harmonics in the motor currents, which, depending on the permissible winding temperature, can make it necessary to reduce the torque. For operation on SINAMICS converters, the permissible torque values can be obtained from the SIZER engineering tool.

For operation on SINAMICS converters with the power ratings specified in the catalog, the motors are used according to temperature class 155 (F), i.e. in this case neither a service factor > 1 nor an increased coolant temperature is possible (order codes **N01**, **N02** and **N03** cannot be ordered).

Introduction

Electrical design

Windings and insulation

Overview

Explosion-protected motors

For converter operation of Ex motors, special measures must be considered, see Chapter 5.

DURIGNIT IR 2000 insulation system

The DURIGNIT IR 2000 insulation system consists of high-quality enamel wires and insulating sheet materials in conjunction with temperature-resistant resin impregnation.

This ensures that these motors will have a high mechanical and electrical strength, high service value, and a long lifetime. The insulation system protects the winding to a large degree against aggressive gases, vapors, dusts, oils and increased air humidity. It can withstand the usual vibration stressing. The insulation is suitable up to an absolute air humidity of 30 g water per m³ of air. Moisture condensation should be prevented from forming on the winding. For higher values, the **N30** and **N31** options are available – see page 1/29.

Please inquire about extreme applications.

Restarting against residual field and opposite phase

All motors can be restarted against 100 % residual field after a line voltage failure.

Winding and insulation version with regard to temperature class

At rated power in line operation, the 1LE5/1MB5 motor series can be utilized in the following temperature class:

- For SIMOTICS SD Add ¹⁾: Temperature class 130 (B)
- For SIMOTICS XP ¹⁾: Temperature class 130 (B)
- For SIMOTICS SD Pro and SIMOTICS XP 1MB58: Temperature class 155 (F)

All motors are designed with temperature class 155 (F). For details of derating for utilization in temperature class 155 (F), see "DURIGNIT IR 2000 insulation system".

Temperature class 155 (F), utilized according to 155 (F), with service factor (SF)

According to the selection table, at rated power and rated voltage, all 1LE./1PC1 motors in line operation have a service factor of 1.15. An exception are IE1 motors, which have a service factor of 1.1.

For the line operation, all motors with frame sizes 400 and 450 have a service factor of 1.05 at rated power.

Order code **N01**

Temperature class 155 (F), utilized according to 155 (F), for higher power

When utilized according to temperature class 155 (F), the rated power specified in the selection and ordering data can be increased by 15 %. Exception for IE1 motors – can be increased by 10 %. For motors of frame sizes 400 and 450, for line operation, when utilized according to temperature class 155 (F), the rated power listed in the selection and ordering data can be increased by 5 %. In this case, the service factor is 1.0.

Order code **N02**

Temperature class 155 (F), utilized acc. to 155 (F), with increased coolant temperature

With power as defined in the catalog and line operation, the coolant temperature is permitted to rise to 55 °C and, for motors of frame sizes 400 and 450, to 45 °C.

In this case, the service factor is 1.0.

Order code **N03**

The service factor (SF) is not indicated on the rating plate for order codes **N02** and **N03**.

For converter operation at the power specified in the catalog, the motors are utilized according to temperature class 155 (F). Order codes **N01**, **N02**, and **N03** are not possible.

Temperature class 155 (F), utilized acc. to 130 (B), coolant temperature 45 °C, derating approx. 4 %

For motor series 1LE1, 1MB. ¹⁾, SIMOTICS SD Add ¹⁾, a version can be ordered according to temperature class 155 (F) for utilization according to temperature class 130 (B) and a maximum coolant temperature of 45 °C with derating of 4 %.

Order code **N05**

Temperature class 155 (F), utilized acc. to 130 (B), coolant temperature 50 °C, derating approx. 8 %

For motor series 1LE1, 1MB. ¹⁾, SIMOTICS SD Add ¹⁾ a version can be ordered according to temperature class 155 (F) for utilization according to temperature class 130 (B) and a maximum coolant temperature of 50 °C with derating of 8 %.

Order code **N06**

Temperature class 155 (F), utilized acc. to 130 (B), coolant temperature 55 °C, derating approx. 13 %

For motor series 1LE1, 1MB. ¹⁾, SIMOTICS SD Add ¹⁾ a version can be ordered according to temperature class 155 (F) for utilization according to temperature class 130 (B) and a maximum coolant temperature of 55 °C with derating of 13 %.

Order code **N07**

Temperature class 155 (F), utilized acc. to 130 (B), coolant temperature 60 °C, derating approx. 18 %

For motor series 1LE1, 1MB. ¹⁾, SIMOTICS SD Add ¹⁾ a version can be ordered according to temperature class 155 (F) for utilization according to temperature class 130 (B) and a maximum coolant temperature of 60 °C with derating of 18 %.

Order code **N08**

Temperature class 180 (H)

With motor series 1LE., 1MB., and 1PC1, utilization according to temperature class 155 (F) is permitted.

For motors of frame sizes 225 to 355, utilization according to H/H is not permissible due to the bearing temperature rise.

Order code **N10** ²⁾

Temperature class 180 (H) at rated power and max. CT 60 °C

With motor series 1LE1, and 1PC1, utilization according to temperature class 180 (H) is permitted at rated power and a maximum coolant temperature of 60 °C (for the SIMOTICS SD Pro motor series not possible).

Order code **N11** ¹⁾ (not possible for 1LE15 and 1LE16 motors with increased power).

The grease lifetime specified is valid for a coolant temperature of 40 °C. If the coolant temperature is increased by 10 K, the grease lifetime and regreasing interval are halved.

¹⁾ Not applicable for 8-pole motors, frame size 450. Utilization in accordance with temperature class 130 (B) only possible on request, specifying order code Y50.

²⁾ Order code for Ex motors of the 1MB5, SIMOTICS XP motor series not available.

Overview

Temperature class 155 (F), utilized acc. to 130 (B), with higher coolant temperature and/or installation altitude

The motors can be ordered according to temperature class 155 (F) for utilization according to temperature class 130 (B) with other customized requirements if they are specified in plain text in the order.

Order code **Y50**

Temperature class 155 (F), utilized according to 155 (F), other requirements

The motors can be ordered according to temperature class 155 (F) for utilization according to temperature class 155 (F) with other customized requirements if they are specified in plain text in the order.

Order code **Y52**

Temperature class 180 (H), utilized according to 155 (F)

The motors can be ordered according to temperature class 180 (H) for utilization according to temperature class 155 (F) with other customized requirements if they are specified in plain text in the order.

Order code **Y75**¹⁾

Increased air humidity/temperature with 30 to 60 g water per m³ of air

With motor series 1LE1, 1LE5, 1MB1, 1MB5 and 1PC1, motors are available in a version designed for increased air humidity in the range of 30 to 60 g water per m³ of air, depending on the temperature, as shown in the table below. This version has condensation drainage holes (sealed). Not possible for 1MB...5 Ex db motors. Order code **N30** (includes order code **H03**²⁾, **M11**, stainless bolts in the terminal box cover, and **S02** standard/special paint finish for Performance Line cast-iron motors).

Please inquire before combining order code **N30** with mountings (e.g. rotary pulse encoder, brakes)!

Increased air humidity/temperature with over 60 to 100 g water per m³ air

With motor series 1LE1, 1LE5, 1MB1, 1MB5 and 1PC1, motors are available in a version designed for increased air humidity of over 60 to 100 g water per m³ of air, depending on the temperature, as shown in the table below. This version has condensation drainage holes. Not possible for 1MB...5 Ex db motors.

Order code **N31** (includes order code **H03**²⁾, **M11**, stainless bolts in the terminal box cover, and either the **S02** special paint finish or the **S03** "sea air resistant" special paint finish for Performance Line cast-iron motors).

Please inquire before combining order code **N31** with mountings (e.g. rotary pulse encoder, brakes)!

Absolute/relative conversion of air humidity

Relative humidity	Temperature							
	up to 20 °C	up to 30 °C	up to 40 °C	up to 50 °C	up to 60 °C	up to 70 °C	up to 80 °C	up to 90 °C
10 %	2	3	5	8	13	20	29	42
15 %	3	5	8	12	19	30	44	63
20 %	3	6	10	17	26	39	58	84
25 %	4	8	13	21	32	49	73	105
30 %	5	9	15	25	39	59	87	126
35 %	6	11	18	29	45	69	102	146
40 %	7	12	20	33	52	79	116	167
45 %	8	14	23	37	58	89	131	188
50 %	9	15	26	41	65	98	145	209
55 %	10	17	28	46	71	108	160	230
60 %	10	19	31	50	78	118	174	251
65 %	11	20	33	54	84	128	189	272
70 %	12	21	36	58	91	138	203	293
75 %	13	23	38	62	97	148	218	314
80 %	14	24	41	66	104	157	233	335
85 %	15	26	43	70	110	167	247	356
90 %	16	27	46	74	117	177	262	377
95 %	16	29	49	79	123	187	276	398
100 %	17	30	51	83	130	197	291	419

The values in the table with a blue background are covered by the standard version (up to < 30 g of water per m³ of air).

The values in the table with a light gray background are covered by order code **N30** (30 to < 60 g of water per m³ of air).

The values in the table with a dark gray background are covered by order code **N31** (60 to < 100 g of water per m³ of air).

Note:

- The coolant temperature and installation altitude can be found from page 1/30 onwards!
- The metal fan cover is available in combination with order code **F74** (not standard). For 1LE5/1MB5 motors with frame sizes 400 and 450 and for cast-iron motors of the Performance Line (1LE16), the metal fan cover is always standard.
- In case of increased thermal stress, please combine with the order codes **N05** to **N08**.
- In conjunction with more stringent requirements for the paint finish or corrosion protection stress (offshore, sea air, etc.), the corresponding order codes **S02**, **S03**, **S04**, and potentially **H07**, must be combined!
- Order code **N31** requires additional specifications for the ambient temperature CT 50 °C to CT 90 °C.

¹⁾ Order code for Ex motors of the 1MB5, SIMOTICS XP motor series not available.

²⁾ Order code for Ex motors of the 1MB.553, SIMOTICS XP motor series not available.

Introduction

Electrical design

1

Coolant temperature and installation altitude

Overview

The specified rated power is applicable for continuous duty in accordance with IEC 60034-1 at the frequency of 50 Hz, a coolant temperature (CT) or ambient temperature of 40 °C and an installation altitude (IA) up to 1000 m above sea level. 1LE1, 1LE5, 1MB1, 1MB5 and 1PC1 motors for ambient temperatures exceeding 40 °C are equipped with various types of seal. Mountings such as brake, terminal box at NDE, flange-mounted motors can sometimes exceed utilization in accordance with temperature class 130 (B).

For higher coolant temperatures and/or installation altitudes greater than 1000 m above sea level, the specified motor power must be reduced using the factor k_{HT} .

Depending on the frame size of the motor or the number of poles, special windings may be added to the motors for the different operating conditions.

This results in an admissible motor power of:

$$P_{adm} = P_{rated} \cdot k_{HT}$$

If the admissible motor power is no longer adequate for the drive, it should be checked whether the motor with the next highest rated power fulfills the requirements.

Abbreviation	Description	Unit
P_{adm}	Admissible motor power	kW
P_{rated}	Rated power	kW
k_{HT}	Factor for abnormal coolant temperature and/or installation altitude	

The motors are designed for temperature class 155 (F) and utilized in temperature class 130 (B). Under non-standard operating conditions, if they are to be used in this class, the admissible power rating must be determined from the table below.

Reduction factor k_{HT} for different installation altitudes and/or coolant temperatures

Installation altitude above sea level m	Coolant temperature					
	< 30 °C	30 ... 40 °C	45 °C	50 °C	55 °C	60 °C
1000	1.07	1.00	0.96	0.92	0.87	0.82
1500	1.04	0.97	0.93	0.89	0.84	0.79
2000	1.00	0.94	0.90	0.86	0.82	0.77
2500	0.96	0.90	0.86	0.83	0.78	0.74
3000	0.92	0.86	0.82	0.79	0.75	0.70
3500	0.88	0.82	0.79	0.75	0.71	0.67
4000	0.82	0.77	0.74	0.71	0.67	0.63

Coolant temperature and installation altitude are rounded to 5 °C and 500 m respectively.

Motors for coolant temperatures other than 40 °C or installation altitudes higher than 1000 m above sea level for utilization in temperature class 130 (B) must always be ordered with the additional identification code "-Z" and plain text. In the case of extreme derating, the operating data for the motors, i.e. efficiency and power factor, will also be less favorable due to partial utilization.

The following special versions are possible for 1LE1 and 1PC1 motors:

- Motors for coolant temperatures from -40 to +40 °C order code **D03**
- Motors for coolant temperatures from -30 to +40 °C order code **D04**

When ordering with order codes **D03** or **D04** in combination with mountings, the respective technical specifications have to be observed and it is necessary to inquire.

For details of order codes for use in temperature class 155 (F), see "DURIGNIT IR 2000 insulation system" under "Windings and insulation" on page 1/28.

Ambient temperature:

All motors can be used in the standard version at ambient temperatures between -20 and +40 °C. Exposure to direct sunlight can result in uncontrollable rises in motor temperature. To prevent this, appropriate shading measures such as a sun-protective cover are recommended.

Motors can be utilized in temperature class 155 (F)

- at 40 °C with service factor 1.1, i.e. the motor can be continuously overloaded with 10 % of the rated power in the case of IE1 motors
- at 40 °C with service factor 1.15, i.e. the motor can be continuously overloaded with 15 % of the rated power in the case of IE2 motors and higher efficiency classes
- above 40 °C at rated power.
- 1LE5 motors are used in accordance with temperature class 155 (F) up to 40 °C occurs with a service factor of 1.05, i.e. the motor can be continuously overloaded with 5 % of the rated power.

When motors are used in temperature class 130 (B) for higher ambient temperatures and/or installation altitudes, derating occurs in accordance with the Table "Reduction factor k_{HT} for different installation altitudes and/or coolant temperatures".

For motors ex stock, the service factor is indicated on the rating plate.

For other temperatures, special measures are necessary.

When brakes are to be mounted on motors intended for operation at temperatures below freezing, please inquire.

Overview**Anti-condensation heating**

Supply voltage 230 V (1AC)
Order code **Q02**

Supply voltage 115 V (1AC)
Order code **Q03**

Supply voltage 400 V (1AC)
Order code **Q06**

For motors with windings at risk of condensation due to the climatic conditions, e.g. inactive motors in humid atmospheres or motors that are subjected to widely fluctuating temperatures, anti-condensation heaters must be used.

An additional cable entry is provided for the connecting cable in the terminal box.

Motor series	Frame size	Cable entry
Aluminum motors (GP)	≤ 200	1 × M16 × 1.5
Cast-iron motors (SD)	≤ 180	1 × M16 × 1.5
	200	1 × M20 × 1.5
	225 ... 315	2 × M20 × 1.5
	355 ... 450	2 × M20 × 1.5

Anti-condensation heating must not be switched on during operation.

Frame size	Heat power of the anti-condensation heating		
	Supply voltage at		
	230 V	115 V (110 V)	400 V (1AC)
	Order code Q02	Order code Q03	Order code Q06
	W	W	W
1LE1/1LE5/1PC1 motors			
63 ... 80	12.5	12.5	–
90 ... 112	25	25	–
132 ... 200	50	50	–
225 ... 250	92	92	–
280 ... 315	109	109	–
315 ... 355	218	218	200
400 ... 450	240	240	370
1MB1, 1MB5 motors			
80 ... 112	7	7	–
132 ... 160	12	12	–
180 ... 200	57	57	–
225 ... 250	92	92	–
280 ... 315	109	109	–
355	218	218	200
400 ... 450	240	240	370

Instead of an anti-condensation heater, another possibility is to connect a voltage that is approximately 4 to 10 % of the rated motor voltage to stator terminals U1 and V1; 20 to 30 % of rated motor current is sufficient to heat the motor.

Fans/separately driven fans

1LE1 and 1MB1 motors of frame size 71 to 315 and 1LE5 and 1MB5 motors with 4 poles or more have radial-flow fans in the standard version (with the exception of option **F90** – version "Forced-air cooled motors without external fan and fan cover") that cool regardless of the direction of rotation of the motor (cooling method IC411 acc. to EN 60034-6). In the standard version, 1LE5 motors with 2 poles are cooled with unidirectional axial-flow fans. The air flow is forced from the non-drive-end (NDE) to the drive end (DE).

For details of separately driven fans for frame size 63 to 450, see also "Separately driven fans" on page 1/80.

Supply voltage of separately driven fan for 1LE1 motors:
The supply voltage tolerance of the separately driven fan is ±5 %. For voltage ranges, see page 1/80.

In confined spaces, it must be ensured that the minimum spacing is maintained between the fan cover and the wall. This also applies to adjacent parts, such as large handwheels and flywheels on the second shaft extension.

Clearance from wall/fan grilles

Frame size	mm
63, 71	15
80, 90, 100	20
112	25
132	30
160	40
180, 200	90
225, 250	100
280, 315	110
355	140
400 ... 450	150

For version of the fan and the fan cover, see the table below.

Motor-series	Frame size	11th position of the Article No.:	Version	Fan material	Fan cover material	
1LE10	63 ... 71	alle		Plastic	Metal	
	80 ... 200				Plastic ¹⁾	
1LE15	71 ... 90		Basic Line	Plastic	Metal	
	100 ... 315				Plastic	
1LE16	100 ... 315		Performance Line	Plastic	Metal	
1LE55	315 Standard power	0, 2, 4, 5, 6 ¹⁾	Basic Line	Plastic	Plastic	
	315 Extended power				Performance Line	Metal
	355 Extended power				Basic Line	Metal
1LE55	400 ... 450 2-pole	only for 2-pole		Metal	Metal	
	400 ... 450 4-... 8-pole				only for 4-... 8-pole	Plastic
1LE56	315 ... 355			Metal	Metal	

Metal external fan impeller

The standard fan impeller made of plastic can be replaced with a fan impeller made of metal. This version is available for the motors (with the exception of 1LE1 with option **F90** – version "Forced-air cooled motors without external fan and fan cover").

In versions with a unidirectional axial-flow fan, the metal external fan is already included. Up to frame size 160 and for the 1LE5/1MB5 motor series, the metal external fan impeller is made of aluminum.

Order code **F76**

Fan cover for textile industry

For 1LE1 motors (with the exception of 1LE1 with option **F90** – version "Forced-air cooled motors without external fan and fan cover") the standard version of the fan cover cannot be used in the textile industry.

For the motor series 1LE1 (with the exception of 1LE1 with option **F90** – version "Forced-air cooled motors without external fan and fan cover") a special version of the fan cover is available for the textile industry. This has a protective cover and is made of non-corrosive sheet steel.

The motor length increases when the fan cover for the textile industry is mounted, see page 1/114, Figure 12.

Order code **F75**

¹⁾ For the frame size codes **A, D, F, H, J, K, L, N, T, U**, and **V**, a screwed-on cover (plastic or metal) is used in conjunction with the option **H03** (condensation drainage holes). Mounted separately driven fans or brakes are only available in sheet metal version.

Introduction

Electrical design

Heating and ventilation

1

Overview

Sheet metal fan cover

In place of the plastic fan cover, a sheet metal fan cover can be ordered for motor series 1LE1 (with the exception of 1LE1 with option **F90** – version "Forced-air cooled motors without external fan and fan cover").

Order code **F74**

The sheet metal fan cover is supplied as standard with 1LE16 (Performance Line), 1LE5, and 1MB5 motors.

Necessary minimum cooling air flow for forced-air cooled motors in standard duty

The cooling air flow specified in the selection table applies to continuous duty according to EN 60034-1 at a coolant temperature (CT) or ambient temperature of 40 °C respectively and an installation altitude (IA) up to 1000 m above sea level.

In the 1LE1/1LE5 motor version without external fan and fan cover, order code **F90**, the motor is located in the air flow of the driven fan that must drive the minimum cooling air flow over the motor housing. The minimum air flow must pass closely over the housing (comparable to self-ventilation of the motor). Otherwise higher air flows are required to comply with admissible motor heating levels.

1LE1 motors

Frame size	Required cooling air flow for number of poles									
	2		4				6		8	
	IE2									
	50 Hz m ³ /min	60 Hz m ³ /min	50 Hz m ³ /min	60 Hz m ³ /min	50 Hz m ³ /min	60 Hz m ³ /min	50 Hz m ³ /min	60 Hz m ³ /min	50 Hz m ³ /min	60 Hz m ³ /min
63	0.83	1.02	0.41	0.48	0.27	0.32	–	–	–	–
71	1.49/1.73	1.81/2.08	0.75/0.86	0.87/1.02	0.49/0.58	0.58/0.71	0.36/0.42	0.43/0.54	–	–
80	1.82	2.18	0.9	1.1	0.6	0.73	0.44	0.53	–	–
90	3.3	4.03	1.64	2.01	1.11	1.31	0.76	0.94	–	–
	IE2/IE1		IE2		IE1		IE2/IE1		IE2/IE1	
	50 Hz m ³ /min	60 Hz m ³ /min	50 Hz m ³ /min	60 Hz m ³ /min	50 Hz m ³ /min	60 Hz m ³ /min	50 Hz m ³ /min	60 Hz m ³ /min	50 Hz m ³ /min	60 Hz m ³ /min
100	3.8	4.4	2.1	2.6	2.3	2.8	1.5	1.8	1.2	1.3
112	5.0/5.4 ¹⁾	5.7/6.1 ¹⁾	2.9	3.5	2.9	3.5	1.9	2.3	1.4	1.6
132	6.3	7.2	4.6	5.7	4.6	5.7	3.1	3.8	2.4	2.9
160	10.9	13.3	6.7	8.1	7.6	9.1	5	6.1	3.8	4.5
180	12.4	14.8	7.8	9.4	7.8	9.4	5.2	6.2	4.8	5.8
200	14.3	17.2	10.4	12.5	10.4	12.5	7.9	9.5	6	7.2
	IE2									
	50 Hz m ³ /min	60 Hz m ³ /min	50 Hz m ³ /min	60 Hz m ³ /min	50 Hz m ³ /min	60 Hz m ³ /min	50 Hz m ³ /min	60 Hz m ³ /min	50 Hz m ³ /min	60 Hz m ³ /min
225	22	26	19	23	15	17.5	11.5	13.5	–	–
250	28	33	21	24.5	19	22.5	14.5	16.3	–	–
280	32	37.5	32.5	39	24	29.5	18	22	–	–
315	48	58	49	58	34	40	25	30.5	–	–
	IE4/IE3									
	50 Hz m ³ /min	60 Hz m ³ /min	50 Hz m ³ /min	60 Hz m ³ /min	50 Hz m ³ /min	60 Hz m ³ /min	50 Hz m ³ /min	60 Hz m ³ /min	50 Hz m ³ /min	60 Hz m ³ /min
180	10.3	12.3	7	8.3	5.2	6.2	–	–	–	–
200	10.4	12.5	7.6	9.1	6.5	7.8	–	–	–	–
225	14	17.5	12	15	15.5	18	11.5	12.5	–	–
250	18.5	22	12	15	16	20	12	13.5	–	–
280	26	30.5	27.5	32.5	22.5	26.5	18	21.5	–	–
315	40	48.5	32.5	39	31	37	25	30.5	–	–
	IE3/IE2									
	50 Hz m ³ /min	60 Hz m ³ /min	50 Hz m ³ /min	60 Hz m ³ /min	50 Hz m ³ /min	60 Hz m ³ /min	50 Hz m ³ /min	60 Hz m ³ /min	50 Hz m ³ /min	60 Hz m ³ /min
80	1.36	1.66	0.66	0.8	0.42	0.51	0.3	0.38	–	–
90	2.86	3.41	1.34	1.7	0.87	1.06	0.65	0.8	–	–

1LE5 motors

Frame size	Required cooling air flow for number of poles							
	2		4		6		8	
	IE3/IE4							
	50 Hz m ³ /min	60 Hz m ³ /min	50 Hz m ³ /min	60 Hz m ³ /min	50 Hz m ³ /min	60 Hz m ³ /min	50 Hz m ³ /min	60 Hz m ³ /min
315	46/44	56/53	38.5/38	46/46	26.5/–	31/–	–	–
355	44/–	53/–	63/63	75/75	40.5/–	48.5/–	–	–
400	72	84	78	96	102	120	78	96
450	90	108	126	150	90	108	72	84

¹⁾ Value: IE2/IE1

Overview

The order variants for motor protection are coded with letters in the 15th position of the Article No. and, if necessary, using order codes.

In the standard version, the motor is designed without motor protection.

15th position of the Article No. letter **A**.

A distinction is made between current-dependent and motor-temperature-dependent protection devices.

The following applies to all motors:

The motors can withstand 1.5 times the rated current at rated voltage and frequency for two minutes (EN 60034).

Note:

Electrically protective separation of the built-in winding components for low-voltage motors is the insulation of the sensors for winding protection.

All sensors for winding protection, which can be selected under the Article No. supplements and options for motor protection meet the requirements of basic insulation.

The basic insulation is tested in accordance with Siemens Product Standard 60034-1 and 60034-18-41 and relates to all sensors and built-in components that are installed in the winding, such as PTC, NTC, KTY, Pt100 and bimetal switch.

For example, by ordering with letter **B** in the 15th position of the Article No or as an option with order code **Q11** "1 or 3 PTC thermistors – for tripping".

The Pt100/1000 already meets the requirements for electrically protective separation according to IEC 61800-5-1.

Current dependent protection devices

Fuses are only used to protect power cables in the event of a short-circuit. They are not suitable for overload protection of the motor.

The motors are usually protected by thermally delayed overload protection devices (circuit breakers for motor protection or overload relays), e.g. with SIRIUS industrial controls and protection relays. For further details, see Catalog IC 10.

This protection is current-dependent and is particularly effective in the case of a locked rotor.

For standard duty with short start-up times and starting currents not too excessive and for low numbers of switching operations, motor protection switches provide adequate protection. Motor protection switches are not suitable for heavy starting duty or large numbers of switching operations. Differences in the thermal time constants for the protection equipment and the motor result in unnecessary early tripping when the protection switch is set to rated current.

Motor-temperature-dependent protective devices and motor temperature detection with converter operation

Depending on the specific requirements, various different components can be built into the motor winding for switching off the motor before it overheats and for monitoring the winding temperature and motor temperature.

Temperature detectors – Bimetal switches

Bimetal switches operate on the principle of mechanical deformation as a result of long-term heating. Bimetal strips bent as a result of such heating have a spring action that results in sudden reversal of the curvature (concave to convex or vice-versa).

When a limit temperature is reached, these temperature detectors (NC contacts) can deactivate an auxiliary circuit. The circuit can only be reclosed following a considerable fall in temperature. Bimetal switches are suitable protection devices in the case of slowly rising motor temperatures. When the motor current rises quickly (e.g. with a locked rotor), these switches are not suitable due to their large thermal time constants.

Temperature detectors for tripping:

15th position of the Article No. letter **Z** and order code **Q3A**.

The temperature detectors have the following current-carrying capacity and switching capacity:

230 V, AC: 2.5 A

24 V, DC: 1.6 A

PTC thermistors – Thermistor motor protection

PTC thermistors provide the most comprehensive protection against thermal overloading of the motor. A rise in the winding temperature over the admissible value can be accurately detected thanks to the low heat capacity of these PTC (Positive Temperature Coefficient) thermistors and their excellent heat contact with the winding. When the limit temperature is reached (rated tripping temperature), the PTC thermistors undergo a sudden change in resistance. This is evaluated by tripping units and can be used to open auxiliary circuits. PTC thermistors cannot themselves be subjected to high currents and voltages. This results in the destruction of the semiconductor. The switching hysteresis of the PTC thermistor and tripping unit is low, which supports fast restarting of the drive. Motor protection of this type is recommended for heavy duty starting, switching duty, extreme changes in load, high ambient temperatures or fluctuating supply systems.

Motor protection with PTC thermistor for tripping. In the terminal box, two auxiliary terminals are required.

15th position of the Article No. letter **B**.

Two temperature sensor circuits are used if a warning is required before the motor is shut down (tripped).

The warning is normally set to 10 K below the tripping temperature.

Motor protection with PTC thermistor for alarm and tripping.

In the terminal box, 4 auxiliary terminals are required.

15th position of the Article No. letter **C**.

The following applies to 1LE1 motors:

Motor protection for frame sizes 80 and 90 is implemented with the 15th position of the Article No. letter **B**, and with the order code **Q11** with a PTC thermistor.

Motor protection for frame sizes 80 and 90 is implemented with the 15th position of the Article No. letter **C**, and with the order code **Q12** with two PTC thermistors.

The following applies to 1MB1 motors:

The motor protection is implemented with the 15th position of the Article No. letter **B** with three PTC thermistors.

The motor protection is implemented with the 15th position of the Article No. letter **C** with six PTC thermistors.

In order to achieve full thermal protection, it is necessary to combine a thermally delayed overcurrent release and a PTC thermistor. For full motor protection implemented only with PTC thermistors, please inquire.

The SIRIUS 3RN2 thermistor motor protection device for protecting motors against overheating by means of direct temperature measurement, also for a hazardous area with ATEX approval, can be ordered separately. For further details, see Catalog IC 10 or www.siemens.com/product?3RN2.

Introduction

Electrical design

Motor protection

1

Overview

PTC thermistor characteristic

The PTC thermistor is a temperature-dependent component. At the smallest changes in temperature in the region of the rated shutdown temperature, the resistance of the PTC increases steeply.

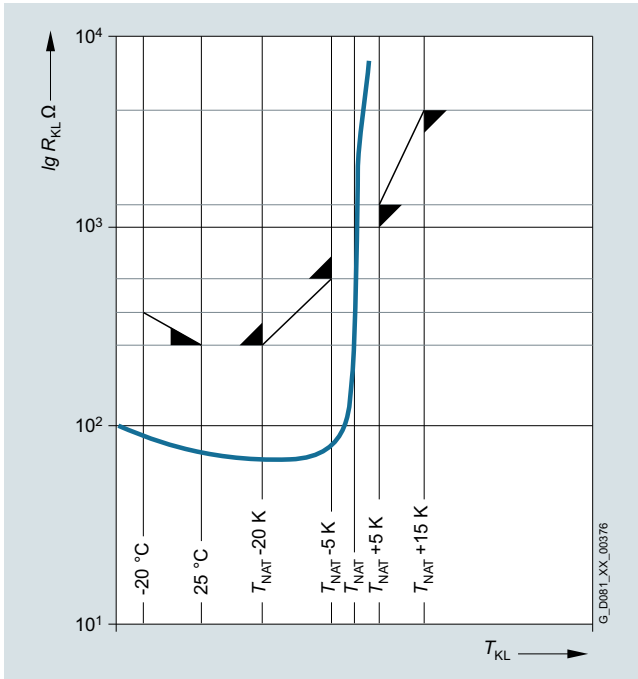

PTC sensor characteristic

NTC thermistor

NTC thermistors have a negative temperature coefficient and conduct current at higher temperatures better than at lower temperatures.

NTC thermistors are typically used for temperature compensation of electronic circuits, or to limit inrush currents, to achieve the soft starting of electrical machines, for example.

Motor temperature monitoring and shutdown using NTC thermistors is unusual, but it is technically possible. The tripping temperature can be set when using suitable tripping devices of this type.

NTC thermistors for tripping: 15th position of the Article No. letter **Z** and order code **Q2A**.

For line operation, the SIRIUS 3RS1, 3RS2 temperature monitoring relay, which forms part of the protection equipment, can be ordered separately.

For further details, see Catalog IC 10 or www.siemens.com/product?3RS1.

NTC thermistor characteristic

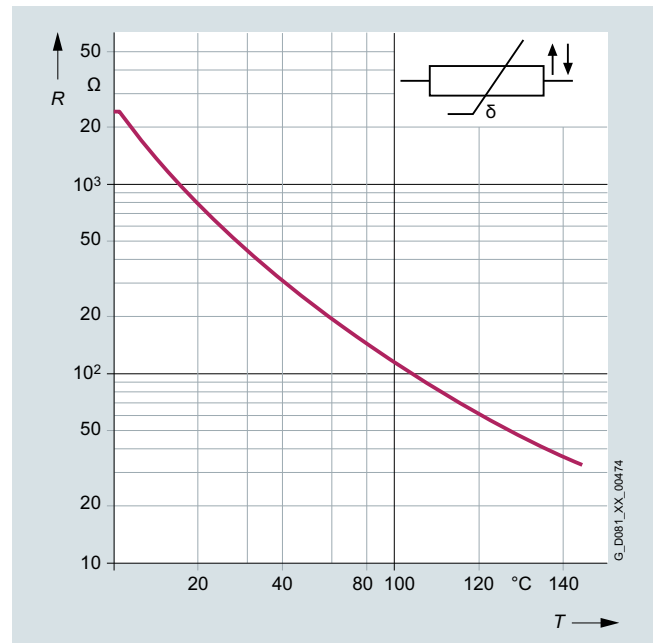

OverviewKTY 84-130 temperature sensor

This temperature sensor is a semiconductor which, in a similar manner to a PTC thermistor, changes its resistance as a function of its temperature at a defined rate. Within the measuring range, however, the KTY 84-130 characteristic rises almost linearly. The temperature sensor is embedded in the winding overhang of the motor in the same way as the components mentioned above. It is characterized by its outstanding precision, high reliability, and temperature stability, as well as a fast response time. Thanks to these properties, which permit the almost analog monitoring of winding temperature, the KTY 84-130 is preferred for converter operation.

Motor temperature detection with embedded KTY 84-130 temperature sensor: In the terminal box, two auxiliary terminals are required.

15th position of the Article No. letter **F**.

Temperatures for alarm and tripping can be set as required when using converters from Siemens that determine the motor temperature in accordance with the measuring principle described above. With these devices, the measured signal is evaluated directly in the converter.

For line operation, the SIRIUS 3RS1, 3RS2 temperature monitoring relay, which forms part of the protection equipment, can be ordered separately.

For further details, see Catalog IC 10 or www.siemens.com/product?3RS1.

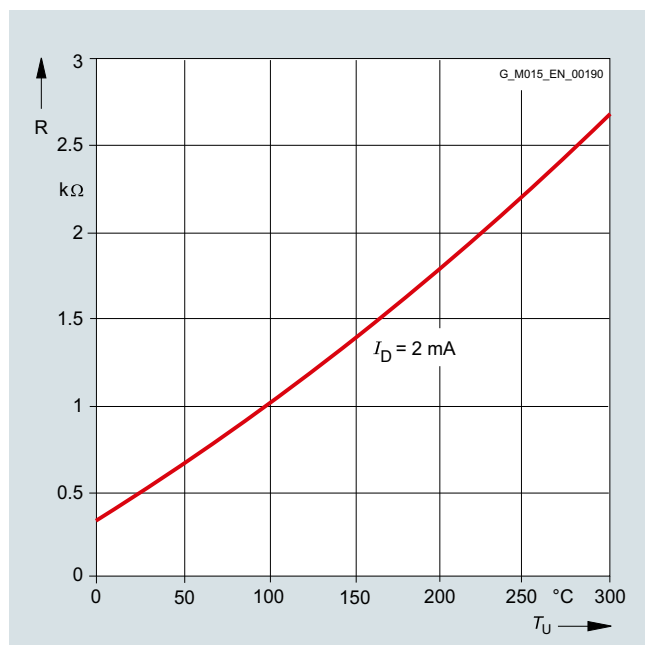
KTY 84-130 temperature sensor characteristicPt100/Pt1000 resistance thermometer

The resistance thermometer has a chip for a temperature sensor, the resistance of which changes in relation to temperature according to a series of reproducible basic values. The changes in resistance are transferred as changes in current. At 0 °C, the measurement resistances are adjusted to 100 Ω for the Pt100 and 1000 Ω for the Pt1000, and correspond to the accuracy class B (i.e. the relationship between resistance and temperature). The limit deviation is ± 0.3 °C, and the admissible deviations are defined in EN 60751.

The Pt1000 resistance thermometer will, in the future, gradually replace the KTY84-130 temperature sensors available today. Similar to the method of operation of the Pt100, the relationship between the temperature and the electrical resistance of conductors is utilized in the Pt1000 to measure the temperature, just like with the additional resistance thermometers described above.

Pure metals undergo larger changes in resistance than alloys and have a relatively constant temperature coefficient.

The order options for the Pt100/Pt1000 temperature sensors are described in Chapter 2 (15th position of the Article No.: **H, J, K, L, P, Q, or R**, or order codes **Q35, Q36, Q60, Q61, Q62, Q63, Q64, Q67, Q68, Q72, Q78, or Q79**).

Temperatures for alarm and tripping can be set as required when using converters from Siemens that determine the motor temperature in accordance with the measuring principle described above. With these devices, the measured signal is evaluated directly in the converter.

In line operation, the SIRIUS 3RS1, 3RS2 temperature monitoring relay can be ordered separately for the protection equipment.

For further details, see Catalog IC 10 or www.siemens.com/product?3RS1.

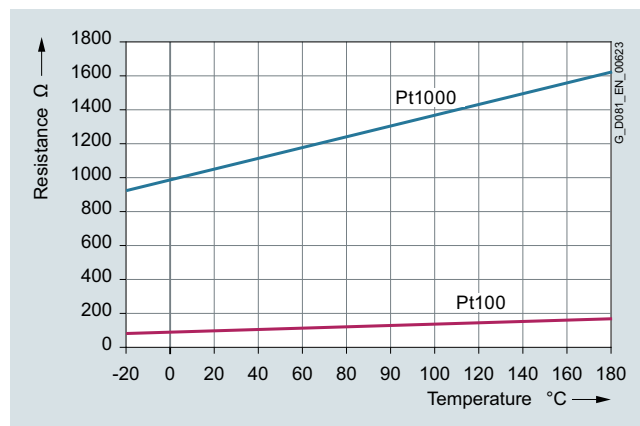
Pt100/Pt1000 resistance thermometer characteristics

Introduction

Electrical design

Connection, circuit and terminal boxes

1

Overview

Location of the terminal box

The terminal box of the motor can be mounted in four different locations or positions. For the motors of the 1LE10 aluminum series, frame sizes 63 and 71, the terminal box can only be mounted on the top (16th position of the Article No. **4**).

The position of the terminal box is coded using the 16th position of the motor Article No.

When defining the position of the terminal box, please observe the following:

- Motors with feet must always be viewed looking onto the drive end with the shaft in the horizontal position. The feet are then always at "6 o'clock". This is especially important with construction types IM B6, IM B7, and IM B8, and also applies to combined construction types such as IM B35.
- Flange-mounted motors (e.g. IM B5) whose drive-end flange has a condensation drainage hole must always be viewed looking onto the drive end with the shaft in the horizontal position. The condensation drainage hole is then always at "6 o'clock".

The aluminum series motors 1LE10 and 1PC10 with feet and standard power range have cast feet in the standard version in frame sizes up to 160, e.g. IM B3, IM B6, etc. (applies only to IE3 and IE4 motors with standard housing; IE3 and IE4 motors with long housing always have screwed-on feet). Motors from frame size 180 upwards have screwed-on feet. If rotation of the terminal box is to be possible in the future, the "Screwed-on feet" option, order code **H01**, must be ordered. In accordance with the type of construction, spare holes that are not used for mounting the feet can be used by the customer. If the customer would like this option, it is advisable to include order code **H10** "Housing with screw mounting" in the order – possible only for frame sizes 80, 90, 180 and 200. Responsibility for any strength calculations required for this type of customer mounting lies with the customer.

For all motors with increased power and with feet, the feet are screwed-on as standard. The terminal box can be rotated later. Motors with frame sizes 225 to 315 are supplied as standard with cast feet.

Terminal box on right-hand side:
16th position of the Article No. digit **5**

Terminal box on left-hand side:
16th position of the Article No. digit **6**

Terminal box below:
16th position of the Article No. digit **7**

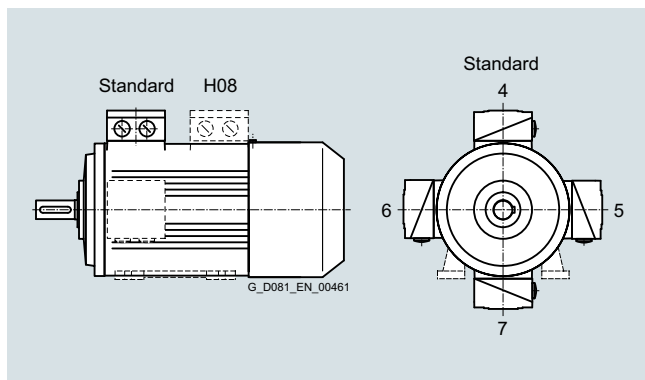

Location of the terminal box with the corresponding digits in the 16th position of the Article No.

The number of winding ends depends on the winding design. Three-phase motors are connected to the three phase conductors L1, L2 and L3 of a three-phase system. The rated voltage of the motor in the running connection must match the phase conductor voltages of the network.

When the three phases are operating in a time sequence and are connected to the terminals of the motor in alphabetical order U1, V1 and W1, clockwise rotation of the motor shaft is established as viewed onto the drive end. The direction of rotation of the motor can be changed to counterclockwise if two connecting leads are interchanged.

Labeled terminals are provided to connect the protective conductor.

A PE terminal is provided in the terminal box for grounding. A grounding terminal is provided on the outside of the motor housing – special version for 1LE1/1PC1 motors.

Order code **H04**

External grounding terminal/external grounding is standard for 1LE15/16 motors from frame size 180 upwards and for 1LE5/1MB5 motors of frame sizes 400 and 450.

A second external grounding connection can also be ordered. Order code **H70** (must be ordered in combination with option **H04**)

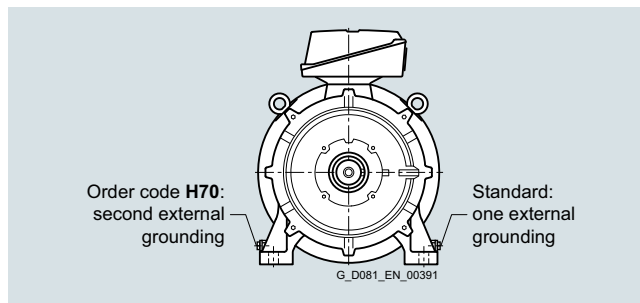

If a brake control system or thermal protection is installed, the connections will also be in the terminal box. The motors are suitable for direct connection to the line supply.

Design of the terminal box

The number of terminals and the size of the terminal box are designed for standard requirements.

For special requirements, or on customer request, a larger terminal box can be supplied.

For motors with frame sizes 71 up to 90, the following constraints apply:

For configuration, note that, when the terminal box is located on the left or right-hand sides, the customer must not align the cable entry towards the housing feet, because this can cause collisions between the motor connection cables and the foundations.

Larger terminal box

Order code **R50**

If the necessary installation angle of the motor would cause machine components to collide with the terminal box, the terminal box can be moved from the drive end (DE) to the non-drive end (NDE). Only use according to temperature class 155 (F). When the terminal box is rotated to the non-drive end (NDE) of the motor, it is important to note that dimensions "C" and "CA" will not comply with the values specified by EN 50347. Dimensional drawings can be requested via DT Configurator.

Order code **H08**

Overview

Motor connection

Line feeder cables

The line feeder cables must be dimensioned acc. to DIN VDE 0298. The number of required feeder cables, if necessary in parallel, is defined by:

- The max. cable cross-section which can be connected,
- The cable type,
- The cable routing,
- The ambient temperature and the corresponding admissible current in accordance with DIN VDE 0298,
- The requirements according to IEC/EN 60204-1,
- The requirements according to IEC/EN 60079-14 for 1MB motors.

For motors with auxiliary terminals (e.g. 15th position of the Article No. letter **B**), additional cable entry holes are provided (M16 × 1.5 or M20 × 1.5 depending on frame size). For further details, see the data sheet function in the DT Configurator.

The terminal box is located on the housing and bolted in place. The terminal box can be turned by 4 × 90° degrees on the terminal base of the machine housing in the case of a terminal board with 6 terminal studs (standard version).

Order code **R09**

Parallel feeders

Some motors must be fitted with parallel feeders due to the maximum permissible current per terminal. These motors are indicated in the selection and ordering data in the respective chapter.

The temperature rises in the terminal box must be taken into account when selecting the connection cable or individual connections.

These approximate temperature rises are as follows:

- Range of ambient temperature (T_{amb}) +50 K for motors with temperature class Th.Cl.155 (F).
- Range of ambient temperature (T_{amb}) +60 K for motors with temperature class Th.Cl.180 (H).
- Without any specifications in field 19 (T_{amb}) on the rating plate, T_{amb} is equal to 40 °C.

Location of the cable entries with the corresponding order codes

Motor	Frame size	Terminal box position				Retrofitting possible Article No. with	Rotation of the terminal box and cable entry			Retrofitting possible	
		Top 16th position of the Article No.	Right-hand side	Left-hand side	Bottom		-90° -Z and order code	+90° R10	180° R11		
Type		4	5	6	7	4	H01	R10	R11	R12	
1FP10, 1LE10, 1MB10, 1PC10	63 ... 71	✓	-	-	-	-		✓	✓	✓	Yes
	80 ... 90	✓	✓	✓	-	-		✓	✓	✓	Yes
	100, 112	✓	✓	✓	✓	-		✓	✓	✓	Yes
	132	✓	✓	✓	✓	-		✓	✓	✓	Yes
	160	✓	✓	✓	✓	-		✓	✓	✓	Yes
	180	✓	✓	✓	-	-		✓	✓	✓	Yes
1FP15, 1LE15, 1MB15 ⁶⁾	71	✓	✓	✓	-	-		✓	✓	✓	Yes
	80, 90	✓	✓	✓	-	-		✓	✓	✓	Yes
1FP15, 1LE15/6, 1MB15/6 ⁶⁾	100 ... 160	✓	✓	✓	✓	-		✓	✓	✓	Yes
	180 ... 315	✓	✓	✓	-	-		✓	✓	✓	Yes
1LE5 ⁷⁾	315	✓	✓	✓	-	-		✓	✓	✓	Yes
1PC13	80, 90	✓	✓	✓	-	✓		✓	✓	✓	Yes
	100 ... 160	✓	✓	✓	✓	✓		✓	✓	✓	Yes
	180 ... 315	✓	✓	✓	-	✓		✓	✓	✓	Yes

Motor	Frame size	Terminal box position				90° right	90° left	Bottom	Rotation of the terminal box and cable entry			Retrofitting possible	
		Top left 16th position of the Article No.	Top right	45° left	45° right				-90° Article No. with -Z and order code	+90° R10	180° R11		
Type		0	1	2	3	4	5	6	9 ^{1) 2)}	R10	R11	R12	
1LE5 ⁸⁾ , 1MB5 ⁶⁾	315	✓	✓	✓	✓	-	✓	✓	✓	✓ ³⁾	✓	✓	Yes
	355	✓	✓	✓	✓	-	✓	✓	✓	✓	✓	✓	Yes
	400 ... 450	✓	✓	✓	✓	-	✓	✓	✓	✓ ⁵⁾	✓	✓	No ⁴⁾
1MB..5, 1MB..6	315 ... 355	-	-	-	-	✓	-	-	-	✓	✓	✓	No

1) Article No with the following order code:
R5L – terminal box on left-hand side (base below)
R6R – terminal box on right-hand side (base below)
R7L – terminal box bottom left
R7R – terminal box bottom right

2) Only possible in combination with type of construction IM B5.

Cable entry on the terminal box

With a view onto the drive end of the motor with the shaft in the horizontal position and the terminal box on the top, the cable entry is always on the right-hand side of the motor, as shown in the figure below – standard position 0°.

The terminal box can be rotated on the base of the motor housing such that the cable entry is located in the positions given below:

- Towards the drive end (DE)
(rotation of terminal box by 90°, entry from DE) for B5 types of constructions only with order code **H08!**

With B14 construction types, the customer must ensure that sufficient space is available for cable outlet.

Order code **R10**

- Towards the fan end (NDE)
(rotation of terminal box by 90°, entry from NDE)
Order code **R11**

- Opposite the standard position 0°
(rotation of terminal box by 180°, entry opposite the standard position 0°)
Order code **R12**

The dimensions of the terminal box are listed in the section "Dimensions" on pages 3/146 to 3/184 in accordance with the frame size and the "Dimensional drawings".

If the position of the terminal box (right-hand side, left-hand side, or top) is changed, the position of the cable entry must be checked and, if necessary, ordered with the corresponding order codes (**R10**, **R11**, and **R12**).

Introduction

Electrical design

Connection, circuit and terminal boxes

1

Overview



Terminal box in standard position, detailed view

Ordering example:

Terminal box on right-hand side (16th position of the Article No. digit **5**):

Cable entry is from below unless another order code is specified.

Cable entry from drive end (DE) – Article No. with **-Z** and order code **R10**.

For cable entry to a standard terminal box, a metal cable gland can be ordered for motor connection.

One metal cable gland – Article No. with **-Z** and order code **R15**.

For special requirements for which standard holes for the cable entries are inadequate for the UK market, reduction pieces for M cable glands in accordance with British Standard that are mounted on both cable entries can be supplied (only up to frame size 160).

Order code **R30**

Frame size	Cable entry acc. to	
	IEC	British Standard
100	2 × M32	2 × M20
112/132	2 × M32	2 × M25
160	2 × M40	2 × M32

Motor connectors

Motors of frame sizes 63 to 132 can be supplied with a motor connector.

The motor connectors are mounted on the specially designed terminal box at the factory and are aligned towards NDE in the basic version. The terminal boxes can be rotated by $4 \times 90^\circ$ on the base of the motor housing (order codes **R10**, **R12**, and **R13**).

The following motor connector variants are available:

- Motor connector HAN10B-10E
Order code **R70**
- Motor connector HAN10B-10E EMC
Order code **R71**
- Motor connector HAN3A-Q12 EMC
Order code **R72**
- Motor connector HAN3A-Q12
Order code **R73**

Motor connector assignment

Motor Type	Frame size	Motor connectors Type	Size of the terminal box
1LE10	63 ... 70	HAN10B-10E HAN10B-10E EMC	TB1B60
	80 ... 90	HAN3A-Q12 HAN3A-Q12 EMC	TB1E00 with mounted brake TB1E10
	80 ... 90	HAN10B-10E HAN10B-10E EMC	Only possible with TB1E10
1LE10, 1PC10	100 ... 132	HAN10B-10E HAN10B-10E EMC	Currently only available with TB1F10 (frame sizes 100 and 112) or TB1H10 (frame size 132)

Technical characteristic values of motor connectors according to EN 60664-1 and EN 61984

Characteristic value	Motor connectors			
	HAN3A-Q12		HAN10B-10E	
Degree of pollution	3		2	
Rated current	10 A		16 A	
Rated voltage	400 V	400/690 V	500 V	400/690 V
Rated voltage acc. to UL/CSA	600 V		600 V	

For further technical specifications of the motor connectors, refer to the catalog of Harting Deutschland GmbH & Co. at www.harting.com

or

<https://b2b.harting.com/ebusiness/de/industrie-steckverbinder-han/100382>.

Protruding cable ends

For confined spaces, protruding cable ends can be ordered without a terminal box with cover plate.

The following lengths of protruding cables can be ordered as standard using order codes:

- 3 cables protruding, 0.5 m long ¹⁾
Order code **R20**
- 3 cables protruding, 1.5 m long ¹⁾
Order code **R21**
- 6 cables protruding, 0.5 m long
Order code **R22**
- 6 cables protruding, 1.5 m long
Order code **R23**
- 6 cables protruding, 3.0 m long
Order code **R24**

The cross-section of the named cable refers to a coolant temperature of up to CT 40 °C.

¹⁾ For 3 protruding cables only, it must be specified in plain text whether star or delta connection is required (voltage code **90** and **M1Y**).

Overview

Terminal box type TB1B00

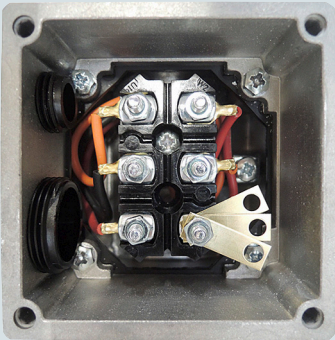

Terminal box type TB1B10

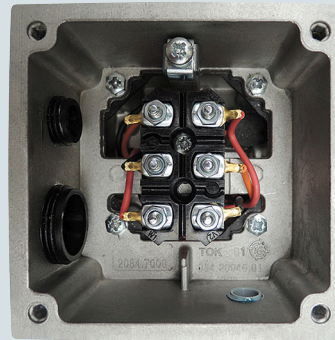

Terminal box type TB1E00

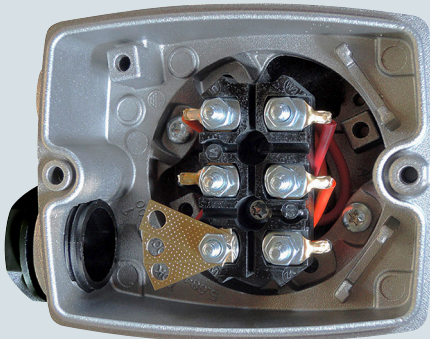

Terminal box type TB1E10 – order code **R50**

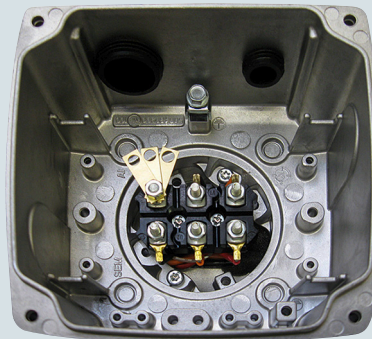

Terminal box types TB1F00, TB1H00, TB1J00

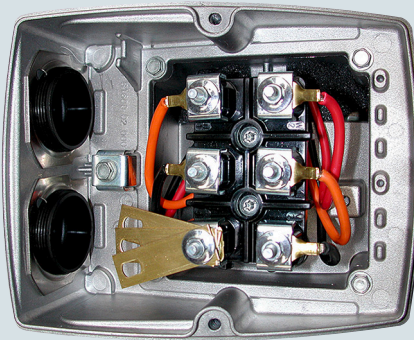

Terminal box types TB1F10, TB1H10, TB1J10 – order code **R50**

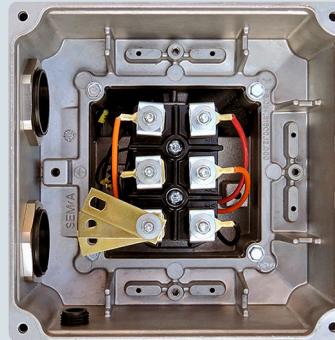

Terminal box type TB1L00

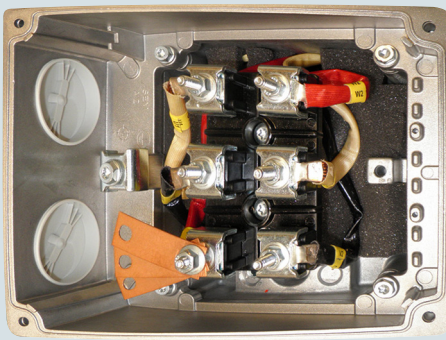

Terminal box type TB1L10 – order code **R50**

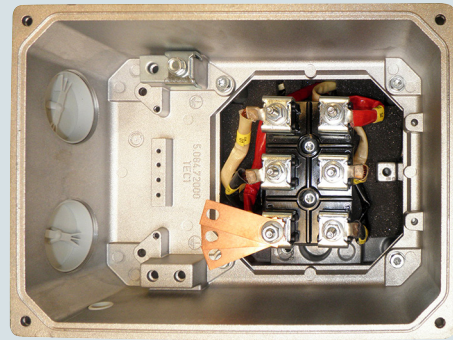

Introduction

Electrical design

Connection, circuit and terminal boxes

1

Overview

Terminal box type TB1J01



Terminal box type TB1L01



Terminal box type TB1N01

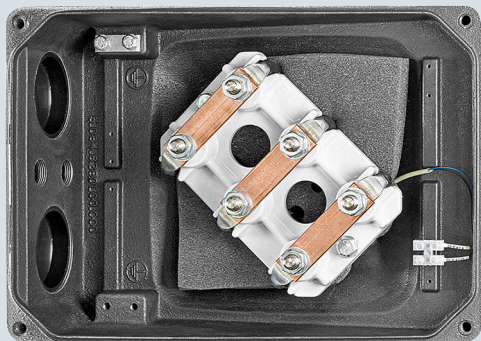

Terminal box type TB1Q01



Motor connector type HAN3A-Q12

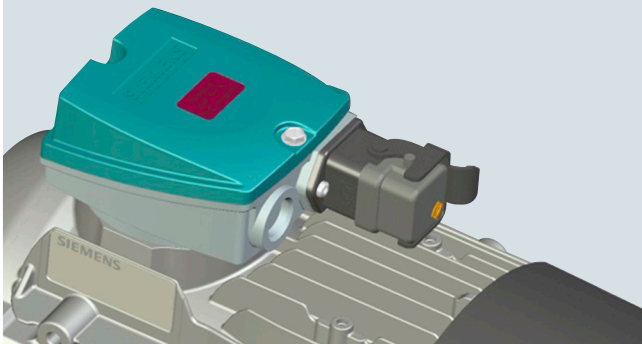

Motor connector type HAN10B-10E

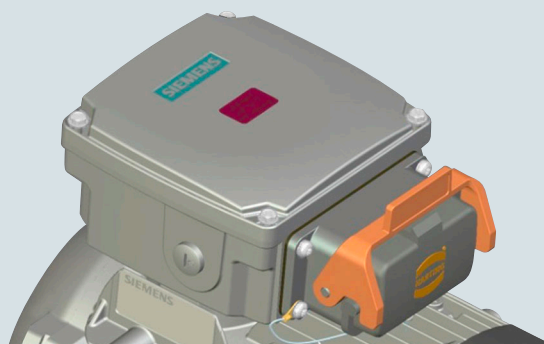

Terminal box type TB3R61

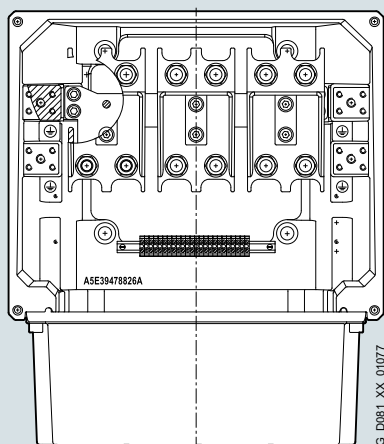

Terminal box type 1XB1631

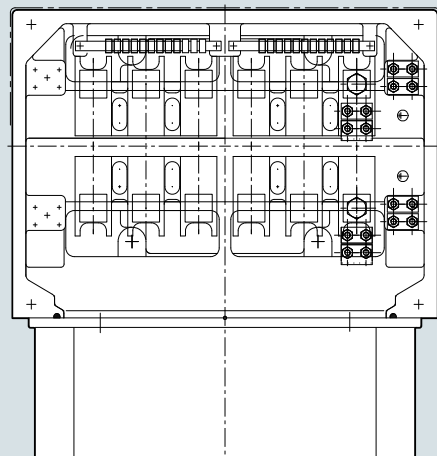

Overview

Terminal box type 1XB7750

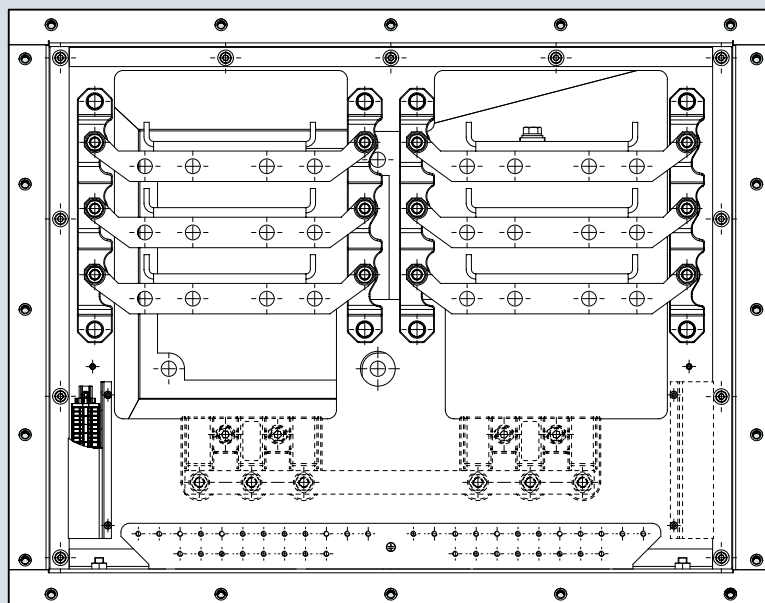

Basic data for terminal boxes for 1LE1, 1MB1, 1PC1, 1LE5, and 1MB5 motors

Motor	Frame size	Terminal box	Cable entries/locking	Terminal box material	Feeder connection
1LE10/1MB10/1PC10					
1LE10	63 ... 71	TB1B00 TB1B10	2 entries complete with sealing plugs, thread in terminal box, terminal box mounted and screwed in place	Aluminum alloy	<ul style="list-style-type: none"> • Cable lug • Rigid cable, no cable lug
1LE10	80 ... 90	TB1E00	1 entry complete with sealing plugs, thread in terminal box (2 entries with additional mounting components in the winding), terminal box mounted and screwed in place	Aluminum alloy	<ul style="list-style-type: none"> • Cable lug • Rigid cable, no cable lug
1LE10/ 1MB10	80 ... 90	TB1E10	2 entries complete with sealing plugs, thread in terminal box, terminal box mounted and screwed in place	Aluminum alloy	<ul style="list-style-type: none"> • Cable lug • Rigid cable, no cable lug
1LE10 1MB10 ¹⁾ 1PC10	100 ... 180 80 ... 160 100 ... 160	TB1F00 TB1H00 TB1J00 TB1F10 TB1H10 TB1J10	2 entries complete with sealing plugs and locknuts, terminal box mounted and screwed in place	Aluminum alloy	<ul style="list-style-type: none"> • Cable lug • Rigid cable, no cable lug
1LE10	200	TB1L00 TB1L10	2 entries complete with sealing plugs, thread in terminal box, terminal box mounted and screwed in place	Aluminum alloy	<ul style="list-style-type: none"> • Cable lug • Rigid cable, no cable lug
1LE15/1LE16/1LE5/1MB15/1MB16/1MB5					
1LE15/ 1MB15 ¹⁾	71 ... 90	TB1D01	2 entries complete with sealing plugs, thread in terminal box, terminal box mounted and screwed in place	Cast iron	<ul style="list-style-type: none"> • Cable lug • Rigid cable, no cable lug
1LE15/ 1LE16/ 1MB15/ 1MB16 ¹⁾	100 ... 315	TB1F01 ... TB1R01	2 entries complete with sealing plugs, thread in terminal box, terminal box mounted and screwed in place	Cast iron	<ul style="list-style-type: none"> • Cable lug • Rigid cable, no cable lug
1LE5 ³⁾ 1MB5 ¹⁾	315 ... 355	TB3Q01 TB3R01	2 entries complete with sealing plugs, thread in terminal box, terminal box mounted and screwed in place	Cast iron	<ul style="list-style-type: none"> • Cable lug • Rigid cable, no cable lug
1LE5 ²⁾	315	TB1Q01	2 entries complete with sealing plugs, thread in terminal box, terminal box mounted and screwed in place	Cast iron	<ul style="list-style-type: none"> • Cable lug • Rigid cable, no cable lug
1LE5, 1MB5 ¹⁾	355 (500 kW)	TB3R01	4 entries complete with sealing plugs, thread in terminal box, terminal box mounted and screwed in place	Cast iron	<ul style="list-style-type: none"> • Cable lug • Rigid cable, no cable lug
1LE5/ 1MB5	400 ... 450	TB3R61 1XB1631 1XB7750	4 entries complete with sealing plugs, thread in terminal box, terminal box mounted and screwed in place 8 entries complete with sealing plugs, thread in terminal box, terminal box mounted and screwed in place	Sheet steel	<ul style="list-style-type: none"> • Cable lug • Rigid cable, no cable lug

¹⁾ The certified cable entries are supplied as standard for explosion-protected motors.
 - Frame sizes 63 to 200: One certified metric cable gland and one certified metric sealing plug
 - Frame sizes ≥ 225 : Two certified metric cable glands
 - 1MB1.5 and 1MB5.6 Ex db eb IIB motors are supplied without cable gland.

²⁾ 11th position of Article No. for all number of poles **0, 2, 4, 5**; for 6-, 8-pole **6**.

³⁾ 11th position of Article No. for all number of poles **7, 8**; for 2-, 4-pole **6**.

Introduction

Electrical design

Connection, circuit and terminal boxes

1

Overview

Technical specifications for terminal boxes for 1LE1, 1LE5, 1MB1, 1MB5, and 1PC1 motors

Frame size	Terminal box ¹⁾ Standard/larger (order code R50)	Number of terminals	Thread of the contact screw	Max. connectable cable mm ²	Outer cable diameter (sealing range) mm	Cable entry ²⁾³⁾
1LE10/1MB10/1PC1						
63 ... 71	TB1B00/TB1B10	6	M4	1.5/2.5 with cable lug	9 ... 17 / 4,5 ... 10 + 9 ... 17	1 × M25 × 1.5/ 1 × M16 × 1.5 + 1 × M25 × 1.5
80 and 90	TB1E00/TB1E10 ⁴⁾	6	M4	1.5/2.5 with cable lug	9 ... 17 / 4,5 ... 10 + 9 ... 17	1 × M25 × 1.5/ 1 × M16 × 1.5 + 1 × M25 × 1.5
100 112	TB1F00/TB1F10	6	M4	4	11 ... 21	2 × M32 × 1.5
132	TB1H00/TB1H10	6	M4	6	11 ... 21	2 × M32 × 1.5
160 180	TB1J00/TB1J10	6	M5	16	19 ... 28	2 × M40 × 1.5
200	TB1L00/TB1L10	6	M6	25	27 ... 35	2 × M50 × 1.5
1LE15/1MB15						
71 ... 90	TB1D01	6	M4	1.5/2.5 with cable lug	4,5 ... 10 + 9 ... 17	1 × M16 × 1.5 + 1 × M25 × 1.5
1LE15/1LE16/1LE5 ⁵⁾/1MB15/1MB16						
100 112	TB1F01/TB1J01	6	M4	4	11 ... 21	2 × M32 × 1.5/ 2 × M40 × 1.5
132	TB1H01/TB1J01	6	M4	6	11 ... 21	2 × M32 × 1.5
160	TB1J01/TB1K01	6	M5	16	19 ... 28	2 × M40 × 1.5
180	TB1J01/TB1K01	6	M5/M6	16/25	19 ... 28/27 ... 35	2 × M40 × 1.5/2 × M50 × 1.5
200	TB1L01/TB1L01	6	M6/M8	25/35	27 ... 35/27 ... 35	2 × M50 × 1.5/2 × M50 × 1.5
225	TB1L01/TB1N01	6	M8/M10	35/120	27 ... 35/34 ... 42	2 × M50 × 1.5/2 × M63 × 1.5
250 280	TB1N01/TB1Q01	6	M10/M12	120/240	34 ... 45	2 × M63 × 1.5 2 × M63 × 1.5
315	TB1Q01/TB1R01	6	M12/M16	240	38 ... 45/ 44 ... 54	2 × M63 × 1.5 2 × M63 × 1.5
	TB3Q01	6	M12	185 /240	38 ... 45/ 42 ... 54	2 × M63 × 1.5
	TB3Q61					
355	TB1R01	6 12	M16 2 × M16	240	56 ... 68.5	2 × M80 × 2 4 × M80 × 2
1LE55/1LE56/1MB5						
315 ⁶⁾	TB3Q01/TB3R01	6	M12/M16	185/240	38 ... 45/ 42 ... 54	2 × M63 × 1.5 2 × M80 × 2
355	TB3R01/TB3R61	12	M16/2 × M16	300	63 ... 70/ 58 ... 64 ⁷⁾	2 × M80 × 2 4 × M80 × 2
400 ... 450	TB3R61/1XB7750	12	M16	240	56 ... 64.5	4 × M80 × 2
	1XB1631/1XB7750		M16	300	56 ... 64.5	4 × M80 × 2
	-/1XB7750	48	M12	300	41 ... 57	8 × M72 × 2

– not available

Technical specifications for auxiliary terminal boxes Ex e option code R54 for 1MB1.5, 1MB1.6, 1MB555

Frame size	Thread of the contact screw	Conductor cross-section max. mm ²	Add-on terminals in the main terminal box max.	Cable entry	Option code R62	Add-on terminals (R62) max.	Option code R63	Add-on terminals (R63) max.	Option code R67	Add-on terminals (R67) max.
SIMOTICS XP 1MB1.5/1MB1.6/1MB555										
71	6 x M5	16	11	2 × M40 × 1,5	ja	12	nein	–	ja	12
80										
90										
100	6 X M5									
112										
132	6 x M6	35	20	2 × M50 × 1,5						
160	6 X M6	50	18							
180										
200	6 x M10	120	24	2 × M63 × 1,5			ja	25		

Terminal connection

The terminal board accommodates the terminals that are connected to the leads to the motor windings. The terminals are designed so that 1LE1-motor types for frame sizes 71 to 315 and for all 1MB-motor types, the external (line) connections can be made without the need for cable lugs.

The description of the connection system applies to 1MB for all types of protection, except in conjunction with terminal box Ex db (option **R48**).

¹⁾ In addition to the exact part designation, please specify the machine type and the serial number in all orders for spare parts and repair parts.

²⁾ Designed for cable glands with O-ring.

³⁾ NPT threads can be ordered with order code **Y61**.

⁴⁾ For 1LE1021, 1LE1023, and 1MB10, terminal box TB1E10 normal version.

⁵⁾ 11th position of Article No. for all number of poles **0, 2, 4, 5**; for 6-, 8-pole **6**.

⁶⁾ 11th position of Article No. for all number of poles **7, 8**; for 2-, 4-pole **6**.

Overview

Number of auxiliary terminal boxes for main terminal box

Number of auxiliary terminal boxes TB2J01, TB2N01 in combination with standard terminal box												
Frame size		100, 112	132	160	180	200	225	250	280	315	355	
Terminal box												
Auxiliary terminal box												
Type	Order code	TB1F01	TB1H01	TB1J01		TB1L01		TB1N01		TB1Q01	TB3Q01	TB3R01
TB2J01	R62	–	–	✓		✓		✓		✓	✓	✓
TB2N01	R63	–	–	–		–		–		–	–	–
2 x TB2J01	R67	–	–	✓		✓		✓		✓	✓	✓
2 x TB2N01	R68	–	–	–		–		–		–	–	–
4 x TB2J01	R69	–	–	–		–		–		–	–	–

Maximum number of auxiliary terminal boxes TB2J01, TB2N01 in combination with large terminal box (order code R50)											
Frame size		100, 112, 132	160	180	200	225	250	280	315		
Terminal box											
Auxiliary terminal box											
Type	Order code	TB1J01		TB1K01		TB1L01	TB1N01	TB1Q01		TB1R01	TB3R01
TB2J01	R62	✓		✓		✓	✓	✓		✓	✓
TB2N01	R63	–		–		–	✓	✓		✓	✓
2 x TB2J01	R67	✓		✓		✓	✓	✓		✓	✓
2 x TB2N01	R68	–		–		–	✓	✓		✓	✓
4 x TB2J01	R69	–		–		–	–	–		✓	✓

Maximum number of auxiliary terminal boxes TB2J01, TB2N01 in combination with universal terminal box (order code R52 or R53)											
Frame size		100 ... 160	180	200	225	250	280	315			
Terminal box											
Auxiliary terminal box											
Type	Order code		TB1J61	TB1L61		TB1N61		TB1Q61	TB3Q41	TB3R41	
TB2J01	R62	Not available	✓	✓		✓		✓	✓	✓	
TB2N01	R63	Not available	–	–		–		–	–	–	
2 x TB2J01	R67	Not available	✓	✓		✓		✓	✓	✓	
2 x TB2N01	R68	Not available	–	–		–		–	–	–	
4 x TB2J01	R69	Not available	–	–		–		–	–	–	

Note:

The type code of the main or auxiliary terminal box change for explosion proof motors 1MB... by ending ...02 (e.g. TB2J02).
The universal terminal box is not available for explosion proof motors 1MB...

Position of auxiliary terminal box in relation to position of TB1J01, TB1L01, TB1N01, TB1Q01, TB1K01 main terminal box

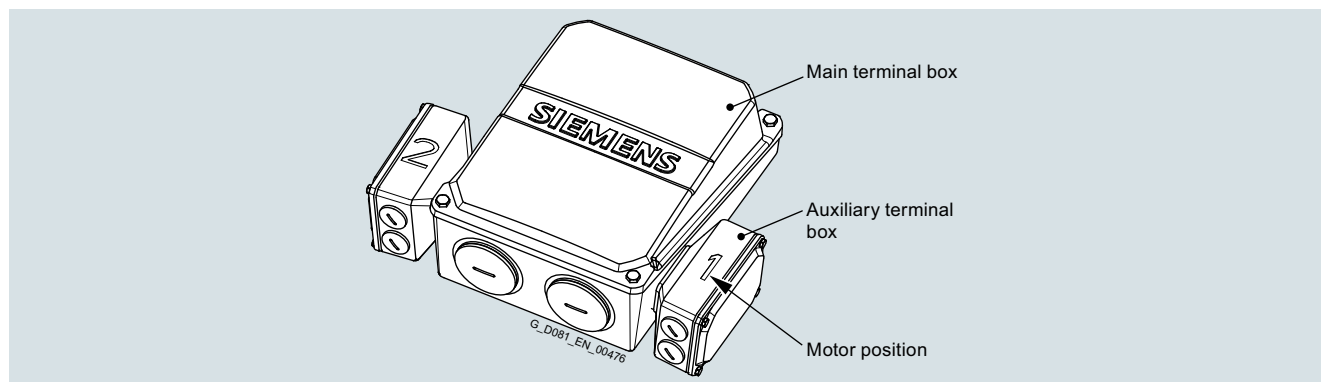

Auxiliary terminal box TB2J01 (order code R62) in combination with TB1J01, TB1L01, TB1N01, TB1Q01, TB1K01 main terminal box															
Position of the main terminal box															
Top				Right-hand side				Left-hand side							
16th position of Article No. and when ordering with order code, Article No. with -Z															
4				5				6							
Rotation of terminal box															
0° (default)		90°, entry from DE		90°, entry from NDE		180°		0° (default)		90°, entry from DE		90°, entry from NDE		180°	
Order code		R10		R11		R12		–		R10		R11		R12	
Number of auxiliary terminal boxes		–		R10		R11		R12		–		R10		R11	
Positions of auxiliary terminal boxes – see Figure															
1	1	1	1	2	1	2	1	2	2	1	2	1			
2	1 + 2	1 + 2	1 + 2	1 + 2	1 + 2	–	–	1 + 2	1 + 2	–	–	1 + 2			1 + 2

Introduction

Electrical design

Connection, circuit and terminal boxes

1

Overview

Position of auxiliary terminal box in relation to position of TB1R01, TB1J61, TB1L61, TB1N61, TB1Q61 main terminal box

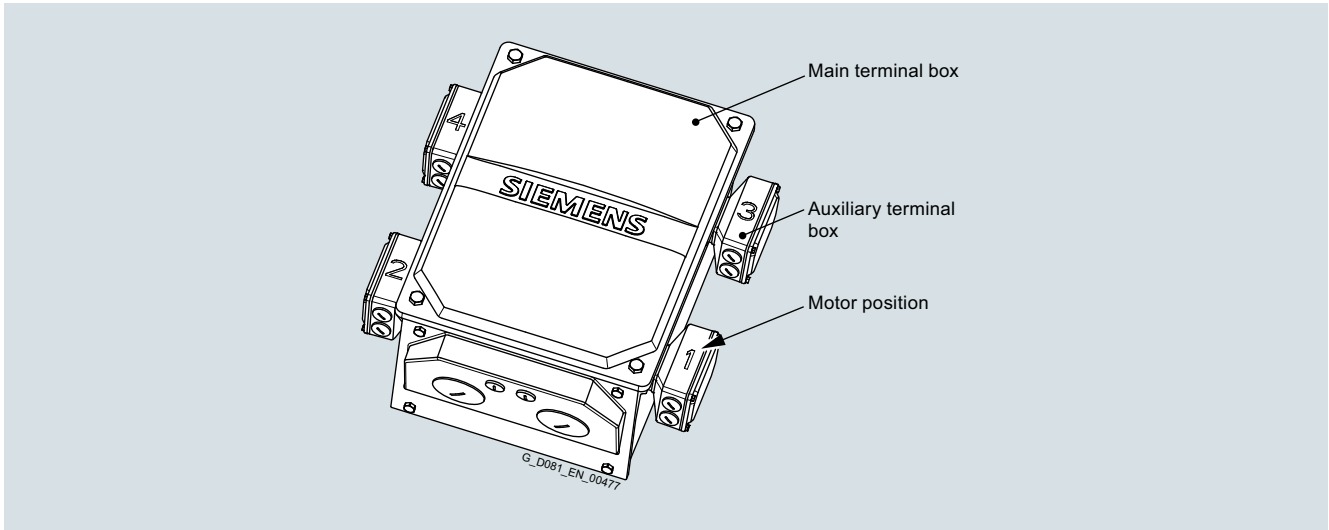

Auxiliary terminal box TB2J01 (order code R62) in combination with TB1R01, TB1J61, TB1L61, TB1N61, TB1Q61 main terminal box

Position of the main terminal box

Top

Right-hand side

Left-hand side

16th position of Article No. and when ordering with order code, Article No. with **-Z**

4

5

6

Rotation of terminal box

0°
(default) 90°,
entry from
DE 90°,
entry from
NDE 180°

0°
(default) 90°,
entry from
DE 90°,
entry from
NDE 180°

0°
(default) 90°,
entry from
DE 90°,
entry from
NDE 180°

Order code

– **R10** **R11** **R12**

– **R10** **R11** **R12**

– **R10** **R11** **R12**

Number of
Auxiliary termi-
nal boxes

Positions of auxiliary terminal boxes – see Figure

	4				5				6			
	1	1	1	2	1	2	1	2	2	1	2	1
1	1	1	1	2	1	2	1	2	2	1	2	1
2	1+3	1+3	1+3	2+4	1+3	2+4	1+3	2+4	2+4	1+3	2+4	1+3
(3 on requ.)	1+2+3	1+2+3	1+2+3	1+2+4	1+2+3	–	–	1+2+4	1+2+4	–	–	1+2+3
(4 on requ.)	1+2+3+ 4	1+2+3+ 4	1+2+3+ 4	1+2+3+ 4	1+2+3+ 4	–	–	1+2+3+ 4	1+2+3+ 4	–	–	1+2+3+ 4

Overview

All motors are designed to IP55 degree of protection. They can be installed in dusty or humid environments. The motors are suitable for operation in tropical climates. Guide value < 60 % relative air humidity at CT 40 °C. Other requirements are available on request (see table on page 1/29).

Brief explanation of the degree of protection**IP54:**

- Protection against harmful dust deposits
- Protected against spray water

IP55:

- Protection against harmful dust deposits
- Protection against water jets from any direction

IP56:

- Protection against harmful dust deposits
- Protection against powerful water jets from any direction

Order code **H22**

Important: Note that submersion by waves or total immersion, even temporarily, is not permitted especially in the case of motors with fans. This corresponds to IP67 or IP68 degree of protection (please inquire).

EN 60034-5 defines protection level 6 for water protection as: "Protection against water due to heavy seas or water in a powerful jet". IP56 degree of protection can only be used with the requirement "Protection against a powerful jet" and not for the requirement "Protection against heavy sea".

Not possible in combination with brake BFK458 (order code **F01**).

IP65:

- Complete protection against dust deposits
- Protection against water jets from any direction

Order code **H20**

In EN 60034-5, the code 6 for protection against the ingress of foreign bodies and touch hazard protection for electrical machines is not listed – Data for code 6 (protection against the ingress of dust) is given in EN 60529.

Not possible in combination with HOG 9 DN 1024 I rotary pulse encoder (order code **G05**) and/or brake BFK458 (order code **F01**) and/or paint finish, cast-iron parts primed (order code **S00**).

EN 60529 contains a comprehensive description of this degree of protection as well as test conditions.

With motors that have a vertical shaft extension, the end user must prevent an ingress of fluid along the shaft.

For motors with shaft extension pointing downwards, the version "Protective cover for types of construction" order code **H00** is urgently recommended, see also the explanations on "Types of construction" on page 1/46.

With flange-mounted motors, for IM V3 type of construction, collection of fluid in the flange basin can be prevented by drainage holes (on request).

The condensation drainage holes at the drive end (DE) and non-drive end (NDE) are sealed (IP55) on delivery. If the condensation drainage holes are ordered for motors of the IM B6, IM B7 or IM B8 type of construction (feet on side or top), the position of the drainage holes will be in the correct position for the type of construction.

Order code **H03**

Introduction









Mechanical version

Types of construction

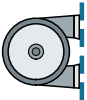
1

Overview

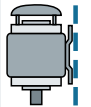
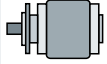
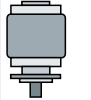
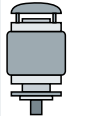

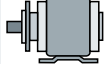
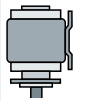





Standard types of construction and special types of construction

Type of construction acc. to EN 60034-7		Frame size	Letter of the 14th position of the Article No.	Additional identification code -Z with order code
Without flange				
IM B3/IM 1001		63 to 450	A	-
IM B6/IM 1051		63 to 355	T	-
IM B7/IM 1061		63 to 355	U	-
IM B8/IM 1071		63 to 355	V	-
IM V5/IM1011 without protective cover		63 to 450	C ¹⁾	-
IM V6/IM 1031		63 to 450	D	-
IM V5/IM 1011 with protective cover		71 to 450	C	+ H00 ²⁾
With flange				
IM B5/IM 3001		63 to 450	F	-
IM V1/IM 3011 without protective cover		63 to 450	G ¹⁾	-
IM V1/IM 3011 with protective cover		71 to 450	G	+ H00 ²⁾
IM V3/IM 3031		63 to 355	H	-
IM B35/IM 2001		63 to 450	J	-
IM V15/IM 2011		71 to 315	W	-

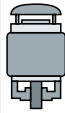
In the EN 50347 standard, flanges FF with through holes and flanges FT with tapped holes are specified.

For footnotes, see next page.

Overview

Type of construction acc. to EN 60034-7		Frame size	Letter of the 14th position of the Article No.	Additional identification code -Z with order code
With flange				
IM B14/IM 3601		63 to 160	K	–
IM V19/IM 3631		80 to 315	L	–
IM V18/IM 3611 without protective cover		80 to 315	M ¹⁾	–
IM V 18/IM 3611 with protective cover		80 to 315	M	+ H00 ²⁾
IM B34/IM 2101		80 to 315	N	–
With flange – next largest				
IM B14/IM 3601		80 to 315	K	+ P01
IM B34/IM 2101		80 to 315	N	+ P01
IM V18/IM 3611 without protective cover		80 to 315	M ¹⁾	+ P01
IM V 18/IM 3611 with protective cover		80 to 315	M	+ P01 + H00 ²⁾
IM V19/IM 3631		80 to 315	L	+ P01

In EN 50347, flanges are assigned to the frame sizes as FT with tapped holes. See the table on the next page for flange dimensions.

The dimensions of the following types of construction are identical: IM B3, IM B6, IM B7, IM B8, IM V5 and IM V6
IM B5, IM V1 and IM V3
IM B14, IM V18 and IM V19

Motors in the standard power range can be ordered in basic types of construction IM B3, IM B5 or IM B14 and operated in mounting positions IM B6, IM B7, IM B8, IM V5, IM V6, IM V1, IM V3 (up to frame size 160 L) or IM V18 and IM V19. Lifting eyes are available for transport and installation in a horizontal position. In conjunction with the lifting eyes, for the purpose of stabilizing the position when the motor is arranged vertically, additional slings (EN 1492-1) and/or lashings (EN 12195-2) must be used.

When a motor for mounting position IM V1 is ordered directly, the motor is supplied with lifting eyes for vertical mounting (up to frame size 90 and frame sizes 180 and 200 for aluminum motors without eyebolts).

¹⁾  The following applies for explosion-protected motors: In the case of the types of construction with shaft extension pointing downwards, the version "with protective cover" is required. For types of construction with shaft extension pointing upwards, a suitable cover must be implemented to prevent small parts from falling into the fan cover (see the standard IEC/EN 60079-0). The cover must not block the cooling air flow.

The motors are designated in accordance with the types of construction on the rating plate.

With motors that have a vertical shaft extension, the end user must prevent an ingress of fluid along the shaft. In the case of all types of construction with shaft extension pointing downwards, the version "with protective cover" is urgently recommended, see section "Degrees of protection" on page 1/45 – housing version.

Motors with feet, in some cases, have two fixing holes at the non-drive end (NDE), see dimension tables on pages 3/146 to 3/184.

A screwed-on cover (made of sheet metal or plastic) is included as standard for horizontal types of construction and types of construction with shaft pointing upwards (14th position of the Article No. letter **A, T, U, V, D, F, H, J, K, L, N**) on motors up to FS 160 in combination with condensation drainage holes, order code **H03**.

²⁾ Standard cylindrical shaft extension (second shaft extension), order code **L05**, is not possible.

Introduction

Mechanical version

Flange dimensions

Overview

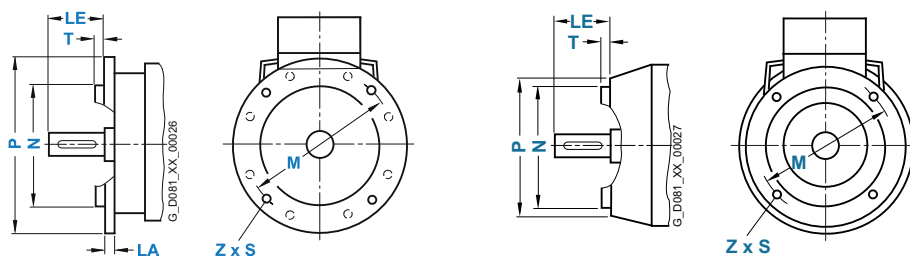

In EN 50347, the frame sizes are allocated flange FF with through holes and flange FT with tapped holes. The designation of DIN 42948 (invalid since September 2003) are also listed for information purposes. See the table below. (**Z** = the number of retaining holes)

Frame size	No. of poles	Type of construction	Flange type – possibly with order code	Flange with • Through holes (FF/A) • Tapped holes (FT/C) Acc. to EN 50347 Acc. to DIN 42948	Dimension designation acc. to IEC								
					LA	LE	M	N	P	S	T	Z	
63 M	2 ... 8	IM B5, IM B35, IM V1, IM V3	Flange	FF115	A 140	–	23	115	95	140	10	3	4
			Next smallest flange – P02	FF100	A 120	–	23	100	80	120	7	3	4
		IM B14, IM B34, IM V18, IM V19	Flange	FT75	C 90	–	23	75	60	90	M6	2.5	4
			Next largest flange ¹⁾ – P01	FT100	C 120	–	23	100	80	120	M6	3	4
71 M	2 ... 8	IM B5, IM B35, IM V1, IM V3	Flange	FF130	A 160	5	30	130	110	160	10	3.5	4
			Next smallest flange – P02	FF115	A 140	–	30	115	95	140	10	3	4
		IM B14, IM B34, IM V18, IM V19	Flange	FT85	C 105	–	30	85	70	105	M6	2.5	4
			Next largest flange ¹⁾ – P01	FT115	C 140	–	30	115	95	140	M8	3	4
80 M	2 ... 8	IM B5, IM B35, IM V1, IM V3	Flange	FF165	A 200	10	40	165	130	200	12	3.5	4
			Next smallest flange – P02	FF130	A 160	–	40	130	110	160	10	3.5	4
		IM B14, IM B34, IM V18, IM V19	Flange	FT100	C 120	–	40	100	80	120	M6	3	4
			Next largest flange ¹⁾ – P01	FT130	C 160	–	40	130	110	160	M8	3.5	4
90 S/L	2 ... 8	IM B5, IM B35, IM V1, IM V3	Flange	FF165	A 200	10	50	165	130	200	12	3.5	4
			Next largest flange – P01	FF215	A 250	–	50	215	180	250	14.5	4	4
		IM B14, IM B34, IM V18, IM V19	Flange	FT115	C 140	–	50	115	95	140	M8	3	4
			Next largest flange – P01	FT130	C 160	–	50	130	110	160	M8	3.5	4
100 L	2 ... 8	IM B5, IM B35, IM V1, IM V3	Flange	FF215	A 250	11	60	215	180	250	14.5	4	4
			Next largest flange – P01	FF265	A 300	12	60	265	230	300	14.5	4	4
		IM B14, IM B34, IM V18, IM V19	Next smallest flange – P02	FF165	A 200	11	60	165	130	200	12	3.5	4
			Flange	FT130	C 160	–	60	130	110	160	M8	3.5	4
112 M	2 ... 8	IM B5, IM B35, IM V1, IM V3	Next largest flange – P01	FT165	C 200	–	60	165	130	200	M10	3.5	4
			Next smallest flange – P02	FT115	C 140	–	60	115	95	140	M8	3	4
		IM B14, IM B34, IM V18, IM V19	Flange	FF215	A 250	11	60	215	180	250	14.5	4	4
			Next largest flange – P01	FF265	A 300	12	60	265	230	300	14.5	4	4
132 S/M	2 ... 8	IM B5, IM B35, IM V1, IM V3	Next smallest flange – P02	FF165	A 200	11	60	165	130	200	12.5	3.5	4
			Flange	FT130	C 160	–	60	130	110	160	M8	3.5	4
		IM B14, IM B34, IM V18, IM V19	Next largest flange – P01	FT165	C 200	–	60	165	130	200	M10	3.5	4
			Flange	FF265	A 300	12	80	265	230	300	14.5	4	4
160 M/L	2 ... 8	IM B5, IM B35, IM V1, IM V3	Next smallest flange – P02	FF215	A 250	11	80	215	180	250	14.5	4	4
			Flange	FT165	C 200	–	80	165	130	200	M10	3.5	4
		IM B14, IM B34, IM V18, IM V19	Next largest flange – P01	FT215	C 250	–	80	215	180	250	M12	4	4
			Flange	FF300	A 350	13	110	300	250	350	18.5	5	4
180 M/L	2 ... 8	IM B5, IM B35, IM V1, IM V3	Next smallest flange – P02	FF265	A 300	12	110	265	230	300	14.5	4	4
			Flange	FT215	C 250	–	110	215	180	250	M12	4	4
		IM B14, IM B34, IM V18, IM V19	Next largest flange – P01	FF300	A 350	13	110	300	250	350	18.5	5	4
			Flange	FF350	A 400	15	110	350	300	400	18.5	5	4
200 L	2 ... 8	IM B5, IM B35, IM V1, IM V3	Next smallest flange – P02	FF300	A 350	13	110	300	250	350	18.5	5	4
			Flange	FF400	A 450	16	110	400	350	450	18.5	5	8
225 S/M	2 4 ... 8	IM B5, IM B35, IM V1, IM V3	Flange	FF500	A 550	18	140	500	450	550	18.5	5	8
			Next smallest flange – P02	FF400	A 450	16	110	400	350	450	18.5	5	8
250 M	2 ... 8	IM B5, IM B35, IM V1, IM V3	Flange	FF500	A 550	18	140	500	450	550	18.5	5	8
			Next smallest flange – P02	FF400	A 450	16	110	400	350	450	18.5	5	8
280 S/M	2 ... 8	IM B5, IM B35, IM V1, IM V3	Flange	FF600	A 660	22	140	600	550	660	24	6	8
			Next smallest flange – P02	FF500	A 550	18	140	500	450	550	18.5	5	8
315 S/M/L	2 4 ... 8	IM B5, IM B35, IM V1, IM V3	Flange	FF740	A 800	25	140	740	680	800	24	6	8
			Next smallest flange – P02	FF600	A 660	22	140	600	550	660	24	6	8
315 L for 1LE5	2 4 2 4	IM B5, IM B35, IM V1, IM V3	Flange	FF840	A 900	25	140	840	780	900	24	6	8
			Next smallest flange – P02	FF740	A 800	25	140	740	680	800	24	6	8
355 M/L for 1LE5	2 4 2 4	IM B5, IM B35, IM V1, IM V3	Flange	FF940	A 1000	28	170	940	880	1000	22	6	8
			Next smallest flange – P02	FF840	A 900	25	140	840	780	900	24	6	8
400 for 1LE5/1MBS	2 4 ... 8	IM B5, IM B35, IM V1	Flange	FF1080	A 1150	30	170	1080	1000	1150	26	6	8
			Next smallest flange – P02	FF940	A 1000	28	170	940	880	1000	22	6	8

¹⁾ With reference to standard EN 50347, flanges that are 2 levels larger are used with option P01 in the frame sizes 63 to 80.

Overview

Shaft extension

60° center hole acc. to DIN 332, Part 2 with M3 to M24 tapped hole depending on the shaft diameter (see dimension tables in section 2 of the catalog).

DE (shaft extension)	
Diameter mm	Thread mm
7 ... 10	DR M3
> 10 ... 13	DR M4
> 13 ... 16	DR M5
> 16 ... 21	DR M6
> 21 ... 24	DR M8
> 24 ... 30	DR M10
> 30 ... 38	DR M12
> 38 ... 50	DR M16/DS M16
> 50 ... 85	DS M20
> 85 ... 130	DS M24

Shaft extension with standard dimensions, without feather keyway

For motor series 1LE1, 1LE5, 1MB1, 1MB5, and 1PC1, the standard shaft extension can be ordered with standard dimensions without a feather keyway. The key convention does not have to be stamped onto the rating plate for balancing.

Order code **L04**

Admissible changes to the shaft extension DE (**Y58**)

Motor series	Frame size	No. of poles	Shaft extension length E in mm		Shaft extension diameter D in mm							
			Standard	min. up to max.	Standard	min. up to max. ¹⁾						
1LE1, 1MB1 ²⁾	63	2 ... 8	23	12 ... 46 (step 1 mm)	11	9 ... 12 (step 1 mm)						
	71		30	15 ... 60 (step 1 mm)	14	11 ... 15 (step 1 mm)						
	80		40	20 ... 80 (step 1 mm)	19	12 ... 20 (step 1 mm)						
	90		50	25 ... 100 (step 1 mm)	24	12 ... 25 (step 1 mm)						
1LE1, 1MB1 ^{2),} 1PC1	100	2 ... 8	60	30 ... 120 (step 1 mm)	28	19 ... 30 (step 1 mm)						
	112		80	40 ... 160 (step 1 mm)	38	24 ... 40 (step 1 mm)						
	132				42	28 ... 45 (step 1 mm)						
	160				110	55 ... 160 (step 1 mm)	48	38 ... 50 (step 1 mm)				
	160								55	38 ... 60 (step 1 mm)		
1LE1,, 1MB1 ²⁾	180	2 ... 8	110	55 ... 160 (step 5 mm)	48	38 ... 50 (step 1 mm)						
	180						160 ... 220 (step 1 mm)	55	38 ... 60 (step 1 mm)			
	200									55 ... 160 (step 1 mm)	65	65 ... 85 (step 1 mm)
	200											
1LE15, 1LE16, 1MB15 ^{2),} 1MB16	225	2	110	55 ... 220 (step 5 mm)	55	48 ... 65 (step 1 mm)						
	250	4 ... 8	140	70 ... 280 (step 5 mm)	60	55 ... 75 (step 1 mm)						
		2					65	65 ... 85 (step 1 mm)				
	280	4 ... 8	170	85 ... 280 (step 5 mm)	85	65 ... 95 (step 1 mm)						
	315	2							140	70 ... 280 (step 5 mm)	65	55 ... 80 (step 1 mm)
		4 ... 8	170	85 ... 280 (step 5 mm)	85	65 ... 95 (step 1 mm)						
	1LE5, 1MB5	315					2	140	70 ... 280 (step 5 mm)	65	55 ... 80 (step 1 mm)	
355		4 ... 8	170	85 ... 280 (step 5 mm)	85	65 ... 95 (step 1 mm)						
		2	140	70 ... 280 (step 5 mm)	75	55 ... 85 (step 1 mm)						
	4 ... 8	170	85 ... 280 (step 5 mm)	95	65 ... 100 (step 1 mm)							

Standard shaft made of stainless steel

A standard shaft made of stainless steel can be ordered for the 1LE1, 1LE5, 1MB1, 1MB5, and 1PC1 motor series (e.g. 1.4021). This is only possible for shaft extensions of standard dimensions. Order code **L06**

Special non-rusting materials are only available on request.

Non-standard cylindrical shaft extension

The non-standard cylindrical shaft extension can be used on the drive end (DE) (with plain text according to table). The feather keys are supplied in every case.

Order code **Y58**

For order code **Y58** non-standard cylindrical shaft extension (DE):

- Dimension D: less than or equal to the inner diameter of the roller bearing, tolerance band less than tolerance band acc. to EN 50347.
- Dimension E: less than or equal to 2 × length E (standard) of the shaft extension.

See the table below "Admissible changes to the shaft extension DE" and the dimension tables in the relevant sections of the catalog.

Introduction

Mechanical version

Shaft and rotor

Overview

Standard, cylindrical shaft extension NDE acc. to EN 50347 (second shaft extension)

Order code **L05** (on request)

For a coupling output, the standard, cylindrical shaft extension can transmit the full rated power.

Please also inquire about the transmitted power and admissible cantilever force if belt pulleys, chains or gear pinions are used on the standard, cylindrical shaft extension.

A standard, cylindrical shaft extension (second shaft extension) NDE is not available if a rotary pulse encoder and/or a separately driven fan has been mounted onto the motor. Please inquire for mounted brakes.

Dimensions and tolerances for keyways and keys are designed to EN 50347. The motors are always supplied with a key inserted in the shaft.

Admissible changes to the shaft extension NDE (Y59)

Motor series	Frame size	No. of poles	Shaft extension length E in mm		Shaft extension diameter D in mm		
			Standard	min. up to max.	Standard	min. up to max. ¹⁾	
1LE1, 1MB1 ²⁾	63	2 ... 8	23	12 ... 46 (step 1 mm)	11	9 ... 12 (step 1 mm)	
	71		30	15 ... 60 (step 1 mm)	14	11 ... 15 (step 1 mm)	
	80		40	20 ... 80 (step 1 mm)	19	12 ... 20 (step 1 mm)	
	90						
1LE1, 1MB1 ²⁾ , 1PC1	100	2 ... 8	50	25 ... 120 (step 1mm)	24	19 ... 25 (step 1 mm)	
	112						
	132		60	30 ... 160 (step 1 mm)	28	24 ... 35 (step 1 mm)	
	160		110	55 ... 160 (step 1 mm)	42	24 ... 45 (step 1 mm)	
1LE1, 1MB1 ²⁾	180	2 ... 8	110	55 ... 160 (step 1 mm)	48	38 ... 48 (step 1 mm)	
	180			160 ... 220 (step 5 mm)			
	200			55 ... 160 (step 1 mm)	55		
	200			160 ... 220 (step 5 mm)			
1LE15, 1LE16, 1MB15 ²⁾ , 1MB16	225	2	110	55 ... 220 (step 5 mm)	48	48 ... 58 (step 1 mm)	
	250	4 ... 8	140	70 ... 280 (step 5 mm)	55	55 ... 73 (step 1 mm)	
		2					
	280	4 ... 8				60	
		2					
	315	4 ... 8				65	65 ... 73 (step 1 mm)
2							
1LE5, 1MB5 ²⁾	315	4 ... 8	170	85 ... 280 (step 5 mm)	60	55 ... 78 (step 1 mm)	
		2	140	70 ... 280 (step 5 mm)	60	55 ... 78 (step 1 mm)	
	355	4 ... 8				70	65 ... 78 (step 1 mm)
		2					
		4 ... 8	170	85 ... 280 (step 5 mm)	80	65 ... 92 (step 1 mm)	

Non-standard, cylindrical shaft extensions up to the specified lengths and diameters can be supplied for the motor series listed in the tables "Admissible changes to the shaft extension DE (Y58)" and "Admissible changes to the shaft extension NDE (Y59)". All other dimensions are available on request.

It is the responsibility of the customer to ensure that the admissible cantilever forces are reduced in accordance with the non-standard shaft extension.

If the second shaft extension has non-standard dimensions, this must be ordered with order code **Y59** non-standard shaft dimensions NDE.

For the order code **Y59** (with plain text specifications according to the table).

- Dimension D: less than or equal to fan hub inner diameter, for frame size 160 tolerance band is less than tolerance band to EN 50347
- Dimension E: less than or equal to 2 × length E (standard) of the shaft extension

See the table below "Admissible changes to the shaft extension NDE" and the dimension tables in the relevant sections of the catalog.

¹⁾ At maximum admissible diameter, a step increase in shaft diameter is not possible.

²⁾ For explosion-protected motors Ex db, Ex eb (Zone 1) on request.

Overview**Shaft extension run-out, concentricity and perpendicularity in accordance with IEC 60072-1 precision class for flange-mounted motors**

In IEC 60072-1, normal class (normal) and precision class (reduced) are defined:

1. Circular run-out tolerances for the shaft extension
2. Concentricity tolerances for the shaft extension and flange centering
3. Perpendicularity tolerances for the shaft extension and flange surface

The shaft extension run-out, concentricity and perpendicularity according to IEC 60072-1 precision class for flange-mounted motors can be ordered using order code **L08**.

This order code can be combined for motors with deep-groove bearings of series 60..., 62... and 63... This is not possible in combination with a mounted brake or encoder.

The shaft extension run-out can be ordered according to IEC 60072-1 precision class for types of construction without flange with order code **L07**.

Circular run-out tolerance for the shaft extension

Diameter of the cylindrical shaft extension D	Circular run-out tolerance	
	Normal class	Precision class (reduced)
mm	mm	mm
≤ 10	0.03	0.015
> 10 ... 18	0.035	0.018
> 18 ... 30	0.04	0.021
> 30 ... 50	0.05	0.025
> 50 ... 80	0.06	0.03
> 80 ... 120	0.07	0.035

Concentricity tolerance of the centering spigot and linear movement tolerance of the flange surface to the shaft extension axis

Flange	Dimension designation acc. to IEC		Concentricity and perpendicularity tolerance	
	N	P	Normal class	Precision class
FF/FT	mm	mm	mm	mm
55	40	70	0.08	0.04
65	50	80	0.08	0.04
75	60	90	0.08	0.04
85	70	105	0.08	0.04
100	80	120	0.08	0.04
115	95	140	0.08	0.04
130	110	160	0.1	0.05
165	130	200	0.1	0.05
215	180	250	0.1	0.05
265	230	300	0.1	0.05
300	250	350	0.125	0.063
350	300	400	0.125	0.063
400	350	450	0.125	0.063
500	450	550	0.125	0.063
600	550	660	0.16	0.08
740	680	800	0.16	0.08
940	880	1000	0.2	0.1
1080	1000	1150	0.2	0.1

Measures for gear mounting**Overview**

The flange-mounted motors can be equipped with a radial sealing ring in order to mount gearing.

Order code **H23**

It must be ensured that the sealing ring is lubricated using grease, oil mist, or oil spray. (It is not admissible to use pressurized oil > 0.1 bar.) We recommend that the admissible bearing loads are carefully checked.

Introduction

Mechanical version

Balance and vibration severity

Overview

All rotors are dynamically balanced with an inserted half key. This corresponds to vibration severity grade A (normal or standard). DIN EN 60034-14 Aug. 2018 regulates the vibrational behavior of machinery. Based on ISO 21940-32, the key convention "half key (H)" must be used for balancing.

Note:

If there is a keyway, a full feather key is always inserted on delivery.

The type of key convention is stamped on the face of the shaft extension at the customer side DE/NDE:

- F = Balancing with full key
(full-key convention)
- H = Balancing with half key
(half-key convention) – standard
- N = Balancing without key –
Plain text required (convention without key)

For motors up to frame size 112 the code is stamped on the rating plate.

Full-key balancing or balancing with full feather key (F) is possible by specifying order code **L02** (additional charge).

Balancing without feather key (N) is possible by specifying order code **L01** (additional charge).

Vibration severity grade A is the standard version and is valid up to a rated frequency of 60 Hz. If 2-pole motors of frame sizes 280 and 315 are to be rigidly installed, cast feet are necessary in order to comply with the vibration requirements of IEC 60034-14. IE4 2-pole motors in frame size 315 and pole-changing motors (4-pole/2-pole) fulfill the vibration requirements specified in IEC 60034-14 only when the motor is elastically suspended.

The low-vibration version B can be supplied to fulfill stricter requirements on smooth running (additional charge).

Vibration severity grade B
Not possible with cylindrical roller bearings.
Order code **L00**

The order code **L00** vibration severity grade B is not possible in combination with order codes **G40, G41, G42**. 2-pole trans-standard aluminum motors in frame sizes 180 and 200 (14th position of the Article No. is A, C, D, J, T, U, V) and order code **L00** have cast-iron feet.

This vibration is assessed in accordance with vibration severity grade A or B according to EN 60034-14 (see table).

The limits stated in the table apply to uncoupled, freely suspended, idling motors.

For converter operation with frequencies higher than 60 Hz, special balancing is required for compliance with the specified limit values (plain text: maximum supply frequency/speed).

For further details, see the online help in the DT Configurator.

Limits (rms values) for max. vibration severity in terms of vibration displacement (s) and vibration velocity (v) for the shaft height H

Vibration severity grade	Machine installation	Shaft height H in mm			
		56 ≤ H ≤ 132		H > 132	
		s_{rms} μm	v_{rms} mm/s	s_{rms} μm	v_{rms} mm/s
A	Free suspension	45	2.8	45	2.8
	Rigid clamping	–	–	37	2.3
B	Free suspension	18	1.1	29	1.8
	Rigid clamping	–	–	24	1.5

For details, see standard EN 60034-14 Aug. 2018, EN 60034-14:2004 + A1:2007

If the type tests for machines with shaft height $H > 132$ mm demonstrate a determining component with twice the line frequency, the limit for maximum vibration severity in the Table (for grade A) can be increased from 2.3 mm/s (rms value) to 2.8 mm/s (rms value) or (for grade B) from 1.5 mm/s (rms value) to 1.8 mm/s (rms value). Higher values must be agreed beforehand. A component with twice the line frequency is regarded as dominant if the type test shows that it is greater than 70 % of 2.3 mm/s (rms value) (for grade A) or 70 % of 1.5 mm/s (rms value) (for grade B).

Overview

The noise is measured in accordance with EN ISO 1680 in a dead room. It is specified as A-weighted enveloping surface sound pressure level L_{pFA} in dB (A).

This value is the spatial average value of the sound pressure levels measured at the measuring surface. The measuring surface is a cube 1 m away from the surface of the motor. The sound power level is also specified as L_{WA} in dB (A).

The specified values are valid at 50 Hz and rated power (see the selection and ordering data). The tolerance is +3 dB. Noise values for motors in converter operation on request.

To reduce noise levels, 2-pole motors from frame size 132 S to frame size 355 and higher can optionally be equipped with a unidirectional axial-flow fan.

For frame sizes 400 and 450, the axial-flow fan is standard. The values are listed in the table "Low-noise version" below.

Clockwise rotation:

Order code **F77**

Counterclockwise rotation:

Order code **F78**

Second shaft extension and/or mountings (mounting of brake, separately driven fan or encoder) not possible except for 1MB.553 motors.

Low-noise version			
Motor series	Frame size	2-pole motors	
		L_{pFA} dB (A)	L_{WA} dB (A)
1LE1 ¹⁾	132	60	72
1MB1 ¹⁾	160	60	72
1LE10, 1LE15/6, 1MB15/6 ²⁾	180	63	76
	200	64	77
1LE15/6, 1MB15/6 ²⁾	225	72	86
	250	73	87
	280	72	85
	315	76	90
1LE5, 1MB5	400	74	90
	450	75	91

For the motor types 1LE5 and 1MB5 of frame sizes 315 and 355, the noise level is reduced by 1 to 2 dB with the low-noise version.

¹⁾ With the exception of 1LE1 and 1MB1 motors with option **F90** – version "Forced-air cooled motors without external fan and fan cover".

²⁾ 1MB15/6 also applies to 1MB154, 1MB164, and 1MB155.

Introduction

Mechanical version

Bearings and lubrication

1

Overview

Bearing lifetime (nominal lifetime)

The nominal bearing lifetime is defined according to standardized calculation procedures (ISO 281) and is reached or even exceeded for 90 % of the bearings when the motors are operated in compliance with the data provided in the catalog.

Under average operating conditions, a lifetime (L_{10h}) of 100 000 hours can be achieved.

Generally, the bearing lifetime is defined by the bearing size, the bearing load, the operating conditions, the speed and the grease lifetime. A bearing lifetime calculation is possible on request.

Bearing system

The bearing lifetime of motors with horizontal mounting is 40 000 hours if there is no additional axial loading at the coupling output and 20 000 hours when utilized according to the maximum admissible load. This assumes that the motor is operated at 50 Hz. The nominal bearing lifetime is reduced for converter operation at higher frequencies.

In order to achieve the calculated lifetime in continuous operation, the admissible vibration values (measured at bearing plate) must be determined according to evaluation zones A and B stipulated in ISO 10816. If higher vibration velocities occur in operation (e.g. with option **H02**), special measures must be taken (please inquire).

Due to their physical characteristics, variable-speed motors have a different bearing lifetime under the same load conditions – this relationship is linear, i.e. if the frequency increases by 20 % from 50 Hz to 60 Hz, the lifetime decreases by 20 % from 20 000 to 16 000 hours under the load conditions specified in the catalog.

If the frequency falls by 20 % from 50 Hz to 40 Hz, under the load conditions specified in the catalog, the lifetime rises by 20 % from 20 000 to 24 000 hours.

It should be observed that, for types of construction IM B6, IM B7, IM B8, IM V5, and IM V6, the belt tension is only permitted to act parallel to the mounting plane or towards the mounting plane and the feet must be supported. Both feet must be secured for foot-mounting types of construction.

In the basic bearing system, the floating bearing is situated at the drive end (DE) and the located bearing is situated at the non-drive end (NDE). For motors of the 1MB.553 series, the located bearing DE is the standard version.

The bearing system is axially preloaded with a spring element at the drive end (DE) to ensure smooth running of the motor without play (see Fig. 1 in the diagrams of bearings on page 1/62).

From frame size 160 upwards, the located bearing is axially secured at the non-drive end (NDE).

For the 1LE5 and 1MB5 motors of frame sizes 400 and 450, the located bearing is situated at the drive end (DE) and the floating bearing is situated at the non-drive end (NDE).

The bearing system on these motors is axially preloaded with a spring element at the non-drive end (NDE) to ensure smooth running of the motor without any play (see Figs. 6 and 7 under the bearing diagrams on page 1/62).

Up to frame size 132, an additional axially-secured located bearing can be supplied on the non-drive end (NDE) complete with a retaining ring (see Fig. 2 under the diagrams of bearings on page 1/62) or, for frame sizes 400 and 450, the located bearing can be supplied at the non-drive end (NDE).

Order code **L21**

Depending on the specific installation conditions (axial forces, cantilever forces and type of construction), testing of additional measures for the bearing version is recommended. The located bearing can also be supplied at the drive end (DE) (see Fig. 3 under the diagrams of bearings on page 1/62). A located bearing at the drive end (DE) is recommended when gearing is installed, for a shaft extension pointing downwards, or pumps and fans are mounted directly on the motor shaft.

Order code **L20**

For increased cantilever forces (e.g. belt drives), reinforced bearings can be used at the drive end (DE).

Versions with cylindrical roller bearings are not axially preloaded, and must always operate under adequate radial loads (it is not permissible that motors are operated on a test stand without additional radial loads). The locating bearing is located at the non-drive end (NDE) when cylindrical roller bearings are fitted.

Order code **L22**

1LE1, 1LE5, 1MB1, 1MB5, and 1PC1 motors can be supplied with reinforced bearings (size range 03) at both ends.

In this case, the bearing plates are made of cast iron (standard for series 1LE16 motors). Standard for motors of the 1MB.553 series from frame size 100 upwards.

Order code **L25**

A measuring nipple for SPM shock pulse measurement can be mounted to check bearing vibration. The motors have an M8 tapped hole for each bearing plate and a measuring nipple with a protective cap. If a second tapped hole is provided, it is fitted with a sealing plug. Not possible for frame sizes < 100.

Order code **Q01**

Bearing selection for increased cantilever forces (see the Table "Bearing selection for 1LE10, 1MB10, and 1PC10 motors – Bearings for increased cantilever forces" on page 1/57) – for the maximum axial load, see page 1/70 onwards.

Bearing insulation

To prevent damage caused by bearing currents, insulated bearings can be supplied for frame sizes 225 to 355 – they are recommended for motors from frame size 225 upwards. For frame sizes 400 and 450 (for converter operation), the bearing insulation is indispensable.

- **L50** (DE bearing insulation) means NDE located bearing as standard
- **L51** (NDE bearing insulation) means DE located bearing as standard
- **L50 + L51** (insulated DE and NDE bearings) means NDE located bearing as standard
- Combination of order codes **L50** or **L51** or **L50 + L51** with **L22** (bearing version for increased cantilever forces) means NDE located bearing as standard.
- In combination of order code **L50** with **L22**, it is necessary to reduce the radial load.

According to IEC 60034-1-11, it is up to the user in the case of DE bearing insulation (order code **L50**) + NDE bearing insulation (order code **L51**) to ensure grounding of the rotor.

The rotor grounding can be implemented either in the system via the coupled driven machine or in the motor via a grounding brush.

The grounding brush (order code **L52**) must always be provided when the driven machine is connected to the motor via an insulating coupling or an insulating belt output shaft.

Permanent lubrication

On motors equipped with permanent lubrication, the bearing grease lifetime is matched to the bearing lifetime. This can, however, only be achieved if the motor is operated in accordance with the catalog specifications.

In the basic version, the motors have permanent lubrication.

Overview**Regreasing**

For motors which can be regreased at defined regreasing intervals, the bearing lifetime can be extended and/or unfavorable factors such as temperature, mounting conditions, speed, bearing size, and mechanical load can be compensated.

This regreasing option is possible in the following frame sizes:

- Frame sizes 100 to 160: M8 × 1 acc. to DIN 71412-A (conical lubricating nipple)
- Frame sizes 180 to 315: M10 × 1 acc. to DIN 3404-A (flat lubricating nipple).
- Frame sizes 400 to 450: M10 × 1-5.8-A acc. to DIN 3404-A.- (flat lubricating nipple)

Order code L23

(frame sizes ≥ 280 basic version, for the Performance Line motors of frame sizes ≥ 160 basic version)

A regreasing device with M10 × 1 conical lubricating nipple to DIN 71412-A can be optionally provided for frame sizes 180 to 450.

Order code L19

In the case of motors equipped with regreasing device, information regarding regreasing intervals, quantity of grease, type of grease and any additional data is provided on the lubrication plate or rating plate. For regreasing intervals for the basic version, see the Table "Grease lifetime and regreasing intervals for horizontal installation". For motors with a mounted holding brake (order code **F01**) a regreasing device cannot be installed, including up to FS 160.

Mechanical stress and grease lifetime

High speeds that exceed the rated speed with converter operation and the resulting increased vibrations alter the mechanical running smoothness and the bearings are subjected to increased mechanical stress. This reduces the grease lifetime and the bearing lifetime (please inquire where applicable).

The use of rigid couplings should be avoided as far as possible. For converter operation in particular, compliance with the mechanical limit speeds n_{\max} at maximum supply frequency f_{\max} is essential, see the following table "Mechanical limit speeds n_{\max} at maximum supply frequency f_{\max} ".

Introduction

Mechanical version

Bearings and lubrication

1

Overview

Mechanical limit speeds n_{max} at maximum supply frequency f_{max} (standard values) for 1LE1, 1LE5, 1PC1 motors – basic version and 1LE15 and 1LE16 motors – basic version with order codes L22, L25, L28 – 1MB10/5/6 motors with order codes L22 and L25

Frame size	Type	2-pole		4-pole		6-pole		8-pole		
		n_{max} rpm	f_{max} Hz	n_{max} rpm	f_{max} Hz	n_{max} rpm	f_{max} Hz	n_{max} rpm	f_{max} Hz	
1LE10 motors, basic version										
1LE10..-										
63	0B...	6000	100	4200	140	3600	180	3000	200	
71	0C...	6000	100	4200	140	3600	180	3000	200	
80 M	0D...	6000	100	4200	140	3600	180	3000	200	
90 S/L	0E...	6000	100	4200	140	3600	180	3000	200	
1LE15 Basic Line motors – bearings for increased cantilever forces – order code L22										
1LE15 Basic Line motors – bearings reinforced at both ends – order code L25										
1LE15..-										
71 M	0C...	6000	100	4200	140	3600	180	3000	200	
80 M	0D...	6000	100	4200	140	3600	180	3000	200	
90 S/L	0E...	6000	100	4200	140	3600	180	3000	200	
1LE10, 1PC1 motors, basic version										
1LE15 Basic Line and 1LE16 Performance Line – bearings for increased cantilever forces – order code L22										
1LE15 Basic Line and 1LE16 Performance Line – bearings reinforced at both ends – order code L25										
1LE1...-										
1PC1...-										
100 L	1A...	6000	100	4200	140	3600	180	3000	200	
112 M	1B...	6000	100	4200	140	3600	180	3000	200	
132 S/M	1C...	5600	90	4200	140	3600	180	3000	200	
160 M/L	1D...	4800	80	4200	140	3600	180	3000	200	
180 M/L	1E...	4600	76	4200	140	3600	180	3000	200	
200 L	2A...	4500	75	4200	140	3600	180	3000	200	
1LE15 Basic Line and 1LE16 Performance Line – basic version										
1LE15 Basic Line and 1LE16 Performance Line – bearings for increased cantilever forces – order code L22										
1LE15 Basic Line and 1LE16 Performance Line – bearings reinforced at both ends – order code L25										
1LE15 Basic Line and 1LE16 Performance Line – DE cylindrical roller bearings and NDE reinforced bearings – order code L28										
1LE15..-										
1LE16..-										
180 M/L	1E...	4600	76	4200	140	3600	180	3000	200	
200 L	2A...	4500	75	4200	140	3600	180	3000	200	
225 S/M	2B...	4500	75	4500	150	4400	220	4400	293	
250 M	2C...	3900	65	3700	123	3700	185	3700	247	
280 S/M	2D...	3600	60	3000	100	3000	150	3000	200	
315 S/M/L	3A...	3600	60	2600	87	2600	130	2600	173	
1LE55 Basic Line and 1LE56 Performance Line – basic version										
1LE55 Basic Line and 1LE56 Performance Line – bearings for increased cantilever forces – order code L22										
1LE55..-										
1LE56..-										
315 L	3A...	5200	87	3400	113	3400	170	3400	227	
355 M/L	3B...	5200	87	2800	93	2800	140	2800	187	
400	4A...	IMB3	3600	60	2200	74	2200	110	2200	147
450	4B...	IMB3	3000/3600 ¹⁾	50	2100	70	2100	105	2100	140
400	4A...	IMV1	–	–	2100	70	2100	105	2100	140
450	4B...	IMV1	–	–	1800	60	1800	90	1800	120

The specified limit speeds are applicable to motors without additional mountings, such as brakes or rotary encoders. In such applications, the characteristics of the respective mounting parts must be taken into account.

Note:

Mechanical limit speeds for SIMOTICS XP 1MB motors, see Chapter 5.

¹⁾ Order on request.

Overview

Grease lifetime and regreasing intervals for horizontal installation

Motor series	Frame size	No. of poles	Grease lifetime up to CT 40 °C ²⁾			
Permanent lubrication ¹⁾						
1LE1/1MB1/1PC1	63 ... 250	2 ... 8	20000 h or 40000 h ³⁾			
Regreasing ¹⁾						
			Lubrication interval ISO CI F 155 °C		Lubrication interval ISO CI H 180 °C	
			CT ≤ 40 °C	40 °C < CT ≤ 80 °C	40 °C < CT ≤ 60 °C	60 °C < CT ≤ 80 °C
1LE1/1MB1/1PC1	100 ... 160	2 ... 8	8000 h	4000 h ²⁾	4000 h	2000 h ²⁾
	180 ... 280	2	4000 h	2000 h ²⁾	1000 h	1000 h ²⁾
		4 ... 8	8000 h	4000 h ²⁾	2000 h	2000 h ²⁾
	315	2	3000 h	1500 h ²⁾	1000 h	1000 h ²⁾
		4 ... 8	6000 h	3000 h ²⁾	1500 h	1500 h ²⁾
1LE5/1MB5			CT ≤ 40 °C	40 °C < CT ≤ 80 °C	CT ≤ 40 °C	40 °C < CT ≤ 80 °C
	315, 355	2	3000 h	1500 h ²⁾	3000 h	1500 h ²⁾
		4, 6	6000 h	3000 h ²⁾	6000 h	3000 h ²⁾
	400	2	4000 h	2000 h	4000 h	2000 h
		4 ... 8	6000 h	3000 h	6000 h	3000 h
	450	2	3000 h	1500 h	3000 h	1500 h
		4 ... 8	6000 h	3000 h	6000 h	3000 h

Bearing selection table for 1LE10, 1MB10, and 1PC10 motors – basic version

The bearing selection tables are only intended for planning purposes. Authoritative information on the actual type of bearings fitted in motors already supplied can be obtained by the factory by quoting the serial number or can be read from the rating plate.

When deep-groove bearings with side plates are used, the side plate is on the inside. Located bearing at drive end (DE) for 1LE1, 1MB1 and 1PC1 motors, see special version Fig. 2 in the "Diagrams of bearings" on Page 1/62.

Frame size	No. of poles	Drive end (DE) bearing Horizontal and vertical types of construction	Non-drive end (NDE) bearing Horizontal and vertical types of construction	Fig. No. on page 1/62
1LE10/1MB10				
63	2 ... 6	6201 2ZC3	6201 2ZC3	–
71	2 ... 8	6202 2ZC3	6202 2ZC3	–
80	2 ... 8	6004 2ZC3	6004 2ZC3	Fig. 1
90	2 ... 8	6205 2ZC3	6004 2ZC3	Fig. 1
1LE10/1MB10/1PC10				
100 L	2 ... 8	6206 2ZC3	6206 2ZC3	Fig. 1
112 M	2 ... 8	6206 2ZC3	6206 2ZC3	Fig. 1
132 S/M	2 ... 8	6208 2ZC3 ⁴⁾	6208 2ZC3 ⁴⁾	Fig. 1
160 M/L	2 ... 8	6209 2ZC3 ⁴⁾	6209 2ZC3 ⁴⁾	Fig. 2
1LE10				
180 M/L	2 ... 8	6210 2ZC3 ⁵⁾	6210 2ZC3 ⁵⁾	Fig. 4
200 L	2 ... 8	6212 2ZC3 ⁵⁾	6212 2ZC3 ⁵⁾	Fig. 4

Bearing selection table for 1LE10, 1MB10, and 1PC10 motors – bearings for increased cantilever forces – order code L22

Please inquire about noise and vibration data. The bearing selection tables are only intended for planning purposes. Authoritative information on the actual type of bearings fitted in motors already supplied can be obtained by the factory by quoting the serial number or can be read from the rating plate.

When deep-groove bearings with side plates are used, the side plate is on the inside.

Frame size	No. of poles	Drive end (DE) bearing Horizontal and vertical types of construction	Non-drive end (NDE) bearing Horizontal and vertical types of construction	Fig. No. on page 1/62
1LE10/1MB10				
80	2 ... 8	6304 2ZC3	6204 2ZC3	–
90	2 ... 8	6305 2ZC3	6204 2ZC3	–
1LE10/1MB10/1PC10				
100 L	2 ... 8	6306 2ZC3	6206 2ZC3	Fig. 1
112 M	2 ... 8	6306 2ZC3	6206 2ZC3	
132 S/M	2 ... 8	6308 2ZC3 ⁴⁾	6208 2ZC3 ⁴⁾	
160 M/L	2 ... 8	6309 2ZC3 ⁴⁾	6209 2ZC3 ⁴⁾	Fig. 2
1LE10				
180 M/L	2 ... 8	6310 2ZC3 ⁵⁾	6210 2ZC3 ⁵⁾	Fig. 4
200 L	2 ... 8	6312 2ZC3 ⁵⁾	6212 2ZC3 ⁵⁾	Fig. 4

¹⁾ For special uses and special greases, please inquire about grease lifetime and regreasing intervals.

²⁾ For every 10 K the coolant temperature is increased above 80 °C, the grease lifetime and regreasing interval are halved.

³⁾ 40 000 hours apply to horizontally installed motors with coupling output without additional axial loads.

⁴⁾ Deep-groove bearings with a side plate are used for regreasable versions (**L23**).

⁵⁾ Deep-groove bearings without a side plate are used for regreasable versions (**L23**).

Introduction

Mechanical version

Bearings and lubrication

Overview

Bearing selection table for 1LE10, 1MB10, and 1PC10 motors – bearings reinforced at both ends – order code L25

Please inquire about noise and vibration data. The bearing selection tables are only intended for planning purposes. Authoritative information on the actual type of bearings fitted in motors already supplied can be obtained by the factory by quoting the serial number or can be read from the rating plate.

When deep-groove bearings with side plates are used, the side plate is on the inside.

Frame size	No. of poles	Drive end (DE) bearing Horizontal and vertical types of construction	Non-drive end (NDE) bearing Horizontal and vertical types of construction	Fig. No. on page 1/62
1LE10/1MB10				
80	2 ... 8	6304 2ZC3	6304 2ZC3	–
90	2 ... 8	6305 2ZC3	6304 2ZC3	–
1LE10/1MB10/1PC10				
100 L	2 ... 8	6306 2ZC3	6306 2ZC3	Fig. 1
112 M	2 ... 8	6306 2ZC3	6306 2ZC3	
132 S/M	2 ... 8	6308 2ZC3 ¹⁾	6308 2ZC3 ¹⁾	
160 M/L	2 ... 8	6309 2ZC3 ¹⁾	6309 2ZC3 ¹⁾	Fig. 2
1LE10				
180 M/L	2 ... 8	6310 2ZC3 ²⁾	6310 2ZC3 ²⁾	Fig. 4
200 L	2 ... 8	6312 2ZC3 ²⁾	6312 2ZC3 ²⁾	Fig. 4

Bearing assignment for 1LE15/1MB15, 1LE16/1MB16, and 1LE5 motors (basic version)

Frame size	No. of poles	Drive end (DE) bearing Horizontal and vertical type of construction	Non-drive end (NDE) bearing Horizontal and vertical type of construction	Fig. No. on page 1/62		
1LE15, 1MB15 – Basic Line						
71 M	2 ... 8	6202 2ZC3	6202 2ZC3	Fig. 1		
80 M	2 ... 8	6204 2ZC3	6204 2ZC3	Fig. 1		
90 S/L	2 ... 8	6205 2ZC3	6204 2ZC3	Fig. 1		
100 L	2 ... 8	6206 2ZC3 ¹⁾	6206 2ZC3 ¹⁾	Fig. 1		
112 M	2 ... 8	6206 2ZC3 ¹⁾	6206 2ZC3 ¹⁾			
132 S/M	2 ... 8	6208 2ZC3 ¹⁾	6208 2ZC3 ¹⁾			
160 M/L	2 ... 8	6209 2ZC3 ¹⁾	6209 2ZC3 ¹⁾	Fig. 2		
180 M/L	2 ... 8	6210 2ZC3 ²⁾	6210 2ZC3 ²⁾	Fig. 4		
200 L	2 ... 8	6212 2ZC3 ²⁾	6212 2ZC3 ²⁾			
225 S/M	2 ... 8	6213 ZC3 ²⁾	6213 ZC3 ²⁾	Fig. 1		
250 M	2 ... 8	6215 ZC3 ²⁾	6215 ZC3 ²⁾			
280 S/M	2	6315 C3	6315 C3	Fig. 2		
	4 ... 8	6317 C3	6317 C3			
315 S/M/L	2	6316 C3	6316 C3			
	4 ... 8	6319 C3	6319 C3			
1LE16, 1MB16 – Performance Line						
100 L	2 ... 8	6306 2ZC3	6306 2ZC3	Fig. 1		
112 M	2 ... 8	6306 2ZC3	6306 2ZC3			
132 S/M	2 ... 8	6308 2ZC3	6308 2ZC3			
160 M/L	2 ... 8	6309 ZC3	6309 ZC3	Fig. 2		
180 M/L	2 ... 8	6310 C3	6310 C3	Fig. 4		
200 L	2 ... 8	6312 C3	6312 C3			
225 S/M	2 ... 8	6313 C3	6313 C3	Fig. 4		
250 M	2 ... 8	6315 C3	6315 C3			
280 S/M	2	6315 C3	6315 C3			
	4 ... 8	6317 C3	6317 C3			
315 S/M/L	2	6316 C3	6316 C3			
	4 ... 8	6319 C3	6319 C3			
		Type of construction	Type of construction			
		Horizontal	Vertical			
1LE5, 1MB5						
315 L	2	6316 C4	6316 C4	6316 C4	7316 B	–
	4, 6	6319 C4	6319 C4	6319 C4	7319 B	–
355 M/L	2	6317 C4	6317 C4	6317 C4	7317 B	–
	4, 6	6320 C4	6320 C4	6320 C4	7320 B	–
400	2	6218 C3	7218 B + 6218 C3	6218 C3	6218 C3	Fig. 6, Fig. 7
	4, 6, 8	6224 C3	7224 B + 6224 C3	6224 C3	6224 C3	Fig. 6, Fig. 7
450	2	6220 C3	–	6220 C3	–	Fig. 6
	4, 6, 8	6226 C3	7226 B + 6226 C3	6226 C3	6226 C3	Fig. 6, Fig. 7

¹⁾ Deep-groove bearings with a side plate are used for regreasable versions (**L23**).

²⁾ Deep-groove bearings without a side plate are used for regreasable versions (**L23**).

Overview

Bearing assignment for 1MB1/1MB5 motors with types of protection Ex db, Ex db eb (basic version)

Frame size	No. of poles	Drive end (DE) bearing		Non-drive end (NDE) bearing		Fig. No. on page 1/62
		Type of construction		Type of construction		
1MB1, 1MB5 with type of protection Ex db, Ex db eb						
		Horizontal	Vertical	Horizontal	Vertical	
71	2 ... 8	6202-2Z C3	6202-2Z C3	6202-2Z C3	6202-2Z C3	–
80	2 ... 8	6204-2Z C3	6204-2Z C3	6204-2Z C3	6204-2Z C3	–
90	2 ... 8	6205-2Z C3	6205-2Z C3	6205-2Z C3	6205-2Z C3	–
100	2 ... 8	6306-2Z C3	6306-2Z C3	6306-2Z C3	6306-2Z C3	–
112	2 ... 8	6306-2Z C3	6306-2Z C3	6306-2Z C3	6306-2Z C3	–
132	2 ... 8	6308-2Z C3	6308-2Z C3	6308-2Z C3	6308-2Z C3	–
160	2 ... 8	6309 C3	6309 C3	6309 C3	6309 C3	–
180	2 ... 8	6310 C3	6310 C3	6310 C3	6310 C3	–
200	2 ... 8	6312 C3	6312 C3	6312 C3	6312 C3	–
225	2 ... 8	6313 C3	6313 C3	6313 C3	6313 C3	–
250	2 ... 8	6315 C3	6315 C3	6315 C3	6315 C3	–
280	2	6315 C3	6315 C3	6315 C3	6315 C3	–
280	4 ... 8	6317 C3	6317 C3	6317 C3	6317 C3	–
315	2	6316 C3	6319 C3	6316 C3	6319 C3	–
315	4 ... 8	6319 C3	6319 C3	6319 C3	6319 C3	–
355	2	6317 C4	6320 C4	6317 C4	6320 C4	–
355	4 ... 8	6320 C4	6320 C4	6320 C4	6320 C4	–

Introduction

Mechanical version

Bearings and lubrication

Overview

Bearing selection table for 1LE15, 1MB15, 1LE16, and 1MB16 motors (bearings for increased cantilever forces – order code L22)

For NU bearings (cylindrical roller bearings), in contrast to ball bearings, a minimum cantilever force is required. Cylindrical roller bearings are not suitable for coupling output.

$$F_{\min} \sim F_{\max}/2$$

Frame size	No. of poles	Drive end (DE) bearing		Non-drive end (NDE) bearing		Fig. No. on page 1/62
		Horizontal and vertical type of construction		Horizontal and vertical type of construction		
1LE15/1MB15 – Basic Line						
71 M	2 ... 8	6302 2ZC3		6202 2ZC3 ³⁾		
80 M	2 ... 8	6304 2ZC3		6204 2ZC3 ³⁾		
90 S/L	2 ... 8	6305 2ZC3		6204 2ZC3		
100 L	2 ... 8	6306 2ZC3 ¹⁾		6206 2ZC3 ¹⁾³⁾		
112 M	2 ... 8	6306 2ZC3 ¹⁾		6206 2ZC3 ¹⁾³⁾		
132 M	2 ... 8	6308 2ZC3 ¹⁾		6208 2ZC3 ¹⁾³⁾		
160 M/L	2 ... 8	6309 2ZC3 ¹⁾		6209 2ZC3 ¹⁾³⁾		
180 M/L	2 ... 8	NU 210		6210 2ZC3 ⁴⁾		Fig. 5
200 L	2 ... 8	NU 212		6212 2ZC3 ⁴⁾		
225 M	2 ... 8	NU 213		6213 C3		
250 M	2 ... 8	NU 215		6215 C3		
280 M	2	NU 315		6315 C3 ³⁾		
	4 ... 8	NU 317		6317 C3 ³⁾		
315 M/L	2	NU 316		6316 C3 ³⁾		
	4 ... 8	NU 319		6319 C3 ³⁾		
1LE16/1MB16 – Performance Line						
100 L	2 ... 8	2)				
112 M	2 ... 8	2)				
132 M	2 ... 8	2)				
160 M/L	2 ... 8	2)				
180 M/L	2 ... 8	NU 310		6310 C3 ³⁾		
200 L	2 ... 8	NU 312		6312 C3 ³⁾		
225 M	2 ... 8	NU 313		6313 C3 ³⁾		Fig. 5
250 M	2 ... 8	NU 315		6315 C3 ³⁾		
280 M	2	NU 315		6315 C3 ³⁾		
	4 ... 8	NU 317		6317 C3 ³⁾		
315 M/L	2	NU 316		6316 C3 ³⁾		
	4 ... 8	NU 319		6319 C3 ³⁾		
		Type of construction		Type of construction		
		Horizontal	Vertical	Horizontal	Vertical	
1LE5, 1MB5						
315 L	2	NU316	NU316	6316 C4	O. R.	–
	4, 6	NU319	NU319	6319 C4	O. R.	–
355 M/L	2	NU317	NU317	6317 C4	O. R.	–
	4, 6	NU320	NU320	6320 C4	O. R.	–
400	2	O. R.	–	O. R.	–	Fig. 6, Fig. 7
	4 ... 8	O. R.	O. R.	O. R.	O. R.	
450	2	O. R.	–	O. R.	–	Fig. 6
	4 ... 8	O. R.	O. R.	O. R.	O. R.	

¹⁾ Deep-groove bearings with a side plate are used for regreasable versions (**L23**).

²⁾ Not permitted.

³⁾ As for basic version.

⁴⁾ Deep-groove bearings without a side plate are used for regreasable versions (**L23**).

Overview

Bearing assignment for 1MB1/1MB5 motors with types of protection Ex db, Ex db eb (bearings for increased cantilever forces – order code L22)

For NU bearings (cylindrical roller bearings), in contrast to ball bearings, a minimum cantilever force is required. Cylindrical roller bearings are not suitable for coupling output.

$$F_{\min} \sim F_{\max}/2$$

Frame size	No. of poles	Drive end (DE) bearing		Non-drive end (NDE) bearing		Fig. No. on page 1/62
		Type of construction		Type of construction		
		Horizontal	Vertical	Horizontal	Vertical	
1MB1, 1MB5 with type of protection Ex db, Ex db eb						
160	2 ... 8	NU309	NU309	6309 C3	6309 C3	–
180	2 ... 8	NU310	NU310	6310 C3	6310 C3	–
200	2 ... 8	NU312	NU312	6312 C3	6312 C3	–
225	2 ... 8	NU313	NU313	6313 C3	6313 C3	–
250	2 ... 8	NU315	NU315	6315 C3	6315 C3	–
280	2	NU315	NU315	6315 C3	6315 C3	–
280	4 ... 8	NU317	NU317	6317 C3	6317 C3	–
315	2	NU316	NU316	6316 C3	6319 C3	–
315	4 ... 8	NU319	NU319	6319 C3	6319 C3	–
355	2	NU317	NU317	6317 C4	6320 C4	–
355	4 ... 8	NU320	NU320	6320 C4	6320 C4	–

Bearing assignment for 1LE15/1MB15 and 1LE16/1MB16 motors and 1LE5 motors (bearings reinforced at both ends – order code L25, for 1LE16 motors – standard)

Frame size	No. of poles	Drive end (DE) bearing		Non-drive end (NDE) bearing		Fig. No. on page 1/62
		Horizontal and vertical type of construction		Horizontal and vertical type of construction		
1LE15, 1MB15 – Basic Line						
71 M	2 ... 8	6302 2ZC3		6302 2ZC3		
80 M	2 ... 8	6304 2ZC3		6304 2ZC3		
90 S/L	2 ... 8	6305 2ZC3		6304 2ZC3		
100 L	2 ... 8	6306 2ZC3 ¹⁾		6306 2ZC3 ¹⁾		
112 M	2 ... 8	6306 2ZC3 ¹⁾		6306 2ZC3 ¹⁾		
132 M	2 ... 8	6308 2ZC3 ¹⁾		6308 2ZC3 ¹⁾		
160 M/L	2 ... 8	6309 2ZC3 ¹⁾		6309 2ZC3 ¹⁾		
180 M/L	2 ... 8	6310 2ZC3 ³⁾		6310 2ZC3 ³⁾		
200 L	2 ... 8	6312 2ZC3 ³⁾		6312 2ZC3 ³⁾		
225 M	2 ... 8	6313 ZC3 ³⁾		6313 ZC3 ³⁾		Fig. 4
250 M	2 ... 8	6315 ZC3 ³⁾		6315 ZC3 ³⁾		
280 M	2	6315 C3 ²⁾		6315 C3 ²⁾		
	4 ... 8	6317 C3 ²⁾		6317 C3 ²⁾		
315 M/L	2	6316 C3 ²⁾		6316 C3 ²⁾		
	4 ... 8	6319 C3 ²⁾		6319 C3 ²⁾		
1LE16, 1MB16 – Performance Line – bearing version as for Performance Line basic version						
		Type of construction		Type of construction		
		Horizontal	Vertical	Horizontal	Vertical	
1LE5						
315 L	2	6316 C4	6316 C4	6316 C4	7316 B	–
	4, 6	6319 C4	6319 C4	6319 C4	7319 B	–
355 M/L	2	6317 C4	6317 C4	6317 C4	7317 B	–
	4, 6	6320 C4	6320 C4	6320 C4	7320 B	–
400	2	O. R.	O. R.	O. R.	O. R.	Fig. 6, Fig. 7
	4,6,8	6324 C3	O. R.	6324 C3	O. R.	
450	2	O. R.	–	O. R.	–	Fig. 6
	4,6,8	6326 C3	O. R.	6326 C3	O. R.	Fig. 6, Fig. 7

¹⁾ Deep-groove bearings with a side plate are used for regreasable versions (**L23**).

²⁾ As for basic version.

³⁾ Deep-groove bearings without a side plate are used for regreasable versions (**L23**).

Introduction

Mechanical version

Bearings and Lubrication

1

Overview

Diagrams of bearings

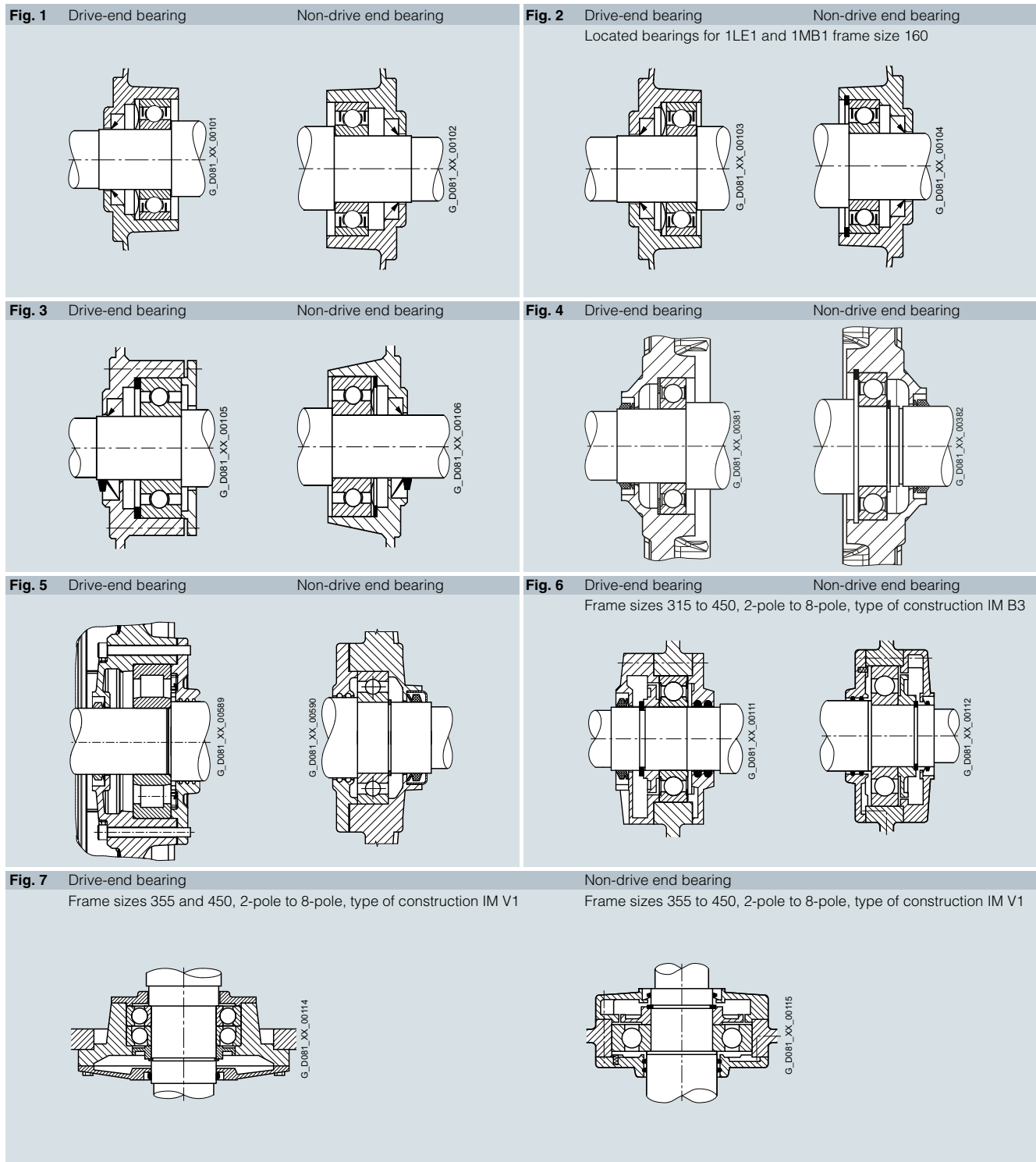

Overview

Admissible cantilever forces

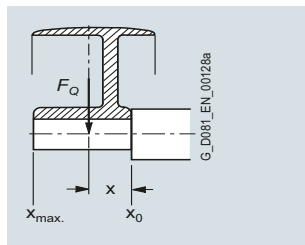

In order to calculate the admissible cantilever forces for a radial load, the line of force (i.e. the centerline of the pulley) of the cantilever force F_Q (N) must be within the free shaft extension (dimension x).

Dimension x (mm) is the distance between the point of application of the force F_Q and the shaft shoulder. The dimension

x_{max} corresponds to the length of the shaft extension.

Total cantilever force $F_Q = c \cdot F_U$

The pre-tension factor c is a value gained from experience from the belt manufacturer. The following approximate value can be assumed:

For normal flat leather belts with an idler pulley $c = 2$;
for V-belts $c = 2$ to 2.5;
for special synthetic belts (depending on the type of load and type of belt) $c = 2$ to 2.5.

The circumferential force F_U (N) is calculated using the following equation

$$F_U = 2 \cdot 10^7 \frac{P}{n \cdot D}$$

- F_U circumferential force in N
- P rated motor power (transmitted power) in kW
- n rated motor speed in rpm
- D belt pulley diameter in mm

Admissible cantilever forces – basic version

1LE10, 1MB10 motors (frame sizes 80 ... 160) and 1PC10 (frame sizes 100 ... 160) at 50 Hz				
Valid are: x_0 values for $x = 0$ and x_{max} values for $x = l$ (l = shaft extension)				
Frame size	Type	No. of poles	Admissible cantilever force F_Q at x_0	Admissible cantilever force F_Q at x_{max}
		N	N	N
1LE1 motors – values for motors with increased power ¹⁾				
80	1LE10..-0DA	2	485	400
	1LE10..-0DB	4	625	515
	1LE10..-0DC	6	735	605
90	1LE10..-0EA	2	725	605
	1LE10..-0EB	4	920	775
	1LE10..-0EC	6	1090	910
100	1LE10..-1AA	2	1010	825
	1LE10..-1AB	4	1230	1010
	1LE10..-1AC	6	1440	1180
112	1LE10..-1BA	2	970	785
	1LE10..-1BB	4	1235	1000
	1LE10..-1BC	6	1440	1165
132	1LE10..-1CA	2	1470	1180
	1LE10..-1CB	4	1830	1470
	1LE10..-1CC	6	2150	1730
160	1LE10..-1DA	2	1550	1270
	1LE10..-1DB	4	1910	1550
	1LE10..-1DC	6	2230	1810
1LE1 motors – standard values ¹⁾				
1MB1 motors – standard values ¹⁾				
1PC1 motors – standard values ¹⁾				
63	1LE10..-0BA	2	270	240
	1LE10..-0BB	4	350	305
71	1LE10..-0CA	2	415	355
	1LE10..-0CB	4	530	450
80	1LE10..-0DA	2	485	400
	1MB10..-0DA			
	1PC10..-0DA			
	1LE10..-0DB	4	625	515
	1MB10..-0DB			
	1PC10..-0DB			
	1LE10..-0DC	6	735	605
	1MB10..-0DC			
	1PC10..-0DC			
	1LE10..-0DD	8	815	675
	1MB10..-0DD			
	1PC10..-0DD			
90	1LE10..-0EA	2	725	605
	1MB10..-0EA			
	1PC10..-0EA			
	1LE10..-0EB	4	920	775
	1MB10..-0EB			
	1PC10..-0EB			
	1LE10..-0EC	6	1090	910
	1MB10..-0EC			
	1PC10..-0EC			
	1LE10..-0ED	8	1230	1030
	1MB10..-0ED			
	1PC10..-0ED			

Note:
1PC10 only for frame sizes 100 to 160.

In the case of cantilever forces that exceed this, see "Bearings for increased cantilever forces".

1LE10, 1MB10 motors (frame sizes 80 ... 160) and 1PC10 (frame sizes 100 ... 160) at 50 Hz				
Valid are: x_0 values for $x = 0$ and x_{max} values for $x = l$ (l = shaft extension)				
Frame size	Type	No. of poles	Admissible cantilever force F_Q at x_0	Admissible cantilever force F_Q at x_{max}
		N	N	N
1LE1 motors – standard values ¹⁾				
1MB1 motors – standard values ¹⁾				
1PC1 motors – standard values ¹⁾				
100	1LE10..-1AA	2	1020	815
	1MB10..-1AA			
	1PC10..-1AA			
	1LE10..-1AB	4	1250	1000
	1MB10..-1AB			
	1PC10..-1AB			
	1LE10..-1AC	6	1450	1155
	1MB10..-1AC			
	1PC10..-1AC			
	1LE10..-1AD	8	1615	1290
	1MB10..-1AD			
	1PC10..-1AD			
112	1LE10..-1BA	2	1000	790
	1MB10..-1BA			
	1PC10..-1BA			
	1LE10..-1BB	4	1250	990
	1MB10..-1BB			
	1PC10..-1BB			
	1LE10..-1BC	6	1450	1150
	1MB10..-1BC			
	1PC10..-1BC			
	1LE10..-1BD	8	1610	1275
	1MB10..-1BD			
	1PC10..-1BD			
132	1LE10..-1CA	2	1505	1170
	1MB10..-1CA			
	1PC10..-1CA			
	1LE10..-1CB	4	1880	1460
	1MB10..-1CB			
	1PC10..-1CB			
	1LE10..-1CC	6	2170	1680
	1MB10..-1CC			
	1PC10..-1CC			
	1LE10..-1CD	8	2420	1880
	1MB10..-1CD			
	1PC10..-1CD			
160	1LE10..-1DA	2	1560	1240
	1MB10..-1DA			
	1PC10..-1DA			
	1LE10..-1DB	4	2040	1590
	1MB10..-1DB			
	1PC10..-1DB			
	1LE10..-1DC	6	2350	1820
	1MB10..-1DC			
	1PC10..-1DC			
	1LE10..-1DD	8	2610	2030
	1MB10..-1DD			
	1PC10..-1DD			
180	1LE10..	2	1670	1380
		4	2150	1740
		6	2500	2000
200	1LE10..	2	2460	2070
		4	3180	2630
		6	3600	2980

¹⁾ For IE1 motors, the admissible cantilever force can be increased by up to 5 %.

Introduction

Mechanical version

Bearings and lubrication

1

Overview

1LE15, 1MB15¹⁾, 1LE55, and 1MB55 motors¹⁾ at 50 Hz

Valid are: x_0 values for $x = 0$ and x_{max} values for $x = l$ (l = shaft extension)

For motors		Admissible cantilever force at x_0	Admissible cantilever force at x_{max}
Frame size	No. of poles	N	N
1LE1501/03/21/23, 1MB15 – Basic Line			
71	2	400	340
	4	500	420
	6	570	490
80	2	680	570
	4	860	720
	6	980	820
90	2	760	620
	4	950	790
	6	1090	900
100	2	1010	815
	4	1230	1000
	6	1440	1155
	8	1615	1290
112	2	970	785
	4	1235	990
	6	1440	1150
	8	1610	1275
132	2	1470	1170
	4	1830	1460
	6	2150	1680
	8	2420	1880
160	2	1550	1240
	4	1910	1550
	6	2230	1810
	8	2610	2030
180	2	1670	1380
	4	2150	1740
	6	2500	2000
	8	2980	2430
200	2	2460	2070
	4	3180	2630
	6	3600	2980
	8	4250	3500
225	2	2850	2300
	4	3550	2800
	6	4050	3240
	8	4500	3500
250	2	3250	2600
	4	4100	3400
	6	4800	4000
	8	5250	4450
280	2	5200	4200
	4	8500	7 000
	6	9800	8150
	8	10800	9000
315 S/M	2	5300	4500
	4	9150	7400
	6	10750	8750
	8	11600	9600
315 L	2	4900	4300
	4	8900	7700
	6	10100	9150
	8	11100	10200
1LE5504/34/03/33, 1MB55			
315 L	2	5800	5200
	4	9300	8 000
	6	10600	9200
	8	12000	9200
400	2	2910	2570
	4	6830	5870
	6	6520	5610
	8	7860	6760
450	2	3820	3410
	4	7130	6220
	6	6970	6080
	8	8110	7070

1LE16, 1MB16, 1LE56, and 1MB56 motors at 50 Hz

Valid are: x_0 values for $x = 0$ and x_{max} values for $x = l$ (l = shaft extension)

For motors		Admissible cantilever force at x_0	Admissible cantilever force at x_{max}
Frame size	No. of poles	N	N
1LE1601/03/21/23, 1MB16 – Performance Line			
100	2	1585	1270
	4	1960	1575
	6	2270	1815
	8	2520	2015
112	2	1545	1240
	4	1960	1555
	6	2270	1800
	8	2510	1990
132	2	2285	1795
	4	2860	2250
	6	3320	2580
	8	3700	2870
160	2	2800	2170
	4	3450	2750
	6	4000	3160
	8	4510	3500
180	2	3250	2610
	4	4110	3270
	6	4720	3740
	8	5480	4500
200	2	4320	3550
	4	5480	4500
	6	6220	5110
	8	7800	6200
225	2	5000	4150
	4	6250	4900
	6	7200	5750
	8	8700	7000
250	2	6000	4800
	4	7600	6200
	6	8750	7350
	8	9500	8 000
280	2	5200	4200
	4	8500	7 000
	6	9800	8150
	8	10800	9000
315 S/M	2	5300	4500
	4	9150	7400
	6	10750	8750
	8	11600	9600
315 L	2	4900	4300
	4	8900	7700
	6	10100	9150
	8	11100	10200
1LE5604/34/03/33, 1MB56 – Performance line			
315 L	2	5800	5200
	4	9300	8 000
	6	10600	9200
	8	12000	9200
355 M/L	2	5800	5200
	4	9900	8700
	6	11200	9800
	8	11200	10000

In the case of cantilever forces that exceed this, see "Bearings for increased cantilever forces".

¹⁾ Not valid for 1MB.55 motors with type of protection Ex db eb.

Overview

1MB1, 1MB5 motors for types of protection Ex db and Ex db eb at 50 HzValid are: x_0 values for $x = 0$, $x_{0.5}$ for $x = 0.5 \times l$ and x_{max} values for $x = l$ (l = shaft extension)

Frame size	No. of poles	Admissible cantilever force		
		at x_0	at $x_{0.5}$	at x_{max}
1MB1/1MB5 – for types of protection Ex db and Ex db eb				
71	2	360	340	300
	4	410	380	300
	6	490	390	300
80	2	570	530	420
	4	700	570	430
	6	800	580	430
90	2	520	480	440
	4	660	660	490
	6	850	690	510
100	2	1340	1110	830
	4	1620	1110	820
	6	1690	1120	830
112	2	1300	1150	860
	4	1630	1300	970
	6	1800	1190	880
132	2	1980	1790	1420
	4	2460	1830	1290
	6	2810	1880	1330
160	2	2770	2510	1950
	4	3430	2850	1940
	6	3700	3290	2230
180	2	3070	2800	2570
	4	3780	3440	2880
	6	4380	3990	2940
200	2	3960	3640	3360
	4	5010	4610	4260
	6	5630	5170	4390
225	2	4500	4170	3890
	4	5590	5090	4660
	6	6260	5690	5220
250	2	5430	4930	4510
	4	6720	6100	5580
	6	7650	6950	6360
280	2	8720	7920	6250
	4	4690	4330	4000
	6	7430	6580	6330
315 S/M	2	8940	8240	7070
	4	8860	8170	6790
	6	9280	6910	4780
315 L	2	5480	5210	4970
	4	8300	7360	5530
	6	9280	6910	4780
355	2	9210	5700	4120
	4	4050	3800	3580
	6	5350	4920	4030
355	2	6830	5800	4210
	4	8600	5350	3880
	6	3900	3700	3520
355	2	3930	3570	2610
	4	O. R.	O. R.	O. R.
	6	O. R.	O. R.	O. R.
355	2	O. R.	O. R.	O. R.
	4	O. R.	O. R.	O. R.
	6	O. R.	O. R.	O. R.

Admissible cantilever forces – bearings for increased cantilever forces – order code **L22****1LE10, 1MB10 motors (frame sizes 80 ... 160) and 1PC10 (frame sizes 100 ... 160) at 50 Hz with reinforced deep-groove bearings at DE**Valid are: x_0 values for $x = 0$ and x_{max} values for $x = l$ (l = shaft extension)

Frame size	Type	No. of poles	Admissible cantilever force F_Q		
			at x_0	at x_{max}	
1LE10 motors – values for motors with increased power ¹⁾					
100	1LE10..-1AA	2	1585	1300	
	1LE10..-1AB	4	1960	1610	
	1LE10..-1AC	6	2270	1865	
112	1LE10..-1BA	2	1545	1250	
	1LE10..-1BB	4	1960	1585	
	1LE10..-1BC	6	2270	1835	
132	1LE10..-1CA	2	2285	1840	
	1LE10..-1CB	4	2860	2300	
	1LE10..-1CC	6	3320	2670	
160	1LE10..-1DA	2	2800	2240	
	1LE10..-1DB	4	3450	2270	
	1LE10..-1DC	6	4000	3200	
1LE1 motors – standard values ¹⁾					
1MB10 motors – standard values ¹⁾					
1PC10 motors – standard values ¹⁾					
100	1LE10..-1AA	2	1585	1270	
	1MB10..-1AA				
	1PC10..-1AA				
100	1LE10..-1AB	4	1960	1575	
	1MB10..-1AB				
	1PC10..-1AB				
100	1LE10..-1AC	6	2270	1815	
	1MB10..-1AC				
	1PC10..-1AC				
100	1LE10..-1AD	8	2520	2015	
	1MB10..-1AD				
	1PC10..-1AD				
112	1LE10..-1BA	2	1545	1240	
	1MB10..-1BA				
	1PC10..-1BA				
112	1LE10..-1BB	4	1960	1555	
	1MB10..-1BB				
	1PC10..-1BB				
112	1LE10..-1BC	6	2270	1800	
	1MB10..-1BC				
	1PC10..-1BC				
112	1LE10..-1BD	8	2510	1990	
	1MB10..-1BD				
	1PC10..-1BD				
132	1LE10..-1CA	2	2285	1795	
	1MB10..-1CA				
	1PC10..-1CA				
132	1LE10..-1CB	4	2860	2250	
	1MB10..-1CB				
	1PC10..-1CB				
132	1LE10..-1CC	6	3320	2580	
	1MB10..-1CC				
	1PC10..-1CC				
132	1LE10..-1CD	8	3700	2870	
	1MB10..-1CD				
	1PC10..-1CD				
160	1LE10..-1DA	2	2800	2170	
	1MB10..-1DA				
	1PC10..-1DA				
160	1LE10..-1DB	4	3450	2750	
	1MB10..-1DB				
	1PC10..-1DB				
160	1LE10..-1DC	6	4000	3160	
	1MB10..-1DC				
	1PC10..-1DC				
160	1LE10..-1DD	8	4510	3500	
	1MB10..-1DD				
	1PC10..-1DD				
180	1LE10..-1EA	2	3250	2610	
		4	4110	3270	
		6	4720	3740	
180		8	5130	4050	
	200	1LE10..-2AA	2	4320	3550
			4	5480	4500
		6	6220	5110	
200		8	6870	5640	

¹⁾ For IE1 motors, the admissible cantilever force can be increased by up to 5 %.

Introduction

Mechanical version

Bearings and lubrication

1

Overview

1LE15 and 1MB15 ¹⁾ motors at 50 Hz with reinforced deep-groove bearings at DE up to frame size 160 with cylindrical roller bearings at DE in frame size 180 and above

Valid are: x_0 values for $x = 0$ and x_{max} values for $x = l$ (l = shaft extension)

For motors

Frame size	Type	No. of poles	N	Admissible cantilever force at x_0	Admissible cantilever force at x_{max}
1LE1501/03/21/23, 1MB15 – Basic Line					
71	1LE15..-0CA	2	400	340	
	1MB15..-0CA				
	1LE15..-0CB	4	490	420	
	1MB15..-0CB				
	1LE15..-0CC	6	570	490	
	1MB15..-0CC				
	1LE15..-0CD	8	640	540	
	1MB15..-0CD				
80	1LE15..-0DA	2	680	570	
	1MB15..-0DA				
	1LE15..-0DB	4	840	720	
	1MB15..-0DB				
	1LE15..-0DC	6	970	820	
	1MB15..-0DC				
	1LE15..-0DD	8	1090	910	
	1MB15..-0DD				
90	1LE15..-0EA	2	720	605	
	1MB15..-0EA				
	1LE15..-0EB	4	920	775	
	1MB15..-0EB				
	1LE15..-0EC	6	1060	910	
	1MB15..-0EC				
	1LE15..-0ED	8	1200	1030	
	1MB15..-0ED				
100	1LE15..-1AA	2	1585	1270	
	1MB15..-1AA				
	1LE15..-1AB	4	1960	1575	
	1MB15..-1AB				
	1LE15..-1AC	6	2270	1815	
	1MB15..-1AC				
	1LE15..-1AD	8	2520	2015	
	1MB15..-1AD				
112	1LE15..-1BA	2	1545	1240	
	1MB15..-1BA				
	1LE15..-1BB	4	1960	1555	
	1MB15..-1BB				
	1LE15..-1BC	6	2270	1800	
	1MB15..-1BC				
	1LE15..-1BD	8	2510	1990	
	1MB15..-1BD				
132	1LE15..-1CA	2	2285	1795	
	1MB15..-1CA				
	1LE15..-1CB	4	2860	2250	
	1MB15..-1CB				
	1LE15..-1CC	6	3320	2580	
	1MB15..-1CC				
	1LE15..-1CD	8	3700	2870	
	1MB15..-1CD				
160	1LE15..-1DA	2	2800	2170	
	1MB15..-1DA				
	1LE15..-1DB	4	3450	2750	
	1MB15..-1DB				
	1LE15..-1DC	6	4000	3160	
	1MB15..-1DC				
	1LE15..-1DD	8	4510	3500	
	1MB15..-1DD				
180	1LE15..-1EA	2	4520	3630	
	1MB15..-1EA				
	1LE15..-1EB	4	5560	4050	
	1MB15..-1EB				
	1LE15..-1EC	6	6280	4050	
	1MB15..-1EC				
	1LE15..-1ED	8	6790	4050	
	1MB15..-1ED				
200	1LE15..-2AA	2	6840	5610	
	1MB15..-2AA				
	1LE15..-2AB	4	8440	6000	
	1MB15..-2AB				
	1LE15..-2AC	6	9480	6000	
	1MB15..-2AC				
	1LE15..-2AD	8	10100	6000	
	1MB15..-2AD				

Note: 1PC10 and 1MB10 not for frame sizes 180 to 200.

1LE15 and 1MB15 motors at 50 Hz with reinforced deep-groove bearings at DE up to frame size 160 with cylindrical roller bearings at DE in frame size 180 and above

Valid are: x_0 values for $x = 0$ and x_{max} values for $x = l$ (l = shaft extension)

For motors

Frame size	Type	No. of poles	N	Admissible cantilever force at x_0	Admissible cantilever force at x_{max}
1LE1501/03/21/23, 1MB15 – Basic Line (continued)					
225	1LE15..-2BA	2	8 000	6800	
	1MB15..-2BA				
	1LE15..-2BB	4	9800	7250	
	1MB15..-2BB				
	1LE15..-2BC	6	11100	7300	
	1MB15..-2BC				
	1LE15..-2BD	8	11300	7300	
	1MB15..-2BD				
250	1LE15..-2CA	2	9500	7400	
	1MB15..-2CA				
	1LE15..-2CB	4	12500	9400	
	1MB15..-2CB				
	1LE15..-2CC	6	13500	9700	
	1MB15..-2CC				
	1LE15..-2CD	8	14700	9700	
	1MB15..-2CD				
280 ²⁾	1LE15..-2DA	2	16500	9800	
	1MB15..-2DA				
315 ²⁾	1LE15..-3AA	2	18400	7600	
	1MB15..-3AA				

1LE16 and 1MB16 motors at 50 Hz with reinforced cylindrical roller bearings DE

Valid are: x_0 values for $x = 0$ and x_{max} values for $x = l$ (l = shaft extension)

For motors

Frame size	No. of poles	N	Admissible cantilever force at x_0	Admissible cantilever force at x_{max}
1LE1601/03/21/23, 1MB16 – Performance Line				
100, 112, 132, 160	2, 4, 6, 8	–	–	–
180	2	8150	4050	
	4	9800	4050	
	6	9800	4050	
200	2	11200	6000	
	4	13600	6000	
	6	13600	6000	
225	2	12700	7900	
	4	15700	7250	
	6	15700	7300	
250	2	17000	7750	
	4	21000	9400	
	6	21000	9700	
280 ²⁾	2	21000	9700	
	4	21000	9700	
	6	21000	9700	
315 S, M ²⁾	2	16500	9800	
315 L ²⁾	2	18400	7600	

Admissible cantilever forces – Bearing for increased cantilever forces – For all motors of frame sizes 400 and 450 at 50 Hz in the horizontal and vertical types of construction (order code **L22**) on request.

Please specify cantilever force and lever arm.

Overview

Admissible cantilever forces – bearings for increased cantilever forces – order code **L22** and **L50****Motors 1LE15 bei 50 Hz
with reinforced cylindrical roller bearings DE****Valid are: x_0 values for $x = 0$ and x_{max} values for $x = l$ (l = shaft extension)**

Frame size	No. of poles	Admissible cantilever force	
		at x_0	at x_{max}
1LE15			
225	2	8000	5300
	4, 6, 8	9800	5300
250	2	9500	6500
	4, 6, 8	12500	7700
280	2	13500	7300
	4, 6, 8	20000	10500
315	2	18400	7600
	4, 6, 8	25500	10000

**Motors 1LE16 bei 50 Hz
with reinforced cylindrical roller bearings DE****Valid are: x_0 values for $x = 0$ and x_{max} values for $x = l$ (l = shaft extension)**

Frame size	No. of poles	Admissible cantilever force	
		at x_0	at x_{max}
1LE16			
225	2	10700	5300
	4, 6, 8	12700	5300
250	2	15000	6500
	4, 6, 8	19000	7700
280	2	13500	7300
	4, 6, 8	20000	10500
315	2	18400	7600
	4, 6, 8	25500	10000

**Motors 1LE55 bei 50 Hz
with reinforced cylindrical roller bearings DE****Valid are: x_0 values for $x = 0$ and x_{max} values for $x = l$ (l = shaft extension)**

Frame size	No. of poles	Admissible cantilever force	
		at x_0	at x_{max}
1LE55			
315	2	18500	7400
	4, 6, 8	34000	11300
355	2	–	–
	4, 6, 8	–	–

**Motors 1LE56 bei 50 Hz
with reinforced cylindrical roller bearings DE****Valid are: x_0 values for $x = 0$ and x_{max} values for $x = l$ (l = shaft extension)**

Frame size	No. of poles	Admissible cantilever force	
		at x_0	at x_{max}
1LE56			
315	2	18500	7400
	4, 6, 8	34000	11300
355	2	20000	9100
	4, 6, 8	28600	13200

1) Not valid for 1MB155 motors with type of protection Ex db eb.

2) For admissible cantilever forces 4, 6, and 8-pole versions, see diagrams on this page.

Introduction

Mechanical version

Bearings and Lubrication

1

Overview

1LE15/6 and 1MB15/6 ¹⁾ motors for 50 Hz with cylindrical roller bearings DE for frame sizes 280 to 315 in 4 to 8-pole version

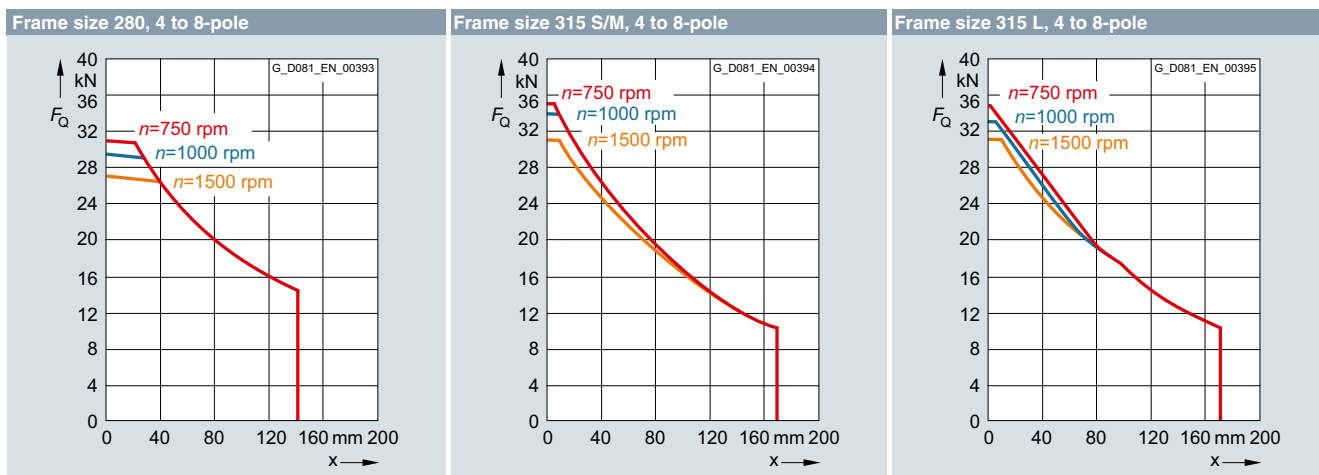

1LE55/6, 1MB55/6 motors for 50 Hz with cylindrical roller bearings DE for frame sizes 315 and 355 in 2 to 8-pole version

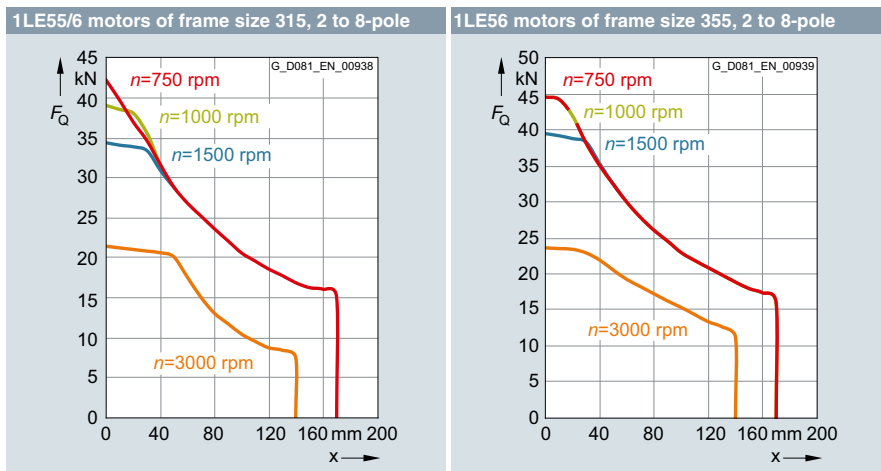

Admissible cantilever forces at 50 Hz – basic version

For motors in a horizontal type of construction, the maximum cantilever forces are specified as a function of the axial forces. See diagrams below.

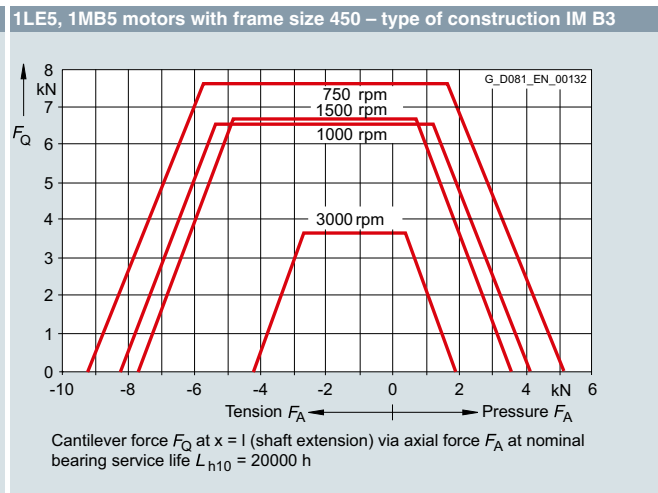
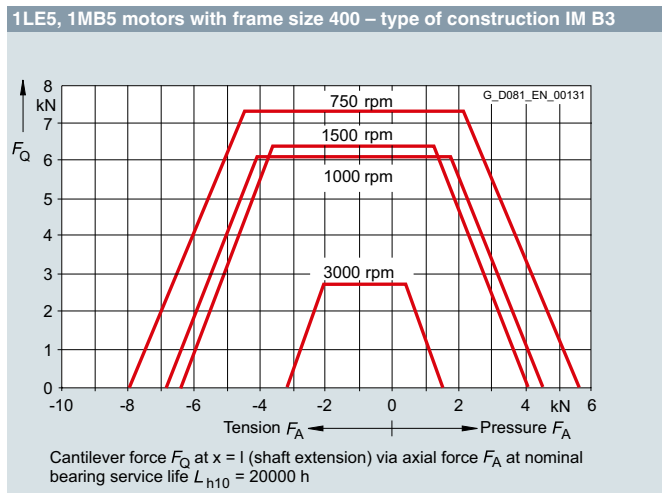

¹⁾ Not valid for 1MB155 motors with type of protection Ex db eb.

Overview

Admissible cantilever forces – bearings reinforced at both ends
– order code **L25**

**1LE10, 1MB10 motors (frame sizes 80 ... 160) and
1PC10 (frame sizes 100 ... 160) for 50 Hz
with deep-groove bearings reinforced at both ends**

Valid are: x_0 values for $x = 0$ and x_{max} values for $x = l$ (l = shaft extension)

Frame size	No. of poles	Admissible cantilever force	
		at x_0	at x_{max}
1LE1501/03/21/23, 1MB15 – Basic Line			
1LE10, 1MB10, 1PC10			
71	2	610	510
	4	760	640
	6	880	740
	8	970	820
80	2	950	800
	4	1190	1000
	6	1370	1150
	8	1520	1270
90	2	1200	1000
	4	1530	1270
	6	1760	1450
	8	1950	1610
100	2	1585	1270
	4	1960	1575
	6	2270	1815
	8	2520	2015
112	2	1545	1240
	4	1960	1555
	6	2270	1800
	8	2510	1990
132	2	2285	1795
	4	2860	2250
	6	3320	2580
	8	3700	2870
160	2	2800	2170
	4	3450	2750
	6	4000	3160
	8	4510	3500
180	2	3250	2610
	4	4110	3270
	6	4720	3740
	8	5130	4050
200	2	4320	3550
	4	5480	4500
	6	6220	5110
	8	6870	5640
225	2	5000	4150
	4	6250	4900
	6	7200	5750
	8	7800	6200
250	2	6000	4800
	4	7600	6200
	6	8750	7350
	8	9500	8000
280 ¹⁾	2, 4, 6, 8	–	–
315 ¹⁾	2, 4, 6, 8	–	–

Note:

1PC10 only for frame sizes 100 to 160,
1MB10 only for frame sizes 80 to 160.

Admissible cantilever forces – bearings reinforced at both ends,
DE bearings for increased cantilever forces – order code **L28**

**1LE15 and 1MB15 motors for 50 Hz
with cylindrical roller bearings DE and with deep-groove bearings NDE**

Valid are: x_0 values for $x = 0$ and x_{max} values for $x = l$ (l = shaft extension)

Frame size	No. of poles	Admissible cantilever force	
		at x_0	at x_{max}
1LE1501/03/21/23, 1MB15 – Basic Line			
100, 112, 132, 160	2, 4, 6, 8	–	–
	2	8150	4050
	4	9800	4050
180	6	9800	4050
	2	11200	6000
	4, 6	13600	6000
200	2	12700	7900
	4	15700	7250
	6, 8	15700	7300
225	2	17000	7750
	4	21000	9400
	6, 8	21000	9700
250	2, 4, 6, 8	–	–
280, 315 S, M, L ¹⁾	2, 4, 6, 8	–	–

Admissible cantilever forces – bearings for increased cantilever
forces – order code **L22**

1MB1 and 1MB5 motors at 50 Hz with reinforced deep-groove bearings DE

**Valid are: x_0 values for $x = 0$; $x_{0.5}$ values for $x = 0.5 \times l$ and
 x_{max} values for $x = l$ (l = shaft extension)**

Frame size	No. of poles	Admissible cantilever force		
		at x_0	at $x_{0.5}$	at x_{max}
1MB1/1MB5				
160	2	5380	2870	1950
	4	5340	2850	1940
	6	6150	3290	2230
	8	4820	2570	1750
180	2	8150	4370	2980
	4	8100	4340	2960
	6	7930	4440	3030
	8	9950	5570	3810
200	2	11030	6140	4240
	4	11410	6350	4390
	6	11010	6130	4230
	8	13450	7490	5180
225	2	14990	8530	5940
	4	14640	8200	5480
	6	16110	8200	5480
	8	14010	7130	4770
250	2	18190	9950	6830
	4	19210	10510	7220
	6	18710	10240	7030
	8	17340	9490	6510
280	2	16480	9640	6710
	4	18070	10480	7270
	6	16800	9740	6750
	8	16140	9350	6490
315 S/M	2	21250	12930	9270
	4	12970	6870	4980
	6	12100	6450	4810
	8	10590	5970	4170
315 L	2	15960	9820	7130
	4	10300	5560	4030
	6	10740	5800	4210
	8	9920	5350	3880
355	2	18700	11400	8200
	4, 6, 8	Values on request		

¹⁾ For values for frame sizes 280 to 315, see page 1/64. For frame sizes 280 to 315, bearings of size 63 are standard.

Introduction

Mechanical version

Bearings and lubrication

Overview

Admissible axial load

1LE10, 1MB10,¹⁾ and 1PC10¹⁾ motors in vertical type of construction – basic version (with the exception of motors with increased power)

Frame size	3000 rpm				1500 rpm				1000 rpm				750 rpm			
	Shaft extension pointing down		Shaft extension pointing up		down		up		down		up		down		up	
	Load down N	up N	down N	up N	down N	up N	down N	up N	down N	up N	down N	up N	down N	up N	down N	up N
63	80	245	230	95	80	330	310	95	80	410	390	95	–	–	–	–
71	105	365	335	130	90	380	440	130	90	590	550	130	90	700	660	130
80	110	425	360	160	100	540	480	165	100	650	590	165	100	760	700	165
90	110	440	360	180	100	680	580	190	100	920	820	190	100	1150	1050	190
100	140	700	550	280	130	990	820	285	130	1280	1110	285	130	1560	1390	285
112	140	710	550	300	130	1000	820	310	130	1290	1110	310	130	1570	1390	310
132	200	1200	950	470	180	1680	1200	470	180	1900	1600	470	190	2200	1900	440
160	1500	1400	950	1900	1900	1800	1300	2200	2200	2200	1600	2700	2700	2700	1950	2900
180	1260	1230	500	1990	1600	1770	840	2530	1920	2150	1160	2900	2050	2500	1290	3260
200	1810	1720	660	2870	2410	2480	1260	3630	2700	3050	1550	4200	3060	3510	1910	4660

The values shown do not assume a cantilever force on the shaft extension.

The admissible loads are valid for operation at 50 Hz; for 60 Hz, please inquire.

The calculation of the admissible axial load was based on the drive with generally available coupling.

For suppliers, see section "Accessories" on page 3/144 in the respective section of the catalog.

Please inquire if the load direction alternates.

1LE10, 1MB10,¹⁾ and 1PC10¹⁾ motors in horizontal type of construction – basic version (with the exception of motors with increased power)

Frame size	3000 rpm				1500 rpm				1000 rpm				750 rpm				
	Tensile load		Thrust load (N)		Tensile load		Thrust load (N)		Tensile load		Thrust load (N)		Tensile load		Thrust load (N)		
	with radial load at		without radial load		with radial load at		without radial load		with radial load at		without radial load		with radial load at		without radial load		
	x_0	$x_{max.}$			x_0	$x_{max.}$			x_0	$x_{max.}$			x_0	$x_{max.}$			
	N	N	N	N	N	N	N	N	N	N	N	N	N	N	N	N	N
63	90	120	90	240	90	140	110	320	90	170	120	400	–	–	–	–	
71	120	150	120	350	120	210	150	460	120	260	180	570	120	300	210	680	
80	140	190	150	400	140	300	260	510	140	330	280	620	140	340	290	730	
90	150	300	280	400	150	400	360	630	150	480	430	870	150	550	500	1100	
100	220	450	350	630	220	600	500	910	220	650	550	1200	220	750	650	1480	
112	220	450	350	630	220	600	500	910	220	650	550	1200	220	750	650	1480	
132	350	650	520	1200	350	850	700	1600	350	1020	890	1900	350	1150	1020	2200	
160	1500	850	720	1500	1500	1050	920	1800	1500	1250	1120	2200	1500	1350	1220	2600	
180	1630	–	–	870	2070	–	–	1310	2420	–	–	1660	2660	–	–	1900	
200	2340	–	–	1190	3020	–	–	1870	3450	–	–	2300	3860	–	–	2710	

The values shown do not assume a cantilever force on the shaft extension.

The admissible loads are valid for operation at 50 Hz; for 60 Hz, please inquire.

The calculation of the admissible axial load was based on the drive with generally available coupling.

For suppliers, see the section "Accessories" on page 3/144.

Please inquire if the load direction alternates.

1MB5 motors for Ex db, Ex db eb with a vertical type of construction – basic version

Frame size	3000 rpm		1500 rpm		1000 rpm		750 rpm	
	Shaft extension pointing down		Shaft extension pointing down		Shaft extension pointing down		Shaft extension pointing down	
	Load down N	up N	down N	up N	down N	up N	down N	up N
160	1790	2390	2460	3170	2730	3730	3420	4260
180	2020	2780	2760	3760	3350	4410	3770	5050
200	2910	4150	4070	5370	4840	6360	5460	7200
225	2570	4230	3590	5740	4250	6690	6110	8190
250	3470	5530	4770	7410	5880	8700	7260	9760
280	2440	5520	4300	8570	5860	9680	6920	10740
315 S/M	1190	6350	4250	10130	5240	11980	6340	13080
315 L	970	7250	3150	11170	3730	13070	4570	14130
355	270	10510	Values on request		Values on request		Values on request	

¹⁾ 1MB10 motors only available with frame sizes 80 to 160 and 1PC10 motors only available with frame sizes 100 to 160.

Overview

Frame size	Type	2-pole – 3000 rpm				4-pole – 1500 rpm				6-pole – 1000 rpm				8-pole – 750 rpm			
		Shaft extension pointing down		Shaft extension pointing up		down		up		down		up		down		up	
		Load down	up	down	up	down	up	down	up	down	up	down	up	down	up	down	up
		N	N	N	N	N	N	N	N	N	N	N	N	N	N	N	N
1LE56 – Performance Line																	
315	1LE56...3A.6	10500	1800	10500	1800	17500	2500	17500	2500	–	–	–	–	–	–	–	–
	1LE56...3A.7	10000	2300	10000	2300	17000	3000	17000	3000	20000	3000	20000	3000	22500	3400	22500	3400
	1LE56...3A.8	–	–	–	–	–	–	–	–	19000	4000	19000	4000	21500	4400	21500	4400
355	1LE56...3B.3	9700	2900	9700	2900	20000	3600	20000	3600	–	–	–	–	–	–	–	–
	1LE56...3B.4	9300	3500	9300	3500	19500	3800	19500	3800	–	–	–	–	–	–	–	–
	1LE56...3B.5	9000	3700	9000	3700	18500	4600	18500	4600	–	–	–	–	–	–	–	–
	1LE56...3BC2	–	–	–	–	–	–	–	–	21500	5000	21500	5000	–	–	–	–
	1LE56...3BC3	–	–	–	–	–	–	–	–	21000	5500	21000	5500	–	–	–	–
	1LE56...3BC4	–	–	–	–	–	–	–	–	21000	5500	21000	5500	–	–	–	–
	1LE56...3BD1	–	–	–	–	–	–	–	–	–	–	–	–	23000	5500	23000	5500
	1LE56...3BD2	–	–	–	–	–	–	–	–	–	–	–	–	22000	5800	22000	5800

1MB15 and 1MB55 motors for Ex db, Ex db eb with a vertical type of construction – basic version

Frame size	2-pole – 3000 rpm				4-pole – 1500 rpm				6-pole – 1000 rpm				8-pole – 750 rpm				
	Shaft extension pointing up		Shaft extension pointing down		up		down		up		down		up		down		
	Load down	up	down	up	down	up	down	up	down	up	down	up	down	up	down	up	
	N	N	N	N	N	N	N	N	N	N	N	N	N	N	N	N	N
71	510	220	190	550	600	340	280	660	700	440	380	760	780	510	450	840	
80	830	350	290	890	1000	540	460	1080	1130	690	590	1230	1220	780	680	1320	
90	860	380	270	980	1050	590	450	1180	1210	760	610	1350	1310	860	720	1450	
100	1660	1000	770	1890	2010	1380	1120	2270	2400	1740	1510	2630	2700	2020	1810	2910	
112	1680	980	790	1860	2070	1430	1180	2320	2380	1760	1490	2640	2620	2030	1730	2920	
132	2410	1480	1140	2750	2930	2100	1660	3370	3370	2580	2100	3850	3740	2970	2470	4240	
160	2810	2310	1710	3420	3560	3170	2460	4270	3930	3820	2820	4920	4590	4320	3480	5430	
180	2980	2620	1860	3740	3700	3580	2580	4700	4370	4310	3250	5430	4850	5010	3730	6130	
200	3850	3380	2140	5080	4940	4540	3240	6250	5650	5460	3940	7160	6260	6300	4560	8010	
225	4240	3950	2290	5900	5230	5430	3280	7380	5970	6460	4020	8400	7150	7280	5200	9230	
250	5140	4820	2760	7200	6350	6610	3970	8990	7400	7840	5020	10220	8710	8830	6330	11210	
280	4510	5210	2130	7590	6510	7980	3710	10780	8190	9210	5390	12010	8160	9180	5360	11980	
315 S/M	4700	7260	2100	9860	7650	10350	4470	13530	8290	11850	5110	15030	9500	13060	6320	16240	
315 L	4770	8450	2170	11050	6090	10930	2910	14110	6880	13040	3700	16220	7740	14120	4560	17300	
355	5160	12600	2360	15400	6210	15170	2730	18650	O. R.	O. R.	O. R.	O. R.	O. R.	O. R.	O. R.	O. R.	

Introduction

Mechanical version

Bearings and lubrication

1

Overview

1LE15 and 1MB15 motors in vertical type of construction – bearings reinforced at both ends – order code **L25**

Frame size	Type	2-pole – 3000 rpm				4-pole – 1500 rpm				6-pole – 1000 rpm				8-pole – 750 rpm				
		Shaft extension pointing down		Shaft extension pointing up		down		up		down		up		down		up		
		Load down	up	down	up	down	up	down	up	down	up	down	up	down	up	down	up	
		N	N	N	N	N	N	N	N	N	N	N	N	N	N	N	N	
1LE15, 1MB15 – Basic Line																		
71/80/90		Available soon																
100	1..15.1-1A.4	220	930	820	330	200	1330	1180	350	180	1640	1450	370	200	1900	1740	360	
	1..15.1-1A.5	–	–	–	–	190	1320	1150	360	–	–	–	–	180	1900	1710	370	
	1..15.1-1A.6	210	930	800	340	170	1320	1110	380	160	1640	1410	390	–	–	–	–	
	1..15.3-1A.4	210	930	800	340	170	1320	1110	380	–	–	–	–	–	–	–	–	
	1..15.3-1A.5	–	–	–	–	170	1320	1110	380	–	–	–	–	–	–	–	–	
112	1..15.1-1B.2	200	940	790	350	180	1340	1150	370	170	1650	1440	380	170	1910	1700	380	
	1..15.1-1B.6	180	940	750	370	170	1340	1120	390	160	1640	1410	390	–	–	–	–	
	1..15.3-1B.2	180	940	750	370	170	1340	1120	390	160	1640	1410	390	–	–	–	–	
132	1..15.1-1C.0	540	1120	890	770	520	1700	1430	790	520	2150	1880	790	510	2530	2240	800	
	1..15.1-1C.1	520	1130	860	790	–	–	–	–	–	–	–	–	–	–	–	–	
	1..15.1-1C.2	–	–	–	–	490	1710	1380	820	500	2150	1840	810	480	2540	2180	840	
	1..15.1-1C.3	–	–	–	–	–	–	–	–	470	2150	1780	840	–	–	–	–	
	1..15.1-1C.6	480	1130	780	830	440	1710	1280	870	420	2160	1690	890	–	–	–	–	
	1..15.3-1C.0	520	1130	860	790	440	1710	1280	870	470	2150	1780	840	–	–	–	–	
	1..15.3-1C.1	480	1130	780	830	–	–	–	–	–	–	–	–	–	–	–	–	
	1..15.3-1C.2	–	–	–	–	440	1710	1280	870	470	2150	1780	840	–	–	–	–	
	1..15.3-1C.3	–	–	–	–	–	–	–	–	420	2160	1690	890	–	–	–	–	
	160	1..15.1-1D.2	2200	1870	1480	2590	2860	2610	2140	3330	3320	3170	2600	3890	3830	3620	3110	4340
1..15.1-1D.3		2150	1880	1430	2600	–	–	–	–	–	–	–	–	3730	3620	3010	4340	
1..15.1-1D.4		2120	1890	1400	2610	2760	2610	2040	3330	3200	3180	2480	3900	3650	3640	2930	4360	
1..15.1-1D.6		2020	1890	1300	2610	2680	2640	1960	3360	3050	3180	2330	3900	–	–	–	–	
1..15.1-1D.7		–	–	–	–	2570	2670	1850	3390	–	–	–	–	–	–	–	–	
1..15.3-1D.2		2150	1880	1430	2600	2760	2610	2040	3330	3200	3180	2480	3900	–	–	–	–	
1..15.3-1D.3		2120	1890	1400	2610	–	–	–	–	–	–	–	–	–	–	–	–	
1..15.3-1D.4		2020	1890	1300	2610	2680	2640	1960	3360	3050	3180	2330	3900	–	–	–	–	
180		1..15...-1E.2	2510	2050	1360	3200	3240	2920	2090	4070	–	–	–	–	–	–	–	–
		1..15...-1E.4	–	–	–	–	3180	2930	2020	4090	3740	3560	2580	4710	4300	4090	3150	5240
	1..15...-1E.6	2490	2060	1330	3220	3160	2950	2010	4100	3740	3570	2580	4730	4090	4140	2940	5290	
200	1..15...-2A.4	2920	3030	2110	3840	–	–	–	–	4570	5010	3760	5820	–	–	–	–	
	1..15...-2A.5	2810	3060	2000	3870	3820	4210	3010	5020	4470	5060	3660	5870	5200	5750	4390	6560	
	1..15...-2A.6	2810	3060	2000	3870	3820	4230	3010	5040	4400	5090	3590	5900	5010	5800	4200	6610	
225	1..15...-2B.0	–	–	–	–	4200	4750	3150	5800	–	–	–	–	5900	6400	4850	7650	
	1..15...-2B.2	3100	3400	2050	4450	4100	4850	3000	5850	4700	5800	3650	6850	5800	6450	4700	7500	
	1..15...-2B.6	3100	3400	2050	4450	4100	4850	3000	5850	4650	5850	3600	6900	5500	6600	4400	7650	
250	1..15...-2C.2	3850	4100	2250	5600	4850	5650	3250	7250	5750	6750	4200	8350	6900	7700	5300	9200	
	1..15...-2C.6	3850	4100	2250	5600	4800	5750	3200	7400	5750	6750	4200	8450	6700	7800	5000	9300	

For frame sizes > 250 standard version.

Introduction

Mechanical version

Bearings and lubrication

Overview

Frame size	Type	2-pole – 3000 rpm		4-pole – 1500 rpm		6-pole – 1000 rpm		8-pole – 750 rpm		Type	2-pole – 3000 rpm		4-pole – 1500 rpm		6-pole – 1000 rpm		8-pole – 750 rpm		
		Load Tension	Thrust	Tension	Thrust	Tension	Thrust	Tension	Thrust		Load Tension	Thrust	Tension	Thrust	Tension	Thrust	Tension	Thrust	Tension
1LE55 and 1MB55 – Basic Line										1LE56 and 1MB56 – Performance Line									
315	1LE55..-3A.6	5400	3000	7750	5400	–	–	–	–	1LE56..-3A.6	5400	3000	7750	5400	–	–	–	–	
	1LE55..-3A.7	5200	2800	7750	5400	9100	6750	–	–	1LE56..-3A.7	5200	2800	7750	5400	9100	6750	–	–	
	1LE55..-3A.8	–	–	–	–	9000	6650	–	–	1LE56..-3A.8	–	–	–	–	9000	6650	–	–	
355	–	–	–	–	–	–	–	–	–	1LE56..-3B.2	–	–	–	–	9900	6000	–	–	
	–	–	–	–	–	–	–	–	–	1LE56..-3B.3	5000	3200	8800	5000	9800	5900	–	–	
	–	–	–	–	–	–	–	–	–	1LE56..-3B.4	5000	3200	8750	4950	9800	5900	–	–	
	–	–	–	–	–	–	–	–	–	1LE56..-3B.5	5000	3200	8700	4900	–	–	–	–	
400	1LE55..-4A.3	11600	8200	15900	5500	19200	3200	20400	4100	–	–	–	–	–	–	–	–		
	1LE55..-4A.5	12000	7800	16300	5200	20000	2600	21200	3300	–	–	–	–	–	–	–	–		
	1LE55..-4A.7	12400	7400	17100	4700	20900	2300	22100	2400	–	–	–	–	–	–	–	–		
450	1LE55..-4B.3	13300	6500	20100	7400	23300	5200	24600	6200	–	–	–	–	–	–	–	–		
	1LE55..-4B.5	13700	6200	20800	7 000	24300	4800	25500	5300	–	–	–	–	–	–	–	–		
	1LE55..-4B.7	14200	5700	21600	6200	25400	4100	26600	4300	–	–	–	–	–	–	–	–		

1LE15 and 1MB15 motors in horizontal type of construction – bearings reinforced at both ends – order code **L25**

Frame size	Type	2-pole – 3000 rpm		4-pole – 1500 rpm		6-pole – 1000 rpm		8-pole – 750 rpm		Frame size	Type	2-pole – 3000 rpm		4-pole – 1500 rpm		6-pole – 1000 rpm		8-pole – 750 rpm		
		Load Tension	Thrust	Tension	Thrust	Tension	Thrust	Tension	Thrust			Load Tension	Thrust	Tension	Thrust	Tension	Thrust	Tension	Thrust	Tension
1LE15, 1MB15 – Basic Line										1LE15, 1MB15 – Basic Line										
71/80/90		Available soon																		
100	1..15.1-1A.4	1440	880	1820	1260	2110	1550	2380	1820	160	1..15.1-1D.2	2400	1680	3100	2380	3610	2890	4090	3370	
	1..15.1-1A.5	–	–	1800	1240	–	–	2370	1810		1..15.1-1D.3	2380	1660	–	–	–	–	4040	3320	
	1..15.1-1A.6	1430	870	1780	1220	2090	1530	–	–		1..15.1-1D.4	2370	1650	3050	2330	3550	2830	4010	3290	
	1..15.3-1A.4	1430	870	1780	1220	–	–	–	–		1..15.1-1D.6	2320	1600	3020	2300	3480	2760	–	–	
	1..15.3-1A.5	–	–	1780	1220	–	–	–	–		1..15.1-1D.7	–	–	2980	2260	–	–	–	–	
112	1..15.1-1B.2	1430	870	1810	1250	2110	1550	2370	1810	180	1..15.3-1D.2	2380	1660	3050	2330	3550	2830	–	–	
	1..15.1-1B.6	1410	850	1790	1230	2090	1530	–	–		1..15.3-1D.3	2370	1650	–	–	–	–	–		
	1..15.3-1B.2	1410	850	1790	1230	2090	1530	–	–		1..15.3-1D.4	2320	1600	3020	2300	3480	2760	–	–	
132	1..15.1-1C.0	2330	1010	2890	1570	3340	2020	3710	2390	200	1..15..-1E.2	2860	1710	3660	2510	–	–	–	–	
	1..15.1-1C.1	2320	1000	–	–	–	–	–	1..15..-1E.4		–	–	3630	2480	4230	3080	4770	3620		
	1..15.1-1C.2	–	–	2870	1550	3320	2000	3680	2360		1..15..-1E.6	2850	1700	3630	2480	4230	3080	4690	3540	
	1..15.1-1C.3	–	–	–	–	3290	1970	–	–		225	1..15..-2A.4	3390	2580	–	–	5210	4400	–	–
	1..15.1-1C.6	2280	960	2820	1500	3250	1930	–	–			1..15..-2A.5	3340	2530	4430	3620	5170	4360	5880	5070
	1..15.3-1C.0	2320	1000	2820	1500	3290	1970	–	–			1..15..-2A.6	3340	2530	4430	3620	5150	4340	5810	5000
	1..15.3-1C.1	2280	960	–	–	–	–	–	–		250	1..15..-2B.0	–	–	4950	3900	–	–	6600	5550
	1..15.3-1C.2	–	–	2820	1500	3290	1970	–	–			1..15..-2B.2	3800	2750	4950	3900	5750	4700	6550	5500
	1..15.3-1C.3	–	–	–	–	3250	1930	–	–			1..15..-2B.6	3800	2750	4900	3850	5700	4650	6500	5450
											1..15..-2C.2	4750	3150	6050	4450	7100	5500	8100	6500	
											1..15..-2C.6	4750	3150	6050	4450	7100	5500	8 000	6400	

For frame sizes > 250 standard version.

Overview

The drainage of condensed water is an important aspect of proper motor maintenance.

Drainage of condensed water is made easy by rotating the outer cap.

If there are condensation drain holes present, these must be opened at regular intervals, depending on climatic conditions and in accordance with the motor operating instructions.

"Modifiable T-Drain" is closed on delivery of the motor and corresponds to IP55/IP56 degree of protection.

When opened, it corresponds to IP45/IP46 degree of protection. The opened T-Drain can be used for continuous drainage of condensed water in environments with low amounts of dust.

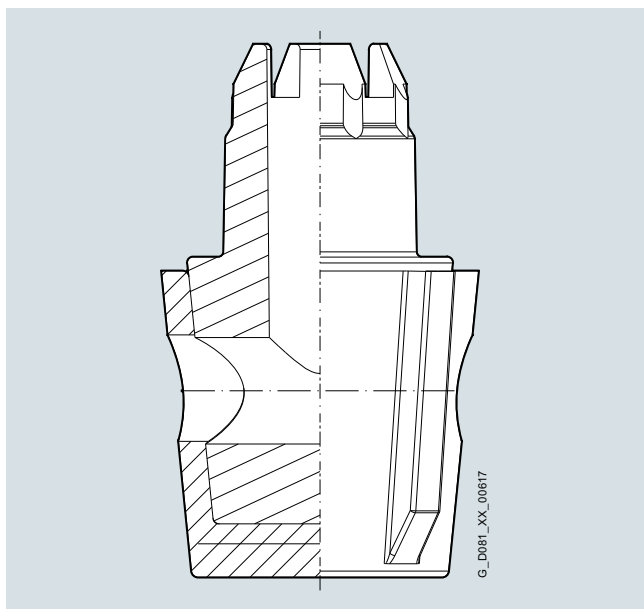
**Note:**

Condensation drain holes are not possible in motors with the types of protection Ex db and Ex db eb.

A screwed-on cover (made of sheet metal or plastic depending on the shaft height) is included as standard for horizontal types of construction and types of construction with shaft pointing upwards (14th position of the Article No. letter **A, T, U, V, D, F, H, J, K, L, N**) in combination with condensation drainage holes, order code **(H03)** to facilitate assembly/disassembly.

When the motors are used or stored outdoors, we recommend that they be kept under some sort of additional cover so that they are not subjected to direct intensive solar radiation, rain, snow, ice or dust over a long period of time. In such cases, technical consultation may be appropriate.

When the motors are used outdoors or in a corrosive environment, it is recommended that non-rusting screws are used externally.

Order code **H07**

Vibration-proof version

Continuous vibration resistance to class 3M4 according to IEC 721-3-3:1994 (order code **H02** in combination with order code **G04, G05, G06, G11**, and **G12** or **F70** on request only).
Order code **H02**

For availability of individual options for the relevant motor series, see section "Special versions" in the respective sections of the catalog.

Introduction

Mechanical version

Lifting eyes and transport

1

Overview

1LE10, 1MB10 and 1PC10 motors without feet have four cast lifting eyes as standard, each offset by 90°; in the case of screwed-on feet, two lifting eyes are covered by the feet, so in this case only two lifting eyes are available for use. This data is only valid up to frame size 200.

Housing material			
Motor series	Frame size	Housing material	Housing feet
1LE10, 1PC1 ²⁾	63 ... 160	Aluminum alloy	cast ¹⁾
	180 ... 200	Aluminum alloy	screwed on ¹⁾
1MB10	100 ... 160	Aluminum alloy	cast ¹⁾
1LE15 1MB15 1PC1301 ³⁾	71 ... 315	Cast iron	cast ¹⁾
1LE5 1MB5	315 ... 450	Cast iron	cast
1LE16 1MB16	100 ... 315	Cast iron	cast ¹⁾

Arrangement of lifting eyes/eyebolts (standard)

Frame size	Terminal box position	Cast-iron motors	Aluminum motors	Arrangement of eyebolts	Thread size
63	–	–	None	–	–
71	–	None	None	–	M8
80	Short housing	None	None	–	M8
	Top (long housing)	Two eyebolts		Left/right center	
	Left/right (long housing)	One eyebolt		Top center	
90	Top	Two eyebolts	None	Left/right center	M8
	Left/right	One eyebolt		Top center	
100		Depending on type of construction ⁴⁾	Lifting eyes	Top; Left DE side/ Right NDE side ¹⁰⁾	M8
112					
132					
160					M10
180		Two eyebolts ¹⁰⁾			M12
200					M16
225		Two eyebolts ¹¹⁾	–	^{5) 6) 7)}	M16
250					M20
280					
315 S/M ¹²⁾					M24
315 L		Four eyebolts		Top;	
315 L (1LE5)		Two eyebolts		Left/right DE and NDE side ^{8) 9)}	M30
355 M/L (1LE5)					
400					
450					

¹⁾ Basic version, cast feet: Special version "Screwed-on feet (instead of cast)" with digits **5**, **6**, and **7** in the 16th position of Article No. or digit **4** with order code **H01**. Screwed-on feet as standard for 1LE10 motors in frame sizes 180 and 200 and motors with increased power.

²⁾ Aluminum motors in frame sizes 80 and 90 and 1PC10 motors in frame sizes 100 to 160 without lifting eyes. Aluminum motors in frame sizes 100 to 200 with cast lifting eyes (does not apply to 1PC10 and 1MB10 motors in frame sizes 180 and 200).

³⁾ 1LE16 motors frame size 100 and above, 1PC1301 motors frame size 180 and above.

⁴⁾ Two eyebolts for
-IM B5, IM B14, IM V1 or
-IM B34, IM B35 with **H01** or left/right, side terminal box position.
Lifting eyes for
-IM B3 or
-IM B34, IM B35 without **H01** or non-side left/right terminal box position.

⁵⁾ For IM B3; IM B5: top; DE side left / NDE side right.
With rotation of the terminal box through 180° (R12): top; NDE side left / DE side right.

⁶⁾ For IM V1: top; NDE side right; down; NDE side left.

⁷⁾ For IM V3: top; DE side left; down; DE side right.

⁸⁾ For IM V1: NDE side, left/right; top/bottom.

⁹⁾ For IM V3: DE side, left/right; top/bottom.

¹⁰⁾ With rotation of the terminal box through 180° (R12): top; NDE side left / DE side right.

¹¹⁾ Motors with brakes have four top eyebolts.

For IM V1: NDE side, left/right; top/bottom.

For IM V3: DE side, left/right; top/bottom.

¹²⁾ The assignment 315 L is used for 1000 kg and over.

Overview

Brakes as well as rotary encoders of the "modular and special technology" can be retrofitted. The motor must be prepared for this. This is possible for all 1LE. motors (with the exception of 1LE1 with option **F90** – version "Forced-air cooled motors without external fan and fan cover").

Preparation of the shaft extension at NDE can be ordered with the option "Prepared for mountings, only center hole", order code **G40** for the following frame sizes and mountings:

- Frame sizes 80 to 450: brakes with order code **F01** and **F04**
- Frame sizes 71 and 90: only rotary encoders with order codes **G11** or **G12** from the "modular technology" range
- Frame sizes 100 to 450: all rotary encoders from the "modular and special technology" ranges

Dimensions of center holes

Frame size	∅	L (drilling depth)
100	16 ^{H7}	34
112	16 ^{H7}	34
132	22 ^{H8}	39
160	28 ^{H8}	42

The length of the motor does not change because the shaft extension is still under the fan cover.

For motors ordered with order code **G40**, the following conversion combinations are possible:

- Frame sizes 71 and 90: either brakes with order code **F01** and **F04** or rotary encoders from the "modular technology" range. The combination of brake (**F01**) and rotary encoder is not possible.
- Frame sizes 100 to 450: Brakes with order code **F01** or rotary encoders from the "modular and special technology" range. The combination of brake (**F01**) and rotary encoder is possible.

Conversion is performed exclusively by the authorized contractual partners of Siemens.

For motors of series 1LE15, 1LE16, and 1LE5 frame sizes 100 to 450, grounding brushes are available for converter operation. Order code **L52**. Please contact your local Siemens office for advice.

For mountings, such as rotary encoders, supplied by the customer, the following applies:

For the Sendix 5020 rotary encoders, order code **G11** and **G12** from the "modular technology" this preparation of the shaft extension on NDE can be ordered with the option "Prepared for mounting with shaft D12".

Order code G41

The length of the motor increases by Δl due to option **G41**. For an explanation of the additional dimensions and weights, see "Modular technology" "Dimensions and weights".

For the rotary encoders:

- LL 861 900 220, order code **G04**
- HOG 9 DN 1024 I, order code **G05**
- HOG 10 D 1024 I, order code **G06**

from the "special technology" this preparation of the shaft extension on NDE can be ordered with the option "Prepared for mounting with shaft D16" for motors of frame sizes 100 to 160 only.

Order code G42

The length of the motor increases by Δl due to option **G42**.

For an explanation of the additional dimensions and weights, see "Modular technology" "Dimensions and weights" from page 1/109.

Motors that are prepared for mountings supplied by the customer (order codes **G41**, **G42**) are supplied without a protective cover as standard. These mountings can be installed by the customer.

If a protective cover is requested as a cover or mechanical protection for mountings provided by the customer, this can be ordered with order code **G43**.

This protective cover is designed and mounted differently as described below according to frame size:

Frame sizes 71 to 90 and 180 to 200:

Motors ordered with order code **G43** are fitted as standard with a screwed-on cover (made of sheet metal or plastic depending on shaft height). The protective cover is mounted in the factory. To install the mountings supplied by the customer, the protective cover must be removed beforehand by unscrewing the external fixing screws and reattached afterwards. Protective covers for motors of these frame sizes are not suitable for mountings that correspond to the shape and size of the rotary encoders of the "special technology" (**G04**, **G05**, **G06**, see above).

Frame sizes 100 to 450:

The protective cover must be installed by the customer in accordance with the assembly instructions supplied. It has supports of varying length that can be used for installation according to the height of the planned mountings.

The standard protective cover (order code **H00**) is not suitable for protection of additional mountings, such as rotary encoders.

Order codes **G40**, **G41**, **G42** are not possible in conjunction with order code **L00** – vibration severity grade B.

Order code **G43** is only appropriate in combination with order codes **G41** and **G42**, and not in combination with **G40**.

Introduction

Mounting technology

Modular technology

1

Overview

The 1LE and 1FP motors (with the exception of 1LE1 and 1LE5 with option **F90** – version "Forced-air cooled motors without external fan and fan cover" and 1PC1) can be used in a much wider range of applications (e.g. as motors with brakes) if the following modules are mounted:

- Separately driven fan
- Brake
- Rotary pulse encoder

Separately driven fan

The use of a separately driven fan is recommended to increase motor utilization at low speeds and to limit noise generation at speeds significantly higher than the synchronous speed. Both of these results can only be achieved with converter operation. Please inquire about traction and vibratory operation.

The separately driven fan can be supplied already fitted, order code **F70**. There is no automatic adjustment of the voltage for the separately driven fan when ordering a "special voltage" for the motor. This must be specified in addition using the **Y81** option. It can also be ordered separately and retrofitted. For selection information and article numbers, see the section "Accessories"

The brake must always be mounted in the factory for safety reasons. The rotary pulse encoder and/or the separately driven fan can also be retrofitted.

The degree of protection of the motors with modular technology is IP55. Higher degrees of protection on request.

Attaching rotary pulse encoder, brake, and separately driven fan increases the length of the motor by dimension Δl . For explanations of the additional dimension and weights, see "Mounting technology" and "Dimensions and weights" from page 1/109.

(available soon). A rating plate listing all the important data is fitted to the separately driven fan. Please note the direction of rotation of the separately driven fan (axial-flow fan) when connecting it. Admissible coolant temperatures $CT_{\min} -25\text{ °C}$, $CT_{\max} +65\text{ °C}$ ¹⁾, for frame sizes 400 and 450 coolant temperatures $CT_{\min} -20\text{ °C}$, $CT_{\max} +40\text{ °C}$, lower/higher coolant temperatures are available on request.

When the separately driven fan is mounted, the length of the motor increases by Δl . For explanations of the additional dimension and weights, see "Mounting technology" and "Dimensions and weights" from page 1/109.

Technical specifications of separately driven fans (according to tolerances of EN 60034-1)

Frame size	Rated voltage range V	Frequency Hz	P_{\max} kW	I_{\max} A
63	1 AC 230 to 277	50	0.046	0.18
	3 AC 200 to 303 Δ	50	0.028	0.15
	3 AC 346 to 525 Y	50	0.028	0.09
	1 AC 230 to 277	60	0.054	0.21
	3 AC 220 to 332 Δ	60	0.029	0.14
	3 AC 380 to 575 Y	60	0.029	0.08
71	1 AC 230 to 277	50	0.048	0.18
	3 AC 200 to 303 Δ	50	0.029	0.15
	3 AC 346 to 525 Y	50	0.029	0.09
	1 AC 230 to 277	60	0.056	0.21
	3 AC 220 to 332 Δ	60	0.028	0.13
	3 AC 380 to 575 Y	60	0.028	0.07
80	1 AC 230 to 277	50	0.048	0.19
	3 AC 200 to 303 Δ	50	0.033	0.16
	3 AC 346 to 525 Y	50	0.033	0.09
	1 AC 230 to 277	60	0.059	0.22
	3 AC 220 to 332 Δ	60	0.036	0.13
	3 AC 380 to 575 Y	60	0.036	0.07
90	1 AC 220 to 277	50	0.059	0.29
	3 AC 200 to 303 Δ	50	0.078	0.39
	3 AC 346 to 525 Y	50	0.078	0.22
	1 AC 220 to 277	60	0.061	0.23
	3 AC 220 to 332 Δ	60	0.071	0.32
	3 AC 380 to 575 Y	60	0.071	0.18
100	1 AC 220 to 277	50	0.062	0.29
	3 AC 200 to 303 Δ	50	0.08	0.37
	3 AC 346 to 525 Y	50	0.08	0.21
	1 AC 220 to 277	60	0.073	0.28
	3 AC 220 to 332 Δ	60	0.08	0.3
	3 AC 380 to 575 Y	60	0.08	0.18
112	1 AC 220 to 277	50	0.064	0.27
	3 AC 200 to 303 Δ	50	0.087	0.35
	3 AC 346 to 525 Y	50	0.087	0.2
	1 AC 220 to 277	60	0.088	0.36
	3 AC 220 to 332 Δ	60	0.093	0.29
	3 AC 380 to 575 Y	60	0.093	0.17
132	1 AC 230 to 277	50	0.125	0.52
	3 AC 200 to 303 Δ	50	0.16	0.64
	3 AC 346 to 525 Y	50	0.16	0.37
	1 AC 230 to 277	60	0.163	0.61
	3 AC 220 to 332 Δ	60	0.18	0.55
	3 AC 380 to 575 Y	60	0.18	0.32

Technical specifications of separately driven fans (according to tolerances of EN 60034-1)

Frame size	Rated voltage range V	Frequency Hz	P_{\max} kW	I_{\max} A
160 to 200	1 AC 230 to 277	50	0.246	1.05
	3 AC 200 to 303 Δ	50	0.314	1.28
	3 AC 346 to 525 Y	50	0.314	0.74
	1 AC 230 to 277	60	0.39	1.52
	3 AC 220 to 332 Δ	60	0.391	1.08
	3 AC 380 to 575 Y	60	0.391	0.62
225 M to 280 M	3 AC 230 Δ	50	0.75	2.7
	3 AC 400 Y	50	0.75	1.56
	3 AC 460 Y	60	0.86	1.63
315	3 AC 230 Δ	50	0.75	2.7
	3 AC 400 Y	50	0.75	1.56
	3 AC 460 Y	60	0.86	1.63
2-pole	3 AC 230 Δ	50	0.75	2.7
	3 AC 400 Y	50	0.75	1.56
	3 AC 460 Y	60	0.86	1.63
315	3 AC 230 Δ	50	0.75	2.7
	3 AC 400 Y	50	0.75	1.56
	3 AC 460 Y	60	0.86	1.63
4-, 6-, 8-pole	3 AC 230 Δ	50	1.1	3.95
	3 AC 400 Y	50	1.1	2.25
	3 AC 460 Y	60	1.27	2.25
315	3 AC 230 Δ	50	0.75	2.7
	3 AC 400 Y	50	0.75	1.56
	3 AC 460 Y	60	0.86	1.63
355	3 AC 200 to 240 Δ	50	0.650	2.85
	3 AC 380 to 420 Y	50	0.650	1.64
	3 AC 440 to 480 Y	60	0.750	1.60
2- and 4-pole	3 AC 230 Δ	50	1.1	3.95
	3 AC 400 Y	50	1.1	2.25
	3 AC 460 Y	60	1.27	2.25
400	3 AC 230 Δ	50	2.20	7.70
	3 AC 400 Y	50	2.20	4.45
	3 AC 460 Y	60	2.54	4.35
450	3 AC 230 Δ	50	4.00	14.00
	3 AC 400 Y	50	4.00	8.00
	3 AC 460 Y	60	4.55	7.90

¹⁾ For single-phase variants (1 AC) of frame size 160, the admissible coolant temperature CT_{\max} is $+50\text{ °C}$.

²⁾ Valid for 1LE5

Overview

For article numbers and type details, see operating instructions.

Sound-power level of the motors under a load, 50 Hz

Frame size	2-pole	4-pole	6-pole	8-pole
	L_{WA} dB (A)	L_{WA} dB (A)	L_{WA} dB (A)	L_{WA} dB (A)
63	70	70	70	70
71	72	72	72	72
80	79	79	79	79
90	79	79	79	79
100	84	84	84	84
112	84	84	84	84
132	84	84	84	84
160	87	87	87	87
180	87	87	87	87
200	87	87	87	87
225	90	87	87	87
250	90	87	87	87
280	90	87	87	87
315	92	92	95	95

Brakes

The brakes with order code **F01** (**F02** brake for increased frequency of operation for SIMOTICS GP motors on request) are designed to be spring-operated brakes. When the brake is ordered, the supply voltage must be specified. For an explanation of the supply voltage, see the descriptions of each brake model in "Modular technology".

For the design of the braking time, run-on revolutions, braking energy per braking procedure as well as the lifetime of the brake linings, see "Configuration of motors with brakes" on page 1/92.

When a brake is mounted, the length of the motor increases by Δl . For explanations of the additional dimension and weights, see "Mounting technology" and "Dimensions and weights" from page 1/109.

*The brake can be retrofitted by authorized partners. The motor must be prepared for this. When the motor is ordered, the option "Prepared for mountings, center hole only" order code **G40** must be specified (see "Mechanical version and degrees of protection" on page 1/79).*

Ambient temperature

- -40 °C to $+45\text{ °C}$ (with nominal excitation) for SFB-SH brake
- -40 °C to $+75\text{ °C}$ (with double excitation) for SFB-SH brake
- -20 °C to $+40\text{ °C}$ holding/operating brake (standard BFK458)
- up to $+60\text{ °C}$ only as holding brake
- -20 °C to $+60\text{ °C}$ holding/operating brake only for FDX brake
- -30 °C to $+60\text{ °C}$ holding/operating brake only for KFB brake

Definition of duty type

- **Operating brake:**
The motor shaft can be braked from full operating speed down to zero speed of the motor. All the kinetic energy produced by the drive train is converted to heat by friction during braking. Braking energy is produced at $n > 0$ rpm. The maximum permissible switching frequency must be taken into account. When this brake is used, installation of a separately driven fan is recommended in order to ensure adequate cooling when the motor is at a standstill. The operating brake is also capable of functioning as a holding brake.
- **Holding brake:**
The purpose of braking or "holding" the motor shaft is merely to suppress unintended rotation caused by externally applied torque forces, e.g. when a load is suspended from a crane rope drum. The holding brake is primarily deployed when the motor is at a standstill ($n = 0$ rpm) by holding the motor shaft or is close to $n = 0$ rpm and coasting down to a standstill. As a result, no additional braking energy or braking heat is transferred to the motor.

Note:

A holding brake must not be used as an operating brake as it could then cause danger to life and damage to property.

Bridge rectifier / half-wave rectifier

Brakes are connected through a standard bridge or half-wave rectifier or directly to the BFK458-/SFB-SH brake. See the circuit diagrams below.

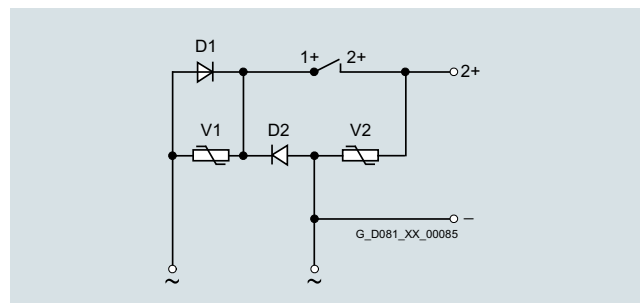

Half-wave rectifier 400 V AC

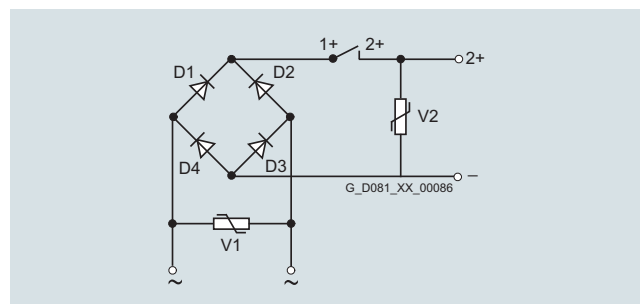

Rectifier bridge 230 V AC

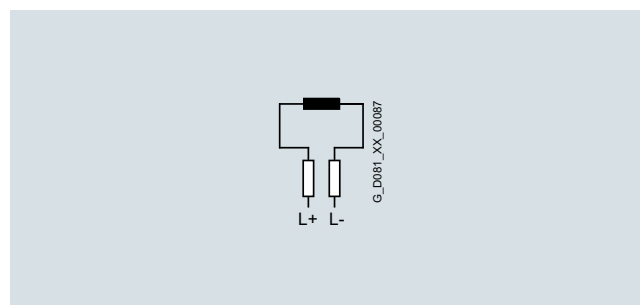

Brake connection for 24 V DC

Introduction

Mounting technology

Modular technology

1

Overview

BFK458 spring-operated disk brake

Motor series

This brake is the standard brake for 1LE1/1FP1 motors in frame sizes 63 to 225 (except for 1LE1 with order code **F90** version "Forced-air cooled motors without external fan and fan cover").

Other characteristics of the BFK458 brake

The BFK458 brake has IP55 degree of protection.

Please inquire if motors with brakes are to be operated below the freezing point or in conjunction with very humid environments (e.g. close to the sea) with long standstill times. Please also inquire if motors with brakes are to be used for low-speed converter operation.

Design and mode of operation

The brake takes the form of a single-disk brake with two friction surfaces.

The braking torque is generated by friction when pressure is applied by one or more pressure springs in the de-energized state. The brake is released electromagnetically.

When the motor brakes, the rotor which can be axially shifted on the hub or the shaft is pressed via the armature disk against the friction surface by means of the springs. In the braked state, there is a gap S_{Gap} between the armature disk and the solenoid component. To release the brake, the solenoid is energized with DC voltage. The resulting magnetic force pulls the armature disk against the spring force on to the solenoid component. The spring force is then no longer applied to the rotor, which can rotate freely.

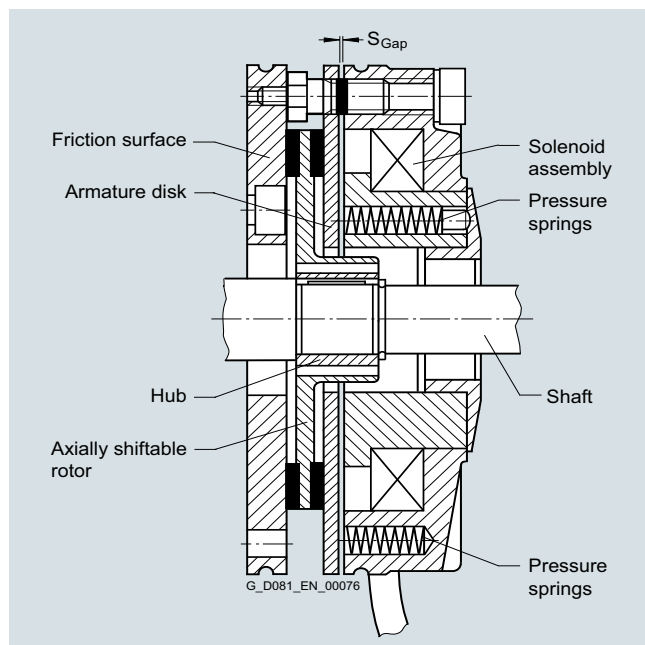

Design of the BFK458 spring-operated disk brake

Rating plate

The following brake data is specified on the motor rating plate:

- Brake type
- Supply voltage
- Frequency
- Current
- Temperature class
- Braking torque

Voltage and frequency

The solenoids and the brake rectifier are designed for connection to the following voltages or can be supplied for the following voltages:

- Brake supply voltage 24 V DC
Order code **F10**
- Brake supply voltage 230 V AC
Order code **F11**
- Brake supply voltage 400 V AC (directly at the terminal strip)
Order code **F12**
- Brake supply voltage 180 V DC
Order code **F17**
- Brake supply voltage 205 V DC
Order code **F18**

When 60 Hz is used, the voltage for the brake must not be increased!

Order codes **F10**, **F11**, **F12**, **F17**, and **F18** must only be used in conjunction with order code **F01**

Lifetime of the brake lining

The braking energy L_N until readjustment of the brake depends on various factors. The main influencing factors include the masses to be braked, the operating speed, the switching frequency, and therefore the temperature at the frictional surfaces. This means it is not possible to specify a value for the friction energy until readjustment that is valid for all operating conditions.

When used as an operating brake, the specific frictional surface wear (wear volume for the frictional work) is approximately 0.05 to 2 cm³/kWh.

Overview

Operating values for spring-operated brakes with standard excitation													Service capability of the brake	
For motor frame size	Brake type	Rated braking torque at 100 rpm	Rated braking torque at 100 rpm in % at the following speeds			Supply voltage	Current/ power input ¹⁾		Brake application time t_2 ²⁾	Brake release time	Brake moment of inertia	Noise level L_p with rated air gap	Lifetime L of the brake lining	Air gap S_{Gap} adjustment required after braking energy L_N
			Nm	%	%		%	V						
63	BFK458-06	5	87	80	65	AC 230	0.1	20	25	56	0.000013	77	105	16
						AC 400	0.11							
						DC 24	0.83							
71	BFK458-06	5	87	80	65	AC 230	0.1	20	25	56	0.000013	77	105	16
						AC 400	0.11							
						DC 24	0.83							
80	BFK458-08	10	85	78	65	AC 230	0.12	25	26	70	0.000045	75	270	29
						AC 400	0.14							
						DC 24	1.04							
90	BFK458-10	20	83	76	66	AC 230	0.15	32	37	90	0.00016	75	740	79
						AC 400	0.17							
						DC 24	1.25							
100	BFK458-12	40	81	74	66	AC 230	0.2	40	43	140	0.00036	80	1350	115
						AC 400	0.22							
						DC 24	1.67							
112	BFK458-14	60	80	73	65	AC 230	0.25	53	60	210	0.00063	77	1600	215
						AC 400	0.28							
						DC 24	2.1							
132	BFK458-16	100	79	72	65	AC 230	0.27	55	50	270	0.0015	77	2450	325
						AC 400	0.31							
						DC 24	2.3							
160	BFK458-20	260	75	68	65	AC 230	0.5	100	165	340	0.0073	79	7300	935
						AC 400	0.47							
						DC 24	4.2							
180	BFK458-20	315	75	68	65	AC 230	0.5	100	152	410	0.0073	79	5500	470
						AC 400	0.56							
						DC 24	4.2							
200, 225 ³⁾	BFK458-25	400	73	68	65	AC 230	0.55	110	230	390	0.0200	93	9450	1260
						AC 400	0.61							
						DC 24	4.6							

¹⁾ For 400 V AC and for 24 V DC, the power can deviate by up to +10 % as a function of the selected supply voltage.

²⁾ The specified switching times are valid for switching on the DC side with a rated release travel and with the coil already warm. They are average values, which may vary depending on factors such as the rectifier type and the release travel. The brake application time for switching on the AC side, for example, is approximately 6 times longer than for switching on the DC side.

³⁾ Für BG225 nicht möglich in Kombination mit Kurzangabe **D02** und **D03**.

Introduction

Mounting technology

Modular technology

1

Overview

Maximum admissible speeds

The maximum admissible speeds from which emergency stops can be made are listed in the next table. These speeds should be considered as guide values and must be checked for the specific operating conditions.

The maximum admissible friction energy depends on the switching frequency and is shown for the individual brakes in the following diagram. Increased wear can be expected when the brakes are used for emergency stops.

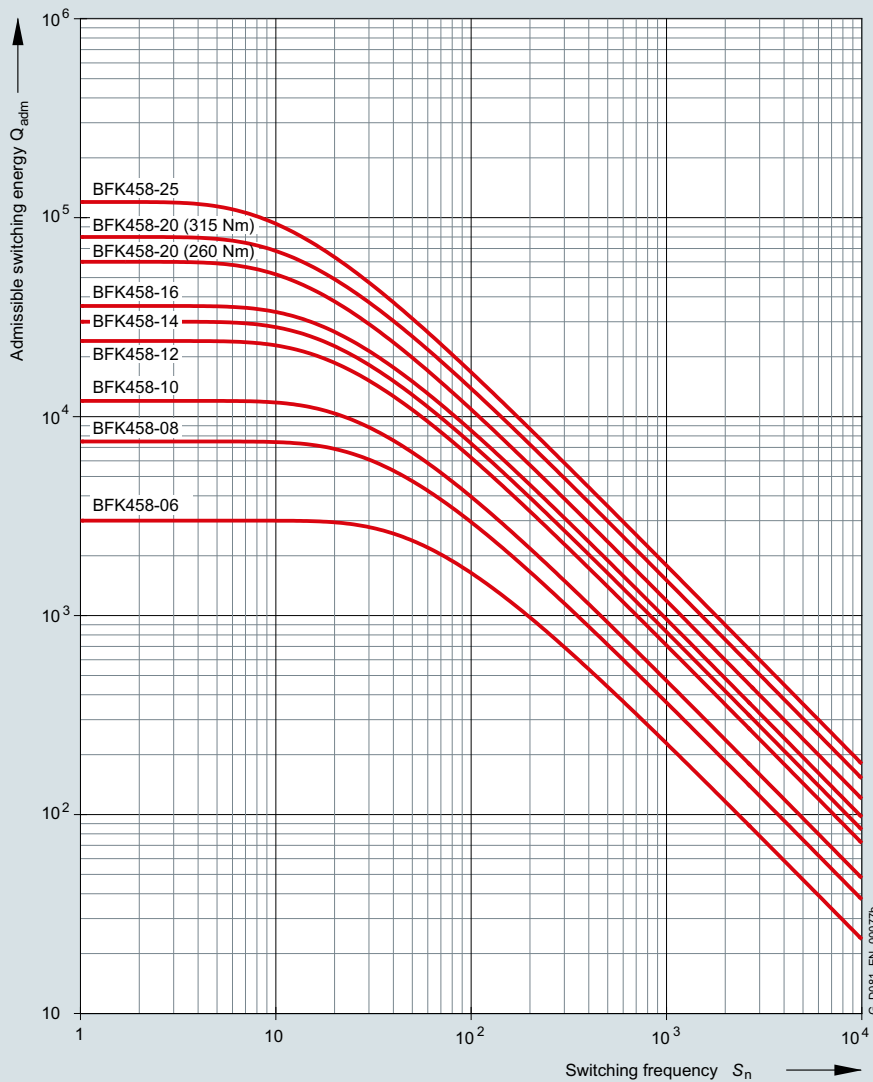

For motor frame size	Brake type	Maximum admissible speeds			Changing the braking torque			Readjusting the air gap		
		Max. adm. operating rpm if max. operating energy utilized	Max. adm. no-load rpm with emergency stop function for horizontal mounting position	Max. adm. no-load rpm with emergency stop function for vertical mounting position	Reduction per notch	Dimension "O ₁ "	Min. braking torque	Rated air gap S _{Gap rated}	Maximum air gap S _{Gap max.}	Minimum rotor thickness h _{min.}
		rpm	rpm	rpm	Nm	mm	Nm	mm	mm	mm
63	BFK458-06	3000	6000	6000	0.17	7	3.7	0.2	0.4	4.5
71	BFK458-06	3000	6000	6000	0.17	7	3.7	0.2	0.4	4.5
80	BFK458-08	3000	6000	6000	0.35	8.0	7.0	0.2	0.45	5.5
90	BFK458-10	3000	6000	6000	0.76	7.5	18.2	0.2	0.55	7.5
100	BFK458-12	3000	6000	6000	1.29	12.5	21.3	0.3	0.65	8.0
112	BFK458-14	3000	6000	6000	1.66	11.0	32.8	0.3	0.75	7.5
132	BFK458-16	3000	5300	5000	1.55	13.0	61.1	0.3	0.75	8.0
160	BFK458-20	1500	4400	3200	5.6	17.0	157.5	0.4	1.2	12.0
180	BFK458-20	1500	4400	3200	5.6	17.0	178.4	0.4	1.0	12.0
200, 225	BFK458-25	1500	3000	3000	6.15	21.0	248.7	0.5	1.5	15.5

Overview**Changing the braking torque**

The brake is supplied with the braking torque already set. For BFK458 brakes, the torque can be reduced to dimension O_1 by unscrewing the adjusting ring with a hook wrench. The braking torque changes by the values shown in the above table for each notch of the adjusting ring.

Readjusting the air gap

Under normal operating conditions, the brake is practically maintenance-free. The air gap S_{Gap} must only be checked at regular intervals if the application requires an extremely large amount of frictional energy and readjusted to the rated air gap $S_{\text{Gap rated}}$ at the latest when the maximum air gap $S_{\text{Gap max}}$ is reached.

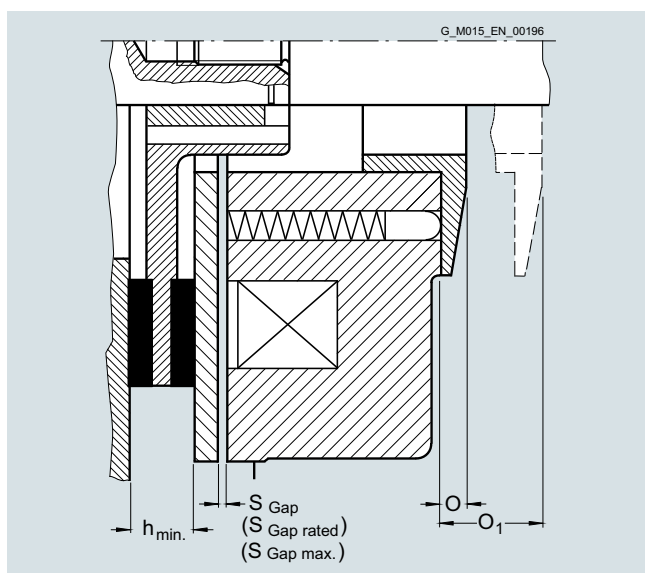
**Connection**

Labeled terminals are provided in the main terminal box of the motor to connect the brake.

The AC voltage for the brake excitation winding is connected to the two free terminals of the rectifier block (~).

The brake can be released when the motor is at a standstill by separately exciting the solenoid. In this case, an AC voltage must be connected at the rectifier block terminals. The brake remains released as long as this voltage is present.

The rectifiers are protected against overvoltages by varistors in the input and output circuits.

For 24 V DC brakes, the brake terminals are directly connected to the DC voltage source.

For this purpose, see the circuit diagrams on page 1/81.

Fast brake application

If the brake is disconnected from the line supply, the brake is applied.

The application time for the brake disk is delayed as a result of the inductance of the solenoid (shutdown on the AC side). This results in a considerable delay before the brake is mechanically applied. In order to achieve short brake application times, the circuit must be interrupted on the DC side. To realize this, the wire jumpers, located between contacts 1+ and 2+ at the rectifier, are removed and replaced by the contacts of an external switch.

For this purpose, see the circuit diagrams on page 1/81.

Mechanical manual brake release with lever

The brakes can be supplied with a mechanical manual release with lever.

Order code **F50**

The dimensions of the brake lever depend on the motor frame size and can be read from the dimensional drawing generator for motors in the DT Configurator tool for low-voltage motors.

Introduction

Mounting technology

Modular technology

1

Overview

KFB spring-operated brake

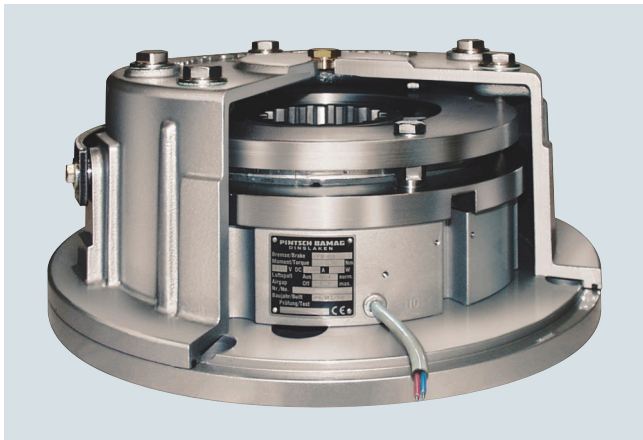

KFB spring-operated brake

The KFB solenoid double-disk spring-operated brake is a safety brake that brakes the motor if the supply is disconnected (power failure, emergency stop). The KFB brake with IP67 degree of protection is mainly used for electric motors for traversing, cross-traversing and lifting gear in cranes as well as for special industrial applications.

Motor series

This brake is the standard brake for 1LE1 motors in frame sizes 250 to 315. For frame sizes 180 to 225, apart from the standard brake BFK458, KFB brakes can also be supplied. Special brake selections are available on request.

Design and mode of operation

When the brake current is switched on, an electromagnetic field develops which overcomes the spring force of the brake. The corresponding modules, including the motor shaft, can rotate freely. The brake is released. If the brake current is switched off or if there is a power failure, the electromagnetic field of the brake disappears. The mechanical braking energy is transferred to the motor shaft. The motor is braked.

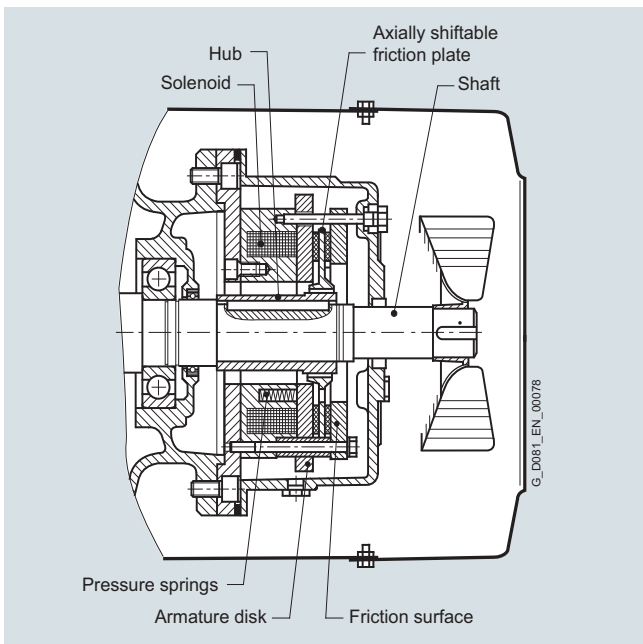

Design of KFB spring-operated brakes

Other characteristics of the KFB brake

- High degree of protection IP67.
- Corrosion-resistant in seawater and in the tropics.
- The brake is a dynamic brake, not simply a holding brake. For this reason there is less wear, especially in the case of emergency stops (commissioning).
- High wear reserves – repeated stepless air gap readjustment is possible. This results in extremely long operating times and low service and operating costs.
- The function and wear can be monitored with microswitches and proximity switches. Microswitch On/Off is standard for 1LE motors, frame size 250 to 315. Microswitch On/Off is not standard for 1LE motors, frame size up to 225. Anti-condensation heating is possible as an option.
- Fully functional brake for housing acceptance test. Visual inspection of brake is possible during operation.
- The brake (air gap) can be adjusted in the factory, for example, and mounted on the drive motor without further adjustments.
- The wearing parts can be replaced without great effort. After the housing has been opened (three screws), it is easy to replace the friction plate. It is not necessary to disassemble the entire brake.

Voltage and frequency

The solenoids and the brake rectifier can be connected to the following voltages:

1 AC 50 Hz 230 V $\pm 10\%$

When 60 Hz is used, the voltage for the brake must not be increased!

The brake can also be supplied for other voltages:

- Brake supply voltage: 24 V DC
Order code **F10**
- Brake supply voltage: 230 V AC
Order code **F11**
- Brake supply voltage: 400 V AC (directly at the terminal strip)
Order code **F12**

Order codes **F10** and **F12** may only be used in conjunction with order code **F01**.

Fast brake application

Not available for the KFB brake.

Mechanical manual brake release with lever

The brake can be released manually with screws as standard. Mechanical manual release with a lever can be ordered with order code **F50**.

The dimensions of the brake lever depend on the motor frame size and can be read from the dimension sheet generator for motors in the DT Configurator tool for low-voltage motors. Up-to-date data are available from the brake manufacturer.

Overview**Connection**

Labeled terminals are provided in the main terminal box of the motor to connect the brake.
KFB brakes are connected through a standard bridge or half-wave rectifier.

A special circuit is not required. Optimal switching times are achieved without the need to use special circuits.

For this purpose, see the circuit diagrams on page 1/81.

Maximum admissible speeds

The maximum admissible speeds from which emergency stops can be made are listed in the next table. These speeds should be considered as guide values and must be checked for the specific operating conditions.

The maximum admissible friction energy depends on the switching frequency and is shown for the individual brakes in the following diagram. Increased wear can be expected when the brakes are used for emergency stops.

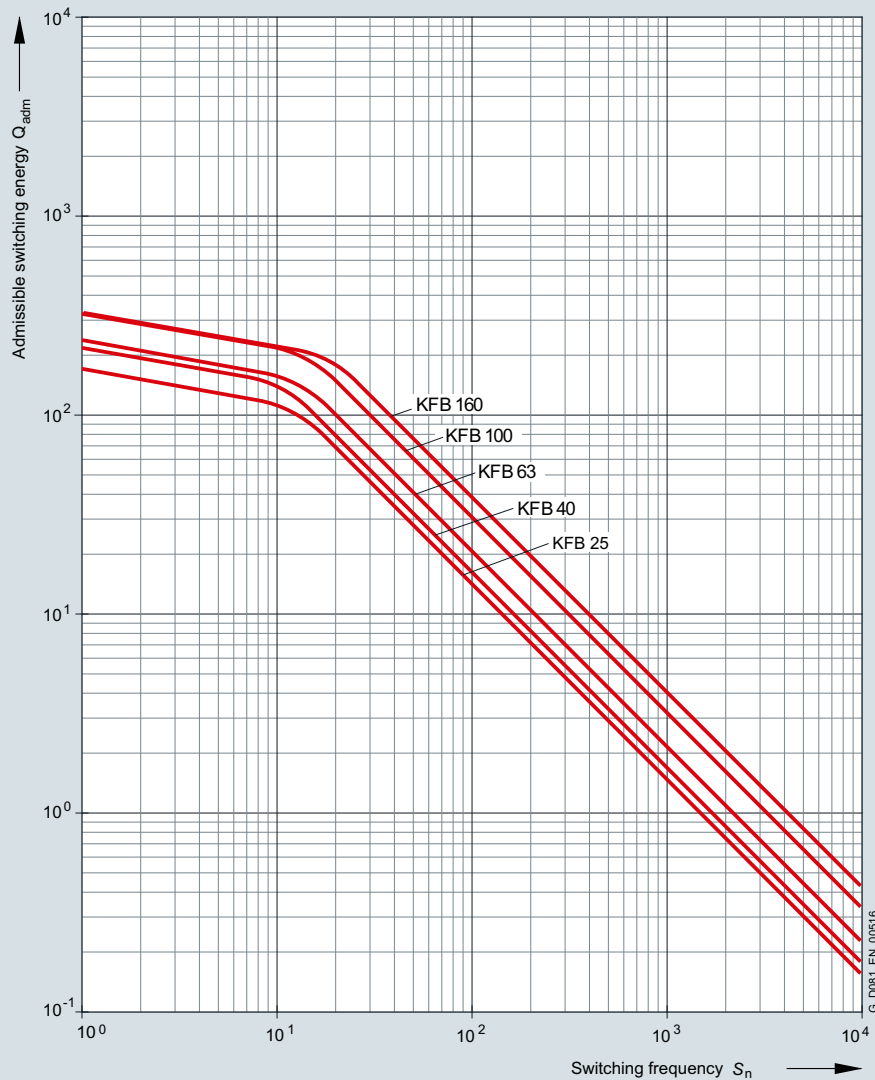

Introduction

Mounting technology

Modular technology

1

Overview

Overview of brake selection for 1LE1 motors		For motor frame sizes					
		180 ¹⁾	200 ¹⁾	225 ¹⁾	250 ²⁾	280 ²⁾	315 ²⁾
No. of poles		2 to 8	2 to 8	2 to 8	2 to 8	4 to 8	4 to 8
Flanged end shield NDE brake installation		A300	A350	A350	A400	A450	A550
Max. diameter of 2nd shaft extension	mm	48 _{k6}	55 _{m6}	55 _{m6}	60 _{m6}	65 _{m6}	70 _{m6}
Brake type		KFB 25	KFB 40	KFB 40	KFB 63	KFB 100	KFB 160
Braking torque	Nm	225	360	360	567	900	1440
Nominal dynamic braking torque according to VDE 0580	Nm/rpm	250/127	400/117	400/117	630/92	1000/78	1600/69
Dynamic braking torque ³⁾	at 750 rpm	Nm	207	332	332	504	780
	at 1000 rpm	Nm	200	316	316	491	760
	at 1500 rpm	Nm	192	304	304	466	720
	at 3000 rpm	Nm	175	276	276	378	580
	at n_{max}	Nm	137	220	220	346	500
Maximum speed n_{max} – IM B3/V1	rpm	6000	5500	5500	4700	4000	3600
Power at 110 V DC	W	158	196	196	220	307	344
Power at 230 V AC	W	160	188	188	206	316	340
Current at 110 V DC	A	1.44	1.78	1.78	2	2.79	3.13
Current at 230 V AC (207 V DC coil voltage)	A	0.77	0.91	0.91	1	1.53	1.64
Current at 400 V AC (180 V DC coil voltage)	A	0.8	1.18	1.18	1.25	1.8	2.1
Current at 24 V DC	A	5.21	6.92	6.92	8.17	12.2	12.8
Weight, approx.	kg	42	55	55	74	106	168
Application time t_1	ms	70	80	80	112	126	183
Release time t_2	ms	240	250	250	342	375	500
Brake moment of inertia	kgm ²	0.0048	0.0068	0.0068	0.0175	0.036	0.05
Lifetime L of the brake lining	Nm · 10 ⁶	3600	3110	3110	4615	7375	10945
Air gap adjustment L_N required after braking energy	Nm · 10 ⁶	810	935	935	1185	2330	3485

¹⁾ The standard brake for frame sizes 180 to 225 is the BFK458 brake. KFB brake on request.

²⁾ The standard brake for frame sizes 250 to 315 is the KFB brake.

³⁾ The dynamic braking torque also depends on the load data; temperatures in excess of the maximum admissible lining surface temperatures must be avoided.

Overview**SFB-SH solenoid double-disk spring-operated brake****Motor series**

This brake is the standard brake for 1LE5 motors in frame sizes 315 to 355.
Special brake selections are available on request.

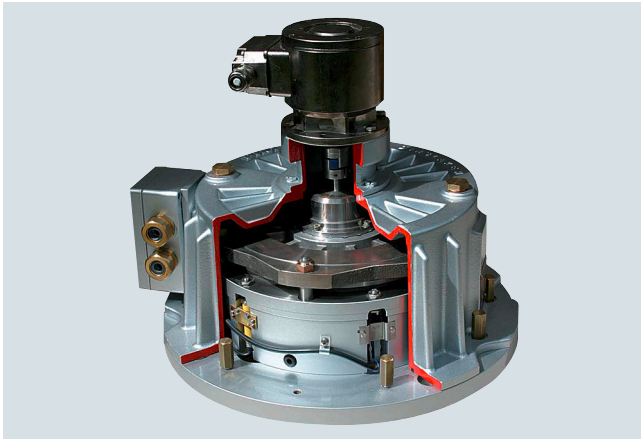

SFB-SH solenoid double-disk spring-operated brake

SFB-SH solenoid double-disk spring-operated brakes are safety brakes that are mechanically operated on a power failure. This ensures that the brake still works during a power failure. These brakes are designed for dry running, must only ever be operated in a safe state, and only installed, commissioned, operated, and maintained by specially trained installation personnel. The brakes of the SFB-SH type series have an increased braking torque due to use of a different friction material and are used for emergency stops as a dynamically loaded brake with a safety margin.

Other characteristics of the SFB-SH brake

- High degree of protection IP67.
- Corrosion-resistant in seawater and in the tropics.
- High wear margins - simple air-gap adjustment. This results in extremely long operating times and low service and operating costs.
- The function and wear can be monitored with microswitches and proximity switches. Microswitch On/Off is standard for 1LE5 motors. Anti-condensation heating is possible as an option.
- Fully functional brake for housing acceptance test. Visual inspection of brake is possible during operation.
- The brake (air gap) can be adjusted in the factory, for example, and mounted on the drive motor without further adjustments.
- The wearing parts can be replaced without great effort. After the housing has been opened (three acorn nuts), it is easy to replace the friction plate. It is not necessary to disassemble the entire brake.

Design and mode of operation

When the brake current is switched on, an electromagnetic field develops which overcomes the spring force of the brake. The corresponding modules, including the motor shaft, can rotate freely. The brake is released. If the brake current is switched off or if there is a power failure, the electromagnetic field of the brake disappears. The mechanical braking energy is transferred to the motor shaft. The motor is braked.

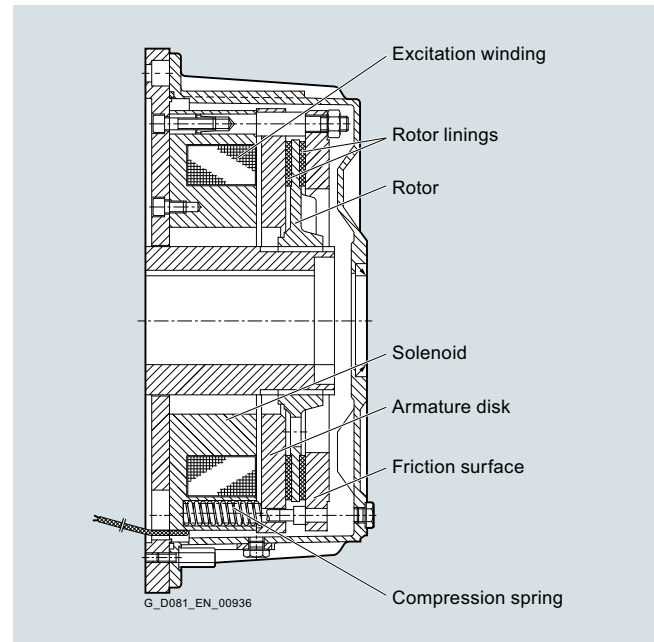

Design of the SFB-SH solenoid double-disk spring-operated brake

Voltage and frequency

The solenoids and the brake rectifier can be connected to the following voltages:
1 AC 50 Hz 230 V $\pm 10\%$

When 60 Hz is used, the voltage for the brake must not be increased!

The brake can also be supplied for other voltages:

- Brake supply voltage: 24 V DC
Order code **F10**
- Brake supply voltage: 230 V AC
Order code **F11**
- Brake supply voltage: 400 V AC (directly at the terminal strip)
Order code **F12**

Order codes **F10** and **F12** may only be used in conjunction with order code **F01**.

Introduction

Mounting technology

Modular technology

1

Overview

Connection

Labeled terminals are provided in the main terminal box of the motor to connect the brake.

The AC voltage for the brake excitation winding is connected to the two free terminals of the rectifier block (~). The rectifier is located in the main terminal box and must be connected in the customer's switchboard.

The brake can be released when the motor is at a standstill by separately exciting the solenoid. In this case, an AC voltage must be connected at the rectifier block terminals. The brake remains released as long as this voltage is present.

For 24 V DC brakes, the brake terminals are directly connected to the DC voltage source.

For this purpose, see the circuit diagrams on page 1/81.

Maximum admissible speeds

The maximum admissible speeds from which emergency stops can be made are listed in the next table. These speeds should be considered as guide values and must be checked for the specific operating conditions.

The maximum admissible friction energy depends on the switching frequency and is shown for the individual brakes in the following diagram. Increased wear can be expected when the brakes are used for emergency stops.

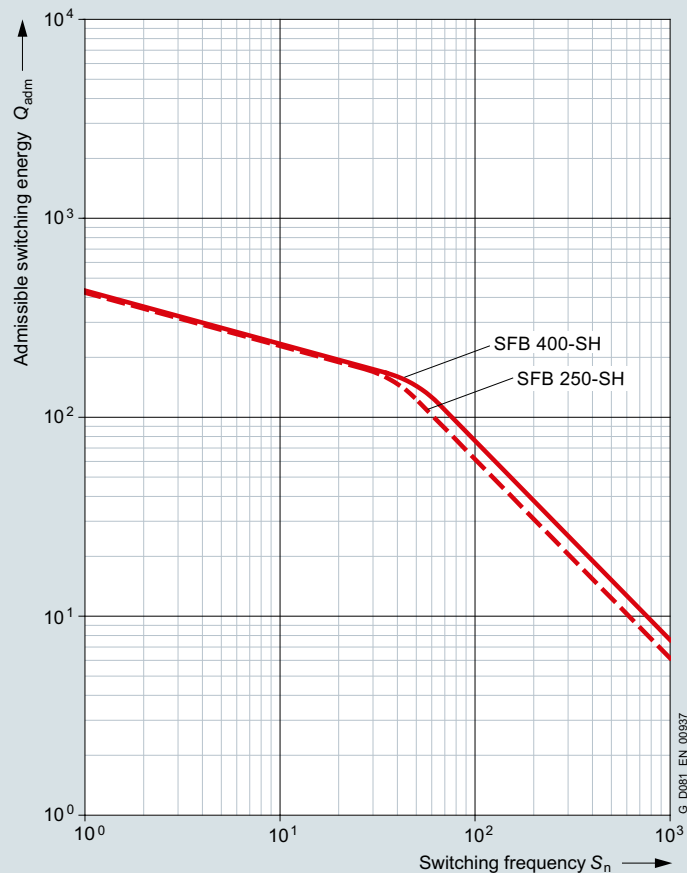

G_D081_EN_00537

Overview

Overview of brake selection for 1LE5 motors		For motor frame sizes	
		315	355
No. of poles		4 to 8	4 to 8
Flanged end shield NDE brake installation		FF500 (A550) ¹⁾	FF600 (A660) ²⁾
Max. diameter of 2nd shaft extension	mm	75 _{m6}	90 _{m6}
Brake type		SFB 250-SH	SFB 400-SH
Braking torque	Nm	2970	4680
Nominal dynamic braking torque according to VDE 0580	Nm/rpm	3300/54	5200/47
Dynamic braking torque ³⁾	at 750 rpm	Nm	2400
	at 1000 rpm	Nm	2200
	at 1500 rpm	Nm	1850
	at n_{max}	Nm	1580
Maximum speed n_{max} – IM B3/V1	rpm	2800	2500
Power at 110 V DC	W	495	553
Power at 230 V AC (207 V DC coil voltage)	W	511	–
Current at 110 V DC	A	4.5	5.03
Current at 230 V AC (207 V DC coil voltage)	A	2.79	3.14
Current at 400 V AC (180 V DC coil voltage)	A	2.98	3.36
Current at 24 V DC	A	19.93	–
Weight, approx.	kg	306	357
Application time t_1	ms	640	700
Release time t_2	ms	690	1100
Brake moment of inertia	kgm ²	0.14	0.325
Minimum air gap	mm	0.4	0.4
Maximum air gap	mm	2.5	2.5

¹⁾ External dimension increases to 560 mm.

²⁾ External dimension decreases to 640 mm.

³⁾ The dynamic braking torque also depends on the load data, temperatures in excess of the maximum admissible lining surface temperatures must be avoided.

⁴⁾ Value is guaranteed by the brake manufacturer.
In practice, a higher braking torque can be expected.
Restrictions are determined at the test station of the brake manufacturer.
Information: www.pintschbubenzler.de

Introduction

Mounting technology

Modular technology

1

Overview

Configuration of motors with brakes

Braking time

The time it takes the motor to come to a standstill comprises two components:

- The application time of the brake t_2
- The braking time t_{Br}

$$t_{Br} = \frac{J \cdot n_{rated}}{9.55 \cdot (T_B \pm T_L)}$$

t_{Br} Braking time in s

J Total moment of inertia in kgm^2

n_{rated} Rated speed of the motor with brake in rpm

T_B Rated braking torque in Nm

T_L Average load torque in Nm (If T_L supports the braking operation, T_L is positive)

Braking energy per braking operation Q_{adm}

The braking energy per braking operation in Nm comprises the energy of the moments of inertia to be braked Q_{Kin} and the energy Q , which must be applied in order to brake against a load torque:

$$Q_{adm} = Q_{Kin} + Q$$

- The energy of the moments of inertia in Nm

$$Q_{Kin} = \frac{J \cdot n_{rated}^2}{182.4}$$

n_{rated} Rated speed before braking in rpm

J Total moment of inertia in kgm^2 . The mass moment of inertia J specified in the formula corresponds to the total moment of inertia of all braked masses referred to the motor/brake speed.

- Braking energy on emergency trip

The braking energy for occasional emergency trips must be checked to ensure that it does not cause the brake to overheat. Please refer to table "Technical specifications of brakes" for admissible values. The braking energy produced for traversing gear can be calculated approximately with the following equation:

$$Q = \frac{J_{tot} \cdot n_{Br}^2}{182.4 \cdot 10^3} \cdot \frac{T_{Br}}{T_{Br} \pm T_L}$$

Q Energy capability/braking energy in kJ

T_{Br} Braking torque in Nm

T_L Total of all load torques in Nm referred to the brake (motor) shaft

n_{Br} Speed of brake (motor) shaft in rpm

J_{tot} Total moment of inertia to be braked in kgm^2 reduced to the brake (motor) shaft

T_L is positive if it supports braking (e.g. hoisting a load)

T_L is negative if it counteracts braking (e.g. lowering a load)

The total moment of inertia J_{tot} is the sum of the individual moments of inertia of the system components to be braked, reduced to the brake (motor) shaft, and the moments of inertia of the linear-motion masses. The equivalent mass inertia J_{Eqv} of a linear-motion mass m with velocity v , referred to the brake (motor) speed n_{Br} , is calculated as follows:

$$J_{Eqv} = 91.2 \cdot m \cdot \left(\frac{v}{n_{Br}}\right)^2$$

m Mass of the linear-motion load in kg

v Velocity of the linear-motion load in m/s

n_{Br} Speed of brake (motor) shaft in rpm

The velocity and/or speed to be entered here must equal the maximum values in normal operation. An increase in velocity resulting from wind forces may also need to be taken into account.

Definition of switching times (VDI 2241)

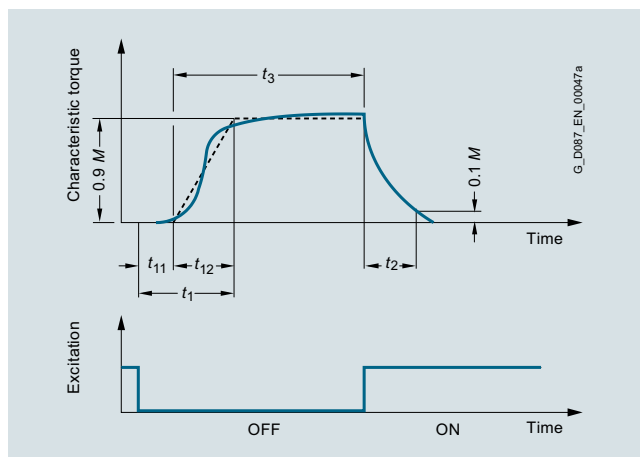

Brake switching times

Switching times:

t_1 Brake application time

t_2 Disconnection time

t_3 Slip time

t_{11} Response delay

t_{12} Rise time

Run-on revolutions U

The number of run-on revolutions U of the motor with brake can be calculated as follows:

$$U = \frac{n_{rated}}{60} \left(t_1 + \frac{t_{Br}}{2} \right)$$

t_1 Brake application time in ms

Lifetime of the brake lining L and readjustment of the air gap

The brake lining wears due to friction which increases the air gap and the release time for the brake at standard excitation.

In order to calculate the lifetime of the brake lining in terms of operations S_{max} , the lifetime of the brake lining L in Nm must be divided by the braking energy Q_{adm} :

$$S_{max} = \frac{L}{Q_{adm}}$$

The interval between adjustments N can be calculated in terms of operations by dividing the braking energy L_N that the brake can output until it is necessary to readjust the working air gap by Q_{adm} :

$$N = \frac{L_N}{Q_{adm}}$$

Overview**FDW/FDX spring-operated brake****Motor series**

This FDW/FDX brake is provided for 1LE1 motors (FDW for frame size 100 to 200; FDX for frame size 225 to 315).

Mode of operation of FDW/FDX spring-operated brake (holding brake/operating brake)

The solenoid spring-operated brakes (order code **F04**), FDW with IP66 and FDX with IP67 degree of protection, are quiescent current brakes, meaning that the braking torque is produced by spring force and increased by magnetic force in normal operation.

During the braking operation, the built-in compression springs apply pressure to the rotor that interlocks radially with the machine shaft using the axially moving armature disk. In turn, this applies pressure to the opposing side against the friction surface (\rightarrow motor label). The braking torque is produced from the linings of the rotor and the armature disk/friction surface being in contact.

During the brake release process, a magnetic force is produced by applying a direct current via the excitation winding in the solenoid. The armature disk is thereby pulled from the solenoid and the rotor is released.

During the manual brake release process (only available for the brake version with manual brake release), the armature disk is pressed mechanically against the solenoid by operating the manual release lever. The brake can therefore still be released in the event of a power failure, for example.

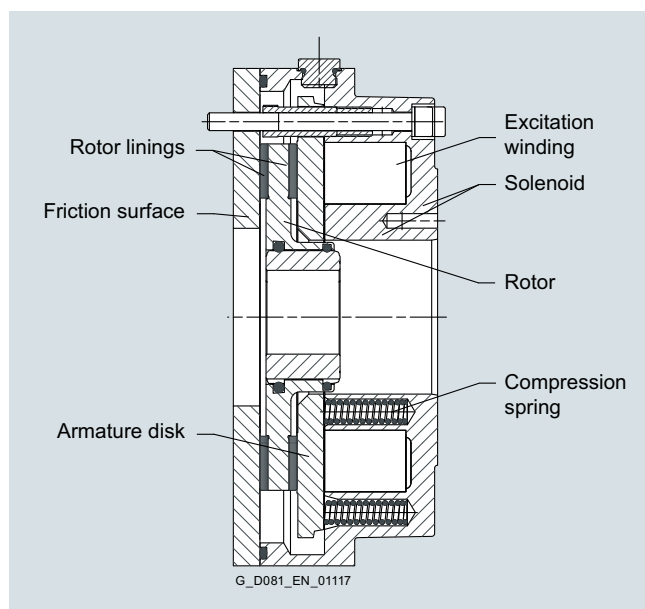

Design of spring-operated brake FDW

Voltage and frequency

The solenoids and the brake rectifier are designed for connection to the following voltages or can be supplied for the following voltages:

- Brake supply voltage 230 V AC
Order code **F11**
- Brake supply voltage 400 V AC
Order code **F12**
- Brake supply voltage 180 V DC
Order code **F17**
- Brake supply voltage 205 V DC
Order code **F18**

When 60 Hz is used, the voltage for the brake must not be increased!

Order codes **F11**, **F12**, **F17** and **F18** may only be used in conjunction with order code **F04**.

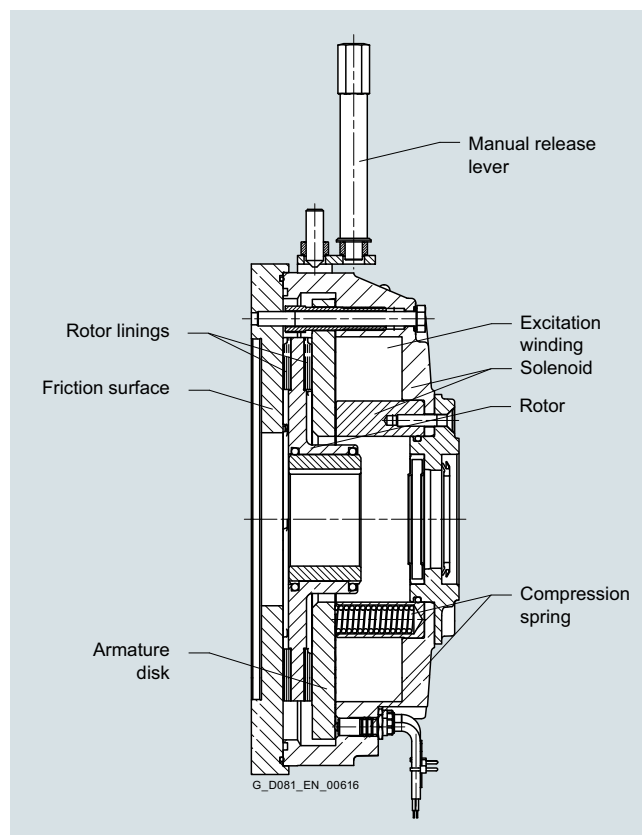

Design of spring-operated brake FDX

Connection

Labeled terminals are provided in the main terminal box of the motor to connect the brake.

The AC voltage for the brake excitation winding is connected to the two free terminals of the rectifier block (\sim).

The brake can be released when the motor is at a standstill by separately exciting the solenoid. In this case, an AC voltage must be connected at the rectifier block terminals. The brake remains released as long as this voltage is present.

The rectifiers are protected against overvoltages by varistors in the input and output circuits. The function and wear can be monitored with microswitches and proximity switches. Microswitch On/Off is standard for 1LE1 motors. Anti-condensation heating is possible as an option.

Mechanical manual brake release with lever

The brake can be supplied with a mechanical manual release with lever.

Order code **F50**

The dimensions of the brake lever depend on the motor frame size and can be read from the dimensional drawing generator for motors in the DT Configurator tool for low-voltage motors.

www.siemens.com/dt-configurator

Introduction

Mounting technology

Modular technology

1

Overview

Lifetime

The amount of frictional energy that can be transferred before the rotor must be replaced depends on various factors:

- Mass to be decelerated
- Switching frequency
- Speed
- Resulting temperature on the friction surfaces

As a result, only guide values can be specified for the frictional energy to be transferred until rotor replacement.

Abbreviations and definitions used (with their units):

T_{LR} = Motor starting torque (Nm)

T_b = Braking torque (Nm)

T_{breq} = Required braking torque (Nm)

$T_{b, rated}$ = Rated torque of the spring-operated brake (Nm)

T_L = Load torque (Nm)

T_{tot} = Total torque (Nm)

F = Force (N)

r = Lever arm (m)

n = Speed (rpm)

K = Safety factor $K \geq 2$

P = Power (kW)

t = Overall braking time (ms)

t_{st} = Startup time (s)

t_B = Braking time (s)

t_2 = Disconnection time (ms)

t_1 = Application time (ms)

t_{11} = Response delay (ms)

P_R = Frictional power (J/s)

W_R = Friction energy (J)

S = Switching cycles (brake operations) per second (Hz)

J_E = Internal moment of inertia (kgm²)

J_{add} = Additional moment of inertia (kgm²)

$J_{2,3..}$ = Moment of inertia (kgm²)

J_{tot} = Total moment of inertia (kgm²)

n_1 = Motor speed (rpm)

$n_{2,3..}$ = Speeds (rpm)

Multiple moments of inertia with different speeds are converted into a moment of inertia relative to the motor shaft:

$$J_{add} = \frac{J_2 \cdot n_2^2 + J_3 \cdot n_3^2 \dots}{n_1^2} \quad (\text{kgm}^2)$$

Torque

A spring-operated brake is designed mainly in accordance with the required braking torque T_{breq} . If the moment of inertia, speed, and admissible braking time of the machine are known, the braking torque of the spring-operated brake can be calculated. If the masses that are to be decelerated by the spring-operated brake are running at a different speed from the shaft decelerated by the spring-operated brake, the moment of inertia of these masses (J_{add}) must be calculated relative to this shaft (see above). In addition, the moment of inertia of the rotor-hub system (J_E) must be taken into account.

Load torque (static loading)

Torque which is present when the system is at a standstill and must be held by the brake. The loading force is converted into the load torque via the relevant lever arm:

$$T_L = F \cdot r \quad (\text{Nm})$$

Braking torque (dynamic loading)

A purely dynamic load is present when flywheels, rollers, etc., are to be delayed and the static load torque is negligibly small.

The required braking torque is calculated as follows:

$$T_b = 1.046 \cdot 10^2 \cdot J_{tot} \cdot \frac{n}{t - t_1} \quad (\text{Nm})$$

$$T_{breq} = T_b \cdot K \leq T_{b, rated} \quad (\text{Nm})$$

Dynamic and static loading

Most applications involve dynamic loading as well as static load torque:

$$T_{breq} = (T_b \pm T_L) \cdot K \quad (\text{Nm})$$

$$T_{breq} = (1.046 \cdot 10^2 \cdot J_{tot} \cdot \frac{n}{t - t_1} \pm T_L) \cdot K \quad (\text{Nm})$$

$$T_{breq} \leq T_{b, rated} \quad (\text{Nm})$$

Sign for T_L :

+ T_L = Load torque is applying force (in the direction of motion)

- T_L = Load torque is applying a decelerating force (opposite to the direction of motion)

If both cases occur, the specific configuration is always adapted to the larger torque.

Approximate determination of T_{breq}

If the moment of inertia is not known and if the input power has been defined, the required braking torque is determined as follows:

$$T_{breq} = 9.55 \cdot 10^3 \cdot \frac{P}{n} \cdot K \leq T_{b, rated} \quad (\text{Nm})$$

$K \geq 2$

Braking time

General information

$$t = 1.046 \cdot 10^2 \cdot J_{tot} \cdot \frac{n}{T_{b, rated} \pm T_L} + t_1 \quad (\text{ms})$$

Sign for T_L :

- T_L = Load torque is applying force (in the direction of motion)

+ T_L = Load torque is applying a decelerating force (opposite to the direction of motion)

Calculation of the starting and braking time for motors

Startup time for motors with brakes

$$t_{st} = J_{tot} \cdot \frac{n_1}{9.55 \cdot (T_{LR} \pm T_L)} + \frac{t_2}{1000} \quad (\text{s})$$

$$J_{tot} = J_E + J_{add} \quad (\text{kgm}^2)$$

Sign for T_L :

+ T_L = Load torque is applying force (in the direction of motion)

- T_L = Load torque is applying a decelerating force (opposite to the direction of motion)

Overview**Braking time for motors with brakes**

$$t_B = J_{\text{tot}} \cdot \frac{n_1}{9.55 \cdot (T_{b, \text{rated}} \pm T_L)} + \frac{t_1}{1000} \quad (\text{s})$$

Sign for T_L :

- T_L = Load torque is applying force (in the direction of motion)
- + T_L = Load torque is applying a decelerating force (opposite to the direction of motion)

Thermal load

When braking, friction energy is applied during the slip phase, which releases thermal energy.

Friction energy per braking operation

$$W_R = J_{\text{tot}} \cdot n^2 \cdot \frac{T_{b, \text{rated}}}{182.5 \cdot (T_{b, \text{rated}} \pm T_L)} \quad (\text{J})$$

Sign for T_L :

- T_L = Load torque is applying force (in the direction of motion)
- + T_L = Load torque is applying a decelerating force (opposite to the direction of motion)

The friction energy per braking operation must be no greater than the admissible value $W_{R\text{max}}$

$$W_R \leq W_{R\text{max}} \quad (\text{J})$$

Frictional power

$$P_R = W_R \cdot S \quad (\text{J/s})$$

The friction energy must be no greater than the admissible value $P_{R\text{max}}$

$$P_R \leq P_{R\text{max}} \quad (\text{J/s})$$

Connection

Load rating of the rectifier diodes as a function of the ambient temperature:

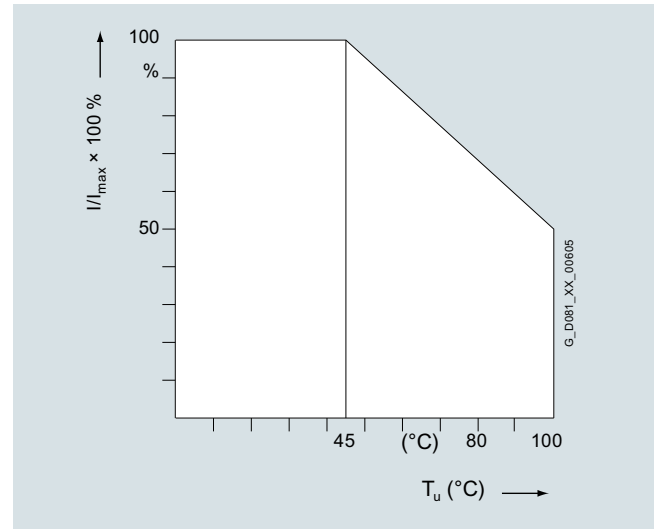

Block diagram:

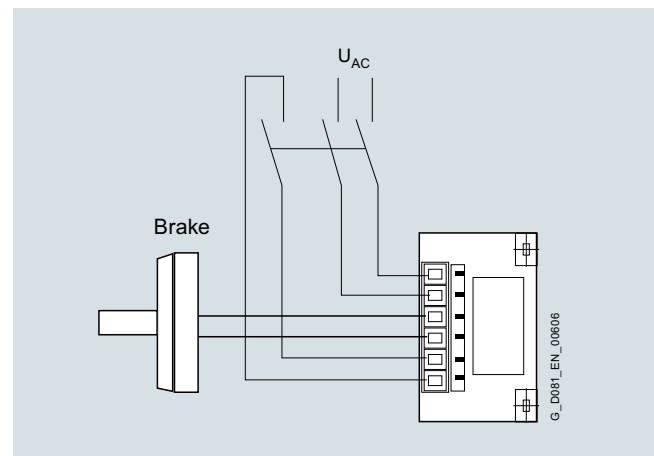

The high-speed rectifier performs the following functions:

- The coil is first supplied with a voltage $U_2 = 0.9 \times U_1$: Over-excitation of the brake
- After excitation time t_1 the voltage is reduced to $U_3 = 0.45 \times U_1$: Non-release voltage of the brake

Designation	Supply voltage (V AC)	Output voltage (V DC)		Ambient temperature
Article No.:	U_1 at 50/60 Hz	U_2	U_3	°C
PMG 480	215 ... 500	$0.9 \times U_1$	$0.45 \times U_1$	-15 ... +80

Introduction

Mounting technology

Modular technology

1

Overview

Maximum admissible speeds

The maximum admissible speeds from which emergency stops can be made are listed in the next table. These speeds should be considered as guide values and must be checked for the specific operating conditions.

The maximum admissible friction energy depends on the switching frequency and is shown for the individual brakes in the following diagram. Increased wear can be expected when the brakes are used for emergency stops.

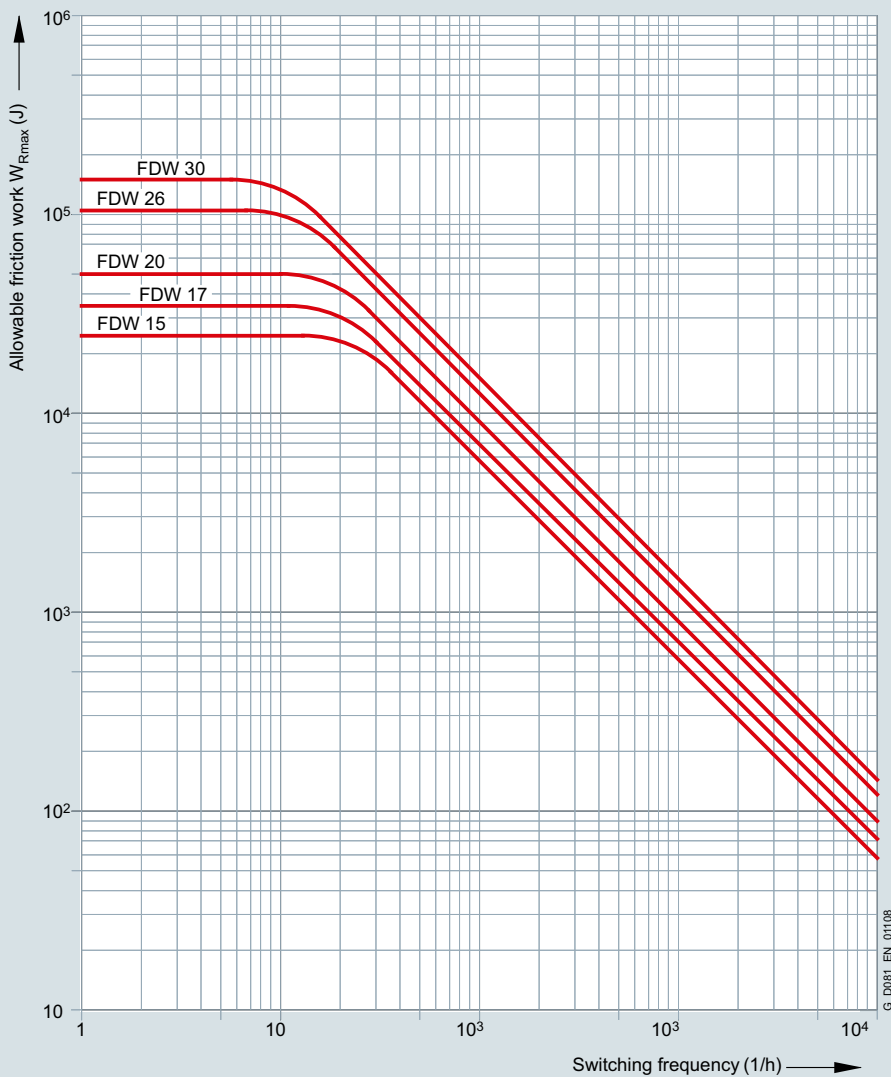

G_D081_EN_01108

Spring-operated brake FDW

Overview

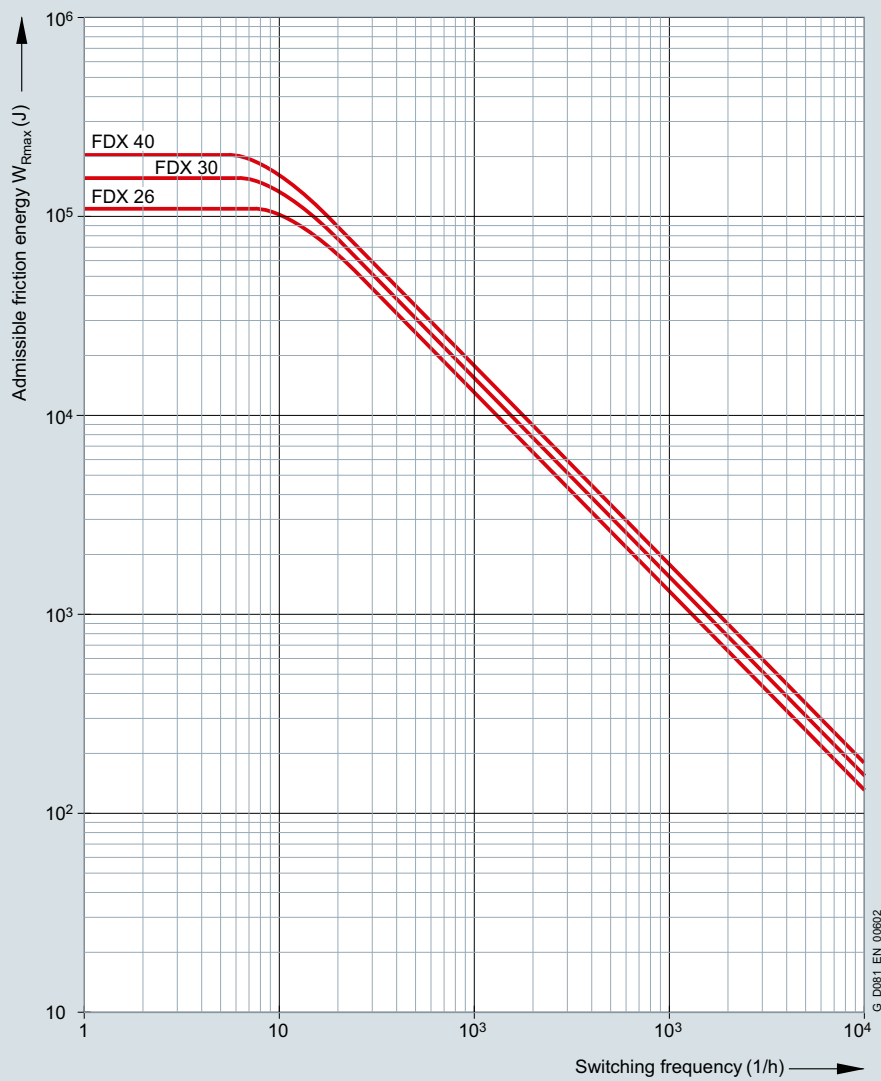

Spring-operated brake FDX

Introduction

Mounting technology

Modular technology

1

Overview

Overview of brake selection for 1LE1 motors (option F04)		For motor frame sizes					
		100	112	132	160	180	200
No. of poles		2 bis 8	2 bis 8	2 bis 8	2 bis 8	2 bis 8	2 bis 8
Max. diameter for the second shaft extensions	mm	25	25	35	45	48	55
Brake type		FDW 15	FDW 17	FDW 20	FDW 26	FDW 26	FDW 30
Static braking torque	Nm	18 (13/10/7,5)	36 (26/21/15) ¹⁾	54 (39/31/23) ¹⁾	225 (169/112) ¹⁾	225 (169/112) ¹⁾	360 (270/180) ¹⁾
Dynamic rated braking torque acc. to DIN VDE 0580	Nm/rpm	20 (14/12/8) ¹⁾ /242	40 (28/23/17) ¹⁾ /194	60 (43/34/26) ¹⁾ /181	250 (187/125) ¹⁾ /108	250 (187/125) ¹⁾ /108	400 (300/200) ¹⁾ /88
	at 750 rpm	Nm	38	58	95	240	380
	at 1000 rpm	Nm	37	55	90	230	370
	at 1500 rpm	Nm	37	55	90	230	370
	at 3000 rpm	Nm	30	45	75	190	300
Admissible speed n_{max}	rpm	6000	6000	6000	3000	3000	3000
Rated current at 205 V DC coil voltage	A	0,28	0,44	0,59	0,68	0,68	0,89
Rated current at 180 V DC coil voltage	A	0,33	0,46	0,59	0,78	0,78	1,16
Rated current at 103 V DC coil voltage	A	0,55	0,82	1,05	1,4	1,4	1,77
Rated current at 24 V DC coil voltage	A	2,67	3,69	4,3	5,7	5,7	7,27
Weight, approx.	kg	6,7	9,2	13,6	30,3	30,3	44,9
Closing time t_1 (switching on the DC side)	ms	70	82	115	178	178	195
Release time t_2 (switching on the DC side)	ms	100	120	150	300	300	400
Brake moment of inertia	kg m ²	0,00045	0,00086	0,00122	0,00665	0,00665	0,0195
Lifetime L of brake lining	Nm · 10 ⁶	350	500	850	1400	1400	1850
Overview of brake selection for 1LE1 motors (option F04)		For motor frame sizes					
		225	250	280	315		
No. of poles		2 to 8	2 to 8	2 to 8	2 to 8		
Flange bearing plate for brake mounting on the NDE side		A350	A400	A450	A535		
Max. diameter for the second shaft extensions	mm	55m6	48m6	65m6	48m6		
Brake type		FDX 30	FDX 30	FDX 40	FDX 40		
Static braking torque	Nm	450	567	900	1440 ²⁾		
Dynamic rated braking torque acc. to DIN VDE 0580	Nm/rpm	500/88	630/88	1000/65	1600 ²⁾ /65		
	at 750 rpm	Nm	480	600	800		
	at 1000 rpm	Nm	460	580	740		
	at 1500 rpm	Nm	460	580	740		
	at 3000 rpm	Nm	380	480	600		
Admissible speed n_{max}	rpm	3000 ³⁾ /6000 ⁴⁾	3000 ³⁾ /6000 ⁴⁾	3000 ³⁾ /6000 ⁴⁾	3000 ³⁾ /6000 ⁴⁾		
Power at 180 V DC	W	880/220	880/220	1080/270	1080/270		
Power at 103 V DC	W	560/140	560/140	560/140	560/140		
Rated current at 230 V AC (103 V DC coil voltage)	A	2.72/1.36	2.72/1.36	2.72/1.36	2.72/1.36		
Rated current at 400 V AC (180 V DC coil voltage)	A	2.44/1.22	2.44/1.22	3/1.5	3/1.5		
Weight, approx.	kg	45	45	80	80		
Closing time t_1 (switching on the DC side)	ms	60	60	160	160		
Release time t_2 (switching on the DC side)	ms	140	140	320	320		
Brake moment of inertia	kgm ²	0.0195	0.0195	0.0445	0.0445		
Lifetime L of brake lining	Nm · 10 ⁶	3700	3700	4900	4900		

¹⁾ Reduced brake torque by decreasing the number of springs

²⁾ Limit: ON time S3 -50 %

³⁾ Operating brake

⁴⁾ Holding brake

Overview

"Special technology" comprises rotary pulse encoders of 1LE1 motors (with the exception of 1LE1 with order code **F90** – version "Forced-air cooled motors without external fan and fan cover" and 1PC1).

1LE1 motors with order codes **F70** (mounting of separately driven fan), **F01** (mounting of holding brake (standard arrangement)) and **F01 + F70** (mounting of brake and separately driven fan) from the modular mounting concept can be combined with rotary pulse encoders LL 861 900 220, HOG 9 DN 1024 I and HOG 10 D 1024 I from the "Special technology" range. The length of the motor increases by Δl when the rotary pulse encoder is mounted. For an explanation of the additional dimensions and weights, please refer to "Mounting technology", "Dimensions and weights" from page 1/109.

The rotary pulse encoders of "Modular technology" and "Special technology" are fitted as standard with a protective cover made of non-corrosive sheet steel.

For mounting of rotary pulse encoders with order codes **G11** and **G12** for frame sizes 71 to 315 and with order codes **G04**, **G05**, and **G06** up to frame size 160, a protective cover (order code **G43**) is supplied as standard.

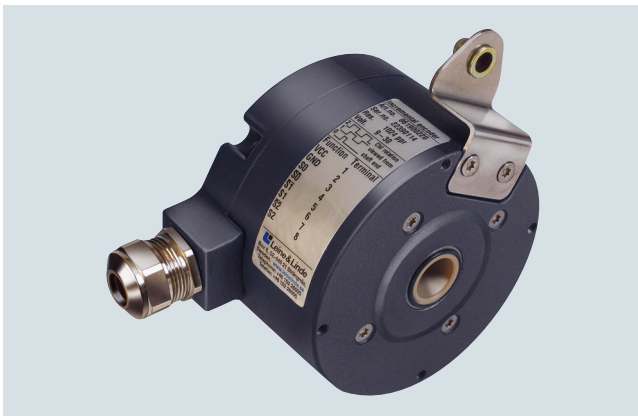
LL 861 900 220 rotary pulse encoder

With its rugged construction, this rotary pulse encoder is also suitable for difficult operating environments. It is resistant to shock and vibration and has insulated bearings.

The LL 861 900 220 rotary pulse encoder can be supplied already mounted.
Order code **G04**

*The LL 861 900 220 rotary pulse encoder can be retrofitted. The motor must be prepared for this. When the motor is ordered, the option "Prepared for mountings, center hole only", order code **G40**, or the option "Prepared for mountings with shaft D16", order code **G42**, must be specified (see "Mechanical version and degrees of protection" on page 1/79). The rotary pulse encoder is not part of the scope of supply in this case.*

The version of the rotary pulse encoder with a diagnostics system (ADS) can be supplied by Leine and Linde.

Manufacturer:
Leine und Linde AG
Olivehällsvägen 8
SE-64542 Strängnäs
Phone +46 152 265 00
Fax +46 152 265 05

www.leinelinde.com
Email: info@leinelinde.de

For frame size 180 and above, a protective cover is **not** supplied as standard when rotary pulse encoders are mounted for order codes **G04**, **G05**, **G06**, **G07** and **G08**.

For mounting of rotary pulse encoders with order codes **G11**, **G12 + F70** (mounting of separately driven fan): The cable end is connected to a connector that is located outside the fan cover. The fan cover does not have to be removed to connect the rotary pulse encoder. The rotary pulse encoder can be connected to the main terminal box or an auxiliary terminal box where necessary.

For mounting of rotary pulse encoders with order codes **G04**, **G05**, **G06 + F70** (mounting of separately driven fan):

- Up to frame size 200, the fan cover has to be removed to connect the rotary pulse encoder. The rotary pulse encoder can also be connected to the main terminal box or an auxiliary terminal box where necessary.
- As of frame size 225, the fan cover does not have to be removed to connect the rotary pulse encoder. The rotary pulse encoder can be connected to the main terminal box and can be connected to the auxiliary terminal box where necessary.

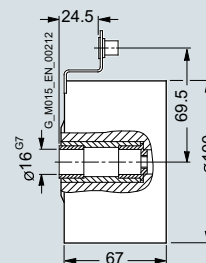

Mounting dimensions of LL 861 900 220 rotary pulse encoder

Technical specifications for LL 861 900 220 (HTL version)

Mounting of encoder for temperatures below -20 °C and higher than $+40\text{ °C}$ available on request.

Supply voltage U_B	+9 V to +30 V
Current input without load	max. 80 mA
Admissible load current per output	40 mA
Pulses per revolution	1024
Outputs	6 short-circuit proof square-wave pulses A, A', B, B', 0, 0'
Pulse offset between the two outputs	$90^\circ \pm 25^\circ$ el.
Output amplitude	$U_{\text{High}} > 20\text{ V}$ $U_{\text{Low}} < 2.5\text{ V}$
Mark space ratio	1:1 $\pm 10\%$
Edge steepness	50 V/ μs (without load)
Maximum frequency	100 kHz for 350 m cable
Maximum speed	4000 rpm
Temperature range	-20 to $+80\text{ °C}$
Degree of protection	IP65
Maximum adm. radial cantilever force	300 N
Maximum adm. axial force	100 N
Connection system	Terminal strips in encoder cable connection M20 x 1.5 radial
Weight	approx. 1.3 kg

Introduction

Mounting technology

Special technology

1

Overview

HOG 9 DN 1024 I rotary pulse encoder



The encoder is fitted with insulated bearings.

The HOG 9 DN 1024 I rotary pulse encoder can be supplied already mounted.

Order code **G05**

*The HOG 9 DN 1024 I rotary pulse encoder can be retrofitted. The motor must be prepared for this. When the motor is ordered, the option "Prepared for mountings, center hole only", order code **G40**, or the option "Prepared for mountings with shaft D16", order code **G42**, must be specified (see "Mechanical version and degrees of protection" on page 1/79). The rotary pulse encoder is not part of the scope of supply in this case.*

Manufacturer:

Baumer Hübner GmbH

Max-Dohrn-Str. 2+4

10589 Berlin, Germany

Phone +49 (30) 69003-0

Fax +49 (30) 69003-104

www.baumer.com

Email: sales@baumerhuebner.com

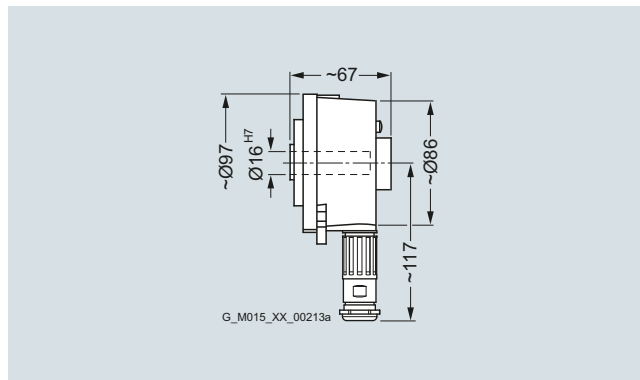

Mounting dimensions of HOG 9 DN 1024 I rotary pulse encoder

Technical specifications for HOG 9 DN 1024 I (HTL version)

Mounting of encoder for temperatures below -20 °C and higher than $+40\text{ °C}$ available on request.

Supply voltage U_B	+9 V to +30 V
Current input without load	50 to 100 mA
Admissible load current per output	150 mA, 800 mA peak
Pulses per revolution	1024
Outputs	6 short-circuit-proof square-wave pulses A+, A-, B+, B-, R+, R-
Pulse offset between the two outputs	$90^\circ \pm 20\%$
Output amplitude	$U_{\text{High}} \geq U_B - 3.5\text{ V}$ $U_{\text{Low}} \leq 1.5\text{ V}$
Mark space ratio	$1:1 \pm 20\%$
Edge steepness	$10\text{ V}/\mu\text{s}$
Maximum frequency	120 kHz
Maximum speed	7000 rpm
Temperature range	$-30\text{ to }+100\text{ °C}$
Degree of protection	IP56
Maximum adm. radial cantilever force	500 N
Maximum adm. axial force	400 N
Connection system	M23 flange socket, radial (mating connector is part of the scope of supply)
Mech. version acc. to Baumer Hübner Ident. No.	73 522 B
Weight	approx. 0.9 kg

Overview

POG 9 rotary pulse encoder



The POG 9 rotary pulse encoder can be supplied already mounted.

Order code **G08**

The POG 9 rotary pulse encoder can be retrofitted. The motor must be prepared for this. When the motor is ordered, the option "Prepared for mountings, center hole only", order code **G40**, or the option "Prepared for mountings with shaft D16", order code **G42**, must be specified (see "Mechanical version and degrees of protection" on page 1/79). The rotary pulse encoder is not part of the scope of supply in this case.

Manufacturer:
Baumer Hübner GmbH
Max-Dohrn-Str. 2+4
10589 Berlin, Germany
Phone +49 (30) 69003-0
Fax +49 (30) 69003-104

www.baumer.com
Email: sales@baumerhuebner.com

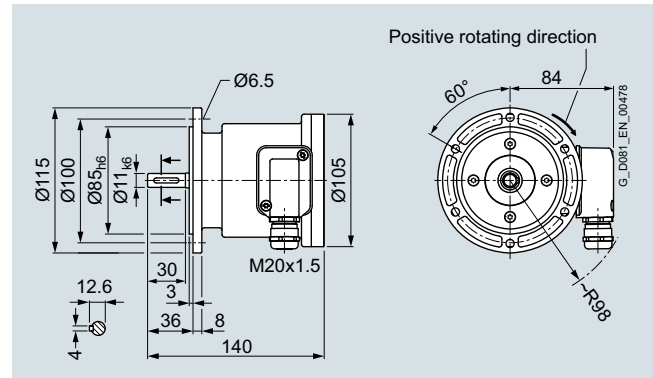

Mounting dimensions of POG 9 rotary pulse encoder

Technical specifications for POG 9

Mounting of encoder for temperatures below -20 °C and higher than $+40\text{ °C}$ available on request.

Supply voltage U_B	+9 V to +30 V	+5 V $\pm 5\%$
Current input without load	< 100 mA	
Admissible load current per output	60 mA average 300 mA peak	25 mA average 75 mA peak
Pulses per revolution	300 ... 2500	
Output amplitude	$U_{High} \geq U_B - 3.5\text{ V}$ $U_{Low} \leq 1.5\text{ V}$	$U_{High} \geq 2.5\text{ V}$ $U_{Low} \leq 0.5\text{ V}$
Mark space ratio	1:1 $\pm 20\%$	
Operating speed	$\leq 12000\text{ rpm}$	
Switching rate	120 kHz	
Temperature range	$-30\text{ to }+100\text{ °C}$	
Degree of protection	IP56	
Maximum adm. radial cantilever force	150 N	
Maximum adm. axial force	80 N	
Connection system	Terminal box	
Weight	approx. 1.4 kg	

Introduction

Mounting technology

Special technology

1

Overview

POG 10 DN 1024 I rotary pulse encoder

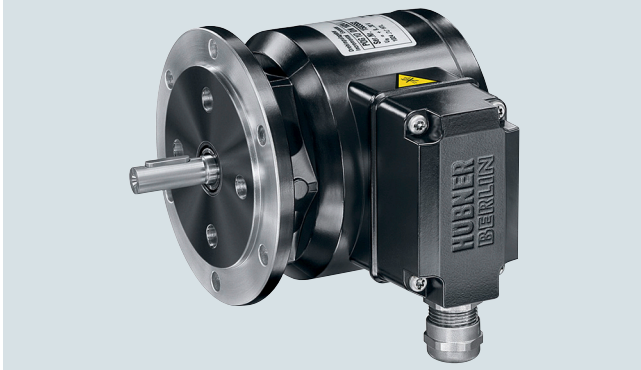

The POG 10 DN 1024 I rotary pulse encoder can be supplied already mounted.

Order code **G07**

*The POG 10 DN 1024 I rotary pulse encoder can be retrofitted. The motor must be prepared for this. When the motor is ordered, the option "Prepared for mountings, center hole only", order code **G40**, or the option "Prepared for mountings with shaft D16", order code **G42**, must be specified (see "Mechanical version and degrees of protection" on page 1/79). The rotary pulse encoder is not part of the scope of supply in this case.*

Manufacturer:

Baumer Hübner GmbH
Max-Dohrn-Str. 2+4
10589 Berlin, Germany
Phone +49 (30) 69003-0
Fax +49 (30) 69003-104

www.baumer.com

Email: sales@baumerhuebner.com

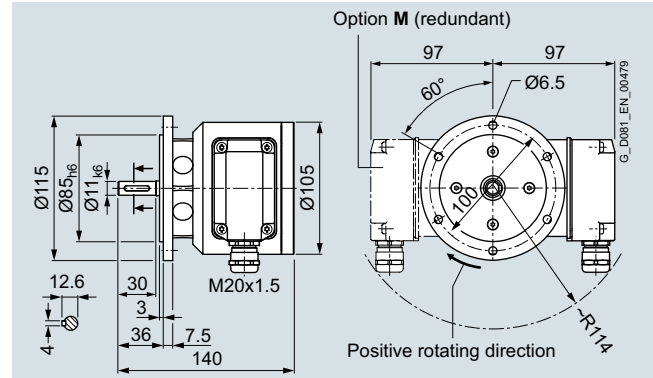

Mounting dimensions of POG 10 DN 1024 I rotary pulse encoder

Technical specifications for POG 10 DN 1024 I

Mounting of encoder for temperatures below -20 °C and higher than $+40\text{ °C}$ available on request.

Supply voltage U_B	+9 V to +30 V	
Current input without load	< 100 mA	
Admissible load current per output	60 mA average 300 mA peak	25 mA average 75 mA peak
Pulses per revolution	300 ... 2500	
Mark space ratio	40:60 ... 60:40	
Operating speed	$\leq 12000\text{ rpm}$	
Switching rate	120 kHz	
Temperature range	$-40\text{ to }+100\text{ °C}$	
Degree of protection	IP66	
Maximum adm. radial cantilever force	$\leq 450\text{ N}$	
Maximum adm. axial force	$\leq 300\text{ N}$	
Connection system	Terminal box	
Weight	approx. 1.9 kg	

Overview

HOG 10 D 1024 I rotary pulse encoder



This encoder is extremely rugged and is therefore suitable for difficult operating conditions. It is fitted with insulated bearings.

The HOG 10 D 1024 I rotary pulse encoder can be supplied already mounted.

Order code **G06**

The HOG 10 D 1024 I rotary pulse encoder can be retrofitted. The motor must be prepared for this. When the motor is ordered, the option "Prepared for mountings, center hole only", order code **G40**, or the option "Prepared for mountings with shaft D16", order code **G42**, must be specified (see "Mechanical version and degrees of protection" on page 1/79). The rotary pulse encoder is not part of the scope of supply in this case. The letters FSL and ESL stand for the following terms:

FSL: (mechanical) centrifugal switch

ESL: electronic speed switch

Both switch types are suitable for tripping the motor when a critical limit speed is reached, or for accelerating the motor along a control ramp into the permissible speed range again, or for shutting down the motor completely (depending on the customer application).

The electronic speed switch is particularly suitable for converter operation.

The critical limit rotational speed to be monitored for the customer's application must be specified in the order.

Further settings might also be necessary. These settings will be made at the Baumer & Hübner factory according to customer specifications.

Manufacturer:

Baumer Hübner GmbH

Max-Dohrn-Str. 2+4

10589 Berlin, Germany

Phone +49 (30) 69003-0

Fax +49 (30) 69003-104

www.baumer.com

Email: sales@baumerhuebner.com

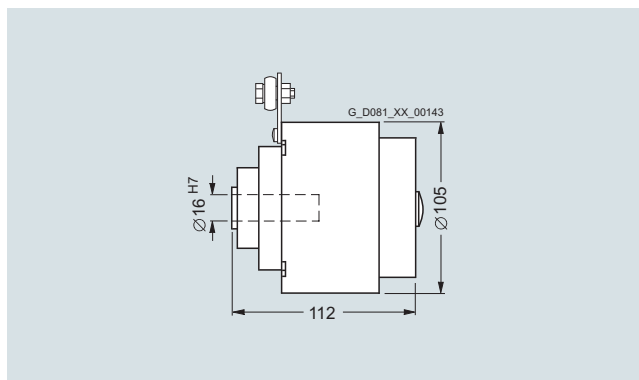

Mounting dimensions of HOG 10 D 1024 I rotary pulse encoder

Technical specifications for HOG 10 D 1024 I (HTL version)

Mounting of encoder for temperatures below -20 °C and higher than $+40\text{ °C}$ available on request.

Supply voltage U_B	+9 V to +30 V
Current input without load	approx. 100 mA
Admissible load current per output	600 mA, 300 mA peak
Pulses per revolution	1024
Outputs	4 short-circuit proof square-wave pulses A, B and A', B'
Pulse offset between the two outputs	$90^\circ \pm 20\%$
Output amplitude	$U_{\text{High}} \geq U_B - 3.5\text{ V}$ $U_{\text{Low}} \leq 1.5\text{ V}$
Mark space ratio	1:1 $\pm 20\%$
Edge steepness	10 V/ μs
Maximum frequency	120 kHz
Maximum speed	7000 rpm
Temperature range	-40 to $+100\text{ °C}$
Degree of protection	IP66
Maximum adm. radial cantilever force	150 N
Maximum adm. axial force	80 N
Connection system	Terminals, cable connection M20 x 1.5
Mech. version acc. to Baumer Hübner Ident. No.	74 055 B
Weight	approx. 1.6 kg

Introduction

Mounting technology

Special technology

1

Overview

Sendix 5020 rotary pulse encoder



The Sendix 5020 rotary pulse encoder can be ordered completely assembled as an HTL version with order code **G11** or as a TTL version with order code **G12**.

Features of the **G11** and **G12** encoders:

- Use of insulation to avoid surge currents
- Safety-lock technology for high resistance to vibrations, shaft loads, and installation errors
- Cable lengths available up to 300 m

In combination with a separately driven fan, the rotary pulse encoders are supplied with an external plug connection. The rotary pulse encoder can only be attached to a standard NDE shaft extension, meaning that a second shaft extension will not be available.

*The encoder can be retrofitted. When the motor is ordered, the option "Prepared for mountings, center hole only" order code **G40** or the option "Prepared for mountings with D12 shaft" order code **G41** must be specified.*

The dimensions of the motor are increased by Δl by mounting the rotary pulse encoder. The "Modular technology" and "Special technology" rotary pulse encoders are fitted with a protective cover made from corrosion-resistant sheet metal as standard. Mounted encoders for temperatures below -20 °C and above $+40\text{ °C}$ are available on request.

Technical specifications for Sendix 5020 (HTL/TTL version)

	Sendix 5020 (HTL version)	Sendix 5020 (TTL version)
Supply voltage	10 ... 30 V DC	5 V DC $\pm 5\%$
Energy consumption with inverted signal (no-load operation)	max. 100 mA	max. 90 mA
Admissible load/channel	max. ± 40 mA	max. ± 20 mA
Pulses per revolution	1024 (2048 and 512 on request)	
Outputs	2 square-wave pulses A, B – 2 inverted square-wave pulses A, B	
Pulse offset between the two outputs	90°	
Signal level	$U_{\text{High}} = \text{min. } U_{\text{B}} - 1\text{ V}$ $U_{\text{High}} = \text{min. } 2.5\text{ V}$ $U_{\text{Low}} = \text{max. } 0.5\text{ V}$	
Edge rise time t_r	max. 1 μs	max. 200 μs
Edge fall time t_f	max. 1 μs	max. 200 μs
Pulse frequency	max. 300 kHz	
Maximum speed	12000 rpm/6000 rpm (continuous)	
Operating temperature range	$-40^{1)}$... $+100\text{ °C}$	
Degree of protection acc. to EN 60529	IP65	
Maximum admissible radial cantilever force	100 N	
Maximum admissible axial force	50 N	
Connection system	12-pin M23 connector (mating connectors are always supplied)	
Certificates	UL, CSA (ATEX on request)	
Weight	0.4 kg	
Explosion protection certificate for explosive areas	Available on request for Zones 2 and 22	
Shock resistance acc. to EN 60068-2-27	3000 m/s ² , 6 ms	
Vibration resistance acc. to EN 60068-2-6	300 m/s ² , 10 ... 2000 Hz	

Manufacturer:
Fritz Kübler GmbH
Schubertstrasse 47
78054 Villingen-Schwenningen, Germany
Phone +49 (7720) 3903-0
Fax +49 (7720) 21564

www.kuebler.com/drehgeber
Email: info@kuebler.com

¹⁾ With connector: -40 °C , permanently installed cable: -30 °C , moving cable: -20 °C .

Overview**Rotary pulse encoders for SIL2, SIL3 safety applications**

The rotary pulse encoders with order codes **G21**, **G22**, **G25**, and **G27** are suitable for SIL2 and SIL3 safety applications and can be used subject to consideration of the mechanical installation conditions. The rotary pulse encoders from Baumer, Leine&Linde, and Kübler are designed for the implementation of safety-related functions, such as speed, direction of rotation, and position.

Functional safety

The safety integrity level SIL2 or SIL3 of the rotary pulse encoders is certified by the manufacturers Baumer, Leine&Linde, and Kübler. To ensure correct functioning of the rotary pulse encoder, various mounting measures are defined that are certified by TÜV and must correspond to safety applications up to levels PLd, category 3, SIL2 and PL e, category 4, SIL3.

The EC Declaration of Conformity complies with the Machinery Directive 42/2006/EC with consideration of EN 61800-5-2.

- Functional safety can only be ensured with the use of a suitable control and evaluation unit. It is mandatory to perform a function test in the safety circuit after initial installation, conversion, repair or modification.
- Installation, first commissioning and service requiring replacement of a rotary encoder on the customer's site must only be performed by qualified persons. If this requirement is not observed, the manufacturer's warranty will be voided.
- Upgrading with the functional safety rotary encoder for the defined SIMOTICS products that were originally manufactured without it is permissible on request provided that the upgrade is performed only in lead repair centers.
- Before you commission the motor with the functional safety encoder, read the information in the operating instructions.

General technical features

- The standard version of the motor is supplied with the order code **G43** (mechanical protection for encoder) and with a torque arm fitted between the encoder and motor.
- The functional safety encoders cannot be combined with the order codes **G40**, **G41**, and **G42** (prepared for externally mounted components) and can only be mounted at the non-drive end (NDE), i.e. a second shaft extension cannot be supplied.
- The safety rotary encoders with order code **G21** or **G22** are mounted with their cable and connector.
- The overall length of the motor and weight of the motor must be considered, see "Dimensions and weights".

Sendix 5834FS2/FS3 rotary pulse encoder

The Sendix 5834 rotary pulse encoder from Kübler in the version SinCos can be used in compliance with safety integrity level SIL2 when mounted complete on motors with the order code **G21** or SIL3 with the order code **G22** for frame sizes 71 to 315.

Technical specifications for Sendix 5834FS2/FS3

	Sendix 5834FS2/FS3
Supply voltage	5 V DC ± 5 %
Current input without load	max. 70 mA
Pulses per revolution	1024
Outputs	Sine signal: B, B_inv Cosine signal: A, A_inv
Maximum frequency	400 kHz
Signal level	1 Vpp
Maximum speed	9000 rpm/6000 rpm (continuous)
Operating temperature range	-40 ... +90 °C
Degree of protection acc. to EN 60529	IP65
Maximum admissible axial force	40 N
Maximum admissible radial cantilever force	80 N
Connection system	12-pin connector M23 with 1 m cable
Certificates	PLD/SIL2 – SIL 3/PLe
Weight	0.45 kg
Shock resistance acc. to EN 60068-2-27	500 m/s ² , 11 ms
Vibration resistance acc. to EN 60068-2-6	200 m/s ² , 10 ... 150 Hz

Manufacturer:
Fritz Kübler GmbH
Schubertstrasse 47
78054 Villingen-Schwenningen, Germany
Phone +49 (7720) 3903-0
Fax +49 (7720) 21564

www.kuebler.com/drehgeber
Email: info@kuebler.com

Introduction

Mounting technology

Special technology

1

Overview

HOGS 100 S rotary pulse encoder



The HOGS 100 S rotary pulse encoder from Baumer in the version SinCos can be used in compliance with safety integrity level SIL2 when mounted complete on motors with order code **G25** for frame sizes 180 to 450.

Technical specifications for HOGS 100 S

Supply voltage	HOGS 100 S 5 V DC \pm 10 %
Current input under load	\leq 150 mA
Sine cycles per revolution	1024
Operating speed	\leq 10000 rpm
Signal frequency	\leq 250 kHz
Temperature range	-20 ... +85 °C
Degree of protection	IP66
Maximum adm. axial force	250 N
Maximum adm. radial cantilever force	400 N
Connection system	Terminal box
Anti-corrosion protection	Complies with corrosivity category C4 acc. to ISO 12944-2
Explosion protection (gas)	II 3G Ex nA IIC T4 Gc
Explosion protection (dust)	II 3D Ex tc IIIC T135°C Dc
Functional safety	PL d / SIL2
Weight	1.8 kg

Manufacturer:

Baumer Hübner GmbH
Max-Dohrn-Str. 2+4
10589 Berlin, Germany
Phone +49 (30) 69003-0
Fax +49 (30) 69003-104

www.baumer.com

Email: sales@baumerhuebner.com

FSI 862 rotary pulse encoder



This FSI 862 rotary pulse encoder is extremely rugged and is therefore suitable for difficult operating conditions. This rotary pulse encoder in a HC HTL (High Current HTL) version can be used in compliance with safety integrity level SIL2 when mounted complete on motors with order code **G27** for frame sizes 180 to 450.

Technical specifications for FSI 862

Supply voltage	FSI 862 9 ... 30 V DC
Current input	60 mA at 24 V DC (max. 80 mA)
Output current	\pm 40 mA
Pulses per revolution	1024 or 2048
Outputs	HCHTL
Pulse offset between the two outputs	90° el \pm 25° el
Pitch error	\pm 50 el
Cable length	max. 350 m at 100 kHz
Maximum speed	6000 rpm
Temperature range	-40 ... +85 °C
Degree of protection	IP66 (IP67)
Maximum adm. radial cantilever force	100 N
Maximum adm. axial force	300 N
Connection system	Cable gland M20
Weight	approx. 1.3 kg
Shock resistance acc. to	\leq 400 g, 3.5 ms EN 60068-2-27
Vibration resistance acc. to	\leq 20 g, 55 ... 2000 Hz EN 60068-2-6

Manufacturer:

Leine und Linde AG
Olivehällsvägen 8
SE-64542 Strängnäs
Phone +46 152 265 00
Fax +46 152 265 05

www.leinelinde.com

Email: info@leinelinde.de

Overview

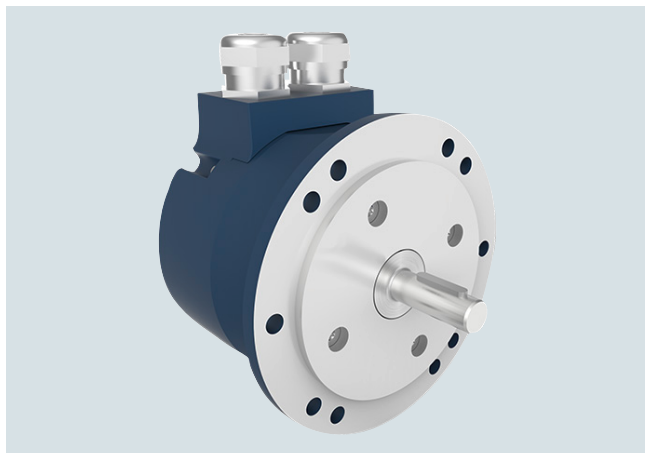
XSI 850 rotary pulse encoder

The XSI 850 with HC HTL (High Current HTL) rotary pulse encoder can be used in compliance when mounted complete on motors with order code **G93** for frame sizes 180 to 450.

More information:

- programming of 4 logical signals
- available settings
 - Overspeed
 - Underspeed
 - Programmable level: Standstill to 6000 rpm
 - Direction

Technical specifications for XSI 850

	XSI 850
Supply voltage	9 ... 30 V DC
Current input	60 mA at 24 V DC (max. 80 mA)
Output current	± 40 mA
Pulses per revolution	1024
Outputs	HCHTL
Pulse offset between the two outputs	90° el ± 25° el
Pitch error	± 50 el
Cable length	max. 350 m at 100 kHz
Maximum speed	6000 rpm
Temperature range	-20 ... +85 °C
Degree of protection	IP67
Maximum adm. radial cantilever force	1200 N
Maximum adm. axial force	500 N
Connection system	Cable gland M20
Weight	approx. 1.3 kg
Shock resistance acc. to	≤ 400 g, 3.5 ms
Vibration resistance acc. to	≤ 20 g, 55 ... 2000 Hz

Manufacturer:

Leine und Linde AG
Olivehällsvägen 8
SE-64542 Strängnäs
Phone +46 152 265 00
Fax +46 152 265 05

www.leinelinde.com
Email: info@leinelinde.de

XHI 861 rotary pulse encoder

The XHI 861 with HC HTL (High Current HTL) rotary pulse encoder can be used in compliance when mounted complete on motors with order code **G94** for frame sizes 180 to 450.

More information:

- programming of 4 logical signals
- available settings
 - Overspeed
 - Underspeed
 - Programmable level: Standstill to 6000 rpm
 - Direction

Technical specifications for XHI 861

	XHI 861
Supply voltage	9 ... 30 V DC
Current input	60 mA at 24 V DC (max. 180 mA)
Output current	± 40 mA
Pulses per revolution	1024
Outputs	HCHTL
Pulse offset between the two outputs	90° el ± 25° el
Pitch error	± 50 el
Cable length	max. 350 m at 100 kHz
Maximum speed	6000 rpm
Temperature range	-20 ... +85 °C
Degree of protection	IP67
Maximum adm. radial cantilever force	1200 N
Maximum adm. axial force	500 N
Connection system	Cable gland M20
Weight	approx. 1.3 kg
Shock resistance acc. to	≤ 200 g, 6 ms
Vibration resistance acc. to	≤ 20 g, 55 ... 2000 Hz

Manufacturer:

Leine und Linde AG
Olivehällsvägen 8
SE-64542 Strängnäs
Phone +46 152 265 00
Fax +46 152 265 05

www.leinelinde.com
Email: info@leinelinde.de

Introduction

Mounting technology

Special technology

1

Overview

Backstop, counterclockwise/clockwise motion blocked

The backstop (order code **F40/F41**) prevents the motor from moving while in de-energized state against its direction of rotation in the energized state.

The backstop is only available for SIMOTICS SD – 1LE15/1LE16, 1LE55/1LE56, VSD10, VSD4000 motors.

- Counterclockwise motion blocked: Option **F40**
- Clockwise motion blocked: Option **F41**

Motor series	Frame size	No. of poles	Backstop Type	Rated torque, theoretical	Start speed	Maximum speed	Order code F40	Order code F41
				Nm	rpm	rpm	Δl mm	Δl mm
1LE15/1LE16 1FP15	132	2, 4, 6, 8	FXM 66-25 NX	950	700	5000	114	114
	160	2, 4, 6, 8	FXM 76-25 NX	1200	670	5000	130	130
	180	2, 4, 6, 8	FXM 76-25 NX	1200	670	5000	126	126
	200	2, 4, 6, 8	FXM 86-25 NX	1600	630	5000	137	137
	225	2, 4, 6, 8	FXM 86-25 NX	1600	630	5000	183	183
	250	2, 4, 6, 8	FXM 86-25 NX	1600	630	5000	106	106
	280	2, 4, 6, 8	FXM 100-40 MX	3700	400	4500	112	112
	315	2, 4, 6, 8	FXM 120-50 MX	7700	320	4000	115	115
1LE55/1LE56	315	2	FXM 120-50 MX	7700	320	4000	115	115
		4, 6, 8	FXM 140-50 MX	10100	320	3000	115	115
	355	2	FXM 120-50 MX	7700	320	4000	155	155
	4	FXM 140-50 MX	10100	320	3000	155	155	
		6, 8	FXM 170-63 MX	20500	250	2700	155	155

Protective cover diameter

Frame size	Protective cover for separately driven fan	Protective cover	Protective cover for encoder		Protective cover for encoder adapter	Protective cover
		H00	G11/G12	G04 ... G06	G41/G42	F75
	mm	mm	mm	mm	mm	mm
71	140	125	125	–	–	–
80	157	155	155	–	155	160
90	177	155	155	–	155	180
100	210	195	195	195	195	195
112	249	195	195	195	195	195
132	300	260	260	260	260	260
160	338	260	260	260	260	260
180	340	340	165	340	340	340
200	338	340	165	340	340	340
225	470	425	165	250	165	–
250	470	470	165	250	165	–
280	525	525	165	250	165	–
315	590	525	165	250	165	–
355	On request	On request	On request	On request	On request	On request
400	On request	On request	On request	On request	On request	On request
450	On request	On request	On request	On request	On request	On request

Overview

Dimensions and weights

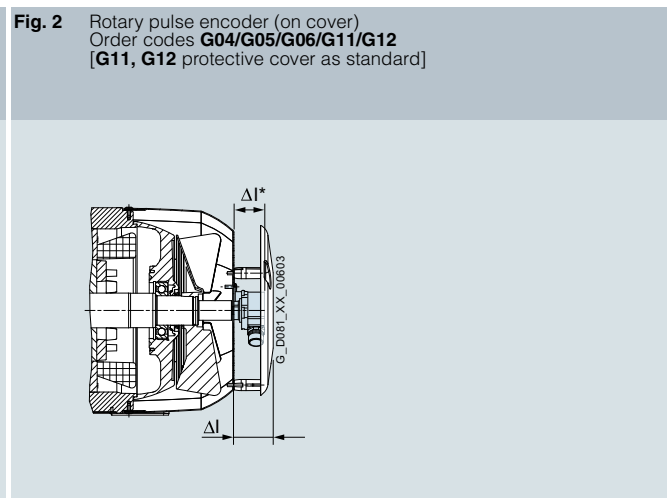
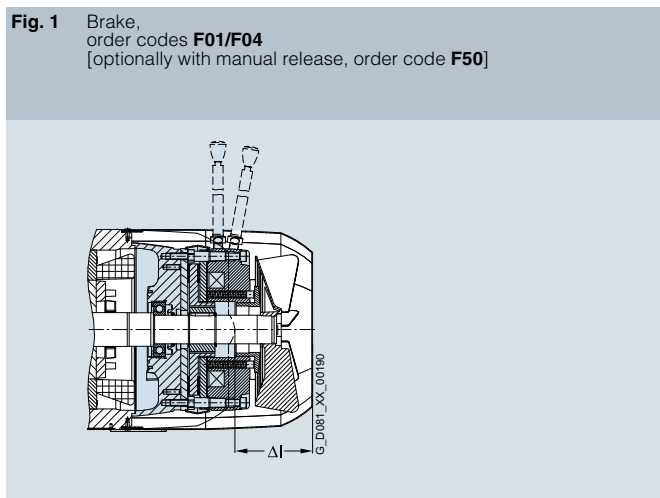

Assignment										
Frame size	Fig. 1 Brake		Fig. 2 Rotary pulse encoder including protective cover (G43)							
	Order codes F01/F04		Order code G04		Order code G05		Order code G06		Order codes G11/G12	
	Δl	Weight, approx.	Δl	Weight, approx.	Δl	Weight, approx.	Δl	Weight, approx.	Δl	Weight, approx.
	mm	kg	mm	kg	mm	kg	mm	kg	mm	kg
1LE1										
80	60	3.5	–	–	–	–	–	–	68.5	0.8
90	77.5	5.3	–	–	–	–	–	–	68.5	0.8
100	81	5.9/9.1	83	1.9	83	1.5	126	2.2	56	1.0
112	88	7.8/11.8	83	1.9	83	1.5	126	2.2	56	0.9
132	114	11.9/17.6	87	2.4	87	2	130	2.7	60	1.4
160	130	30.7/40.5	87	2.7	87	2.3	130	3	60	1.6
180	126	28/37.8	136.5	2.3	136.5	1.9	136.5	2.6	87	2.2
200	137	38/53.8	136.5	2.5	136.5	2.1	136.5	2.8	87	2.4
225	135/199	63/49	135	2	135	1.6	135	2.3	87	1
250	225/185	83/54	135	2	135	1.6	135	2.3	87	1
280	297/192	118/92	135	2	135	1.6	135	2.3	87	1
315	308/188	256/167	135	2	135	1.6	135	2.3	87	1
1LE5										
315	309	355	135	2	135	1.6	135	2.3	87	1
355	324	425	135	2	135	1.6	135	2.3	87	1
400	On request	On request	On request	On request	On request	On request	On request	On request	On request	On request
450	On request	On request	On request	On request	On request	On request	On request	On request	On request	On request

Assignment										
Frame size	Fig. 2 Rotary pulse encoder without protective cover		HOG 9 DN 1024 I				HOG 10 D 1024 I		Sendix 5020	
	Order code G04		Order code G05		Order code G06		Order codes G11/G12		Order codes G11/G12	
	Δl	Weight, approx.	Δl	Weight, approx.	Δl	Weight, approx.	Δl	Weight, approx.	Δl	Weight, approx.
	mm	kg	mm	kg	mm	kg	mm	kg	mm	kg
1LE1										
225	75	1.3	72	0.9	116	1.6	65	0.4	65	0.4
250	75	1.3	72	0.9	116	1.6	65	0.4	65	0.4
280	75	1.3	72	0.9	116	1.6	65	0.4	65	0.4
315	75	1.3	72	0.9	116	1.6	65	0.4	65	0.4
1LE5										
355	On request	On request	On request	On request	On request	On request	On request	On request	On request	On request
400	On request	On request	On request	On request	On request	On request	On request	On request	On request	On request
450	On request	On request	On request	On request	On request	On request	On request	On request	On request	On request

Introduction

Mounting technology

Dimensions and weights of the mountings

1

Overview

Fig. 3 Brake and rotary pulse encoder (on cover), order codes **F01/F04 + G04/G05/G06/G11/G12** [optionally with manual release, order code **F50**; **G11, G12** protective cover as standard]

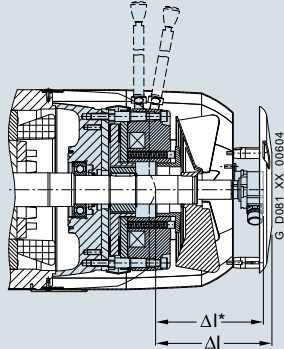
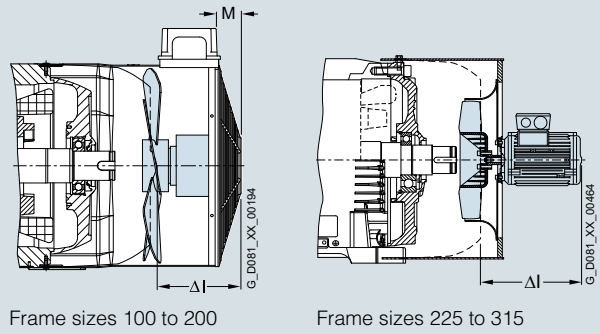

Fig. 4 Separately driven fan, order code **F70**



Frame size	Assignment Fig. 3 Brake and rotary pulse encoder (on cover) LL 861 900 220				HOG 9 D 1024 I		HOG 10 D 1024 I		Sendix 5020		Fig. 4 Separately driven fan	
	Order codes F01 + G04	Weight, approx.	Order codes F01 + G05	Weight, approx.	Order codes F01 + G06	Weight, approx.	Order codes F01 + G11/G12	Weight, approx.	Order code F70	M	Weight, approx.	
	Δl	kg	Δl	kg	Δl	kg	Δl	kg	Δl	mm	kg	
	mm		mm		mm		mm		mm			
1LE1												
71	–	–	–	–	–	–	–	–	75	20	1.9	
80	–	–	–	–	–	–	128.5	4.3	88	20	1.9	
90	–	–	–	–	–	–	146	6.1	104	30	2.5	
100	164	7.8/11	164	7.4/10.6	207	8.1/11.3	137	6.9/10.1	86.5	30	2.6	
112	171	9.7/13.7	171	9.3/13.3	214	10/14	144	8.7/12.7	81.5	30	2.9	
132	201	14.3/20	201	13.9/19.6	244	14.6/20.3	174	13.3/19	116	40	3.9	
160	217	33.4/43.2	217	33/42.8	260	33.7/43.5	190	32.3/42.1	135.5	40	5.6	
180	216	30.3/40.1	216	29.9/39.7	252	30.6/40.4	216	30.2/40	257	40	8.3	
200	228	40.5/56.3	228	40.1/55.9	264	40.8/56.6	228	40.4/56.2	262	40	9.3	
225	210	64.3	207	64.2	251	63.9	186	63.4	259	–	27	
250	300	84.3	297	84.2	341	83.9	276	83.4	264	–	30	
280	372	119.3	369	119.2	413	118.9	348	118.4	260	–	33	
315	383	256.3	380	256.2	424	255.9	359	256.4	312 ¹⁾	–	44,8 ¹⁾	
315	–	–	–	–	–	–	–	–	274 ²⁾	–	41 ²⁾	
1LE5												
315 2-pole	444	357	444	356.6	444	357.3	396	356	307	–	44.6	
4-, 6- and 8-pole	–	–	–	–	–	–	–	–	272	–	41.3	
355	459	427	459	426.6	459	427.3	411	426	320	–	34.5	
400	On request	On request	On request	On request	On request	On request	On request	On request	On request	On request	On request	
450	On request	On request	On request	On request	On request	On request	On request	On request	On request	On request	On request	

Frame size	Assignment Fig. 3 Brake and rotary pulse encoder (on cover) LL 861 900 220				HOG 9 D 1024 I		HOG 10 D 1024 I		Sendix 5020	
	Order codes F04 + G04	Weight, approx.	Order codes F04 + G05	Weight, approx.	Order codes F04 + G06	Weight, approx.	Order codes F04 + G11/G12	Weight, approx.	Order code F70	M
	Δl	kg	Δl	kg	Δl	kg	Δl	kg	Δl	mm
	mm		mm		mm		mm		mm	
1LE1										
225	274	50.3	271	49.9	315	50.6	285.5	49.4		
250	260	55.3	257	54.9	301	55.6	271.5	54.4		
280	267	93.3	264	92.9	308	93.6	278.5	92.4		
315	263	168.3	260	167.9	304	168.6	274.5	167.4		

¹⁾ Valid for 4-pole, 6-pole, and 8-pole motors

²⁾ Valid for 2-pole motors

Overview

Fig. 5 Brake and separately driven fan, order codes **F01/F04 + F70** [optionally with manual release, order code **F50**]

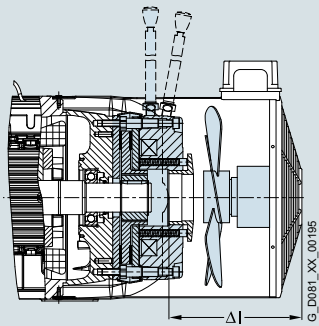

Frame sizes 100 to 200

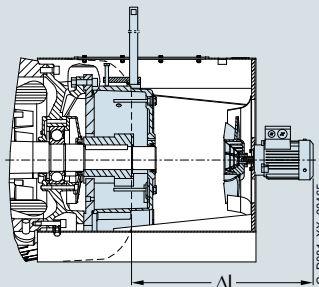

Frame sizes 225 to 355

Fig. 6 Rotary pulse encoder (under cover) and separately driven fan, order codes **F70 + G04/G05/G06/G11/G12**

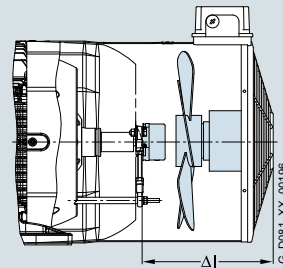

Frame sizes 100 to 200

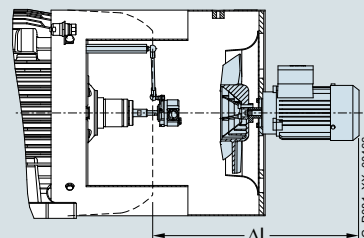

Frame sizes 225 to 355

Assignment

Frame size	Fig. 5 Brake and separately driven fan				Fig. 6 Separately driven fan and rotary pulse encoder (under cover)							
	Order codes F01 + F70		Order codes F04 + F70		Order codes F70 + G04		Order codes F70 + G05		Order codes F70 + G06		Order codes F70 + G11/G12	
	Δl	Weight, approx.	Δl	Weight, approx.	Δl	Weight, approx.	Δl	Weight, approx.	Δl	Weight, approx.	Δl	Weight, approx.
	mm	kg	mm	kg	mm	kg	mm	kg	mm	kg	mm	kg
1LE1												
71	–	–	–	–	–	–	–	–	–	–	165	2.7
80	161.5	5.4	–	–	–	–	–	–	–	–	161.5	3
90	174	7.7	–	–	–	–	–	–	–	–	174	3.6
100	161.5	6.9	161.5	10.1	161.5	4.8	161.5	4.4	246.5	5.3	161.5	3.9
112	156.5	8.7	156.5	12.7	156.5	5.1	156.5	4.7	241.5	5.6	156.5	4.1
132	186	13.3	186	19	186	6.8	186	6.4	291	7.4	186	5.8
160	205.5	32.3	205.5	42.1	205.5	9.8	205.5	9.4	320.5	10.5	205.5	8.7
180	257	30.2	257	40	257	10.6	257	10.2	400	10.9	257	10.5
200	262	40.4	262	56.2	262	11.8	262	11.4	397	12.1	262	11.7
225	601	92	448	65	448	31	448	31	448	31	448	30
250	618	115	418	81	463	33	463	33	463	33	463	32
280	577	154	577	125	467	36	467	36	467	36	467	35
315 2-pole	617	305	–	–	509	51	509	50	509	51	509	50
315 4-, 6- and 8-pole	579	301	579	208	471	47	471	47	471	47	471	46
1LE5												
315 2-pole	633	415.7	–	–	497	46.6	497	46.2	497	46.9	497	45.6
315 4-, 6- and 8-pole	593	413.7	–	–	462	42.3	462	41.9	462	42.6	462	41.3
355	628	471.7	–	–	381	29.5	381	29.1	381	29.8	381	28.5
400	On request	On request	On request	On request	On request	On request	On request	On request	On request	On request	On request	On request
450	On request	On request	On request	On request	On request	On request	On request	On request	On request	On request	On request	On request

Introduction

Mounting technology

Dimensions and weights of the mountings

1

Overview

Fig. 7 Brake, rotary pulse encoder (under cover) and separately driven fan, order codes **F01/F04 + F70 + G04/G05/G06/G11/G12** [optionally with manual release, order code **F50**]

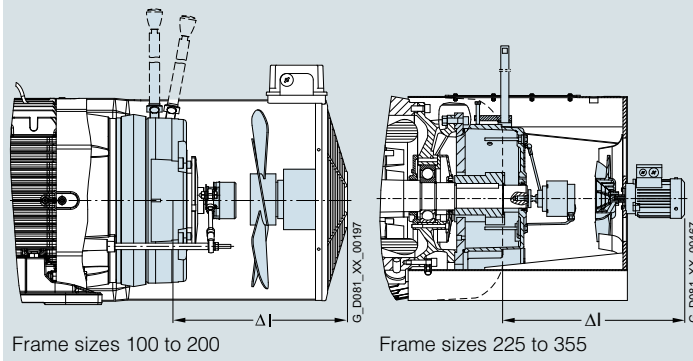
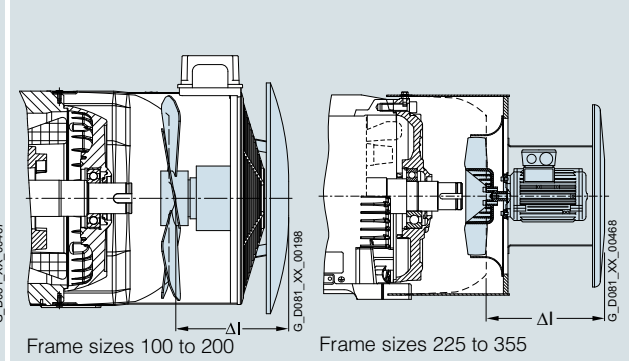

Fig. 8 Protective cover for separately driven fan, order code **H00**



Frame size	Assignment Fig. 7 Brake, separately driven fan, and rotary pulse encoder (under cover)						Sendix 5020 Order codes F01 + F70 + G11/G12		Fig. 8 Protective cover for separately driven fan Order code F70+H00		
	Order codes F01 + F70 + G04	Weight, approx.	Order codes F01 + F70 + G05	Weight, approx.	Order codes F01 + F70 + G06	Weight, approx.	Δl	Weight, approx.	Δl	Weight, approx.	Diameter of the separately-driven-fan cover
	mm	kg	mm	kg	mm	kg	mm	kg	mm	kg	mm
1LE1											
80	–	–	–	–	–	–	186.5	6.7	124.5	0.2	157
90	–	–	–	–	–	–	199	9	141.5	0.2	177
100	196.5	10.9	196.5	10.5	246.5	11.5	196.5	10	124	1.4	210
112	191.5	13.1	191.5	12.7	241.5	13.6	191.5	12.1	122	1.8	249
132	241	19	241	18.6	291	19.6	241	18	149	2.4	300
160	270.5	40.9	270.5	40.5	320.5	41.6	270.5	39.8	177	3	338
180	257	38.6	257	38.2	400	40.6	257	38.5	288	1.7	338
200	262	49.9	262	49.1	397	51.5	262	49.7	293	1.7	338
225	601	93.3	601	93.2	601	93.9	601	92.4	305	2.5	427
250	618	116.3	618	116.2	618	116.9	618	115.4	311	2.5	485
280	577	155.3	577	155.2	577	155.9	577	154.4	307	2.5	535
315 2-pole	617	306.3	617	306.2	617	306.9	617	306.9	–	–	–
315 4-, 6- and 8-pole	579	302.3	579	302.2	579	302.9	579	301.4	321 ¹⁾	2.5 ¹⁾	600 ¹⁾
1LE5											
315 2-pole	665	422	665	421.9	665	422.6	665	421.1	402	46.1	618
315 4-, 6- and 8-pole	630	421	630	420.9	630	421.6	630	420.1	317	43.5	618
355	700	478	700	477.9	700	478.6	700	477.1	330	36	695
400	On request	On request	On request	On request	On request	On request	On request	On request	On request	On request	On request
450	On request	On request	On request	On request	On request	On request	On request	On request	On request	On request	On request

Frame size	Assignment Fig. 7 Brake, separately driven fan, and rotary pulse encoder (under cover)						Sendix 5020 Order codes F04 + F70 + G11/G12	
	Order codes F04 + F70 + G04	Weight, approx.	Order codes F04 + F70 + G05	Weight, approx.	Order codes F04 + F70 + G06	Weight, approx.	Δl	Weight, approx.
	mm	kg	mm	kg	mm	kg	mm	kg
1LE1								
225	601	72.3	601	71.9	601	72.6	601	71.4
250	618	85.3	618	84.9	618	85.6	618	84.4
280	577	126.3	577	125.9	577	126.6	577	125.4
315	579	209.3	579	208.9	579	209.6	579	208.4
1LE5								
315 2-pole	665	424.7	665	424.3	665	425	665	423.7
315 4-, 6- and 8-pole	630	421.7	630	421.6	630	422	630	420.7
355	700	480.7	700	480.3	700	481	700	479.7

¹⁾ Valid for FS 315 (2, 4, 6, and 8-pole)

Overview

Fig. 9 Prepared for mountings, center hole only (for BFK458 brake, order code **F01** and/or encoder order code **G04/G05/G06/G11/G12**), order code **G40** (up to frame size 160, standard with frame size 180 and above)

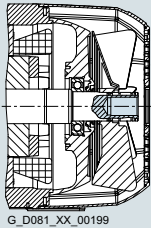
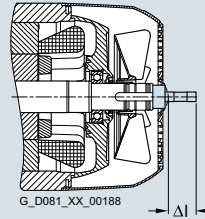

Fig. 10 Prepared for mountings with shaft D12/D16, order code **G41/G42**



Assignment

Fig. 9

Frame size Prepared for mountings, center hole only (for BFK458 brake, order code **F01** and/or encoder order codes **G04/G05/G06/G11/G12**) order code **G40**

Order code **G40**

Δl Weight, approx.
mm kg

Fig. 10

Prepared for mountings with shaft D12/D16, order code **G41/G42**

Order code **G41**

Δl Weight, approx.
mm kg

Order code **G42**

Δl Weight, approx.
mm kg

	Δl mm	Weight, approx. kg	Order code G41 Δl mm	Weight, approx. kg	Order code G42 Δl mm	Weight, approx. kg
1LE1						
71	–	–	–	–	–	–
80	–	–	22	0.1	52	0.1
90	–	–	22	0.1	52	0.1
100	–	–	18.3	0.15	54.3	0.2
112	–	–	14.5	0.15	54.3	0.2
132	–	0.1	18.8	0.3	58.8	0.4
160	–	0.2	18.6	0.4	55.6	0.7
180	–	–	18	0.27	57	0.33
200	–	–	17	0.27	56	0.27
225	–	–	23	0.27	58	0.33
250	–	–	23	0.27	58	0.33
280	–	–	23	0.27	58	0.33
315	–	–	23	0.27	58	0.33
1LE5						
315	–	–	23	0.27	58	0.33
355	–	–	23	0.27	58	0.33
400	On request	On request	On request	On request	On request	On request
450	On request	On request	On request	On request	On request	On request

Introduction

Mounting technology

Notes

1

Overview

Fig. 11 Standard protective cover for types of construction, order code **H00**

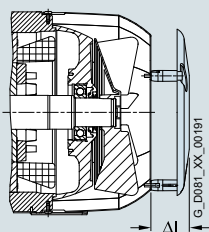
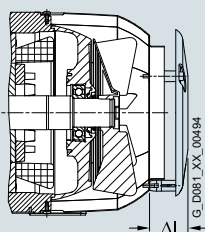

Fig. 12 Protective cover for textile industry, order code **F75**



Assignment

Fig. 11

Fig. 12

Frame size Protective cover
Order code
H00

Protective cover
Order code
F75

Frame size	Δl mm	Weight, approx. kg	Δl mm	Weight, approx. kg
71	29	0.15	–	–
80	128	0.3	17	0.3
90	144	0.4	15	0.4
100	137	0.5	64	0.7
112	122	0.7	64	0.9
132	156	1.3	71	1.3
160	182.5	1.7	71	1.9
180	285	1.7	90	3.2
200	297	1.7	90	3.4
225	100	2.2	On request	On request
250	100	2.4	On request	On request
280	110	3.4	On request	On request
315	110	4	On request	On request
1LE5				
315	110	8	–	–
355	140	8.5	–	–
400	On request	On request	–	–
450	On request	On request	–	–

Standard motors SIMOTICS CONNECT 400 / SIDRIVE IQ Fleet

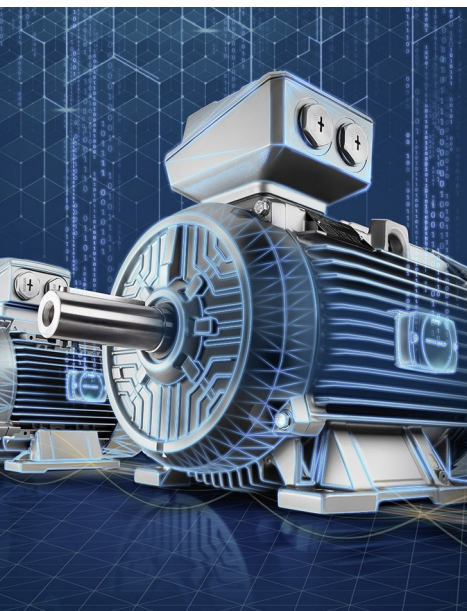

2/2	Orientation
2/2	Overview
2/2	Benefits
2/3	Design
2/3	More information
2/4	Connectivity Module
2/4	Technical specifications
2/5	Design
2/6	Ordering data
2/6	Dimensional drawings
2/7	Analytic software
2/7	Overview
2/8	Ordering data
2/9	Commissioning and Usage
2/9	Ordering data

SIMOTICS GP and SIMOTICS SD standard motors

SIMOTICS CONNECT 400 / SIDRIVE IQ Fleet

Orientation

Overview

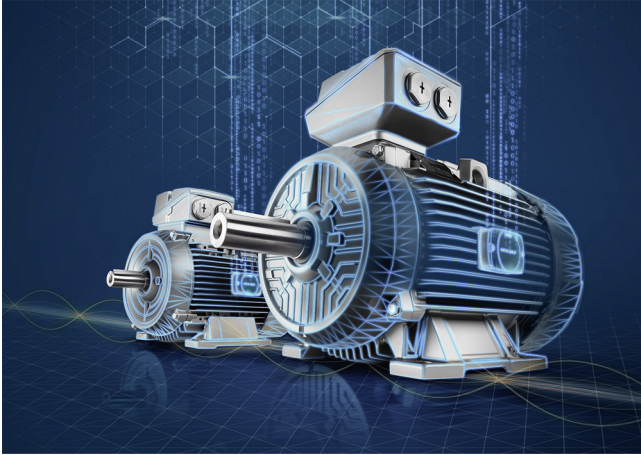

Drive systems keep production running and play a key role in countless production processes. Faults or the failure of individual drive components often result in costly production outages, which is why it's so important to monitor the condition of the machine park. The prevention of failures through timely and planned action requires end-to-end operational transparency and measures such as targeted, proactive maintenance.

With the plug&play connectivity module SIMOTICS CONNECT 400 and the analytics app SIDRIVE IQ Fleet, you can implement a cost effective, cloud-based solution for continuous condition monitoring and comprehensive fleet management of your low-voltage motors – worldwide and 24/7.

Your low-voltage motors are equipped with SIMOTICS CONNECT 400, a connectivity module for measuring and preprocessing the motor-specific status data that's analyzed in SIDRIVE IQ Fleet.

Whether you're monitoring new motors or flexibly upgrading your installed base – in many use cases, the SIDRIVE IQ Fleet MindSphere application improves the reliability, availability, efficiency, performance, and productivity of your low-voltage motors. You take advantage of preventive maintenance for your motors using reliable status data and information on maintenance intervals.

Benefits

- Simplicity and user-friendliness:
 - Simple mounting by gluing the sensor module SIMOTICS CONNECT 400 to the motor
 - Fast commissioning and configuration, thanks to the intuitively operated smartphone app SIDRIVE IQ Config
 - Use of standard network hardware (no manufacturer-specific gateways needed)
- Autonomous design: Power supply via battery pack and data transfer via WLAN require no connecting cables
- Optimized serviceability: Simple as well as ecologically and economically practical maintenance by replacing the battery pack
- Optimum operational transparency: SIMOTICS CONNECT 400 and SIDRIVE IQ Fleet help machine operators to better understand their machines and all relevant components. With knowledge of how the motors are currently running and what changes in operation have occurred, it's possible to make predictions about operational performance in the future.
- Anomaly detection and trend analyses based on historical data for optimizing your plant
- Adjustable limit values and automated alarms help you to detect impending failures well in advance and prevent them through maintenance activities
- Take advantage of our expert knowledge of drive technology by taking into account operational data (including historical), digital twins of the motors, intelligent algorithms, and analytics
- Access to cloud-based analytics in MindSphere from any terminal device via a web browser, without software installation
- Higher data quality and precision for Siemens motors, thanks to the use of equivalent electrical circuit diagrams, product-specific data from production, and other additional elements from the digital twin of the motor

Design

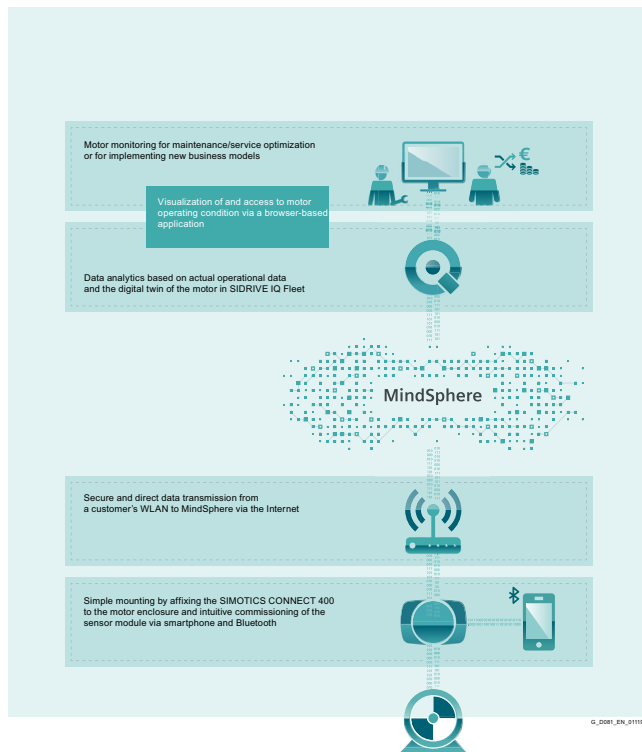

Besides monitoring the actual health of your motor fleet, the cloud-based SIDRIVE IQ Fleet application embedded in the MindSphere ecosystem provides nearly endless opportunities for customer business models.

Enabling new digital business models is a key feature and differentiator in the architecture of SIDRIVE IQ Fleet.

Plug&play is key:

Installation, commissioning and configuration of SIMOTICS CONNECT 400 is as easy as it gets. Operators have the system up and running within minutes.

Data is transferred automatically and therefore guarantees a continuous condition monitoring of your motor fleet.

More information

For further information, please get in touch with your local Siemens contact or use the Digital Motor website.

Contacts: www.siemens.com/automation/partner

Digital Motor: www.siemens.com/digital-motor

Wherever possible, you will find a local contact for:

- Technical support
- Spare parts/repairs
- Service
- Training
- Marketing & Sales
- Technical consultation/engineering

You start by selecting a:

- Country
- Product
- Sector

SIMOTICS GP and SIMOTICS SD standard motors

SIMOTICS CONNECT 400 / SIDRIVE IQ Fleet

Connectivity Module

Technical specifications

General information	
Product category	Sensor and communication module
Product description	SIMOTICS CONNECT 400 with integrated sensors monitors the condition of the motor to make its operation transparent, which facilitates application and process optimizations. SIMOTICS CONNECT 400 can be used in conjunction with the MindSphere app SIDRIVE IQ Fleet only.
Monitoring application	Visualization of motor health status and data analytics based on digital motor twins are offered in the comprehensive SIDRIVE IQ Fleet MindSphere app.
Measured motor parameters	Temperature, radial/tangential/axial vibration, electrical stator frequency, slip frequency.
Calculated motor parameters	Motor state (on/off), rotation speed, torque ¹⁾ , electrical power ¹⁾ , energy consumption ¹⁾ , number of starts, hours of operation
Extended monitoring and maintenance support	External noise cancelling via peak detection for vibration monitoring, automatic threshold suggestions, maintenance requirements, such as relubrication interval
Supported motors	Fin-cooled, 3-phase asynchronous low-voltage motors in line operation (DOL) and converter operation (VSD), IEC frames sizes 80 to 450 and NEMA frame sizes 48 to 680.
Installation/mounting	
Mounting type and position	Externally mounted on the motor's cooling fins with a mounting bracket (glued). As described in the installation instructions.
Qualified adhesives	HENKEL LOCTITE HY 4090, Weicon Fast Metal Minute Adhesive, 3M Scotch-Weld DP 8407 NS
Power supply	
Type of supply	Battery pack (Li/SOCI ₂ , 3,6 V, 4 cells, AA size, non-rechargeable)
Battery lifetime	Operating time up to 2 years ²⁾ , replaceable for lifetime extension.
Internal data storage	
Internal flash	Data storage of min. 48 hours ³⁾ , when MindSphere connection is interrupted.
Communication	
Bluetooth	Used for configuration and commissioning ⁴⁾ <ul style="list-style-type: none"> • Compliance with Bluetooth v4.1 • Frequency: 2400 to 2482 GHz • Range: up to 10 m
WLAN	Used for data transmission ⁵⁾ and firmware updates. <ul style="list-style-type: none"> • IEEE 802.11 b/g/n • Frequency: 2400 to 2485 GHz • Range: up to 100 m
Status information	
Indication LED (blue)	Status information during configuration process.
Integrated sensors	
Measurement interval	Configurable between 1 minute and 1 hour (default: 5 minutes).
Temperature measurement	
Range	-40 to +85 °C
Resolution	0,03° Temperature measured at the contact between connectivity module and mounting bracket.
Vibration measurement	
Physical measuring principle	Overall vibration V_{RMS} 3-axis
Range	0.02 to 180 mm/s 10 Hz to 1.6 kHz
Magnetic field measurement	
Range	0.01 to 300 Hz Rotary stray field
Standards, approvals, certificates	
	CE, FCC, IC, SRRC, RCM, ETA, SDPPI, ICASA, SUBTEL, ARCOTEL, MTC, FAC, CNC, CRC, NBTC, IMDA, OFCA, MOC, KVALITET, ICT, SIGET
Degree and class of protection	
Degree of protection acc. to EN 60529	IP54 (device variant ≤ FS03 up to 12-2021) IP65 (device variant FS03 from 12-2021)
Shock resistance	Max. 100 m/s ² (tested acc. Class 3M4)

¹⁾ For motors in converter operation (VSD) not available, extension via firmware update.

²⁾ At an ambient temperature of 0 to 40° C, a measurement interval of 5 minutes and a transmission of the stored data once every 24 hours.

³⁾ At measurement interval of 1 minute.

⁴⁾ Commissioning consists of integration into the local WLAN network and onboarding to MindSphere.

⁵⁾ MindSphere synchronization interval adjustable between 1 and 48 hours (default: 24 hours).

Technical specifications

Ambient conditions	
Ambient temperature during operation	-40 to +80 °C
Ambient temperature during storage/ transportation	-20 to +40 °C
Relative humidity	5 to 95 % (without condensation)
Software	
Mobile app for commissioning and configuration	SIDRIVE IQ Config (iOS, Android)
SIMOTICS CONNECT Firmware Update	Prepared for remote firmware update via MindSphere (v0.6.0.0 or newer)
Mechanics/material	
Housing material	Industrial Plastic Durethan® (polyamide, halogen-free, glass-fiber reinforced)
Material of the	
• mounting bracket	stainless steel
• screws	steel, galvanized and passivated
Dimensions	
• Length x height x depth	IP54 version: 125 x 76 x 29 mm IP65 version: 125.4 x 77.5 x 29 mm
Weight	
Weight connectivity module, approx..	0.25 kg
Weight connectivity module including mounting material, approx.	0.5 kg
Documentation and information	
More technical product information and documentation is available at:	www.siemens.com/digital-motor

Design



The delivery is made as a single product packaging:

- SIMOTICS CONNECT 400 connectivity module including batteries (battery plug disconnected during transport)
- Metal mounting bracket for installation on the motor housing
- Retaining screws
- Assembly instructions
- Safety and security information sheet
- CD with license texts

Note:

The adhesive is NOT included in the scope of delivery. We recommend using one of the below listed adhesives, which have been tested and qualified by Siemens:
 Henkel LOCTITE HY 4090, Weicon Fast Metal Minute Adhesive, 3M Scotch-Weld DP 8407 NS

SIMOTICS GP and SIMOTICS SD standard motors

SIMOTICS CONNECT 400 / SIDRIVE IQ Fleet

Connectivity Module

Ordering data

Description	Article No.
SIMOTICS CONNECT 400 Connectivity Kit (1 unit) for connecting low voltage motors to the MindSphere application SIDRIVE IQ Fleet	9LD2200-0BA00-0AA0
SIMOTICS CONNECT 400 Connectivity Kit (10 units) for connecting low voltage motors to the MindSphere application SIDRIVE IQ Fleet	9LD2200-0BA00-0AB0
SIMOTICS CONNECT 400 Connectivity Kit (35 units) for connecting low voltage motors to the MindSphere application SIDRIVE IQ Fleet	9LD2200-0BA00-0AC0
SIMOTICS CONNECT 400 Connectivity Kit (200 units) for connecting low voltage motors to the MindSphere application SIDRIVE IQ Fleet	9LD2200-0BA00-0AD0

One unit corresponds to one SIMOTICS CONNECT 400 Connectivity Kit as described above. Each kit is individually packed. Multi-unit packages are additionally bundled in a bigger outer packaging.

Dimensional drawings

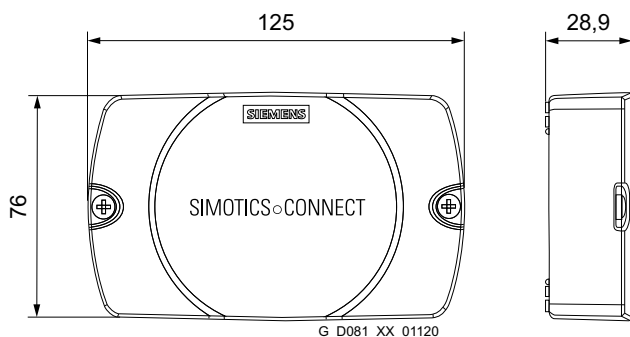

SIMOTICS GP and SIMOTICS SD standard motors

SIMOTICS CONNECT 400 / SIDRIVE IQ Fleet

Analytic software

Overview

MindSphere – the Siemens IoT-as-a-service solution

MindSphere is the leading industrial IoT as a service solution. Using advanced analytics and AI, MindSphere powers IoT solutions from the edge to the cloud – with data from connected products, plants and systems – to optimize operations, create

better quality products and deploy new business models. MindSphere empowers customers and partners to quickly build and integrate personalized IoT applications or utilize the existing ones, such as SIDRIVE IQ Fleet.

Applications

Powerful industry solutions with advanced analytics



SIDRIVE IQ Fleet

IoT offering for motor fleet monitoring



Develop robust industrial IoT solutions faster with global scalability

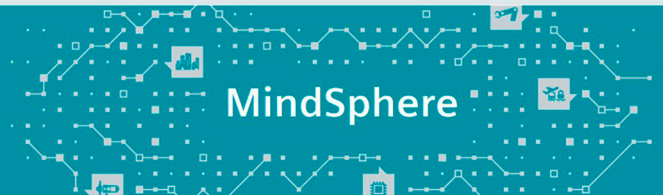

Connectivity

Connect products, plants, systems, machines and enterprise applications

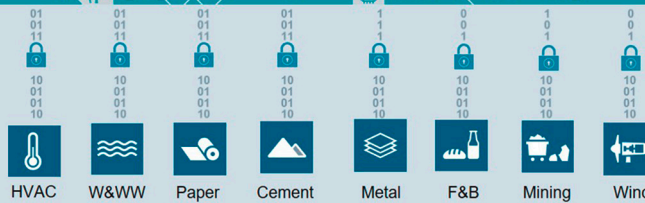

SIMOTICS CONNECT 400

for connecting Low Voltage Motors



SIDRIVE IQ Fleet – cloud-based solution for motor monitoring

The MindSphere application SIDRIVE IQ Fleet allows you to access all relevant data of your installed motors.

The application includes a variety of functions which assist you in managing motors' maintenance and operations. SIDRIVE IQ Fleet provides you with aggregated statistics and localization of your fleet, as well as individual KPIs, logbook, motor profile and product documentation.

By using SIDRIVE IQ Fleet you can optimize your fleet maintenance tasks, reduce unscheduled downtime and increase your plant availability.

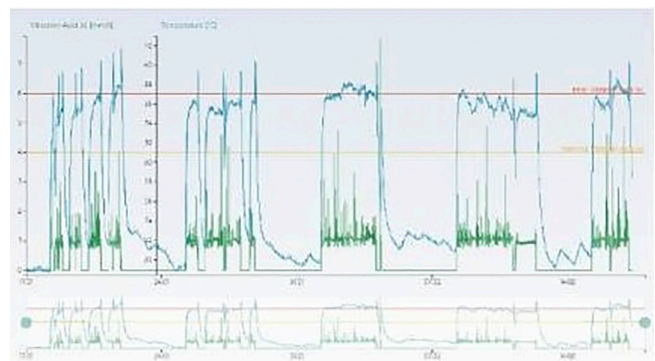
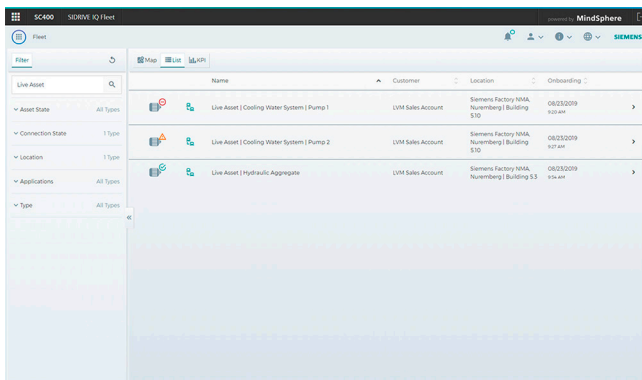

SIMOTICS GP and SIMOTICS SD standard motors

SIMOTICS CONNECT 400 / SIDRIVE IQ Fleet

Analytic software

Ordering data

The SIDRIVE IQ Fleet offering consists of two main package types:

SIDRIVE IQ Fleet Package Basic includes the MindSphere base tenant, the application SIDRIVE IQ Fleet and selected MindSphere resources which are required to access the Platform and to utilize the application.

SIDRIVE IQ Fleet Asset Packages enable you to connect additional motors to your tenant.

Benefit from the pre-defined SIDRIVE IQ Fleet Packages, tailored to your needs. Find the complete SIDRIVE IQ Fleet offering in the MindSphere Store and choose between multiple packages to start your IoT experience by connecting your motors.



G_D081_EN_01121

SIDRIVE IQ Fleet Package Basic

Description:

- provides unique customer tenant with customizable URL and pre-installed SIDRIVE IQ Fleet application
- deployable also on existing customer IoT Value Plan

Provided value:

- free-of-charge access to MindSphere and motor monitoring application SIDRIVE IQ Fleet
- easy-to-understand business model without any hidden costs

SIDRIVE IQ Fleet Asset Packages

Description:

- increases the connectable assets to the tenant by x assets, depending on the package you purchase
- provides the exact amount of MindSphere resources needed for connecting and monitoring x motors

Provided value:

- risk-free and convenient scalability thanks to a flexible asset-based payment model
- benefit of lower per-asset-prices by selecting multiple-asset-packages

All the packages have a standard subscription duration of one year and get automatically renewed at the end of the 12 months. You can find additional information and the terms & conditions in the SIDRIVE IQ Fleet Package Product Sheet.

Purchasing process via MindSphere Store

Process for your MindSphere account creation and SIDRIVE IQ Fleet Packages purchase via MindSphere Store

If you do not have yet a MindSphere Account, access MindSphere Store and follow the steps below to start your journey with SIDRIVE IQ Fleet.

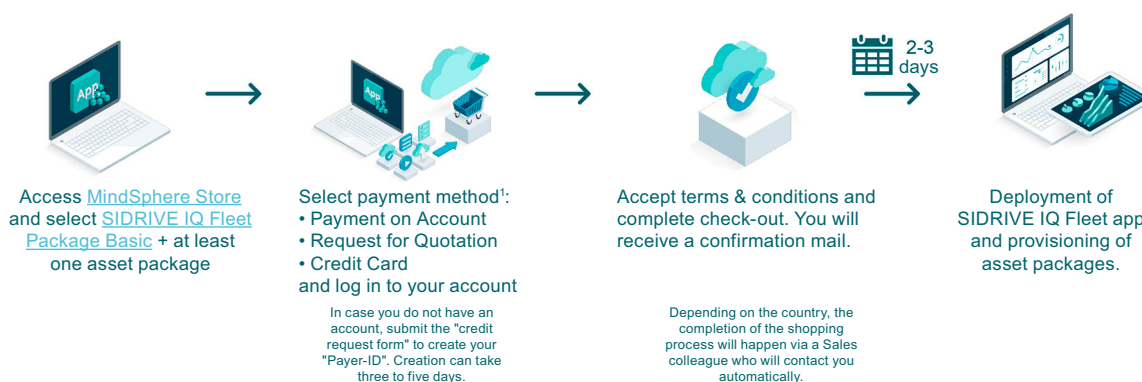

¹ not all payment methods are available for all released countries

G_D081_EN_01122

If you already have a MindSphere payer account, you can purchase the packages starting directly with step 3.

You can find more information and a tutorial SIDRIVE IQ Fleet Packages purchasing process on our website www.siemens.com/digital-motor.

SIMOTICS GP and SIMOTICS SD standard motors

SIMOTICS CONNECT 400 / SIDRIVE IQ Fleet

Commissioning of SIMOTICS CONNECT 400

Ordering data

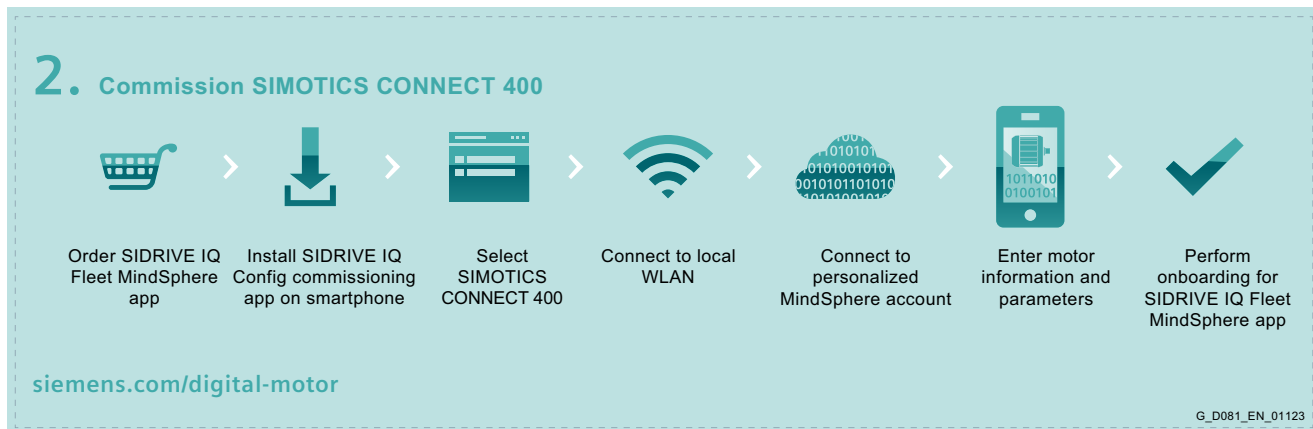

- **Get SIDRIVE IQ Fleet app via the MindSphere Store**
 - Order SIDRIVE IQ Fleet Package Basic (tenant and application) plus at least one SIDRIVE IQ Fleet Asset Package,
 - e.g. SIDRIVE IQ Fleet Package 1 Asset
- **Download commissioning app onto your smartphone**
Install SIDRIVE IQ Config on your mobile device to configure SIMOTICS CONNECT 400
- **Commission SIMOTICS CONNECT 400**
Integrate the sensor module into the local WLAN network and onboard it to MindSphere by using our intuitive mobile app SIDRIVE IQ Config

SIMOTICS GP and SIMOTICS SD standard motors

SIMOTICS CONNECT 400 / SIDRIVE IQ Fleet

Notes

2

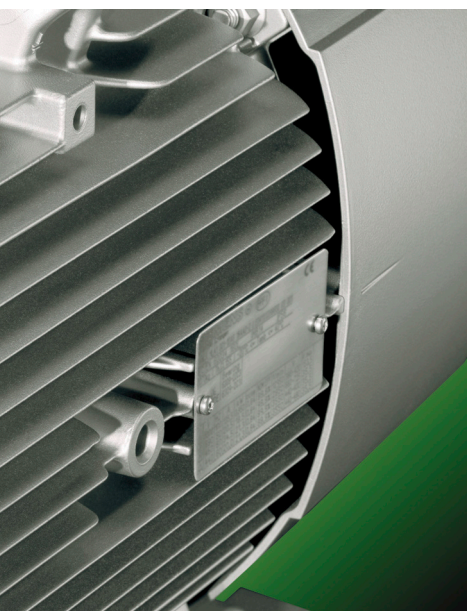

3/2 3/6 3/7	Orientation Converter operation Article number code	3/82 3/82	Eagle Line · NEMA Premium Efficient MG1 Table 12-12 Aluminum series SIMOTICS GP 1LE1023 Cast-iron series SIMOTICS SD • 1LE1523 Basic Line • 1LE1623 Performance Line
3/8 3/8 3/9 3/11	IE4 Super Premium Efficiency Aluminum series SIMOTICS GP 1LE1004 Cast-iron series SIMOTICS SD • 1LE1504 Basic Line • 1LE1604 Performance Line	3/92 3/93	Eagle Line · NEMA Energy Efficient MG1 Table 12-11 Aluminum series SIMOTICS GP 1LE1021 Cast-iron series SIMOTICS SD 1LE1521 Basic Line
3/13 3/13 3/16 3/17 3/18 3/22 3/26 3/28 3/29	IE3 Premium Efficiency Aluminum series SIMOTICS GP • 1LE1003 • 1LE1003 with increased power • 1LE1083 Cast-iron series SIMOTICS SD • 1LE1503 Basic Line • 1LE1603 Performance Line • 1LE1503 Basic Line with increased power • 1LE1603 Performance Line with increased power • 1LE1583	3/94 3/94 3/95	Pole-changing Aluminum series SIMOTICS GP • 1LE1011 for constant load torque • 1LE1011/1LE1012 for square-law load torque
3/32 3/32 3/36 3/38 3/42 3/46 3/48	IE2 High Efficiency Aluminum series SIMOTICS GP • 1LE1001 • 1LE1001 with increased power Cast-iron series SIMOTICS SD • 1LE1501 Basic Line • 1LE1601 Performance Line • 1LE1501 Basic Line with increased power • 1LE1601 Performance Line with increased power	3/97 3/103 3/116 3/119 3/122 3/144	Article No. supplements and special versions Voltages Types of construction Motor protection Terminal box position Options Accessories
3/50 3/50 3/53 3/54 3/58	IE1 Standard Efficiency Aluminum series SIMOTICS GP • 1LE1002 • 1LE1002 with increased power Cast-iron series SIMOTICS SD • 1LE1502 Basic Line • 1LE1502 Basic Line with increased power	3/145 3/145 3/146 3/148 3/150 3/152 3/154	Dimensions Notes on the dimensions Dimension sheet generator Dimensions · Aluminum series SIMOTICS GP IE1, IE2, NEMA Energy Efficient, pole-changing • Frame sizes 63 M to 200 L IE1, IE2 with increased power • Frame sizes 80 M to 200 L IE1, IE2 • Frame sizes 80 M to 200 L IE3, NEMA Premium Efficient • Frame sizes 80 M to 90 L • Frame sizes 100 L to 200 L IE3 with increased power • Frame sizes 100 L to 200 L IE3 • Frame sizes 80 M to 90 L • Frame sizes 100 L to 200 L IE4 • Frame sizes 100 L to 200 L IR3 Rendimento Premium • Frame sizes 80 M to 160 L
3/60 3/60 3/62 3/63 3/66 3/69 3/71	APAC Line · IE3 Premium Efficiency Aluminum series SIMOTICS GP • 1LE1043 • 1LE1043 with increased power Cast-iron series SIMOTICS SD • 1LE1543 Basic Line • 1LE1643 Performance Line • 1LE1543 Basic Line with increased power • 1LE1643 Performance Line with increased power	3/158 3/160 3/162 3/164 3/166	Dimensions · Cast-iron series SIMOTICS SD IE1, IE2, NEMA Energy Efficient • Frame sizes 71 M to 160 L • Frame sizes 180 M to 250 M • Frame sizes 280 S to 315 L IE3, NEMA Premium Efficient • Frame sizes 71 M to 160 L • Frame sizes 180 M to 315 L IE3 1LE1583 • Frame sizes 100 L to 200 L • Frame sizes 225 S to 315 L IE4 • Frame sizes 100 L to 160 L • Frame sizes 180 M to 315 L IR3 Rendimento Premium • Frame sizes 180 M to 280 M • Frame sizes 315 S to 315 L
3/72 3/72 3/74 3/75 3/77	APAC Line · IE2 High Efficiency Aluminum series SIMOTICS GP • 1LE1041 • 1LE1041 with increased power Cast-iron series SIMOTICS SD • 1LE1541 Basic Line • 1LE1541 Basic Line with increased power	3/168 3/170 3/172 3/174 3/176	
3/78 3/78 3/80	ABNT Line · IR3 Rendimento Premium Aluminum series SIMOTICS GP 1E1073 Cast-iron series SIMOTICS SD 1LE1573, 1LE5773	3/178 3/180 3/182 3/184 3/186 3/188	

SIMOTICS GP and SIMOTICS SD standard motors

Orientation

Overview



Increasing energy costs have resulted in greater emphasis on the power consumption of drive systems. It is extremely important to utilize the full potential for minimizing energy consumption here to secure competitiveness today and in the future. The environment will also profit from reduced energy consumption.

This is the reason why we have already developed a new generation of low-voltage motors. Innovative rotors create the best requisites for motors with a high degree of efficiency. IE1 and IE2 motors with the same power have the same dimensions. The new motors for IE2, IE3 and IE4 offer considerable energy savings and protect our environment. We also consider environmental compatibility and sustainable use of resources during production. Potting compounds and coatings are, for example, solvent-free.

The modular mounting concept provides total flexibility. Each motor is based on a uniform concept for all markets worldwide. Our motors are manufactured according to the most advanced ecological standards.

The new 1LE1 motor family is therefore one of the most compact in the world, because it is manufactured using innovative technology. For an optimized design, a compound of highly conductive materials is used in the rotor (up to frame size 200). This results in minimum rotor losses and an excellent starting and switching response.

The design of the 1LE1 motors ensures maximum flexibility and minimum installation costs. Users benefit from integral lifting eyes, screw-on feet, reinforced bearing plates with optimum mechanical properties and easily accessible terminal boxes. Encoders, brakes and separately driven fans can also be added without any problems. Smaller inventories make stockkeeping easier, so motor suppliers can respond to customer requirements more quickly.

The 1LE1/1LE5/1PC1 motor family comprises two main series:

- SIMOTICS GP for general purpose applications: Motors with an aluminum housing

SIMOTICS GP 1LE1/1PC1 motors with an aluminum housing are suitable for a wide range of standard drive tasks in the industrial environment. Thanks to their particular low weight, they are predestined for applications in pumps, fans and compressors. But they also reliably fulfill their tasks in conveyor systems and lifting gear.

Brief overview	
Power and voltage range:	0.09 ... 45 kW for all commonly used voltages
Frame sizes and types of construction:	63 ... 200 in all common types of construction
Rated speed:	750 ... 3600 rpm
Number of poles:	2, 4, 6, 8
Efficiency classes:	<ul style="list-style-type: none"> • IE1 (Standard Efficiency) • IE2 (High Efficiency) • IE3 (Premium Efficiency) • IE4 (Super Premium Efficiency) • IR3 (Rendimento Premium) • NEE (NEMA Energy Efficient, acc. to NEMA MG, Table 12-11) • NPE (NEMA Premium Efficient, acc. to NEMA MG, Table 12-12)

- SIMOTICS SD for severe duty applications: Motors with cast-iron housing

SIMOTICS SD 1LE1/1LE5 motors with a cast-iron housing are extremely rugged and are therefore the first choice for applications under harsh environmental conditions. They master dust or vibration in mills and mixers as well as the corrosive atmosphere in the petrochemical industry.

Brief overview	
Power and voltage range:	0.09 ... 1000 kW for all commonly used voltages
Frame sizes and types of construction:	71 ... 450 in all common types of construction
Rated speed:	750 ... 3600 rpm
Number of poles:	2, 4, 6, 8
Efficiency classes:	<ul style="list-style-type: none"> • IE1 (Standard Efficiency) • IE2 (High Efficiency) • IE3 (Premium Efficiency) • IE4 (Super Premium Efficiency) • IR3 (Rendimento Premium) • NEE (NEMA Energy Efficient, acc. to NEMA MG, Table 12-11) • NPE (NEMA Premium Efficient, acc. to NEMA MG, Table 12-12)

Overview

High efficiency energy-saving motors for a positive energy balance

Depending on requirements, energy-saving motors for a positive energy balance are available that are compliant with the legal requirements applicable in the European economic area in accordance with EU Directive 640/2009 as well as for the North American market in accordance with US federal law EISA (Energy Independence Security Act).

Motors with increased power and compact construction (1LE1)

Motors with increased power and compact construction can be used to advantage in confined spaces. For a slightly longer overall length, the power is at least as high as that of the next largest frame size. These compact motors are also optimized for efficiency. They are offered in IE2 and IE3 and therefore reduce operating costs.

Motors without fan cover and without external fan (1LE1 with order code F90)

Forced-air cooled motors with surface cooling without fan cover and without external fan are mainly used for driving fans.

Motors with reduced power without fan cover and without external fan (1PC1 motors on request)

Naturally cooled motors with surface cooling without fan cover and without external fan are suitable for the following operating conditions:

- Types of duty with adequate cooling times (e.g. temporary duty for positioning drives)
- Environmental conditions that demand compact installation space (e.g. in motors with a stopping function)

Requirements that make an external fan disadvantageous, e.g. simple cleaning in the food industry, textile industry.

Benefits

There is considerable potential in the new 1LE1/1PC1 series of low-voltage motors. As a consistent further development of existing motors, the 1LE1/1PC1 motors offer numerous advantages.

Greater efficiency

Innovative rotor technology and manufacturing technology has been implemented for the IE3 and IE4 high efficiency motor variants. The energy-efficient motors are therefore considerably more compact.

The SinaSave Webtool can be used to calculate the energy saving potential and life cycle costs of all motors. SinaSave can be downloaded free of charge from the following website:
www.sinasave.siemens.com

The 1LE1 motors also impress customers with their extremely long life and their weight-optimized design has a positive effect on the stability of the equipment unit.

A wider range of applications

The motors are certified for worldwide use and satisfy high standards of quality (confirmed, for example, by CSA ¹⁾, UL ²⁾, CQC ³⁾).

Improved design

The rugged housing in modern EMC design has an attractive appearance and enhances functionality. The rotatable, accessible terminal boxes, integral lifting eyes, screw-on feet and reinforced bearing plates ensure this.

Greater power

For the same frame size, the high-performance motors offer one complete rated power level more. We are also consistently implementing energy efficiency improvements here, too. The motors are offered (based on the categories of IEC 60034-30-1) in various efficiency classes.

More flexibility

The optimized design of the motors makes installation easier in general. Encoders, brakes and separately driven fans can be retrofitted easily. Terminal boxes and feet for flexible mounting can be selected. Smaller inventories make stockkeeping easier and motor suppliers can respond to customer requirements more quickly. Optimized manufacturing processes support fast availability. All motors up to 480 V can be operated either directly on the line or on a converter.

For general purpose applications: SIMOTICS GP motors with an aluminum housing

Particularly user friendly

The previously introduced, well-proven, obliquely partitioned terminal box is being implemented consistently throughout the entire motor series.

Special export line

For exporting to NAFTA, the Eagle Line is available. The motors are supplied with the electrical values stamped on the rating plate in accordance with EISA requirements.

¹⁾ Canadian Standard Association

²⁾ Underwriters Laboratories Inc.

³⁾ China Quality Certification

SIMOTICS GP and SIMOTICS SD standard motors

Orientation

Benefits

For severe duty applications: SIMOTICS SD motors with a cast-iron housing

The right motor for various challenges

The following lines are available for severe duty applications:

- **Basic Line (1LE15):** rugged, reliable motors for machine construction
- **Performance Line (1LE16):** Motors for the process industry with reinforced bearings and a more rugged coating – for requirements that extend beyond the Basic Line
- **"Eagle Line":** Motors for exporting to the NAFTA zone; they fulfill the requirements of UL and CSA and are supplied with the electrical values stamped on the rating plate in accordance with EISA requirements

Comparison: Basic Line versus Performance Line

Function	Basic Line	Performance Line
Bearing size	62 (63 from frame size 280 upwards)	63
Relubrication	Optional (standard from frame size 280 upwards)	Standard from frame size 160 upwards (optional for frame size 100 to 132)
Paint system	Standard paint finish, corrosivity category C2 ¹⁾	Special paint finish, corrosivity category C3 ¹⁾
Drainage	Drain plugs	T drains
Rating plate	Aluminum, plastic	Steel
Motor protection	Optional	PTC
Fan cover	Plastic	Steel
Warranty	Optionally 12 or 36 months for frame sizes 180 to 315	Standard 36 months for frame sizes 180 to 315

Compact design

The size of a motor is often an important aspect in the case of machines. For this reason, the 1LE1 motors in IE2 and IE3 are not any longer than their predecessors in the 1LG series in IE2.

Another highlight: some of the IE3 motors fit in the same housing as the IE2 motors. The efficiency classes naturally do not differ with regard to shaft height, so that the mechanical interface to the equipment unit remains the same. This also supports a largely problem-free efficiency upgrade to IE3 – without the need to adapt the mechanical design of a machine.

Greater power

In severe duty applications, motors with increased power can also be the right solution if sufficient space is not available for a standard motor. Because these motors offer the same power range in the next smallest frame size.

Application

As soon as the range of motors and options is complete, it will be possible to use the 1LE1/1PC1 motors from Siemens in all areas and sectors of industry due to their numerous options. They are suitable both for special environmental conditions such as those that predominate in the chemical or petrochemical industry as well as for most climatic requirements such as those of offshore applications.

Their large range of line voltages enables them to be used all over the world.

The wide field of implementation includes the following applications:

- Pumps
- Fan
- Compressors
- Conveyor systems such as cranes, belts and lifting gear
- High-bay warehouses
- Packaging machines
- Automation and drives
- Manufacturing industry
- General machine construction

Motors with a cast-iron housing are particularly suitable for the following severe duty applications:

- Petrochemical industry
- Pharmaceuticals
- Chemical industry
- Printing industry
- Process industry

¹⁾ See also Chapter 1, pages 1/14 and 1/15.

Technical specifications

Overview of technical specifications

This table lists the most important technical specifications. For more information and details, see Catalog Section 1 "Introduction".

Type of motor	SIMOTICS GP/SD 1LE1/1LE5/1PC1 IEC Low-Voltage Motors
Connection types	Star/delta connection The connection type to be used can be established from the Article No. supplements for the required motor.
Number of poles	2, 4, 6, 8
Frame sizes	63 M ... 315 L
Rated power	0.09 ... 300 kW (1LE1/1LE5 motor series)/0.3 ... 9 kW (1PC1 motor series)
Frequencies	50 Hz and 60 Hz
Versions	Self-ventilated 1LE1 energy-saving motors with: <ul style="list-style-type: none"> • IE1 (Standard Efficiency) • IE2 (High Efficiency) • IE3 (Premium Efficiency) • IE4 (Super Premium Efficiency) • IR3 (Rendimento Premium) • NEE (NEMA Energy Efficient, acc. to NEMA MG, Table 12-11) • NPE (NEMA Premium Efficient, acc. to NEMA MG, Table 12-12) Self-ventilated 1LE1 motors with increased power with: <ul style="list-style-type: none"> • IE1 (Standard Efficiency) • IE2 (High Efficiency) • IE3 (Premium Efficiency) Forced-air cooled 1LE1 motors without external fan and fan cover with: <ul style="list-style-type: none"> • IE1 (Standard Efficiency) • IE2 (High Efficiency) • IE3 (Premium Efficiency) • IE4 (Super Premium Efficiency) • IR3 (Rendimento Premium) Naturally cooled 1PC1 motors without external fan and fan cover with: <ul style="list-style-type: none"> • IE1 (Standard Efficiency) • IE2 (High Efficiency) • IE3 (Premium Efficiency) • IE4 (Super Premium Efficiency)
Marking	IEC 60034-30-1 IE1, IE2, IE3, IE4: 2, 4, 6 and 8-pole; NBR 17094-1: IR3 Rendimento Premium: 2, 4, 6, and 8-pole US Energy Independence Security Act EISA: 2, 4, 6 and 8-pole
Rated speed (synchronous speed)	750 ... 3000 rpm
Rated torque	0.6 ... 1978 Nm (1LE1/1LE5 motor series)
Insulation of the stator winding in accordance with EN 60034-1 (IEC 60034-1)	Temperature class 155 (F), utilized acc. to temperature class 130 (B) (also for motors with increased power) DURIGNIT IR 2000 insulation system
Degree of protection according to EN 60034-5 (IEC 60034-5)	IP55 as standard
Cooling according to EN 60034-6 (IEC 60034-6)	<ul style="list-style-type: none"> • Self-ventilated (IC411) (1LE1/1LE5 motor series) frame size 80 M to 315 L • Forced-air cooled (IC418) (1LE1/1LE5 motor series with order code F90), frame size 80 M to 200 L • Naturally cooled (IC410) (1PC1 motor series) frame size 100 L to 160 L
Permissible coolant temperature and installation altitude	-20 ... +40 °C as standard, installation altitude up to 1000 m above sea level. See "Coolant temperature and installation altitude" in Catalog Section 1 "Introduction".
Standard voltages according to EN 60038 (IEC 60038)	50 Hz: 230 V, 400 V, 500 V, 690 V The voltage to be used can be found in the "Selection and ordering data" for the required motor.
Type of construction according to EN 60034-7 (IEC 60034-7)	<ul style="list-style-type: none"> • Without flange: IM B3, IM B6, IM B7, IM B8, IM V5 without protective cover, IM V6, IM V5 with protective cover • With flange: IM B5, IM V1, IM V3, IM B35 • With flange (next largest): IM B14, IM V19, IM V18, IM B34
Paint finish Suitability of paint finish for climate group according to IEC 60721, Part 2-1	Standard: Color RAL 7030 stone gray See "Paint finish" in Catalog Section 1 "Introduction".
Vibration severity grade according to EN 60034-14 (IEC 60034-14)	Grade A (normal – without special vibration requirements) Optionally: Grade B (with special vibration requirements) See "Balance and vibration severity" in Catalog Section 1 "Introduction".
Shaft extension according to DIN 748 (IEC 60072)	Balancing type: half-key balancing as standard See "Balance and vibration severity" in Catalog Section 1 "Introduction".
Sound pressure level according to EN ISO 1680 (tolerance +3 dB)	The corresponding sound pressure level is listed in the selection and ordering data for the required motor.
Weights	The corresponding weight is listed in the selection and ordering data for the required motor.
Modular mounting concept	Rotary pulse encoder, brake, separately driven fan or prepared for mountings
Consistent series concept	<ul style="list-style-type: none"> • Cast housing feet, screwed-on feet available as an option and retrofittable • Terminal box obliquely partitioned and rotatable through 4 × 90° • Bearings at DE and NDE are of identical design, reinforced bearings available as an option
Options	See "Article No. supplements and special versions"

More information

For further information, please get in touch with your local Siemens contact and use the DT Configurator.

Contacts: www.siemens.com/automation/partner
DT Configurator: www.siemens.com/dt-configurator

Wherever possible, you will find a local contact for:

- Technical support
- Spare parts/repairs
- Service
- Training

- Sales
- Technical consultation/engineering

You start by selecting a:

- country,
- product or
- sector.

By further specifying the remaining criteria you will find exactly the right contact partner with his/her respective expertise.

SIMOTICS GP and SIMOTICS SD standard motors

Orientation

Converter operation

Overview

Converter operation up to 480 V +10 % line voltage

See Chapter 1, page 1/27.

During installation, the EMC guidelines must be complied with

Note:

When motors are operated on SINAMICS converters additional losses occur which, depending on the admissible winding temperature, can make it necessary to reduce the torque. The admissible torque values can be obtained from the SIZER (www.siemens.com/sizer) configuring tool. The lowest frequency specified there is 5 Hz. For stationary converter operation at lower frequencies, particularly in the case of frame sizes < 100, it is necessary to inquire at the Quotation Center.

Benefits

Motors operating with frequency converters offer the user numerous advantages.

The motors feature the future-oriented insulation system DURIGNIT IR 2000 (IR = Inverter Resistant). The DURIGNIT IR 2000 insulation system consists of high-quality enamel wires and insulating sheet materials in conjunction with temperature-resistant resin impregnation.

Application

The wide field of implementation includes the following applications:

- Conveyor systems such as cranes, belts and lifting gear
- High-bay warehouses
- Packaging machines
- Automation and drives

Their large range of line voltages enables them to be used all over the world.

Technical specifications

General note

All the data listed in the catalog is applicable for a 50 Hz line supply. With converter operation, the torque reduction factors for constant torque and drives for fans, pumps and compressors must be configured using the "SIZER for Siemens Drives" engineering tool. Higher noise levels must be expected at frequencies other than 50 Hz for motors operating with converters due to the harmonic content of the supply.

Mechanical limit speeds

When the motor is operated above its rated frequency, it is important to note that the maximum speeds are limited by the limits for the roller bearings, critical rotor speed and rigidity of the rotating parts (see page 1/54).

Motor protection

A motor protection function can be implemented using the I^2t sensing capability implemented in the converter software.

If required, more precise motor protection can be afforded by direct temperature measurement using KTY84 sensors, PTC thermistors, or Pt1000 resistance thermometers in the motor winding. Some converters from Siemens determine the motor temperature using the resistance of the temperature sensor. They can be set to a required temperature for alarm and tripping.

Insulation

The insulation of 1LE motors is designed such that converter operation is possible at voltages up to 480 V¹⁾.
 $\hat{U}_{\text{phase-to-phase}} \leq 1500 \text{ V}$, $\hat{U}_{\text{phase-to-ground}} \leq 1100 \text{ V}$, voltage rise times of $t_s > 0.1 \mu\text{s}$.

For converter operation with the power ratings specified in the catalog, the motors are used according to temperature class 155 (F), i.e. in this case neither a service factor > 1 nor an increased coolant temperature is possible (order codes N01, N02 and N03 cannot be ordered).

¹⁾ See also IEC 60034-1 Edition 13.0

SIMOTICS GP and SIMOTICS SD standard motors

Orientation

Article number code

3

Selection and ordering data

The article number consists of a combination of digits and letters and is divided into three hyphenated blocks to provide a better overview, e.g.:

**1LE1001-1DB22-2CB5-Z
H00**

The first block (positions 1 to 7) identifies the motor type. The second block (positions 8 to 12) defines the motor frame size and length, the number of poles and power and in some cases the frequency/voltage. In the third block (positions 13 to 16), the frequency/voltage, type of construction and further design features are encoded.

For deviations in the second and third block from the catalog codes either **Z** or **90** should be used as appropriate.

Ordering data:

- Complete Article No. and order code(s) or plain text
- If a quotation has been requested, please specify the quotation number in addition to the Article No.
- When ordering a complete motor as a spare part, please specify the works serial No. for the previously supplied motor as well as the Article No.

Structure of the Article No.:	Position:	1	2	3	4	5	6	7	-	8	9	10	11	12	-	13	14	15	16		
1st to 4th position: Digit, letter, letter, digit	<ul style="list-style-type: none"> • Self-ventilated by fan mounted on and driven by the rotor • Forced-air cooled by air flow from the fan to be driven with option extension F90 • ABNT Line – self-ventilated or forced-air cooled as for 1LE1 • Naturally cooled without external fan and fan cover 	1	L	E	1																
5th position: Digit	Aluminum housing Cast-iron housing Basic Line Cast-iron housing Performance Line Cast-iron housing ABNT Line IR3 (IE3)					0 5 6 7															
6th to 7th position: 2 digits	Motors with IE2 High Efficiency APAC Line motors with IE2 High Efficiency Motors with IE1 Standard Efficiency Motors with IE3 Premium Efficiency Motors with IE3 Premium Efficiency (converter operation) APAC Line motors with IE3 Premium Efficiency Motors with IE4 Super Premium Efficiency Pole-changing motors with one winding connected in Dahlander circuit Pole-changing motors with two windings NEMA Energy Efficient MG1 motors, Table 12-11 – Eagle Line NEMA Premium Efficient MG1 motors, Table 12-12 – Eagle Line ABNT Line IR3 (IE3) motors					0 1 4 1 0 2 0 3 8 3 4 3 0 4 1 1 1 2 2 1 2 3 7 3															
8th, 9th and 11th position: Digit, letter, digit	Motor frame size (frame size as a combination of shaft height and overall length, encoded)									0 ... 3	A ... E		0 ... 8								
10th position: Letter	No. of poles A: 2-pole, B: 4-pole, C: 6-pole, D: 8-pole, J: 4/2-pole const. load torque, L: 8/4-pole const. load torque, P: 4/2-pole square-law load torque, Q: 6/4-pole square-law load torque, R: 8/4-pole square-law load torque											A ... R									
12th and 13th position: 2 digits	Voltage, circuit and frequency (encoded with two digits, 9-0 requires order code M.. (e.g. M1Y))													0 ... 9		0 ... 8					
14th position: Letter	Type of construction (encoded with A ... Z; Z requires order code Q.. (e.g. H00))																	A ... V			
15th position: Letter	Motor protection (encoded with A ... Z; Z requires order code Q.. (e.g. Q2A))																		A ... Z		
16th position: Digit	Terminal box position 4: Terminal box top, 5: Terminal box right, 6: Terminal box left, 7: Terminal box bottom																			4 ... 7	
	Special order versions: encoded – additional order code required not encoded – additional plain text required																				- Z

Ordering example

Selection criteria	Requirement	Structure of the Article No.
Motor type 1LE1	Standard motor with IE3 High Efficiency, IP55 degree of protection, aluminum housing	1LE1003-■■■■■-■■■■■
Motor frame size/No. of poles/Speed	160 M/4-pole/1500 rpm	1LE1003-1DB2■-■■■■■
Rated power	11 kW	
Voltage and frequency	230 VΔ/400 VY, 50 Hz	1LE1003-1DB22-2■■■■■
Type of construction with special version	IM V5 with protective cover ¹⁾	1LE1003-1DB22-2C■■■-Z H00
Motor protection	1 or 3 PTC thermistors – for tripping (2 terminals)	1LE1003-1DB22-2CB■-Z H00
Terminal box position	Terminal box right (viewed from DE)	1LE1003-1DB22-2CB5-Z H00

¹⁾ Standard without protective cover – the protective cover is defined with order code **H00** and must be ordered in addition to the Article No. with **-Z** and this order code.

SIMOTICS GP and SIMOTICS SD standard motors

IE4 Super Premium Efficiency



Aluminum series SIMOTICS GP 1LE1004 – self-ventilated or forced-air cooled

Selection and ordering data

P _{rated} 50 Hz/ P50 kW	P _{rated} 60 Hz/ P60 kW	Frame size FS	Operating values at rated power													Aluminum series 1LE1004 Article No.	m _{IM B3} kg	J kgm ²	
			n _{rated} 50 Hz rpm	T _{rated} 50 Hz Nm	η _{rated} 50 Hz %	η _{rated} 50 Hz %	η _{rated} 50 Hz %	η _{rated} 50 Hz %	cosφ _{rated} 50 Hz %	I _{rated} 400 V A	T _{LR} /I _{rated} 50 Hz %	I _{LR} /I _{rated} 50 Hz %	T _B /I _{rated} 50 Hz %	L _{pfA} 50 Hz dB(A)	L _{WA} 50 Hz dB(A)				
• Cooling: Self-ventilated (IC411) or with order code F90 forced-air cooled without external fan and fan cover (IC418) • Efficiency according to IEC 60034-30-1: IE4 Super Premium Efficiency, service factor (SF) 1.15 • Insulation: Thermal class 155 (temperature class F), IP55 degree of protection, utilization in accordance with thermal class 130 (temperature class B)																			
2-pole: 3000 rpm at 50 Hz, 3600 rpm at 60 Hz ¹⁾																			
3	3.45	100 L	2920	9.8	89.1	89.8	89.4	0.86	5.7	3.7	9	4.9	62	74	1LE1004-1AA4	26	0.0054		
4	4.55	112 M	2950	12.9	90	90.4	89.7	0.89	7.2	2.6	8.8	4.1	68	80	1LE1004-1BA2	34	0.012		
5.5	6.3	132 S	2960	17.7	90.9	90.9	89.8	0.84	10.4	2.1	8.6	4.6	67	84	1LE1004-1CA0	43	0.024		
7.5	8.6	132 S	2955	24	91.7	92.4	92.2	0.91	13	2.2	8.6	4.3	67	80	1LE1004-1CA1	55	0.031		
11	12.6	160 M	2955	35.5	92.6	92.8	92	0.9	19.1	2.8	8.6	4.2	74	87	1LE1004-1DA2	84	0.061		
15	17.3	160 M	2955	48.5	93.3	93.5	92.9	0.9	26	3.1	9	4.5	74	87	1LE1004-1DA3	94	0.068		
18.5	21.3	160 L	2955	60	93.7	94.1	93.8	0.91	31.5	3.1	8.9	4.3	74	87	1LE1004-1DA4	120	0.073		
22	24.5	180 M	2950	71	94	94.4	94.1	0.89	38	2.8	8.9	4.3	71	84	1LE1004-1EA2	139	0.091		
30	33.5	200 L	2955	97	94.5	94.8	94.4	0.85	54	2.8	7.9	4	69	83	1LE1004-2AA4	173	0.14		
37	41.5	200 L	2955	120	94.8	95.1	94.9	0.88	64	2.9	7.8	4	69	83	1LE1004-2AA5	214	0.19		
4-pole: 1500 rpm at 50 Hz, 1800 rpm at 60 Hz ¹⁾																			
2.2	2.55	100 L	1465	14.3	89.5	89.6	88.3	0.79	4.5	3.3	8.5	4.7	59	71	1LE1004-1AB4	30	0.014		
3	3.45	100 L	1460	19.6	90.4	91	90.5	0.81	5.9	3.5	8.8	4.2	59	71	1LE1004-1AB5	42	0.016		
4	4.55	112 M	1465	26	91.1	91.6	91	0.81	7.8	3.1	8.3	4.3	63	75	1LE1004-1BB2	49	0.02		
5.5	6.3	132 S	1470	35.5	91.9	92.5	92.3	0.83	10.4	2.6	8.3	3.5	56	68	1LE1004-1CB0	49	0.034		
7.5	8.6	132 S	1470	48.5	92.6	93.1	92.7	0.81	14.4	3	7.7	4	56	68	1LE1004-1CB2	64	0.046		
11	12.6	160 M	1480	71	93.3	93.4	92.5	0.82	20.5	2.9	8.1	4.1	63	76	1LE1004-1DB2	100	0.085		
15	17.3	160 L	1480	97	93.9	94	93.3	0.8	29	3.7	7.8	4.3	63	76	1LE1004-1DB4	111	0.099		
18.5	21.3	180 M	1470	120	94.2	94.7	94.5	0.81	35	2.7	7.9	3.6	59	72	1LE1004-1EB2	153	0.17		
22	25.3	180 L	1475	142	94.5	95	94.8	0.81	41.5	2.9	7.7	3.8	59	72	1LE1004-1EB4	158	0.18		
30	34.5	200 L	1475	194	94.9	95.2	94.9	0.81	56	3.2	7.3	3.6	60	73	1LE1004-2AB5	205	0.27		
Voltagess																			
Frame sizes 100 L to 200 L: Use of the 4 x 90° rotatable terminal box															Version		Order code		
50 Hz 230 VΔ/400 VY			60 Hz ¹⁾ 460 VY			Standard			2 2		-								
50 Hz 400 VΔ/690 VY			60 Hz ¹⁾ 460 VΔ			Standard			3 4		-								
For other voltages ¹⁾ and more information, see from page 3/97																			
Types of construction																			
Without flange IM B3 ²⁾															Standard		A	-	
With flange IM B5 ²⁾															With additional charge		F		-
With flange IM B14 ²⁾															With additional charge		K		-
For other types of construction and more information, see from page 3/103																			
Motor protection																			
Frame sizes 100 L to 200 L: Use of the 4 x 90° rotatable terminal box															Version		Order code		
Without															Standard		A		-
PTC thermistor with 3 temperature sensors															With additional charge		B		-
For other motor protection and more information, see from page 3/116																			
Terminal box position																			
Terminal box at top															Standard		4		-
For other terminal box positions and more information, see from page 3/119																			
Special versions																			
Forced-air cooled motors w/o ext. fan/fan cover (IC418)															1LE1004-		-Z		F90 + . . . + . . .
For options, see from page 3/122																			

3

¹⁾ Operating values at rated power for 60 Hz are stored in the Drive Technology Configurator (DT Configurator; see Appendix, "Tools and engineering").

²⁾ Types derived from IM B3 (IM B6/7/8, IM V6, and IM V5), from IM B5 (IM V3 and IM V1) and from IM B14 (IM V19 and IM V18) are possible, provided that no requirements exist for condensation drainage holes (H03) or stamping of the type on the rating plate. The basic type IM B3, IM B5, or IM B14 is stamped as standard on the rating plate. For orders with condensation drainage holes (H03), the type must be specified.



Selection and ordering data

P _{rated} 50 Hz/ P50 kW	P _{rated} 60 Hz/ P60 kW	Frame size FS	Operating values at rated power													Cast-iron series		m _{IM B3} kg	J kgm ²
			n _{rated} 50 Hz rpm	T _{rated} 50 Hz Nm	η _{rated} 50 Hz %	η _{rated} 50 Hz %	η _{rated} 50 Hz %	η _{rated} 50 Hz %	cosφ _{rated} 50 Hz %	I _{rated} 50 Hz A	T _{L,R} / T _{rated} 50 Hz	I _{L,R} / I _{rated} 50 Hz	T _B / T _{rated} 50 Hz	L _{pFA} 50 Hz dB(A)	L _{WA} 50 Hz dB(A)	1LE1504 – Basic Line	Article No.		
3	3.45	100 L	2920	9.8	89.1	89.8	89.4	0.86	5.7	3.7	9	4.9	62	74	1LE1504-1AA4	37	0.0054		
4	4.55	112 M	2950	12.9	90	90.4	89.7	0.89	7.2	2.6	8.8	4.1	68	80	1LE1504-1BA2	43	0.012		
5.5	6.3	132 S	2960	17.7	90.9	90.9	89.8	0.84	10.4	2.1	8.6	4.6	67	84	1LE1504-1CA0	50	0.024		
7.5	8.6	132 S	2955	24	91.7	92.4	92.2	0.91	13	2.2	8.6	4.3	67	80	1LE1504-1CA1	75	0.031		
11	12.6	160 M	2955	35.5	92.6	92.8	92	0.9	19.1	2.8	8.6	4.2	74	87	1LE1504-1DA2	111	0.061		
15	17.3	160 M	2955	48.5	93.3	93.5	92.9	0.9	26	3.1	9	4.5	74	87	1LE1504-1DA3	130	0.068		
18.5	21.3	160 L	2955	60	93.7	94.1	93.8	0.91	31.5	3.1	8.9	4.3	74	87	1LE1504-1DA4	131	0.073		
22	24.5	180 M	2950	71	94	94.4	94.1	0.89	38	2.8	8.9	4.3	71	84	1LE1504-1EA2	175	0.091		
30	33.5	200 L	2955	97	94.5	94.8	94.4	0.85	54	2.8	7.9	4	69	83	1LE1504-2AA4	220	0.14		
37	41.5	200 L	2955	120	94.8	95.1	94.9	0.88	64	2.9	7.8	4	69	83	1LE1504-2AA5	265	0.19		
45	51	225 M	2970	145	95	95	94.4	0.85	80	3.1	8.8	4.1	73	86	1LE1504-2BA2	330	0.26		
55	62	250 M	2978	176	95.3	95.2	94.5	0.88	95	2.5	7.5	3.2	73	86	1LE1504-2CA2	430	0.48		
75	84	280 S	2980	240	95.6	95.6	95	0.89	127	2.7	8.4	3.5	73	87	1LE1504-2DA0	610	0.94		
90	101	280 M	2978	290	95.8	95.9	95.4	0.89	152	2.7	8.4	3.5	77	91	1LE1504-2DA2	625	1.0		
110	123	315 S	2985	350	96	96	95.3	0.89	186	2.6	8.8	3.4	77	91	1LE1504-3AA0	750	1.4		
132	148	315 M	2988	420	96.2	96.2	95.6	0.9	220	3.1	10.5	4	77	91	1LE1504-3AA2	980	1.9		
160	180	315 L	2986	510	96.3	96.3	95.8	0.9	265	3.6	10	3.9	76	90	1LE1504-3AA4	1060	2.1		
200	224	315 L	2986	640	96.5	96.5	96.1	0.92	325	3.5	10	3.9	78	93	1LE1504-3AA5	1180	2.4		

Voltages ²⁾		Version	Order code
50 Hz 230 VΔ/400 VY	60 Hz ¹⁾ 460 VY	Standard	2 2 –
50 Hz 400 VΔ/690 VY	60 Hz ¹⁾ 460 VA	Standard	3 4 –
For other voltages and more information, see from page 3/100			9 0 ...

Types of construction		Version	Order code
Without flange	IM B3 ³⁾	Standard	A –
With flange	IM B5 ³⁾	With additional charge	F –
With flange	IM B5 ³⁾	With additional charge	K –
For other types of construction and more information, see from page 3/107			... –

Motor protection		Version	Order code
Without		Standard	A –
PTC thermistor with 3 temperature sensors		With additional charge	B –
For other motor protection and more information, see from page 3/117			... –

Terminal box position		Version	Order code
Terminal box at top		Standard	4
For other terminal box positions and more information, see from page 3/120			

Special versions		Order code(s)
Forced-air cooled motors w/o ext. fan/fan cover (IC418)		1LE1504-...-Z F90 +...+...+...
For options, see from page 3/129		1LE1504-...-Z ...+...+...+...

Note: IE4 motors (2-pole) in frame size 315 do not comply with the vibration values stipulated in IEC 60034-14 when rigidly installed (see also page 1/52).

¹⁾ Operating values at rated power for 60 Hz are stored in the Drive Technology Configurator (DT Configurator; see Appendix, "Tools and engineering").

²⁾ Parallel supply lines are required in the case of connection to ≤ 240 V. For frame size 315 with connection to ≤ 240 V, due to the high current, a drilled, removable entry plate (order code **R52**) or a larger terminal box (order code **R50**) can be used. Order codes **R52** and **R50** alter the motor dimensions.

³⁾ Types derived from IM B3 (IM B6/7/8, IM V6 and IM V5), from IM B5 (IM V3 and IM V1) and from IM B14 (IM V19 and IM V18) are possible, provided that no requirement exists for stamping of the type on the rating plate. The basic type IM B3, IM B5, or IM B14 is stamped as standard on the rating plate. If mounted in a different position, the position must be specified to ensure that the condensation drainage holes are positioned correctly.

SIMOTICS GP and SIMOTICS SD standard motors

IE4 Super Premium Efficiency



Cast-iron series SIMOTICS SD 1LE1504 Basic Line – self-ventilated or forced-air cooled

Selection and ordering data

Operating values at rated power														Cast-iron series		m _{IM B3}	J	
P _{rated} 50 Hz/	P _{rated} 60 Hz/	Frame size	n _{rated} 50 Hz	T _{rated} 50 Hz	Different IE class	η _{rated} 50 Hz	η _{rated} 50 Hz	η _{rated} 50 Hz	cosφ _{rated} 50 Hz	I _{rated} 50 Hz	T _{LR} / I _{LR}	T _B / I _B	L _{pfA} 50 Hz	L _{WA} 50 Hz	1LE1504 – Basic Line			Article No.
P50	P60	FS	rpm	Nm	60 Hz/P60	4/4	3/4	2/4	4/4	400 V	50 Hz	50 Hz	50 Hz	50 Hz				
• Cooling: Self-ventilated (IC411) or with order code F90 forced-air cooled without external fan and fan cover (IC418) • Efficiency according to IEC 60034-30-1: IE4 Super Premium Efficiency, service factor (SF) 1.15 • Insulation: Thermal class 155 (temperature class F), IP55 degree of protection, utilization in accordance with thermal class 130 (temperature class B)																		
4-pole: 1500 rpm at 50 Hz, 1800 rpm at 60 Hz																		
2.2	2.55	100 L	1465	14.3		89.5	89.6	88.3	0.79	4.5	3.3	8.5	4.7	59	71	1LE1504-1AB4	40	0.014
3	3.45	100 L	1460	19.6		90.4	91	90.5	0.81	5.9	3.5	8.8	4.2	59	71	1LE1504-1AB5	52	0.016
4	4.55	112 M	1465	26		91.1	91.6	91	0.81	7.8	3.1	8.3	4.3	63	75	1LE1504-1BB2	60	0.02
5.5	6.3	132 S	1470	35.5		91.9	92.5	92.3	0.83	10.4	2.6	8.3	3.5	56	68	1LE1504-1CB0	84	0.034
7.5	8.6	132 M	1470	48.5		92.6	93.1	92.7	0.81	14.4	3	7.7	4	56	68	1LE1504-1CB2	82	0.046
11	12.6	160 M	1480	71		93.3	93.4	92.5	0.82	20.5	2.9	8.1	4.1	63	76	1LE1504-1DB2	127	0.085
15	17.3	160 L	1480	97		93.9	94	93.3	0.8	29	3.7	7.8	4.3	63	76	1LE1504-1DB4	137	0.099
18.5	21.3	180 M	1470	120		94.2	94.7	94.5	0.81	35	2.7	7.9	3.6	59	72	1LE1504-1EB2	187	0.17
22	25.3	180 L	1475	142		94.5	95	94.8	0.81	41.5	2.9	7.7	3.8	59	72	1LE1504-1EB4	192	0.18
30	34.5	200 L	1475	194		94.9	95.2	94.9	0.81	56	3.2	7.3	3.6	60	73	1LE1504-2AB5	258	0.27
37	42.5	225 S	1485	240		95.2	95.5	95.2	0.84	67	3.2	8.4	3.2	69	83	1LE1504-2BB0	345	0.52
45	52	225 M	1485	290	IE3	95.4	95.7	95.4	0.84	81	3.4	8	3.3	69	83	1LE1504-2BB2	415	0.66
55	63	250 M	1486	355		95.7	95.8	95.4	0.86	96	3	8.2	3.3	68	82	1LE1504-2CB2	490	1.1
75	86	280 S	1490	480		96	96.1	95.6	0.85	133	3.4	9.2	3.8	69	83	1LE1504-2DB0	670	1.7
90	104	280 M	1488	580		96.1	96.3	96.1	0.86	157	3.2	9	3.4	70	84	1LE1504-2DB2	730	2.0
110	127	315 M ⁴⁾	1491	700		96.3	96.4	95.9	0.86	192	3.2	8.6	3.3	73	87	1LE1504-3AB0	910	2.7
132	152	315 M	1491	850		96.4	96.6	96.2	0.87	225	3.3	8.7	3.3	73	87	1LE1504-3AB2	990	3.1
160	184	315 L	1490	1030		96.6	96.7	96.5	0.86	280	3.6	9	3.2	76	90	1LE1504-3AB4	1220	3.7
200	230	315 L	1490	1280		96.7	96.9	96.6	0.86	345	3.8	9.2	3.4	76	90	1LE1504-3AB5	1300	4.4
Voltages²⁾														Version		Order code		
50 Hz 230 VΔ/400 VY			60 Hz ¹⁾ 460 VY			Standard		2 2		-		-		-		-		
50 Hz 400 VΔ/690 VY			60 Hz ¹⁾ 460 VΔ			Standard		3 4		-		-		-		-		
For other voltages and more information, see from page 3/100														9 0		...		
Types of construction														Version		Order code		
Without flange			IM B3 ³⁾			Standard		A		-		-		-		-		
With flange			IM B5 ³⁾			With additional charge		F		-		-		-		-		
With flange			IM B5 ³⁾			With additional charge		K		-		-		-		-		
For other types of construction and more information, see from page 3/107															
Motor protection														Version		Order code		
Without						Standard		A		-		-		-		-		
PTC thermistor with 3 temperature sensors						With additional charge		B		-		-		-		-		
For other motor protection and more information, see from page 3/117															
Terminal box position														Version		Order code		
Terminal box at top						Standard		4		-		-		-		-		
For other terminal box positions and more information, see from page 3/120															
Special versions														Version		Order code(s)		
Forced-air cooled motors w/o ext. fan/fan cover (IC418)														1LE1504- ...		-Z F90 +...+...+		
For options, see from page 3/129														1LE1504- ...		-Z ...+...+...+		

¹⁾ Operating values at rated power for 60 Hz are stored in the Drive Technology Configurator (DT Configurator; see Appendix, "Tools and engineering").

²⁾ Parallel supply lines are required in the case of connection to ≤ 240 V. For frame size 315 with connection to ≤ 240 V, due to the high current, a drilled, removable entry plate (order code R52) or a larger terminal box (order code R50) can be used. Order codes R52 and R50 alter the motor dimensions.

³⁾ Types derived from IM B3 (IM B6/7/8, IM V6 and IM V5), from IM B5 (IM V3 and IM V1) and from IM B14 (IM V19 and IM V18) are possible, provided that no requirement exists for stamping of the type on the rating plate. The basic type IM B3, IM B5, or IM B14 is stamped as standard on the rating plate. If mounted in a different position, the position must be specified to ensure that the condensation drainage holes are positioned correctly.

⁴⁾ As 315 M version (not the same as 315 S according to EN 50347).



Selection and ordering data

P _{rated} 50 Hz/ P50 kW	P _{rated} 60 Hz/ P60 kW	Frame size FS	Operating values at rated power													Cast-iron series 1LE1604 – Performance Line Article No.	m _{IM B3} kg	J kgm ²
			n _{rated} 50 Hz rpm	T _{rated} 50 Hz Nm	η _{rated} 50 Hz %	η _{rated} 60 Hz %	η _{rated} 50 Hz %	η _{rated} 60 Hz %	cosφ _{rated} 50 Hz %	I _{rated} 50 Hz A	T _{L,R} / T _{rated} 50 Hz	I _{L,R} / I _{rated} 50 Hz	T _B / T _{rated} 50 Hz	L _{pFA} 50 Hz dB(A)	L _{WA} 50 Hz dB(A)			
3	3.45	100 L	2920	9.8	89.1	89.8	89.4	0.86	5.7	3.7	9	4.9	62	74	1LE1604-1AA4	37	0.0054	
4	4.55	112 M	2950	12.9	90	90.4	89.7	0.89	7.2	2.6	8.8	4.1	68	80	1LE1604-1BA2	43	0.012	
5.5	6.3	132 S	2960	17.7	90.9	90.9	89.8	0.84	10.4	2.1	8.6	4.6	67	84	1LE1604-1CA0	50	0.024	
7.5	8.6	132 S	2955	24	91.7	92.4	92.2	0.91	13	2.2	8.6	4.3	67	80	1LE1604-1CA1	75	0.031	
11	12.6	160 M	2955	35.5	92.6	92.8	92	0.9	19.1	2.8	8.6	4.2	74	87	1LE1604-1DA2	111	0.061	
15	17.3	160 M	2955	48.5	93.3	93.5	92.9	0.9	26	3.1	9	4.5	74	87	1LE1604-1DA3	130	0.068	
18.5	21.3	160 L	2955	60	93.7	94.1	93.8	0.91	31.5	3.1	8.9	4.3	74	87	1LE1604-1DA4	131	0.073	
22	24.5	180 M	2950	71	94	94.4	94.1	0.89	38	2.8	8.9	4.3	71	84	1LE1604-1EA2	175	0.091	
30	33.5	200 L	2955	97	94.5	94.8	94.4	0.85	54	2.8	7.9	4	69	83	1LE1604-2AA4	220	0.14	
37	41.5	200 L	2955	120	94.8	95.1	94.9	0.88	64	2.9	7.8	4	69	83	1LE1604-2AA5	265	0.19	
45	51	225 M	2970	145	95	95	94.4	0.85	80	3.1	8.8	4.1	73	86	1LE1604-2BA2	330	0.26	
55	62	250 M	2978	176	95.3	95.2	94.5	0.88	95	2.5	7.5	3.2	73	86	1LE1604-2CA2	430	0.48	
75	84	280 S	2980	240	95.6	95.6	95	0.89	127	2.7	8.4	3.5	73	87	1LE1604-2DA0	610	0.94	
90	101	280 M	2978	290	95.8	95.9	95.4	0.89	152	2.7	8.4	3.5	77	91	1LE1604-2DA2	625	1.0	
110	123	315 S	2985	350	96	96	95.3	0.89	186	2.6	8.8	3.4	77	91	1LE1604-3AA0	750	1.4	
132	148	315 M	2988	420	96.2	96.2	95.6	0.9	220	3.1	10.5	4	77	91	1LE1604-3AA2	980	1.9	
160	180	315 L	2986	510	96.3	96.3	95.8	0.9	265	3.6	10	3.9	76	90	1LE1604-3AA4	1060	2.1	
200	224	315 L	2986	640	96.5	96.5	96.1	0.92	325	3.5	10	3.9	78	93	1LE1604-3AA5	1180	2.4	
Voltages ²⁾			Version											Order code				
50 Hz 230 VΔ/400 VY			60 Hz ¹⁾ 460 VY											Standard				
50 Hz 400 VΔ/690 VY			60 Hz ¹⁾ 460 VA											Standard				
For other voltages and more information, see from page 3/100														2 2 3 4 9 0				
Types of construction			Version											Order code				
Without flange			IM B3 ³⁾											Standard				
With flange			IM B5 ³⁾											With additional charge				
With flange			IM B5 ³⁾											With additional charge				
For other types of construction and more information, see from page 3/107														A F K				
Motor protection			Version											Order code				
PTC thermistor with 3 temperature sensors			Standard											B				
For other motor protection and more information, see from page 3/117														...				
Terminal box position			Version											Order code				
Terminal box at top			Standard											4				
For other terminal box positions and more information, see from page 3/120																		
Special versions														Order code(s)				
Forced-air cooled motors w/o ext. fan/fan cover (IC418)														1LE1604-...-Z F90 +...+...+...				
For options, see from page 3/129														1LE1604-...-Z ...+...+...+...				

Note: IE4 motors (2-pole) in frame size 315 do not comply with the vibration values stipulated in IEC 60034-14 when rigidly installed (see also page 1/52).

¹⁾ Operating values at rated power for 60 Hz are stored in the Drive Technology Configurator (DT Configurator; see Appendix, "Tools and engineering").

²⁾ Parallel supply lines are required in the case of connection to ≤ 240 V. For frame size 315 with connection to ≤ 240 V, due to the high current, a drilled, removable entry plate (order code **R52**) or a larger terminal box (order code **R50**) can be used. Order codes **R52** and **R50** alter the motor dimensions.

³⁾ Types derived from IM B3 (IM B6/7/8, IM V6 and IM V5), from IM B5 (IM V3 and IM V1) and from IM B14 (IM V19 and IM V18) are possible, provided that no requirement exists for stamping of the type on the rating plate. The basic type IM B3, IM B5, or IM B14 is stamped as standard on the rating plate. If mounted in a different position, the position must be specified to ensure that the condensation drainage holes are positioned correctly.

SIMOTICS GP and SIMOTICS SD standard motors

IE4 Super Premium Efficiency



Cast-iron series SIMOTICS SD 1LE1604 Performance Line – self-ventilated or forced-air cooled

Selection and ordering data

Operating values at rated power															Cast-iron series			
P_{rated} 50 Hz/ P50	P_{rated} 60 Hz/ P60	Frame size	n_{rated} 50 Hz	T_{rated} 50 Hz	Different IE class 60 Hz/P60	η_{rated} 50 Hz	η_{rated} 50 Hz	η_{rated} 50 Hz	$\cos\phi_{rated}$ 50 Hz	I_{rated} 50 Hz	$T_{LR}/$ T_{rated}	$I_{LR}/$ I_{rated}	$T_B/$ T_{rated}	L_{pfA} 50 Hz	L_{WA} 50 Hz	1LE1604 – Performance Line Article No.	$m_{IM B3}$	J
kW	kW	FS	rpm	Nm		%	%	%	%	A							kg	kgm ²
• Cooling: Self-ventilated (IC411) or with order code F90 forced-air cooled without external fan and fan cover (IC418) • Efficiency according to IEC 60034-30-1: IE4 Super Premium Efficiency, service factor (SF) 1.15 • Insulation: Thermal class 155 (temperature class F), IP55 degree of protection, utilization in accordance with thermal class 130 (temperature class B)																		
4-pole: 1500 rpm at 50 Hz, 1800 rpm at 60 Hz																		
2.2	2.55	100 L	1465	14.3		89.5	89.6	88.3	0.79	4.5	3.3	8.5	4.7	59	71	1LE1604-1AB4	40	0.014
3	3.45	100 L	1460	19.6		90.4	91	90.5	0.81	5.9	3.5	8.8	4.2	59	71	1LE1604-1AB5	52	0.016
4	4.55	112 M	1465	26		91.1	91.6	91	0.81	7.8	3.1	8.3	4.3	63	75	1LE1604-1BB2	60	0.02
5.5	6.3	132 S	1470	35.5		91.9	92.5	92.3	0.83	10.4	2.6	8.3	3.5	56	68	1LE1604-1CB0	84	0.034
7.5	8.6	132 M	1470	48.5		92.6	93.1	92.7	0.81	14.4	3	7.7	4	56	68	1LE1604-1CB2	82	0.046
11	12.6	160 M	1480	71		93.3	93.4	92.5	0.82	20.5	2.9	8.1	4.1	63	76	1LE1604-1DB2	127	0.085
15	17.3	160 L	1480	97		93.9	94	93.3	0.8	29	3.7	7.8	4.3	63	76	1LE1604-1DB4	137	0.099
18.5	21.3	180 M	1470	120		94.2	94.7	94.5	0.81	35	2.7	7.9	3.6	59	72	1LE1604-1EB2	187	0.17
22	25.3	180 L	1475	142		94.5	95	94.8	0.81	41.5	2.9	7.7	3.8	59	72	1LE1604-1EB4	192	0.18
30	34.5	200 L	1475	194		94.9	95.2	94.9	0.81	56	3.2	7.3	3.6	60	73	1LE1604-2AB5	258	0.27
37	42.5	225 S	1485	240		95.2	95.5	95.2	0.84	67	3.2	8.4	3.2	69	83	1LE1604-2BB0	345	0.52
45	52	225 M	1485	290	IE3	95.4	95.7	95.4	0.84	81	3.4	8	3.3	69	83	1LE1604-2BB2	415	0.66
55	63	250 M	1486	355		95.7	95.8	95.4	0.86	96	3	8.2	3.3	68	82	1LE1604-2CB2	490	1.1
75	86	280 S	1490	480		96	96.1	95.6	0.85	133	3.4	9.2	3.8	69	83	1LE1604-2DB0	670	1.7
90	104	280 M	1488	580		96.1	96.3	96.1	0.86	157	3.2	9	3.4	70	84	1LE1604-2DB2	730	2.0
110	127	315 M ⁴⁾	1491	700		96.3	96.4	95.9	0.86	192	3.2	8.6	3.3	73	87	1LE1604-3AB0	910	2.7
132	152	315 M	1491	850		96.4	96.6	96.2	0.87	225	3.3	8.7	3.3	73	87	1LE1604-3AB2	990	3.1
160	184	315 L	1490	1030		96.6	96.7	96.5	0.86	280	3.6	9	3.2	76	90	1LE1604-3AB4	1220	3.7
200	230	315 L	1490	1280		96.7	96.9	96.6	0.86	345	3.8	9.2	3.4	76	90	1LE1604-3AB5	1300	4.4
Voltages²⁾															Version		Order code	
50 Hz 230 VΔ/400 VY			60 Hz ¹⁾ 460 VY			Standard									2	2	–	
50 Hz 400 VΔ/690 VY			60 Hz ¹⁾ 460 VΔ			Standard									3	4	–	
For other voltages and more information, see from page 3/100															9	0	...	
Types of construction															Version		Order code	
Without flange			IM B3 ³⁾			Standard									A	–		
With flange			IM B5 ³⁾			With additional charge									F	–		
With flange			IM B5 ³⁾			With additional charge									K	–		
For other types of construction and more information, see from page 3/107															–	–	...	
Motor protection															Version		Order code	
PTC thermistor with 3 temperature sensors			Standard												B	–		
For other motor protection and more information, see from page 3/117															–	–	...	
Terminal box position															Version		Order code	
Terminal box at top			Standard												4	–		
For other terminal box positions and more information, see from page 3/120															–	–	...	
Special versions																	Order code(s)	
Forced-air cooled motors w/o ext. fan/fan cover (IC418)															1LE1604-....		-Z F90 +...+...+...	
For options, see from page 3/129															1LE1604-....		-Z ...+...+...+...	

3

¹⁾ Operating values at rated power for 60 Hz are stored in the Drive Technology Configurator (DT Configurator; see Appendix, "Tools and engineering").

²⁾ Parallel supply lines are required in the case of connection to ≤ 240 V. For frame size 315 with connection to ≤ 240 V, due to the high current, a drilled, removable entry plate (order code **R52**) or a larger terminal box (order code **R50**) can be used. Order codes **R52** and **R50** alter the motor dimensions.

³⁾ Types derived from IM B3 (IM B6/7/8, IM V6 and IM V5), from IM B5 (IM V3 and IM V1) and from IM B14 (IM V19 and IM V18) are possible, provided that no requirement exists for stamping of the type on the rating plate. The basic type IM B3, IM B5, or IM B14 is stamped as standard on the rating plate. If mounted in a different position, the position must be specified to ensure that the condensation drainage holes are positioned correctly.

⁴⁾ As 315 M version (not the same as 315 S according to EN 50347).



Selection and ordering data

Operating values at rated power															Aluminum series				
$P_{rated, 50 Hz}$	$P_{rated, 60 Hz}$	Frame size	$n_{rated, 50 Hz}$	$T_{rated, 50 Hz}$	Different IE class	$\eta_{rated, 50 Hz}$	$\eta_{rated, 50 Hz}$	$\eta_{rated, 50 Hz}$	$\cos\phi_{rated, 50 Hz}$	$I_{rated, 50 Hz}$	$T_{LR}/I_{rated, 50 Hz}$	$I_{LR}/I_{rated, 50 Hz}$	$T_B/I_{rated, 50 Hz}$	$L_{pfA, 50 Hz}$	$L_{WA, 50 Hz}$	1LE1003	$m_{IM B3}$	J	
P50	P60 ¹⁾	FS	rpm	Nm	60 Hz/P60	4/4	3/4	2/4	4/4	400 V	50 Hz	50 Hz	50 Hz			Article No.	kg	kgm ²	
kW	kW	FS	rpm	Nm		%	%	%		A							kg	kgm ²	
• Cooling: Self-ventilated (IC411) or with order code F90 forced-air cooled without external fan and fan cover (IC418) • Efficiency according to IEC 60034-30-1: IE3 Premium Efficiency, service factor (SF) 1.15 • Insulation: Thermal class 155 (temperature class F), IP55 degree of protection, utilization in accordance with thermal class 130 (temperature class B)																			
2-pole: 3000 rpm at 50 Hz, 3600 rpm at 60 Hz ¹⁾																			
0.75	0.86	80 M	2850	2.5		80.7	82.2	81.9	0.86	1.56	2.6	6.2	3	60	71	1LE1003-0DA2	12	0.0011	
1.1	1.27	80 M	2885	3.65		82.7	83.9	83.1	0.85	2.25	3	7.1	3.3	60	71	1LE1003-0DA3	13	0.0013	
1.5	1.75	90 S	2910	4.9		84.2	84.6	83.2	0.86	3	2.7	8.1	4.2	65	77	1LE1003-0EA0	16	0.0021	
2.2	2.55	90 L	2910	7.2		85.9	86.8	86.1	0.88	4.2	2.6	8.3	4	65	77	1LE1003-0EA4	20	0.0031	
3	3.45	100 L	2910	9.8		87.1	87.7	87	0.87	5.7	4.4	9.4	4.5	72	80	1LE1003-1AA4	25	0.0041	
4	4.55	112 M	2945	13		88.1	88.8	87.9	0.89	7.4	2.6	9.1	3.6	73	81	1LE1003-1BA2	32	0.0079	
5.5	6.3	132 S	2945	17.8		89.2	89.5	88.6	0.88	10.1	2.5	8.9	3.8	69	77	1LE1003-1CA0	48	0.0168	
7.5	8.6	132 S	2950	24.5		90.1	91	91	0.92	13.1	1.9	8.3	3.9	68	80	1LE1003-1CA1	57	0.031	
11	12.6	160 M	2955	35.5		91.2	91	89.5	0.89	19.6	2.4	7.9	3.8	70	82	1LE1003-1DA2	75	0.053	
15	17.3	160 M	2960	48.5		91.9	91.8	90.5	0.87	27	2.8	8.8	4.3	70	82	1LE1003-1DA3	84	0.061	
18.5	21.3	160 L	2955	60		92.4	92.8	92.4	0.9	32	2.8	9	4.2	70	82	1LE1003-1DA4	94	0.068	
22	24.5	180 M	2950	71		92.7	93.2	92.9	0.89	38.5	2.3	7.5	3.5	67	80	1LE1003-1EA2	129	0.08	
30	33.5	200 L	2955	97		93.3	93.5	92.9	0.87	53	2.5	7	3.3	67	80	1LE1003-2AA4	173	0.134	
37	41.5	200 L	2955	120		93.7	94.2	94	0.88	65	2.5	7.1	3.2	67	80	1LE1003-2AA5	194	0.158	
Voltages															Version		Order code		
50 Hz 230 VΔ/400 VY			60 Hz ¹⁾ 460 VY			Standard		2 2		-									
50 Hz 400 VΔ/690 VY			60 Hz ¹⁾ 460 VA			Standard		3 4		-									
50 Hz 500 VY						Without additional charge		2 7		-									
50 Hz 500 VΔ						Without additional charge		4 0		-									
For other voltages ¹⁾ and more information, see from page 3/97								9 0		...									
Types of construction															Version		Order code		
Without flange			IM B3 ²⁾			Standard		A		-									
With flange			IM B5 ²⁾			With additional charge		F		-									
With flange			IM B14 ²⁾			With additional charge		K		-									
For other types of construction and more information, see from page 3/103										...									
Motor protection															Version		Order code		
Without						Standard		A		-									
PTC thermistor with 1 or 3 temperature sensors (frame sizes 80, 90 or 100 to 200)						With additional charge		B		-									
For other motor protection and more information, see from page 3/116										...									
Terminal box position															Version		Order code(s)		
Terminal box at top						Standard		4											
For other terminal box positions and more information, see from page 3/119																			
Special versions																	Order code(s)		
For options, see from page 3/122																1LE1003-...-Z		...+...+...+...	



¹⁾ Operating values at rated power for 60 Hz are stored in the Drive Technology Configurator (DT Configurator; see Appendix, "Tools and engineering").

²⁾ Types derived from IM B3 (IM B6/7/8, IM V6, and IM V5), from IM B5 (IM V3 and IM V1) and from IM B14 (IM V19 and IM V18) are possible, provided that no requirements exist for condensation drainage holes (H03) or stamping of the type on the rating plate. The basic type IM B3, IM B5, or IM B14 is stamped as standard on the rating plate. For orders with condensation drainage holes (H03), the type must be specified.

SIMOTICS GP and SIMOTICS SD standard motors

IE3 Premium Efficiency



Aluminum series SIMOTICS GP 1LE1003 – self-ventilated

Selection and ordering data

Operating values at rated power															Aluminum series			
$P_{rated, 50 Hz}$	$P_{rated, 60 Hz}$	Frame size	$n_{rated, 50 Hz}$	$T_{rated, 50 Hz}$	Different IE class	$\eta_{rated, 50 Hz}$	$\eta_{rated, 50 Hz}$	$\eta_{rated, 50 Hz}$	$\cos\phi_{rated, 50 Hz}$	$I_{rated, 50 Hz}$	T_{LR}/I_{rated}	I_{LR}/I_{rated}	T_B/I_{rated}	$L_{pfA, 50 Hz}$	$L_{WA, 50 Hz}$	1LE1003	$m_{IM B3}$	J
P50	P60	FS	rpm	Nm	60 Hz/P60	%	%	%	%	A						Article No.	kg	kgm ²
• Cooling: Self-ventilated (IC411) or with order code F90 forced-air cooled without external fan and fan cover (IC418) • Efficiency according to IEC 60034-30-1: IE3 Premium Efficiency, service factor (SF) 1.15 • Insulation: Thermal class 155 (temperature class F), IP55 degree of protection, utilization in accordance with thermal class 130 (temperature class B)																		
4-pole: 1500 rpm at 50 Hz, 1800 rpm at 60 Hz ¹⁾																		
0.55	0.63	80 M	1440	3.65		80.8	81.5	79.8	0.78	1.26	2.1	5.9	3.1	52	60	1LE1003-0DB2	11	0.0021
0.75	0.86	80 M	1450	4.95		82.5	82.3	80.1	0.75	1.75	2.7	7.1	3.9	58	66	1LE1003-0DB3	13	0.0029
1.1	1.27	90 S	1440	7.3	IE2	84.1	84.7	83.4	0.78	2.4	2.9	6.9	3.6	56	68	1LE1003-0EB0	16	0.0036
1.5	1.75	90 L	1445	9.9		85.3	85.7	84.4	0.8	3.15	2.9	7.3	3.5	62	70	1LE1003-0EB4	20	0.0049
2.2	2.55	100 L	1455	14.4		86.7	87.2	86.3	0.82	4.45	3	8.3	3.8	67	75	1LE1003-1AB4	25	0.0101
3	3.45	100 L	1450	19.8	IE2	87.7	88.1	87.1	0.8	6.2	3.1	8	3.8	67	75	1LE1003-1AB5	26	0.01
4	4.55	112 M	1460	26		88.6	89.2	88.6	0.82	7.9	2.4	7.1	3.7	58	70	1LE1003-1BB2	34	0.017
5.5	6.3	132 S	1470	35.5		89.6	90	89.4	0.82	10.8	2.9	8.5	3.7	64	76	1LE1003-1CB0	49	0.034
7.5	8.6	132 M	1465	49	IE2	90.4	90.7	90.4	0.8	15	3	8.5	3.8	72	80	1LE1003-1CB2	59	0.0334
11	12.6	160 M	1470	71		91.4	91.9	91.9	0.82	21	2.5	8	3.5	67	75	1LE1003-1DB2	78	0.0583
15	17.3	160 L	1475	97	IE2	92.1	92.3	91.5	0.82	28.5	2.5	8.5	3.8	65	77	1LE1003-1DB4	100	0.085
18.5	21.3	180 L	1470	120	IE2	92.6	93.1	92.9	0.82	35	2.5	7.2	3.3	66	73	1LE1003-1EB2	134	0.13
22	25.3	180 L	1470	143		93	93.6	93.6	0.83	41	2.3	6.8	3.3	68	75	1LE1003-1EB4	142	0.14
30	34.5	200 L	1470	195	IE2	93.6	94	93.7	0.84	55	2.6	7.3	3.1	65	72	1LE1003-2AB5	189	0.24
Voltages															Version		Order code	
50 Hz 230 VΔ/400 VY			60 Hz ¹⁾ 460 VY			Standard			2 2		-							
50 Hz 400 VΔ/690 VY			60 Hz ¹⁾ 460 VA			Standard			3 4		-							
50 Hz 500 VY						Without additional charge			2 7		-							
50 Hz 500 VΔ						Without additional charge			4 0		-							
For other voltages ¹⁾ and more information, see from page 3/97									9 0		...							
Types of construction															Version		Order code	
Without flange			IM B3 ²⁾			Standard			A		-							
With flange			IM B5 ²⁾			With additional charge			F		-							
With flange			IM B14 ²⁾			With additional charge			K		-							
For other types of construction and more information, see from page 3/103											...							
Motor protection															Version		Order code	
Without						Standard			A		-							
PTC thermistor with 1 or 3 temperature sensors (frame sizes 80, 90 or 100 to 200)						With additional charge			B		-							
For other motor protection and more information, see from page 3/116											...							
Terminal box position															Version		Order code(s)	
Terminal box at top						Standard			4									
For other terminal box positions and more information, see from page 3/119																		
Special versions																	Order code(s)	
For options, see from page 3/122											1LE1003-...-Z		...+...+...+...					

¹⁾ Operating values at rated power for 60 Hz are stored in the Drive Technology Configurator (DT Configurator; see Appendix, "Tools and engineering").

²⁾ Types derived from IM B3 (IM B6/7/8, IM V6, and IM V5), from IM B5 (IM V3 and IM V1) and from IM B14 (IM V19 and IM V18) are possible, provided that no requirements exist for condensation drainage holes (H03) or stamping of the type on the rating plate. The basic type IM B3, IM B5, or IM B14 is stamped as standard on the rating plate. For orders with condensation drainage holes (H03), the type must be specified.



Selection and ordering data

Operating values at rated power															Aluminum series					
$P_{rated, 50 Hz}$	$P_{rated, 60 Hz}$	Frame size	$n_{rated, 50 Hz}$	$T_{rated, 50 Hz}$	Different IE class	$\eta_{rated, 50 Hz}$	$\eta_{rated, 50 Hz}$	$\eta_{rated, 50 Hz}$	$\cos\phi_{rated, 50 Hz}$	$I_{rated, 50 Hz}$	$T_{LR}/I_{rated, 50 Hz}$	$I_{LR}/I_{rated, 50 Hz}$	$T_B/I_{rated, 50 Hz}$	$L_{pfA, 50 Hz}$	$L_{WA, 50 Hz}$	1LE1003	$m_{IM B3}$	J		
kW	kW	FS	rpm	Nm	60 Hz/P60	%	%	%	%	A						Article No.	kg	kgm ²		
• Cooling: Self-ventilated (IC411) or with order code F90 forced-air cooled without external fan and fan cover (IC418) • Efficiency according to IEC 60034-30-1: IE3 Premium Efficiency, service factor (SF) 1.15 • Insulation: Thermal class 155 (temperature class F), IP55 degree of protection, utilization in accordance with thermal class 130 (temperature class B)																				
6-pole: 1000 rpm at 50 Hz, 1200 rpm at 60 Hz ¹⁾																				
0.37	0.43	80 M	940	3.75		73.5	73.1	69.4	0.66	1.1	2.3	4.2	2.7	42	53	1LE1003-0DC2	12	0.0025		
0.55	0.63	80 M	935	5.6	IE2	77.2	77	73.9	0.67	1.53	2.5	4.5	2.8	42	53	1LE1003-0DC3	13	0.0031		
0.75	0.86	90 S	945	7.6	IE2	78.9	80	78.8	0.7	1.96	2.2	4.6	2.6	43	55	1LE1003-0EC0	16	0.004		
1.1	1.27	90 L	950	11.1		81	81.4	79.3	0.66	2.95	2.8	5	3	60	68	1LE1003-0EC4	19	0.0048		
1.5	1.75	100 L	970	14.8		82.5	83.1	81.5	0.73	3.6	1.9	5.2	2.8	59	71	1LE1003-1AC4	25	0.011		
2.2	2.55	112 M	970	21.5		84.3	85	83.9	0.75	5	2.2	5.6	2.8	65	74	1LE1003-1BC2	34	0.017		
3	3.45	132 S	975	29.5	IE2	85.6	85.8	84.3	0.73	6.9	2.3	6.6	3.2	58	66	1LE1003-1CC0	52	0.029		
4	4.55	132 M	975	39	IE2	86.8	87.3	86.2	0.73	9.1	2.2	6.2	3	67	75	1LE1003-1CC2	61	0.037		
5.5	6.3	132 M	975	54	IE1	88	88.1	86.9	0.72	12.5	2.7	6.8	3.4	64	72	1LE1003-1CC3	64	0.046		
7.5	8.6	160 M	985	73	IE2	89.1	89.7	89	0.81	15	2.3	7.9	3.2	71	79	1LE1003-1DC2	93	0.098		
11	12.6	160 L	980	107	IE2	90.3	90.7	89.8	0.8	22	2.9	6.8	2.8	66	74	1LE1003-1DC4	115	0.12		
15	18	180 L	975	147	IE1	91.2	92	91.9	0.8	29.5	2.3	5.9	2.8	61	68	1LE1003-1EC4	130	0.19		
18.5	22	200 L	978	181	IE2	91.7	92.5	92.4	0.79	37	2.5	5.6	2.6	64	71	1LE1003-2AC4	166	0.28		
22	26.5	200 L	978	215	IE1	92.2	92.8	92.3	0.79	43.5	2.5	5.6	2.6	61	68	1LE1003-2AC5	179	0.32		
8-pole: 750 rpm at 50 Hz, 900 rpm at 60 Hz ¹⁾																				
0.18	0.21	80 M	705	2.45		58.7	55.8	49.2	0.49	0.9	2.3	3	2.8	48	61.3	▲ 1LE1003-0DD2	12	0.0021		
0.25	0.29	80 M	695	3.45		64.1	62.7	57.8	0.57	0.93	1.8	2.9	2.1	52	59	▲ 1LE1003-0DD3	13	0.003		
0.37	0.43	90 S	685	5.2		69.3	68.3	63.7	0.68	1.13	1.7	2.9	1.8	56	53	▲ 1LE1003-0ED0	16	0.0045		
0.55	0.63	90 L	695	7.6		73	71.2	66.5	0.67	1.62	2	3.5	2.3	61	68	▲ 1LE1003-0ED4	19	0.0045		
0.75	0.86	100 L	710	10.1		75	75.7	73.1	0.67	2.1	1.5	3.7	2.1	61.4	69.4	▲ 1LE1003-1AD4	20	0.0096		
1.1	1.27	100 L	710	14.8		77.7	76.4	75.1	0.67	3.05	1.8	4.1	2.3	61.9	69.9	▲ 1LE1003-1AD5	26	0.013		
1.5	1.75	112 M	720	19.9	IE2	79.7	85.6	77.3	0.63	4.15	2.6	5.1	3.1	61.7	69.7	▲ 1LE1003-1BD2	34	0.028		
2.2	2.55	132 S	725	29	IE2	81.9	82.5	80.9	0.71	5.3	1.9	5	2.5	65	73	1LE1003-1CD0	42	0.046		
3	3.45	132 M	725	39.5	IE2	83.5	83.8	82.2	0.72	7.1	2	5.2	2.5	70	78	1LE1003-1CD2	58	0.061		
4	4.55	160 M	730	52		84.5	85.5	84.7	0.74	9.1	1.6	4.7	2.1	68	76	1LE1003-1DD2	67	0.076		
5.5	6.3	160 M	730	72		86.2	87	86.3	0.73	12.4	2	5.5	2.4	68	76	1LE1003-1DD3	78	0.1		
7.5	8.6	160 L	730	98	IE2	87.3	87.9	86.9	0.73	16.9	2.3	5.8	2.7	70	78	1LE1003-1DD4	86	0.13		
11	13.2	180 L	725	145	IE2	88.6	89.6	89	0.74	24	2.1	5.1	2.4	67	74	1LE1003-1ED4	161	0.267		
15	18	200 L	730	196		89.6	90.1	89.4	0.73	33.5	3	6.8	3.7	57	70	1LE1003-2AD5	212	0.42		
Voltages															Version		Order code			
50 Hz 230 VΔ/400 VY			60 Hz ¹⁾ 460 VY			Standard			2		2		-							
50 Hz 400 VΔ/690 VY			60 Hz ¹⁾ 460 VA			Standard			3		4		-							
50 Hz 500 VY						Without additional charge			2		7		-							
50 Hz 500 VA						Without additional charge			4		0		-							
For other voltages ¹⁾ and more information, see from page 3/97															9		0		...	
Types of construction															Version		Order code			
Without flange			IM B3 ²⁾			Standard			A		-									
With flange			IM B5 ²⁾			With additional charge			F		-									
With flange			IM B14 ²⁾			With additional charge			K		-									
For other types of construction and more information, see from page 3/103															B		...			
Motor protection															Version		Order code			
Without						Standard			A		-									
PTC thermistor with 1 or 3 temperature sensors (frame sizes 80, 90 or 100 to 200)						With additional charge			B		-									
For other motor protection and more information, see from page 3/116															B		...			
Terminal box position															Version		Order code(s)			
Terminal box at top						Standard			4											
For other terminal box positions and more information, see from page 3/119															4					
Special versions																	Order code(s)			
For options, see from page 3/122															1LE1003-...		-Z ...+...+...+...			



¹⁾ Operating values at rated power for 60 Hz are stored in the Drive Technology Configurator (DT Configurator; see Appendix, "Tools and engineering").

²⁾ Types derived from IM B3 (IM B6/7/8, IM V6, and IM V5), from IM B5 (IM V3 and IM V1) and from IM B14 (IM V19 and IM V18) are possible, provided that no requirements exist for condensation drainage holes (**H03**) or stamping of the type on the rating plate. The basic type IM B3, IM B5, or IM B14 is stamped as standard on the rating plate. For orders with condensation drainage holes (**H03**), the type must be specified.

SIMOTICS GP and SIMOTICS SD standard motors

IE3 Premium Efficiency



Aluminum series SIMOTICS GP 1LE1003 with increased power – self-ventilated

Selection and ordering data

Operating values at rated power															Aluminum series 1LE1003		m _{IM B3} J	
P _{rated} 50 Hz/ P50	30. P _{ra} ted, 60 Hz/ P60	Frame size	n _{rated} 50 Hz	T _{rated} 50 Hz	Different IE class	η _{rated} 50 Hz	η _{rated} 50 Hz	η _{rated} 50 Hz	cosφ _{rated} 50 Hz	I _{rated} 50 Hz	T _{LR} /I _{rated} 50 Hz	I _{LR} /I _{rated} 50 Hz	T _B /I _{rated} 50 Hz	L _{pfA} 50 Hz	L _{WA} 50 Hz	Article No.	kg	J
kW	kW	FS	rpm	Nm		%	%	%		A						▲ New	kg	kgm ²
• Cooling: Self-ventilated (IC411) or with order code F90 forced-air cooled without external fan and fan cover (IC418) • Efficiency according to IEC 60034-30-1: IE3 Premium Efficiency, service factor (SF) 1.15 • Insulation: Thermal class 155 (temperature class F), IP55 degree of protection, utilization in accordance with thermal class 130 (temperature class B)																		
2-pole: 3000 rpm at 50 Hz, 3600 rpm at 60 Hz ¹⁾																		
1.5	1.75	80 M	2865	5		84.2	84.8	84.4	0.84	3.05	3.2	8	3.7	69	77	▲ 1LE1003-0DA6	13	0.0015
3	3.45	90 L	2920	9.8	IE2	87.1	87.2	85.9	0.84	5.9	4.4	10.2	4.6	71	78	▲ 1LE1003-0EA6	20	0.00301
4	4.55	100 L	2910	13.1		88.1	88.9	87.8	0.83	7.9	3.5	8.9	4.6	77	85	▲ 1LE1003-1AA6	26	0.00462
5.5	6.3	112 M	2950	17.8		89.2	89.5	88.8	0.86	10.4	2.7	8.8	3.9	69	77	▲ 1LE1003-1BA6	36	0.00959
11	12.6	132 M	2955	35.5		91.2	91.7	91.8	0.86	20	2.5	9.4	4.1	72	80	1LE1003-1CA6	57	0.031
15	17.3	132 M	2960	48.5		91.9	92	91.1	0.84	28	2.9	9.1	4.4	73	81	▲ 1LE1003-1CA7	65	0.0321
22	25.3	160 L	2945	71		92.7	92.8	92.2	0.91	37.5	3.5	9.9	4.4	76	84	1LE1003-1DA6	108	0.0603
30	33.5	180 L	2950	97		93.3	93.5	93.1	0.88	53	2.6	8.6	3.9	67	80	1LE1003-1EA6	139	0.094
45	51	200 L	2950	146		94	94.5	93.9	0.87	79	2.5	7.1	3.2	77	77	1LE1003-2AA6	194	0.17
4-pole: 1500 rpm at 50 Hz, 1800 rpm at 60 Hz ¹⁾																		
1.1	1.27	80 M	1445	7.3	IE2	84.1	84.6	83.6	0.78	2.4	3	7	3.5	63	70	▲ 1LE1003-0DB6	-	0.00329
4	4.55	100 L	1455	26.5		88.6	89.4	88.8	0.81	8	2.9	7.5	3.7	67	75	▲ 1LE1003-1AB6	42	0.0149
5.5	6.3	112 M	1460	36		89.6	89.9	89.4	0.8	11.1	3.2	8	4.1	67	75	▲ 1LE1003-1BB6	49	0.0186
11	12.6	132 M	1470	71		91.4	91.8	91.1	0.79	22	2.8	8.3	3.8	71	79	1LE1003-1CB6	81	0.041
18.5	21.3	160 L	1480	119	IE2	92.6	92.7	91.8	0.76	38	2.7	8.1	3.8	62	75	1LE1003-1DB6	111	0.099
30	34.5	180 L	1470	195	IE2	93.6	94	93.8	0.79	59	3	8.2	3.8	66	74	1LE1003-1EB6	158	0.173
37	42.5	200 L	1475	240	IE2	93.9	94	93.6	0.81	70	3.1	8.1	3.5	65	72	1LE1003-2AB6	205	0.275
6-pole: 1000 rpm at 50 Hz, 1200 rpm at 60 Hz ¹⁾																		
18.5	22	180 L	975	181	IE2	91.7	92.3	91.9	0.77	38	2.6	6.9	3.3	68	80	1LE1003-1EC6	148	0.24
30	36	200 L	978	295	IE2	92.9	93.6	93.7	0.79	59	2.8	6.5	2.8	61	68	1LE1003-2AC6	220	0.421
8-pole: 750 rpm at 50 Hz, 900 rpm at 60 Hz ¹⁾																		
18.5	22	200 L	725	245		90.1	90.5	89.5	0.71	41.5	3.1	6.7	3.7	60	68	▲ 1LE1003-2AD6	205	0.405
Voltages															Version		Order code	
50 Hz 230 VΔ/400 VY			60 Hz ¹⁾ 460 VY			Standard			2 2		-							
50 Hz 400 VΔ/690 VY			60 Hz ¹⁾ 460 VΔ			Standard			3 4		-							
50 Hz 500 VY						Without additional charge			2 7		-							
50 Hz 500 VΔ						Without additional charge			4 0		-							
For other voltages ¹⁾ and more information, see from page 3/97									9 0		...							
Types of construction															Version		Order code	
Without flange			IM B3 ²⁾			Standard			A		-							
With flange			IM B5 ²⁾			With additional charge			F		-							
For other types of construction and more information, see from page 3/103											...							
Motor protection															Version		Order code	
Without						Standard			A		-							
PTC thermistor with 3 temperature sensors						With additional charge			B		-							
For other motor protection and more information, see from page 3/116											...							
Terminal box position															Version		Order code(s)	
Terminal box at top						Standard			4									
For other terminal box positions and more information, see from page 3/119																		
Special versions																	Order code(s)	
For options, see from page 3/122															1LE1003- -		-Z . . . + . . . + . . .	

3

¹⁾ Operating values at rated power for 60 Hz are stored in the Drive Technology Configurator (DT Configurator; see Appendix, "Tools and engineering").

²⁾ Types derived from IM B3 (IM B6/7/8, IM V6, and IM V5), from IM B5 (IM V3 and IM V1) and from IM B14 (IM V19 and IM V18) are possible, provided that no requirements exist for condensation drainage holes (**H03**) or stamping of the type on the rating plate. The basic type IM B3, IM B5, or IM B14 is stamped as standard on the rating plate. For orders with condensation drainage holes (**H03**), the type must be specified.



Selection and ordering data

Operating values at rated power														Aluminum series				
P_{rated} 50 Hz/ P50 kW	P_{rated} 60 Hz/ P60 ¹⁾ kW	Frame size	n_{rated} 50 Hz rpm	T_{rated} 50 Hz Nm	Different IE class 60 Hz/P60	η_{rated} 50 Hz %	η_{rated} 50 Hz %	η_{rated} 50 Hz %	$\cos\phi_{rated}$ 50 Hz %	I_{rated} 50 Hz A	T_{LR}/I_{rated} 50 Hz	I_{LR}/I_{rated} 50 Hz	T_B/I_{rated} 50 Hz	L_{pfA} 50 Hz dB(A)	L_{WA} 50 Hz dB(A)	1LE1083	$m_{IM B3}$	J
														Article No.	kg	kgm ²		
• Cooling: Self-ventilated (IC411) or with order code F90 forced-air cooled without external fan and fan cover (IC418) • Efficiency according to IEC 60034-30-1: IE3 Premium Efficiency, service factor (SF) 1.0 • Insulation: Thermal class 155 (temperature class F), IP55 degree of protection, utilization in accordance with thermal class 130 (temperature class B)																		
2-pole: 3000 rpm at 50 Hz, 3600 rpm at 60 Hz ¹⁾																		
3	3.45	100 L	2920	9.8		87.1	87.8	87.4	0.88	5.6	3.2	8.1	4.6	67	79	1LE1083-1AA4	26	0.0054
4	4.55	112 M	2950	12.9		88.1	88.7	88.2	0.89	7.4	2.5	9.2	3.4	69	81	1LE1083-1BA2	34	0.012
5.5	6.3	132 S	2960	17.7		89.2	89.6	88.9	0.91	9.8	2.1	9.7	3.6	72	79	1LE1083-1CA0	57	0.031
7.5	8.6	132 S	2950	24.5		90.1	90.9	90.7	0.91	13.2	2.1	9	3.3	68	80	1LE1083-1CA1	57	0.031
11	12.6	160 M	2955	35.5		91.2	91.5	90.7	0.9	19.3	2.5	8.5	3.4	79	86	1LE1083-1DA2	84	0.061
15	17.3	160 M	2960	48.5		91.9	91.9	91	0.86	27.5	2.8	9.5	4	70	82	1LE1083-1DA3	84	0.061
18.5	21.3	160 L	2960	60		92.4	92.9	92.6	0.92	31.5	2.8	9.7	3.8	78	85	1LE1083-1DA4	109	0.073
22	24.5	180 M	2950	71		92.7	93	92.4	0.89	38.5	2.3	7.5	3.5	67	80	1LE1083-1EA2	129	0.08
30	33.5	200 L	2955	97		93.3	93.6	93.3	0.86	54	2.6	7.5	3.3	68	81	1LE1083-2AA4	173	0.134
37	41.5	200 L	2950	120		93.7	93.9	93.5	0.88	65	2.6	7.8	3.4	68	81	1LE1083-2AA5	194	0.158
4-pole: 1500 rpm at 50 Hz, 1800 rpm at 60 Hz ¹⁾																		
2.2	2.55	100 L	1465	14.3	IE2	86.7	87	85.9	0.83	4.4	2.5	9.2	3.8	60	72	1LE1083-1AB4	30	0.014
3	3.45	100 L	1460	19.6	IE2	87.7	88.4	87.8	0.84	5.9	2.4	8.5	3.4	68	75	1LE1083-1AB5	42	0.016
4	4.55	112 M	1460	26		88.6	89.6	89.4	0.85	7.7	2.1	7.5	3	67	74	1LE1083-1BB2	49	0.02
5.5	6.3	132 S	1470	35.5		89.6	90.1	89.7	0.82	10.8	2.5	8.3	3.6	64	76	1LE1083-1CB0	64	0.034
7.5	8.6	132 M	1465	49	IE2	90.4	91.1	90.8	0.84	14.3	2.5	8.1	3.3	64	76	1LE1083-1CB2	61	0.046
11	12.6	160 M	1475	71		91.4	91.8	91.2	0.84	20.5	2.3	7.2	3	65	77	1LE1083-1DB2	83	0.071
15	17.3	160 L	1480	97	IE2	92.1	92.4	92	0.85	27.5	2.9	8.1	3.3	67	74	1LE1083-1DB4	111	0.099
18.5	21.3	180 M	1470	120		92.6	93.1	93	0.82	35	2.7	8	3.5	66	73	1LE1083-1EB2	134	0.13
22	25.3	180 L	1470	143	IE2	93	93.4	93.1	0.82	41.5	2.6	7.7	3.3	62	75	1LE1083-1EB4	142	0.14
30	34.5	200 L	1470	196	IE2	93.6	94.3	94.5	0.84	55	2.6	7.3	3.1	59	72	1LE1083-2AB5	189	0.24
6-pole: 1000 rpm at 50 Hz, 1200 rpm at 60 Hz ¹⁾																		
1.5	1.8	180 L	975	147	IE2	91.2	91.6	91.2	0.77	31	2.3	6.4	3	55	68	1LE1083-1EC4	130	0.19
18.5	22	200 L	978	181	IE2	91.7	92.1	91.9	0.79	37	2.5	5.6	2.6	58	71	1LE1083-2AC4	166	0.28
22	26.5	200 L	978	215	IE1	92.2	93.3	93.5	0.79	43.5	2.5	5.6	2.6	55	68	1LE1083-2AC5	179	0.32
8-pole: 750 rpm at 50 Hz, 900 rpm at 60 Hz ¹⁾																		
1.1	1.3	180 L	725	145		88.6	89.5	89.2	0.74	24	2.1	5.4	2.6	62	75	1LE1083-1ED4	161	0.267
1.5	1.8	200 L	730	196		89.6	89.8	89.1	0.73	33	3	6.8	3.7	57	70	1LE1083-2AD5	212	0.42
Voltagess																		
50 Hz 230 VΔ/400 VY														Version		Order code		
60 Hz ¹⁾ 460 VY														Standard		2 2		
50 Hz 400 VΔ/690 VY														Standard		3 4		
50 Hz 500 VY														Without additional charge		2 7		
50 Hz 500 VΔ														Without additional charge		4 0		
																9 0		
For other voltages ¹⁾ and more information, see from page 3/97																		
Types of construction																		
Without flange														Version		Order code		
IM B3 ²⁾														Standard		A		
With flange														With additional charge		F		
IM B5 ²⁾														With additional charge		K		
With flange																		
IM B14 ²⁾																		
For other types of construction and more information, see from page 3/103																		
Motor protection																		
Without														Version		Order code		
PTC thermistor with 1 or 3 temperature sensors														Standard		A		
														With additional charge		B		
For other motor protection and more information, see from page 3/116																		
Terminal box position																		
Terminal box at top														Version		Order code		
														Standard		4		
For other terminal box positions and more information, see from page 3/119																		
Special versions																		
For options, see from page 3/122														Order code(s)		1LE1083-....-Z ...+...+...+...		



¹⁾ Operating values at rated power for 60 Hz are stored in the Drive Technology Configurator (DT Configurator; see Appendix, "Tools and engineering").

²⁾ Types derived from IM B3 (IM B6/7/8, IM V6, and IM V5), from IM B5 (IM V3 and IM V1) and from IM B14 (IM V19 and IM V18) are possible, provided that no requirements exist for condensation drainage holes (H03) or stamping of the type on the rating plate. The basic type IM B3, IM B5, or IM B14 is stamped as standard on the rating plate. For orders with condensation drainage holes (H03), the type must be specified.

SIMOTICS GP and SIMOTICS SD standard motors

IE3 Premium Efficiency

Cast-iron series SIMOTICS SD 1LE1503 Basic Line – self-ventilated or forced-air cooled

Selection and ordering data

P _{rated} 50 Hz/ P50 kW	P _{rated} 60 Hz/ P60 ¹⁾ kW	Frame size	Operating values at rated power											Cast-iron series 1LE1503 – Basic Line Article No.	m _{IM B3} kg	J kgm ²		
			n _{rated} 50 Hz rpm	T _{rated} 50 Hz Nm	Different IE class 60 Hz/P60	η _{rated} 50 Hz %	η _{rated} 50 Hz %	η _{rated} 50 Hz %	cosφ _{rated} 50 Hz %	I _{rated} 400 V A	T _{LR} / T _{rated} 50 Hz	I _{LR} / I _{rated} 50 Hz	T _B / T _{rated} 50 Hz				L _{pfA} 50 Hz dB(A)	L _{WA} 50 Hz dB(A)
0.37	0.43	71 M	2850	1.24		73.8	73.3	69.7	0.76	0.95	3.5	5.8	3.5	52	63	1LE1503-0CA2	13	0.00045
0.55	0.63	71 M	2850	1.84		77.8	77.5	74.5	0.76	1.34	3.7	6.1	3.7	57	68	1LE1503-0CA3	15	0.00056
0.75	0.86	80 M	2850	2.5		80.7	82.2	81.9	0.86	1.56	2.6	6.2	3	60	71	1LE1503-0DA2	18	0.0011
1.1	1.27	80 M	2885	3.65		82.7	83.9	83.1	0.85	2.25	3	7.1	3.3	60	71	1LE1503-0DA3	21	0.0013
1.5	1.75	90 S	2910	4.9		84.2	84.6	83.2	0.86	3	2.7	8.1	4.2	65	77	1LE1503-0EA0	26	0.0021
2.2	2.55	90 L	2910	7.2	IE2	85.9	86.8	86.1	0.88	4.2	2.6	8.3	4	65	77	1LE1503-0EA4	32	0.0031
3	3.45	100 L	2910	9.8		87.1	87.7	87	0.87	5.7	4.4	9.4	4.5	72	80	1LE1503-1AA4	37	0.0041
4	4.55	112 M	2945	13		88.1	88.8	87.9	0.89	7.4	2.6	9.1	3.6	73	81	1LE1503-1BA2	41	0.0079
5.5	6.3	132 S	2945	17.8		89.2	89.5	88.6	0.88	10.1	2.5	8.9	3.8	69	77	1LE1503-1CA0	66	0.0168
7.5	8.6	132 S	2950	24.5		90.1	91	91	0.92	13.1	1.9	8.3	3.9	68	80	1LE1503-1CA1	75	0.031
11	12.6	160 M	2955	35.5	IE2	91.2	91	89.5	0.89	19.6	2.4	7.9	3.8	70	82	1LE1503-1DA2	102	0.053
15	17.3	160 M	2960	48.5		91.9	91.8	90.5	0.87	27	2.8	8.8	4.3	70	82	1LE1503-1DA3	111	0.061
18.5	21.3	160 L	2955	60		92.4	92.8	92.4	0.9	32	2.8	9	4.2	70	82	1LE1503-1DA4	123	0.068
22	24.5	180 M	2950	71		92.7	93.2	92.9	0.89	38.5	2.3	7.5	3.5	67	80	1LE1503-1EA2	165	0.08
30	33.5	200 L	2955	97		93.3	93.5	92.9	0.87	53	2.5	7	3.3	67	80	1LE1503-2AA4	220	0.134
37	41.5	200 L	2955	120	IE2	93.7	94.2	94	0.88	65	2.5	7.1	3.2	67	80	1LE1503-2AA5	245	0.158
45	51	225 M	2960	145		94	94.5	94.4	0.89	78	2.4	6.9	3.1	73	87	1LE1503-2BA2	315	0.26
55	62	250 M	2975	177		94.3	94.5	93.9	0.89	95	2.3	6.7	3.1	73	87	1LE1503-2CA2	385	0.46
75	84	280 S	2975	240	IE2	94.7	94.8	94.1	0.89	128	2.4	6.8	3	74	88	1LE1503-2DA0	510	0.77
90	101	280 M	2975	290	IE2	95	95.1	94.6	0.9	152	2.4	7.2	3.1	74	88	1LE1503-2DA2	590	0.94
110	123	315 S	2982	350		95.2	95.4	94.9	0.91	183	2.4	7.1	3.1	75	89	1LE1503-3AA0	750	1.4
132	148	315 M	2982	425		95.4	95.5	95.2	0.91	220	2.5	7.2	3.1	75	89	1LE1503-3AA2	880	1.6
160	180	315 L	2982	510	IE2	95.6	95.7	95.2	0.92	265	2.8	7.8	3.3	77	91	1LE1503-3AA4	980	1.7
200	224	315 L	2982	640		95.8	95.9	95.5	0.92	330	2.5	7.2	3	77	91	1LE1503-3AA5	1150	1.3
Voltages ²⁾													Version		Order code			
50 Hz 230 VΔ/400 VY			60 Hz ¹⁾ 460 VY			Standard						2	2	-				
50 Hz 400 VΔ/690 VY			60 Hz ¹⁾ 460 VΔ			Standard						3	4	-				
50 Hz 500 VY						Without additional charge						2	7	-				
50 Hz 500 VΔ						Without additional charge						4	0	-				
For other voltages ¹⁾ and more information, see from page 3/100													9	0	...			
Types of construction													Version		Order code			
Without flange			IM B3 ³⁾			Standard						A		-				
With flange			IM B5 ³⁾			With additional charge						F		-				
For other types of construction and more information, see from page 3/107															...			
Motor protection													Version		Order code			
Without						Standard						A		-				
PTC thermistor with 3 temperature sensors						With additional charge						B		-				
For other motor protection and more information, see from page 3/117															...			
Terminal box position													Version		Order code(s)			
Terminal box at top						Standard						4		-				
For other terminal box positions and more information, see from page 3/120																		
Special versions															Order code(s)			
Forced-air cooled motors w/o ext. fan/fan cover (IC418)															1LE1503-...-Z F90+...+...+...			
For options, see from page 3/129															1LE1503-...-Z ...+...+...+...			

¹⁾ Operating values at rated power for 60 Hz are stored in the Drive Technology Configurator (DT Configurator; see Appendix, "Tools and engineering").

²⁾ Parallel supply lines are required in the case of connection to ≤ 240 V. For frame size 315 with connection to ≤ 240 V, due to the high current, a drilled, removable entry plate (order code **R52**) or a larger terminal box (order code **R50**) can be used. Order codes **R52** and **R50** alter the motor dimensions.

³⁾ Types derived from IM B3 (IM B6/7/8, IM V6 and IM V5), from IM B5 (IM V3 and IM V1) and from IM B14 (IM V19 and IM V18) are possible, provided that no requirement exists for stamping of the type on the rating plate. The basic type IM B3, IM B5, or IM B14 is stamped as standard on the rating plate. If mounted in a different position, the position must be specified to ensure that the condensation drainage holes are positioned correctly.



Selection and ordering data

Operating values at rated power														Cast-iron series		m _{IM B3}	J		
P _{rated} , 50 Hz/ P50 kW	P _{rated} , 60 Hz/ P60 ¹⁾ kW	Frame size	n _{rated} , 50 Hz rpm	T _{rated} , 50 Hz Nm	Different IE class	η _{rated} , 50 Hz %	η _{rated} , 50 Hz %	η _{rated} , 50 Hz %	cosφ _{rated} , 50 Hz %	I _{rated} , 400 V A	T _{LR} / 50 Hz dB(A)	I _{LR} / 50 Hz dB(A)	T _B / 50 Hz dB(A)	L _{pfA} , 50 Hz dB(A)	L _{WA} , 50 Hz dB(A)			1LE1503 – Basic Line	Article No.
• Cooling: Self-ventilated (IC411) or with order code F90 forced-air cooled without external fan and fan cover (IC418) • Efficiency according to IEC 60034-30-1: IE3 Premium Efficiency, service factor (SF) 1.15 • Insulation: Thermal class 155 (temperature class F), IP55 degree of protection, utilization in accordance with thermal class 130 (temperature class B)																			
4-pole: 1500 rpm at 50 Hz, 1800 rpm at 60 Hz ¹⁾																			
0.25	0.29	71 M	1395	1.71		73.5	73.7	70.4	0.72	0.68	2.5	4.2	2.6	44	55	1LE1503-0CB2	-	13	0.0095
0.37	0.43	71 M	1410	2.5		77.3	76.8	73.2	0.7	0.99	3.1	4.8	3.1	56	67	1LE1503-0CB3	-	16	0.0014
0.55	0.63	80 M	1440	3.65		80.8	81.5	79.8	0.78	1.26	2.1	5.9	3.1	52	60	1LE1503-0DB2	-	18	0.0021
0.75	0.86	80 M	1450	4.95		82.5	82.3	80.1	0.75	1.75	2.7	7.1	3.9	58	66	1LE1503-0DB3	-	22	0.0029
1.1	1.27	90 S	1440	7.3	IE2	84.1	84.7	83.4	0.78	2.4	2.9	6.9	3.6	56	68	1LE1503-0EB0	-	25	0.0036
1.5	1.75	90 L	1445	9.9		85.3	85.7	84.4	0.8	3.15	2.9	7.3	3.5	62	70	1LE1503-0EB4	-	31	0.0049
2.2	2.55	100 L	1455	14.4		86.7	87.2	86.3	0.82	4.45	3	8.3	3.8	67	75	1LE1503-1AB4	-	40	0.0101
3	3.45	100 L	1450	19.8	IE2	87.7	88.1	87.1	0.8	6.2	3.1	8	3.8	67	75	1LE1503-1AB5	-	40	0.01
4	4.55	112 M	1460	26		88.6	89.2	88.6	0.82	7.9	2.4	7.1	3.7	58	70	1LE1503-1BB2	-	46	0.017
5.5	6.3	132 S	1470	35.5		89.6	90	89.4	0.82	10.8	2.9	8.5	3.7	64	76	1LE1503-1CB0	-	74	0.034
7.5	8.6	132 M	1465	49	IE2	90.4	90.7	90.4	0.8	15	3	8.5	3.8	72	80	1LE1503-1CB2	-	80	0.0334
11	12.6	160 M	1470	71		91.4	91.9	91.9	0.82	21	2.5	8	3.5	67	75	1LE1503-1DB2	-	105	0.0583
15	17.3	160 L	1475	97	IE2	92.1	92.3	91.5	0.82	28.5	2.5	8.5	3.8	65	77	1LE1503-1DB4	-	127	0.085
18.5	21.3	180 M	1470	120	IE2	92.6	93.1	92.9	0.82	35	2.5	7.2	3.3	66	73	1LE1503-1EB2	-	165	0.13
22	25.3	180 L	1470	143		93	93.6	93.6	0.83	41	2.3	6.8	3.3	68	75	1LE1503-1EB4	-	170	0.14
30	34.5	200 L	1470	195	IE2	93.6	94	93.7	0.84	55	2.6	7.3	3.1	65	72	1LE1503-2AB5	-	240	0.24
37	42.5	225 S	1478	240	IE2	93.9	94.5	94.4	0.86	66	2.5	6.4	2.7	65	78	1LE1503-2BB0	-	285	0.42
45	52	225 M	1478	290	IE2	94.2	94.9	95	0.86	80	2.6	6.6	2.6	66	79	1LE1503-2BB2	-	340	0.52
55	63	250 M	1482	355	IE2	94.6	95.1	95	0.87	96	2.5	6.8	2.9	66	79	1LE1503-2CB2	-	420	0.85
75	86	280 S	1485	480	IE2	95	95.3	95	0.86	133	2.5	6.9	3	69	83	1LE1503-2DB0	-	570	1.4
90	104	280 M	1485	580	IE2	95.2	95.5	95.3	0.87	157	2.6	7.2	3	70	84	1LE1503-2DB2	-	670	1.7
110	127	315 S	1488	710		95.4	95.8	95.5	0.87	191	2.6	6.8	2.9	70	84	1LE1503-3AB0	-	760	1.2
132	152	315 M	1490	850		95.6	95.9	95.9	0.87	230	2.8	7.3	3	73	87	1LE1503-3AB2	-	960	1.9
160	184	315 L	1490	1030		95.8	96.1	96.1	0.87	275	2.9	7.3	3.1	73	87	1LE1503-3AB4	-	990	3.1
200	230	315 L	1488	1280	IE2	96	96.3	96.1	0.88	340	3.2	7.4	3	73	87	1LE1503-3AB5	-	1190	3.7
Voltsages²⁾														Version				Order code	
50 Hz 230 VΔ/400 VY				60 Hz ¹⁾ 460 VY				Standard		2 2				-					
50 Hz 400 VΔ/690 VY				60 Hz ¹⁾ 460 VΔ				Standard		3 4				-					
50 Hz 500 VY								Without additional charge		2 7				-					
50 Hz 500 VΔ								Without additional charge		4 0				-					
For other voltsages ¹⁾ and more information, see from page 3/100														9 0				...	
Types of construction														Version				Order code	
Without flange				IM B3 ³⁾				Standard		A				-					
With flange				IM B5 ³⁾				With additional charge		F				-					
For other types of construction and more information, see from page 3/107														
Motor protection														Version				Order code	
Without								Standard		A				-					
PTC thermistor with 3 temperature sensors								With additional charge		B				-					
For other motor protection and more information, see from page 3/117														
Terminal box position														Version				Order code	
Terminal box at top								Standard		4									
For other terminal box positions and more information, see from page 3/120														
Special versions																		Order code(s)	
Forced-air cooled motors w/o ext. fan/fan cover (IC418)														1LE1503-....		-Z		F90+. .+. .+. .+	
For options, see from page 3/129														1LE1503-....		-Z		. .+. .+. .+. .+	

¹⁾ Operating values at rated power for 60 Hz are stored in the Drive Technology Configurator (DT Configurator; see Appendix, "Tools and engineering").

²⁾ Parallel supply lines are required in the case of connection to ≤ 240 V. For frame size 315 with connection to ≤ 240 V, due to the high current, a drilled, removable entry plate (order code **R52**) or a larger terminal box (order code **R50**) can be used. Order codes **R52** and **R50** alter the motor dimensions.

³⁾ Types derived from IM B3 (IM B6/7/8, IM V6 and IM V5), from IM B5 (IM V3 and IM V1) and from IM B14 (IM V19 and IM V18) are possible, provided that no requirement exists for stamping of the type on the rating plate. The basic type IM B3, IM B5, or IM B14 is stamped as standard on the rating plate. If mounted in a different position, the position must be specified to ensure that the condensation drainage holes are positioned correctly.



SIMOTICS GP and SIMOTICS SD standard motors

IE3 Premium Efficiency



Cast-iron series SIMOTICS SD 1LE1503 Basic Line – self-ventilated or forced-air cooled

Selection and ordering data

P _{rated} 50 Hz/ P50 kW	P _{rated} 60 Hz/ P60 ¹⁾ kW	Frame size	Operating values at rated power		Different IE class	η _{rated} 50 Hz	η _{rated} 50 Hz	η _{rated} 50 Hz	cosφ _{rated} 50 Hz	I _{rated} 400 V	T _{LR} / T _{rated} 50 Hz	I _{LR} / I _{rated} 50 Hz	T _B / T _{rated} 50 Hz	L _{pFA} 50 Hz	L _{WA} 50 Hz	Cast-iron series 1LE1503 – Basic Line	m _{IM B3}	J
			n _{rated} 50 Hz	T _{rated} 50 Hz														
0.18	0.21	71 M	885	1.94		63.9	64.8	60.8	0.69	0.59	2.3	2.8	2.3	39	50	1LE1503-0CC2	13	0.001
0.25	0.29	71 M	885	2.7		68.6	69.5	66.2	0.69	0.76	2.6	3.2	2.6	46	57	1LE1503-0CC3	16	0.0015
0.37	0.43	80 M	940	3.75		73.5	73.1	69.4	0.66	1.1	2.3	4.2	2.7	42	53	1LE1503-0DC2	19	0.0025
0.55	0.63	80 M	935	5.6	IE2	77.2	77	73.9	0.67	1.53	2.5	4.5	2.8	42	53	1LE1503-0DC3	22	0.0031
0.75	0.86	90 S	945	7.6	IE2	78.9	80	78.8	0.7	1.96	2.2	4.6	2.6	43	55	1LE1503-0EC0	26	0.004
1.1	1.27	90 L	950	11.1		81	81.4	79.3	0.66	2.95	2.8	5	3	60	68	1LE1503-0EC4	31	0.0048
1.5	1.75	100 L	970	14.8		82.5	83.1	81.5	0.73	3.6	1.9	5.2	2.8	59	71	1LE1503-1AC4	36	0.011
2.2	2.55	112 M	970	21.5		84.3	85	83.9	0.75	5	2.2	5.6	2.8	65	74	1LE1503-1BC2	53	0.017
3	3.45	132 S	975	29.5	IE2	85.6	85.8	84.3	0.73	6.9	2.3	6.6	3.2	58	66	1LE1503-1CC0	60	0.029
4	4.55	132 M	975	39	IE2	86.8	87.3	86.2	0.73	9.1	2.2	6.2	3	67	75	1LE1503-1CC2	64	0.037
5.5	6.3	132 M	975	54	IE1	88	88.1	86.9	0.72	12.5	2.7	6.8	3.4	64	72	1LE1503-1CC3	76	0.046
7.5	8.6	160 M	985	73	IE2	89.1	89.7	89	0.81	15	2.3	7.9	3.2	71	79	1LE1503-1DC2	124	0.098
11	12.6	160 L	980	107	IE2	90.3	90.7	89.8	0.8	22	2.9	6.8	2.8	66	74	1LE1503-1DC4	138	0.12
15	18	180 L	975	147	IE1	91.2	92	91.9	0.8	29.5	2.3	5.9	2.8	61	68	1LE1503-1EC4	180	0.19
18.5	22	200 L	978	181	IE2	91.7	92.5	92.4	0.79	37	2.5	5.6	2.6	64	71	1LE1503-2AC4	215	0.28
22	26.5	200 L	978	215	IE1	92.2	92.8	92.3	0.79	43.5	2.5	5.6	2.6	61	68	1LE1503-2AC5	230	0.32
30	36	225 M	982	290	IE2	92.9	93.6	93.5	0.83	56	2.6	6.6	3	64	77	1LE1503-2BC2	325	0.67
37	44.5	250 M	985	360	IE2	93.3	94	94	0.85	67	2.7	7	2.9	62	75	1LE1503-2CC2	405	1
45	54	280 S	988	435	IE2	93.7	94.3	94.2	0.85	82	3	6.8	2.8	60	74	1LE1503-2DC0	510	1.4
55	66	280 M	988	530	IE2	94.1	94.5	94.4	0.85	99	3.3	7.2	3	65	79	1LE1503-2DC2	560	1.64
75	90	315 S	990	720		94.6	94.9	94.4	0.84	136	2.6	7.5	3.1	63	78	1LE1503-3AC0	750	2.6
90	108	315 M	991	870	IE2	94.9	95.2	94.9	0.85	161	2.5	6.7	2.8	63	78	1LE1503-3AC2	890	3.1
110	132	315 L	991	1060	IE2	95.1	95.5	95.3	0.84	199	2.8	7.2	3	63	78	1LE1503-3AC4	990	3.9
132	158	315 L	992	1270	IE2	95.4	95.7	95.4	0.82	245	3.3	8	3.3	66	81	1LE1503-3AC5	1130	4.48
160	192	315 L	992	1540	IE2	95.6	95.8	95.5	0.82	295	3.5	8.5	3.6	66	81	1LE1503-3AC6	1260	5.41

Voltages ²⁾		Version	Order code
50 Hz 230 VΔ/400 VY	60 Hz ¹⁾ 460 VY	Standard	2 2
50 Hz 400 VΔ/690 VY	60 Hz ¹⁾ 460 VΔ	Standard	3 4
50 Hz 500 VY		Without additional charge	2 7
50 Hz 500 VΔ		Without additional charge	4 0
For other voltages ¹⁾ and more information, see from page 3/100			9 0

Types of construction		Version	Order code
Without flange	IM B3 ³⁾	Standard	A
With flange	IM B5 ³⁾	With additional charge	F
For other types of construction and more information, see from page 3/107			...

Motor protection		Version	Order code
Without		Standard	A
PTC thermistor with 3 temperature sensors		With additional charge	B
For other motor protection and more information, see from page 3/117			...

Terminal box position		Version	Order code
Terminal box at top		Standard	4
For other terminal box positions and more information, see from page 3/120			...

Special versions		Order code(s)
Forced-air cooled motors w/o ext. fan/fan cover (IC418)		1LE1503-...-Z F90+...+...+...
For options, see from page 3/129		1LE1503-...-Z ...+...+...+...

¹⁾ Operating values at rated power for 60 Hz are stored in the Drive Technology Configurator (DT Configurator; see Appendix, "Tools and engineering").

²⁾ Parallel supply lines are required in the case of connection to ≤ 240 V. For frame size 315 with connection to ≤ 240 V, due to the high current, a drilled, removable entry plate (order code **R52**) or a larger terminal box (order code **R50**) can be used. Order codes **R52** and **R50** alter the motor dimensions.

³⁾ Types derived from IM B3 (IM B6/7/8, IM V6 and IM V5), from IM B5 (IM V3 and IM V1) and from IM B14 (IM V19 and IM V18) are possible, provided that no requirement exists for stamping of the type on the rating plate. The basic type IM B3, IM B5, or IM B14 is stamped as standard on the rating plate. If mounted in a different position, the position must be specified to ensure that the condensation drainage holes are positioned correctly.



Cast-iron series SIMOTICS SD 1LE1503 Basic Line – self-ventilated or forced-air cooled

Selection and ordering data

Operating values at rated power														Cast-iron series						
P_{rated} , 50 Hz/ P50 kW	P_{rated} , 60 Hz/ P60 ¹⁾ kW	Frame size	n_{rated} , 50 Hz rpm	T_{rated} , 50 Hz Nm	Different IE class 60 Hz/P60	η_{rated} , 50 Hz %	η_{rated} , 50 Hz %	η_{rated} , 50 Hz %	$\cos\phi_{rated}$, 50 Hz %	I_{rated} , 400 V A	$T_{LR}/$ T_{rated} , 50 Hz °C	$I_{LR}/$ I_{rated} , 50 Hz %	$T_{\beta}/$ T_{rated} , 50 Hz °C	L_{pA} , 50 Hz dB(A)	L_{WA} , 50 Hz dB(A)	1LE1503 – Basic Line	$m_{IM B3}$	J		
															Article No.	kg	kgm ²			
<ul style="list-style-type: none"> • Cooling: Self-ventilated (IC411) or with order code F90 forced-air cooled without external fan and fan cover (IC418) • Efficiency according to IEC 60034-30-1: IE3 Premium Efficiency, service factor (SF) 1.15 • Insulation: Thermal class 155 (temperature class F), IP55 degree of protection, utilization in accordance with thermal class 130 (temperature class B) 																				
8-pole: 750rpm at 50 Hz, 900 rpm at 60 Hz ¹⁾																				
0.09	0.11	71 M	650	1.32		44.1	42.8	37.3	0.64	0.46	1.9	2.2	1.9	46	53	▲ 1LE1503-0CD2	13	0.0098		
0.12	0.12	71 M	660	1.74		50.7	49.9	44.8	0.63	0.54	2.1	2.5	2.1	46	53	▲ 1LE1503-0CD3	16	0.0014		
0.18	0.18	80 M	705	2.45		58.7	55.8	49.2	0.49	0.9	2.3	3	2.8	48	61.3	▲ 1LE1503-0DD2	18	0.0021		
0.25	0.25	80 M	695	3.45		64.1	62.7	57.8	0.57	0.93	1.8	2.9	2.1	52	59	▲ 1LE1503-0DD3	22	0.003		
0.37	0.37	90 S	685	5.2		69.3	68.3	63.7	0.68	1.13	1.7	2.9	1.8	56	53	▲ 1LE1503-0ED0	26	0.0045		
0.55	0.55	90 L	695	7.6		73	71.2	66.5	0.67	1.62	2	3.5	2.3	61	68	▲ 1LE1503-0ED4	26	0.0045		
0.75	0.75	100 L	710	10.1		75	75.7	73.1	0.67	2.1	1.5	3.7	2.1	61.4	69.4	▲ 1LE1503-1AD4	31	0.0096		
1.1	1.1	100	710	14.8		77.7	76.4	75.1	0.67	3.05	1.8	4.1	2.3	61.9	69.9	▲ 1LE1503-1AD5	36	0.013		
1.5	1.5	1112	720	19.9	IE2	79.7	85.6	77.3	0.63	4.15	2.6	5.1	3.1	61.7	69.7	▲ 1LE1503-1BD2	46	0.028		
Voltages ²⁾															Version		Order code			
50 Hz 230 VΔ/400 VY			60 Hz ¹⁾ 460 VY												Standard		2 2		–	
50 Hz 400 VΔ/690 VY			60 Hz ¹⁾ 460 VΔ												Standard		3 4		–	
50 Hz 500 VY															Without additional charge		2 7		–	
50 Hz 500 VΔ															Without additional charge		4 0		–	
For other voltages ¹⁾ and more information, see from page 3/100															9 0		...			
Types of construction															Version		Order code			
Without flange			IM B3 ³⁾												Standard		A		–	
With flange			IM B5 ³⁾												With additional charge		F		–	
For other types of construction and more information, see from page 3/107															B		...			
Motor protection															Version		Order code			
Without															Standard		A		–	
PTC thermistor with 3 temperature sensors															With additional charge		B		–	
For other motor protection and more information, see from page 3/117															B		...			
Terminal box position															Version		Order code			
Terminal box at top															Standard		4		–	
For other terminal box positions and more information, see from page 3/120															B		...			
Special versions																	Order code(s)			
Forced-air cooled motors w/o ext. fan/fan cover (IC418)															1LE1503-....		-Z F90+...+...+...			
For options, see from page 3/129															1LE1503-....		-Z ...+...+...+...			



¹⁾ Operating values at rated power for 60 Hz are stored in the Drive Technology Configurator (DT Configurator; see Appendix, "Tools and engineering").

²⁾ Parallel supply lines are required in the case of connection to ≤ 240 V. For frame size 315 with connection to ≤ 240 V, due to the high current, a drilled, removable entry plate (order code R52) or a larger terminal box (order code R50) can be used. Order codes R52 and R50 alter the motor dimensions.

³⁾ Types derived from IM B3 (IM B6/7/8, IM V6 and IM V5), from IM B5 (IM V3 and IM V1) and from IM B14 (IM V19 and IM V18) are possible, provided that no requirement exists for stamping of the type on the rating plate. The basic type IM B3, IM B5, or IM B14 is stamped as standard on the rating plate. If mounted in a different position, the position must be specified to ensure that the condensation drainage holes are positioned correctly.

SIMOTICS GP and SIMOTICS SD standard motors

IE3 Premium Efficiency



Cast-iron series SIMOTICS SD 1LE1603 Performance Line – self-ventilated or forced-air cooled

Selection and ordering data

P _{rated} 50 Hz/ P50 kW	P _{rated} 60 Hz/ P60 ¹⁾ kW	Frame size	Operating values at rated power													Cast-iron series 1LE1603 – Performance Line Article No.	m _{IM B3} kg	J kgm ²			
			n _{rated} 50 Hz rpm	T _{rated} 50 Hz Nm	Different IE class 60 Hz/P60	η _{rated} 50 Hz %	η _{rated} 50 Hz %	η _{rated} 50 Hz %	cosφ _{rated} 50 Hz %	I _{rated} 400 V A	T _{LR} / T _{rated} 50 Hz	I _{LR} / I _{rated} 50 Hz	T _B / T _{rated} 50 Hz	L _{pfA} 50 Hz dB(A)	L _{WA} 50 Hz dB(A)						
3	3.45	100 L	2910	9.8		87.1	87.7	87	0.87	5.7	4.4	9.4	4.5	72	80	1LE1603-1AA4	37	0.0041			
4	4.55	112 M	2945	13		88.1	88.8	87.9	0.89	7.4	2.6	9.1	3.6	73	81	1LE1603-1BA2	41	0.0079			
5.5	6.3	132 S	2945	17.8		89.2	89.5	88.6	0.88	10.1	2.5	8.9	3.8	69	77	1LE1603-1CA0	66	0.0168			
7.5	8.6	132 S	2950	24.5		90.1	91	91	0.92	13.1	1.9	8.3	3.9	68	80	1LE1603-1CA1	75	0.031			
11	12.6	160 M	2955	35.5	IE2	91.2	91	89.5	0.89	19.6	2.4	7.9	3.8	70	82	1LE1603-1DA2	102	0.053			
15	17.3	160 M	2960	48.5		91.9	91.8	90.5	0.87	27	2.8	8.8	4.3	70	82	1LE1603-1DA3	111	0.061			
18.5	21.3	160 L	2955	60		92.4	92.8	92.4	0.9	32	2.8	9	4.2	70	82	1LE1603-1DA4	123	0.068			
22	24.5	180 M	2950	71		92.7	93.2	92.9	0.89	38.5	2.3	7.5	3.5	67	80	1LE1603-1EA2	165	0.08			
30	33.5	200 L	2955	97		93.3	93.5	92.9	0.87	53	2.5	7	3.3	67	80	1LE1603-2AA4	220	0.134			
37	41.5	200 L	2955	120	IE2	93.7	94.2	94	0.88	65	2.5	7.1	3.2	67	80	1LE1603-2AA5	245	0.158			
45	51	225 M	2960	145		94	94.5	94.4	0.89	78	2.4	6.9	3.1	73	87	1LE1603-2BA2	315	0.26			
55	62	250 M	2975	177		94.3	94.5	93.9	0.89	95	2.3	6.7	3.1	73	87	1LE1603-2CA2	385	0.46			
75	84	280 S	2975	240	IE2	94.7	94.8	94.1	0.89	128	2.4	6.8	3	74	88	1LE1603-2DA0	510	0.77			
90	101	280 M	2975	290	IE2	95	95.1	94.6	0.9	152	2.4	7.2	3.1	74	88	1LE1603-2DA2	590	0.94			
110	123	315 S	2982	350		95.2	95.4	94.9	0.91	183	2.4	7.1	3.1	75	89	1LE1603-3AA0	750	1.4			
132	148	315 M	2982	425		95.4	95.5	95.2	0.91	220	2.5	7.2	3.1	75	89	1LE1603-3AA2	880	1.6			
160	180	315 L	2982	510	IE2	95.6	95.7	95.2	0.92	265	2.8	7.8	3.3	77	91	1LE1603-3AA4	980	1.7			
200	224	315 L	2982	640		95.8	95.9	95.5	0.92	330	2.5	7.2	3	77	91	1LE1603-3AA5	1150	1.3			
Voltages ²⁾			Version													Order code					
50 Hz 230 VΔ/400 VY			60 Hz ¹⁾ 460 VY			Standard													2 2		-
50 Hz 400 VΔ/690 VY			60 Hz ¹⁾ 460 VA			Standard													3 4		-
50 Hz 500 VY			Without additional charge													2 7		-			
50 Hz 500 VA			Without additional charge													4 0		-			
For other voltages ¹⁾ and more information, see from page 3/100																9 0		...			
Types of construction			Version													Order code					
Without flange			IM B3 ³⁾			Standard													A		-
With flange			IM B5 ³⁾			With additional charge													F		-
For other types of construction and more information, see from page 3/107																		...			
Motor protection			Line													Version		Order code			
PTC thermistor with 3 temperature sensors			Standard													B		-			
For other motor protection and more information, see from page 3/117																		...			
Terminal box position			Version													Order code					
Terminal box at top			Standard													4					
For other terminal box positions and more information, see from page 3/120																					
Special versions																Order code(s)					
Forced-air cooled motors w/o ext. fan/fan cover (IC418)			1LE1603-....													-Z F90+...+...+...					
For options, see from page 3/129			1LE1603-....													-Z ...+...+...+...					

¹⁾ Operating values at rated power for 60 Hz are stored in the Drive Technology Configurator (DT Configurator; see Appendix, "Tools and engineering").

²⁾ Parallel supply lines are required in the case of connection to ≤ 240 V. For frame size 315 with connection to ≤ 240 V, due to the high current, a drilled, removable entry plate (order code **R52**) or a larger terminal box (order code **R50**) can be used. Order codes **R52** and **R50** alter the motor dimensions.

³⁾ Types derived from IM B3 (IM B6/7/8, IM V6 and IM V5), from IM B5 (IM V3 and IM V1) and from IM B14 (IM V19 and IM V18) are possible, provided that no requirement exists for stamping of the type on the rating plate. The basic type IM B3, IM B5, or IM B14 is stamped as standard on the rating plate. If mounted in a different position, the position must be specified to ensure that the condensation drainage holes are positioned correctly.



SIMOTICS GP and SIMOTICS SD standard motors
IE3 Premium Efficiency

Cast-iron series SIMOTICS SD 1LE1603 Performance Line – self-ventilated or forced-air cooled

Selection and ordering data

Operating values at rated power														Cast-iron series		m _{IM B3}	J	
P _{rated} , 50 Hz/ P50 kW	P _{rated} , 60 Hz/ P60 ¹⁾ kW	Frame size	n _{rated} , 50 Hz rpm	T _{rated} , 50 Hz Nm	Different IE class 60 Hz/P60	η _{rated} , 50 Hz %	η _{rated} , 50 Hz %	η _{rated} , 50 Hz %	cosφ _{rated} , 50 Hz %	I _{rated} , 50 Hz A	T _{LR} / r _{rated} , 50 Hz dB(A)	I _{LR} / r _{rated} , 50 Hz dB(A)	T _B / r _{rated} , 50 Hz dB(A)	L _{pfA} , 50 Hz dB(A)	L _{WA} , 50 Hz dB(A)			1LE1603 – Performance Line Article No.
• Cooling: Self-ventilated (IC411) or with order code F90 forced-air cooled without external fan and fan cover (IC418) • Efficiency according to IEC 60034-30-1: IE3 Premium Efficiency, service factor (SF) 1.15 • Insulation: Thermal class 155 (temperature class F), IP55 degree of protection, utilization in accordance with thermal class 130 (temperature class B)																		
4-pole: 1500 rpm at 50 Hz, 1800 rpm at 60 Hz ¹⁾																		
2.2	2.55	100 L	1455	14.4		86.7	87.2	86.3	0.82	4.45	3	8.3	3.8	67	75	1LE1603-1AB4	40	0.0101
3	3.45	100 L	1450	19.8	IE2	87.7	88.1	87.1	0.8	6.2	3.1	8	3.8	67	75	1LE1603-1AB5	40	0.01
4	4.55	112 M	1460	26		88.6	89.2	88.6	0.82	7.9	2.4	7.1	3.7	58	70	1LE1603-1BB2	46	0.017
5.5	6.3	132 S	1470	35.5		89.6	90	89.4	0.82	10.8	2.9	8.5	3.7	64	76	1LE1603-1CB0	74	0.034
7.5	8.6	132 M	1465	49	IE2	90.4	90.7	90.4	0.8	15	3	8.5	3.8	72	80	1LE1603-1CB2	80	0.0334
11	12.6	160 M	1470	71		91.4	91.9	91.9	0.82	21	2.5	8	3.5	67	75	1LE1603-1DB2	105	0.0583
15	17.3	160 L	1475	97	IE2	92.1	92.3	91.5	0.82	28.5	2.5	8.5	3.8	65	77	1LE1603-1DB4	127	0.085
18.5	21.3	180 M	1470	120	IE2	92.6	93.1	92.9	0.82	35	2.5	7.2	3.3	66	73	1LE1603-1EB2	165	0.13
22	25.3	180 L	1470	143		93	93.6	93.6	0.83	41	2.3	6.8	3.3	68	75	1LE1603-1EB4	170	0.14
30	34.5	200 L	1470	195	IE2	93.6	94	93.7	0.84	55	2.6	7.3	3.1	65	72	1LE1603-2AB5	240	0.24
37	42.5	225 S	1478	240	IE2	93.9	94.5	94.4	0.86	66	2.5	6.4	2.7	65	78	1LE1603-2BB0	285	0.42
45	52	225 M	1478	290	IE2	94.2	94.9	95	0.86	80	2.6	6.6	2.6	66	79	1LE1603-2BB2	340	0.52
55	63	250 M	1482	355	IE2	94.6	95.1	95	0.87	96	2.5	6.8	2.9	66	79	1LE1603-2CB2	420	0.85
75	86	280 S	1485	480	IE2	95	95.3	95	0.86	133	2.5	6.9	3	69	83	1LE1603-2DB0	570	1.4
90	104	280 M	1485	580	IE2	95.2	95.5	95.3	0.87	157	2.6	7.2	3	70	84	1LE1603-2DB2	670	1.7
110	127	315 S	1488	710		95.4	95.8	95.5	0.87	191	2.6	6.8	2.9	70	84	1LE1603-3AB0	760	1.2
132	152	315 M	1490	850		95.6	95.9	95.9	0.87	230	2.8	7.3	3	73	87	1LE1603-3AB2	960	1.9
160	184	315 L	1490	1030		95.8	96.1	96.1	0.87	275	2.9	7.3	3.1	73	87	1LE1603-3AB4	990	3.1
200	230	315 L	1488	1280	IE2	96	96.3	96.1	0.88	340	3.2	7.4	3	73	87	1LE1603-3AB5	1190	3.7
Voltages²⁾														Version		Order code		
50 Hz 230 VΔ/400 VY				60 Hz ¹⁾ 460 VY				Standard		2 2		-						
50 Hz 400 VΔ/690 VY				60 Hz ¹⁾ 460 VΔ				Standard		3 4		-						
50 Hz 500 VY								Without additional charge		2 7		-						
50 Hz 500 VΔ								Without additional charge		4 0		-						
For other voltages ¹⁾ and more information, see from page 3/100														9 0		...		
Types of construction														Version		Order code		
Without flange				IM B3 ³⁾				Standard		A		-						
With flange				IM B5 ³⁾				With additional charge		F		-						
For other types of construction and more information, see from page 3/107														B		...		
Motor protection Line														Version		Order code		
PTC thermistor with 3 temperature sensors								Standard		B		-						
For other motor protection and more information, see from page 3/117														4		...		
Terminal box position														Version		Order code(s)		
Terminal box at top								Standard		4								
For other terminal box positions and more information, see from page 3/120																		
Special versions																Order code(s)		
Forced-air cooled motors w/o ext. fan/fan cover (IC418)														1LE1603-....		-Z F90+...+...+...		
For options, see from page 3/129														1LE1603-....		-Z ...+...+...+...		

¹⁾ Operating values at rated power for 60 Hz are stored in the Drive Technology Configurator (DT Configurator; see Appendix, "Tools and engineering").

²⁾ Parallel supply lines are required in the case of connection to ≤ 240 V. For frame size 315 with connection to ≤ 240 V, due to the high current, a drilled, removable entry plate (order code **R52**) or a larger terminal box (order code **R50**) can be used. Order codes **R52** and **R50** alter the motor dimensions.

³⁾ Types derived from IM B3 (IM B6/7/8, IM V6 and IM V5), from IM B5 (IM V3 and IM V1) and from IM B14 (IM V19 and IM V18) are possible, provided that no requirement exists for stamping of the type on the rating plate. The basic type IM B3, IM B5, or IM B14 is stamped as standard on the rating plate. If mounted in a different position, the position must be specified to ensure that the condensation drainage holes are positioned correctly.



SIMOTICS GP and SIMOTICS SD standard motors

IE3 Premium Efficiency



Cast-iron series SIMOTICS SD 1LE1603 Performance Line – self-ventilated or forced-air cooled

Selection and ordering data

P _{rated} 50 Hz/ P50 kW	P _{rated} 60 Hz/ P60 kW	Frame size	Operating values at rated power													Cast-iron series 1LE1603 – Performance Line Article No.	m _{IM B3} kg	J kgm ²
			n _{rated} 50 Hz rpm	T _{rated} 50 Hz Nm	Different IE class 60 Hz/P60	η _{rated} 50 Hz %	η _{rated} 50 Hz %	η _{rated} 50 Hz %	cosφ _{rated} 50 Hz %	I _{rated} 400 V A	T _{LR} / 50 Hz dB(A)	I _{LR} / 50 Hz dB(A)	T _B / 50 Hz dB(A)	L _{pfA} 50 Hz dB(A)	L _{WA} 50 Hz dB(A)			
1.5	1.75	100 L	970	14.8		82.5	83.1	81.5	0.73	3.6	1.9	5.2	2.8	59	71	1LE1603-1AC4	36	0.011
2.2	2.55	112 M	970	21.5		84.3	85	83.9	0.75	5	2.2	5.6	2.8	65	74	1LE1603-1BC2	53	0.017
3	3.45	132 S	975	29.5	IE2	85.6	85.8	84.3	0.73	6.9	2.3	6.6	3.2	58	66	1LE1603-1CC0	60	0.029
4	4.55	132 M	975	39	IE2	86.8	87.3	86.2	0.73	9.1	2.2	6.2	3	67	75	1LE1603-1CC2	64	0.037
5.5	6.3	132 M	975	54	IE1	88	88.1	86.9	0.72	12.5	2.7	6.8	3.4	64	72	1LE1603-1CC3	76	0.046
7.5	8.6	160 M	985	73	IE2	89.1	89.7	89	0.81	15	2.3	7.9	3.2	71	79	1LE1603-1DC2	124	0.098
11	12.6	160 L	980	107	IE2	90.3	90.7	89.8	0.8	22	2.9	6.8	2.8	66	74	1LE1603-1DC4	138	0.12
15	18	180 L	975	147	IE1	91.2	92	91.9	0.8	29.5	2.3	5.9	2.8	61	68	1LE1603-1EC4	180	0.19
18.5	22	200 L	978	181	IE2	91.7	92.5	92.4	0.79	37	2.5	5.6	2.6	64	71	1LE1603-2AC4	215	0.28
22	26.5	200 L	978	215	IE1	92.2	92.8	92.3	0.79	43.5	2.5	5.6	2.6	61	68	1LE1603-2AC5	230	0.32
30	36	225 M	982	290	IE2	92.9	93.6	93.5	0.83	56	2.6	6.6	3	64	77	1LE1603-2BC2	325	0.67
37	44.5	250 M	985	360	IE2	93.3	94	94	0.85	67	2.7	7	2.9	62	75	1LE1603-2CC2	405	1
45	54	280 S	988	435	IE2	93.7	94.3	94.2	0.85	82	3	6.8	2.8	60	74	1LE1603-2DC0	510	1.4
55	66	280 M	988	530	IE2	94.1	94.5	94.4	0.85	99	3.3	7.2	3	65	79	1LE1603-2DC2	560	1.64
75	90	315 S	990	720		94.6	94.9	94.4	0.84	136	2.6	7.5	3.1	63	78	1LE1603-3AC0	750	2.6
90	108	315 M	991	870	IE2	94.9	95.2	94.9	0.85	161	2.5	6.7	2.8	63	78	1LE1603-3AC2	890	3.1
110	132	315 L	991	1060	IE2	95.1	95.5	95.3	0.84	199	2.8	7.2	3	63	78	1LE1603-3AC4	990	3.9
132	158	315 L	992	1270	IE2	95.4	95.7	95.4	0.82	245	3.3	8	3.3	66	81	1LE1603-3AC5	1130	4.48
160	192	315 L	992	1540	IE2	95.6	95.8	95.5	0.82	295	3.5	8.5	3.6	66	81	1LE1603-3AC6	1260	5.41
Voltages ²⁾															Version	Order code		
50 Hz 230 VΔ/400 VY			60 Hz ¹⁾ 460 VY			Standard			2 2		-							
50 Hz 400 VΔ/690 VY			60 Hz ¹⁾ 460 VΔ			Standard			3 4		-							
50 Hz 500 VY						Without additional charge			2 7		-							
50 Hz 500 VΔ						Without additional charge			4 0		-							
For other voltages ¹⁾ and more information, see from page 3/100									9 0		...							
Types of construction															Version	Order code		
Without flange			IM B3 ³⁾			Standard			A		-							
With flange			IM B5 ³⁾			With additional charge			F		-							
For other types of construction and more information, see from page 3/107											...							
Motor protection															Version	Order code		
PTC thermistor with 3 temperature sensors						Standard			B		-							
For other motor protection and more information, see from page 3/117											...							
Terminal box position															Version	Order code		
Terminal box at top						Standard			4									
For other terminal box positions and more information, see from page 3/120																		
Special versions															Order code(s)			
Forced-air cooled motors w/o ext. fan/fan cover (IC418)						1LE1603-... -Z			F90+...+...+...									
For options, see from page 3/129						1LE1603-... -Z			...+...+...+...									

¹⁾ Operating values at rated power for 60 Hz are stored in the Drive Technology Configurator (DT Configurator; see Appendix, "Tools and engineering").

²⁾ Parallel supply lines are required in the case of connection to ≤ 240 V. For frame size 315 with connection to ≤ 240 V, due to the high current, a drilled, removable entry plate (order code **R52**) or a larger terminal box (order code **R50**) can be used. Order codes **R52** and **R50** alter the motor dimensions.

³⁾ Types derived from IM B3 (IM B6/7/8, IM V6 and IM V5), from IM B5 (IM V3 and IM V1) and from IM B14 (IM V19 and IM V18) are possible, provided that no requirement exists for stamping of the type on the rating plate. The basic type IM B3, IM B5, or IM B14 is stamped as standard on the rating plate. If mounted in a different position, the position must be specified to ensure that the condensation drainage holes are positioned correctly.



Selection and ordering data

Operating values at rated power															Cast-iron series		m _{IM B3}	J	
P _{rated} 50 Hz/ P50 kW	P _{rated} 60 Hz/ P60 kW	Frame size	n _{rated} 50 Hz rpm	T _{rated} 50 Hz Nm	Different IE class 60 Hz/P60	η _{rated} 50 Hz %	η _{rated} 50 Hz %	η _{rated} 50 Hz %	cosφ _{rated} 50 Hz %	I _{rated} 400 V A	T _{LR} / 50 Hz	I _{LR} / 50 Hz	T _B / 50 Hz	L _{ptA} 50 Hz dB(A)	L _{WA} 50 Hz dB(A)	1LE1603 – Performance Line Article No.			▲ New
0.75	0.86	100 L	710	10.1		75	75.7	73.1	0.67	2.1	1.5	3.7	2.1	61.4	69.4	▲ 1LE1603-1AD4		31	0.0096
1.1	1.27	100	710	14.8		77.7	76.4	75.1	0.67	3.05	1.8	4.1	2.3	61.9	69.9	▲ 1LE1603-1AD5		36	0.013
1.5	1.75	1112	720	19.9	IE2	79.7	85.6	77.3	0.63	4.15	2.6	5.1	3.1	61.7	69.7	▲ 1LE1603-1BD2		46	0.028
2.2	2.55	132 S	725	29	IE2	81.9	82.5	80.9	0.71	5.3	1.9	5	2.5	65	73	1LE1603-1CD0		60	0.046
3	3.45	132 M	725	39.5	IE2	83.5	83.8	82.2	0.72	7.1	2	5.2	2.5	70	78	1LE1603-1CD2		78	0.061
4	4.55	160 M	730	52		84.8	86	85.5	0.74	9.1	1.6	4.7	2.1	62.5	70.5	1LE1603-1DD2		98	0.076
5.5	6.3	160 M	730	72		86.2	87	86.3	0.73	12.4	2	5.5	2.4	68	76	1LE1603-1DD3		109	0.1
7.5	8.6	160 L	730	98	IE2	87.3	87.9	86.9	0.73	16.9	2.3	5.8	2.7	70	78	1LE1603-1DD4		117	0.13
11	13.2	180 L	725	145	IE2	88.6	89.6	89	0.74	24	2.1	5.1	2.4	67	74	1LE1603-1ED4		187	0.267
15	18	200 L	730	196		89.6	90.1	89.4	0.73	33.5	3	6.8	3.7	57	70	1LE1603-2AD5		249	0.42
18.5	22	225 S	732	240	IE2	90.1	90.6	90	0.75	39.5	2.5	5.9	3	56	70	1LE1603-2BD0		270	0.5
22	26.5	225 M	732	285	IE2	90.6	91.4	91.2	0.77	45.5	2.6	5.9	2.9	56	70	1LE1603-2BD2		280	0.55
30	36	250 M	735	390		91.3	91.8	91.5	0.79	60	2.6	6.1	3	60	74	1LE1603-2CD2		370	0.86
37	44.5	280 S	736	480		91.8	92.5	92.4	0.78	75	2.3	5.4	2.4	63	77	1LE1603-2DD0		460	1.1
45	54	280 M	738	580	IE2	92.2	92.8	92.6	0.8	88	2.5	5.9	2.5	65	79	1LE1603-2DD2		550	1.6
55	66	315 S	740	710		92.5	92.9	92.6	0.81	106	2.3	6	2.7	66	81	1LE1603-3AD0		650	2
75	90	315 M	738	970		93.1	93.5	93.3	0.81	144	2.3	5.9	2.7	69	84	1LE1603-3AD2		720	2.5
90	108	315 L	740	1160		93.4	94.2	94.3	0.83	168	2.2	5.8	2.5	71	85	1LE1603-3AD4		860	3.1
110	132	315 L	740	1420		93.7	94.2	94.1	0.82	205	2.7	6.7	2.9	74	88	1LE1603-3AD5		980	3.9
132	158	315 L	740	1700		94	94.4	94.1	0.81	250	2.9	7.2	3.3	76	90	1LE1603-3AD6		1160	4.5

Voltages ²⁾		Version	Order code
50 Hz 230 VΔ/400 VY	60 Hz ¹⁾ 460 VY	Standard	2 2 –
50 Hz 400 VΔ/690 VY	60 Hz ¹⁾ 460 VΔ	Standard	3 4 –
50 Hz 500 VY		Without additional charge	2 7 –
50 Hz 500 VΔ		Without additional charge	4 0 –
For other voltages ¹⁾ and more information, see from page 3/100			9 0 ...

Types of construction		Version	Order code
Without flange	IM B3 ³⁾	Standard	A –
With flange	IM B5 ³⁾	With additional charge	F –
For other types of construction and more information, see from page 3/107			... B

Motor protection		Version	Order code
PTC thermistor with 3 temperature sensors		Standard	B –
For other motor protection and more information, see from page 3/117			... B

Terminal box position		Version	Order code
Terminal box at top		Standard	4 –
For other terminal box positions and more information, see from page 3/120			... 4

Special versions		Order code(s)
Forced-air cooled motors w/o ext. fan/fan cover (IC418)		1LE1603-...-Z F90+...+...+...
For options, see from page 3/129		1LE1603-...-Z ...+...+...+...

¹⁾ Operating values at rated power for 60 Hz are stored in the Drive Technology Configurator (DT Configurator; see Appendix, "Tools and engineering").

²⁾ Parallel supply lines are required in the case of connection to ≤ 240 V. For frame size 315 with connection to ≤ 240 V, due to the high current, a drilled, removable entry plate (order code **R52**) or a larger terminal box (order code **R50**) can be used. Order codes **R52** and **R50** alter the motor dimensions.

³⁾ Types derived from IM B3 (IM B6/7/8, IM V6 and IM V5), from IM B5 (IM V3 and IM V1) and from IM B14 (IM V19 and IM V18) are possible, provided that no requirement exists for stamping of the type on the rating plate. The basic type IM B3, IM B5, or IM B14 is stamped as standard on the rating plate. If mounted in a different position, the position must be specified to ensure that the condensation drainage holes are positioned correctly.



SIMOTICS GP and SIMOTICS SD standard motors
IE3 Premium Efficiency



Cast-iron series SIMOTICS SD 1LE1503 Basic Line with increased power – self-ventilated

Selection and ordering data

Operating values at rated power																Cast-iron series			
P_{rated} 50 Hz/ P50	P_{rated} 60 Hz/ P60	Frame size	n_{rated} 50 Hz	T_{rated} 50 Hz	Different IE class 60 Hz/P60	η_{rated} 50 Hz	η_{rated} 50 Hz	η_{rated} 50 Hz	$\cos\phi_{rated}$ 50 Hz	I_{rated} 400 V	$T_{LR}/$ T_{rated} 50 Hz	$I_{LR}/$ I_{rated} 50 Hz	$T_{\beta}/$ T_{rated} 50 Hz	L_{pfA} 50 Hz	L_{WA} 50 Hz	1LE1503 – Basic Line	$m_{IM\ B3}$	J	
kW	kW	FS	rpm	Nm		%	%	%	%	A					Article No.	kg	kgm ²		
<ul style="list-style-type: none"> • Cooling: Self-ventilated (IC411) or with order code F90 forced-air cooled without external fan and fan cover (IC418) • Efficiency according to IEC 60034-30-1: IE3 Premium Efficiency, service factor (SF) 1.15 • Insulation: Thermal class 155 (temperature class F), IP55 degree of protection, utilization in accordance with thermal class 130 (temperature class B) 																			
2-pole: 3000 rpm at 50 Hz, 3600 rpm at 60 Hz ¹⁾																			
1.5	1.75	80 M	2865	5		84.2	84.8	84.4	0.84	3.05	3.2	8	3.7	69	77	▲ 1LE1503-0DA6	22	0.0015	
3	3.45	90 L	2920	9.8	IE2	87.1	87.2	85.9	0.84	5.9	4.4	10.2	4.6	71	78	▲ 1LE1503-0EA6	31	0.00301	
4	4.55	100 L	2910	13.1		88.1	88.9	87.8	0.83	7.9	3.5	8.9	4.6	77	85	▲ 1LE1503-1AA6	34	0.00462	
5.5	6.3	112 M	2950	17.8		89.2	89.5	88.8	0.86	10.4	2.7	8.8	3.9	69	77	▲ 1LE1503-1BA6	43	0.00959	
11	12.6	132 M	2955	35.5		91.2	91.7	91.8	0.86	20	2.5	9.4	4.1	72	80	1LE1503-1CA6	75	0.031	
15	17.3	132 M	2960	48.5		91.9	92	91.1	0.84	28	2.9	9.1	4.4	73	81	▲ 1LE1503-1CA7	83	0.0321	
22	25.3	160 L	2945	71		92.7	92.8	92.2	0.91	37.5	3.5	9.9	4.4	76	84	1LE1503-1DA6	137	0.0603	
30	33.5	180 L	2950	97		93.3	93.5	93.1	0.88	53	2.6	8.6	3.9	67	80	1LE1503-1EA6	175	0.094	
45	51	200 L	2950	146		94	94.5	93.9	0.87	79	2.5	7.1	3.2	77	77	1LE1503-2AA6	245	0.17	
55	62	225 M	2965	177		94.3	94.6	94.4	0.88	96	2.8	8	3.7	76	89	1LE1503-2BA6	370	0.31	
75	84	250 M	2970	240	IE2	94.7	94.9	94.5	0.9	127	2.2	6.8	2.9	78	92	1LE1503-2CA6	470	0.56	
110	123	280 M	2975	355		95.2	95.4	95.1	0.91	183	2.5	7.7	3.2	78	92	1LE1503-2DA6	670	1.1	
4-pole: 1500 rpm at 50 Hz, 1800 rpm at 60 Hz ¹⁾																			
1.1	1.27	80 M	1445	7.3	IE2	84.1	84.6	83.6	0.78	2.4	3	7	3.5	63	70	▲ 1LE1503-0DB6	24	0.00329	
4	4.55	100 L	1455	26.5		88.6	89.4	88.8	0.81	8	2.9	7.5	3.7	67	75	▲ 1LE1503-1AB6	53	0.0149	
5.5	6.3	112 M	1460	36		89.6	89.9	89.4	0.8	11.1	3.2	8	4.1	67	75	▲ 1LE1503-1BB6	60	0.0186	
11	12.6	132 M	1470	71		91.4	91.8	91.1	0.79	22	2.8	8.3	3.8	71	79	1LE1503-1CB6	99	0.041	
18.5	21.3	160 L	1480	119	IE2	92.6	92.7	91.8	0.76	38	2.7	8.1	3.8	62	75	1LE1503-1DB6	126	0.099	
30	34.5	180 L	1470	195	IE2	93.6	94	93.8	0.79	59	3	8.2	3.8	66	74	1LE1503-1EB6	191	0.173	
37	42.5	200 L	1475	240	IE2	93.9	94	93.6	0.81	70	3.1	8.1	3.5	65	72	1LE1503-2AB6	258	0.275	
55	63	225 M	1478	355	IE2	94.6	95.3	95.5	0.86	98	2.8	6.5	2.7	70	83	1LE1503-2BB6	405	0.65	
75	86	250 M	1486	480		95	95.2	94.8	0.85	134	3	7.9	3.4	70	83	1LE1503-2CB6	510	1.1	
110	127	280 M	1486	710	IE2	95.4	95.5	95	0.85	196	3	8.3	3.4	73	87	1LE1503-2DB6	720	1.7	
Voltages ²⁾																Version		Order code	
50 Hz 230 VΔ/400 VY				60 Hz ¹⁾ 460 VY				Standard				2 2		-					
50 Hz 400 VΔ/690 VY				60 Hz ¹⁾ 460 VΔ				Standard				3 4		-					
50 Hz 500 VY								Without additional charge				2 7		-					
50 Hz 500 VΔ								Without additional charge				4 0		-					
For other voltages ¹⁾ and more information, see from page 3/100																			
Types of construction																Version		Order code	
Without flange				IM B3 ³⁾				Standard				A		-					
With flange				IM B5 ³⁾				With additional charge				F		-					
With flange				IM B14 ³⁾				With additional charge				K		-					
For other types of construction and more information, see from page 3/107																			
Motor protection																Version		Order code	
Without								Standard				A		-					
PTC thermistor with 3 temperature sensors								With additional charge				B		-					
For other motor protection and more information, see from page 3/117																			
Terminal box position																Version		Order code(s)	
Terminal box at top								Standard				4		-					
For other terminal box positions and more information, see from page 3/120																			
Special versions																Version		Order code(s)	
For options, see from page 3/129																1LE1503-		-Z . . . + . . . + . . .	

¹⁾ Operating values at rated power for 60 Hz are stored in the Drive Technology Configurator (DT Configurator; see Appendix, "Tools and engineering").
²⁾ Parallel supply lines are required in the case of connection to ≤ 240 V. For frame size 315 with connection to ≤ 240 V, due to the high current, a drilled, removable entry plate (order code **R52**) or a larger terminal box (order code **R50**) can be used. Order codes **R52** and **R50** alter the motor dimensions.

³⁾ Types derived from IM B3 (IM B6/7/8, IM V6 and IM V5), from IM B5 (IM V3 and IM V1) and from IM B14 (IM V19 and IM V18) are possible, provided that no requirement exists for stamping of the type on the rating plate. The basic type IM B3, IM B5, or IM B14 is stamped as standard on the rating plate. If mounted in a different position, the position must be specified to ensure that the condensation drainage holes are positioned correctly.



Cast-iron series SIMOTICS SD 1LE1503 Basic Line with increased power – self-ventilated

Selection and ordering data

Operating values at rated power																Cast-iron series			
P_{rated} 50 Hz/ P50	P_{rated} 60 Hz/ P60	Frame size	n_{rated} 50 Hz	T_{rated} 50 Hz	Different IE class	η_{rated} 50 Hz	η_{rated} 50 Hz	η_{rated} 50 Hz	$\cos\phi_{rated}$ 50 Hz	I_{rated} 400 V	$T_{LR}/$ T_{rated}	$I_{LR}/$ I_{rated}	$T_{\beta}/$ T_{rated}	L_{pfA} 50 Hz	L_{WA} 50 Hz	1LE1503 – Basic Line	$m_{IM B3}$	J	
kW	kW	FS	rpm	Nm	60 Hz/P60	%	%	%	%	A						Article No.	kg	kgm ²	
• Cooling: Self-ventilated (IC411) or with order code F90 forced-air cooled without external fan and fan cover (IC418) • Efficiency according to IEC 60034-30-1: IE3 Premium Efficiency, service factor (SF) 1.15 • Insulation: Thermal class 155 (temperature class F), IP55 degree of protection, utilization in accordance with thermal class 130 (temperature class B)																			
6-pole: 1000 rpm at 50 Hz. 1200 rpm at 60 Hz ¹⁾																			
18.5	22	180 L	975	181	IE2	91.7	92.3	91.9	0.77	38	2.6	6.9	3.3	68	80	1LE1503-1EC6	185	0.247	
30	36	200 L	978	295	IE2	92.9	93.6	93.7	0.79	59	2.8	6.5	2.8	61	68	1LE1503-2AC6	264	0.434	
37	44.5	225 M	982	360	IE2	93.3	93.9	93.7	0.81	71	3	7.1	3.2	65	79	1LE1503-2BC6	395	0.84	
45	54	250 M	986	435	IE2	93.7	94.3	94.2	0.84	83	2.8	7	2.9	68	81	1LE1503-2CC6	480	1.3	
75	90	280 M	988	720		94.6	95	94.8	0.83	138	3.7	8.6	3.3	68	81	1LE1503-2DC6	630	1.9	
8-pole: 750 rpm at 50 Hz. 900 rpm at 60 Hz ¹⁾																			
18,5	22	200 L	725	245	IE2	90,1	90,5	89,5	0,71	41,5	3,1	6,7	3,7	60	68	▲ 1LE1503-2AD6	256	0,405	
30	36	225 M	732	390	IE2	91.3	92	91.8	0.75	63	2.7	6.1	3.1	60	74	▲ 1LE1503-2BD6	325	0.67	
37	44,5	250 M	730	485	IE2	91.8	92.9	93.2	0.81	72	2.3	5.7	2.6	61	75	▲ 1LE1503-2CD6	405	1	
55	66	280 M	736	710	IE2	92.5	93.3	92.6	0.8	107	2.5	5.9	2.5	70	81	▲ 1LE1503-2DD6	550	1.6	
Voltages ²⁾																Version		Order code	
50 Hz 230 VΔ/400 VY			60 Hz ¹⁾ 460 VY													Standard		–	
50 Hz 400 VΔ/690 VY			60 Hz ¹⁾ 460 VΔ													Standard		–	
50 Hz 500 VY																Without additional charge		–	
50 Hz 500 VΔ																Without additional charge		–	
For other voltages ¹⁾ and more information, see from page 3/100																9 0		...	
Types of construction																Version		Order code	
Without flange			IM B3 ³⁾													Standard		–	
With flange			IM B5 ³⁾													With additional charge		–	
With flange			IM B14 ³⁾													With additional charge		–	
For other types of construction and more information, see from page 3/107																K		...	
Motor protection																Version		Order code	
Without																Standard		–	
PTC thermistor with 3 temperature sensors																With additional charge		–	
For other motor protection and more information, see from page 3/117																B		...	
Terminal box position																Version		Order code	
Terminal box at top																Standard		4	
For other terminal box positions and more information, see from page 3/120																			
Special versions																		Order code(s)	
For options, see from page 3/129																1LE1503- -		-Z . . . + . . . + . . .	

¹⁾ Operating values at rated power for 60 Hz are stored in the Drive Technology Configurator (DT Configurator; see Appendix, "Tools and engineering").
²⁾ Parallel supply lines are required in the case of connection to ≤ 240 V. For frame size 315 with connection to ≤ 240 V, due to the high current, a drilled, removable entry plate (order code R52) or a larger terminal box (order code R50) can be used. Order codes R52 and R50 alter the motor dimensions.

³⁾ Types derived from IM B3 (IM B6/7/8, IM V6 and IM V5), from IM B5 (IM V3 and IM V1) and from IM B14 (IM V19 and IM V18) are possible, provided that no requirement exists for stamping of the type on the rating plate. The basic type IM B3, IM B5, or IM B14 is stamped as standard on the rating plate. If mounted in a different position, the position must be specified to ensure that the condensation drainage holes are positioned correctly.



SIMOTICS GP and SIMOTICS SD standard motors

IE3 Premium Efficiency



Cast-iron series SIMOTICS SD 1LE1603 Performance Line with increased power – self-ventilated

Selection and ordering data

P _{rated} , 50 Hz/ P50 kW	P _{rated} , 60 Hz/ P60 kW	Frame size FS	Operating values at rated power														Cast-iron series 1LE1603 – Performance Line Article No.	m _{IM B3} kg	J kgm ²
			n _{rated} , 50 Hz rpm	T _{rated} , 50 Hz Nm	Different IE class 60 Hz/P60	η _{rated} , 50 Hz %	η _{rated} , 50 Hz %	η _{rated} , 50 Hz %	cosφ _{rated} , 50 Hz %	I _{rated} , 50 Hz A	T _{LR} / T _{rated} , 50 Hz	I _{LR} / I _{rated} , 50 Hz	T _p / T _{rated} , 50 Hz	L _{pfA} , 50 Hz dB(A)	L _{WA} , 50 Hz dB(A)				
<ul style="list-style-type: none"> Cooling: Self-ventilated (IC411) or with order code F90 forced-air cooled without external fan and fan cover (IC418) Efficiency according to IEC 60034-30-1: IE3 Premium Efficiency, service factor (SF) 1.15 Insulation: Thermal class 155 (temperature class F), IP55 degree of protection, utilization in accordance with thermal class 130 (temperature class B) 																			
2-pole: 3000 rpm at 50 Hz, 3600 rpm at 60 Hz ¹⁾																			
4	4,55	100 L	2910	13.1		88.1	88.9	87.8	0.83	7.9	3.5	8.9	4.6	77	85	▲ 1LE1603-1AA6	34	0.00462	
5.5	6,3	112 M	2950	17.8		89.2	89.5	88.8	0.86	10.4	2.7	8.8	3.9	69	77	▲ 1LE1603-1BA6	43	0.00959	
11	12,6	132 M	2955	35.5		91.2	91.7	91.8	0.86	20	2.5	9.4	4.1	72	80	1LE1603-1CA6	75	0.031	
15	17,3	132 M	2960	48.5		91.9	92	91.1	0.84	28	2.9	9.1	4.4	73	81	▲ 1LE1603-1CA7	83	0.0321	
22	25,3	160 L	2945	71		92.7	92.8	92.2	0.91	37.5	3.5	9.9	4.4	76	84	1LE1603-1DA6	137	0.0603	
30	33,5	180 L	2950	97		93.3	93.5	93.1	0.88	53	2.6	8.6	3.9	67	80	1LE1603-1EA6	175	0.094	
45	51	200 L	2950	146		94	94.5	93.9	0.87	79	2.5	7.1	3.2	77	77	1LE1603-2AA6	245	0.17	
55	62	225 M	2965	177		94.3	94.6	94.4	0.88	96	2.8	8	3.7	76	89	1LE1603-2BA6	370	0.31	
75	84	250 M	2970	240	IE2	94.7	94.9	94.5	0.9	127	2.2	6.8	2.9	78	92	1LE1603-2CA6	470	0.56	
110	123	280 M	2975	355		95.2	95.4	95.1	0.91	183	2.5	7.7	3.2	78	92	1LE1603-2DA6	670	1.1	
4-pole: 1500 rpm at 50 Hz, 1800 rpm at 60 Hz ¹⁾																			
4	4,55	100 L	1455	26.5		88.6	89.4	88.8	0.81	8	2.9	7.5	3.7	67	75	▲ 1LE1603-1AB6	24	0.00329	
5.5	6,3	112 M	1460	36		89.6	89.9	89.4	0.8	11.1	3.2	8	4.1	67	75	▲ 1LE1603-1BB6	60	0.0186	
11	12,6	132 M	1470	71		91.4	91.8	91.1	0.79	22	2.8	8.3	3.8	71	79	1LE1603-1CB6	53	0.0149	
18.5	21,3	160 L	1480	119	IE2	92.6	92.7	91.8	0.76	38	2.7	8.1	3.8	62	75	1LE1603-1DB6	99	0.041	
30	34,5	180 L	1470	195	IE2	93.6	94	93.8	0.79	59	3	8.2	3.8	66	74	1LE1603-1EB6	126	0.099	
37	42,5	200 L	1475	240	IE2	93.9	94	93.6	0.81	70	3.1	8.1	3.5	65	72	1LE1603-2AB6	191	0.173	
55	63	225 M	1478	355	IE2	94.6	95.3	95.5	0.86	98	2.8	6.5	2.7	70	83	1LE1603-2BB6	258	0.275	
75	86	250 M	1486	480		95	95.2	94.8	0.85	134	3	7.9	3.4	70	83	1LE1603-2CB6	405	0.65	
110	127	280 M	1486	710	IE2	95.4	95.5	95	0.85	196	3	8.3	3.4	73	87	1LE1603-2DB6	510	1.1	
6-pole: 1000 rpm at 50 Hz, 1200 rpm at 60 Hz ¹⁾																			
18.5	22	180 L	975	181	IE2	91.7	92.3	91.9	0.77	38	2.6	6.9	3.3	68	80	1LE1603-1EC6	185	0.247	
30	36	200 L	978	295	IE2	92.9	93.6	93.7	0.79	59	2.8	6.5	2.8	61	68	1LE1603-2AC6	264	0.434	
37	44,5	225 M	982	360	IE2	93.3	93.9	93.7	0.81	71	3	7.1	3.2	65	79	1LE1603-2BC6	395	0.84	
45	54	250 M	986	435	IE2	93.7	94.3	94.2	0.84	83	2.8	7	2.9	68	81	1LE1603-2CC6	480	1.3	
75	90	280 M	988	720		94.6	95	94.8	0.83	138	3.7	8.6	3.3	68	81	1LE1603-2DC6	630	1.9	
8-pole: 750 rpm at 50 Hz, 900 rpm at 60 Hz ¹⁾																			
18,5	22	200 L	725	245	IE2	90,1	90,5	89,5	0,71	41,5	3,1	6,7	3,7	60	68	▲ 1LE1603-2AD6	256	0,405	
30	36	225 M	732	390	IE2	91.3	92	91.8	0.75	63	2.7	6.1	3.1	60	74	▲ 1LE1603-2BD6	325	0.67	
37	44,5	250 M	730	485	IE2	91.8	92.9	93.2	0.81	72	2.3	5.7	2.6	61	75	▲ 1LE1603-2CD6	405	1	
55	66	280 M	736	710	IE2	92.5	93.3	92.6	0.8	107	2.5	5.9	2.5	70	81	▲ 1LE1603-2DD6	550	1.6	
Voltages²⁾																			
50 Hz 230 VΔ/400 VY										Version			Order code						
60 Hz ¹⁾ 460 VY										Standard			2 2						
50 Hz 400 VΔ/690 VY										Standard			3 4						
50 Hz 500 VY										Without additional charge			2 7						
50 Hz 500 VΔ										Without additional charge			4 0						
For other voltages ¹⁾ and more information, see from page 3/100													9 0						
													...						
Types of construction																			
Without flange IM B3 ³⁾										Version			Order code						
With flange IM B5 ³⁾										Standard			A						
With flange IM B14 ³⁾										With additional charge			F						
										With additional charge			K						
For other types of construction and more information, see from page 3/107													...						
Motor protection																			
PTC thermistor with 3 temperature sensors										Version			Order code						
										Standard			B						
For other motor protection and more information, see from page 3/117													...						
Terminal box position																			
Terminal box at top										Version			Order code						
										Standard			4						
For other terminal box positions and more information, see from page 3/120																			
Special versions																			
For options, see from page 3/129													Order code(s)						
													1LE1603-... -Z ...+...+...+...						

¹⁾ Operating values at rated power for 60 Hz are stored in the Drive Technology Configurator (DT Configurator; see Appendix, "Tools and engineering").

²⁾ Parallel supply lines are required in the case of connection to ≤ 240 V. For frame size 315 with connection to ≤ 240 V, due to the high current, a drilled, removable entry plate (order code R52) or a larger terminal box (order code R50) can be used. Order codes R52 and R50 alter the motor dimensions.

³⁾ Types derived from IM B3 (IM B6/7/8, IM V6 and IM V5), from IM B5 (IM V3 and IM V1) and from IM B14 (IM V19 and IM V18) are possible, provided that no requirement exists for stamping of the type on the rating plate. The basic type IM B3, IM B5, or IM B14 is stamped as standard on the rating plate. If mounted in a different position, the position must be specified to ensure that the condensation drainage holes are positioned correctly.

Selection and ordering data

Operating values at rated power															Cast-iron series		$m_{IM B3}$	J	
P_{rated} 50 Hz/ P50	P_{rated} 60 Hz/ P60 ¹⁾	Frame size	n_{rated} 50 Hz	T_{rated} 50 Hz	Different IE class	η_{rated} 50 Hz	η_{rated} 50 Hz	η_{rated} 50 Hz	$\cos\phi_{rated}$ 50 Hz	I_{rated} 50 Hz	T_{LR} 50 Hz	I_{LR} 50 Hz	T_B 50 Hz	L_{pFA} 50 Hz	L_{WA} 50 Hz	1LE1583			Article No.
kW	kW	FS	rpm	Nm		%	%	%	%	A				dB(A)	dB(A)			kg	kgm ²
<ul style="list-style-type: none"> Cooling: Self-ventilated (IC411) or with order code F90 forced-air cooled without external fan and fan cover (IC418) Efficiency according to IEC 60034-30-1: IE3 Premium Efficiency, service factor (SF) 1.0 Insulation: Thermal class 155 (temperature class F), IP55 degree of protection, utilization in accordance with thermal class 130 (temperature class B) Optional and suitable for converter operation; $U_{line} \leq 690 V$ - IVIC-C premiuminsulation system 																			
2-pole: 3000 rpm at 50 Hz, 3600 rpm at 60 Hz ¹⁾																			
3	3.45	100 L	2920	9.8		87.1	87.8	87.4	0.88	5.6	3.2	8.1	4.6	67	79	1LE1583-1AA4		37	0.0054
4	4.55	112 M	2950	12.9		88.1	88.7	88.2	0.89	7.4	2.5	9.2	3.4	69	81	1LE1583-1BA2		43	0.012
5.5	6.3	132 S	2960	17.7		89.2	89.6	88.9	0.91	9.8	2.1	9.7	3.6	72	79	1LE1583-1CA0		75	0.031
7.5	8.6	132 S	2950	24.5		90.1	90.9	90.7	0.91	13.2	2.1	9	3.3	68	80	1LE1583-1CA1		75	0.031
11	12.6	160 M	2955	35.5		91.2	91.5	90.7	0.9	19.3	2.5	8.5	3.4	79	86	1LE1583-1DA2		111	0.061
15	17.3	160 M	2960	48.5		91.9	91.9	91	0.86	27.5	2.8	9.5	4	70	82	1LE1583-1DA3		111	0.061
18.5	21.3	160 L	2960	60		92.4	92.9	92.6	0.92	31.5	2.8	9.7	3.8	78	85	1LE1583-1DA4		131	0.073
22	24.5	180 M	2950	71		92.7	93	92.4	0.89	38.5	2.3	7.5	3.5	67	80	1LE1583-1EA2		165	0.08
30	33.5	200 L	2955	97		93.3	93.6	93.3	0.86	54	2.6	7.5	3.3	68	81	1LE1583-2AA4		220	0.134
37	41.5	200 L	2950	120		93.7	93.9	93.5	0.88	65	2.6	7.8	3.4	68	81	1LE1583-2AA5		245	0.158
45	51	225 M	2960	145		94	94.5	94.4	0.89	78	2.4	6.9	3.1	73	87	1LE1583-2BA2		315	0.265
55	62	250 M	2975	177		94.3	94.5	94	0.89	95	2.1	7	3	73	87	1LE1583-2CA2		385	0.463
75	84	280 S	2980	240		94.7	94.8	94.1	0.89	128	2.6	8.7	3.5	73	87	1LE1583-2DA0		610	0.926
90	101	280 M	2980	290		95	95.2	94.8	0.9	152	2.7	8.4	3.2	77	91	1LE1583-2DA2		620	0.934
110	123	315 S	2982	350		95.2	95.4	95	0.91	183	2.2	7.5	2.9	75	89	1LE1583-3AA0		750	1.37
132	148	315 M	2984	420		95.4	95.6	95.3	0.9	220	2.7	8.4	3	77	91	1LE1583-3AA2		980	1.9
160	180	315 L	2982	510	IE2	95.6	95.7	95.1	0.91	265	2.6	8.5	3.3	77	91	1LE1583-3AA4		980	1.9
200	225	315 L	2986	640		95.8	95.9	95.5	0.92	330	3.9	10	3.6	78	93	1LE1583-3AA5		1080	2.45
Voltages ²⁾															Version				Order code
50 Hz 230 VΔ/400 VY			60 Hz ¹⁾ 460 VY												Standard	2 2	–		
50 Hz 400 VΔ/690 VY			60 Hz ¹⁾ 460 VΔ												Standard	3 4	–		
50 Hz 500 VY															Without additional charge	2 7	–		
50 Hz 500 VΔ															Without additional charge	4 0	–		
For other voltages ¹⁾ and more information, see from page 3/100															9 0	...			
Types of construction															Version				Order code
Without flange			IM B3 ³⁾												Standard	A	–		
With flange			IM B5 ³⁾												With additional charge	F	–		
For other types of construction and more information, see from page 3/107																...			
Motor protection															Version				Order code
Without															Standard	A	–		
PTC thermistor with 3 temperature sensors															With additional charge	B	–		
For other motor protection and more information, see from page 3/117																...			
Terminal box position															Version				Order code
Terminal box at top															Standard	4	–		
For other terminal box positions and more information, see from page 3/120																–			
Special versions																			Order code(s)
Forced-air cooled motors w/o ext. fan/fan cover (IC418)															1LE1583-....	-Z	F90+...+...+...		
For options, see from page 3/129																1LE1583-....	-Z	...+...+...+...	

¹⁾ Operating values at rated power for 60 Hz are stored in the Drive Technology Configurator (DT Configurator; see Appendix, "Tools and engineering").

²⁾ Parallel supply lines are required in the case of connection to $\leq 240 V$. For frame size 315 with connection to $\leq 240 V$, due to the high current, a drilled, removable entry plate (order code R52) or a larger terminal box (order code R50) can be used. Order codes R52 and R50 alter the motor dimensions.

³⁾ Types derived from IM B3 (IM B6/7/8, IM V6 and IM V5), from IM B5 (IM V3 and IM V1) and from IM B14 (IM V19 and IM V18) are possible, provided that no requirement exists for stamping of the type on the rating plate. The basic type IM B3, IM B5, or IM B14 is stamped as standard on the rating plate. If mounted in a different position, the position must be specified to ensure that the condensation drainage holes are positioned correctly.



SIMOTICS GP and SIMOTICS SD standard motors
IE3 Premium Efficiency



Cast-iron series SIMOTICS SD 1LE1583 – self-ventilated or forced-air cooled

Selection and ordering data

P _{rated} 50 Hz/ P50 kW	P _{rated} 60 Hz/ P60 ¹⁾ kW	Frame size FS	Operating values at rated power											Cast-iron series 1LE1583 Article No.	m _{IM B3} kg	J kgm ²		
			n _{rated} 50 Hz rpm	T _{rated} 50 Hz Nm	Different IE class 60 Hz/P60	η _{rated} 50 Hz %	η _{rated} 50 Hz %	η _{rated} 50 Hz %	cosφ _{rated} 50 Hz %	I _{rated} 50 Hz A	T _{LR} /I _R 50 Hz	I _R /I _R 50 Hz	T _B /I _R 50 Hz				L _{pfA} dB(A)	L _{WA} dB(A)
2.2	2.55	100 L	1465	14.3	IE2	86.7	87	85.9	0.83	4.4	2.5	9.2	3.8	60	72	1LE1583-1AB4	40	0.014
3	3.45	100 L	1460	19.6	IE2	87.7	88.4	87.8	0.84	5.9	2.4	8.5	3.4	68	75	1LE1583-1AB5	52	0.016
4	4.55	112 M	1460	26		88.6	89.6	89.4	0.85	7.7	2.1	7.5	3	67	74	1LE1583-1BB2	60	0.02
5.5	6.3	132 S	1470	35.5		89.6	90.1	89.7	0.82	10.8	2.5	8.3	3.6	64	76	1LE1583-1CB0	67	0.034
7.5	8.6	132 M	1465	49	IE2	90.4	91.1	90.8	0.84	14.3	2.5	8.1	3.3	64	76	1LE1583-1CB2	82	0.046
11	12.6	160 M	1475	71		91.4	91.8	91.2	0.84	20.5	2.3	7.2	3	65	77	1LE1583-1DB2	110	0.071
15	17.3	160 L	1480	97	IE2	92.1	92.4	92	0.85	27.5	2.9	8.1	3.3	67	74	1LE1583-1DB4	137	0.099
18.5	21.3	180 M	1470	120		92.6	93.1	93	0.82	35	2.7	8	3.5	66	73	1LE1583-1EB2	166	0.13
22	25.3	180 L	1470	143	IE2	93	93.4	93.1	0.82	41.5	2.6	7.7	3.3	62	75	1LE1583-1EB4	178	0.14
30	34.5	200 L	1470	195	IE2	93.6	94.3	94.5	0.84	55	2.6	7.3	3.1	59	72	1LE1583-2AB5	240	0.24
37	42.5	225 S	1482	240	IE2	93.9	94.3	94	0.84	68	3.2	8.3	3.1	69	83	1LE1583-2BB0	380	0.52
45	52	225 M	1484	290	IE2	94.2	94.6	94.4	0.84	82	3.4	8.3	3.2	69	83	1LE1583-2BB2	450	0.655
55	63	250 M	1486	355	IE2	94.6	94.9	94.4	0.86	98	3	8.3	3.3	68	82	1LE1583-2CB2	525	1.07
75	86	280 S	1488	480		95	95.1	94.5	0.85	134	3.4	9.6	3.7	69	83	1LE1583-2DB0	670	2.01
90	104	280 M	1486	580	IE2	95.2	95.5	95.3	0.86	159	2.5	7.5	3	70	84	1LE1583-2DB2	705	2.01
110	127	315 M ⁴⁾	1491	700		95.4	95.6	95.3	0.86	194	3.3	9	3.2	73	87	1LE1583-3AB0	950	2.66
132	152	315 M	1491	850		95.6	95.9	95.8	0.86	230	3.3	8.6	3.3	73	87	1LE1583-3AB2	990	3.05
160	184	315 L	1490	1030		95.8	96.2	96.1	0.86	280	3.3	8.3	3	73	87	1LE1583-3AB4	990	3.07
200	230	315 L	1490	1280		96	96.2	96	0.87	345	3.8	9	3.5	76	90	1LE1583-3AB5	1300	4.2
Voltages ²⁾			Version											Order code				
50 Hz 230 VΔ/400 VY			60 Hz ¹⁾ 460 VY											Standard		2 2	-	
50 Hz 400 VΔ/690 VY			60 Hz ¹⁾ 460 VΔ											Standard		3 4	-	
50 Hz 500 VY														Without additional charge		2 7	-	
50 Hz 500 VΔ														Without additional charge		4 0	-	
For other voltages ¹⁾ and more information, see from page 3/100																9 0	...	
Types of construction			Version											Order code				
Without flange			IM B3 ³⁾											Standard		A	-	
With flange			IM B5 ³⁾											With additional charge		F	-	
For other types of construction and more information, see from page 3/107																	...	
Motor protection			Version											Order code				
Without														Standard		A	-	
PTC thermistor with 3 temperature sensors														With additional charge		B	-	
For other motor protection and more information, see from page 3/117																	...	
Terminal box position			Version											Order code(s)				
Terminal box at top														Standard		4	-	
For other terminal box positions and more information, see from page 3/120																	-	
Special versions														Order code(s)				
Forced-air cooled motors w/o ext. fan/fan cover (IC418)														1LE1583-... -Z		F90+...+...+...		
For options, see from page 3/129														1LE1583-... -Z		...+...+...+...		

¹⁾ Operating values at rated power for 60 Hz are stored in the Drive Technology Configurator (DT Configurator; see Appendix, "Tools and engineering").

²⁾ Parallel supply lines are required in the case of connection to ≤ 240 V. For frame size 315 with connection to ≤ 240 V, due to the high current, a drilled, removable entry plate (order code **R52**) or a larger terminal box (order code **R50**) can be used. Order codes **R52** and **R50** alter the motor dimensions.

³⁾ Types derived from IM B3 (IM B6/7/8, IM V6 and IM V5), from IM B5 (IM V3 and IM V1) and from IM B14 (IM V19 and IM V18) are possible, provided that no requirement exists for stamping of the type on the rating plate. The basic type IM B3, IM B5, or IM B14 is stamped as standard on the rating plate. If mounted in a different position, the position must be specified to ensure that the condensation drainage holes are positioned correctly.

⁴⁾ Version as 315 M (different from 315 S according to DIN EN 50347).

Selection and ordering data

Operating values at rated power																Cast-iron series 1LE1583		$m_{IM B3}$	J
$P_{rated, 50 Hz/ P50}$	$P_{rated, 60 Hz/ P60}$	Frame size	$n_{rated, 50 Hz}$	$T_{rated, 50 Hz}$	Different IE class	$\eta_{rated, 50 Hz}$	$\eta_{rated, 50 Hz}$	$\eta_{rated, 50 Hz}$	$\cos\phi_{rated, 50 Hz}$	$I_{rated, 50 Hz}$	$T_{LR/ rated, 50 Hz}$	$I_{LR/ rated, 50 Hz}$	$T_B/ rated, 50 Hz$	$L_{pfA, 50 Hz}$	$L_{WA, 50 Hz}$	Article No.	$m_{IM B3}$	J	
kW	FS		rpm	Nm		%	%	%	%	A	A	A	A	dB(A)	dB(A)		kg	kgm ²	
• Cooling: Self-ventilated (IC411) or with order code F90 forced-air cooled without external fan and fan cover (IC418) • Efficiency according to IEC 60034-30-1: IE3 Premium Efficiency, service factor (SF) 1.0 • Insulation: Thermal class 155 (temperature class F), IP55 degree of protection, utilization in accordance with thermal class 130 (temperature class B) • Optional and suitable for converter operation; $U_{line} \leq 690 V$ - IVIC-C premiuminsulation system																			
6-pole: 1000 rpm at 50 Hz, 1200 rpm at 60 Hz ¹⁾																			
15	18	180 L	975	147	IE2	91.2	91.6	91.2	0.77	31	2.3	6.4	3	55	68	1LE1583-1EC4	180	0.19	
18.5	22	200 L	978	181	IE2	91.7	92.1	91.9	0.79	37	2.5	5.6	2.6	58	71	1LE1583-2AC4	213	0.28	
22	26.5	200 L	978	215	IE1	92.2	93.3	93.5	0.79	43.5	2.5	5.6	2.6	55	68	1LE1583-2AC5	230	0.32	
30	36	225 M	982	290	IE2	92.9	93.7	93.7	0.81	58	2.6	7	2.9	65	79	1LE1583-2BC2	395	0.82	
37	44.5	250 M	986	360	IE2	93.3	94	94	0.84	68	2.8	7.5	2.9	68	81	1LE1583-2CC2	480	1.27	
45	54	280 S	990	435	IE2	93.7	94.2	94.1	0.84	83	3.1	8	3	60	74	1LE1583-2DC0	560	2.11	
55	66	280 M	988	530	IE2	94.1	94.8	94.9	0.84	100	3.2	8.6	3	68	81	1LE1583-2DC2	630	2.39	
75	90	315 S	992	720	IE2	94.6	95	94.7	0.84	136	2.4	7.5	2.8	63	78	1LE1583-3AC0	890	3.05	
90	108	315 M ⁴⁾	992	870	IE2	94.9	95.3	95.1	0.84	163	2.8	7.9	3	63	78	1LE1583-3AC2	990	3.86	
110	132	315 L	993	1060	IE2	95.1	95.4	95.2	0.84	199	2.8	8.3	3.2	67	82	1LE1583-3AC4	1110	4.3	
132	158	315 L	993	1270		95.4	95.6	95.3	0.8	250	3.2	8.8	3.6	67	82	1LE1583-3AC5	1110	4.53	
160	192	315 L	992	1540		95.6	95.9	95.7	0.82	295	3.5	9	3.6	67	82	1LE1583-3AC6	1270	5.41	
8-pole: 750 rpm at 50 Hz, 900 rpm at 60 Hz ¹⁾																			
11	13.2	180 L	725	145		88.6	89.5	89.2	0.74	24	2.1	5.4	2.6	62	75	1LE1583-1ED4	190	0.267	
15	18	200 L	730	196		89.6	89.8	89.1	0.73	33	3	6.8	3.7	57	70	1LE1583-2AD5	255	0.42	
18.5	22	225 S	732	240	IE2	90.1	91.3	91.3	0.74	40	2.4	5.9	2.9	56	70	1LE1583-2BD0	270	0.502	
22	26.5	225 M	732	285	IE2	90.6	91.8	92	0.77	45.5	2.4	6	2.8	56	70	1LE1583-2BD2	280	0.549	
30	36	250 M	734	390	IE2	91.3	92	91.8	0.78	61	2.5	6.4	2.9	60	74	1LE1583-2CD2	370	0.851	
37	44.5	280 S	736	480		91.8	93	93.3	0.78	75	2.2	5.6	2.3	63	77	1LE1583-2DD0	460	1.57	
45	54	280 M	738	580		92.2	93.2	93.5	0.81	87	2.4	6.2	2.4	65	79	1LE1583-2DD2	550	2.09	
55	66	315 S	740	710		92.5	93.5	93.7	0.8	107	2.2	6.2	2.6	66	81	1LE1583-3AD0	650	2.08	
75	90	315 M	738	970	IE2	93.1	94.1	94.4	0.8	145	2.2	6	2.6	69	84	1LE1583-3AD2	720	2.48	
90	108	315 L	738	1160	IE2	93.4	94.4	94.9	0.83	168	2.1	6	2.5	71	85	1LE1583-3AD4	860	3.13	
110	132	315 L	740	1420		93.7	94.5	94.9	0.8	210	2.5	6.7	2.9	74	88	1LE1583-3AD5	960	3.94	
132	158	315 L	741	1700		94	94.6	94.8	0.79	255	3	8	3.3	76	90	1LE1583-3AD6	1250	5.51	
Voltages²⁾																			
50 Hz 230 VΔ/400 VY										60 Hz ¹⁾ 460 VY		Version			Order code				
50 Hz 400 VΔ/690 VY										60 Hz ¹⁾ 460 VΔ		Standard			2 2				
50 Hz 500 VY												Without additional charge			3 4				
50 Hz 500 VΔ												Without additional charge			2 7				
															4 0				
															9 0				
For other voltages ¹⁾ and more information, see from page 3/100																			
Types of construction																			
Without flange										IM B3 ³⁾		Version			Order code				
With flange										IM B5 ³⁾		Standard			A				
												With additional charge			F				
For other types of construction and more information, see from page 3/107																			
Motor protection																			
Without												Version			Order code				
PTC thermistor with 3 temperature sensors												Standard			A				
												With additional charge			B				
For other motor protection and more information, see from page 3/117																			
Terminal box position																			
Terminal box at top												Version			Order code				
												Standard			4				
For other terminal box positions and more information, see from page 3/120																			
Special versions																			
Forced-air cooled motors w/o ext. fan/fan cover (IC418)															1LE1583-... -Z F90+...+...+...				
For options, see from page 3/129																			
															1LE1583-... -Z ...+...+...+...				

¹⁾ Operating values at rated power for 60 Hz are stored in the Drive Technology Configurator (DT Configurator; see Appendix, "Tools and engineering").

²⁾ Parallel supply lines are required in the case of connection to $\leq 240 V$. For frame size 315 with connection to $\leq 240 V$, due to the high current, a drilled, removable entry plate (order code **R52**) or a larger terminal box (order code **R50**) can be used. Order codes **R52** and **R50** alter the motor dimensions.

³⁾ Types derived from IM B3 (IM B6/7/8, IM V6 and IM V5), from IM B5 (IM V3 and IM V1) and from IM B14 (IM V19 and IM V18) are possible, provided that no requirement exists for stamping of the type on the rating plate. The basic type IM B3, IM B5, or IM B14 is stamped as standard on the rating plate. If mounted in a different position, the position must be specified to ensure that the condensation drainage holes are positioned correctly.

⁴⁾ Version as 315 M (different from 315 S according to DIN EN 50347).

SIMOTICS GP and SIMOTICS SD standard motors

IE2 High Efficiency

IE2



Aluminum series SIMOTICS GP 1LE1001 – self-ventilated or forced-air cooled

Selection and ordering data

Operating values at rated power															Aluminum series		$m_{IM B3}$	J	
$P_{rated, 50 Hz}$	$P_{rated, 60 Hz}$	Frame size	$n_{rated, 50 Hz}$	$T_{rated, 50 Hz}$	Different IE class	$\eta_{rated, 50 Hz}$	$\eta_{rated, 50 Hz}$	$\eta_{rated, 50 Hz}$	$\cos\phi_{rated, 50 Hz}$	$I_{rated, 50 Hz}$	T_{LR}	I_{LR}	T_p	L_{pTA}	L_{WA}	1LE1001			
kW	kW	FS	rpm	Nm	60 Hz/P60	4/4	3/4	2/4	4/4	A	50 Hz	50 Hz	50 Hz	50 Hz	50 Hz	Article No.			
2-pole: 3000 rpm at 50 Hz, 3600 rpm at 60 Hz¹⁾																			
0.18	0.21	63 M	2850	0.6		60.4	59.4	53.7	0.78	0.55	2.2	4.5	2.7	57	64	1LE1001-0BA2	4		0.00022
0.25	0.29	63 M	2835	0.84		64.8	63.5	57.3	0.81	0.69	1.9	4.1	2.5	57	64	1LE1001-0BA3	5		0.00026
0.37	0.43	71 M	2770	1.28		69.5	70.5	67.9	0.81	0.95	2.5	4.1	2.5	58	69	1LE1001-0CA2	6		0.00035
0.55	0.63	71 M	2780	1.89		74.1	75.2	72.9	0.8	1.34	2.6	4.6	2.6	58	69	1LE1001-0CA3	7		0.00045
0.75	0.86	80 M	2805	2.55		77.4	80	80.1	0.84	1.67	1.9	4.9	2.3	60	71	1LE1001-0DA2	9		0.0008
1.1	1.27	80 M	2835	3.7		79.6	81.3	80.9	0.83	2.4	2.7	6	3.1	60	71	1LE1001-0DA3	11		0.0011
1.5	1.75	90 S	2900	4.95		81.3	81.7	79.7	0.84	3.15	2.7	6.9	3.6	65	77	1LE1001-0EA0	14		0.0017
2.2	2.55	90 L	2890	7.3		83.2	83.7	82	0.85	4.5	2.5	7.1	3.7	65	77	1LE1001-0EA4	16		0.0021
3	3.45	100 L	2905	9.9		84.6	85.5	84.6	0.84	6.1	2.3	7	3.3	67	79	1LE1001-1AA4	21		0.0044
4	4.55	112 M	2945	13		85.8	86.2	85.1	0.85	7.9	2.1	8	3.6	69	81	1LE1001-1BA2	27		0.0092
5.5	6.3	132 S	2950	17.8		87	88	87.6	0.87	10.5	1.8	6.6	2.9	68	80	1LE1001-1CA0	39		0.02
7.5	8.6	132 S	2950	24.5		88.1	88.5	87.6	0.87	14.1	2.2	7.5	3.1	68	80	1LE1001-1CA1	43		0.024
11	12.6	160 M	2955	35.5		89.4	89.3	88	0.87	20.5	2.1	7.4	3.2	70	82	1LE1001-1DA2	67		0.045
15	17.3	160 M	2955	48.5		90.3	90.7	90	0.88	27	2.4	7.6	3.4	70	82	1LE1001-1DA3	75		0.053
18.5	21.3	160 L	2955	60		90.9	91.2	90.6	0.88	33.5	2.9	7.9	3.6	70	82	1LE1001-1DA4	84		0.061
22	24.5	180 M	2940	71		91.3	91.8	91.3	0.87	40	2.7	7.4	3.6	77	84	1LE1001-1EA2	123		0.069
30	33.5	200 L	2960	97		92	92.3	91.8	0.87	54	2.5	6.9	3.3	78	85	1LE1001-2AA4	158		0.13
37	41.5	200 L	2960	119		92.5	93	92.7	0.88	66	2.7	7.4	3.5	78	85	1LE1001-2AA5	178		0.15

Voltages		Version	Order code
50 Hz 230 VΔ/400 VY	60 Hz ¹⁾ 460 VY	Standard	2 2 -
50 Hz 400 VΔ/690 VY	60 Hz ¹⁾ 460 VΔ	Standard	3 4 -
50 Hz 500 VY		Without additional charge	2 7 -
50 Hz 500 VΔ		Without additional charge	4 0 -
For other voltages ¹⁾ and more information, see from page 3/97			9 0 ...

Types of construction		Version	Order code
Without flange	IM B3 ³⁾	Standard	A -
With flange	IM B5 ³⁾	With additional charge	F -
With flange	IM B14 ³⁾	With additional charge	K -
For other types of construction and more information, see from page 3/103			... -

Motor protection		Version	Order code
Without		Standard	A -
PTC thermistor with 1 or 3 temperature sensors (frame sizes 63 to 90 or 100 to 200)		With additional charge	B -
For other motor protection and more information, see from page 3/116			... -

Terminal box position		Version	Order code
Terminal box at top		Standard	4 -
For other terminal box positions and more information, see from page 3/119			... -

Special versions	Order code(s)
Forced-air cooled motors w/o ext. fan/fan cover (IC418)	1LE1001-... -Z F90 +...+...+
For options, see from page 3/122	1LE1001-... -Z ...+...+...+

3

¹⁾ Operating values at rated power for 60 Hz are stored in the Drive Technology Configurator (DT Configurator; see Appendix, "Tools and engineering").

²⁾ For converter operation of shaft heights 63 and 90, ordering with PTC thermistors and their connection to the converter is recommended.

³⁾ Types derived from IM B3 (IM B6/7/8, IM V6, and IM V5), from IM B5 (IM V3 and IM V1) and from IM B14 (IM V19 and IM V18) are possible, provided that no requirements exist for condensation drainage holes (**H03**) or stamping of the type on the rating plate. The basic type IM B3, IM B5, or IM B14 is stamped as standard on the rating plate. For orders with condensation drainage holes (**H03**), the type must be specified.



IE2

SIMOTICS GP and SIMOTICS SD standard motors IE2 High Efficiency

Aluminum series SIMOTICS GP 1LE1001 – self-ventilated or forced-air cooled

Selection and ordering data

P _{rated} , 50 Hz/ P50 kW	P _{rated} , 60 Hz/ P60 ¹⁾ kW	Frame size	Operating values at rated power														Aluminum series 1LE1001	m _{IM B3} kg	J kgm ²
			η _{rated} , 50 Hz	T _{rated} , 50 Hz	Different IE class 60 Hz/P60	η _{rated} , 50 Hz	η _{rated} , 50 Hz	η _{rated} , 50 Hz	cosφ _{rated} , 50 Hz	I _{rated} , 400 V	T _{LR} / T _{rated} , 50 Hz	I _{LR} / I _{rated} , 50 Hz	T _B / T _{rated} , 50 Hz	L _{ptA} , 50 Hz	L _{WA} , 50 Hz	Article No.			
0.12	0.14	63 M	1390	0.82		59.1	56.4	49.0	0.66	0.44	2.4	3.1	2.5	50	58	1LE1001-0BB2	5	0.00037	
0.18	0.21	63 M	1385	1.2		64.7	62.4	55.7	0.65	0.62	2.6	3.3	2.6	57	64	1LE1001-0BB3	5	0.00045	
0.25	0.29	71 M	1395	1.7		68.5	68.4	64.2	0.69	0.76	2.4	3.7	2.5	50	61	1LE1001-0CB2	6	0.00076	
0.37	0.43	71 M	1380	2.6		72.7	73.2	69.9	0.72	1.02	2.3	3.8	2.4	50	61	1LE1001-0CB3	7	0.00095	
0.55	0.63	80 M	1440	3.6		77.1	76.8	73.7	0.74	1.39	2.2	5.3	3.1	53	64	1LE1001-0DB2	10	0.0017	
0.75	0.86	80 M	1440	5		79.6	79.9	77.5	0.76	1.79	2.2	5.6	3.1	53	64	1LE1001-0DB3	11	0.0021	
1.1	1.27	90 S	1425	7.4		81.4	81.8	80	0.78	2.5	2.3	5.6	2.9	56	68	1LE1001-0EB0	13	0.0028	
1.5	1.75	90 L	1435	10		82.8	83.5	82.2	0.79	3.3	2.6	6.4	3.4	56	68	1LE1001-0EB4	16	0.0036	
2.2	2.55	100 L	1455	14		84.3	85.1	84.2	0.81	4.65	2.1	6.9	3.3	60	72	1LE1001-1AB4	21	0.0086	
3	3.45	100 L	1455	20		85.5	86.4	85.6	0.82	6.2	2	6.9	3.1	60	72	1LE1001-1AB5	25	0.011	
4	4.55	112 M	1460	26		86.6	87.3	86.4	0.81	8.2	2.5	7.1	3.2	58	70	1LE1001-1BB2	29	0.014	
5.5	6.3	132 S	1465	36		87.7	88.4	87.6	0.8	11.3	2.3	6.9	2.9	64	76	1LE1001-1CB0	42	0.022	
7.5	8.6	132 M	1465	49		88.7	89.8	89.8	0.83	14.7	2.3	6.9	2.9	64	76	1LE1001-1CB2	49	0.028	
11	12.6	160 M	1470	71		89.8	91	90.9	0.85	21	2.1	6.7	2.8	65	77	1LE1001-1DB2	71	0.055	
15	17.3	160 L	1475	97		90.6	91.2	90.8	0.85	28	2.3	7.3	3	65	77	1LE1001-1DB4	83	0.071	
18.5	21.3	180 M	1465	121		91.2	92	91.9	0.84	35	2.5	7.2	3.4	61	74	1LE1001-1EB2	128	0.12	
22	25.3	180 L	1465	143		91.6	92.2	91.9	0.84	41.5	2.6	7.3	3.5	69	76	1LE1001-1EB4	132	0.13	
30	34.5	200 L	1470	195		92.3	92.9	92.6	0.84	56	2.5	6.7	3.3	70	77	1LE1001-2AB5	173	0.2	
Voltages			Version														Order code		
50 Hz 230 VΔ/400 VY			Standard														2 2		-
50 Hz 400 VΔ/690 VY			Standard														3 4		-
50 Hz 500 VY			Without additional charge														2 7		-
50 Hz 500 VΔ			Without additional charge														4 0		-
For other voltages ¹⁾ and more information, see from page 3/97																	9 0		...
Types of construction			Version														Order code		
Without flange			Standard														A		-
With flange			With additional charge														F		-
With flange			With additional charge														K		-
For other types of construction and more information, see from page 3/103																			...
Motor protection			Version														Order code		
Without			Standard														A		-
PTC thermistor with 1 or 3 temperature sensors (frame sizes 63 to 90 or 100 to 200)			With additional charge														B		-
For other motor protection and more information, see from page 3/116																			...
Terminal box position			Version														Order code(s)		
Terminal box at top			Standard														4		-
For other terminal box positions and more information, see from page 3/119																			-
Special versions																	Order code(s)		
Forced-air cooled motors w/o ext. fan/fan cover (IC418)																	1LE1001-...-Z		F90 +...+...+...
For options, see from page 3/122																	1LE1001-...-Z		...+...+...+...

1) Operating values at rated power for 60 Hz are stored in the Drive Technology Configurator (DT Configurator; see Appendix, "Tools and engineering").
2) For converter operation of shaft heights 63 and 90, ordering with PTC thermistors and their connection to the converter is recommended.

3) Types derived from IM B3 (IM B6/7/8, IM V6, and IM V5), from IM B5 (IM V3 and IM V1) and from IM B14 (IM V19 and IM V18) are possible, provided that no requirements exist for condensation drainage holes (H03) or stamping of the type on the rating plate. The basic type IM B3, IM B5, or IM B14 is stamped as standard on the rating plate. For orders with condensation drainage holes (H03), the type must be specified.



SIMOTICS GP and SIMOTICS SD standard motors

IE2 High Efficiency

IE2

Aluminum series SIMOTICS GP 1LE1001 – self-ventilated or forced-air cooled

Selection and ordering data

Operating values at rated power																Aluminum series		$m_{IM\ B3}$	J
$P_{rated, 50\ Hz/}$	$P_{rated, 60\ Hz/}$	Frame size	$n_{rated, 50\ Hz}$	$T_{rated, 50\ Hz}$	Different IE class	$\eta_{rated, 50\ Hz}$	$\eta_{rated, 50\ Hz}$	$\eta_{rated, 50\ Hz}$	$\cos\phi_{rated, 50\ Hz}$	$I_{rated, 50\ Hz}$	T_{LR}/I_{LR}	I_{LR}/T_{LR}	T_{β}/I_{β}	$L_{ptA, 50\ Hz}$	$L_{WA, 50\ Hz}$	1LE1001	Article No.		
P50 kW	P60 kW	FS	rpm	Nm	60 Hz/P60	4/4 %	3/4 %	2/4 %	4/4 %	A	A	A	A	A	A	▲ New			
0.09	0.11	63 M	895	0.96		42.7	38.5	30.4	0.63	0.48	1.8	2	1.9	56	62	▲ 1LE1001-0BC2	-	4	0.00034
0.18	0.21	71 M	875	1.96		56.6	56.9	52.7	0.68	0.68	2.2	2.5	2.3	46	57	▲ 1LE1001-0CC2	-	6	0.00077
0.25	0.29	71 M	870	2.75		61.6	62.7	59.2	0.7	0.84	2.3	2.6	2.3	46	57	▲ 1LE1001-0CC3	-	7	0.00098
0.37	0.43	80 M	925	3.8		67.6	67.9	64.4	0.69	1.14	2.1	4	2.4	42	53	1LE1001-0DC2	-	9	0.0017
0.55	0.63	80 M	935	5.6		73.1	73.8	70.8	0.66	1.65	2.5	4.4	2.9	42	53	1LE1001-0DC3	-	13	0.0025
0.75	0.86	90 S	935	7.7		75.9	76.8	74.5	0.7	2.05	2	4.1	2.5	43	55	1LE1001-0EC0	-	13	0.003
1.1	1.27	90 L	935	11.2	IE1	78.1	79.3	77.7	0.7	2.9	2.2	4.4	2.6	43	55	1LE1001-0EC4	-	16	0.004
1.5	1.75	100 L	970	14.8		79.8	80.5	79	0.73	3.7	2	5.4	2.8	59	71	1LE1001-1AC4	-	25	0.011
2.2	2.55	112 M	965	22		81.8	82.7	81.7	0.75	5.2	2	5	2.8	62	74	1LE1001-1BC2	-	29	0.014
3	3.45	132 S	970	29.5		83.3	83.4	81	0.72	7.2	1.6	5	2.5	63	75	1LE1001-1CC0	-	38	0.024
4	4.55	132 M	970	39.5		84.6	85.5	84.3	0.75	9.1	1.6	5	2.3	63	75	1LE1001-1CC2	-	43	0.029
5.5	6.3	132 M	970	54		86	87.1	86.4	0.76	12.1	1.9	5.6	2.6	63	75	1LE1001-1CC3	-	52	0.037
7.5	8.6	160 M	975	73		87.2	87.9	87.2	0.74	16.8	1.9	4.7	2.2	67	79	1LE1001-1DC2	-	77	0.075
11	12.6	160 L	975	108		88.7	89.7	89.3	0.76	23.5	1.9	4.8	2.2	67	79	1LE1001-1DC4	-	93	0.098
15	18	180 L	975	147		89.7	90.1	89.5	0.78	31	2.5	6	3.1	57	70	1LE1001-1EC4	-	121	0.17
18.5	22	200 L	978	181	IE1	90.4	91.4	91.3	0.82	36	2.4	5.8	2.6	63	76	1LE1001-2AC4	-	151	0.25
22	26.5	200 L	978	215	IE1	90.9	91.7	91.4	0.82	42.5	2.5	6.2	2.6	63	76	1LE1001-2AC5	-	173	0.3

Voltagess	Version	Order code
50 Hz 230 VΔ/400 VY	Standard	2 2
50 Hz 400 VΔ/690 VY	Standard	3 4
50 Hz 500 VY	Without additional charge	2 7
50 Hz 500 VΔ	Without additional charge	4 0
For other voltages ¹⁾ and more information, see from page 3/97		
9 0		...
Types of construction	Version	Order code
Without flange	Standard	A
With flange	With additional charge	F
With flange	With additional charge	K
For other types of construction and more information, see from page 3/103		
...		...
Motor protection	Version	Order code
Without	Standard	A
PTC thermistor with 1 or 3 temperature sensors (frame sizes 80, 90 or 100 to 200)	With additional charge	B
For other motor protection and more information, see from page 3/116		
...		...
Terminal box position	Version	Order code
Terminal box at top	Standard	4
For other terminal box positions and more information, see from page 3/119		
Special versions	Order code(s)	
Forced-air cooled motors w/o ext. fan/fan cover (IC418)	1LE1001-...-Z F90 +...+...+...	
For options, see from page 3/122	1LE1001-...-Z ...+...+...+...	

¹⁾ Operating values at rated power for 60 Hz are stored in the Drive Technology Configurator (DT Configurator; see Appendix, "Tools and engineering").

²⁾ For converter operation of shaft heights 63 and 90, ordering with PTC thermistors and their connection to the converter is recommended.

³⁾ Types derived from IM B3 (IM B6/7/8, IM V6, and IM V5), from IM B5 (IM V3 and IM V1) and from IM B14 (IM V19 and IM V18) are possible, provided that no requirements exist for condensation drainage holes (**H03**) or stamping of the type on the rating plate. The basic type IM B3, IM B5, or IM B14 is stamped as standard on the rating plate. For orders with condensation drainage holes (**H03**), the type must be specified.



SIMOTICS GP and SIMOTICS SD standard motors

IE2 High Efficiency

Aluminum series SIMOTICS GP 1LE1001 – self-ventilated or forced-air cooled

Selection and ordering data

P _{rated} 50 Hz/ P50	P _{rated} 60 Hz/ P60 ¹⁾	Frame size	Operating values at rated power													Aluminum series	
			n _{rated} 50 Hz	T _{rated} 50 Hz	Different IE class	η _{rated} 50 Hz	η _{rated} 50 Hz	η _{rated} 50 Hz	cosφ _{rated} 50 Hz	I _{rated} 50 Hz	T _{L,R} / T _{rated}	I _{L,R} / I _{rated}	T _p / T _{rated}	L _{ptA} 50 Hz	L _{WA} 50 Hz	Article No.	m _{IM B3}
kW	kW	FS	rpm	Nm	%	%	%	%	A							kg	kgm ²
• Cooling: Self-ventilated (IC411) or with order code F90 forced-air cooled without external fan and fan cover (IC418) • Efficiency according to IEC 60034-30-1: IE2 High Efficiency, service factor (SF) 1.15 • Insulation: Thermal class 155 (temperature class F), IP55 degree of protection, utilization in accordance with thermal class 130 (temperature class B)																	
8-pole: 750 rpm at 50 Hz, 900 rpm at 60 Hz ¹⁾																	
0.04	0.046	63 M	645	0.59	30	25.5	18.8	0.62	0.31	1.6	1.6	1.8	45	53	▲ 1LE1001-0BD3	-	0.00034
0.09	0.11	63 M	630	1.36	40.1	40.6	35.8	0.67	0.5	1.7	1.6	1.7	59	63	▲ 1LE1001-0CD2	6	0.00077
0.12	0.14	71 M	640	1.79	39.8	39.3	34.5	0.66	0.66	1.8	1.8	1.8	48	59	▲ 1LE1001-0CD3	7	0.00098
0.18	0.21	80 M	690	2.5	45.9	43.6	37.8	0.6	0.93	1.7	2.2	2.1	51	62	▲ 1LE1001-0DD2	9	0.0017
0.25	0.29	80 M	705	3.4	50.6	48.1	41.9	0.55	1.3	2	2.5	2.5	51	62	▲ 1LE1001-0DD3	13	0.0024
0.37	0.43	90 S	675	5.2	56.1	55.6	49.6	0.71	1.34	1.4	2.6	1.7	53	65	▲ 1LE1001-0ED0	11	0.0019
0.55	0.63	90 L	665	7.9	61.7	63.4	59.8	0.74	1.74	1.5	2.7	1.7	53	65	▲ 1LE1001-0ED4	13	0.0026
0.75	0.86	100 L	705	10.2	66.2	65.7	61.5	0.61	2.7	1.5	3.2	2.1	60	72	1LE1001-1AD4	21	0.0086
1.1	1.27	100 L	695	15.1	70.8	72.3	69.6	0.65	3.45	1.4	3.2	1.9	60	72	1LE1001-1AD5	25	0.011
1.5	1.75	112 M	725	19.8	74.1	73.9	71.2	0.63	4.65	1.6	4	2.4	63	75	1LE1001-1BD2	29	0.017
2.2	2.55	132 S	725	29	77.6	78.2	76.6	0.62	6.6	1.4	3.5	2	63	75	1LE1001-1CD0	41	0.034
3	3.45	132 M	720	40	80	80.7	79.2	0.62	8.7	1.4	3.7	2	63	75	1LE1001-1CD2	49	0.037
4	4.55	160 M	730	52	81.9	82.6	81.4	0.67	10.5	1.6	3.7	1.9	63	75	1LE1001-1DD2	69	0.065
5.5	6.3	160 M	730	72	83.8	84.2	83	0.67	14.1	1.7	3.9	2	63	75	1LE1001-1DD3	82	0.083
7.5	8.6	160 L	725	99	85.3	86.4	86	0.7	18.1	1.6	3.8	1.9	63	75	1LE1001-1DD4	94	0.098
11	13.2	180 L	720	146	86.9	88	87.6	0.7	26	2.3	4.9	2.6	72	80	1LE1001-1ED4	122	0.195
15	18	200 L	718	199	88	89.5	89.9	0.76	32.5	2.4	5.4	2.8	58	65	1LE1001-2AD5	172	0.344
Voltages													Version	Order code			
50 Hz 230 VΔ/400 VY			60 Hz ¹⁾ 460 VY			Standard			2 2		-						
50 Hz 400 VΔ/690 VY			60 Hz ¹⁾ 460 VΔ			Standard			3 4		-						
50 Hz 500 VY						Without additional charge			2 7		-						
50 Hz 500 VΔ						Without additional charge			4 0		-						
									9 0		...						
Types of construction													Version	Order code			
Without flange			IM B3 ²⁾			Standard			A		-						
With flange			IM B5 ²⁾			With additional charge			F		-						
With flange			IM B14 ²⁾			With additional charge			K		-						
													...				
Motor protection													Version	Order code			
Without						Standard			A		-						
PTC thermistor with 3 temperature sensors						With additional charge			B		-						
													...				
Terminal box position													Version	Order code(s)			
Terminal box at top						Standard			4								
													...				
Special versions															Order code(s)		
Forced-air cooled motors w/o ext. fan/fan cover (IC418)													1LE1001-...		-Z F90 +...+...+		
For options, see from page 3/122													1LE1001-...		-Z ...+...+...+...		

3

¹⁾ Operating values at rated power for 60 Hz are stored in the Drive Technology Configurator (DT Configurator; see Appendix, "Tools and engineering").

²⁾ Types derived from IM B3 (IM B6/7/8, IM V6, and IM V5), from IM B5 (IM V3 and IM V1) and from IM B14 (IM V19 and IM V18) are possible, provided that no requirements exist for condensation drainage holes (**H03**) or stamping of the type on the rating plate. The basic type IM B3, IM B5, or IM B14 is stamped as standard on the rating plate. For orders with condensation drainage holes (**H03**), the type must be specified.

SIMOTICS GP and SIMOTICS SD standard motors

IE2 High Efficiency



Aluminum series SIMOTICS GP 1LE1001 with increased power – self-ventilated

Selection and ordering data

Operating values at rated power															Aluminum series					
$P_{rated, 50 Hz}$	$P_{rated, 60 Hz}$	Frame size	$n_{rated, 50 Hz}$	$T_{rated, 50 Hz}$	Different IE class	$\eta_{rated, 50 Hz}$	$\eta_{rated, 50 Hz}$	$\eta_{rated, 50 Hz}$	$\cos\phi_{rated, 50 Hz}$	$I_{rated, 50 Hz}$	T_{LR}/I_{LR}	T_p/I_p	$L_{ptA, 50 Hz}$	$L_{WA, 50 Hz}$	1LE1001	$m_{IM B3}$	J			
P50	P60 ¹⁾	FS	rpm	Nm	60 Hz/P60	4/4	3/4	2/4	4/4	400 V	50 Hz	50 Hz	50 Hz	50 Hz	Article No.	kg	kgm ²			
kW	kW	FS	rpm	Nm	%	%	%	%	A	dB(A)	dB(A)	dB(A)	dB(A)	▲ New	kg	kgm ²				
• Cooling: Self-ventilated (IC411) or with order code F90 forced-air cooled without external fan and fan cover (IC418) • Efficiency according to IEC 60034-30-1: IE2 High Efficiency, service factor (SF) 1.15 • Insulation: Thermal class 155 (temperature class F), IP55 degree of protection, utilization in accordance with thermal class 130 (temperature class B)																				
2-pole: 3000 rpm at 50 Hz, 3600 rpm at 60 Hz ¹⁾																				
0.37	0.43	63 M	2800	1.26		69.5	69.9	66.4	0.81	0.95	2.4	4.4	2.5	55	63	▲ 1LE1001-0BA6	6	0.0021		
1.5	1.75	80 M	2830	5.1		81.3	83.4	83.6	0.85	3.15	2.6	6.1	2.8	60	71	1LE1001-0DA6	16	0.0013		
3	3.45	90 L	2895	9.9		84.6	85.5	84.5	0.86	6	3.4	7.9	3.6	65	77	1LE1001-0EA6	20	0.0031		
4	4.55	100 L	2905	13.1		85.8	86.9	86.5	0.86	7.8	2.5	7.6	3.5	67	79	1LE1001-1AA6	26	0.0054		
5.5	6.3	112 M	2945	17.8		87	87.8	87.4	0.88	10.4	2.3	8.5	3.8	69	81	1LE1001-1BA6	34	0.012		
11	12.6	132 M	2950	35.5		89.4	90.1	89.9	0.89	20	2.3	7.9	3.2	68	80	1LE1001-1CA6	57	0.031		
22	25.3	160 L	2955	71		91.3	91.8	91.4	0.89	39	3.1	8.4	3.7	70	82	1LE1001-1DA6	94	0.068		
30	33.5	180 L	2940	97		92	92.6	92.3	0.89	53	2.3	7.8	3.4	76	83	1LE1001-1EA6	139	0.094		
45	51	200 L	2950	146		92.9	93.2	92.9	0.87	81	2.5	7.1	3.2	77	84	1LE1001-2AA6	194	0.176		
4-pole: 1500 rpm at 50 Hz, 1800 rpm at 60 Hz ¹⁾																				
1.1	1.27	80 M	1440	7.3		81.4	82	80.1	0.78	2.5	2.4	6.1	3	62	70	1LE1001-0DB6	16	0.0029		
2.2	2.55	90 L	1425	14.7	IE1	84.3	85.6	85	0.81	4.65	2.8	6.1	3.1	56	68	1LE1001-0EB6	21	0.0049		
4	4.55	100 L	1460	26		86.6	88	87.5	0.8	8.3	2.2	7.5	3.5	60	72	1LE1001-1AB6	30	0.014		
5.5	6.3	112 M	1460	36		87.7	88.2	87.2	0.81	11.2	2.5	7.1	3.2	58	70	1LE1001-1BB6	34	0.017		
11	12.6	132 M	1465	72		89.8	90.9	90.9	0.84	21	2.6	7.7	3.1	64	76	1LE1001-1CB6	64	0.046		
18.5	21.3	160 L	1475	120		91.2	91.8	91.3	0.85	34.5	2.5	7.7	3.3	65	77	1LE1001-1DB6	100	0.085		
30	34.5	180 L	1465	196		92.3	92.8	92.6	0.81	58	2.5	7.3	3.3	70	77	1LE1001-1EB6	148	0.159		
37	42.5	200 L	1470	240		92.7	93.3	93.1	0.84	69	2.4	7	3	68	75	1LE1001-2AB6	189	0.246		
Voltages															Version		Order code			
50 Hz 230 VΔ/400 VY				60 Hz ¹⁾ 460 VY				Standard								2	2	-		
50 Hz 400 VΔ/690 VY				60 Hz ¹⁾ 460 VA				Standard								3	4	-		
50 Hz 500 VY								Without additional charge								2	7	-		
50 Hz 500 VA								Without additional charge								4	0	-		
For other voltages ¹⁾ and more information, see from page 3/97															9	0	...			
Types of construction															Version		Order code			
Without flange				IM B3 ²⁾				Standard								A	-			
With flange				IM B5 ²⁾				With additional charge								F	-			
With flange				IM B14 ²⁾				With additional charge								K	-			
For other types of construction and more information, see from page 3/103															-	-	...			
Motor protection															Version		Order code			
Without								Standard								A	-			
PTC thermistor with 1 or 3 temperature sensors (frame sizes 80, 90 or 100 to 200)								With additional charge								B	-			
For other motor protection and more information, see from page 3/116															-	-	...			
Terminal box position															Version		Order code(s)			
Terminal box at top								Standard								4	-			
For other terminal box positions and more information, see from page 3/119															-	-	...			
Special versions																	Order code(s)			
For options, see from page 3/122															1LE1001-	...	-	...	-Z	...+...+...+...

¹⁾ Operating values at rated power for 60 Hz are stored in the Drive Technology Configurator (DT Configurator; see Appendix, "Tools and engineering").

²⁾ Types derived from IM B3 (IM B6/7/8, IM V6, and IM V5), from IM B5 (IM V3 and IM V1) and from IM B14 (IM V19 and IM V18) are possible, provided that no requirements exist for condensation drainage holes (H03) or stamping of the type on the rating plate. The basic type IM B3, IM B5, or IM B14 is stamped as standard on the rating plate. For orders with condensation drainage holes (H03), the type must be specified.



IE2

SIMOTICS GP and SIMOTICS SD standard motors IE2 High Efficiency

Aluminum series SIMOTICS GP 1LE1001 with increased power – self-ventilated

Selection and ordering data

Operating values at rated power															Aluminum series			
P_{rated} 50 Hz/ P50 kW	P_{rated} 60 Hz/ P60 ¹⁾ kW	Frame size	n_{rated} 50 Hz rpm	T_{rated} 50 Hz Nm	Different IE class 60 Hz/P60	η_{rated} 50 Hz %	η_{rated} 50 Hz %	η_{rated} 50 Hz %	$\cos\phi_{rated}$ 50 Hz %	I_{rated} 50 Hz A	$T_{LR}/$ T_{rated} 50 Hz	$I_{LR}/$ I_{rated} 50 Hz	$T_{\beta}/$ T_{rated} 50 Hz	L_{ptA} 50 Hz dB(A)	L_{WA} 50 Hz dB(A)	1LE1001 Article No.	$m_{IM\ B3}$ kg	J kgm ²
<ul style="list-style-type: none"> • Cooling: Self-ventilated (IC411) or with order code F90 forced-air cooled without external fan and fan cover (IC418) • Efficiency according to IEC 60034-30-1: IE2 High Efficiency, service factor (SF) 1.15 • Insulation: Thermal class 155 (temperature class F), IP55 degree of protection, utilization in accordance with thermal class 130 (temperature class B) 																		
6-pole: 1000 rpm at 50 Hz, 1200 rpm at 60 Hz ¹⁾																		
2.2	2.55	100 L	965	22	IE1	81.8	83.3	82.7	0.76	5.1	1.7	4.9	2.5	59	71	1LE1001-1AC6	30	0.014
3	3.45	112 M	965	29.5		83.3	84	82.7	0.74	7	2.1	5.4	2.7	62	74	1LE1001-1BC6	34	0.017
7.5	8.6	132 M	970	74		87.2	88.1	87.1	0.75	16.6	2	5.6	2.6	63	75	1LE1001-1CC6	64	0.046
15	17.3	160 L	975	147	IE1	89.7	90.4	89.7	0.75	32	2	5.2	2.4	67	79	1LE1001-1DC6	115	0.12
18.5	22	180 L	975	181		90.4	90.9	90.5	0.77	38.5	2.3	6	2.9	67	80	1LE1001-1EC6	130	0.206
30	34.5	200 L	975	295		91.7	92.5	92.4	0.77	61	2.6	6.3	2.7	68	75	1LE1001-2AC6	192	0.381
8-pole: 750 rpm at 50 Hz, 900 rpm at 60 Hz ¹⁾																		
15	18	180 L	720	199	IE1	88	89.2	89	0.73	33.5	2.2	4.9	2.5	67	75	1LE1001-1ED6	151	0.263
18.5	22	200 L	720	245	IE1	88.6	89.9	90.2	0.78	38.5	2.6	5.8	3	65	72	1LE1001-2AD6	198	0.416
Voltages															Version		Order code	
50 Hz 230 VΔ/400 VY			60 Hz ¹⁾ 460 VY			Standard		2 2		-								
50 Hz 400 VΔ/690 VY			60 Hz ¹⁾ 460 VΔ			Standard		3 4		-								
50 Hz 500 VY						Without additional charge		2 7		-								
50 Hz 500 VΔ						Without additional charge		4 0		-								
For other voltages ¹⁾ and more information, see from page 3/97								9 0		...								
Types of construction															Version		Order code	
Without flange			IM B3 ²⁾			Standard		A		-								
With flange			IM B5 ²⁾			With additional charge		F		-								
With flange			IM B14 ²⁾			With additional charge		K		-								
For other types of construction and more information, see from page 3/103										...								
Motor protection															Version		Order code	
Without						Standard		A		-								
PTC thermistor with 3 temperature sensors						With additional charge		B		-								
For other motor protection and more information, see from page 3/116										...								
Terminal box position															Version		Order code	
Terminal box at top						Standard		4										
For other terminal box positions and more information, see from page 3/119																		
Special versions															Order code(s)			
For options, see from page 3/122																1LE1001-...-Z-...+...+...+...		

3

¹⁾ Operating values at rated power for 60 Hz are stored in the Drive Technology Configurator (DT Configurator; see Appendix, "Tools and engineering").

²⁾ Types derived from IM B3 (IM B6/7/8, IM V6, and IM V5), from IM B5 (IM V3 and IM V1) and from IM B14 (IM V19 and IM V18) are possible, provided that no requirements exist for condensation drainage holes (H03) or stamping of the type on the rating plate. The basic type IM B3, IM B5, or IM B14 is stamped as standard on the rating plate. For orders with condensation drainage holes (H03), the type must be specified.

SIMOTICS GP and SIMOTICS SD standard motors

IE2 High Efficiency



Cast-iron series SIMOTICS SD 1LE1501 Basic Line – self-ventilated or forced-air cooled

Selection and ordering data

P _{rated} 50 Hz/ P50	P _{rated} 60 Hz/ P60 ¹⁾	Frame size	Operating values at rated power													Cast-iron series 1LE1501 – Basic Line Article No.	m _{IM B3}	J
			n _{rated} 50 Hz	T _{rated} 50 Hz	η _{rated} 50 Hz	η _{rated} 50 Hz	η _{rated} 50 Hz	cosφ _{rated} 50 Hz	I _{rated} 50 Hz	T _{LR} / I _{LR} 50 Hz	T _{LR} / I _{LR} 50 Hz	T _B / I _B 50 Hz	L _{pfA} 50 Hz	L _{WA} 50 Hz				
kW	kW	FS	rpm	Nm	%	%	%	A	A	A	A	A	A	A	A	kg	kgm ²	
• Cooling: Self-ventilated (IC411) or with order code F90 forced-air cooled without external fan and fan cover (IC418) • Efficiency according to IEC 60034-30-1: IE2 High Efficiency, service factor (SF) 1.15 • Insulation: Thermal class 155 (temperature class F), IP55 degree of protection, utilization in accordance with thermal class 130 (temperature class B)																		
2-pole: 3000 rpm at 50 Hz, 3600 rpm at 60 Hz ¹⁾																		
0.37	0.43	71 M	2770	1.28	69.5	70.5	67.9	0.81	0.95	2.5	4.1	2.5	58	69	1LE1501-0CA2	12	0.00035	
0.55	0.63	71 M	2780	1.89	74.1	75.2	72.9	0.8	1.34	2.6	4.6	2.6	58	69	1LE1501-0CA3	13	0.00045	
0.75	0.86	80 M	2805	2.55	77.4	80	80.1	0.84	1.67	1.9	4.9	2.3	60	71	1LE1501-0DA2	16	0.0008	
1.1	1.27	80 M	2835	3.7	79.6	81.3	80.9	0.83	2.4	2.7	6	3.1	60	71	1LE1501-0DA3	18	0.0011	
1.5	1.75	90 S	2900	4.95	81.3	81.7	79.7	0.84	3.15	2.7	6.9	3.6	65	77	1LE1501-0EA0	23	0.0017	
2.2	2.55	90 L	2890	7.3	83.2	83.7	82	0.85	4.5	2.5	7.1	3.7	65	77	1LE1501-0EA4	25	0.0021	
3	3.45	100 L	2905	9.9	84.6	85.5	84.6	0.84	6.1	2.3	7	3.3	67	79	1LE1501-1AA4	32	0.0044	
4	4.55	112 M	2945	13	85.8	86.2	85.1	0.85	7.9	2.1	8	3.6	69	81	1LE1501-1BA2	38	0.0092	
5.5	6.3	132 S	2950	17.8	87	88	87.6	0.87	10.5	1.8	6.6	2.9	68	80	1LE1501-1CA0	57	0.02	
7.5	8.6	132 S	2950	24.5	88.1	88.5	87.6	0.87	14.1	2.2	7.5	3.1	68	80	1LE1501-1CA1	61	0.024	
11	12.6	160 M	2955	35.5	89.4	89.3	88	0.87	20.5	2.1	7.4	3.2	70	82	1LE1501-1DA2	94	0.045	
15	17.3	160 M	2955	48.5	90.3	90.7	90	0.88	27	2.4	7.6	3.4	70	82	1LE1501-1DA3	102	0.053	
18.5	21.3	160 L	2955	60	90.9	91.2	90.6	0.88	33.5	2.9	7.9	3.6	70	82	1LE1501-1DA4	111	0.061	
22	24.5	180 M	2940	71	91.3	91.8	91.3	0.87	40	2.7	7.4	3.6	77	84	1LE1501-1EA2	145	0.069	
30	33.5	200 L	2960	97	92	92.3	91.8	0.87	54	2.5	6.9	3.3	78	85	1LE1501-2AA4	205	0.13	
37	41.5	200 L	2960	119	92.5	93	92.7	0.88	66	2.7	7.4	3.5	78	85	1LE1501-2AA5	225	0.15	
45	51	225 M	2965	145	92.9	93.1	92.5	0.88	79	2.7	7.8	3.7	76	89	1LE1501-2BA2	295	0.23	
55	62	250 M	2970	177	93.2	93.3	92.4	0.88	97	2.3	6.8	3.1	76	89	1LE1501-2CA2	360	0.4	
75	84	280 S	2978	240	93.8	93.6	92.4	0.86	134	2.5	7.2	3.2	76	89	1LE1501-2DA0	490	0.71	
90	101	280 M	2975	290	94.1	94.2	93.5	0.88	157	2.5	7.1	3.1	76	89	1LE1501-2DA2	530	0.83	
110	123	315 S	2982	350	94.3	94.2	93.3	0.9	187	2.4	7.3	3	77	91	1LE1501-3AA0	720	1.3	
132	148	315 M	2982	425	94.6	94.7	94.1	0.91	220	2.4	7.2	3.1	77	91	1LE1501-3AA2	880	1.6	
160	180	315 L	2982	510	94.8	94.9	94.3	0.92	265	2.3	7	3.1	80	95	1LE1501-3AA4	930	1.8	
200	224	315 L	2982	640	95	95.2	94.8	0.92	330	2.5	7.3	3	80	95	1LE1501-3AA5	1130	2.2	
Voltages²⁾															Version		Order code	
50 Hz 230 VΔ/400 VY			60 Hz ¹⁾ 460 VY			Standard			2	2	-							
50 Hz 400 VΔ/690 VY			60 Hz ¹⁾ 460 VΔ			Standard			3	4	-							
50 Hz 500 VY						Without additional charge			2	7	-							
50 Hz 500 VΔ						Without additional charge			4	0	-							
For other voltages ¹⁾ and more information, see from page 3/100																		
Types of construction															Version		Order code	
Without flange			IM B3 ³⁾			Standard			A	F	-							
With flange			IM B5 ³⁾			With additional charge			F	K	-							
With flange			IM B14 ³⁾			With additional charge			K		-							
For other types of construction and more information, see from page 3/107																		
Motor protection															Version		Order code	
Without						Standard			A		-							
PTC thermistor with 3 temperature sensors						With additional charge			B		-							
For other motor protection and more information, see from page 3/117																		
Terminal box position															Version		Order code(s)	
Terminal box at top						Standard			4		-							
For other terminal box positions and more information, see from page 3/120																		
Special versions															Version		Order code(s)	
Forced-air cooled motors w/o ext. fan/fan cover (IC418)						1LE1501-...-Z			F90+							
For options, see from page 3/129																		

¹⁾ Operating values at rated power for 60 Hz are stored in the Drive Technology Configurator (DT Configurator; see Appendix, "Tools and engineering").

²⁾ Parallel supply lines are required in the case of connection to ≤ 240 V. For frame size 315 with connection to ≤ 240 V, due to the high current, a drilled, removable entry plate (order code R52) or a larger terminal box (order code R50) can be used. Order codes R52 and R50 alter the motor dimensions.

³⁾ Types derived from IM B3 (IM B6/7/8, IM V6 and IM V5), from IM B5 (IM V3 and IM V1) and from IM B14 (IM V19 and IM V18) are possible, provided that no requirement exists for stamping of the type on the rating plate. The basic type IM B3, IM B5, or IM B14 is stamped as standard on the rating plate. If mounted in a different position, the position must be specified to ensure that the condensation drainage holes are positioned correctly.



IE2

SIMOTICS GP and SIMOTICS SD standard motors IE2 High Efficiency

Cast-iron series SIMOTICS SD 1LE1501 Basic Line – self-ventilated or forced-air cooled

Selection and ordering data

P _{rated} 50 Hz/ P50 kW	P _{rated} 60 Hz/ P60 ¹⁾ kW	Frame size FS	Operating values at rated power													Cast-iron series 1LE1501 – Basic Line Article No.	m _{IM B3} kg	J kgm ²
			n _{rated} 50 Hz rpm	T _{rated} 50 Hz Nm	η _{rated} 50 Hz %	η _{rated} 50 Hz %	η _{rated} 50 Hz %	cosφ _{rated} 50 Hz %	I _{rated} 50 Hz A	T _{L/R} / I _{L/R} 50 Hz %	I _{L/R} / I _{rated} 50 Hz %	T _B / I _B 50 Hz %	L _{pfA} 50 Hz dB(A)	L _{WA} 50 Hz dB(A)				
0.25	0.29	71 M	1395	1.71	68.5	68.4	64.2	0.69	0.76	2.4	3.7	2.5	50	61	1LE1501-0CB2	12	0.00076	
0.37	0.43	71 M	1380	2.55	72.7	73.2	69.9	0.72	1.02	2.5	4	2.5	59	67	1LE1501-0CB3	13	0.00095	
0.55	0.63	80 M	1440	3.65	77.1	76.8	73.7	0.74	1.39	2.2	5.3	3.1	53	64	1LE1501-0DB2	17	0.0017	
0.75	0.86	80 M	1440	4.95	79.6	79.5	77	0.76	1.79	2.2	5.6	3.1	58	66	1LE1501-0DB3	18	0.0021	
1.1	1.27	90 S	1425	7.4	81.4	82.3	81.1	0.78	2.5	2.3	5.6	2.9	54	62	1LE1501-0EB0	23	0.0028	
1.5	1.75	90 L	1435	10	82.8	83.5	82.2	0.79	3.3	2.6	6.4	3.4	56	68	1LE1501-0EB4	25	0.0036	
2.2	2.55	100 L	1455	14.4	84.3	85.1	84.2	0.81	4.65	2.1	6.9	3.3	60	72	1LE1501-1AB4	32	0.0086	
3	3.45	100 L	1455	19.7	85.5	86.4	85.6	0.82	6.2	2	6.9	3.1	60	72	1LE1501-1AB5	37	0.011	
4	4.55	112 M	1460	26	86.6	87.3	86.4	0.81	8.2	2.5	7.1	3.2	58	70	1LE1501-1BB2	46	0.014	
5.5	6.3	132 S	1465	36	87.7	88.4	87.6	0.8	11.3	2.3	6.9	2.9	64	76	1LE1501-1CB0	61	0.022	
7.5	8.6	132 M	1465	49	88.7	89.8	89.8	0.83	14.7	2.3	6.9	2.9	64	76	1LE1501-1CB2	75	0.028	
11	12.6	160 M	1470	71	89.8	91	90.9	0.85	21	2.1	6.7	2.8	65	77	1LE1501-1DB2	96	0.055	
15	17.3	160 L	1475	97	90.6	91.2	90.8	0.85	28	2.3	7.3	3	65	77	1LE1501-1DB4	104	0.071	
18.5	21.3	180 M	1465	121	91.2	92	91.9	0.84	35	2.5	7.2	3.4	61	74	1LE1501-1EB2	160	0.12	
22	25.3	180 L	1465	143	91.6	92.2	91.9	0.84	41.5	2.6	7.3	3.5	69	76	1LE1501-1EB4	170	0.13	
30	34.5	200 L	1470	195	92.3	92.9	92.6	0.84	56	2.5	6.7	3.3	70	77	1LE1501-2AB5	230	0.2	
37	42.5	225 S	1470	240	92.7	93.5	93.5	0.88	65	2.3	6.6	2.9	66	79	1LE1501-2BB0	280	0.42	
45	52	225 M	1475	290	93.1	93.8	93.7	0.87	80	2.5	6.9	3.1	66	79	1LE1501-2BB2	305	0.46	
55	63	250 M	1480	355	93.5	93.9	93.5	0.85	100	2.7	6.8	3	66	79	1LE1501-2CB2	385	0.75	
75	86	280 S	1485	480	94	94.2	93.8	0.87	132	2.5	6.8	3	71	85	1LE1501-2DB0	550	1.3	
90	104	280 M	1486	580	94.2	94.3	93.6	0.87	159	2.6	7.3	3.1	71	85	1LE1501-2DB2	570	1.4	
110	127	315 S	1490	700	94.5	94.6	94	0.86	195	2.7	7.4	3	72	86	1LE1501-3AB0	740	2	
132	152	315 M	1490	850	94.7	94.9	94.6	0.87	230	2.7	7.1	2.9	75	89	1LE1501-3AB2	870	2.3	
160	184	315 L	1490	1030	94.9	95	94.5	0.87	280	2.8	7.2	3.1	76	91	1LE1501-3AB4	940	2.8	
200	230	315 L	1490	1280	95.1	95.3	94.7	0.87	350	3.1	7.5	3.2	77	92	1LE1501-3AB5	1140	3.5	

Voltages ²⁾		Version	Order code
50 Hz 230 VΔ/400 VY	60 Hz ¹⁾ 460 VY	Standard	2 2
50 Hz 400 VΔ/690 VY	60 Hz ¹⁾ 460 VΔ	Standard	3 4
50 Hz 500 VY		Without additional charge	2 7
50 Hz 500 VΔ		Without additional charge	4 0
For other voltages ¹⁾ and more information, see from page 3/100			9 0

Types of construction		Version	Order code
Without flange	IM B3 ³⁾	Standard	A
With flange	IM B5 ³⁾	With additional charge	F
With flange	IM B14 ³⁾	With additional charge	K
For other types of construction and more information, see from page 3/107			...

Motor protection		Version	Order code
Without		Standard	A
PTC thermistor with 3 temperature sensors		With additional charge	B
For other motor protection and more information, see from page 3/117			...

Terminal box position		Version	Order code
Terminal box at top		Standard	4
For other terminal box positions and more information, see from page 3/120			...

Special versions		Order code(s)
Forced-air cooled motors w/o ext. fan/fan cover (IC418)		1LE1501-... -Z F90+...+...+...
For options, see from page 3/129		1LE1501-... -Z ...+...+...+...

¹⁾ Operating values at rated power for 60 Hz are stored in the Drive Technology Configurator (DT Configurator; see Appendix, "Tools and engineering").

²⁾ Parallel supply lines are required in the case of connection to ≤ 240 V. For frame size 315 with connection to ≤ 240 V, due to the high current, a drilled, removable entry plate (order code **R52**) or a larger terminal box (order code **R50**) can be used. Order codes **R52** and **R50** alter the motor dimensions.

³⁾ Types derived from IM B3 (IM B6/7/8, IM V6 and IM V5), from IM B5 (IM V3 and IM V1) and from IM B14 (IM V19 and IM V18) are possible, provided that no requirement exists for stamping of the type on the rating plate. The basic type IM B3, IM B5, or IM B14 is stamped as standard on the rating plate. If mounted in a different position, the position must be specified to ensure that the condensation drainage holes are positioned correctly.

3

SIMOTICS GP and SIMOTICS SD standard motors

IE2 High Efficiency

IE2



Cast-iron series SIMOTICS SD 1LE1501 Basic Line – self-ventilated or forced-air cooled

Selection and ordering data

Operating values at rated power															Cast-iron series		m _{IM B3}	J			
P _{rated} 50 Hz/ P50	P _{rated} 60 Hz/ P60 ¹⁾	Frame size	n _{rated} 50 Hz	T _{rated} 50 Hz	Different IE class 60 Hz/P60	η _{rated} 50 Hz	η _{rated} 50 Hz	η _{rated} 50 Hz	cosφ _{rated} 50 Hz	I _{rated} 400 V	T _{LR} / T _{rated} 50 Hz	I _{LR} / I _{rated} 50 Hz	T _B / T _{rated} 50 Hz	L _{pfA} 50 Hz	L _{WA} 50 Hz	1LE1501 – Basic Line			Article No.	kg	kgm ²
kW	kW	FS	rpm	Nm		%	%	%	%	A								kg	kgm ²		
• Cooling: Self-ventilated (IC411) or with order code F90 forced-air cooled without external fan and fan cover (IC418) • Efficiency according to IEC 60034-30-1: IE2 High Efficiency, service factor (SF) 1.15 • Insulation: Thermal class 155 (temperature class F), IP55 degree of protection, utilization in accordance with thermal class 130 (temperature class B)																					
6-pole: 1000 rpm at 50 Hz, 1200 rpm at 60 Hz ¹⁾																					
0.18	0.21	71 M	875	1.96		56.6	56.9	52.7	0.68	0.68	2.2	2.5	2.3	46	57	1LE1501-0CC2	-	12	0.0008		
0.25	0.29	71 M	870	2.75		61.6	62.7	59.2	0.7	0.84	2.3	2.6	2.3	46	57	1LE1501-0CC3	-	13	0.001		
0.37	0.43	80 M	925	3.8		67.6	67.9	64.4	0.69	1.14	2.1	4	2.4	42	53	1LE1501-0DC2	-	17	0.0017		
0.55	0.63	80 M	935	5.6		73.1	73.8	70.8	0.66	1.65	2.5	4.4	2.9	42	53	1LE1501-0DC3	-	19	0.0025		
0.75	0.86	90 S	935	7.7		75.9	76.8	74.5	0.7	2.05	2	4.1	2.5	43	55	1LE1501-0EC0	-	23	0.003		
1.1	1.27	90 L	935	11.2	IE1	78.1	79.3	77.7	0.7	2.9	2.2	4.4	2.6	43	55	1LE1501-0EC4	-	26	0.004		
1.5	1.75	100 L	970	14.8		79.8	80.5	79	0.73	3.7	2	5.4	2.8	59	71	1LE1501-1AC4	-	36	0.011		
2.2	2.55	112 M	965	22		81.8	82.7	81.7	0.75	5.2	2	5	2.8	62	74	1LE1501-1BC2	-	41	0.014		
3	3.45	132 S	970	29.5		83.3	83.4	81	0.72	7.2	1.6	5	2.5	63	75	1LE1501-1CC0	-	56	0.024		
4	4.55	132 M	970	39.5		84.6	85.5	84.3	0.75	9.1	1.6	5	2.3	63	75	1LE1501-1CC2	-	61	0.029		
5.5	6.3	132 M	970	54		86	87.1	86.4	0.76	12.1	1.9	5.6	2.6	63	75	1LE1501-1CC3	-	70	0.037		
7.5	8.6	160 M	975	73		87.2	87.9	87.2	0.74	16.8	1.9	4.7	2.2	67	79	1LE1501-1DC2	-	106	0.075		
11	12.6	160 L	975	108		88.7	89.7	89.3	0.76	23.5	1.9	4.8	2.2	67	79	1LE1501-1DC4	-	122	0.098		
15	18	180 L	975	147		89.7	90.1	89.5	0.78	31	2.5	6	3.1	57	70	1LE1501-1EC4	-	153	0.17		
18.5	22	200 L	978	181	IE1	90.4	91.4	91.3	0.82	36	2.4	5.8	2.6	63	76	1LE1501-2AC4	-	198	0.25		
22	26.5	200 L	978	215	IE1	90.9	91.7	91.4	0.82	42.5	2.5	6.2	2.6	63	76	1LE1501-2AC5	-	220	0.3		
30	36	225 M	980	290	IE1	91.7	92.5	92.3	0.83	57	2.5	5.6	2.7	65	78	1LE1501-2BC2	-	300	0.58		
37	44.5	250 M	982	360	IE1	92.2	93.1	93.1	0.83	70	2.8	6	2.5	62	77	1LE1501-2CC2	-	370	0.86		
45	54	280 S	985	435	IE1	92.7	93.4	93.2	0.84	83	2.7	6.3	2.6	65	79	1LE1501-2DC0	-	460	1.1		
55	66	280 M	985	530	IE1	93.1	93.9	94	0.86	99	2.5	6.4	2.6	65	79	1LE1501-2DC2	-	510	1.37		
75	90	315 S	988	720	IE1	93.7	94	93.6	0.84	138	2.5	6.7	2.8	65	79	1LE1501-3AC0	-	660	2.1		
90	108	315 M	988	870	IE1	94	94.3	93.6	0.84	165	2.6	6.9	2.8	65	79	1LE1501-3AC2	-	730	2.5		
110	132	315 L	988	1060	IE1	94.3	94.6	94.5	0.86	196	2.7	7	2.8	68	82	1LE1501-3AC4	-	940	3.6		
132	158	315 L	988	1280		94.6	94.9	94.7	0.86	235	3	7.5	2.9	69	84	1LE1501-3AC5	-	990	4.02		
160	192	315 L	988	1550		94.8	94.7	94.4	0.86	285	3.1	7.7	3.3	69	84	1LE1501-3AC6	-	1160	4.7		
Voltsages²⁾															Version				Order code		
50 Hz 230 VΔ/400 VY				60 Hz ¹⁾ 460 VY				Standard		2	2										
50 Hz 400 VΔ/690 VY				60 Hz ¹⁾ 460 VΔ				Standard		3	4										
50 Hz 500 VY								Without additional charge		2	7										
50 Hz 500 VΔ								Without additional charge		4	0										
For other voltsages ¹⁾ and more information, see from page 3/100															9	0			...		
Types of construction															Version				Order code		
Without flange				IM B3 ³⁾				Standard				A									
With flange				IM B5 ³⁾				With additional charge				F									
With flange				IM B14 ³⁾				With additional charge				K									
For other types of construction and more information, see from page 3/107																			...		
Motor protection															Version				Order code		
Without								Standard				A									
PTC thermistor with 3 temperature sensors								With additional charge				B									
For other motor protection and more information, see from page 3/117																			...		
Terminal box position															Version				Order code		
Terminal box at top								Standard													
For other terminal box positions and more information, see from page 3/120																			4		
Special versions																			Order code(s)		
Forced-air cooled motors w/o ext. fan/fan cover (IC418)															1LE1501-....				-Z F90+...+...+...		
For options, see from page 3/129															1LE1501-....				-Z ...+...+...+...		

¹⁾ Operating values at rated power for 60 Hz are stored in the Drive Technology Configurator (DT Configurator; see Appendix, "Tools and engineering").

²⁾ Parallel supply lines are required in the case of connection to ≤ 240 V. For frame size 315 with connection to ≤ 240 V, due to the high current, a drilled, removable entry plate (order code **R52**) or a larger terminal box (order code **R50**) can be used. Order codes **R52** and **R50** alter the motor dimensions.

³⁾ Types derived from IM B3 (IM B6/7/8, IM V6 and IM V5), from IM B5 (IM V3 and IM V1) and from IM B14 (IM V19 and IM V18) are possible, provided that no requirement exists for stamping of the type on the rating plate. The basic type IM B3, IM B5, or IM B14 is stamped as standard on the rating plate. If mounted in a different position, the position must be specified to ensure that the condensation drainage holes are positioned correctly.



IE2

SIMOTICS GP and SIMOTICS SD standard motors
IE2 High Efficiency

Cast-iron series SIMOTICS SD 1LE1501 Basic Line – self-ventilated or forced-air cooled

Selection and ordering data

Operating values at rated power														Cast-iron series		m _{IM B3}	J		
P _{rated} , 50 Hz/ P50 kW	P _{rated} , 60 Hz/ P60 ¹⁾ kW	Frame size	n _{rated} , 50 Hz rpm	T _{rated} , 50 Hz Nm	Different IE class 60 Hz/P60	η _{rated} , 50 Hz %	η _{rated} , 50 Hz %	η _{rated} , 50 Hz %	cosφ _{rated} , 50 Hz %	I _{rated} , 50 Hz A	T _{LR} / I _{LR} , 50 Hz %	T _{LP} / I _{LP} , 50 Hz %	L _{pfA} , 50 Hz dB(A)	L _{WA} , 50 Hz dB(A)	1LE1501 – Basic Line			Article No.	kg
<ul style="list-style-type: none"> • Cooling: Self-ventilated (IC411) or with order code F90 forced-air cooled without external fan and fan cover (IC418) • Efficiency according to IEC 60034-30-1: IE2 High Efficiency, service factor (SF) 1.15 • Insulation: Thermal class 155 (temperature class F), IP55 degree of protection, utilization in accordance with thermal class 130 (temperature class B) 																			
8-pole: 750 rpm at 50 Hz, 900 rpm at 60 Hz ¹⁾																			
0.09	0.11	71 M	630	1.36 ⁴⁾		40.1	40.6	35.8	0.67	0.5	1.7	1.6	1.7	59	63	1LE1501-0CD2	-	12	0.00077
0.12	0.14	71 M	640	1.79		39.8	39.3	34.5	0.66	0.66	1.8	1.8	1.8	48	59	1LE1501-0CD3	-	13	0.001
0.18	0.21	80 M	690	2.5		45.9	43.6	37.8	0.6	0.93	1.7	2.2	2.1	51	62	1LE1501-0DD2	-	17	0.00175
0.25	0.29	80 M	705	3.4		50.6	48.1	41.9	0.55	1.3	2	2.5	2.5	51	62	1LE1501-0DD3	-	19	0.00246
0.37	0.43	90 S	675	5.2		56.1	55.6	49.6	0.71	1.34	1.4	2.6	1.7	53	65	1LE1501-0ED0	-	23	0.00225
0.55	0.63	90 L	665	7.9		61.7	63.4	59.8	0.74	1.74	1.5	2.7	1.7	53	65	1LE1501-0ED4	-	26	0.00305
0.75	0.86	100 L	705	10.2		66.2	65.7	61.5	0.61	2.7	1.5	3.2	2.1	60	72	1LE1501-1AD4	-	32	0.0086
1.1	1.27	100 L	695	15.1		70.8	72.3	69.6	0.65	3.45	1.4	3.2	1.9	60	72	1LE1501-1AD5	-	36	0.011
1.5	1.75	112 M	725	19.8		74.1	73.9	71.2	0.63	4.65	1.6	4	2.4	63	75	1LE1501-1BD2	-	41	0.017
2.2	2.55	132 S	725	29		77.6	78.2	76.6	0.62	6.6	1.4	3.5	2	63	75	1LE1501-1CD0	-	59	0.034
3	3.45	132 M	720	40	IE1	80	80.7	79.2	0.62	8.7	1.4	3.7	2	63	75	1LE1501-1CD2	-	67	0.037
4	4.55	160 M	730	52		81.9	82.6	81.4	0.67	10.5	1.6	3.7	1.9	63	75	1LE1501-1DD2	-	98	0.065
5.5	6.3	160 M	730	72		83.8	84.2	83	0.67	14.1	1.7	3.9	2	63	75	1LE1501-1DD3	-	111	0.083
7.5	8.6	160 L	725	99		85.3	86.4	86	0.7	18.1	1.6	3.8	1.9	63	75	1LE1501-1DD4	-	123	0.098
11	13.2	180 L	720	146	IE1	86.9	88	87.6	0.7	26	2.3	4.9	2.6	72	80	1LE1501-1ED4	-	153	0.195
15	18	200 L	718	199		88	89.5	89.9	0.76	32.5	2.4	5.4	2.8	58	65	1LE1501-2AD5	-	220	0.344
18.5	22	225 S	730	240	IE1	89	89.9	89.5	0.78	38.5	2.2	5.4	2.7	59	72	1LE1501-2BD0	-	250	0.43
22	26.5	225 M	730	290		90.3	91.3	91.1	0.8	44	2.3	5.5	2.7	58	71	1LE1501-2BD2	-	270	0.5
30	36	250 M	732	390		91.3	92.2	92	0.8	59	2.4	5.6	2.7	60	73	1LE1501-2CD2	-	370	0.86
37	44.5	280 S	736	480		91.9	92.5	92.1	0.78	75	2.3	5.4	2.4	63	77	1LE1501-2DD0	-	460	1.1
45	54	280 M	738	580		92.4	92.8	92.4	0.79	89	2.5	5.7	2.5	66	80	1LE1501-2DD2	-	510	1.4
55	66	315 S	740	710		92.9	93.3	92.9	0.8	107	2.2	5.8	2.6	69	83	1LE1501-3AD0	-	640	2
75	90	315 M	738	970		93.5	94.4	94.5	0.81	143	2.3	5.9	2.7	69	84	1LE1501-3AD2	-	710	2.5
90	108	315 L	740	1160		93.5	94.3	94.4	0.83	167	2.2	5.8	2.5	69	84	1LE1501-3AD4	-	860	3.1
110	132	315 L	740	1420		94.2	95	95.1	0.82	205	2.7	6.7	2.9	74	88	1LE1501-3AD5	-	980	3.9
Voltages²⁾														Version				Order code	
50 Hz 230 VΔ/400 VY				60 Hz ¹⁾ 460 VY				Standard		2 2		-							
50 Hz 400 VΔ/690 VY				60 Hz ¹⁾ 460 VΔ				Standard		3 4		-							
50 Hz 500 VY								Without additional charge		2 7		-							
50 Hz 500 VΔ								Without additional charge		4 0		-							
For other voltages ¹⁾ and more information, see from page 3/100														9 0		...			
Types of construction														Version				Order code	
Without flange				IM B3 ³⁾				Standard		A		-							
With flange				IM B5 ³⁾				With additional charge		F		-							
With flange				IM B14 ³⁾				With additional charge		K		-							
For other types of construction and more information, see from page 3/107																...			
Motor protection														Version				Order code	
Without								Standard		A		-							
PTC thermistor with 3 temperature sensors								With additional charge		B		-							
For other motor protection and more information, see from page 3/117																...			
Terminal box position														Version				Order code(s)	
Terminal box at top								Standard		4									
For other terminal box positions and more information, see from page 3/120																			
Special versions																		Order code(s)	
Forced-air cooled motors w/o ext. fan/fan cover (IC418)														1LE1501-....		-Z		F90+...+...+...	
For options, see from page 3/129														1LE1501-....		-Z		...+...+...+...	

1) Operating values at rated power for 60 Hz are stored in the Drive Technology Configurator (DT Configurator; see Appendix, "Tools and engineering").

2) Parallel supply lines are required in the case of connection to ≤ 240 V. For frame size 315 with connection to ≤ 240 V, due to the high current, a drilled, removable entry plate (order code R52) or a larger terminal box (order code R50) can be used. Order codes R52 and R50 alter the motor dimensions.

3) Types derived from IM B3 (IM B6/7/8, IM V6 and IM V5), from IM B5 (IM V3 and IM V1) and from IM B14 (IM V19 and IM V18) are possible, provided that no requirement exists for stamping of the type on the rating plate. The basic type IM B3, IM B5, or IM B14 is stamped as standard on the rating plate. If mounted in a different position, the position must be specified to ensure that the condensation drainage holes are positioned correctly.

4) No IE class for 50 and 60 Hz because the motor is outside the validity for the efficiency classes according to IEC 60034-30-1:2014.

SIMOTICS GP and SIMOTICS SD standard motors

IE2 High Efficiency

IE2



Cast-iron series SIMOTICS SD 1LE1601 Performance Line – self-ventilated or forced-air cooled

Selection and ordering data

P _{rated} 50 Hz/ P50 kW	P _{rated} 60 Hz/ P60 ¹⁾ kW	Frame size FS	Operating values at rated power													Cast-iron series 1LE1601 – Performance Line Article No.	m _{IM B3} kg	J kgm ²
			n _{rated} 50 Hz rpm	T _{rated} 50 Hz Nm	η _{rated} 50 Hz %	η _{rated} 50 Hz %	η _{rated} 50 Hz %	cosφ _{rated} 50 Hz %	I _{rated} 50 Hz A	T _{LR} /I _{rated} 50 Hz %	I _{LR} /I _{rated} 50 Hz %	T _B /I _{rated} 50 Hz %	L _{pfA} 50 Hz dB(A)	L _{WA} 50 Hz dB(A)				
3	3.45	100 L	2905	9.9	84.6	85.5	84.6	0.84	6.1	2.3	7	3.3	67	79	1LE1601-1AA4	32	0.0044	
4	4.55	112 M	2945	13	85.8	86.2	85.1	0.85	7.9	2.1	8	3.6	69	81	1LE1601-1BA2	38	0.0092	
5.5	6.3	132 S	2950	17.8	87	88	87.6	0.87	10.5	1.8	6.6	2.9	68	80	1LE1601-1CA0	57	0.02	
7.5	8.6	132 S	2950	24.5	88.1	88.5	87.6	0.87	14.1	2.2	7.5	3.1	68	80	1LE1601-1CA1	61	0.024	
11	12.6	160 M	2955	35.5	89.4	89.3	88	0.87	20.5	2.1	7.4	3.2	70	82	1LE1601-1DA2	94	0.045	
15	17.3	160 M	2955	48.5	90.3	90.7	90	0.88	27	2.4	7.6	3.4	70	82	1LE1601-1DA3	102	0.053	
18.5	21.3	160 L	2955	60	90.9	91.2	90.6	0.88	33.5	2.9	7.9	3.6	70	82	1LE1601-1DA4	111	0.061	
22	24.5	180 M	2940	71	91.3	91.8	91.3	0.87	40	2.7	7.4	3.6	77	84	1LE1601-1EA2	145	0.069	
30	33.5	200 L	2960	97	92	92.3	91.8	0.87	54	2.5	6.9	3.3	78	85	1LE1601-2AA4	205	0.13	
37	41.5	200 L	2960	119	92.5	93	92.7	0.88	66	2.7	7.4	3.5	78	85	1LE1601-2AA5	225	0.15	
45	51	225 M	2965	145	92.9	93.1	92.5	0.88	79	2.7	7.8	3.7	76	89	1LE1601-2BA2	295	0.23	
55	62	250 M	2970	177	93.2	93.3	92.4	0.88	97	2.3	6.8	3.1	76	89	1LE1601-2CA2	360	0.4	
75	84	280 S	2978	240	93.8	93.6	92.4	0.86	134	2.5	7.2	3.2	76	89	1LE1601-2DA0	490	0.71	
90	101	280 M	2975	290	94.1	94.2	93.5	0.88	157	2.5	7.1	3.1	76	89	1LE1601-2DA2	530	0.83	
110	123	315 S	2982	350	94.3	94.2	93.3	0.9	187	2.4	7.3	3	77	91	1LE1601-3AA0	720	1.3	
132	148	315 M	2982	425	94.6	94.7	94.1	0.91	220	2.4	7.2	3.1	77	91	1LE1601-3AA2	880	1.6	
160	180	315 L	2982	510	94.8	94.9	94.3	0.92	265	2.3	7	3.1	80	95	1LE1601-3AA4	930	1.8	
200	224	315 L	2982	640	95	95.2	94.8	0.92	330	2.5	7.3	3	80	95	1LE1601-3AA5	1130	2.2	
Voltages ²⁾			Version											Order code				
50 Hz 230 VΔ/400 VY			Standard											2 2		-		
50 Hz 400 VΔ/690 VY			Standard											3 4		-		
50 Hz 500 VY			Without additional charge											2 7		-		
50 Hz 500 VΔ			Without additional charge											4 0		-		
For other voltages ¹⁾ and more information, see from page 3/100														9 0		...		
Types of construction			Version											Order code				
Without flange IM B3 ³⁾			Standard											A		-		
With flange IM B5 ³⁾			With additional charge											F		-		
With flange IM B14 ³⁾			With additional charge											K		-		
For other types of construction and more information, see from page 3/107																...		
Motor protection			Version											Order code				
PTC thermistor with 3 temperature sensors			Standard											B		-		
For other motor protection and more information, see from page 3/117																...		
Terminal box position			Version											Order code				
Terminal box at top			Standard											4				
For other terminal box positions and more information, see from page 3/120																		
Special versions														Order code(s)				
Forced-air cooled motors w/o ext. fan/fan cover (IC418)														1LE1601-...-Z		F90+...+...+...		
For options, see from page 3/129														1LE1601-...-Z		...+...+...+...		

¹⁾ Operating values at rated power for 60 Hz are stored in the Drive Technology Configurator (DT Configurator; see Appendix, "Tools and engineering").

²⁾ Parallel supply lines are required in the case of connection to ≤ 240 V. For frame size 315 with connection to ≤ 240 V, due to the high current, a drilled, removable entry plate (order code **R52**) or a larger terminal box (order code **R50**) can be used. Order codes **R52** and **R50** alter the motor dimensions.

³⁾ Types derived from IM B3 (IM B6/7/8, IM V6 and IM V5), from IM B5 (IM V3 and IM V1) and from IM B14 (IM V19 and IM V18) are possible, provided that no requirement exists for stamping of the type on the rating plate. The basic type IM B3, IM B5, or IM B14 is stamped as standard on the rating plate. If mounted in a different position, the position must be specified to ensure that the condensation drainage holes are positioned correctly.



IE2

SIMOTICS GP and SIMOTICS SD standard motors IE2 High Efficiency

Cast-iron series SIMOTICS SD 1LE1601 Performance Line – self-ventilated or forced-air cooled

Selection and ordering data

P _{rated} 50 Hz/ P50 kW	P _{rated} 60 Hz/ P60 ¹⁾ kW	Frame size FS	Operating values at rated power													Cast-iron series 1LE1601 – Performance Line Article No.	m _{IM B3} kg	J kgm ²
			n _{rated} 50 Hz rpm	T _{rated} 50 Hz Nm	η _{rated} 50 Hz %	η _{rated} 50 Hz %	η _{rated} 50 Hz %	cosφ _{rated} 50 Hz %	I _{rated} 50 Hz A	T _{LR} / I _{LR} 50 Hz %	T _{LR} / I _{LR} 50 Hz %	T _B / I _B 50 Hz %	L _{pfA} 50 Hz dB(A)	L _{WA} 50 Hz dB(A)				
<ul style="list-style-type: none"> • Cooling: Self-ventilated (IC411) or with order code F90 forced-air cooled without external fan and fan cover (IC418) • Efficiency according to IEC 60034-30-1: IE2 High Efficiency, service factor (SF) 1.15 • Insulation: Thermal class 155 (temperature class F), IP55 degree of protection, utilization in accordance with thermal class 130 (temperature class B) 																		
4-pole: 1500 rpm at 50 Hz, 1800 rpm at 60 Hz ¹⁾																		
2.2	2.55	100 L	1455	14.4	84.3	85.1	84.2	0.81	4.65	2.1	6.9	3.3	60	72	1LE1601-1AB4	32	0.0086	
3	3.45	100 L	1455	19.7	85.5	86.4	85.6	0.82	6.2	2	6.9	3.1	60	72	1LE1601-1AB5	37	0.011	
4	4.55	112 M	1460	26	86.6	87.3	86.4	0.81	8.2	2.5	7.1	3.2	58	70	1LE1601-1BB2	46	0.014	
5.5	6.3	132 S	1465	36	87.7	88.4	87.6	0.8	11.3	2.3	6.9	2.9	64	76	1LE1601-1CB0	61	0.022	
7.5	8.6	132 M	1465	49	88.7	89.8	89.8	0.83	14.7	2.3	6.9	2.9	64	76	1LE1601-1CB2	75	0.028	
11	12.6	160 M	1470	71	89.8	91	90.9	0.85	21	2.1	6.7	2.8	65	77	1LE1601-1DB2	96	0.055	
15	17.3	160 L	1475	97	90.6	91.2	90.8	0.85	28	2.3	7.3	3	65	77	1LE1601-1DB4	104	0.071	
18.5	21.3	180 M	1465	121	91.2	92	91.9	0.84	35	2.5	7.2	3.4	61	74	1LE1601-1EB2	160	0.12	
22	25.3	180 L	1465	143	91.6	92.2	91.9	0.84	41.5	2.6	7.3	3.5	69	76	1LE1601-1EB4	170	0.13	
30	34.5	200 L	1470	195	92.3	92.9	92.6	0.84	56	2.5	6.7	3.3	70	77	1LE1601-2AB5	230	0.2	
37	42.5	225 S	1470	240	92.7	93.5	93.5	0.88	65	2.3	6.6	2.9	66	79	1LE1601-2BB0	280	0.42	
45	52	225 M	1475	290	93.1	93.8	93.7	0.87	80	2.5	6.9	3.1	66	79	1LE1601-2BB2	305	0.46	
55	63	250 M	1480	355	93.5	93.9	93.5	0.85	100	2.7	6.8	3	66	79	1LE1601-2CB2	385	0.75	
75	86	280 S	1485	480	94	94.2	93.8	0.87	132	2.5	6.8	3	71	85	1LE1601-2DB0	550	1.3	
90	104	280 M	1486	580	94.2	94.3	93.6	0.87	159	2.6	7.3	3.1	71	85	1LE1601-2DB2	570	1.4	
110	127	315 S	1490	700	94.5	94.6	94	0.86	195	2.7	7.4	3	72	86	1LE1601-3AB0	740	2	
132	152	315 M	1490	850	94.7	94.9	94.6	0.87	230	2.7	7.1	2.9	75	89	1LE1601-3AB2	870	2.3	
160	184	315 L	1490	1030	94.9	95	94.5	0.87	280	2.8	7.2	3.1	76	91	1LE1601-3AB4	940	2.8	
200	230	315 L	1490	1280	95.1	95.3	94.7	0.87	350	3.1	7.5	3.2	77	92	1LE1601-3AB5	1140	3.5	
Voltages²⁾																		
Version																		
Standard																		
Standard																		
Without additional charge																		
Without additional charge																		
For other voltages ¹⁾ and more information, see from page 3/100																		
Types of construction																		
Version																		
Standard																		
With additional charge																		
With additional charge																		
For other types of construction and more information, see from page 3/107																		
Motor protection																		
Version																		
Standard																		
For other motor protection and more information, see from page 3/117																		
Terminal box position																		
Version																		
Standard																		
For other terminal box positions and more information, see from page 3/120																		
Special versions																		
Order code(s)																		
Forced-air cooled motors w/o ext. fan/fan cover (IC418)																		
1LE1601-...-Z F90+...+...+...																		
For options, see from page 3/129																		
1LE1601-...-Z ...+...+...+...																		

¹⁾ Operating values at rated power for 60 Hz are stored in the Drive Technology Configurator (DT Configurator; see Appendix, "Tools and engineering").

²⁾ Parallel supply lines are required in the case of connection to ≤ 240 V. For frame size 315 with connection to ≤ 240 V, due to the high current, a drilled, removable entry plate (order code **R52**) or a larger terminal box (order code **R50**) can be used. Order codes **R52** and **R50** alter the motor dimensions.

³⁾ Types derived from IM B3 (IM B6/7/8, IM V6 and IM V5), from IM B5 (IM V3 and IM V1) and from IM B14 (IM V19 and IM V18) are possible, provided that no requirement exists for stamping of the type on the rating plate. The basic type IM B3, IM B5, or IM B14 is stamped as standard on the rating plate. If mounted in a different position, the position must be specified to ensure that the condensation drainage holes are positioned correctly.

SIMOTICS GP and SIMOTICS SD standard motors

IE2 High Efficiency

IE2



Cast-iron series SIMOTICS SD 1LE1601 Performance Line – self-ventilated or forced-air cooled

Selection and ordering data

Operating values at rated power															Cast-iron series		$m_{IM\ B3}$	J
$P_{rated, 50\ Hz/ P50}$	$P_{rated, 60\ Hz/ P60}^{1)}$	Frame size	$n_{rated, 50\ Hz}$	$T_{rated, 50\ Hz}$	Different IE class	$\eta_{rated, 50\ Hz}$	$\eta_{rated, 50\ Hz}$	$\eta_{rated, 50\ Hz}$	$\cos\phi_{rated, 50\ Hz}$	$I_{rated, 50\ Hz}$	T_{LR}/T_{rated}	I_{LR}/I_{rated}	T_B/T_{rated}	$L_{pFA, 50\ Hz}$	$L_{WA, 50\ Hz}$	1LE1601 – Performance Line Article No.		
kW	kW	FS	rpm	Nm		%	%	%		A								
• Cooling: Self-ventilated (IC411) or with order code F90 forced-air cooled without external fan and fan cover (IC418) • Efficiency according to IEC 60034-30-1: IE2 High Efficiency, service factor (SF) 1.15 • Insulation: Thermal class 155 (temperature class F), IP55 degree of protection, utilization in accordance with thermal class 130 (temperature class B)																		
6-pole: 1000 rpm at 50 Hz, 1200 rpm at 60 Hz ¹⁾																		
1.5	1.75	100 L	970	14.8		79.8	80.5	79	0.73	3.7	2	5.4	2.8	59	71	1LE1601-1AC4	36	0.011
2.2	2.55	112 M	965	22		81.8	82.7	81.7	0.75	5.2	2	5	2.8	62	74	1LE1601-1BC2	41	0.014
3	3.45	132 S	970	29.5		83.3	83.4	81	0.72	7.2	1.6	5	2.5	63	75	1LE1601-1CC0	56	0.024
4	4.55	132 M	970	39.5		84.6	85.5	84.3	0.75	9.1	1.6	5	2.3	63	75	1LE1601-1CC2	61	0.029
5.5	6.3	132 M	970	54		86	87.1	86.4	0.76	12.1	1.9	5.6	2.6	63	75	1LE1601-1CC3	70	0.037
7.5	8.6	160 M	975	73		87.2	87.9	87.2	0.74	16.8	1.9	4.7	2.2	67	79	1LE1601-1DC2	106	0.075
11	12.6	160 L	975	108		88.7	89.7	89.3	0.76	23.5	1.9	4.8	2.2	67	79	1LE1601-1DC4	122	0.098
15	18	180 L	975	147		89.7	90.1	89.5	0.78	31	2.5	6	3.1	57	70	1LE1601-1EC4	153	0.17
18.5	22	200 L	978	181	IE1	90.4	91.4	91.3	0.82	36	2.4	5.8	2.6	63	76	1LE1601-2AC4	198	0.25
22	26.5	200 L	978	215	IE1	90.9	91.7	91.4	0.82	42.5	2.5	6.2	2.6	63	76	1LE1601-2AC5	220	0.3
30	36	225 M	980	290	IE1	91.7	92.5	92.3	0.83	57	2.5	5.6	2.7	65	78	1LE1601-2BC2	300	0.58
37	44.5	250 M	982	360	IE1	92.2	93.1	93.1	0.83	70	2.8	6	2.5	62	77	1LE1601-2CC2	370	0.86
45	54	280 S	985	435	IE1	92.7	93.4	93.2	0.84	83	2.7	6.3	2.6	65	79	1LE1601-2DC0	460	1.1
55	66	280 M	985	530	IE1	93.1	93.9	94	0.86	99	2.5	6.4	2.6	65	79	1LE1601-2DC2	510	1.37
75	90	315 S	988	720	IE1	93.7	94	93.6	0.84	138	2.5	6.7	2.8	65	79	1LE1601-3AC0	660	2.1
90	108	315 M	988	870	IE1	94	94.3	93.6	0.84	165	2.6	6.9	2.8	65	79	1LE1601-3AC2	730	2.5
110	132	315 L	988	1060	IE1	94.3	94.6	94.5	0.86	196	2.7	7	2.8	68	82	1LE1601-3AC4	940	3.6
132	158	315 L	988	1280		94.6	94.9	94.7	0.86	235	3	7.5	2.9	69	84	1LE1601-3AC5	990	4.02
160	192	315 L	988	1550		94.8	94.7	94.4	0.86	285	3.1	7.7	3.3	69	84	1LE1601-3AC6	1160	4.7
Voltages ²⁾															Version			Order code
50 Hz 230 VΔ/400 VY			60 Hz ¹⁾ 460 VY			Standard		2	2					-				
50 Hz 400 VΔ/690 VY			60 Hz ¹⁾ 460 VΔ			Standard		3	4					-				
50 Hz 500 VY						Without additional charge		2	7					-				
50 Hz 500 VΔ						Without additional charge		4	0					-				
For other voltages ¹⁾ and more information, see from page 3/100																		
Types of construction															Version			Order code
Without flange			IM B3 ³⁾			Standard		A					-					
With flange			IM B5 ³⁾			With additional charge		F					-					
With flange			IM B14 ³⁾			With additional charge		K					-					
For other types of construction and more information, see from page 3/107																		
Motor protection															Version			Order code
PTC thermistor with 3 temperature sensors						Standard		B					-					
For other motor protection and more information, see from page 3/117																		
Terminal box position															Version			Order code
Terminal box at top						Standard		4					-					
For other terminal box positions and more information, see from page 3/120																		
Special versions																		Order code(s)
Forced-air cooled motors w/o ext. fan/fan cover (IC418)								1LE1601-...-Z	F90+...+...+...									
For options, see from page 3/129																		

¹⁾ Operating values at rated power for 60 Hz are stored in the Drive Technology Configurator (DT Configurator; see Appendix, "Tools and engineering").

²⁾ Parallel supply lines are required in the case of connection to ≤ 240 V. For frame size 315 with connection to ≤ 240 V, due to the high current, a drilled, removable entry plate (order code **R52**) or a larger terminal box (order code **R50**) can be used. Order codes **R52** and **R50** alter the motor dimensions.

³⁾ Types derived from IM B3 (IM B6/7/8, IM V6 and IM V5), from IM B5 (IM V3 and IM V1) and from IM B14 (IM V19 and IM V18) are possible, provided that no requirement exists for stamping of the type on the rating plate. The basic type IM B3, IM B5, or IM B14 is stamped as standard on the rating plate. If mounted in a different position, the position must be specified to ensure that the condensation drainage holes are positioned correctly.



IE2

SIMOTICS GP and SIMOTICS SD standard motors IE2 High Efficiency

Cast-iron series SIMOTICS SD 1LE1601 Performance Line – self-ventilated or forced-air cooled

Selection and ordering data

Operating values at rated power															Cast-iron series			
P_{rated} , 50 Hz/ P50 kW	P_{rated} , 60 Hz/ P60 ¹⁾ kW	Frame size	n_{rated} , 50 Hz rpm	T_{rated} , 50 Hz Nm	Different IE class 60 Hz/P60	η_{rated} , 50 Hz %	η_{rated} , 50 Hz %	η_{rated} , 50 Hz %	$\cos\phi_{rated}$, 50 Hz %	I_{rated} , 50 Hz A	T_{LR}/I_{rated} , 50 Hz	I_{LR}/I_{rated} , 50 Hz	T_{β}/I_{rated} , 50 Hz	L_{pfA} , 50 Hz dB(A)	L_{WA} , 50 Hz dB(A)	1LE1601 – Performance Line Article No.	$m_{IM B3}$ kg	J kgm ²
<ul style="list-style-type: none"> • Cooling: Self-ventilated (IC411) or with order code F90 forced-air cooled without external fan and fan cover (IC418) • Efficiency according to IEC 60034-30-1: IE2 High Efficiency, service factor (SF) 1.15 • Insulation: Thermal class 155 (temperature class F), IP55 degree of protection, utilization in accordance with thermal class 130 (temperature class B) 																		
8-pole: 750 rpm at 50 Hz, 900 rpm at 60 Hz ¹⁾																		
0.75	0.86	100 L	705	10.2		66.2	65.7	61.5	0.61	2.7	1.5	3.2	2.1	60	72	1LE1601-1AD4	32	0.0086
1.1	1.27	100 L	695	15.1		70.8	72.3	69.6	0.65	3.45	1.4	3.2	1.9	60	72	1LE1601-1AD5	36	0.011
1.5	1.75	112 M	725	19.8		74.1	73.9	71.2	0.63	4.65	1.6	4	2.4	63	75	1LE1601-1BD2	41	0.017
2.2	2.55	132 S	725	29		77.6	78.2	76.6	0.62	6.6	1.4	3.5	2	63	75	1LE1601-1CD0	59	0.034
3	3.45	132 M	720	40	IE1	80	80.7	79.2	0.62	8.7	1.4	3.7	2	63	75	1LE1601-1CD2	67	0.037
4	4.55	160 M	730	52		81.9	82.6	81.4	0.67	10.5	1.6	3.7	1.9	63	75	1LE1601-1DD2	98	0.065
5.5	6.3	160 M	730	72		83.8	84.2	83	0.67	14.1	1.7	3.9	2	63	75	1LE1601-1DD3	111	0.083
7.5	8.6	160 L	725	99		85.3	86.4	86	0.7	18.1	1.6	3.8	1.9	63	75	1LE1601-1DD4	123	0.098
11	13.2	180 L	720	146	IE1	86.9	88	87.6	0.7	26	2.3	4.9	2.6	72	80	1LE1601-1ED4	153	0.195
15	18	200 L	718	199		88	89.5	89.9	0.76	32.5	2.4	5.4	2.8	58	65	1LE1601-2AD5	220	0.344
18.5	22	225 S	730	240	IE1	89	89.9	89.5	0.78	38.5	2.2	5.4	2.7	59	72	1LE1601-2BD0	250	0.43
22	26.5	225 M	730	290		90.3	91.3	91.1	0.8	44	2.3	5.5	2.7	58	71	1LE1601-2BD2	270	0.5
30	36	250 M	732	390		91.3	92.2	92	0.8	59	2.4	5.6	2.7	60	73	1LE1601-2CD2	370	0.86
37	44.5	280 S	736	480		91.9	92.5	92.1	0.78	75	2.3	5.4	2.4	63	77	1LE1601-2DD0	460	1.1
45	54	280 M	738	580		92.4	92.8	92.4	0.79	89	2.5	5.7	2.5	66	80	1LE1601-2DD2	510	1.4
55	66	315 S	740	710		92.9	93.3	92.9	0.8	107	2.2	5.8	2.6	69	83	1LE1601-3AD0	640	2
75	90	315 M	738	970		93.5	94.4	94.5	0.81	143	2.3	5.9	2.7	69	84	1LE1601-3AD2	710	2.5
90	108	315 L	740	1160		93.5	94.3	94.4	0.83	167	2.2	5.8	2.5	69	84	1LE1601-3AD4	860	3.1
110	132	315 L	740	1420		94.2	95	95.1	0.82	205	2.7	6.7	2.9	74	88	1LE1601-3AD5	980	3.9
Voltages²⁾															Version		Order code	
50 Hz 230 VΔ/400 VY			60 Hz ¹⁾ 460 VY			Standard									2	2	-	
50 Hz 400 VΔ/690 VY			60 Hz ¹⁾ 460 VΔ			Standard									3	4	-	
50 Hz 500 VY						Without additional charge									2	7	-	
50 Hz 500 VΔ						Without additional charge									4	0	-	
For other voltages ¹⁾ and more information, see from page 3/100															9	0	...	
Types of construction															Version		Order code	
Without flange			IM B3 ³⁾			Standard									A	-		
With flange			IM B5 ³⁾			With additional charge									F	-		
With flange			IM B14 ³⁾			With additional charge									K	-		
For other types of construction and more information, see from page 3/107																	...	
Motor protection															Version		Order code	
PTC thermistor with 3 temperature sensors						Standard									B	-		
For other motor protection and more information, see from page 3/117																	...	
Terminal box position															Version		Order code	
Terminal box at top						Standard									4	-		
For other terminal box positions and more information, see from page 3/120																		
Special versions																	Order code(s)	
Forced-air cooled motors w/o ext. fan/fan cover (IC418)						1LE1601-...-Z									F90+	...		
For options, see from page 3/129						1LE1601-...-Z										

1) Operating values at rated power for 60 Hz are stored in the Drive Technology Configurator (DT Configurator; see Appendix, "Tools and engineering").

2) Parallel supply lines are required in the case of connection to ≤ 240 V. For frame size 315 with connection to ≤ 240 V, due to the high current, a drilled, removable entry plate (order code R52) or a larger terminal box (order code R50) can be used. Order codes R52 and R50 alter the motor dimensions.

3) Types derived from IM B3 (IM B6/7/8, IM V6 and IM V5), from IM B5 (IM V3 and IM V1) and from IM B14 (IM V19 and IM V18) are possible, provided that no requirement exists for stamping of the type on the rating plate. The basic type IM B3, IM B5, or IM B14 is stamped as standard on the rating plate. If mounted in a different position, the position must be specified to ensure that the condensation drainage holes are positioned correctly.

4) No IE class for 50 and 60 Hz because the motor is outside the validity for the efficiency classes according to IEC 60034-30-1:2014.

SIMOTICS GP and SIMOTICS SD standard motors

IE2 High Efficiency



Cast-iron series SIMOTICS SD 1LE1501 Basic Line with increased power – self-ventilated

Selection and ordering data

Operating values at rated power															Cast-iron series			
P_{rated} , 50 Hz/ P50	P_{rated} , 60 Hz/ P60 ¹⁾	Frame size	n_{rated} , 50 Hz	T_{rated} , 50 Hz	Different IE class	η_{rated} , 50 Hz	η_{rated} , 50 Hz	η_{rated} , 50 Hz	$\cos\phi_{rated}$, 50 Hz	I_{rated} , 50 Hz	$T_{LR}/$ T_{rated} , 50 Hz	$I_{LR}/$ I_{rated} , 50 Hz	$T_B/$ T_{rated} , 50 Hz	L_{pA} , 50 Hz	L_{WA} , 50 Hz	1LE1501 – Basic Line	$m_{IM B3}$	J
kW	kW	FS	rpm	Nm	60 Hz/P60	4/4	3/4	2/4	4/4	A					Article No.	kg	kgm ²	
• Cooling: Self-ventilated (IC411) or with order code F90 forced-air cooled without external fan and fan cover (IC418) • Efficiency according to IEC 60034-30-1: IE2 High Efficiency, service factor (SF) 1.15 • Insulation: Thermal class 155 (temperature class F), IP55 degree of protection, utilization in accordance with thermal class 130 (temperature class B)																		
2-pole: 3000 rpm at 50 Hz, 3600 rpm at 60 Hz ¹⁾																		
4	4.55	100 L	2905	13.1		85.8	86.9	86.5	0.86	7.8	2.5	7.6	3.5	67	79	1LE1501-1AA6	37	0.0054
5.5	6.3	112 M	2945	17.8		87	87.8	87.4	0.88	10.4	2.3	8.5	3.8	69	81	1LE1501-1BA6	43	0.012
11	12.6	132 M	2950	35.5		89.4	90.1	89.9	0.89	20	2.3	7.9	3.2	68	80	1LE1501-1CA6	75	0.031
22	25.3	160 L	2955	71		91.3	91.8	91.4	0.89	39	3.1	8.4	3.7	70	82	1LE1501-1DA6	123	0.068
30	33.5	180 L	2940	97		92	92.6	92.3	0.89	53	2.3	7.8	3.4	76	83	1LE1501-1EA6	175	0.094
45	51	200 L	2950	146		92.9	93.2	92.9	0.87	81	2.5	7.1	3.2	77	84	1LE1501-2AA6	245	0.176
55	62	225 M	2960	177		93.2	93.6	93.2	0.88	97	2.5	7	3.3	76	89	1LE1501-2BA6	320	0.26
75	84	250 M	2970	240		93.8	93.6	92.6	0.84	137	2.2	7	3.3	75	89	1LE1501-2CA6	390	0.463
110	123	280 M	2978	355		94.3	94.5	94.1	0.9	187	2.9	8.5	3.6	80	91	1LE1501-2DA6	650	1.2
4-pole: 1500 rpm at 50 Hz, 1800 rpm at 60 Hz ¹⁾																		
4	4.55	100 L	1460	26		86.6	88	87.5	0.8	8.3	2.2	7.5	3.5	60	72	1LE1501-1AB6	41	0.014
5.5	6.3	112 M	1460	36		87.7	88.2	87.2	0.81	11.2	2.5	7.1	3.2	58	70	1LE1501-1BB6	44	0.017
11	12.6	132 M	1465	72		89.8	90.9	90.9	0.84	21	2.6	7.7	3.1	64	76	1LE1501-1CB6	82	0.046
18.5	21.3	160 L	1475	120		91.2	91.8	91.3	0.85	34.5	2.5	7.7	3.3	65	77	1LE1501-1DB6	129	0.085
30	34.5	180 L	1465	196		92.3	92.8	92.6	0.81	58	2.5	7.3	3.3	70	77	1LE1501-1EB6	184	0.159
37	42.5	200 L	1470	240		92.7	93.3	93.1	0.84	69	2.4	7	3	68	75	1LE1501-2AB6	240	0.246
55	63	225 M	1475	355		93.5	94.2	94.1	0.84	101	2.5	5.8	2.7	69	82	1LE1501-2BB6	320	0.47
75	86	250 M	1480	485		94	94.5	94.3	0.86	134	2.3	6.2	2.8	74	87	1LE1501-2CB6	440	0.85
110	127	280 M	1485	710		94.5	94.9	94.8	0.87	193	2.5	6.9	3	73	87	1LE1501-2DB6	680	1.7
Voltages²⁾															Version		Order code	
50 Hz 230 VΔ/400 VY			60 Hz ¹⁾ 460 VY			Standard		2 2		-		-		-		-		
50 Hz 400 VΔ/690 VY			60 Hz ¹⁾ 460 VΔ			Standard		3 4		-		-		-		-		
50 Hz 500 VY						Without additional charge		2 7		-		-		-		-		
50 Hz 500 VΔ						Without additional charge		4 0		-		-		-		-		
For other voltages ¹⁾ and more information, see from page 3/100															9 0		...	
Types of construction															Version		Order code	
Without flange			IM B3 ³⁾			Standard		A		-		-		-		-		
With flange			IM B5 ³⁾			With additional charge		F		-		-		-		-		
With flange			IM B14 ³⁾			With additional charge		K		-		-		-		-		
For other types of construction and more information, see from page 3/107															-		...	
Motor protection															Version		Order code	
Without						Standard		A		-		-		-		-		
PTC thermistor with 3 temperature sensors						With additional charge		B		-		-		-		-		
For other motor protection and more information, see from page 3/117															-		...	
Terminal box position															Version		Order code	
Terminal box at top						Standard		4		-		-		-		-		
For other terminal box positions and more information, see from page 3/120															-		-	
Special versions																	Order code(s)	
For options, see from page 3/129															1LE1501-....		-Z ...+...+...+...	

¹⁾ Operating values at rated power for 60 Hz are stored in the Drive Technology Configurator (DT Configurator; see Appendix, "Tools and engineering").

²⁾ Parallel supply lines are required in the case of connection to ≤ 240 V. For frame size 315 with connection to ≤ 240 V, due to the high current, a drilled, removable entry plate (order code **R52**) or a larger terminal box (order code **R50**) can be used. Order codes **R52** and **R50** alter the motor dimensions.

³⁾ Types derived from IM B3 (IM B6/7/8, IM V6 and IM V5), from IM B5 (IM V3 and IM V1) and from IM B14 (IM V19 and IM V18) are possible, provided that no requirement exists for stamping of the type on the rating plate. The basic type IM B3, IM B5, or IM B14 is stamped as standard on the rating plate. If mounted in a different position, the position must be specified to ensure that the condensation drainage holes are positioned correctly.



IE2

SIMOTICS GP and SIMOTICS SD standard motors IE2 High Efficiency

Cast-iron series SIMOTICS SD 1LE1501 Basic Line with increased power – self-ventilated

Selection and ordering data

Operating values at rated power																	Cast-iron series		
P_{rated} 50 Hz/ P50 kW	P_{rated} 60 Hz/ P60 ¹⁾ kW	Frame size	n_{rated} 50 Hz rpm	T_{rated} 50 Hz Nm	Different IE class 60 Hz/P60	η_{rated} 50 Hz %	η_{rated} 50 Hz %	η_{rated} 50 Hz %	$\cos\phi_{rated}$ 50 Hz %	I_{rated} 50 Hz A	$T_{LR}/$ T_{rated} 50 Hz	$I_{LR}/$ I_{rated} 50 Hz	$T_B/$ T_{rated} 50 Hz	L_{pfA} 50 Hz dB(A)	L_{WA} 50 Hz dB(A)	1LE1501 – Basic Line	$m_{IM B3}$	J	
															Article No.	kg	kgm ²		
• Cooling: Self-ventilated (IC411) or with order code F90 forced-air cooled without external fan and fan cover (IC418) • Efficiency according to IEC 60034-30-1: IE2 High Efficiency, service factor (SF) 1.15 • Insulation: Thermal class 155 (temperature class F), IP55 degree of protection, utilization in accordance with thermal class 130 (temperature class B)																			
6-pole: 1000 rpm at 50 Hz, 1200 rpm at 60 Hz ¹⁾																			
2.2	2.55	100 L	965	22	IE1	81.8	83.3	82.7	0.76	5.1	1.7	4.9	2.5	59	71	1LE1501-1AC6	41	0.014	
3	3.45	112 M	965	29.5		83.3	84	82.7	0.74	7	2.1	5.4	2.7	62	74	1LE1501-1BC6	44	0.017	
7.5	8.6	132 M	970	74		87.2	88.1	87.1	0.75	16.6	2	5.6	2.6	63	75	1LE1501-1CC6	83	0.046	
15	17.3	160 L	975	147	IE1	89.7	90.4	89.7	0.75	32	2	5.2	2.4	67	79	1LE1501-1DC6	147	0.12	
18.5	22	180 L	975	181		90.4	90.9	90.5	0.77	38.5	2.3	6	2.9	67	80	1LE1501-1EC6	166	0.206	
30	34.5	200 L	975	295		91.7	92.5	92.4	0.77	61	2.6	6.3	2.7	68	75	1LE1501-2AC6	243	0.381	
37	44.5	225 M	978	360	IE1	92.2	93	92.9	0.83	70	2.5	6.3	2.9	64	77	1LE1501-2BC6	325	0.67	
45	54	250 M	985	435	IE1	92.7	93.4	93.4	0.84	83	2.4	6.6	2.7	67	81	1LE1501-2CC6	410	1	
75	90	280 M	986	730		93.7	94.3	94.4	0.85	136	3.2	7	2.9	66	80	1LE1501-2DC6	570	1.8	
8-pole: 750 rpm at 50 Hz, 900 rpm at 60 Hz ¹⁾																			
15	18	180 L	720	199	IE1	88	89.2	89	0.73	33.5	2.2	4.9	2.5	67	75	1LE1501-1ED6	187	0.263	
18.5	22	200 L	720	245	IE1	88.6	89.9	90.2	0.78	38.5	2.6	5.8	3	65	72	1LE1501-2AD6	250	0.416	
30	36	225 M	732	390		90.8	92	92.1	0.76	63	2.8	6.1	3.2	62	76	1LE1501-2BD6	325	0.67	
37	44.5	250 M	730	485		91.6	92.6	92.7	0.83	70	2.3	5.5	2.6	63	77	1LE1501-2CD6	405	1	
55	66	280 M	736	710		92.9	93.4	93	0.8	107	2.5	5.9	2.5	70	81	1LE1501-2DD6	550	1.6	
Voltages²⁾																	Order code		
50 Hz 230 VΔ/400 VY			60 Hz ¹⁾ 460 VY			Standard											2	2	–
50 Hz 400 VΔ/690 VY			60 Hz ¹⁾ 460 VΔ			Standard											3	4	–
50 Hz 500 VY						Without additional charge											2	7	–
50 Hz 500 VΔ						Without additional charge											4	0	–
For other voltages ¹⁾ and more information, see from page 3/100																	9	0	...
Types of construction																	Order code		
Without flange			IM B3 ³⁾			Standard											A	–	
With flange			IM B5 ³⁾			With additional charge											F	–	
With flange			IM B14 ³⁾			With additional charge											K	–	
For other types of construction and more information, see from page 3/107																	–	–	...
Motor protection																	Order code		
Without						Standard											A	–	
PTC thermistor with 1 or 3 temperature sensors						With additional charge											B	–	
For other motor protection and more information, see from page 3/117																	–	–	...
Terminal box position																	Order code		
Terminal box at top						Standard											4	–	
For other terminal box positions and more information, see from page 3/120																	–	–	...
Special versions																	Order code(s)		
For options, see from page 3/129																	1LE1501-...-Z		...+...+...+...

3

¹⁾ Operating values at rated power for 60 Hz are stored in the Drive Technology Configurator (DT Configurator; see Appendix, "Tools and engineering").

²⁾ Parallel supply lines are required in the case of connection to ≤ 240 V. For frame size 315 with connection to ≤ 240 V, due to the high current, a drilled, removable entry plate (order code **R52**) or a larger terminal box (order code **R50**) can be used. Order codes **R52** and **R50** alter the motor dimensions.

³⁾ Types derived from IM B3 (IM B6/7/8, IM V6 and IM V5), from IM B5 (IM V3 and IM V1) and from IM B14 (IM V19 and IM V18) are possible, provided that no requirement exists for stamping of the type on the rating plate. The basic type IM B3, IM B5, or IM B14 is stamped as standard on the rating plate. If mounted in a different position, the position must be specified to ensure that the condensation drainage holes are positioned correctly.

SIMOTICS GP and SIMOTICS SD standard motors

IE2 High Efficiency

IE2



Cast-iron series SIMOTICS SD 1LE1601 Performance Line with increased power – self-ventilated

Selection and ordering data

Operating values at rated power														Cast-iron series		$m_{IM\ B3}$	J	
$P_{rated, 50\ Hz/}$ P_{50}	$P_{rated, 60\ Hz/}$ $P_{60}^{1)}$	Frame size	$n_{rated, 50\ Hz}$	$T_{rated, 50\ Hz}$	Different IE class	$\eta_{rated, 50\ Hz}$	$\eta_{rated, 50\ Hz}$	$\eta_{rated, 50\ Hz}$	$\cos\phi_{rated, 50\ Hz}$	$I_{rated, 50\ Hz}$	$T_{LR}/I_{rated, 50\ Hz}$	$I_{LR}/I_{rated, 50\ Hz}$	$T_B/I_{rated, 50\ Hz}$	$L_{pfA, 50\ Hz}$	$L_{WA, 50\ Hz}$			1LE1601 – Performance Line Article No.
kW	kW	FS	rpm	Nm	60 Hz/P60	%	%	%	%	A				dB(A)	dB(A)		kg	kgm ²
• Cooling: Self-ventilated (IC411) or with order code F90 forced-air cooled without external fan and fan cover (IC418) • Efficiency according to IEC 60034-30-1: IE2 High Efficiency, service factor (SF) 1.15 • Insulation: Thermal class 155 (temperature class F), IP55 degree of protection, utilization in accordance with thermal class 130 (temperature class B)																		
2-pole: 3000 rpm at 50 Hz, 3600 rpm at 60 Hz ¹⁾																		
4	4.55	100 L	2905	13.1		85.8	86.9	86.5	0.86	7.8	2.5	7.6	3.5	67	79	1LE1601-1AA6	37	0.0054
5.5	6.3	112 M	2945	17.8		87	87.8	87.4	0.88	10.4	2.3	8.5	3.8	69	81	1LE1601-1BA6	43	0.012
11	12.6	132 M	2950	35.5		89.4	90.1	89.9	0.89	20	2.3	7.9	3.2	68	80	1LE1601-1CA6	75	0.031
22	25.3	160 L	2955	71		91.3	91.8	91.4	0.89	39	3.1	8.4	3.7	70	82	1LE1601-1DA6	123	0.068
30	33.5	180 L	2940	97		92	92.6	92.3	0.89	53	2.3	7.8	3.4	76	83	1LE1601-1EA6	175	0.094
45	51	200 L	2950	146		92.9	93.2	92.9	0.87	81	2.5	7.1	3.2	77	84	1LE1601-2AA6	245	0.176
55	62	225 M	2960	177		93.2	93.6	93.2	0.88	97	2.5	7	3.3	76	89	1LE1601-2BA6	320	0.26
75	84	250 M	2970	240		93.8	93.6	92.6	0.84	137	2.2	7	3.3	75	89	1LE1601-2CA6	390	0.463
110	123	280 M	2978	355		94.3	94.5	94.1	0.9	187	2.9	8.5	3.6	80	91	1LE1601-2DA6	650	1.2
4-pole: 1500 rpm at 50 Hz, 1800 rpm at 60 Hz ¹⁾																		
4	4.55	100 L	1460	26		86.6	88	87.5	0.8	8.3	2.2	7.5	3.5	60	72	1LE1601-1AB6	41	0.014
5.5	6.3	112 M	1460	36		87.7	88.2	87.2	0.81	11.2	2.5	7.1	3.2	58	70	1LE1601-1BB6	44	0.017
11	12.6	132 M	1465	72		89.8	90.9	90.9	0.84	21	2.6	7.7	3.1	64	76	1LE1601-1CB6	82	0.046
18.5	21.3	160 L	1475	120		91.2	91.8	91.3	0.85	34.5	2.5	7.7	3.3	65	77	1LE1601-1DB6	129	0.085
30	34.5	180 L	1465	196		92.3	92.8	92.6	0.81	58	2.5	7.3	3.3	70	77	1LE1601-1EB6	184	0.159
37	42.5	200 L	1470	240		92.7	93.3	93.1	0.84	69	2.4	7	3	68	75	1LE1601-2AB6	240	0.246
55	63	225 M	1475	355		93.5	94.2	94.1	0.84	101	2.5	5.8	2.7	69	82	1LE1601-2BB6	320	0.47
75	86	250 M	1480	485		94	94.5	94.3	0.86	134	2.3	6.2	2.8	74	87	1LE1601-2CB6	440	0.85
110	127	280 M	1485	710		94.5	94.9	94.8	0.87	193	2.5	6.9	3	73	87	1LE1601-2DB6	680	1.7
Voltages ²⁾														Version				Order code
50 Hz 230 VΔ/400 VY				60 Hz ¹⁾ 460 VY				Standard		2 2				-				
50 Hz 400 VΔ/690 VY				60 Hz ¹⁾ 460 VΔ				Standard		3 4				-				
50 Hz 500 VY								Without additional charge		2 7				-				
50 Hz 500 VΔ								Without additional charge		4 0				-				
For other voltages ¹⁾ and more information, see from page 3/100														9 0				...
Types of construction														Version				Order code
Without flange				IM B3 ³⁾				Standard		A				-				
With flange				IM B5 ³⁾				With additional charge		F				-				
With flange				IM B14 ³⁾				With additional charge		K				-				
For other types of construction and more information, see from page 3/107														B				...
Motor protection														Version				Order code
PTC thermistor with 3 temperature sensors								Standard		B				-				
For other motor protection and more information, see from page 3/117																		...
Terminal box position														Version				Order code
Terminal box at top								Standard		4								
For other terminal box positions and more information, see from page 3/120																		
Special versions																		Order code(s)
For options, see from page 3/129														1LE1601-...		-Z		...+...+...+...

¹⁾ Operating values at rated power for 60 Hz are stored in the Drive Technology Configurator (DT Configurator; see Appendix, "Tools and engineering").

²⁾ Parallel supply lines are required in the case of connection to ≤ 240 V. For frame size 315 with connection to ≤ 240 V, due to the high current, a drilled, removable entry plate (order code **R52**) or a larger terminal box (order code **R50**) can be used. Order codes **R52** and **R50** alter the motor dimensions.

³⁾ Types derived from IM B3 (IM B6/7/8, IM V6 and IM V5), from IM B5 (IM V3 and IM V1) and from IM B14 (IM V19 and IM V18) are possible, provided that no requirement exists for stamping of the type on the rating plate. The basic type IM B3, IM B5, or IM B14 is stamped as standard on the rating plate. If mounted in a different position, the position must be specified to ensure that the condensation drainage holes are positioned correctly.



IE2

SIMOTICS GP and SIMOTICS SD standard motors IE2 High Efficiency

Cast-iron series SIMOTICS SD 1LE1601 Performance Line with increased power – self-ventilated

Selection and ordering data

Operating values at rated power																	Cast-iron series		
P_{rated} 50 Hz/ P50 kW	P_{rated} 60 Hz/ P60 ¹⁾ kW	Frame size	n_{rated} 50 Hz rpm	T_{rated} 50 Hz Nm	Different IE class 60 Hz/P60	η_{rated} 50 Hz %	η_{rated} 50 Hz %	η_{rated} 50 Hz %	$\cos\phi_{rated}$ 50 Hz %	I_{rated} 400 V A	$T_{LR}/$ T_{rated} 50 Hz	$I_{LR}/$ I_{rated} 50 Hz	$T_{B}/$ T_{rated} 50 Hz	L_{pfA} 50 Hz dB(A)	L_{WA} 50 Hz dB(A)	1LE1601 – Performance Line Article No.	$m_{IM B3}$ kg	J kgm ²	
<ul style="list-style-type: none"> Cooling: Self-ventilated (IC411) or with order code F90 forced-air cooled without external fan and fan cover (IC418) Efficiency according to IEC 60034-30-1: IE2 High Efficiency, service factor (SF) 1.15 Insulation: Thermal class 155 (temperature class F), IP55 degree of protection, utilization in accordance with thermal class 130 (temperature class B) 																			
6-pole: 1000 rpm at 50 Hz, 1200 rpm at 60 Hz ¹⁾																			
2.2	2.55	100 L	965	22	IE1	81.8	83.3	82.7	0.76	5.1	1.7	4.9	2.5	59	71	1LE1601-1AC6	41	0.014	
3	3.45	112 M	965	29.5		83.3	84	82.7	0.74	7	2.1	5.4	2.7	62	74	1LE1601-1BC6	44	0.017	
7.5	8.6	132 M	970	74		87.2	88.1	87.1	0.75	16.6	2	5.6	2.6	63	75	1LE1601-1CC6	83	0.046	
15	17.3	160 L	975	147	IE1	89.7	90.4	89.7	0.75	32	2	5.2	2.4	67	79	1LE1601-1DC6	147	0.12	
18.5	22	180 L	975	181		90.4	90.9	90.5	0.77	38.5	2.3	6	2.9	67	80	1LE1601-1EC6	166	0.206	
30	34.5	200 L	975	295		91.7	92.5	92.4	0.77	61	2.6	6.3	2.7	68	75	1LE1601-2AC6	243	0.381	
37	44.5	225 M	978	360	IE1	92.2	93	92.9	0.83	70	2.5	6.3	2.9	64	77	1LE1601-2BC6	325	0.67	
45	54	250 M	985	435	IE1	92.7	93.4	93.4	0.84	83	2.4	6.6	2.7	67	81	1LE1601-2CC6	410	1	
75	90	280 M	986	730		93.7	94.3	94.4	0.85	136	3.2	7	2.9	66	80	1LE1601-2DC6	570	1.8	
8-pole: 750 rpm at 50 Hz, 900 rpm at 60 Hz ¹⁾																			
15	18	180 L	720	199	IE1	88	89.2	89	0.73	33.5	2.2	4.9	2.5	67	75	1LE1601-1ED6	187	0.263	
18.5	22	200 L	720	245	IE1	88.6	89.9	90.2	0.78	38.5	2.6	5.8	3	65	72	1LE1601-2AD6	250	0.416	
30	36	225 M	732	390		90.8	92	92.1	0.76	63	2.8	6.1	3.2	62	76	1LE1601-2BD6	325	0.67	
37	44.5	250 M	730	485		91.6	92.6	92.7	0.83	70	2.3	5.5	2.6	63	77	1LE1601-2CD6	405	1	
55	66	280 M	736	710		92.9	93.4	93	0.8	107	2.5	5.9	2.5	70	81	1LE1601-2DD6	550	1.6	
Voltages²⁾																	Order code		
50 Hz 230 VΔ/400 VY			60 Hz ¹⁾ 460 VY			Standard											2	2	–
50 Hz 400 VΔ/690 VY			60 Hz ¹⁾ 460 VΔ			Standard											3	4	–
50 Hz 500 VY						Without additional charge											2	7	–
50 Hz 500 VΔ						Without additional charge											4	0	–
For other voltages ¹⁾ and more information, see from page 3/100																	9	0	...
Types of construction																	Order code		
Without flange			IM B3 ³⁾			Standard											A	–	
With flange			IM B5 ³⁾			With additional charge											F	–	
With flange			IM B14 ³⁾			With additional charge											K	–	
For other types of construction and more information, see from page 3/107																	–	–	...
Motor protection																	Order code		
PTC thermistor with 1 or 3 temperature sensors						Standard											B	–	
For other motor protection and more information, see from page 3/117																	–	–	...
Terminal box position																	Order code		
Terminal box at top						Standard											4	–	
For other terminal box positions and more information, see from page 3/120																	–	–	...
Special versions																	Order code(s)		
For options, see from page 3/129																	1LE1601-...-Z		...+...+...+...

3

¹⁾ Operating values at rated power for 60 Hz are stored in the Drive Technology Configurator (DT Configurator; see Appendix, "Tools and engineering").

²⁾ Parallel supply lines are required in the case of connection to ≤ 240 V. For frame size 315 with connection to ≤ 240 V, due to the high current, a drilled, removable entry plate (order code **R52**) or a larger terminal box (order code **R50**) can be used. Order codes **R52** and **R50** alter the motor dimensions.

³⁾ Types derived from IM B3 (IM B6/7/8, IM V6 and IM V5), from IM B5 (IM V3 and IM V1) and from IM B14 (IM V19 and IM V18) are possible, provided that no requirement exists for stamping of the type on the rating plate. The basic type IM B3, IM B5, or IM B14 is stamped as standard on the rating plate. If mounted in a different position, the position must be specified to ensure that the condensation drainage holes are positioned correctly.

SIMOTICS GP and SIMOTICS SD standard motors

IE1 Standard Efficiency



Aluminum series SIMOTICS GP 1LE1002 – self-ventilated or forced-air cooled

Selection and ordering data

Operating values at rated power															Aluminum series			
P_{rated} 50 Hz/ P50	P_{rated} 60 Hz/ P60 ¹⁾	Frame size	n_{rated} 50 Hz	T_{rated} 50 Hz	η_{rated} 50 Hz, 4/4	η_{rated} 50 Hz, 3/4	η_{rated} 50 Hz, 2/4	η_{rated} 50 Hz, 1/4	$\cos\phi_{rated}$ 50 Hz, 4/4	I_{rated} 50 Hz, 400 V	T_{LR} 50 Hz	I_{LR} 50 Hz	T_B 50 Hz	L_{pFA} 50 Hz	L_{WA} 50 Hz	1LE1002	$m_{IM B3}$	J
kW	kW	FS	rpm	Nm	%	%	%	%	A	A	A	A	A	A	Article No.	kg	kgm ²	
• Cooling: Self-ventilated (IC411) or with order code F90 forced-air cooled without external fan and fan cover (IC418) • Efficiency according to IEC 60034-30-1: IE1 Standard Efficiency, service factor (SF) 1.1 • Insulation: Thermal class 155 (temperature class F), IP55 degree of protection, utilization in accordance with thermal class 130 (temperature class B)																		
2-pole: 3000 rpm at 50 Hz, 3600 rpm at 60 Hz ¹⁾																		
0.18	0.21	63 M	2805	0.61	52.8	50.1	44.2	0.79	0.62	1.7	3.4	2.2	55	62	1LE1002-0BA2	4	0.00018	
0.25	0.29	63 M	2835	0.84	58.2	55.5	48.6	0.75	0.83	1.9	3.6	2.6	56	63	1LE1002-0BA3	4	0.00022	
0.37	0.43	71 M	2755	1.28	63.9	64.5	61.1	0.79	1.06	2.2	3.4	2.2	56	67	1LE1002-0CA2	5	0.00022	
0.55	0.63	71 M	2750	1.91	69	69.9	66.5	0.79	1.46	2.2	3.7	2.2	62	73	1LE1002-0CA3	6	0.00029	
0.75	0.86	80 M	2835	2.55	72.1	72.6	69.9	0.86	1.75	2.1	5.2	2.3	64	71	1LE1002-0DA2	9	0.001689	
1.1	1.27	80 M	2840	3.7	75	75.7	73.4	0.86	2.45	2.5	5.7	2.5	64	71	1LE1002-0DA3	12	0.002228	
1.5	1.75	90 S	2835	5.1	77.2	78.2	76.8	0.85	3.3	2.6	5.5	2.9	70	77	1LE1002-0EA0	13	0.003641	
2.2	2.55	90 L	2855	7.4	79.7	80.9	81.3	0.85	4.7	2.8	6.5	3.2	71	78	1LE1002-0EA4	14	0.004612	
3	3.45	100 L	2835	10.1	81.5	83.2	82.7	0.87	6.1	3.2	6.4	3.5	66	80	1LE1002-1AA4	20	0.0034	
4	4.55	112 M	2935	13	83.1	82.9	80.5	0.85	8.2	3.3	8.3	4.2	70	83	1LE1002-1BA2	25	0.0067	
5.5	6.3	132 S	2910	18	84.7	85.8	85.3	0.88	10.7	1.8	5.7	2.6	68	82	1LE1002-1CA0	35	0.013	
7.5	8.6	132 S	2925	24.5	86	86.6	86.1	0.88	14.3	2.2	6.8	3.1	68	82	1LE1002-1CA1	40	0.016	
11	12.6	160 M	2925	36	87.6	88.2	87	0.86	21	2	5.7	2.7	79	86	1LE1002-1DA2	60	0.03	
15	17.3	160 M	2935	49	88.7	88.9	87.2	0.85	28.5	2.4	6.8	3.2	78	85	1LE1002-1DA3	68	0.036	
18.5	21.3	160 L	2935	60	89.3	89.7	88.5	0.87	34.5	2.7	7.6	3.4	78	85	1LE1002-1DA4	78	0.044	
22	24.5	180 M	2945	71	89.9	90.6	90.4	0.87	40.5	2.5	7.7	3.5	72	85	1LE1002-1EA2	112	0.069	
30	33.5	200 L	2960	97	90.7	90.9	90.2	0.79	60	2.5	7.3	3.6	72	85	1LE1002-2AA4	149	0.124	
37	41.5	200 L	2955	120	91.2	91.6	91.2	0.88	67	2.7	8.2	3.5	72	85	1LE1002-2AA5	169	0.15	

Voltages		Version	Order code
50 Hz 230 VΔ/400 VY	60 Hz ¹⁾ 460 VY	Standard	2 2
50 Hz 400 VΔ/690 VY	60 Hz ¹⁾ 460 VΔ	Standard	3 4
50 Hz 500 VY		Without additional charge	2 7
50 Hz 500 VΔ		Without additional charge	4 0
For other voltages ¹⁾ and more information, see from page 3/97			9 0

Types of construction		Version	Order code
Without flange	IM B3 ²⁾	Standard	A
With flange	IM B5 ²⁾	With additional charge	F
With flange	IM B14 ²⁾	With additional charge	K
For other types of construction and more information, see from page 3/103			...

Motor protection		Version	Order code
Without		Standard	A
PTC thermistor with 1 or 3 temperature sensors (frame sizes 63 to 90 or 100 to 200)		With additional charge	B
For other motor protection and more information, see from page 3/116			...

Terminal box position		Version	Order code
Terminal box at top		Standard	4
For other terminal box positions and more information, see from page 3/119			...

Special versions		Order code(s)
Forced-air cooled motors w/o ext. fan/fan cover (IC418)		1LE1002-...-Z F90+...+...+...
For options, see from page 3/122		1LE1002-...-Z ...+...+...+...

3

¹⁾ Operating values at rated power for 60 Hz are stored in the Drive Technology Configurator (DT Configurator; see Appendix, "Tools and engineering").

²⁾ Types derived from IM B3 (IM B6/7/8, IM V6, and IM V5), from IM B5 (IM V3 and IM V1) and from IM B14 (IM V19 and IM V18) are possible, provided that no requirements exist for condensation drainage holes (H03) or stamping of the type on the rating plate. The basic type IM B3, IM B5, or IM B14 is stamped as standard on the rating plate. For orders with condensation drainage holes (H03), the type must be specified.



IE1

SIMOTICS GP and SIMOTICS SD standard motors
IE1 Standard Efficiency

Aluminum series SIMOTICS GP 1LE1002 – self-ventilated or forced-air cooled

Selection and ordering data

P _{rated} 50 Hz/ P50 kW	P _{rated} 60 Hz/ P60 ¹⁾ kW	Frame size FS	Operating values at rated power													Aluminum series 1LE1002		m _{IM B3} kg	J kgm ²
			n _{rated} 50 Hz rpm	T _{rated} 50 Hz Nm	η _{rated} 50 Hz %	η _{rated} 50 Hz %	η _{rated} 50 Hz %	η _{rated} 50 Hz %	cosφ _{rated} 50 Hz %	I _{rated} 50 Hz A	T _{LR} / I _{rated} 50 Hz	I _{LR} / I _{rated} 50 Hz	T _B / I _{rated} 50 Hz	L _{pfA} 50 Hz dB(A)	L _{WA} 50 Hz dB(A)	Article No.			
0.12	0.14	63 M	1360	0.84	50	47.3	39.1	0.71	0.49	1.6	2.5	1.8	48	55	1LE1002-0BB2	4	0.00029		
0.18	0.21	63 M	1360	1.26	57	55.1	47.8	0.71	0.64	1.9	2.8	2.1	55	62	1LE1002-0BB3	4	0.00037		
0.25	0.29	71 M	1365	1.75	61.5	61.4	56.1	0.73	0.8	1.8	3	2	49	60	1LE1002-0CB2	5	0.00052		
0.37	0.43	71 M	1350	2.6	66	67.7	65	0.75	1.08	2	3.2	2	54	65	1LE1002-0CB3	6	0.00077		
0.55	0.63	80 M	1385	3.8	70	70.7	67.7	0.79	1.44	2.1	3.7	2.2	56	63	1LE1002-0DB2	9	0.002842		
0.75	0.86	80 M	1385	5.2	72.1	72	67	0.76	1.98	2.1	3.6	2.3	59	66	1LE1002-0DB3	11	0.003767		
1.1	1.27	90 S	1405	7.5	75	75.9	73.6	0.81	2.6	2.1	4.5	2.3	60	67	1LE1002-0EB0	12	0.005004		
1.5	1.75	90 L	1410	10.2	77.2	77.8	75.1	0.8	3.5	2.4	4.7	2.6	61	68	1LE1002-0EB4	15	0.005957		
2.2	2.55	100 L	1425	14.7	79.7	80.3	78.1	0.81	4.9	2.3	5.1	2.7	60	72	1LE1002-1AB4	18	0.0059		
3	3.45	100 L	1425	20	81.5	82.6	81.5	0.85	6.3	2.4	5.4	2.6	60	72	1LE1002-1AB5	22	0.0078		
4	4.55	112 M	1435	26.5	83.1	84.3	84	0.83	8.4	2.5	6.1	2.9	57	70	1LE1002-1BB2	27	0.01		
5.5	6.3	132 S	1450	36	84.7	85.3	84.2	0.82	11.4	2.3	5.7	2.7	64	76	1LE1002-1CB0	38	0.019		
7.5	8.6	132 M	1450	49.5	86	86.5	85.4	0.82	15.4	2.6	6.6	3.1	64	76	1LE1002-1CB2	44	0.024		
11	12.6	160 M	1460	72	87.6	87.9	86.7	0.81	22.5	2.7	6.9	3.3	70	82	1LE1002-1DB2	62	0.044		
15	17.3	160 L	1460	98	88.7	89	87.8	0.82	30	3	7.5	3.6	70	82	1LE1002-1DB4	73	0.056		
18.5	21.3	180 M	1468	120	89.3	90.2	90.2	0.85	35	2.2	7.3	3.1	63	76	1LE1002-1EB2	131	0.13		
22	25.3	180 L	1465	143	89.9	90.8	90.7	0.83	42.5	2.7	8	3.6	63	76	1LE1002-1EB4	132	0.13		
30	34.5	200 L	1472	195	90.7	91.5	91.4	0.83	58	2.3	6.9	3.1	64	78	1LE1002-2AB5	169	0.2		
Voltages			Version												Order code				
50 Hz 230 VΔ/400 VY			Standard												2 2		-		
50 Hz 400 VΔ/690 VY			Standard												3 4		-		
50 Hz 500 VY			Without additional charge												2 7		-		
50 Hz 500 VΔ			Without additional charge												4 0		-		
For other voltages ¹⁾ and more information, see from page 3/97															9 0		...		
Types of construction			Version												Order code				
Without flange IM B3 ²⁾			Standard												A		-		
With flange IM B5 ²⁾			With additional charge												F		-		
With flange IM B14 ²⁾			With additional charge												K		-		
For other types of construction and more information, see from page 3/103																	...		
Motor protection			Version												Order code				
Without			Standard												A		-		
PTC thermistor with 1 or 3 temperature sensors (frame sizes 63 to 90 or 100 to 200)			With additional charge												B		-		
For other motor protection and more information, see from page 3/116																	...		
Terminal box position			Version												Order code(s)				
Terminal box at top			Standard												4				
For other terminal box positions and more information, see from page 3/119																			
Special versions															Order code(s)				
Forced-air cooled motors w/o ext. fan/fan cover (IC418)															1LE1002-...-Z		F90+...+...+...		
For options, see from page 3/122															1LE1002-...-Z		...+...+...+...		

3

¹⁾ Operating values at rated power for 60 Hz are stored in the Drive Technology Configurator (DT Configurator; see Appendix, "Tools and engineering").

²⁾ Types derived from IM B3 (IM B6/7/8, IM V6, and IM V5), from IM B5 (IM V3 and IM V1) and from IM B14 (IM V19 and IM V18) are possible, provided that no requirements exist for condensation drainage holes (H03) or stamping of the type on the rating plate. The basic type IM B3, IM B5, or IM B14 is stamped as standard on the rating plate. For orders with condensation drainage holes (H03), the type must be specified.



SIMOTICS GP and SIMOTICS SD standard motors

IE1 Standard Efficiency

Aluminum series SIMOTICS GP 1LE1002 – self-ventilated or forced-air cooled

Selection and ordering data

Operating values at rated power															Aluminum series			
P _{rated} 50 Hz/ P50	P _{rated} 60 Hz/ P60 ¹⁾	Frame size	n _{rated} 50 Hz	T _{rated} 50 Hz	η _{rated} 50 Hz, 4/4	η _{rated} 50 Hz, 3/4	η _{rated} 50 Hz, 2/4	cosφ _{rated} 50 Hz, 4/4	I _{rated} 50 Hz, 400 V	T _{L,R} / T _{rated} 50 Hz	I _{L,R} / I _{rated} 50 Hz	T _B / T _{rated} 50 Hz	L _{pTA} 50 Hz	L _{WA} 50 Hz	Article No.	m _{IM} B3	J	
kW	kW	FS	rpm	Nm	%	%	%	A	A				dB(A)	dB(A)		kg	kgm ²	
<ul style="list-style-type: none"> • Cooling: Self-ventilated (IC411) or with order code F90 forced-air cooled without external fan and fan cover (IC418) • Efficiency according to IEC 60034-30-1: IE1 Standard Efficiency, service factor (SF) 1.1 • Insulation: Thermal class 155 (temperature class F), IP55 degree of protection, utilization in accordance with thermal class 130 (temperature class B) 																		
6-pole: 1000 rpm at 50 Hz, 1200 rpm at 60 Hz ¹⁾																		
0.09	0.11	63 M	895	0.96	42.7	38.5	30.4	0.63	0.48	1.8	2	1.9	56	62	1LE1002-0BC2	4	0.00037	
0.18	0.21	71 M	875	1.96	45.5	44.4	38.3	0.67	0.85	1.9	2	2	47	58	1LE1002-0CC2	5	0.00055	
0.25	0.29	71 M	860	2.8	52.1	52.8	48.4	0.71	0.98	2	2.2	2	51	62	1LE1002-0CC3	6	0.0008	
0.37	0.43	80 M	915	3.85	59.7	58.6	52.7	0.7	1.28	1.6	2.7	1.8	56	64	1LE1002-0DC2	9	0.001976	
0.55	0.63	80 M	900	5.8	65.8	66.6	62.6	0.72	1.68	1.7	2.7	1.9	54	61	1LE1002-0DC3	12	0.002378	
0.75	0.86	90 S	940	7.6	70	70	66	0.67	2.3	2	3.8	2.2	59	70	1LE1002-0EC0	13	0.003329	
1.1	1.27	90 L	925	11.4	72.9	73.8	71.2	0.69	3.15	2.2	3.8	2.4	58	69	1LE1002-0EC4	15	0.004023	
1.5	1.75	100 L	940	15.2	75.2	75.6	72.3	0.74	3.9	2	4	2.2	59	71	1LE1002-1AC4	19	0.0065	
2.2	2.55	112 M	940	22.5	77.7	78.4	76.6	0.72	5.7	2.6	4.6	2.7	59	71	1LE1002-1BC2	25	0.0092	
3	3.45	132 S	955	30	79.7	79.9	77.1	0.74	7.3	2	4.6	2.6	63	75	1LE1002-1CC0	34	0.017	
4	4.55	132 M	955	40	81.4	82.5	81.9	0.76	9.3	2.3	5.2	2.6	65	78	1LE1002-1CC2	39	0.021	
5.5	6.3	132 M	955	55	83.1	84	82.8	0.75	12.7	2.7	5.7	3	70	77	1LE1002-1CC3	48	0.027	
7.5	8.6	160 M	970	74	84.7	84.8	83.2	0.73	17.5	2.1	5.5	2.9	67	79	1LE1002-1DC2	72	0.056	
11	12.6	160 L	965	109	86.4	86.8	85.9	0.77	24	1.9	5.9	2.7	67	79	1LE1002-1DC4	92	0.078	
15	18	180 L	975	147	87.7	88.5	87.9	0.77	32	2.3	6.1	3	56	69	1LE1002-1EC4	119	0.17	
18.5	22	200 L	978	181	88.6	89.8	89.8	0.79	38	2.5	6.3	2.6	59	72	1LE1002-2AC4	149	0.25	
22	26.5	200 L	980	215	89.2	90	89.6	0.79	45	2.8	6.8	2.9	59	72	1LE1002-2AC5	166	0.3	
8-pole: 750 rpm at 50 Hz, 900 rpm at 60 Hz ¹⁾																		
0.09	0.11	71 M	635	1.35	39	35.7	28.6	0.63	0.53	1.8	1.8	2	49	56	1LE1002-0CD2	6	0.00055	
0.12	0.14	71 M	625	1.83	31	30.5	27.1	0.68	0.82	1.7	2	1.7	49	56	1LE1002-0CD3	6	0.0008	
0.75	0.86	100 L	705	10.2	61.2	58.1	50.5	0.62	2.85	1.9	3	2.2	60	72	1LE1002-1AD4	17	0.0056	
1.1	1.27	100 L	690	15.2	66.5	65.9	61.5	0.61	3.9	2	3.2	2.3	64	72	1LE1002-1AD5	22	0.0078	
1.5	1.75	112 M	700	20.5	70.2	71.2	69.4	0.66	4.65	1.9	3.5	2.1	67	78	1LE1002-1BD2	29	0.0094	
2.2	2.55	132 S	715	29.5	74.2	74.1	71.4	0.66	6.5	1.7	3.9	2.4	63	75	1LE1002-1CD0	37	0.019	
3	3.45	132 M	715	40	77	77.4	75.2	0.68	8.3	1.8	3.9	2.2	63	75	1LE1002-1CD2	44	0.024	
4	4.55	160 M	720	53	79.2	79.2	76.3	0.67	10.9	1.6	4.1	2.3	63	75	1LE1002-1DD2	60	0.044	
5.5	6.3	160 M	720	73	81.4	81.9	80.3	0.68	14.3	1.6	4	2.2	63	75	1LE1002-1DD3	72	0.056	
7.5	8.6	160 L	715	100	83.1	83.7	82.4	0.69	18.9	1.7	3.8	2.2	63	75	1LE1002-1DD4	91	0.077	
11	13.2	180 L	720	146	85	86.2	86	0.7	26.5	1.9	5	2.5	65	78	1LE1002-1ED4	122	0.2	
15	18	200 L	718	199	86.2	87.9	88.4	0.75	33.5	2.5	5.5	2.9	55	69	1LE1002-2AD5	170	0.3	
Voltagess															Version		Order code	
50 Hz 230 VΔ/400 VY			60 Hz ¹⁾ 460 VY			Standard									2	2	-	
50 Hz 400 VΔ/690 VY			60 Hz ¹⁾ 460 VΔ			Standard									3	4	-	
50 Hz 500 VY						Without additional charge									2	7	-	
50 Hz 500 VΔ						Without additional charge									4	0	-	
For other voltages ¹⁾ and more information, see from page 3/97															9	0	...	
Types of construction															Version		Order code	
Without flange			IM B3 ²⁾			Standard									A		-	
With flange			IM B5 ²⁾			With additional charge									F		-	
With flange			IM B14 ²⁾			With additional charge									K		-	
For other types of construction and more information, see from page 3/103																	...	
Motor protection															Version		Order code	
Without						Standard									A		-	
PTC thermistor with 1 or 3 temperature sensors (frame sizes 63 to 90 or 100 to 200)						With additional charge									B		-	
For other motor protection and more information, see from page 3/116																	...	
Terminal box position															Version		Order code(s)	
Terminal box at top						Standard									4			
For other terminal box positions and more information, see from page 3/119																		
Special versions																		
Forced-air cooled motors w/o ext. fan/fan cover (IC418)															1LE1002-....		-Z F90+...+...+...	
For options, see from page 3/122															1LE1002-....		-Z ...+...+...+...	

¹⁾ Operating values at rated power for 60 Hz are stored in the Drive Technology Configurator (DT Configurator; see Appendix, "Tools and engineering").

²⁾ Types derived from IM B3 (IM B6/7/8, IM V6, and IM V5), from IM B5 (IM V3 and IM V1) and from IM B14 (IM V19 and IM V18) are possible, provided that no requirements exist for condensation drainage holes (**H03**) or stamping of the type on the rating plate. The basic type IM B3, IM B5, or IM B14 is stamped as standard on the rating plate. For orders with condensation drainage holes (**H03**), the type must be specified.



IE1

SIMOTICS GP and SIMOTICS SD standard motors
IE1 Standard Efficiency

Aluminum series SIMOTICS GP 1LE1002 with increased power – self-ventilated

Selection and ordering data

P _{rated} 50 Hz/ P50 kW	P _{rated} 60 Hz/ P60 ¹⁾ kW	Frame size FS	Operating values at rated power													Aluminum series 1LE1002 Article No.	m _{IM B3} kg	J kgm ²		
			n _{rated} 50 Hz rpm	T _{rated} 50 Hz Nm	η _{rated} 50 Hz %	η _{rated} 50 Hz %	η _{rated} 50 Hz %	cosφ _{rated} 50 Hz %	I _{rated} 50 Hz A	T _{LR} / I _{rated} 50 Hz	I _{LR} / I _{rated} 50 Hz	T _B / I _{rated} 50 Hz	L _{ptA} 50 Hz dB(A)	L _{WA} 50 Hz dB(A)						
• Cooling: Self-ventilated (IC411) or with order code F90 forced-air cooled without external fan and fan cover (IC418) • Efficiency according to IEC 60034-30-1: IE1 Standard Efficiency, (SF) 1.1 • Insulation: Thermal class 155 (temperature class F), IP55 degree of protection, utilization in accordance with thermal class 130 (temperature class B)																				
2-pole: 3000 rpm at 50 Hz, 3600 rpm at 60 Hz ¹⁾																				
0.37	0.43	63 M	2795	1.26	63.9	60.3	51.9	0.71	1.18	2.4	3.5	2.6	58	65	1LE1002-0BA6	5	0.0022			
0.75	0.86	71 M	2780	2.6	72.1	72.5	70.2	0.83	1.81	2.2	4.5	2.2	65	72	1LE1002-0CA6	5	0.00051			
4	4.55	100 L	2850	13.4	83.1	83.9	83	0.85	8.2	4.5	7	4.1	67	79	1LE1002-1AA6	25	0.0044			
5.5	6.3	112 L	2935	17.9	84.7	84.7	82.7	0.86	10.9	2.9	7.5	3.8	69	81	1LE1002-1BA6	31	0.0085			
11	12.6	132 M	2920	36	87.6	88.3	87.8	0.9	20	2.8	7.5	3.7	68	80	1LE1002-1CA6	53	0.022			
22	24.5	160 L	2935	72	89.9	90.2	89.5	0.9	39	2.6	7.5	3.4	70	82	1LE1002-1DA6	85	0.049			
4-pole: 1500 rpm at 50 Hz, 1800 rpm at 60 Hz ¹⁾																				
0.25	0.29	63 M	1365	1.75	61.5	59.6	53.5	0.68	0.86	2.3	2.9	2.3	52	59	1LE1002-0BB6	5	0.00045			
0.55	0.63	71 M	1365	3.85	70	70.5	67.4	0.7	1.62	2.5	3.6	2.5	59	66	1LE1002-0CB6	7	0.00095			
4	4.55	100 L	1435	26.5	83.1	83.8	82.3	0.81	8.6	2.9	5.8	3.1	60	72	1LE1002-1AB6	27	0.01			
5.5	6.3	112 M	1420	37	84.7	85.9	85.3	0.81	11.6	3	5.8	3.1	58	70	1LE1002-1BB6	33	0.012			
11	12.6	132 M	1450	72	87.6	88.2	87.6	0.84	21.5	2.5	7.2	3	64	76	1LE1002-1CB6	58	0.033			
18.5	21.3	160M	1460	121	89.3	89.8	89.2	0.85	35	2.7	7.2	3.2	65	77	1LE1002-1DB6	85	0.068			
6-pole: 1000 rpm at 50 Hz, 1200 rpm at 60 Hz ¹⁾																				
2.2	2.55	100 L	930	22.5	77.7	79.5	78.1	0.78	5.2	2	4	2.2	59	71	1LE1002-1AC6	24	0.0084			
3	3.45	112 M	945	30.5	79.7	79.5	76.3	0.72	7.5	2.9	4.6	3	57	69	1LE1002-1BC6	32	0.013			
7.5	8.6	132 M	950	75	84.7	85.3	84.1	0.74	17.3	2.4	5.3	3	63	75	1LE1002-1CC6	54	0.032			
15	17.3	160 M	965	148	87.7	87.9	86.5	0.75	33	2.9	6	3.4	67	79	1LE1002-1DC6	109	0.094			
Voltages																				
50 Hz 230 VΔ/400 VY			60 Hz ¹⁾ 460 VY			Standard			2 2			-			Order code					
50 Hz 400 VΔ/690 VY			60 Hz ¹⁾ 460 VΔ			Standard			3 4			-			Order code					
50 Hz 500 VY						Without additional charge			2 7			-			Order code					
50 Hz 500 VΔ						Without additional charge			4 0			-			Order code					
For other voltages ¹⁾ and more information, see from page 3/97																				
Types of construction																				
Without flange			IM B3 ²⁾			Standard			A			-			Order code					
With flange			IM B5 ²⁾			With additional charge			F			-			Order code					
With flange			IM B14 ²⁾			With additional charge			K			-			Order code					
For other types of construction and more information, see from page 3/103																				
Motor protection																				
Without						Standard			A			-			Order code					
PTC thermistor with 1 or 3 temperature sensors (frame sizes 63 to 90 or 100 to 200)						With additional charge			B			-			Order code					
For other motor protection and more information, see from page 3/116																				
Terminal box position																				
Terminal box at top						Standard			4			-			Order code(s)					
For other terminal box positions and more information, see from page 3/119																				
Special versions																				
For options, see from page 3/122																				
1LE1002- -															Z			. . . + . . . + . . . + . . .		

3

¹⁾ Operating values at rated power for 60 Hz are stored in the Drive Technology Configurator (DT Configurator; see Appendix, "Tools and engineering").

²⁾ Types derived from IM B3 (IM B6/7/8, IM V6, and IM V5), from IM B5 (IM V3 and IM V1) and from IM B14 (IM V19 and IM V18) are possible, provided that no requirements exist for condensation drainage holes (H03) or stamping of the type on the rating plate. The basic type IM B3, IM B5, or IM B14 is stamped as standard on the rating plate. For orders with condensation drainage holes (H03), the type must be specified.



SIMOTICS GP and SIMOTICS SD standard motors

IE1 Standard Efficiency

Cast-iron series SIMOTICS SD 1LE1502 Basic Line – self-ventilated or forced-air cooled

Selection and ordering data

Operating values at rated power															Cast-iron series			
P_{rated} 50 Hz/ P50	P_{rated} 60 Hz/ P60	Frame size	n_{rated} 50 Hz	T_{rated} 50 Hz	η_{rated} 50 Hz, 4/4	η_{rated} 50 Hz, 3/4	η_{rated} 50 Hz, 2/4	$\cos\phi_{rated}$ 50 Hz, 4/4	I_{rated} 50 Hz, 400 V	$T_{LR}/$ T_{rated} , 50 Hz	$I_{LR}/$ I_{rated} , 50 Hz	$T_B/$ T_{rated} , 50 Hz	L_{pFA} , 50 Hz	L_{WA} , 50 Hz	Article No.	$m_{IM B3}$	J	
kW	kW	FS	rpm	Nm	%	%	%	A							kg	kgm ²		
<ul style="list-style-type: none"> • Cooling: Self-ventilated (IC411) or with order code F90 forced-air cooled without external fan and fan cover (IC418) • Efficiency according to IEC 60034-30-1: IE1 Standard Efficiency, service factor (SF) 1.1 • Insulation: Thermal class 155 (temperature class F), IP55 degree of protection, utilization in accordance with thermal class 130 (temperature class B) 																		
2-pole: 3000 rpm at 50 Hz, 3600 rpm at 60 Hz ¹⁾																		
3	3.45	100 L	2835	10.1	81.5	83.2	82.7	0.87	6.1	3.2	6.4	3.5	66	80	1LE1502-1AA4	31	0.0034	
4	4.55	112 M	2935	13	83.1	82.9	80.5	0.85	8.2	3.3	8.3	4.2	70	83	1LE1502-1BA2	36	0.0067	
5.5	6.3	132 S	2910	18	84.7	85.8	85.3	0.88	10.7	1.8	5.7	2.6	68	82	1LE1502-1CA0	53	0.013	
7.5	8.6	132 S	2925	24.5	86	86.6	86.1	0.88	14.3	2.2	6.8	3.1	68	82	1LE1502-1CA1	58	0.016	
11	12.6	160 M	2925	36	87.6	88.2	87	0.86	21	2	5.7	2.7	79	86	1LE1502-1DA2	87	0.03	
15	18	160 M	2935	49	88.7	88.9	87.2	0.85	28.5	2.4	6.8	3.2	78	85	1LE1502-1DA3	95	0.036	
18.5	22	160 L	2935	60	89.3	89.7	88.5	0.87	34.5	2.7	7.6	3.4	78	85	1LE1502-1DA4	105	0.044	
22	24.5	180 M	2945	71	89.9	90.6	90.4	0.87	40.5	2.5	7.7	3.5	72	85	1LE1502-1EA2	145	0.069	
30	33.5	200 L	2960	97	90.7	90.9	90.2	0.79	60	2.5	7.3	3.6	72	85	1LE1502-2AA4	191	0.124	
37	41.5	200 L	2955	120	91.2	91.6	91.2	0.88	67	2.7	8.2	3.5	72	85	1LE1502-2AA5	223	0.15	
45	51	225 M	2960	145	91.7	92	91.6	0.88	80	2.3	6.7	3	73	86	1LE1502-2BA2	280	0.22	
55	62	250 M	2970	177	92.1	92.1	91.2	0.88	98	2.1	6.7	3	76	90	1LE1502-2CA2	360	0.4	
75	84	280 S	2975	240	92.7	92.5	91.3	0.86	136	2.2	6.8	3	78	92	1LE1502-2DA0	470	0.72	
90	101	280 M	2975	290	93	93.1	92.4	0.88	159	2.5	7.1	3.1	76	89	1LE1502-2DA2	530	0.83	
110	123	315 S	2982	350	93.3	92.9	91.5	0.86	198	2.3	7.5	3.3	80	94	1LE1502-3AA0	680	1.2	
132	148	315 M	2982	425	93.5	93.2	92.5	0.89	230	2.3	7.6	3	80	94	1LE1502-3AA2	740	1.4	
160	180	315 L	2982	510	93.8	93.6	93.1	0.91	270	2.3	7.4	2.9	80	94	1LE1502-3AA4	880	1.6	
200	224	315 L	2982	640	94	93.9	93.5	0.92	335	2.2	7.1	2.8	80	94	1LE1502-3AA5	1000	2.1	
Voltages ²⁾															Version		Order code	
50 Hz 230 VΔ/400 VY				60 Hz ¹⁾ 460 VY				Standard				2	2	-				
50 Hz 400 VΔ/690 VY				60 Hz ¹⁾ 460 VA				Standard				3	4	-				
50 Hz 500 VY								Without additional charge				2	7	-				
50 Hz 500 VA								Without additional charge				4	0	-				
For other voltages ¹⁾ and more information, see from page 3/100																		
Types of construction															Version		Order code	
Without flange				IM B3 ³⁾				Standard				A		-				
With flange				IM B5 ³⁾				With additional charge				F		-				
With flange				IM B14 ³⁾				With additional charge				K		-				
For other types of construction and more information, see from page 3/107																		
Motor protection															Version		Order code	
Without								Standard				A		-				
PTC thermistor with 3 temperature sensors								With additional charge				B		-				
For other motor protection and more information, see from page 3/117																		
Terminal box position															Version		Order code	
Terminal box at top								Standard				4		-				
For other terminal box positions and more information, see from page 3/120																		
Special versions																	Order code(s)	
Forced-air cooled motors w/o ext. fan/fan cover (IC418)															1LE1502-		-Z F90 + . . . + . . .	
For options, see from page 3/129															1LE1502-		-Z . . . + . . . + . . .	

3

¹⁾ Operating values at rated power for 60 Hz are stored in the Drive Technology Configurator (DT Configurator; see Appendix, "Tools and engineering").

²⁾ Parallel supply lines are required in the case of connection to ≤ 240 V. For frame size 315 with connection to ≤ 240 V, due to the high current, a drilled, removable entry plate (order code **R52**) or a larger terminal box (order code **R50**) can be used. Order codes **R52** and **R50** alter the motor dimensions.

³⁾ Types derived from IM B3 (IM B6/7/8, IM V6 and IM V5), from IM B5 (IM V3 and IM V1) and from IM B14 (IM V19 and IM V18) are possible, provided that no requirement exists for stamping of the type on the rating plate. The basic type IM B3, IM B5, or IM B14 is stamped as standard on the rating plate. If mounted in a different position, the position must be specified to ensure that the condensation drainage holes are positioned correctly.



IE1

SIMOTICS GP and SIMOTICS SD standard motors
IE1 Standard Efficiency

Cast-iron series SIMOTICS SD 1LE1502 Basic Line – self-ventilated or forced-air cooled

Selection and ordering data

P _{rated} 50 Hz/ P50 kW	P _{rated} 60 Hz/ P60 ¹⁾ kW	Frame size FS	Operating values at rated power													Cast-iron series	
			n _{rated} 50 Hz rpm	T _{rated} 50 Hz Nm	η _{rated} 50 Hz %	η _{rated} 50 Hz %	η _{rated} 50 Hz %	cosφ _{rated} 50 Hz %	I _{rated} 50 Hz A	T _{L/R} 50 Hz °C	I _{L/R} 50 Hz A	T _B 50 Hz °C	L _{pfA} 50 Hz dB(A)	L _{WA} 50 Hz dB(A)	Article No.	m _{IM B3} kg	J kgm ²
2.2	2.55	100 L	1425	14.7	79.7	80.3	78.1	0.81	4.9	2.3	5.1	2.7	60	72	1LE1502-1AB4	29	0.0059
3	3.45	100 L	1425	20	81.5	82.6	81.5	0.85	6.3	2.4	5.4	2.6	60	72	1LE1502-1AB5	33	0.0078
4	4.55	112 M	1435	26.5	83.1	84.3	84	0.83	8.4	2.5	6.1	2.9	57	70	1LE1502-1BB2	38	0.01
5.5	56.3	132 S	1450	36	84.7	85.3	84.2	0.82	11.4	2.3	5.7	2.7	64	76	1LE1502-1CB0	-	0.019
7.5	8.6	132 M	1450	49.5	86	86.5	85.4	0.82	15.4	2.6	6.6	3.1	64	76	1LE1502-1CB2	62	0.024
11	12.6	160 M	1460	72	87.6	87.9	86.7	0.81	22.5	2.7	6.9	3.3	70	82	1LE1502-1DB2	89	0.044
15	17.3	160 L	1460	98	88.7	89	87.8	0.82	30	3	7.5	3.6	70	82	1LE1502-1DB4	100	0.056
18.5	21.3	180 M	1468	120	89.3	90.2	90.2	0.85	35	2.2	7.3	3.1	63	76	1LE1502-1EB2	168	0.13
22	25.3	180 L	1465	143	89.9	90.8	90.7	0.83	42.5	2.7	8	3.6	63	76	1LE1502-1EB4	168	0.13
30	34.5	200 L	1472	195	90.7	91.5	91.4	0.83	58	2.3	6.9	3.1	64	78	1LE1502-2AB5	220	0.2
37	42.5	225 S	1475	240	91.2	91.6	91.1	0.85	69	2.3	7	3.2	69	83	1LE1502-2BB0	260	0.37
45	52	225 M	1475	290	91.7	92.1	91.7	0.86	82	2.6	7.2	3.2	69	82	1LE1502-2BB2	290	0.45
55	63	250 M	1475	355	92.1	92.5	92.1	0.85	101	2.4	6.1	2.6	69	83	1LE1502-2CB2	360	0.69
75	86	280 S	1485	480	92.7	92.9	92.2	0.85	137	2.3	7	2.8	75	89	1LE1502-2DB0	540	1.2
90	104	280 M	1482	580	93	93.4	93.1	0.87	161	2.2	6.5	2.8	73	87	1LE1502-2DB2	560	1.4
110	127	315 S	1488	710	93.3	93.4	92.8	0.84	205	2.3	6.5	2.7	76	90	1LE1502-3AB0	730	1.9
132	152	315 M	1488	850	93.5	93.7	93.3	0.85	240	2.5	6.8	2.7	76	91	1LE1502-3AB2	760	2.2
160	184	315 L	1486	1030	93.8	93.9	93.5	0.86	285	2.7	7.2	2.7	76	90	1LE1502-3AB4	940	2.9
200	230	315 L	1486	1290	94	94.2	94	0.87	355	2.5	6.9	2.7	76	91	1LE1502-3AB5	1140	3.5
Voltages ²⁾			Version											Order code			
50 Hz 230 VΔ/400 VY			60 Hz ¹⁾ 460 VY											Standard			
50 Hz 400 VΔ/690 VY			60 Hz ¹⁾ 460 VΔ											Standard			
50 Hz 500 VY														Without additional charge			
50 Hz 500 VΔ														Without additional charge			
For other voltages ¹⁾ and more information, see from page 3/100														...			
Types of construction			Version											Order code			
Without flange			IM B3 ³⁾											Standard			
With flange			IM B5 ³⁾											With additional charge			
With flange			IM B14 ³⁾											With additional charge			
For other types of construction and more information, see from page 3/107														...			
Motor protection			Version											Order code			
Without														Standard			
PTC thermistor with 3 temperature sensors														With additional charge			
For other motor protection and more information, see from page 3/117														...			
Terminal box position			Version											Order code			
Terminal box at top														Standard			
For other terminal box positions and more information, see from page 3/120														4			
Special versions														Order code(s)			
Forced-air cooled motors w/o ext. fan/fan cover (IC418)														1LE1502-...-Z F90 +...+...+...			
For options, see from page 3/129														1LE1502-...-Z ...+...+...+...			

3

¹⁾ Operating values at rated power for 60 Hz are stored in the Drive Technology Configurator (DT Configurator; see Appendix, "Tools and engineering").
²⁾ Parallel supply lines are required in the case of connection to ≤ 240 V. For frame size 315 with connection to ≤ 240 V, due to the high current, a drilled, removable entry plate (order code **R52**) or a larger terminal box (order code **R50**) can be used. Order codes **R52** and **R50** alter the motor dimensions.

³⁾ Types derived from IM B3 (IM B6/7/8, IM V6 and IM V5), from IM B5 (IM V3 and IM V1) and from IM B14 (IM V19 and IM V18) are possible, provided that no requirement exists for stamping of the type on the rating plate. The basic type IM B3, IM B5, or IM B14 is stamped as standard on the rating plate. If mounted in a different position, the position must be specified to ensure that the condensation drainage holes are positioned correctly.



SIMOTICS GP and SIMOTICS SD standard motors

IE1 Standard Efficiency

Cast-iron series SIMOTICS SD 1LE1502 Basic Line – self-ventilated or forced-air cooled

Selection and ordering data

Operating values at rated power														Cast-iron series			
P_{rated} 50 Hz/ P50	P_{rated} 60 Hz/ P60 ¹⁾	Frame size	n_{rated} 50 Hz	T_{rated} 50 Hz	η_{rated} 50 Hz	η_{rated} 50 Hz	η_{rated} 50 Hz	$\cos\phi_{rated}$ 50 Hz	I_{rated} 400 V	T_{LR}/T_{rated} 50 Hz	I_{LR}/I_{rated} 50 Hz	T_B/T_{rated} 50 Hz	L_{pFA} 50 Hz	L_{WA} 50 Hz	1LE1502 – Basic Line	$m_{IM B3}$	J
kW	kW	FS	rpm	Nm	%	%	%		A				dB(A)	dB(A)	Article No.	kg	kgm ²
• Cooling: Self-ventilated (IC411) or with order code F90 forced-air cooled without external fan and fan cover (IC418) • Efficiency according to IEC 60034-30-1: IE1 Standard Efficiency, service factor (SF) 1.1 • Insulation: Thermal class 155 (temperature class F), IP55 degree of protection, utilization in accordance with thermal class 130 (temperature class B)																	
6-pole: 1000 rpm at 50 Hz, 1200 rpm at 60 Hz ¹⁾																	
1.5	1.75	100 L	940	15.2	75.2	75.6	72.3	0.74	3.9	2	4	2.2	59	71	1LE1502-1AC4	30	0.0065
2.2	2.55	112 M	940	22.5	77.7	78.4	76.6	0.72	5.7	2.6	4.6	2.7	59	71	1LE1502-1BC2	37	0.0092
3	3.45	132 S	955	30	79.7	79.9	77.1	0.74	7.3	2	4.6	2.6	63	75	1LE1502-1CC0	52	0.017
4	4.55	132 M	955	40	81.4	82.5	81.9	0.76	9.3	2.3	5.2	2.6	65	78	1LE1502-1CC2	57	0.021
5.5	6.3	132 M	955	55	83.1	84	82.8	0.75	12.7	2.7	5.7	3	70	77	1LE1502-1CC3	66	0.027
7.5	8.6	160 M	970	74	84.7	84.8	83.2	0.73	17.5	2.1	5.5	2.9	67	79	1LE1502-1DC2	100	0.056
11	12.6	160 L	965	109	86.4	86.8	85.9	0.77	24	1.9	5.9	2.7	67	79	1LE1502-1DC4	120	0.078
15	18	180 L	975	147	87.7	88.5	87.9	0.77	32	2.3	6.1	3	56	69	1LE1502-1EC4	153	0.17
18.5	22	200 L	978	181	88.6	89.8	89.8	0.79	38	2.5	6.3	2.6	59	72	1LE1502-2AC4	196	0.25
22	26.5	200 L	980	215	89.2	90	89.6	0.79	45	2.8	6.8	2.9	59	72	1LE1502-2AC5	218	0.3
30	36	225 M	978	295	90.2	91	90.7	0.82	59	2.7	6	2.5	65	77	1LE1502-2BC2	270	0.49
37	44.5	250 M	980	360	90.8	91.5	91.3	0.82	72	2.7	6	2.4	63	77	1LE1502-2CC2	330	0.76
45	54	280 S	986	435	91.4	92	91.6	0.84	85	2.6	7	2.6	63	77	1LE1502-2DC0	465	1.1
55	66	280 M	986	530	91.9	92.5	92.6	0.85	102	2.6	6.7	2.6	63	77	1LE1502-2DC2	500	1.3
75	90	315 S	988	720	92.6	92.8	92.1	0.83	141	2.5	7.1	2.7	62	77	1LE1502-3AC0	660	2.1
90	108	315 M	988	870	92.9	93.2	92.8	0.83	168	2.6	7.3	2.6	61	77	1LE1502-3AC2	740	2.5
110	132	315 L	988	1060	93.3	93.6	93.4	0.86	198	2.6	6.8	2.8	61	78	1LE1502-3AC4	880	3.2
132	158	315 L	988	1280	93.5	93.7	93.4	0.86	235	3	7.5	2.9	61	78	1LE1502-3AC5	1030	4
160	192	315 L	988	1550	93.8	93.9	93.6	0.86	285	3.1	7.7	3	64	79	1LE1502-3AC6	1160	4.7
Voltages²⁾														Version		Order code	
50 Hz 230 VΔ/400 VY				60 Hz ¹⁾ 460 VY				Standard				2	2	-			
50 Hz 400 VΔ/690 VY				60 Hz ¹⁾ 460 VΔ				Standard				3	4	-			
50 Hz 500 VY								Without additional charge				2	7	-			
50 Hz 500 VΔ								Without additional charge				4	0	-			
For other voltages ¹⁾ and more information, see from page 3/100														9	0	...	
Types of construction														Version		Order code	
Without flange				IM B3 ³⁾				Standard				A	-				
With flange				IM B5 ³⁾				With additional charge				F	-				
With flange				IM B14 ³⁾				With additional charge				K	-				
For other types of construction and more information, see from page 3/107																	
Motor protection														Version		Order code	
Without								Standard				A	-				
PTC thermistor with 3 temperature sensors								With additional charge				B	-				
For other motor protection and more information, see from page 3/117																	
Terminal box position														Version		Order code	
Terminal box at top								Standard				4					
For other terminal box positions and more information, see from page 3/120																	
Special versions																Order code(s)	
Forced-air cooled motors w/o ext. fan/fan cover (IC418)														1LE1502- -Z		F90 + . . . + . . . + . . .	
For options, see from page 3/129														1LE1502- -Z		. . . + . . . + . . . + . . .	

3

¹⁾ Operating values at rated power for 60 Hz are stored in the Drive Technology Configurator (DT Configurator; see Appendix, "Tools and engineering").
²⁾ Parallel supply lines are required in the case of connection to ≤ 240 V. For frame size 315 with connection to ≤ 240 V, due to the high current, a drilled, removable entry plate (order code **R52**) or a larger terminal box (order code **R50**) can be used. Order codes **R52** and **R50** alter the motor dimensions.

³⁾ Types derived from IM B3 (IM B6/7/8, IM V6 and IM V5), from IM B5 (IM V3 and IM V1) and from IM B14 (IM V19 and IM V18) are possible, provided that no requirement exists for stamping of the type on the rating plate. The basic type IM B3, IM B5, or IM B14 is stamped as standard on the rating plate. If mounted in a different position, the position must be specified to ensure that the condensation drainage holes are positioned correctly.

SIMOTICS GP and SIMOTICS SD standard motors

IE1 Standard Efficiency

Cast-iron series SIMOTICS SD 1LE1502 Basic Line – self-ventilated or forced-air cooled

Selection and ordering data

P _{rated} 50 Hz/ P50 kW	P _{rated} 60 Hz/ P60 kW	Frame size FS	Operating values at rated power												Cast-iron series 1LE1502 – Basic Line Article No.	m _{IM B3} kg	J kgm ²
			n _{rated} 50 Hz rpm	T _{rated} 50 Hz Nm	η _{rated} 50 Hz %	η _{rated} 50 Hz %	η _{rated} 50 Hz %	cosφ _{rated} 50 Hz %	I _{rated} 50 Hz A	T _{LR} / I _{LR} 50 Hz %	T _{LR} / I _{LR} 50 Hz %	T _β / I _β 50 Hz %	L _{pfA} 50 Hz dB(A)	L _{WA} 50 Hz dB(A)			
0.75	0.86	100 L	705	10.2	61.2	58.1	50.5	0.62	2.85	1.9	3	2.2	60	72	1LE1502-1AD4	28	0.0056
1.1	1.27	100 L	690	15.2	66.5	65.9	61.5	0.61	3.9	2	3.2	2.3	64	72	1LE1502-1AD5	33	0.0078
1.5	1.75	112 M	700	20.5	70.2	71.2	69.4	0.66	4.65	1.9	3.5	2.1	67	78	1LE1502-1BD2	42	0.0094
2.2	2.55	132 S	715	29.5	74.2	74.1	71.4	0.66	6.5	1.7	3.9	2.4	63	75	1LE1502-1CD0	60	0.019
3	3.45	132 M	715	40	77	77.4	75.2	0.68	8.3	1.8	3.9	2.2	63	75	1LE1502-1CD2	62	0.024
4	4.55	160 M	720	53	79.2	79.2	76.3	0.67	10.9	1.6	4.1	2.3	63	75	1LE1502-1DD2	89	0.044
5.5	6.3	160 M	720	73	81.4	81.9	80.3	0.68	14.3	1.6	4	2.2	63	75	1LE1502-1DD3	102	0.056
7.5	8.6	160 L	715	100	83.1	83.7	82.4	0.69	18.9	1.7	3.8	2.2	63	75	1LE1502-1DD4	120	0.077
11	13.2	180 L	720	146	85	86.2	86	0.7	26.5	1.9	5	2.5	65	78	1LE1502-1ED4	153	0.2
15	18	200 L	718	199	86.2	87.9	88.4	0.75	33.5	2.5	5.5	2.9	55	69	1LE1502-2AD5	218	0.3
18.5	22	225 S	730	240	86.9	87.9	87.6	0.78	39.5	2.2	5.5	2.7	59	72	1LE1502-2BD0	265	0.43
22	26.5	225 M	730	290	87.4	88.3	88.1	0.79	46	2.3	5.5	2.7	60	73	1LE1502-2BD2	280	0.5
30	36	250 M	732	390	88.3	89.2	89.2	0.81	61	2.3	5.5	2.6	54	68	1LE1502-2CD2	370	0.84
37	44.5	280 S	735	480	88.8	89.7	89.7	0.81	74	2.1	5	2.1	54	68	1LE1502-2DD0	460	1.22
45	54	280 M	735	580	89.2	90.4	90.8	0.81	90	2.1	5.3	2.1	62	77	1LE1502-2DD2	500	1.42
55	66	315 S	740	710	89.7	90.1	89.7	0.8	111	2.1	5.7	2.6	69	83	1LE1502-3AD0	640	2
75	90	315 M	738	970	90.3	90.7	90.5	0.81	148	2.3	5.9	2.7	69	84	1LE1502-3AD2	720	2.5
90	108	315 L	738	1160	90.7	91.2	91.2	0.84	171	2.2	5.9	2.6	68	83	1LE1502-3AD4	840	3.1
110	132	315 L	740	1420	91.1	91.6	91.5	0.82	215	2.7	6.7	2.9	73	87	1LE1502-3AD5	1000	3.9
132	158	315 L	740	1700	91.5	91.9	91.6	0.81	255	2.9	7.2	3.3	75	89	1LE1502-3AD6	1080	4.5
Voltages ²⁾			Version										Order code				
50 Hz 230 VΔ/400 VY			Standard										2 2				
50 Hz 400 VΔ/690 VY			Standard										3 4				
50 Hz 500 VY			Without additional charge										2 7				
50 Hz 500 VΔ			Without additional charge										4 0				
For other voltages ¹⁾ and more information, see from page 3/100													9 0				
Types of construction			Version										Order code				
Without flange			IM B3 ³⁾										Standard				
With flange			IM B5 ³⁾										A				
With flange			IM B14 ³⁾										F				
For other types of construction and more information, see from page 3/107													K				
Motor protection			Version										Order code				
Without			Standard										A				
PTC thermistor with 3 temperature sensors			With additional charge										B				
For other motor protection and more information, see from page 3/117																	
Terminal box position			Version										Order code(s)				
Terminal box at top			Standard										4				
For other terminal box positions and more information, see from page 3/120																	
Special versions													Order code(s)				
Forced-air cooled motors w/o ext. fan/fan cover (IC418)													1LE1502-...-Z F90+...+...				
For options, see from page 3/129													1LE1502-...-Z ...+...+...				

¹⁾ Operating values at rated power for 60 Hz are stored in the Drive Technology Configurator (DT Configurator; see Appendix, "Tools and engineering").

²⁾ Parallel supply lines are required in the case of connection to ≤ 240 V. For frame size 315 with connection to ≤ 240 V, due to the high current, a drilled, removable entry plate (order code **R52**) or a larger terminal box (order code **R50**) can be used. Order codes **R52** and **R50** alter the motor dimensions.

³⁾ Types derived from IM B3 (IM B6/7/8, IM V6 and IM V5), from IM B5 (IM V3 and IM V1) and from IM B14 (IM V19 and IM V18) are possible, provided that no requirement exists for stamping of the type on the rating plate. The basic type IM B3, IM B5, or IM B14 is stamped as standard on the rating plate. If mounted in a different position, the position must be specified to ensure that the condensation drainage holes are positioned correctly.

⁴⁾ The noise limit values specified as permissible in IEC 60034-9 under load can be exceeded.





SIMOTICS GP and SIMOTICS SD standard motors

IE1 Standard Efficiency

Cast-iron series SIMOTICS SD 1LE1502 Basic Line with increased power – self-ventilated or forced-air cooled

Selection and ordering data

P _{rated} 50 Hz/ P50 kW	P _{rated} 60 Hz/ P60 ¹⁾ kW	Frame size FS	Operating values at rated power												Cast-iron series		m _{IM} B3 kg	J kgm ²
			n _{rated} 50 Hz rpm	T _{rated} 50 Hz Nm	η _{rated} 50 Hz %	η _{rated} 50 Hz %	η _{rated} 50 Hz %	cosφ _{rated} 50 Hz %	I _{rated} 50 Hz A	T _{LR} / T _{rated} 50 Hz	I _{LR} / I _{rated} 50 Hz	T _B / T _{rated} 50 Hz	L _{pfA} 50 Hz dB(A)	L _{WA} 50 Hz dB(A)	Article No.			
• Cooling: Self-ventilated (IC411) or with order code F90 forced-air cooled without external fan and fan cover (IC418) • Efficiency according to IEC 60034-30-1: IE1 Standard Efficiency, service factor (SF) 1.1 • Insulation: Thermal class 155 (temperature class F), IP55 degree of protection, utilization in accordance with thermal class 155 (temperature class F)																		
2-pole: 3000 rpm at 50 Hz, 3600 rpm at 60 Hz ¹⁾																		
4	4.6	100 L	2850	13.4	83.1	83.9	83	0.85	8.2	4.5	7	4.1	67	79	1LE1502-1AA6	33	0.0044	
5.5	6.3	112 M	2935	17.9	84.7	84.7	82.7	0.86	10.9	2.9	7.5	3.8	69	81	1LE1502-1BA6	40	0.0085	
11	12.6	132 M	2920	36	87.6	88.3	87.8	0.9	20	2.8	7.5	3.7	68	80	1LE1502-1CA6	76	0.022	
22	24.5	160 L	2935	72	89.9	90.2	89.5	0.9	39	2.6	7.5	3.4	70	82	1LE1502-1DA6	125	0.049	
30	33.5	180 L	2940	97	90.7	91.5	91.5	0.89	54	2.4	8.1	3.5	72	85	1LE1502-1EA6	175	0.094	
45	51	200 L	2955	145	91.7	92.3	92.4	0.85	83	2.5	8.1	3.6	71	85	1LE1502-2AA6	241	0.176	
55	62	225 M	2960	177	92.1	92.4	92	0.88	98	2.5	7.3	3.2	76	89	1LE1502-2BA6	330	0.27	
75	84	250 M	2970	240	92.7	92.8	92.1	0.87	134	2.4	7.3	3.1	76	89	1LE1502-2CA6	420	0.48	
110	123	280 M	2975	355	93.3	93.5	93.1	0.9	189	2.4	7.3	3.1	77	90	1LE1502-2DA6	620	1	
4-pole: 1500 rpm at 50 Hz, 1800 rpm at 60 Hz ¹⁾																		
4	4.6	100 L	1435	26.5	83.1	83.8	82.3	0.81	8.6	2.9	5.8	3.1	60	72	1LE1502-1AB6	36	0.01	
5.5	6.3	112 M	1420	37	84.7	85.9	85.3	0.81	11.6	3	5.8	3.1	58	70	1LE1502-1BB6	43	0.012	
11	12.6	132 M	1450	72	87.6	88.2	87.6	0.84	21.5	2.5	7.2	3	64	76	1LE1502-1CB6	76	0.033	
18.5	21.3	160 L	1460	121	89.3	89.8	89.2	0.85	35	2.7	7.2	3.2	65	77	1LE1502-1DB6	125	0.068	
30	34.5	180 L	1465	196	90.7	91	90.6	0.79	60	2.6	7.2	3.4	70	77	1LE1502-1EB6	184	0.159	
37	42.5	200 L	1470	240	91.2	92	92.1	0.82	71	2.4	6.8	2.9	64	78	1LE1502-2AB6	236	0.246	
55	63	225 M	1475	355	92.1	92.8	92.6	0.86	100	2.5	6.7	2.6	70	83	1LE1502-2BB6	320	0.49	
75	86	250 M	1482	485	92.7	93.1	92.6	0.84	139	2.5	7.4	3	73	87	1LE1502-2CB6	440	0.86	
110	127	280 M	1486	710	93.3	93.5	93	0.85	200	2.6	8	3.3	75	89	1LE1502-2DB6	680	1.7	
Voltagess²⁾																		
50 Hz 230 VΔ/400 VY												60 Hz ¹⁾ 460 VY		Version		Order code		
50 Hz 400 VΔ/690 VY												60 Hz ¹⁾ 460 VΔ		Standard		2 2		
50 Hz 500 VY														Standard		3 4		
50 Hz 500 VΔ														Without additional charge		2 7		
														Without additional charge		4 0		
For other voltages ¹⁾ and more information, see from page 3/100																9 0		
Types of construction																		
Without flange												IM B3 ³⁾		Version		Order code		
With flange												IM B5 ³⁾		Standard		A		
With flange												IM B14 ³⁾		With additional charge		F		
														With additional charge		K		
For other types of construction and more information, see from page 3/107																		
Motor protection																		
Without														Version		Order code		
PTC thermistor with 3 temperature sensors														Standard		A		
														With additional charge		B		
For other motor protection and more information, see from page 3/117																		
Terminal box position																		
Terminal box at top														Version		Order code		
														Standard		4		
For other terminal box positions and more information, see from page 3/120																		
Special versions																		
Forced-air cooled motors w/o ext. fan/fan cover (IC418)														Version		Order code(s)		
For options, see from page 3/129														1LE1502-...-Z		F90 +...+...+...		
														1LE1502-...-Z		...+...+...+...		

¹⁾ Operating values at rated power for 60 Hz are stored in the Drive Technology Configurator (DT Configurator; see Appendix, "Tools and engineering").

²⁾ Parallel supply lines are required in the case of connection to ≤ 240 V. For frame size 315 with connection to ≤ 240 V, due to the high current, a drilled, removable entry plate (order code **R52**) or a larger terminal box (order code **R50**) can be used. Order codes **R52** and **R50** alter the motor dimensions.

³⁾ Types derived from IM B3 (IM B6/7/8, IM V6 and IM V5), from IM B5 (IM V3 and IM V1) and from IM B14 (IM V19 and IM V18) are possible, provided that no requirement exists for stamping of the type on the rating plate. The basic type IM B3, IM B5, or IM B14 is stamped as standard on the rating plate. If mounted in a different position, the position must be specified to ensure that the condensation drainage holes are positioned correctly.



IE1

SIMOTICS GP and SIMOTICS SD standard motors
IE1 Standard Efficiency

Cast-iron series SIMOTICS SD 1LE1502 Basic Line with increased power – self-ventilated or forced-air cooled

Selection and ordering data

Operating values at rated power															Cast-iron series			
P_{rated} 50 Hz/ P50 kW	P_{rated} 60 Hz/ P60 ¹⁾ kW	Frame size FS	n_{rated} 50 Hz rpm	T_{rated} 50 Hz Nm	η_{rated} 50 Hz %	η_{rated} 50 Hz %	η_{rated} 50 Hz %	$\cos\phi_{rated}$ 50 Hz %	I_{rated} 50 Hz A	T_{LR}/I_{rated} 50 Hz A	I_{LR}/I_{rated} 50 Hz %	T_B/I_{rated} 50 Hz A	L_{pFA} 50 Hz dB(A)	L_{WA} 50 Hz dB(A)	1LE1502 – Basic Line	$m_{IM B3}$ kg	J kgm ²	
Article No.																		
<ul style="list-style-type: none"> • Cooling: Self-ventilated (IC411) or with order code F90 forced-air cooled without external fan and fan cover (IC418) • Efficiency according to IEC 60034-30-1: IE1 Standard Efficiency, service factor (SF) 1.1 • Insulation: Thermal class 155 (temperature class F), IP55 degree of protection, utilization in accordance with thermal class 155 (temperature class F) 																		
6-pole: 1000 rpm at 50 Hz, 1200 rpm at 60 Hz ¹⁾																		
2.2	2.55	100 L	930	22.5	77.7	79.5	78.1	0.78	5.2	2	4	2.2	59	71	1LE1502-1AC6	35	0.0084	
3	3.45	112 M	945	30.5	79.7	79.5	76.3	0.72	7.5	2.9	4.6	3	57	69	1LE1502-1BC6	45	0.013	
7.5	8.6	132 M	950	75	84.7	85.3	84.1	0.74	17.3	2.4	5.3	3	63	75	1LE1502-1CC6	78	0.032	
15	17.3	160 L	965	148	87.7	87.9	86.5	0.75	33	2.9	6	3.4	67	79	1LE1502-1DC6	140	0.094	
18.5	22	180 L	970	182	88.6	89.4	89.1	0.77	39	2.2	5.9	2.9	56	69	1LE1502-1EC6	166	0.206	
30	34.5	200 L	975	295	90.2	91.4	91.7	0.78	62	2.6	6	2.7	61	75	1LE1502-2AC6	241	0.381	
37	44.5	225 M	978	360	90.8	91.5	91.5	0.82	72	2.5	6.1	2.8	76	93	1LE1502-2BC6	310	0.62	
45	54	250 M	982	440	91.4	92.2	92.1	0.83	86	2.7	6.6	2.3	76	95	1LE1502-2CC6	390	0.93	
75	90	280 M	985	730	92.6	93.3	93.2	0.84	139	2.9	7	2.7	61	75	1LE1502-2DC6	560	1.7	
8-pole: 750 rpm at 50 Hz, 900 rpm at 60 Hz ¹⁾																		
15	18	180 L	718	199	86.2	87.5	87.2	0.74	34	2.1	4.7	2.3	64	78	1LE1502-1ED6	187	0.263	
18.5	22	200 L	720	245	86.9	88.2	88.4	0.76	40	2.7	6.1	3.2	59	72	1LE1502-2AD6	250	0.416	
30	36	225 M	730	390	88.3	89.1	89.1	0.79	62	2.6	5.6	2.8	57	70	1LE1502-2BD6	320	0.73	
37	44.5	250 M	730	485	88.8	89.8	89.9	0.83	72	2.3	5.7	2.6	63	77	1LE1502-2CD6	420	1	
55	66	280 M	736	710	89.7	90.4	90.5	0.8	111	2.5	5.7	2.5	70	81	1LE1502-2DD6	550	1.6	
Voltages²⁾															Version		Order code	
50 Hz 230 VΔ/400 VY			60 Hz ¹⁾ 460 VY			Standard			2		3		4		-			
50 Hz 400 VΔ/690 VY			60 Hz ¹⁾ 460 VΔ			Standard		3		4		-		-				
50 Hz 500 VY			-			Without additional charge		2		7		-		-				
50 Hz 500 VΔ			-			Without additional charge		4		0		-		-				
For other voltages ¹⁾ and more information, see from page 3/100															9		0	...
Types of construction															Version		Order code	
Without flange			IM B3 ³⁾			Standard		A		-		-		-				
With flange			IM B5 ³⁾			With additional charge		F		-		-		-				
With flange			IM B14 ³⁾			With additional charge		K		-		-		-				
For other types of construction and more information, see from page 3/107															-		...	
Motor protection															Version		Order code	
Without			-			Standard		A		-		-		-				
PTC thermistor with 3 temperature sensors			-			With additional charge		B		-		-		-				
For other motor protection and more information, see from page 3/117															-		...	
Terminal box position															Version		Order code(s)	
Terminal box at top			-			Standard		4		-		-		-				
For other terminal box positions and more information, see from page 3/120															-		-	
Special versions															Version		Order code(s)	
Forced-air cooled motors w/o ext. fan/fan cover (IC418)			-			1LE1502- -Z		F90 + . . . + . . . + . . .		-		-		-				
For options, see from page 3/129															-		. . . + . . . + . . . + . . .	

3

¹⁾ Operating values at rated power for 60 Hz are stored in the Drive Technology Configurator (DT Configurator; see Appendix, "Tools and engineering").
²⁾ Parallel supply lines are required in the case of connection to ≤ 240 V. For frame size 315 with connection to ≤ 240 V, due to the high current, a drilled, removable entry plate (order code R52) or a larger terminal box (order code R50) can be used. Order codes R52 and R50 alter the motor dimensions.

³⁾ Types derived from IM B3 (IM B6/7/8, IM V6 and IM V5), from IM B5 (IM V3 and IM V1) and from IM B14 (IM V19 and IM V18) are possible, provided that no requirement exists for stamping of the type on the rating plate. The basic type IM B3, IM B5, or IM B14 is stamped as standard on the rating plate. If mounted in a different position, the position must be specified to ensure that the condensation drainage holes are positioned correctly.

Aluminum series SIMOTICS GP 1LE1043 – self-ventilated or forced-air cooled

Selection and ordering data

Technical specifications at 60 Hz/P50 power rating

Operating values at rated power														Aluminum series 1LE1043		m _{IM B3} J		
P _{rated} , 60 Hz/ P50	P _{rated} , 60 Hz/ P60	Frame size	n _{rated} , 60 Hz	T _{rated} , 60 Hz	Different IE class	η _{rated} , 60 Hz, 4/4	η _{rated} , 60 Hz, 3/4	η _{rated} , 60 Hz, 2/4	cosφ _{rated} , 60 Hz, 4/4	I _{rated} , 60 Hz, 460 V	T _{LR} / I _{rated} , 60 Hz	I _{LR} / I _{rated} , 60 Hz	T _B / I _{rated} , 60 Hz	L _{pfiA} , 60 Hz	L _{WA} , 60 Hz	Article No.	kg	kgm ²
<ul style="list-style-type: none"> Cooling: Self-ventilated (IC411) or with order code F90 forced-air cooled without external fan and fan cover (IC418) Efficiency according to IEC 60034-30-1: IE3 Premium Efficiency Insulation: Thermal class 155 (temperature class F), IP55 degree of protection, utilization in accordance with thermal class 130 (temperature class B) 																		
2-pole: 3000 rpm at 50 Hz, 3600 rpm at 60 Hz																		
0.75	0.86	80 M	3480	2.05		77	77.2	75.7	0.84	1.45	3	7.1	3.6	64	75	1LE1043-0DA2	12	0.0011
1.1	1.27	80 M	3500	3		84	84	82	0.83	1.98	3.3	8.4	4	64	75	1LE1043-0DA3	12	0.0013
1.5	1.75	90 S	3525	4.05		85.5	84.8	82.3	0.84	2.6	3.1	9.8	4.9	69	81	1LE1043-0EA0	13	0.0029
2.2	2.55	90 L	3530	6	IE2	86.5	86.4	84.5	0.87	3.65	3	9.6	4.9	69	81	1LE1043-0EA4	16	0.0021
3	3.45	100 L	3525	8.1		88.5	88.7	87.2	0.87	4.9	3.8	9.7	5.5	71	83	1LE1043-1AA4	20	0.0031
4	4.55	112 M	3560	9.9		88.5	88	86.2	0.88	6	3.2	10.8	5.1	73	85	1LE1043-1BA2	15	0.0036
5.5	6.3	132 S	3555	14.8		89.5	89.4	88.2	0.9	8.6	2.1	8.6	4.4	72	84	1LE1043-1CA0	20	0.0049
7.5	8.6	132 S	3555	20		90.2	90.5	90	0.91	11.5	2.4	9.5	4.7	72	84	1LE1043-1CA1	16	0.004
11	12.6	160 M	3560	29.5		91	90.4	88.3	0.88	17.2	2.8	8.5	4.3	77	89	1LE1043-1DA2	26	0.0054
15	17.3	160 M	3565	40		91	90.5	88.9	0.86	24	3.1	9.7	4.8	77	89	1LE1043-1DA3	25	0.0054
18.5	21.3	160 L	3560	49.5		91.7	91.5	90.3	0.9	28	3.1	9.4	4.4	77	89	1LE1043-1DA4	30	0.014
22	24.5	180 M	3560	59		91.7	91.4	90	0.89	34	2.8	8.2	3.9	77	89	1LE1043-1EA2	30	0.014
30	33.5	200 L	3560	80		92.4	92.2	91.4	0.87	47	2.9	7.6	3.6	77	84	1LE1043-2AA4	25	0.011
37	41.5	200 L	3560	99		93	92.8	91.6	0.88	57	2.8	7.5	3.6	77	84	1LE1043-2AA5	34	0.012
4-pole: 1500 rpm at 50 Hz, 1800 rpm at 60 Hz																		
0.75	0.86	80 M	1760	4.05		83.5	82.6	79.7	0.71	1.59	3.1	8.3	4.7	58	66	1LE1043-0DB3	34	0.017
1.1	1.27	90 S	1750	6	IE2	86.5	86.4	84.2	0.75	2.15	3.4	8.2	4.4	58	70	1LE1043-0EB0	34	0.017
1.5	1.75	90 L	1755	8.2		86.5	86.6	84.7	0.77	2.85	3.4	8.6	4.3	59	67	1LE1043-0EB4	43	0.024
2.2	2.55	100 L	1770	11.9		89.5	89.2	87.2	0.81	3.8	3.5	9.6	5.1	62	74	1LE1043-1AB4	57	0.031
3	3.45	100 L	1760	16.3	IE2	89.5	89.5	88.3	0.82	5.1	3.1	9.5	4.6	62	74	1LE1043-1AB5	57	0.031
4	4.55	112 M	1770	20		89.5	89.4	87.7	0.8	6.5	2.9	8.2	4.3	62	74	1LE1043-1BB2	65	0.035
5.5	6.3	132 S	1775	29.5		91.7	91.6	90.5	0.81	9.3	3.1	10	4.2	68	80	1LE1043-1CB0	64	0.034
7.5	8.6	132 M	1770	40.5		91.7	91.8	91	0.83	12.4	2.7	9.6	4.2	68	80	1LE1043-1CB2	64	0.046
11	12.6	160 M	1775	59		92.4	92.3	91.1	0.83	18	3	8.9	3.8	69	81	1LE1043-1DB2	80	0.083
15	17.3	160 L	1780	80	IE2	93	92.8	91.4	0.81	25	2.9	9.5	4.3	69	81	1LE1043-1DB4	52	0.037
18.5	21.3	180 M	1775	100		93.6	93.7	93.1	0.81	30.5	2.7	7.8	3.6	68	75	1LE1043-1EB2	52	0.037
22	25.3	180 L	1775	118		93.6	93.8	93.3	0.81	36.5	2.8	7.7	3.7	70	77	1LE1043-1EB4	61	0.037
30	34.5	200 L	1778	161	IE2	94.1	94.3	93.8	0.83	48	3	8.1	3.5	70	77	1LE1043-2AB5	64	0.046
Voltages																		
50 Hz 230 VΔ/400 VY														Version		Order code		
60 Hz 460 VY														Standard		2 2		
50 Hz 400 VΔ/690 VY														Standard		3 4		
60 Hz 460 VΔ														Without additional charge		2 7		
50 Hz 500 VY														Without additional charge		4 0		
50 Hz 500 VΔ																9 0		
For other voltages and more information, see from page 3/97																		
Types of construction																		
Without flange														Version		Order code		
IM B3 ¹⁾														Standard		A		
With flange														With additional charge		F		
IM B5 ¹⁾														With additional charge		K		
With flange														IM B14 ¹⁾				
For other types of construction and more information, see from page 3/103																		
Motor protection																		
Without														Version		Order code		
Standard														Standard		A		
PTC thermistor with 1 or 3 temperature sensors (frame sizes 80, 90 or 100 to 200)														With additional charge		B		
For other motor protection and more information, see from page 3/116																		
Terminal box position																		
Terminal box at top														Version		Order code		
Standard														Standard		4		
For other terminal box positions and more information, see from page 3/119																		
Special versions																		
Forced-air cooled motors w/o ext. fan/fan cover (IC416)																1LE1043-... -Z F90 +...+...+...		
For options and information, see from page 3/122																		

3

¹⁾ Types derived from IM B3 (IM B6/7/8, IM V6, and IM V5), from IM B5 (IM V3 and IM V1) and from IM B14 (IM V19 and IM V18) are possible, provided that no requirements exist for condensation drainage holes (H03) or stamping of the type on the rating plate. The basic type IM B3, IM B5, or IM B14 is stamped as standard on the rating plate. For orders with condensation drainage holes (H03), the type must be specified.



SIMOTICS GP and SIMOTICS SD standard motors
APAC Line · IE3 Premium Efficiency

Aluminum series SIMOTICS GP 1LE1043 – self-ventilated or forced-air cooled

Selection and ordering data

Technical specifications at 60 Hz/P50 power rating

Operating values at rated power															Aluminum series		m _{IM B3}	J		
P _{rated} 60 Hz P50	P _{rated} 60 Hz P60	Frame size	n _{rated} 60 Hz	T _{rated} 60 Hz	Different IE class 60 Hz/P60	η _{rated} 60 Hz, 4/4	η _{rated} 60 Hz, 3/4	η _{rated} 60 Hz, 2/4	cosφ _{rated} 60 Hz, 4/4	I _{rated} 60 Hz, 460 V	T _{LR} / T _{rated} 60 Hz	I _{LR} / I _{rated} 60 Hz	T _B / T _{rated} 60 Hz	L _{pifA} 60 Hz	L _{WA} 60 Hz	1LE1043			Article No.	kg
6-pole: 1000 rpm at 50 Hz, 1200 rpm at 60 Hz																				
0.75	0.86	90 S	1155	6.2	IE2	82.5	82.4	79.9	0.65	1.76	2.4	5.3	3.1	46	58	1LE1043-0EC0	-	75	0.053	
1.1	1.27	100 L	1180	8.9	IE2	87.5	87.2	84.8	0.69	2.3	2.4	6.7	3.3	62	74	1LE1043-1AC3	-	84	0.061	
1.5	1.75	112 S	1175	12.2	IE2	88.5	88.3	86.2	0.73	2.9	2.2	6.9	3.2	65	77	1LE1043-1BC1	-	94	0.068	
2.2	2.55	132 S	1180	17.8	IE2	89.5	89.2	87.7	0.72	4.3	2.4	7.3	3.5	63	71	1LE1043-1CC1	-	120	0.073	
3	3.45	132 S	1180	24.5	IE2	89.5	89.5	87.9	0.7	6	2.6	7.6	3.8	62	70	1LE1043-1CC0	-	83	0.071	
4	4.55	132 M	1180	30	IE2	89.5	89.2	87.5	0.69	7.5	2.8	7.5	3.8	64	72	1LE1043-1CC2	-	100	0.085	
5.5	6.3	132 M	1180	44.5	IE2	91	90.8	89.2	0.69	11	3	7.8	4	69	77	1LE1043-1CC3	-	111	0.099	
7.5	8.6	160 M	1185	60		91	90.8	89.4	0.8	12.9	2.7	9.3	3.7	75	83	1LE1043-1DC2	-	93	0.098	
11	12.6	160 L	1185	89	IE2	91.7	91.7	90.5	0.78	19.3	3.4	8	3.2	73	81	1LE1043-1DC4	-	115	0.12	
15	18	180 L	1178	122	IE2	91.7	92	91.4	0.79	26	2.5	6.8	3	61	68	1LE1043-1EC4	-	129	0.08	
18.5	22	200 L	1180	150	IE2	93	93.8	93.8	0.78	32	2.8	6.5	3	64	71	1LE1043-2AC4	-	139	0.094	
22	26.5	200 L	1180	178	IE1	93	93.5	93.4	0.79	37.5	2.6	6.3	2.8	63	70	1LE1043-2AC5	-	134	0.13	
8-pole: 750 rpm at 50 Hz, 900 rpm at 60 Hz																				
0.09	0.11	80 M	865	1.99		64	60.6	53	0.44	0.78	2.6	3.5	3.5	54.8	68.1	▲ 1LE1043-0CD2	-	13	0.00098	
0.12	0.14	80 M	855	2.8		68	65.5	59.8	0.51	0.91	2	3.3	2.6	56	64	▲ 1LE1043-0CD3	-	16	0.0014	
0.18	0.21	90 S	850	4.15		72	69.9	64.2	0.63	1.02	2	3.4	2.1	54	61	▲ 1LE1043-0DD2	-	18	0.0021	
0.25	0.29	90 L	855	6.1		74	71.6	65.8	0.62	1.5	2.3	4	2.8	59	66	▲ 1LE1043-0DD3	-	22	0.003	
0.37	0.43	100 L	870	8.2		75.5	74.9	71.7	0.62	1.87	1.9	4.4	2.5	64	72	▲ 1LE1043-0ED0	-	26	0.0045	
0.55	0.63	100 L	865	12.1		78.5	78	75.7	0.62	2.7	2.3	4.8	3	65.4	73.4	▲ 1LE1043-0ED4	-	26	0.0045	
0.75	0.86	112 M	875	16.4	IE2	84	83.1	80	0.59	3.75	2.9	5.8	3.6	65	73	▲ 1LE1043-1AD4	-	31	0.0096	
Voltages															Version				Order code	
50 Hz 230 VΔ/400 VY					60 Hz 460 VY					Standard					2	2	-			
50 Hz 400 VΔ/690 VY					60 Hz 460 VΔ					Standard					3	4	-			
50 Hz 500 VY										Without additional charge					2	7	-			
50 Hz 500 VΔ										Without additional charge					4	0	-			
For other voltages and more information, see from page 3/97															9	0			...	
Types of construction															Version				Order code	
Without flange			IM B3 ¹⁾		Standard					A		-								
With flange			IM B5 ¹⁾		With additional charge					F		-								
With flange			IM B14 ¹⁾		With additional charge					K		-								
For other types of construction and more information, see from page 3/103																			...	
Motor protection															Version				Order code	
Without					Standard					A		-								
PTC thermistor with 1 or 3 temperature sensors (frame sizes 90 or 100 to 200)					With additional charge					B		-								
For other motor protection and more information, see from page 3/116																			...	
Terminal box position															Version				Order code	
Terminal box at top					Standard					4		-								
For other terminal box positions and more information, see from page 3/119																				
Special versions																			Order code(s)	
Forced-air cooled motors w/o ext. fan/fan cover (IC416)															1LE1043-	-	-	-	-	-Z F90 + . . . + . . .
For options and information, see from page 3/122															1LE1043-	-	-	-	-	-Z . . . + . . . + . . .



¹⁾ Types derived from IM B3 (IM B6/7/8, IM V6, and IM V5), from IM B5 (IM V3 and IM V1) and from IM B14 (IM V19 and IM V18) are possible, provided that no requirements exist for condensation drainage holes (H03) or stamping of the type on the rating plate. The basic type IM B3, IM B5, or IM B14 is stamped as standard on the rating plate. For orders with condensation drainage holes (H03), the type must be specified.

SIMOTICS GP and SIMOTICS SD standard motors

APAC Line · IE3 Premium Efficiency



Aluminum series SIMOTICS GP 1LE1043 with increased power – self-ventilated or forced-air cooled

Selection and ordering data

Technical specifications at 60 Hz/P50 power rating

Operating values at rated power														Aluminum series		m _{IM B3}	J		
P _{rated} 60 Hz P50	P _{rated} 60 Hz P60	Frame size	n _{rated} 60 Hz	T _{rated} 60 Hz	Different IE class	η _{rated} 60 Hz	η _{rated} 60 Hz	η _{rated} 60 Hz	cosφ _{rated} 60 Hz	I _{rated} 60 Hz	T _{LR} / I _{rated} 60 Hz	I _R / I _{rated} 60 Hz	T _P / I _{rated} 60 Hz	L _{pTA} 60 Hz	L _{WA} 60 Hz			1LE1043	Article No.
kW	kW	FS	rpm	Nm		%	%	%		A				dB(A)	dB(A)	▲ New			
<ul style="list-style-type: none"> • Cooling: Self-ventilated (IC411) or with order code F90 forced-air cooled without external fan and fan cover (IC418) • Efficiency according to IEC 60034-30-1: IE3 Premium Efficiency • Insulation: Thermal class 155 (temperature class F), IP55 degree of protection, utilization in accordance with thermal class 130 (temperature class B) 																			
2-pole: 3000 rpm at 50 Hz, 3600 rpm at 60 Hz																			
1.5	1.75	80 M	3485	4,1		85,5	85,5	83,6	0,83	2,65	4,7	10,1	4,7	76	84	▲ 1LE1043-0DA6	-	13	0.0015
3	3.45	90 L	3530	8,1	IE2	88,5	88,1	86,3	0,83	5,1	4,9	12,4	5,6	76	83	▲ 1LE1043-0EA6	-	20	0.00301
4	4.55	100 L	3530	10		88,5	88	86,4	0,8	6,6	4,5	12,4	5,8	75	83	1LE1043-1AA6	-	142	0.14
5.5	6.3	112 M	3560	14,8		89,5	89,3	88,2	0,86	9	3,1	10,4	4,7	76	84	▲ 1LE1043-1BA6	-	36	0.00959
11	12.6	132 M	3565	29,5		91	91,3	90,4	0,86	17,6	2,9	10,9	4,7	75	83	1LE1043-1CA6	-	158	0.173
15	17.3	132 L	3570	40		91	90,9	90,1	0,83	25	3,4	11,1	5,4	78	86	1LE1043-1CA7	-	130	0.19
22	25.3	160 L	3560	59		91,7	91,8	90,9	0,9	33,5	3,1	9,7	4,5	77	89	1LE1043-1DA6	-	173	0.134
30	33.5	180 L	3560	80		92,4	92,6	92,1	0,87	47	2,9	8,8	4,5	77	89	1LE1043-1EA6	-	194	0.158
45	51	200 L	3560	121		93,6	93,6	92,9	0,86	70	3	8,4	3,7	77	84	1LE1043-2AA6	-	194	0.170
4-pole: 1500 rpm at 50 Hz, 1800 rpm at 60 Hz																			
1.1	1.27	80 M	1750	6	IE2	86,5	86,4	84,2	0,75	2,15	3,5	8,6	4,4	60	68	▲ 1LE1043-0DB6	-	15	0.00329
4	4.55	100 L	1768	20		89,5	89,5	87,7	0,77	6,7	3,8	9,5	4,8	71	79	▲ 1LE1043-1AB6	-	42	0.0149
11	12.6	132 M	1775	59	IE2	92,4	92,6	91,8	0,79	18,9	3,1	8,7	4,1	68	81	1LE1043-1CB6	-	189	0.24
18.5	21.3	160 L	1780	99	IE3	93,6	93,5	92,3	0,75	33	3	9	4,2	67	86	1LE1043-1DB6	-	205	0.275
30	34.5	180 L	1775	161	IE2	94,1	94,2	93,5	0,78	51	3,3	9,5	4,3	78	77	1LE1043-1EB6	-	166	0.28
37	42.5	200 L	1780	198	IE2	94,5	94,6	94,2	0,8	61	3,3	9	4	70	81	1LE1043-2AB6	-	179	0.32
6-pole: 1000 rpm at 50 Hz, 1120 rpm at 60 Hz																			
18.5	22	180 L	1180	150	IE2	93	93,2	92,6	0,75	33,5	2,9	7,9	3,7	69	70	▲ 1LE1043-1EC6	-	148	0.24
30	36	200 L	1182	240	IE2	94,1	94,5	94,2	0,77	52	3,2	7,6	3,2	63	76	▲ 1LE1043-2AC6	-	220	0.421
8-pole: 750 rpm at 50 Hz, 900 rpm at 60 Hz																			
0,09	0,11		880	163		90,2	90,6	89,6	0,73	28,5	2,6	6,4	3,2	68	75	▲ 1LE1043-2AD6	-	13	0,00098
Voltages														Version				Order code	
50 Hz 230 VΔ/400 VY				60 Hz 460 VY				Standard		2 2		-		-					
50 Hz 400 VΔ/690 VY				60 Hz 460 VΔ				Standard		3 4		-		-					
50 Hz 500 VY								Without additional charge		2 7		-		-					
50 Hz 500 VΔ								Without additional charge		4 0		-		-					
For other voltages and more information, see from page 3/97														9 0		...			
Types of construction														Version				Order code	
Without flange				IM B3 ¹⁾				Standard		A		-		-					
With flange				IM B5 ¹⁾				With additional charge		F		-		-					
With flange				IM B14 ¹⁾				With additional charge		K		-		-					
For other types of construction and more information, see from page 3/103																...			
Motor protection														Version				Order code	
Without								Standard		A		-		-					
PTC thermistor with 3 temperature sensors								With additional charge		B		-		-					
For other motor protection and more information, see from page 3/116																...			
Terminal box position														Version				Order code(s)	
Terminal box at top								Standard		4									
For other terminal box positions and more information, see from page 3/119																			
Special versions																		Order code(s)	
Forced-air cooled motors w/o ext. fan/fan cover (IC416)														1LE1043-		-Z F90 +. . . +. . .			
For options and information, see from page 3/122														1LE1043-		-Z . . . +. . . +. . .			

¹⁾ Types derived from IM B3 (IM B6/7/8, IM V6, and IM V5), from IM B5 (IM V3 and IM V1) and from IM B14 (IM V19 and IM V18) are possible, provided that no requirements exist for condensation drainage holes (H03) or stamping of the type on the rating plate. The basic type IM B3, IM B5, or IM B14 is stamped as standard on the rating plate. For orders with condensation drainage holes (H03), the type must be specified.

Selection and ordering data

Technical specifications at 60 Hz/P50 power rating

Operating values at rated power														Cast-iron series				
P_{rated} , 60 Hz/ P50	P_{rated} , 60 Hz/ P60	Frame size	n_{rated} , 60 Hz	T_{rated} , 60 Hz	Different IE class 60 Hz/P60	η_{rated} , 60 Hz, 4/4	η_{rated} , 60 Hz, 3/4	η_{rated} , 60 Hz, 2/4	$\cos\phi_{rated}$, 60 Hz, 4/4	I_{rated} , 60 Hz, 460 V	$T_{LR}/$ T_{rated} , 60 Hz	$I_{LR}/$ I_{rated} , 60 Hz	$T_B/$ T_{rated} , 60 Hz	L_{pFA} , 60 Hz	L_{WA} , 60 Hz	1LE1543 – Basic Line	$m_{IM B3}$	J
kW	kW	FS	rpm	Nm		%	%	%		A						Article No.	kg	kgm ²
<ul style="list-style-type: none"> • Cooling: Self-ventilated (IC411) or with order code F90 forced-air cooled without external fan and fan cover (IC418) • Efficiency according to IEC 60034-30-1: IE3 Premium Efficiency • Insulation: Thermal class 155 (temperature class F), IP55 degree of protection, utilization in accordance with thermal class 130 (temperature class B) 																		
2-pole: 3000 rpm at 50 Hz, 3600 rpm at 60 Hz																		
0.75	0.86	80 M	3480	2.05		77	77.2	75.7	0.84	1.45	3	7.1	3.6	64	75	1LE1543-0DA2	18	0.0011
1.1	1.27	80 M	3500	3		84	84	82	0.83	1.98	3.3	8.4	4	64	81	1LE1543-0DA3	21	0.0013
1.5	1.75	90 S	3525	4.05		85.5	84.8	82.3	0.84	2.6	3.1	9.8	4.9	69	81	1LE1543-0EA0	-	0.0021
2.2	2.55	90 L	3530	6		86.5	86.4	84.5	0.87	3.65	3	9.6	4.9	69	83	1LE1543-0EA4	32	0.0031
3	3.45	100 L	3525	8.1		88.5	88.7	87.2	0.87	4.9	3.8	9.7	5.5	71	85	1LE1543-1AA4	37	0.0054
3.7	4.55	112 M	3560	9.9		88.5	88	86.2	0.88	6	3.2	10.8	5.1	73	84	1LE1543-1BA2	43	0.012
5.5	6.3	132 S	3555	14.8		89.5	89.4	88.2	0.9	8.6	2.1	8.6	4.4	72	84	1LE1543-1CA0	61	0.024
7.5	8.6	132 S	3555	20		90.2	90.5	90	0.91	11.5	2.4	9.5	4.7	72	89	1LE1543-1CA1	75	0.031
11	12.6	160 M	3560	29.5		91	90.4	88.3	0.88	17.2	2.8	8.5	4.3	77	89	1LE1543-1DA2	102	0.053
15	17.3	160 M	3565	40		91	90.5	88.9	0.86	24	3.1	9.7	4.8	77	89	1LE1543-1DA3	111	0.061
18.5	21.3	160 L	3560	49.5		91.7	91.5	90.3	0.9	28	3.1	9.4	4.4	77	89	1LE1543-1DA4	123	0.068
22	24.5	180 M	3560	59		91.7	91.4	90	0.89	34	2.8	8.2	3.9	77	84	1LE1543-1EA2	165	0.08
30	33.5	200 L	3560	80		92.4	92.2	91.4	0.87	47	2.9	7.6	3.6	77	84	1LE1543-2AA4	220	0.134
37	41.5	200 L	3560	99		93	92.8	91.6	0.88	57	2.8	7.5	3.6	77	89	1LE1543-2AA5	245	0.158
45	51	225 M	3570	120		93.6	93.7	93.1	0.88	69	2.7	7.6	3.3	75	90	1LE1543-2BA2	315	0.26
55	62	250 M	3578	147		93.6	93.4	92.3	0.89	83	2.5	7.3	3.3	76	92	1LE1543-2CA2	385	0.46
75	84	280 S	3578	200	IE2	94.1	93.9	92.7	0.89	112	2.7	7.6	3.2	78	92	1LE1543-2DA0	510	0.77
90	101	280 M	3578	240	IE2	95	94.8	93.8	0.9	132	2.7	8.1	3.3	78	93	1LE1543-2DA2	590	0.94
110	123	315 S	3585	295		95	94.8	93.8	0.91	160	2.6	8	3.3	79	93	1LE1543-3AA0	750	1.39
132	148	315 M	3585	350		95.4	95.1	94	0.91	191	2.8	8	3.4	79	96	1LE1543-3AA2	880	1.6
160	180	315 L	3588	425	IE2	95.4	95.1	93.9	0.91	230	3.2	8.8	3.5	82	96	1LE1543-3AA4	980	1.9
200	224	315 L	3586	530		95.8	95.7	94.8	0.92	285	3.2	8.3	3.3	82	66	1LE1543-3AA5	1150	2.3
Voltages														Version		Order code		
50 Hz 230 VΔ/400 VY			60 Hz 460 VY			Standard		2 2						-				
50 Hz 400 VΔ/690 VY			60 Hz 460 VΔ			Standard		3 4						-				
50 Hz 500 VY						Without additional charge		2 7						-				
50 Hz 500 VΔ						Without additional charge		4 0						-				
For other voltages and more information, see from page 3/100														9 0		...		
Types of construction														Version		Order code		
Without flange			IM B3 ¹⁾			Standard		A						-				
With flange			IM B5 ¹⁾			With additional charge		F						-				
For other types of construction and more information, see from page 3/107																...		
Motor protection														Version		Order code		
Without						Standard		A						-				
PTC thermistor with 3 temperature sensors						With additional charge		B						-				
For other motor protection and more information, see from page 3/117																...		
Terminal box position														Version		Order code(s)		
Terminal box at top						Standard		4										
For other terminal box positions and more information, see from page 3/120																		
Special versions																Order code(s)		
Forced-air cooled motors w/o ext. fan/fan cover (IC418)														1LE1543-....		-Z F90+...+...+...		
For options, see from page 3/129														1LE1543-....		-Z ...+...+...+...		

¹⁾ Types derived from IM B3 (IM B6/7/8, IM V6 and IM V5), from IM B5 (IM V3 and IM V1) and from IM B14 (IM V19 and IM V18) are possible, provided that no requirement exists for stamping of the type on the rating plate. The basic type IM B3, IM B5, or IM B14 is stamped as standard on the rating plate. If mounted in a different position, the position must be specified to ensure that the condensation drainage holes are positioned correctly.



SIMOTICS GP and SIMOTICS SD standard motors

APAC Line · IE3 Premium Efficiency



Cast-iron series SIMOTICS SD 1LE1543 Basic Line – self-ventilated or forced-air cooled

Selection and ordering data

Technical specifications at 60 Hz/P50 power rating

Operating values at rated power														Cast-iron series		m _{IM B3}	J		
P _{rated} , 60 Hz/ P50	P _{rated} , 60 Hz/ P60	Frame size	n _{rated} , 60 Hz	T _{rated} , 60 Hz	Different IE class 60 Hz/P60	η _{rated} , 60 Hz, 4/4	η _{rated} , 60 Hz, 3/4	η _{rated} , 60 Hz, 2/4	cosφ _{rated} , 60 Hz, 4/4	I _{rated} , 60 Hz, 460 V	T _{LR} /I _{rated} , 60 Hz	I _{LR} /I _{rated} , 60 Hz	T _B /I _{rated} , 60 Hz	L _p μA, 60 Hz	L _{WA} , 60 Hz			1LE1543 – Basic Line	Article No.

- Cooling: Self-ventilated (IC411) or with order code F90 forced-air cooled without external fan and fan cover (IC418)
- Efficiency according to IEC 60034-30-1: IE3 Premium Efficiency
- Insulation: Thermal class 155 (temperature class F), IP55 degree of protection, utilization in accordance with thermal class 130 (temperature class B)

4-pole: 1500 rpm at 50 Hz, 1800 rpm at 60 Hz																			
0.75	0.86	80 M	1760	4.05		83.5	82.6	79.7	0.71	1.59	3.1	8.3	4.7	58	70	1LE1543-0DB3	22	0.0029	
1.1	1.27	90 S	1750	6	IE2	86.5	86.4	84.2	0.75	2.15	3.4	8.2	4.4	58	67	1LE1543-0EB0	25	0.0036	
1.5	1.75	90 L	1755	8.2		86.5	86.6	84.7	0.77	2.85	3.4	8.6	4.3	59	74	1LE1543-0EB4	31	0.0049	
2.2	2.55	100 L	1770	11.9		89.5	89.2	87.2	0.81	3.8	3.5	9.6	5.1	62	74	1LE1543-1AB4	40	0.014	
3	3.45	100 L	1760	16.3	IE2	89.5	89.5	88.3	0.82	5.1	3.1	9.5	4.6	62	74	1LE1543-1AB5	40	0.014	
4	4.55	112 M	1770	20		89.5	89.4	87.7	0.8	6.5	2.9	8.2	4.3	62	80	1LE1543-1BB2	43	0.017	
5.5	6.3	132 S	1775	29.5		91.7	91.6	90.5	0.81	9.3	3.1	10	4.2	68	80	1LE1543-1CB0	67	0.046	
7.5	8.6	132 M	1770	40.5		91.7	91.8	91	0.83	12.4	2.7	9.6	4.2	68	81	1LE1543-1CB2	82	0.046	
11	12.6	160 M	1775	59		92.4	92.3	91.1	0.83	18	3	8.9	3.8	69	81	1LE1543-1DB2	110	0.083	
15	17.3	160 L	1780	80	IE2	93	92.8	91.4	0.81	25	2.9	9.5	4.3	69	75	1LE1543-1DB4	129	0.099	
18.5	21.3	180 M	1775	100		93.6	93.7	93.1	0.81	30.5	2.7	7.8	3.6	68	77	1LE1543-1EB2	166	0.13	
22	25.3	180 L	1775	118		93.6	93.8	93.3	0.81	36.5	2.8	7.7	3.7	70	77	1LE1543-1EB4	178	0.14	
30	34.5	200 L	1778	161	IE2	94.1	94.3	93.8	0.83	48	3	8.1	3.5	70	82	1LE1543-2AB5	240	0.22	
37	42.5	225 S	1782	198	IE2	94.5	94.7	94.2	0.85	58	2.8	7.5	3	68	81	1LE1543-2BB0	285	0.42	
45	52	225 M	1782	240	IE2	95	95.3	95.1	0.85	70	3	7.7	3	67	82	1LE1543-2BB2	340	0.52	
55	63	250 M	1786	295	IE2	95.4	95.6	95.1	0.86	84	2.8	7.6	3.2	68	91	1LE1543-2CB2	420	0.85	
75	86	280 S	1788	400	IE2	95.4	95.3	94.5	0.85	116	2.8	7.7	3.3	77	93	1LE1543-2DB0	570	1.39	
90	104	280 M	1788	480	IE2	95.4	95.5	94.9	0.87	136	2.9	8	3.3	79	88	1LE1543-2DB2	670	1.7	
110	127	315 S	1790	590		95.8	95.9	95.4	0.86	168	3	7.5	3.1	74	92	1LE1543-3AB0	760	2.2	
132	152	315 M	1790	700		96.2	96.3	95.8	0.87	198	3.1	8.2	3.2	78	92	1LE1543-3AB2	960	2.9	
160	184	315 L	1791	850		96.2	96.2	95.7	0.87	240	3.3	8.4	3.3	78	93	1LE1543-3AB4	990	3.1	
200	230	315 L	1791	1070	IE2	96.2	96.2	95.5	0.87	300	3.5	8.7	3.2	78	58	1LE1543-3AB5	1190	3.7	

Voltages		Version	Order code
50 Hz 230 VΔ/400 VY	60 Hz 460 VY	Standard	2 2
50 Hz 400 VΔ/690 VY	60 Hz 460 VΔ	Standard	3 4
50 Hz 500 VY		Without additional charge	2 7
50 Hz 500 VΔ		Without additional charge	4 0
For other voltages and more information, see from page 3/100			9 0
Types of construction		Version	Order code
Without flange	IM B3 ¹⁾	Standard	A
With flange	IM B5 ¹⁾	With additional charge	F
For other types of construction and more information, see from page 3/107			
Motor protection		Version	Order code
Without		Standard	A
PTC thermistor with 3 temperature sensors		With additional charge	B
For other motor protection and more information, see from page 3/117			
Terminal box position		Version	Order code(s)
Terminal box at top		Standard	4
For other terminal box positions and more information, see from page 3/120			
Special versions			Order code(s)
Forced-air cooled motors w/o ext. fan/fan cover (IC418)			1LE1543-...-Z F90+...+...+...
For options, see from page 3/129			1LE1543-...-Z ...+...+...+...

¹⁾ Types derived from IM B3 (IM B6/7/8, IM V6 and IM V5), from IM B5 (IM V3 and IM V1) and from IM B14 (IM V19 and IM V18) are possible, provided that no requirement exists for stamping of the type on the rating plate. The basic type IM B3, IM B5, or IM B14 is stamped as standard on the rating plate. If mounted in a different position, the position must be specified to ensure that the condensation drainage holes are positioned correctly.

Selection and ordering data

Technical specifications at 60 Hz/P50 power rating

Operating values at rated power														Cast-iron series				
P_{rated} 60 Hz P50	P_{rated} 60 Hz P60	Frame size	n_{rated} 60 Hz	T_{rated} 60 Hz	Different IE class 60 Hz/P60	η_{rated} 60 Hz, 4/4	η_{rated} 60 Hz, 3/4	η_{rated} 60 Hz, 2/4	$\cos\phi_{\text{rated}}$ 60 Hz, 4/4	I_{rated} 60 Hz, 460 V	T_{LR} / I_{LR} 60 Hz	T_{L} / I_{L} 60 Hz	T_{B} / I_{B} 60 Hz	L_{pifA} 60 Hz	L_{WA} 60 Hz	1LE1543 – Basic Line	$m_{\text{IM B3}}$	J
kW	kW	FS	rpm	Nm		%	%	%		A				dB(A)	dB(A)	Article No.	kg	kgm ²

- Cooling: Self-ventilated (IC411) or with order code F90 forced-air cooled without external fan and fan cover (IC418)
- Efficiency according to IEC 60034-30-1: IE3 Premium Efficiency
- Insulation: Thermal class 155 (temperature class F), IP55 degree of protection, utilization in accordance with thermal class 130 (temperature class B)

6-pole: 1000 rpm at 50 Hz, 1200 rpm at 60 Hz

0.75	0.86	90 S	1155	6.2	IE2	82.5	82.4	79.9	0.65	1.76	2.4	5.3	3.1	46	74	1LE1543-0EC0	27	0.004
1.1	1.27	100 L	1180	8.9	IE2	87.5	87.2	84.8	0.69	2.3	2.4	6.7	3.3	62	77	1LE1543-1AC3	25	0.011
1.5	1.75	112 M	1175	12.2	IE2	88.5	88.3	86.2	0.73	2.9	2.2	6.9	3.2	65	71	1LE1543-1BC1	53	0.017
2.2	2.55	132 S	1180	17.8	IE2	89.5	89.2	87.7	0.72	4.3	2.4	7.3	3.5	63	70	1LE1543-1CC1	60	0.033
3	3.45	132 S	1180	24.5	IE2	89.5	89.5	87.9	0.7	6	2.6	7.6	3.8	62	72	1LE1543-1CC0	70	0.034
4	4.55	132 M	1180	30	IE2	89.5	89.2	87.5	0.69	7.5	2.8	7.5	3.8	64	77	1LE1543-1CC2	80	0.039
5.5	6.3	132 M	1180	44.5	IE2	91	90.8	89.2	0.69	11	3	7.8	4	69	83	1LE1543-1CC3	82	0.05
7.5	8.6	160 M	1185	60	IE3	91	90.8	89.4	0.8	12.9	2.7	9.3	3.7	75	81	1LE1543-1DC2	122	0.132
11	12.6	160 L	1185	89	IE2	91.7	91.7	90.5	0.78	19.3	3.4	8	3.2	73	68	1LE1543-1DC4	147	0.164
15	18	180 L	1178	122	IE2	91.7	92	91.4	0.79	26	2.5	6.8	3	61	71	1LE1543-1EC4	180	0.19
18.5	22	200 L	1180	150	IE2	93	93.8	93.8	0.78	32	2.8	6.5	3	64	70	1LE1543-2AC4	213	0.28
22	26.5	200 L	1180	178	IE1	93	93.5	93.4	0.79	37.5	2.6	6.3	2.8	63	76	1LE1543-2AC5	230	0.32
30	36	200 L	1182	240		94.1	94.5	94.2	0.77	52	3.2	7.6	3.2	63	70	1LE1543-2AC6		
37	44.5	250 M	1188	295	IE2	94.1	94.4	93.9	0.83	59	3.1	8	3.1	63	80	1LE1543-2CC2	405	1
45	54	280 S	1190	360	IE2	94.5	94.6	94.1	0.83	72	3.3	7.7	3.1	66	80	1LE1543-2DC0	510	1.4
55	66	280 M	1190	440	IE2	94.5	94.6	93.9	0.84	87	3.6	9.2	3.3	66	79	1LE1543-2DC2	560	1.64
75	90	315 S	1192	600	IE3	95	94.9	94.1	0.82	121	3.1	8.4	3.3	64	79	1LE1543-3AC0	750	2.6
90	108	315 M	1192	720	IE2	95	95	94.4	0.84	142	2.7	7.7	3	64	79	1LE1543-3AC2	890	3.1
110	132	315 L	1192	880	IE2	95.8	95.9	95.5	0.83	174	3.2	8.2	3.4	64	80	1LE1543-3AC4	990	3.9
132	158	315 L	1193	1060	IE2	95.8	95.9	95.4	0.81	215	3.7	9.6	3.7	65	83	1LE1543-3AC5	1130	4.48

8-pole: 750 rpm at 50 Hz, 900 rpm at 60 Hz

0.09	0.11	71 M	825	1.04		57.1	53.7	45.8	0.55	0.36	2.3	2.6	2.4	45	56	▲ 1LE1543-0CD2	13	0.00098
0.12	0.14	71 M	830	1.38		59.5	56.9	50.3	0.56	0.45	2.6	2.9	2.7	49	68.1	▲ 1LE1543-0CD3	16	0.0014
0.18	0.21	80 M	865	1.99		64	60.6	53	0.44	0.78	2.6	3.5	3.5	54.8	64	▲ 1LE1543-0DD2	18	0.0021
0.25	0.29	80 M	855	2.8		68	65.5	59.8	0.51	0.91	2	3.3	2.6	56	61	▲ 1LE1543-0DD3	22	0.003
0.37	0.43	90 S	850	4.15		72	69.9	64.2	0.63	1.02	2	3.4	2.1	54	66	▲ 1LE1543-0ED0	26	0.0045
0.55	0.63	90 L	855	6.1		74	71.6	65.8	0.62	1.5	2.3	4	2.8	59	72	▲ 1LE1543-0ED4	26	0.0045
0.75	0.86	100 L	870	8.2		75.5	74.9	71.7	0.62	1.87	1.9	4.4	2.5	64	73.4	▲ 1LE1543-1AD4	31	0.0096
1.1	1.27	100 L	865	12.1		78.5	78	75.7	0.62	2.7	2.3	4.8	3	65.4	73	▲ 1LE1543-1AD5	36	0.013
1.5	1.75	112 M	875	16.4	IE2	84	83.1	80	0.59	3.75	2.9	5.8	3.6	65	84	▲ 1LE1543-1BD2	46	0.028

Voltages		Version		Order code
50 Hz 230 VΔ/400 VY	60 Hz 460 VY	Standard		2 2
50 Hz 400 VΔ/690 VY	60 Hz 460 VΔ	Standard		3 4
50 Hz 500 VY		Without additional charge		2 7
50 Hz 500 VΔ		Without additional charge		4 0
For other voltages and more information, see from page 3/100				9 0
Types of construction		Version		Order code
Without flange	IM B3 ¹⁾	Standard		A
With flange	IM B5 ¹⁾	With additional charge		F
For other types of construction and more information, see from page 3/107				
Motor protection		Version		Order code
Without		Standard		A
PTC thermistor with 3 temperature sensors		With additional charge		B
For other motor protection and more information, see from page 3/117				
Terminal box position		Version		Order code
Terminal box at top		Standard		4
For other terminal box positions and more information, see from page 3/120				
Special versions				Order code(s)
Forced-air cooled motors w/o ext. fan/fan cover (IC418)				1LE1543-....-Z F90+...+...+...
For options, see from page 3/129				1LE1543-....-Z ...+...+...+...

¹⁾ Types derived from IM B3 (IM B6/7/8, IM V6 and IM V5), from IM B5 (IM V3 and IM V1) and from IM B14 (IM V19 and IM V18) are possible, provided that no requirement exists for stamping of the type on the rating plate. The basic type IM B3, IM B5, or IM B14 is stamped as standard on the rating plate. If mounted in a different position, the position must be specified to ensure that the condensation drainage holes are positioned correctly.

Cast-iron series SIMOTICS SD 1LE1643 Performance Line – self-ventilated or forced-air cooled

Selection and ordering data

Technical specifications at 60 Hz/P50 power rating

Operating values at rated power														Cast-iron series 1LE1643 – Performance Line Article No.	$m_{IM B3}$ kg	J kgm ²		
P_{rated} 60 Hz/ P50 kW	P_{rated} 60 Hz/ P60 kW	Frame size FS	n_{rated} 60 Hz rpm	T_{rated} 60 Hz Nm	Different IE class 60 Hz/P60	η_{rated} 60 Hz, 4/4 %	η_{rated} 60 Hz, 3/4 %	η_{rated} 60 Hz, 2/4 %	$\cos\phi_{rated}$ 60 Hz, 4/4	I_{rated} 60 Hz, 460 V A	T_{LR} I_{LR}/I_{rated} 60 Hz	I_{LF} I_{LF}/I_{rated} 60 Hz	T_B T_B/I_{rated} 60 Hz				L_{pFA} 60 Hz dB(A)	L_{WA} 60 Hz dB(A)
<ul style="list-style-type: none"> • Cooling: Self-ventilated (IC411) or with order code F90 forced-air cooled without external fan and fan cover (IC418) • Efficiency according to IEC 60034-30-1: IE3 Premium Efficiency • Insulation: Thermal class 155 (temperature class F), IP55 degree of protection, utilization in accordance with thermal class 130 (temperature class B) 																		
2-pole: 3000 rpm at 50 Hz, 3600 rpm at 60 Hz																		
0.75	0.86	80 M	3480	2.05		77	77.2	75.7	0.84	1.45	3	7.1	3.6	64	75	1LE1643-0DA2	18	0.0011
1.1	1.27	80 M	3500	3		84	84	82	0.83	1.98	3.3	8.4	4	64	81	1LE1643-0DA3	21	0.0013
1.5	1.75	90 S	3525	4.05		85.5	84.8	82.3	0.84	2.6	3.1	9.8	4.9	69	81	1LE1643-0EA0	26	0.0021
2.2	2.55	90 L	3530	6		86.5	86.4	84.5	0.87	3.65	3	9.6	4.9	69	83	1LE1643-0EA4	32	0.0031
3	3.45	100 L	3525	8.1		88.5	88.7	87.2	0.87	4.9	3.8	9.7	5.5	71	85	1LE1643-1AA4	37	0.0054
3.7	4.55	112 M	3560	9.9		88.5	88	86.2	0.88	6	3.2	10.8	5.1	73	84	1LE1643-1BA2	43	0.012
5.5	6.3	132 S	3555	14.8		89.5	89.4	88.2	0.9	8.6	2.1	8.6	4.4	72	84	1LE1643-1CA0	61	0.024
7.5	8.6	132 S	3555	20		90.2	90.5	90	0.91	11.5	2.4	9.5	4.7	72	89	1LE1643-1CA1	75	0.031
11	12.6	160 M	3560	29.5		91	90.4	88.3	0.88	17.2	2.8	8.5	4.3	77	89	1LE1643-1DA2	102	0.053
15	17.3	160 M	3565	40		91	90.5	88.9	0.86	24	3.1	9.7	4.8	77	89	1LE1643-1DA3	111	0.061
18.5	21.3	160 L	3560	49.5		91.7	91.5	90.3	0.9	28	3.1	9.4	4.4	77	89	1LE1643-1DA4	123	0.068
22	24.5	180 M	3560	59		91.7	91.4	90	0.89	34	2.8	8.2	3.9	77	84	1LE1643-1EA2	165	0.08
30	33.5	200 L	3560	80		92.4	92.2	91.4	0.87	47	2.9	7.6	3.6	77	84	1LE1643-2AA4	220	0.134
37	41.5	200 L	3560	99		93	92.8	91.6	0.88	57	2.8	7.5	3.6	77	89	1LE1643-2AA5	245	0.158
45	51	225 M	3570	120		93.6	93.7	93.1	0.88	69	2.7	7.6	3.3	75	90	1LE1643-2BA2	315	0.26
55	62	250 M	3578	147		93.6	93.4	92.3	0.89	83	2.5	7.3	3.3	76	92	1LE1643-2CA2	385	0.46
75	84	280 S	3578	200	IE2	94.1	93.9	92.7	0.89	112	2.7	7.6	3.2	78	92	1LE1643-2DA0	510	0.77
90	101	280 M	3578	240	IE2	95	94.8	93.8	0.9	132	2.7	8.1	3.3	78	93	1LE1643-2DA2	590	0.94
110	123	315 S	3585	295		95	94.8	93.8	0.91	160	2.6	8	3.3	79	93	1LE1643-3AA0	750	1.39
132	148	315 M	3585	350		95.4	95.1	94	0.91	191	2.8	8	3.4	79	96	1LE1643-3AA2	880	1.6
160	180	315 L	3588	425	IE2	95.4	95.1	93.9	0.91	230	3.2	8.8	3.5	82	96	1LE1643-3AA4	980	1.9
200	224	315 L	3586	530		95.8	95.7	94.8	0.92	285	3.2	8.3	3.3	82	66	1LE1643-3AA5	1150	2.3

Voltagess	Version	Order code
50 Hz 230 VΔ/400 VY	Standard	2 2
50 Hz 400 VΔ/690 VY	Standard	3 4
50 Hz 500 VY	Without additional charge	2 7
50 Hz 500 VΔ	Without additional charge	4 0
		9 0
For other voltages and more information, see from page 3/100		
Types of construction	Version	Order code
Without flange	Standard	A
With flange	With additional charge	F
For other types of construction and more information, see from page 3/107		
Motor protection	Version	Order code
PTC thermistor with 3 temperature sensors	Standard	B
For other motor protection and more information, see from page 3/117		
Terminal box position	Version	Order code(s)
Terminal box at top	Standard	4
For other terminal box positions and more information, see from page 3/120		
Special versions	Version	Order code(s)
Forced-air cooled motors w/o ext. fan/fan cover (IC418)		1LE1643-...-Z F90+...+...+...
For options, see from page 3/129		1LE1643-...-Z ...+...+...+...

¹⁾ Types derived from IM B3 (IM B6/7/8, IM V6 and IM V5), from IM B5 (IM V3 and IM V1) and from IM B14 (IM V19 and IM V18) are possible, provided that no requirement exists for stamping of the type on the rating plate. The basic type IM B3, IM B5, or IM B14 is stamped as standard on the rating plate. If mounted in a different position, the position must be specified to ensure that the condensation drainage holes are positioned correctly.



SIMOTICS GP and SIMOTICS SD standard motors
APAC Line · IE3 Premium Efficiency

Cast-iron series SIMOTICS SD 1LE1643 Performance Line – self-ventilated or forced-air cooled

Selection and ordering data

Technical specifications at 60 Hz/P50 power rating

Operating values at rated power														Cast-iron series 1LE1643 – Performance Line Article No.	m _{IM B3}	J		
P _{rated} , 60 Hz/ P50	P _{rated} , 60 Hz/ P60	Frame size	n _{rated} , 60 Hz	T _{rated} , 60 Hz	Different IE class 60 Hz/P60	η _{rated} , 60 Hz, 4/4	η _{rated} , 60 Hz, 3/4	η _{rated} , 60 Hz, 2/4	cosφ _{rated} , 60 Hz, 4/4	I _{rated} , 60 Hz, 460 V	T _{LR} / I _{rated} , 60 Hz	I _{LR} / I _{rated} , 60 Hz	T _B / I _{rated} , 60 Hz				L _{plA} , 60 Hz	L _{WA} , 60 Hz
kW	kW	FS	rpm	Nm		%	%	%		A				dB(A)	dB(A)	kg	kgm ²	
• Cooling: Self-ventilated (IC411) or with order code F90 forced-air cooled without external fan and fan cover (IC418) • Efficiency according to IEC 60034-30-1: IE3 Premium Efficiency • Insulation: Thermal class 155 (temperature class F), IP55 degree of protection, utilization in accordance with thermal class 130 (temperature class B)																		
4-pole: 1500 rpm at 50 Hz, 1800 rpm at 60 Hz																		
3	3.45	100 L	1760	16.3	IE2	89.5	89.5	88.3	0.82	5.1	3.1	9.5	4.6	62	74	1LE1643-1AB5	40	0.014
4	4.55	112 M	1770	20		89.5	89.4	87.7	0.8	6.5	2.9	8.2	4.3	62	80	1LE1643-1BB2	43	0.017
5.5	6.3	132 S	1775	29.5		91.7	91.6	90.5	0.81	9.3	3.1	10	4.2	68	80	1LE1643-1CB0	67	0.046
7.5	8.6	132 M	1770	40.5		91.7	91.8	91	0.83	12.4	2.7	9.6	4.2	68	81	1LE1643-1CB2	82	0.046
11	12.6	160 M	1775	59		92.4	92.3	91.1	0.83	18	3	8.9	3.8	69	81	1LE1643-1DB2	110	0.083
15	17.3	160 L	1780	80	IE2	93	92.8	91.4	0.81	25	2.9	9.5	4.3	69	75	1LE1643-1DB4	129	0.099
18.5	21.3	180 M	1775	100		93.6	93.7	93.1	0.81	30.5	2.7	7.8	3.6	68	77	1LE1643-1EB2	166	0.13
22	25.3	180 L	1775	118		93.6	93.8	93.3	0.81	36.5	2.8	7.7	3.7	70	77	1LE1643-1EB4	178	0.14
30	34.5	200 L	1778	161	IE2	94.1	94.3	93.8	0.83	48	3	8.1	3.5	70	82	1LE1643-2AB5	240	0.22
37	42.5	225 S	1782	198	IE2	94.5	94.7	94.2	0.85	58	2.8	7.5	3	68	81	1LE1643-2BB0	285	0.42
45	52	225 M	1782	240	IE2	95	95.3	95.1	0.85	70	3	7.7	3	67	82	1LE1643-2BB2	340	0.52
55	63	250 M	1786	295	IE2	95.4	95.6	95.1	0.86	84	2.8	7.6	3.2	68	91	1LE1643-2CB2	420	0.85
75	86	280 S	1788	400	IE2	95.4	95.3	94.5	0.85	116	2.8	7.7	3.3	77	93	1LE1643-2DB0	570	1.39
90	104	280 M	1788	480	IE2	95.4	95.5	94.9	0.87	136	2.9	8	3.3	79	88	1LE1643-2DB2	670	1.7
110	127	315 S	1790	590		95.8	95.9	95.4	0.86	168	3	7.5	3.1	74	92	1LE1643-3AB0	760	2.2
132	152	315 M	1790	700		96.2	96.3	95.8	0.87	198	3.1	8.2	3.2	78	92	1LE1643-3AB2	960	2.9
160	184	315 L	1791	850		96.2	96.2	95.7	0.87	240	3.3	8.4	3.3	78	93	1LE1643-3AB4	990	3.1
200	230	315 L	1791	1070	IE2	96.2	96.2	95.5	0.87	300	3.5	8.7	3.2	78	58	1LE1643-3AB5	1190	3.7
Voltagess														Version		Order code		
50 Hz 230 VΔ/400 VY				60 Hz 460 VY				Standard				2	2	-				
50 Hz 400 VΔ/690 VY				60 Hz 460 VΔ				Standard				3	4	-				
50 Hz 500 VY								Without additional charge				2	7	-				
50 Hz 500 VΔ								Without additional charge				4	0	-				
For other voltages and more information, see from page 3/100														9	0	...		
Types of construction														Version		Order code		
Without flange				IM B3 ¹⁾				Standard				A		-				
With flange				IM B5 ¹⁾				With additional charge				F		-				
For other types of construction and more information, see from page 3/107																...		
Motor protection														Version		Order code		
PTC thermistor with 3 temperature sensors								Standard				B		-				
For other motor protection and more information, see from page 3/117																...		
Terminal box position														Version		Order code(s)		
Terminal box at top								Standard				4						
For other terminal box positions and more information, see from page 3/120																		
Special versions																Order code(s)		
Forced-air cooled motors w/o ext. fan/fan cover (IC418)												1LE1643-....	-Z	F90+...+...+...				
For options, see from page 3/129														1LE1643-....	-Z	...+...+...+...		



¹⁾ Types derived from IM B3 (IM B6/7/8, IM V6 and IM V5), from IM B5 (IM V3 and IM V1) and from IM B14 (IM V19 and IM V18) are possible, provided that no requirement exists for stamping of the type on the rating plate. The basic type IM B3, IM B5, or IM B14 is stamped as standard on the rating plate. If mounted in a different position, the position must be specified to ensure that the condensation drainage holes are positioned correctly.

Selection and ordering data

Technical specifications at 60 Hz/P50 power rating

Operating values at rated power													Cast-iron series		$m_{IM\ B3}$	J		
$P_{rated, 60\ Hz}$ P50 kW	$P_{rated, 60\ Hz}$ P60 kW	Frame size	$n_{rated, 60\ Hz}$ rpm	$T_{rated, 60\ Hz}$ Nm	Different IE class	$\eta_{rated, 60\ Hz, 4/4}$	$\eta_{rated, 60\ Hz, 3/4}$	$\eta_{rated, 60\ Hz, 2/4}$	$\cos\phi_{rated, 60\ Hz, 4/4}$	$I_{rated, 60\ Hz, 460\ V}$	$I_{LR}/I_{rated, 60\ Hz}$	$I_{LR}/I_{rated, 60\ Hz}$	$T_p/I_{rated, 60\ Hz}$	$L_{p/A, 60\ Hz}$			$L_{WA, 60\ Hz}$	1LE1643 – Performance Line Article No.
<ul style="list-style-type: none"> • Cooling: Self-ventilated (IC411) or with order code F90 forced-air cooled without external fan and fan cover (IC418) • Efficiency according to IEC 60034-30-1: IE3 Premium Efficiency • Insulation: Thermal class 155 (temperature class F), IP55 degree of protection, utilization in accordance with thermal class 130 (temperature class B) 																		
6-pole: 1000 rpm at 50 Hz, 1200 rpm at 60 Hz																		
1.1	1.27	100 L	1180	8.9	IE2	87.5	87.2	84.8	0.69	2.3	2.4	6.7	3.3	62	77	1LE1643-1AC3	25	0.011
1.5	1.75	112 M	1175	12.2	IE2	88.5	88.3	86.2	0.73	2.9	2.2	6.9	3.2	65	71	1LE1643-1BC1	53	0.017
2.2	2.55	132 S	1180	17.8	IE2	89.5	89.2	87.7	0.72	4.3	2.4	7.3	3.5	63	70	1LE1643-1CC1	60	0.033
3	3.45	132 S	1180	24.5	IE2	89.5	89.5	87.9	0.7	6	2.6	7.6	3.8	62	72	1LE1643-1CC0	70	0.034
4	4.55	132 M	1180	30	IE2	89.5	89.2	87.5	0.69	7.5	2.8	7.5	3.8	64	77	1LE1643-1CC2	80	0.039
5.5	6.3	132 M	1180	44.5	IE2	91	90.8	89.2	0.69	11	3	7.8	4	69	83	1LE1643-1CC3	82	0.05
7.5	8.6	160 M	1185	60	IE3	91	90.8	89.4	0.8	12.9	2.7	9.3	3.7	75	81	1LE1643-1DC2	122	0.132
11	12.6	160 L	1185	89	IE2	91.7	91.7	90.5	0.78	19.3	3.4	8	3.2	73	68	1LE1643-1DC4	147	0.164
15	18	180 L	1178	122	IE2	91.7	92	91.4	0.79	26	2.5	6.8	3	61	71	1LE1643-1EC4	180	0.19
18.5	22	200 L	1180	150	IE2	93	93.8	93.8	0.78	32	2.8	6.5	3	64	70	1LE1643-2AC4	213	0.28
22	26.5	200 L	1180	178	IE1	93	93.5	93.4	0.79	37.5	2.6	6.3	2.8	63	76	1LE1643-2AC5	230	0.32
30	36	200 L	1182	240		94.1	94.5	94.2	0.77	52	3.2	7.6	3.2	63	70	1LE1643-2AC6		
37	44.5	250 M	1188	295	IE2	94.1	94.4	93.9	0.83	59	3.1	8	3.1	63	80	1LE1643-2CC2	405	1
45	54	280 S	1190	360	IE2	94.5	94.6	94.1	0.83	72	3.3	7.7	3.1	66	80	1LE1643-2DC0	510	1.4
55	66	280 M	1190	440	IE2	94.5	94.6	93.9	0.84	87	3.6	9.2	3.3	66	79	1LE1643-2DC2	560	1.64
75	90	315 S	1192	600	IE3	95	94.9	94.1	0.82	121	3.1	8.4	3.3	64	79	1LE1643-3AC0	750	2.6
90	108	315 M	1192	720	IE2	95	95	94.4	0.84	142	2.7	7.7	3	64	79	1LE1643-3AC2	890	3.1
110	132	315 L	1192	880	IE2	95.8	95.9	95.5	0.83	174	3.2	8.2	3.4	64	80	1LE1643-3AC4	990	3.9
132	158	315 L	1193	1060	IE2	95.8	95.9	95.4	0.81	215	3.7	9.6	3.7	65	83	1LE1643-3AC5	1130	4.48
8-pole: 750 rpm at 50 Hz, 900 rpm at 60 Hz																		
0.75	0.86	100 L	870	8.2		75.5	74.9	71.7	0.62	1.87	1.9	4.4	2.5	64	73.4	1LE1643-1AD4	31	0.0096
1.1	1.27	100 L	865	12.1		78.5	78	75.7	0.62	2.7	2.3	4.8	3	65.4	73	1LE1643-1AD5	36	0.013
1.5	1.75	112 M	875	16.4	IE2	84	83.1	80	0.59	3.75	2.9	5.8	3.6	65	84	1LE1643-1BD2	46	0.028
Voltages													Version		Order code			
50 Hz 230 VΔ/400 VY			60 Hz 460 VY			Standard			2 2		-							
50 Hz 400 VΔ/690 VY			60 Hz 460 VΔ			Standard			3 4		-							
50 Hz 500 VY						Without additional charge			2 7		-							
50 Hz 500 VΔ						Without additional charge			4 0		-							
For other voltages and more information, see from page 3/100													9 0		...			
Types of construction													Version		Order code			
Without flange			IM B3 ¹⁾			Standard			A		-							
With flange			IM B5 ¹⁾			With additional charge			F		-							
For other types of construction and more information, see from page 3/107															...			
Motor protection													Version		Order code			
PTC thermistor with 3 temperature sensors						Standard			B		-							
For other motor protection and more information, see from page 3/117															...			
Terminal box position													Version		Order code(s)			
Terminal box at top						Standard			4									
For other terminal box positions and more information, see from page 3/120																		
Special versions																		
Forced-air cooled motors w/o ext. fan/fan cover (IC418)											1LE1643-...-Z		F90+...+...+...					
For options, see from page 3/129															1LE1643-...-Z ...+...+...+...			

¹⁾ Types derived from IM B3 (IM B6/7/8, IM V6 and IM V5), from IM B5 (IM V3 and IM V1) and from IM B14 (IM V19 and IM V18) are possible, provided that no requirement exists for stamping of the type on the rating plate. The basic type IM B3, IM B5, or IM B14 is stamped as standard on the rating plate. If mounted in a different position, the position must be specified to ensure that the condensation drainage holes are positioned correctly.

Selection and ordering data

Technical specifications at 60 Hz/P50 power rating

Operating values at rated power														Cast-iron series 1LE1543 – Basic Line		$m_{IM\ B3}$	J	
P_{rated} 60 Hz/ P50	P_{rated} 60 Hz/ P60	Frame size	n_{rated} 60 Hz	T_{rated} 60 Hz	Different IE class 60 Hz/P60	η_{rated} 60 Hz, 4/4	η_{rated} 60 Hz, 3/4	η_{rated} 60 Hz, 2/4	$\cos\phi_{rated}$ 60 Hz, 4/4	I_{rated} 60 Hz, 460 V	T_{LR}/I_{LR} 60 Hz	I_{LR}/I_{rated} 60 Hz	T_{β}/I_{β} 60 Hz	$L_{p/A}$ 60 Hz	L_{WA} 60 Hz	Article No.	kg	kgm^2
kW	kW	FS	rpm	Nm		%	%	%		A					dB(A)	dB(A)	▲ New	
<ul style="list-style-type: none"> • Cooling: Self-ventilated (IC411) or with order code F90 forced-air cooled without external fan and fan cover (IC418) • Efficiency according to IEC 60034-30-1: IE3 Premium Efficiency • Insulation: Thermal class 155 (temperature class F), IP55 degree of protection, utilization in accordance with thermal class 130 (temperature class B) 																		
2-pole: 3000 rpm at 50 Hz, 3600 rpm at 60 Hz																		
1.5	1.75	80 M	3485	4.1		85.5	85.5	83.6	0.83	2.65	4.7	10.1	4.7	76	83	▲ 1LE1543-0DA6	22	0.0015
3	3.45	90 L	3530	8.1	IE2	88.5	88.1	86.3	0.83	5.1	4.9	12.4	5.6	76	83	▲ 1LE1543-0EA6	31	0.00301
4	4.55	100 L	3530	10		88.5	88	86.4	0.8	6.6	4.5	12.4	5.8	75	84	1LE1543-1AA6	37	0.0054
5.5	6.3	112 M	3560	14.8		89.5	89.3	88.2	0.86	9	3.1	10.4	4.7	76	83	▲ 1LE1543-1BA6	43	0.00959
11	12.6	132 M	3565	29.5		91	91.3	90.4	0.86	17.6	2.9	10.9	4.7	75	86	1LE1543-1CA6	75	0.031
15	17.3	132 M	3570	40		91	90.9	90.1	0.83	25	3.4	11.1	5.4	78	89	1LE1543-1CA7	85	0.035
22	25.3	160 L	3560	59		91.7	91.8	90.9	0.9	33.5	3.1	9.7	4.5	77	89	1LE1543-1DA6	149	0.073
30	33.5	180 L	3560	80		92.4	92.6	92.1	0.87	47	2.9	8.8	4.5	77	84	1LE1543-1EA6	175	0.094
45	51	200 L	3560	121		93.6	93.6	92.9	0.86	70	3	8.4	3.7	77	88	1LE1543-2AA6	245	0.17
55	62	225 M	3570	147		93.6	93.6	92.8	0.88	84	3.2	8.9	4	75	95	1LE1543-2BA6	370	0.31
75	84	250 M	3575	200	IE2	94.1	93.9	92.9	0.9	111	2.5	7.5	3.2	81	95	1LE1543-2CA6	455	0.56
110	123	280 M	3578	295		95	94.8	94	0.91	160	2.9	8.5	3.5	81	68	1LE1543-2DA6	670	1.1
4-pole: 1500 rpm at 50 Hz, 1800 rpm at 60 Hz																		
1.1	1.27	80 M	1750	6	IE2	86.5	86.4	84.2	0.75	2.15	3.5	8.6	4.4	60	80	▲ 1LE1543-0DB6	24	0.00329
4	4.55	100 L	1768	20		89.5	89.5	87.7	0.77	6.7	3.8	9.5	4.8	71	79	▲ 1LE1543-1AB6	53	0.0149
11	12.6	132 M	1775	59	IE2	92.4	92.6	91.8	0.79	18.9	3.1	8.7	4.1	68	86	1LE1543-1CB6	98	0.046
18.5	21.3	160 L	1780	99		93.6	93.5	92.3	0.75	33	3	9	4.2	67	77	1LE1543-1DB6	126	0.099
30	34.5	180 L	1775	161	IE2	94.1	94.2	93.5	0.78	51	3.3	9.5	4.3	78	88	1LE1543-1EB6	191	0.173
37	42.5	200 L	1780	198	IE2	94.5	94.6	94.2	0.8	61	3.3	9	4	70	88	1LE1543-2AB6	258	0.275
55	63	225 M	1782	295	IE2	95.4	95.7	95.4	0.85	85	3.1	7.4	3	74	95	1LE1543-2BB6	405	0.65
75	86	250 M	1788	400		95.4	95.4	94.8	0.84	117	3.4	8.8	3.8	74	81	1LE1543-2CB6	510	1.1
110	127	280 M	1788	590	IE2	95.8	95.7	94.9	0.85	170	3.4	9.2	3.7	81		1LE1543-2DB6	710	1.8
Voltages																		
50 Hz 230 VΔ/400 VY														Version		Order code		
60 Hz 460 VY														Standard		2		
50 Hz 400 VΔ/690 VY														Standard		3 4		
60 Hz 460 VΔ														Without additional charge		-		
50 Hz 500 VY														Without additional charge		2 7		
50 Hz 500 VΔ														Without additional charge		4 0		
For other voltages and more information, see from page 3/100																9 0		
Types of construction																		
Without flange														Version		Order code		
IM B3 ¹⁾														Standard		A		
With flange														With additional charge		F		
IM B5 ¹⁾																-		
For other types of construction and more information, see from page 3/107																...		
Motor protection																		
Without														Version		Order code		
PTC thermistor with 3 temperature sensors														Standard		A		
For other motor protection and more information, see from page 3/117														With additional charge		B		
																-		
																...		
Terminal box position																		
Terminal box at top														Version		Order code		
For other terminal box positions and more information, see from page 3/120														Standard		4		
Special versions																		
For options, see from page 3/129														1LE1543-		-Z . . . + . . . + . . .		

¹⁾ Types derived from IM B3 (IM B6/7/8, IM V6 and IM V5), from IM B5 (IM V3 and IM V1) and from IM B14 (IM V19 and IM V18) are possible, provided that no requirement exists for stamping of the type on the rating plate. The basic type IM B3, IM B5, or IM B14 is stamped as standard on the rating plate. If mounted in a different position, the position must be specified to ensure that the condensation drainage holes are positioned correctly.

SIMOTICS GP and SIMOTICS SD standard motors

APAC Line · IE3 Premium Efficiency



Cast-iron series SIMOTICS SD 1LE1543 Basic Line with increased power – self-ventilated

Selection and ordering data

Technical specifications at 60 Hz/P50 power rating

Operating values at rated power														Cast-iron series					
P_{rated} , 60 Hz/ P50	P_{rated} , 60 Hz/ P60	Frame size	n_{rated} , 60 Hz	T_{rated} , 60 Hz	Different IE class	η_{rated} , 60 Hz, 4/4	η_{rated} , 60 Hz, 3/4	η_{rated} , 60 Hz, 2/4	$\cos\phi_{rated}$, 60 Hz, 4/4	I_{rated} , 60 Hz, 460 V	T_{LR}/I_{LR} , 60 Hz	I_{LR}/I_{rated} , 60 Hz	T_{β}/I_{β} , 60 Hz	L_{pfA} , 60 Hz	L_{WA} , 60 Hz	1LE1543 – Basic Line	$m_{IM B3}$	J	
kW	kW	FS	rpm	Nm		%	%	%		A						Article No.	kg	kgm ²	
<ul style="list-style-type: none"> Cooling: Self-ventilated (IC411) or with order code F90 forced-air cooled without external fan and fan cover (IC418) Efficiency according to IEC 60034-30-1: IE3 Premium Efficiency Insulation: Thermal class 155 (temperature class F), IP55 degree of protection, utilization in accordance with thermal class 130 (temperature class B) 																			
6-pole: 1000 rpm at 50 Hz, 1200 rpm at 60 Hz																			
18.5	22	180 L	1180	150	IE2	93	93.2	92.6	0.75	33.5	2.9	7.9	3.7	69	84	1LE1543-1EC6	185	0.247	
30	36	200 L	1182	240	IE2	94.1	94.5	94.2	0.77	52	3.2	7.6	3.2	63	83	1LE1543-2AC6	270	0.434	
37	44.5	225 M	1186	300	IE2	94.1	94.3	93.7	0.8	62	3.3	8.2	3.5	70	84	1LE1543-2BC6	395	0.84	
45	54	250 M	1188	360	IE2	94.5	94.7	94.2	0.83	72	2.8	8.1	3.2	69	74	1LE1543-2CC6	480	1.3	
75	90	280 M	1190	600		95	95.1	94.6	0.82	121	4.2	9.5	3.6	70	78	1LE1543-2DC6	630	1.9	
160	192	315 L	1193	1280	IE2	95.8	95.8	95.2	0.81	260	4	9.8	4	68	83	1LE1543-3AC6	1260	5.41	
8-pole: 750 rpm at 50 Hz, 900 rpm at 60 Hz																			
18.5	22	200 L	880	200	IE2	90.2	90.2	89	0.69	37.5	3.5	7.7	4.3	66	83	▲ 1LE1543-2AD6	256	0.405	
37	44.5	250 M	884	400	IE2	92.4	92.9	92.6	0.8	63	2.7	6.5	2.9	64		▲ 1LE1543-2CD6	405	1	
55	66	280 M	890	590	IE2	93.6	93.9	93.4	0.79	93	2.8	6.5	2.8	72		▲ 1LE1543-2DD6	550	1.6	
Voltagess																			
50 Hz 230 VΔ/400 VY														Version		Order code			
60 Hz 460 VY														Standard		2 2		-	
50 Hz 400 VΔ/690 VY														Standard		3 4		-	
50 Hz 500 VY														Without additional charge		2 7		-	
50 Hz 500 VΔ														Without additional charge		4 0		-	
																9 0		...	
For other voltages and more information, see from page 3/100																			
Types of construction																			
Without flange														Version		Order code			
IM B3 ¹⁾														Standard		A		-	
With flange														With additional charge		F		-	
																■		...	
For other types of construction and more information, see from page 3/107																			
Motor protection																			
Without														Version		Order code			
PTC thermistor with 3 temperature sensors														Standard		A		-	
														With additional charge		B		-	
																■		...	
For other motor protection and more information, see from page 3/117																			
Terminal box position																			
Terminal box at top														Version		Order code(s)			
														Standard		4			
For other terminal box positions and more information, see from page 3/120																			
Special versions																			
																1LE1543-...-Z		...+...+...+...	
For options, see from page 3/129																			

¹⁾ Types derived from IM B3 (IM B6/7/8, IM V6 and IM V5), from IM B5 (IM V3 and IM V1) and from IM B14 (IM V19 and IM V18) are possible, provided that no requirement exists for stamping of the type on the rating plate. The basic type IM B3, IM B5, or IM B14 is stamped as standard on the rating plate. If mounted in a different position, the position must be specified to ensure that the condensation drainage holes are positioned correctly.



Cast-iron series SIMOTICS SD 1LE1643 Performance Line with increased power – self-ventilated

Selection and ordering data

Technical specifications at 60 Hz/P50 power rating

Operating values at rated power															Cast-iron series 1LE1643 – Performance Line Article No.	$m_{IM\ B3}$	J		
$P_{rated, 60\ Hz/ P50}$ kW	$P_{rated, 60\ Hz/ P60}$ kW	Frame size FS	$n_{rated, 60\ Hz}$ rpm	$T_{rated, 60\ Hz}$ Nm	Different IE class 60 Hz/P60	$\eta_{rated, 60\ Hz, 4/4}$ %	$\eta_{rated, 60\ Hz, 3/4}$ %	$\eta_{rated, 60\ Hz, 2/4}$ %	$\cos\phi_{rated, 60\ Hz, 4/4}$	$I_{rated, 60\ Hz, 460\ V}$ A	$T_{LR}/I_{rated, 60\ Hz}$	$I_{LR}/I_{rated, 60\ Hz}$	$T_{\beta}/I_{rated, 60\ Hz}$	$L_{p\ \mu A, 60\ Hz}$ dB(A)				$L_{WA, 60\ Hz}$ dB(A)	▲ New
2-pole: 3000 rpm at 50 Hz, 3600 rpm at 60 Hz																			
4	4.55	100 L	3530	10			88.5	88	86.4	0.8	6.6	4.5	12.4	5.8	75	84	1LE1643-1AA6	37	0.0054
11	12.6	132 M	3565	29.5			91	91.3	90.4	0.86	17.6	2.9	10.9	4.7	75	86	1LE1643-1CA6	75	0.031
15	17.3	132 M	3570	40			91	90.9	90.1	0.83	25	3.4	11.1	5.4	78	89	1LE1643-1CA7	85	0.035
22	25.3	160 L	3560	59			91.7	91.8	90.9	0.9	33.5	3.1	9.7	4.5	77	89	1LE1643-1DA6	149	0.073
30	33.5	180 L	3560	80			92.4	92.6	92.1	0.87	47	2.9	8.8	4.5	77	84	1LE1643-1EA6	175	0.094
45	51	200 L	3560	121			93.6	93.6	92.9	0.86	70	3	8.4	3.7	77	88	1LE1643-2AA6	245	0.17
55	62	225 M	3570	147			93.6	93.6	92.8	0.88	84	3.2	8.9	4	75	95	1LE1643-2BA6	370	0.31
75	84	250 M	3575	200	IE2		94.1	93.9	92.9	0.9	111	2.5	7.5	3.2	81	95	1LE1643-2CA6	455	0.56
110	123	280 M	3578	295			95	94.8	94	0.91	160	2.9	8.5	3.5	81	68	1LE1643-2DA6	670	1.1
4-pole: 1500 rpm at 50 Hz, 1800 rpm at 60 Hz																			
11	12.6	132 M	1775	59	IE2		92.4	92.6	91.8	0.79	18.9	3.1	8.7	4.1	68	86	1LE1643-1CB6	98	0.046
18.5	21.3	160 L	1780	99			93.6	93.5	92.3	0.75	33	3	9	4.2	67	77	1LE1643-1DB6	126	0.099
30	34.5	180 L	1775	161	IE2		94.1	94.2	93.5	0.78	51	3.3	9.5	4.3	78	88	1LE1643-1EB6	191	0.173
37	42.5	200 L	1780	198	IE2		94.5	94.6	94.2	0.8	61	3.3	9	4	70	88	1LE1643-2AB6	258	0.275
55	63	225 M	1782	295	IE2		95.4	95.7	95.4	0.85	85	3.1	7.4	3	74	95	1LE1643-2BB6	405	0.65
75	86	250 M	1788	400			95.4	95.4	94.8	0.84	117	3.4	8.8	3.8	74	81	1LE1643-2CB6	510	1.1
110	127	280 M	1788	590	IE2		95.8	95.7	94.9	0.85	170	3.4	9.2	3.7	81		1LE1643-2DB6	710	1.8
6-pole: 1000 rpm at 50 Hz, 1200 rpm at 60 Hz																			
18.5	22	180 L	1180	150	IE2		93	93.2	92.6	0.75	33.5	2.9	7.9	3.7	69	84	1LE1643-1EC6	185	0.247
30	36	200 L	1182	240	IE2		94.1	94.5	94.2	0.77	52	3.2	7.6	3.2	63	83	1LE1643-2AC6	270	0.434
37	44.5	225 M	1186	300	IE2		94.1	94.3	93.7	0.8	62	3.3	8.2	3.5	70	84	1LE1643-2BC6	395	0.84
45	54	250 M	1188	360	IE2		94.5	94.7	94.2	0.83	72	2.8	8.1	3.2	69	74	1LE1643-2CC6	480	1.3
75	90	280 M	1190	600			95	95.1	94.6	0.82	121	4.2	9.5	3.6	70	78	1LE1643-2DC6	630	1.9
160	192	315 L	1193	1280	IE2		95.8	95.8	95.2	0.81	260	4	9.8	4	68	83	1LE1643-3AC6	1260	5.41
8-pole: 750 rpm at 50 Hz, 900 rpm at 60 Hz																			
18.5	22	200 L	880	200	IE2		90.2	90.2	89	0.69	37.5	3.5	7.7	4.3	66	83	▲ 1LE1643-2AD6	256	0.405
37	44.5	250 M	884	400	IE2		92.4	92.9	92.6	0.8	63	2.7	6.5	2.9	64		▲ 1LE1643-2CD6	405	1
55	66	280 M	890	590	IE2		93.6	93.9	93.4	0.79	93	2.8	6.5	2.8	72		▲ 1LE1643-2DD6	550	1.6
Voltages															Version		Order code		
50 Hz 230 VΔ/400 VY					60 Hz 460 VY					Standard		2 2		-					
50 Hz 400 VΔ/690 VY					60 Hz 460 VΔ					Standard		3 4		-					
50 Hz 500 VY										Without additional charge		2 7		-					
50 Hz 500 VΔ										Without additional charge		4 0		-					
For other voltages and more information, see from page 3/100															9 0		...		
Types of construction															Version		Order code		
Without flange					IM B3 ¹⁾					Standard		A		-					
With flange					IM B5 ¹⁾					With additional charge		F		-					
For other types of construction and more information, see from page 3/107																	...		
Motor protection															Version		Order code		
PTC thermistor with 3 temperature sensors										Standard		B		-					
For other motor protection and more information, see from page 3/117																	...		
Terminal box position															Version		Order code(s)		
Terminal box at top										Standard		4							
For other terminal box positions and more information, see from page 3/120																			
Special versions																	Order code(s)		
For options, see from page 3/129																	1LE1643-...-Z ...+...+...+...		



¹⁾ Types derived from IM B3 (IM B6/7/8, IM V6 and IM V5), from IM B5 (IM V3 and IM V1) and from IM B14 (IM V19 and IM V18) are possible, provided that no requirement exists for stamping of the type on the rating plate. The basic type IM B3, IM B5, or IM B14 is stamped as standard on the rating plate. If mounted in a different position, the position must be specified to ensure that the condensation drainage holes are positioned correctly.

SIMOTICS GP and SIMOTICS SD standard motors

APAC Line · IE2 High Efficiency



Aluminum series SIMOTICS GP 1LE1041 – self-ventilated or forced-air cooled

Selection and ordering data

Technical specifications at 60 Hz/P50 power rating

Operating values at rated power														Aluminum series		m _{IM B3}	J	
P _{rated} , 60 Hz/ P50	P _{rated} , 60 Hz/ P60	Frame size	n _{rated} , 60 Hz	T _{rated} , 60 Hz	η _{rated} , 60 Hz, 4/4	η _{rated} , 60 Hz, 3/4	η _{rated} , 60 Hz, 2/4	η _{rated} , 60 Hz, 4/4	cosφ _{rated} , 60 Hz, 460 V	I _{rated} , 60 Hz	T _{LR} / T _{rated} , 60 Hz	I _{LR} / I _{rated} , 60 Hz	T _β / T _{rated} , 60 Hz	L _p fA, 60 Hz	L _{WA} , 60 Hz			1LE1041
kW	kW	FS	rpm	Nm	%	%	%	%	A	A				dB(A)	dB(A)			
<ul style="list-style-type: none"> • Cooling: Self-ventilated (IC411) or with order code F90 forced-air cooled without external fan and fan cover (IC418) • Efficiency according to IEC 60034-30-1: IE2 High Efficiency • Insulation: Thermal class 155 (temperature class F), IP55 degree of protection, utilization in accordance with thermal class 130 (temperature class B) 																		
2-pole: 3000 rpm at 50 Hz, 3600 rpm at 60 Hz																		
0.75	0.86	80 M	3445	2.1	75.5	76.2	74.8	0.83	1.5	2.1	6	3	64	75		1LE1041-0DA2	9	0.0008
1.5	1.75	90 S	3505	4.1	84	83.5	80.7	0.82	2.75	3.1	8.5	4.5	69	81		1LE1041-0EA0	13	0.0017
2.2	2.55	90 L	3510	6	85.5	85.2	82.6	0.83	3.9	3	8.7	4.6	69	81		1LE1041-0EA4	16	0.0021
4	4.55	112 M	3555	9.9	87.5	86.9	84.6	0.83	6.4	2.7	9.9	4.5	73	85		1LE1041-1BA2	27	0.0092
5.5	6.3	132 S	3555	14.8	88.5	88.4	87	0.86	9.1	2	7.6	3.3	72	84		1LE1041-1CA0	39	0.02
7.5	8.6	132 S	3560	20	89.5	89.7	88.7	0.87	12.1	2.3	8.2	3.6	72	84		1LE1041-1CA1	43	0.024
11	12.6	160 M	3560	29.5	90.2	89.6	87.4	0.86	17.8	2.4	8.2	3.6	77	89		1LE1041-1DA2	67	0.045
15	17.3	160 M	3565	40	90.2	90	88.6	0.87	24	2.8	8.4	3.9	77	89		1LE1041-1DA3	75	0.053
18.5	21.3	160 L	3565	49.5	91	90.8	89.5	0.87	29.5	3.3	8.9	4.1	77	89		1LE1041-1DA4	84	0.061
4-pole: 1500 rpm at 50 Hz, 1800 rpm at 60 Hz																		
0.75	0.86	80 M	1750	4.1	78	77.3	74.4	0.72	1.68	2.5	6.8	3.8	60	68		1LE1041-0DB3	11	0.0021
1.5	1.75	90 L	1745	8.2	84	84	81.9	0.75	3	2.9	7.5	4	58	70		1LE1041-0EB4	15	0.0036
2.2	2.55	100 L	1760	11.9	87.5	88.3	87.4	0.78	4.05	2.5	8.1	3.9	62	74		1LE1041-1AB4	21	0.0086
4	4.55	112 M	1770	20	87.5	87.2	85.1	0.77	6.9	3	8.7	4	62	74		1LE1041-1BB2	29	0.014
5.5	6.3	132 S	1770	29.5	89.5	89.6	88.1	0.78	9.9	2.6	8	3.3	68	80		1LE1041-1CB0	42	0.022
7.5	8.6	132 M	1770	40.5	89.5	90	89.3	0.82	12.8	2.7	8	3.4	68	80		1LE1041-1CB2	49	0.028
11	12.6	160 M	1775	59	91	91.2	90.1	0.84	18.1	2.5	7.7	3.2	69	81		1LE1041-1DB2	71	0.055
15	17.3	160 L	1780	80	91	91.1	90.1	0.84	24.5	2.6	8.5	3.4	69	81		1LE1041-1DB4	83	0.071
Voltages (≤ 600 V)																		
50 Hz 230 VΔ/400 VY														Version		Order code		
50 Hz 400 VΔ														Standard		2 2		
50 Hz 500 VY														Standard		3 4		
50 Hz 500 VΔ														Without additional charge		2 7		
														Without additional charge		4 0		
																9 0		
For other voltages and more information, see from page 3/97																		
Types of construction																		
With flange IM B5 ¹⁾														Version		Order code		
With flange IM B14 ¹⁾														With additional charge		F		
														With additional charge		K		
For other types of construction and more information, see from page 3/103																		
Motor protection																		
Without														Version		Order code		
PTC thermistor with 1 or 3 temperature sensors (frame sizes 80, 90 or 100 to 200)														Standard		A		
														With additional charge		B		
For other motor protection and more information, see from page 3/116																		
Terminal box position																		
Terminal box at top														Version		Order code		
														Standard		4		
For other terminal box positions and more information, see from page 3/119																		
Special versions																		
Forced-air cooled motors w/o ext. fan/fan cover (IC418)																Order code(s)		
														1LE1041-....		-Z F90+...+...+...		
														1LE1041-....		-Z ...+...+...+...		
For options, see from page 3/122																		

¹⁾ Types derived from IM B5 (IM V3 and IM V1) and from IM B14 (IM V19 and IM V18) are possible, provided that no requirements exist for condensation drainage holes (H03) and stamping of the type on the rating plate. The basic type IM B5 or IM B14 is stamped as standard on the rating plate. For orders with condensation drainage holes (H03), the type must be specified.

Selection and ordering data

Technical specifications at 60 Hz/P50 power rating

Operating values at rated power													Aluminum series		m _{IM} B3		J		
P _{rated} , 60 Hz/ P50	P _{rated} , 60 Hz/ P60	Frame size	n _{rated} , 60 Hz	T _{rated} , 60 Hz	η _{rated} , 60 Hz	η _{rated} , 60 Hz	η _{rated} , 60 Hz	η _{rated} , 60 Hz	cosφ _{rated} , 60 Hz	I _{rated} , 60 Hz	T _{LR} / I _{LR} , 60 Hz	T _B / I _B , 60 Hz	L _p fA, 60 Hz	L _{WA} , 60 Hz	1LE1041	Article No.			
kW	kW	FS	rpm	Nm	%	%	%	%	A	A			dB(A)	dB(A)					
<ul style="list-style-type: none"> Cooling: Self-ventilated (IC411) or with order code F90 forced-air cooled without external fan and fan cover (IC418) Efficiency according to IEC 60034-30-1: IE2 High Efficiency Insulation: Thermal class 155 (temperature class F), IP55 degree of protection, utilization in accordance with thermal class 130 (temperature class B) 																			
6-pole: 1000 rpm at 50 Hz, 1200 rpm at 60 Hz																			
0.75	0.86	90 S	1145	6.3	73	72.7	69.7	0.65	1.98	2.2	4.5	3	46	58	1LE1041-0EC0	16			0.003
1.5	1.75	100 L	1175	12.2	86.5	86.3	84.2	0.69	3.15	2.2	6.4	3.2	62	74	1LE1041-1AC4	25			0.011
2.2	2.55	112 M	1170	18	87.5	87.6	85.9	0.73	4.3	2.1	6.3	3.2	65	77	1LE1041-1BC2	29			0.014
4	4.55	132 M	1180	30	87.5	87.5	85.7	0.71	7.5	1.9	6.2	3	67	79	1LE1041-1CC2	43			0.029
5.5	6.3	132 M	1175	44.5	89.5	89.9	88.9	0.73	10.6	2.1	6.5	2.9	67	79	1LE1041-1CC3	52			0.037
7.5	8.6	160 M	1180	61	89.5	89.6	88.4	0.73	14.4	2.1	5.4	2.5	70	82	1LE1041-1DC2	77			0.075
11	12.6	160 L	1180	89	90.2	90.5	89.5	0.74	20.5	2.2	5.5	2.5	70	82	1LE1041-1DC4	93			0.098
Voltages (≤ 600 V)													Version				Order code		
50 Hz 230 VΔ/400 VY			60 Hz 460 VY			Standard			2		2				-				
50 Hz 400 VΔ			60 Hz 460 VΔ			Standard			3		4				-				
50 Hz 500 VY						Without additional charge			2		7				-				
50 Hz 500 VΔ						Without additional charge			4		0				-				
For other voltages and more information, see from page 3/97																			
Types of construction													Version				Order code		
With flange			IM B5 ¹⁾			With additional charge			F						-				
With flange			IM B14 ¹⁾			With additional charge			K						-				
For other types of construction and more information, see from page 3/103																			
Motor protection													Version				Order code		
Without						Standard			A						-				
PTC thermistor with 1 or 3 temperature sensors (frame sizes 90 or 100 to 200)						With additional charge			B						-				
For other motor protection and more information, see from page 3/116																			
Terminal box position													Version				Order code(s)		
Terminal box at top						Standard			4										
For other terminal box positions and more information, see from page 3/119																			
Special versions																	Order code(s)		
Forced-air cooled motors w/o ext. fan/fan cover (IC418)													1LE1041-....		-Z		F90+...+...+...		
For options, see from page 3/122													1LE1041-....		-Z		...+...+...+...		



¹⁾ Types derived from IM B5 (IM V3 and IM V1) and from IM B14 (IM V19 and IM V18) are possible, provided that no requirements exist for condensation drainage holes (H03) and stamping of the type on the rating plate. The basic type IM B5 or IM B14 is stamped as standard on the rating plate. For orders with condensation drainage holes (H03), the type must be specified.

SIMOTICS GP and SIMOTICS SD standard motors

APAC Line · IE2 High Efficiency



Aluminum series SIMOTICS GP 1LE1041 with increased power – self-ventilated or forced-air cooled

Selection and ordering data

Technical specifications at 60 Hz/P50 power rating

Operating values at rated power														Aluminum series					
P_{rated} 60 Hz/ P50	P_{rated} 60 Hz/ P60	Frame size	n_{rated} 60 Hz	T_{rated} 60 Hz	Different IE class	η_{rated} 60 Hz, 4/4	η_{rated} 60 Hz, 3/4	η_{rated} 60 Hz, 2/4	$\cos\phi_{rated}$ 60 Hz, 4/4	I_{rated} 60 Hz, 460 V	T_{LR}/I_{rated} 60 Hz	I_{LR}/I_{rated} 60 Hz	T_B/I_{rated} 60 Hz	L_{pFA} 60 Hz	L_{WA} 60 Hz	Article No.	$m_{IM B3}$	J	
kW	kW	FS	rpm	Nm		%	%	%		A							kg	kgm ²	
<ul style="list-style-type: none"> Cooling: Self-ventilated (IC411) or with order code F90 forced-air cooled without external fan and fan cover (IC418) Efficiency according to IEC 60034-30-1: IE2 High Efficiency Insulation: Thermal class 155 (temperature class F), IP55 degree of protection, utilization in accordance with thermal class 130 (temperature class B) 																			
2-pole: 3000 rpm at 50 Hz, 3600 rpm at 60 Hz																			
4	4.55	100 L	3530	10		87.5	87.5	85.9	0.84	6.3	3.3	9.6	4.6	71	83	1LE1041-1AA6	26	0.0054	
5.5	6.3	112 M	3550	14.8		88.5	88.6	87.4	0.87	9	2.8	9.9	4.5	73	85	1LE1041-1BA6	34	0.012	
11	12.6	132 M	3555	29.5		90.2	90.5	89.8	0.9	17	2.7	9.3	3.6	72	84	1LE1041-1CA6	57	0.031	
15	17.3	132 L	3555	40.5		90.2	90.6	90.3	0.91	23	2.5	10	4.7	72	84	1LE1041-1CA7	65	0.035	
22	25.3	160 L	3565	59		91	91	89.9	0.89	34	3.6	9.6	4.3	77	89	1LE1041-1DA6	94	0.068	
4-pole: 1500 rpm at 50 Hz, 1800 rpm at 60 Hz																			
4	4.55	100 L	1770	20		87.5	87.7	86.3	0.76	7	2.8	9.2	4.3	62	74	1LE1041-1AB6	30	0.014	
5.5	6.3	112 M	1765	30		89.5	89.3	87.4	0.8	9.6	2.8	8.3	3.6	62	74	1LE1041-1BB6	34	0.017	
11	12.6	132 M	1770	59		91	91.5	90.8	0.82	18.5	2.9	8.5	3.6	68	80	1LE1041-1CB6	64	0.046	
18.5	21.3	160 L	1780	99		92.4	92.4	91.3	0.84	30	2.9	8.8	3.6	69	81	1LE1041-1DB6	100	0.085	
6-pole: 1000 rpm at 50 Hz, 1200 rpm at 60 Hz																			
7.5	8.6	132 M	1175	61		89.5	89.8	88.7	0.72	14.6	2.2	6.4	3	67	79	1LE1041-1CC6	64	0.046	
15	17.3	160 L	1180	121	IE1	90.2	90.3	89.2	0.73	28.5	2.3	5.8	2.6	70	82	1LE1041-1DC6	115	0.12	
Voltages (≤ 600 V) ¹⁾														Version		Order code			
50 Hz 230 V Δ /400 VY				60 Hz 460 VY				Standard		2	2			-					
50 Hz 400 V Δ				60 Hz 460 V Δ				Standard		3	4			-					
50 Hz 500 VY								Without additional charge		2	7			-					
50 Hz 500 V Δ								Without additional charge		4	0			-					
														9	0			...	
For other voltages and more information, see from page 3/97																			
Types of construction ²⁾														Version		Order code			
With flange				IM B5 ³⁾				With additional charge				F		-					
With flange				IM B14 ³⁾				With additional charge				K		-					
																...			
For other types of construction and more information, see from page 3/103																			
Motor protection														Version		Order code			
Without								Standard				A		-					
PTC thermistor with 3 temperature sensors								With additional charge				B		-					
																...			
For other motor protection and more information, see from page 3/116																			
Terminal box position														Version		Order code			
Terminal box at top								Standard				4							
For other terminal box positions and more information, see from page 3/119																			
Special versions																Order code(s)			
Forced-air cooled motors w/o ext. fan/fan cover (IC418)														1LE1041-....		-Z F90+...+...+...			
For options, see from page 3/122														1LE1041-....		-Z ...+...+...+...			

1) Operating voltages only ≤ 600 V admissible in accordance with MG1 Table 12-11.

2) Types of construction with feet are not possible for 2-pole, 4-pole and 6-pole motors ≤ 200 hp in accordance with MG1 Table 12-11.

3) Types derived from IM B5 (IM V3 and IM V1) and from IM B14 (IM V19 and IM V18) are possible, provided that no requirements exist for condensation drainage holes (H03) and stamping of the type on the rating plate. The basic type IM B5 or IM B14 is stamped as standard on the rating plate. For orders with condensation drainage holes (H03), the type must be specified.

Selection and ordering data

Technical specifications at 60 Hz/P50 power rating

Operating values at rated power														Cast-iron series		m _{IM B3}	J				
P _{rated} , 60 Hz/ P50	P _{rated} , 60 Hz/ P60	Frame size	n _{rated} , 60 Hz	T _{rated} , 60 Hz	Differ- ent IE class	η _{rated} , 60 Hz, 4/4	η _{rated} , 60 Hz, 3/4	η _{rated} , 60 Hz, 2/4	η _{rated} , 60 Hz, 4/4	cosφ _{rated} , 60 Hz, 4/4	I _{rated} , 60 Hz, 460 V	T _{LR} / I _{rated} , 60 Hz	I _{LR} / I _{rated} , 60 Hz	T _B / I _{rated} , 60 Hz	L _p fA, 60 Hz			L _{WA} , 60 Hz	1LE1541 – Basic Line	Article No.	kg
kW	kW	FS	rpm	Nm		%	%	%	%		A										
<ul style="list-style-type: none"> Cooling: Self-ventilated (IC411) or with order code F90 forced-air cooled without external fan and fan cover (IC418) Efficiency according to IEC 60034-30-1: IE2 High Efficiency Insulation: Thermal class 155 (temperature class F), IP55 degree of protection, utilization in accordance with thermal class 130 (temperature class B) 																					
2-pole: 3000 rpm at 50 Hz, 3600 rpm at 60 Hz																					
22	24.5	180 M	3550	59		91	90.8	89.5	0.86	35.5	3	8.4	4.1	81	84		1LE1541-1EA2	145	0.069		
30	33.5	200 L	3565	80		91.7	91.2	89.6	0.86	47.5	2.9	7.7	3.8	82	89		1LE1541-2AA4	205	0.13		
37	41.5	200 L	3565	99		92.4	92.2	91	0.87	58	3.3	8.1	3.8	82	89		1LE1541-2AA5	225	0.15		
45	51	225 M	3570	120		93	92.7	91.3	0.88	69	3.1	8.7	3.8	77	90		1LE1541-2BA2	295	0.23		
55	62	250 M	3575	147		93	92.5	91	0.89	83	2.4	7.4	3.5	80	94		1LE1541-2CA2	360	0.4		
75	84	280 S	3580	200		93.6	92.9	91.1	0.87	116	2.8	7.7	3.5	81	95		1LE1541-2DA0	490	0.71		
90	101	280 M	3578	240		94.5	94.2	93.1	0.88	136	2.7	7.9	3.4	81	95		1LE1541-2DA2	530	0.83		
110	123	315 S	3585	295		94.5	94	92.5	0.9	162	2.6	7.9	3.3	82	96		1LE1541-3AA0	720	1.3		
132	148	315 M	3585	350		95	94.7	93.6	0.91	192	2.7	8.1	3.4	82	96		1LE1541-3AA2	880	1.6		
160	180	315 L	3585	425		95	94.6	93.3	0.92	230	2.7	8	3.2	84	99		1LE1541-3AA4	930	1.8		
200	224	315 L	3585	530		95.4	95.2	94.2	0.92	285	3.1	8.3	3.2	84	99		1LE1541-3AA5	1130	2.2		
4-pole: 1500 rpm at 50 Hz, 1800 rpm at 60 Hz																					
18.5	21.3	180 M	1770	100		92.4	92.6	91.9	0.83	30.5	2.8	7.7	3.9	64	77		1LE1541-1EB2	160	0.12		
22	25.3	180 L	1770	119		92.4	92.5	91.8	0.83	36	3	8.4	3.9	72	79		1LE1541-1EB4	168	0.13		
30	34.5	200 L	1778	161		93	93.1	92.2	0.84	48	3.2	8.2	3.7	72	79		1LE1541-2AB5	220	0.2		
37	42.5	225 S	1778	199		93	93.2	92.5	0.87	57	2.7	7.2	3.3	69	82		1LE1541-2BB0	280	0.42		
45	52	225 M	1778	240		93.6	93.8	93.1	0.86	70	3	7.6	3.5	69	83		1LE1541-2BB2	305	0.46		
55	63	250 M	1785	295		94.1	94.1	93.3	0.84	87	3.1	7.3	3.3	69	83		1LE1541-2CB2	385	0.75		
75	86	280 S	1788	400		94.5	94.3	93.2	0.87	114	2.7	7.6	3.2	79	92		1LE1541-2DB0	550	1.3		
90	104	280 M	1788	480		94.5	94.3	93.3	0.87	137	2.9	8.1	3.4	78	92		1LE1541-2DB2	570	1.4		
110	127	315 S	1790	590		95	94.8	93.8	0.86	169	3.1	8	3.3	79	94		1LE1541-3AB0	740	2		
132	152	315 M	1790	700		95	94.8	94	0.86	205	3.1	7.8	3.2	79	93		1LE1541-3AB2	870	2.3		
160	184	315 L	1790	850		95	94.7	93.5	0.87	245	3.1	8.3	3.2	80	95		1LE1541-3AB4	940	2.8		
200	230	315 L	1792	1070		95.4	94.7	93.6	0.86	305	3.8	9	3.2	84	98		1LE1541-3AB5	1140	3.5		
Voltagess														Version		Order code					
50 Hz 230 VΔ/400 VY			60 Hz 460 VY			Standard		2		2		-									
50 Hz 400 VΔ/690 VY			60 Hz 460 VΔ			Standard		3		4		-									
50 Hz 500 VY						Without additional charge		2		7		-									
50 Hz 500 VΔ						Without additional charge		4		0		-									
For other voltages and more information, see from page 3/100														9		0		...			
Types of construction														Version		Order code					
With flange			IM B5 ¹⁾			With additional charge		F				-									
For other types of construction and more information, see from page 3/107																...					
Motor protection														Version		Order code					
Without						Standard		A				-									
PTC thermistor with 3 temperature sensors						With additional charge		B				-									
For other motor protection and more information, see from page 3/117																...					
Terminal box position														Version		Order code(s)					
Terminal box at top						Standard		4													
For other terminal box positions and more information, see from page 3/120																					
Special versions														Version		Order code(s)					
Forced-air cooled motors w/o ext. fan/fan cover (IC418)														1LE1541-....		-Z F90 +...+...+...+...					
For options, see from page 3/129														1LE1541-....		-Z ...+...+...+...+...					

¹⁾ Types derived from IM B5 (IM V3 and IM V1) and from IM B14 (IM V19 and IM V18) are possible, provided that no requirement exists for stamping of the type on the rating plate. The basic type IM B5 or IM B14 is stamped as standard on the rating plate. If mounted in a different position, the position must be specified to ensure that the condensation drainage holes are positioned correctly.



SIMOTICS GP and SIMOTICS SD standard motors

APAC Line · IE2 High Efficiency



Cast-iron series SIMOTICS SD 1LE1541 Basic Line – self-ventilated or forced-air cooled

Selection and ordering data

Technical specifications at 60 Hz/P50 power rating

Operating values at rated power														Cast-iron series				
$P_{rated, 60 Hz}$	$P_{rated, P50}$	Frame size	$n_{rated, 60 Hz}$	$T_{rated, 60 Hz}$	Different IE class	$\eta_{rated, 60 Hz, 4/4}$	$\eta_{rated, 60 Hz, 3/4}$	$\eta_{rated, 60 Hz, 2/4}$	$\cos\phi_{rated, 60 Hz, 4/4}$	$I_{rated, 60 Hz, 460 V}$	$T_{LR}/T_{rated, 60 Hz}$	$I_{LR}/I_{rated, 60 Hz}$	$T_p/I_{rated, 60 Hz}$	$L_{pFA, 60 Hz}$	$L_{WA, 60 Hz}$	1LE1541 – Basic Line	$m_{IM B3}$	J
kW	kW	FS	rpm	Nm		%	%	%		A						Article No.	kg	kgm ²

- Cooling: Self-ventilated (IC411) or with order code F90 forced-air cooled without external fan and fan cover (IC418)
- Efficiency according to IEC 60034-30-1: IE2 High Efficiency
- Insulation: Thermal class 155 (temperature class F), IP55 degree of protection, utilization in accordance with thermal class 130 (temperature class B)

6-pole: 1000 rpm at 50 Hz, 1200 rpm at 60 Hz

15	18	180 L	1178	122		90.2	90.2	89	0.77	27	2.8	6.9	3.4	60	73	1LE1541-1EC4	153	0.17
18.5	22	200 L	1182	149	IE1	91.7	92	91.5	0.81	31.5	2.6	6.7	3	66	79	1LE1541-2AC4	198	0.25
22	26.5	200 L	1182	178	IE1	91.7	92.1	91.6	0.81	37	3	7.4	3	66	79	1LE1541-2AC5	220	0.3
30	36	225 M	1182	240	IE1	93	93.3	92.6	0.83	49	2.9	7	3.1	66	79	1LE1541-2BC2	300	0.58
37	44.5	250 M	1185	300	IE1	93	93.3	92.6	0.83	60	3.3	7.3	2.8	66	79	1LE1541-2CC2	370	0.86
45	54	280 S	1188	360	IE1	93.6	93.8	93.1	0.84	72	3.1	7.4	3	67	81	1LE1541-2DC0	460	1.1
55	66	280 M	1188	440	IE1	93.6	93.9	93.4	0.85	87	3.1	7.2	2.9	67	81	1LE1541-2DC2	510	1.37
75	90	315 S	1190	600	IE1	94.1	94.1	93.2	0.83	121	2.7	7.5	3	67	82	1LE1541-3AC0	660	2.1
90	108	315 M	1190	720	IE1	94.1	94.4	93.5	0.84	143	2.9	7.6	3.1	68	83	1LE1541-3AC2	730	2.5
110	132	315 L	1190	880	IE1	95	95	94.6	0.85	171	3.3	8.1	3.2	69	84	1LE1541-3AC4	940	3.6
132	158	315 L	1190	1060		95	95	94.4	0.85	205	3.7	9.2	3.6	69	84	1LE1541-3AC5	990	4.02
160	192	315 L	1192	1280		95	94.9	94.2	0.85	250	3.8	9.3	3.4	71	85	1LE1541-3AC6	1160	4.7

Voltages		Version	Order code
50 Hz 230 VΔ/400 VY	60 Hz 460 VY	Standard	2 2
50 Hz 400 VΔ/690 VY	60 Hz 460 VΔ	Standard	3 4
50 Hz 500 VY		Without additional charge	2 7
50 Hz 500 VΔ		Without additional charge	4 0
For other voltages and more information, see from page 3/100			9 0

Types of construction ¹⁾		Version	Order code
With flange	IM B5 ²⁾	With additional charge	F
For other types of construction and more information, see from page 3/107			...

Motor protection		Version	Order code
Without		Standard	A
PTC thermistor with 3 temperature sensors		With additional charge	B
For other motor protection and more information, see from page 3/117			...

Terminal box position		Version	Order code
Terminal box at top		Standard	4
For other terminal box positions and more information, see from page 3/120			...

Special versions		Version	Order code(s)
Forced-air cooled motors w/o ext. fan/fan cover (IC418)			1LE1541-...-Z F90 +...+...+...
For options, see from page 3/129			1LE1541-...-Z ...+...+...+...

¹⁾ Types of construction with feet are not possible for 2-pole, 4-pole and 6-pole motors ≤ 200 hp in accordance with MG1 Table 12-11.

²⁾ Types derived from IM B5 (IM V3 and IM V1) and from IM B14 (IM V19 and IM V18) are possible, provided that no requirement exists for stamping of the type on the rating plate. The basic type IM B5 or IM B14 is stamped as standard on the rating plate. If mounted in a different position, the position must be specified to ensure that the condensation drainage holes are positioned correctly.



Selection and ordering data

Technical specifications at 60 Hz/P50 power rating

Operating values at rated power														Cast-iron series				
$P_{rated, 60 Hz}$ P50 kW	$P_{rated, 60 Hz}$ P60 kW	Frame size	$n_{rated, 60 Hz}$ rpm	$T_{rated, 60 Hz}$ Nm	Different IE class	$\eta_{rated, 60 Hz, 4/4}$ %	$\eta_{rated, 60 Hz, 3/4}$ %	$\eta_{rated, 60 Hz, 2/4}$ %	$\cos\phi_{rated, 60 Hz, 4/4}$ %	$I_{rated, 60 Hz, 460 V}$ A	$T_{LR}/I_{rated, 60 Hz}$ °C/A	$I_{R}/I_{rated, 60 Hz}$ %	$T_{P}/I_{rated, 60 Hz}$ °C/A	$L_{p/A, 60 Hz}$ dB(A)	$L_{WA, 60 Hz}$ dB(A)	1LE1541 – Basic Line	$m_{IM B3}$ kg	J kgm ²
• Cooling: Self-ventilated (IC411) or with order code F90 forced-air cooled without external fan and fan cover (IC418) • Efficiency according to IEC 60034-30-1: IE2 High Efficiency • Insulation: Thermal class 155 (temperature class F), IP55 degree of protection, utilization in accordance with thermal class 130 (temperature class B)																		
2-pole: 3000 rpm at 50 Hz, 3600 rpm at 60 Hz																		
30	33.5	180 L	3550	81		91.7	91.7	90.6	0.89	46	2.5	8.5	3.7	81	83	1LE1541-1EA6	175	0.094
45	51	200 L	3560	121		93	93	92.4	0.86	71	3	8.4	3.7	82	89	1LE1541-2AA6	245	0.176
55	62	225 M	3565	147		93	92.8	91.8	0.88	84	2.8	7.9	3.6	78	91	1LE1541-2BA6	320	0.26
75	84	250 M	3578	200		93.6	93.1	91.6	0.85	118	2.4	7.7	3.5	80	94	1LE1541-2CA6	390	0.463
110	123	280 M	3582	295		94.5	94.4	93.5	0.9	162	3.5	9.6	3.9	84	96	1LE1541-2DA6	650	1.2
4-pole: 1500 rpm at 50 Hz, 1800 rpm at 60 Hz																		
30	34.5	180 L	1770	162		93	93.2	92.7	0.8	51	2.6	8.7	3.9	71	78	1LE1541-1EB6	184	0.159
37	42.5	200 L	1775	199		93	93.4	93.1	0.84	59	2.6	8.4	3.3	71	78	1LE1541-2AB6	240	0.246
55	63	225 M	1780	295		94.1	94.4	94	0.84	87	2.8	7.1	3	72	85	1LE1541-2BB6	320	0.47
75	86	250 M	1785	400		94.5	94.6	94	0.85	117	2.6	7.1	3.1	78	91	1LE1541-2CB6	440	0.85
110	127	280 M	1786	590		95	95.1	94.5	0.86	169	2.9	7.9	3.3	82	96	1LE1541-2DB6	680	1.7
6-pole: 1000 rpm at 50 Hz, 1200 rpm at 60 Hz																		
18.5	22	180 L	1180	150		91.8	90.9		0.75	34	2.6	7	3.4	70	83	1LE1541-1EC6	166	0.206
30	34.5	200 L	1180	245		93	93.4	93	0.77	53	2.9	7.4	3.1	71	78	1LE1541-2AC6	243	0.381
37	44.5	225 M	1182	300	IE1	93	93.3	92.8	0.82	61	2.8	7.3	3.2	67	80	1LE1541-2BC6	325	0.67
45	54	250 M	1186	360	IE1	93.6	93.9	93.4	0.84	72	2.7	7.8	3	71	85	1LE1541-2CC6	410	1
75	90	280 M	1188	600		94.1	94.3	93.9	0.84	119	3.7	8	3.2	69	83	1LE1541-2DC6	570	1.8
Voltagess																		
50 Hz 230 VΔ/400 VY														Version		Order code		
50 Hz 400 VΔ/690 VY														Standard		-		
50 Hz 500 VY														Standard		-		
50 Hz 500 VΔ														Without additional charge		-		
														Without additional charge		-		
														9 0		...		
Types of construction ¹⁾																		
With flange														Version		Order code		
IM B5 ²⁾														With additional charge		-		
														F		...		
Motor protection																		
Without														Version		Order code		
PTC thermistor with 3 temperature sensors														Standard		-		
														With additional charge		-		
														A		...		
														B		...		
Terminal box position																		
Terminal box at top														Version		Order code(s)		
														Standard		4		
Special versions																		
Forced-air cooled motors w/o ext. fan/fan cover (IC418)														1LE1541-....		-Z F90 +.+.+.+.+		
For options, see from page 3/129														1LE1541-....		-Z ...+.+.+.+.+		

¹⁾ Types of construction with feet are not possible for 2-pole, 4-pole and 6-pole motors ≤ 200 hp in accordance with MG1 Table 12-11.

²⁾ Types derived from IM B5 (IM V3 and IM V1) and from IM B14 (IM V19 and IM V18) are possible, provided that no requirement exists for stamping of the type on the rating plate. The basic type IM B5 or IM B14 is stamped as standard on the rating plate. If mounted in a different position, the position must be specified to ensure that the condensation drainage holes are positioned correctly.



SIMOTICS GP and SIMOTICS SD standard motors

ABNT Line · IR3 Rendimento Premium

Aluminum series SIMOTICS GP 1LE1073 – self-ventilated or forced-air cooled

Selection and ordering data

Technical specifications at 60 Hz/P50 power rating

Operating values at rated power														Aluminum series		m _{IM B3}	J	
P _{rated} 60 Hz/ P50	P _{rated} 60 Hz/ P50	Frame size	n _{rated} 60 Hz	T _{rated} 60 Hz	η _{rated} 60 Hz, 4/4	η _{rated} 60 Hz, 3/4	η _{rated} 60 Hz, 2/4	cosφ _{rated} 60 Hz, 4/4	I _{rated} 60 Hz, 440 V	T _{LR} / T _{rated} 60 Hz	I _{LR} / I _{rated} 60 Hz	T _B / T _{rated} 60 Hz	L _p fA, 60 Hz	L _{WA} , 60 Hz	1LE1073			Article No.
kW	CV (hp)	FS	rpm	Nm	%	%	%		A									

- Cooling: Self-ventilated (IC411) or with order code F90 forced-air cooled without external fan and fan cover (IC418)
- Efficiency according to NBR 17094-1: IR3 Rendimento Premium
- Insulation: Thermal class 155 (temperature class F), IP55 degree of protection, utilization in accordance with thermal class 130 (temperature class B)

2-pole: 3000 rpm at 50 Hz, 3600 rpm at 60 Hz

1.1	1.5	80 M	3485	3	84.0	84.3	82.5	0.84	2.05	3.5	8.5	3.6	69	77	1LE1073-0DA3	12	0.0013
1.5	2	80 M	3470	4.15	85.5	85.7	85.0	0.85	2.7	4.2	9.2	4.2	74	82	1LE1073-0DA6	18	0.0014
2.2	3	90 S	3515	6	86.5	86.5	84.2	0.88	3.8	2.7	9.1	4.6	74	82	1LE1073-0EA4	20	0.0031
3	4	100 L	3520	8.1	88.5	88.9	88.0	0.90	4.95	3.2	9.4	4.6	75	83	1LE1073-1AA4	26	0.0054
3.7	5	100 L	3515	10.1	88.5	89.1	88.4	0.87	6.3	3.7	9.6	4.1	75	83	1LE1073-1AA6	26	0.0054
4.5	6	112 M	3550	12.1	88.5	89.2	87.9	0.90	7.4	2.4	9.6	3.9	79	87	1LE1073-1BA5	36	0.012
5.5	7.5	112 M	3545	14.8	89.5	90.6	90.6	0.88	9.2	2.4	9.7	3.7	79	87	1LE1073-1BA6	36	0.012
7.5	10	132 S	3560	20	90.2	90.3	89.7	0.92	11.9	2.3	10	3.8	75	83	1LE1073-1CA1	57	0.0031
9.2	12.5	132 M	3550	24.5	91.0	91.5	91.5	0.82	14.4	2.0	8.8	3.3	76	84	1LE1073-1CA5	62	0.0031
11	15	132 M	3555	29.5	91.0	91.8	91.8	0.90	17.6	2.1	9.6	4.5	76	84	1LE1073-1CA6	62	0.0031
15	20	160 M	3560	40	91.0	90.9	89.6	0.90	24	2.3	9.2	3.9	81	89	1LE1073-1DA3	84	0.0061
18.5	25	160 M	3555	49.5	91.7	91.8	90.8	0.91	29	2.6	9.0	3.8	81	89	1LE1073-1DA4	94	0.0068
22	30	160 L	3550	59	91.7	92.1	91.5	0.92	34	2.7	9.1	3.8	81	89	1LE1073-1DA6	120	0.077

4-pole: 1500 rpm at 50 Hz, 1800 rpm at 60 Hz

0.75	1	80 M	1760	4.05	83.0	81.6	77.8	0.70	1.69	3.2	7.8	4.2	58	66	1LE1073-0DB3	13	0.0029
1.1	1.5	80 M	1750	6	84.0	84.4	83.1	0.78	2.2	3.1	8.0	3.9	58	66	1LE1073-0DB6	14	0.0032
1.5	2	90 S	1750	8.2	86.5	86.7	85.1	0.79	2.9	2.8	8.0	4.1	62	70	1LE1073-0EB4	20	0.0049
2.2	3	90 L	1745	12	87.5	87.3	85.7	0.79	4.2	3.1	8.5	4.2	65	73	1LE1073-0EB6	25	0.0057
3	4	100 L	1760	16.3	89.5	90.8	89.7	0.84	5.2	2.8	8.9	4.2	66	74	1LE1073-1AB5	30	0.014
3.7	5	100 L	1760	20	89.5	90.4	90.2	0.82	6.6	2.7	8.6	3.7	66	74	1LE1073-1AB6	42	0.016
4.5	6	112 M	1765	24.5	89.5	89.8	88.9	0.83	7.9	2.3	8.5	3.6	68	76	1LE1073-1BB5	34	0.017
5.5	7.5	112 M	1765	30	91.0	91.2	90.5	0.80	9.9	3.0	9.8	4.2	71	79	1LE1073-1BB6	39	0.020
7.5	10	132 S	1770	40.5	91.7	92.2	91.6	0.85	12.6	2.4	8.9	3.8	72	80	1LE1073-1CB2	61	0.046
9.2	12.5	132 M	1770	49.5	92.4	92.8	93.1	0.84	15.6	2.5	8.2	3.2	70	78	1LE1073-1CB5	80	0.049
11	15	132 M	1765	60	92.4	92.9	92.3	0.84	18.6	2.5	8.2	3.4	68	76	1LE1073-1CB6	80	0.049
15	20	160 M	1780	80	93.0	93.3	92.5	0.84	25	2.5	7.6	3.7	69	77	1LE1073-1DB4	100	0.099
18.5	25	160 L	1780	99	93.6	93.7	93.1	0.81	32	2.5	8.5	3.6	69	77	1LE1073-1DB6	110	0.101

Voltagess	Version	Order code
50 Hz 220 VΔΔ/380 VYY/440 VΔ; 12 Leitungen frei herausgeführt ohne Klemmenbrett	Standard	-
For other voltages and more information, see from page 3/102		
Types of construction	Version	Order code
Without flange IM B3 ¹⁾	Standard	-
With flange IM B5 ¹⁾	With additional charge	-
For other types of construction and more information, see from page 3/112		
Motor protection	Version	Order code
Without	Standard	-
PTC thermistor with 3 temperature sensors	With additional charge	-
For other motor protection and more information, see from page 3/118		
Terminal box position	Version	Order code
Terminal box at top	Standard	-
For other terminal box positions and more information, see from page 3/121		
Special versions	Order code(s)	
Forced-air cooled motors w/o ext. fan/fan cover (IC418)	1LE1073-...-Z F90 +...+...+...	
For options, see from page 3/138	1LE1073-...-Z ...+...+...+...	

¹⁾ Types derived from IM B3 (IM B6/7/8, IM V6 and IM V5), from IM B5 (IM V3 and IM V1) and from IM B14 (IM V19 and IM V18) are possible, provided that no requirement exists for stamping of the type on the rating plate. The basic type IM B3, IM B5, or IM B14 is stamped as standard on the rating plate. If mounted in a different position, the position must be specified to ensure that the condensation drainage holes are positioned correctly.

SIMOTICS GP and SIMOTICS SD standard motors

ABNT Line · IR3 Rendimento Premium

Aluminum series SIMOTICS GP 1LE1073 – self-ventilated or forced-air cooled

Selection and ordering data

Technical specifications at 60 Hz/P50 power rating

Operating values at rated power														Aluminum series 1LE1073		$m_{IM\ B3}$	J	
P_{rated} 60 Hz/ P50	P_{rated} 60 Hz/ P50	Frame size	n_{rated} 60 Hz	T_{rated} 60 Hz	η_{rated} 60 Hz, 4/4	η_{rated} 60 Hz, 3/4	η_{rated} 60 Hz, 2/4	$\cos\phi_{rated}$ 60 Hz, 4/4	I_{rated} 60 Hz, 440 V	$T_{LR}/$ T_{rated} 60 Hz	$I_{LR}/$ I_{rated} 60 Hz	$T_B/$ T_{rated} 60 Hz	$L_{p(A)}$ 60 Hz	L_{WA} 60 Hz	Article No.		kg	kgm ²
kW	CV (hp)	FS	rpm	Nm	%	%	%	A										
<ul style="list-style-type: none"> • Cooling: Self-ventilated (IC411) or with order code F90 forced-air cooled without external fan and fan cover (IC418) • Efficiency according to NBR 17094-1: IR3 Rendimento Premium • Insulation: Thermal class 155 (temperature class F), IP55 degree of protection, utilization in accordance with thermal class 130 (temperature class B) 																		
6-pole: 1000 rpm at 50 Hz, 1200 rpm at 60 Hz																		
0.37	0.5	80 M	1150	3.05	75.3	73.8	68.7	0.59	1.09	3.2	4.8	3.5	55	63	1LE1073-0DC2	12	0.0025	
0.55	0.75	80 M	1135	4.65	79.5	79.3	76.3	0.66	1.38	2.8	4.9	3.1	58	66	1LE1073-0DC3	13	0.0031	
0.75	1	90 S	1150	6.2	82.5	83.3	81.8	0.70	1.78	2.2	5.2	2.8	61	69	1LE1073-0EC0	16	0.004	
1.1	1.5	100 L	1170	9	87.5	87.2	87.2	0.66	2.5	3.0	7.0	3.9	62	70	1LE1073-1AC3	28	0.014	
1.5	2	112 M	1175	12.2	88.5	88.2	86.2	0.70	3.2	3.5	9.0	4.3	62	70	1LE1073-1BC1	32	0.017	
2.2	3	132 S	1175	17.9	89.5	89.5	88.2	0.74	4.35	2.1	6.8	3.2	63	71	1LE1073-1CC1	43	0.037	
3	4	132 S	1178	24.5	89.5	89.5	88.0	0.70	6.3	2.5	7.2	3.6	63	71	1LE1073-1CC0	43	0.037	
3.7	5	132 S	1180	30	89.5	89.3	88.0	0.71	7.6	2.7	7.6	3.7	65	73	1LE1073-1CC2	47	0.037	
4.5	6	132 S	1175	36.5	89.5	89.7	88.2	0.70	9	2.7	7.1	3.6	67	75	1LE1073-1CC4	47	0.037	
5.5	7.5	132 M	1175	44.5	91.0	91.0	89.8	0.73	10.9	2.7	7.3	3.6	67	75	1LE1073-1CC3	58	0.046	
7.5	10	132 M	1180	61	91.0	91.5	91.2	0.69	15.7	3.2	7.7	4.0	67	75	1LE1073-1CC6	58	0.046	
9.2	12.5	160 M	1185	74	91.7	91.9	90.5	0.78	16.9	3.1	7.8	3.1	71	79	1LE1073-1DC3	105	0.12	
11	15	160 M	1180	89	91.7	91.9	91.1	0.80	19.7	3.1	7.3	2.9	72	80	1LE1073-1DC4	105	0.12	
15	20	160 L	1185	121	91.7	91.7	90.5	0.74	29	3.8	8.1	3.5	73	81	1LE1073-1DC6	105	0.12	
8-pole: 750 rpm at 50 Hz, 900 rpm at 60 Hz																		
0.25	0.33	80 M	855	2.8	68.0	66.6	61.0	0.54	0.89	1.9	3.3	2.5	56	64	1LE1073-0DD3	13	0.003	
0.37	0.5	90 S	840	4.2	72.0	72.1	68.8	0.67	1.01	1.6	3.2	2.1	64	72	1LE1073-0ED0	16	0.004	
0.55	0.75	90 L	850	6.2	74.0	73.9	70.9	0.66	1.48	2.1	3.9	2.6	63	71	1LE1073-0ED4	19	0.0048	
0.75	1	100 L	855	8.4	75.5	76.6	74.4	0.70	1.86	1.6	4.0	2.2	65	73	1LE1073-1AD4	21	0.0089	
2.2	3	132 S	880	24	85.5	84.9	82.3	0.68	4.95	2.2	6.1	3.1	62	70	1LE1073-1CD0	42	0.048	
3.7	5	132 M	875	40.5	86.5	86.2	83.8	0.66	7.9	2.5	6.1	3.2	67	75	1LE1073-1CD6	58	0.069	
4.5	6	160 M	875	49	86.5	86.5	85.3	0.72	9.5	1.9	6.1	2.8	74	82	1LE1073-1DD1	60	0.078	
5.5	7.5	160 M	880	60	86.5	88.5	89.9	0.73	11.4	1.8	5.1	2.1	73	81	1LE1073-1DD3	60	0.078	
7.5	10	160 L	885	81	89.5	90.0	88.8	0.72	15.3	2.4	6.3	2.8	70	78	1LE1073-1DD4	78	0.131	
Voltages														Version		Order code		
50 Hz 220 V $\Delta\Delta$ /380 VYY/440 V Δ ; 12 Leitungen frei herausgeführt ohne Klemmenbrett														Standard		-		
For other voltages and more information, see from page 3/102																...		
Types of construction														Version		Order code		
Without flange IM B3 ¹⁾														Standard		-		
With flange IM B5 ¹⁾														With additional charge		-		
For other types of construction and more information, see from page 3/112																...		
Motor protection														Version		Order code		
Without														Standard		-		
PTC thermistor with 3 temperature sensors														With additional charge		-		
For other motor protection and more information, see from page 3/118																...		
Terminal box position														Version		Order code		
Terminal box at top														Standard		4		
For other terminal box positions and more information, see from page 3/121																		
Special versions														Order code(s)				
Forced-air cooled motors w/o ext. fan/fan cover (IC418)														1LE1073-...-Z F90 +...+...+				
For options, see from page 3/138														1LE1073-...-Z ...+...+...+				



¹⁾ Types derived from IM B3 (IM B6/7/8, IM V6 and IM V5), from IM B5 (IM V3 and IM V1) and from IM B14 (IM V19 and IM V18) are possible, provided that no requirement exists for stamping of the type on the rating plate. The basic type IM B3, IM B5, or IM B14 is stamped as standard on the rating plate. If mounted in a different position, the position must be specified to ensure that the condensation drainage holes are positioned correctly.

SIMOTICS GP and SIMOTICS SD standard motors

ABNT Line · IR3 Rendimento Premium

Cast-iron series SIMOTICS SD 1LE1573, 1LE5773 – self-ventilated or forced-air cooled

Selection and ordering data

Technical specifications at 60 Hz/P50 power rating

Operating values at rated power														Cast-iron series 1LE1573/1LE5773		$m_{IM\ B3}$	J
P_{rated} 60 Hz/ P50	P_{rated} 60 Hz/ P50	Frame size	n_{rated} 60 Hz	T_{rated} 60 Hz	η_{rated} 60 Hz, 4/4	η_{rated} 60 Hz, 3/4	η_{rated} 60 Hz, 2/4	$\cos\phi_{rated}$ 60 Hz, 4/4	I_{rated} 60 Hz, 440 V	$T_{LR}/$ T_{rated} 60 Hz	$I_{LR}/$ I_{rated} 60 Hz	$T_B/$ T_{rated} 60 Hz	L_{pifA} 60 Hz	L_{WA} 60 Hz	Article No.	kg	kgm ²
kW	CV (hp)	FS	rpm	Nm	%	%	%	A									
<ul style="list-style-type: none"> • Cooling: Self-ventilated (IC411) or with order code F90 forced-air cooled without external fan and fan cover (IC418) • Efficiency according to NBR 17094-1: IR3 Rendimento Premium • Insulation: Thermal class 155 (temperature class F), IP55 degree of protection, utilization in accordance with thermal class 130 (temperature class B) 																	
2-pole: 3000 rpm at 50 Hz, 3600 rpm at 60 Hz																	
30	40	200 L	3565	80	92.4	92.6	92.1	0.86	49.5	2.9	8.2	3.7	78	86	1LE1573-2AA4	220	0.134
37	50	200 L	3560	99	93.0	93.4	92.3	0.87	60	3.1	8.5	3.7	78	86	1LE1573-2AA5	245	0.158
45	60	225 S	3565	121	93.6	93.7	92.9	0.89	71	2.7	7.2	3.1	75	89	1LE1573-2BA2	325	0.265
55	75	225 M	3555	148	93.6	94.0	93.8	0.88	88	2.2	6.6	2.8	76	89	1LE1573-2BA6	385	0.315
75	100	250 M	3570	201	94.1	94.1	93.3	0.90	116	2.1	6.6	2.7	82	96	1LE1573-2CA6	475	0.564
90	125	280 S	3575	240	95.0	95.0	94.2	0.90	138	2.2	7.0	2.7	78	92	1LE1573-2DA2	610	0.934
110	150	280 M	3570	294	95.0	95.0	94.3	0.91	167	2.3	7.0	2.8	82	96	1LE1573-2DA6	680	1.08
132	175	315 S	3575	353	95.4	95.3	94.3	0.88	205	1.7	6.1	2.3	84	99	1LE5773-3AA2	1030	2.0
150	200	315 M	3582	400	95.4	95.1	94.0	0.90	230	2.4	8.0	3.1	84	99	1LE5773-3AA4	1190	2.0
185	250	315 M	3578	494	95.8	95.9	95.4	0.90	280	1.5	6.1	2.2	82	96	1LE5773-3AA5	1280	2.38
220	300	315 L	3582	587	95.8	95.8	95.2	0.91	330	2.2	8.0	2.9	84	99	1LE5773-3AA6	1340	2.73
4-pole: 1500 rpm at 50 Hz, 1800 rpm at 60 Hz																	
22	30	180 M	1775	118	93.6	93.9	93.4	0.81	38	2.7	8.3	3.7	69	77	1LE1573-1EB4	178	0.14
30	40	200 L	1775	161	94.1	94.6	94.5	0.84	50	2.7	7.9	3.1	66	74	1LE1573-2AB5	240	0.22
37	50	200 L	1775	199	94.5	94.7	94.6	0.83	62	2.9	8.4	3.3	66	74	1LE1573-2AB6	258	0.275
45	60	225 S	1782	241	95.0	95.3	94.9	0.84	74	2.9	7.6	2.9	69	82	1LE1573-2BB2	315	0.47
55	75	225 M	1782	295	95.4	95.8	95.6	0.85	89	3.0	7.8	2.9	75	89	1LE1573-2BB6	420	0.655
75	100	250 M	1780	403	95.4	95.6	95.4	0.85	121	2.1	6.2	2.5	75	89	1LE1573-2CB6	530	1.07
90	125	280 S	1782	482	95.4	95.7	95.4	0.88	141	2.2	6.6	2.5	79	93	1LE1573-2DB2	690	1.56
110	150	280 M	1785	589	95.8	96.0	95.7	0.90	167	2.5	7.2	2.7	82	96	1LE1573-2DB6	740	1.67
132	175	315 S	1790	704	96.2	96.3	95.7	0.86	210	2.1	7.5	2.6	79	93	1LE5773-3AB2	1350	2.8
150	200	315 M	1790	800	96.2	96.3	95.7	0.85	240	1.9	6.9	2.6	81	96	1LE5773-3AB4	1110	3.13
185	250	315 M	1790	987	96.2	96.3	95.8	0.90	280	2.3	8	2.8	82	96	1LE5773-3AB5	1210	3.64
220	300	315 L	1790	1174	96.2	96.3	95.8	0.87	345	2.3	7.2	2.7	81	96	1LE5773-3AB6	1400	4.53
300	400	315 L	1788	1602	96.2	96.5	96.4	0.86	475	2.3	6.8	2.7	81	95	1LE5773-3AB7	1560	5.28
Voltagess														Version		Order code	
50 Hz 220 VΔΔ/380 VYY/440 VΔ; 12 Leitungen frei herausgeführt ohne Klemmenbrett														Standard		-	
For other voltages and more information, see from page 3/102																...	
Types of construction														Version		Order code	
Without flange IM B3 ¹⁾														Standard		-	
With flange IM B5 ¹⁾														With additional charge		-	
For other types of construction and more information, see from page 3/112																...	
Motor protection														Version		Order code	
Without														Standard		-	
PTC thermistor with 3 temperature sensors														With additional charge		-	
For other motor protection and more information, see from page 3/118																...	
Terminal box position														Version		Order code	
Terminal box at top														Standard		4	
For other terminal box positions and more information, see from page 3/121																	
Special versions														Order code(s)			
Forced-air cooled motors w/o ext. fan/fan cover (IC418)														1LE .. 73- ... -Z F90 +...+...+...			
For options, see from page 3/138														1LE .. 73- ... -Z ...+...+...+...			

¹⁾ Types derived from IM B3 (IM B6/7/8, IM V6 and IM V5), from IM B5 (IM V3 and IM V1) and from IM B14 (IM V19 and IM V18) are possible, provided that no requirement exists for stamping of the type on the rating plate. The basic type IM B3, IM B5, or IM B14 is stamped as standard on the rating plate. If mounted in a different position, the position must be specified to ensure that the condensation drainage holes are positioned correctly.

SIMOTICS GP and SIMOTICS SD standard motors

ABNT Line · IR3 Rendimento Premium

Cast-iron series SIMOTICS SD 1LE1573, 1LE5773 – self-ventilated or forced-air cooled

Selection and ordering data

Technical specifications at 60 Hz/P50 power rating

Operating values at rated power														Cast-iron series 1LE1573/1LE5773		m _{IM B3}	J	
P _{rated} , 60 Hz/ P50	P _{rated} , 60 Hz/ P50	Frame size	n _{rated} , 60 Hz	T _{rated} , 60 Hz	η _{rated} , 60 Hz, 4/4	η _{rated} , 60 Hz, 3/4	η _{rated} , 60 Hz, 2/4	cosφ _{rated} , 60 Hz, 4/4	I _{rated} , 60 Hz, 440 V	T _{LR} / I _{rated} , 60 Hz	I _{LR} / I _{rated} , 60 Hz	T _B / T _{rated} , 60 Hz	L _p fA, 60 Hz	L _{WA} , 60 Hz	Article No.			kg
kW	CV (hp)	FS	rpm	Nm	%	%	%		A				dB(A)	dB(A)				
<ul style="list-style-type: none"> Cooling: Self-ventilated (IC411) or with order code F90 forced-air cooled without external fan and fan cover (IC418) Efficiency according to NBR 17094-1: IR3 Rendimento Premium Insulation: Thermal class 155 (temperature class F), IP55 degree of protection, utilization in accordance with thermal class 130 (temperature class B) 																		
6-pole: 1000 rpm at 50 Hz, 1200 rpm at 60 Hz																		
18.5	25	180 L	1180	150	93.0	93.3	92.8	0.75	35	2.9	7.9	3.7	73	81	1LE1573-1EC6	185	0.247	
22	30	200 L	1180	178	93.0	93.4	93.3	0.78	40	2.6	6.5	2.8	62	70	1LE1573-2AC5	230	0.32	
30	40	200 L	1182	240	94.1	94.3	93.7	0.75	56	3.2	7.8	3.3	66	74	1LE1573-2AC6	264	0.434	
37	50	225 M	1186	298	94.1	94.5	94.2	0.81	64	3.0	7.7	3.1	71	85	1LE1573-2BC6	320	0.815	
45	60	250 S	1186	363	94.5	95.0	94.7	0.84	74	2.8	7.7	2.9	69	83	1LE1573-2CC6	500	1.27	
55	75	280 S	1186	443	94.5	95.0	94.8	0.85	90	2.5	6.8	2.3	66	80	1LE1573-2DC2	580	1.64	
75	100	280 S	1186	604	95.0	95.7	95.9	0.84	123	3.2	7.4	2.7	70	84	1LE1573-2DC6	650	1.93	
90	125	280 M	1186	725	95.0	95.7	95.8	0.85	146	3.2	7.9	2.7	71	85	1LE1573-2DC7	760	2.41	
110	150	315 M	1190	883	95.8	96.3	96.3	0.86	175	2.2	7.3	2.8	67	82	1LE5773-3AC4	1080	4.36	
132	175	315 M	1188	1061	95.8	96.5	96.6	0.85	215	2.0	6.5	2.6	68	82	1LE5773-3AC5	1160	4.99	
150	200	315 M	1191	1203	95.8	96.1	96.0	0.83	250	2.3	7.3	2.8	69	83	1LE5773-3AC6	1250	5.56	
185	250	315 L	1191	1483	95.8	96.2	96.2	0.83	305	2.3	7.0	2.6	71	86	1LE5773-3AC7	1410	6.06	
8-pole: 750 rpm at 50 Hz, 900 rpm at 60 Hz																		
9.2	12.5	180 M	875	100	89.5	90.2	89.9	0.72	18.7	2.1	5.2	2.5	75	83	1LE1573-1ED3	153	0.195	
11	15	180 L	875	120	89.5	90.1	89.7	0.74	22.0	2.3	5.8	2.7	68	76	1LE1573-1ED4	190	0.267	
15	20	180 L	875	164	90.2	91.4	91.6	0.75	29.0	2.1	5.4	2.5	69	77	1LE1573-1ED6	187	0.267	
18.5	25	200 L	880	200	90.2	90.3	89.2	0.68	39.5	3.3	7.2	4.1	62	76	1LE1573-2AD6	255	0.420	
22	30	225 S	882	238	91.7	92.2	91.8	0.78	40.5	2.6	6.4	3.0	60	74	1LE1573-2BD2	315	0.549	
30	40	225 M	886	323	91.7	92.4	92.1	0.76	56.0	2.8	6.4	3.2	66	79	1LE1573-2BD6	335	0.672	
37	50	250 M	886	399	92.4	92.5	91.6	0.78	67.0	2.8	7.0	3.0	65	79	1LE1573-2CD6	425	1.02	
45	60	250 M	882	487	92.4	93.2	93.2	0.82	78.0	2.4	6.3	2.7	66	80	1LE1573-2CD7	435	1.02	
55	75	280 S	888	591	93.6	94.1	93.8	0.79	98.0	2.5	6.1	2.5	70	81	1LE1573-2DD6	580	1.62	
75	100	280 M	888	807	93.6	94.1	93.8	0.79	133	2.8	6.8	2.7	69	80	1LE1573-2DD7	680	1.89	
90	125	315 M	893	962.4	94.1	94.4	94.0	0.82	153	2.5	7.0	2.6	74	88	1LE5773-3AD4	1000	3.74	
110	150	315 M	891	1179	94.1	94.5	94.4	0.83	185	2.2	6.5	2.4	79	93	1LE5773-3AD5	1100	4.48	
132	175	315 L	890	1416	94.5	95.0	94.9	0.84	220	2.1	6.0	2.3	82	97	1LE5773-3AD6	1150	5.36	
150	200	315 L	890	1609	94.5	95.3	95.5	0.80	260	2.1	5.9	2.1	76	90	1LE5773-3AD7	1420	6.76	
185	250	315 L	893	1978	95.0	95.3	95.0	0.78	330	2.7	7.3	2.9	76	90	1LE5773-3AD8	1660	8.4	
Voltagess														Version		Order code		
50 Hz 220 VΔΔ/380 VYY/440 VΔ; 12 Leitungen frei herausgeführt ohne Klemmenbrett														Standard		-		
For other voltages and more information, see from page 3/102														6 4		...		
9 0														A		...		
Types of construction														Version		Order code		
Without flange IM B3 ¹⁾														Standard		-		
With flange IM B5 ¹⁾														With additional charge		-		
For other types of construction and more information, see from page 3/112														A		...		
Motor protection														Version		Order code		
Without														Standard		-		
PTC thermistor with 3 temperature sensors														With additional charge		-		
For other motor protection and more information, see from page 3/118														A		...		
Terminal box position														Version		Order code(s)		
Terminal box at top														Standard		4		
For other terminal box positions and more information, see from page 3/121																		
Special versions																Order code(s)		
Forced-air cooled motors w/o ext. fan/fan cover (IC418)														1LE .. 73- .. .		-Z F90 +.+.+.+.+. . .		
For options, see from page 3/138														1LE .. 73- .. .		-Z .+.+.+.+.+. . .		

3

¹⁾ Types derived from IM B3 (IM B6/7/8, IM V6 and IM V5), from IM B5 (IM V3 and IM V1) and from IM B14 (IM V19 and IM V18) are possible, provided that no requirement exists for stamping of the type on the rating plate. The basic type IM B3, IM B5, or IM B14 is stamped as standard on the rating plate. If mounted in a different position, the position must be specified to ensure that the condensation drainage holes are positioned correctly.

SIMOTICS GP and SIMOTICS SD standard motors
Eagle Line · NEMA Premium Efficient MG1 Table 12-12



Aluminum series SIMOTICS GP 1LE1023 – self-ventilated or forced-air cooled

Selection and ordering data

Operating values at rated power															Aluminum series					
P_{rated} 60 Hz/ P50	P_{rated} 60 Hz/ P60	Frame size	n_{rated} 60 Hz	T_{rated} 60 Hz	EISA CC No. CC032A	η_{rated} 60 Hz, 4/4	η_{rated} 60 Hz, 3/4	η_{rated} 60 Hz, 2/4	$\cos\phi_{rated}$ 60 Hz, 4/4	I_{rated} 60 Hz, 460 V	T_{LR} 60 Hz	I_{LR} 60 Hz	T_B 60 Hz	L_{pFA} 60 Hz	L_{WA} 60 Hz	1LE1023	$m_{IM B3}$	J		
kW	hp	FS	rpm	Nm		%	%	%		A	°C	A	°C	dB(A)	dB(A)	Article No.	kg	kgm ²		
• Cooling: Self-ventilated (IC411) or with order code F90 forced-air cooled without external fan and fan cover (IC418) • Efficiency: NEMA Premium Efficient, UL, CSA, and service factor (SF) 1.15 – for operation in the USA and Canada, not admissible for exporting to Mexico • Insulation: Thermal class 155 (temperature class F), IP55 degree of protection, utilization in accordance with thermal class 130 (temperature class B)																				
2-pole: 3000 rpm at 50 Hz, 3600 rpm at 60 Hz																				
0.75	1	80 M	3480	2.05	✓	77	77.2	75.7	0.84	1.45	3	7.1	3.6	64	75	1LE1023-0DA2	11	0.0011		
1.1	1.5	80 M	3500	3	✓	84	84	82	0.83	1.98	3.3	8.4	4	64	75	1LE1023-0DA3	12	0.0013		
1.5	2	90 S	3525	4.05	✓	85.5	84.8	82.3	0.84	2.6	3.1	9.8	4.9	69	81	1LE1023-0EA0	15	0.0021		
2.2	3	90 L	3530	6	✓	86.5	86.4	84.5	0.87	3.65	3	9.6	4.9	69	81	1LE1023-0EA4	19	0.0031		
3	4	100 L	3525	8.1	✓	88.5	88.7	87.2	0.87	4.9	3.8	9.7	5.5	71	83	1LE1023-1AA4	26	0.0054		
3.7	5	112 M	3560	9.9	✓	88.5	88	86.2	0.88	6	3.2	10.8	5.1	73	85	1LE1023-1BA2	34	0.012		
5.5	7.5	132 S	3555	14.8	✓	89.5	89.4	88.2	0.9	8.6	2.1	8.6	4.4	72	84	1LE1023-1CA0	43	0.024		
7.5	10	132 S	3555	20	✓	90.2	90.5	90	0.91	11.5	2.4	9.5	4.7	72	84	1LE1023-1CA1	57	0.031		
11	15	160 M	3560	29.5	✓	91	90.4	88.3	0.88	17.2	2.8	8.5	4.3	77	89	1LE1023-1DA2	75	0.053		
15	20	160 M	3565	40	✓	91	90.5	88.9	0.86	24	3.1	9.7	4.8	77	89	1LE1023-1DA3	84	0.061		
18.5	25	160 L	3560	49.5	✓	91.7	91.5	90.3	0.9	28	3.1	9.4	4.4	77	89	1LE1023-1DA4	94	0.068		
22	30	180 M	3560	59	✓	91.7	91.4	90	0.89	34	2.8	8.2	3.9	77	89	1LE1023-1EA2	129	0.08		
30	40	200 L	3560	80	✓	92.4	92.2	91.4	0.87	47	2.9	7.6	3.6	77	84	1LE1023-2AA4	173	0.134		
37	50	200 L	3560	99	✓	93	92.8	91.6	0.88	57	2.8	7.5	3.6	77	84	1LE1023-2AA5	194	0.158		
4-pole: 1500 rpm at 50 Hz, 1800 rpm at 60 Hz																				
0.55	0.75	80 M	1750	3	–	81.1	80.9	78.6	0.74	1.15	2.7	6.9	3.8	53	61	1LE1023-0DB2	11	0.0021		
0.75	1	80 M	1760	4.05	✓	83.5	82.6	79.7	0.71	1.59	3.1	8.3	4.7	58	66	1LE1023-0DB3	14	0.0029		
1.1	1.5	90 S	1750	6	✓	86.5	86.4	84.2	0.75	2.15	3.4	8.2	4.4	58	70	1LE1023-0EB0	16	0.0036		
1.5	2	90 L	1755	8.2	✓	86.5	86.6	84.7	0.77	2.85	3.4	8.6	4.3	59	67	1LE1023-0EB4	19	0.0049		
2.2	3	100 L	1770	11.9	✓	89.5	89.2	87.2	0.81	3.8	3.5	9.6	5.1	62	74	1LE1023-1AB4	30	0.014		
3	4	100 L	1760	16.3	✓	89.5	89.5	88.3	0.82	5.1	3.1	9.5	4.6	62	74	1LE1023-1AB5	30	0.014		
3.7	5	112 M	1770	20	✓	89.5	89.4	87.7	0.8	6.5	2.9	8.2	4.3	62	74	1LE1023-1BB2	34	0.017		
5.5	7.5	132 S	1775	29.5	✓	91.7	91.6	90.5	0.81	9.3	3.1	10	4.2	68	80	1LE1023-1CB0	64	0.046		
7.5	10	132 M	1770	40.5	✓	91.7	91.8	91	0.83	12.4	2.7	9.6	4.2	61	80	1LE1023-1CB2	64	0.046		
11	15	160 M	1775	59	✓	92.4	92.3	91.1	0.83	18	3	8.9	3.8	66	81	1LE1023-1DB2	83	0.083		
15	20	160 L	1780	80	✓	93	92.8	91.4	0.81	25	2.9	9.5	4.3	70	81	1LE1023-1DB4	100	0.099		
18.5	25	180 M	1775	100	✓	93.6	93.7	93.1	0.81	30.5	2.7	7.8	3.6	67	75	1LE1023-1EB2	134	0.13		
22	30	180 L	1775	118	✓	93.6	93.8	93.3	0.81	36.5	2.8	7.7	3.7	70	77	1LE1023-1EB4	142	0.14		
30	40	200 L	1778	161	✓	94.1	94.3	93.8	0.83	48	3	8.1	3.5	70	77	1LE1023-2AB5	189	0.22		
Voltages (≤ 600 V)¹⁾															Version		Order code			
50 Hz 230 VΔ/400 VY			60 Hz 460 VY			Standard			2		2		–							
50 Hz 400 VΔ			60 Hz 460 VΔ			Standard			3		4		–							
50 Hz 500 VY			–			Without additional charge			2		7		–							
50 Hz 500 VΔ			–			Without additional charge			4		0		–							
For other voltages and more information, see from page 3/97															9		0		...	
Types of construction															Version		Order code			
Without flange			IM B3 ²⁾			Standard			A		–									
With flange			IM B5 ²⁾			With additional charge			F		–									
With flange			IM B14 ²⁾			With additional charge			K		–									
For other types of construction and more information, see from page 3/103															4		0		...	
Motor protection															Version		Order code			
Without			–			Standard			A		–									
PTC thermistor with 1 or 3 temperature sensors (frame sizes 80, 90 or 100 to 200)			–			With additional charge			B		–									
For other motor protection and more information, see from page 3/116															4		0		...	
Terminal box position															Version		Order code			
Terminal box at top			–			Standard			4		–									
For other terminal box positions and more information, see from page 3/119															4		0		...	
Special versions															Version		Order code(s)			
Forced-air cooled motors w/o ext. fan/fan cover (IC418)			–			1LE1023-...-Z			F90		+...+...+...									
For options, see from page 3/122															4		0		...	

- Not required
- ✓ Available

¹⁾ Operating voltages only ≤ 600 V admissible in accordance with MG1 Table 12-12.

²⁾ Types derived from IM B3 (IM B6/7/8, IM V6, and IM V5), from IM B5 (IM V3 and IM V1) and from IM B14 (IM V19 and IM V18) are possible, provided that no requirements exist for condensation drainage holes (H03) or stamping of the type on the rating plate. The basic type IM B3, IM B5, or IM B14 is stamped as standard on the rating plate. For orders with condensation drainage holes (H03), the type must be specified.



SIMOTICS GP and SIMOTICS SD standard motors
Eagle Line · NEMA Premium Efficient MG1 Table 12-12

Aluminum series SIMOTICS GP 1LE1023 – self-ventilated or forced-air cooled

Selection and ordering data

Operating values at rated power															Aluminum series		m _{IM B3}	J						
P _{rated} 60 Hz/ P50	P _{rated} 60 Hz/ P60	Frame size	n _{rated} 60 Hz	T _{rated} 60 Hz	EISA CC No. CC032A	η _{rated} 60 Hz	η _{rated} 60 Hz	η _{rated} 60 Hz	cosφ _{rated} 60 Hz	I _{rated} 460 V	T _{LR} 60 Hz	I _{LR} 60 Hz	T _B 60 Hz	L _{pfA} 60 Hz	L _{WA} 60 Hz	Article No.			kg	kgm ²				
• Cooling: Self-ventilated (IC411) or with order code F90 forced-air cooled without external fan and fan cover (IC418) • Efficiency: NEMA Premium Efficient, UL, CSA, and service factor (SF) 1.15 – for operation in the USA and Canada, not admissible for exporting to Mexico • Insulation: Thermal class 155 (temperature class F), IP55 degree of protection, utilization in accordance with thermal class 130 (temperature class B)																								
6-pole: 1000 rpm at 50 Hz, 1200 rpm at 60 Hz																								
0.37	0.5	80 M	1150	3.05	–	75.3	74.3	70	0.61	1.01	2.7	5	3.3	45	56	1LE1023-0DC2	12	0.0025						
0.55	0.75	80 M	1145	4.6	–	81.7	80.5	76.4	0.63	1.34	2.8	5.3	3.4	45	56	1LE1023-0DC3	14	0.0031						
0.75	1	90 S	1155	6.2	✓	82.5	82.4	79.9	0.65	1.76	2.4	5.3	3.1	46	58	1LE1023-0EC0	16	0.004						
1.1	1.5	100 L	1180	8.9	✓	87.5	87.2	84.8	0.69	2.3	2.4	6.7	3.3	62	74	1LE1023-1AC3	30	0.011						
3	4	132 S	1180	24.5	✓	89.5	89.5	87.9	0.7	6	2.6	7.6	3.8	62	69	1LE1023-1CC0	42	0.037						
3.7	5	132 M	1180	30	✓	89.5	89.2	87.5	0.69	7.5	2.8	7.5	3.8	64	70	1LE1023-1CC2	46	0.037						
5.5	7.5	132 M	1180	44.5	✓	91	90.8	89.2	0.69	11	3	7.8	4	69	75	1LE1023-1CC3	58	0.046						
7.5	10	160 M	1185	60	✓	91	90.8	89.4	0.8	12.9	2.7	9.3	3.7	75	81	1LE1023-1DC2	95	0.098						
11	15	160 L	1185	89	✓	91.7	91.7	90.5	0.78	19.3	3.4	8	3.2	73	80	1LE1023-1DC4	106	0.12						
15	20	180 L	1178	122	✓	91.7	92	91.4	0.79	26	2.5	6.8	3	61	68	1LE1023-1EC4	130	0.19						
18.5	25	200 L	1180	150	✓	93	93.8	93.8	0.78	32	2.8	6.5	3	64	71	1LE1023-2AC4	166	0.28						
22	30	200 L	1180	178	✓	93	93.5	93.4	0.79	37.5	2.6	6.3	2.8	63	70	1LE1023-2AC5	179	0.32						
8-pole: 750 rpm at 50 Hz, 900 rpm at 60 Hz																								
0.18	0.24	80 M	865	1.99	–	64	60.6	53	0.44	0.78	2.6	3.5	3.5	54.8	68.1	▲ 1LE1023-0DD2	12	0.0021						
0.25	0.33	80 M	855	2.8	–	68	65.5	59.8	0.51	0.91	2	3.3	2.6	56	64	▲ 1LE1023-0DD3	13	0.003						
0.37	0.5	90 S	850	4.15	–	72	69.9	64.2	0.63	1.02	2	3.4	2.1	54	61	▲ 1LE1023-0ED0	16	0.0045						
0.55	0.75	90 L	855	6.1	–	74	71.6	65.8	0.62	1.5	2.3	4	2.8	59	66	▲ 1LE1023-0ED4	19	0.0045						
0.75	1	100 L	870	8.2	–	75.5	74.9	71.7	0.62	1.87	1.9	4.4	2.5	64	72	▲ 1LE1023-1AD4	20	0.0096						
1.1	1.5	100 L	865	12.1	–	78.5	78	75.7	0.62	2.7	2.3	4.8	3	65.4	73.4	▲ 1LE1023-1AD5	26	0.013						
1.5	2	112 M	875	16.4	–	84	83.1	80	0.59	3.75	2.9	5.8	3.6	65	73	▲ 1LE1023-1BD2	34	0.028						
2.2	3	132 S	880	24	–	85.5	85.2	82.9	0.68	4.75	2.3	5.8	3	65	73	▲ 1LE1023-1CD0	42	0.046						
2.2	3	132 S	880	24	✓	85.5	85.2	82.9	0.68	4.75	2.3	5.8	3	65	80	1LE1023-1CD0	42	0.046						
3	4	132 M	880	32.5	✓	86.5	85.9	83.5	0.69	6.3	2.2	6	3	67	80	1LE1023-1CD2	58	0.061						
3.7	5	160 M	885	40	✓	86.5	86.7	85.3	0.71	7.5	2	5.8	2.6	69.3	79	1LE1023-1DD2	67	0.076						
5.5	7.5	160 M	885	59	✓	86.5	86.7	85.5	0.72	10.8	2.3	6.3	2.8	66	79	1LE1023-1DD3	78	0.1						
7.5	10	160 L	885	81	✓	89.5	89.5	88.1	0.71	14.8	2.6	6.7	2.6	66	79	1LE1023-1DD4	86	0.13						
11	15	180 L	880	119	✓	89.5	89.9	89.3	0.72	21.5	2.3	5.8	2.7	65	78	1LE1023-1ED4	161	0.267						
15	20	200 L	882	162	✓	90.2	90.2	89.2	0.7	30	3.4	7.7	4.2	60	73	1LE1023-2AD5	212	0.42						
Voltages (≤ 600 V)¹⁾															Version		Order code							
50 Hz 230 VΔ/400 VY			60 Hz 460 VY			Standard			2		2		–											
50 Hz 400 VΔ			60 Hz 460 VΔ			Standard			3		4		–											
50 Hz 500 VY						Without additional charge			2		7		–											
50 Hz 500 VΔ						Without additional charge			4		0		–											
For other voltages and more information, see from page 3/97															9		0		...					
Types of construction															Version		Order code							
Without flange			IM B3 ²⁾			Standard			A				–											
With flange			IM B5 ²⁾			With additional charge			F				–											
With flange			IM B14 ²⁾			With additional charge			K				–											
For other types of construction and more information, see from page 3/103																	...							
Motor protection															Version		Order code							
Without						Standard			A				–											
PTC thermistor with 1 or 3 temperature sensors (frame sizes 80, 90 or 100 to 200)						With additional charge			B				–											
For other motor protection and more information, see from page 3/116																	...							
Terminal box position															Version		Order code							
Terminal box at top						Standard			4				–											
For other terminal box positions and more information, see from page 3/119																								
Special versions																	Order code(s)							
Forced-air cooled motors w/o ext. fan/fan cover (IC418)						1LE1023-....-Z F90+....+....																		
For options, see from page 3/122																	1LE1023-....-Z ...+....+....							

- Not required
- ✓ Available

¹⁾ Operating voltages only ≤ 600 V admissible in accordance with MG1 Table 12-12.

²⁾ Types derived from IM B3 (IM B6/7/8, IM V6, and IM V5), from IM B5 (IM V3 and IM V1) and from IM B14 (IM V19 and IM V18) are possible, provided that no requirements exist for condensation drainage holes (H03) or stamping of the type on the rating plate. The basic type IM B3, IM B5, or IM B14 is stamped as standard on the rating plate. For orders with condensation drainage holes (H03), the type must be specified.

SIMOTICS GP and SIMOTICS SD standard motors
Eagle Line · NEMA Premium Efficient MG1 Table 12-12



Cast-iron series SIMOTICS SD 1LE1523 Basic Line – self-ventilated or forced-air cooled

Selection and ordering data

Operating values at rated power																Cast-iron series			
P_{rated} 60 Hz/ P50	P_{rated} 60 Hz/ P60	Frame size	n_{rated} 60 Hz	T_{rated} 60 Hz	EISA CC No. CC032A	η_{rated} 60 Hz, 4/4	η_{rated} 60 Hz, 3/4	η_{rated} 60 Hz, 2/4	$\cos\phi_{rated}$ 60 Hz, 4/4	I_{rated} 60 Hz, 460 V	T_{LR}/I_{rated} 60 Hz	I_{LR}/I_{rated} 60 Hz	T_p/I_{rated} 60 Hz	L_{pFA} 60 Hz	L_{WA} 60 Hz	1LE1523 – Basic Line	$m_{IM B3}$	J	
kW	hp	FS	rpm	Nm		%	%	%		A						Article No.	kg	kgm ²	
• Cooling: Self-ventilated (IC411) or with order code F90 forced-air cooled without external fan and fan cover (IC418) • Efficiency: NEMA Premium Efficient, UL, CSA, and service factor (SF) 1.15 – for operation in the USA and Canada, not admissible for exporting to Mexico • Insulation: Thermal class 155 (temperature class F), IP55 degree of protection, utilization in accordance with thermal class 130 (temperature class B)																			
2-pole: 3000 rpm at 50 Hz, 3600 rpm at 60 Hz																			
0.37	0.5	71 M	3470	1,02	–	73,4	71,7	67	0,73	0,87	4,2	6,8	4,2	57	68	1LE1523-0CA2	13	0,00045	
0.55	0.75	71 M	3470	1,51	–	76,8	75,3	71	0,73	1,23	4,5	7,2	4,5	62	73	1LE1523-0CA3	15	0,00056	
0.75	1	80 M	3480	2,05	✓	77	77,2	75,7	0,84	1,45	3	7,1	3,6	64	75	1LE1523-0DA2	18	0,0011	
1.1	1.5	80 M	3500	3	✓	84	84	82	0,83	1,98	3,3	8,4	4	64	75	1LE1523-0DA3	21	0,0013	
1.5	2	90 S	3525	4,05	✓	85,5	84,8	82,3	0,84	2,6	3,1	9,8	4,9	69	81	1LE1523-0EA0	26	0,0021	
2.2	3	90 L	3530	6	✓	86,5	86,4	84,5	0,87	3,65	3	9,6	4,9	69	81	1LE1523-0EA4	32	0,0031	
3	4	100 L	3525	8,1	✓	88,5	88,7	87,2	0,87	4,9	3,8	9,7	5,5	71	83	1LE1523-1AA4	36	0,0054	
3.7	5	112 M	3560	9,9	✓	88,5	88	86,2	0,88	6	3,2	10,8	5,1	73	85	1LE1523-1BA2	45	0,012	
5.5	7.5	132 S	3555	14,8	✓	89,5	89,4	88,2	0,9	8,6	2,1	8,6	4,4	72	84	1LE1523-1CA0	58	0,024	
7.5	10	132 S	3555	20	✓	90,2	90,5	90	0,91	11,5	2,4	9,5	4,7	72	84	1LE1523-1CA1	73	0,031	
11	15	160 M	3560	29,5	✓	91	90,4	88,3	0,88	17,2	2,8	8,5	4,3	77	89	1LE1523-1DA2	100	0,053	
15	20	160 M	3565	40	✓	91	90,5	88,9	0,86	24	3,1	9,7	4,8	77	89	1LE1523-1DA3	110	0,061	
18.5	25	160 L	3560	49,5	✓	91,7	91,5	90,3	0,9	28	3,1	9,4	4,4	77	89	1LE1523-1DA4	127	0,068	
22	30	180 M	3560	59	✓	91,7	91,4	90	0,89	34	2,8	8,2	3,9	77	89	1LE1523-1EA2	160	0,08	
30	40	200 L	3560	80	✓	92,4	92,2	91,4	0,87	47	2,9	7,6	3,6	77	84	1LE1523-2AA4	225	0,134	
37	50	200 L	3560	99	✓	93	92,8	91,6	0,88	57	2,8	7,5	3,6	77	84	1LE1523-2AA5	250	0,158	
45	60	225 M	3570	120	✓	93,6	93,7	93,1	0,88	69	2,7	7,6	3,3	75	89	1LE1523-2BA2	315	0,26	
55	75	250 M	3578	147	✓	93,6	93,4	92,3	0,89	83	2,5	7,3	3,3	76	90	1LE1523-2CA2	385	0,46	
75	100	280 S	3578	200	✓	94,1	93,9	92,7	0,89	112	2,7	7,6	3,2	78	92	1LE1523-2DA0	510	0,77	
90	125	280 M	3578	240	✓	95	94,8	93,8	0,9	132	2,7	8,1	3,3	78	92	1LE1523-2DA2	590	0,94	
110	150	315 S	3585	295	✓	95	94,8	93,8	0,91	160	2,6	8	3,3	79	93	1LE1523-3AA0	750	1,39	
132	175	315 M	3585	350	✓	95,4	95,1	94	0,91	191	2,8	8	3,4	79	93	1LE1523-3AA2	880	1,6	
150	200	315 L	3588	400	✓	95,4	95,1	93,9	0,91	215	3,3	9,1	3,7	82	96	1LE1523-3AA4	980	1,9	
185	250	315 L	3586	495	✓	95,8	95,7	94,8	0,92	265	3,5	8,5	3,5	82	96	1LE1523-3AA5	1150	2,3	
Voltages (≤ 600 V) ¹⁾																Version		Order code	
50 Hz 230 VΔ/400 VY				60 Hz 460 VY				Standard				2	2	–					
50 Hz 400 VΔ				60 Hz 460 VΔ				Standard				3	4	–					
50 Hz 500 VY								Without additional charge				2	7	–					
50 Hz 500 VΔ								Without additional charge				4	0	–					
For other voltages and more information, see from page 3/100																			
Types of construction																Version		Order code	
Without flange				IM B3 ²⁾				Standard				A	–						
With flange				IM B5 ²⁾				With additional charge				F	–						
With flange				IM B14 ²⁾				With additional charge				K	–						
For other types of construction and more information, see from page 3/107																			
Motor protection																Version		Order code	
Without								Standard				A	–						
PTC thermistor with 3 temperature sensors								With additional charge				B	–						
For other motor protection and more information, see from page 3/117																			
Terminal box position																Version		Order code	
Terminal box at top								Standard				4	–						
For other terminal box positions and more information, see from page 3/120																			
Special versions																		Order code(s)	
Forced-air cooled motors w/o ext. fan/fan cover (IC418)																1LE1523- -Z		F90+	
For options, see from page 3/129																1LE1523- -Z		

- Not required
- ✓ Available

¹⁾ Operating voltages only ≤ 600 V admissible in accordance with MG1 Table 12-12. Parallel supply lines are required in the case of connection to ≤ 240 V. For frame size 315 with connection to ≤ 240 V, due to the high current, a drilled, removable entry plate (order code R52) or a larger terminal box (order code R50) can be used. Order codes R52 and R50 alter the motor dimensions.

²⁾ Types derived from IM B3 (IM B6/7/8, IM V6, and IM V5), from IM B5 (IM V3 and IM V1) and from IM B14 (IM V19 and IM V18) are possible, provided that no requirement exists for stamping of the type on the rating plate. The basic type IM B3, IM B5, or IM B14 is stamped as standard on the rating plate. If mounted in a different position, the position must be specified to ensure that the condensation drainage holes are positioned correctly.



SIMOTICS GP and SIMOTICS SD standard motors
Eagle Line · NEMA Premium Efficient MG1 Table 12-12

Cast-iron series SIMOTICS SD 1LE1523 Basic Line – self-ventilated or forced-air cooled

Selection and ordering data

Operating values at rated power															Cast-iron series		m _{IM B3}	J
P _{rated} 60 Hz/ P50	P _{rated} 60 Hz/ P60	Frame size	n _{rated} 60 Hz	T _{rated} 60 Hz	EISA CC No. CC032A	η _{rated} 60 Hz 4/4	η _{rated} 60 Hz 3/4	η _{rated} 60 Hz 2/4	cosφ _{rated} 60 Hz 4/4	I _{rated} 460 V	T _{LR} 60 Hz	I _{LR} 60 Hz	T _β 60 Hz	L _{pFA} 60 Hz	L _{WA} 60 Hz	Article No.		
kW	hp	FS	rpm	Nm		%	%	%		A								
4-pole: 1500 rpm at 50 Hz, 1800 rpm at 60 Hz																		
0.25	0.33	71 M	1715	1.39	-	73.4	72.3	68	0.68	0.63	2.9	4.9	3.1	47	58	1LE1523-0CB2	13	0.0095
0.37	0.5	71 M	1720	2.05	-	78.2	76.9	72.5	0.66	0.9	3.6	5.7	3.8	62	73	1LE1523-0CB3	16	0.0014
0.55	0.75	80 M	1750	3	-	81.1	80.9	78.6	0.74	1.15	2.7	6.9	3.8	53	61	1LE1523-0DB2	19	0.0021
0.75	1	80 M	1760	4.05	✓	83.5	82.6	79.7	0.71	1.59	3.1	8.3	4.7	58	66	1LE1523-0DB3	23	0.0029
1.1	1.5	90 S	1750	6	✓	86.5	86.4	84.2	0.75	2.15	3.4	8.2	4.4	58	70	1LE1523-0EB0	25	0.0036
1.5	2	90 L	1755	8.2	✓	86.5	86.6	84.7	0.77	2.85	3.4	8.6	4.3	59	67	1LE1523-0EB4	31	0.0049
2.2	3	100 L	1770	11.9	✓	89.5	89.2	87.2	0.81	3.8	3.5	9.6	5.1	62	74	1LE1523-1AB4	40	0.014
3	4	100 L	1760	16.3	✓	89.5	89.5	88.3	0.82	5.1	3.1	9.5	4.6	62	74	1LE1523-1AB5	40	0.014
3.7	5	112 M	1770	20	✓	89.5	89.4	87.7	0.8	6.5	2.9	8.2	4.3	62	74	1LE1523-1BB2	46	0.017
5.5	7.5	132 S	1775	29.5	✓	91.7	91.6	90.5	0.81	9.3	3.1	10	4.2	68	80	1LE1523-1CB0	74	0.034
7.5	10	132 M	1770	40.5	✓	91.7	91.8	91	0.83	12.4	2.7	9.6	4.2	68	80	1LE1523-1CB2	80	0.046
11	15	160 M	1775	59	✓	92.4	92.3	91.1	0.83	18	3	8.9	3.8	69	81	1LE1523-1DB2	109	0.071
15	20	160 L	1780	80	✓	93	92.8	91.4	0.81	25	2.9	9.5	4.3	69	81	1LE1523-1DB4	127	0.085
18.5	25	180 M	1775	100	✓	93.6	93.7	93.1	0.81	30.5	2.7	7.8	3.6	68	75	1LE1523-1EB2	165	0.13
22	30	180 L	1775	118	✓	93.6	93.8	93.3	0.81	36.5	2.8	7.7	3.7	70	77	1LE1523-1EB4	170	0.14
30	40	200 L	1778	161	✓	94.1	94.3	93.8	0.83	48	3	8.1	3.5	70	77	1LE1523-2AB5	240	0.24
37	50	225 S	1782	198	✓	94.5	94.7	94.2	0.85	58	2.8	7.5	3	68	80	1LE1523-2BB0	285	0.42
45	60	225 M	1782	240	✓	95	95.3	95.1	0.85	70	3	7.7	3	67	80	1LE1523-2BB2	340	0.52
55	75	250 M	1786	295	✓	95.4	95.6	95.1	0.86	84	2.8	7.6	3.2	68	81	1LE1523-2CB2	420	0.85
75	100	280 S	1788	400	✓	95.4	95.3	94.5	0.85	116	2.8	7.7	3.3	77	91	1LE1523-2DB0	570	1.39
90	125	280 M	1788	480	✓	95.4	95.5	94.9	0.87	136	2.9	8	3.3	79	93	1LE1523-2DB2	670	1.7
110	150	315 S	1790	590	✓	95.8	95.9	95.4	0.86	168	3	7.5	3.1	74	87	1LE1523-3AB0	760	2.2
132	175	315 M	1790	700	✓	96.2	96.3	95.8	0.87	198	3.1	8.2	3.2	78	90	1LE1523-3AB2	960	2.9
150	200	315 L	1791	800	✓	96.2	96.2	95.7	0.87	225	3.5	8.8	3.6	78	90	1LE1523-3AB4	990	3.1
185	250	315 L	1791	990	✓	96.2	96.2	95.5	0.87	275	3.9	9	3.6	78	93	1LE1523-3AB5	1190	3.7
Voltages (≤ 600 V)¹⁾															Version		Order code	
50 Hz 230 VΔ/400 VY			60 Hz 460 VY			Standard		2 2		-								
50 Hz 400 VΔ			60 Hz 460 VΔ			Standard		3 4		-								
50 Hz 500 VY						Without additional charge		2 7		-								
50 Hz 500 VΔ						Without additional charge		4 0		-								
For other voltages and more information, see from page 3/100															9 0		...	
Types of construction															Version		Order code	
Without flange			IM B3 ²⁾			Standard		A		-								
With flange			IM B5 ²⁾			With additional charge		F		-								
With flange			IM B14 ²⁾			With additional charge		K		-								
For other types of construction and more information, see from page 3/107															4		...	
Motor protection															Version		Order code	
Without						Standard		A		-								
PTC thermistor with 3 temperature sensors						With additional charge		B		-								
For other motor protection and more information, see from page 3/117															4		...	
Terminal box position															Version		Order code(s)	
Terminal box at top						Standard		4										
For other terminal box positions and more information, see from page 3/120															4		...	
Special versions																	Order code(s)	
Forced-air cooled motors w/o ext. fan/fan cover (IC418)															1LE1523-....		-Z F90+...+...+...	
For options, see from page 3/129															1LE1523-....		-Z ...+...+...+...	

- Not required
- ✓ Available

¹⁾ Operating voltages only ≤ 600 V admissible in accordance with MG1 Table 12-12. Parallel supply lines are required in the case of connection to ≤ 240 V. For frame size 315 with connection to ≤ 240 V, due to the high current, a drilled, removable entry plate (order code **R52**) or a larger terminal box (order code **R50**) can be used. Order codes **R52** and **R50** alter the motor dimensions.

²⁾ Types derived from IM B3 (IM B6/7/8, IM V6 and IM V5), from IM B5 (IM V3 and IM V1) and from IM B14 (IM V19 and IM V18) are possible, provided that no requirement exists for stamping of the type on the rating plate. The basic type IM B3, IM B5, or IM B14 is stamped as standard on the rating plate. If mounted in a different position, the position must be specified to ensure that the condensation drainage holes are positioned correctly.

SIMOTICS GP and SIMOTICS SD standard motors
Eagle Line · NEMA Premium Efficient MG1 Table 12-12



Cast-iron series SIMOTICS SD 1LE1523 Basic Line – self-ventilated or forced-air cooled

Selection and ordering data

Operating values at rated power															Cast-iron series		m _{IM B3}	J
P _{rated} 60 Hz/ P50	P _{rated} 60 Hz/ P60	Frame size	n _{rated} 60 Hz	T _{rated} 60 Hz	EISA CC No. CC032A	η _{rated} 60 Hz, 4/4	η _{rated} 60 Hz, 3/4	η _{rated} 60 Hz, 2/4	cosφ _{rated} 60 Hz, 4/4	I _{rated} 60 Hz, 460 V	T _{LR} / I _{LR} 60 Hz	T _{LR} / I _{LR} 60 Hz	T _B / I _B 60 Hz	L _{pFA} 60 Hz	L _{WA} 60 Hz	Article No.		
• Cooling: Self-ventilated (IC411) or with order code F90 forced-air cooled without external fan and fan cover (IC418) • Efficiency: NEMA Premium Efficient, UL, CSA, and service factor (SF) 1.15 – for operation in the USA and Canada, not admissible for exporting to Mexico • Insulation: Thermal class 155 (temperature class F), IP55 degree of protection, utilization in accordance with thermal class 130 (temperature class B)																		
6-pole: 1000 rpm at 50 Hz, 1200 rpm at 60 Hz																		
0.18	0.25	71 M	1110	1.55	-	67.5	66.3	61	0.63	0.53	2.8	3.5	2.9	42	53	1LE1523-0CC2	13	0.001
0.25	0.33	71 M	1110	2.15	-	71.4	70.6	66.4	0.64	0.69	3.2	3.9	3.2	48	59	1LE1523-0CC3	16	0.0015
0.37	0.5	80 M	1150	3.05	-	75.3	74.3	70	0.61	1.01	2.7	5	3.3	45	56	1LE1523-0DC2	19	0.0025
0.55	0.75	80 M	1145	4.6	-	81.7	80.5	76.4	0.63	1.34	2.8	5.3	3.4	45	56	1LE1523-0DC3	23	0.0031
0.75	1	90 S	1155	6.2	✓	82.5	82.4	79.9	0.65	1.76	2.4	5.3	3.1	46	58	1LE1523-0EC0	27	0.004
3	4	132 S	1180	24.5	✓	89.5	89.5	87.9	0.7	6	2.6	7.6	3.8	62	69	1LE1523-1CC0	60	0.037
3.7	5	132 M	1180	30	✓	89.5	89.2	87.5	0.69	7.5	2.8	7.5	3.8	64	70	1LE1523-1CC2	64	0.037
5.5	7.5	132 M	1180	44.5	✓	91	90.8	89.2	0.69	11	3	7.8	4	69	75	1LE1523-1CC3	76	0.046
7.5	10	160 M	1185	60	✓	91	90.8	89.4	0.8	12.9	2.7	9.3	3.7	75	81	1LE1523-1DC2	124	0.098
11	15	160 L	1185	89	✓	91.7	91.7	90.5	0.78	19.3	3.4	8	3.2	73	80	1LE1523-1DC4	138	0.12
15	20	180 L	1178	122	✓	91.7	92	91.4	0.79	26	2.5	6.8	3	61	68	1LE1523-1EC4	180	0.19
18.5	25	200 L	1180	150	✓	93	93.8	93.8	0.78	32	2.8	6.5	3	64	71	1LE1523-2AC4	215	0.28
22	30	200 L	1180	178	✓	93	93.5	93.4	0.79	37.5	2.6	6.3	2.8	63	70	1LE1523-2AC5	230	0.32
30	40	225 M	1185	240	✓	94.1	94.4	94.1	0.82	49	2.9	7.6	3.3	66	79	1LE1523-2BC2	325	0.67
37	50	250 M	1188	295	✓	94.1	94.4	93.9	0.83	59	3.1	8	3.1	63	76	1LE1523-2CC2	405	1
45	60	280 S	1190	360	✓	94.5	94.6	94.1	0.83	72	3.3	7.7	3.1	66	80	1LE1523-2DC0	510	1.4
55	75	280 M	1190	440	✓	94.5	94.6	93.9	0.84	87	3.6	9.2	3.3	66	80	1LE1523-2DC2	560	1.64
75	100	315 S	1192	600	✓	95	94.9	94.1	0.82	121	3.1	8.4	3.3	64	79	1LE1523-3AC0	750	2.6
90	125	315 M	1192	720	✓	95	95	94.4	0.84	142	2.7	7.7	3	64	79	1LE1523-3AC2	890	3.1
110	150	315 L	1192	880	✓	95.8	95.9	95.5	0.83	174	3.2	8.2	3.4	64	79	1LE1523-3AC4	990	3.9
132	175	315 L	1193	1060	✓	95.8	95.9	95.4	0.81	215	3.7	9.6	3.7	65	80	1LE1523-3AC5	1130	4.48
150	200	315 L	1194	1200	✓	95.8	95.7	95	0.8	245	4.3	10.5	4.3	68	83	1LE1523-3AC6	1260	5.41
Voltages (≤ 600 V)¹⁾															Version		Order code	
50 Hz 230 VΔ/400 VY			60 Hz 460 VY			Standard			2 2		-							
50 Hz 400 VΔ			60 Hz 460 VΔ			Standard			3 4		-							
50 Hz 500 VY						Without additional charge			2 7		-							
50 Hz 500 VΔ						Without additional charge			4 0		-							
For other voltages and more information, see from page 3/100															9 0		...	
Types of construction															Version		Order code	
Without flange			IM B3 ²⁾			Standard			A		-							
With flange			IM B5 ²⁾			With additional charge			F		-							
With flange			IM B14 ²⁾			With additional charge			K		-							
For other types of construction and more information, see from page 3/107															...			
Motor protection															Version		Order code	
Without						Standard			A		-							
PTC thermistor with 3 temperature sensors						With additional charge			B		-							
For other motor protection and more information, see from page 3/117															...			
Terminal box position															Version		Order code	
Terminal box at top						Standard			4									
For other terminal box positions and more information, see from page 3/120															...			
Special versions															Order code(s)			
Forced-air cooled motors w/o ext. fan/fan cover (IC418)															1LE1523-....		-Z F90+...+...+...	
For options, see from page 3/129															1LE1523-....		-Z ...+...+...+...	

- Not required
- ✓ Available

¹⁾ Operating voltages only ≤ 600 V admissible in accordance with MG1 Table 12-12. Parallel supply lines are required in the case of connection to ≤ 240 V. For frame size 315 with connection to ≤ 240 V, due to the high current, a drilled, removable entry plate (order code R52) or a larger terminal box (order code R50) can be used. Order codes R52 and R50 alter the motor dimensions.

²⁾ Types derived from IM B3 (IM B6/7/8, IM V6 and IM V5), from IM B5 (IM V3 and IM V1) and from IM B14 (IM V19 and IM V18) are possible, provided that no requirement exists for stamping of the type on the rating plate. The basic type IM B3, IM B5, or IM B14 is stamped as standard on the rating plate. If mounted in a different position, the position must be specified to ensure that the condensation drainage holes are positioned correctly.



SIMOTICS GP and SIMOTICS SD standard motors
Eagle Line · NEMA Premium Efficient MG1 Table 12-12

Cast-iron series SIMOTICS SD 1LE1523 Basic Line – self-ventilated or forced-air cooled

Selection and ordering data

Operating values at rated power															Cast-iron series			
P_{rated} 60 Hz/ P50	P_{rated} 60 Hz/ P60	Frame size	n_{rated} 60 Hz	T_{rated} 60 Hz	EISA CC No. CC032A	η_{rated} 60 Hz, 4/4	η_{rated} 60 Hz, 3/4	η_{rated} 60 Hz, 2/4	$\cos\phi_{rated}$ 60 Hz, 4/4	I_{rated} 60 Hz, 460 V	T_{LR} 60 Hz	I_{LR} 60 Hz	T_B 60 Hz	L_{pFA} 60 Hz	L_{WA} 60 Hz	Article No.	$m_{IM B3}$	J
kW	hp	FS	rpm	Nm	%	%	%	%	A	°C	A	°C	°C	dB(A)	dB(A)	▲ New	kg	kgm ²
8-pole: 750 rpm at 50 Hz, 900 rpm at 60 Hz																		
0.09	0.12	71 M	825	1.04	-	57.1	53.7	45.8	0.55	0.36	2.3	2.6	2.4	45	57	▲ 1LE1523-0CD2	13	0.0098
0.12	0.17	71 M	830	1.38	-	59.5	56.9	50.3	0.56	0.45	2.6	2.9	2.7	49	56	▲ 1LE1523-0CD3	16	0.0014
0.18	0.24	80 M	865	1.99	-	64	60.6	53	0.44	0.78	2.6	3.5	3.5	54.8	68.1	▲ 1LE1523-0DD2	18	0.0021
0.25	0.33	80 M	855	2.8	-	68	65.5	59.8	0.51	0.91	2	3.3	2.6	56	64	▲ 1LE1523-0DD3	22	0.003
0.37	0.5	90 S	850	4.15	-	72	69.9	64.2	0.63	1.02	2	3.4	2.1	54	61	▲ 1LE1523-0ED0	26	0.0045
0.55	0.75	90 L	855	6.1	-	74	71.6	65.8	0.62	1.5	2.3	4	2.8	59	66	▲ 1LE1523-0ED4	26	0.0045
0.75	1	100 L	870	8.2	-	75.5	74.9	71.7	0.62	1.87	1.9	4.4	2.5	64	72	▲ 1LE1523-1AD4	31	0.0096
1.1	1.5	100 L	865	12.1	-	78.5	78	75.7	0.62	2.7	2.3	4.8	3	65.4	73.4	▲ 1LE1523-1AD5	36	0.013
1.5	2	112 M	875	16.4	-	84	83.1	80	0.59	3.75	2.9	5.8	3.6	65	73	▲ 1LE1523-1BD2	46	0.028
Voltages (≤ 600 V) ¹⁾															Version		Order code	
50 Hz 230 VΔ/400 VY				60 Hz 460 VY				Standard				2	2	-				
50 Hz 400 VΔ				60 Hz 460 VΔ				Standard				3	4	-				
50 Hz 500 VY								Without additional charge				2	7	-				
50 Hz 500 VΔ								Without additional charge				4	0	-				
For other voltages and more information, see from page 3/100															9	0	...	
Types of construction															Version		Order code	
Without flange				IM B3 ²⁾				Standard				A	-					
With flange				IM B5 ²⁾				With additional charge				F	-					
With flange				IM B14 ²⁾				With additional charge				K	-					
For other types of construction and more information, see from page 3/107															...			
Motor protection															Version		Order code	
Without								Standard				A	-					
PTC thermistor with 3 temperature sensors								With additional charge				B	-					
For other motor protection and more information, see from page 3/117															...			
Terminal box position															Version		Order code	
Terminal box at top								Standard				4	-					
For other terminal box positions and more information, see from page 3/120															...			
Special versions															Version		Order code(s)	
Forced-air cooled motors w/o ext. fan/fan cover (IC418)															1LE1523-....		-Z F90+...+...+...	
For options, see from page 3/129															1LE1523-....		-Z ...+...+...+...	

-Not required



SIMOTICS GP and SIMOTICS SD standard motors
Eagle Line · NEMA Premium Efficient MG1 Table 12-12



Cast-iron series SIMOTICS SD 1LE1623 Performance Line – self-ventilated or forced-air cooled

Selection and ordering data

Operating values at rated power															Cast-iron series			
P_{rated} 60 Hz/ P50	P_{rated} 60 Hz/ P60	Frame size	n_{rated} 60 Hz	T_{rated} 60 Hz	EISA CC No. CC032A	η_{rated} 60 Hz	η_{rated} 60 Hz	η_{rated} 60 Hz	$\cos\phi_{rated}$ 60 Hz	I_{rated} 460 V	T_{LR}/I_{rated} 60 Hz	I_{LR}/I_{rated} 60 Hz	T_{β}/I_{rated} 60 Hz	L_{pFA} 60 Hz	L_{WA} 60 Hz	1LE1623 – Performance Line Article No.	$m_{IM B3}$	J
kW	hp	FS	rpm	Nm		%	%	%		A							kg	kgm ²
• Cooling: Self-ventilated (IC411) or with order code F90 forced-air cooled without external fan and fan cover (IC418) • Efficiency: NEMA Premium Efficient, UL, CSA, and service factor (SF) 1.15 – for operation in the USA and Canada, not admissible for exporting to Mexico • Insulation: Thermal class 155 (temperature class F), IP55 degree of protection, utilization in accordance with thermal class 130 (temperature class B)																		
2-pole: 3000 rpm at 50 Hz, 3600 rpm at 60 Hz																		
3	4	100 L	3525	8.1	✓	88.5	88.7	87.2	0.87	4.9	3.8	9.7	5.5	71	83	1LE1623-1AA4	36	0.0054
3.7	5	112 M	3560	9.9	✓	88.5	88	86.2	0.88	6	3.2	10.8	5.1	73	85	1LE1623-1BA2	45	0.012
5.5	7.5	132 S	3555	14.8	✓	89.5	89.4	88.2	0.9	8.6	2.1	8.6	4.4	72	84	1LE1623-1CA0	58	0.024
7.5	10	132 S	3555	20	✓	90.2	90.5	90	0.91	11.5	2.4	9.5	4.7	72	84	1LE1623-1CA1	73	0.031
11	15	160 M	3560	29.5	✓	91	90.4	88.3	0.88	17.2	2.8	8.5	4.3	77	89	1LE1623-1DA2	100	0.053
15	20	160 M	3565	40	✓	91	90.5	88.9	0.86	24	3.1	9.7	4.8	77	89	1LE1623-1DA3	110	0.061
18.5	25	160 L	3560	49.5	✓	91.7	91.5	90.3	0.9	28	3.1	9.4	4.4	77	89	1LE1623-1DA4	127	0.068
22	30	180 M	3560	59	✓	91.7	91.4	90	0.89	34	2.8	8.2	3.9	77	89	1LE1623-1EA2	160	0.08
30	40	200 L	3560	80	✓	92.4	92.2	91.4	0.87	47	2.9	7.6	3.6	77	84	1LE1623-2AA4	225	0.134
37	50	200 L	3560	99	✓	93	92.8	91.6	0.88	57	2.8	7.5	3.6	77	84	1LE1623-2AA5	250	0.158
45	60	225 M	3570	120	✓	93.6	93.7	93.1	0.88	69	2.7	7.6	3.3	75	89	1LE1623-2BA2	315	0.26
55	75	250 M	3578	147	✓	93.6	93.4	92.3	0.89	83	2.5	7.3	3.3	76	90	1LE1623-2CA2	385	0.46
75	100	280 S	3578	200	✓	94.1	93.9	92.7	0.89	112	2.7	7.6	3.2	78	92	1LE1623-2DA0	510	0.77
90	125	280 M	3578	240	✓	95	94.8	93.8	0.9	132	2.7	8.1	3.3	78	92	1LE1623-2DA2	590	0.94
110	150	315 S	3585	295	✓	95	94.8	93.8	0.91	160	2.6	8	3.3	79	93	1LE1623-3AA0	750	1.39
132	175	315 M	3585	350	✓	95.4	95.1	94	0.91	191	2.8	8	3.4	79	93	1LE1623-3AA2	880	1.6
150	200	315 L	3588	400	✓	95.4	95.1	93.9	0.91	215	3.3	9.1	3.7	82	96	1LE1623-3AA4	980	1.9
185	250	315 L	3586	495	✓	95.8	95.7	94.8	0.92	265	3.5	8.5	3.5	82	96	1LE1623-3AA5	1150	2.3
Voltages (≤ 600 V)¹⁾															Version		Order code	
50 Hz 230 VΔ/400 VY			60 Hz 460 VY			Standard			2 2		-							
50 Hz 400 VΔ			60 Hz 460 VΔ			Standard			3 4		-							
50 Hz 500 VY						Without additional charge			2 7		-							
50 Hz 500 VΔ						Without additional charge			4 0		-							
For other voltages and more information, see from page 3/100															9 0		...	
Types of construction															Version		Order code	
Without flange			IM B3 ²⁾			Standard			A		-							
With flange			IM B5 ²⁾			With additional charge			F		-							
With flange			IM B14 ²⁾			With additional charge			K		-							
For other types of construction and more information, see from page 3/107															B		...	
Motor protection															Version		Order code	
PTC thermistor with 3 temperature sensors						Standard			B		-							
For other motor protection and more information, see from page 3/117															4		...	
Terminal box position															Version		Order code(s)	
Terminal box at top						Standard			4									
For other terminal box positions and more information, see from page 3/120																		
Special versions																	Order code(s)	
Forced-air cooled motors w/o ext. fan/fan cover (IC418)									1LE1623-....-Z		F90+...+...+...							
For options, see from page 3/129																	1LE1623-....-Z ...+...+...+...	

- Not required
- ✓ Available

¹⁾ Operating voltages only ≤ 600 V admissible in accordance with MG1 Table 12-12. Parallel supply lines are required in the case of connection to ≤ 240 V. For frame size 315 with connection to ≤ 240 V, due to the high current, a drilled, removable entry plate (order code R52) or a larger terminal box (order code R50) can be used. Order codes R52 and R50 alter the motor dimensions.

²⁾ Types derived from IM B3 (IM B6/7/8, IM V6, and IM V5), from IM B5 (IM V3 and IM V1) and from IM B14 (IM V19 and IM V18) are possible, provided that no requirement exists for stamping of the type on the rating plate. The basic type IM B3, IM B5, or IM B14 is stamped as standard on the rating plate. If mounted in a different position, the position must be specified to ensure that the condensation drainage holes are positioned correctly.



SIMOTICS GP and SIMOTICS SD standard motors
Eagle Line · NEMA Premium Efficient MG1 Table 12-12

Cast-iron series SIMOTICS SD 1LE1623 Performance Line – self-ventilated or forced-air cooled

Selection and ordering data

Operating values at rated power															Cast-iron series		m _{IM B3}	J						
P _{rated} 60 Hz/ P50	P _{rated} 60 Hz/ P60	Frame size	n _{rated} 60 Hz	T _{rated} 60 Hz	EISA CC No. CC032A	η _{rated} 60 Hz, 4/4	η _{rated} 60 Hz, 3/4	η _{rated} 60 Hz, 2/4	cosφ _{rated} 60 Hz, 4/4	I _{rated} 60 Hz, 460 V	T _{LR} / T _{rated} 60 Hz	I _{LR} / I _{rated} 60 Hz	T _B / T _{rated} 60 Hz	L _{pFA} 60 Hz	L _{WA} 60 Hz	1LE1623 – Performance Line Article No.			kg	kgm ²				
kW	hp	FS	rpm	Nm		%	%	%		A														
4-pole: 1500 rpm at 50 Hz, 1800 rpm at 60 Hz																								
2.2	3	100 L	1770	11.9	✓	89.5	89.2	87.2	0.81	3.8	3.5	9.6	5.1	62	74	1LE1623-1AB4	40	0.014						
3	4	100 L	1760	16.3	✓	89.5	89.5	88.3	0.82	5.1	3.1	9.5	4.6	62	74	1LE1623-1AB5	40	0.014						
3.7	5	112 M	1770	20	✓	89.5	89.4	87.7	0.8	6.5	2.9	8.2	4.3	62	74	1LE1623-1BB2	46	0.017						
5.5	7.5	132 S	1775	29.5	✓	91.7	91.6	90.5	0.81	9.3	3.1	10	4.2	68	80	1LE1623-1CB0	74	0.034						
7.5	10	132 M	1770	40.5	✓	91.7	91.8	91	0.83	12.4	2.7	9.6	4.2	68	80	1LE1623-1CB2	80	0.046						
11	15	160 M	1775	59	✓	92.4	92.3	91.1	0.83	18	3	8.9	3.8	69	81	1LE1623-1DB2	109	0.071						
15	20	160 L	1780	80	✓	93	92.8	91.4	0.81	25	2.9	9.5	4.3	69	81	1LE1623-1DB4	127	0.085						
18.5	25	180 M	1775	100	✓	93.6	93.7	93.1	0.81	30.5	2.7	7.8	3.6	68	75	1LE1623-1EB2	165	0.13						
22	30	180 L	1775	118	✓	93.6	93.8	93.3	0.81	36.5	2.8	7.7	3.7	70	77	1LE1623-1EB4	170	0.14						
30	40	200 L	1778	161	✓	94.1	94.3	93.8	0.83	48	3	8.1	3.5	70	77	1LE1623-2AB5	240	0.24						
37	50	225 S	1782	198	✓	94.5	94.7	94.2	0.85	58	2.8	7.5	3	68	80	1LE1623-2BB0	285	0.42						
45	60	225 M	1782	240	✓	95	95.3	95.1	0.85	70	3	7.7	3	67	80	1LE1623-2BB2	340	0.52						
55	75	250 M	1786	295	✓	95.4	95.6	95.1	0.86	84	2.8	7.6	3.2	68	81	1LE1623-2CB2	420	0.85						
75	100	280 S	1788	400	✓	95.4	95.3	94.5	0.85	116	2.8	7.7	3.3	77	91	1LE1623-2DB0	570	1.39						
90	125	280 M	1788	480	✓	95.4	95.5	94.9	0.87	136	2.9	8	3.3	79	93	1LE1623-2DB2	670	1.7						
110	150	315 S	1790	590	✓	95.8	95.9	95.4	0.86	168	3	7.5	3.1	74	87	1LE1623-3AB0	760	2.2						
132	175	315 M	1790	700	✓	96.2	96.3	95.8	0.87	198	3.1	8.2	3.2	78	90	1LE1623-3AB2	960	2.9						
150	200	315 L	1791	800	✓	96.2	96.2	95.7	0.87	225	3.5	8.8	3.6	78	90	1LE1623-3AB4	990	3.1						
185	250	315 L	1791	990	✓	96.2	96.2	95.5	0.87	275	3.9	9	3.6	78	93	1LE1623-3AB5	1190	3.7						
Voltages (≤ 600 V)¹⁾															Version		Order code							
50 Hz 230 VΔ/400 VY			60 Hz 460 VY			Standard		2 2		-		-		-		-								
50 Hz 400 VΔ			60 Hz 460 VΔ			Standard		3 4		-		-		-		-								
50 Hz 500 VY						Without additional charge		2 7		-		-		-		-								
50 Hz 500 VΔ						Without additional charge		4 0		-		-		-		-								
For other voltages and more information, see from page 3/100															9 0		...							
Types of construction															Version		Order code							
Without flange			IM B3 ²⁾			Standard		A		-		-		-		-								
With flange			IM B5 ²⁾			With additional charge		F		-		-		-		-								
With flange			IM B14 ²⁾			With additional charge		K		-		-		-		-								
For other types of construction and more information, see from page 3/107															B		...							
Motor protection															Version		Order code							
PTC thermistor with 3 temperature sensors						Standard		B		-		-		-		-								
For other motor protection and more information, see from page 3/117																	...							
Terminal box position															Version		Order code							
Terminal box at top						Standard		4		-		-		-		-								
For other terminal box positions and more information, see from page 3/120																	...							
Special versions																	Order code(s)							
Forced-air cooled motors w/o ext. fan/fan cover (IC418)								1LE1623-...-Z		F90+...+...+...														
For options, see from page 3/129																	1LE1623-...-Z		...+...+...+...					

- Not required
- ✓ Available

¹⁾ Operating voltages only ≤ 600 V admissible in accordance with MG1 Table 12-12. Parallel supply lines are required in the case of connection to ≤ 240 V. For frame size 315 with connection to ≤ 240 V, due to the high current, a drilled, removable entry plate (order code **R52**) or a larger terminal box (order code **R50**) can be used. Order codes **R52** and **R50** alter the motor dimensions.

²⁾ Types derived from IM B3 (IM B6/7/8, IM V6 and IM V5), from IM B5 (IM V3 and IM V1) and from IM B14 (IM V19 and IM V18) are possible, provided that no requirement exists for stamping of the type on the rating plate. The basic type IM B3, IM B5, or IM B14 is stamped as standard on the rating plate. If mounted in a different position, the position must be specified to ensure that the condensation drainage holes are positioned correctly.

SIMOTICS GP and SIMOTICS SD standard motors
Eagle Line · NEMA Premium Efficient MG1 Table 12-12



Cast-iron series SIMOTICS SD 1LE1623 Performance Line – self-ventilated or forced-air cooled

Selection and ordering data

Operating values at rated power															Cast-iron series			
P_{rated} 60 Hz/ P50	P_{rated} 60 Hz/ P60	Frame size	n_{rated} 60 Hz	T_{rated} 60 Hz	EISA CC No. CC032A	η_{rated} 60 Hz, 4/4	η_{rated} 60 Hz, 3/4	η_{rated} 60 Hz, 2/4	$\cos\phi_{rated}$ 60 Hz, 4/4	I_{rated} 60 Hz, 460 V	T_{LR} 60 Hz	I_{LR} 60 Hz	T_B 60 Hz	L_{pFA} 60 Hz	L_{WA} 60 Hz	1LE1623 – Performance Line Article No.	$m_{IM B3}$	J
kW	hp	FS	rpm	Nm		%	%	%		A	°C	A	°C	dB(A)	dB(A)		kg	kgm ²
6-pole: 1000 rpm at 50 Hz, 1200 rpm at 60 Hz																		
3	4	132 S	1180	24.5	✓	89.5	89.5	87.9	0.7	6	2.6	7.6	3.8	62	69	1LE1623-1CC0	60	0.037
3.7	5	132 M	1180	30	✓	89.5	89.2	87.5	0.69	7.5	2.8	7.5	3.8	64	70	1LE1623-1CC2	64	0.037
5.5	7.5	132 M	1180	44.5	✓	91	90.8	89.2	0.69	11	3	7.8	4	69	75	1LE1623-1CC3	76	0.046
7.5	10	160 M	1185	60	✓	91	90.8	89.4	0.8	12.9	2.7	9.3	3.7	75	81	1LE1623-1DC2	124	0.098
11	15	160 L	1185	89	✓	91.7	91.7	90.5	0.78	19.3	3.4	8	3.2	73	80	1LE1623-1DC4	138	0.12
15	20	180 L	1178	122	✓	91.7	92	91.4	0.79	26	2.5	6.8	3	61	68	1LE1623-1EC4	180	0.19
18.5	25	200 L	1180	150	✓	93	93.8	93.8	0.78	32	2.8	6.5	3	64	71	1LE1623-2AC4	215	0.28
22	30	200 L	1180	178	✓	93	93.5	93.4	0.79	37.5	2.6	6.3	2.8	63	70	1LE1623-2AC5	230	0.32
30	40	225 M	1185	240	✓	94.1	94.4	94.1	0.82	49	2.9	7.6	3.3	66	79	1LE1623-2BC2	325	0.67
37	50	250 M	1188	295	✓	94.1	94.4	93.9	0.83	59	3.1	8	3.1	63	76	1LE1623-2CC2	405	1
45	60	280 S	1190	360	✓	94.5	94.6	94.1	0.83	72	3.3	7.7	3.1	66	80	1LE1623-2DC0	510	1.4
55	75	280 M	1190	440	✓	94.5	94.6	93.9	0.84	87	3.6	9.2	3.3	66	80	1LE1623-2DC2	560	1.64
75	100	315 S	1192	600	✓	95	94.9	94.1	0.82	121	3.1	8.4	3.3	64	79	1LE1623-3AC0	750	2.6
90	125	315 M	1192	720	✓	95	95	94.4	0.84	142	2.7	7.7	3	64	79	1LE1623-3AC2	890	3.1
110	150	315 L	1192	880	✓	95.8	95.9	95.5	0.83	174	3.2	8.2	3.4	64	79	1LE1623-3AC4	990	3.9
132	175	315 L	1193	1060	✓	95.8	95.9	95.4	0.81	215	3.7	9.6	3.7	65	80	1LE1623-3AC5	1130	4.48
150	200	315 L	1194	1200	✓	95.8	95.7	95	0.8	245	4.3	10.5	4.3	68	83	1LE1623-3AC6	1260	5.41
Voltages (≤ 600 V) ¹⁾															Version		Order code	
50 Hz 230 VΔ/400 VY			60 Hz 460 VY			Standard			Standard			2	2	-				
50 Hz 400 VΔ			60 Hz 460 VΔ			Standard			Standard			3	4	-				
50 Hz 500 VY			Without additional charge			Without additional charge			Without additional charge			2	7	-				
50 Hz 500 VΔ			Without additional charge			Without additional charge			Without additional charge			4	0	-				
For other voltages and more information, see from page 3/100															9	0	...	
Types of construction															Version		Order code	
Without flange			IM B3 ²⁾			Standard			Standard			A	-					
With flange			IM B5 ²⁾			With additional charge			With additional charge			F	-					
With flange			IM B14 ²⁾			With additional charge			With additional charge			K	-					
For other types of construction and more information, see from page 3/107															Version		Order code	
PTC thermistor with 3 temperature sensors			Standard			Standard			Standard			B	-					
For other motor protection and more information, see from page 3/117															Version		Order code(s)	
Terminal box at top			Standard			Standard			Standard			4	-					
For other terminal box positions and more information, see from page 3/120															Version		Order code(s)	
Forced-air cooled motors w/o ext. fan/fan cover (IC418)			1LE1623- -Z F90+ . . . + . . .			1LE1623- -Z . . . + . . . + . . .			1LE1623- -Z . . . + . . . + . . .									
For options, see from page 3/129																		

- Not required
- ✓ Available

¹⁾ Operating voltages only ≤ 600 V admissible in accordance with MG1 Table 12-12. Parallel supply lines are required in the case of connection to ≤ 240 V. For frame size 315 with connection to ≤ 240 V, due to the high current, a drilled, removable entry plate (order code **R52**) or a larger terminal box (order code **R50**) can be used. Order codes **R52** and **R50** alter the motor dimensions.

²⁾ Types derived from IM B3 (IM B6/7/8, IM V6 and IM V5), from IM B5 (IM V3 and IM V1) and from IM B14 (IM V19 and IM V18) are possible, provided that no requirement exists for stamping of the type on the rating plate. The basic type IM B3, IM B5, or IM B14 is stamped as standard on the rating plate. If mounted in a different position, the position must be specified to ensure that the condensation drainage holes are positioned correctly.



SIMOTICS GP and SIMOTICS SD standard motors
Eagle Line · NEMA Premium Efficient MG1 Table 12-12

Cast-iron series SIMOTICS SD 1LE1623 Performance Line – self-ventilated or forced-air cooled

Selection and ordering data

Operating values at rated power															Cast-iron series			
P_{rated} 60 Hz/ P50	P_{rated} 60 Hz/ P60	Frame size	n_{rated} 60 Hz	T_{rated} 60 Hz	EISA CC No. CC032A	η_{rated} 60 Hz, 4/4	η_{rated} 60 Hz, 3/4	η_{rated} 60 Hz, 2/4	$\cos\phi_{rated}$ 60 Hz, 4/4	I_{rated} 60 Hz, 460 V	T_{LR} 60 Hz	I_{LR} 60 Hz	T_{β} 60 Hz	L_{pFA} 60 Hz	L_{WA} 60 Hz	1LE1623 – Performance Line Article No.	$m_{IM B3}$	J
kW	hp	FS	rpm	Nm		%	%	%		A	°C	A	°C	dB(A)	dB(A)	▲ New	kg	kgm ²
8-pole: 750 rpm at 50 Hz, 900 rpm at 60 Hz																		
0.75	1	100 L	870	8.2	-	75.5	74.9	71.7	0.62	1.87	1.9	4.4	2.5	64	72	▲ 1LE1623-1AD4	31	0.0096
1.1	1.5	100 L	865	12.1	-	78.5	78	75.7	0.62	2.7	2.3	4.8	3	65.4	73.4	▲ 1LE1623-1AD5	36	0.013
1.5	2	112 M	875	16.4	-	84	83.1	80	0.59	3.75	2.9	5.8	3.6	65	73	▲ 1LE1623-1BD2	46	0.028
2.2	3	132 S	880	24	✓	85.5	85.2	82.9	0.68	4.75	2.3	5.8	3	65	80	1LE1623-1CD0	66	0.038
3	4	132 M	880	32.5	✓	86.5	85.9	83.5	0.69	6.3	2.2	6	3	67	80	1LE1623-1CD2	78	0.048
3.7	5	160 M	885	40	✓	86.5	86.7	85.3	0.71	7.5	2	5.8	2.6	69.3	79	1LE1623-1DD2	98	0.065
5.5	7.5	160 M	885	59	✓	86.5	86.7	85.5	0.72	10.8	2.3	6.3	2.8	66	79	1LE1623-1DD3	110	0.083
7.5	10	160 L	885	81	✓	89.5	89.5	88.1	0.71	14.8	2.6	6.7	2.6	66	79	1LE1623-1DD4	135	0.116
11	15	180 L	880	119	✓	89.5	89.9	89.3	0.72	21.5	2.3	5.8	2.7	65	78	1LE1623-1ED4	190	0.267
15	20	200 L	882	162	✓	90.2	90.2	89.2	0.7	30	3.4	7.7	4.2	60	73	1LE1623-2AD5	255	0.420
18.5	25	225 S	886	199	✓	90.2	90.2	89	0.73	35.5	2.9	6.6	3.4	58	72	1LE1623-2BD0	270	0.50
22	30	225 M	886	235	✓	91.7	91.8	90.8	0.76	39.5	2.9	6.8	3.3	62	74	1LE1623-2BD2	280	0.55
30	40	250 M	888	325	✓	91.7	91.9	91.1	0.77	53	2.9	7	3.3	65	77	1LE1623-2CD2	370	0.86
37	50	280 S	890	395	✓	92.4	92.6	91.9	0.77	65	2.5	6.1	2.6	65	78	1LE1623-2DD0	460	1.1
45	60	280 M	890	485	✓	92.4	92.5	91.9	0.79	77	2.7	6.8	2.7	66	79	1LE1623-2DD2	550	1.6
55	75	315 S	891	590	✓	93.6	93.6	92.9	0.79	93	2.6	6.8	3	73	82	1LE1623-3AD0	650	2.0
75	100	315 M	890	800	✓	93.6	93.7	93	0.8	126	2.5	6.7	3	73	87	1LE1623-3AD2	720	2.5
90	125	315 L	890	970	✓	94.1	94.4	94.1	0.81	148	2.4	6.5	2.8	76	88	1LE1623-3AD4	860	3.1
110	150	315 L	891	1180	✓	94.1	94.2	93.7	0.81	181	2.8	7.2	3.2	76	88	1LE1623-3AD5	980	3.9
132	175	315 L	892	1410	✓	94.5	94.5	93.9	0.8	220	3.2	7.9	3.7	81	92	1LE1623-3AD6	1070	4.5
Voltages (≤ 600 V) ¹⁾															Version		Order code	
50 Hz 230 VΔ/400 VY				60 Hz 460 VY				Standard		2		2		-				
50 Hz 400 VΔ				60 Hz 460 VΔ				Standard		3		4		-				
50 Hz 500 VY								Without additional charge		3		7		-				
50 Hz 500 VΔ								Without additional charge		4		0		-				
For other voltages and more information, see from page 3/100																		
Types of construction															Version		Order code	
Without flange				IM B3 ²⁾				Standard		A		-						
With flange				IM B5 ²⁾				With additional charge		F		-						
With flange				IM B14 ²⁾				With additional charge		K		-						
For other types of construction and more information, see from page 3/107																		
Motor protection															Version		Order code	
PTC thermistor with 3 temperature sensors								Standard		B		-						
For other motor protection and more information, see from page 3/117																		
Terminal box position															Version		Order code	
Terminal box at top								Standard		4		-						
For other terminal box positions and more information, see from page 3/120																		
Special versions																	Order code(s)	
Forced-air cooled motors w/o ext. fan/fan cover (IC418)										1LE1623- -Z		F90+ +						
For options, see from page 3/129																		

- Not required
- ✓ Available

¹⁾ Operating voltages only ≤ 600 V admissible in accordance with MG1 Table 12-12.
Parallel supply lines are required in the case of connection to ≤ 240 V. For frame size 315 with connection to ≤ 240 V, due to the high current, a drilled, removable entry plate (order code **R52**) or a larger terminal box (order code **R50**) can be used. Order codes **R52** and **R50** alter the motor dimensions.

²⁾ Types derived from IM B3 (IM B6/7/8, IM V6 and IM V5), from IM B5 (IM V3 and IM V1) and from IM B14 (IM V19 and IM V18) are possible, provided that no requirement exists for stamping of the type on the rating plate. The basic type IM B3, IM B5, or IM B14 is stamped as standard on the rating plate. If mounted in a different position, the position must be specified to ensure that the condensation drainage holes are positioned correctly.



SIMOTICS GP and SIMOTICS SD standard motors
Eagle Line · NEMA Energy Efficient MG1 Table 12-11



Aluminum series SIMOTICS GP 1LE1021 – self-ventilated or forced-air cooled

Selection and ordering data

Operating values at rated power																Aluminum series		
P_{rated} , 60 Hz/ P50	P_{rated} , 60 Hz/ P60	Frame size	n_{rated} , 60 Hz	T_{rated} , 60 Hz	EISA CC No. CC032A	η_{rated} , 60 Hz, 4/4	η_{rated} , 60 Hz, 3/4	η_{rated} , 60 Hz, 2/4	$\cos\phi_{rated}$, 60 Hz, 4/4	I_{rated} , 60 Hz, 460 V	$T_{LR}/$ T_{rated} , 60 Hz	$I_{LR}/$ I_{rated} , 60 Hz	$T_B/$ T_{rated} , 60 Hz	L_{pFA} , 60 Hz	L_{WA} , 60 Hz	1LE1021	m_{IM} B3	J
kW	hp	FS	rpm	Nm		%	%	%		A						Article No.		
<ul style="list-style-type: none"> • Cooling: Self-ventilated (IC411) or with order code F90 forced-air cooled without external fan and fan cover (IC418) • Efficiency: NEMA Energy Efficient, UL, CSA, and service factor (SF) 1.15 – for operation in the USA and Canada, not admissible for exporting to Mexico • Insulation: Thermal class 155 (temperature class F), IP55 degree of protection, utilization in accordance with thermal class 130 (temperature class B) 																		
4-pole: 1500 rpm at 50 Hz, 1800 rpm at 60 Hz																		
0.55	0.75	80 M	1750	3	-	75.5	74.6	71.1	0.71	1.29	2.7	6.4	3.8	55	66	1LE1021-0DB2	10	0.0017
6-pole: 1000 rpm at 50 Hz, 1200 rpm at 60 Hz																		
0.37	0.5	80 M	1140	3.1	-	64	63	59.1	0.63	1.15	2.3	4.6	2.9	45	56	1LE1021-0DC2	9	0.0017
0.55	0.75	80 M	1135	4.6	-	68	67.4	63.7	0.61	1.66	2.9	5.2	3.6	45	56	1LE1021-0DC3	12	0.0025
8-pole: 750 rpm at 50 Hz, 900 rpm at 60 Hz																		
0.18	0.25	80 M	855	2	-	46	43.5	37	0.53	0.93	2	2.5	2.6	55	66	▲ 1LE1021-0DD2	9	0.0017
0.25	0.33	80 M	860	2.8	-	52	49	43	0.51	1.21	2.2	2.9	3	55	66	▲ 1LE1021-0DD3	13	0.0024
0.37	0.5	90 S	845	4.2	-	58	55.8	49.5	0.64	1.25	1.6	3	2.1	57	69	▲ 1LE1021-0ED0	11	0.0019
0.55	0.75	90 L	840	6.3	-	62	61.2	56.5	0.66	1.69	1.8	3.1	2.1	57	69	▲ 1LE1021-0ED4	13	0.0026
Voltages (≤ 600 V) ¹⁾																Version		Order code
50 Hz 230 VΔ/400 VY			60 Hz 460 VY			Standard		2 2								-		
50 Hz 400 VΔ			60 Hz 460 VΔ			Standard		3 4								-		
50 Hz 500 VY						Without additional charge		2 7								-		
50 Hz 500 VΔ						Without additional charge		4 0								-		
For other voltages and more information, see from page 3/97																9 0		...
Types of construction ²⁾																Version		Order code
With flange			IM B5 ³⁾			With additional charge		F								-		
With flange			IM B14 ³⁾			With additional charge		K								-		
For other types of construction and more information, see from page 3/103																		...
Motor protection																Version		Order code
Without						Standard		A								-		
PTC thermistor with 1 temperature sensor						With additional charge		B								-		
For other motor protection and more information, see from page 3/116																		...
Terminal box position																Version		Order code(s)
Terminal box at top						Standard		4										
For other terminal box positions and more information, see from page 3/119																		
Special versions																		Order code(s)
Forced-air cooled motors w/o ext. fan/fan cover (IC418)																1LE1021-....		-Z F90 +.+.+.+.+.+
For options, see from page 3/122																1LE1021-....		-Z ...+.+.+.+.+.+

- Not required
- ✓ Available

¹⁾ Operating voltages only ≤ 600 V admissible in accordance with MG1 Table 12-11.

²⁾ Types of construction with feet are not possible for 2-pole, 4-pole and 6-pole motors ≤ 200 hp in accordance with MG1 Table 12-11.

³⁾ Types derived from IM B5 (IM V3 and IM V1) and from IM B14 (IM V19 and IM V18) are possible, provided that no requirements exist for condensation drainage holes (H03) and stamping of the type on the rating plate. The basic type IM B5 or IM B14 is stamped as standard on the rating plate. For orders with condensation drainage holes (H03), the type must be specified.



SIMOTICS GP and SIMOTICS SD standard motors
Eagle Line · NEMA Energy Efficient MG1 Table 12-11

Cast-iron series SIMOTICS SD 1LE1521 Basic Line – self-ventilated or forced-air cooled

Selection and ordering data

Operating values at rated power														Cast-iron series		m _{IM B3}	J	
P _{rated} 60 Hz/ P50 kW	P _{rated} 60 Hz/ P60 hp	Frame size FS	n _{rated} 60 Hz rpm	T _{rated} 60 Hz Nm	EISA CC No. CC032A	η _{rated} 60 Hz %	η _{rated} 60 Hz %	η _{rated} 60 Hz %	cosφ _{rated} 60 Hz %	I _{rated} 60 Hz A	T _{LR} / I _{LR} T _B / I _B 60 Hz dB(A)	T _{LR} / I _{LR} T _B / I _B 60 Hz dB(A)	L _{pfA} 60 Hz dB(A)	L _{WA} 60 Hz dB(A)	1LE1521 – Basic Line			Article No.
• Cooling: Self-ventilated (IC411) or with order code F90 forced-air cooled without external fan and fan cover (IC418) • Efficiency: NEMA Energy Efficient, UL, CSA, and service factor (SF) 1.15 – for operation in the USA and Canada, not admissible for exporting to Mexico • Insulation: Thermal class 155 (temperature class F), IP55 degree of protection, utilization in accordance with thermal class 130 (temperature class B)																		
2-pole: 3000 rpm at 50 Hz, 3600 rpm at 60 Hz																		
0.37	0.5	71 M	3410	1.0	-	72	71.4	67.8	0.77	0.84	2.9	5.1	3	63	74	1LE1521-0CA2	12	0.00035
0.55	0.75	71 M	3420	1.5	-	74	73.4	69.6	0.76	1.23	3.4	5.4	3.4	63	74	1LE1521-0CA3	13	0.00045
4-pole: 1500 rpm at 50 Hz, 1800 rpm at 60 Hz																		
0.25	0.33	71 M	1715	1.4	-	70	68.5	63.6	0.64	0.7	2.8	4.4	3.1	53	64	1LE1521-0CB2	12	0.00076
0.37	0.5	71 M	1705	2.1	-	72	71.2	66.9	0.67	0.96	2.8	4.4	2.8	53	64	1LE1521-0CB3	13	0.00095
0.55	0.75	80 M	1750	3.0	-	75.5	74.6	71.1	0.71	1.29	2.7	6.4	3.8	55	66	1LE1521-0DB2	17	0.0017
6-pole: 1000 rpm at 50 Hz, 1200 rpm at 60 Hz																		
0.18	0.25	71 M	1105	1.6	-	55	53.6	48.8	0.61	0.67	2.9	2.7	2.9	49	60	1LE1521-0CC2	12	0.00080
0.25	0.33	71 M	1100	2.4	-	59.5	58.9	54.7	0.64	0.82	2.7	3	2.7	49	60	1LE1521-0CC3	13	0.00100
0.37	0.5	80 M	1140	3.1	-	64	63	59.1	0.63	1.15	2.3	4.6	2.9	45	56	1LE1521-0DC2	17	0.0017
0.55	0.75	80 M	1135	4.6	-	68	67.4	63.7	0.61	1.66	2.9	5.2	3.6	45	56	1LE1521-0DC3	19	0.0025
8-pole: 750 rpm at 50 Hz, 900 rpm at 60 Hz																		
0.09	0.12	71 M	815	1.1	-	40	38	33	0.59	0.5	2.1	1.8	2.1	59	63	1LE1521-0CD2	12	0.00077
0.12	0.16	71 M	815	1.4	-	40	38	33	0.57	0.7	2.3	2.1	2.4	52	63	1LE1521-0CD3	13	0.00100
0.18	0.25	80 M	855	2.1	-	46	43.5	37	0.53	0.93	2	2.5	2.6	55	66	1LE1521-0DD2	17	0.00175
0.25	0.33	80 M	860	2.8	-	52	49	43	0.51	1.21	2.2	2.9	3	55	66	1LE1521-0DD3	19	0.00246
0.37	0.5	90 S	845	4.2	-	58	55.8	49.5	0.64	1.25	1.6	3	2.1	57	69	1LE1521-0ED0	23	0.00225
0.55	0.75	90 L	840	6.3	-	62	61.2	56.5	0.66	1.69	1.8	3.1	2.1	57	69	1LE1521-0ED4	26	0.00305
Voltages (≤ 600 V)¹⁾														Version		Order code		
50 Hz 230 VΔ/400 VY			60 Hz 460 VY			Standard								2	2	-		
50 Hz 400 VΔ			60 Hz 460 VΔ			Standard								3	4	-		
50 Hz 500 VY						Without additional charge								2	7	-		
50 Hz 500 VΔ						Without additional charge								4	0	-		
For other voltages and more information, see from page 3/100														9	0	...		
Types of construction²⁾														Version		Order code		
Without flange			IM B3 ³⁾			Standard								A	-			
With flange			IM B5 ³⁾			With additional charge								F	-			
For other types of construction and more information, see from page 3/107																...		
Motor protection														Version		Order code		
Without						Standard								A	-			
PTC thermistor with 1 temperature sensor						With additional charge								B	-			
For other motor protection and more information, see from page 3/117																...		
Terminal box position														Version		Order code		
Terminal box at top						Standard								4	-			
For other terminal box positions and more information, see from page 3/120																-		
Special versions																Order code(s)		
Forced-air cooled motors w/o ext. fan/fan cover (IC418)														1LE1521-		-Z F90+ . . . + . . .		
For options, see from page 3/129														1LE1521-		-Z . . . + . . . + . . .		

- Not required
- ✓ Available

1) Operating voltages only ≤ 600 V admissible in accordance with MG1 Table 12-11. Parallel supply lines are required in the case of connection to ≤ 240 V. For frame size 315 with connection to ≤ 240 V, due to the high current, a drilled, removable entry plate (order code **R52**) or a larger terminal box (order code **R50**) can be used. Order codes **R52** and **R50** alter the motor dimensions.

2) Types of construction with feet are not possible for 2-pole, 4-pole and 6-pole motors ≤ 200 hp in accordance with MG1 Table 12-11.

3) Types derived from IM B5 (IM V3 and IM V1) and from IM B14 (IM V19 and IM V18) are possible, provided that no requirement exists for stamping of the type on the rating plate. The basic type IM B5 or IM B14 is stamped as standard on the rating plate. If mounted in a different position, the position must be specified to ensure that the condensation drainage holes are positioned correctly.



SIMOTICS GP and SIMOTICS SD standard motors

Pole-changing

Aluminum series SIMOTICS GP 1LE1011 for constant load torque – self-ventilated

Selection and ordering data

P _{rated1} , P _{rated2} 50 Hz 50 Hz		Frame size	Operating values at rated power for N1										Operating values at rated power for N2										Aluminum series	m _{IM B3}	J
			n _{rated1} , 50 Hz	T _{rated1} , 50 Hz	η _{rated1} , 50 Hz	cosφ _{rated1} , 50 Hz	I _{rated1} , 50 Hz	T _{LR} / I _{rated1}	I _{LR} / I _{rated1}	T _B / I _{rated1}	n _{rated2} , 50 Hz	T _{rated2} , 50 Hz	η _{rated2} , 50 Hz	cosφ _{rated2} , 50 Hz	I _{rated2} , 50 Hz	T _{LR} / I _{rated2}	I _{LR} / I _{rated2}	T _B / I _{rated2}	1LE1011 – one winding						
			4/4	4/4	4/4	4/4	400 V	50 Hz	50 Hz	50 Hz	4/4	50 Hz	50 Hz	4/4	50 Hz, 400 V	50 Hz	50 Hz	50 Hz	Article No.						
KW	KW	FS	rpm	Nm	%	A				rpm	Nm	%	A					kg	kgm ²						
<ul style="list-style-type: none"> • Cooling: Self-ventilated (IC411) • Line operation: Double pole-changing for constant load torque • Insulation: Thermal class 155 (temperature class F), IP55 degree of protection, utilization in accordance with thermal class 130 (temperature class B) 																									
4/2-pole: 1500/3000 rpm at 50 Hz with one winding connected in Dahlander circuit																									
1500 rpm	3000 rpm	1500 rpm											3000 rpm												
1.9	2.4	100 L	1390	13.1	72	0.87	4.40	1.7	4.1	1.8	2800	8.2	70	0.88	5.6	1.8	4.2	1.8	1LE1011-1AJ4	18	0.0059				
2.5	3.1	100 L	1440	16.6	76.3	0.87	5.4	1.9	5.2	2.8	2840	10.4	77.3	0.9	6.4	2.1	5.2	2.9	1LE1011-1AJ5	22	0.0078				
3.7	4.4	112 M	1420	24.9	79.9	0.86	7.8	1.8	4.9	2.3	2885	14.6	80.8	0.92	8.5	2.1	6.4	2.6	1LE1011-1BJ2	27	0.01				
4.7	5.9	132 S	1440	31.2	82	0.84	9.8	1.6	5.6	2.7	2875	19.6	80	0.89	12.0	1.8	5.6	2.8	1LE1011-1CJ0	38	0.019				
6.5	8.0	132 M	1435	43.3	82	0.86	13.3	1.7	5.4	2.6	2880	26.5	82	0.92	15.3	1.8	6.3	2.8	1LE1011-1CJ2	44	0.024				
9.3	11.5	160 M	1440	61.7	84.5	0.87	18.3	1.7	5.7	2.8	2870	38.3	82	0.92	22.0	1.8	6	2.9	1LE1011-1DJ2	62	0.044				
13.0	16	160 L	1450	85.6	87	0.85	25.5	1.6	6	2.3	2920	52.3	86	0.94	35.5	1.9	7.1	2.8	1LE1011-1DJ6	85	0.068				
8/4-pole: 750/1500 rpm at 50 Hz with one winding connected in Dahlander circuit																									
750 rpm	1500 rpm	750 rpm											1500 rpm												
0.55	1.1	100 L	715	7.3	57	0.53	2.65	2	3	2.7	1425	7.4	77.7	0.87	2.35	1.7	4.6	2.1	1LE1011-1AL4	18	0.0059				
0.9	1.5	100 L	700	12.3	64.2	0.64	3.15	1.5	2.9	2	1415	10.1	77.7	0.89	3.15	1.5	4.5	1.9	1LE1011-1AL5	22	0.0078				
1.1	1.9	112 M	715	14.7	66.5	0.6	4.00	1.6	3.2	2.3	1440	12.6	80.9	0.87	3.90	1.6	5.4	2.3	1LE1011-1BL2	27	0.01				
1.6	3.2	132 S	730	20.9	61.5	0.53	7.1	1.6	3.3	2.6	1450	21.1	82.3	0.87	6.5	1.4	5	2.1	1LE1011-1CL0	38	0.019				
2.2	4.4	132 M	730	28.8	68	0.52	9.0	2	3.8	3	1450	29	84.5	0.88	8.5	1.5	5.5	2.3	1LE1011-1CL2	44	0.024				
3.5	7	160 M	730	45.8	77.5	0.57	11.4	2	4.2	2.8	1450	46.1	84	0.9	13.4	1.6	5.2	2.2	1LE1011-1DL2	62	0.044				
5.6	11	160 L	725	73.8	80.2	0.6	16.8	1.9	4	2.7	1445	72.7	84.4	0.9	21.0	1.5	5.1	2.2	1LE1011-1DL4	73	0.056				
Voltages																						Version		Order code	
50 Hz 230 V																						Standard	2 2	–	
50 Hz 400 V																						Standard	3 4	–	
50 Hz 500 V																						Without additional charge	4 0	–	
50 Hz 690 V																						Without additional charge	4 7	–	
For other voltages ¹⁾ and more information, see from page 3/99																							9 0	...	
Types of construction																						Version		Order code	
Without flange IM B3 ²⁾																						Standard	A	–	
With flange IM B5 ²⁾																						With additional charge	F	–	
With flange IM B14 ²⁾																						With additional charge	K	–	
For other types of construction and more information, see from page 3/103																								...	
Motor protection																						Version		Order code	
Without																						Standard	A	–	
PTC thermistor with 3 temperature sensors																						With additional charge	B	–	
For other motor protection and more information, see from page 3/116																								...	
Terminal box position																						Version		Order code	
Terminal box at top																						Standard	4	–	
For other terminal box positions and more information, see from page 3/119																									
Special versions																								Order code(s)	
For options, see from page 3/122																							1LE1011-....-Z	...+...+...+...	

Note: Pole-changing motors (4/2-pole) do not comply with the vibration values stipulated in IEC 60034-14 when rigidly installed (see also page 1/52).

¹⁾ Operating values for 60 Hz are available on request.

²⁾ Types derived from IM B3 (IM B6/7/8, IM V6, and IM V5), from IM B5 (IM V3 and IM V1) and from IM B14 (IM V19 and IM V18) are possible, provided that no requirements exist for condensation drainage holes (H03) or stamping of the type on the rating plate. The basic type IM B3, IM B5, or IM B14 is stamped as standard on the rating plate. For orders with condensation drainage holes (H03), the type must be specified.

SIMOTICS GP and SIMOTICS SD standard motors

Pole-changing

Aluminum series SIMOTICS GP 1LE1011/1LE1012 for square-law load torque – self-ventilated

Selection and ordering data

P _{rated1} , P _{rated2} 50 Hz 50 Hz		Frame size	Operating values at rated power for N1										Operating values at rated power for N2										Aluminum series 1LE1011 – one winding 1LE1012 – two windings Article No.	m _{IM B3}	J
n _{rated1} , 50 Hz	T _{rated1} , 50 Hz		η _{rated1} , 50 Hz	cos φ _{rated1} , 50 Hz	I _{rated1} , 50 Hz	T _{LR1} , 50 Hz	I _{LR1} , 50 Hz	T _{B1} , 50 Hz	n _{rated2} , 50 Hz	T _{rated2} , 50 Hz	η _{rated2} , 50 Hz	cos φ _{rated2} , 50 Hz	I _{rated2} , 50 Hz	T _{LR2} , 50 Hz	I _{LR2} , 50 Hz	T _{B2} , 50 Hz									
kW kW		FS	rpm	Nm	%	A				rpm	Nm	%	A												
<ul style="list-style-type: none"> Cooling: Self-ventilated (IC411) Line operation: Double pole-changing for square-law load torque, e.g. for driving fans Insulation: Thermal class 155 (temperature class F), IP55 degree of protection, utilization in accordance with thermal class 130 (temperature class B) 																									
4/2-pole: 1500/3000 rpm at 50 Hz with one winding connected in Dahlander circuit																									
1500 rpm	3000 rpm		1500 rpm					3000 rpm																	
0.65	2.4	100 L	1415	4.4	75	0.86	1.45	1.6	4.1	1.8	2800	8.2	70	0.88	5.6	1.8	4.2	1.8	1LE1011-1AP4	18	0.0059				
0.8	3.1	100 L	1435	5.3	79	0.85	1.72	1.9	5.2	2.8	2840	10.4	77.3	0.9	6.4	2.1	5.2	2.8	1LE1011-1AP5	22	0.0078				
1.1	4.4	112 M	1455	7.2	83.4	0.85	2.25	2.2	6.1	2.5	2885	14.6	80.8	0.92	8.5	2.1	6.4	2.5	1LE1011-1BP2	27	0.01				
1.45	5.9	132 S	1460	9.5	84	0.84	2.95	1.6	5.8	2.8	2875	19.6	80	0.89	12.0	1.8	5.6	2.8	1LE1011-1CP0	38	0.019				
2.0	8.0	132 M	1455	13.1	85	0.85	4.00	1.8	5.6	2.8	2880	26.5	82	0.92	15.3	1.8	6.3	2.8	1LE1011-1CP2	44	0.024				
2.9	11.5	160 M	1465	18.9	86.5	0.86	5.6	1.8	5.9	2.9	2870	38.3	82	0.92	22.0	1.8	6	2.9	1LE1011-1DP2	62	0.044				
4.3	16	160 L	1455	28.2	87	0.85	8.4	1.6	6	2.3	2920	52.3	86	0.94	28.5	1.9	7.1	2.3	1LE1011-1DP6	85	0.068				
6/4-pole: 1000/1500 rpm at 50 Hz with two windings																									
1000 rpm	1500 rpm		1000 rpm								1500 rpm														
0.6	1.7	100 L	970	5.9	55.5	0.62	2.50	1.7	3.4	2.7	1435	11.3	76.2	0.83	3.90	1.8	4.6	2.7	1LE1012-1AQ4	18	0.0059				
0.75	2.1	100 L	955	8	64.2	0.77	2.20	1.2	3.4	2	1435	14	78.4	0.84	4.60	2	5.4	2	1LE1012-1AQ5	22	0.0078				
0.9	3.0	112 M	975	8.8	64.7	0.66	3.05	1.6	3.9	2.5	1455	19.7	81.4	0.78	6.8	2.1	6.4	2.5	1LE1012-1BQ2	27	0.01				
1.2	3.9	132 S	980	11.7	72.3	0.7	3.40	1.4	4.6	2.5	1455	25.6	83.1	0.83	8.2	1.5	5.7	2.5	1LE1012-1CQ0	38	0.019				
1.7	5.4	132 M	980	16.6	74.1	0.71	4.65	1.7	5	2.5	1465	35.2	85.9	0.82	11.1	2	6.9	2.5	1LE1012-1CQ2	44	0.024				
2.5	7.2	160 M	985	24.2	77.7	0.71	6.5	1.5	4.7	2.6	1470	46.8	86.9	0.85	14.1	1.8	6.3	2.6	1LE1012-1DQ2	62	0.044				
3.7	12.0	160 L	985	35.9	82.4	0.69	9.4	2.3	6.2	3.5	1475	77.7	87.9	0.8	24.5	2.1	7.5	3.5	1LE1012-1DQ4	73	0.059				
6.5	19	180 L	985	63	81.0	0.7	16.5	1.8	5.5	2.7	1475	123	0.9	0.8	38.0	2.5	8.1	3.7	1LE1012-1EQ4	132	0.13				
9.5	26	200 L	985	92	84.5	0.7	23.0	2.3	6.5	2.8	1475	168	0.91	0.8	52	2.3	7.5	3.4	1LE1012-2AQ5	173	0.20				
Voltages 50 Hz 230 V Standard 2 2 Order code 50 Hz 400 V Standard 3 4 – 50 Hz 500 V Without additional charge 4 0 – 50 Hz 690 V Without additional charge 4 7 – For other voltages ¹⁾ and more information, see from page 3/99 9 0 ...																									
Types of construction Without flange IM B3 ²⁾ Standard A Order code With flange IM B5 ²⁾ With additional charge F – With flange IM B14 ²⁾ With additional charge K – For other types of construction and more information, see from page 3/103 ...																									
Motor protection Without Standard A Order code PTC thermistor with 3 temperature sensors With additional charge B – For other motor protection and more information, see from page 3/116 ...																									
Terminal box position Terminal box at top Standard 4 Order code																									
Special versions For options, see from page 3/122 1LE1011-...-Z ...+...+... Order code(s)																									

Note: Pole-changing motors (4/2-pole) do not comply with the vibration values stipulated in IEC 60034-14 when rigidly installed (see also page 1/52).

¹⁾ Operating values for 60 Hz are available on request.

²⁾ Types derived from IM B3 (IM B6/7/8, IM V6, and IM V5), from IM B5 (IM V3 and IM V1) and from IM B14 (IM V19 and IM V18) are possible, provided that no requirements exist for condensation drainage holes (H03) or stamping of the type on the rating plate. The basic type IM B3, IM B5, or IM B14 is stamped as standard on the rating plate. For orders with condensation drainage holes (H03), the type must be specified.

SIMOTICS GP and SIMOTICS SD standard motors

Pole-changing

Aluminum series SIMOTICS GP 1LE1011/1LE1012 for square-law load torque – self-ventilated

Selection and ordering data

P _{rated1} , P _{rated2} 50 Hz 50 Hz		Frame size	Operating values at rated power for N1										Operating values at rated power for N2					Aluminum series 1LE1011 – one winding Article No.	m _{IM B3}	J					
n _{rated1} , 50 Hz	T _{rated1} , 50 Hz		η _{rated1} , 50 Hz	cos φ _{rated1} , 50 Hz	I _{rated1} , 50 Hz	T _{LR1} / 4/4	I _{LR1} / 50 Hz	T _{B1} / 4/4	n _{rated2} , 50 Hz	T _{rated2} , 50 Hz	η _{rated2} , 50 Hz	cos φ _{rated2} , 50 Hz	I _{rated2} , 50 Hz	T _{LR2} / 50 Hz	I _{LR2} / 50 Hz	T _{B2} / 50 Hz									
kW	kW	FS	rpm	Nm	%	A				rpm	Nm	%	A												
<ul style="list-style-type: none"> Cooling: Self-ventilated (IC411) Line operation: Double pole-changing for square-law load torque, e.g. for driving fans Insulation: Thermal class 155 (temperature class F), IP55 degree of protection, utilization in accordance with thermal class 130 (temperature class B) 																			8/4-pole: 750/1500 rpm at 50 Hz with one winding connected in Dahlander circuit						
750 rpm	1500 rpm	750 rpm											1500 rpm												
0.5	2.0	100 L	720	6.6	52	0.5	2.80	1.3	3.3	3.4	1440	13.3	82	0.79	4.45	3	7.5	3.4	1LE1011-1AR4	22	0.0078				
0.65	2.5	100 L	715	8.7	56	0.58	2.90	1	3.2	2.6	1425	16.8	81	0.84	5.3	2.3	6.3	2.6	1LE1011-1AR5	22	0.0078				
0.9	3.6	112 M	715	12	56	0.57	4.05	1	2.8	2.1	1430	24	82	0.84	7.5	1.9	5.6	2.1	1LE1011-1BR2	27	0.01				
1.1	4.7	132 S	730	14.4	62	0.54	4.75	1	3.2	2.2	1430	31.4	82	0.86	9.6	1.7	5.2	2.2	1LE1011-1CR0	38	0.019				
1.4	6.4	132 M	730	18.3	67.5	0.52	5.8	1.1	3.5	2.3	1440	42.4	84.5	0.87	12.6	1.9	5.7	2.3	1LE1011-1CR2	44	0.024				
2.2	9.5	160 M	730	28.8	80.6	0.63	6.3	1.5	4	2.5	1465	61.9	86.1	0.84	19.0	2	6.3	2.5	1LE1011-1DR2	62	0.044				
3.3	14	160 L	735	42.9	81.4	0.56	10.4	2.5	4.8	3.3	1475	90.6	85.8	0.73	32.5	2.5	7.2	3.3	1LE1011-1DR4	73	0.056				
4.5	16	180 M	730	59	79.3	0.59	13.9	1.4	3.8	2.3	1470	104	84.6	0.83	33.0	1.4	7	2.9	1LE1011-1ER2	128	0.12				
5	18.5	180 L	730	65	78.3	0.6	15.4	1.5	3.8	2.1	1470	120	86.6	0.83	37.0	2.3	7	2.7	1LE1011-1ER4	132	0.13				
7.5	28	200 L	735	97	85.0	0.6	21.0	1.7	4	2.1	1475	181	90.5	0.85	53	2.7	7.4	3.1	1LE1011-2AR5	173	0.20				
Voltages												Version							Order code						
50 Hz 230 V												Standard					2 2		-						
50 Hz 400 V												Standard					3 4		-						
50 Hz 500 V												Without additional charge					4 0		-						
50 Hz 690 V												Without additional charge					4 7		-						
For other voltages ¹⁾ and more information, see from page 3/99																	9 0		...						
Types of construction												Version							Order code						
Without flange IM B3 ²⁾												Standard					A		-						
With flange IM B5 ²⁾												With additional charge					F		-						
With flange IM B14 ²⁾												With additional charge					K		-						
For other types of construction and more information, see from page 3/103																			...						
Motor protection												Version							Order code						
Without												Standard					A		-						
PTC thermistor with 3 temperature sensors												With additional charge					B		-						
For other motor protection and more information, see from page 3/116																			...						
Terminal box position												Version							Order code(s)						
Terminal box at top												Standard					4								
For other terminal box positions and more information, see from page 3/119																									
Special versions																			Order code(s)						
For options, see from page 3/122																			1LE1011-...-Z ...+...+...						

Note: Pole-changing motors (4/2-pole) do not comply with the vibration values stipulated in IEC 60034-14 when rigidly installed (see also page 1/52).

¹⁾ Operating values for 60 Hz are available on request.

²⁾ Types derived from IM B3 (IM B6/7/8, IM V6, and IM V5), from IM B5 (IM V3 and IM V1) and from IM B14 (IM V19 and IM V18) are possible, provided that no requirements exist for condensation drainage holes (H03) or stamping of the type on the rating plate. The basic type IM B3, IM B5, or IM B14 is stamped as standard on the rating plate. For orders with condensation drainage holes (H03), the type must be specified.

SIMOTICS GP and SIMOTICS SD standard motors

Article No. supplements and special versions · Voltages

Aluminum series SIMOTICS GP 1LE10

Selection and ordering data

Voltages	Article No. supplement		Frame size										Motor version		
	Voltage code 12th and 13th position of the Article No.	Additional identification code with order code and plain text if required	63	71	80	90	100	112	132	160	180	200			
								1LE1004					IEC	IE4	①
								1LE1003						IE3	②
								1LE1083							③
							1LE1001							IE2	④
							1LE1002							IE1	⑤
								1LE1043					APAC Line	IE3	⑥
								1LE1041						IE2	⑦
								1LE1023					Eagle Line	NPE (NEMA)	⑧
								1LE1021						NEE (NEMA)	⑨
1LE10 - - - - -															
															Order code
Voltage at 50 Hz or 60 Hz – Operating values at rated power for 60 Hz are stored in the Drive Technology Configurator (DTC)															
50 Hz 230 VΔ/400 VY, 60 Hz 460 VY	2	2	–												
50 Hz 400 VΔ/690 VY, 60 Hz 460 VΔ ¹⁾	3	4	–										Not for:	APAC Line Eagle Line	⑥, ⑦ ⑧, ⑨
50 Hz 400 VΔ, 60 Hz 460 VΔ ¹⁾			–	–									Only for:	APAC Line Eagle Line	⑥, ⑦ ⑧, ⑨
50 Hz 400 VY, 60 Hz 460 VY ^{2) 3)}	0	2	–	–									Not for:	IEC IE3	③
50 Hz 400 VΔ, 60 Hz 460 VΔ ⁴⁾	0	4	–	–									Not for:	IEC IE3	③
50 Hz 500 VY 60 Hz 575 VY ⁷⁾	2	7	–	○	○	○	○	○	○	○	○	○	Not for:	IEC IE4 ① frame size 100 ... 160	
50 Hz 500 VΔ 60 Hz 575 VΔ	4	0	–	○	○	–	–	○	○	○	○	○	Not for:	IEC IE4 ① frame size 100 ... 160	
50 Hz 690 VY	0	6	–	–	–	○	○	○	○	○	○	○	Only for:	IEC IE3	③
50 Hz 690 VΔ	4	7	–	–	–	○	○	○	○	○	○	○	Only for:	IEC IE3	③
50 Hz 220 VΔ/380 VY 60 Hz 440 VY	2	1	–	✓	✓	✓	✓	✓	✓	✓	✓	✓	Not for:	IEC IE3	③
50 Hz 380 VΔ/660 VY ¹⁾ , 60 Hz 440 VΔ	3	3	–	✓	✓	✓	✓	✓	✓	✓	✓	✓	Not for:	APAC Line Eagle Line IEC IE3	⑥, ⑦ ⑧, ⑨ ③
50 Hz 380 VΔ ¹⁾ 60 Hz 440 VΔ			–	–	✓	✓	✓	✓	✓	✓	✓	✓	Only for:	APAC Line Eagle Line IEC IE3	⑥, ⑦ ⑧, ⑨ ③
50 Hz 240 VΔ/415 VY, 60 Hz 480 VY	2	3	–	✓	✓	✓	✓	✓	✓	✓	✓	✓	Not for:	IEC IE3	③
50 Hz 415 VΔ, 60 Hz 480 VΔ	3	5	–	✓	✓	✓	✓	✓	✓	✓	✓	✓	Not for:	IEC IE3	③
60 Hz 220 VΔ/380 VY	1	7	–	–	–	✓	✓	✓	✓	✓	✓	✓	Only for:	IEC IE1 IEC IE3	
60 Hz 230 VΔ/400 VY	1	8	–	–	–	✓	✓	✓	✓	✓	✓	✓	Only for:	IEC IE1 IEC IE3	
60 Hz 380 VΔ/660 VY ¹⁾	3	0	–	–	–	✓	✓	✓	✓	✓	✓	✓	Only for:	IEC IE1 IEC IE3	
60 Hz 380 VΔ ¹⁾			–	–	–	✓	✓	✓	✓	✓	✓	✓	Only for:	IEC IE1 IEC IE3	
60 Hz 400 VΔ/690 VY ¹⁾	3	1	–	–	–	✓	✓	✓	✓	✓	✓	✓	Only for:	IEC IE1 IEC IE3	
60 Hz 400 VΔ ¹⁾			–	–	–	✓	✓	✓	✓	✓	✓	✓	Only for:	IEC IE1 IEC IE3	
Voltage at 60 Hz and required power at 60 Hz															
220 VΔ/380 VY; 50 Hz power	9	0	M2A	✓	✓	✓	✓	✓	✓	✓	✓	✓	Not for:	IEC IE3	③
220 VΔ/380 VY; 60 Hz power	9	0	M1A	✓	✓	✓	✓	✓	✓	✓	✓	✓	Not for:	APAC Line Eagle Line IEC IE3	⑥, ⑦ ⑧, ⑨ ③
380 VΔ/660 VY; 50 Hz power ¹⁾	9	0	M2B	✓	✓	✓	✓	✓	✓	✓	✓	✓	Not for:	APAC Line Eagle Line IEC IE3	⑥, ⑦ ⑧, ⑨ ③
380 VΔ; 50 Hz power ¹⁾				–	–	–	–	✓	✓	✓	✓	✓	Only for:	APAC Line Eagle Line	⑥, ⑦ ⑧, ⑨

For legends and footnotes, see page 3/98.



SIMOTICS GP and SIMOTICS SD standard motors

Article No. supplements and special versions · Voltages

Aluminum series SIMOTICS GP 1LE10

Voltages	Article No. supplement		Frame size										Motor version				
	Voltage code 12th and 13th position of the Article No.	Additional identifica- tion code with order code and plain text if required	63	71	80	90	100	112	132	160	180	200					
								1LE1004					IEC	IE4	①		
								1LE1003						IE3	②		
														IE2	④		
								1LE1083						IE1	⑤		
								1LE1001						IE3	⑥		
								1LE1002						IE2	⑦		
								1LE1043					APAC Line	NPE (NEMA)	⑧		
								1LE1041						NEE (NEMA)	⑨		
								1LE1023					Eagle Line				
	1LE10...-...-...-...-...-...	Order code						1LE1021									
Voltage at 60 Hz and required power at 60 Hz (continued)																	
380 VΔ/660 VY; 60 Hz power ^{1) 5)}	9	0	M1B	✓	✓	✓	✓	✓	✓	✓	✓	✓	✓	✓	Not for:	APAC Line Eagle Line IEC IE3	⑥, ⑦ ⑧, ⑨ ③
440 VY; 50 Hz power	9	0	M2C	✓	✓	✓	✓	✓	✓	✓	✓	✓	✓	✓	Not for:	IEC IE3	③
440 VY; 60 Hz power	9	0	M1C	✓	✓	✓	✓	✓	✓	✓	✓	✓	✓	✓	Not for:	APAC Line Eagle Line IEC IE3	⑥, ⑦ ⑧, ⑨ ③
440 VΔ; 50 Hz power	9	0	M2D	✓	✓	✓	✓	✓	✓	✓	✓	✓	✓	✓	Not for:	IEC IE3	③
440 VΔ; 60 Hz power	9	0	M1D	✓	✓	✓	✓	✓	✓	✓	✓	✓	✓	✓	Not for:	APAC Line Eagle Line IEC IE3	⑥, ⑦ ⑧, ⑨ ③
460 VY; 50 Hz power	9	0	M2E	✓	✓	✓	✓	✓	✓	✓	✓	✓	✓	✓	Not for:	IEC IE3	③
460 VY; 60 Hz power	9	0	M1E	○	○	○	○	○	○	○	○	○	○	○	Not for:	APAC Line Eagle Line IEC IE3	⑥, ⑦ ⑧, ⑨ ③
460 VΔ; 50 Hz power	9	0	M2F	✓	✓	✓	✓	✓	✓	✓	✓	✓	✓	✓	Not for:	IEC IE3	③
460 VΔ; 60 Hz power	9	0	M1F	○	○	○	○	○	○	○	○	○	○	○	Not for:	APAC Line Eagle Line IEC IE3	⑥, ⑦ ⑧, ⑨ ③
575 VY; 50 Hz power ⁷⁾	9	0	M2G	✓	✓	✓	✓	✓	✓	✓	✓	✓	✓	✓	Not for:	IEC IE4 IEC IE3	① ③
575 VY; 60 Hz power ⁷⁾	9	0	M1G	✓	✓	✓	✓	✓	✓	✓	✓	✓	✓	✓	Not for:	APAC Line Eagle Line IEC IE3	⑥, ⑦ ⑧, ⑨ ③
575 VΔ; 50 Hz power ⁷⁾	9	0	M2H	✓	✓	✓	✓	✓	✓	✓	✓	✓	✓	✓	Not for:	IEC IE4 IEC IE3	① ③
575 VΔ; 60 Hz power ⁷⁾	9	0	M1H	✓	✓	✓	✓	✓	✓	✓	✓	✓	✓	✓	Not for:	APAC Line Eagle Line IEC IE3	⑥, ⑦ ⑧, ⑨ ③
400 VΔ/690 VY; 50 Hz power ¹⁾	9	0	M2J	✓	✓	✓	✓	✓	✓	✓	✓	✓	✓	✓	Not for:	Eagle Line IEC IE3	⑧, ⑨ ③
400 VΔ; 50 Hz power				-	-	✓	✓	✓	✓	✓	✓	✓	✓	✓	Only for:	Eagle Line IEC IE3	⑧, ⑨ ③
400 VΔ/690 VY; 60 Hz power	9	0	M1J	✓	✓	✓	✓	✓	✓	✓	✓	✓	✓	✓	Not for:	Eagle Line IEC IE3	⑧, ⑨ ③
480 VY; 50 Hz power	9	0	M2K	✓	✓	✓	✓	✓	✓	✓	✓	✓	✓	✓	Not for:	IEC IE3	③
480 VY; 60 Hz power	9	0	M1K	✓	✓	✓	✓	✓	✓	✓	✓	✓	✓	✓	Not for:	Eagle Line IEC IE3	⑧, ⑨ ③
480 VΔ; 50 Hz power	9	0	M2L	✓	✓	✓	✓	✓	✓	✓	✓	✓	✓	✓	Not for:	IEC IE3	③
480 VΔ; 60 Hz power	9	0	M1L	✓	✓	✓	✓	✓	✓	✓	✓	✓	✓	✓	Not for:	Eagle Line IEC IE3	⑧, ⑨ ③
230 VΔ/400 VY; 50 Hz power	9	0	M2M	✓	✓	✓	✓	✓	✓	✓	✓	✓	✓	✓	Not for:	IEC IE3	③
230 VΔ/400 VY; 60 Hz power	9	0	M1M	✓	✓	✓	✓	✓	✓	✓	✓	✓	✓	✓	Not for:	Eagle Line IEC IE3	⑧, ⑨ ③
Voltage at 87 Hz and 87 Hz power																	
400 VΔ ⁵⁾	9	0	M3A	-	-	✓	✓	✓	✓	✓	✓	✓	✓	✓	Not for:	IEC IE3	③
Non-standard voltage and/or frequencies																	
Non-standard winding ⁶⁾	9	0	M1Y • and customer specifica- tions	✓	✓	✓	✓	✓	✓	✓	✓	✓	✓	✓			

- Standard version
- Without additional charge
- This order code only determines the price of the version – Additional plain text is required.
- ✓ With additional charge
- Not possible

¹⁾ For North America export versions Eagle Line 1LE1021 NEMA Energy Efficient, 1LE1023 NEMA Premium Efficient and 1LE1083, voltages above 600 V will not be stamped.

²⁾ Frame sizes 80 and 90 with voltage code 02 can only be supplied without motor protection (motor protection code letter A).

³⁾ Delta connection is not possible.

⁴⁾ Star connection is not possible.

⁵⁾ Only possible for 4-pole, 6-pole and 8-pole motors. The operating data for converter operation is also provided in a table on the rating plate.

⁶⁾ Plain text must be specified in the order: Voltage between 200 and 690 V (voltages outside this range are available on request), frequency, circuit, for 60 Hz additionally required rated power in kW.

⁷⁾ Not possible for 2-pole and 4-pole motors with increased power (11th position of the Article No.: 6) in frame sizes 80 and 90.

SIMOTICS GP and SIMOTICS SD standard motors

Article No. supplements and special versions · Voltages

Aluminum series SIMOTICS GP 1LE1011, 1LE1012 – pole-changing

Selection and ordering data

Voltages	Article No. supplement		Frame size						Motor version	
	Voltage code 12th and 13th position of the Article No.	Additional identification code with order code and plain text if required	100	112	132	160	180	200		
			1LE1011							Pole-changing
			1LE1012							
1LE10.....	■	■	Order code							
Voltage at 50 Hz and 50 Hz power										
230 V	2	2	–	□	□	□	□	□	□	
400 V	3	4	–	□	□	□	□	□	□	
500 V	4	0	–	○	○	○	○	○	○	
690 V	4	7	–	○	○	○	○	○	○	
Voltage at 60 Hz and required power										
220 V; 50 Hz power	9	0	M5K	O. R.	O. R.	O. R.	O. R.	O. R.	O. R.	
220 V; 60 Hz power	9	0	M5C	O. R.	O. R.	O. R.	O. R.	O. R.	O. R.	
380 V; 50 Hz power	9	0	M5L	O. R.	O. R.	O. R.	O. R.	O. R.	O. R.	
380 V; 60 Hz power	9	0	M5D	O. R.	O. R.	O. R.	O. R.	O. R.	O. R.	
440 V; 50 Hz power	9	0	M5M	O. R.	O. R.	O. R.	O. R.	O. R.	O. R.	
440 V; 60 Hz power	9	0	M5E	O. R.	O. R.	O. R.	O. R.	O. R.	O. R.	
460 V; 50 Hz power	9	0	M5N	O. R.	O. R.	O. R.	O. R.	O. R.	O. R.	
460 V; 60 Hz power	9	0	M5F	O. R.	O. R.	O. R.	O. R.	O. R.	O. R.	
575 V; 50 Hz power	9	0	M5P	O. R.	O. R.	O. R.	O. R.	O. R.	O. R.	
575 V; 60 Hz power	9	0	M5G	O. R.	O. R.	O. R.	O. R.	O. R.	O. R.	
Non-standard voltage and/or frequencies										
Non-standard winding ¹⁾	9	0	M1Y • and customer specifications	✓	✓	✓	✓	✓	✓	

- Standard version
- Without additional charge
- This order code only determines the price of the version – Additional plain text is required.
- ✓ With additional charge
- O. R. Possible on request

¹⁾ Plain text must be specified in the order: Voltage between 200 and 690 V (voltages outside this range are available on request), frequency, circuit, for 60 Hz additionally required rated power in kW.

SIMOTICS GP and SIMOTICS SD standard motors

Article No. supplements and special versions · Voltages

Cast-iron series SIMOTICS SD 1LE15 Basic Line, 1LE16 Performance Line

Selection and ordering data

Voltages	Article No.	supplement	Frame size													Motor version		
			71	80	90	100	112	132	160	180	200	225	250	280	315			
							1LE1504 Basic Line						IEC	IE4		①		
							1LE1604 Performance Line									②		
						1LE1503 Basic Line							IE3		③			
							1LE1603 Performance Line									④		
							1LE1583									⑤		
						1LE1501 Basic Line							IE2		⑥			
							1LE1601 Performance Line									⑦		
							1LE1502 Basic Line							IE1		⑧		
						1LE1543 Basic Line						APAC Line	IE3		⑨			
							1LE1643 Performance Line									⑩		
							1LE1541 Basic Line							IE2		⑪		
						1LE1523 Basic Line						Eagle Line	NPE (NEMA)		⑫			
							1LE1623 Performance Line									⑬		
							1LE1521 Basic Line							NEE (NEMA)		⑭		

1LE1 - - - - -

Order code

Voltage at 50 Hz or 60 Hz

50 Hz 230 VΔ/400 VY, 60 Hz 460 VY	2	2	-	□	□	□	□	□	□	□	□	□	□	□	□	□	□	
50 Hz 400 VΔ/690 VY, 60 Hz 460 VΔ ¹⁾	3	4	-	□	□	□	□	□	□	□	□	□	□	□	□	□	□	Not for: APAC Line ⑨, ⑩, ⑪ Eagle Line ⑫, ⑬, ⑭
50 Hz 400 VΔ, 60 Hz 460 VΔ ¹⁾				□	□	□	□	□	□	□	□	□	□	□	□	□	□	Only for: APAC Line ⑨, ⑩, ⑪ Eagle Line ⑫, ⑬, ⑭
50 Hz 400 VY, 60 Hz 460 VY ^{2) 3)}	0	2	-	□	□	□	□	□	□	□	□	□	□	□	□	□	□	Not for: IEC IE3 ⑤
50 Hz 400 VΔ, 60 Hz 460 VΔ ⁴⁾	0	4	-	□	□	□	□	□	□	□	□	□	□	□	□	□	□	Not for: IEC IE3 ⑤
50 Hz 500 VY/575 VY	2	7	-	○	○	○	○	○	○	○	○	○	○	○	○	○	○	Not for: IEC IE4 ①, ② frame sizes 100 ... 160
50 Hz 500 VΔ, 60 Hz 575 VΔ	4	0	-	-	-	-	○	○	○	○	○	○	○	○	○	○	○	Not for: IEC IE4 ①, ② frame sizes 100 ... 160
50 Hz 690 VY	0	6	-	-	-	-	○	○	○	○	○	○	○	○	○	○	○	Only for: IEC IE3 ⑤
50 Hz 690 VΔ	4	7	-	-	-	-	✓	✓	✓	✓	✓	✓	✓	✓	✓	✓	✓	Only for: IEC IE3 ⑤
50 Hz 220 VΔ/380 VY, 60 Hz 440 VY	2	1	-	✓	✓	✓	✓	✓	✓	✓	✓	✓	✓	✓	✓	✓	✓	Not for: IEC IE3 ⑤
50 Hz 380 VΔ/660 VY, 60 Hz 440 VΔ ¹⁾	3	3	-	✓	✓	✓	✓	✓	✓	✓	✓	✓	✓	✓	✓	✓	✓	Not for: APAC Line ⑨, ⑩, ⑪ Eagle Line ⑫, ⑬, ⑭ IEC IE3 ⑤
50 Hz 380 VΔ ¹⁾ 60 Hz 440 VΔ				✓	✓	✓	✓	✓	✓	✓	✓	✓	✓	✓	✓	✓	✓	Only for: APAC Line ⑨, ⑩, ⑪ Eagle Line ⑫, ⑬, ⑭
50 Hz 240 VΔ/415 VY, 60 Hz 480 VY	2	3	-	✓	✓	✓	✓	✓	✓	✓	✓	✓	✓	✓	✓	✓	✓	Not for: IEC IE3 ⑤
50 Hz 415 VΔ, 60 Hz 480 VΔ	3	5	-	✓	✓	✓	✓	✓	✓	✓	✓	✓	✓	✓	✓	✓	✓	Not for: IEC IE3 ⑤
60 Hz 220 VΔ/380 VY	1	7	-	✓	✓	✓	✓	✓	✓	✓	✓	✓	✓	✓	✓	✓	✓	Only for: IEC IE1 IEC IE2
60 Hz 230 VΔ/400 VY	1	8	-	✓	✓	✓	✓	✓	✓	✓	✓	✓	✓	✓	✓	✓	✓	Only for: IEC IE1 IEC IE2
60 Hz 380 VΔ/660 VY ¹⁾	3	0	-	✓	✓	✓	✓	✓	✓	✓	✓	✓	✓	✓	✓	✓	✓	Only for: IEC IE1 IEC IE2
60 Hz 380 VΔ ¹⁾				✓	✓	✓	✓	✓	✓	✓	✓	✓	✓	✓	✓	✓	✓	Only for: IEC IE1 IEC IE2
60 Hz 400 VΔ/690 VY ¹⁾	3	1	-	✓	✓	✓	✓	✓	✓	✓	✓	✓	✓	✓	✓	✓	✓	Only for: IEC IE1 IEC IE2
60 Hz 400 VΔ ¹⁾				✓	✓	✓	✓	✓	✓	✓	✓	✓	✓	✓	✓	✓	✓	Only for: IEC IE1 IEC IE2

Voltage at 60 Hz and required power

220 VΔ/380 VY; 50 Hz power	9	0	M2A	✓	✓	✓	✓	✓	✓	✓	✓	✓	✓	✓	✓	✓	✓	Not for: IEC IE3 ⑤
220 VΔ/380 VY; 60 Hz power ²⁾	9	0	M1A	✓	✓	✓	✓	✓	✓	✓	✓	✓	✓	✓	✓	✓	✓	Not for: APAC Line ⑨, ⑩, ⑪ Eagle Line ⑫, ⑬, ⑭ IEC IE3 ⑤
380 VΔ/660 VY; 50 Hz power ¹⁾	9	0	M2B	-	-	-	✓	✓	✓	✓	✓	✓	✓	✓	✓	✓	✓	Not for: APAC Line ⑨, ⑩, ⑪ Eagle Line ⑫, ⑬, ⑭ IEC IE3 ⑤
380 VΔ; 50 Hz power ¹⁾				-	-	-	✓	✓	✓	✓	✓	✓	✓	✓	✓	✓	✓	Only for: APAC Line ⑨, ⑩, ⑪ Eagle Line ⑫, ⑬, ⑭
380 VΔ/660 VY; 60 Hz power ^{1) 2)}	9	0	M1B	-	-	-	✓	✓	✓	✓	✓	✓	✓	✓	✓	✓	✓	Not for: APAC Line ⑨, ⑩, ⑪ Eagle Line ⑫, ⑬, ⑭ IEC IE3 ⑤
440 VY; 50 Hz power	9	0	M2C	-	-	-	✓	✓	✓	✓	✓	✓	✓	✓	✓	✓	✓	Not for: IEC IE3 ⑤
440 VY; 60 Hz power ²⁾	9	0	M1C	-	-	-	✓	✓	✓	✓	✓	✓	✓	✓	✓	✓	✓	Not for: APAC Line ⑧, ⑨, ⑩ Eagle Line ⑪, ⑫, ⑬

For legends and footnotes, see page 3/101.

SIMOTICS GP and SIMOTICS SD standard motors

Article No. supplements and special versions · Voltages

Cast-iron series SIMOTICS SD 1LE15 Basic Line, 1LE16 Performance Line

Voltages	Article No. supplement		Frame size											Motor version					
	Voltage code	Additional identification code with order code and plain text if required	71	80	90	100	112	132	160	180	200	225	250	280	315				
						1LE1504 Basic Line											IEC	IE4	①
						1LE1604 Performance Line													②
						1LE1503 Basic Line												IE3	③
						1LE1603 Performance Line													④
						1LE1583													⑤
						1LE1501 Basic Line												IE2	⑥
						1LE1601 Performance Line													⑦
						1LE1502 Basic Line												IE1	⑧
						1LE1543 Basic Line											APAC Line	IE3	⑨
						1LE1643 Performance Line													⑩
						1LE1541 Basic Line												IE2	⑪
						1LE1523 Basic Line											Eagle Line	NPE (NEMA)	⑫
						1LE1623 Performance Line													⑬
						1LE1521 Basic Line												NEE (NEMA)	⑭

Voltage at 60 Hz and required power (continued)																		
440 VΔ; 50 Hz power	9	0	M2D	-	-	✓	✓	✓	✓	✓	✓	✓	✓	✓	✓	✓	Not for:	IEC IE3 ⑤
440 VΔ; 60 Hz power ²⁾	9	0	M1D	-	-	✓	✓	✓	✓	✓	✓	✓	✓	✓	✓	✓	Not for:	APAC Line ⑨, ⑩, ⑪ Eagle Line ⑫, ⑬, ⑭ IEC IE3 ⑤
460 VY; 50 Hz power	9	0	M2E	-	-	✓	✓	✓	✓	✓	✓	✓	✓	✓	✓	✓	Not for:	IEC IE3 ⑤
460 VY; 60 Hz power ²⁾	9	0	M1E	-	-	○	○	○	○	○	○	○	○	○	○	○	Not for:	APAC Line ⑨, ⑩, ⑪ Eagle Line ⑫, ⑬, ⑭ IEC IE3 ⑤
460 VΔ; 50 Hz power	9	0	M2F	-	-	✓	✓	✓	✓	✓	✓	✓	✓	✓	✓	✓	Not for:	IEC IE3 ⑤
460 VΔ; 60 Hz power ²⁾	9	0	M1F	-	-	○	○	○	○	○	○	○	○	○	○	○	Not for:	APAC Line ⑨, ⑩, ⑪ Eagle Line ⑫, ⑬, ⑭ IEC IE3 ⑤
575 VY; 50 Hz power	9	0	M2G	-	-	✓	✓	✓	✓	✓	✓	✓	✓	✓	✓	✓	Not for:	IEC IE4 ①, ② frame sizes 100 ... 160 IEC IE3 ⑤
575 VY; 60 Hz power ²⁾	9	0	M1G	-	-	✓	✓	✓	✓	✓	✓	✓	✓	✓	✓	✓	Not for:	①, ②, ③, ④ and ①, ② frame sizes 100 ... 160
575 VΔ; 50 Hz power	9	0	M2H	-	-	✓	✓	✓	✓	✓	✓	✓	✓	✓	✓	✓	Not for:	IEC IE4 ①, ② frame sizes 100 ... 160 IEC IE3 ⑤
575 VΔ; 60 Hz power ²⁾	9	0	M1H	-	-	✓	✓	✓	✓	✓	✓	✓	✓	✓	✓	✓	Not for:	①, ②, ③, ④ and ①, ② frame sizes 100 ... 160
400 VΔ/690 VY; 50 Hz power ¹⁾	9	0	M2J	✓	✓	✓	✓	✓	✓	✓	✓	✓	✓	✓	✓	✓	Not for:	IEC IE1 ⑧ Eagle Line ⑫, ⑬
400 VΔ; 50 Hz power ¹⁾				✓	✓	✓	✓	✓	✓	✓	✓	✓	✓	✓	✓	✓	Only for:	IEC IE1 ⑧ Eagle Line ⑫, ⑬
400 VΔ/690 VY; 60 Hz power	9	0	M1J	✓	✓	✓	✓	✓	✓	✓	✓	✓	✓	✓	✓	✓	Not for:	IEC IE1 ⑧ Eagle Line ⑫, ⑬
480 VY; 50 Hz power	9	0	M2K	✓	✓	✓	✓	✓	✓	✓	✓	✓	✓	✓	✓	✓	Not for:	IEC IE3 ⑤
480 VY; 60 Hz power	9	0	M1K	✓	✓	✓	✓	✓	✓	✓	✓	✓	✓	✓	✓	✓	Not for:	IEC IE1 ⑧ Eagle Line ⑫, ⑬
480 VΔ; 50 Hz power	9	0	M2L	✓	✓	✓	✓	✓	✓	✓	✓	✓	✓	✓	✓	✓	Not for:	IEC IE3 ⑤
480 VΔ; 60 Hz power	9	0	M1L	✓	✓	✓	✓	✓	✓	✓	✓	✓	✓	✓	✓	✓	Not for:	IEC IE1 ⑧ Eagle Line ⑫, ⑬
230 VΔ/400 VY; 50 Hz power	9	0	M2M	✓	✓	✓	✓	✓	✓	✓	✓	✓	✓	✓	✓	✓	Not for:	IEC IE3 ⑤
230 VΔ/400 VY; 60 Hz power	9	0	M1M	✓	✓	✓	✓	✓	✓	✓	✓	✓	✓	✓	✓	✓	Not for:	IEC IE1 ⑧ Eagle Line ⑫, ⑬
Voltage at 87 Hz and 87 Hz power																		
400 VΔ ⁵⁾	9	0	M3A	✓	✓	✓	✓	✓	✓	✓	✓	✓	✓	✓	✓	✓	Not for:	IEC IE3 ⑤
Non-standard voltage and/or frequencies																		
Non-standard winding ⁶⁾	9	0	M1Y • and customer specifications	✓	✓	✓	✓	✓	✓	✓	✓	✓	✓	✓	✓	✓		

- Standard version
- Without additional charge
- ✓ With additional charge
- O. R. Possible on request
- Not possible
- This order code only determines the price of the version – Additional plain text is required.

¹⁾ For North America export versions Eagle Line 1LE1521 NEMA Energy Efficient, 1LE1523/1LE1623 NEMA Premium Efficient and 1LE1583, voltages above 600 V will not be stamped.

²⁾ Not admissible for North America export versions Eagle Line 1LE1521 NEMA Energy Efficient and 1LE1523/1LE1623 NEMA Premium Efficient.

³⁾ Delta connection is not possible.

⁴⁾ Star connection is not possible.

⁵⁾ Only possible for 4-pole, 6-pole and 8-pole motors. The operating data for converter operation is also provided in a table on the rating plate.

⁶⁾ Plain text must be specified in the order: Voltage between 200 and 690 V (voltages outside this range are available on request), frequency, circuit, for 60 Hz additionally required rated power in kW.



SIMOTICS GP and SIMOTICS SD standard motors

Article No. supplements and special versions · Voltages

Aluminum series SIMOTICS GP 1LE1073 and cast-iron series SIMOTICS SD 1LE1573, 1LE5773

Selection and ordering data

Voltages	Article No.	supplement	Frame size											Motor version	
			80	90	100	112	132	160	180	200	225	250	280	315	IEC
			1LE1073					1LE1573				1LE5773			
Order code			1LE.....-.....-.....												
Voltage at 60 Hz and 50 Hz power															
220 VΔ/380 VYY, 440 VΔ 50 Hz power	6	4	–	<input type="checkbox"/>	<input type="checkbox"/>	<input type="checkbox"/>	<input type="checkbox"/>	<input type="checkbox"/>	<input type="checkbox"/>	<input type="checkbox"/>	<input type="checkbox"/>	<input type="checkbox"/>	<input type="checkbox"/>	<input type="checkbox"/>	<input type="checkbox"/>
220 VΔ/380 VY; 50 Hz power	9	0	M2A	✓	✓	✓	✓	✓	✓	✓	✓	✓	✓	✓	–
380 VΔ/660 VY; 50 Hz power	9	0	M2B	✓	✓	✓	✓	✓	✓	✓	✓	✓	✓	✓	✓
440 VY; 50 Hz power	9	0	M2C	✓	✓	✓	✓	✓	✓	✓	✓	✓	✓	✓	–
440 VΔ; 50 Hz power	9	0	M2D	✓	✓	✓	✓	✓	✓	✓	✓	✓	✓	✓	✓
460 VY; 50 Hz power	9	0	M2E	✓	✓	✓	✓	✓	✓	✓	✓	✓	✓	✓	–
460 VΔ; 50 Hz power	9	0	M2F	✓	✓	✓	✓	✓	✓	✓	✓	✓	✓	✓	✓
575 VY; 50 Hz power	9	0	M2G	✓	✓	✓	✓	✓	✓	✓	✓	✓	✓	✓	–
575 VΔ; 50 Hz power	9	0	M2H	✓	✓	✓	✓	✓	✓	✓	✓	✓	✓	✓	✓
400 VΔ/690 VY; 50 Hz power	9	0	M2J	✓	✓	✓	✓	✓	✓	✓	✓	✓	✓	✓	✓
480 VY; 50 Hz power	9	0	M2K	✓	✓	✓	✓	✓	✓	✓	✓	✓	✓	✓	–
480 VΔ; 50 Hz power	9	0	M2L	✓	✓	✓	✓	✓	✓	✓	✓	✓	✓	✓	✓
230 VΔ/400 VY; 50 Hz power	9	0	M2M	✓	✓	✓	✓	✓	✓	✓	✓	✓	✓	✓	–
Non-standard voltage and/or frequencies															
Non-standard winding ¹⁾	9	0	M1Y • and customer specifica- tions	✓	✓	✓	✓	✓	✓	✓	✓	✓	✓	✓	✓

- Standard version
- With additional charge
- This order code only determines the price of the version – Additional plain text is required.
- Not possible













¹⁾ Plain text must be specified in the order: Voltage between 200 and 690 V (voltages outside this range are available on request), frequency, circuit, for 60 Hz additionally required rated power in kW.

SIMOTICS GP and SIMOTICS SD standard motors

Article No. supplements and special versions · Types of construction

Aluminum series SIMOTICS GP 1LE10

Selection and ordering data

Types of construction	Article No.	supplement	Frame size										Motor version					
			63	71	80	90	100	112	132	160	180	200						
		For types of construction with order code(s) Article No. with additional identification code -Z					1LE1004									IEC	IE4	①
				1LE1003													IE3	②
								1LE1083										③
			1LE1001														IE2	④
			1LE1002														IE1	⑤
					1LE1043											APAC Line	IE3	⑥
					1LE1041												IE2	⑦
					1LE1023											Eagle Line	NPE (NEMA)	⑧
						1LE1021											NEE (NEMA)	⑨
								1LE1011									Pole-changing	⑩
	1LE10.....	Order code						1LE1012										⑪
Without flange																		
IM B3 ^{1) 2) 3)}		A	-													Not for:	APAC Line IE2 ^⑦	Eagle Line NEE ^⑨
IM B6 ^{2) 3)}		T	-													Not for:	APAC Line IE2 ^⑦	Eagle Line NEE ^⑨
IM B7 ^{2) 3) 9)}		U	-													Not for:	APAC Line IE2 ^⑦	Eagle Line NEE ^⑨
IM B8 ^{2) 3)}		V	-													Not for:	APAC Line IE2 ^⑦	Eagle Line NEE ^⑨
IM V6 ^{2) 3)}		D	-													Not for:	APAC Line IE2 ^⑦	Eagle Line NEE ^⑨
IM V5 without protective cover ^{2) 3)}		C	-													Not for:	APAC Line IE2 ^⑦	Eagle Line NEE ^⑨
IM V5 with protective cover ^{2) 3) 4) 5) 6)}		C	H00	✓	✓	✓	✓	✓	✓	✓	✓	✓	✓	✓	✓	Not for:	APAC Line IE2 ^⑦	Eagle Line NEE ^⑨ Combination with order code F90
With flange																		
		EN 50347 DIN 42948		FF115 A 140	FF130 A 160	FF165 A 200	FF165 A 200	FF215 A 250	FF215 A 250	FF265 A 300	FF300 A 350	FF300 A 350	FF350 A 400					
IM B5 ^{2) 7)}		F	-	✓	✓	✓	✓	✓	✓	✓	✓	✓	✓	✓	✓			
IM V1 without protective cover ²⁾		G	-	✓	✓	✓	✓	✓	✓	✓	✓	✓	✓	✓	✓			
IM V1 with protective cover ^{2) 4) 5) 6)}		G	H00	✓	✓	✓	✓	✓	✓	✓	✓	✓	✓	✓	✓	Not for:	Combination with order code F90	
IM V3 ⁴⁾		H	-	✓	✓	✓	✓	✓	✓	✓	✓	✓	✓	✓	✓			
IM B35 ³⁾		J	-	✓	✓	✓	✓	✓	✓	✓	✓	✓	✓	✓	✓	Not for:	APAC Line IE2 ^⑦	Eagle Line NEE ^⑨









For legends and footnotes, see page 3/106.

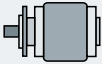

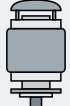
SIMOTICS GP and SIMOTICS SD standard motors

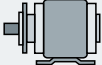
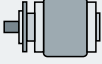
Article No. supplements and special versions · Types of construction

Aluminum series SIMOTICS GP 1LE10











Types of construction	Article No.	supplement	Frame size										Motor version				
			63	71	80	90	100	112	132	160	180	200					
								1LE1004							IEC	IE4	①
								1LE1003								IE3	②
																	③
								1LE1001								IE2	④
								1LE1002								IE1	⑤
								1LE1043							APAC Line	IE3	⑥
								1LE1041								IE2	⑦
								1LE1023							Eagle Line	NPE (NEMA)	⑧
								1LE1021								NEE (NEMA)	⑨
																	⑩
																	⑪
1LE10 (-Z)		Order code															
With flange next largest	EN 50347 DIN 42948		-	-	-	FF215 A 250	FF265 A 300	FF265 A 300	FF300 A 350	-	-	-	-				
IM B5 ^{2) 7)}		F	P01	-	-	-	✓	✓	✓	✓	-	-	-				
IM V1 without protective cover ²⁾		G	P01	-	-	-	✓	✓	✓	✓	-	-	-				
IM V1 with protective cover ^{2) 4) 5) 6)}		G	P01+H00	-	-	-	✓	✓	✓	✓	-	-	-	Not for:	Combination with order code F90		
IM V3 ⁴⁾		H	P01	-	-	-	✓	✓	✓	✓	-	-	-				
IM B35 ³⁾		J	P01	-	-	-	✓	✓	✓	✓	-	-	-	Not for:	APAC Line IE2 ^⑦ Eagle Line NEE ^⑨		
With flange next smallest	EN 50347 DIN 42948			FF100 A 120	FF115 A 140	FF130 A 160	FF165 A 200	FF165 A 200	FF215 A 250	FF265 A 300	FF265 A 300	FF300 A 350					
IM B5 ^{2) 7)}		F	P02	✓	✓	✓	-	✓	✓	✓	✓	✓	✓	Not for:	IEC IE3 ^③		
IM V1 without protective cover ²⁾		G	P02	✓	✓	✓	-	✓	✓	✓	✓	✓	✓	Not for:	IEC IE3 ^③		
IM V1 with protective cover ^{2) 4) 5) 6)}		G	P02+H00	✓	✓	✓	-	✓	✓	✓	✓	✓	✓	Not for:	Combination with order code F90 IEC IE3 ^③		
IM V3 ⁴⁾		H	P02	✓	✓	✓	-	✓	✓	✓	✓	✓	✓	Not for:	IEC IE3 ^③		
IM B35 ³⁾		J	P02	✓	✓	✓	-	✓	✓	✓	✓	✓	✓	Not for:	APAC Line IE2 ^⑦ Eagle Line NEE ^⑨		

For legends and footnotes, see page 3/106.

SIMOTICS GP and SIMOTICS SD standard motors

Article No. supplements and special versions · Types of construction

Aluminum series SIMOTICS GP 1LE10

Types of construction	Article No.	supplement	Frame size										Motor version				
			63	71	80	90	100	112	132	160	180	200					
		For types of construction with order code(s) Article No. with additional identification code -Z					1LE1004								IEC	IE4	①
					1LE1003											IE3	②
						1LE1083											③
					1LE1001											IE2	④
					1LE1002											IE1	⑤
					1LE1043									APAC Line	IE3		⑥
					1LE1041										IE2		⑦
					1LE1023									Eagle Line	NPE (NEMA)		⑧
					1LE1021										NEE (NEMA)		⑨
								1LE1011							Pole-changing		⑩
								1LE1012									⑪
1LE10 (-Z)	EN 50347 DIN 42948	Order code															
With flange	EN 50347 DIN 42948		FT75 C 90	FT85 C 105	FT100 C 120	FT115 C 140	FT130 C 160	FT130 C 160	FT165 C 200	FT215 C 250							
IM B14 ^{2) 8)}		K	✓	✓	✓	✓	✓	✓	✓	✓							
IM V19 ²⁾		L	✓	✓	✓	✓	✓	✓	✓	✓							
IM V18 without protective cover ²⁾		M	✓	✓	✓	✓	✓	✓	✓	✓							
IM V18 with protective cover ^{2) 4) 5) 6)}		M	H00	✓	✓	✓	✓	✓	✓	✓						Not for:	Combination with order code F90
IM B34 ³⁾		N	✓	✓	✓	✓	✓	✓	✓	✓						Not for:	Eagle Line NEE ⑨
With flange next largest ¹⁰⁾	EN 50347 DIN 42948		FT100 C 120	FT115 C 140	FT130 C 160	FT130 C 160	FT165 C 200	FT165 C 200	FT215 C 250								
IM B14 ^{2) 8)}		K	P01	✓	✓	✓	✓	✓	✓	✓							
IM V19 ²⁾		L	P01	✓	✓	✓	✓	✓	✓	✓							
IM V18 without protective cover ²⁾		M	P01	✓	✓	✓	✓	✓	✓	✓							
IM V18 with protective cover ^{2) 4) 5) 6)}		M	P01+H00	✓	✓	✓	✓	✓	✓	✓						Not for:	Combination with order code F90
IM B34 ³⁾		N	P01	✓	✓	✓	✓	✓	✓	✓						Not for:	APAC Line IE2 ⑦ Eagle Line NEE ⑨





3

For legends and footnotes, see page 3/106.

SIMOTICS GP and SIMOTICS SD standard motors

Article No. supplements and special versions · Types of construction

Aluminum series SIMOTICS GP 1LE10

Types of construction	Article No.	supplement	Frame size									Motor version				
			63	71	80	90	100	112	132	160	180	200				
								1LE1004						IEC	IE4	①
								1LE1003							IE3	②
																③
								1LE1001							IE2	④
								1LE1002							IE1	⑤
								1LE1043						APAC	IE3	⑥
								1LE1041					Line	IE2	⑦	
								1LE1023					Eagle	NPE (NEMA)	⑧	
								1LE1021					Line	NEE (NEMA)	⑨	
														Pole-changing	⑩	
1LE10 (-Z)		Order code						1LE1011								⑪
								1LE1012								
With flange next smallest	EN 50347 DIN 42948		FT65 C 80	FT75 C 90	–	–	FT115 C 140	–	–	–	–	–	–	–	–	–
IM B14 ^{2) 8)}		K	P02	✓	✓	–	–	✓	–	–	–	–	–	–	–	Not for: EC IE4 ① IEC IE3 ③
IM V19 ²⁾		L	P02	✓	✓	–	–	✓	–	–	–	–	–	–	–	Not for: IEC IE4 ① IEC IE3 ③
IM V18 without protective cover ²⁾		M	P02	✓	✓	–	–	✓	–	–	–	–	–	–	–	Not for: IEC IE4 ① IEC IE3 ③
IM V18 with protective cover ^{2) 4) 5) 6)}		M	P02+H00	✓	✓	–	–	✓	–	–	–	–	–	–	–	Not for: IEC IE4 ① Combination with order code F90 IEC IE3 ③
IM B34 ³⁾		N	P02	✓	✓	–	–	✓	–	–	–	–	–	–	–	Not for: IEC IE4 ① IEC IE3 ③ APAC Line IE2 ⑦ Eagle Line NEE ⑨

- Standard version
- ✓ With additional charge
- Not possible







- 1) The types of construction IM B6/7/8, IM V6 and IM V5 with/without protective cover are also possible as long as there are no condensation drainage holes (order code **H03**) and these types of construction do not have to be stamped on the rating plate. As standard the type of construction IM B3 is then stamped on the rating plate. With type of construction IM V5 with protective cover, the protective cover has to be additionally ordered with order code **H00**. The protective cover is not stamped on the rating plate.
- 2) The type of construction is stamped on the rating plate. For orders with condensation drainage holes (order code **H03**), if mounted in a different position, the position must be specified to ensure that the condensation drainage holes are positioned correctly.
- 3) For North America export version Eagle Line 1LE1021 NEMA Energy Efficient, types of construction with feet are not possible for 2-pole, 4-pole and 6-pole motors ≤ 200 hp in accordance with NEMA MG1 Table 12-11.
- 4) The "Standard cylindrical shaft extension (second shaft extension)" option (order code **L05**) is not possible.
- 5) In combination with an encoder, it is not necessary to order the protective cover (order code **H00**), as this is delivered as a protection for the encoder as standard. In this case the protective cover is standard version (without additional charge).
- 6) Not possible for forced-air cooled 1LE1 motors with order code **F90** without external fan and fan cover.
- 7) The types of construction IM V3 and IM V1 with/without protective cover are also possible as long as there are no condensation drainage holes (order code **H03**) and these types of construction do not have to be stamped on the rating plate. As standard the type of construction IM B5 is then stamped on the rating plate. With type of construction IM V1 with protective cover, the protective cover has to be additionally ordered with order code **H00**. The protective cover is not stamped on the rating plate.
- 8) The types of construction IM V19 and IM V18 with/without protective cover are also possible as long as there are no condensation drainage holes (order code **H03**) and these types of construction do not have to be stamped on the rating plate. As standard the type of construction IM B14 is then stamped on the rating plate. With type of construction IM V18 with protective cover, the protective cover has to be additionally ordered with order code **H00**. The protective cover is not stamped on the rating plate.
- 9) When ordering frame size B7 and the required cable outlet below, option **R12** must also be ordered.
- 10) For the standard EN 50347, flanges which are 2 levels larger are used in frame size 80 with option **P01**.

SIMOTICS GP and SIMOTICS SD standard motors

Article No. supplements and special versions · Types of construction

Cast-iron series SIMOTICS SD 1LE15 Basic Line, 1LE16 Performance Line

Selection and ordering data

Types of construction	Article No. supplement	Frame size	Motor version																
			71	80	90	100	112	132	160	180	200	225	250	280	315 S/M	315 L 2-pole	315 L 4- to 8-pole	IEC	IE4
			1LE1504 Basic Line														IEC	IE4	①
			1LE1604 Performance Line																②
			1LE1503 Basic Line															IE3	③
			1LE1603 Performance Line																④
			1LE1583																⑤
			1LE1501 Basic Line															IE2	⑥
			1LE1601 Performance Line																⑦
			1LE1502 Basic Line															IE1	⑧
			1LE1543 Basic Line														APAC Line	IE3	⑨
			1LE1643 Performance Line																⑩
			1LE1541 Basic Line															IE2	⑪
			1LE1523 Basic Line														Eagle Line	NPE (NEMA)	⑫
			1LE1623 Performance Line																⑬
			1LE1521 Basic Line															NEE (NEMA)	⑭
Without flange																			
IM B3 1) 2) 3)		A	-	<input type="checkbox"/>	<input type="checkbox"/>	<input type="checkbox"/>	<input type="checkbox"/>	<input type="checkbox"/>	<input type="checkbox"/>	<input type="checkbox"/>	<input type="checkbox"/>	<input type="checkbox"/>	<input type="checkbox"/>	<input type="checkbox"/>	<input type="checkbox"/>	<input type="checkbox"/>	<input type="checkbox"/>	Not for:	⑪, ⑭ 2, 4, 6-pole ≤ 200 hp; ⑫, ⑬ 8-pole ≤ 200 hp
IM B6 2) 3)		T	-	<input type="checkbox"/>	<input type="checkbox"/>	<input type="checkbox"/>	<input type="checkbox"/>	<input type="checkbox"/>	<input type="checkbox"/>	<input type="checkbox"/>	<input type="checkbox"/>	<input type="checkbox"/>	<input type="checkbox"/>	<input type="checkbox"/>	<input type="checkbox"/>	<input type="checkbox"/>	<input type="checkbox"/>	Not for:	⑪, ⑭ 2, 4, 6-pole ≤ 200 hp; ⑫, ⑬ 8-pole ≤ 200 hp
IM B7 2) 3) 9)		U	-	<input type="checkbox"/>	<input type="checkbox"/>	<input type="checkbox"/>	<input type="checkbox"/>	<input type="checkbox"/>	<input type="checkbox"/>	<input type="checkbox"/>	<input type="checkbox"/>	<input type="checkbox"/>	<input type="checkbox"/>	<input type="checkbox"/>	<input type="checkbox"/>	<input type="checkbox"/>	<input type="checkbox"/>	Not for:	⑪, ⑭ 2, 4, 6-pole ≤ 200 hp; ⑫, ⑬ 8-pole ≤ 200 hp
IM B8 2) 3)		V	-	<input type="checkbox"/>	<input type="checkbox"/>	<input type="checkbox"/>	<input type="checkbox"/>	<input type="checkbox"/>	<input type="checkbox"/>	<input type="checkbox"/>	<input type="checkbox"/>	<input type="checkbox"/>	<input type="checkbox"/>	<input type="checkbox"/>	<input type="checkbox"/>	<input type="checkbox"/>	<input type="checkbox"/>	Not for:	⑪, ⑭ 2, 4, 6-pole ≤ 200 hp; ⑫, ⑬ 8-pole ≤ 200 hp
IM V6 2) 3)		D	-	<input type="checkbox"/>	<input type="checkbox"/>	<input type="checkbox"/>	<input type="checkbox"/>	<input type="checkbox"/>	<input type="checkbox"/>	<input type="checkbox"/>	<input type="checkbox"/>	<input type="checkbox"/>	<input type="checkbox"/>	<input type="checkbox"/>	<input type="checkbox"/>	<input checked="" type="checkbox"/>	<input type="checkbox"/>	Not for:	⑪, ⑭ 2, 4, 6-pole ≤ 200 hp; ⑫, ⑬ 8-pole ≤ 200 hp
IM V5 without protective cover 2) 3)		C	-	<input type="checkbox"/>	<input type="checkbox"/>	<input type="checkbox"/>	<input type="checkbox"/>	<input type="checkbox"/>	<input type="checkbox"/>	<input type="checkbox"/>	<input type="checkbox"/>	<input type="checkbox"/>	<input type="checkbox"/>	<input type="checkbox"/>	<input type="checkbox"/>	<input checked="" type="checkbox"/>	<input type="checkbox"/>	Not for:	⑪, ⑭ 2, 4, 6-pole ≤ 200 hp; ⑫, ⑬ 8-pole ≤ 200 hp
IM V5 with protective cover 2) 3) 4) 5)		C	H00	<input checked="" type="checkbox"/>	<input checked="" type="checkbox"/>	<input checked="" type="checkbox"/>	<input checked="" type="checkbox"/>	<input checked="" type="checkbox"/>	<input checked="" type="checkbox"/>	<input checked="" type="checkbox"/>	<input checked="" type="checkbox"/>	<input checked="" type="checkbox"/>	<input checked="" type="checkbox"/>	<input checked="" type="checkbox"/>	<input checked="" type="checkbox"/>	<input checked="" type="checkbox"/>	<input checked="" type="checkbox"/>	Not for:	⑪, ⑭ 2, 4, 6-pole ≤ 200 hp; ⑫, ⑬ 8-pole ≤ 200 hp

3

For legends and footnotes, see page 3/111.

SIMOTICS GP and SIMOTICS SD standard motors

Article No. supplements and special versions · Types of construction

Cast-iron series SIMOTICS SD 1LE15 Basic Line, 1LE16 Performance Line

Types of construction	Article No. supplement	Frame size														Motor version							
		71	80	90	100	112	132	160	180	200	225	250	280	315 S/M	315 L 2-pole	315 L 4- to 8-pole							
					1LE1504 Basic Line														IEC	IE4	①		
					1LE1604 Performance Line																②		
				1LE1503 Basic Line															IE3	③			
							1LE1603 Performance Line																④
							1LE1583																⑤
				1LE1501 Basic Line															IE2	⑥			
							1LE1601 Performance Line																⑦
							1LE1502 Basic Line															IE1	⑧
						1LE1543 Basic Line														APAC Line	IE3	⑨	
							1LE1643 Performance Line																⑩
							1LE1541 Basic Line															IE2	⑪
				1LE1523 Basic Line														Eagle Line	NPE (NEMA)	⑫			
							1LE1623 Performance Line																⑬
				1LE1521 Basic Line															NEE (NEMA)	⑭			
With flange	EN 50347 DIN 42948	FF130 A 160	FF165 A 200	FF165 A 200	FF215 A 250	FF215 A 250	FF265 A 300	FF300 A 350	FF300 A 350	FF350 A 400	FF400 A 450	FF500 A 550	FF500 A 550	FF600 A 660	FF600 A 660	FF600 A 660							
IM B5 2) 6)	F	-	✓	✓	✓	✓	✓	✓	✓	✓	✓	✓	✓	✓	✓	✓	✓	✓	✓	Not for:	IEC IE3 ⑤		
IM V1 without protective cover 2)	G	-	✓	✓	✓	✓	✓	✓	✓	✓	✓	✓	✓	✓	✓	✓	✓	✓	✓	Not for:	IEC IE3 ⑤		
IM V1 with protective cover 2) 4) 5)	G	H00	✓	✓	✓	✓	✓	✓	✓	✓	✓	✓	✓	✓	✓	✓	✓	✓	✓	Not for:	IEC IE3 ⑤		
IM V3 5)	H	-	✓	✓	✓	✓	✓	✓	✓	✓	✓	✓	✓	✓	✓	✓	✓	✓	✓	Not for:	IEC IE3 ⑤		
IM B35 3)	J	-	✓	✓	✓	✓	✓	✓	✓	✓	✓	✓	✓	✓	✓	✓	✓	✓	✓	Not for:	⑩, ⑭ 2, 4, 6-pole ≤ 200 hp; ⑫, ⑬ 8-pole ≤ 200 hp IEC IE3 ⑤		
With flange next largest	EN 50347 DIN 42948	-	-	FF215 A 250	FF265 A 300	FF265 A 300	FF300 A 350	-	-	-	-	-	-	-	-	-	-	-	-				
IM B5 2) 6)	F	P01	-	-	✓	✓	✓	✓	-	-	-	-	-	-	-	-	-	-	-				
IM V1 without protective cover 2)	G	P01	-	-	✓	✓	✓	✓	-	-	-	-	-	-	-	-	-	-	-				
IM V1 with protective cover 2) 4) 5)	G	P01+ H00	-	-	✓	✓	✓	✓	-	-	-	-	-	-	-	-	-	-	-				
IM V3 5)	H	P01	-	-	✓	✓	✓	✓	-	-	-	-	-	-	-	-	-	-	-				
IM B35 3)	J	P01	-	-	✓	✓	✓	✓	-	-	-	-	-	-	-	-	-	-	-	Not for:	⑩, ⑭ 2, 4, 6-pole ≤ 200 hp; ⑫, ⑬ 8-pole ≤ 200 hp		

For legends and footnotes, see page 3/111.

SIMOTICS GP and SIMOTICS SD standard motors

Article No. supplements and special versions · Types of construction

Cast-iron series SIMOTICS SD 1LE15 Basic Line, 1LE16 Performance Line

Types of construction	Article No. supplement	Frame size	Motor version																		
			71	80	90	100	112	132	160	180	200	225	250	280	315 S/M	315 L 2-pole	315 L 4- to 8-pole				
	Type of construction code letter 14th position of the Article No. For types of construction with order code(s) Article No. with additional identification code -Z Order code	1LE1504 Basic Line															IEC	IE4	①		
		1LE1604 Performance Line																			②
		1LE1503 Basic Line																		IE3	③
		1LE1603 Performance Line																			④
		1LE1583																			⑤
		1LE1501 Basic Line																		IE2	⑥
		1LE1601 Performance Line																			⑦
		1LE1502 Basic Line																		IE1	⑧
		1LE1543 Basic Line																	APAC Line	IE3	⑨
		1LE1643 Performance Line																			⑩
		1LE1541 Basic Line																		IE2	⑪
		1LE1523 Basic Line																	Eagle Line	NPE (NEMA)	⑫
		1LE1623 Performance Line																			⑬
		1LE1521 Basic Line																		NEE (NEMA)	⑭
1LE1 (-Z)																			
With flange next smallest	EN 50347 DIN 42948	-	FF130 - A 160 -	FF165 A 200	FF165 A 200	FF215 A 250	FF265 A 300	FF265 A 300	FF300 A 350	-	-	-	-	-	-	-					
IM B5 ^{2) 6)}	F	P02	-	✓	-	✓	✓	✓	✓	✓	-	-	-	-	-	-					
IM V1 without protective cover ²⁾	G	P02	-	✓	-	✓	✓	✓	✓	✓	-	-	-	-	-	-					
IM V1 with protective cover ^{2) 4) 5)}	G	P02+H00	-	✓	-	✓	✓	✓	✓	✓	-	-	-	-	-	-					
IM V3 ⁵⁾	H	P02	-	✓	-	✓	✓	✓	✓	✓	-	-	-	-	-	-					
IM B35 ³⁾	J	P02	-	✓	-	✓	✓	✓	✓	✓	-	-	-	-	-	-	Not for:	⑫, ⑬ 2, 4, 6-pole ≤ 200 hp; ⑭, ⑮ 8-pole ≤ 200 hp			

3

For legends and footnotes, see page 3/111.

SIMOTICS GP and SIMOTICS SD standard motors

Article No. supplements and special versions · Types of construction

Cast-iron series SIMOTICS SD 1LE15 Basic Line, 1LE16 Performance Line

Types of construction	Article No. supplement	Frame size													Motor version				
		71	80	90	100	112	132	160	180	200	225	250	280	315 S/M	315 L 2-pole	315 L 4- to 8-pole			
					1LE1504 Basic Line										IEC	IE4	①		
					1LE1604 Performance Line												②		
				1LE1503 Basic Line														IE3	③
							1LE1603 Performance Line									④			
							1LE1583									⑤			
				1LE1501 Basic Line														IE2	⑥
							1LE1601 Performance Line									⑦			
							1LE1502 Basic Line							IE1	⑧				
							1LE1543 Basic Line							APAC Line	IE3	⑨			
							1LE1643 Performance Line									⑩			
							1LE1541 Basic Line							IE2	⑪				
				1LE1523 Basic Line													Eagle Line	NPE (NEMA)	⑫
							1LE1623 Performance Line									⑬			
				1LE1521 Basic Line													Eagle Line	NEE (NEMA)	⑭
1LE1 (-Z)																		
With flange	EN 50347 DIN 42948	FT85 C 105	FT100 C 120	FT115 C 140	FT130 C 160	FT165 C 200	FT215 C 250	-	-	-	-	-	-	-	-	-	-	-	
IM B14 2) 7)	K	-	✓	✓	✓	✓	✓	✓	✓	✓	✓	✓	✓	✓	✓	✓	✓	✓	
IM V19 2)	L	-	✓	✓	✓	✓	✓	✓	✓	✓	✓	✓	✓	✓	✓	✓	✓	✓	
IM V18 without protective cover 2)	M	-	✓	✓	✓	✓	✓	✓	✓	✓	✓	✓	✓	✓	✓	✓	✓	✓	
IM V18 with protective cover 2) 4) 5)	M	H00	✓	✓	✓	✓	✓	✓	✓	✓	✓	✓	✓	✓	✓	✓	✓	✓	
IM B34 3)	N	-	✓	✓	✓	✓	✓	✓	✓	✓	✓	✓	✓	✓	✓	✓	✓	✓	
With flange next largest	EN 50347 DIN 42948	FT115 C 140	FT130 C 160	FT130 C 160	FT165 C 200	FT165 C 200	FT215 C 250	-	-	-	-	-	-	-	-	-	-	-	
IM B14 2) 7) 8)	K	P01	✓	✓	✓	✓	✓	✓	✓	✓	✓	✓	✓	✓	✓	✓	✓	✓	
IM V19 2) 8)	L	P01	✓	✓	✓	✓	✓	✓	✓	✓	✓	✓	✓	✓	✓	✓	✓	✓	
IM V18 without protective cover 2) 8)	M	P01	✓	✓	✓	✓	✓	✓	✓	✓	✓	✓	✓	✓	✓	✓	✓	✓	
IM V18 with protective cover 2) 4) 5) 8)	M	P01+ H00	✓	✓	✓	✓	✓	✓	✓	✓	✓	✓	✓	✓	✓	✓	✓	✓	
IM B34 3) 8)	N	P01	✓	✓	✓	✓	✓	✓	✓	✓	✓	✓	✓	✓	✓	✓	✓	✓	
																		Not for: ⑫, ⑬ 2, 4, 6-pole ≤ 200 hp; ⑭, ⑮ 8-pole ≤ 200 hp	

For legends and footnotes, see page 3/111.

SIMOTICS GP and SIMOTICS SD standard motors

Article No. supplements and special versions · Types of construction

Cast-iron series SIMOTICS SD 1LE15 Basic Line, 1LE16 Performance Line

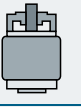
Types of construction	Article No. supplement	Frame size													Motor version					
		71	80	90	100	112	132	160	180	200	225	250	280	315 S/M	315 L 2-pole	315 L 4- to 8-pole				
	Type of construction code letter 14th position of the Article No.				1LE1504 Basic Line													IEC	IE4	①
	For types of construction with order code(s)				1LE1604 Performance Line															②
	Article No. with additional identification code -Z				1LE1503 Basic Line														IE3	③
					1LE1603 Performance Line															④
					1LE1583															⑤
					1LE1501 Basic Line														IE2	⑥
					1LE1601 Performance Line															⑦
					1LE1502 Basic Line														IE1	⑧
					1LE1543 Basic Line													APAC Line	IE3	⑨
					1LE1643 Performance Line															⑩
					1LE1541 Basic Line														IE2	⑪
					1LE1523 Basic Line													Eagle Line	NPE (NEMA)	⑫
					1LE1623 Performance Line															⑬
	Order code				1LE1521 Basic Line														NEE (NEMA)	⑭
1LE1 (-Z)																			
With flange next smallest	EN 50347 DIN 42948	-	-	-	FT115	-	-	-	-	-	-	-	-	-	-	-	-	-		
		-	-	-	C 140	-	-	-	-	-	-	-	-	-	-	-	-	-		
IM B14 2) 7)	 K	P02	-	-	✓	-	-	-	-	-	-	-	-	-	-	-	-	Not for: IEC IE3 ⑤		
IM V19 2)	 L	P02	-	-	✓	-	-	-	-	-	-	-	-	-	-	-	-	Not for: IEC IE3 ⑤		
IM V18 without protective cover 2)	 M	P02	-	-	✓	-	-	-	-	-	-	-	-	-	-	-	-	Not for: IEC IE3 ⑤		
IM V18 with protective cover 2) 4) 5)	 M	P02+H00	-	-	✓	-	-	-	-	-	-	-	-	-	-	-	-	Not for: IEC IE3 ⑤		
IM B34 3)	 N	P02	-	-	✓	-	-	-	-	-	-	-	-	-	-	-	-	Not for: IEC IE3 ⑤		

- Standard version
- ✓ With additional charge
- O. R. Possible on request
- Not possible

- 1) The types of construction IM B6/7/8, IM V6 and IM V5 with/without protective cover are also possible as long as no stamping of these types of construction on the rating plate is required. As standard the type of construction IM B3 is then stamped on the rating plate. With type of construction IM V5 with protective cover, the protective cover has to be additionally ordered with order code **H00**. The protective cover is not stamped on the rating plate.
- 2) The type of construction is stamped on the rating plate. If mounted in a different position, the position must be specified to ensure that the condensation drainage holes are positioned correctly.
- 3) For North America export version Eagle Line 1LE1521 NEMA Energy Efficient, types of construction with feet are not possible for 2-pole, 4-pole and 6-pole motors ≤ 200 hp in accordance with NEMA MG1 Table 12-11.
- 4) In combination with an encoder, it is not necessary to order the protective cover (order code **H00**), as this is delivered as a protection for the encoder as standard. In this case the protective cover is standard design (without additional charge).
- 5) The "Standard cylindrical shaft extension (second shaft extension)" option (order code **L05**) is not possible.
- 6) The types of construction IM V3 and IM V1 with/without protective cover are also possible as long as no stamping of these types of construction on the rating plate is required. As standard the type of construction IM B5 is then stamped on the rating plate. With type of construction IM V1 with protective cover, the protective cover has to be additionally ordered with order code **H00**. The protective cover is not stamped on the rating plate.
- 7) The types of construction IM V19 and IM V18 with/without protective cover are also possible as long as no stamping of these types of construction on the rating plate is required. As standard the type of construction IM B14 is then stamped on the rating plate. With type of construction IM V18 with protective cover, the protective cover has to be additionally ordered with order code **H00**. The protective cover is not stamped on the rating plate.
- 8) With reference to standard EN 50347, flanges that are 2 levels larger are used with option **P01** in the frame sizes 71 and 80.
- 9) When ordering frame size B7 and the required cable outlet below, option **R12** must also be ordered.















SIMOTICS GP and SIMOTICS SD standard motors

Article No. supplements and special versions · Types of construction

Aluminum series SIMOTICS GP 1LE1073 and cast-iron series SIMOTICS SD 1LE1573, 1LE5773

Selection and ordering data

Types of construction	Article No. supplement	For types of construction with order code(s)	Frame size													Motor version	
			80	90	100	112	132	160	180	200	225	250	280	315	IEC	IE3	
			1LE1073						1LE1573				1LE5773				
	1LE.....-Z	Order code															
Without flange																	
IM B3 ^{1) 2)}	 A	-	□	□	□	□	□	□	□	□	□	□	□	□	□		
IM B6 ²⁾	 T	-	□	□	□	□	□	□	□	□	□	□	□	□	□		
IM B7 ^{2) 8)}	 U	-	□	□	□	□	□	□	□	□	□	□	□	□	□		
IM B8 ²⁾	 V	-	□	□	□	□	□	□	□	□	□	□	□	□	□		
IM V6 ²⁾	 D	-	□	□	□	□	□	□	□	□	□	□	□	□	□		
IM V5 without protective cover ²⁾	 C	-	□	□	□	□	□	□	□	□	□	□	□	□	□		
IM V5 with protective cover ^{2) 3) 4) 5)}	 C	H00	✓	✓	✓	✓	✓	✓	✓	✓	✓	✓	✓	✓	✓		
With flange																	
	EN 50347		FF165	FF165	FF215	FF215	FF265	FF300	FF300	FF350	FF400	FF500	FF500	FF600			
	DIN 42948		A 200	A 200	A 250	A 250	A 300	A 350	A 350	A 400	A 450	A 550	A 550	A 660			
IM B5 ^{2) 6)}	 F	-	✓	✓	✓	✓	✓	✓	✓	✓	✓	✓	✓	✓	✓		
IM V1 without protective cover ²⁾	 G	-	✓	✓	✓	✓	✓	✓	✓	✓	✓	✓	✓	✓	✓		
IM V1 with protective cover ^{2) 3) 4) 5)}	 G	H00	-	-	✓	✓	✓	✓	✓	✓	✓	✓	✓	✓	✓		
IM V3 ³⁾	 H	-	✓	✓	✓	✓	✓	✓	✓	✓	✓	✓	✓	✓	✓		
IM B35	 J	-	✓	✓	✓	✓	✓	✓	✓	✓	✓	✓	✓	✓	✓		









For legends and footnotes, see page 3/115.

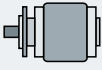

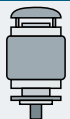
SIMOTICS GP and SIMOTICS SD standard motors

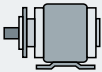
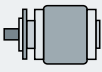
Article No. supplements and special versions · Types of construction

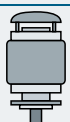
Aluminum series SIMOTICS GP 1LE1073 and cast-iron series SIMOTICS SD 1LE1573, 1LE5773

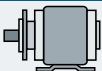









Types of construction	Article No.	supplement	Frame size											Motor version		
			80	90	100	112	132	160	180	200	225	250	280	315	IEC	IE3
		For types of construction with order code(s) Article No. with additional identification code -Z Order code	1LE1073				1LE1573				1LE5773			IEC	IE3	
1LE.....-.....-...(-Z)																
With flange next largest	EN 50347 DIN 42948		-	FF215	FF265	FF265	FF300	-	-	-	-	-	-	-	-	-
			-	A 250	A 300	A 300	A 350	-	-	-	-	-	-	-	-	-
IM B5 ^{2) 6)}		F	P01	-	✓	✓	✓	✓	-	-	-	-	-	-	-	-
IM V1 without protective cover ²⁾		G	P01	-	✓	✓	✓	✓	-	-	-	-	-	-	-	-
IM V1 with protective cover ^{2) 3) 4) 5)}		G	P01+H00	-	✓	✓	✓	✓	-	-	-	-	-	-	-	-
IM V3 ³⁾		H	P01	-	✓	✓	✓	✓	-	-	-	-	-	-	-	-
IM B35		J	P01	-	✓	✓	✓	✓	-	-	-	-	-	-	-	-
With flange next smallest	EN 50347 DIN 42948			FF130	-	FF165	FF165	FF215	FF265	FF265	FF300	-	-	-	-	-
				A 160	-	A 200	A 200	A 250	A 300	A 300	A 350	-	-	-	-	-
IM B5 ^{2) 6)}		F	P02	✓	-	✓	✓	✓	✓	✓	✓	-	-	-	-	-
IM V1 without protective cover ²⁾		G	P02	✓	-	✓	✓	✓	✓	✓	✓	-	-	-	-	-
IM V1 with protective cover ^{2) 3) 4) 5)}		G	P02+H00	✓	-	✓	✓	✓	✓	✓	✓	-	-	-	-	-
IM V3 ³⁾		H	P02	✓	-	✓	✓	✓	✓	✓	✓	-	-	-	-	-
IM B35		J	P02	✓	-	✓	✓	✓	✓	✓	✓	-	-	-	-	-

For legends and footnotes, see page 3/115.

SIMOTICS GP and SIMOTICS SD standard motors

Article No. supplements and special versions · Types of construction

Aluminum series SIMOTICS GP 1LE1073 and cast-iron series SIMOTICS SD 1LE1573, 1LE5773





Types of construction	Article No. supplement	Type of construction code letter 14th position of the Article No.	For types of construction with order code(s) Article No. with additional identification code -Z Order code	Frame size											Motor version	
				80	90	100	112	132	160	180	200	225	250	280	315	IEC
				1LE1073				1LE1573				1LE5773				
1LE.....-.....-...(-Z)																
With flange	EN 50347			FT100	FT115	FT130	FT130	FT165	FT215	-	-	-	-	-	-	
	DIN 42948			C 120	C 140	C 160	C 160	C 200	C 250	-	-	-	-	-	-	
IM B14 ^{2) 7)}		K	-	✓	✓	✓	✓	✓	✓	-	-	-	-	-	-	
IM V19 ²⁾		L	-	✓	✓	✓	✓	✓	✓	-	-	-	-	-	-	
IM V18 without protective cover ²⁾		M	-	✓	✓	✓	✓	✓	✓	-	-	-	-	-	-	
IM V18 with protective cover ^{2) 3) 4) 5)}		M	H00	✓	✓	✓	✓	✓	✓	-	-	-	-	-	-	
IM B34		N	-	✓	✓	✓	✓	✓	✓	-	-	-	-	-	-	
With flange next largest ⁹⁾	EN 50347			FT130	FT130	FT165	FT165	FT215	-	-	-	-	-	-	-	
	DIN 42948			C 160	C 160	C 200	C 200	C 250	-	-	-	-	-	-	-	
IM B14 ^{2) 7)}		K	P01	✓	✓	✓	✓	✓	-	-	-	-	-	-	-	
IM V19 ²⁾		L	P01	✓	✓	✓	✓	✓	-	-	-	-	-	-	-	
IM V18 without protective cover ²⁾		M	P01	✓	✓	✓	✓	✓	-	-	-	-	-	-	-	
IM V18 with protective cover ^{2) 3) 4) 5)}		M	P01+H00	✓	✓	✓	✓	✓	-	-	-	-	-	-	-	
IM B34		N	P01	✓	✓	✓	✓	✓	-	-	-	-	-	-	-	

For legends and footnotes, see page 3/115.

SIMOTICS GP and SIMOTICS SD standard motors

Article No. supplements and special versions · Types of construction

Aluminum series SIMOTICS GP 1LE1073 and cast-iron series SIMOTICS SD 1LE1573, 1LE5773

Types of construction	Article No.	supplement	Frame size													Motor version		
			80	90	100	112	132	160	180	200	225	250	280	315	IEC	IE3		
	Type of construction code letter	For types of construction with order code(s)	1LE1073				1LE1573				1LE5773							
	14th position of the Article No.	Article No. with additional identification code -Z																
1LE (-Z)																		
With flange next smallest	EN 50347		-	-	FT115	FT115	FT130	FT165	-	-	-	-	-	-	-	-		
	DIN 42948		-	-	C 140	C 140	C 160	C 200	-	-	-	-	-	-	-	-		
IM B14 ^{2) 7)}		K	P02		✓	O. R.	O. R.	O. R.	-	-	-	-	-	-	-			
IM V19 ²⁾		L	P02		✓	O. R.	O. R.	O. R.	-	-	-	-	-	-	-			
IM V18 without protective cover ²⁾		M	P02		✓	O. R.	O. R.	O. R.	-	-	-	-	-	-	-			
IM V18 with protective cover ^{2) 3) 4) 5)}		M	P02+H00		✓	O. R.	O. R.	O. R.	-	-	-	-	-	-	-			
IM B34		N	P02		✓	O. R.	O. R.	O. R.	-	-	-	-	-	-	-			

- Standard version
- ✓ With additional charge
- Not possible
- O. R. Possible on request

- ¹⁾ The types of construction IM B6/7/8, IM V6 and IM V5 with/without protective cover are also possible as long as there are no condensation drainage holes (order code **H03**) and these types of construction do not have to be stamped on the rating plate. As standard the type of construction IM B3 is then stamped on the rating plate. With type of construction IM V5 with protective cover, the protective cover has to be additionally ordered with order code **H00**. The protective cover is not stamped on the rating plate.
- ²⁾ The type of construction is stamped on the rating plate. For orders with condensation drainage holes (order code **H03**), if mounted in a different position, the position must be specified to ensure that the condensation drainage holes are positioned correctly.
- ³⁾ The "Standard cylindrical shaft extension (second shaft extension)" option (order code **L05**) is not possible.
- ⁴⁾ In combination with an encoder, it is not necessary to order the protective cover (order code **H00**), as this is delivered as a protection for the encoder as standard. In this case the protective cover is standard version (without additional charge).
- ⁵⁾ Not possible for forced-air cooled 1LE1 motors with order code **F90** without external fan and fan cover.

- ⁶⁾ The types of construction IM V3 and IM V1 with/without protective cover are also possible as long as there are no condensation drainage holes (order code **H03**) and these types of construction do not have to be stamped on the rating plate. As standard the type of construction IM B5 is then stamped on the rating plate. With type of construction IM V1 with protective cover, the protective cover has to be additionally ordered with order code **H00**. The protective cover is not stamped on the rating plate.
- ⁷⁾ The types of construction IM V19 and IM V18 with/without protective cover are also possible as long as there are no condensation drainage holes (order code **H03**) and these types of construction do not have to be stamped on the rating plate. As standard the type of construction IM B14 is then stamped on the rating plate. With type of construction IM V18 with protective cover, the protective cover has to be additionally ordered with order code **H00**. The protective cover is not stamped on the rating plate.
- ⁸⁾ When ordering frame size B7 and the required cable outlet below, option **R12** must also be ordered.
- ⁹⁾ For the standard EN 50347, flanges which are 2 levels larger are used in frame size 80 with option **P01**.

SIMOTICS GP and SIMOTICS SD standard motors

Article No. supplements and special versions · Motor protection

Aluminum series SIMOTICS GP 1LE10

Selection and ordering data

Motor protection	Article No.	supplement	Frame size									Motor version				
			63	71	80	90	100	112	132	160	180	200				
								1LE1004						IEC	IE4	①
								1LE1003							IE3	②
								1LE1083								③
							1LE1001								IE2	④
							1LE1002								IE1	⑤
								1LE1043						APAC	IE3	⑥
								1LE1041					Line	IE2	⑦	
								1LE1023					Eagle	NPE (NEMA)	⑧	
								1LE1021					Line	NEE (NEMA)	⑨	
								1LE1011						Pole-changing	⑩	
	1LE10	Order code						1LE1012								⑪

Motor protection															
None (standard)	A	-	□	□	□	□	□	□	□	□	□	□	□		
1 or 3 PTC thermistors – for tripping (2 terminals) ¹⁾	B	-	✓	✓	✓	✓	✓	✓	✓	✓	✓	✓	✓		
2 or 6 PTC thermistors – for alarm and tripping (4 terminals) ¹⁾	C	-	✓	✓	✓	✓	✓	✓	✓	✓	✓	✓	✓		
1 KTY84-130 temperature sensor (2 terminals) ¹⁾	F	-	✓	✓	✓	✓	✓	✓	✓	✓	✓	✓	✓		
2 KTY84-130 temperature sensors (4 terminals) ¹⁾	G	-	✓	✓	✓	✓	✓	✓	✓	✓	✓	✓	✓		
3 Pt100 resistance thermometers – 2-wire input (6 terminals) ¹⁾	H	-	-	-	-	-	✓	✓	✓	✓	✓	✓	✓		
6 Pt100 resistance thermometers – 2-wire input (12 terminals)	J	-	-	-	-	-	✓	✓	✓	✓	✓	✓	✓	Only for:	IEC IE3 ③
1 Pt1000 resistance thermometer (2 terminals)	K	-	✓	✓	✓	✓	✓	✓	✓	✓	✓	✓	✓		
2 Pt1000 resistance thermometers (4 terminals)	L	-	✓	✓	✓	✓	✓	✓	✓	✓	✓	✓	✓		
1 Pt100 resistance thermometer – 2-wire input (2 terminals)	P	-	-	-	-	-	✓	✓	✓	✓	✓	✓	✓		
3 Pt100 resistance thermometers – 3-wire input (9 terminals)	Q	-	-	-	-	-	✓	✓	✓	✓	✓	✓	✓		
6 Pt100 resistance thermometers – 3-wire input (18 terminals)	R	-	-	-	-	-	✓	✓	✓	✓	✓	✓	✓		
3 NTC thermistors – for tripping (6 terminals) ¹⁾	Z	Q2A	-	-	-	-	✓	✓	✓	✓	-	-	-		
3 bimetal sensors (NC contacts) – for tripping (2 terminals) ¹⁾	Z	Q3A	✓	✓	✓	✓	✓	✓	✓	✓	✓	✓	✓		

- Standard version
- ✓ With additional charge
- Not possible

¹⁾ Evaluation with appropriate tripping unit (see Catalog IC 10) is recommended. For pole-changing motors with two separate windings, double the number of temperature sensors or temperature detectors is required. This also results in a double additional charge.

SIMOTICS GP and SIMOTICS SD standard motors

Article No. supplements and special versions · Motor protection

Cast-iron series SIMOTICS SD 1LE15 Basic Line, 1LE16 Performance Line

Selection and ordering data

Motor protection	Article No.	supplement	Frame size													Motor version			
			71	80	90	100	112	132	160	180	200	225	250	280	315				
						1LE1504 Basic Line										IEC	IE4	①	
						1LE1604 Performance Line													②
			1LE1503 Basic Line															IE3	③
			1LE1603 Performance Line																④
			1LE1583																⑤
			1LE1501 Basic Line															IE2	⑥
			1LE1601 Performance Line																⑦
			1LE1502 Basic Line															IE1	⑧
			1LE1543 Basic Line													APAC Line		IE3	⑨
			1LE1643 Performance Line																
			1LE1541 Basic Line															IE2	⑪
			1LE1523 Basic Line													Eagle Line		NPE (NEMA)	⑫
			1LE1623 Performance Line																
	1LE1	Order code	1LE1521 Basic Line															NEE (NEMA)	⑭

Motor protection																	
Without (standard) ¹⁾	A	-	□	□	□	□	□	□	□	□	□	□	□	□	□	□	Only for: Basic Line ①, ③, ⑥, ⑧, ⑨, ⑪, ⑫, ⑭
1 or 3 PTC thermistors – for tripping (2 terminals) ^{1) 2)}	B	-	✓	✓	✓	✓	✓	✓	✓	✓	✓	✓	✓	✓	✓	Only for: Basic Line ①, ③, ⑥, ⑧, ⑨, ⑪, ⑫, ⑭	
			□	□	□	□	□	□	□	□	□	□	□	□	□	Only for: Performance Line ②, ④, ⑦, ⑩, ⑬	
2 or 6 PTC thermistors – for alarm and tripping (4 terminals) ²⁾	C	-	✓	✓	✓	✓	✓	✓	✓	✓	✓	✓	✓	✓	✓		
1 KTY84-130 temperature sensor (2 terminals) ²⁾	F	-	✓	✓	✓	✓	✓	✓	✓	✓	✓	✓	✓	✓	✓		
2 KTY84-130 temperature sensors (4 terminals) ²⁾	G	-	✓	✓	✓	✓	✓	✓	✓	✓	✓	✓	✓	✓	✓		
3 Pt100 resistance thermometers – 2-wire input (6 terminals)	H	-	✓	✓	✓	✓	✓	✓	✓	✓	✓	✓	✓	✓	✓		
6 Pt100 resistance thermometers – 2-wire input (12 terminals)	J	-	-	-	-	-	-	-	✓	✓	✓	✓	✓	✓	✓		
1 Pt1000 resistance thermometers (2 terminals)	K	-	✓	✓	✓	✓	✓	✓	✓	✓	✓	✓	✓	✓	✓		
2 Pt1000 resistance thermometers (4 terminals)	L	-	✓	✓	✓	✓	✓	✓	✓	✓	✓	✓	✓	✓	✓		
1 Pt100 resistance thermometer – 2-wire input (2 terminals)	P	-	-	-	-	✓	✓	✓	✓	✓	✓	✓	✓	✓	✓		
3 Pt100 resistance thermometers – 3-wire input (9 terminals)	Q	-	-	-	-	✓	✓	✓	✓	✓	✓	✓	✓	✓	✓		
6 Pt100 resistance thermometers – 3-wire input (18 terminals)	R	-	-	-	-	✓	✓	✓	✓	✓	✓	✓	✓	✓	✓		
3 NTC thermistors – for tripping (6 terminals)	Z	Q2A	✓	✓	✓	✓	✓	✓	✓	-	-	-	-	-	-		
3 bimetal sensors (NC contacts) – for tripping (2 terminals) ²⁾	Z	Q3A	✓	✓	✓	✓	✓	✓	✓	✓	✓	✓	✓	✓	✓		
6 bimetal sensors (NC contacts) for alarm and tripping (4 terminals) ²⁾	Z	Q9A	-	-	-	✓	✓	✓	✓	✓	✓	✓	✓	✓	✓		

- Standard version
- ✓ With additional charge
- Not possible

Note:

Options are available specifically for bearing protection – for order codes and descriptions, see from page 3/129.

¹⁾ For the Performance Line, motor protection by means of PTC thermistors with 3 built-in temperature sensors for tripping (motor protection code letter B) is already included in the basic price. For the Performance Line, the option "Without motor protection" (motor protection code letter A) is not possible.

²⁾ Evaluation with appropriate tripping unit (see Catalog IC 10) is recommended.



SIMOTICS GP and SIMOTICS SD standard motors

Article No. supplements and special versions · Motor protection

Aluminum series SIMOTICS GP 1LE1073 and cast-iron series SIMOTICS SD 1LE1573, 1LE5773

Selection and ordering data

Motor protection	Article No.	supplement	Frame size													Motor version	
			80	90	100	112	132	160	180	200	225	250	280	315	IEC	IE3	
			1LE1073						1LE1573			1LE5773					
			Order code														
	1LE.....		Order code														

Motor protection																
Motor protection	Article No.	supplement	80	90	100	112	132	160	180	200	225	250	280	315	IEC	IE3
None (standard)	A	–	□	□	□	□	□	□	□	□	□	□	□	□		
1 or 3 PTC thermistors – for tripping (2 terminals) ¹⁾	B	–	✓	✓	✓	✓	✓	✓	✓	✓	✓	✓	✓	✓		
2 or 6 PTC thermistors – for alarm and tripping (4 terminals) ¹⁾	C	–	✓	✓	✓	✓	✓	✓	✓	✓	✓	✓	✓	✓		
1 KTY84-130 temperature sensor (2 terminals) ¹⁾	F	–	✓	✓	✓	✓	✓	✓	✓	✓	✓	✓	✓	✓		
2 KTY84-130 temperature sensors (4 terminals) ¹⁾	G	–	✓	✓	✓	✓	✓	✓	✓	✓	✓	✓	✓	✓		
3 Pt100 resistance thermometers – 2-wire input (6 terminals)	H	–	–	–	✓	✓	✓	✓	✓	✓	✓	✓	✓	✓		
6 Pt100 resistance thermometers – 2-wire input (12 terminals)	J	–	–	–	–	–	–	–	✓	✓	✓	✓	✓	✓		
1 Pt1000 resistance thermometer (2 terminals)	K	–	✓	✓	✓	✓	✓	✓	✓	✓	✓	✓	✓	✓		
2 Pt1000 resistance thermometers (4 terminals)	L	–	✓	✓	✓	✓	✓	✓	✓	✓	✓	✓	✓	✓		
1 Pt100 resistance thermometer – 2-wire input (2 terminals)	P	–	–	–	✓	✓	✓	✓	✓	✓	✓	✓	✓	✓		
3 Pt100 resistance thermometers – 3-wire input (9 terminals)	Q	–	–	–	✓	✓	✓	✓	✓	✓	✓	✓	✓	✓		
6 Pt100 resistance thermometers – 3-wire input (18 terminals)	R	–	–	–	✓	✓	✓	✓	✓	✓	✓	✓	✓	✓		
3 NTC thermistors – for tripping (6 terminals)	Z	Q2A	–	–	✓	✓	✓	✓	–	–	–	–	–	–		
3 bimetal sensors (NC contacts) – for tripping (2 terminals) ¹⁾	Z	Q3A	✓	✓	✓	✓	✓	✓	✓	✓	✓	✓	✓	✓		
6 bimetal sensors (NC contacts) for alarm and tripping (4 terminals) ¹⁾	Z	Q9A	–	–	✓	✓	✓	✓	✓	✓	✓	✓	✓	✓		

- Standard version
- ✓ With additional charge
- Not possible

Note:

Options are available specifically for bearing protection – for order codes and descriptions, see from page 3/129.

¹⁾ Evaluation with appropriate tripping unit (see Catalog IC 10) is recommended.

SIMOTICS GP and SIMOTICS SD standard motors

Article No. supplements and special versions · Terminal box position

Aluminum series SIMOTICS GP 1LE10

Selection and ordering data

Terminal box position	Article No. supplement		Frame size										Motor version			
	Terminal box position code 16th position of the Article No.	Additional identification code with order code and plain text if required	63	71	80	90	100	112	132	160	180	200				
							1LE1004						IEC	IE4	①	
					1LE1003									IE3	②	
							1LE1083									③
			1LE1001											IE2	④	
			1LE1002											IE1	⑤	
					1LE1043									APAC Line	IE3	⑥
					1LE1041									IE2	⑦	
					1LE1023									Eagle Line	NPE (NEMA)	⑧
							1LE1021							Eagle Line	NEE (NEMA)	⑨
									1LE1011						Pole-changing	⑩
								1LE1012							⑪	
1LE10																
		Order code														
Terminal box position																
Terminal box top ¹⁾	4	-	□	□	□	□	□	□	□	□	□	□	□	□	□	
Terminal box right-hand side ²⁾	5	-	-	-	✓	✓	✓	✓	✓	✓	✓	✓	✓	✓	✓	
Terminal box left-hand side ²⁾	6	-	-	-	✓	✓	✓	✓	✓	✓	✓	✓	✓	✓	✓	
Terminal box at bottom ^{2) 3)}	7	-	-	-	-	-	✓	✓	✓	✓	✓	✓	-	-	-	

- Standard version
- ✓ With additional charge
- Not possible

¹⁾ For types of construction with feet up to and including frame size 160, cast feet are standard. Screwed-on feet are available with order code **H01**. Frame sizes 180 and 200 are fitted as standard with screwed-on feet.

²⁾ For types of construction with feet, screwed-on feet are standard.
³⁾ Not generally possible for motors with feet.

SIMOTICS GP and SIMOTICS SD standard motors

Article No. supplements and special versions · Terminal box position

Cast-iron series SIMOTICS SD 1LE15 Basic Line, 1LE16 Performance Line

Selection and ordering data

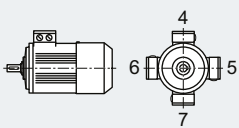
Terminal box position 	Article No. supplement Terminal box position code 16th position of the Article No.	Additional identification code with order code and plain text if required	Frame size													Motor version										
			71	80	90	100	112	132	160	180	200	225	250	280	315											
1LE1																		IEC	IE4	①						
																					②					
																						③				
																							④			
																								⑤		
																									⑥	
																									⑦	
																										⑧
																										⑨
																										⑩
																										⑪
																										⑫
																										⑬
																										⑭

Terminal box position	Terminal box top ¹⁾	Terminal box right-hand side ²⁾	Terminal box left-hand side ²⁾	Terminal box bottom ³⁾
4	-	-	-	-
5	-	✓	✓	✓
6	-	✓	✓	✓
7	-	-	-	✓

- Standard version
- ✓ With additional charge
- Not possible

1) For types of construction with feet and flange-mounted with feet, cast feet are standard. Screwed-on feet are available with order code **H01**.
 2) For types of construction with feet and flange-mounted with feet, screwed-on feet are standard. Except for frame sizes 225, 250, 280 and 315: in which case for types of construction with feet and flange-mounted with feet, cast feet are standard. Screwed-on feet are available with order code **H01**.
 3) Not generally possible for motors with feet.

SIMOTICS GP and SIMOTICS SD standard motors

Article No. supplements and special versions · Terminal box position

Aluminum series SIMOTICS GP 1LE1073 and cast-iron series SIMOTICS SD 1LE1573, 1LE5773

Selection and ordering data

Terminal box position	Article No. supplement		Frame size													Motor version	
	Terminal box position code 16th position of the Article No.	Additional identification code with order code and plain text if required	80	90	100	112	132	160	180	200	225	250	280	315	IEC	IE3	
			1LE1073						1LE1573				1LE5773				
1LE - -		Order code															
Terminal box position																	
Terminal box base left with terminal box at the top	0	–	–	–	–	–	–	–	–	–	–	–	–	–	–	✓	
Terminal box base right with terminal box at the top	1	–	–	–	–	–	–	–	–	–	–	–	–	–	–	✓	
Terminal box base left with oblique terminal box 45°	2	–	–	–	–	–	–	–	–	–	–	–	–	–	○		
Terminal box base right with oblique terminal box 45°	3	–	–	–	–	–	–	–	–	–	–	–	–	–	□		
Terminal box at top	4	–	□	□	□	□	□	□	□	□	□	□	□	□	–		
Terminal box on right-hand side	5	–	✓	✓	✓	✓	✓	✓	✓	✓	✓	✓	✓	✓	✓		
Terminal box on left-hand side	6	–	✓	✓	✓	✓	✓	✓	✓	✓	✓	✓	✓	✓	✓		
Terminal box bottom ¹⁾	7	–	–	–	✓	✓	✓	✓	–	–	–	–	–	–	–		
Terminal box left-hand side (base below) ¹⁾	9	R5L	–	–	–	–	–	–	–	–	–	–	–	–	✓		
Terminal box right-hand side (base below) ¹⁾	9	R6R	–	–	–	–	–	–	–	–	–	–	–	–	✓		
Terminal box bottom left ¹⁾	9	R7L	–	–	–	–	–	–	–	–	–	–	–	–	✓		
Terminal box bottom right ¹⁾	9	R7R	–	–	–	–	–	–	–	–	–	–	–	–	✓		

- Standard version
- Without additional charge
- ✓ With additional charge
- Not possible

¹⁾ Not generally possible for motors with feet.

SIMOTICS GP and SIMOTICS SD standard motors

Article No. supplements and special versions · Options

Aluminum series SIMOTICS GP 1LE10

Selection and ordering data

Special versions	Additional identification code -Z with order code and plain text if required	Frame size									Motor version			
		63	71	80	90	100	112	132	160	180	200			
						1LE1004						IEC	IE4	①
				1LE1003									IE3	②
						1LE1083								③
				1LE1001									IE2	④
				1LE1002									IE1	⑤
					1LE1043							APAC Line	IE3	⑥
					1LE1041								IE2	⑦
					1LE1023							Eagle Line	NPE (NEMA)	⑧
					1LE1021								NEE (NEMA)	⑨
										1LE1011			Pole-changing	⑩
										1LE1012				⑪
	1LE10 -Z	Order code												

Motor protection

1 or 3 PTC thermistors – for tripping (2 terminals)	Q11	✓	✓	✓	✓	✓	✓	✓	✓	✓	✓			
2 or 6 PTC thermistors – for alarm and tripping (4 terminals)	Q12	✓	✓	✓	✓	✓	✓	✓	✓	✓	✓			
1 KTY84-130 temperature sensor (2 terminals)	Q23	✓	✓	✓	✓	✓	✓	✓	✓	✓	✓			
2 KTY84-130 temperature sensors (4 terminals)	Q25	✓	✓	✓	✓	✓	✓	✓	✓	✓	✓			
3 bimetal sensors (NC contacts) for tripping (2 terminals)	Q31	–	–	✓	✓	✓	✓	✓	✓	✓	✓			
6 bimetal sensors (NC contacts) for alarm and tripping (4 terminals)	Q32	–	–	✓	✓	✓	✓	✓	✓	✓	✓			
3 bimetal sensors (NC contacts) for tripping (6 terminals)	Q33	–	–	–	–	–	–	–	–	✓	✓			
6 bimetal sensors (NC contacts) for alarm and tripping (12 terminals)	Q34	–	–	–	–	–	–	–	–	✓	✓			
1 Pt1000 resistance thermometer (2 terminals)	Q35	✓	✓	✓	✓	✓	✓	✓	✓	✓	✓			
2 Pt1000 resistance thermometers (4 terminals)	Q36	✓	✓	✓	✓	✓	✓	✓	✓	✓	✓			
3 Pt100 resistance thermometers – 2-wire input (6 terminals)	Q60	–	–	–	–	✓	✓	✓	✓	✓	✓			
6 Pt100 resistance thermometers – 2-wire input (12 terminals)	Q61	–	–	–	–	✓	✓	✓	✓	✓	✓			
1 Pt100 resistance thermometer – 2-wire input (2 terminals)	Q62	–	–	–	–	✓	✓	✓	✓	✓	✓			
3 Pt100 resistance thermometers – 3-wire input (9 terminals)	Q63	–	–	–	–	✓	✓	✓	✓	✓	✓			
6 Pt100 resistance thermometers – 3-wire input (18 terminals)	Q64	–	–	–	–	✓	✓	✓	✓	✓	✓			
2 Pt100 resistance thermometers in basic configuration for bearings (2 terminals)	Q72	–	–	–	–	O. R.	O. R.	O. R.	O. R.	✓	✓			
2 Pt100 resistance thermometers in 3-wire input for bearing (6 terminals)	Q78	–	–	–	–	O. R.	O. R.	O. R.	O. R.	✓	✓			
2 Pt100 double resistance thermometers in 3-wire input for bearing (12 terminals)	Q79	–	–	–	–	O. R.	O. R.	O. R.	O. R.	✓	✓			

Motor connection and terminal box

External grounding	H04	✓	✓	✓	✓	✓	✓	✓	✓	✓	✓			
Terminal box on NDE ³⁾	H08	✓	✓	✓	✓	✓	✓	✓	✓	✓	✓			
Rotation of the terminal box through 90°, entry from DE ¹⁾	R10	○	○	○	○	○	○	○	○	○	✓	✓		
Rotation of the terminal box through 90°, entry from NDE	R11	○	○	○	○	○	○	○	○	○	✓	✓		
Rotation of the terminal box through 180°	R12	○	○	○	○	○	○	○	○	○	✓	✓		
Terminal box in position 0°, connection from right ⁴⁾	R13	○	○	○	○	○	○	○	○	–	–	–		
One metal cable gland	R15	✓	✓	✓	✓	✓	✓	✓	✓	✓	✓			
Metal cable gland, maximum configuration	R18	✓	✓	✓	✓	✓	✓	✓	✓	✓	✓			
3 cables protruding, 0.5 m long ⁴⁾⁵⁾	R20	✓	✓	✓	✓	✓	✓	✓	✓	–	–	Not for:	⑩, ⑪	
3 cables protruding, 1.5 m long ⁴⁾⁵⁾	R21	✓	✓	✓	✓	✓	✓	✓	✓	O. R.	O. R.	Not for:	⑩, ⑪	
6 cables protruding, 0.5 m long ⁴⁾	R22	✓	✓	✓	✓	✓	✓	✓	✓	O. R.	O. R.			
6 cables protruding, 1.5 m long ⁴⁾	R23	✓	✓	✓	✓	✓	✓	✓	✓	O. R.	O. R.			

For legends and footnotes, see page 3/128.

SIMOTICS GP and SIMOTICS SD standard motors

Article No. supplements and special versions · Options

Aluminum series SIMOTICS GP 1LE10

Special versions	Additional identification code -Z with order code and plain text if required	Frame size									Motor version			
		63	71	80	90	100	112	132	160	180	200			
						1LE1004						IEC	IE4	①
						1LE1003							IE3	②
													IE3	③
					1LE1001								IE2	④
					1LE1002								IE1	⑤
												APAC Line	IE3	⑥
					1LE1043								IE2	⑦
					1LE1041								IE2	⑦
					1LE1023							Eagle Line	NPE (NEMA)	⑧
													NEE (NEMA)	⑨
													NEE (NEMA)	⑨
													Pole-changing	⑩
	1LE10 -Z	Order code				1LE1011								⑩
						1LE1012								⑩
Motor connection and terminal box (continued)														
6 cables protruding, 3 m long ⁴⁾	R24		✓	✓	✓	✓	✓	✓	✓	✓	✓	O. R.	O. R.	
Reduction piece for M cable gland in accordance with British Standard, mounted on both cable entries ²⁾	R30		-	-	-	-	✓	✓	✓	✓	-	-		
Larger terminal box	R50		✓	✓	✓	✓	✓	✓	✓	✓	✓	✓	✓	Not for: ⑧, ⑨ < frame size 100
	-		-	-	□	□	□	□	□	□	□	□	□	Only for: ⑧, ⑨ < frame size 100
Auxiliary terminal box, aluminum	R60		-	-	-	-	-	-	-	-	✓	✓		
Motor connector Han-Drive 10e for 230 VΔ/400 VY ³⁰⁾	R70		✓	✓	✓	✓	✓	✓	✓	-	-	-		
Motor connector Han-Drive 10e EMC for 230 VΔ/400 VY ³⁰⁾	R71		✓	✓	✓	✓	✓	✓	✓	-	-	-		
Small motor connector CQ12 with EMC	R72		-	-	✓	✓	-	-	-	-	-	-	Not for: ③	
Small motor connector CQ12 without EMC	R73		-	-	✓	✓	-	-	-	-	-	-	Not for: ③	
Windings and insulation														
Temperature class 155 (F), utilized acc. to 155 (F), with service factor	N01		-	-	-	-	✓	✓	✓	✓	✓	✓	✓	Not for: ③
Temperature class 155 (F), utilized acc. to 155 (F), with increased power	N02		-	-	-	-	✓	✓	✓	✓	✓	✓	✓	Not for: ③
Temperature class 155 (F), utilized acc. to 155 (F), with increased coolant temperature	N03		✓	✓	✓	✓	✓	✓	✓	✓	✓	✓	✓	Not for: ③
Temperature class 155 (F), utilized acc. to 130 (B), coolant temperature 45 °C, derating approx. 4 %	N05		✓	✓	✓	✓	✓	✓	✓	✓	✓	✓	✓	
Temperature class 155 (F), utilized acc. to 130 (B), coolant temperature 50 °C, derating approx. 8 %	N06		✓	✓	✓	✓	✓	✓	✓	✓	✓	✓	✓	
Temperature class 155 (F), utilized acc. to 130 (B), coolant temperature 55 °C, derating approx. 13 %	N07		✓	✓	✓	✓	✓	✓	✓	✓	✓	✓	✓	
Temperature class 155 (F), utilized acc. to 130 (B), coolant temperature 60 °C, derating approx. 18 %	N08		✓	✓	✓	✓	✓	✓	✓	✓	✓	✓	✓	
Temperature class 180 (H) ³¹⁾	N10		✓	✓	✓	✓	-	-	-	-	-	-	-	Not for: ①, ③, ⑥, ⑦, ⑨, ⑩
Temperature class 180 (H) at rated power and max. CT 60 °C ^{6) 31)}	N11		✓	✓	✓	✓	✓	✓	✓	✓	✓	✓	✓	Not for: ①, ③
Increased air humidity/temperature with 30 to 60 g water per m ³ of air	N30		✓	✓	✓	✓	✓	✓	✓	✓	✓	✓	✓	
Increased air humidity/temperature with 60 to 100 g water per m ³ of air	N31		✓	✓	✓	✓	✓	✓	✓	✓	✓	✓	✓	
Temperature class 155 (F), utilized acc. to 130 (B), with higher coolant temperature and/or installation altitude	Y50 • CT .. °C or IA m above sea level		✓	✓	✓	✓	✓	✓	✓	✓	✓	✓	✓	
Temperature class 155 (F), utilized acc. to 155 (F), other requirements	Y52 • CT .. °C or IA m above sea level		✓	✓	✓	✓	✓	✓	✓	✓	✓	✓	✓	Not for: ③
Temperature class 180 (H), utilized according to 155 (F)	Y75 • CT .. °C or IA m above sea level		-	-	-	-	O. R.	O. R.	O. R.	O. R.	-	-	-	Not for: ①, ③

3

For legends and footnotes, see page 3/128.

SIMOTICS GP and SIMOTICS SD standard motors

Article No. supplements and special versions · Options

Aluminum series SIMOTICS GP 1LE10

Special versions	Additional identification code -Z with order code and plain text if required	Frame size										Motor version		
		63	71	80	90	100	112	132	160	180	200			
						1LE1004						IEC	IE4	①
						1LE1003							IE3	②
													IE3	③
						1LE1001							IE2	④
						1LE1002							IE1	⑤
												APAC Line	IE3	⑥
													IE2	⑦
												Eagle Line	NPE (NEMA)	⑧
													NEE (NEMA)	⑨
													Pole-changing	⑩
														⑪
	1LE10 -Z	Order code												

Colors and paint finish

Standard paint finish C2 in RAL 7030 stone gray		☐	☐	☐	☐	☐	☐	☐	☐	☐	☐
Unpainted (only cast-iron parts primed)	S00	○	○	○	○	○	○	○	○	○	○
Unpainted, only primed	S01	✓	✓	✓	✓	✓	✓	✓	✓	✓	✓
Special paint finish C3	S02	✓	✓	✓	✓	✓	✓	✓	✓	✓	✓
Special paint finish sea air resistant C4	S03	✓	✓	✓	✓	✓	✓	✓	✓	✓	✓
Internal coating	S05	✓	✓	✓	✓	✓	✓	✓	✓	✓	✓
Top coat polyurethane ³⁴⁾	S06	✓	✓	✓	✓	✓	✓	✓	✓	✓	✓
Paint finish in other standard RAL colors: RAL 1015, 3000, 5002, 5009, 5010, 5012, 5015, 6011, 7001, 7011, 7016, 7031, 7032, 7035, 7037, 8012, 9005, 9010 (see Catalog Section 1 "Introduction")	Y53 • and paint finish RAL....	✓	✓	✓	✓	✓	✓	✓	✓	✓	✓
Paint finish in special RAL colors: For RAL colors, see "Special paint finish in special RAL colors" (see Catalog Section 1 "Introduction")	Y56 • and paint finish RAL....	✓	✓	✓	✓	✓	✓	✓	✓	✓	✓
Non-standard colors Colors see "Paint finish in non-standard colors" (see Catalog Section 1 "Introduction")	Y66 • and paint finish	✓	✓	✓	✓	✓	✓	✓	✓	✓	✓

Modular technology – Basic versions ⁷⁾

Mounting of holding brake (standard assignment) ^{5) 28)}	F01	✓	✓	✓	✓	✓	✓	✓	✓	✓	✓
Mounting of brake for higher switching frequency (operating brake)	F02	O. R.	O. R.	O. R.	O. R.	O. R.	O. R.	O. R.	O. R.	–	–
Mounting of PRECIMA-brake	F04	–	–	–	–	✓	✓	✓	✓	✓	✓
Mounting of separately driven fan ²⁹⁾	F70	✓	✓	✓	✓	✓	✓	✓	✓	✓	✓
Mounting of Kübler Sendix 5020 HTL, 1024 l rotary pulse encoder	G11	✓	✓	✓	✓	✓	✓	✓	✓	✓	✓
Mounting of Kübler Sendix 5020 TTL, 1024 l rotary pulse encoder	G12	✓	✓	✓	✓	✓	✓	✓	✓	✓	✓

Modular technology – Additional versions

Brake supply voltage 24 V DC	F10	✓	✓	✓	✓	✓	✓	✓	✓	✓	✓
Brake supply voltage 230 V AC, 50/60 Hz	F11	✓	✓	✓	✓	○	○	○	○	○	○
Brake supply voltage 400 V AC, 50/60 Hz	F12	✓	✓	✓	✓	✓	✓	✓	✓	✓	✓
Brake supply voltage 180 V DC	F17	✓	✓	✓	✓	✓	✓	✓	✓	✓	✓
Brake supply voltage 205 V DC	F18	✓	✓	✓	✓	✓	✓	✓	✓	✓	✓
Mechanical manual brake release with lever (no locking)	F50	✓	✓	✓	✓	✓	✓	✓	✓	✓	✓

Special technology ⁷⁾

Mounting of LL 861 900 220 rotary pulse encoder ⁹⁾	G04	–	–	–	–	✓	✓	✓	✓	✓	✓
Mounting of HOG 9 DN 1024 l rotary pulse encoder ⁹⁾	G05	–	–	–	–	✓	✓	✓	✓	✓	✓
Mounting of HOG 10 D 1024 l rotary pulse encoder ⁹⁾	G06	–	–	–	–	✓	✓	✓	✓	✓	✓
Mounting of Kübler Sendix 5834FS2 1024, SIL-2 rotary pulse encoder	G21	–	–	–	–	✓	✓	✓	✓	✓	✓
Mounting of Kübler Sendix 5834FS3 1024, SIL-3 rotary pulse encoder	G22	–	–	–	–	✓	✓	✓	✓	✓	✓
Mounting of HOGS100S-B76.626.01024.1 rotary pulse encoder	G25	–	–	–	–	–	–	–	–	✓	✓
Mounting of LL FSI 862-184560-1024, SIL-2 rotary pulse encoder	G27	–	–	–	–	–	–	–	–	✓	✓

For legends and footnotes, see page 3/128.

SIMOTICS GP and SIMOTICS SD standard motors

Article No. supplements and special versions · Options

Aluminum series SIMOTICS GP 1LE10

Special versions	Additional identification code -Z with order code and plain text if required	Frame size									Motor version			
		63	71	80	90	100	112	132	160	180	200			
						1LE1004						IEC	IE4	①
						1LE1003							IE3	②
													IE2	③
					1LE1001								IE2	④
					1LE1002								IE1	⑤
												APAC Line	IE3	⑥
					1LE1043								IE2	⑦
					1LE1041								NPE (NEMA)	⑧
					1LE1023							Eagle Line	NEE (NEMA)	⑨
										1LE1021				⑩
										1LE1011			Pole-changing	⑪
										1LE1012				⑪
	Order code													
Special technology (continued) 7)														
Mounting of rotary pulse encoder XSI 850 Overspeed	G93	-	-	-	-	-	-	-	-	✓	✓			
Mounting of rotary pulse encoder XHI 861 Overspeed	G94	-	-	-	-	-	-	-	-	✓	✓			
Mechanical version and degrees of protection														
Low-noise version for 2-pole motors with clockwise direction of rotation	F77	-	-	-	-	-	-	✓	✓	✓	✓			
Low-noise version for 2-pole motors with counterclockwise direction of rotation	F78	-	-	-	-	-	-	✓	✓	✓	✓			
Prepared for mountings, centering hole only 10)	G40	-	-	✓	✓	✓	✓	✓	✓	□	□			
Prepared for mountings with shaft D12 15)	G41	✓	✓	✓	✓	✓	✓	✓	✓	✓	✓			
Prepared for mountings with shaft D16 15)	G42	-	-	O. R.	O. R.	✓	✓	✓	✓	✓	✓			
Mechanical protection for encoder	G43	O. R.	O. R.	✓	✓	✓	✓	✓	✓	✓	✓			
Protective cover 9) 11)	H00	✓	✓	✓	✓	✓	✓	✓	✓	✓	✓			
Screwed-on (instead of cast) feet	H01	-	-	✓	✓	✓	✓	✓	✓	□	□			
Vibration-proof version; vibration resistance to Class 3M4 according to IEC 60721-3-3:1994 39)	H02	✓	✓	✓	✓	✓	✓	✓	✓	✓	✓			
Condensation drainage holes 14)	H03	✓	✓	✓	✓	✓	✓	✓	✓	✓	✓			
Rust-resistant screws (externally)	H07	✓	✓	✓	✓	✓	✓	✓	✓	✓	✓			
Housing with screw mounting 32)	H10	-	-	✓	✓	-	-	-	-	✓	✓		Only for: ②, ④, ⑥, ⑦ (frame sizes 80, 90), ⑧, ⑨	
Degree of protection IP66	H19	✓	✓	✓	✓	✓	✓	✓	✓	✓	✓			
Degree of protection IP65 13)	H20	✓	✓	✓	✓	✓	✓	✓	✓	✓	✓			
Degree of protection IP56 12)	H22	✓	✓	✓	✓	✓	✓	✓	✓	✓	✓			
Drive-end seal for flange-mounting motors, oil-tight to 0.1 bar 16)	H23	✓	✓	✓	✓	✓	✓	✓	✓	✓	✓			
Coolant temperature and installation altitude														
Coolant temperature -40 to +40 °C 16) 28)	D03	✓	✓	✓	✓	✓	✓	✓	✓	✓	✓			
Coolant temperature -30 to +40 °C 16) 28)	D04	✓	✓	✓	✓	✓	✓	✓	✓	✓	✓			
Versions in accordance with standards and specifications														
VIK version	C02	-	-	✓	✓	✓	✓	✓	✓	-	-		Only for: ②	
CCC China Compulsory Certification 17)	D01	✓	✓	✓	✓	-	-	-	-	-	-		Only for: Voltage code 21st or 22nd	
Motor without CE marking for export outside EEA (see EU Directive 640/2009)	D22	-	○	○	○	○	○	○	○	○	○		Only for: ④	
Motor exclusively according to the Energy-related Products Law, Article 1 dated 27.2.2008, motor to be used in means of transport for persons and goods	D23	-	○	○	○	○	○	○	○	○	○		Only for: ④, ⑤, ⑦, ⑨, ⑩, ⑪	
Electrical according to NEMA MG1-12 15)	D30	✓	✓	✓	✓	✓	✓	✓	✓	✓	✓		Not for: ⑧, ⑨	
-		-	-	□	□	□	□	□	□	□	□		Only for: ⑧, ⑨	
Design according to UL with "Recognition Mark" 19)	D31	✓	✓	✓	✓	✓	✓	✓	✓	✓	✓		Not for: ⑧, ⑨	
-		-	-	□	□	□	□	□	□	□	□		Only for: ⑧, ⑨	
KEMCO Korea Energy Efficiency Label	D33	-	-	✓	✓	✓	✓	✓	✓	✓	✓		Only for: ⑥, ⑦	
-		-	-	-	-	O. R.	O. R.	O. R.	O. R.	O. R.	O. R.		Only for: ③ (2-pole to 6-pole)	
China Energy Efficiency Label 38)	D34	-	-	○	○	○	○	○	○	○	○		Not for: ④, ⑤, ⑦, ⑩, ⑪	
-		-	-	-	-	O. R.	O. R.	O. R.	O. R.	O. R.	O. R.		Only for: ③	
Canadian regulations (CSA) 33) 37)	D40	✓	✓	✓	✓	✓	✓	✓	✓	✓	✓		Not for: ⑤, ⑧, ⑨, ⑩, ⑪	
-		-	-	□	□	□	□	□	□	□	□		Only for: ⑧, ⑨	
NEMA Premium Efficient, North America version acc. to NEMA MG1, Table 12-11, incl. UL and CSA	D41	-	-	-	-	O. R.	O. R.	O. R.	O. R.	O. R.	O. R.		Only for: ③	
TR CU product safety certificate EAC for Eurasian Customs Union 35)	D47	✓	✓	✓	✓	✓	✓	✓	✓	✓	✓			
MEPS Australia	D70	-	-	-	-	O. R.	O. R.	O. R.	O. R.	O. R.	O. R.		Only for: ③	

For legends and footnotes, see page 3/128.

SIMOTICS GP and SIMOTICS SD standard motors

Article No. supplements and special versions · Options

Aluminum series SIMOTICS GP 1LE10

Special versions	Additional identification code -Z with order code and plain text if required	Frame size										Motor version			
		63	71	80	90	100	112	132	160	180	200				
						1LE1004						IEC	IE4	①	
						1LE1003							IE3	②	
														③	
					1LE1001								IE2	④	
					1LE1002								IE1	⑤	
												APAC Line	IE3	⑥	
													IE2	⑦	
												Eagle Line	NPE (NEMA)	⑧	
													NEE (NEMA)	⑨	
														⑩	
														⑪	
	1LE10 -Z	Order code													
Versions in accordance with standards and specifications (continued)															
Version suitable for railways IC411, EN IEC 60349, without EN 45545, with external fan and fan cover in plastic ⁴¹⁾	L90		-	-	✓	✓	✓	✓	✓	✓	✓	✓	✓	✓	Not for: ①, ③
Version suitable for railways IC411, EN IEC 60349, with EN 45545, with external fan and fan cover in meta ⁴¹⁾	L91		✓	✓	✓	✓	✓	✓	✓	✓	✓	✓	✓	✓	Not for: ①, ③
Version suitable for railways IC418, EN IEC 60349, without EN 45545, with external fan and fan cover ⁴¹⁾	L92		✓	✓	✓	✓	✓	✓	✓	✓	✓	✓	✓	✓	Not for: ①, ③
Bearings and lubrication															
Regreasing device with M10 × 1 grease nipple according to DIN 71412-A ²⁰⁾	L19		-	-	-	-	-	-	-	✓	✓				
Located bearing DE	L20		✓	✓	✓	✓	✓	✓	✓	✓	✓				
Located bearing NDE	L21		✓	✓	✓	✓	✓	✓	□	□	□				
Bearing design for increased cantilever forces ³⁶⁾	L22		-	-	✓	✓	✓	✓	✓	✓	✓				Not for: Motors of frame sizes 80 and 90 in combination with order code F01
Regreasing device ²⁰⁾	L23		-	-	-	✓	✓	✓	✓	✓	✓				
Bearings reinforced at both ends for DE and NDE, bearing size 63	L25		-	-	✓	✓	✓	✓	✓	✓	✓				Not for: Motors of frame sizes 80 and 90 in combination with order code F01
Bearing insulation NDE	L51		-	-	-	✓	✓	✓	✓	✓	✓				
Measuring nipple for SPM shock pulse measurement for bearing inspection ²⁰⁾	Q01		-	-	-	✓	✓	✓	✓	✓	✓				
Balance and vibration severity															
Vibration severity grade A			□	□	□	□	□	□	□	□	□				
Vibration severity grade B	L00		✓	✓	✓	✓	✓	✓	✓	✓	✓				
Half-key balancing (standard)			□	□	□	□	□	□	□	□	□				
Balancing without feather key	L01		✓	✓	✓	✓	✓	✓	✓	✓	✓				
Full-key balancing	L02		-	-	✓	✓	✓	✓	✓	✓	✓				
Shaft and rotor															
Shaft extension with standard dimensions, without feather keyway	L04		✓	✓	✓	✓	✓	✓	✓	✓	✓				
Standard, cylindrical shaft extension (second shaft extension) NDE acc. to EN 50347	L05		✓	✓	✓	✓	✓	✓	✓	✓	✓				
Standard shaft made of stainless steel (e.g. 1.4021)	L06		✓	✓	✓	✓	✓	✓	✓	✓	✓				
Shaft extension run-out in accordance with IEC 60072-1 precision class	L07		✓	✓	✓	✓	✓	✓	✓	✓	✓				
Shaft extension run-out, concentricity and perpendicularity in accordance with IEC 60072-1 precision class for flange-mounted motors	L08		✓	✓	✓	✓	✓	✓	✓	✓	✓				
Non-standard cylindrical shaft extension, DE ²¹⁾	Y58 • and customer specifications		✓	✓	✓	✓	✓	✓	✓	✓	✓				
Non-standard cylindrical shaft extension, NDE ²¹⁾	Y59 • and customer specifications		✓	✓	✓	✓	✓	✓	✓	✓	✓				
Heating and ventilation															
Sheet metal fan cover	F74		-	-	✓	✓	✓	✓	✓	✓	✓				
Fan cover for textile industry ²²⁾	F75		✓	✓	✓	✓	✓	✓	✓	✓	✓				
Metal external fan ^{23) 29)}	F76		✓	✓	✓	✓	✓	✓	✓	✓	✓				
Without external fan and without fan cover	F90		✓	✓	✓	✓	✓	✓	✓	✓	✓				Not for: ⑩, ⑪
Anti-condensation heating for 230 V (2 terminals)	Q02		✓	✓	✓	✓	✓	✓	✓	✓	✓				
Anti-condensation heating for 115 V (2 terminals)	Q03		✓	✓	✓	✓	✓	✓	✓	✓	✓				

For legends and footnotes, see page 3/128.

SIMOTICS GP and SIMOTICS SD standard motors

Article No. supplements and special versions · Options

Aluminum series SIMOTICS GP 1LE10

Special versions	Additional identification code -Z with order code and plain text if required	Frame size										Motor version			
		63	71	80	90	100	112	132	160	180	200				
						1LE1004						IEC	IE4	①	
						1LE1003							IE3	②	
													IE2	③	
					1LE1001								IE1	④	
					1LE1002								IE1	⑤	
						1LE1043						APAC Line	IE3	⑥	
						1LE1041							IE2	⑦	
						1LE1023						Eagle Line	NPE (NEMA)	⑧	
													NEE (NEMA)	⑨	
														⑩	
														⑪	
	1LE10 -Z	Order code													
Rating plate and additional rating plates															
Additional rating plate for voltage tolerance ²⁴⁾	B07		✓	✓	✓	✓	✓	✓	✓	✓	✓	✓	✓	✓	Not for: ⑩, ⑪, 8-pole motors
Second rating plate, loose ²⁵⁾	M10		✓	✓	✓	✓	✓	✓	✓	✓	✓	✓	✓	✓	
Rating plate, stainless steel	M11		✓	✓	✓	✓	✓	✓	✓	✓	✓	✓	✓	✓	
Additional rating plate with deviating rating plate data	Y80 • and customer specifications		✓	✓	✓	✓	✓	✓	✓	✓	✓	✓	✓	✓	
Additional rating plate with customer specifications	Y82 • and customer specifications		✓	✓	✓	✓	✓	✓	✓	✓	✓	✓	✓	✓	
Additional information on rating plate and on package label (max. 20 characters)	Y84 • and customer specifications		✓	✓	✓	✓	✓	✓	✓	✓	✓	✓	✓	✓	
Adhesive label, supplied loose (printed with: Article No., Serial No.; 2 lines of text)	Y85 • and customer specifications		-	-	-	-	✓	✓	✓	✓	✓	✓	✓	✓	
Packaging, safety notes, documentation and test certificates															
A printed version of the safety notes in German/English and safety notes in the language of the country of use is supplied in each wire-lattice pallet ²⁷⁾	B01		○	○	○	○	○	○	○	○	○	○	○	○	
Inspection certificate 3.1 according to EN 10204 ²⁶⁾	B02		✓	✓	✓	✓	✓	✓	✓	✓	✓	✓	✓	✓	
Document - Electrical datasheet	B60		✓	✓	✓	✓	✓	✓	✓	✓	✓	✓	✓	✓	
Document - Order dimensional drawing	B61		✓	✓	✓	✓	✓	✓	✓	✓	✓	✓	✓	✓	
Type test with heat run for horizontal motors, with acceptance	B83		✓	✓	✓	✓	✓	✓	✓	✓	✓	✓	✓	✓	
"Basic" documentation package	B90		✓	✓	✓	✓	✓	✓	✓	✓	✓	✓	✓	✓	
"Advanced" documentation package	B91		✓	✓	✓	✓	✓	✓	✓	✓	✓	✓	✓	✓	
"Projects" documentation package	B92		✓	✓	✓	✓	✓	✓	✓	✓	✓	✓	✓	✓	
Wire-lattice pallet packaging	B99		○	○	○	○	○	○	○	○	○	○	○	○	
Connected in star for dispatch	M01		✓	✓	✓	✓	✓	✓	✓	✓	✓	✓	✓	✓	
Connected in delta for dispatch	M02		✓	✓	✓	✓	✓	✓	✓	✓	✓	✓	✓	✓	

SIMOTICS GP and SIMOTICS SD standard motors

Article No. supplements and special versions · Options

Aluminum series SIMOTICS GP 1LE10

- Standard version
- Without additional charge
- This order code only determines the price of the version – Additional plain text is required.
- ✓ With additional charge
- O. R. Possible on request
- Not possible

- 1) With IM B5 flange, only possible in combination with **H08**.
- 2) Not possible in combination with order code **R15** "One metal cable gland".
- 3) With **H08**, feet dimensions C and CA differ from EN 50347! Further information is available in the DT Configurator (see Appendix, "Tools and engineering").
- 4) In conjunction with motor protection (15th position of the Article No.) or anti-condensation heating option, please inquire before ordering.
- 5) Not possible in combination with voltage code **22** or **34**.
- 6) Cannot be used for motors in UL version (order code **D31**). The grease lifetime specified in Catalog Section 1 "Introduction" refers to CT 40 °C. If the coolant temperature is increased by 10 K, the grease lifetime and greasing interval are halved.
- 7) A second shaft extension is not possible. Please inquire for mounted brakes.
- 8) For order codes **F10**, **F11**, **F12**, **F17**, and **F18**, the brake supply voltage must be specified or ordered.
- 9) All encoders are supplied with a protective cover as standard. The protective cover is omitted at the factory when a rotary pulse encoder is combined with a separately driven fan, because in this case the rotary pulse encoder is installed under the fan cover. In combination with a separately driven fan (order code **F70**) the 1XP8032-10 rotary pulse encoder is used instead of 1XP8012-10 or 1XP8032-20 is used instead of 1XP8012-20.
- 10) As standard, motors that are prepared for additional mountings (order codes **G40**, **G41**, **G42**) are shipped without protective cover. If a protective cover is requested as a cover or mechanical protection for mountings provided by the customer, this can be ordered with order code **G43**. Not possible in combination with order code **L00** vibration severity grade B. In combination with a separately driven fan (order code **F70**) the 1XP8032-10 rotary pulse encoder is used instead of 1XP8012-10 or 1XP8032-20 is used instead of 1XP8012-20.
- 11) Order code **H00** provides mechanical protection for encoders.
- 12) Not possible in combination with brake BFK458 – order code **F01**.
- 13) Not possible in combination with HOG 9 DN 1024 I rotary pulse encoder (order code **G05**) and/or brake BFK458 (order code **F01**).
- 14) Supplied with the condensation drainage holes sealed at the drive end DE and non-drive end NDE (IP55, IP56, IP65). If the condensation drainage holes are required for motors of the IM B6, IM B7 or IM B8 type of construction (feet on side or top), the motors must be ordered in the respective type of construction and with order code **H03**, so that the condensation drainage holes will be placed in the correct position.
- 15) As standard, motors that are prepared for additional mountings (order codes **G40**, **G41**, **G42**) are shipped without protective cover. If a protective cover is requested as a cover or mechanical protection for mountings provided by the customer, this can be ordered with order code **G43**. Not possible in combination with order code **L00** vibration severity grade B.
- 16) In connection with mountings, the respective technical specifications must be observed, please inquire before ordering.
- 17) CCC mandatory certification, see Chapter 1 Page 1/19.
- 18) Possible up to 600 V max. The rated voltage is indicated on the rating plate without voltage range. Order codes **D30** and **D31** do not authorize importing into USA and Mexico. The North America export versions Eagle Line 1LE1021 NEMA Energy Efficient and 1LE1023 NEMA Premium Efficient are available for this purpose.
- 19) In connection with mountings, the respective technical specifications must be observed, please inquire before ordering.
- 20) Not possible when brake is mounted.
- 21) When motors are ordered that have a longer or shorter shaft extension than normal, the required position and length of the feather keyway must be specified in a sketch. It must be ensured that only feather keys in accordance with EN 50347, Form A are used. The feather keyway is positioned centrally on the shaft extension. The length is defined by the manufacturer in accordance with the appropriate standard. Not valid for: Conical shafts, non-standard threaded journals, non-standard shaft tolerances, friction welded journals, extremely "thin" shafts, special geometry dimensions (e.g. square journals), hollow shafts. Valid for non-standard shaft extensions DE or NDE. The feather keys are supplied in every case. For order codes **Y58**, **Y59** and **L05** the following applies:
 - Dimensions D and DA ≤ ball bearing inner diameter (see dimension tables for "Dimensions")
 - Dimensions E and EA ≤ 2 × length E (standard) of the shaft extension.
- 22) The special requirements of the textile industry regarding the sheet metal cover open up the possibility that a finger may be inserted between the cover and housing. The customer must implement appropriate measures to ensure that the installed system is "finger-safe".
- 23) Converter operation is permitted for 1LE1 motors with metal external fans. The metal external fan is not possible in combination with the low-noise version – order code **F77** or **F78**.
- 24) Can be ordered for 230 VΔ/400 VY or 400 VΔ/690 VY (voltage code **22** or **34**). Not possible in combination with order code **D34**.
- 25) As adhesive label for frame sizes 80 and 90.
- 26) The delivery time for the manufacturer's test certificate may differ from the delivery time for the motor and will be dispatched by e-mail.
- 27) The manual "Low-Voltage motors SIMOTICS GP, SD, DP Safety instructions SH 63 ... 355" is available in the Internet as PDF in all official languages of the EU: <https://support.industry.siemens.com/cs/ww/en/view/109756537>
- 28) Not possible in combination with order codes **N05**, **N06**, **N07**, **N08**, and **N11**.
- 29) Order codes **F70** and **F76** cannot be combined.
- 30) When ordering with order code **R70** and **R71**, order code **R50** is included.
- 31) Not possible for 2-pole and 4-pole motors with increased power (11th position of the Article No.: 6) in frame sizes 80 and 90.
- 32) Possible with frame sizes 180 and 200 with screw-mounted fan cover.
- 33) For frame sizes 180 and 200, constructed with metric entry thread.
- 34) Order code **S06** cannot be combined with order code **S00** and **S01**. It can be combined with **Y53** and **Y56** on request.
- 35) Please note the additional use of order code **D22** "Motor without CE marking for export outside EEA (see EU Directive 640/2009)".
- 36) A minimum cantilever force F_{\min} of $0.5 \cdot F_{\max}$ is required for NU bearings (cylindrical roller bearings) in contrast to ball bearings. Cylindrical roller bearings are not suitable for coupling output or for brief periods of no-load operation without cantilever force.
- 37) The rated voltage is indicated on the rating plate without voltage range. Order code **D40** does not authorize importing into Canada. The North America export versions Eagle Line 1LE1021 NEMA Energy Efficient and 1LE1023 NEMA Premium Efficient are available for this purpose.
- 38) Not possible in combination with voltage code (12th or 13th position of the Article No.) 17, 18, 30, 31, 60, 61, 62, 63 and 90 with the additional order codes **M1A**; **M2A**; **M2B**; **M1B**; **M1C**; **M2C**; **M1D**; **M2D**; **M1E**; **M2E**; **M1F**; **M2F**; **M1G**; **M2G**; **M1H**; **M2H**; **1K**; **M2K**; **M1J**; **M2J**; **M1L**; **M2L**; **M1M**; **M2M** and **M3A**.
- 39) Not possible in combination with order code **R50**.
- 40) Only possible in combination with order codes **R70**, **R71**, **R72**, and **R73**.
- 41) When ordering with order code **L90**, **L91** and **L92**, order code **B02** is included.

SIMOTICS GP and SIMOTICS SD standard motors

Article No. supplements and special versions · Options

Cast-iron series SIMOTICS SD 1LE15 Basic Line, 1LE16 Performance Line

Selection and ordering data

Special versions	Additional identification code -Z with order code and plain text if required	Frame size											Motor version					
		71	80	90	100	112	132	160	180	200	225	250	280	315				
					1LE1504 Basic Line											IEC	IE4	①
					1LE1604 Performance Line													②
					1LE1503 Basic Line												IE3	③
					1LE1603 Performance Line													④
					1LE1583													⑤
					1LE1501 Basic Line												IE2	⑥
					1LE1601 Performance Line													⑦
					1LE1502 Basic Line												IE1	⑧
					1LE1543 Basic Line											APAC Line	IE3	⑨
					1LE1643 Performance Line													⑩
												1LE1541 Basic Line					IE2	⑪
					1LE1523 Basic Line											Eagle Line	NPE (NEMA)	⑫
					1LE1623 Performance Line													⑬
					1LE1521 Basic Line												NEE (NEMA)	⑭

1LE1 -Z Order code

Motor protection																	
1 or 3 PTC thermistors – for tripping (2 terminals)	Q11				✓	✓	✓	✓	✓	✓	✓	✓	✓	✓	✓	✓	
2 or 6 PTC thermistors – for alarm and tripping (4 terminals)	Q12				✓	✓	✓	✓	✓	✓	✓	✓	✓	✓	✓	✓	
1 KTY84-130 temperature sensor (2 terminals)	Q23				✓	✓	✓	✓	✓	✓	✓	✓	✓	✓	✓	✓	
2 KTY84-130 temperature sensors (4 terminals)	Q25				✓	✓	✓	✓	✓	✓	✓	✓	✓	✓	✓	✓	
3 bimetal sensors (NC contacts) for tripping (2 terminals)	Q31				✓	✓	✓	✓	✓	✓	✓	✓	✓	✓	✓	✓	
6 bimetal sensors (NC contacts) for alarm and tripping (4 terminals)	Q32				✓	✓	✓	✓	✓	✓	✓	✓	✓	✓	✓	✓	
3 bimetal sensors (NC contacts) for tripping (6 terminals)	Q33				✓	✓	✓	✓	✓	✓	✓	✓	✓	✓	✓	✓	
6 bimetal sensors (NC contacts) for alarm and tripping (12 terminals)	Q34				✓	✓	✓	✓	✓	✓	✓	✓	✓	✓	✓	✓	
1 Pt1000 resistance thermometer (2 terminals)	Q35				✓	✓	✓	✓	✓	✓	✓	✓	✓	✓	✓	✓	
2 Pt1000 resistance thermometers (4 terminals)	Q36				✓	✓	✓	✓	✓	✓	✓	✓	✓	✓	✓	✓	
3 Pt100 resistance thermometers – 2-wire input (6 terminals)	Q60				✓	✓	✓	✓	✓	✓	✓	✓	✓	✓	✓	✓	
6 Pt100 resistance thermometers – 2-wire input (12 terminals) ²⁷⁾	Q61				✓	✓	✓	✓	✓	✓	✓	✓	✓	✓	✓	✓	
1 Pt100 resistance thermometer – 2-wire input (2 terminals)	Q62				✓	✓	✓	✓	✓	✓	✓	✓	✓	✓	✓	✓	
3 Pt100 resistance thermometers – 3-wire input (9 terminals) ³⁰⁾	Q63				✓	✓	✓	✓	✓	✓	✓	✓	✓	✓	✓	✓	
6 Pt100 resistance thermometers – 3-wire input (18 terminals) ³⁰⁾	Q64				✓	✓	✓	✓	✓	✓	✓	✓	✓	✓	✓	✓	
2 Pt100 resistance thermometers in basic configuration for bearing (2 terminals) ²⁾	Q72								✓	✓	✓	✓	✓	✓	✓	✓	
2 Pt100 resistance thermometers in 3-wire input for bearing (6 terminals)	Q78								✓	✓	✓	✓	✓	✓	✓	✓	
2 Pt100 double resistance thermometers in 3-wire input for bearing (12 terminals)	Q79								✓	✓	✓	✓	✓	✓	✓	✓	
Motor connection and terminal box																	
External grounding	H04				✓	✓	✓	✓	✓	✓	✓	✓	✓	✓	✓	✓	
Terminal box on NDE ²⁷⁾	H08				✓	✓	✓	✓	✓	✓	✓	✓	✓	✓	✓	✓	
Second external grounding	H70								✓	✓	✓	✓	✓	✓	✓	✓	
Rotation of the terminal box through 90°, entry from DE ⁴⁰⁾	R10				○	○	○	○	○	○	○	○	○	○	○	○	
Rotation of the terminal box through 90°, entry from NDE	R11				○	○	○	○	○	○	○	○	○	○	○	○	
Rotation of the terminal box through 180°	R12				○	○	○	○	○	○	○	○	○	○	○	○	
One EMC cable gland	R14				✓	✓	✓	✓	✓	✓	✓	✓	✓	✓	✓	✓	
One metal cable gland	R15				✓	✓	✓	✓	✓	✓	✓	✓	✓	✓	✓	✓	
EMC cable gland, maximum configuration	R16				✓	✓	✓	✓	✓	✓	✓	✓	✓	✓	✓	✓	
Stud terminal for cable connection, accessories pack (3 items)	R17															✓	
Metal cable gland, maximum configuration	R18				✓	✓	✓	✓	✓	✓	✓	✓	✓	✓	✓	✓	

For legends and footnotes, see page 3/137.

SIMOTICS GP and SIMOTICS SD standard motors

Article No. supplements and special versions · Options

Cast-iron series SIMOTICS SD 1LE15 Basic Line, 1LE16 Performance Line

Special versions	Additional identification code -Z with order code and plain text if required	Frame size										Motor version					
		71	80	90	100	112	132	160	180	200	225	250	280	315			
					1LE1504 Basic Line										IEC	IE4	①
					1LE1604 Performance Line												②
			1LE1503 Basic Line											IE3	③		
					1LE1603 Performance Line												④
					1LE1583												⑤
			1LE1501 Basic Line											IE2	⑥		
					1LE1601 Performance Line												⑦
					1LE1502 Basic Line											IE1	⑧
					1LE1543 Basic Line										APAC Line	IE3	⑨
					1LE1643 Performance Line												⑩
					1LE1541 Basic Line											IE2	⑪
			1LE1523 Basic Line										Eagle Line	NPE (NEMA)	⑫		
					1LE1623 Performance Line												⑬
			1LE1521 Basic Line											NEE (NEMA)	⑭		

1LE1 -Z Order code

Motor connection and terminal box (continued)																		
Saddle terminal for connection without cable lug, accessories pack	R19		-	-	-	-	-	-	-	-	-	-	-	✓	✓	✓		
3 cables protruding, 0.5 m long	R20		✓	✓	✓	✓	✓	✓	✓	✓	✓	✓	✓	✓	✓	✓		
3 cables protruding, 1.5 m long	R21		✓	✓	✓	✓	✓	✓	✓	✓	✓	✓	✓	O.R.	O.R.	O.R.	O.R.	
6 cables protruding, 0.5 m long	R22		✓	✓	✓	✓	✓	✓	✓	✓	✓	✓	✓	✓	✓	✓		
6 cables protruding, 1.5 m long	R23		✓	✓	✓	✓	✓	✓	✓	✓	✓	✓	✓	O.R.	O.R.	O.R.	O.R.	
6 cables protruding, 3 m long	R24		✓	✓	✓	✓	✓	✓	✓	✓	✓	✓	✓	O.R.	O.R.	O.R.	O.R.	
Reduction piece for M cable gland in accordance with British Standard, mounted on both cable entries	R30		-	-	-	✓	✓	✓	✓	✓	✓	✓	✓	-	-	-	-	
Larger terminal box	R50		✓	✓	✓	✓	✓	✓	✓	✓	✓	✓	✓	✓	✓	✓	✓	
Terminal box without cable entry opening	R51		-	-	-	○	○	○	○	○	○	○	○	○	○	○	○	
Drilled removable entry plate	R52		-	-	-	-	-	-	-	-	✓	✓	✓	✓	✓	✓	✓	
Undrilled removable entry plate	R53		-	-	-	-	-	-	-	-	✓	✓	✓	✓	✓	✓	✓	
Cast-iron auxiliary terminal box (small) 30)	R62		-	-	-	-	-	-	✓	✓	✓	✓	✓	✓	✓	✓	✓	
			-	-	-	✓	✓	✓	-	-	-	-	-	-	-	-	Only for: Motors with order code R50 possible	
Non-standard threaded through hole (NPT or G thread)	Y61 • and customer specifications		-	-	-	✓	✓	✓	✓	✓	✓	✓	✓	✓	✓	✓	✓	
Windings and insulation																		
Temperature class 155 (F), utilized according to 155 (F), with service factor	N01		✓	✓	✓	✓	✓	✓	✓	✓	✓	✓	✓	✓	✓	✓	✓	Not for: ⑤
Temperature class 155 (F), utilized acc. to 155 (F), with increased power	N02		✓	✓	✓	✓	✓	✓	✓	✓	✓	✓	✓	✓	✓	✓	✓	Not for: ⑤
Temperature class 155 (F), utilized acc. to 155 (F), with increased coolant temperature	N03		✓	✓	✓	✓	✓	✓	✓	✓	✓	✓	✓	✓	✓	✓	✓	Not for: ⑤
Temperature class 155 (F), utilized acc. to 130 (B), coolant temperature 45 °C, derating approx. 4 %	N05		✓	✓	✓	✓	✓	✓	✓	✓	✓	✓	✓	✓	✓	✓	✓	
Temperature class 155 (F), utilized acc. to 130 (B), coolant temperature 50 °C, derating approx. 8 %	N06		✓	✓	✓	✓	✓	✓	✓	✓	✓	✓	✓	✓	✓	✓	✓	
Temperature class 155 (F), utilized acc. to 130 (B), coolant temperature 55 °C, derating approx. 13 %	N07		✓	✓	✓	✓	✓	✓	✓	✓	✓	✓	✓	✓	✓	✓	✓	
Temperature class 155 (F), utilized acc. to 130 (B), coolant temperature 60 °C, derating approx. 18 %	N08		✓	✓	✓	✓	✓	✓	✓	✓	✓	✓	✓	✓	✓	✓	✓	
Temperature class 180 (H)	N10		✓	✓	✓	✓	✓	✓	✓	✓	✓	✓	✓	✓	✓	✓	✓	Not for: ①, ②, ⑤, ⑨, ⑩, ⑪, ⑫, ⑬, ⑭
Temperature class 180 (H) at rated power and max. CT 60 °C 4) 5)	N11		✓	✓	✓	✓	✓	✓	✓	✓	✓	✓	✓	✓	✓	✓	✓	Not for: ①, ②, ⑤
Increased air humidity/temperature with 30 to 60 g water per m ³ of air	N30		✓	✓	✓	✓	✓	✓	✓	✓	✓	✓	✓	✓	✓	✓	✓	
Increased air humidity/temperature with 60 to 100 g water per m ³ of air	N31		✓	✓	✓	✓	✓	✓	✓	✓	✓	✓	✓	✓	✓	✓	✓	

For legends and footnotes, see page 3/137.

SIMOTICS GP and SIMOTICS SD standard motors

Article No. supplements and special versions · Options

Cast-iron series SIMOTICS SD 1LE15 Basic Line, 1LE16 Performance Line

Special versions	Additional identification code -Z with order code and plain text if required	Frame size											Motor version				
		71	80	90	100	112	132	160	180	200	225	250	280	315	IEC	IE4	①
																	②
																	③
																	④
																	⑤
																	⑥
																	⑦
																	⑧
																	⑨
																	⑩
																	⑪
																	⑫
																	⑬
																	⑭
	1LE1	-Z Order code															

Windings and insulation (continued)

Temperature class 155 (F), utilized acc. to 130 (B), with higher coolant temperature and/or installation altitude	Y50 • CT .. °C or IA m above sea level																
Temperature class 155 (F), utilized acc. to 155 (F), other requirements ⁵⁾	Y52 • CT .. °C or IA m above sea level	✓	✓	✓	✓	✓	✓	✓	✓	✓	✓	✓	✓	✓	✓	✓	Not for: ⑤
Temperature class 180 (H), utilized according to 155 (F)	Y75 • CT .. °C or IA m above sea level	–	–	–	✓	✓	✓	✓	✓	✓	✓	✓	✓	✓	✓	✓	Not for: ①, ②, ⑤

Colors and paint finish

Standard paint finish C2 in RAL 7030 stone gray																	
Unpainted (only cast-iron parts primed)	S00	○	○	○	○	○	○	○	○	○	○	○	○	○	○	○	○
Unpainted, only primed	S01	✓	✓	✓	✓	✓	✓	✓	✓	✓	✓	✓	✓	✓	✓	✓	
Special paint finish C3	S02	✓	✓	✓	✓	✓	✓	✓	✓	✓	✓	✓	✓	✓	✓	✓	Not for: ②, ④, ⑦, ⑩, ⑬
	–	✓	✓	✓	✓	✓	✓	✓	✓	✓	✓	✓	✓	✓	✓	✓	Only for: ②, ④, ⑦, ⑩, ⑬
Special paint finish sea air resistant C4	S03	✓	✓	✓	✓	✓	✓	✓	✓	✓	✓	✓	✓	✓	✓	✓	
Special paint finish for use offshore C5	S04	✓	✓	✓	✓	✓	✓	✓	✓	✓	✓	✓	✓	✓	✓	✓	
Internal coating	S05	–	–	–	✓	✓	✓	✓	✓	✓	✓	✓	✓	✓	✓	✓	
Top coat polyurethane ³³⁾	S06	✓	✓	✓	✓	✓	✓	✓	✓	✓	✓	✓	✓	✓	✓	✓	
C5mid Special paint system with durability "medium"	S08				✓	✓	✓	✓	✓	✓	✓	✓	✓	✓	✓	✓	
CX Special paint system for offshore with durability "high"	S09				✓	✓	✓	✓	✓	✓	✓	✓	✓	✓	✓	✓	
Paint finish in other standard RAL colors: RAL 1015, 3000, 5002, 5009, 5010, 5012, 5015, 6011, 7001, 7011, 7016, 7031, 7032, 7035, 7037, 8012, 9005, 9010 (see Catalog Section 1 "Introduction")	Y53 • and paint finish RAL....	✓	✓	✓	✓	✓	✓	✓	✓	✓	✓	✓	✓	✓	✓	✓	Only for: ①, ③, ⑤, ⑥, ⑧, ⑨, ⑪, ⑫, ⑭
Paint finish in special RAL colors: For RAL colors, see "Special paint finish in special RAL colors" (see Catalog Section 1 "Introduction")	Y56 • and paint finish RAL....	✓	✓	✓	✓	✓	✓	✓	✓	✓	✓	✓	✓	✓	✓	✓	
Non-standard colors Colors see "Paint finish in non-standard colors" (see Catalog Section 1 "Introduction")	Y66 • and paint finish	✓	✓	✓	✓	✓	✓	✓	✓	✓	✓	✓	✓	✓	✓	✓	

Modular technology – Basic versions ⁶⁾

Mounting of holding brake (standard assignment) ^{7) 31) 32)}	F01	–	–	–	✓	✓	✓	✓	✓	✓	✓	✓	✓	✓	✓	✓	✓
Mounting of PRECIMA brake	F04	–	–	–	✓	✓	✓	✓	✓	✓	✓	✓	✓	✓	✓	✓	✓
Mounting of separately driven fan ^{28) 34)}	F70	✓	✓	✓	✓	✓	✓	✓	✓	✓	✓	✓	✓	✓	✓	✓	✓
Mounting of Kübler Sendix 5020 HTL, 1024 I rotary pulse encoder	G11	✓	✓	✓	✓	✓	✓	✓	✓	✓	✓	✓	✓	✓	✓	✓	✓
Mounting of Kübler Sendix 5020 TTL, 1024 I rotary pulse encoder	G12	✓	✓	✓	✓	✓	✓	✓	✓	✓	✓	✓	✓	✓	✓	✓	✓

For legends and footnotes, see page 3/137.

SIMOTICS GP and SIMOTICS SD standard motors

Article No. supplements and special versions · Options

Cast-iron series SIMOTICS SD 1LE15 Basic Line, 1LE16 Performance Line

Special versions	Additional identification code -Z with order code and plain text if required	Frame size											Motor version				
		71	80	90	100	112	132	160	180	200	225	250	280	315			
					1LE1504 Basic Line							IEC		IE4		①	
					1LE1604 Performance Line											②	
		1LE1503 Basic Line												IE3		③	
					1LE1603 Performance Line											④	
					1LE1583											⑤	
		1LE1501 Basic Line												IE2		⑥	
					1LE1601 Performance Line											⑦	
					1LE1502 Basic Line									IE1		⑧	
		1LE1543 Basic Line										APAC Line		IE3		⑨	
					1LE1643 Performance Line											⑩	
					1LE1541 Basic Line									IE2		⑪	
		1LE1523 Basic Line										Eagle Line		NPE (NEMA)		⑫	
					1LE1623 Performance Line											⑬	
	1LE1 -Z	Order code			1LE1521 Basic Line									NEE (NEMA)		⑭	
Special technology (continued)⁶⁾																	
Mounting of rotary pulse encoder HOG 10 DN 1024 I + ESL 93, (integrated electronic speed switch, speed rpm), terminal box dust protection	Y79 • and spec. speed (max 3) rpm									✓	✓	✓	✓	✓	✓		
Mechanical version and degrees of protection																	
Low-noise version for 2-pole motors with clockwise direction of rotation	F77									✓	✓	✓	✓	✓	✓		Not for: Motors in combination with order code F90
Low-noise version for 2-pole motors with counterclockwise direction of rotation	F78									✓	✓	✓	✓	✓	✓		Not for: Motors in combination with order code F90
Prepared for mounted components, centering hole only	G40		✓	✓	✓	✓	✓	✓	✓	□	□	□	□	□	□		Not for: Motors in combination with order code F90
Prepared for mountings with D12 shaft	G41	✓	✓	✓	✓	✓	✓	✓	✓	✓	✓	✓	✓	✓	✓		Not for: Motors in combination with order code F90
Prepared for mountings with D16 shaft	G42		✓	✓	✓	✓	✓	✓	✓	✓	✓	✓	✓	✓	✓		Not for: Motors in combination with order code F90
Mechanical protection for encoder	G43	✓	✓	✓	✓	✓	✓	✓	✓	✓	✓	✓	✓	✓	✓		Not for: Motors in combination with order code F90
Protective cover ⁸⁾ 10) 12)	H00	✓	✓	✓	✓	✓	✓	✓	✓	✓	✓	✓	✓	✓	✓		Not for: Motors in combination with order code F90
Screwed-on (instead of cast) feet	H01				✓	✓	✓	✓	✓	✓	✓	✓	✓	✓	✓		
Vibration-proof version; vibration resistance to Class 3M4 according to IEC 60721-3-3:1994 ³⁹⁾	H02	✓	✓	✓	✓	✓	✓	✓	✓	✓	✓	✓	✓	✓	✓		
Condensation drainage holes ³⁸⁾	H03	✓	✓	✓	□	□	□	□	□	□	□	□	□	□	□		
Rust-resistant screws (externally)	H07	✓	✓	✓	✓	✓	✓	✓	✓	✓	✓	✓	✓	✓	✓		
Degree of protection IP66	H19	✓	✓	✓	✓	✓	✓	✓	✓	✓	✓	✓	✓	✓	✓		
Degree of protection IP65 ¹⁴⁾	H20	✓	✓	✓	✓	✓	✓	✓	✓	✓	✓	✓	✓	✓	✓		
Degree of protection IP54	H21									✓	✓	✓	✓	✓	✓		
Degree of protection IP56 ¹⁵⁾	H22	✓	✓	✓	✓	✓	✓	✓	✓	✓	✓	✓	✓	✓	✓		
Drive-end seal for flange-mounting motors, oil-tight to 0.1 bar ^{13) 29)}	H23	✓	✓	✓	✓	✓	✓	✓	✓	✓	✓	✓	✓	✓	✓		
Grounding brush for converter operation	L52														✓	✓	
Coolant temperature and installation altitude																	
Coolant temperature -50 to +40 °C	D02				✓	✓	✓	✓	✓	✓	✓	✓	✓	✓	✓		
Coolant temperature -40 to +40 °C ¹⁶⁾	D03	✓	✓	✓	✓	✓	✓	✓	✓	✓	✓	✓	✓	✓	✓		
Coolant temperature -30 to +40 °C ¹⁶⁾	D04	✓	✓	✓	✓	✓	✓	✓	✓	✓	✓	✓	✓	✓	✓		
Versions in accordance with standards and specifications																	
VIK version	C02				✓	✓	✓	✓	✓	✓	✓	✓	✓	✓	✓		Only for: ③, ④ Not for: ⑤
Version Chemstar chemical industry	C03	✓	✓	✓													
Version Chemstar oil & gas industry	C04	✓	✓	✓													
CCC China Compulsory Certification	D01	✓	✓	✓													Only for: Voltage code 21 or 22 Not for: ⑤
Motor without CE marking for export outside EEA (see EU Directive 640/2009)	D22	○	○	○	○	○	○	○	○	○	○	○	○	○	○		Not for: ①, ②
Motor exclusively according to the Energy-related Products Law, Article 1 dated 27.2.2008, motor to be used in means of transport for persons and goods	D23	○	○	○	○	○	○	○	○	○	○	○	○	○	○		Only for: ⑥, ⑦, ⑧, ⑪
Electrical according to NEMA MG1-12 ¹⁵⁾	D30				✓	✓	✓	✓	✓	✓	✓	✓	✓	✓	✓		Not for: ⑫, ⑬, ⑭
	-	□	□	□	□	□	□	□	□	□	□	□	□	□	□		Only for: ⑫, ⑬, ⑭
Design according to IUL with "Recognition Mark" ¹⁸⁾	D31		✓	✓	✓	✓	✓	✓	✓	✓	✓	✓	✓	✓	✓		Not for: ⑫, ⑬, ⑭
	-	□	□	□	□	□	□	□	□	□	□	□	□	□	□		Only for: ⑫, ⑬, ⑭

For legends and footnotes, see page 3/137.

SIMOTICS GP and SIMOTICS SD standard motors

Article No. supplements and special versions · Options

Cast-iron series SIMOTICS SD 1LE15 Basic Line, 1LE16 Performance Line

Special versions	Additional identification code -Z with order code and plain text if required	Frame size											Motor version					
		71	80	90	100	112	132	160	180	200	225	250	280	315				
					1LE1504 Basic Line									IEC	IE4	①		
					1LE1604 Performance Line											②		
		1LE1503 Basic Line													IE3	③		
					1LE1603 Performance Line											④		
					1LE1583											⑤		
		1LE1501 Basic Line													IE2	⑥		
					1LE1601 Performance Line											⑦		
					1LE1502 Basic Line											⑧		
		1LE1543 Basic Line													APAC Line	IE3		
					1LE1643 Performance Line											⑩		
					1LE1541 Basic Line											⑪		
		1LE1523 Basic Line													Eagle Line	NPE (NEMA)		
					1LE1623 Performance Line											⑬		
		1LE1521 Basic Line														NEE (NEMA)		
		1LE1 -Z			Order code													⑭

Versions in accordance with standards and specifications (continued)

KEMCO Korea Energy Efficiency Label	D33	-	✓	✓	✓	✓	✓	✓	✓	✓	✓	✓	✓	✓	✓	✓	Only for: ⑨, ⑩, ⑪
China Energy Efficiency Label ⁴¹⁾	D34	○	○	○	○	○	○	○	○	○	○	○	○	○	○	○	Not for: ⑥, ⑦, ⑧, ⑩, ⑭
Canadian regulations (CSA) ¹⁷⁾	D40	✓	✓	✓	✓	✓	✓	✓	✓	✓	✓	✓	✓	✓	✓	Not for: ⑫, ⑬, ⑭	
NEMA Premium Efficient, North America version acc. to NEMA MG1, Table 12-11, incl. UL and CSA	D41	-	-	-	□	□	□	□	□	□	□	□	□	□	□	Only for: ⑫, ⑬, ⑭	
TR CU product safety certificate EAC for Eurasian Customs Union ³⁵⁾	D47	✓	✓	✓	✓	✓	✓	✓	✓	✓	✓	✓	✓	✓	✓	Only for: ⑤	
MEPS Australia	D70	-	-	-	O.R.	O.R.	O.R.	O.R.	O.R.	O.R.	O.R.	O.R.	O.R.	O.R.	O.R.	Only for: ⑤	

Bearings and lubrication

Regreasing device with M10 x 1 grease nipple according to DIN 71412-A ¹⁾	L19	-	-	-	-	-	-	✓	✓	✓	✓	○	○			Only for: ①, ③, ⑤, ⑥, ⑧, ⑨, ⑫, ⑭
Located bearing DE	L20	✓	✓	✓	✓	✓	✓	✓	✓	✓	✓	✓	✓	✓	✓	Only for: ②, ④, ⑦, ⑩, ⑬
Located bearing NDE	L21	✓	✓	✓	✓	✓	✓	□	□	□	□	□	□	□	□	
Bearing design for increased cantilever forces ³⁶⁾	L22	✓	✓	✓	✓	✓	✓	✓	✓	✓	✓	✓	✓	✓	✓	Not for: ②, ④, ⑦, ⑩, ⑬
Regreasing device ¹⁾	L23	-	-	-	✓	✓	✓	✓	✓	✓	✓	□	□	□	□	Not for: ②, ④, ⑦, ⑩, ⑬
Bearings reinforced at both ends for DE and NDE, bearing size 63 ¹⁹⁾	L25	✓	✓	✓	✓	✓	✓	✓	✓	✓	✓	✓	✓	✓	✓	Not for: ②, ④, ⑦, ⑩, ⑬
Reinforced bearings at both DE and NDE, DE bearing for increased cantilever forces	L28	-	-	-	-	-	-	✓	✓	✓	✓	-	-			Only for: ②, ④, ⑦, ⑩, ⑬
Bearing insulation DE	L50	-	-	-	-	-	-	-	-	✓	✓	✓	✓	✓	✓	
Bearing insulation NDE	L51	-	-	-	✓	✓	✓	✓	✓	✓	✓	✓	✓	✓	✓	
Measuring nipple for SPM shock pulse measurement for bearing inspection ¹⁾	Q01	-	-	-	✓	✓	✓	✓	✓	✓	✓	✓	✓	✓	✓	

Balance and vibration severity

Vibration severity grade A		□	□	□	□	□	□	□	□	□	□	□	□	□	□	
Vibration severity grade B ²⁰⁾	L00	✓	✓	✓	✓	✓	✓	✓	✓	✓	✓	✓	✓	✓	✓	
Half-key balancing (standard)		□	□	□	□	□	□	□	□	□	□	□	□	□	□	
Balancing without feather key	L01	✓	✓	✓	✓	✓	✓	✓	✓	✓	✓	✓	✓	✓	✓	
Full-key balancing	L02	✓	✓	✓	✓	✓	✓	✓	✓	✓	✓	✓	✓	✓	✓	

Shaft and rotor

Shaft extension with standard dimensions, without feather keyway	L04	✓	✓	✓	✓	✓	✓	✓	✓	✓	✓	✓	✓	✓	✓	
Standard, cylindrical shaft extension (second shaft extension) NDE acc. to EN 50347	L05	✓	✓	✓	✓	✓	✓	✓	✓	✓	✓	✓	✓	✓	✓	
Standard shaft made of stainless steel (e.g. 1.4021)	L06	✓	✓	✓	✓	✓	✓	✓	✓	✓	✓	✓	✓	✓	✓	
Shaft extension run-out in accordance with IEC 60072-1 precision class	L07	✓	✓	✓	✓	✓	✓	✓	✓	✓	✓	✓	✓	✓	✓	
Shaft extension run-out, concentricity and perpendicularity in accordance with IEC 60072-1 precision class for flange-mounted motors	L08	✓	✓	✓	✓	✓	✓	✓	✓	✓	✓	✓	✓	✓	✓	

SIMOTICS GP and SIMOTICS SD standard motors

Article No. supplements and special versions · Options

Cast-iron series SIMOTICS SD 1LE15 Basic Line, 1LE16 Performance Line

Special versions	Additional identification code -Z with order code and plain text if required	Frame size												Motor version			
		71	80	90	100	112	132	160	180	200	225	250	280	315			
					1LE1504 Basic Line								IEC	IE4	①		
					1LE1604 Performance Line										②		
		1LE1503 Basic Line													IE3	③	
					1LE1603 Performance Line										④		
					1LE1583										⑤		
		1LE1501 Basic Line													IE2	⑥	
					1LE1601 Performance Line										⑦		
					1LE1502 Basic Line									IE1	⑧		
					1LE1543 Basic Line								APAC Line	IE3	⑨		
					1LE1643 Performance Line										⑩		
					1LE1541 Basic Line									IE2	⑪		
		1LE1523 Basic Line												Eagle Line	NPE (NEMA)	⑫	
					1LE1623 Performance Line										⑬		
	1LE1 -Z	Order code			1LE1521 Basic Line									NEE (NEMA)	⑭		
Shaft and rotor (continued)																	
Non-standard cylindrical shaft extension, DE ²¹⁾	Y58 • and customer specifications		✓	✓	✓	✓	✓	✓	✓	✓	✓	✓	✓	✓	✓	✓	
Non-standard cylindrical shaft extension, NDE ²¹⁾	Y59 • and customer specifications		✓	✓	✓	✓	✓	✓	✓	✓	✓	✓	✓	✓	✓	✓	
Special shaft steel	Y60 • and customer specifications		-	-	-	O.R.	O.R.	O.R.	O.R.	O.R.	O.R.	O.R.	O.R.	O.R.	O.R.	O.R.	
Heating and ventilation																	
Sheet metal fan cover	F74		☐	☐	☐	☑	☑	☑	☑	☑	☑	☑	☑	☑	☑	☑	Only for: ①, ③, ⑤, ⑥, ⑧, ⑨, ⑪, ⑫, ⑭
	-		☐	☐	☐	☐	☐	☐	☐	☐	☐	☐	☐	☐	☐	☐	Only for: ②, ④, ⑦, ⑩, ⑬
Metal external fan ^{22) 28)}	F76		✓	✓	✓	✓	✓	✓	✓	✓	✓	✓	✓	✓	✓	✓	
Without external fan and without fan cover	F90		✓	✓	✓	✓	✓	✓	✓	✓	✓	✓	✓	✓	✓	✓	
Anti-condensation heating for 230 V (2 terminals)	Q02		✓	✓	✓	✓	✓	✓	✓	✓	✓	✓	✓	✓	✓	✓	
Anti-condensation heating for 115 V (2 terminals)	Q03		✓	✓	✓	✓	✓	✓	✓	✓	✓	✓	✓	✓	✓	✓	
Separately driven fan with non-standard voltage and/or frequency	Y81 • and customer specifications		-	-	-	-	-	-	-	-	✓	✓	✓	✓	✓		
Rating plate and additional rating plates																	
Additional rating plate for voltage tolerance ²³⁾	B07		✓	✓	✓	✓	✓	✓	✓	✓	✓	✓	✓	✓	✓	✓	Not for: 8-pole motors
Second rating plate, loose	M10		✓	✓	✓	✓	✓	✓	✓	✓	✓	✓	✓	✓	✓	✓	
Rating plate, stainless steel	M11		✓	✓	✓	✓	✓	✓	✓	✓	✓	✓	✓	✓	✓	✓	Only for: ①, ③, ⑤, ⑥, ⑧, ⑨, ⑪, ⑫, ⑭
	-		-	-	-	☐	☐	☐	☐	☐	☐	☐	☐	☐	☐	☐	Only for: ④, ⑦, ⑩, ⑬
	-		-	-	-	-	-	-	-	-	-	-	-	-	-	-	Only for: ②
Additional rating plate with deviating rating plate data	Y80 • and customer specifications		✓	✓	✓	✓	✓	✓	✓	✓	✓	✓	✓	✓	✓	✓	
Additional rating plate with customer specifications	Y82 • and customer specifications		✓	✓	✓	✓	✓	✓	✓	✓	✓	✓	✓	✓	✓	✓	
Additional information on rating plate and on package label (max. 20 characters)	Y84 • and customer specifications		✓	✓	✓	✓	✓	✓	✓	✓	✓	✓	✓	✓	✓	✓	
Adhesive label, supplied loose (printed with: Article No., Serial No.; 2 lines of text)	Y85 • and customer specifications		-	-	-	✓	✓	✓	✓	✓	✓	✓	✓	✓	✓	✓	
Extension of the liability for defects																	
Extension of the liability for defects by 12 months to a total of 24 months (2 years) from delivery ²⁴⁾	Q80		-	-	-	-	-	-	-	✓	✓	✓	✓	✓	✓	✓	Only for: ①, ③, ⑤, ⑥, ⑧, ⑨, ⑪, ⑫, ⑭
Extension of the liability for defects by 24 months to a total of 36 months (3 years) from delivery ²⁴⁾	Q82		-	-	-	-	-	-	-	✓	✓	✓	✓	✓	✓	✓	Only for: ①, ③, ⑤, ⑥, ⑧, ⑨, ⑪, ⑫, ⑭
	-		-	-	-	☐	☐	☐	☐	☐	☐	☐	☐	☐	☐	☐	Only for: ②, ④, ⑦, ⑩, ⑬ 36 months
Packaging, safety notes, documentation and test certificates																	
Inspection certificate 3.1 according to EN 10204 ²⁵⁾	B02		✓	✓	✓	✓	✓	✓	✓	✓	✓	✓	✓	✓	✓	✓	
Document - Electrical datasheet	B60		✓	✓	✓	✓	✓	✓	✓	✓	✓	✓	✓	✓	✓	✓	

For legends and footnotes, see page 3/137.



SIMOTICS GP and SIMOTICS SD standard motors

Article No. supplements and special versions · Options

Cast-iron series SIMOTICS SD 1LE15 Basic Line, 1LE16 Performance Line

Special versions	Additional identification code -Z with order code and plain text if required	Frame size											Motor version					
		71	80	90	100	112	132	160	180	200	225	250	280	315				
																IEC	IE4	①
																		②
																	IE3	③
																		④
																		⑤
																	IE2	⑥
																		⑦
																	IE1	⑧
																APAC Line	IE3	⑨
																		⑩
																	IE2	⑪
																Eagle Line	NPE (NEMA)	⑫
																		⑬
																	NEE (NEMA)	⑭
	1LE1 - - - - Z	Order code																

Packaging, safety notes, documentation and test certificates (continued)														
Document - Order dimensional drawing	B61	✓	✓	✓	✓	✓	✓	✓	✓	✓	✓	✓	✓	✓
Standard test (routine test) with acceptance	B65	-	-	-	✓	✓	✓	✓	✓	✓	✓	✓	✓	✓
Type test with heat run for horizontal motors, without acceptance	B82	✓	✓	✓	✓	✓	✓	✓	✓	✓	✓	✓	✓	✓
Type test with heat run for horizontal motors, with acceptance	B83	✓	✓	✓	✓	✓	✓	✓	✓	✓	✓	✓	✓	✓
"Basic" documentation package	B90	✓	✓	✓	✓	✓	✓	✓	✓	✓	✓	✓	✓	✓
"Advanced" documentation package	B91	✓	✓	✓	✓	✓	✓	✓	✓	✓	✓	✓	✓	✓
"Projects" documentation package	B92	✓	✓	✓	✓	✓	✓	✓	✓	✓	✓	✓	✓	✓
Connected in star for dispatch	M01	✓	✓	✓	✓	✓	✓	✓	✓	✓	✓	✓	✓	✓
Connected in delta for dispatch	M02	✓	✓	✓	✓	✓	✓	✓	✓	✓	✓	✓	✓	✓

3

SIMOTICS GP and SIMOTICS SD standard motors

Article No. supplements and special versions · Options

Cast-iron series SIMOTICS SD 1LE15 Basic Line, 1LE16 Performance Line

- Standard version
- Without additional charge
- This order code only determines the price of the version – Additional plain text is required.
- ✓ With additional charge
- O. R. Possible on request
- Not possible

- 1) Up to frame size 160 not possible when brake is mounted.
- 2) Evaluation with appropriate tripping unit (see Catalog IC 10) is recommended.
- 3) Parallel Whitworth threaded pipe DIN ISO 228 (DIN 259) BSPP (British Standard Pipe Parallel) threaded pipe for connections not sealed in the thread (cylindrical), external = G.
- 4) Cannot be used for motors in UL version (order code **D31**). The grease lifetime specified in Catalog Section 1 "Introduction" refers to CT 40 °C. If the coolant temperature is increased by 10 K, the grease lifetime and regreasing interval are halved.
- 5) Not possible for 1LE15 and 1LE16 motors with increased power.
- 6) A second shaft extension is not possible. Please inquire for mounted brakes.
- 7) For order codes **F10**, **F11**, **F12**, **F17**, and **F18**, the brake supply voltage must be specified or ordered.
- 8) The 1XP8 rotary pulse encoders are fitted with a protective cover as standard. The protective cover is omitted at the factory when a rotary pulse encoder is combined with a separately driven fan, because in this case the rotary pulse encoder is installed under the fan cover.
- 9) In combination with a separately driven fan (order code **F70**) the 1XP8032-10 rotary pulse encoder is used instead of 1XP8012-10 or 1XP8032-20 is used instead of 1XP8012-20.
- 10) LL and HOG rotary pulse encoders up to frame size 160 are fitted with a protective cover as standard. The protective cover is omitted at the factory when a rotary pulse encoder is combined with a separately driven fan, because in this case the rotary pulse encoder is installed under the fan cover.
- 11) Option (encoder mounting) is only possible for motors with a mounted separately driven fan or for naturally cooled motors (without an external fan). This option can be used in combination with brakes of type KFB! This option cannot be used in combination with brakes of type BFK458!
- 12) Order code **H00** provides mechanical protection for encoders.
- 13) Not possible for type of construction IM V3.
- 14) Not possible in combination with HOG 9 DN 1024 I rotary pulse encoder (order code **G05**) and/or brake BFK458 (order code **F01**).
- 15) Not possible in combination with brake BFK458 – order code **F01**.
- 16) In connection with mountings, the respective technical specifications must be observed, please inquire before ordering.
- 17) The rated voltage is indicated on the rating plate without voltage range. Order code **D40** does not authorize importing into Canada. The North America export versions Eagle Line 1LE1521 NEMA Energy Efficient and 1LE1523/1LE1623 NEMA Premium Efficient are available for this purpose.
- 18) Possible up to 600 V max. The rated voltage is indicated on the rating plate without voltage range. Order codes **D30** and **D31** do not authorize importing into USA and Mexico. The North America export versions Eagle Line 1LE1521 NEMA Energy Efficient and 1LE1523/1LE1623 NEMA Premium Efficient are available for this purpose.
- 19) For Performance Line motors (all frame sizes) and Basic Line motors (from frame size 280) in the standard version.
- 20) On request for 2-pole motors (concerns frame sizes 225 to 315).
- 21) When motors are ordered that have a longer or shorter shaft extension than normal, the required position and length of the feather keyway must be specified in a sketch. It must be ensured that only feather keys in accordance with EN 50347, Form A are used. The feather keyway is positioned centrally on the shaft extension. The length is defined by the manufacturer in accordance with the appropriate standard. Not valid for: Conical shafts, non-standard threaded journals, non-standard shaft tolerances, friction welded journals, extremely "thin" shafts, special geometry dimensions (e.g. square journals), hollow shafts. Valid for non-standard shaft extensions DE or NDE. The feather keys are supplied in every case. For order codes **Y58**, **Y59** and **L05** the following applies:
 - Dimensions D and DA ≤ ball bearing inner diameter (see dimension tables for "Dimensions")
 - Dimensions E and EA ≤ 2 × length E (standard) of the shaft extension.
- 22) Converter operation is permitted for 1LE1 motors with metal external fans.
- 23) Can be ordered for 230 VΔ/400 VY or 400 VΔ/690 VY (voltage code **"22"** or **"34"**). Not possible for 8-pole motors and in combination with order code **D34**.
- 24) Wearing parts (bearings) are excluded from the warranty extension.
- 25) The delivery time for the manufacturer's test certificate may differ from the delivery time for the motor.
- 26) The Operating Instructions (compact) are available in PDF format for all official EU languages at <http://support.automation.siemens.com/WWW/view/en/40761976>.
- 27) With **H08**, feet dimensions C and CA differ from EN 50347! Further information is available in the DT Configurator (see Appendix, "Tools and engineering").
- 28) Order codes **F70** and **F76** cannot be combined.
- 29) Not possible in combination with order codes **Q72** and **Q78**.
- 30) For frame sizes 100 to 132 only possible in combination with order code **R50**.
- 31) Not possible in combination with order codes **N05**, **N06**, **N07**, **N08**, and **N11**.
- 32) For frame size 315, when combining order codes **F01** and **F12**, the rectifier for the brake will be supplied separately as a single part.
- 33) Order code **S06** cannot be combined with order codes **S00**, **S01**, and **S02**. It can be combined with **Y53** and **Y56** on request.
- 34) Order codes **F70** (separately driven fan) and **H02** (vibration-proof version) cannot be combined for motors in frame sizes 71, 80, and 90.
- 35) Please note the additional use of order code **D22** "Motor without CE marking for export outside EEA (see EU Directive 640/2009)".
- 36) A minimum cantilever force F_{\min} of $0.5 \cdot F_{\max}$ is required for NU bearings (cylindrical roller bearings) in contrast to ball bearings. Cylindrical roller bearings are not suitable for coupling output or for brief periods of no-load operation without cantilever force.
- 37) Order code **R62** only possible in combination with **R50**.
- 38) Supplied with the condensation drainage holes sealed at the drive end DE and non-drive end NDE (IP55, IP56, IP65). If the condensation drainage holes are required for motors of the IM B6, IM B7 or IM B8 type of construction (feet on side or top), the motors must be ordered in the respective type of construction and with order code **H03**, so that the condensation drainage holes will be placed in the correct position.
- 39) Not possible in combination with order code **R50**.
- 40) With IM B5 flange, only possible in combination with **H08**.
- 41) Not possible in combination with voltage code (12th or 13th position of the Article No.) 17, 18, 30, 31 and 90 with the additional order codes M1E; M2E; M1F; M2F; M1G; M2G; M1H; M2H; M1J; M2J; M1K; M2K; M1L; M2L; M1M; M2M and M3A.

SIMOTICS GP and SIMOTICS SD standard motors

Article No. supplements and special versions · Options

Aluminum series SIMOTICS GP 1LE1073 and cast-iron series SIMOTICS SD 1LE1573, 1LE5773

Selection and ordering data

Special versions	Additional identification code -Z with order code and plain text if required	Frame size											Motor version		
		80	90	100	112	132	160	180	200	225	250	280	315	IEC	IE3
		1LE1073					1LE1573					1LE5773			
1LE1 -Z		Order code													
Motor protection															
1 or 3 PTC thermistors – for tripping (2 terminals)	Q11	✓	✓	✓	✓	✓	✓	✓	✓	✓	✓	✓	✓		
2 or 6 PTC thermistors – for alarm and tripping (4 terminals)	Q12	✓	✓	✓	✓	✓	✓	✓	✓	✓	✓	✓	✓		
1 KTY84-130 temperature sensor (2 terminals)	Q23	✓	✓	✓	✓	✓	✓	✓	✓	✓	✓	✓	✓		
2 KTY84-130 temperature sensors (4 terminals)	Q25	✓	✓	✓	✓	✓	✓	✓	✓	✓	✓	✓	✓		
3 bimetal sensors (NC contacts) for tripping (2 terminals)	Q31	✓	✓	✓	✓	✓	✓	✓	✓	✓	✓	✓	✓		
6 bimetal sensors (NC contacts) for alarm and tripping (4 terminals)	Q32	✓	✓	✓	✓	✓	✓	✓	✓	✓	✓	✓	✓		
3 bimetal sensors (NC contacts) for tripping (6 terminals)	Q33	-	-	-	-	-	-	✓	✓	✓	✓	✓	✓		
6 bimetal sensors (NC contacts) for alarm and tripping (12 terminals)	Q34	-	-	-	-	-	-	✓	✓	✓	✓	✓	✓		
1 Pt1000 resistance thermometer (2 terminals)	Q35	✓	✓	✓	✓	✓	✓	✓	✓	✓	✓	✓	✓		
2 Pt1000 resistance thermometer (4 terminals)	Q36	✓	✓	✓	✓	✓	✓	✓	✓	✓	✓	✓	✓		
3 Pt100 resistance thermometers – 2-wire input (6 terminals)	Q60	-	-	-	-	-	-	✓	✓	✓	✓	✓	✓		
6 Pt100 resistance thermometers – 2-wire input (12 terminals) ¹⁹⁾	Q61	-	-	-	-	-	-	✓	✓	✓	✓	✓	✓		
1 Pt100 resistance thermometer – 2-wire input (2 terminals)	Q62	-	-	-	-	-	-	✓	✓	✓	✓	✓	✓		
3 Pt100 resistance thermometers – 3-wire input (9 terminals) ²²⁾	Q63	-	-	-	-	-	-	✓	✓	✓	✓	✓	✓		
6 Pt100 resistance thermometers – 3-wire input (18 terminals) ²²⁾	Q64	-	-	-	-	-	-	✓	✓	✓	✓	✓	✓		
2 Pt100 resistance thermometers in basic configuration for bearing (2 terminals) ²⁾	Q72	-	-	-	-	-	-	✓	✓	✓	✓	✓	✓		
2 Pt100 resistance thermometers in 3-wire input for bearing (6 terminals)	Q78	-	-	-	-	-	-	✓	✓	✓	✓	✓	✓		
2 Pt100 double resistance thermometers in 3-wire input for bearing (12 terminals)	Q79	-	-	-	-	-	-	✓	✓	✓	✓	✓	✓	Not for:	Motors in combination with order codes F40 and F41 (frame sizes 225 to 315)
Motor connection and terminal box															
External grounding	H04	✓	✓	✓	✓	✓	✓	□	□	□	□	□	□		
Terminal box on NDE ¹⁹⁾	H08	O	R	O	R	O	R	O	R	O	R	O	R	✓	✓
Second external grounding	H70	-	-	-	-	-	-	✓	✓	✓	✓	✓	✓		
Rotation of the terminal box through 90°, entry from DE ³⁰⁾	R10	O	O	O	O	O	O	✓	✓	✓	✓	✓	✓		
Rotation of the terminal box through 90°, entry from NDE	R11	O	O	O	O	O	O	✓	✓	✓	✓	✓	✓		
Rotation of the terminal box through 180°	R12	O	O	O	O	O	O	✓	✓	✓	✓	✓	✓		
One EMC cable gland	R14	✓	✓	✓	✓	✓	✓	✓	✓	✓	✓	✓	✓		
One metal cable gland	R15	✓	✓	✓	✓	✓	✓	✓	✓	✓	✓	✓	✓		
EMC cable gland, maximum configuration	R16	✓	✓	✓	✓	✓	✓	✓	✓	✓	✓	✓	✓		
Stud terminal for cable connection, accessories pack (3 items)	R17	-	-	-	-	-	-	-	-	-	✓	✓	✓		
Metal cable gland, maximum configuration	R18	✓	✓	✓	✓	✓	✓	✓	✓	✓	✓	✓	✓		
Saddle terminal for connection without cable lug, accessories pack	R19	-	-	-	-	-	-	-	-	-	✓	✓	✓		
3 cables protruding, 0.5 m long	R20	✓	✓	✓	✓	✓	✓	✓	-	-	-	-	-		
3 cables protruding, 1.5 m long	R21	✓	✓	✓	✓	✓	✓	O	R	O	R	O	R	O	R
6 cables protruding, 0.5 m long	R22	✓	✓	✓	✓	✓	✓	✓	-	-	-	-	-		
6 cables protruding, 1.5 m long	R23	✓	✓	✓	✓	✓	✓	O	R	O	R	O	R	O	R
6 cables protruding, 3 m long	R24	✓	✓	✓	✓	✓	✓	O	R	O	R	O	R	O	R

For legends and footnotes, see page 3/143.

SIMOTICS GP and SIMOTICS SD standard motors

Article No. supplements and special versions · Options

Aluminum series SIMOTICS GP 1LE1073 and cast-iron series SIMOTICS SD 1LE1573, 1LE5773

Special versions	Additional identification code -Z with order code and plain text if required	Frame size											Motor version			
		80	90	100	112	132	160	180	200	225	250	280	315	IEC	IE3	
		1LE1073						1LE1573					1LE5773			
1LE1 -Z	Order code															
Motor connection and terminal box (continued)																
12 cables protruding with cable lugs		☐	☐	☐	☐	☐	☐	☐	☐	☐	☐	☐	☐			
Larger terminal box	R50	✓	✓	✓	✓	✓	✓	✓	✓	✓	✓	✓	✓			
Terminal box without cable entry opening	R51	-	-	-	-	-	○	○	○	○	○	○				
Drilled removable entry plate	R52	-	-	-	-	-	✓	✓	✓	✓	✓	✓				
Undrilled removable entry plate	R53	-	-	-	-	-	✓	✓	✓	✓	✓	✓				
Cast-iron auxiliary terminal box (small 22)	R62	-	-	-	-	✓	✓	✓	✓	✓	✓	✓				
Cast-iron auxiliary terminal box (large)	R63	-	-	-	-	-	-	-	-	-	-	✓				
Non-standard threaded through hole (NPT or G thread)	Y61 • and customer specifications	-	-	-	-	-	✓	✓	✓	✓	✓	✓				
Windings and insulation																
Temperature class 155 (F), utilized according to 155 (F), with service factor	N01	✓	✓	✓	✓	✓	✓	✓	✓	✓	✓	✓	✓			
Temperature class 155 (F), utilized acc. to 155 (F), with increased power	N02	✓	✓	✓	✓	✓	✓	✓	✓	✓	✓	✓	✓			
Temperature class 155 (F), utilized acc. to 155 (F), with increased coolant temperature	N03	✓	✓	✓	✓	✓	✓	✓	✓	✓	✓	✓	✓			
Temperature class 155 (F), utilized acc. to 130 (B), coolant temperature 45 °C, derating approx. 4 %	N05	✓	✓	✓	✓	✓	✓	✓	✓	✓	✓	✓	✓			
Temperature class 155 (F), utilized acc. to 130 (B), coolant temperature 50 °C, derating approx. 8 %	N06	✓	✓	✓	✓	✓	✓	✓	✓	✓	✓	✓	✓			
Temperature class 155 (F), utilized acc. to 130 (B), coolant temperature 55 °C, derating approx. 13 %	N07	✓	✓	✓	✓	✓	✓	✓	✓	✓	✓	✓	✓			
Temperature class 155 (F), utilized acc. to 130 (B), coolant temperature 60 °C, derating approx. 18 %	N08	✓	✓	✓	✓	✓	✓	✓	✓	✓	✓	✓	✓			
Temperature class 180 (H)	N10	O. R.	O. R.	O. R.	O. R.	O. R.	O. R.	O. R.	✓	✓	✓	✓	✓			
Temperature class 180 (H) at rated power and max. CT 60 °C ⁴⁾	N11	✓	✓	✓	✓	✓	✓	✓	✓	✓	✓	✓	✓			
Increased air humidity/temperature with 30 to 60 g water per m ³ of air	N30	✓	✓	✓	✓	✓	✓	✓	✓	✓	✓	✓	✓			
Increased air humidity/temperature with 60 to 100 g water per m ³ of air	N31	✓	✓	✓	✓	✓	✓	✓	✓	✓	✓	✓	✓			
Temperature class 155 (F), utilized acc. to 130 (B), with higher coolant temperature and/or installation altitude	Y50 • CT .. °C or IA m above sea level	-	-	✓	✓	✓	✓	✓	✓	✓	✓	✓	✓			
Temperature class 155 (F), utilized acc. to 155 (F), other requirements	Y52 • CT .. °C or IA m above sea level	✓	✓	✓	✓	✓	✓	✓	✓	✓	✓	✓	✓			
Temperature class 180 (H), utilized according to 155 (F)	Y75 • CT .. °C or IA m above sea level	-	-	O. R.	O. R.	O. R.	O. R.	O. R.	✓	✓	✓	✓	✓			
Colors and paint finish																
Unpainted (only cast-iron parts primed)	S00	○	○	○	○	○	○	○	○	○	○	○	○			
Unpainted, only primed	S01	✓	✓	✓	✓	✓	✓	✓	✓	✓	✓	✓	✓			
Special paint finish C3	S02	☐	☐	☐	☐	☐	☐	☐	☐	☐	☐	☐	☐			
Special paint finish sea air resistant C4	S03	✓	✓	✓	✓	✓	✓	✓	✓	✓	✓	✓	✓			
Special paint finish for use offshore C5	S04	-	-	-	-	-	✓	✓	✓	✓	✓	✓	✓			
Internal coating	S05	✓	✓	✓	✓	✓	✓	✓	✓	✓	✓	✓	✓			
Top coat polyurethane ²⁵⁾	S06	✓	✓	✓	✓	✓	✓	✓	✓	✓	✓	✓	✓			
C5mid Special paint system with durability "medium"	S08	-	-	-	-	-	✓	✓	✓	✓	✓	✓	✓			
CX Special paint system for offshore with durability "high"	S09	-	-	-	-	-	✓	✓	✓	✓	✓	✓	✓			

For legends and footnotes, see page 3/143.



SIMOTICS GP and SIMOTICS SD standard motors

Article No. supplements and special versions · Options

Aluminum series SIMOTICS GP 1LE1073 and cast-iron series SIMOTICS SD 1LE1573, 1LE5773

Special versions	Additional identification code -Z with order code and plain text if required	Frame size											Motor version			
		80	90	100	112	132	160	180	200	225	250	280	315	IEC	IE3	
		1LE1073					1LE1573					1LE5773				
1LE1 -Z	Order code															
Colors and paint finish (continued)																
Paint finish in other standard RAL colors: RAL 1015, 3000, 5002, 5009, 5010, 5012, 5015, 6011, 7001, 7011, 7016, 7031, 7032, 7035, 7037, 8012, 9005, 9010 (see Catalog Section 1 "Introduction")	Y53 • and paint finish RAL....	✓	✓	✓	✓	✓	✓	✓	✓	✓	✓	✓	✓			
Paint finish in special RAL colors: For RAL colors, see "Special paint finish in special RAL colors" (see Catalog Section 1 "Introduction")	Y56 • and paint finish RAL....	✓	✓	✓	✓	✓	✓	✓	✓	✓	✓	✓	✓			
Non-standard colors Colors see "Paint finish in non-standard colors" (see Catalog Section 1 "Introduction")	Y66 • and paint finish	✓	✓	✓	✓	✓	✓	✓	✓	✓	✓	✓	✓			
Modular technology – Basic versions ⁵⁾																
Mounting of holding brake (standard assignment) ^{6) 23) 24)}	F01	✓	✓	✓	✓	✓	✓	✓	✓	✓	✓	✓	✓			
Mounting of PRECIMA brake	F04	–	–	✓	✓	✓	✓	✓	✓	✓	✓	✓	✓	–		
Mounting of separately driven fan ^{20) 26)}	F70	✓	✓	✓	✓	✓	✓	✓	✓	✓	✓	✓	✓			
Mounting of Kübler Sendix 5020 HTL, 1024 I rotary pulse encoder	G11	✓	✓	✓	✓	✓	✓	✓	✓	✓	✓	✓	✓			
Mounting of Kübler Sendix 5020 TTL, 1024 I rotary pulse encoder	G12	✓	✓	✓	✓	✓	✓	✓	✓	✓	✓	✓	✓			
Modular technology – Additional versions																
Brake supply voltage 24 V DC	F10	✓	✓	✓	✓	✓	✓	✓	✓	✓	✓	✓	✓			
Brake supply voltage 230 V AC, 50/60 Hz	F11	✓	✓	○	○	○	○	○	○	○	○	○	○			
Brake supply voltage 400 V AC, 50/60 Hz ²⁴⁾	F12	✓	✓	✓	✓	✓	✓	✓	✓	✓	✓	✓	✓			
Brake supply voltage 180 V DC	F17	✓	✓	✓	✓	✓	✓	✓	✓	–	–	–	–			
Brake supply voltage 205 V DC	F18	✓	✓	✓	✓	✓	✓	✓	✓	–	–	–	–			
Backstop, counterclockwise motion blocked, clockwise direction of rotation	F40	–	–	–	–	✓	✓	✓	✓	✓	✓	✓	✓			
Backstop, clockwise motion blocked, counterclockwise direction of rotation	F41	–	–	–	–	–	–	✓	✓	✓	✓	✓	✓			
Mechanical manual brake release with lever (no locking)	F50	✓	✓	✓	✓	✓	✓	✓	✓	✓	✓	✓	✓			
Special technology ⁵⁾																
Mounting of LL 861 900 220 rotary pulse encoder ⁷⁾	G04	–	–	✓	✓	✓	✓	✓	✓	✓	✓	✓	✓			
Mounting of HOG 9 DN 1024 I rotary pulse encoder ⁷⁾	G05	–	–	✓	✓	✓	✓	✓	✓	✓	✓	✓	✓			
Mounting of HOG 10 D 1024 I rotary pulse encoder ⁷⁾	G06	–	–	✓	✓	✓	✓	✓	✓	✓	✓	✓	✓			
Mounting of POG 10 DN rotary pulse encoder (only in combination with separately driven fan or brake) ⁷⁾	G07	–	–	–	–	–	–	✓	✓	✓	✓	✓	✓			
Mounting of POG 9 rotary pulse encoder (only in combination with separately driven fan or brake) ⁸⁾	G08	–	–	–	–	–	–	✓	✓	✓	✓	✓	✓			
Mounting of HOG 10 DN 1024 I rotary pulse encoder, terminal box moisture protection	G15	–	–	–	–	–	–	✓	✓	✓	✓	✓	✓			
Mounting of HOG 10 DN 1024 I rotary pulse encoder, terminal box dust protection	G16	–	–	–	–	–	–	✓	✓	✓	✓	✓	✓			
Mounting of Kübler Sendix 5834FS2 1024, SIL-2 rotary pulse encoder	G21	✓	✓	✓	✓	✓	✓	✓	✓	✓	✓	✓	✓			
Mounting of Kübler Sendix 5834FS3 1024, SIL-3 rotary pulse encoder	G22	✓	✓	✓	✓	✓	✓	✓	✓	✓	✓	✓	✓			
Mounting of HOGS100S-B76.626.01024.1 rotary pulse encoder	G25	–	–	–	–	–	–	✓	✓	✓	✓	✓	✓			
Mounting of LL FSI 862-184560-1024, SIL-2 rotary pulse encoder	G27	–	–	–	–	–	–	✓	✓	✓	✓	✓	✓			
Mounting of rotary pulse encoder XSI 850 Overspeed	G93							✓	✓	✓	✓	✓	✓			
Mounting of rotary pulse encoder XHI 861 Overspeed	G94							✓	✓	✓	✓	✓	✓			

For legends and footnotes, see page 3/143.

SIMOTICS GP and SIMOTICS SD standard motors

Article No. supplements and special versions · Options

Aluminum series SIMOTICS GP 1LE1073 and cast-iron series SIMOTICS SD 1LE1573, 1LE5773

Special versions	Additional identification code -Z with order code and plain text if required	Frame size											Motor version		
		80	90	100	112	132	160	180	200	225	250	280	315	IEC	IE3
		1LE1073						1LE1573					1LE5773		
1LE1 -Z		Order code													
Special technology ⁵⁾ (continued)															
Mounting of rotary pulse encoder HOG 10 DN 1024 I + FSL, (integrated centrifugal switch, speed ... rpm), terminal box moisture protection	Y74 • and spec. speed rpm	-	-	-	-	-	-	✓	✓	✓	✓	✓	✓		
Mounting of rotary pulse encoder HOG 10 DN 1024 I + FSL, (integrated centrifugal switch, speed rpm), terminal box dust protection	Y76 • and spec. speed rpm	-	-	-	-	-	-	✓	✓	✓	✓	✓	✓		
Mounting of rotary pulse encoder HOG 10 DN 1024 I + ESL 93, (integrated electronic speed switch, speed rpm), terminal box dust protection	Y79 • and spec. speed (max 3) rpm	-	-	-	-	-	-	✓	✓	✓	✓	✓	✓		
Mechanical version and degrees of protection															
Low-noise version for 2-pole motors with clockwise direction of rotation	F77	-	-	-	-	✓	✓	✓	✓	✓	✓	✓	✓		
Low-noise version for 2-pole motors with counterclockwise direction of rotation	F78	-	-	-	-	✓	✓	✓	✓	✓	✓	✓	✓		
Prepared for mounted components, centering hole only	G40	✓	✓	✓	✓	✓	✓	□	□	□	□	□	□		
Prepared for mountings with D12 shaft	G41	✓	✓	✓	✓	✓	✓	✓	✓	✓	✓	✓	✓		
Prepared for mountings with D16 shaft	G42	✓	✓	✓	✓	✓	✓	✓	✓	✓	✓	✓	✓		
Mechanical protection for encoder	G43	✓	✓	✓	✓	✓	✓	✓	✓	✓	✓	✓	✓		
Protective cover ^{7) 9)}	H00	✓	✓	✓	✓	✓	✓	✓	✓	✓	✓	✓	✓		
Screwed-on (instead of cast) feet	H01	□	□	□	□	□	□	□	□	□	□	□	-		
Vibration-proof version; vibration resistance to Class 3M4 according to IEC 60721-3-3:1994 ²⁹⁾	H02	✓	✓	✓	✓	✓	✓	✓	✓	✓	✓	✓	✓		
Condensation drainage holes ²⁸⁾	H03	✓	✓	✓	✓	✓	✓	□	□	□	□	□	□		
Rust-resistant screws (externally)	H07	✓	✓	✓	✓	✓	✓	✓	✓	✓	✓	✓	✓		
Degree of protection IP66	H19	✓	✓	✓	✓	✓	✓	✓	✓	✓	✓	✓	✓		
Degree of protection IP56 ¹²⁾	H22	✓	✓	✓	✓	✓	✓	✓	✓	✓	✓	✓	✓		
Drive-end seal for flange-mounting motors, oil-tight to 0.1 bar ^{10) 21)}	H23	✓	✓	✓	✓	✓	✓	✓	✓	✓	✓	✓	✓		
Grounding brush for converter operation	L52	-	-	-	-	-	-	-	-	-	-	✓	✓		
Coolant temperature and installation altitude															
Coolant temperature -50 to +40 °C	D02	-	-	-	-	-	-	✓	✓	✓	✓	✓	✓		
Coolant temperature -40 to +40 °C ¹³⁾	D03	✓	✓	✓	✓	✓	✓	✓	✓	✓	✓	✓	✓		
Coolant temperature -30 to +40 °C	D04	✓	✓	✓	✓	✓	✓	✓	✓	✓	✓	✓	✓		
Bearings and lubrication															
Regreasing device with M10 x 1 grease nipple according to DIN 71412-A ¹⁾	L19	-	-	-	-	-	-	✓	✓	✓	✓	○	○		
Located bearing DE	L20	✓	✓	✓	✓	✓	✓	✓	✓	✓	✓	✓	✓		
Located bearing NDE	L21	✓	✓	✓	✓	✓	□	□	□	□	□	□	□		
Bearing design for increased cantilever forces ²⁷⁾	L22	✓	✓	✓	✓	✓	✓	✓	✓	✓	✓	✓	✓		
Regreasing device ¹⁾	L23	-	-	✓	✓	✓	✓	✓	✓	✓	✓	□	□		
Bearings reinforced at both ends for DE and NDE, bearing size 63 ¹⁴⁾	L25	✓	✓	✓	✓	✓	✓	✓	✓	✓	✓	□	□		
Reinforced bearings at both DE and NDE, DE bearing for increased cantilever forces	L28	-	-	-	-	-	-	✓	✓	✓	✓	-	-		
Bearing insulation DE	L50	-	-	-	-	-	-	-	-	✓	✓	✓	✓		
Bearing insulation NDE	L51	-	-	✓	✓	✓	✓	✓	✓	✓	✓	✓	✓		
Measuring nipple for SPM shock pulse measurement for bearing inspection ¹⁾	Q01	-	-	✓	✓	✓	✓	✓	✓	✓	✓	✓	✓		
Balance and vibration severity															
Vibration severity grade A		□	□	□	□	□	□	□	□	□	□	□	□		
Vibration severity grade B ¹⁵⁾	L00	✓	✓	✓	✓	✓	✓	✓	✓	✓	✓	✓	✓		
Half-key balancing (standard)		□	□	□	□	□	□	□	□	□	□	□	□		
Balancing without feather key	L01	✓	✓	✓	✓	✓	✓	✓	✓	✓	✓	✓	✓		
Full-key balancing	L02	✓	✓	✓	✓	✓	✓	✓	✓	✓	✓	✓	✓		

3

SIMOTICS GP and SIMOTICS SD standard motors

Article No. supplements and special versions · Options

Aluminum series SIMOTICS GP 1LE1073 and cast-iron series SIMOTICS SD 1LE1573, 1LE5773

Special versions	Additional identification code -Z with order code and plain text if required	Frame size											Motor version		
		80	90	100	112	132	160	180	200	225	250	280	315	IEC	IE3
		1LE1073						1LE1573				1LE5773			
1LE1 -Z		Order code													
Shaft and rotor															
Shaft extension with standard dimensions, without feather keyway	L04	✓	✓	✓	✓	✓	✓	✓	✓	✓	✓	✓	✓		
Standard, cylindrical shaft extension (second shaft extension) NDE acc. to EN 50347	L05	✓	✓	✓	✓	✓	✓	✓	✓	✓	✓	✓	✓		
Standard shaft made of stainless steel (e.g. 1.4021)	L06	✓	✓	✓	✓	✓	✓	✓	✓	✓	✓	✓	✓		
Shaft extension run-out in accordance with IEC 60072-1 precision class	L07	✓	✓	✓	✓	✓	✓	✓	✓	✓	✓	✓	✓		
Shaft extension run-out, concentricity and perpendicularity in accordance with IEC 60072-1 precision class for flange-mounted motors	L08	✓	✓	✓	✓	✓	✓	✓	✓	✓	✓	✓	✓		
Non-standard cylindrical shaft extension, DE ¹⁶⁾	Y58 • and customer specifications	✓	✓	✓	✓	✓	✓	✓	✓	✓	✓	✓	✓		
Non-standard cylindrical shaft extension, NDE ¹⁶⁾	Y59 • and customer specifications	✓	✓	✓	✓	✓	✓	✓	✓	✓	✓	✓	✓		
Special shaft steel	Y60 • and customer specifications	-	-	-	-	-	-	O. R.	O. R.	O. R.	O. R.	O. R.	O. R.	O. R.	
Heating and ventilation															
Sheet metal fan cover	F74	✓	✓	✓	✓	✓	✓	✓	✓	✓	✓	✓	✓		
Metal external fan ^{17) 29)}	F76	✓	✓	✓	✓	✓	✓	✓	✓	✓	✓	✓	✓		
Without external fan and without fan cover	F90	✓	✓	✓	✓	✓	✓	✓	✓	✓	✓	✓	✓		
Anti-condensation heating for 230 V (2 terminals)	Q02	✓	✓	✓	✓	✓	✓	✓	✓	✓	✓	✓	✓		
Anti-condensation heating for 115 V (2 terminals)	Q03	✓	✓	✓	✓	✓	✓	✓	✓	✓	✓	✓	✓		
Separately driven fan with non-standard voltage and/or frequency	Y81 • and customer specifications	-	-	-	-	-	-	-	-	✓	✓	✓	✓		
Rating plate and additional rating plates															
Second rating plate, loose	M10	✓	✓	✓	✓	✓	✓	✓	✓	✓	✓	✓	✓		
Rating plate, stainless steel	M11	□	□	□	□	□	□	□	□	□	□	□	□		
Additional rating plate with deviating rating plate data	Y80 • and customer specifications	✓	✓	✓	✓	✓	✓	✓	✓	✓	✓	✓	✓		
Additional rating plate with customer specifications	Y82 • and customer specifications	✓	✓	✓	✓	✓	✓	✓	✓	✓	✓	✓	✓		
Additional information on rating plate and on package label (max. 20 characters)	Y84 • and customer specifications	✓	✓	✓	✓	✓	✓	✓	✓	✓	✓	✓	✓		
Adhesive label, supplied loose (printed with: Article No., Serial No.; 2 lines of text)	Y85 • and customer specifications	-	-	✓	✓	✓	✓	✓	✓	✓	✓	✓	✓		
Packaging, safety notes, documentation and test certificates															
Inspection certificate 3.1 ¹⁸⁾ according to EN 10204	B02	✓	✓	✓	✓	✓	✓	✓	✓	✓	✓	✓	✓		
Document - Electrical datasheet	B60	✓	✓	✓	✓	✓	✓	✓	✓	✓	✓	✓	✓		
Document - Order dimensional drawing	B61	✓	✓	✓	✓	✓	✓	✓	✓	✓	✓	✓	✓		
Standard test (routine test) with acceptance	B65	-	-	✓	✓	✓	✓	✓	✓	✓	✓	✓	✓		
Type test with heat run for horizontal motors, without acceptance	B82	✓	✓	✓	✓	✓	✓	✓	✓	✓	✓	✓	✓		
Type test with heat run for horizontal motors, with acceptance	B83	✓	✓	✓	✓	✓	✓	✓	✓	✓	✓	✓	✓		
Connected in star for dispatch	M01	✓	✓	✓	✓	✓	✓	✓	✓	✓	✓	✓	✓		
Connected in delta for dispatch	M02	✓	✓	✓	✓	✓	✓	✓	✓	✓	✓	✓	✓		

For legends and footnotes, see page 3/143.

SIMOTICS GP and SIMOTICS SD standard motors

Article No. supplements and special versions · Options

Aluminum series SIMOTICS GP 1LE1073 and cast-iron series SIMOTICS SD 1LE1573, 1LE5773

- Standard version
- Without additional charge
- This order code only determines the price of the version – Additional plain text is required.
- ✓ With additional charge
- O. R. Possible on request
- Not possible

- 1) Up to frame size 160 not possible when brake is mounted.
- 2) Evaluation with appropriate tripping unit (see Catalog IC 10) is recommended.
- 3) Parallel Whitworth threaded pipe DIN ISO 228 (DIN 259) BSPP (British Standard Pipe Parallel) threaded pipe for connections not sealed in the thread (cylindrical), external = G.
- 4) Cannot be used for motors in UL version (order code **D31**). The grease lifetime specified in Catalog Section 1 "Introduction" refers to CT 40 °C. If the coolant temperature is increased by 10 K, the grease lifetime and regreasing interval are halved.
- 5) A second shaft extension is not possible. Please inquire for mounted brakes.
- 6) For order codes **F10**, **F11**, **F12**, **F17**, and **F18**, the brake supply voltage must be specified or ordered.
- 7) LL and HOG rotary pulse encoders up to frame size 160 are fitted with a protective cover as standard. The protective cover is omitted at the factory when a rotary pulse encoder is combined with a separately driven fan, because in this case the rotary pulse encoder is installed under the fan cover.
- 8) Option (encoder mounting) is only possible for motors with a mounted separately driven fan or for naturally cooled motors (without an external fan). This option can be used in combination with brakes of type KFB! This option cannot be used in combination with brakes of type 2LM8!
- 9) Order code **H00** provides mechanical protection for encoders.
- 10) Not possible for type of construction IM V3.
- 11) Not possible in combination with HOG 9 DN 1024 I rotary pulse encoder (order code **G05**) and/or brake 2LM8 (order code **F01**).
- 12) Not possible in combination with 2LM8 brake – order code **F01**.
- 13) In connection with mountings, the respective technical specifications must be observed, please inquire before ordering.
- 14) From frame size 280 standard version.
- 15) On request for 2-pole motors (concerns frame sizes 225 to 315).
- 16) When motors are ordered that have a longer or shorter shaft extension than normal, the required position and length of the feather keyway must be specified in a sketch. It must be ensured that only feather keys in accordance with EN 50347, Form A are used. The feather keyway is positioned centrally on the shaft extension. The length is defined by the manufacturer in accordance with the appropriate standard. Not valid for: Conical shafts, non-standard threaded journals, non-standard shaft tolerances, friction welded journals, extremely "thin" shafts, special geometry dimensions (e.g. square journals), hollow shafts. Valid for non-standard shaft extensions DE or NDE. The feather keys are supplied in every case. For order codes **Y58**, **Y59** and **L05** the following applies:
 - Dimensions D and DA ≤ ball bearing inner diameter (see dimension tables for "Dimensions")
 - Dimensions E and EA ≤ 2 × length E (standard) of the shaft extension.
- 17) Converter operation is permitted for 1LE1 motors with metal external fans.
- 18) The delivery time for the manufacturer's test certificate may differ from the delivery time for the motor.
- 19) With **H08**, feet dimensions C and CA differ from EN 50347! Further information is available in the DT Configurator (see Appendix, "Tools and engineering").
- 20) Order codes **F70** and **F76** cannot be combined.
- 21) Not possible in combination with order codes **Q72** and **Q78**.
- 22) For frame sizes 100 to 132 only possible in combination with order code **R50**.
- 23) Not possible in combination with order codes **N05**, **N06**, **N07**, **N08**, and **N11**.
- 24) For frame size 315, when combining order codes **F01** and **F12**, the rectifier for the brake will be supplied separately as a single part.
- 25) Order code **S06** cannot be combined with order codes **S00**, **S01**, and **S02**. It can be combined with **Y53** and **Y56** on request.
- 26) Order codes **F70** (separately driven fan) and **H02** (vibration-proof version) cannot be combined for motors in frame sizes 71, 80, and 90.
- 27) A minimum cantilever force F_{\min} of $0.5 \cdot F_{\max}$ is required for NU bearings (cylindrical roller bearings) in contrast to ball bearings. Cylindrical roller bearings are not suitable for coupling output or for brief periods of no-load operation without cantilever force.
- 28) Supplied with the condensation drainage holes sealed at the drive end DE and non-drive end NDE (IP55, IP56, IP65). If the condensation drainage holes are required for motors of the IM B6, IM B7 or IM B8 type of construction (feet on side or top), the motors must be ordered in the respective type of construction and with order code **H03**, so that the condensation drainage holes will be placed in the correct position.
- 29) Not possible in combination with order code **R50**.
- 30) With IM B5 flange, only possible in combination with **H08**.

SIMOTICS GP and SIMOTICS SD standard motors

Article No. supplements and special versions · Accessories

Overview

Couplings

The motor from Siemens is connected to the machine or gear unit through a coupling. Flender is an important coupling manufacturer with a wide range of products.

For standard applications, Siemens recommends that flexible couplings, types N-EUPEX and RUPEX or torsionally rigid couplings, types ARPEX and ZAPEX are used. For special applications, FLUDEX and ELPEX-S couplings are recommended.

Available from:

Siemens contact partner – ordering from catalog
Siemens MD 10.1 "FLENDER Standard Couplings"

or

Flender GmbH
Kupplungswerk Mussum
Industriepark Bocholt
Schlavenhorst 100
46395 Bocholt, Germany
Phone +49 (2871) 922185
Fax +49 (2871) 922579

www.flender.com

Email: flender-kupplungen-2.pd.de@siemens.com

Taper pins according to DIN 258 with threaded ends and constant taper lengths

Taper pins are used for components that are repeatedly removed. The drilled hole is conically ground using a conical reamer until the pin can be pushed in by hand until the cone shoulder lies approx. 3 to 4 mm above the rim of the hole.

It can then be driven in using a hammer until it is correctly seated. The pin is removed from the drilled hole by screwing on the nut and tightening it.

Standardized taper pins are commercially available.

For instance, available from:

Otto Roth GmbH & Co. KG
Rutesheimer Strasse 22
70499 Stuttgart, Germany
Phone +49 (711) 1388-0
Fax +49 (711) 1388-233

www.ottoroth.de

Email: info@ottoroth.de

Foundation block according to DIN 799

The foundation blocks are inserted into the stone foundation and embedded in concrete. They are used for fixing machines of medium size, slide rails, pedestal bearings, base frames, etc. After the fixing bolts have been unscrewed, the machines can be shifted without them having to be lifted.

When the machine is initially installed, the foundation block that is bolted to the machine (without washers) and fitted with taper pins is not embedded with concrete until the machine has been fully aligned. In this case, the machine is positioned 2 to 3 mm lower. The difference in shaft height is compensated by inserting shims on final installation. The taper pins safeguard the exact position of the machine when it is repeatedly removed and replaced without the need for realignment.

Available from:

Lütgert & Co. GmbH
Postfach 42 51
33276 Gütersloh, Germany
Phone +49 (5241) 7407-0
Fax +49 (5241) 7407-90

www.luetgert-antriebe.de

Email: info@luetgert-antriebe.de

Slide rails with fixing bolts and tensioning screws according to DIN 42923

Slide rails are used to tension the belt of a machine easily and conveniently when there is no belt-tensioning pulley. They are fixed to the base using stone bolts or foundation blocks.

The assignment of slide rails to motor size can be found in DIN 42923.

For motors of frame sizes 355 to 450, there are no standardized slide rails (please inquire).

Available from:

Lütgert & Co. GmbH
Postfach 42 51
33276 Gütersloh, Germany
Phone +49 (5241) 7407-0
Fax +49 (5241) 7407-90

www.luetgert-antriebe.de

Email: info@luetgert-antriebe.de

More information

Replacement motors and repair parts

- Commitment to provide replacement motors and repair parts following delivery of the motor:
 - For up to 3 years after delivery of the original motor, in the event of total motor failure, Siemens will supply a comparable replacement motor with regard to the mounting dimensions and functions (the type series may vary).
 - If a replacement motor is supplied within the 3-year period, this does not mean that the warranty restarts.
 - Replacement motors delivered after the active production of the machine series are also identified as spare motors on the rating plate.
 - Spare parts are offered only for these spare motors on request; repair and replacement are not possible.
 - After a period of 3 years (after the delivery of the original motor), it is only possible to repair these motors (depending on the availability of the spare parts required).
 - For up to 5 years after the delivery of the original motor, spare parts will be available and for a further 5 years, Siemens will provide information about spare parts and will supply documents when required.

- When repair parts are ordered, the following details must be provided:
 - Designation and part number
 - Article No. and factory number of the motor.

Example for ordering a fan cover 1LE1003, frame size 112 M, 4-pole:

Fan cover No. 7.40, 1LE1003-1BB23-4AA4-Z, part No. E1001/5236197_01_001

- For bearing types, see Catalog Section 1 "Introduction".
- Repair parts for 1MJ6, 1MJ7, 1MJ8, 1MJ1, 1ME8, 1ML8 motors are available on request.
- For standard components, a commitment to supply repaired parts does not apply.
- Support hotline
In Germany
Phone +49 (180) 5050448

You will find telephone numbers for other countries on our Internet site:

www.siemens.com/automation/service&support

Overview

- Dimensional designations according to EN 50347 and IEC 60072.

Fits

The shaft extensions specified in the dimension tables (DIN 748) and centering spigot diameters (EN 50347) are machined with the following fits:

Dimension designation	ISO fit DIN ISO 286-2	
D, DA	to 30	j6
	over 30 to 50	k6
	over 50	m6
N	to 250	j6
	over 250	h6
F, FA		h9
K		H17
S	flange (FF)	H17

The drilled holes of couplings and belt pulleys should have an ISO fit of at least H7.

- Dimensional tolerances

For the following dimensions, the admissible deviations are given below:

Dimension designation	Dimension	Admissible deviation
H	to 250	- 0.5
	over 250	- 1.0
E, EA		- 0.5

Keyways and feather keyways (dimensions GA, GC, F, and FA) are made in compliance with DIN 6885 Part 1.

- All dimensions are specified in mm.

Dimension sheet generator (within the DT Configurator)

Overview

A dimensional drawing can be created in the "Drive Technology Configurator" (DT Configurator) for every configurable motor. A dimensional drawing can be requested for every other motor.

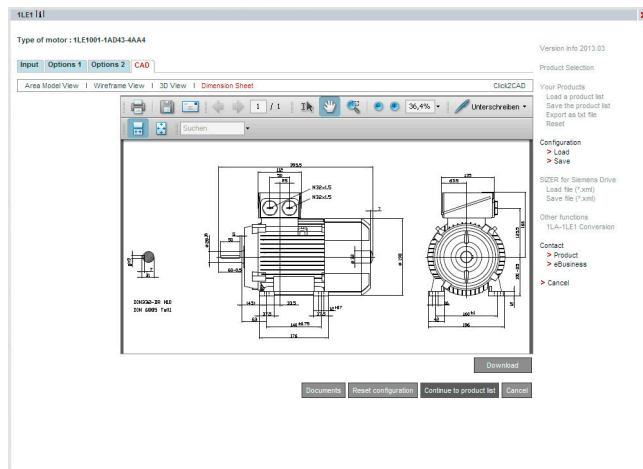

When a complete Article No. is entered with or without order codes, a dimensional drawing can be called up under the "Documentation" tab.

These dimensional drawings can be presented in different views and sections and printed.

The corresponding dimension sheets can be exported, saved and processed further in DXF format (interchange/import format for CAD systems) or as bitmap graphics.

Online access in the Siemens Industry Mall

The DT Configurator is integrated into the Siemens Industry Mall and can be used on the Internet without installation.

German: www.siemens.de/dt-konfigurator
English: www.siemens.com/dt-configurator

SIMOTICS GP and SIMOTICS SD standard motors

Dimensions · Aluminum series SIMOTICS GP

IE1, IE2, NEMA Energy Efficient and pole-changing – self-ventilated · Frame sizes 63 M to 200

Dimensional drawings

Type of construction IM B3

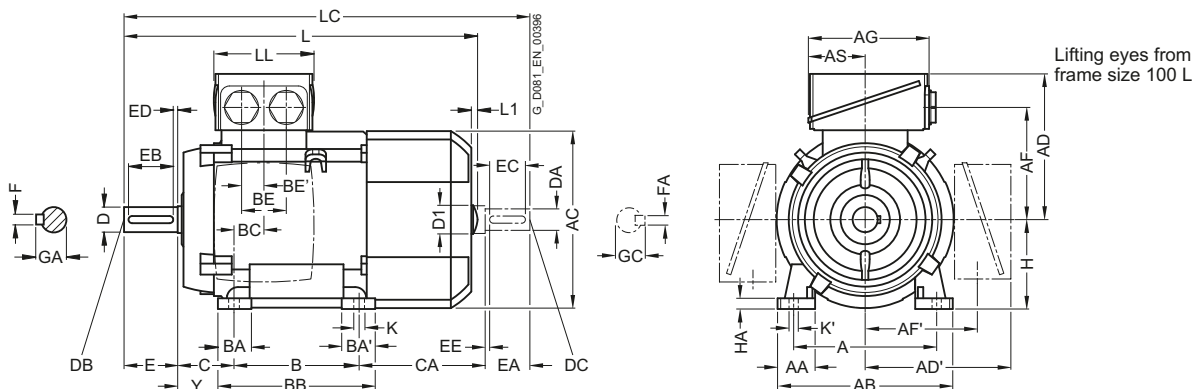

Types of construction IM B5 and IM V1

For flange dimensions, see page 1/48 (Z = the number of retaining holes)

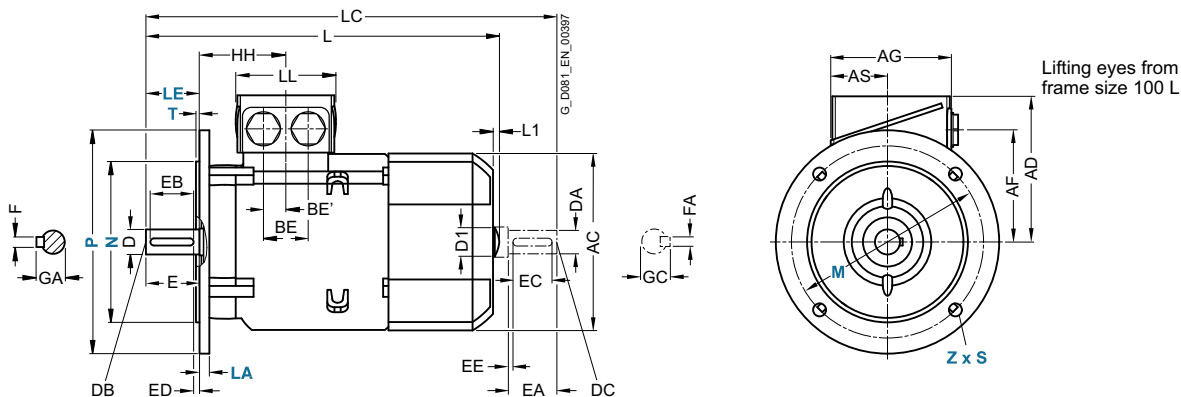

For motor	Motor type	No. of poles	Dimension designation acc. to IEC																					
Frame size			A	AA	AB	AC	AD	AD'	AF	AF'	AG	AS	B	BA	BA'	BB	BC	BE	BE'	C	CA	H	HA	Y
63 M	1LE100. 1LE101. 1LE1021	2, 4, 6	100	27	120	124	101	-	78	-	75	37.5	80	27	-	96	30	32	18	40	66	63	7	32
	1LE1001-0B.2 1LE1002-0B.3 1LE1001-0B.3 1LE1002-0B.6	2, 4																			92			
71 M	1LE1001, 1LE1002	2, 4, 6, 8	112	30.5	132	145	111	-	88	-	75	37.5	90	27	-	106	18	32	18	45	83	71	7	40
80 M	1LE1001	2, 4, 6	125	30.5	150	159	121.5	121.5	96.5	96.5	93	43	100	32	32	118	23	-	18 ¹⁾	50	113	80	8	41
90 S	1LE1041	2, 4, 6	140	30.5	165	178	126	126	101.5	101.5	93	43	100	33	54	143	22.5	-	18 ¹⁾	56	174	90	10	47
90 L		2, 4, 6	140	30.5	165	178	126	126	101.5	101.5	93	43	125	33	54	143	22.5	-	18 ¹⁾	56	174	90	10	47
100 L	All	2, 4, 6, 8	160	42	196	198	166	166	125.5	125.5	135	63.5	140	37.5	37.5	176	33.5	50	25	63	141	100	12	45
112 M	All	2, 4, 6, 8	190	46	226	222	177	177	136.5	136.5	135	63.5	140	37.5	37.5	176	26	50	25	70	130	112	12	52
132 S	All	2, 4, 6, 8	216	53	256	262	202	202	159.5	159.5	155	70.5	140	38	76 ³⁾	218 ⁴⁾	26.5	48	24	89	167	132	15	69
132 M	All	2, 4, 6, 8	216	53	256	262	202	202	159.5	159.5	155	70.5	178	38	76	218	26.5	48	24	89	179	132	15	69
160 M	All	2, 4, 6, 8	254	60	300	314	236.5	236.5	190	190	175	77.5	210	44	89 ⁵⁾	300 ⁶⁾	47	57	28.5	108	192	160	18	85
160 L	All	2, 4, 6, 8	254	60	300	314	236.5	236.5	190	190	175	77.5	254	44	89	300	47	57	28.5	108	148 ²⁾	160	18	85
180 M	All	2, 4, 6, 8	279	65	339	356	259	259	212.5	212.5	175	77.5	241	80	100	328	30	57	28.5	121	232	180	20	95
180 L	All	2, 4, 6, 8	279	65	339	356	259	259	212.5	212.5	175	77.5	279	80	100	328	30	57	28.5	121	194	180	20	95
200 L	All	2, 4, 6, 8	318	70	378	396	296	296	238	238	225	102.5	305	90	100	355	45	75	37.5	133	202	200	25	108

1) Only one termination hole available.

2) Only for pole-changing types 1LE1011-1DP6 and 1LE1012-1DQ6 the dimension CA* is 208 mm.

3) With screwed-on feet, dimension BA' is 38 mm.

4) With screwed-on feet, dimension BB is 180 mm.

5) With screwed-on feet, dimension BA' is 44 mm.

6) With screwed-on feet, dimension BB is 256 mm.

SIMOTICS GP and SIMOTICS SD standard motors

Dimensions · Aluminum series SIMOTICS GP

IE1, IE2, NEMA Energy Efficient and pole-changing – self-ventilated · Frame sizes 63 M to 200

Dimensional drawings

Type of construction IM B35

For flange dimensions, see page 1/48 (Z = the number of retaining holes)

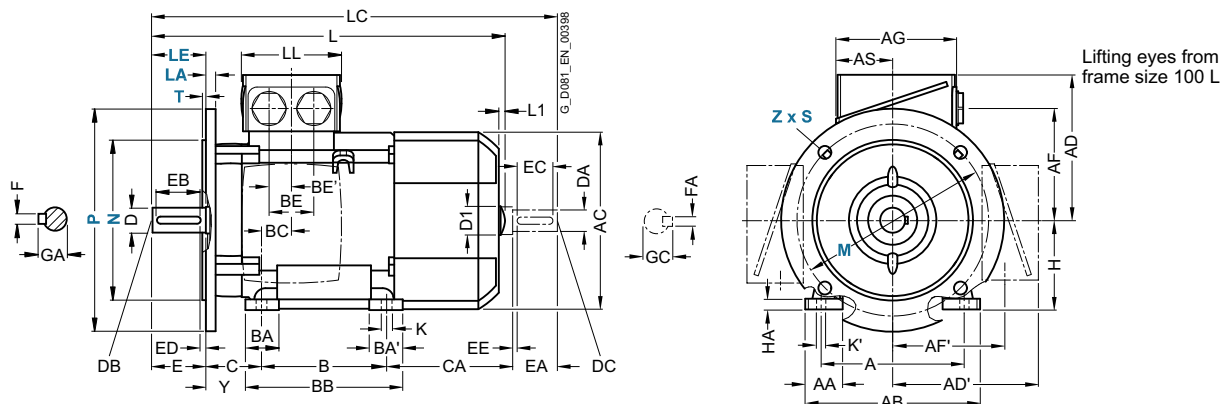

Type of construction IM B14

For flange dimensions, see page 1/48 (Z = the number of retaining holes)

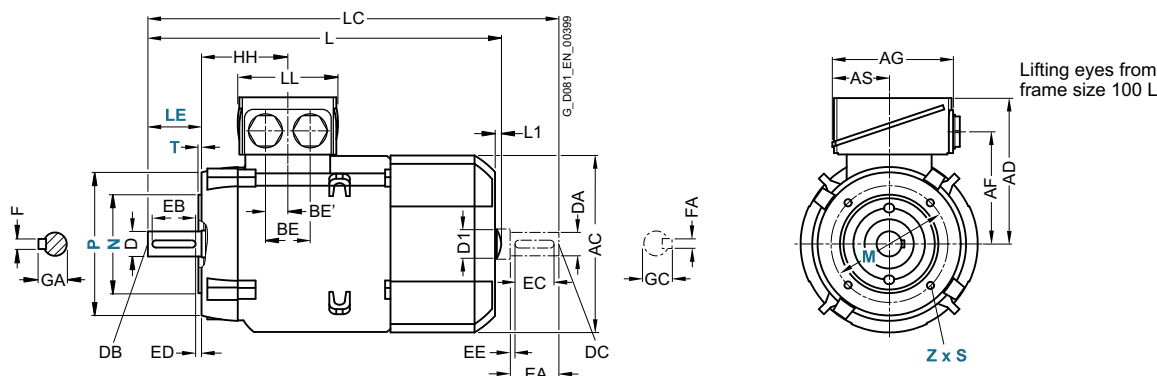

For motor			Dimension designation acc. to IEC					DE shaft extension					NDE shaft extension											
Frame size	Motor type	No. of poles	HH	K	K'	L ¹⁾	L1	D1	LC	LL	D	DB	E	EB	ED	F	GA	DA	DC	EA	EC	EE	FA	GC
63 M	1LE100-0B.2 1LE1001. 1LE1021	2, 4, 6	69.5	7	10	202.5⁴⁾	-	-	232 ⁴⁾	75	11	M4	23	16	3.5	4	12.5	11	M4	23	16	3.5	4	12.5
	1LE1001-0B.3 1LE1002-0B.6	2, 4				228.5			258															
71 M	1LE1001, 1LE1002	2, 4, 6, 8	63.5	7	10	240	-	-	278	75	14	M5	30	22	4	5	16	14	M5	30	22	4	5	16
80 M	1LE1001	2, 4, 6	73	9.5	13.5	292	-	-	342.5	79	19	M6	40	32	4	6	21.5	19	M6	40	32	4	6	21.5
90 S	1LE1041	2, 4, 6	78.5	10	14	347	-	-	405	79	24	M8	50	40	5	8	27	19	M6	40	32	4	6	21.5
90 L		2, 4, 6	78.5	10	14	347	-	-	405	79	24	M8	50	40	5	8	27	19	M6	40	32	4	6	21.5
100 L	All	2, 4, 6, 8	96.5	12	16	395.5	7	32	454	112	28	M10	60	50	5	8	31	24	M8	50	40	5	8	27
112 M	All	2, 4, 6, 8	96	12	16	389	7	32	450	112	28	M10	60	50	5	8	31	24	M8	50	40	5	8	27
						414																		
132 S	All	2, 4, 6, 8	115.5	12	16	465	8.5	39	535.5	130	38	M12	80	70	5	10	41	28	M10	60	50	5	8	31
132 M	All	2, 4, 6, 8	115.5	12	16	465	8.5	39	535.5	130	38	M12	80	70	5	10	41	28	M10	60	50	5	8	31
160 M	All	2, 4, 6, 8	155	15	19	604	10	45	730	145	42	M16	110	90	10	12	45	42	M16	110	90	10	12	45
160 L	All	2, 4, 6, 8	155	15	19	604²⁾	10	45	730 ³⁾	145	42	M16	110	90	10	12	45	42	M16	110	90	10	12	45
180 M	All	2, 4, 6, 8	151	14.5	19	698	-	-	814	145	48	M16	110	100	5	14	52	48	M16	110	100	5	14	52
180 L	All	2, 4, 6, 8	151	14.5	19	698	-	-	814	145	48	M16	110	100	5	14	52	48	M16	110	100	5	14	52
200 L	All	2, 4, 6, 8	178	18.5	25	746	-	-	860	185	55	M20	110	100	5	16	59	55	M20	110	100	5	16	59

¹⁾ The length is specified as far as the tip of the fan cover.

²⁾ Only for pole-changing types 1LE1011-1DP6 and 1LE1012-1DQ6 the dimension L is 664 mm.

³⁾ Only for pole-changing types 1LE1011-1DP6 and 1LE1012-1DQ6 the dimension LC is 790 mm.

⁴⁾ For 1LE1002-0B.3 with the type of construction code letters (14th position of the article number) **F, G, H** (IM B5, IM V1 without protective cover, IM V3) is dimension L 228.5 mm. Dimension LC is 258 mm.

SIMOTICS GP and SIMOTICS SD standard motors

Dimensions · Aluminum series SIMOTICS GP

IE1, IE2 – self-ventilated with increased power · Frame sizes 80 M to 200 L

Dimensional drawings

Type of construction IM B3

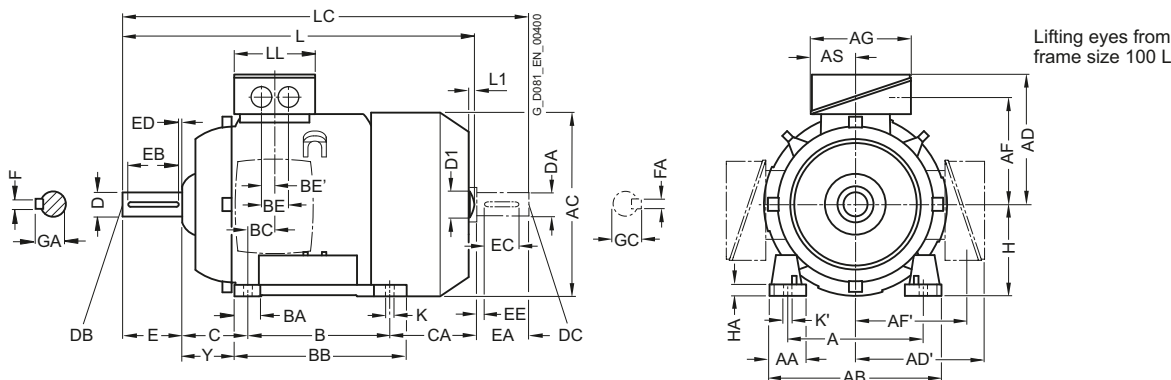

Types of construction IM B5 and IM V1

For flange dimensions, see page 1/48 (Z = the number of retaining holes)

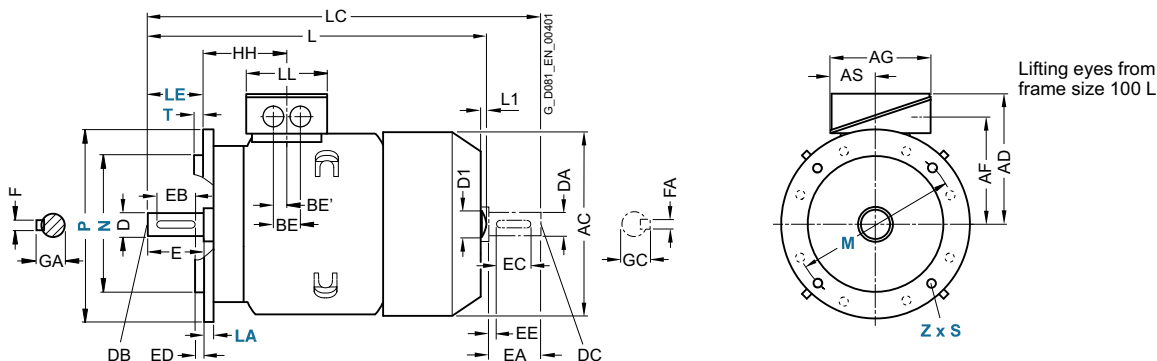

For motor		Dimension designation acc. to IEC																						
Frame size	Motor type	No. of poles	A	AA	AB	AC	AD	AD'	AF	AF'	AG	AS	B	BA	BA'	BB	BC	BE	BE'	C	CA	H	HA	Y
80 M	All	2, 4	125	30.5	150	159	121.5	121.5	96.5	96.5	93	43	100	32	32	118	23	–	18 ¹⁾	50	148	80	8	41
90 L	All	2, 4	140	30.5	165	178	126	126	101.5	101.5	93	43	125	33	54	143	22.5	–	18 ¹⁾	56	174	90	10	47
100 L	All	2, 4, 6, 8	160	42	196	198	166	166	125.5	125.5	135	63.5	140	37.5	37.5	176	33.5	50	25	63	176	100	12	45
112 M	All	2, 4, 6, 8	190	46	226	222	177	177	136.5	136.5	135	63.5	140	37.5	37.5	176	26	50	25	70	155	112	12	52
132 M	All	2, 4, 6, 8	216	53	256	262	202	202	159.5	159.5	155	70.5	178	38	76	218	26.5	48	24	89	179	132	15	69
160 L	All	2, 4, 6, 8	254	60	300	314	236.5	236.5	190	190	175	77.5	254	44	89	300	47	57	28.5	108	208	160	18	85
180 L	1LE1001 1LE1002	2, 4, 6, 8	279	65	339	356	259	259	212.5	212.5	175	77.5	279	80	100	328	30	57	28.5	121	194	180	20	95
200 L	1LE1001 1LE1002	2, 4, 6, 8	318	70	378	396	296	296	238	238	225	102.5	305	90	100	355	45	75	37.5	133	202	200	25	108

¹⁾ Only one termination hole available.

SIMOTICS GP and SIMOTICS SD standard motors

Dimensions · Aluminum series SIMOTICS GP

IE1, IE2 – self-ventilated with increased power · Frame sizes 80 M to 200 L

Dimensional drawings

Type of construction IM B35

For flange dimensions, see page 1/48 (Z = the number of retaining holes)

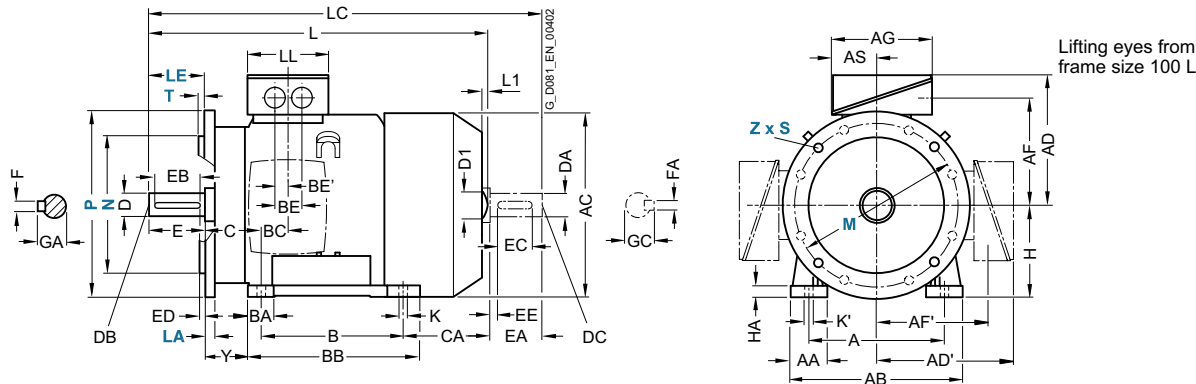

Type of construction IM B14

For flange dimensions, see page 1/48 (Z = the number of retaining holes)

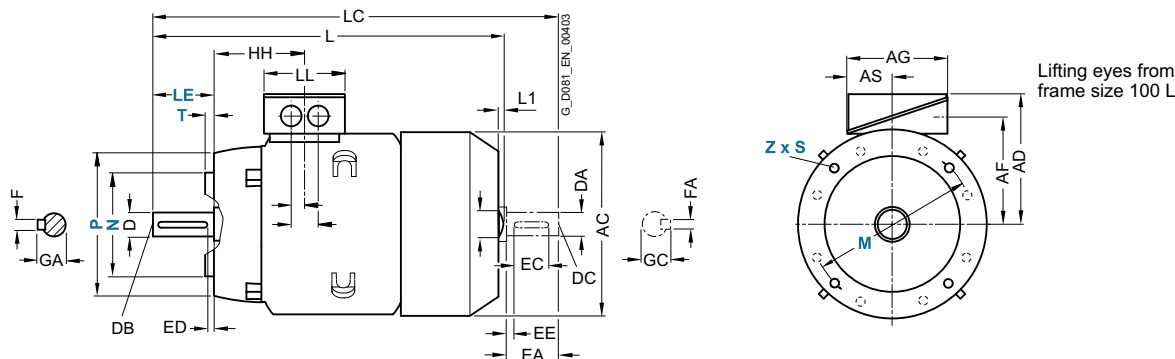

For motor			Dimension designation acc. to IEC							DE shaft extension					NDE shaft extension									
Frame size	Motor type	No. of poles	HH	K	K'	L ¹⁾	L1	D1	LC	LL	D	DB	E	EB	ED	F	GA	DA	DC	EA	EC	EE	FA	GC
80 M	All	2, 4	73	9.5	13.5	327	327	–	378	79	19	M6	40	32	4	6	21.5	19	M6	40	32	4	6	21.5
90 L	All	2, 4	78.5	10	14	387	–	–	445	79	24	M8	50	40	5	8	27	19	M6	40	32	4	6	21.5
100 L	All	2, 4, 6, 8	96.5	12	16	430.5	7	32	489	112	28	M10	60	50	5	8	31	24	M8	50	40	5	8	27
112 M	All	2, 4, 6, 8	96	12	16	414	7	32	475	112	28	M10	60	50	5	8	31	24	M8	50	40	5	8	27
132 M	All	2, 4, 6, 8	115.5	12	16	515	8.5	39	585.5	130	38	M12	80	70	5	10	41	28	M10	60	50	5	8	31
160 L	All	2, 4, 6, 8	155	15	19	664	10	45	790	145	42	M16	110	90	10	12	45	42	M16	110	90	10	12	45
180 L	1LE1001 1LE1002	2, 4, 6	151	14.5	19	698	–	–	814	145	48	M16	110	100	5	14	52	48	M16	110	100	5	14	52
200 L	1LE1001 1LE1002	2, 4, 6	178	18.5	25	746	–	–	860	185	55	M20	110	100	5	16	59	55	M20	110	100	5	16	59

¹⁾ The length is specified as far as the tip of the fan cover.

SIMOTICS GP and SIMOTICS SD standard motors

Dimensions · Aluminum series SIMOTICS GP

IE1, IE2 – forced-air/naturally cooled · Frame sizes 80 M to 200 L

Dimensional drawings

Type of construction IM B3

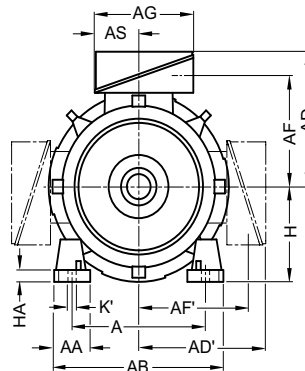
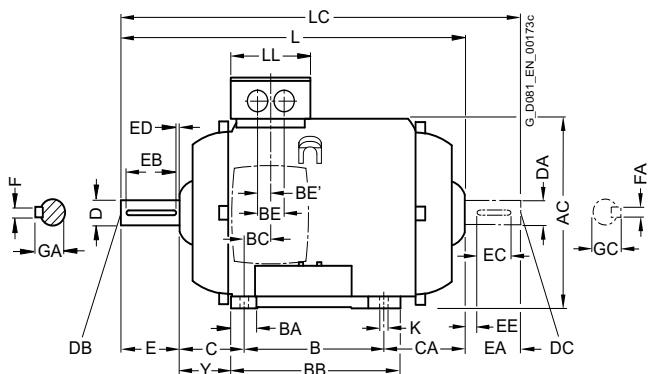

Lifting eyes from frame size 100 L

Only cast housing feet for frame sizes 132 S/M and 160 L/M each have 2 holes at NDE.

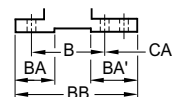

Types of construction IM B5 and IM V1

For flange dimensions, see page 1/48 (Z = the number of retaining holes)

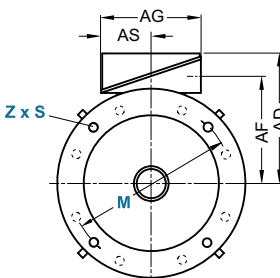
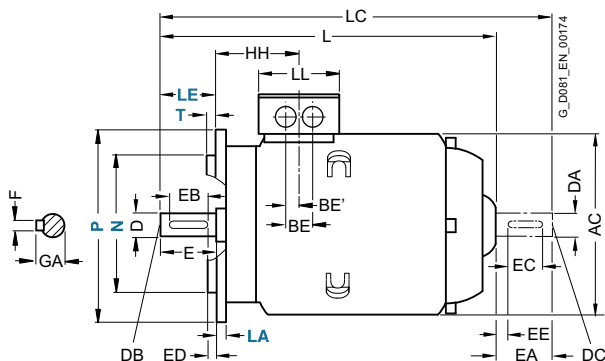

Lifting eyes from frame size 100 L

For motor			Dimension designation acc. to IEC																					
Frame size	Motor type	No. of poles	A	AA	AB	AC	AD	AD'	AF	AF'	AG	AS	B	BA	BA'	BB	BC	BE	BE'	C	CA	H	HA	Y
80 M	1LE1001	2, 4, 6	125	30.5	150	159	121.5	121.5	96.5	96.5	93	43	100	32	32	118	23	-	18 ⁵⁾	50	70.5	80	8	41
	1LE1021	2, 4, 6					149.5	149.5	112.5	112.5	119.5	61.5												
90 S	1LE1001	2, 4, 6	140	30.5	165	178	126	126	101.5	101.5	93	43	100	33	54	143	22.5	- ⁵⁾	18 ⁵⁾	56	103	90	10	47
	1LE1021	2, 4, 6					154.5	154.5	117.5	117.5	119.5	61.5												
90 L	1LE1001	2, 4, 6	140	30.5	165	178	126	126	101.5	101.5	93	43	125	33	54	143	22.5	- ⁵⁾	18 ⁵⁾	56	78	90	10	47
	1LE1021	2, 4, 6					154.5	154.5	117.5	117.5	119.5	61.5												
100 L	All	2, 4, 6, 8	160	42	196	198	166	166	125.5	125.5	135	63.5	140	37.5	37.5	176	33.5	50	25	63	63	100	12	45
112 M	All	2, 4, 6, 8	190	46	226	222	177	177	136.5	136.5	135	63.5	140	37.5	37.5	176	26	50	25	70	45	112	12	52
																					70			
132 S	All	2, 4, 6, 8	216	53	256	261	202	202	159.5	159.5	155	70.5	140	38	76 ¹⁾	218 ²⁾	26.5	48	24	89	77	132	15	69
132 M	All	2, 4, 6, 8	216	53	256	261	202	202	159.5	159.5	155	70.5	178	38	76	218	26.5	48	24	89	39	132	15	69
160 M	All	2, 4, 6, 8	254	60	300	314	236.5	236.5	190	190	175	77.5	210	44	89 ³⁾	300 ⁴⁾	47	57	28.5	108	92	160	18	85
160 L	All	2, 4, 6, 8	254	60	300	314	236.5	236.5	190	190	175	77.5	254	44	89	300	47	57	28.5	108	48	160	18	85
180 M	1LE1001 1LE1021	2, 4, 6, 8	279	65	339	356	259	259	212.5	212.5	175	77.5	241	80	100	328	30	57	28.5	121	124	180	20	95
200 L	1LE1001 1LE1021	2, 4, 6, 8	318	70	378	396	296	296	238	238	225	102.5	305	90	100	355	45	75	37.5	133	101	200	25	108

1) With screwed-on feet, dimension BA' is 38 mm.
 2) With screwed-on feet, dimension BB is 180 mm.
 3) With screwed-on feet, dimension BA' is 44 mm.
 4) With screwed-on feet, dimension BB is 256 mm.

5) Only one termination hole available, except for 1LE1021. In this case, dimension BE is 32 mm.

SIMOTICS GP and SIMOTICS SD standard motors

Dimensions · Aluminum series SIMOTICS GP

IE1, IE2 – forced-air/naturally cooled · Frame sizes 80 M to 200 L

Dimensional drawings

Type of construction IM B35

For flange dimensions, see page 1/48 (Z = the number of retaining holes)

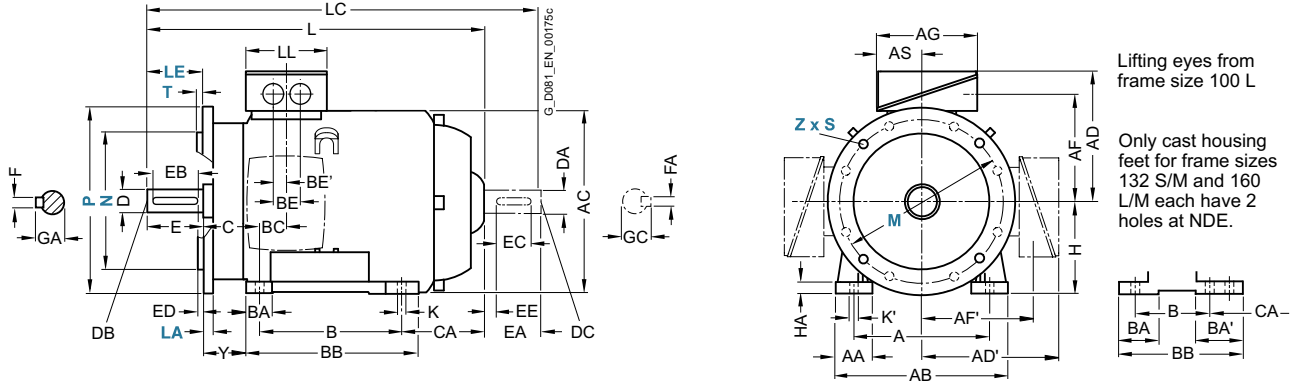

Type of construction IM B14

For flange dimensions, see page 1/48 (Z = the number of retaining holes)

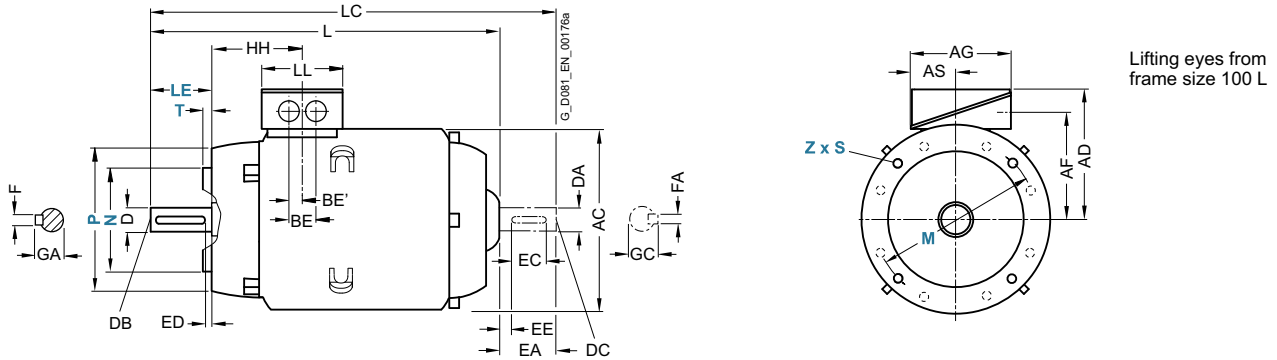

For motor			Dimension designation acc. to IEC						DE shaft extension					NDE shaft extension								
Frame size	Motor type	No. of poles	HH	K	K'	L	LC	LL	D	DB	E	EB	ED	F	GA	DA	DC	EA	EC	EE	FA	GC
80 M	1LE1001	2, 4, 6	73	9.5	13.5	253	300.5	79	19	M6	40	32	4	6	21.5	19	M6	40	32	4	6	21.5
	1LE1021	2, 4, 6						123														
90 S	1LE1021	2, 4, 6	78.5	10	14	294.5	349	79	24	M8	50	40	5	8	27	19	M6	40	32	4	6	21.5
	1LE1021	2, 4, 6						123														
90 L	1LE1021	2, 4, 6	78.5	10	14	294.5	349	123	24	M8	50	40	5	8	27	19	M6	40	32	4	6	21.5
	1LE1021	2, 4, 6						123														
100 L	All	2, 4, 6, 8	96.5	12	16	324	376	112	28	M10	60	50	5	8	31	24	M8	50	40	5	8	27
112 M	All	2, 4, 6, 8	96	12	16	311	365	112	28	M10	60	50	5	8	31	24	M8	50	40	5	8	27
						336	390															
132 S	All	2, 4, 6, 8	115.5	12	16	380.5	446	130	38	M12	80	70	5	10	41	28	M10	60	50	5	8	31
132 M	All	2, 4, 6, 8	115.5	12	16	380.5	446	130	38	M12	80	70	5	10	41	28	M10	60	50	5	8	31
160 M	All	2, 4, 6, 8	155	15	19	510	630	145	42	M16	110	90	10	12	45	42	M16	110	90	10	12	45
160 L	All	2, 4, 6, 8	155	15	19	510	630	145	42	M16	110	90	10	12	45	42	M16	110	90	10	12	45
180 M	1LE1001	2, 4, 6, 8	151	14.5	19	698	706	145	48	M16	110	100	5	14	52	48	M16	110	100	5	14	51.5
	1LE1021																					
200 L	1LE1001	2, 4, 6, 8	178	18.5	25	746	759	185	55	M20	110	100	5	16	59	55	M20	110	100	100	16	59
	1LE1021																					

SIMOTICS GP and SIMOTICS SD standard motors

Dimensions · Aluminum series SIMOTICS GP

IE3, NEMA Premium Efficient – self-ventilated · Frame sizes 80 M to 90 L

Dimensional drawings

Type of construction IM B3

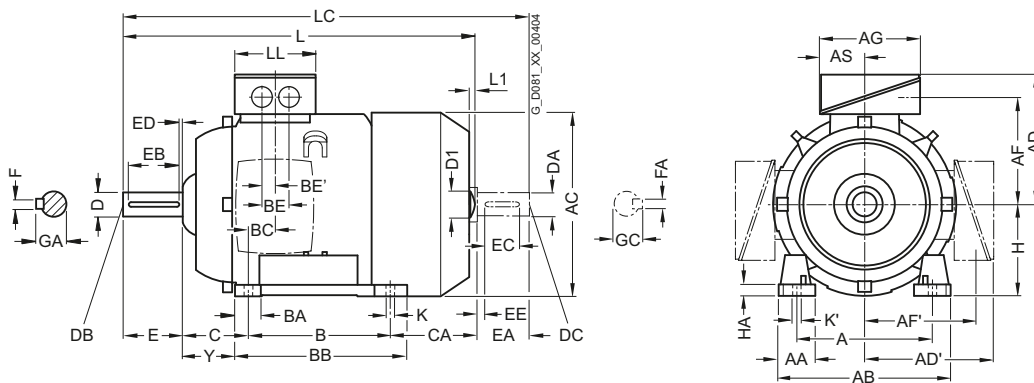

Types of construction IM B5 and IM V1

For flange dimensions, see page 1/48 (Z = the number of retaining holes)

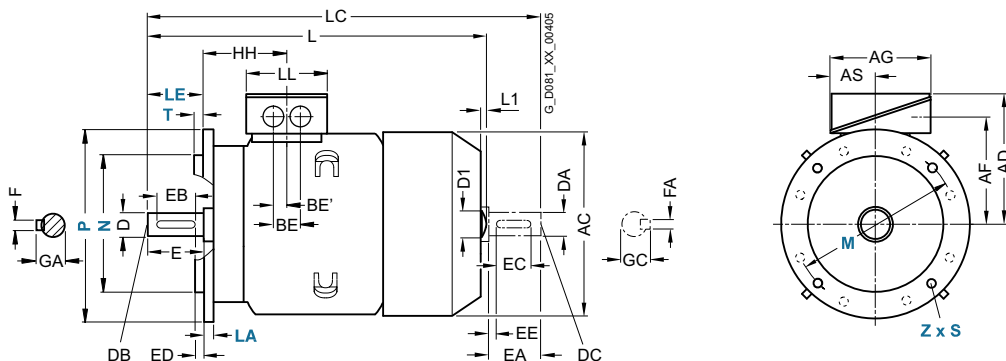

For motor		Dimension designation acc. to IEC																					
Frame size	Motor type	No. of poles	A	AA	AB	AC	AD	AD'	AF	AF'	AG	AS	B	BA	BB	BC	BE	BE'	C	CA	H	HA	Y
80 M	1LE1003, 1LE1043	2, 4, 6, 8	125	30,5	150	159	121,5	121,5	96,5	96,5	93	43	100	32	118	23	- ¹⁾	18 ¹⁾	50	113	80	8	41
	-ODA2, -ODB2, -ODC2, -ODD2, -ODA3, -ODB3, -ODC3, -ODD3																						148
	1LE1023-ODA2, -ODB2, -ODC2, -ODD2, -ODA3, -ODB3, -ODC3, -ODD3						149,5	149,5	112	112	119,5	61,5						50	25		113		
90 S	1LE1003, 1IE1043	2, 4, 6, 8	140	30,5	165	178	126	126	101,5	101,5	93	43	100	33	143	22,5	- ¹⁾	18 ¹⁾	56	159	90	10	47
	-0EA0, -0EB0, -0EC0, -0ED0																						
	1LE1023-0EA0, -0EB0, -0EC0, -0ED0						154,5		117,5	117	119,5	61,5											
90 L	1LE1003, 1LE1043	2, 4, 6, 8	140	30,5	165	178	126	126	101,5	101,5	93	43	125	33	143	22,5	- ¹⁾	18 ¹⁾	56	174	90	10	47
	-0EA4, -0EB4, -0EC4, -0ED4																						134
	1LE1023-0EA4, -0EB4, -0ED4						154,5		117,5	117,5	119,5	61,5											134

¹⁾ Only one termination hole available, except for 1LE1023. In this case, dimension BE is 32 mm.

SIMOTICS GP and SIMOTICS SD standard motors

Dimensions · Aluminum series SIMOTICS GP

IE3, NEMA Premium Efficient – self-ventilated · Frame sizes 80 M to 90 L

Dimensional drawings

Type of construction IM B35

For flange dimensions, see page 1/48 (Z = the number of retaining holes)

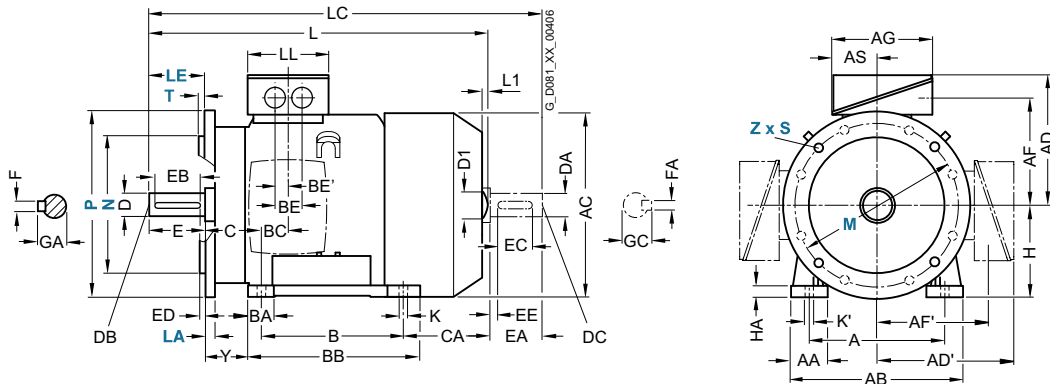

Type of construction IM B14

For flange dimensions, see page 1/48 (Z = the number of retaining holes)

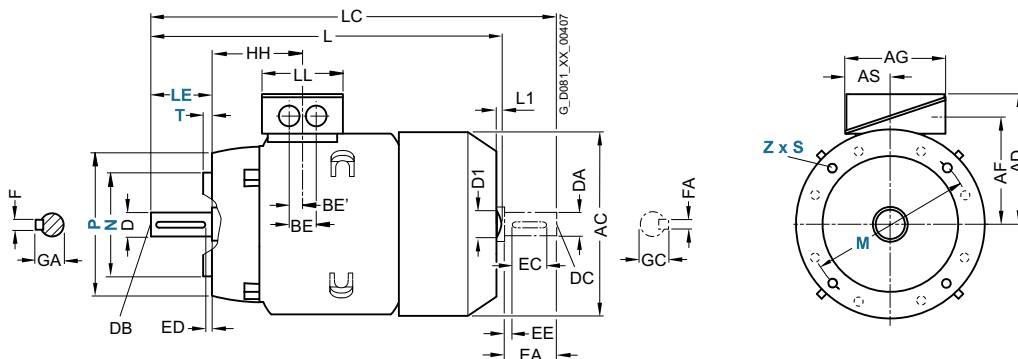

Frame size	Motor type	No. of poles	Dimension designation acc. to IEC							DE shaft extension						NDE shaft extension								
			HH	K	K'	L ¹⁾	L1	D1	LC	LL	D	DB	E	EB	ED	F	GA	DA	DC	EA	EC	EE	FA	GC
80 M	1LE1003, 1LE1043	2, 4, 6, 8	73	9,5	13,5	292	-	-	343	79	19	M6	40	32	4	6	21,5	19	M6	40	32	4	6	21,5
	-0DA2, -0DB2,					327			378															
	-0DC2, -0DD2,																							
	-0DA3, -0DB3,																							
	1LE1023-0DA2,					292			343	123														
	-0DB2, -0DC2,					327			378															
	-0DD2																							
	-0DA3, -0DB3,																							
	-0DC3, -0DD3																							
90 S	1LE1003, 1IE1043	2, 4, 6, 8	78,5	10	14	347	-	-	405	79	24	M8	50	40	5	8	27	19	M6	40	32	4	6	21,5
	-0EA0, -0EB0,																							
	-0EC0, -0ED0																							
	1LE1023-0EA0,									123														
	-0EB0, -0EC0,																							
	-0ED0																							
90 L	1LE1003, 1LE1043	2, 4, 6, 8	78,5	10	14	387	-	-	445	79	24	M8	50	40	5	8	27	19	M6	40	32	4	6	21,5
	-0EA4, -0EB4																							
	-0EC4																							
	-0ED4					347			405															
	1LE1023-0EA4,									123														
	-0EB4,																							
	-0ED4																							

¹⁾ The length is specified as far as the tip of the fan cover.

SIMOTICS GP and SIMOTICS SD standard motors

Dimensions · Aluminum series SIMOTICS GP

IE3, NEMA Premium Efficient – self-ventilated · Frame sizes 100 L to 200 L

Dimensional drawings

Type of construction IM B3

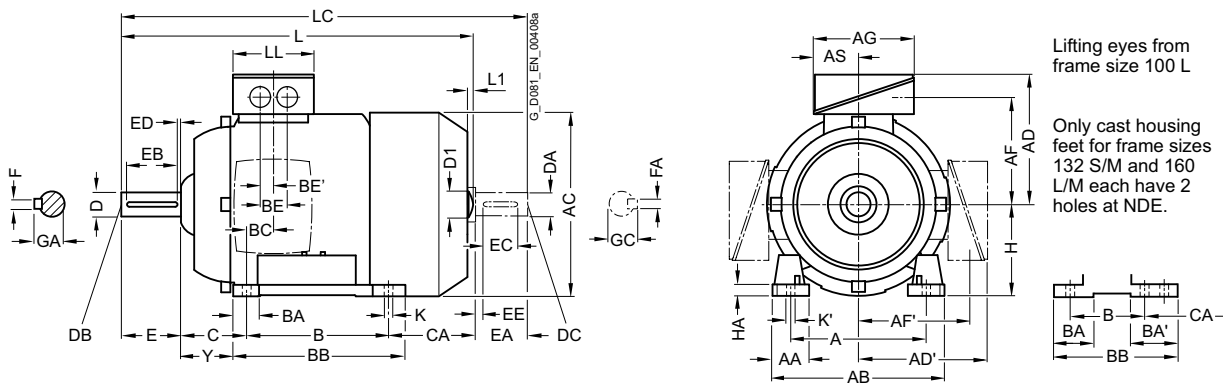

Types of construction IM B5 and IM V1

For flange dimensions, see page 1/48 (Z = the number of retaining holes)

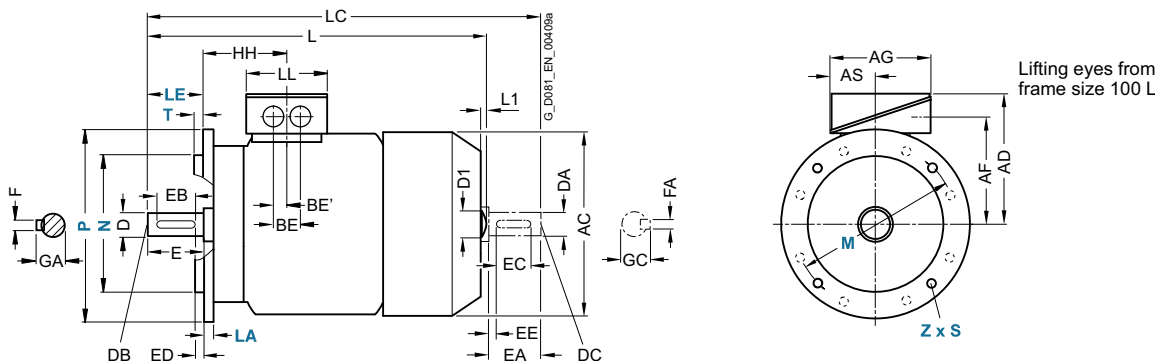

For motor		Dimension designation acc. to IEC																						
Frame size	Motor type	No. of poles	A	AA	AB	AC	AD	AD'	AF	AF'	AG	AS	B	BA	BA'	BB	BC	BE	BE'	C	CA	H	HA	Y
100 L	1AA4, 1AB4, 1AB5, 1AC3, 1AD5, 1AC4, 1AD4	2, 4, 6, 8	160	42	196	198	166	166	125.5	125.5	135	63.5	140	37.5	37.5	176	33.5	50	25	63	176	100	12	45
																						141		
112 M	1BA2, 1BB2, 1BC1, 1BC2, 1BD1	2, 4, 6	190	46	226	222	177	177	136.5	136.5	135	63.5	140	37.5	37.5	176	26	50	25	70	155	112	12	52
132 S	1CA0, 1CC0, 1CC1, 1CD0, 1CA1, 1CB0	2, 6, 8	216	53	256	262	202	202	159.5	159.5	155	70.5	140	38	76 ¹⁾	218 ²⁾	26.5	48	24	89	167	132	15	69
		2, 4													38	180						217		
132 M	1CC2, 1CB2, 1CC3, 1CD2	6, 4, 6, 8	216	53	256	262	202	202	159.5	159.5	155	70.5	178	38	76	218	26.5	48	24	89	129	132	15	69
															38							179		
160 M	1DA2, 1DA3, 1DB2, 1DC2, 1DD2, 1DD3	2, 4, 6, 8	254	60	300	314	236.5	236.5	190	190	175	77.5	210	44	89 ³⁾	300 ⁴⁾	47	57	28.5	108	192	160	18	85
160 L	1DA4, 1DB4, 1DC4, 1DD4	2, 4, 6, 8	254	60	300	314	236.5	236.5	190	190	175	77.5	254	44	89	300	47	57	28.5	108	208	160	18	85
																					148			
180 M	1EA2 1EB2	2, 4	279	65	339	356	259	259	212.5	212.5	175	77.5	241	80	100	328	30	57	28.5	121	232	180	20	95
180 L	1EB4, 1EC4, 1ED4	4, 6, 8	279	65	339	356	259	259	212.5	212.5	175	77.5	279	80	100	328	30	57	28.5	121	194	180	20	95
200 L	2AA4, 2AA5, 2AB5, 2AC4, 2AC5, 2AD5	2, 4, 6, 8	318	70	378	396	296	296	238	238	225	102.5	305	90	100	355	45	75	37.5	133	202	200	25	108

1) With screwed-on feet, dimension BA' is 38 mm.
 2) With screwed-on feet, dimension BB is 180 mm.
 3) With screwed-on feet, dimension BA' is 44 mm.

4) With screwed-on feet, dimension BB is 256 mm.
 5) Only one termination hole available except for 1LE1023. Here the dimension BE 32 mm.

SIMOTICS GP and SIMOTICS SD standard motors

Dimensions · Aluminum series SIMOTICS GP

IE3, NEMA Premium Efficient – self-ventilated · Frame sizes 100 L to 200 L

Dimensional drawings

Type of construction IM B35

For flange dimensions, see page 1/48 (Z = the number of retaining holes)

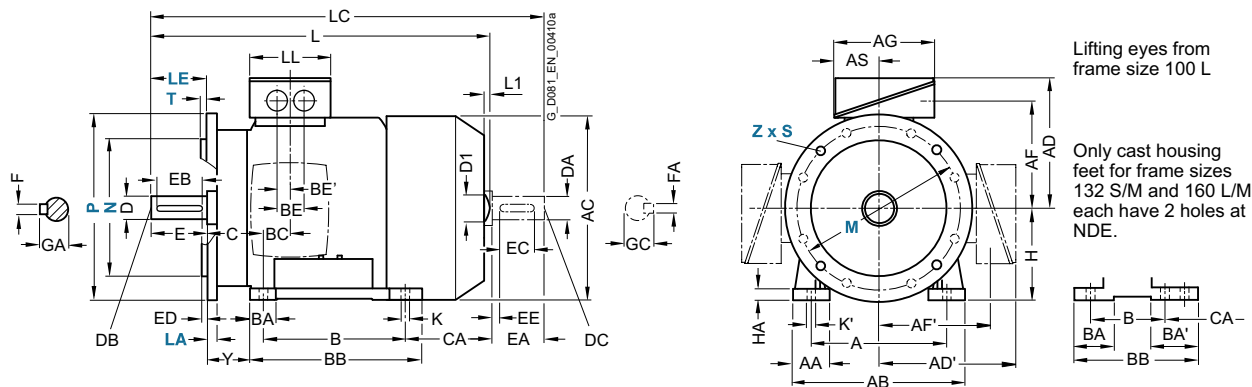

Type of construction IM B14

For flange dimensions, see page 1/48 (Z = the number of retaining holes)

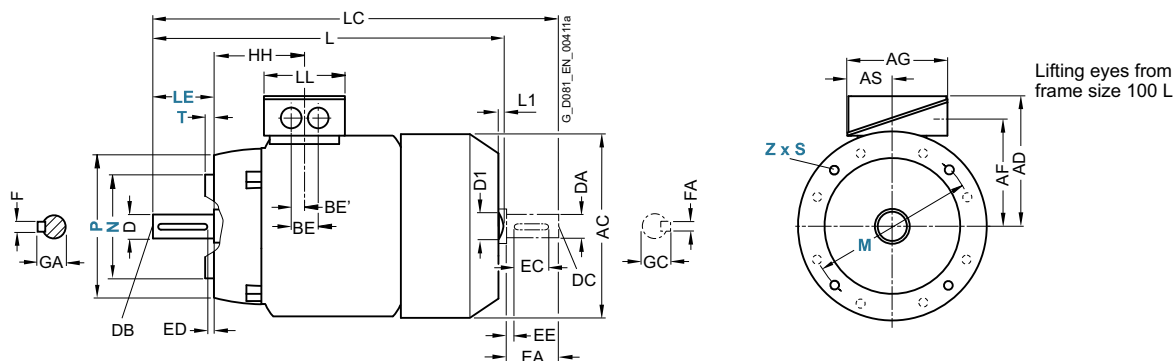

For motor Frame size	Motor type	No. of poles	Dimension designation acc. to IEC						DE shaft extension						NDE shaft extension									
			HH	K	K'	L ¹⁾	L1	D1	LC	LL	D	DB	E	EB	ED	F	GA	DA	DC	EA	EC	EE	FA	GC
100 L	1AA4, 1AB4, 1AB5,	2, 4, 6, 8	96.5	12	16	430.5	7	32	489	112	28	M10	60	50	5	8	31	24	M8	50	40	5	8	27
	1AC3, 1AD5					395.5																		
	1AC4, 1AD4																							
112 M	1BA2, 1BB2, 1BC1,	2, 4, 6	96	12	16	414	7	32	475	112	28	M10	60	50	5	8	31	24	M8	50	40	5	8	27
	1BC2, 1BD2																							
132 S	1CA0, 1CC0, 1CC1,	2, 4, 8	115.5	12	16	465	8.5	39	535.5	130	38	M12	80	70	5	10	41	28	M10	60	50	5	8	31
	1CA1, 1CB0					515																		
132 M	1CC2	4, 6, 8	115.5	12	16	465	8.5	39	535.5	130	38	M12	80	70	5	10	41	28	M10	60	50	5	8	31
	1CB2, 1CC3, 1CD2					515																		
160 M	1DA2, 1DA3, 1DB2,	2, 4, 6, 8	155	15	19	604	10	45	730	145	42	M16	110	90	10	12	45	42	M16	110	90	10	12	45
	1DC2, 1DD2, 1DD3																							
160 L	1DA4, 1DB4, 1DC4,	2, 4, 6, 8	155	15	19	664	10	45	790	145	42	M16	110	90	10	12	45	42	M16	110	90	10	12	45
	1DD4					604																		
180 M	1EA2 1EB2	2, 4	151	14.5	19	698	-	-	814	145	48	M16	110	100	5	14	52	48	M16	110	100	5	14	52
180 L	1EB4, 1EC4, 1ED4	4, 6, 8	151	14.5	19	698	-	-	814	145	48	M16	110	100	5	14	52	48	M16	110	100	5	14	52
200 L	2AA4, 2AA5, 2AB5,	2, 4, 6, 8	178	18.5	25	746	-	-	860	185	55	M20	110	100	5	16	59	55	M20	110	100	5	16	59
	2AC4, 2AC5, 2AD5																							

¹⁾ The length is specified as far as the tip of the fan cover.

SIMOTICS GP and SIMOTICS SD standard motors

Dimensions · Aluminum series SIMOTICS GP

IE3, NEMA Premium Efficient – self-ventilated · Frame sizes 100 L to 200 L

Dimensional drawings

Type of construction IM B3

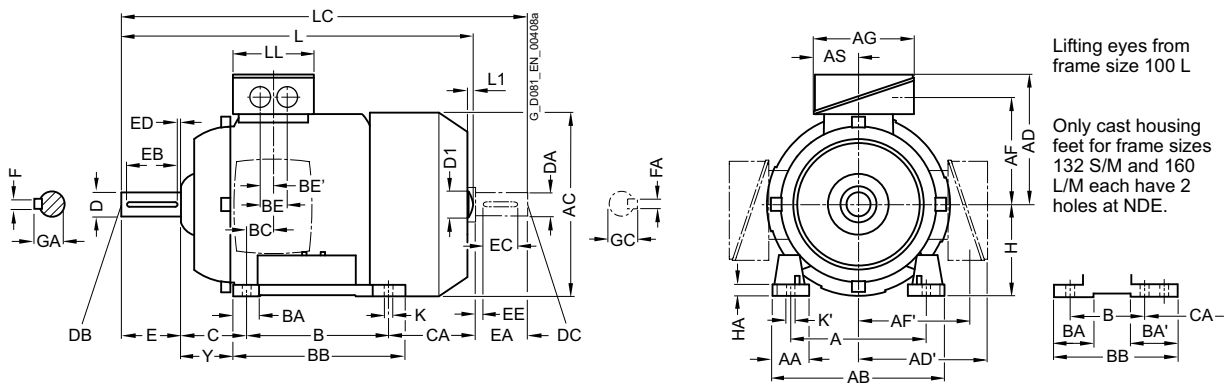

Types of construction IM B5 and IM V1

For flange dimensions, see page 1/48 (Z = the number of retaining holes)

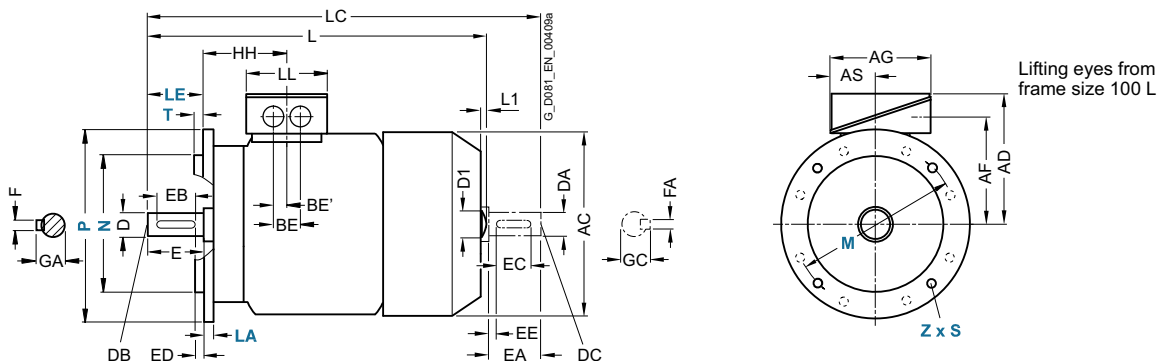

For motor			Dimension designation acc. to IEC																					
Frame size	Motor type	No. of poles	A	AA	AB	AC	AD	AD'	AF	AF'	AG	AS	B	BA	BA'	BB	BC	BE	BE'	C	CA	H	HA	Y
100 L	1AA4, 1AB4	2, 4	160	42	196	198	166	166	125.5	125.5	135	63.5	140	37.5	37.5	176	33.5	50	25	63	176	100	12	45
	1AB5	4																				216		
112 M	1BA2	2	190	46	226	222	177	177	136.5	136.5	135	63.5	140	37.5	37.5	176	26	50	25	70	155	112	12	52
	1BB2	4																				200		
132 S	1CA0, 1CA1, 1CB0	2, 4	216	53	256	262	202	202	159.5	159.5	155	70.5	140	38	76 ¹⁾	218 ²⁾	26.5	48	24	89	167	132	15	69
132 M	1CB2	4	216	53	256	262	202	202	159.5	159.5	155	70.5	178	38	76	218	26.5	48	24	89	179	132	15	69
160 M	1DA2, 1DA3, 1DB2	2, 4	254	60	300	314	236.5	236.5	190	190	175	77.5	210	44	89 ³⁾	300 ⁴⁾	47	57	28.5	108	192	160	18	85
160 L	1DA4, 1DB4	2, 4	254	60	300	314	236.5	236.5	190	190	175	77.5	254	44	89	300	47	57	28.5	108	208	160	18	85
180 M	1EA2 1EB2	2, 4	279	65	339	356	259	259	212.5	212.5	175	77.5	241	80	100	328	30	57	28.5	121	232	180	20	95
180 L	1EB4, 1EC4, 1ED4	4, 6, 8	279	65	339	356	259	259	212.5	212.5	175	77.5	279	80	100	328	30	57	28.5	121	194	180	20	95
200 L	2AA4, 2AA5, 2AB5, 2AC4, 2AC5, 2AD5	2, 4, 6, 8	318	70	378	396	296	296	238	238	225	102.5	305	90	100	355	45	75	37.5	133	202	200	25	108

1) With screwed-on feet, dimension BA' is 38 mm.
 2) With screwed-on feet, dimension BB is 180 mm.

3) With screwed-on feet, dimension BA' is 44 mm.
 4) With screwed-on feet, dimension BB is 256 mm.

SIMOTICS GP and SIMOTICS SD standard motors

Dimensions · Aluminum series SIMOTICS GP

IE3, NEMA Premium Efficient – self-ventilated · Frame sizes 100 L to 200 L

Dimensional drawings

Type of construction IM B35

For flange dimensions, see page 1/48 (Z = the number of retaining holes)

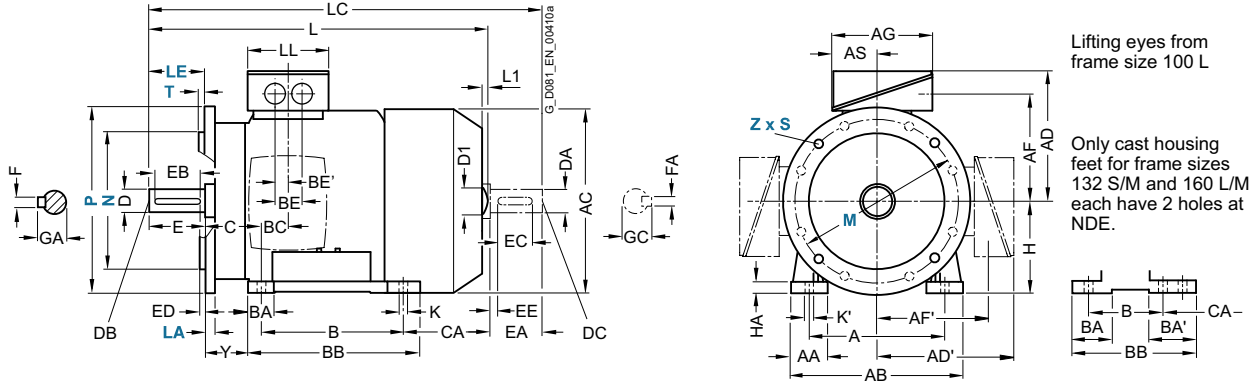

Type of construction IM B14

For flange dimensions, see page 1/48 (Z = the number of retaining holes)

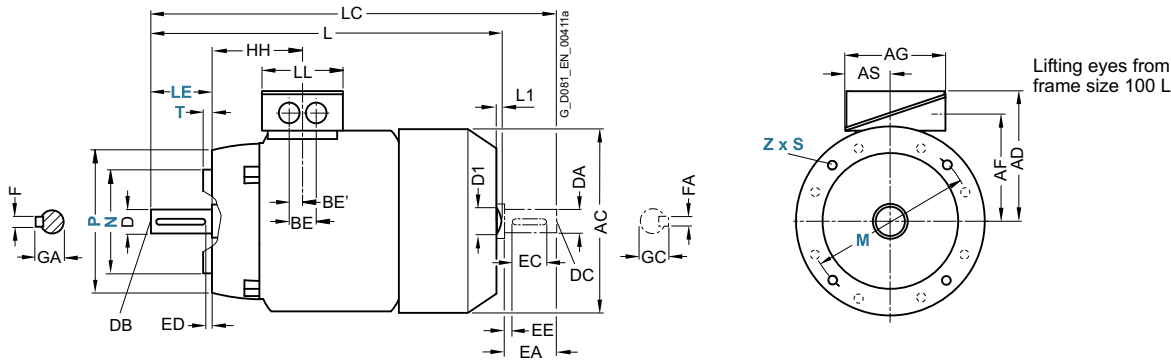

For motor		No. of poles	Dimension designation acc. to IEC							DE shaft extension					NDE shaft extension									
Frame size	Motor type		HH	K	K'	L ¹⁾	L1	D1	LC	LL	D	DB	E	EB	ED	F	GA	DA	DC	EA	EC	EE	FA	GC
100 L	1AA4, 1AB4	2, 4	96.5	12	16	430.5	7	32	489	112	28	M10	60	50	5	8	31	24	M8	50	40	5	8	27
	1AB5	4				470.5			529															
112 M	1BA2	2	96	12	16	414	7	32	475	112	28	M10	60	50	5	8	31	24	M8	50	40	5	8	27
	1BB2	4				459			520															
132 S	1CA0, 1CA1, 1CB0	2, 4	115.5	12	16	515	8.5	39	585.5	130	38	M12	80	70	5	10	41	28	M10	60	50	5	8	31
132 M	1CB2	4	115.5	12	16	515	8.5	39	585.5	130	38	M12	80	70	5	10	41	28	M10	60	50	5	8	31
160 M	1DA2, 1DA3, 1DB2	2, 4	155	15	19	604	10	45	730	145	42	M16	110	90	10	12	45	42	M16	110	90	10	12	45
160 L	1DA4, 1DB4	2, 4	155	15	19	664	10	45	790	145	42	M16	110	90	10	12	45	42	M16	110	90	10	12	45
180 M	1EA2 1EB2	2, 4	151	14.5	19	698	-	-	814	145	48	M16	110	100	5	14	52	48	M16	110	100	5	14	52
180 L	1EB4, 1EC4, 1ED4	4, 6, 8	151	14.5	19	698	-	-	814	145	48	M16	110	100	5	14	52	48	M16	110	100	5	14	52
200 L	2AA4, 2AA5, 2AB5, 2AC4, 2AC5, 2AD5	2, 4, 6, 8	178	18.5	25	746	-	-	860	185	55	M20	110	100	5	16	59	55	M20	110	100	5	16	59

¹⁾ The length is specified as far as the tip of the fan cover.

SIMOTICS GP and SIMOTICS SD standard motors

Dimensions · Aluminum series SIMOTICS GP

IE3 – self-ventilated with increased power · Frame sizes 80 M to 200 L

Dimensional drawings

Type of construction IM B3

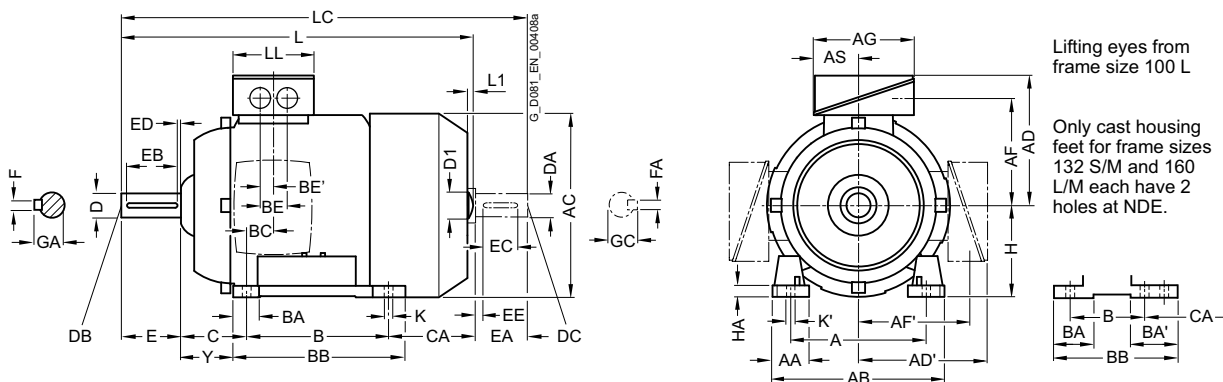

Types of construction IM B5 and IM V1

For flange dimensions, see page 1/48 (Z = the number of retaining holes)

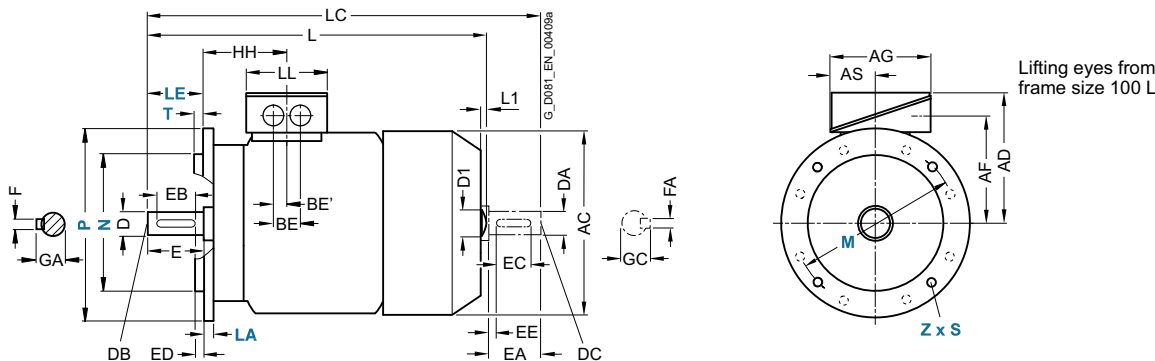

For motor		Dimension designation acc. to IEC																						
Frame size	Motor type	No. of poles	A	AA	AB	AC	AD	AD'	AF	AF'	AG	AS	B	BA	BA'	BB	BC	BE	BE'	C	CA	H	HA	Y
80 M	1LE1003-0DA6, -0DB6 1LE1043-0DA6, -0DB6	2, 4	125	30.5	150	159	121.5	121.5	96.5	96.5	93	43	100	32	32	118	23	-	18	50	148	80	8	41
90 L	1LE1003-0EA6, 1LE1043-0EA6,	2	140	30.5	165	178	126	101.5	101.5	101.5	93	43	125	33	54	143	22.5	-	18	56	174	90	10	47
100 L	1LE1003-1AA6, -1AB6 1LE1043-1AA6, -1AB6	2, 4	160	42	196	198	166	125.5	125.5	125.5	135	63.5	140	37.5	37.5	176	33.5	50	25	63	176	100	12	45
112 M	1LE1003-1BA6, -1BB6 1LE1043-1BA6,	2, 4	190	46	226	22	177	136.5	136.5	136.5	135	63.5	140	37.5	37.5	176	26	50	25	70	155	112	12	52
132 M	1LE1003, 1LE1043 -1CA6, -1CA7 1LE1043-1CA6	2	216	53	256	262	202	202	159.5	159.5	155	70.5	178	38	38	218	26.5	48	24	89	179	132	15	69
160 L	1LE1003-1DA6 -1DB6 1LE1043-1DA6	2, 4	254	60	300	314	236.5	236.5	190	190	175	77.5	254	44	44	300	47	57	28.5	108	268	160	18	85
180 L	1LE1003-1EA6 -1EB6, -1EC6 1LE1043-1EC6	2, 4, 6	279	65	339	356	259	259	212.5	212.5	175	77.5	279	80	100	328	30	57	28.5	121	194	180	20	95
200 L	1LE1003-2AA6 -2AB6, -2AC6, - 2AD6 1LE1043-2AC6, -2AD6	2, 4, 6, 8	318	70	378	396	296	296	238	238	225	102.5	305	90	100	355	45	75	37.5	133	202	200	25	108

SIMOTICS GP and SIMOTICS SD standard motors

Dimensions · Aluminum series SIMOTICS GP

IE3 – self-ventilated with increased power · Frame sizes 80 M to 200 L

Dimensional drawings

Type of construction IM B35

For flange dimensions, see page 1/48 (Z = the number of retaining holes)

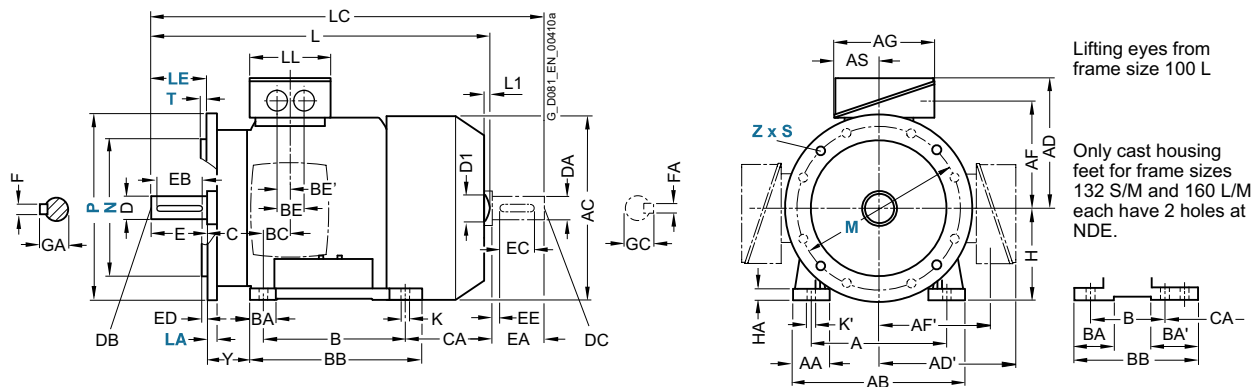

Type of construction IM B14

For flange dimensions, see page 1/48 (Z = the number of retaining holes)

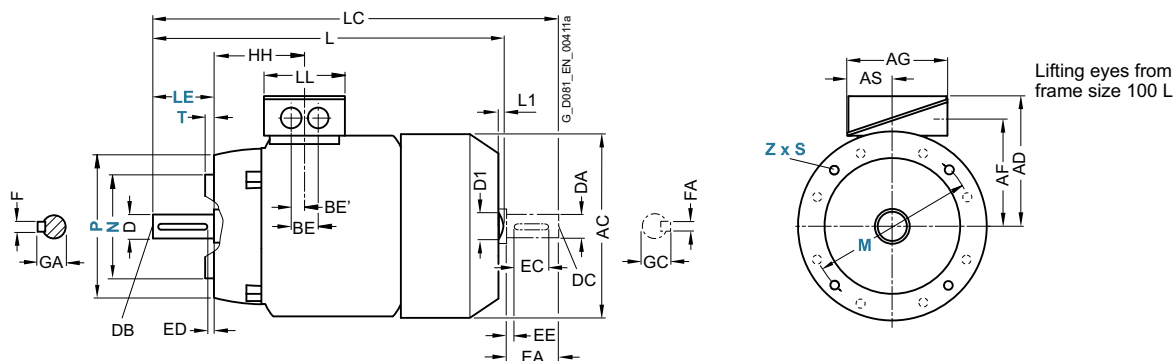

Frame size	Motor type	No. of poles	Dimension designation acc. to IEC							DE shaft extension						NDE shaft extension								
			HH	K	K'	L ¹⁾	L1	D1	LC	LL	D	DB	E	EB	ED	F	GA	DA	DC	EA	EC	EE	FA	GC
80 M	1LE1003-0DA6, -0DB6 1LE1043-0DA6, -0DB6	2, 4	73	9,5	13,5	327	-	-	378	79	19	M6	6	32	4	6	21,5	19	M6	40	32	4	6	21,5
90 L	1LE1003-0EA6, 1LE1043-0EA6	2	78,5	10	14	387	-	-	445	79	24	M8	8	40	5	8	27	19	M6	40	32	4	6	21,5
100 L	1LE1003-1AA6, -1AB6 1LE1043-1AA6, -1AB6	2, 4	96,5	12	16	430,5 480,5 430,5 480,5	7	32	489 529 489 529	112	28	M10	8	50	5	8	31	24	M8	50	40	5	8	27
112 M	1LE1003-1BA6, -1BB6 1LE1043-1BA6	2	96	12	16	414 464 414	7	32	475 520 475	112	28	M10	8	50	5	8	31	24	M8	50	40	5	8	27
132 M	1LE1003, 1LE1043 -1CA6, -1CA7 1LE1043-1CA6	2	115,5	12	16	515	8,5	39	585,5	130	38	M12	80	70	5	10	41	28	M10	60	50	5	8	31
160 L	1LE1003-1DA6, -1DB6 1LE1043-1DA6	2, 4	155	15	19	664	10	45	790	145	42	M16	110	90	10	12	45	42	M16	110	90	10	12	45
180 L	1LE1003-1EA6, -1EB6, -1EC6 1LE1043-1EC6	2, 4, 6	151	14,5	19	698	-	-	814	145	48	M16	110	100	5	14	52	48	M16	110	100	5	14	52
200 L	1LE1003-2AA6, -2AB6, -2AC6, -2AD6 1LE1043-2AC6, -2AD6	2, 4, 6, 8	178	18,5	25	746	-	-	860	185	55	M20	110	100	5	16	59	55	M20	110	100	5	16	59

¹⁾ The length is specified as far as the tip of the fan cover.

SIMOTICS GP and SIMOTICS SD standard motors

Dimensions · Aluminum series SIMOTICS GP

IE3 – forced-air cooled · Frame sizes 80 M to 90 L

Dimensional drawings

Type of construction IM B3

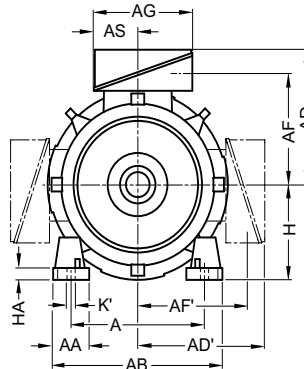
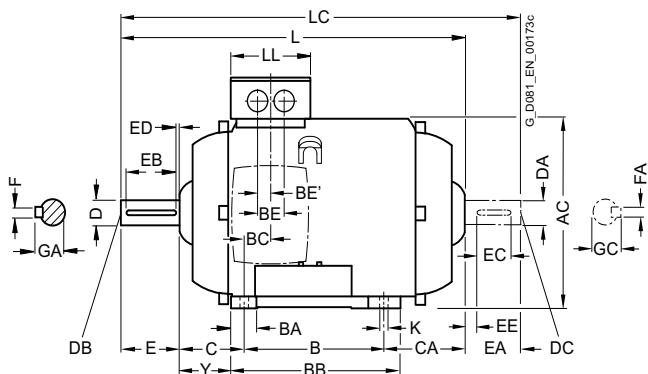

Lifting eyes from frame size 100 L

Only cast housing feet for frame sizes 132 S/M and 160 L/M each have 2 holes at NDE.

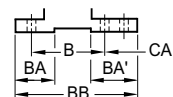

Types of construction IM B5 and IM V1

For flange dimensions, see page 1/48 (Z = the number of retaining holes)

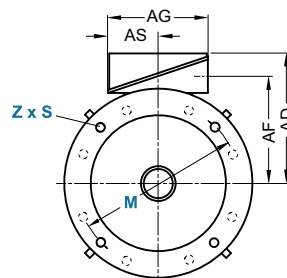
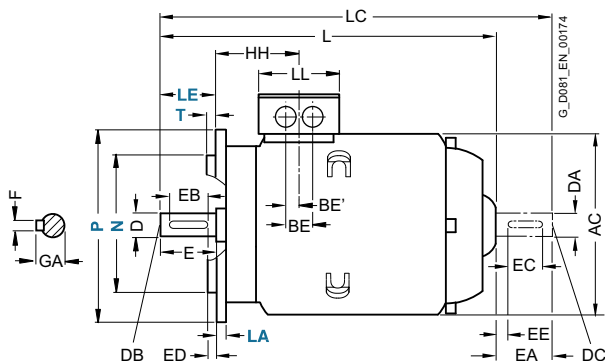

Lifting eyes from frame size 100 L

Frame size	Motor type	No. of poles	Dimension designation acc. to IEC																					
			A	AA	AB	AC	AD	AD'	AF	AF'	AG	AS	B	BA	BA'	BB	BC	BE	BE'	C	CA	H	HA	Y
80 M	0DA2, 0DB2, 0DC2	2, 4, 6	125	30.5	150	159	121.5	121.5	96.5	96.5	93	43	100	32	32	118	23	-	18 ¹⁾	50	70	80	8	41
	0DA3, 0DB3, 0DC3	2, 4, 6																			105.5			
90 S	0EA0, 0EB0, 0EC0	2, 4, 6	140	30.5	165	178	126	126	101.5	101.5	93	43	100	33	54	143	22.5	-	18 ¹⁾	56	130	90	10	47
90 L	0EA4, 0EB4, 0EC4	2, 4, 6	140	30.5	165	178	126	126	101.5	101.5	93	43	125	33	54	143	22.5	-	18 ¹⁾	56	118	90	10	47

¹⁾ Only one termination hole available.

SIMOTICS GP and SIMOTICS SD standard motors

Dimensions · Aluminum series SIMOTICS GP

IE3 – forced-air cooled · Frame sizes 80 M to 90 L

Dimensional drawings

Type of construction IM B35

For flange dimensions, see page 1/48 (Z = the number of retaining holes)

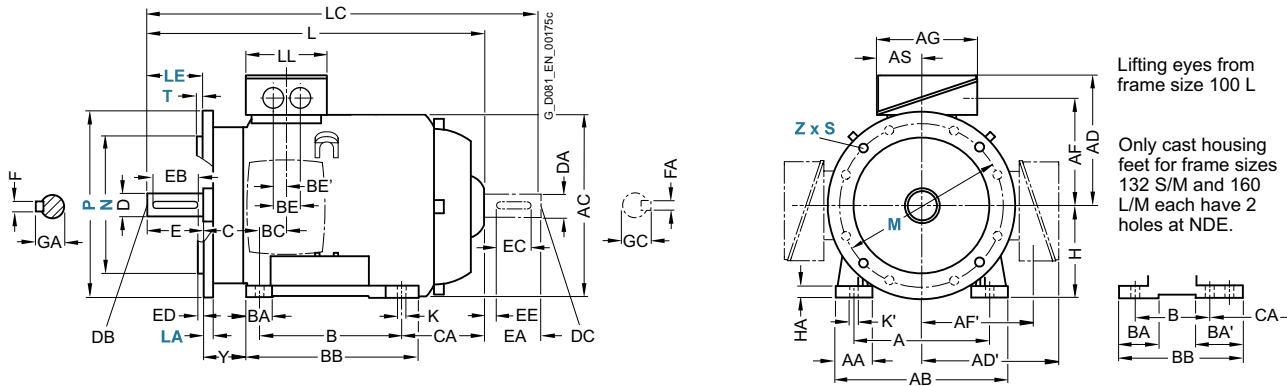

Lifting eyes from frame size 100 L

Only cast housing feet for frame sizes 132 S/M and 160 L/M each have 2 holes at NDE.

Type of construction IM B14

For flange dimensions, see page 1/48 (Z = the number of retaining holes)

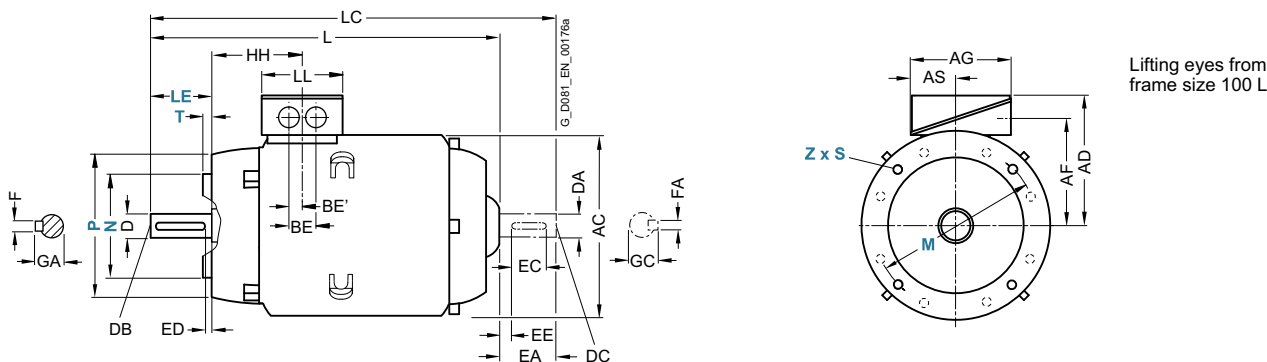

Lifting eyes from frame size 100 L

For motor			Dimension designation acc. to IEC										DE shaft extension					NDE shaft extension				
Frame size	Motor type	No. of poles	HH	K	K'	L	LC	LL	D	DB	E	EB	ED	F	GA	DA	DC	EA	EC	EE	FA	GC
80 M	0DA2, 0DB2, 0DC2	2, 4, 6	73	9.5	13.5	253.5	300.5	79	19	M6	40	32	4	6	21.5	19	M6	40	32	4	6	21.5
	0DA3, 0DB3, 0DC3	2, 4, 6				288	335.5															
90 S	0EA0, 0EB0, 0EC0	2, 4, 6	78.5	10	14	294.5	349	79	19	M6	40	32	5	8	27	19	M6	40	32	4	6	21.5
90 L	0EA4, 0EB4, 0EC4	2, 4, 6	78.5	10	14	334.5	389	79	19	M6	40	32	5	8	27	19	M6	40	32	4	6	21.5

SIMOTICS GP and SIMOTICS SD standard motors

Dimensions · Aluminum series SIMOTICS GP

IE3 – forced-air cooled · Frame sizes 100 L to 200 L

Dimensional drawings

Type of construction IM B3

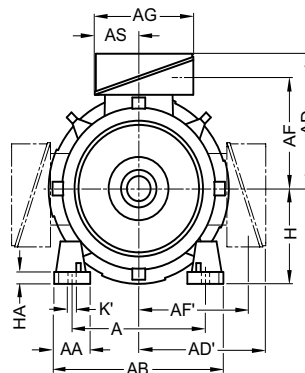
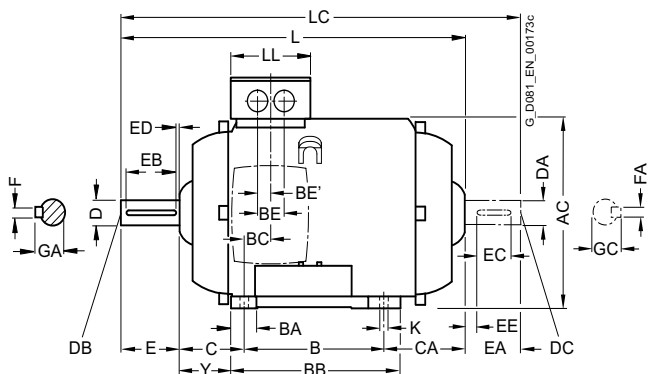

Lifting eyes from frame size 100 L

Only cast housing feet for frame sizes 132 S/M and 160 L/M each have 2 holes at NDE.

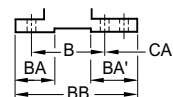

Types of construction IM B5 and IM V1

For flange dimensions, see page 1/48 (Z = the number of retaining holes)

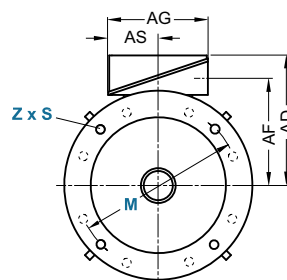
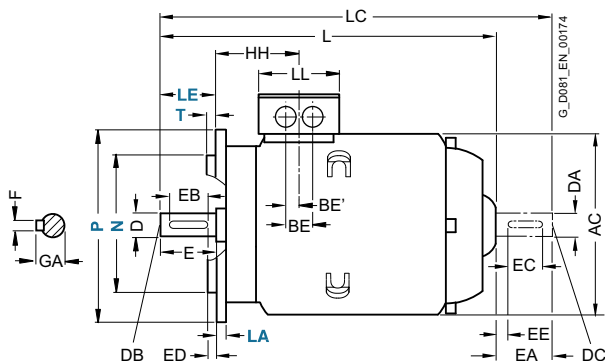

Lifting eyes from frame size 100 L

For motor		Dimension designation acc. to IEC																						
Frame size	Motor type	No. of poles	A	AA	AB	AC	AD	AD'	AF	AF'	AG	AS	B	BA	BA'	BB	BC	BE	BE'	C	CA	H	HA	Y
100 L	1AA4, 1AB4, 1AB5, 1AC3	2, 4 6	160	42	196	198	166	166	125.5	125.5	135	63.5	140	37.5	37.5	176	33.5	50	25	63	-	100	12	45
112 M	1BA2, 1BB2	2, 4	190	46	226	222	177	177	136.5	136.5	135	63.5	140	37.5	37.5	176	26	50	25	70	-	112	12	52
132 S	1CA0, 1CC0	2, 6	216	53	256	262	202	202	159.5	159.5	155	70.5	140	38	76 ¹⁾	218 ²⁾	26.5	48	24	89	-	132	15	69
132 M	1CC2	6	216	53	256	262	202	202	159.5	159.5	155	70.5	178	38	76	218	26.5	48	24	89	-	132	15	69
	1CB2, 1CC3	4, 6													38	180								
160 M	1DA2, 1DA3, 1DB2, 1DC2	2, 4, 6	254	60	300	314	236.5	236.5	190	190	175	77.5	210	44	89 ³⁾	300 ⁴⁾	47	57	28.5	108	-	160	18	85
160 L	1DA4, 1DB4, 1DC4	2, 4, 6	254	60	300	314	236.5	236.5	190	190	175	77.5	254	44	44	300	47	57	28.5	108	-	160	18	85
180 M	1EA2, 1EB2	2, 4	279	65	339	356	259	259	212.5	212.5	175	77.5	241	80	100	328	30	57	28.5	121	-	180	20	95
180 L	1EB4, 1EC4	4, 6	279	65	339	356	259	259	212.5	212.5	175	77.5	279	80	100	328	30	57	28.5	121	-	180	20	95
200 L	2AA4, 2AA5, 2AB5, 2AC4, 2AC5	2, 4, 6	318	70	378	396	296	296	238	238	225	102.5	305	90	100	355	45	75	37.5	133	-	200	25	108

1) With screwed-on feet, dimension BA' is 38 mm.
 2) With screwed-on feet, dimension BB is 180 mm.
 3) With screwed-on feet, dimension BA' is 44 mm.

4) With screwed-on feet, dimension BB is 256 mm.

SIMOTICS GP and SIMOTICS SD standard motors

Dimensions · Aluminum series SIMOTICS GP

IE3 – forced-air cooled · Frame sizes 100 L to 200 L

Dimensional drawings

Type of construction IM B35

For flange dimensions, see page 1/48 (Z = the number of retaining holes)

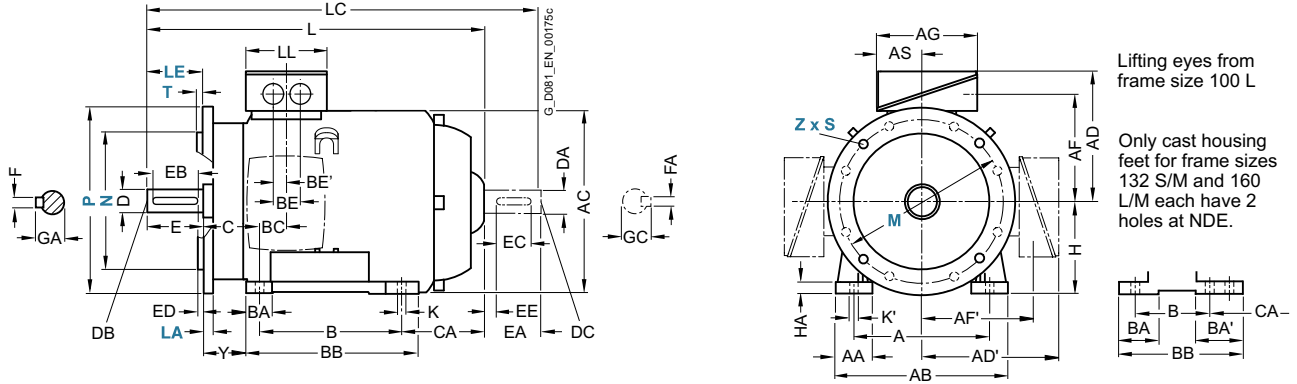

Type of construction IM B14

For flange dimensions, see page 1/48 (Z = the number of retaining holes)

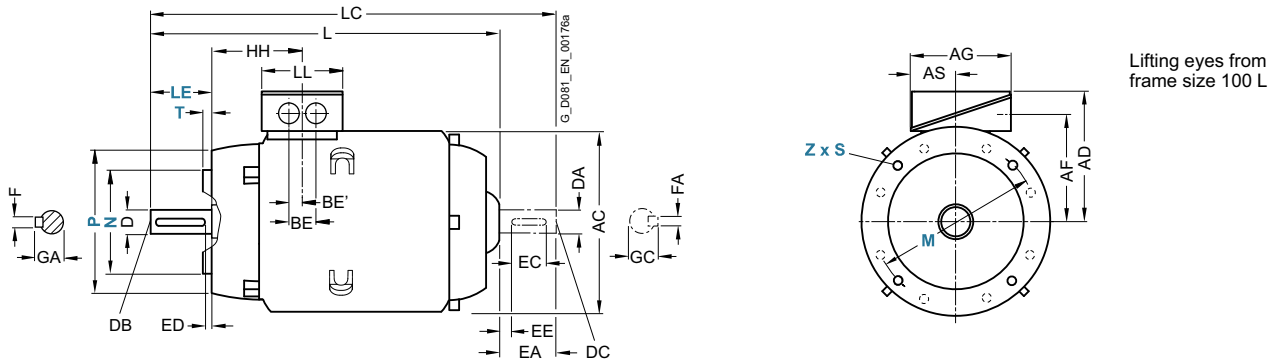

For motor			Dimension designation acc. to IEC						DE shaft extension						NDE shaft extension							
Frame size	Motor type	No. of poles	HH	K	K'	L	LC	LL	D	DB	E	EB	ED	F	GA	DA	DC	EA	EC	EE	FA	GC
100 L	1AA4, 1AB4, 1AB5, 1AC3	2, 4 6	96.5	12	16	356.5	411	112	28	M10	60	50	5	8	31	24	M8	50	40	5	8	27
112 M	1BA2, 1BB2	2, 4	96	12	16	336	390	112	28	M10	60	50	5	8	31	24	M8	50	40	5	8	27
132 S	1CA0, 1CC0	2, 6	115.5	12	16	380.5	446	130	38	M12	80	70	5	10	41	28	M10	60	50	5	8	31
	1CA1, 1CB0	2, 4																				
132 M	1CC2	6	115.5	12	16	380.5	446	130	38	M12	80	70	5	10	41	28	M10	60	50	5	8	31
	1CB2, 1CC3	4, 6																				
160 M	1DA2, 1DA3, 1DB2, 1DC2	2, 4, 6	155	15	19	510	630	145	42	M16	110	90	10	12	45	42	M16	110	90	10	12	45
160 L	1DA4, 1DB4, 1DC4	2, 4, 6	155	15	19	570	690	145	42	M16	110	90	10	12	45	42	M16	110	90	10	12	45
180 M	1EA2, 1EB2	2, 4	151	14.5	19	592	706	145	48	M16	110	100	5	14	52	48	M16	110	100	5	14	52
180 L	1EB4, 1EC4	4, 6	151	14.5	19	592	706	145	48	M16	110	100	5	14	52	48	M16	110	100	5	14	52
200 L	2AA4, 2AA5, 2AB5, 2AC4, 2AC5	2, 4, 6	178	18.5	25	642	772	185	55	M20	110	100	5	16	59	55	M20	110	100	5	16	59

SIMOTICS GP and SIMOTICS SD standard motors

Dimensions · Aluminum series SIMOTICS GP

IE4 – self-ventilated · Frame sizes 100 L to 200 L

Dimensional drawings

Type of construction IM B3

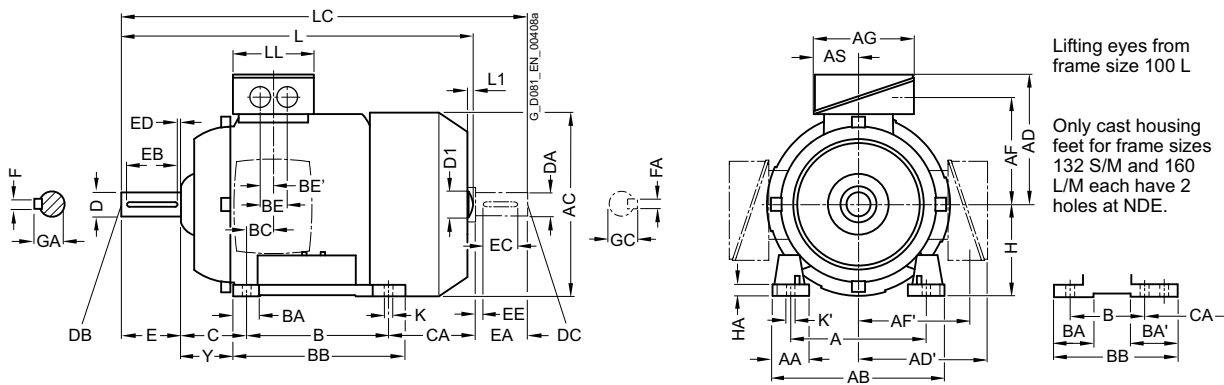

Types of construction IM B5 and IM V1

For flange dimensions, see page 1/48 (Z = the number of retaining holes)

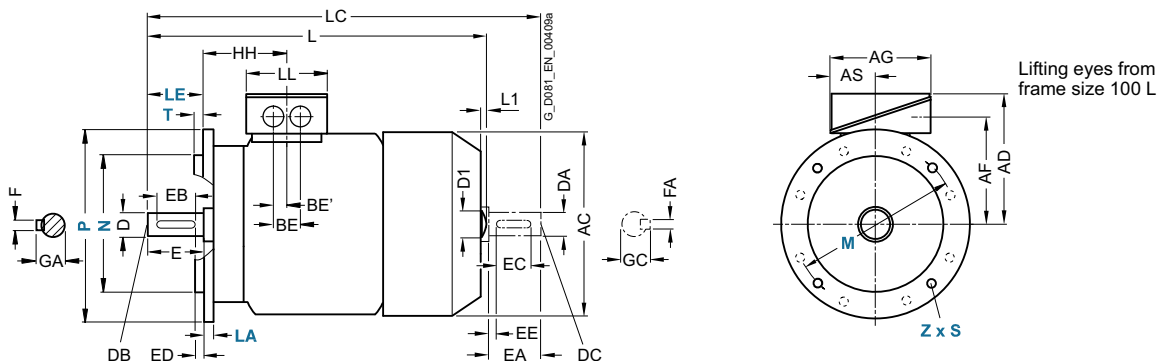

For motor			Dimension designation acc. to IEC																					
Frame size	Motor type	No. of poles	A	AA	AB	AC	AD	AD'	AF	AF'	AG	AS	B	BA	BA'	BB	BC	BE	BE'	C	CA	H	HA	Y
100 L	1AA4	2	160	42	196	198	166	166	125.5	125.5	135	63.5	140	37.5	37.5	176	33.5	50	25	63	176	100	12	45
	1AB4	4																						
	1AB5	4																				216		
112 M	1BA2	2	190	46	226	222	177	177	136.5	136.5	135	63.5	140	37.5	37.5	176	26	50	25	70	155	112	12	52
	1BB2	4																			200			
132 S	1CA0	2	216	53	256	262	202	202	159.5	159.5	155	70.5	140	38	76 ¹⁾	218 ²⁾	26.5	48	24	89	166.5	132	15	69
	1CA1	2													38	180					216.5			
	1CB0	4																						
132 M	1CB2	4	216	53	256	262	202	202	159.5	159.5	155	70.5	178	38	76	218	26.5	48	24	89	178.5	132	15	69
160 M	1DA2	2	254	60	300	314	236.5	236.5	190	190	175	77.5	210	44	89 ³⁾	300 ⁴⁾	47	57	28.5	108	192	160	18	85
	1DA3	2													44	256					252			
	1DB2	4																						
160 L	1DA4	2	254	60	300	314	236.5	236.5	190	190	175	77.5	254	44	44	300	47	57	28.5	108	208	160	18	85
	1DB4	4																						
180 M	1EA2	2	279	65	339	356	259	259	212.5	212.5	175	77.5	241	80	100	328	30	57	28.5	121	232	180	20	95
	1EB2	4																						
180 L	1EB4	4	279	65	339	356	259	259	212.5	212.5	175	77.5	279	80	100	328	30	57	28.5	121	194	180	20	95
200 L	2AA4	2	318	70	378	396	296	296	238	238	225	102.5	305	90	100	355	45	75	37.5	133	202	200	25	108
	2AA5	2																						
	2AB5	4																						

1) With screwed-on feet, dimension BA' is 38 mm.
 2) With screwed-on feet, dimension BB is 180 mm.
 3) With screwed-on feet, dimension BA' is 44 mm.

4) With screwed-on feet, dimension BB is 256 mm.
 5) With screwed-on feet, dimension CA is 192 mm.

SIMOTICS GP and SIMOTICS SD standard motors

Dimensions · Aluminum series SIMOTICS GP

IE4 – self-ventilated · Frame sizes 100 L to 200 L

Dimensional drawings

Type of construction IM B35

For flange dimensions, see page 1/48 (Z = the number of retaining holes)

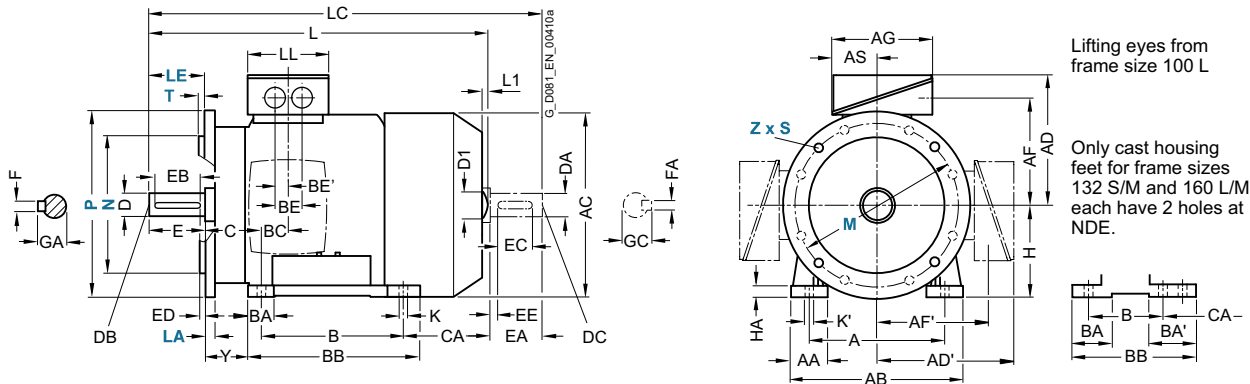

Type of construction IM B14

For flange dimensions, see page 1/48 (Z = the number of retaining holes)

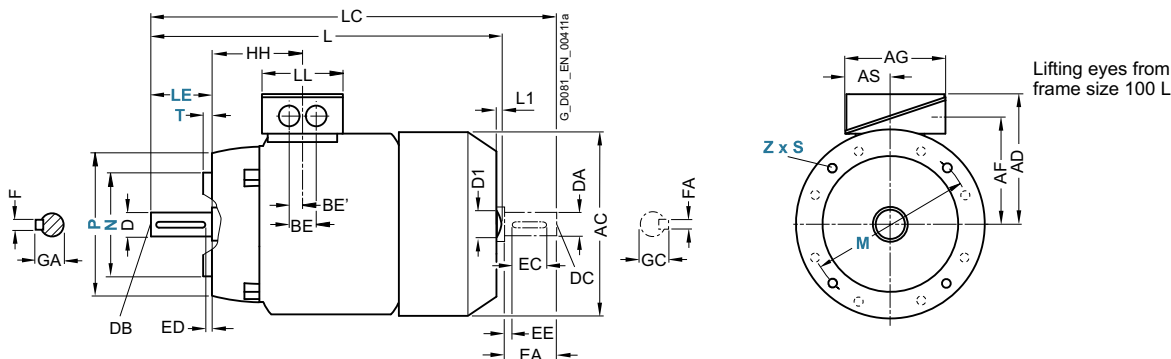

For motor			Dimension designation acc. to IEC								DE shaft extension					NDE shaft extension									
Frame size	Motor type 1LE1004-	No. of poles	HH	K	K'	L ¹⁾	L1	D1	LC	LL	D	DB	E	EB	ED	F	GA	DA	DC	EA	EC	EE	FA	GC	
100 L	1AA4	2	96.5	12	16	430.5	7	32	489	112	28	M10	60	50	5	8	31	24	M8	50	40	5	8	27	
	1AB4	4				480.5																			
	1AB5	4																							529
112 M	1BA2	2	96	12	16	414	7	32	475	112	28	M10	60	50	5	8	31	24	M8	50	40	5	8	27	
	1BB2	4				464																			520
132 S	1CA0	2	115.5	12	16	465	8.5	39	535.5	130	38	M12	80	70	5	10	41	28	M10	60	50	5	8	31	
	1CA1	2				515																			585.5
	1CB0	4																							
132 M	1CB2	4	115.5	12	16	515	8.5	39	585.5	130	38	M12	80	70	5	10	41	28	M10	60	50	5	8	31	
160 M	1DA2	2	155	15	19	604	10	45	730	145	42	M16	110	90	10	12	45	42	M16	110	90	10	12	45	
	1DA3	2				664																			790
	1DB2	4																							
160 L	1DA4	2	155	15	19	664	10	45	790	145	42	M16	110	90	10	12	45	42	M16	110	90	10	12	45	
	1DB4	4																							
180 M	1EA2	2	151	14.5	19	698	-	-	814	145	48	M16	110	100	5	14	52	48	M16	110	100	5	14	52	
	1EB2	4																							
180 L	1EB4	4	151	14.5	19	698	-	-	814	145	48	M16	110	100	5	14	52	48	M16	110	100	5	14	52	
200 L	2AA4	2	178	18.5	25	746	-	-	860	185	55	M20	110	100	5	16	59	55	M20	110	100	5	16	59	
	2AA5	2																							
	2AB5	4																							

¹⁾ The length is specified as far as the tip of the fan cover.



SIMOTICS GP and SIMOTICS SD standard motors

Dimensions · Aluminum series SIMOTICS GP

IR3 Rendimento Premium – self-ventilated · Frame sizes 80 M to 160 L

Dimensional drawings

Type of construction IM B3

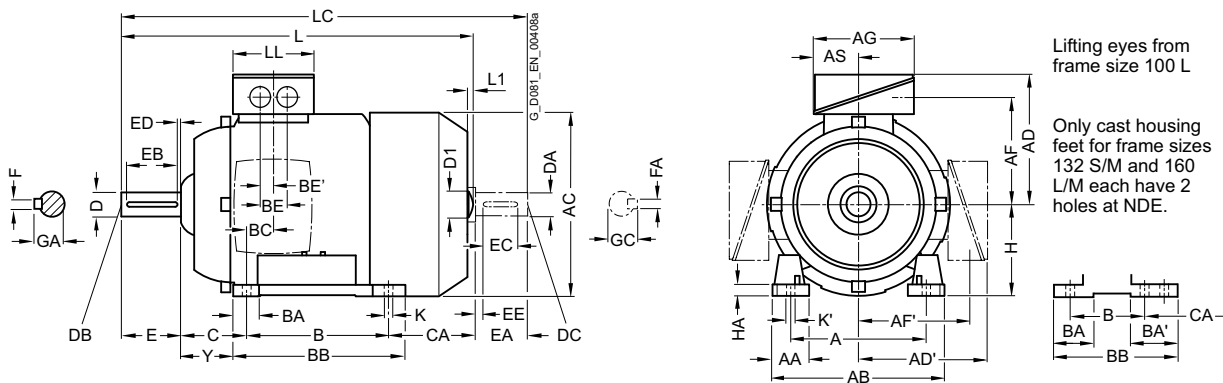

Types of construction IM B5 and IM V1

For flange dimensions, see page 1/48 (Z = the number of retaining holes)

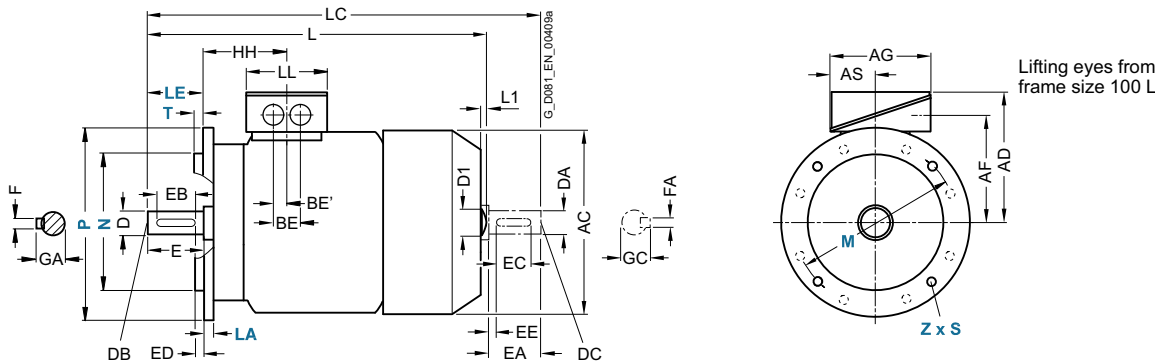

Frame size	Motor type	No. of poles	Dimension designation acc. to IEC																					
			A	AA	AB	AC	AD	AD'	AF	AF'	AG	AS	B	BA	BA'	BB	BC	BE	BE'	C	CA	H	HA	Y
80 M	0DA3, 0DA6, 0DB3, 0DB6, 0DC3, 0DD3	2, 4, 6, 8	125	30.5	150	159	121.5	121.5	96.5	96.5	93	43	100	32	-	118	23	-	18	50	113	80	8	41
	0DC2	6, 8																						
90 S	0EA4, 0EB4	2, 4	140	305	165	178	126	126	101.5	101.5	93	43	100	33	-	143	22.5	-	18	56	159	90	10	47
	0EC0, 0EDO	6, 8																						
90 L	0EB6	4	140	305	165	178	126	126	101.5	101.5	93	43	125	33	-	143	22.5	-	18	56	154	90	10	47
	0ED4	8																						
100 L	1AA4, 1AA6, 1AB5, 1AC3	2, 4, 6, 8	160	42	196	198	166	166	125.5	125.5	135	63.5	140	37.5	37.5	176	33.5	50	25	63	176	100	12	45
	1AB6	4																						
	1AD4	8																						
112 M	1BA5, 1BA6, 1BB5, 1BC1, 1BB6	2, 4, 6, 8	190	46	226	222	177	177	136.5	136.5	135	63.5	140	37.5	37	176	26	50	25	70	155	112	12	52
132 S	1CA1, 1CB2	2, 4	216	53	256	262	202	202	159.5	159.5	155	70.5	140	38	76	218	26.5	48	24	89	178.5	132	15	69
	1CC0, 1CC1	6, 8													38	180					128.5			
	1CC2, 1CC4, 1CD0																							
132 M	1CA5, 1CA6, 1CC3, 1CC6, 1CB5, 1CB6	2, 6, 8	216	53	256	262	202	202	159.5	159.5	155	70.5	178	38	76	218	26.5	48	24	89	178.5	132	15	69
160 M	1DA4, 1DB4, 1DC3, 1DC4	2, 4, 6	254	60	300	314	236.5	236.5	190	190	175	77.5	210	44	44	256	47	57	28.5	108	192	160	18	85
	1DA3, 1DD1, 1DD3	2, 8																						
160 L	1DA6, 1DB6, 1DC6, 1DD4	2, 4, 6, 8	254	60	300	314	236.5	236.5	190	190	175	77.5	254	44	89	300	47	57	28.5	108	208	160	18	85

SIMOTICS GP and SIMOTICS SD standard motors

Dimensions · Aluminum series SIMOTICS GP

IR3 Rendimento Premium – self-ventilated · Frame sizes 80 M to 160 L

Dimensional drawings

Type of construction IM B35

For flange dimensions, see page 1/48 (Z = the number of retaining holes)

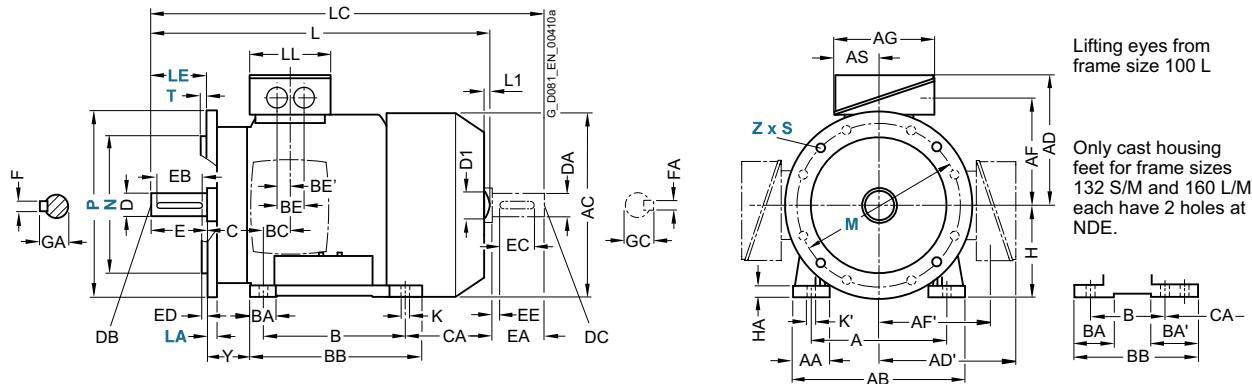

Type of construction IM B14

For flange dimensions, see page 1/48 (Z = the number of retaining holes)

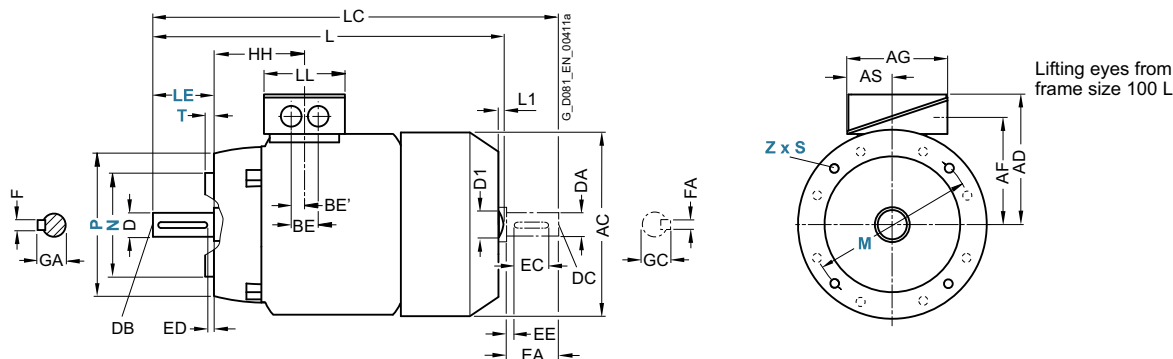

Frame size	Motor type	No. of poles	Dimension designation acc. to IEC							DE shaft extension					NDE shaft extension									
			HH	K	K'	L ¹⁾	L1	D1	LC	LL	D	DB	E	EB	ED	F	GA	DA	DC	EA	EC	EE	FA	GC
80 M	0DA3, 0DA6, 0DB3, 0DB6, 0DC3, 0DD3	2, 4, 6, 8	73	9.5	13.5	327	-	-	378	79	19	M6	40	32	4	6	21.5	19	M6	40	32	4	6	21.5
	0DC2	6, 8				292			343															
90 S	0EA4, 0EB4	2, 4	78.5	10	14	387	-	-	445	79	24	M8	50	40	5	8	27	19	M6	40	32	4	6	21.5
	0EC0, 0EDO	6, 8				347			405															
90 L	0EB6	4	78.5	10	14	433	-	-	491	79	24	M8	50	40	5	8	27	19	M6	40	32	4	6	21.5
	0ED4	8				347			405															
100 L	1AA4, 1AA6, 1AB5, 1AC3	2, 4, 6, 8	96.5	12	16	430.5	7	32	489	112	28	M10	60	50	5	8	31	24	M8	50	40	5	8	27
	1AB6	4				480.5			529															
	1AD4	8				395.5			454															
112 M	1BA5, 1BA6, 1BB5, 1BC1, 1BB6	2, 4, 6, 8	96	12	16	414	7	32	475	112	28	M10	60	50	5	8	31	24	M8	50	40	5	8	27
		4				464			520															
132 S	1CA1, 1CB2	2, 4	115.5	12	16	515	8.5	39	585.5	130	38	M12	80	70	5	10	41	28	M10	60	50	5	8	31
	1CC0, 1CC1, 1CC2, 1CC4, 1CD0	6, 8				465			535.5															
		4				574			644.5															
160 M	1DA4, 1DB4, 1DC3, 1DC4	2, 4, 6	155	15	19	664	10	45	730	145	42	M16	110	90	10	12	45	42	M16	110	90	10	12	45
	1DA3, 1DD1, 1DD3	2, 8				604																		
		4																						
160 L	1DA6, 1DB6, 1DC6, 1DD4	2, 4, 6, 8	155	15	19	664	10	54	790	145	42	M16	110	90	10	12	45	42	M16	110	90	10	12	45
		4																						

¹⁾ In the low-noise version, a second shaft extension and/or mounted encoder is not possible.

SIMOTICS GP and SIMOTICS SD standard motors

Dimensions · Cast-iron series SIMOTICS SD

IE1, IE2, NEMA Energy Efficient – self-ventilated · Frame sizes 71 M to 160 L

Dimensional drawings

Type of construction IM B3

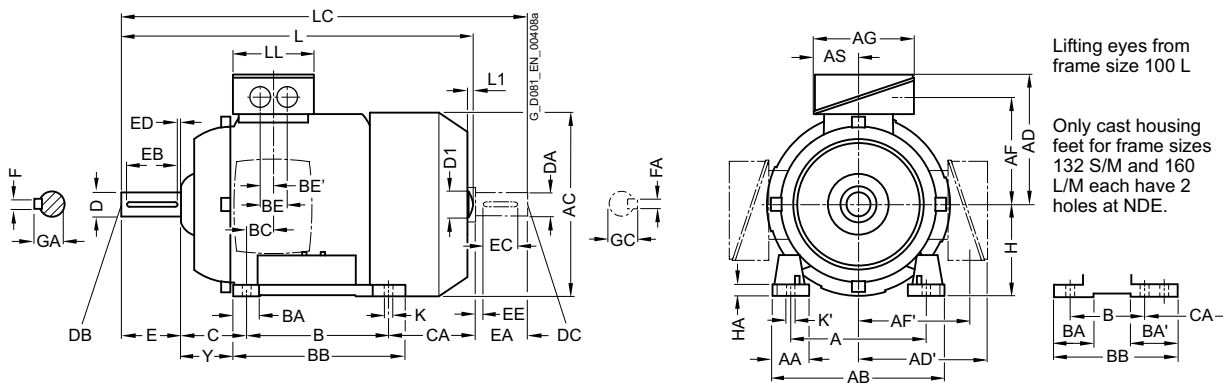

Types of construction IM B5 and IM V1

For flange dimensions, see page 1/48 (Z = the number of retaining holes)

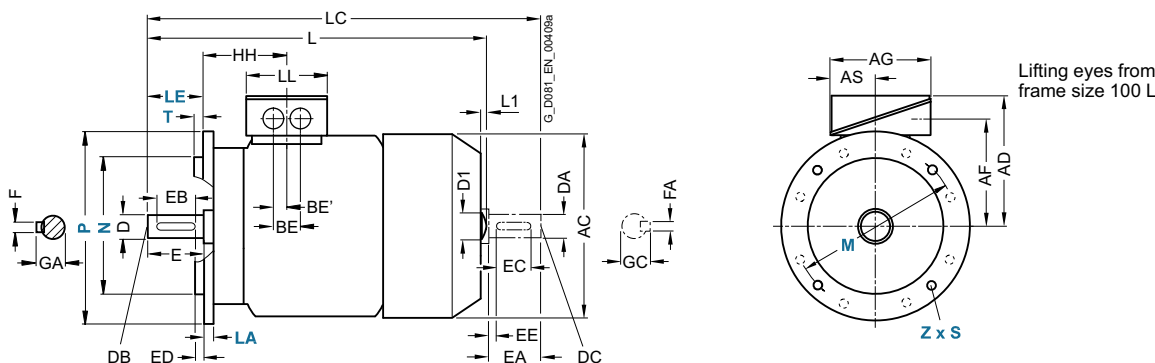

For motor			Dimension designation acc. to IEC																					
Frame size	Motor type	No. of poles	A	AA	AB	AC	AD	AD'	AF	AF'	AG	AS	B	BA	BA'	BB	BC	BE	BE'	C	CA	H	HA	Y
71 M	1LE15.1, 1LE16.1, 1LE1502	2, 4, 6	112	30.5	132	145	149	149	112	112	126	62	90	32	32	106	21	36	18	45	83	71	7	37
80 M	1LE15.1	2, 4, 6	125	30.5	150	162	159	159	122	122	126	62	100	32	32	118	22.5	36	18	50	112.5	80	8	41
90 S	1LE15.1	2, 4, 6	140	30.5	165	180	164	164	127	127	126	62	100	33	54	143	24.5	36	18	56	159	90	11	47
90 L	1LE15.1	2, 4, 6	140	30.5	165	180	164	164	127	127	126	62	125	33	54	143	24.5	36	18	56	134	90	11	47
100 L	All	2, 4, 6, 8	160	42	196	217	193	193	147	147	163	80.5	140	48	48	176	37.5	48	24	63	141	100	12	45
112 M	All	2, 4, 6, 8	190	46	226	239	195	195	150	150	163	80.5	140	48	48	176	30	48	24	70	130	112	12	52
132 S	All	2, 4, 6, 8	216	53	256	281	214.5	214.5	169	169	163	80.5	140	52 ⁵⁾	89 ¹⁾	218 ³⁾	26.5	48	24	89	166.5	132	15	69
132 M	All	2, 4, 6, 8	216	53	256	281	214.5	214.5	169	169	163	80.5	178	52 ⁵⁾	89 ¹⁾	218	26.5	48	24	89	128.5	132	15	69
160 M	All	2, 4, 6, 8	254	60	300	333.5	265	265	213	213	190	92	210	73 ⁶⁾	117 ²⁾	300 ⁴⁾	37	60	30	108	192	160	18	85
160 L	All	2, 4, 6, 8	254	60	300	333.5	265	265	213	213	190	92	254	73 ⁶⁾	117 ²⁾	300	37	60	30	108	148	160	18	85

1) With screwed-on feet, dimension BA' is 41 mm.
 2) With screwed-on feet, dimension BA' is 51 mm.
 3) With screwed-on feet, dimension BB is 180 mm.

4) With screwed-on feet, dimension BB is 256 mm.
 5) With screwed-on feet, dimension BA is 41 mm.
 6) With screwed-on feet, dimension BA is 51 mm.

SIMOTICS GP and SIMOTICS SD standard motors

Dimensions · Cast-iron series SIMOTICS SD

IE1, IE2, NEMA Energy Efficient – self-ventilated · Frame sizes 71 M to 160 L

Dimensional drawings

Type of construction IM B35

For flange dimensions, see page 1/48 (**Z** = the number of retaining holes)

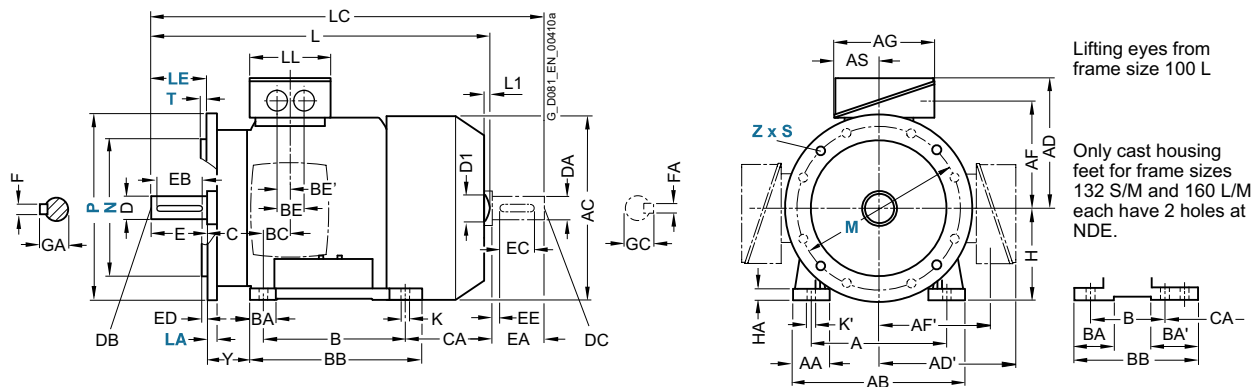

Type of construction IM B14

For flange dimensions, see page 1/48 (**Z** = the number of retaining holes)

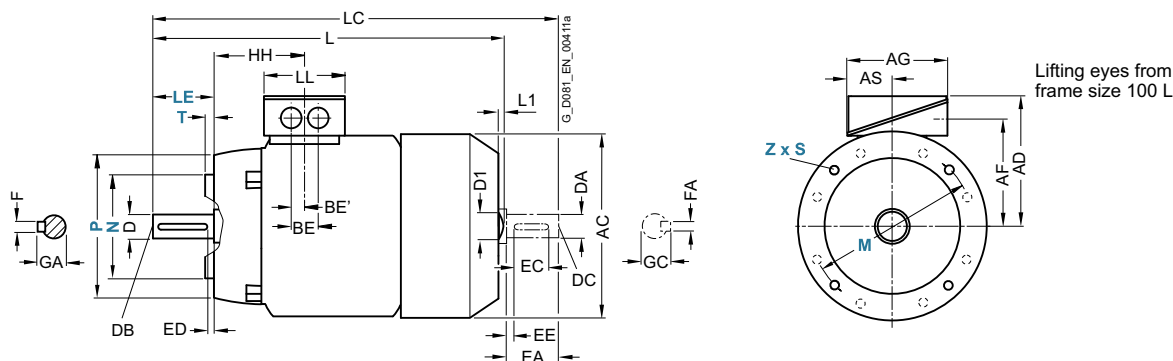

For motor			Dimension designation acc. to IEC							DE shaft extension					NDE shaft extension									
Frame size	Motor type	No. of poles	HH	K	K'	L ¹⁾	L1 ²⁾	D1	LC	LL	D	DB	E	EB	ED	F	GA	DA	DC	EA	EC	EE	FA	GC
71 M	1LE15.1	2, 4, 6	64.5	7.5	7.5	240	-	-	278	102	14	M5	30	22	4	5	16	14	M5	30	22	4	5	16
80 M	1LE15.1	2, 4, 6	71.5	10	10	292	-	-	342.5	102	19	M6	40	32	4	6	21.5	19	M6	40	32	4	6	21.5
90 S	1LE15.1	2, 4, 6	79.5	10	10	347	-	-	405	102	24	M8	50	40	5	8	27	19	M6	40	32	4	6	21.5
90 L	1LE15.1	2, 4, 6	79.5	10	10	347	-	-	405	102	24	M8	50	40	5	8	27	19	M6	40	32	4	6	21.5
100 L	All	2, 4, 6, 8	100.5	12	16	397.5	7	32	454	134	28	M10	60	50	5	8	31	24	M8	50	40	5	8	27
112 M	All	2, 4, 6, 8	100.5	12	16	390.5 415.5	7	32	450 475	134	28	M10	60	50	5	8	31	24	M8	50	40	5	8	27
132 S	All	2, 4, 6, 8	115.5	12	16	466.5	8.5	39	535.5	134	38	M12	80	70	5	10	41	28	M10	60	50	5	8	31
132 M	All	2, 4, 6, 8	115.5	12	16	466.5	8.5	39	535.5	134	38	M12	80	70	5	10	41	28	M10	60	50	5	8	31
160 M	All	2, 4, 6, 8	145	14.5	18	606	10	45	730	165	42	M16	110	90	10	12	45	42	M16	110	90	10	12	45
160 L	All	2, 4, 6, 8	145	14.5	18	606	10	45	730	165	42	M16	110	90	10	12	45	42	M16	110	90	10	12	45

1) For 1LE16 motors less dimension L1.

2) Only for 1LE15 motors.



SIMOTICS GP and SIMOTICS SD standard motors

Dimensions · Cast-iron series SIMOTICS SD

IE1, IE2, NEMA Energy Efficient – self-ventilated · Frame sizes 180 M to 250 M

Dimensional drawings

Type of construction IM B3

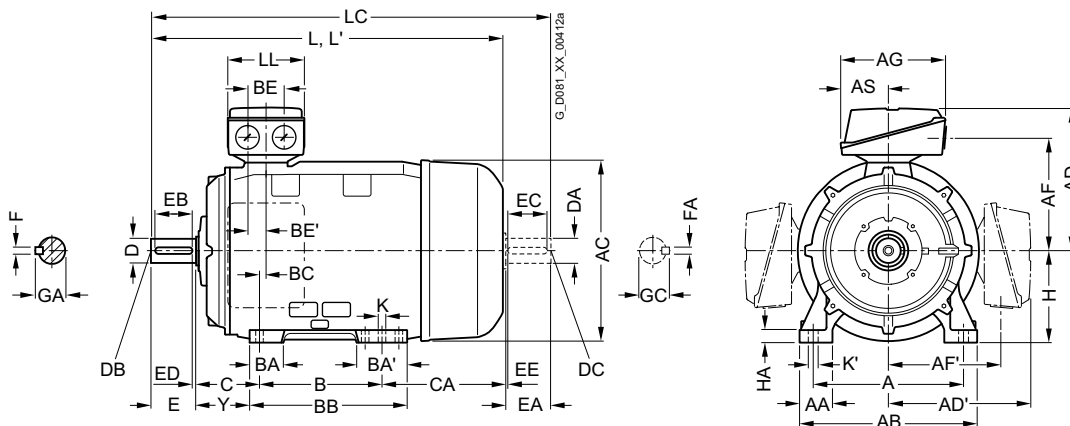

Types of construction IM B5 and IM V1

For flange dimensions, see page 1/48 (Z = the number of retaining holes)

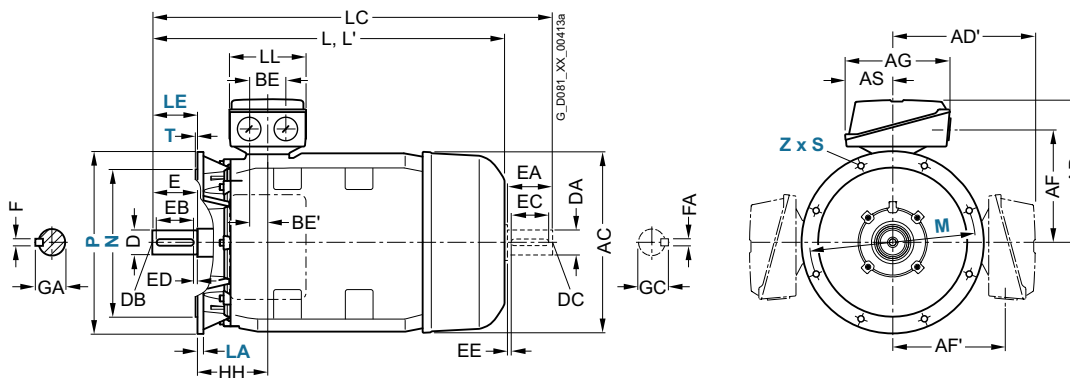

For motor			Dimension designation acc. to IEC																		
Frame size	Motor type	No. of poles	A	AA	AB	AC	AD	AD'	AF	AF'	AG	AS	B	BA	BA'	BB	BC	BE	BE'	C	CA
180 M/ 180 L	1LE1501-, 1LE1521-, 1LE1541- 1LE1601- 1LE1502-	2, 4, 6	279	65	339	356	286	286	234	234	189	91	241	85	120	328	34	60	30	121	202
	1EB4, 1EA6, 1EB6, 1EC6	2, 4, 6											279								
200 L	2AA4, 2AA5, 2AB5, 2AC4, 2AC5, 2AD5 2AA6, 2AB6, 2AC6, 2AD6	2, 4, 6, 8	318	70	378	396	315	315	258.5	258.5	265	112	305	104	104	355	31	85	42.5	133	177
225 S/ 225 M	2BB0, 2BD0,	4, 8	356	80	436	449	338	338	282	282	266	112	311	92	117	361	15	85	42.5	149	253
	2BB2, 2BC2, 2BD2, 2BB6, 2BC6, 2BD6	4, 6, 8											286 ¹⁾								
	2BA2, 2BA6	2											286 ¹⁾								
250 M	2CA2, 2CA6	2	406	100	490	497	410	410	322	322	319	145	349	102	102	409	24	110	55	168	230
	2CB2, 2CC2, 2CD2, 2CC6, 2CD6,	4, 6, 8																			
	2CB6	4																			

300

¹⁾ Only applicable for 1LE1502.

SIMOTICS GP and SIMOTICS SD standard motors

Dimensions · Cast-iron series SIMOTICS SD

IE1, IE2, NEMA Energy Efficient – self-ventilated · Frame sizes 180 M to 250 M

Dimensional drawings

Type of construction IM B35

For flange dimensions, see page 1/48 (**Z** = the number of retaining holes)

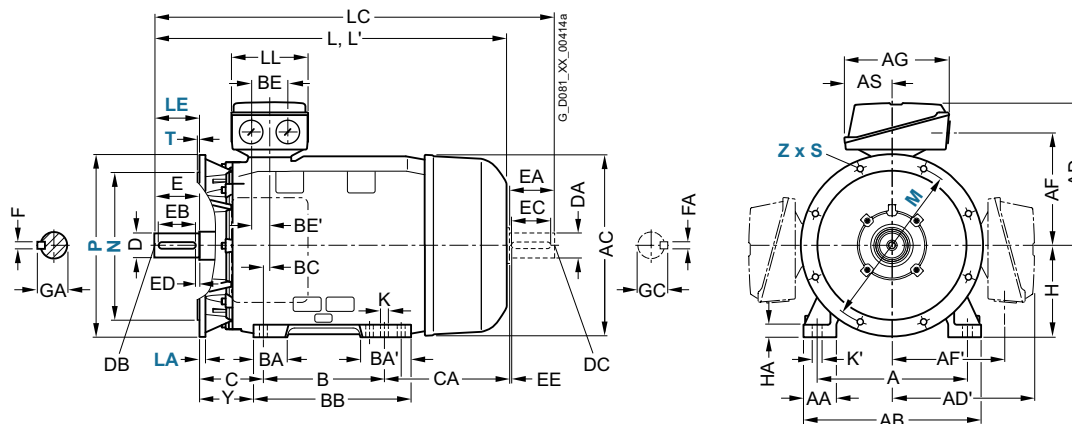

For motor Motor type 1LE1501-, 1LE1521-, 1LE1541- 1LE1601- 1LE1502- 1EB2 ²⁾ , 1EA2, 1EB2, 1EC4 1EB4, 1EA6, 1EB6, 1EC6 2AA4, 2AA5, 2AB5, 2AC4, 2AC5, 2AD5 2AA6, 2AB6, 2AC6, 2AD6 2BB0, 2BD0 2BB2, 2BC2, 2BD2, 2BB6, 2BC6, 2BD6 2BA2, 2BA6 2CA2, 2CA6 2CB2, 2CC2, 2CD2, 2CC6, 2CD6 2CB6	Dimension designation acc. to IEC							DE shaft extension						NDE shaft extension									
	H	HA	Y	HH	K	K'	L	LC ¹⁾	LL	D	DB	E	EB	ED	F	GA	DA	DC	EA	EC	EE	FA	GC
	180	20	95	155	15	19	668	784	164	48	M16	110	100	5	14	51.5	48	M16	110	100	5	14	51.5
							698	814															
	200	25	108	164	19	25	721	835	197	55	M20	110	100	5	16	59	55	M20	110	100	5	16	59
							746	860															
	225	34	124	164	19	25	788	903	197	60	M20	140	125	10	18	64	55	M20	110	100	5	16	59
								963															
							848																
							818	933	55		M16	110	100	5	16	59	48	M16				14	51.5
	250	40	138	192	24	30	887	1002	233	60	M20	140	125	10	18	64	55	M20	110	100	5	16	59
								1032	65							69	60		140	125	10	18	64
							957	1072															

¹⁾ In the low-noise version, a second shaft extension and/or mounted encoder is not possible.

²⁾ Only applicable for 1LE1502.

SIMOTICS GP and SIMOTICS SD standard motors

Dimensions · Cast-iron series SIMOTICS SD

IE1, IE2, NEMA Energy Efficient – self-ventilated · Frame sizes 280 S to 315 L

Dimensional drawings

Type of construction IM B3

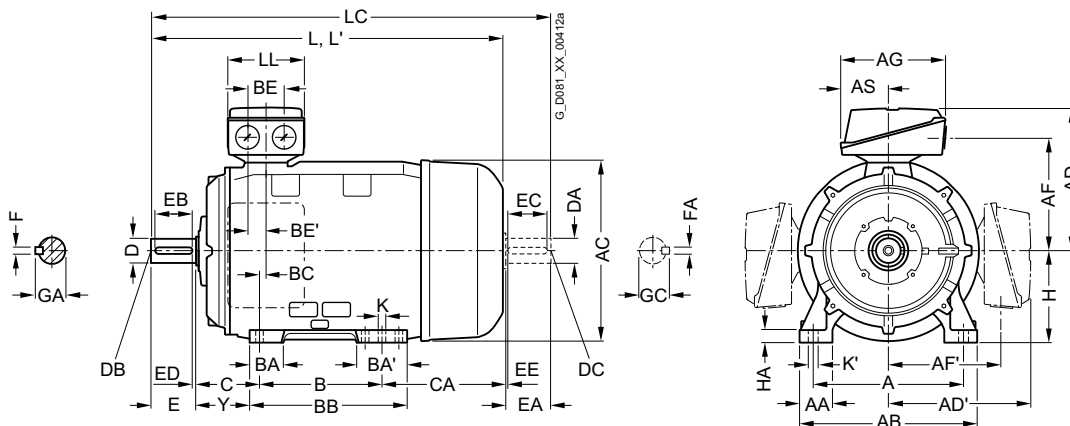

Types of construction IM B5 and IM V1

For flange dimensions, see page 1/48 (Z = the number of retaining holes)

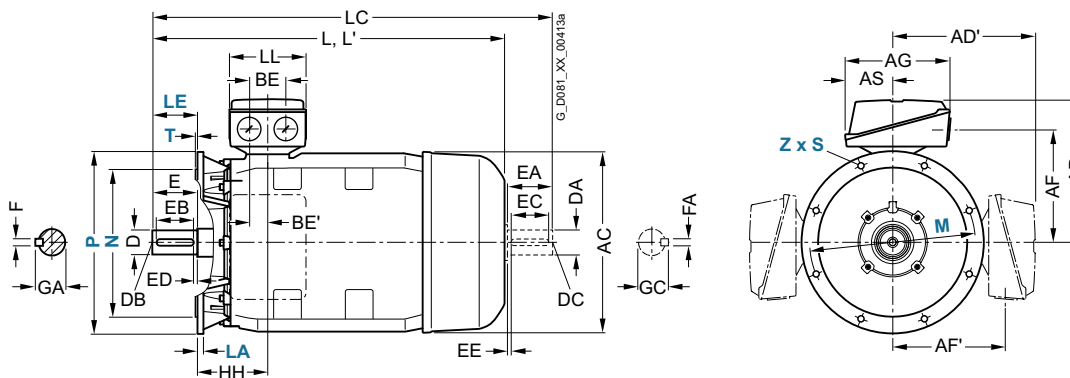

For motor			Dimension designation acc. to IEC																		
Frame size	Motor type	No. of poles	A	AA	AB	AC	AD	AD'	AF	AF'	AG	AS	B	BA	BA'	BB	BC	BE	BE'	C	CA
280 S	2DA0	2	457	100	540	551	433	433	345	345	319	145	368	101	152	479	20	110	55	190	267
	2DB0, 2DC0, 2DD0	4, 6, 8																			267
280 M	2DA6	2											419								326
	2DA2																				216
	2DB2, 2DC2, 2DD2, 2DC6, 2DD6	4, 6, 8																			
	2DB6	4																			326
315 S	3AA0, 3AA2 ²⁾	2	508	120	610	616	515	515	404	404	374	164	406	113	170	527	22	110	55	216	295
	3AB0, 3AC0, 3AD0	4, 6, 8																			
315 M	3AA2 ¹⁾ , 3AA5 ²⁾	2											457			578					409
	3AB2 ¹⁾	4																			
	3AC2, 3AD2	6, 8																			
315 L ¹⁾	3AA4	2											508			578					358
	3AB4, 3AC4, 3AD4, 3AC5, 3AD5, 3AD6	4, 6, 8																			
	3AA5, 3AA6	2											508	176	227	648					
	3AB5, 3AC6	4, 6																			

¹⁾ For orders with screwed-on feet (order code **H01**), these screwed-on feet have 3 drilled holes on the NDE side with the dimension B 406 mm, 457 mm, and 508 mm respectively; the dimension BB is 666 mm.

²⁾ Only applicable for 1LE1502.

SIMOTICS GP and SIMOTICS SD standard motors

Dimensions · Cast-iron series SIMOTICS SD

IE1, IE2, NEMA Energy Efficient – self-ventilated · Frame sizes 280 S to 315 L

Dimensional drawings

Type of construction IM B35

For flange dimensions, see page 1/48 (**Z** = the number of retaining holes)

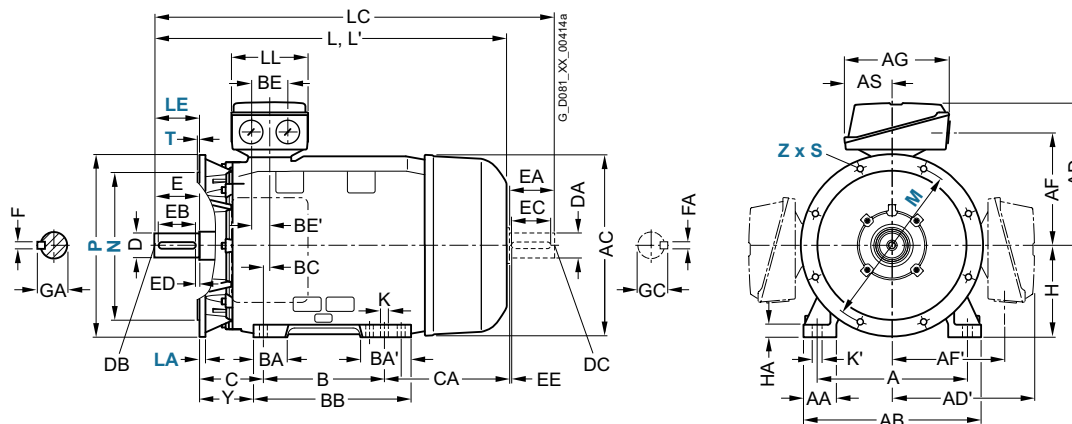

3

For motor Motor type 1LE1501-, 1LE1521-, 1LE1541- 1LE1601- 1LE1502-	Dimension designation acc. to IEC							DE shaft extension							NDE shaft extension								
	H	HA	Y	HH	K	K'	L	LC ¹⁾	LL	D	DB	E	EB	ED	F	GA	DA	DC	EA	EC	EE	FA	GC
2DA0	280	40	160	210	24	30	960	1105	233	65	M20	140	125	10	18	69	60	M20	140	125	10	18	64
2DB0, 2DC0, 2DD0										75					20	79.5	65						69
2DA6							1070	1215		65					18	69	60						64
2DA2							960	1105															
2DB2, 2DC2, 2DD2, 2DC6, 2DD6										75					20	79.5	65						69
2DB6							1070	1215															
3AA0, 3AA2 ²⁾	315	50	181	238	28	35	1052	1197	299	65	M20	140	125	10	18	69	60	M20	140	125	10	18	64
3AB0, 3AC0, 3AD0							1082	1227		80		170	140	25	22	85	70					20	74.5
3AA2, 3AA5 ²⁾							1217	1362		65		140	125	10	18	69	60					18	64
3AB2							1247	1392		80		170	140	25	22	85	70					20	74.5
3AC2, 3AD2							1082	1227															
3AA4							1217	1362		65		140	125	10	18	69	60					18	64
3AB4, 3AC4, 3AD4, 3AC5, 3AD5, 3AD6							1247	1392		80		170	140	25	22	85	70					20	74.5
3AA5, 3AA6			146				1372	1517		65		140	125	10	18	69	60					18	64
3AB5, 3AC6							1402	1547		80		170	140	25	22	85	70					20	74.5

¹⁾ In the low-noise version, a second shaft extension and/or mounted encoder is not possible.

²⁾ Only applicable for 1LE1502.

SIMOTICS GP and SIMOTICS SD standard motors

Dimensions · Cast-iron series SIMOTICS SD

IE3, NEMA Premium Efficient – self-ventilated · Frame sizes 71 M to 160 L

Dimensional drawings

Type of construction IM B3

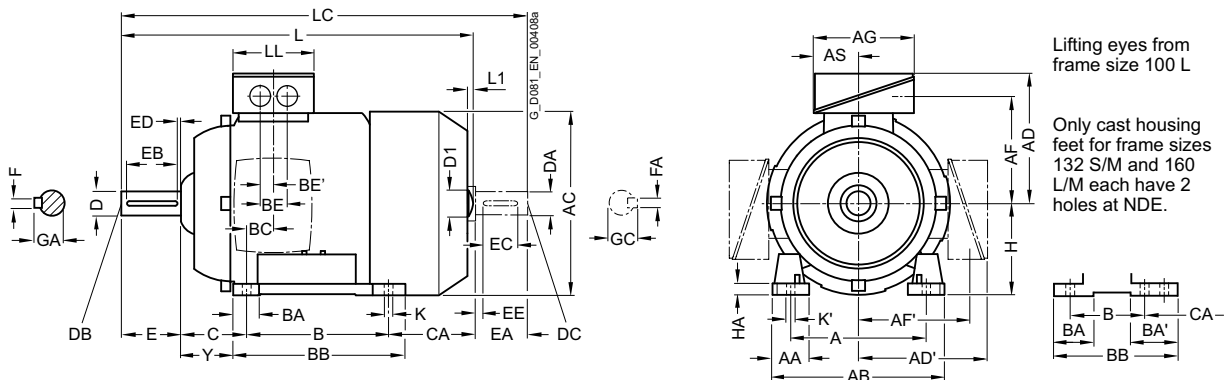

Lifting eyes from frame size 100 L

Only cast housing feet for frame sizes 132 S/M and 160 L/M each have 2 holes at NDE.

Types of construction IM B5 and IM V1

For flange dimensions, see page 1/48 (Z = the number of retaining holes)

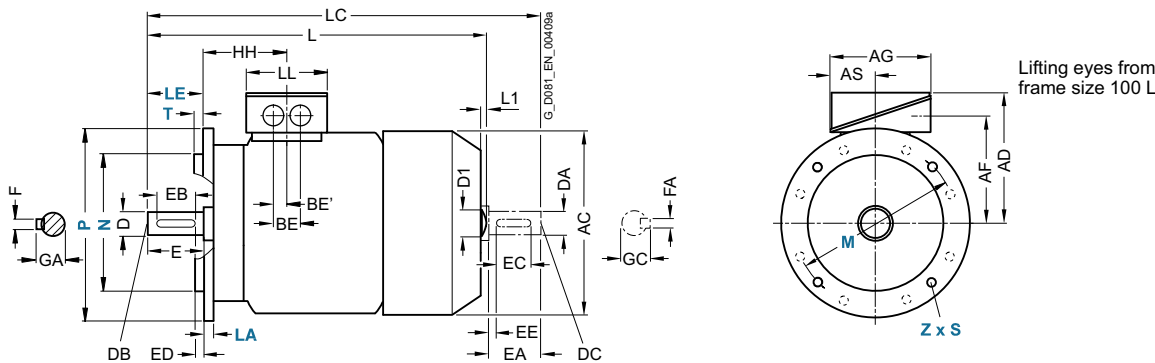

Lifting eyes from frame size 100 L

For motor			Dimension designation acc. to IEC																					
Frame size	Motor type	No. of poles	A	AA	AB	AC	AD	AD'	AF	AF'	AG	AS	B	BA	BA'	BB	BC	BE	BE'	C	CA	H	HA	Y
71 M	1LE15.3-0.0, 0..2	2, 4, 6	112	30,5	132	145	149	149	112	112	126	62	90	32	32	106	21	36	18	45	83	71	7	37
	1LE16.3-0.3																							
80 M	1LE15.3-0.0, 0..2, 0..3, 0..6	2, 4, 6	125	30,5	150	162	159	159	122	122	126	62	100	32	32	118	22,5	36	18	50	112,5	80	8	41
																						148		
90 S	1LE15.3-0.0, 0..2, 0..3	2, 4, 6	140	30,5	165	180	164	164	127	127	126	62	100	33	54	143	24,5	36	18	56	159	90	11	47
90 L	1LE15.3-0..6	2, 4, 6	140	30,5	165	180	164	164	127	127	126	62	125	33	54	143	24,5	36	18	56	174	90	11	47
100 L	1AA4, 1AA6, 1AB4, 1AB5, 1AB6, 1AC4	2, 4 6	160	42	196	217	193	193	147	147	163	80,5	140	48	48	176	37,5	48	24	63	176	100	12	45
																					216 176			
112 M	1BA2, 1BA6, 1BB2, 1BC2, 1BD2, 1BB6	2, 4, 6	190	46	226	239	195	195	150	150	163	80,5	140	48	48	176	30	48	24	70	155	112	12	52
																					200			
132 S	1CA0, 1CC0, 1CD0	2, 6, 8	216	53	256	281	214,5	214,5	169	169	163	80,5	140	52 ^{b)}	89 ¹⁾	218 ²⁾	26,5	48	24	89	166,5	132	15	69
	1CA1, 1CA6, 1CA7, 1CB0	2, 4																			178,5			
132 M	1CC2	6	216	53	256	281	214,5	214,5	169	169	163	80,5	178	52 ^{b)}	89 ¹⁾	218	26,5	48	24	89	128,5	132	15	69
	1CB2, 1CC3, 1CD2, 1CB6	4, 6, 8 4																			178,5			
160 M	alle	2, 4, 6, 8	254	60	300	333,5	261	261	213	213	190	92	210	73 ^{b)}	117 ³⁾	300 ⁴⁾	37	60	30	108	192	160	18	85
160 L	alle	2, 4, 6, 8	254	60	300	333,5	261	261	213	213	190	92	254	73 ^{b)}	117 ³⁾	300	37	60	30	108	148	160	18	85

1) With screwed-on feet, dimension BA' is 41 mm.
 2) With screwed-on feet, dimension BB is 180 mm.
 3) With screwed-on feet, dimension BA' is 51 mm.

4) With screwed-on feet, dimension BB is 256 mm.
 5) With screwed-on feet, dimension BA is 41 mm.
 6) With screwed-on feet, dimension BA is 51 mm.

SIMOTICS GP and SIMOTICS SD standard motors

Dimensions · Cast-iron series SIMOTICS SD

IE3, NEMA Premium Efficient – self-ventilated · Frame sizes 71 M to 160 L

Dimensional drawings

Type of construction IM B35

For flange dimensions, see page 1/48 (Z = the number of retaining holes)

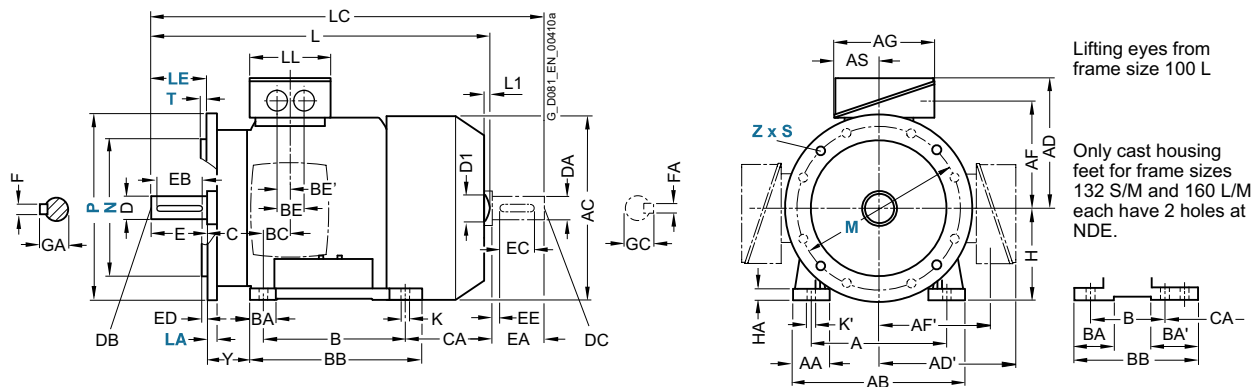

Type of construction IM B14

For flange dimensions, see page 1/48 (Z = the number of retaining holes)

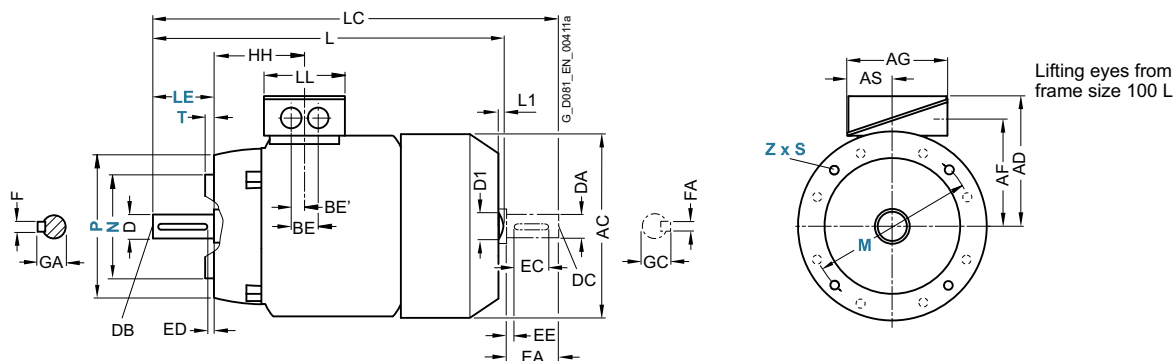

For motor			Dimension designation acc. to IEC							DE shaft extension						NDE shaft extension										
Frame size	Motor type	No. of poles	HH	K	K'	L ¹⁾	L ¹⁾²⁾	D1	LC	LL	D	DB	E	EB	ED	F	GA	DA	DC	EA	EC	EE	FA	GC		
71 M	1LE15.3-0.0, 0.2	2, 4, 6	64.5	7.5	7.5	240	-	-	278	102	14	M5	30	22	4	5	16	14	M5	30	22	4	5	16		
	280					-	-	318																		
80 M	1LE15.3-0.0, 0.2	2, 4, 6	71.5	10	10	292	-	-	343	102	19	M6	40	32	4	6	21.5	19	M6	40	32	4	6	21.5		
	327					-	-	378																		
90 S	1LE15.3-0.0, 0.2, 0.3	2, 4, 6	79.5	10	10	347	-	-	405	102	24	M8	50	40	5	8	27	19	M6	40	27	4	6	21.5		
90 L	1LE15.3-0.6	2, 4, 6	79.5	10	10	387	-	-	445	102	24	M8	50	40	5	8	27	19	M6	40	27	4	6	21.5		
100 L	1AA4, 1AA6, 1AB4, 1AB5, 1AB6, 1AC4	2, 4	100.5	12	16	432.5	7	32	489	134	28	M10	60	50	5	8	31	24	M8	50	40	5	8	27		
	6	397				-	-	342.5																		
112 M	1BA2, 1BA6, 1BB2, 1BC2, 1BD2, 1BB6	2, 4, 6	100.5	12	16	415.5	7	32	475	134	28	M10	60	50	5	8	31	24	M8	50	40	5	8	27		
	465.5	-				-	520																			
132 S	1CA0, 1CC0, 1CD0	2, 6, 8	115.5	12	16	466.5	8.5	39	535.5	134	38	M12	80	70	5	10	41	28	M10	60	50	5	8	31		
	1CA1, 1CA6, 1CA7, 1CB0	2, 4				516.5	-	-	585.5																	
132 M	1CC2	6	115.5	12	16	466.5	8.5	39	535.5	134	38	M12	80	70	5	10	41	28	M10	60	50	5	8	31		
	1CB2, 1CC3, 1CD2	4, 6, 8				516.5	-	-	585.5																	
	1CB6	4				567.5	-	-	630.5																	
160 M	All	2, 4, 6, 8	145	14.5	18	606	10	45	730	165	42	M16	110	90	10	12	45	42	M16	110	90	10	12	45		
160 L	All	2, 4, 6, 8	145	14.5	18	666	10	45	790	165	42	M16	110	90	10	12	45	42	M16	110	90	10	12	45		

1) For 1LE16 motors less dimension L1.

2) Only for 1LE15 motors.

SIMOTICS GP and SIMOTICS SD standard motors

Dimensions · Cast-iron series SIMOTICS SD

IE3, NEMA Premium Efficient – self-ventilated · Frame sizes 180 M to 315 L

Dimensional drawings

Type of construction IM B3

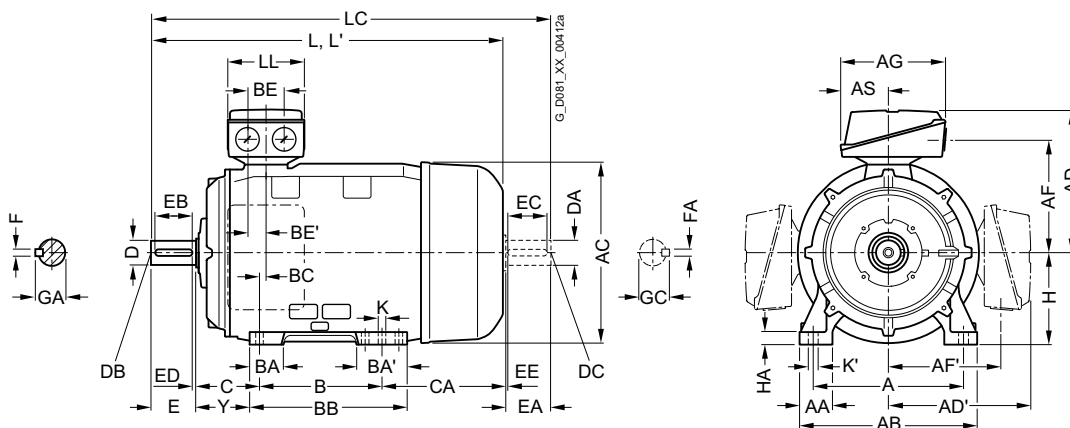

Types of construction IM B5 and IM V1

For flange dimensions, see page 1/48 (Z = the number of retaining holes)

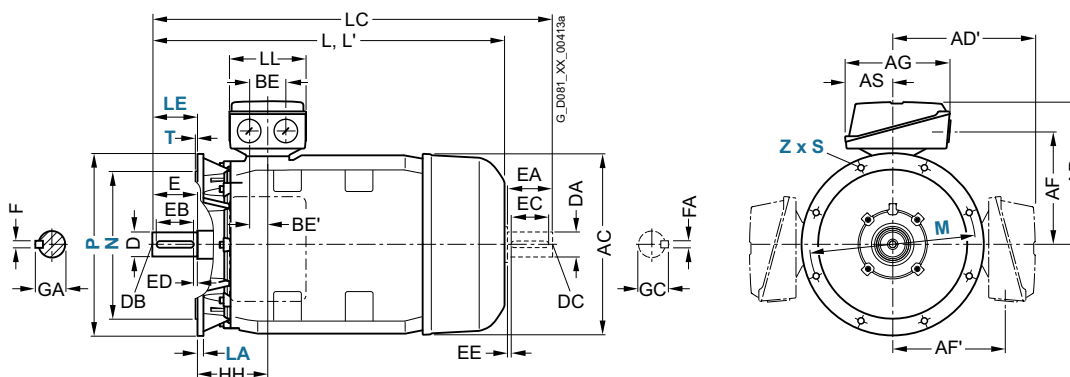

For motor		No. of poles	Dimension designation acc. to IEC																		
Frame size	Motor type		A	AA	AB	AC	AD	AD'	AF	AF'	AG	AS	B	BA	BA'	BB	BC	BE	BE'	C	CA
180 M/ 180 L	1EB2, 1EC4 1EA2, 1EB4, 1ED4	4, 6 2, 4, 8	279	65	339	356	286	286	234	234	190	92	241	85	120	328	34	60	30	121	202
200 L	2AA4, 2AC4 2AA5, 2AB5, 2AC5, 2AD5, 2AD6	2, 6 2, 4, 6, 8	318	70	378	396	315	315	259	259	266	112	305	104	104	355	31	85	42.5	133	177 202
225 S 225 M	2BB0, 2BD0 2BA2 2BB2, 2BC2, 2BD2	4, 8 2 4, 6, 8	356	80	436	449	338	338	282	282	266	112	286	92	117	361	15	85	42.5	149	218 253
250 M	2CA2 2CB2, 2CC2, 2CD2, 2CD6	2 4, 6, 8	406	100	490	497	410	410	322	322	319	145	349	102	102	409	24	110	55	168	230
280 S 280 M	2DA0 2DB0, 2DC0, 2DD0 2DC2, 2DD2, 2DD6 2DA2 2DB2	2 4, 6, 8 6, 8 2 4	457	100	540	551	433	433	345	345	319	145	368	101	152	479	20	110	55	190	267 326
315 S 315 M ¹⁾	3AA0 3AB0, 3AC0, 3AD0 3AA2 3AB2, 3AC2, 3AD2	2 4, 6, 8 2 4, 6, 8	508	120	610	616	515	515	404	404	374	164	406	113	170	527	22	110	55	216	295 409
315 L ¹⁾	3AA4 3AB4, 3AC4, 3AD4 3AA5 3AB5, 3AC5, 3AC6, 3AD5, 3AD6	2 4, 6, 8 2 4, 6, 8	508	120	610	616	515	515	404	404	374	164	508	113	170	578	22	110	55	216	358 513

¹⁾ With terminal box position right, terminal box left, and with order code **H01** only screwed-on feet with 3 drilled holes with dimension "B" (406, 457, and 508 mm). The dimension "BB" will then be 666 mm.

SIMOTICS GP and SIMOTICS SD standard motors

Dimensions · Cast-iron series SIMOTICS SD

IE3, NEMA Premium Efficient – self-ventilated · Frame sizes 180 M to 315 L

Dimensional drawings

Type of construction IM B35

For flange dimensions, see page 1/48 (Z = the number of retaining holes)

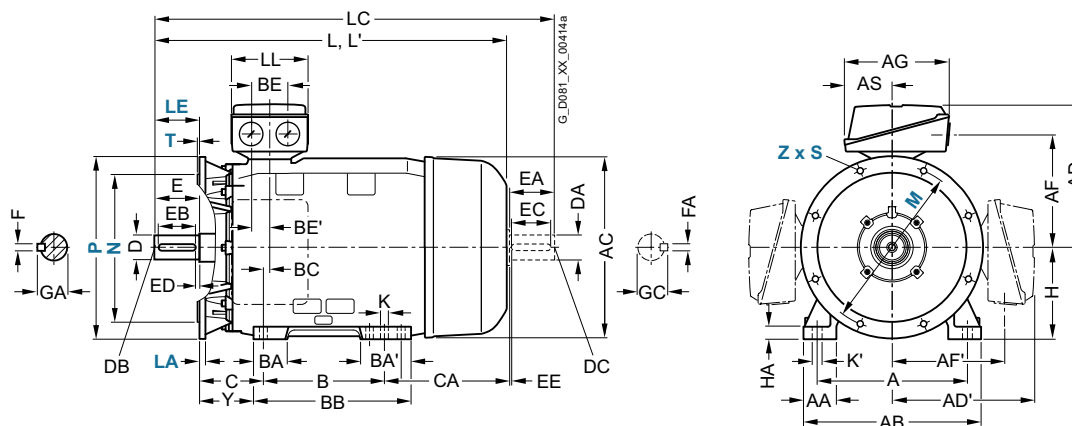

For motor Motor type	Dimension designation acc. to IEC								DE shaft extension						NDE shaft extension								
	H	HA	Y	HH	K	K'	L	LC ¹⁾	LL	D	DB	E	EB	ED	F	GA	DA	DC	EA	EC	EE	FA	GC
1LE1503-, 1LE1523-, 1LE1543- 1LE1603-, 1LE1623-, 1LE1643- 1EB2, 1EC4 1EA2, 1EB4, 1ED4	180	20	95	155	15	19	668 698	784 814	164	48	M16	110	100	5	14	51.5	48	M16	110	100	5	14	51.5
2AA4, 2AC4 2AA5, 2AB5, 2AC5, 2AD5, 2AD6	200	25	108	164	19	25	721 746	835 860	197	55	M20	110	100	5	16	59	55	M20	110	100	5	16	59
2BB0, 2BD0 2BA2 2BB2, 2BC2, 2BD2	225	34	124	164	19	25	788 818 848	903 933 963	197 197	60	M20	140 110	125 100	10 5	18 16	64 59	55	M20	110 M16	100	5	16 14	59 51.5
2CA2 2CB2, 2CC2, 2CD2, 2CD6	250	40	138	192	24	30	887	1002 1032	233	60	M20	140	125	10	18	64	55	M20	110	100	5	16	59
2DA0 2DB0, 2DC0, 2DD0 2DC2, 2DD2, 2DD6 2DA2 2DB2	280	40	160	210	24	30	960 1070	1105 1215	233	65	M20	140	125	10	18	69 20 79.5	60 65	M20	140	125	10	18	64 69 69
3AA0 3AB0, 3AC0, 3AD0 3AA2 3AB2, 3AC2, 3AD2 3AA4 3AB4, 3AC4, 3AD4 3AA5 3AB5, 3AC5, 3AC6, 3AD5, 3AD6	315	50	181	238	28	35	1052 1082 1217 1247 1217 1247 1372 1402	1197 1227 1362 1392 1362 1392 1517 1547	299 80 299	65	M20	140 170	125 140	10 25	18 22	69 85	60 70	M20	140	125	10	18	64 74.5 64 74.5 64 74.5 64 74.5

¹⁾ In the low-noise version, a second shaft extension and/or mounted encoder is not possible.



SIMOTICS GP and SIMOTICS SD standard motors

Dimensions · Cast-iron series SIMOTICS SD

IE3 – 1LE1583 self-ventilated · Frame sizes 100 L to 200 L

Dimensional drawings

Type of construction IM B3

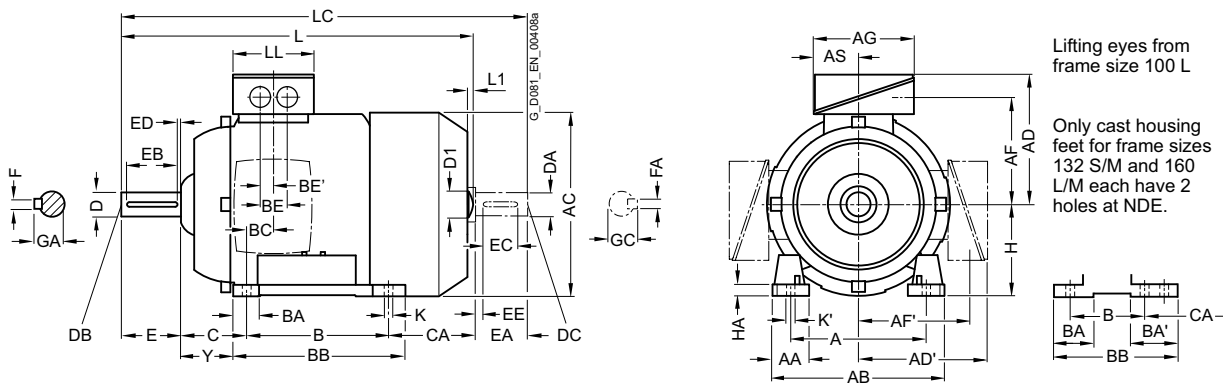

Types of construction IM B5 and IM V1

For flange dimensions, see page 1/48 (Z = the number of retaining holes)

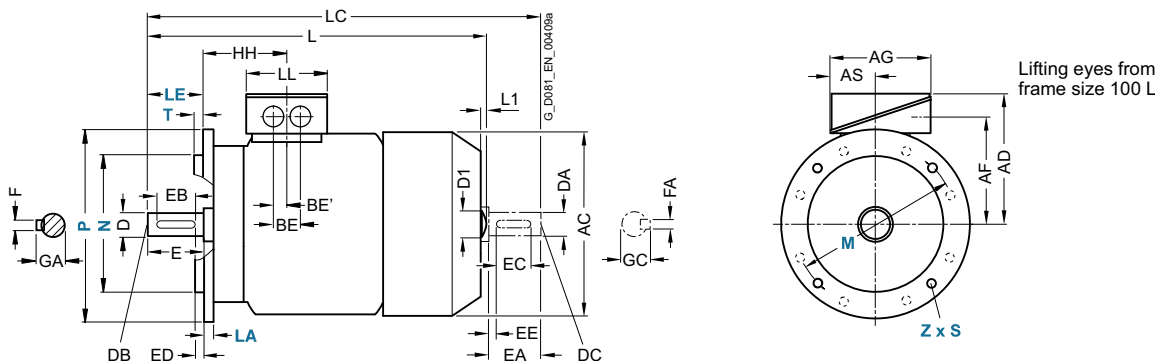

For motor			Dimension designation acc. to IEC																					
Frame size	Motor type	No. of poles	A	AA	AB	AC	AD	AD'	AF	AF'	AG	AS	B	BA	BA'	BB	BC	BE	BE'	C	CA	H	HA	Y
100 L	1AA4, 1AB4, 1AB5	2, 4	160	42	196	217	193	193	147	147	163	80.5	140	48	48	176	37.5	48	24	63	141	100	12	45
112 M	1BA2, 1BB2	2, 4	190	46	226	239	195	195	150	150	163	80.5	140	48	48	176	30	48	24	70	130	112	12	52
132 S	1CA0, 1CA1, 1CB0	2, 4	216	53	256	281	214.5	214.5	169	169	163	80.5	140	52 ^{b)}	89 ¹⁾	218 ²⁾	26.5	48	24	89	178.5	132	15	69
132 M	1CB2		216	53	256	281	214.5	214.5	169	169	163	80.5	178	52 ^{b)}	89 ¹⁾	218	26.5	48	24	89	128.5	132	15	69
160 M	1DA2, 1DA3, 1DB2	2, 4	254	60	300	333.5	261	261	213	213	190	92	210	73 ^{b)}	117 ³⁾	300 ⁴⁾	37	60	30	108	192	160	18	85
160 L	1DA4, 1DB4	2, 4	254	60	300	333.5	261	261	213	213	190	92	254	73 ^{b)}	117 ³⁾	300	37	60	30	108	208	160	18	85
180 M/180 L	1EB2, 1EC4, 1EA2, 1EB4	4, 6, 2, 4	279	65	339	356	286	286	234	234	190	92	241	85	120	328	34	60	30	121	164	180	20	95
200 L	2AA4, 2AC4, 2AA5, 2AB5, 2AC5	2, 6, 2, 4, 6	318	70	378	396	315	315	259	259	266	112	305	104	104	355	31	85	42.5	133	177	200	25	108

1) With screwed-on feet, dimension BA' is 41 mm.
 2) With screwed-on feet, dimension BB is 180 mm.
 3) With screwed-on feet, dimension BA' is 51 mm.

4) With screwed-on feet, dimension BB is 256 mm.
 5) With screwed-on feet, dimension BA is 41 mm.
 6) With screwed-on feet, dimension BA is 51 mm.

SIMOTICS GP and SIMOTICS SD standard motors

Dimensions · Cast-iron series SIMOTICS SD

IE3 – 1LE1583 self-ventilated · Frame sizes 100 L to 200 L

Dimensional drawings

Type of construction IM B35

For flange dimensions, see page 1/48 (Z = the number of retaining holes)

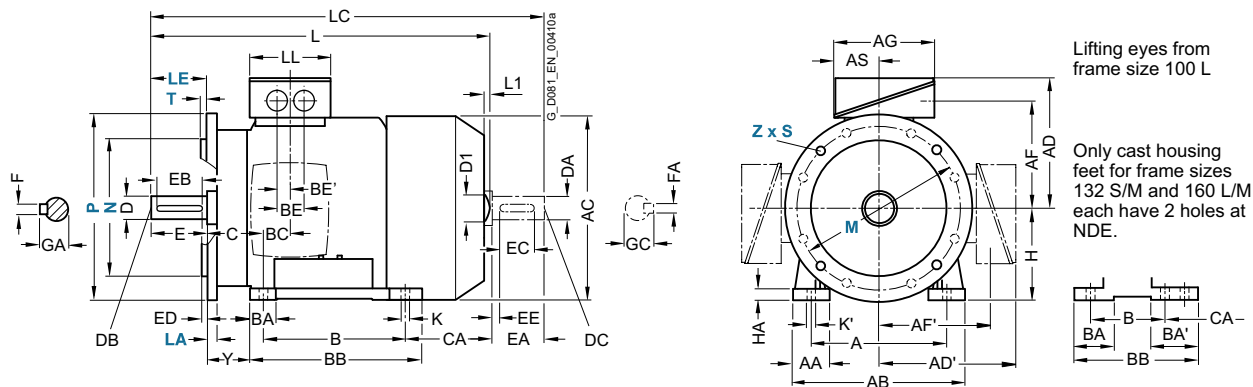

Type of construction IM B14

For flange dimensions, see page 1/48 (Z = the number of retaining holes)

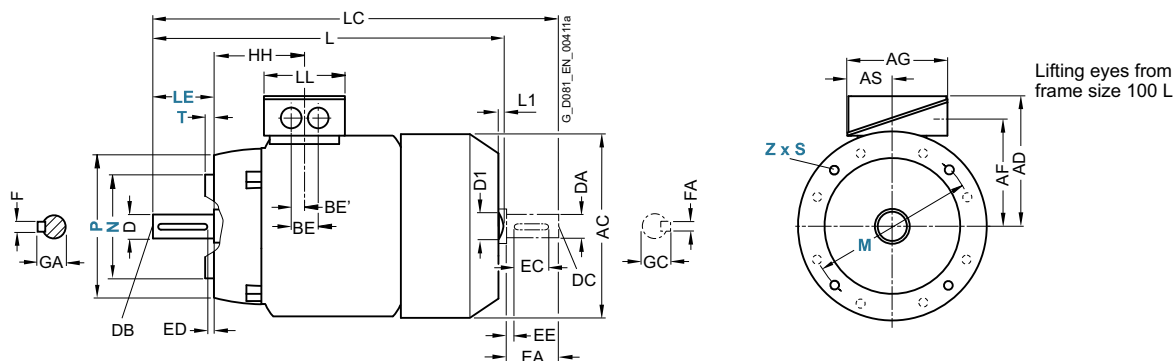

For motor		Dimension designation acc. to IEC										DE shaft extension					NDE shaft extension							
Frame size	Motor type 1LE1583	No. of poles	HH	K	K'	L	L1 ¹⁾	D1	LC	LL	D	DB	E	EB	ED	F	GA	DA	DC	EA	EC	EE	FA	GC
100 L	1AA4, 1AB4,	2	100.5	12	16	432.5	7	32	489	134	28	M10	60	50	5	8	31	24	M8	50	40	5	8	27
	1AB5	4				472.5																		
112 M	1BA2,	2	100.5	12	16	415.5	7	32	475	134	28	M10	60	50	5	8	31	24	M8	50	40	5	8	27
	1BB2	4				450.5																		
132 S	1CA0, 1CA1, 1CB0	2, 4	115.5	12	16	516.5	8.5	39	585.5	134	38	M12	80	70	5	10	41	28	M10	60	50	5	8	31
132 M	1CB2	4	115.5	12	16	516.5	8.5	39	585.5	134	38	M12	80	70	5	10	41	28	M10	60	50	5	8	31
160 M	1DA2, 1DA3, 1DB2	2, 4	145	14.5	18	606	10	45	730	165	42	M16	110	90	10	12	45	42	M16	110	90	10	12	45
160 L	1DA4, 1DB4	2, 4	145	14.5	18	666	10	45	790	165	42	M16	110	90	10	12	45	42	M16	110	90	10	12	45
180 M/ 180 L	180 M/	4, 6	155	15	19	668	-	-	784	164	48	M16	110	100	5	14	51.5	48	M16	110	100	5	14	51.5
	180 L	2, 4				698																		
200 L	2A4, 2AC4,	2, 6	164	19	25	721	-	-	835	197	55	M20	110	100	5	16	59	55	M20	110	100	5	16	59
	2AA5, 2AB5, 2AC5	2, 4, 6				746																		

¹⁾ In the low-noise version, a second shaft extension and/or mounted encoder is not possible.

SIMOTICS GP and SIMOTICS SD standard motors

Dimensions · Cast-iron series SIMOTICS SD

IE3 – 1LE1583 self-ventilated · Frame sizes 225 S to 315 L

Dimensional drawings

Type of construction IM B3

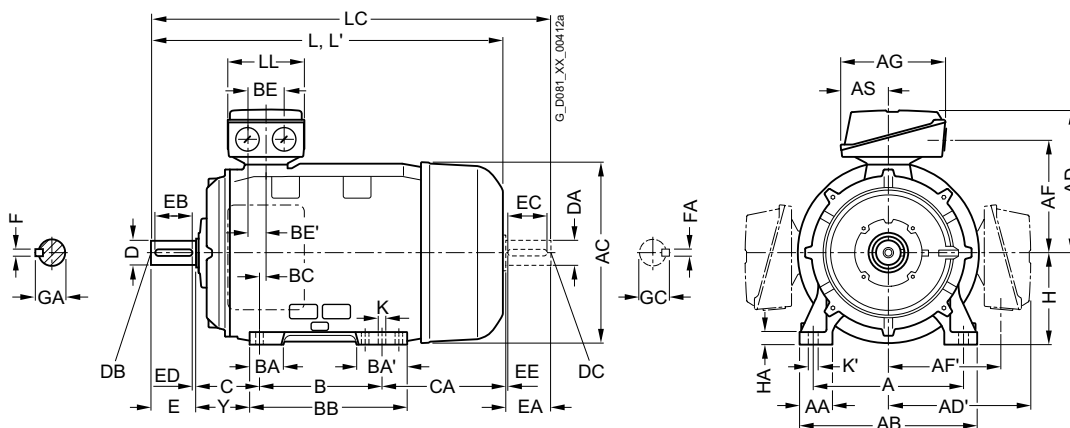

Types of construction IM B5 and IM V1

For flange dimensions, see page 1/48 (Z = the number of retaining holes)

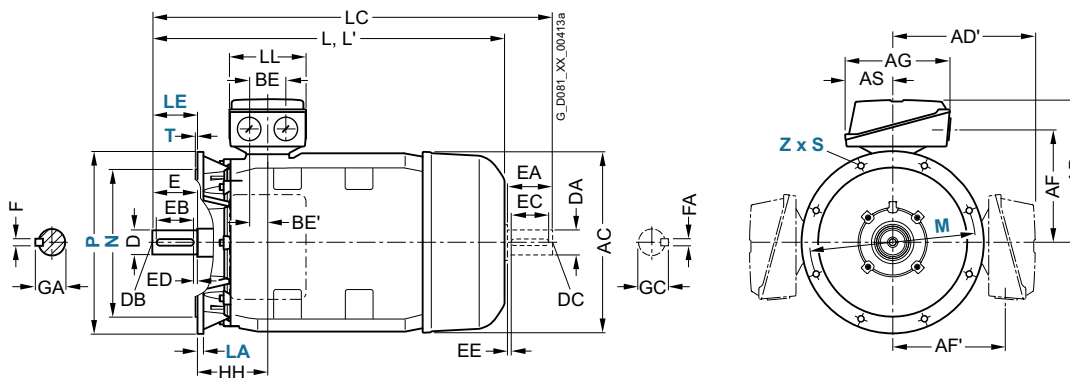

For motor		No. of poles	Dimension designation acc. to IEC																		
Frame size	Motor type		A	AA	AB	AC	AD	AD'	AF	AF'	AG	AS	B	BA	BA'	BB	BC	BE	BE'	C	CA
225 S	2BB0	4	356	80	436	449	338	338	282	282	266	112	286	92	117	361	15	85	42.5	149	278
	2BD0	8													118						218
225 M	2BB2, 2BC2	4, 6	356	80	436	449	338	338	282	282	266	112	311	92	117	361	15	85	42.5	149	333
	2BA2	2																			253
	2BD2	8													118						193
250 M	2CA2, 2CD2	2, 8	406	100	490	497	410	410	322	322	319	145	349	102	102	409	24	110	55	168	235
	2CB2, 2CC2	4, 6																			305
	2DA0, 2DB0	2, 4	457	100	540	551	433	433	345	345	319	145	368	101	152	479	20	110	55	190	377
	2DC0, 2DD0	6, 8																			267
280 M	2DA2, 2DB2, 2DC2	2, 6, 8	457	100	540	551	433	433	345	345	319	145	419	101	152	479	20	110	55	190	326
	2DD2	8																			216
	3AA0, 3AD0	2, 8	508	120	610	616	515	515	404	404	374	164	406	113	170	527	22	110	55	216	295
315 M	3AA2 ¹⁾ , 3AB0, 3AB2 ¹⁾ , 3AC0, 3AC2	2, 4, 6	508	120	610	616	515	515	404	404	374	164	457	113	170	578	22	110	55	216	409
	3AD2 ¹⁾	8													527						244
	3AA4, 3AB4, 3AD4, 3AD5, 3AD6	2, 4, 6, 8	508	120	610	616	515	515	404	404	374	164	508	113	170	578	22	110	55	216	358
315 L ¹⁾	3AA5, 3AC4, 3AC5, 3AC6	2, 6													176	227	648				513
	3AB5	4																			

¹⁾ With terminal box position right, terminal box left, and with order code **H01** only screwed-on feet with 3 drilled holes with dimension "B" (406, 457, and 508 mm). The dimension "BB" will then be 666 mm.

SIMOTICS GP and SIMOTICS SD standard motors

Dimensions · Cast-iron series SIMOTICS SD

IE3 – 1LE1583 self-ventilated · Frame sizes 225 S to 315 L

Dimensional drawings

Type of construction IM B35

For flange dimensions, see page 1/48 (**Z** = the number of retaining holes)

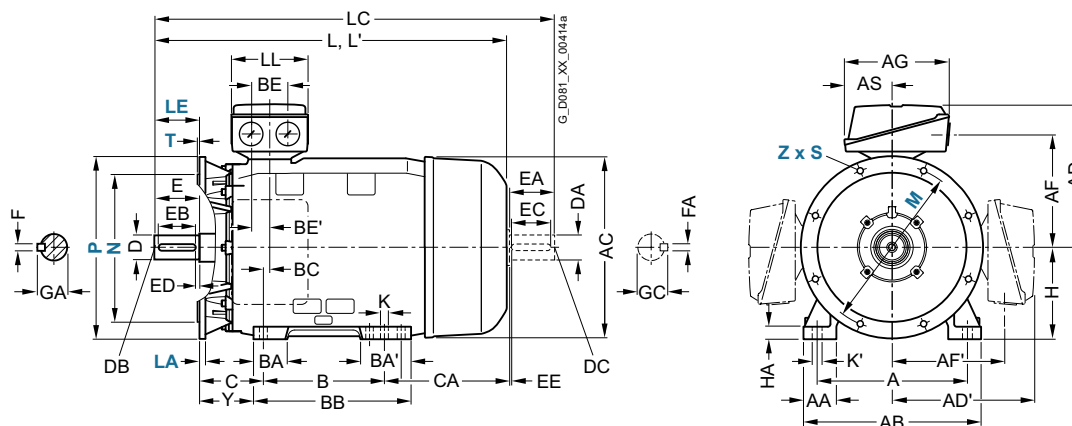

For motor Motor type 1LE1583-	Dimension designation acc. to IEC							DE shaft extension							NDE shaft extension								
	H	HA	Y	HH	K	K'	L	LC ¹⁾	LL	D	DB	E	EB	ED	F	GA	DA	DC	EA	EC	EE	FA	GC
2BB0	225	34	124	164	19	25	848	903	197	60	M20	140	125	10	18	64	55	M20	110	100	5	16	59
2BD0							788																
2BB2, 2BC2	225	34	124	164	19	25	928	963	197	60	M20	140	125	10	18	64	55	M20	110	100	5	16	59
2BA2							818	933		55	110	100	5	16	59	48	M16					14	51.5
2BD2							788	903		60	140	125	10	18	64	55	M20					16	59
2CA2, 2CD2	250	40	138	192	24	30	887	1002 1032	233	60 65	M20	140	125	10	18	64 69	55 60	M20	110 140	100 125	5 10	16 18	59 64
2CB2, 2CC2							957	1032 1072								64							
2DA0, 2DB0	280	40	160	210	24	30	1070	1215 75	233	65 75	M20	140	125	10	18	69 79.5	60 65	M20	140	125	10	18	64 69
2DC0, 2DD0							960	1105															
2DA2, 2DB2, 2DC2	280	40	160	210	24	30	1070	1215 75	233	65 75	M20	140	125	10	18	69 79.5	60 65	M20	140	125	10	18	64 69
2DD2							960	1105															
3AA0, 3AD0	315	50	181	238	28	35	1052 1082	1197 1227	299	65 80	M20	140 170	125 140	10 25	18 22	69 85	60 70	M20	140	125	10	18	64 74.5
3AA2, 3AB0, 3AB2, 3AC0, 3AC2	315	50	181	238	28	35	1217 1247	1362 1392	299	65 80	M20	140 170	125 140	10 25	18 22	69 85	60 70	M20	140	125	10	18	64 74.5
3AD2							1082	1227															
3AA4, 3AB4, 3AD4, 3AD5, 3AD6	315	50	181	238	28	35	1217 1247	1362 1392	299	65 80	M20	140 170	125 140	10 25	18 22	69 85	60 70	M20	140	125	10	18	64 74.5
3AA5, 3AC4, 3AC5, 3AC6			146				1372 1402	1517 1547		65 80	140 170	125 140	10 25	18 22	69 85	60 70						18 20	64 74.5
3AB5						22																	

¹⁾ In the low-noise version, a second shaft extension and/or mounted encoder is not possible.

SIMOTICS GP and SIMOTICS SD standard motors

Dimensions · Cast-iron series SIMOTICS SD

IE4 – self-ventilated · Frame sizes 100 L to 160 L

Dimensional drawings

Type of construction IM B3

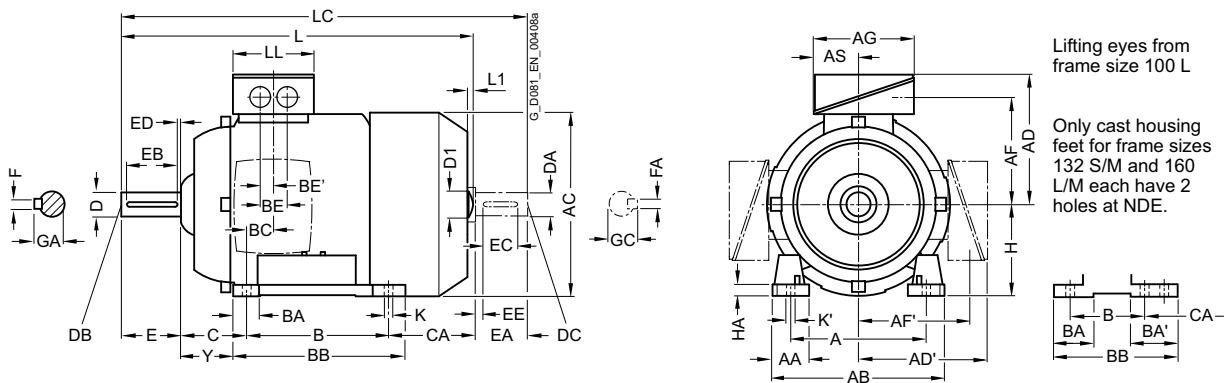

Types of construction IM B5 and IM V1

For flange dimensions, see page 1/48 (Z = the number of retaining holes)

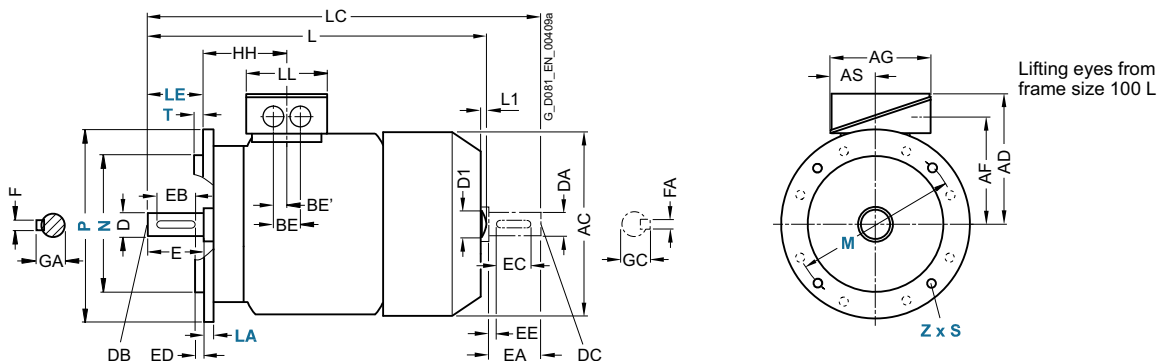

For motor			Dimension designation acc. to IEC																					
Frame size	Motor type	No. of poles	A	AA	AB	AC	AD	AD'	AF	AF'	AG	AS	B	BA	BA'	BB	BC	BE	BE'	C	CA	H	HA	Y
100 L	1AA4	2	160	42	196	217	193	193	147	147	163	80.5	140	48	48	176	37.5	48	24	63	176	100	12	45
	1AB4	4																						
	1AB5	4																						
112 M	1BA2	2	190	46	226	239	195	195	150	150	163	80.5	140	48	48	176	30	48	24	70	155	112	12	52
	1BB2	4																						
132 S	1CA0	2	216	53	256	281	214.5	214.5	169	169	163	80.5	140	52 ¹⁾	89 ⁵⁾	218 ²⁾	26.5	48	24	89	130	132	15	69
	1CA1, 1CB0	2, 4																			178.5			
132 M	1CB2	4	216	53	256	281	214.5	214.5	169	169	163	80.5	178	52 ¹⁾	89 ⁶⁾	218	26.5	48	24	89	178.5	132	15	69
160 M	1DA2	2	254	60	300	333.5	261	261	213	213	190	92	210	73 ³⁾	117 ⁷⁾	300 ⁴⁾	37	60	30	108	148	160	18	85
	1DA3, 1DB2	2, 4																						
160 L	1DA4	2	254	60	300	333.5	261	261	213	213	190	92	254	73 ³⁾	117 ⁸⁾	300	37	60	30	108	208	160	18	85
	1DB4	4																						

1) With screwed-on feet, dimension BA is 41 mm.
 2) With screwed-on feet, dimension BB is 180 mm.
 3) With screwed-on feet, dimension BA is 51 mm.
 4) With screwed-on feet, dimension BB is 256 mm.

5) With screwed-on feet, dimension BA' is 41 mm.
 6) With screwed-on feet, dimension BA' is 79 mm.
 7) With screwed-on feet, dimension BA' is 51 mm.
 8) With screwed-on feet, dimension BA' is 95 mm.

SIMOTICS GP and SIMOTICS SD standard motors

Dimensions · Cast-iron series SIMOTICS SD

IE4 – self-ventilated · Frame sizes 100 L to 160 L

Dimensional drawings

Type of construction IM B35

For flange dimensions, see page 1/48 (Z = the number of retaining holes)

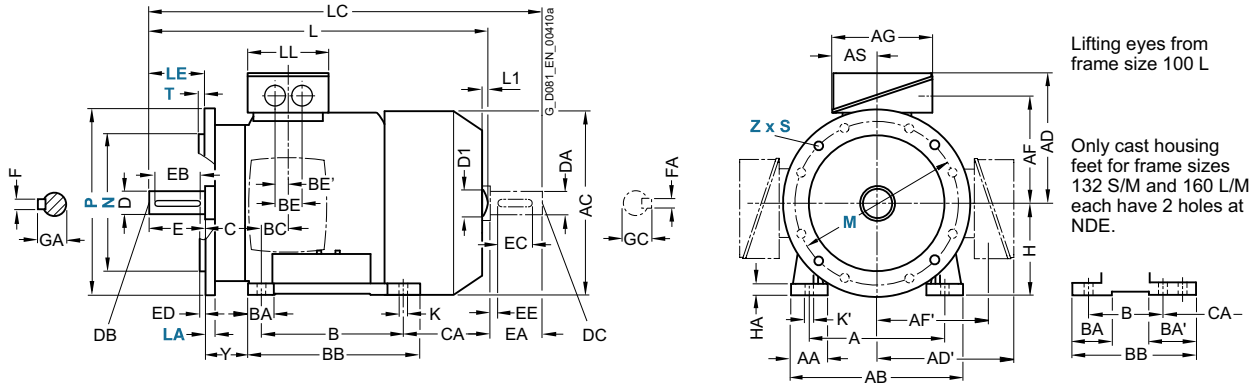

Type of construction IM B14

For flange dimensions, see page 1/48 (Z = the number of retaining holes)

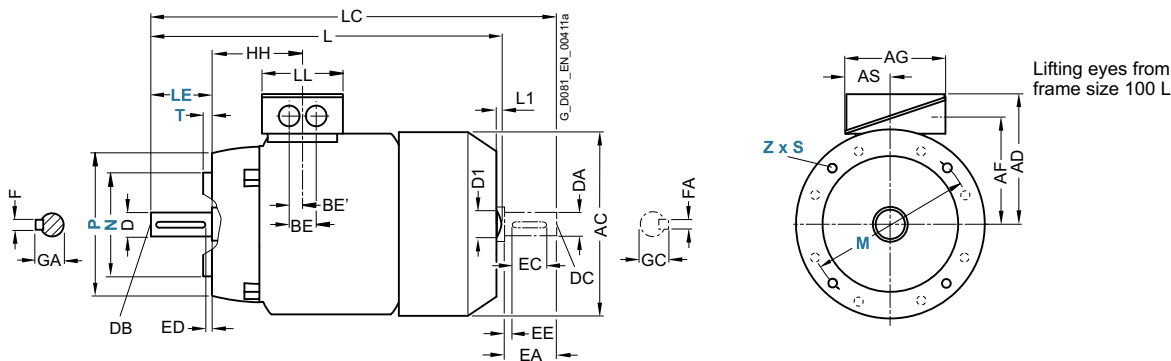

For motor			Dimension designation acc. to IEC							DE shaft extension					NDE shaft extension									
Frame size	Motor type	No. of poles	HH	K	K'	L ¹⁾	L1 ²⁾	D1	LL	D	DB	E	EB	ED	F	GA	DA	DC	EA	EC	EE	FA	GC	
100 L	1AA4	2	100.5	12	16	432.5	7	32	134	28	M10	60	50	5	8	31	24	M8	50	40	5	8	27	
	1AB4	4				482.5																		7
	1AB5	4				482.5																		7
112 M	1BA2	2	100.5	12	16	415.5	7	32	134	28	M10	60	50	5	8	31	24	M8	50	40	5	8	27	
	1BB2	4				465.5																		7
132 S	1CA0	2	115.5	12	16	466.5	8.5	39	134	38	M12	80	70	5	10	41	28	M10	60	50	5	8	31	
	1CA1, 1CB0	2, 4				516.5																		8.5
132 M	1CB2	4	115.5	12	16	516.5	8.5	39	134	38	M12	80	70	5	10	41	28	M10	60	50	5	8	31	
160 M	1DA2	2	145	15	19	606	10	45	730	165	42	M16	110	90	10	12	45	42	M16	110	90	10	12	45
	1DA3, 1DB2	2, 4				666																		
160 L	1DA4	2	145	15	19	666	10	45	790	165	42	M16	110	90	10	12	45	42	M16	110	90	10	12	45
	1DB4	4				666																		

1) For 1LE16 motors less dimension L1.

2) Only for 1LE15 motors.

SIMOTICS GP and SIMOTICS SD standard motors

Dimensions · Cast-iron series SIMOTICS SD

IE4 – self-ventilated · Frame sizes 180 M to 315 L

Dimensional drawings

Type of construction IM B3

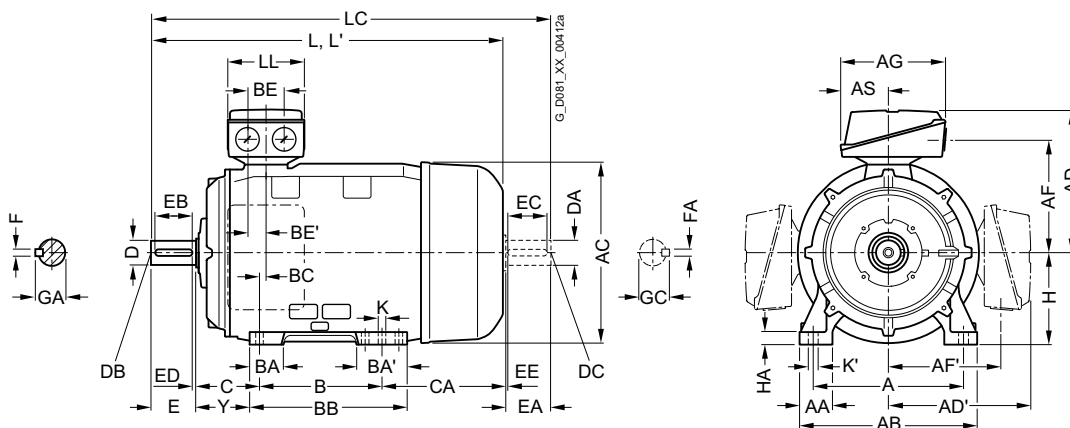

Types of construction IM B5 and IM V1

For flange dimensions, see page 1/48 (Z = the number of retaining holes)

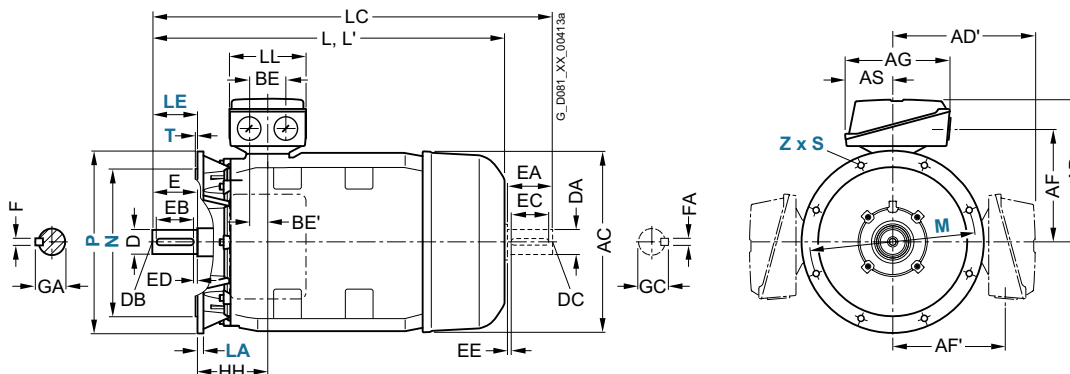

For motor			Dimension designation acc. to IEC																		
Frame size	Motor type 1LE1504- 1LE1604-	No. of poles	A	AA	AB	AC	AD	AD'	AF	AF'	AG	AS	B*	BA	BA'	BB	BC	BE	BE'	C	CA*
180 M	1EA2	2	279	65	339	356	286	286	234	234	189	92	241/ 279	85	120	328	34	60	30	121	202
180 M	1EB2	4																			
180 L	1EB4	4																			
200 L	2AA4 2AA5, 2AB5	2 2, 4	318	70	378	396	315	315	258.5	258.5	265	112	305	104	104	355	31	85	42.5	133	177
225 S	2BB0	4	356	80	436	449	338	338	282	282	266	112	286	92	117	361	15	85	42.5	149	218
225 M	2BA2 2BB2	2 4	356	80	436	449	338	338	282	282	266	112	311	92	117	361	15	85	42.5	149	253
250 M	2CA2 2CB2	2 4	406	100	490	497	410	410	322	322	319	145	349	102	102	409	24	110	55	168	230
280 S	2DA0 2DB0	2 4	457	100	540	551	433	433	345	345	319	145	368	101	152	479	20	110	55	190	267
280 M	2DA2 2DB2	2 4	457	100	540	551	433	433	345	345	319	145	419	101	152	479	20	110	55	190	216 326
315 S	3AA0	2	508	120	610	616	515	515	404	404	374	164	406	113	170	527	22	110	55	216	295
315 M ²⁾	3AB0	4	508	120	610	616	515	515	404	404	374	164	457	113	170	578	22	110	55	216	295
315 M ¹⁾	3AA2 3AB2	2 4																			409
315 L ¹⁾	3AA4 3AB4 3AA5 3AB5	2 4 2 4	508	120	610	616	515	515	404	404	374	164	508	113	170	578	22	110	55	216	358 513

* Please note that version 3AB0 does not comply with EN 50347 with respect to assignment of this dimension to the frame size.

¹⁾ With terminal box position right, terminal box left, and with order code **H01** only screwed-on feet with 3 drilled holes with dimension "B" (406, 457, and 508 mm). The dimension "BB" will then be 666 mm.

²⁾ 1LE1504-3AB0 and 1LE1604-3AB0 4-pole motors cannot be constructed in standard frame size 315 S because they require the longer housing of frame size 315 M in order to achieve the requisite efficiency levels. The foot clearance dimension "B" therefore changes from 406 to 457 mm. The motors comply with standard IEC 60034, but not with standard EN 50347 in this respect.

SIMOTICS GP and SIMOTICS SD standard motors
Dimensions · Cast-iron series SIMOTICS SD

IE4 – self-ventilated · Frame sizes 180 M to 315 L

Dimensional drawings

Type of construction IM B35

For flange dimensions, see page 1/48 (**Z** = the number of retaining holes)

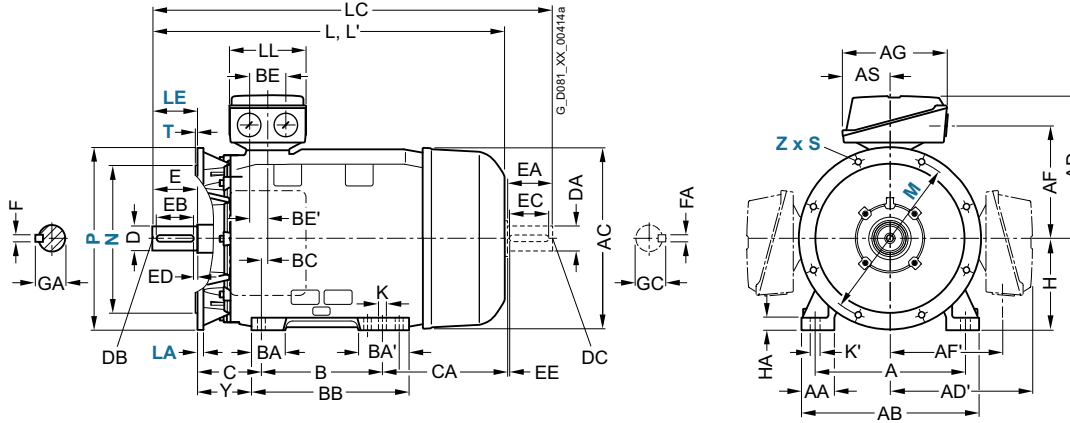

For motor		Dimension designation acc. to IEC									DE shaft extension						NDE shaft extension																										
Motor type	No. of poles	H	HA	Y	HH	K	K'	L	LC ¹⁾	LL	D	DB	E	EB	ED	F	GA	DA	DC	EA	EC	EE	FA	GC																			
1EA2	2	180	20	95	155	15	19	698	814	164	48	M16	110	100	5	14	51.5	48	M16	110	100	5	14	51.5																			
1EB2	4							668	784																																		
1EB4	4							698	814																																		
2AA4	2	200	25	108	164	19	25	746	860	197	55	M20	110	100	5	16	59	55	M20	110	100	5	16	59																			
2AA5	2, 4							746																																			
2AB5								746																																			
2BB0	4	225	34	124	164	19	25	848	903	197	60	M20	140	125	10	18	64	55	M20	110	100	5	16	59																			
2BA2	2							818	933	197															55	M20	110	100	5	16	59	48	M16	110	100	5	14	51.5					
2BB2	4							928	963	60																													140	125	10	18	64
2CA2	2	250	40	138	192	24	30	887	1002	233	60	M20	140	125	10	18	64	55	M20	110	100	5	16	59																			
2CB2	4							957	1032	65																																	
2DA0	2							1070	1105	233															65	M20	140	125	10	18	69	60	M20	140	125	10	18	64	65				
2DB0	4				75	20	79.5	65																																			
2DA2	2	280	40	160	210	24	30	1070	1215	233	65	M20	140	125	10	18	69	60	M20	140	125	10	18	64																			
2DB2	4																								75	20	79.5	65															
3AA0	2							1052	1197	299															65	M20	140	125	10	18	69	60	M20	140	125	10	18	64					
3AB0	4	1247	1392	299	80	M20	170	140	25	22	85	70	M20	140	125	10	20	74.5																									
3AA2	2	315	50	181	238	28	35	1217	1362		65	140	125	10	18	69	60	M20	140	125	10	18	64																				
3AB2	4							1247	1392															80	170	140	25	22	85	70													
3AA4	2							1217	1362	299														65	M20	140	125	10	18	69	60	M20	140	125	10	18	64						
3AB4	4	1402	1392		80	170	140	25	22	85	70																																
3AA5	2	315	50	181	238	28	35	1372	1517		65	140	125	10	18	69	60	M20	140	125	10	18	64																				
3AB5	4							1402	1547															80	170	140	25	22	85	70													
										146																																	

¹⁾ In the low-noise version, a second shaft extension and/or mounted encoder is not possible.

SIMOTICS GP and SIMOTICS SD standard motors

Dimensions · Cast-iron series SIMOTICS SD

IR3 Rendimento Premium – self-ventilated · Frame sizes 180 M to 280 M

Dimensional drawings

Type of construction IM B3

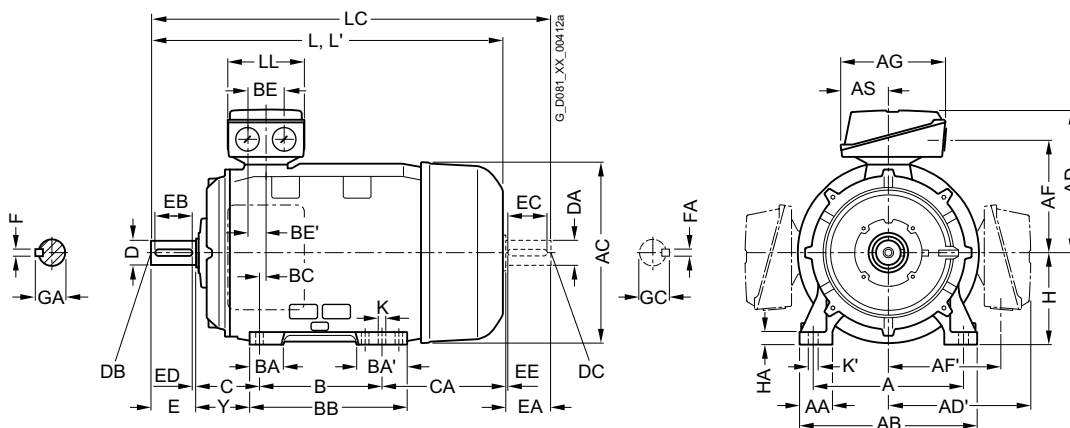

Types of construction IM B5 and IM V1

For flange dimensions, see page 1/48 (Z = the number of retaining holes)

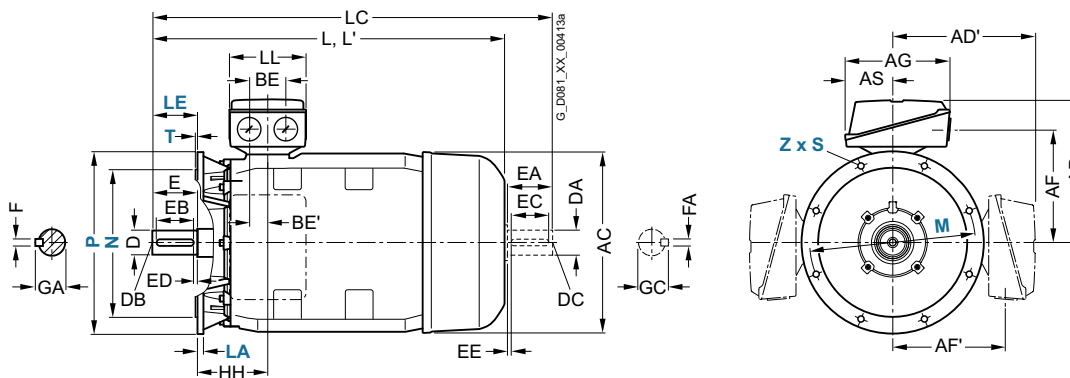

For motor		Dimension designation acc. to IEC																			
Frame size	Motor type 1LE1573-	No. of poles	A	AA	AB	AC	AD	AD'	AF	AF'	AG	AS	B	BA	BA'	BB	BC	BE	BE'	C	CA
180 M	1EB4	4	279	65	339	356	286	286	234	234	190	92	241	85	120	328	34	60	30	121	202
	1ED3	8																			
180 L	1EC6, 1ED4, 6, 8	2, 4, 6, 8	279	65	339	356	286	286	234	234	190	92	279	85	120	328	34	60	30	121	202
	1ED6	6, 8																			
200 L	2AA5, 2AB5, 2AB6, 2AC5, 2AC6, 2AD6	2, 4, 6, 8	318	70	378	396	315	315	259	259	266	112	305	104	104	355	31	85	42.5	133	177
	2AA4	2																			
225 S	2BA2	2	356	80	436	449	338	338	282	282	266	112	286	92	115	361	15	85	42.5	149	278
	2BB2	4																			
225 M	2BD2	8	356	80	436	449	338	338	282	282	266	112	286	92	118	361	15	85	42.5	149	218
	2BA6	2											311		117						253
	2BB6, 2BC6	4, 6																			
	2BD6	8													115						
250 M	2CA6	2	406	100	490	497	410	410	322	322	319	145	349	102	102	409	24	110	55	168	305
	2CB6, 2CC6	4, 6																			235
	2CD6, 2CD7	8																			
280 S	2DA2	2	457	100	540	551	433	433	345	345	319	145	368	101	152	479	20	110	55	190	377
	2DB2	4																			
	2DC2	6																			267
	2DC6	6																			377
	2DD6	8																			267
280 M	2DA6	2	457	100	540	551	433	433	345	345	319	145	419	101	152	479	20	110	55	190	326
	2DB6	4																			
	2DC7, 2DD7	6, 8											368								377

SIMOTICS GP and SIMOTICS SD standard motors

Dimensions · Cast-iron series SIMOTICS SD

IR3 Rendimento Premium – self-ventilated · Frame sizes 180 M to 280 M

Dimensional drawings

Type of construction IM B35

For flange dimensions, see page 1/48 (Z = the number of retaining holes)

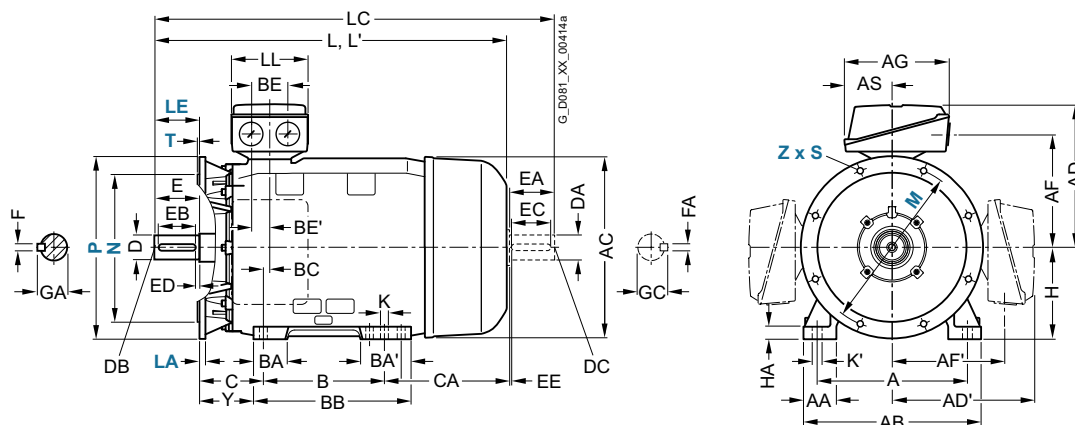

For motor Frame size	Motor type 1LE1573-	No. of poles	Dimension designation acc. to IEC								DE shaft extension							NDE shaft extension										
			H	HA	Y	HH	K	K'	L	LC ¹⁾	LL	D	DB	E	EB	ED	F	GA	DA	DC	EA	EC	EE	FA	GC			
180 M	1EB4	4	180	20	95	155	15	19	698	814	164	48	M16	110	100	5	14	51.5	48	M16	110	100	5	14	51.5			
	1ED3	8							668	784																		
180 L	1EC6, 1ED4, 1ED6	6, 8	180	20	95	155	15	19	698	814	164	48	M16	110	100	5	14	51.5	48	M16	110	100	5	14	51.5			
	2AA5, 2AB5, 2AB6, 2AC5, 2AC6, 2AD6	2, 4, 6, 8	200	25	108	164	19	25	746	860	197	55	M20	110	100	5	16	59	55	M20	110	100	5	16	59			
225 S	2AA4	2							721	835																		
	2BA2	2	225	34	124	164	19	25	818	933	197	55	M20	110	100	5	16	59	48	M16	110	100	5	14	51.5			
225 M	2BB2	4							848	963	60		140	125	10	18	64	55	M20					16	59			
	2BD2	8	225	34	124	164	19	25	788	903	197	60	M20	140	125	10	18	64	55	M20	110	100	5	16	59			
	2BA6	2							898	933	55		110	100	5	16	59	48						14	51.5			
	2BB6, 2BC6, 2BD6	4, 6, 8							928	963	60		140	125	10	18	64	55							16	59		
250 M	2CA6	2	250	40	138	192	24	30	957	1002	233	60	M20	140	125	10	18	64	55	M20	110	100	5	16	59			
	2CB6, 2CC6	4, 6								1072	65							69	60					140	125	10	18	64
	2CD6, 2CD7	8							887	1032																		
280 S	2DA2	2	280	40	160	210	24	30	1070	1215	233	65	M20	140	125	10	18	69	60	M20	140	125	10	18	64			
	2DB2	4																20	79.5	65						69		
	2DC2	6							960	1105																		
	2DC6	6							1070																			
	2DD6	8							960																			
280 M	2DA6	2	280	40	160	210	24	30	1070	1215	233	65	M20	140	125	10	18	69	60	M20	140	125	10	18	64			
	2DB6	4																20	79.5	65						69		
	2DC7, 2DD7	6, 8								1105																		

¹⁾ In the low-noise version, a second shaft extension and/or mounted encoder is not possible.

SIMOTICS GP and SIMOTICS SD standard motors

Dimensions · Cast-iron series SIMOTICS SD

IR3 Rendimento Premium – self-ventilated · Frame sizes 315 S to 315 L

Dimensional drawings

Type of construction IM B3

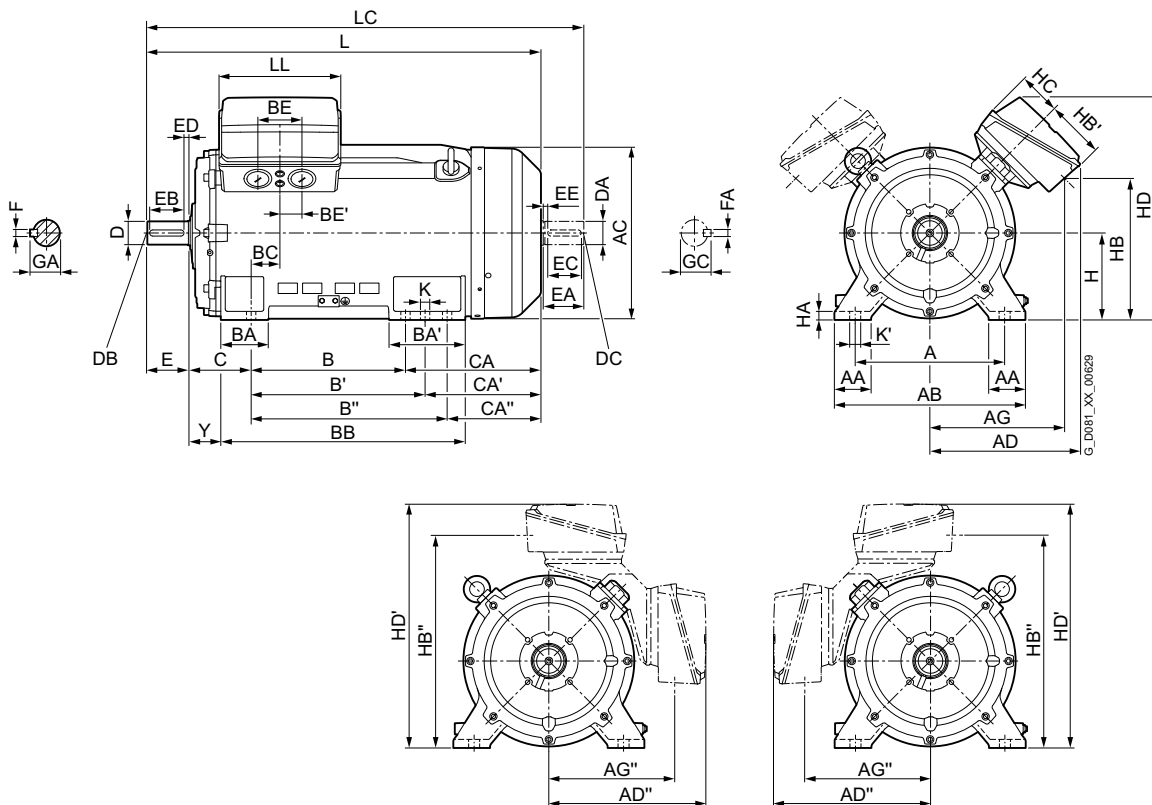

Types of construction IM B5 and IM V1

For flange dimensions, see page 1/48 (Z = the number of retaining holes)

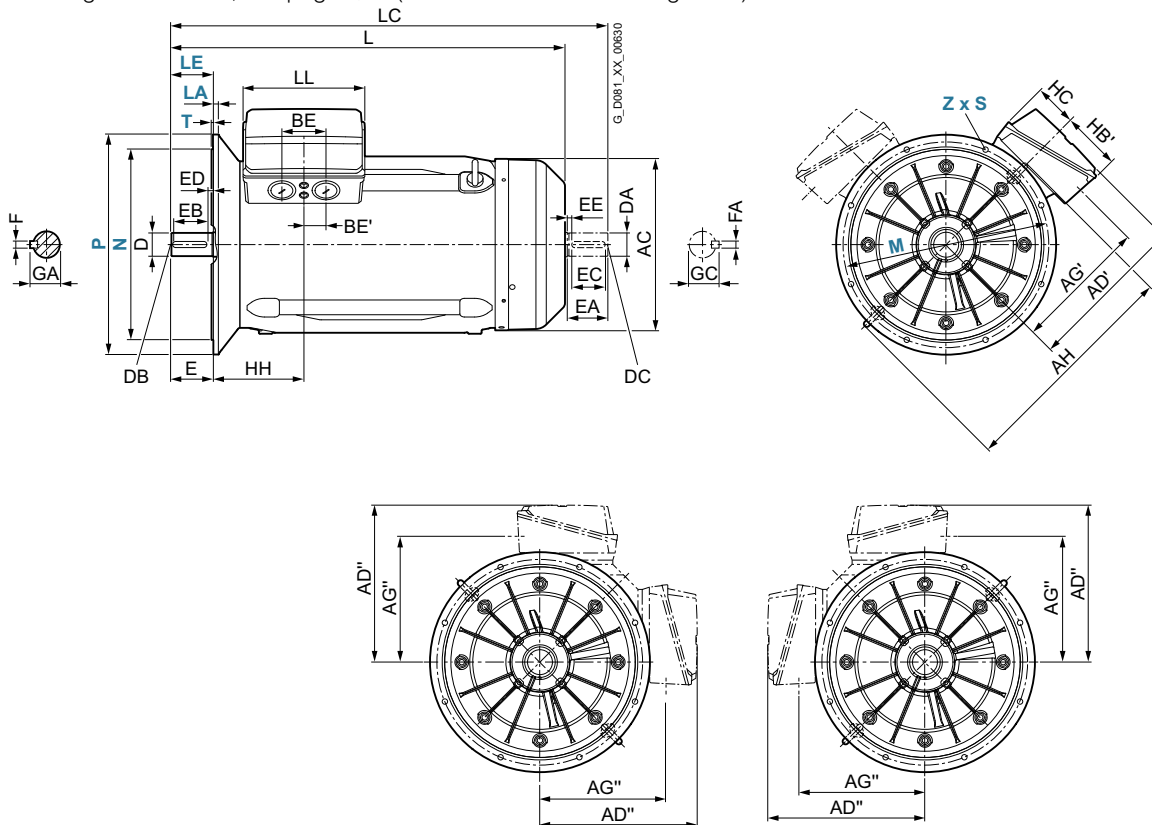

SIMOTICS GP and SIMOTICS SD standard motors

Dimensions · Cast-iron series SIMOTICS SD

IR3 Rendimento Premium – self-ventilated · Frame sizes 315 S to 315 L

Dimensional drawings

Type of construction IM B35

For flange dimensions, see page 1/48 (**Z** = the number of retaining holes)

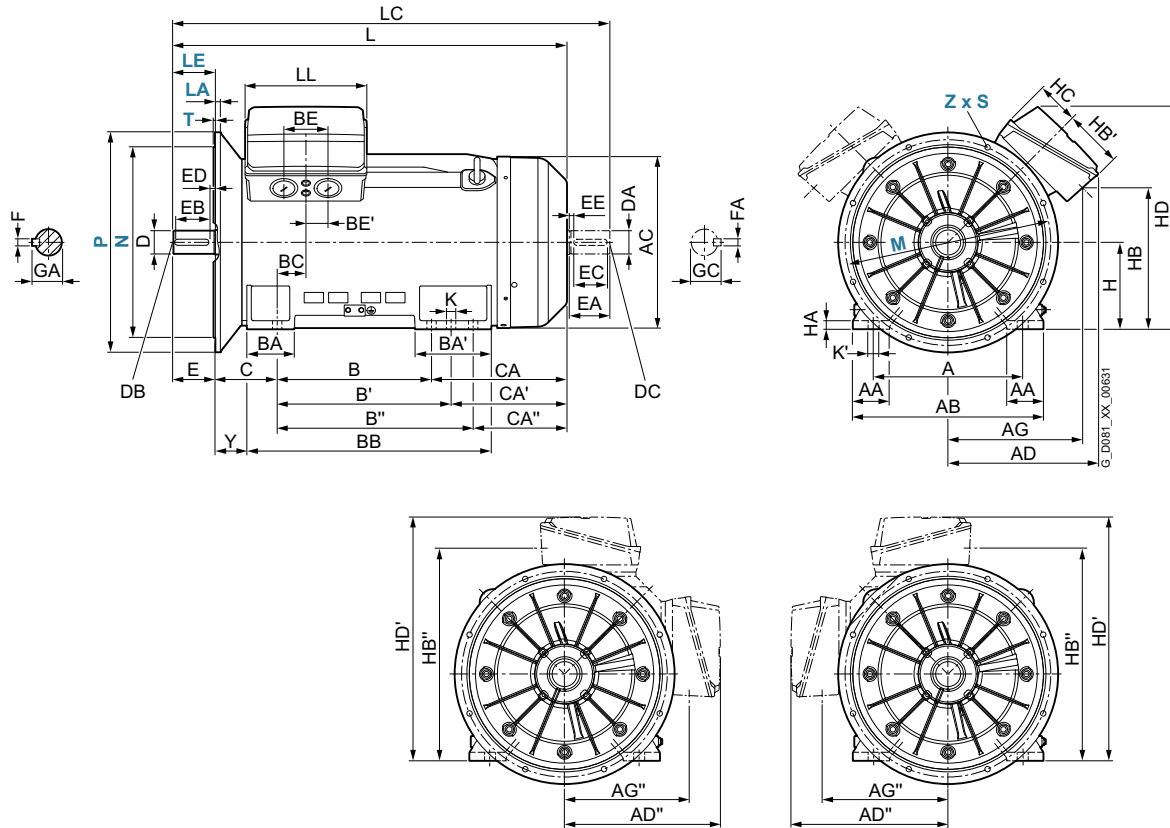

For motor		Dimension designation acc. to IEC																											
Frame size	Motor type	No. of poles	A	AA	AB	AC	AD	AD'	AD''	AG	AG'	AG''	AH	B	B'	B''	BA	BA'	BB	BC	BE	BE'	C	CA	CA'	CA''	H	HA	HB
315 S	3AA2	2	508	120	610	624	544	565	540	554	459	444	680	457	508	-	176	227	648	139	120	60	216	469	418	-	315	50	413
	3AB2	4								491	480	434									135	67.5						491	
315 M	3AA4	2	508	120	610	624	544	565	540	554	459	444	680	457	508	-	176	227	648	139	120	60	216	469	418	-	315	50	413
	3AA5	2																										491	
	3AB4, 3AB5,	4, 6, 8											491	480	434							135	67.5					491	
	3AC4, 3AC5,																												
	3AC6, 3AD4,																												
315 L	3AB6	4	508	120	610	624	544	565	540	553	459	434	805	508	560	630	176	299	770	139	120	60	216	528	476	406	315	50	413
	3AB7	4								554	446												618	566	496		497		
	3AC7, 3AD7	6, 8								491	470	421									135	67.5		528	476	406		491	
	3AD8	8								554	459	446											618	566	496		497		
	3AA6	2										434	805	457	508	-	176	227	648	139	120	60		469	418	-	413		
	3AD6	8								491	480		680									135	67.5					491	

For motor		Dimension designation acc. to IEC														DE shaft extension				NDE shaft extension									
Frame size	Motor type	No. of poles	HB'	HB''	HC	HD	HD'	HH	Y	K	K'	L	LC ¹⁾	LL	D	DB	E	EB	ED	F	GA	DA	DC	EA	EC	EE	FA	GC	
315 S	3AA2	2	336	759	167	800	855	355	146	28	35	1132	1427	327	65	M20	140	125	10	18	69	60	M20	140	125	10	18	64	
	3AB2	4	226	761								1312	1457		85		170	140	25	22	90	70					20	74.5	
315 M	3AA4	2	336	759	167	800	855	355	146	28	35	1132	1427	327	65	M20	140	125	10	18	69	60	M20	140	125	10	18	64	
	3AA5	2		749								1282																	
	3AB4, 3AB5,	4, 6, 8	226	761	167	800	855	355	146	28	35	1312	1457	327	85	M20	170	140	25	22	90	70	M20	140	125	10	20	74.5	
	3AC4, 3AC5,																												
	3AC6, 3AD4,																												
315 L	3AB6	4	336	749	167	800	855	355	146	28	35	1422	1567	327	85	M20	170	140	25	22	90	70	M20	140	125	10	20	74.5	
	3AB7	4		749		885						1512	1657																
	3AC7, 3AD7	6, 8		763		800						1422	1567																
	3AD8	8		749								1512	1657																
	3AA6	2										1282	1427		65		140	125	10	18	69	60					18	64	
	3AD6	8		226	761							1312	1457		85		170	140	25	22	90	70					20	74.5	

¹⁾ In the low-noise version, a second shaft extension and/or mounted encoder is not possible.



SIMOTICS GP and SIMOTICS SD standard motors

Notes

SIMOTICS SD standard motors next generation

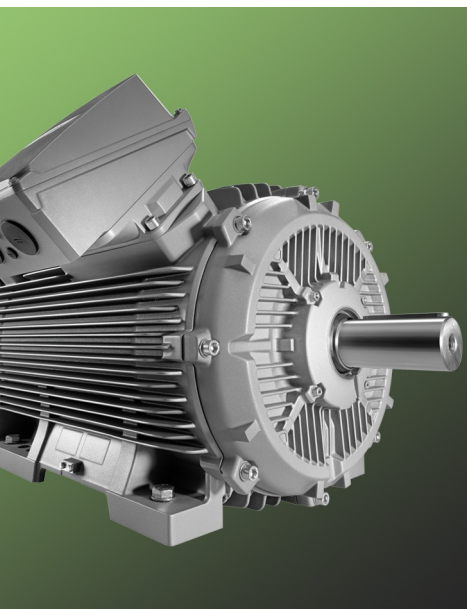

4/2	Orientation
4/8	<u>Article number code</u>
4/9	IE4 Super Premium Efficiency
4/9	<u>Cast-iron series SIMOTICS SD</u>
4/10	• 1LE5504 Basic Line
	• 1LE5604 Performance Line
	<u>Cast-iron series SIMOTICS SD Add</u>
4/11	• 1LE5534 Basic Line
4/13	• 1LE5634 Performance Line
4/11	• 1LE5534 (frame sizes 400 and 450)
4/14	IE3 Premium Efficiency
	<u>Cast-iron series SIMOTICS SD</u>
4/14	• 1LE5503 Basic Line
4/15	• 1LE5603 Performance Line
	<u>Cast-iron series SIMOTICS SD Add</u>
4/16	• 1LE5533 Basic Line
4/18	• 1LE5633 Performance Line
4/16	• 1LE5533 (frame sizes 400 and 450)
	<u>Cast-iron series SIMOTICS SD Pro</u>
4/19	• 1LE5583 Basic Line
4/20	• 1LE5683 Performance Line
4/19	• 1LE5583 (frame sizes 400 and 450)
4/21	Article No. supplements and special versions
	<u>Voltages</u>
4/21	• Cast-iron series SIMOTICS SD 1LE55, 1LE56
	<u>Types of construction</u>
4/22	• Cast-iron series SIMOTICS SD 1LE55, 1LE56
	<u>Motor protection</u>
4/24	• Cast-iron series SIMOTICS SD 1LE55, 1LE56
	<u>Terminal box position</u>
4/25	• Cast-iron series SIMOTICS SD 1LE55, 1LE56
	<u>Options</u>
4/26	• Cast-iron series SIMOTICS SD 1LE55, 1LE56
4/35	<u>Accessories</u>
4/37	Dimensions
4/37	Notes on the dimensions
4/37	Dimension sheet generator
	<u>Cast-iron series SIMOTICS SD</u>
4/38	• IE4, IE3 – Frame sizes 315 L to 355 L
	<u>Cast-iron series SIMOTICS SD Add</u>
4/40	• IE4, IE3 – Frame sizes 315 L to 355 L
	<u>Cast-iron series SIMOTICS SD Pro</u>
4/42	• IE3 – Frame sizes 315 L to 355 L
4/44	• IE3 – Frame sizes 400 and 450

SIMOTICS SD standard motors next generation

Orientation

Overview

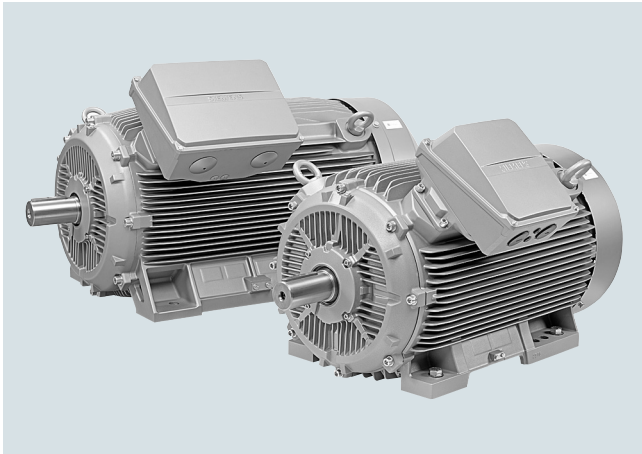

The SIMOTICS SD next generation is a new scalable generation of low-voltage motors. With their impressive performance and the additional versatility in their range of applications, this new motor series offers entry into a future-proof drive technology.

In addition to the future topics of digitalization and energy efficiency, this motor generation was developed with the focus on design optimization, which has resulted in a very compact motor design with a high power density. A standardized option range and the variable terminal box concept also enable flexible use of the motors in different system configurations and applications. The fact that the motors can either be operated on the line supply or with a converter is part of their versatility.

The following versions are available in the new 1LE5 motor series, differentiated by their performance features and functionality:

- **SIMOTICS SD**

These motors are characterized by reliable and powerful performance even in the toughest environmental conditions. The characteristics with higher torques ensure that higher starting and breakaway torques are available.

- **SIMOTICS SD Add**

The characteristic product feature of the SIMOTICS SD Add are the low starting currents. These not only meet industry-specific specifications, above all, in process industries, but also have a positive impact on the operating quality (higher power system stability, lower thermal load, increased motor lifetime). Through the availability of country-specific certificates, these motors can be used in all the important global regions and markets.

- **SIMOTICS SD Pro**

The SIMOTICS SD Pro range is characterized by its extremely flexible concept, which makes it universally deployable, in any plant, in any country in the world. Line and converter operation are generally possible up to 690 V and all important global, country and sector-specific certificates are available. Depending on the frame size - additional combinations of features are possible that further increase the flexibility. For SIMOTICS SD Pro frame sizes 315 and 355, which are above all used in the series business and are characterized by high starting and breakaway torques, this flexibility is manifested particularly through multi-voltage capability and efficiency stability irrespective of the line frequency 50 Hz/60 Hz. SIMOTICS SD Pro, frame sizes 400 to 450, have low starting currents. This version is aimed more at project business and is primarily used when converter operation up to 690 V is required in this power range.

One decisive advantage of these SIMOTICS SD next generation motors is the possibility of digital communication. This results in many advantages not just for engineering but throughout the product lifecycle.

SIMOTICS Digital Data App – Access to motor data at any time

The freely available SIMOTICS Digital Data App enables access to all motor-specific data and documents (electrical and mechanical data, dimensional drawings, operating instructions, spare part information, etc.) by reading in the data matrix codes present on every motor as standard. This increases transparency and makes commissioning and servicing easier.

SIMOTICS SD Next Generation – The first motors to have an interface with the digital world

The SIMOTICS SD next generation motors will be the first low-voltage motors to support cloud-based condition data analysis via MindSphere and MindApp with SIMOTICS CONNECT 400. The motors are therefore ready for preventive maintenance and fast service, which further increases the availability and productivity of your system.

Benefits

- Rugged design in the cast-iron housing increases reliability and availability.
- Compact dimensions/high power density enable use even in confined space conditions.
- High energy efficiency in line (IE3, IE4) and converter operation (IES2) enable energy-saving operation.
- A standardized range of options and a variable terminal box concept increase the flexible adaptation to the requirements of the application.
- Support of line and converter operation reduces the variety.
- Provision of comprehensive CAD data simplifies the design and engineering phase.
- Digital features, such as the data matrix code and support by the cloud-based condition data analysis via MindSphere as part of SIDRIVE IQ Fleet permit efficient service and preventive maintenance.

Application

SIMOTICS SD 1LE5 motors are ideal for use in a large number of standard applications, such as

- Pumps, fans, compressors
- Conveyors
- Winders
- Mixers
- Extruders
- Cranes

They are preferably used in industries such as

- Mining, cement
- Chemical industry
- Oil and gas
- Steel industry
- Water, waste water
- Heating, ventilation and air conditioning (HVAC)
- Pulp and paper industry
- Marine engineering

Configuration

Terminal box positions
Standard ²⁾

Rotated 180° ²⁾

Rotated 90°, cable entry DE ²⁾

Rotated 90°, cable entry NDE ²⁾

1LE5.....	1LE5.....-Z	1LE5.....-Z	1LE5.....-Z
 6	 6 R12	 6 R10	 6 R11
 2	 2 R12	 2 R10	 2 R11
 0	 0 R12	 0 R10	 0 R11
 1	 1 R12	 1 R10	 1 R11
 3	 3 R12	 3 R10	 3 R11
 5	 5 R12	 5 R10	 5 R11

SIMOTICS SD standard motors next generation

Orientation

Configuration

Terminal box positions for flanged types of construction only

Standard

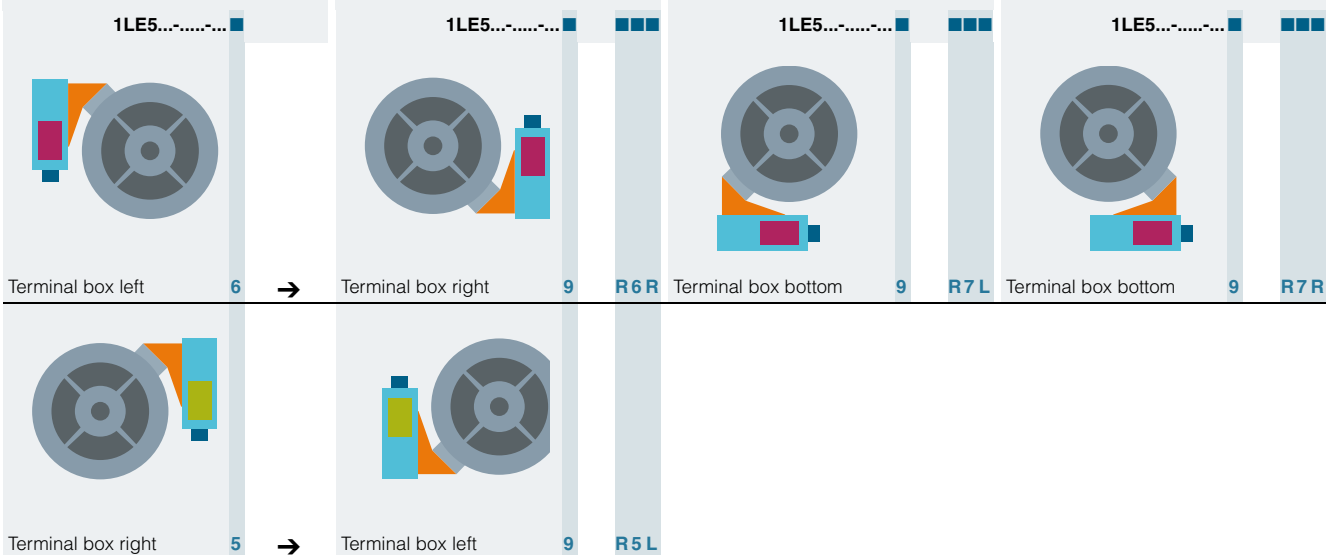



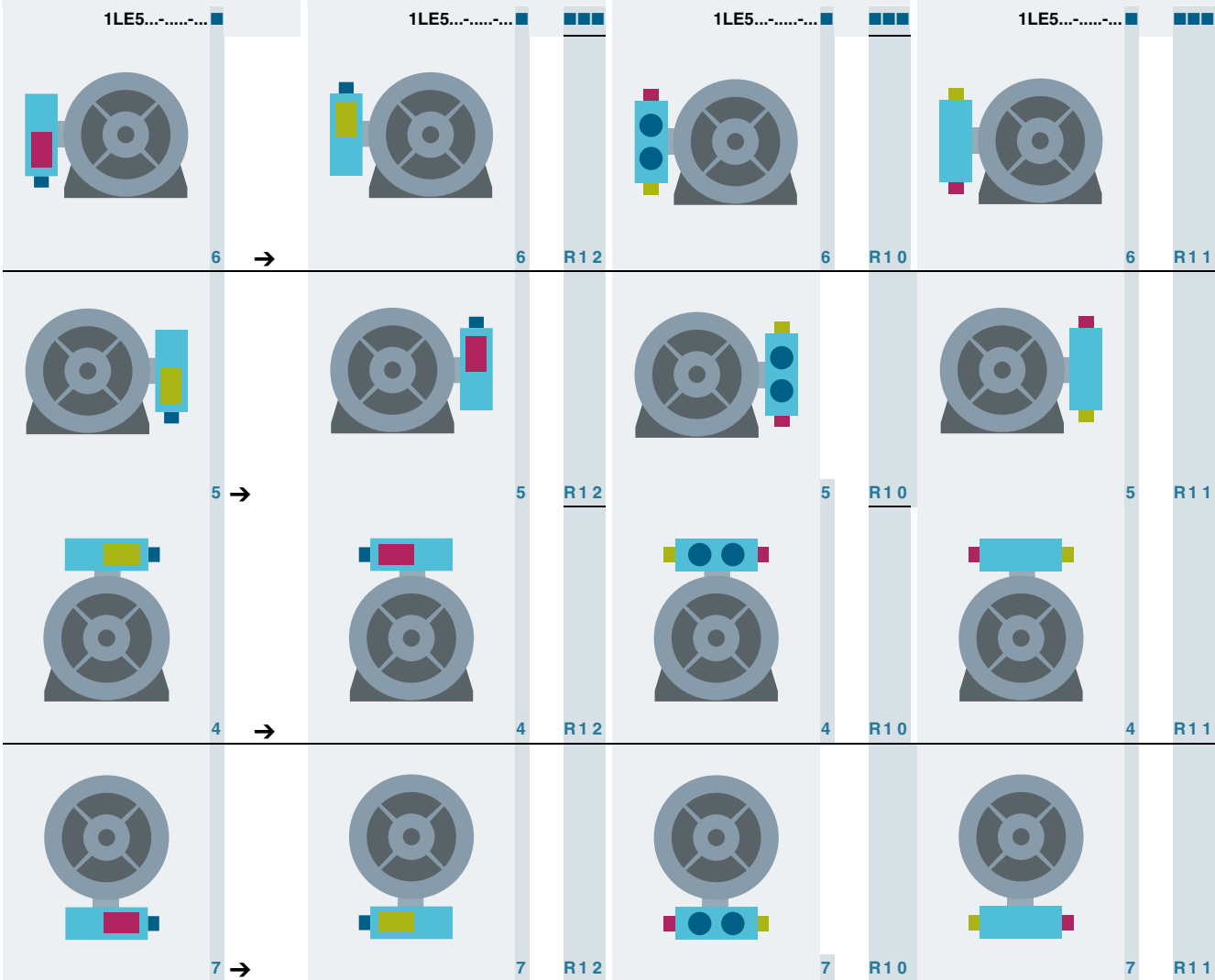

Standard ¹⁾

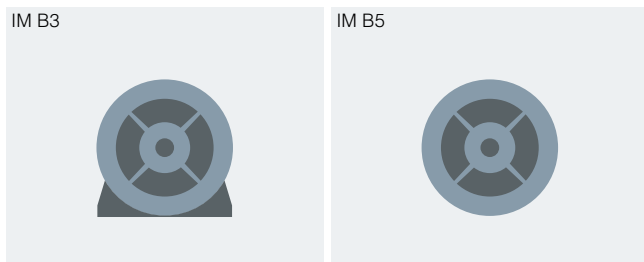

4

Types of constructionLegend

	Auxiliary terminal box 1 (3)
	Auxiliary terminal box 2 (4)
	Terminal box
	Adapter
	Cable entry

¹⁾ Only for frame size 315 if 11th position of Article No. for 2-, 4-pole motors **6, 7**, for 6-, 8-pole motors **7, 8**.

²⁾ Only for frame size 315 if 11th position of Article No. for all poles **0, 2, 4, 5**; for 6-, 8-pole motors **6**.

SIMOTICS SD standard motors next generation

Orientation

Technical specifications

Overview of technical specifications

This table lists the most important technical specifications. For more information and details, see Catalog Section 1 "Introduction".

Type of motor	SIMOTICS SD 1LE5 IEC Low-Voltage Motors
Connection types	Star/delta connection The connection type to be used can be taken from the Article No. supplements for the required motor.
Number of poles	2, 4, 6, 8
Frame sizes	315 S ... 450
Rated power	55 ... 1000 kW
Frequencies	50 Hz and 60 Hz
Versions	<ul style="list-style-type: none"> • IE3 (Premium Efficiency) • IE4 (Super Premium Efficiency)
Marking	IEC 60034-30-1 IE3, IE4: 2, 4, 6 and 8-pole
Rated speed (synchronous speed)	750 ... 3600 rpm
Rated torque	352 ... 8100 Nm
Insulation of the stator winding in accordance with EN 60034-1 (IEC 60034-1)	<ul style="list-style-type: none"> • SD and SD Add: Temperature class 155 (F), utilized to temperature class 130 (B) DURIGNIT IR 2000 insulation system • SD Pro: Temperature class 155 (F), utilized to temperature class 155 (F) DURIGNIT IR 2000 insulation system
Degree of protection according to EN 60034-5 (IEC 60034-5)	IP55 as standard
Cooling in accordance with EN 60034-6 (IEC 60034-6)	<ul style="list-style-type: none"> • Self-ventilated (IC411) • Forced-air cooled motors w/o ext. fan/fan cover (IC418) • Forced-air cooled (IC416)
Permissible coolant temperature and installation altitude	-20 ... +40 °C as standard, installation altitude up to 1000 m above sea level. See "Coolant temperature and installation altitude" in Catalog Section 1 "Introduction".
Standard voltages according to EN 60038 (IEC 60038)	50 Hz: 400 V, 500 V, 690 V The voltage used can be found in the "Selection and ordering data" for the required motor.
Type of construction according to EN 60034-7 (IEC 60034-7)	<ul style="list-style-type: none"> • Without flange: IM B3, IM B6, IM B7, IM B8, IM V5, IM V6 • With flange: IM B5, IM V1, IM V3, IM B35
Paint finish	Standard: color RAL 7030 stone gray
Suitability of paint finish for climate group according to IEC 60721, Part 2-1	See "Paint finish" in Catalog Section 1 "Introduction".
Vibration severity grade according to EN 60034-14 (IEC 60034-14)	Grade A (normal – without special vibration requirements) Optionally: Grade B (with special vibration requirements) See "Balance and vibration severity" in Catalog Section 1 "Introduction".
Shaft extension according to DIN 748 (IEC 60072)	Balancing type: Half-key balancing as standard See "Balance and vibration severity" in Catalog Section 1 "Introduction".
Sound pressure level according to EN ISO 1680 (tolerance +3 dB)	The sound pressure level is listed in the selection and ordering data for the required motor.
Weights	The weight is listed in the selection and ordering data for the required motor.
Modular mounting concept	Rotary pulse encoder, brake, separately driven fan or prepared for mountings
Consistent series concept	<ul style="list-style-type: none"> • Terminal box diagonally split - and can be optionally rotated through 4 x 90° • Bearings at DE and NDE are of identical design, reinforced bearings available as an option
Options	See "Article No. supplements and special versions"

Converter operation

The motors are suitable for line operation and optionally for converter operation (bearing insulation NDE, order code **L51**). The values specified in the selection tables apply for pure sinusoidal supplies.

Rated voltage

The tolerance for the rated voltage is in accordance with EN 60034-1 in all cases, a rated voltage range is not specified.

Motor protection

A motor protection function can be implemented using the I2t sensing circuit implemented in the converter software.

If required, more precise motor protection can be provided by directly measuring the temperature using KTY84 sensors, Pt100 / Pt1000 resistance thermometers or PTC thermistors in the motor winding. Some converters from Siemens determine the motor temperature using the resistance of the temperature sensor. They can be set to a required temperature for alarm and tripping.

Bearings

To avoid damage caused by bearing currents, insulated bearings (L51) must be ordered.

When operating multiphase induction motors with a converter, the bearings are electrically stressed as a result of a capacitively induced voltage across the bearing lubricating film (as a result of the inherent principle of operation). The physical cause of this is the common-mode voltage at the converter output that is inherent in the control method for a converter: The sum of the three phase voltages is – in contrast to pure line operation – not equal to zero at every point in time. The high-frequency, pulsed common-mode voltage results in a residual current that flows back to the converter DC link via the internal capacitances of the motor, the motor housing and the grounding circuit. The machine's internal capacitances include the main insulation winding capacitance, the geometric capacitance between the rotor and stator, the lubricating film capacitance and the capacitance of any bearing insulation that may be present. The current flowing through the internal capacitances is proportional to the gradient, i.e. the voltage change of the common-mode voltage ($i(t) = C \cdot du/dt$).

Technical specifications

In order to apply currents to the motor which are sinusoidal as far as possible (smooth running, oscillation torques, stray losses), a high clock frequency is required for the converter's output voltage. The related (very steep) switching edges of the converter output voltage (and also, therefore, of the common-mode voltage) cause correspondingly high capacitive currents and voltages on the machine's internal capacitances.

In the worst-case scenario, the capacitive voltage induced via the bearing can lead to random arcing through the bearing lubricating film, thus causing premature bearing aging or damage. (The current pulses caused by the arcing across the lubricating film are referred to as EDM (Electrostatic Discharge Machining) currents in the literature.)

This physical effect, which occurs in isolated cases, has mostly been observed in connection with larger motors. EMC-compliant installation of the drive system is a basic prerequisite for preventing premature bearing damage via bearing currents. The most important measures for reducing damage to bearings.

- Insulated bearing at the non-drive end (NDE) (order code **L51**)
- Use cables with a symmetrical cable cross-section

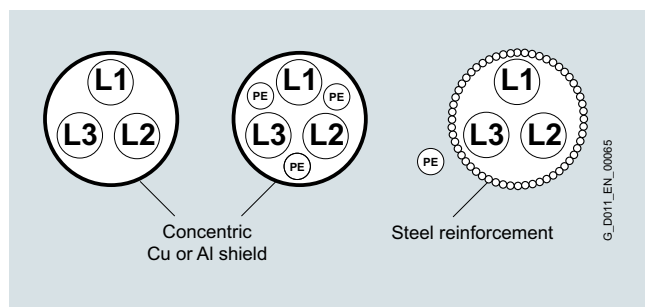

- Preference given to a supply with insulated neutral point (IT system)
- Using grounding cables with low impedance over a wide frequency range (DC up to approximately 70 MHz): for example, plaited copper ribbon cables, HF litz wires
- Separate HF equipotential-bonding cable between motor housing and driven machine
- Separate HF equipotential-bonding cable between motor housing and converter PE busbar
- 360° HF contacting of the cable shield on the motor housing and the converter PE busbar. This can be achieved using EMC screwed glands on the motor end and EMC shield clips at the converter, for example
- Using motor reactors at the converter
- Common-mode filters at the converter output.

More information

For further information, please get in touch with your local Siemens contact and use the DT Configurator.

Contacts: www.siemens.com/automation/partner

DT Configurator: www.siemens.com/dt-configurator

Here, you can find out about certain technologies through Siemens contact partners worldwide.

Wherever possible, you will find a local contact for:

- Technical support
- Spare parts/repairs
- Service
- Training
- Sales
- Technical consultation/engineering

Thermal torque limits

In the case of self-ventilated motors, the thermally admissible load torques are reduced for continuous operation for speeds below the rated speed. This must be taken into account for applications, especially those that do not have a square law load torque. Also in the case of forced-air cooled motors (order code F70), the maximum load torques are reduced slightly for high speed ranges.

When motors are operated at speeds above their rated speed (in the field-weakening range), the maximum load torque is also reduced.

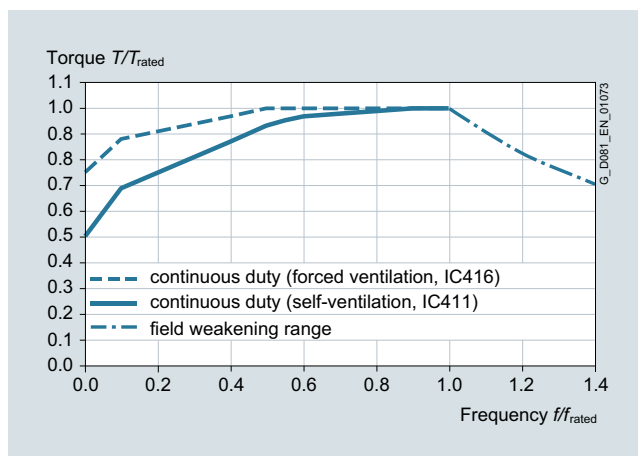

SIMOTICS SD standard motors next generation

Orientation

Article number code

Selection and ordering data

The article number consists of a combination of digits and letters and is divided into three hyphenated blocks to provide a better overview, e.g.:

1LE5504-3AA63-4AA2-Z

H00

The first block (positions 1 to 7) identifies the motor type. The second block (positions 8 to 12) defines the motor frame size and length, the number of poles and power and in some cases the frequency/voltage. In the third block (positions 13 to 16), the frequency/voltage, type of construction and further design features are encoded.

For deviations in the second and third block from the catalog codes either **Z** or **90** should be used as appropriate.

Ordering data:

- Complete Article No. and order code(s) or plain text
- If a quotation has been requested, please specify the quotation number in addition to the Article No.
- When ordering a complete motor as a spare part, please specify the works serial No. for the previously supplied motor as well as the Article No.

Structure of the Article No.:		Position:	1	2	3	4	5	6	7	-	8	9	10	11	12	-	13	14	15	16	
1st to 4th position: Digit, letter, letter, digit	<ul style="list-style-type: none"> • Self-ventilated by fan mounted on and driven by the rotor • Forced-air cooled by air flow from the fan to be driven with option extension F90 		1	L	E	5															
5th position: Digit	Cast-iron housing Basic Line Cast-iron housing Performance Line						5 6														
6th to 7th position: 2 digits	SIMOTICS SD motors with IE3 Premium Efficiency SIMOTICS SD Add motors with IE3 Premium Efficiency SIMOTICS SD motors with IE4 Super Premium Efficiency SIMOTICS SD Add motors with IE4 Super Premium Efficiency SIMOTICS SD Pro motors with IE3 Premium Efficiency							0 3 0 3 8	3 3 4 4 3												
8th, 9th and 11th position: Digit, letter, digit	Motor frame size (frame size as a combination of shaft height and overall length, encoded)										3 4	A B		3 8							
10th position: Letter	No. of poles A: 2-pole B: 4-pole C: 6-pole D: 8-pole											A B C D									
12th and 13th position: 2 digits	Voltage, circuit and frequency (encoded with two digits, 9-0 requires order code M.. (e.g. M1Y))														0 9		0 7				
14th position: Letter	Type of construction (encoded with A ... V)																	A V			
15th position: Letter	Motor protection (encoded with A ... Z; Z requires order code Q.. (e.g. Q3A))																		A Z		
16th position: Digit	Terminal box position Terminal box base left with terminal box at the top ²⁾ Terminal box base right with terminal box at the top ²⁾ Terminal box base left with terminal box 45° ²⁾ Terminal box base right with terminal box 45° ²⁾ Terminal box at the top ³⁾ Terminal box on right-hand side Terminal box on left-hand side																			0 1 2 3 4 5 6	
	Special order versions: encoded – additional order code required not encoded – additional plain text required																				- Z

Ordering example

Selection criteria	Requirement	Structure of the Article No.
Motor type 1LE5	Standard motor with IE4 Super Premium Efficiency, self-ventilated, IP55 degree of protection, cast-iron version, Performance Line	1LE5604-■■■■■-■■■■■
Motor frame size/No. of poles/Speed	315 L/2-pole/3000 rpm	1LE5604-3AA6■-■■■■■
Rated power	250 kW	1LE5604-3AA63-4■■■■■
Voltage and frequency	400 VΔ/690 VY, 50 Hz	1LE5604-3AA63-4C■■■■■-Z
Type of construction with special version	IM V5 with protective cover ¹⁾	1LE5604-3AA63-4C■■■■■-Z H00
Motor protection	1 or 3 PTC thermistors – for tripping (2 terminals)	1LE5604-3AA63-4CB■-Z H00
Terminal box position	Terminal box base left with terminal box 45°	1LE5604-3AA63-4CB2-Z H00

¹⁾ Standard without protective cover – the protective cover is defined with order code **H00** and must be ordered in addition to the Article No. with **-Z** and this order code.

²⁾ Only for frame size 315 if 11th position of Article No. for 2-, 4-pole motors **6, 7**, for 6-, 8-pole motors **7, 8** and for frame size 355 to 450.

³⁾ Only for frame size 315 if 11th position of Article No. for all poles **0, 2, 4, 5**; for 6-, 8-pole motors **6**.

SIMOTICS SD standard motors next generation

IE4 Super Premium Efficiency

Cast-iron series SIMOTICS SD 1LE5504 Basic Line – self-ventilated or forced-air cooled

Selection and ordering data

P _{rated}	Frame size	Operating values at rated power											Cast-iron series 1LE5504 Basic Line Article No.	m _{IM B3}	J	
		n _{rated}	T _{rated}	η _{rated, 4/4}	η _{rated, 3/4}	η _{rated, 2/4}	cosφ _{rated, 4/4}	I _{rated}	T _{LR} /I _{rated}	I _{LR} /I _{rated}	T _B /I _{rated}	L _{pfA}				L _{WA}
kW	FS	rpm	Nm	%	%	%	A					dB(A)	dB(A)		kg	kgm ²
<ul style="list-style-type: none"> • Cooling: Self-ventilated (IC411) • Efficiency according to IEC 60034-30: IE4 Super Premium Efficiency • Insulation: Thermal class 155 (temperature class F), IP55 degree of protection, utilization in accordance with thermal class 130 (temperature class B) 																
2-pole: 3000 rpm at 50 Hz																
110	315 S	2988	352	96	95.9	95.1	0.9	184	2.5	9.1	3.7	72	86	1LE5504-3AA0	916	1.84
132	315 M	2988	422	96.2	96.2	95.6	0.9	220	2.6	9.8	3.9	73	88	1LE5504-3AA2	1010	2.08
160	315 L	2986	512	96.3	96.3	95.8	0.9	265	2.5	9.6	3.9	75	89	1LE5504-3AA4	1050	2.25
200	315 L	2986	640	96.5	96.6	96.2	0.91	330	2.7	9.7	3.7	74	89	1LE5504-3AA5	1240	2.75
250	315 L	2986	800	96.5	96.4	95.7	0.88	425	3	9.3	4.2	80	94	1LE5504-3AA6	1340	2.82
315	315 L	2986	1007	96.5	96.3	95.5	0.87	540	3.5	9.9	4.2	81	96	1LE5504-3AA7	1520	3.27
4-pole: 1500 rpm at 50 Hz																
110	315 S	1491	705	96.3	96.4	96	0.86	192	3.3	8.6	3.3	66	80	1LE5504-3AB0	922	2.74
132	315 M	1490	846	96.4	96.6	96.3	0.85	235	3.3	8.2	3.2	67	81	1LE5504-3AB2	942	2.91
160	315 L	1490	1025	96.6	96.8	96.6	0.85	280	3.3	7.9	3.1	68	83	1LE5504-3AB4	1200	3.79
200	315 L	1490	1282	96.7	96.9	96.8	0.85	350	3.4	7.8	3.1	69	83	1LE5504-3AB5	1290	4.37
250	315 L	1490	1602	96.7	96.8	96.5	0.86	435	2.8	7.9	3.2	75	90	1LE5504-3AB6	1500	4.98
315	315 L	1490	2019	96.7	96.7	96.3	0.83	570	3.2	8.5	3.5	75	90	1LE5504-3AB7	1560	5.39
6-pole: 1000 rpm at 50 Hz																
75	315 S	992	722	95.4	95.6	95.2	0.84	135	2.7	8.2	3.5	63	77	1LE5504-3AC0	830	3.18
90	315 M	992	866	95.6	95.9	95.7	0.85	160	2.8	8.2	3.5	62	76	1LE5504-3AC2	900	3.77
110	315 L	992	1059	95.8	96.1	96	0.86	193	2.8	8.3	3.5	63	78	1LE5504-3AC4	1020	4.49
132	315 L	992	1271	96	96.3	96.3	0.87	230	2.8	8.4	3.5	64	79	1LE5504-3AC5	1130	5.32
160	315 L	993	1539	96.2	96.4	96.1	0.82	295	2.9	8	3.1	70	85	1LE5504-3AC6	1260	5.67
200	315 L	992	1925	96.3	96.4	96.1	0.82	365	3	7.5	3.2	68	83	1LE5504-3AC7	1410	6.28
250	315 L	992	2407	96.5	96.6	96.3	0.81	460	3.2	8.2	3.3	69	84	1LE5504-3AC8	1700	8.00
8-pole: 750 rpm at 50 Hz																
55	315 S	743	707	93.7	93.9	93.4	0.8	106	2.3	6.1	2.5	58	73	1LE5504-3AD0	762	2.53
75	315 M	742	965	94.2	94.5	94.1	0.81	142	2.4	6.3	2.6	58	72	1LE5504-3AD2	834	3.13
90	315 L	742	1158	94.4	94.7	94.4	0.82	168	2.5	6.1	2.5	58	73	1LE5504-3AD4	943	3.73
110	315 L	742	1416	94.7	95.1	94.9	0.82	205	2.4	6.3	2.6	61	75	1LE5504-3AD5	1030	4.44
132	315 L	741	1701	94.9	95.3	95.1	0.82	245	2.4	6.1	2.5	65	80	1LE5504-3AD6	1110	5.09
160	315 L	741	2062	95.1	95.5	95.5	0.79	305	2.5	6.3	2.5	67	82	1LE5504-3AD7	1420	6.78
200	315 L	742	2574	95.4	95.6	95.3	0.78	390	2.7	6.7	2.9	72	87	1LE5504-3AD8	1660	8.60
Voltages ¹⁾																
50 Hz 400 VΔ/690 VY											60 Hz ¹⁾ 460 VΔ		Version		Order code	
50 Hz 500 VΔ													Standard		3 4	
50 Hz 690 VΔ													Without additional charge		4 0	
													With additional charge		4 7	
For other voltages ¹⁾ and more information, see from page 4/21																
Types of construction																
Without flange											IM B3 ²⁾		Version		Order code	
With flange											IM B5 ²⁾		Standard		A	
													With additional charge		F	
For other types of construction and more information, see from page 4/22																
Motor protection																
Without													Version		Order code	
PTC thermistor with 3 temperature sensors													Standard		A	
													With additional charge		B	
For other motor protection and more information, see from page 4/24																
Terminal box position																
Terminal box base right with terminal box 45° ³⁾													Version		Order code	
Terminal box top ⁴⁾													Standard		3	
													Standard		4	
For other terminal box positions and more information, see from page 4/25																
Special versions																
Forced-air cooled motors w/o ext. fan/fan cover (IC418)													Version		Order code(s)	
													Standard		1LE5504-... -Z F90+...+...	
													With additional charge		1LE5504-... -Z ...+...+...	
For options, see from page 4/26																



¹⁾ Parallel supply lines are required, except in the case of connection to 690 V.
²⁾ For a power rating of 315 kW, 2-pole, 60 Hz and 315 kW, 4-pole, 50 Hz, a larger terminal box can be used (order code **R50**) due to the magnitude of the current. Order code **R50** alters the motor dimensions.

³⁾ Only for frame size 315 if 11th position of Article No. for 2-, 4-pole motors **6, 7**, for 6-, 8-pole motors **7, 8** and for shaft height 355 to 450.
⁴⁾ Only for frame size 315 if 11th position of Article No. for all poles **0, 2, 4, 5**; for 6-, 8-pole motors **6**.

SIMOTICS SD standard motors next generation

IE4 Super Premium Efficiency

Cast-iron series SIMOTICS SD 1LE5604 Performance Line – self-ventilated or forced-air cooled

Selection and ordering data

P _{rated}	Frame size	Operating values at rated power											Cast-iron series 1LE5604 Performance Line Article No.	m _{IM B3}	J	
		n _{rated}	T _{rated}	η _{rated, 4/4}	η _{rated, 3/4}	η _{rated, 2/4}	cosφ _{rated, 4/4}	I _{rated}	T _{LR} /I _{rated}	I _{LR} /I _{rated}	T _B /I _{rated}	L _{pfA}				L _{WA}
kW	FS	rpm	Nm	%	%	%		A							kg	kgm ²
• Cooling: Self-ventilated (IC411)																
• Efficiency according to IEC 60034-30: IE4 Super Premium Efficiency																
• Insulation: Thermal class 155 (temperature class F), IP55 degree of protection, utilization in accordance with thermal class 130 (temperature class B)																
2-pole: 3000 rpm at 50 Hz																
250	315 L	2986	800	96.5	96.4	95.7	0.88	425	3	9.3	4.2	80	94	1LE5604-3AA6	1340	2.82
315	315 L	2986	1007	96.5	96.3	95.5	0.87	540	3.5	9.9	4.2	81	96	1LE5604-3AA7	1520	3.27
355	355 L	2988	1135	96.5	96.3	95.5	0.89	600	2.6	8.9	4	84	99	1LE5604-3BA3	2100	4.74
400	355 L	2986	1279	96.5	96.4	95.9	0.92	650	2.6	8.5	3.4	83	98	1LE5604-3BA4	2240	5.36
500	355 L	2988	1598	96.5	96.4	95.8	0.89	840	3	8.9	3.8	84	98	1LE5604-3BA5	2340	5.76
4-pole: 1500 rpm at 50 Hz																
250	315 L	1490	1602	96.7	96.8	96.5	0.86	435	2.8	7.9	3.2	75	90	1LE5604-3AB6	1500	4.98
315	315 L	1490	2019	96.7	96.7	96.3	0.83	570	3.2	8.5	3.5	75	90	1LE5604-3AB7	1560	5.39
355	355 L	1492	2272	96.7	96.7	96.2	0.83	640	2.8	7.9	2.8	81	96	1LE5604-3BB3	2050	6.76
400	355 L	1492	2560	96.7	96.7	96.2	0.82	730	3.2	7.9	2.9	81	96	1LE5604-3BB4	2080	7.16
500	355 L	1491	3202	96.7	96.8	96.6	0.86	870	3.1	8.1	3.3	80	96	1LE5604-3BB5	2290	8.36
6-pole: 1000 rpm at 50 Hz																
200	315 L	992	1925	96.3	96.4	96.1	0.82	365	3	7.5	3.2	68	83	1LE5604-3AC7	1410	6.28
250	315 L	992	2407	96.5	96.6	96.3	0.81	460	3.2	8.2	3.3	69	84	1LE5604-3AC8	1700	8.00
315	355 L	993	3029	96.6	96.6	96.1	0.82	570	2.9	7.8	3.2	75	90	1LE5604-3BC2	2040	11.6
355	355 L	993	3414	96.6	96.7	96.3	0.83	640	2.9	8.4	3.3	74	89	1LE5604-3BC3	2250	13.7
400	355 L	993	3847	96.6	96.7	96.5	0.84	710	2.8	8.1	3	75	90	1LE5604-3BC4	2240	13.4
8-pole: 750 rpm at 50 Hz																
160	315 L	741	2062	95.1	95.5	95.5	0.79	305	2.5	6.3	2.5	67	82	1LE5604-3AD7	1420	6.78
200	315 L	742	2574	95.4	95.6	95.3	0.78	390	2.7	6.7	2.9	72	87	1LE5604-3AD8	1660	8.60
250	355 L	744	3209	95.4	95.8	95.8	0.80	475	2.4	7.1	2.7	68	83	1LE5604-3BD1	2280	13.3
315	355 L	744	4043	95.4	95.7	95.4	0.80	600	2.5	7.3	3.0	68	83	1LE5604-3BD2	2360	14
Voltages ¹⁾																
50 Hz 400 VΔ/690 VY											60 Hz ¹⁾ 460 VΔ		Version		Order code	
50 Hz 500 VΔ													Standard		3 4	
50 Hz 690 VΔ													Without additional charge		4 0	
													With additional charge		4 7	
															...	
For other voltages ¹⁾ and more information, see from page 4/21																
Types of construction																
Without flange											IM B3 ²⁾		Version		Order code	
With flange											IM B5 ²⁾		Standard		A	
													With additional charge		F	
															...	
For other types of construction and more information, see from page 4/22																
Motor protection																
PTC thermistor with 3 temperature sensors											Version		Order code			
											Standard		B			
															...	
For other motor protection and more information, see from page 4/24																
Terminal box position																
Terminal box base right with terminal box 45° ³⁾											Version		Order code			
Terminal box top ⁴⁾											Standard		3			
											Standard		4			
															...	
For other terminal box positions and more information, see from page 4/25																
Special versions																
Forced-air cooled motors w/o ext. fan/fan cover (IC418)											Version		Order code(s)			
											1LE5604-		-Z F90+			
											1LE5604-		-Z			
For options, see from page 4/26																

¹⁾ Parallel supply lines are required, except in the case of connection to 690 V.
²⁾ For a power rating of 315 kW, 2-pole, 60 Hz and 315 kW, 4-pole, 50 Hz, a larger terminal box can be used (order code **R50**) due to the magnitude of the current.
 Order code **R50** alters the motor dimensions.

³⁾ Only for frame size 315 if 11th position of Article No. for 2-, 4-pole motors **6, 7**, for 6-, 8-pole motors **7, 8** and for shaft height 355 to 450.
⁴⁾ Only for frame size 315 if 11th position of Article No. for all poles **0, 2, 4, 5**; for 6-, 8-pole motors **6**.

Selection and ordering data

P_{rated}	Frame size	Operating values at rated power										Cast-iron series	$m_{IM B3}$	J		
		n_{rated}	T_{rated}	$\eta_{rated, 4/4}$	$\eta_{rated, 3/4}$	$\eta_{rated, 2/4}$	$\cos\phi_{rated, 4/4}$	I_{rated}	T_{LR}/I_{rated}	I_{LR}/I_{rated}	T_B/T_{rated}				L_{pFA}	L_{WA}
kW	FS	rpm	Nm	%	%	%	A									
<ul style="list-style-type: none"> • Cooling: Self-ventilated (IC411) • Efficiency: IE4 Super Premium Efficiency • Insulation: Thermal class 155 (temperature class F), IP55 degree of protection, utilization in accordance with thermal class 130 (temperature class B) 																
2-pole: 3000 rpm at 50 Hz																
110	315 S	2982	352	96	95.9	95.2	0.91	182	2.1	6.5	2.7	74	89	1LE5534-3AA0	898	1.67
132	315 M	2984	422	96.2	96.1	95.5	0.91	220	2.4	7.2	3	75	89	1LE5534-3AA2	1010	1.97
160	315 L	2982	512	96.3	96.3	95.7	0.92	260	2.4	7.1	2.8	75	90	1LE5534-3AA4	1090	2.25
200	315 L	2980	641	96.5	96.7	96.5	0.92	325	2.3	6.6	2.7	74	88	1LE5534-3AA5	1280	2.65
250	315 L	2982	801	96.5	96.6	96.4	0.91	410	2.6	7.5	3	80	95	1LE5534-3AA6	1340	2.82
315	315 L	2980	1009	96.5	96.7	96.5	0.91	520	2.4	7.5	2.9	81	96	1LE5534-3AA7	1490	3.11
560 ¹⁾²⁾	400	2988	1790	97	96.9	96.5	0.89	940	1.6	7.3	3.1	74	90	1LE5534-4AA3	2850	8.9
630 ¹⁾²⁾	400	2988	2000	97	97.1	96.8	0.9	1040	1.6	7.3	3	74	90	1LE5534-4AA5	3000	9.8
710 ³⁾	400	2988	2250	97.1	97.2	96.9	0.9	680	1.7	7.3	2.9	74	90	1LE5534-4AA7	3200	10.8
800 ¹⁾²⁾³⁾⁴⁾	450	2990	2550	97.4	97.4	97.1	0.87	790	1.2	7.7	3.3	75	91	1LE5534-4BA3	4000	12.3
900 ¹⁾²⁾³⁾⁴⁾	450	2988	2900	97.4	97.5	97.4	0.89	870	1.2	7.2	3	75	91	1LE5534-4BA5	4250	13.5
1000 ¹⁾²⁾³⁾⁴⁾	450	2988	3200	97.4	97.6	97.6	0.9	950	1.2	7	2.7	75	91	1LE5534-4BA7	4450	14.7
4-pole: 1500 rpm at 50 Hz																
110	315 S	1490	705	96.3	96.5	96.2	0.85	194	2.2	6.9	2.7	68	83	1LE5534-3AB0	920	2.64
132	315 M	1490	846	96.4	96.6	96.5	0.86	230	2.2	6.9	2.6	67	81	1LE5534-3AB2	1080	3.38
160	315 L	1490	1025	96.6	96.8	96.7	0.86	280	2.3	7.2	2.7	70	85	1LE5534-3AB4	1240	3.91
200	315 L	1490	1282	96.7	97	97	0.87	345	2.6	7	2.5	74	88	1LE5534-3AB5	1350	4.62
250	315 L	1488	1604	96.7	97	97	0.86	435	2.3	6.5	2.6	75	90	1LE5534-3AB6	1520	5.09
315	315 L	1488	2022	96.7	96.9	96.8	0.85	550	2.2	7.2	2.8	75	90	1LE5534-3AB7	1530	5.28
560 ¹⁾²⁾	400	1493	3600	96.9	97	96.6	0.86	970	2.2	7.5	3.1	72	88	1LE5534-4AB3	3050	14.9
630 ¹⁾²⁾	400	1492	4050	96.8	96.9	96.6	0.87	1080	2.2	6.9	2.8	74	90	1LE5534-4AB5	3150	15.6
710 ³⁾	400	1492	4550	97	97	96.8	0.87	700	2.2	7.2	2.9	74	90	1LE5534-4AB7	3250	16.9
800 ³⁾	450	1492	5100	96.9	97.1	96.9	0.87	790	1.4	6.5	2.4	79	95	1LE5534-4BB3	4000	24
900 ³⁾	450	1492	5800	97	97.2	97	0.88	880	1.4	6.5	2.5	79	95	1LE5534-4BB5	4150	25.4
1000 ¹⁾³⁾	450	1492	6400	97.1	97.2	97.1	0.88	980	1.5	6.8	2.6	79	95	1LE5534-4BB7	4350	28
Voltages⁶⁾																
Version																
Standard																
Without additional charge																
With additional charge																
For other voltages ⁵⁾ and more information, see from page 4/21																
Types of construction																
Version																
Standard																
Without flange IM B3 ⁷⁾																
With flange IM B5 ⁷⁾																
For other types of construction and more information, see from page 4/22																
Motor protection																
Version																
Standard																
Without																
PTC thermistor with 3 temperature sensors																
For other motor protection and more information, see from page 4/24																
Terminal box position																
Version																
Standard																
Terminal box base right with terminal box 45° ³⁾																
Terminal box top ⁴⁾																
For other terminal box positions and more information, see from page 4/25																
Special versions																
Version																
Standard																
Forced-air cooled motors w/o ext. fan/fan cover (IC418)																
1LE5534-... -Z F90+...+...+...+...																
For options and information, see from page 4/26																
1LE5534-... -Z ...+...+...+...																



SIMOTICS SD standard motors next generation

IE4 Super Premium Efficiency

Cast-iron series SIMOTICS SD Add 1LE5534 Basic Line – self-ventilated or forced-air cooled

Selection and ordering data

P_{rated}	Frame size	Operating values at rated power											Cast-iron series 1LE5534 Basic Line Article No.	$m_{IM B3}$	J	
		n_{rated}	T_{rated}	$\eta_{rated, 4/4}$	$\eta_{rated, 3/4}$	$\eta_{rated, 2/4}$	$\cos\phi_{rated, 4/4}$	I_{rated}	T_{LR}/T_{rated}	I_{LR}/I_{rated}	T_B/T_{rated}	L_{pFA}				L_{WA}
kW	FS	rpm	Nm	%	%	%		A							kg	kgm ²
6-pole: 1000 rpm at 50 Hz																
75	315 S	993	721	95.4	95.5	95.1	0.82	138	2.3	7	2.8	63	77	1LE5534-3AC0	831	3.02
90	315 M	993	865	95.6	95.7	95.2	0.83	164	2.4	7	2.8	62	77	1LE5534-3AC2	903	3.57
110	315 L	992	1059	95.8	96	95.8	0.83	200	2.4	7	2.8	65	79	1LE5534-3AC4	1020	4.25
132	315 L	993	1269	96	96.1	95.6	0.83	240	2.7	7.6	3	64	79	1LE5534-3AC5	1100	4.86
160	315 L	992	1540	96.2	96.4	96.2	0.82	295	2.5	7.1	3	66	81	1LE5534-3AC6	1260	5.73
200	315 L	992	1925	96.3	96.5	96.3	0.81	370	2.8	7	3	68	83	1LE5534-3AC7	1410	6.28
250	315 L	992	2407	96.5	96.6	96.3	0.81	460	2.9	7.3	3	68	83	1LE5534-3AC8	1640	8.1
450	400	994	4300	96.6	96.8	96.4	0.85	790	2.2	7.2	2.7	70	86	1LE5534-4AC3	3100	25.5
500 ¹⁾	400	994	4800	96.7	96.8	96.5	0.85	880	2.3	7.3	2.8	70	86	1LE5534-4AC5	3250	27.4
560	400	994	5400	96.7	96.8	96.4	0.84	1000	2.4	7.5	2.9	70	86	1LE5534-4AC7	3300	28.6
630 ¹⁾²⁾	450	995	6000	96.8	97	96.7	0.83	1130	2	7	2.8	72	88	1LE5534-4BC3	4050	38.6
710 ³⁾	450	994	6800	96.8	97	96.9	0.84	730	1.8	6.6	2.5	72	88	1LE5534-4BC5	4200	41
800 ¹⁾³⁾	450	994	7700	96.8	97	96.8	0.84	820	1.8	6.6	2.4	74	90	1LE5534-4BC7	4300	43.3
8-pole: 750 rpm at 50 Hz																
55	315 S	743	707	93.7	93.9	93.4	0.8	106	2.3	6.1	2.5	58	73	1LE5534-3AD0	762	2.53
75	315 M	742	965	94.2	94.5	94.1	0.81	142	2.4	6.3	2.6	58	72	1LE5534-3AD2	834	3.13
90	315 L	742	1158	94.4	94.7	94.4	0.82	168	2.5	6.1	2.5	58	73	1LE5534-3AD4	943	3.73
110	315 L	742	1416	94.7	95.1	94.9	0.82	205	2.4	6.3	2.6	61	75	1LE5534-3AD5	1030	4.44
132	315 L	741	1701	94.9	95.3	95.1	0.82	245	2.4	6.1	2.5	65	80	1LE5534-3AD6	1110	5.09
160	315 L	741	2062	95.1	95.5	95.5	0.79	305	2.4	6.2	2.4	67	82	1LE5534-3AD7	1420	6.78
200	315 L	742	2574	95.4	95.6	95.3	0.78	390	2.7	6.7	2.9	72	87	1LE5534-3AD8	1660	8.6
355	400	744	4550	95.8	96.1	95.8	0.8	670	2	6.5	2.6	64	80	1LE5534-4AD3	2850	21.9
400	400	744	5100	96	96.2	95.9	0.8	750	2.1	6.8	2.7	64	80	1LE5534-4AD5	3050	24.5
450	400	744	5800	96	96.3	96	0.8	850	2.1	6.8	2.7	64	80	1LE5534-4AD7	3250	27.5
500 ⁵⁾	450	745	6400	96.2	96.4	96.1	0.79	950	2	6.8	2.5	67	83	1LE5534-4BD3	3800	34
560 ⁵⁾	450	745	7200	96.3	96.5	96.1	0.79	1060	2	6.9	2.6	67	83	1LE5534-4BD5	4000	38
630 ¹⁾⁵⁾	450	745	8100	96.4	96.6	96.3	0.8	1180	2	6.9	2.5	67	83	1LE5534-4BD7	4250	42.5
Voltages⁶⁾																
50 Hz 400 VΔ/690 VY											Version		Order code			
60 Hz ⁶⁾ 460 VΔ											Standard		3 4			
50 Hz 500 VΔ											Without additional charge		4 0			
50 Hz 690 VΔ											With additional charge		4 7			
For other voltages ⁶⁾ and more information, see from page 4/21																
Types of construction																
Without flange											Version		Order code			
IM B3 ⁷⁾											Standard		-			
With flange											With additional charge		A F			
For other types of construction and more information, see from page 4/22																
Motor protection																
Without											Version		Order code			
PTC thermistor with 3 temperature sensors											Standard		-			
											With additional charge		A B			
For other motor protection and more information, see from page 4/24																
Terminal box position																
Terminal box base right with terminal box 45° ⁸⁾											Version		Order code			
Terminal box top ⁹⁾											Standard		3			
											Standard		4			
For other terminal box positions and more information, see from page 4/25																
Special versions																
Forced-air cooled motors w/o ext. fan/fan cover (IC418)											1LE5534-....		-Z F90+...+...+...			
For options and information, see from page 4/26																
											1LE5534-....		-Z ...+...+...+...			

- 1) Terminal box 1XB1631.
- 2) Terminal box position NDE can only be ordered using order code **H09** (2 x terminal box TB3R61). Order code **H08** not available.
- 3) The standard version is 50 Hz 690 VΔ (voltage code **4-7**) or 60 Hz 575 VΔ (voltage code **4-0**).
- 4) In the series version, the maximum speed is $n_{max} = 3000$ rpm. Operation up to 3600 rpm at higher speeds on request for an additional charge.
- 5) Utilization with sinusoidal supply in accordance with thermal class 155 (temperature class F).
- 6) For frame size 315, parallel supply lines are required, except in the case of connection to 690 V.
- 7) For frame size 315 with power rating 315 kW, 2-pole, 60 Hz and 315 kW, 4-pole, 50 Hz, a larger terminal box can be used (order code **R50**) due to the magnitude of the current. Order code **R50** alters the motor dimensions.
- 8) Only for frame size 315 if 11th position of Article No. for 2-, 4-pole motors **6, 7**, for 6-, 8-pole motors **7, 8** and for shaft height 355 to 450.
- 9) Only for frame size 315 if 11th position of Article No. for all poles **0, 2, 4, 5**; for 6-, 8-pole motors **6**.



SIMOTICS SD standard motors next generation
IE4 Super Premium Efficiency

Cast-iron series SIMOTICS SD Add 1LE5634 Performance Line – self-ventilated or forced-air cooled

Selection and ordering data

P _{rated}	Frame size	Operating values at rated power											Cast-iron series 1LE5634 Performance Line Article No.	m _{IM B3}	J		
		n _{rated}	T _{rated}	η _{rated, 4/4}	η _{rated, 3/4}	η _{rated, 2/4}	cosφ _{rated, 4/4}	I _{rated}	T _{LR} /T _{rated}	I _{LR} /I _{rated}	T _B /T _{rated}	L _{pFA}				L _{WA}	
kW	FS	rpm	Nm	%	%	%		A							kg	kgm ²	
2-pole: 3000 rpm at 50 Hz																	
250	315 L	2982	801	96.5	96.6	96.4	0.91	410	2.6	7.5	3	80	95	1LE5634-3AA6	1340	2.82	
315	315 L	2980	1009	96.5	96.7	96.5	0.91	520	2.4	7.5	2.9	81	96	1LE5634-3AA7	1490	3.11	
355	355 L	2984	1136	96.5	96.4	95.9	0.9	590	2.3	8.4	3.1	83	98	1LE5634-3BA3	2170	5.09	
400	355 L	2986	1279	96.5	96.5	96	0.91	660	2.3	7.7	3.1	83	98	1LE5634-3BA4	2240	5.46	
500	355 L	2988	1598	96.5	96.4	95.8	0.89	840	2.8	8.5	3.7	83	98	1LE5634-3BA5	2340	5.76	
4-pole: 1500 rpm at 50 Hz																	
250	315 L	1488	1604	96.7	97	97	0.86	435	2.3	6.5	2.6	75	90	1LE5634-3AB6	1520	5.09	
315	315 L	1488	2022	96.7	96.9	96.8	0.85	550	2.2	7.2	2.8	75	90	1LE5634-3AB7	1530	5.28	
355	355 L	1491	2274	96.7	96.8	96.5	0.85	620	2.2	7.5	3.2	78	93	1LE5634-3BB3	1960	6.26	
400	355 L	1491	2562	96.7	96.9	96.6	0.85	700	2.3	7.3	3.2	79	95	1LE5634-3BB4	2080	7.06	
500	355 L	1491	3202	96.7	96.8	96.6	0.86	870	3.1	7.9	3.3	80	96	1LE5634-3BB5	2290	8.36	
6-pole: 1000 rpm at 50 Hz																	
200	315 L	992	1925	96.3	96.5	96.3	0.81	370	2.8	7	3	68	83	1LE5634-3AC7	1410	6.39	
250	315 L	992	2407	96.5	96.6	96.3	0.81	460	2.9	7.3	3	68	83	1LE5634-3AC8	1640	8.10	
315	355 L	992	3032	96.6	96.9	96.9	0.86	550	2.4	6.8	2.8	75	90	1LE5634-3BC2	2150	12.9	
355	355 L	993	3414	96.6	96.7	96.4	0.84	630	2.6	7.4	3.2	76	91	1LE5634-3BC3	2250	13.8	
400	355 L	994	3843	96.6	96.7	96.5	0.84	710	2.7	7.7	2.9	75	90	1LE5634-3BC4	2240	13.4	
8-pole: 750 rpm at 50 Hz																	
160	315 L	741	2062	95.1	95.5	95.5	0.79	305	2.4	6.2	2.4	67	82	1LE5634-3AD7	1420	6.78	
200	315 L	742	2574	95.4	95.6	95.3	0.78	390	2.7	6.7	2.9	72	87	1LE5634-3AD8	1660	8.60	
250	355 L	744	3200	95.4	95.8	95.8	0.80	475	2.4	7.1	2.7	68	83	1LE5634-3BD1	2280	13.3	
315	355 L	744	4050	95.4	95.7	95.4	0.80	600	2.4	7.0	2.9	68	83	1LE5634-3BD2	2310	14	
Voltages ¹⁾																	
50 Hz 400 VΔ/690 VY		60 Hz ¹⁾ 460 VΔ											Version	Order code			
50 Hz 500 VΔ													Standard	3 4	-		
50 Hz 690 VΔ													Without additional charge	4 0	-		
													With additional charge	4 7	-		
															...		
Types of construction																	
Without flange		IM B3 ²⁾											Version	Order code			
With flange		IM B5 ²⁾											Standard	A	-		
													With additional charge	F	-		
															...		
Motor protection																	
PTC thermistor with 3 temperature sensors											Version	Order code					
											Standard	B	-				
													...				
Terminal box position																	
Terminal box base left with terminal box 45°											Version	Order code					
Terminal box base right with terminal box 45°											Without additional charge	2	-				
											Standard	3	-				
													...				
Special versions																	
Forced-air cooled motors w/o ext. fan/fan cover (IC418)											1LE5634-...-Z F90+...+...+...						
											1LE5634-...-Z ...+...+...+...						



¹⁾ Parallel supply lines are required, except in the case of connection to 690 V.

²⁾ For a power rating of 315 kW, 2-pole, 60 Hz and 315 kW, 4-pole, 50 Hz, a larger terminal box can be used (order code **R50**) due to the magnitude of the current. Order code **R50** alters the motor dimensions.

SIMOTICS SD standard motors next generation

IE3 Premium Efficiency



Cast-iron series SIMOTICS SD 1LE5503 Basic Line – self-ventilated or forced-air cooled

Selection and ordering data

P _{rated}	Frame size	Operating values at rated power											Cast-iron series 1LE5503 Basic Line Article No.	m _{IM B3}	J	
		n _{rated}	T _{rated}	η _{rated, 4/4}	η _{rated, 3/4}	η _{rated, 2/4}	cosφ _{rated, 4/4}	I _{rated}	T _{LFR} /T _{rated}	I _{LR} /I _{rated}	T _B /T _{rated}	L _{pFA}				L _{WA}
kW	FS	rpm	Nm	%	%	%		A							kg	kgm ²
<ul style="list-style-type: none"> • Cooling: Self-ventilated (IC411) • Efficiency according to IEC 60034-30: IE3 Premium Efficiency • Insulation: Thermal class 155 (temperature class F), IP55 degree of protection, utilization in accordance with thermal class 130 (temperature class B) 																
2-pole: 3000 rpm at 50 Hz																
250	315 L	2986	800	95.8	95.7	95	0.88	430	3	9.3	4.2	80	94	1LE5503-3AA6	1340	2.82
315	315 L	2986	1007	95.8	95.6	94.8	0.87	550	3.5	9.9	4.2	81	96	1LE5503-3AA7	1520	3.27
4-pole: 1500 rpm at 50 Hz																
250	315 L	1490	1602	96	96.1	95.7	0.85	440	2.8	7.9	3.2	75	91	1LE5503-3AB6	1290	4.27
315	315 L	1490	2019	96	96	95.6	0.83	570	3.2	8.5	3.5	75	90	1LE5503-3AB7	1560	5.39
6-pole: 1000 rpm at 50 Hz																
200	315 L	992	1925	95.8	95.9	95.6	0.82	365	3	7.5	3.2	68	83	1LE5503-3AC7	1410	6.28
250	315 L	992	2407	95.8	95.9	95.6	0.81	465	3.2	8.2	3.3	69	84	1LE5503-3AC8	1700	8.00
8-pole: 750 rpm at 50 Hz																
160	315 L	741	2062	94.3	94.7	94.7	0.79	310	2.5	6.3	2.5	67	82	1LE5503-3AD7	1420	6.78
200	315 L	742	2574	94.6	94.8	94.5	0.78	390	2.7	6.7	2.9	72	87	1LE5503-3AD8	1660	8.60
Voltages ¹⁾																
50 Hz 400 VΔ/690 VY											60 Hz ¹⁾ 460 VΔ		Version		Order code	
50 Hz 500 VΔ													Standard		3 4	
50 Hz 690 VΔ													Without additional charge		4 0	
													With additional charge		4 7	
															...	
For other voltages ¹⁾ and more information, see from page 4/21																
Types of construction																
Without flange											IM B3 ²⁾		Version		Order code	
With flange											IM B5 ²⁾		Standard		A	
													With additional charge		F	
															...	
For other types of construction and more information, see from page 4/22																
Motor protection																
Without											PTC thermistor with 3 temperature sensors		Version		Order code	
													Standard		A	
													With additional charge		B	
															...	
For other motor protection and more information, see from page 4/24																
Terminal box position																
Terminal box base left with terminal box 45°											Terminal box base right with terminal box 45°		Version		Order code	
													Without additional charge		2	
													Standard		3	
															...	
For other terminal box positions and more information, see from page 4/25																
Special versions																
For options, see from page 4/26																
														1LE5503- -Z	

4

¹⁾ Parallel supply lines are required, except in the case of connection to 690 V.

²⁾ For a power rating of 315 kW, 2-pole, 60 Hz and 315 kW, 4-pole, 50 Hz, a larger terminal box can be used (order code **R50**) due to the magnitude of the current. Order code **R50** alters the motor dimensions.

Selection and ordering data

P _{rated} kW	Frame size FS	Operating values at rated power											Cast-iron series 1LE5603 Performance Line Article No.	m _{IM B3} kg	J kgm ²		
		n _{rated} rpm	T _{rated} Nm	η _{rated, 4/4} %	η _{rated, 3/4} %	η _{rated, 2/4} %	cosφ _{rated, 4/4} %	I _{rated} A	T _{LR} /T _{rated}	I _{LR} /I _{rated}	T _B /T _{rated}	L _{pfA} dB(A)				L _{WA} dB(A)	
<ul style="list-style-type: none"> Cooling: Self-ventilated (IC411) Efficiency according to IEC 60034-30: IE3 Premium Efficiency Insulation: Thermal class 155 (temperature class F), IP55 degree of protection, utilization in accordance with thermal class 130 (temperature class B) 																	
2-pole: 3000 rpm at 50 Hz																	
250	315 L	2986	800	95.8	95.6	95.0	0.88	430	3.0	9	4.2	80	94	1LE5603-3AA6	1340	2.82	
315	315 L	2986	1007	95.8	95.6	94.8	0.87	550	3.5	9.9	4.2	81	96	1LE5603-3AA7	1520	3.27	
355	355 L	2988	1135	95.8	95.6	94.8	0.89	600	2.6	8.9	4.0	84	99	1LE5603-3BA3	2100	4.74	
400	355 L	2986	1279	95.8	95.7	95.2	0.92	660	2.6	8.5	3.4	83	98	1LE5603-3BA4	2240	5.36	
500	355 L	2988	1598	95.8	95.7	95.1	0.89	850	3.0	8.9	3.8	84	98	1LE5603-3BA5	2340	5.76	
4-pole: 1500 rpm at 50 Hz																	
250	315 L	1490	1602	96.0	96.1	95.7	0.85	440	2.8	7.9	3.2	75	91	1LE5603-3AB6	1290	4.27	
315	315 L	1490	2019	96.0	96.0	95.6	0.83	570	3.2	8.5	3.5	75	90	1LE5603-3AB7	1560	5.39	
355	355 L	1492	2272	96.0	96.0	95.4	0.86	620	2.9	7.9	2.8	81	96	1LE5603-3BB3	2290	6.76	
400	355 L	1492	2560	96.0	96.0	95.5	0.84	720	3.4	8.4	3.0	81	96	1LE5603-3BB4	2110	7.16	
500	355 L	1491	3202	96.0	96.1	95.9	0.86	870	3.0	8.1	3.3	82	96	1LE5603-3BB5	2290	8.36	
6-pole: 1000 rpm at 50 Hz																	
200	315 L	992	1925	95.8	95.9	95.6	0.82	365	3	7.5	3.2	68	83	1LE5603-3AC7	1410	6.28	
250	315 L	992	2407	95.8	95.9	95.6	0.81	465	3.2	8.2	3.3	69	84	1LE5603-3AC8	1700	8.00	
315	355 L	993	3029	95.8	95.8	95.3	0.82	580	2.9	7.8	3.2	75	90	1LE5603-3BC2	2040	11.6	
355	355 L	993	3414	95.8	95.9	95.5	0.83	640	2.9	8.4	3.3	74	89	1LE5603-3BC3	2250	13.7	
400	355 L	994	3843	95.8	96	95.8	0.84	720	2.8	8.1	3	75	90	1LE5603-3BC4	2240	13.4	
8-pole: 750 rpm at 50 Hz																	
160	315 L	741	2062	94.3	94.7	94.7	0.79	310	2.5	6.3	2.5	67	82	1LE5603-3AD7	1420	6.78	
200	315 L	742	2574	94.6	94.8	94.5	0.78	390	2.7	6.7	2.9	72	87	1LE5603-3AD8	1660	8.60	
250	355 L	744	3209	94.6	95.0	95.0	0.80	475	2.4	7.1	2.7	73	88	1LE5603-3BD1	2280	13.3	
315	355 L	744	4043	94.6	94.9	94.6	0.80	600	2.5	7.3	3.0	68	83	1LE5603-3BD2	2360	14	
Voltages ¹⁾																	
50 Hz 400 VΔ/690 VY		60 Hz ¹⁾ 460 VΔ												Version		Order code	
50 Hz 500 VΔ												Standard		3 4		-	
50 Hz 690 VΔ												Without additional charge		4 0		-	
												With additional charge		4 7		-	
														...			
For other voltages ¹⁾ and more information, see from page 4/21																	
Types of construction																	
Without flange		IM B3 ²⁾												Version		Order code	
With flange		IM B5 ²⁾												Standard		-	
												With additional charge		A F		-	
														...			
For other types of construction and more information, see from page 4/22																	
Motor protection																	
PTC thermistor with 3 temperature sensors												Version		Order code			
												Standard		B		-	
														...			
For other motor protection and more information, see from page 4/24																	
Terminal box position																	
Terminal box base left with terminal box 45°												Version		Order code			
Terminal box base right with terminal box 45°												Without additional charge		2		-	
												Standard		3		-	
														...			
For other terminal box positions and more information, see from page 4/25																	
Special versions																	
For options, see from page 4/26																	
														1LE5603- ...		-Z ...+...+...+...	

¹⁾ Parallel supply lines are required, except in the case of connection to 690 V.

²⁾ For a power rating of 315 kW, 2-pole, 60 Hz and 315 kW, 4-pole, 50 Hz, a larger terminal box can be used (order code **R50**) due to the magnitude of the current. Order code **R50** alters the motor dimensions.

SIMOTICS SD standard motors next generation

IE3 Premium Efficiency



Cast-iron series SIMOTICS SD Add 1LE5533 Basic Line – self-ventilated or forced-air cooled

Selection and ordering data

P _{rated}	Frame size	Operating values at rated power										Cast-iron series 1LE5533 Basic Line Article No.	m _{IM B3}	J			
		n _{rated}	T _{rated}	η _{rated, 4/4}	η _{rated, 3/4}	η _{rated, 2/4}	cosφ _{rated, 4/4}	I _{rated}	T _{LR} /T _{rated}	I _{LR} /I _{rated}	T _B /T _{rated}				L _{pfA}	L _{WA}	
kW	FS	rpm	Nm	%	%	%		A							kg	kgm ²	
• Cooling: Self-ventilated (IC411)																	
• Efficiency: IE3 Premium Efficiency																	
• Insulation: Thermal class 155 (temperature class F), IP55 degree of protection, utilization in accordance with thermal class 130 (temperature class B)																	
2-pole: 3000 rpm at 50 Hz																	
250	315 L	2982	801	95.8	95.9	95.6	0.91	415	2.8	7.2	3	80	94	1LE5533-3AA6	1340	2.82	
315	315 L	2980	1009	95.8	96	95.8	0.91	520	2.4	7.5	2.9	81	96	1LE5533-3AA7	1490	3.11	
560 ^{1) 2)}	400	2986	1790	96.6	96.7	96.3	0.90	930	1.6	7.0	2.8	74	90	1LE5533-4AA3	2850	8.9	
630 ^{1) 2)}	400	2986	2000	96.6	96.7	96.6	0.91	1030	1.6	7.0	2.8	74	90	1LE5533-4AA5	3000	9.8	
710 ³⁾	400	2986	2250	96.8	96.9	96.7	0.91	670	1.7	7.0	2.8	74	90	1LE5533-4AA7	3200	10.8	
800 ^{1) 2) 3) 4)}	450	2988	2550	97.0	97.0	96.6	0.88	780	1.1	7.5	3.1	75	91	1LE5533-4BA3	4000	12.3	
900 ^{1) 2) 3) 4)}	450	2986	2900	97.0	97.1	96.9	0.90	860	1.1	7.0	2.8	75	91	1LE5533-4BA5	4250	13.5	
1000 ^{1) 2) 3) 4)}	450	2984	3200	97.0	97.1	97.0	0.91	950	1.1	6.8	2.6	75	91	1LE5533-4BA7	4450	14.7	
4-pole: 1500 rpm at 50 Hz																	
250	315 L	1490	1602	96	96.2	95.9	0.87	430	2.1	7.2	2.8	75	91	1LE5533-3AB6	1400	4.55	
315	315 L	1488	2022	96	96.2	96.1	0.85	560	2.2	7.2	2.8	75	90	1LE5533-3AB7	1530	5.28	
560	400	1492	3600	96.2	96.3	95.8	0.87	970	1.8	6.5	2.7	78	94	1LE5533-4AB3	2800	12.8	
630 ^{1) 2)}	400	1492	4050	96.4	96.5	95.9	0.87	1080	1.9	6.8	2.7	78	94	1LE5533-4AB5	3000	14.4	
710 ³⁾	400	1492	4550	96.5	96.6	96.2	0.88	700	1.9	6.8	2.7	78	94	1LE5533-4AB7	3200	16.5	
800 ³⁾	450	1492	5100	96.5	96.6	96.1	0.88	790	1.6	7.0	2.6	81	97	1LE5533-4BB3	3850	22.2	
900 ³⁾	450	1492	5800	96.6	96.7	96.2	0.87	900	1.5	7.0	2.6	81	97	1LE5533-4BB5	4100	24.8	
1000 ^{1) 3)}	450	1492	6400	96.6	96.7	96.3	0.89	970	1.7	7.0	2.6	81	97	1LE5533-4BB7	4300	27.4	
Voltagess⁶⁾																	
50 Hz 400 VΔ/690 VY										60 Hz ⁶⁾ 460 VΔ		Version		Order code			
50 Hz 500 VΔ										Standard		3 4		-			
50 Hz 690 VΔ										Without additional charge		4 0		-			
										With additional charge		4 7		-			
														...			
Types of construction																	
Without flange										IM B3 ⁷⁾		Version		Order code			
With flange										IM B5 ²⁷⁾		Standard		A		-	
												With additional charge		F		-	
														...			
Motor protection																	
Without										Standard		Version		Order code			
PTC thermistor with 3 temperature sensors										With additional charge		A		-			
												B		-			
														...			
Terminal box position																	
Terminal box base left with terminal box 45°										Without additional charge		Version		Order code			
Terminal box base right with terminal box 45°										Standard		2		-			
												3		-			
														...			
Special versions																	
Forced-air cooled motors w/o ext. fan/fan cover (IC418)										1LE5533-....		-Z		F90+...+...+...			
														...			
														...			

For options and information, see from page 4/26

Selection and ordering data

P _{rated}	Frame size	Operating values at rated power										Cast-iron series 1LE5533 Basic Line Article No.	m _{IM B3}	J		
		n _{rated}	T _{rated}	η _{rated, 4/4}	η _{rated, 3/4}	η _{rated, 2/4}	cosφ _{rated, 4/4}	I _{rated}	T _{LR} /T _{rated}	I _{LR} /I _{rated}	T _B /T _{rated}				L _{pfA}	L _{WA}
kW	FS	rpm	Nm	%	%	%	A								kg	kgm ²
• Cooling: Self-ventilated (IC411)																
• Efficiency: IE3 Premium Efficiency																
• Insulation: Thermal class 155 (temperature class F), IP55 degree of protection, utilization in accordance with thermal class 130 (temperature class B)																
6-pole: 1000 rpm at 50 Hz																
200	315 L	992	1925	95.8	96	95.8	0.81	370	2.8	7	3	68	83	1LE5533-3AC7	1410	6.39
250	315 L	992	2407	95.8	95.9	95.6	0.81	465	2.9	7.2	3	68	83	1LE5533-3AC8	1640	8.10
450	400	992	4350	96.0	96.1	95.8	0.86	790	2.1	6.5	2.7	72	88	1LE5533-4AC3	2900	22.0
500	400	992	4800	96.0	96.1	95.8	0.86	870	2.2	6.5	2.7	72	88	1LE5533-4AC5	3050	24.7
560 ¹⁾	400	992	5400	96.2	96.3	96.0	0.86	980	2.2	6.5	2.7	72	88	1LE5533-4AC7	3250	27.8
630 ¹⁾	450	993	6100	96.3	96.4	96.2	0.85	1110	2.0	6.5	2.6	74	90	1LE5533-4BC3	3800	34.4
710 ³⁾	450	993	6800	96.3	96.4	96.4	0.85	730	2.0	6.5	2.5	74	90	1LE5533-4BC5	4050	38.5
800 ¹⁾³⁾	450	993	7700	96.5	96.7	96.5	0.85	820	2.0	6.5	2.5	74	90	1LE5533-4BC7	4300	43.1
8-pole: 750 rpm at 50 Hz																
160	315 L	741	2062	94.3	94.7	94.7	0.79	310	2.4	6.2	2.4	67	82	1LE5533-3AD7	1420	6.78
200	315 L	742	2574	94.6	94.8	94.5	0.78	390	2.7	6.7	2.9	72	87	1LE5533-3AD8	1660	8.60
355	400	742	4550	95.6	95.7	95.5	0.81	660	1.9	6.2	2.5	64	80	1LE5533-4AD3	2850	21.9
400	400	742	5100	95.7	95.8	95.5	0.81	740	2.0	6.5	2.6	64	80	1LE5533-4AD5	3050	24.5
450	400	742	5800	95.8	95.9	95.8	0.81	840	2.0	6.5	2.6	64	80	1LE5533-4AD7	3250	27.5
500 ⁵⁾	450	744	6400	95.9	96.0	95.7	0.80	940	1.9	6.5	2.4	67	83	1LE5533-4BD3	3800	34.0
560 ⁵⁾	450	744	7200	96.0	96.1	95.8	0.80	1050	1.9	6.5	2.4	67	83	1LE5533-4BD5	4000	38.0
630 ¹⁾⁵⁾	450	744	8100	96.1	96.2	95.9	0.81	1170	1.9	6.5	2.4	67	83	1LE5533-4BD7	4250	42.5
Voltagess⁶⁾																
50 Hz 400 VΔ/690 VY										60 Hz ⁶⁾ 460 VΔ		Version		Order code		
50 Hz 500 VΔ												Standard		3 4		
50 Hz 690 VΔ												Without additional charge		4 0		
												With additional charge		4 7		
														...		
For other voltages ⁶⁾ and more information, see from page 4/21																
Types of construction																
Without flange										IM B3 ⁷⁾		Version		Order code		
With flange										IM B5 ⁷⁾		Standard		A		
												Without additional charge		F		
												With additional charge		...		
For other types of construction and more information, see from page 4/22																
Motor protection																
Without										Standard		Version		Order code		
PTC thermistor with 3 temperature sensors										With additional charge		A		B		
														...		
For other motor protection and more information, see from page 4/24																
Terminal box position																
Terminal box base left with terminal box 45°										Without additional charge		Version		Order code		
Terminal box base right with terminal box 45°										Standard		A		3		
														...		
For other terminal box positions and more information, see from page 4/25																
Special versions																
Forced-air cooled motors w/o ext. fan/fan cover (IC418)												1LE5533-....		-Z F90+...+...+...		
												1LE5533-....		-Z ...+...+...+...		
For options and information, see from page 4/26																

1) Terminal box 1XB1631.

2) Terminal box position NDE can only be ordered using order code **H09** (2 × terminal box TB3R61). Order code **H08** not available.3) The standard version is 50 Hz 690 VΔ (voltage code **4-7**) or 60 Hz 575 VΔ (voltage code **4-0**).4) In the series version, the maximum speed is n_{max} = 3000 rpm. Operation up to 3600 rpm on request for an additional charge.

5) Utilization with sinusoidal supply in accordance with thermal class 155 (temperature class F).

6) For frame size 315, parallel supply lines are required, except in the case of connection to 690 V.

7) For frame size 315 with power rating 315 kW, 2-pole, 60 Hz and 315 kW, 4-pole, 50 Hz, a larger terminal box can be used (order code **R50**) due to the magnitude of the current. Order code **R50** alters the motor dimensions

SIMOTICS SD standard motors next generation

IE3 Premium Efficiency



Cast-iron series SIMOTICS SD Add 1LE5633 Performance Line – self-ventilated or forced-air cooled

Selection and ordering data

P _{rated}	Frame size	Operating values at rated power											Cast-iron series 1LE5633 Performance Line Article No.	m _{IM B3}	J	
		n _{rated}	T _{rated}	η _{rated, 4/4}	η _{rated, 3/4}	η _{rated, 2/4}	cos φ _{rated, 4/4}	I _{rated}	T _{LR} /T _{rated}	I _{LR} /I _{rated}	T _B /T _{rated}	L _{pfA}				L _{WA}
kW	FS	rpm	Nm	%	%	%	A								kg	kgm ²
• Cooling: Self-ventilated (IC411)																
• Efficiency: IE3 Premium Efficiency																
• Insulation: Thermal class 155 (temperature class F), IP55 degree of protection, utilization in accordance with thermal class 130 (temperature class B)																
2-pole: 3000 rpm at 50 Hz																
250	315 L	2982	801	95.8	95.9	95.6	0.91	415	2.8	7.2	3	80	94	1LE5633-3AA6	1340	2.82
315	315 L	2980	1009	95.8	96	95.8	0.91	520	2.4	7.5	2.9	81	96	1LE5633-3AA7	1490	3.11
355	355 L	2984	1136	95.8	95.7	95.2	0.9	590	2.3	8.4	3.1	83	98	1LE5633-3BA3	2170	5.07
400	355 L	2986	1279	95.8	95.8	95.3	0.91	660	2.3	7.7	3.1	83	98	1LE5633-3BA4	2240	5.46
500	355 L	2988	1598	95.8	95.7	95.1	0.89	850	2.8	8.5	3.7	83	98	1LE5633-3BA5	2340	5.76
4-pole: 1500 rpm at 50 Hz																
250	315 L	1490	1602	96	96.2	95.9	0.87	430	2.1	7.2	2.8	75	91	1LE5633-3AB6	1400	4.55
315	315 L	1488	2022	96	96.2	96.1	0.85	560	2.2	7.2	2.8	75	90	1LE5633-3AB7	1530	5.28
355	355 L	1491	2274	96	96.1	95.8	0.88	610	2.2	7.5	3.1	81	95	1LE5633-3BB3	2070	6.36
400	355 L	1491	2562	96	96.1	95.9	0.87	690	2.1	7.3	3	80	95	1LE5633-3BB4	2100	7.06
500	355 L	1491	3202	96	96.1	95.9	0.86	870	3.1	7.9	3.3	80	96	1LE5633-3BB5	2290	8.36
6-pole: 1000 rpm at 50 Hz																
200	315 L	992	1925	95.8	96	95.8	0.81	370	2.8	7	3	68	83	1LE5633-3AC7	1410	6.39
250	315 L	992	2407	95.8	95.9	95.6	0.81	465	2.9	7.2	3	68	83	1LE5633-3AC8	1640	8.10
315	355 L	992	3032	95.8	96.1	96.1	0.86	550	2.4	6.8	2.8	75	90	1LE5633-3BC2	2150	12.9
355	355 L	993	3414	95.8	95.9	95.6	0.84	640	2.6	7.4	3.2	76	91	1LE5633-3BC3	2250	13.8
400	355 L	994	3843	95.8	96	95.8	0.84	720	2.7	7.7	2.9	75	90	1LE5633-3BC4	2240	13.4
8-pole: 750 rpm at 50 Hz																
160	315 L	741	2062	94.3	94.7	94.7	0.79	310	2.4	6.2	2.4	67	82	1LE5633-3AD7	1420	6.78
200	315 L	742	2574	94.6	94.8	94.5	0.78	390	2.7	6.7	2.9	72	87	1LE5633-3AD8	1660	8.60
250	355 L	744	3200	94.6	95.0	95.0	0.80	475	2.4	7.1	2.7	68	83	1LE5633-3BD1	2280	13.3
315	355 L	744	4050	94.6	94.9	94.6	0.80	600	2.4	7.0	2.9	68	83	1LE5633-3BD2	2310	14
Voltages ¹⁾																
50 Hz 400 VΔ/690 VY		60 Hz ¹⁾ 460 VΔ												Version	Order code	
50 Hz 500 VΔ												Standard	3 4	-		
50 Hz 690 VΔ												Without additional charge	4 0	-		
												With additional charge	4 7	-		
														...		
For other voltages ¹⁾ and more information, see from page 4/21																
Types of construction																
Without flange		IM B3 ²⁾												Version	Order code	
With flange		IM B5 ²⁾												Standard	A	-
												With additional charge	F	-		
														...		
For other types of construction and more information, see from page 4/22																
Motor protection																
PTC thermistor with 3 temperature sensors												Version	Order code			
												Standard	B	-		
														...		
For other motor protection and more information, see from page 4/24																
Terminal box position																
Terminal box base left with terminal box 45°												Version	Order code			
Terminal box base right with terminal box 45°												Without additional charge	2	-		
												Standard	3	-		
														...		
For other terminal box positions and more information, see from page 4/25																
Special versions																
Forced-air cooled motors w/o ext. fan/fan cover (IC418)												Version	Order code(s)			
												1LE5633-...-Z	F90+...+...+...	-		
												1LE5633-...-Z	...+...+...+...	-		
For options and information, see from page 4/26																

¹⁾ Parallel supply lines are required, except in the case of connection to 690 V.

²⁾ For a power rating of 315 kW, 2-pole, 60 Hz and 315 kW, 4-pole, 50 Hz, a larger terminal box can be used (order code **R50**) due to the magnitude of the current. Order code **R50** alters the motor dimensions.



Cast-iron series SIMOTICS SD Pro 1LE5583 Basic Line – self-ventilated or forced-air cooled

Selection and ordering data

P _{rated} kW	Frame size FS	Operating values at rated power											Cast-iron series 1LE5583 Basic Line Article No.	m _{IM B3} kg	J kgm ²	
		n _{rated} rpm	T _{rated} Nm	η _{rated, 4/4} %	η _{rated, 3/4} %	η _{rated, 2/4} %	cos φ _{rated, 4/4}	I _{rated} A	T _{LR} /T _{rated}	I _{LR} /I _{rated}	T _β /T _{rated}	L _{pfA} dB(A)				L _{WA} dB(A)
<ul style="list-style-type: none"> • Cooling: Self-ventilated (IC411) • Efficiency: IE3 Premium Efficiency • Insulation: Thermal class 155 (temperature class F), IP55 degree of protection, utilization in accordance with thermal class 155 (temperature class F) 																
2-pole: 3000 rpm at 50 Hz																
250	315 L	2986	800	95.8	95.7	95	0.88	430	3	9.4	3.8	81	94	1LE5583-3AA6	1340	2.82
315	315 L	2988	1007	95.8	95.6	94.7	0.87	550	3.7	10	4.3	82	96	1LE5583-3AA7	1510	3.27
545 ¹⁾	400	2988	1740	96.9	96.9	96.4	0.90	900	1.6	7.3	3.1	74	90	1LE5583-4AA3	2850	8.9
610 ¹⁾	400	2988	1950	97.0	97.0	96.7	0.91	1000	1.6	7.3	3.1	74	90	1LE5583-4AA5	3000	9.8
680 ²⁾	400	2988	2150	97.0	97.1	96.8	0.91	640	1.7	7.3	3	74	90	1LE5583-4AA7	3200	10.8
775 ¹⁾²⁾³⁾	450	2990	2500	97.4	97.4	97.0	0.88	760	1.2	7.7	3.4	75	91	1LE5583-4BA3	4000	12.3
875 ¹⁾²⁾³⁾	450	2988	2800	97.4	97.5	97.3	0.90	840	1.2	7.2	3	75	91	1LE5583-4BA5	4250	13.5
970 ¹⁾²⁾³⁾	450	2986	3100	97.4	97.5	97.4	0.91	920	1.2	7.0	2.8	75	91	1LE5583-4BA7	4450	14.7
4-pole: 1500 rpm at 50 Hz																
250	315 L	1491	1601	96	96	95.6	0.84	445	3.2	8.1	3	75	90	1LE5583-3AB6	1450	4.6
315	315 L	1490	2019	96	96.1	95.8	0.82	580	3	8.4	3.1	80	95	1LE5583-3AB7	1600	5.39
545	400	1492	3500	96.4	96.4	96.0	0.87	940	1.8	6.7	2.7	78	94	1LE5583-4AB3	2800	12.8
615	400	1492	3950	96.6	96.6	96.2	0.87	1060	1.9	6.9	2.8	78	94	1LE5583-4AB5	3000	14.4
690 ²⁾	400	1492	4400	96.6	96.7	96.4	0.88	680	2.0	7.0	2.7	78	94	1LE5583-4AB7	3200	16.5
785 ²⁾	450	1492	5000	96.6	96.6	96.1	0.88	770	1.6	7.2	2.7	81	97	1LE5583-4BB3	3850	22.2
880 ²⁾	450	1492	5600	96.8	96.8	96.3	0.87	870	1.5	7.2	2.6	81	97	1LE5583-4BB5	4100	24.8
980 ²⁾	450	1492	6300	96.9	96.9	96.5	0.89	950	1.7	7.1	2.6	81	97	1LE5583-4BB7	4300	27.4
6-pole: 1000 rpm at 50 Hz																
200	315 L	993	1923	95.8	95.9	95.5	0.83	365	3.1	8.9	3.3	70	85	1LE5583-3AC7	1500	6.89
250	315 L	993	2404	95.8	95.9	95.6	0.81	465	3.4	8.8	3.3	70	84	1LE5583-3AC8	1630	8.0
435	400	993	4200	96.2	96.3	96.0	0.85	770	2.1	6.7	2.8	72	88	1LE5583-4AC3	2900	22.0
485	400	993	4650	96.2	96.4	96.1	0.86	850	2.2	6.7	2.8	72	88	1LE5583-4AC5	3050	24.7
545 ¹⁾	400	993	5200	96.3	96.5	96.2	0.86	950	2.2	6.7	2.7	72	88	1LE5583-4AC7	3250	27.8
615 ¹⁾	450	993	5900	96.5	96.7	96.4	0.84	1100	2.1	6.6	2.7	74	90	1LE5583-4BC3	3800	34.4
690 ²⁾	450	993	6600	96.6	96.8	96.6	0.85	700	2.0	6.8	2.5	74	90	1LE5583-4BC5	4050	38.5
780 ²⁾	450	993	7500	96.7	96.9	96.7	0.85	790	2.0	6.7	2.6	74	90	1LE5583-4BC7	4300	43.1
8-pole: 750 rpm at 50 Hz																
335	400	744	4300	95.8	96.0	95.6	0.80	630	2.0	6.9	2.6	64	80	1LE5583-4AD3	2850	21.9
375	400	744	4800	95.9	96.1	95.7	0.80	710	2.1	7.2	2.8	64	80	1LE5583-4AD5	3050	24.5
425	400	744	5500	96.1	96.2	95.8	0.80	800	2.1	7.2	2.7	64	80	1LE5583-4AD7	3250	27.5
485	450	745	6200	96.1	96.2	95.9	0.79	920	2.0	7.0	2.6	67	83	1LE5583-4BD3	3800	34.0
545	450	745	7000	96.2	96.4	96.0	0.79	1040	2.0	7.0	2.6	67	83	1LE5583-4BD5	4000	38.0
600 ¹⁾	450	745	7700	96.3	96.5	96.1	0.80	1120	2.1	7.3	2.6	67	83	1LE5583-4BD7	4250	42.5
Voltages⁴⁾																
50 Hz 400 VΔ/690 VY											60 Hz ⁴⁾ 460 VΔ		Version		Order code	
50 Hz 500 VΔ													Standard		3 4	
50 Hz 690 VΔ													Without additional charge		4 0	
													With additional charge		4 7	
															...	
Types of construction																
Without flange											IM B3 ⁵⁾		Version		Order code	
With flange											IM B5 ⁵⁾		Standard		A	
													With additional charge		F	
															...	
Motor protection																
Without													Version		Order code	
PTC thermistor with 3 temperature sensors													Standard		A	
													With additional charge		B	
															...	
Terminal box position																
Terminal box base left with terminal box 45°													Version		Order code	
Terminal box base right with terminal box 45°													Without additional charge		2	
													Standard		3	
															...	
Special versions																
Forced-air cooled motors w/o ext. fan/fan cover (IC418)													Version		Order code(s)	
													1LE5583-...-Z		F90+...+...	
													1LE5583-...-Z		...+...+...	

1) Terminal box 1XB1631.
 2) The standard version is 50 Hz 690 VΔ (voltage code **4-7**) or 60 Hz 575 VΔ (voltage code **4-0**).
 3) In the series version, the maximum speed is n_{max} = 3000 rpm. Operation up to 3600 rpm on request.

4) Parallel supply lines are required, except in the case of connection to 690 V.
 5) For frame size 315 with power rating 315 kW, 2-pole, 60 Hz and 315 kW, 4-pole, 50 Hz, a larger terminal box can be used (order code **R50**) due to the magnitude of the current. Order code **R50** alters the motor dimensions.

SIMOTICS SD standard motors next generation

IE3 Premium Efficiency

Cast-iron series SIMOTICS SD Pro 1LE5683 Performance Line – self-ventilated or forced-air cooled

Selection and ordering data

P _{rated}	Frame size	Operating values at rated power											Cast-iron series 1LE5683 Performance Line Article No.	m _{IM B3}	J	
		n _{rated}	T _{rated}	η _{rated, 4/4}	η _{rated, 3/4}	η _{rated, 2/4}	cosφ _{rated, 4/4}	I _{rated}	T _{LR} /T _{rated}	I _{LR} /I _{rated}	T _B /T _{rated}	L _{pfA}				L _{WA}
kW	FS	rpm	Nm	%	%	%		A							kg	kgm ²
• Cooling: Self-ventilated (IC411)																
• Efficiency: IE3 Premium Efficiency																
• Insulation: Thermal class 155 (temperature class F), IP55 degree of protection, utilization in accordance with thermal class 155 (temperature class F)																
2-pole: 3000 rpm at 50 Hz																
250	315 L	2986	800	95.8	95.7	95	0.88	430	3	9.4	3.8	81	94	1LE5683-3AA6	1340	2.82
315	315 L	2988	1007	95.8	95.6	94.7	0.87	550	3.7	10	4.3	82	96	1LE5683-3AA7	1510	3.27
355	355 L	2988	1135	95.8	95.6	94.8	0.89	600	2.5	10	3.8	83	99	1LE5683-3BA3	2070	4.74
400	355 L	2986	1279	95.8	95.7	95.2	0.92	660	2.6	8.7	3.3	83	98	1LE5683-3BA4	2220	5.36
500	355 L	2988	1598	95.8	95.8	95.3	0.89	850	2.8	9.1	3.8	81	96	1LE5683-3BA5	2330	5.76
4-pole: 1500 rpm at 50 Hz																
250	315 L	1491	1601	96	96	95.6	0.84	445	3.2	8.1	3	75	90	1LE5683-3AB6	1450	4.6
315	315 L	1490	2019	96	96.1	95.8	0.82	580	3	8.4	3.1	80	95	1LE5683-3AB7	1600	5.39
355	355 L	1492	2272	96	96	95.5	0.86	620	2.7	8.8	3.4	80	95	1LE5683-3BB3	2010	6.76
400	355 L	1490	2564	96	96.2	95.9	0.87	690	2.5	7.7	2.9	80	95	1LE5683-3BB4	2080	7.06
500	355 L	1491	3202	96	96.1	95.8	0.85	880	2.9	8.2	3.2	81	96	1LE5683-3BB5	2310	8.36
6-pole: 1000 rpm at 50 Hz																
200	315 L	993	1923	95.8	95.9	95.5	0.83	365	3.1	8.9	3.3	70	85	1LE5683-3AC7	1500	6.89
250	315 L	993	2404	95.8	95.9	95.6	0.81	465	3.4	8.8	3.3	70	84	1LE5683-3AC8	1630	8.0
315	355 L	994	3026	95.8	95.8	95.1	0.81	590	2.9	8.2	3.2	75	90	1LE5683-3BC2	2020	11.4
355	355 L	994	3410	95.8	96	95.7	0.85	630	2.5	8.2	3.1	75	90	1LE5683-3BC3	2230	13.4
400	355 L	993	3847	95.8	96	95.7	0.84	720	2.7	8	2.9	77	92	1LE5683-3BC4	2260	13.4

Voltagess¹⁾	Version	Order code
50 Hz 400 VΔ/690 VY 60 Hz ¹⁾ 460 VΔ	Standard	3 4 –
50 Hz 500 VΔ	Without additional charge	4 0 –
50 Hz 690 VΔ	With additional charge	4 7 –
For other voltagess ¹⁾ and more information, see from page 4/21		
Types of construction	Version	Order code
Without flange IM B3 ²⁾	Standard	A –
With flange IM B5 ²⁾	With additional charge	F –
For other types of construction and more information, see from page 4/22		
Motor protection	Version	Order code
PTC thermistor with 3 temperature sensors	Standard	B –
For other motor protection and more information, see from page 4/24		
Terminal box position	Version	Order code
Terminal box base left with terminal box 45°	Without additional charge	2 –
Terminal box base right with terminal box 45°	Standard	3 –
For other terminal box positions and more information, see from page 4/25		
Special versions		Order code(s)
Forced-air cooled motors w/o ext. fan/fan cover (IC418)	1LE5683-...-Z	F90+...+...+...
For options and information, see from page 4/26	1LE5683-...-Z	...+...+...+...

4

¹⁾ Parallel supply lines are required, except in the case of connection to 690 V.

²⁾ For a power rating of 315 kW, 2-pole, 60 Hz and 315 kW, 4-pole, 50 Hz, a larger terminal box can be used (order code **R50**) due to the magnitude of the current. Order code **R50** alters the motor dimensions.

SIMOTICS SD standard motors next generation

Article No. supplements and special versions · Voltages

Cast-iron series SIMOTICS SD 1LE55, 1LE56

Selection and ordering data

Voltages	Article No. supplement	Additional identification code with order code and plain text, if required	Frame size										Motor version			
			315	355	400				450				IEC	IE4		
1LE5 ■ - ■			1LE55.4 Basic Line		1LE5534										IEC	IE4
			1LE56.4 Performance Line													
			1LE55.3 Basic Line		1LE55.3										IE3	
1LE56.3 Performance Line																

Voltage at 50 Hz or 60 Hz												
50 Hz 400 VΔ/690 VY, 60 Hz 460 VΔ ¹⁾	3	4	–	□	□	□	□	O. R.	O. R.	O. R.	O. R.	□
50 Hz 500 VΔ	4	0	–	○	○	○	○	○	○	○	○	○
60 Hz 575 VΔ			–	–	–	○	○	□	□	O. R.	□	○
50 Hz 690 VΔ	4	7	–	✓	✓	○	○	□	□	□	□	○
50 Hz 380 VΔ/660 VY, 60 Hz 440 VΔ ¹⁾	3	3	–	✓	✓	O. R.	✓	O. R.	O. R.	O. R.	O. R.	✓
50 Hz 415 VΔ, 60 Hz 480 VΔ	3	5	–	✓	✓	O. R.	✓	O. R.	O. R.	O. R.	O. R.	✓
60 Hz 380 VΔ/660 VY ¹⁾	3	0	–	✓	✓	–	–	–	–	–	–	–
60 Hz 400 VΔ/690 VY ¹⁾	3	1	–	✓	✓	–	–	–	–	–	–	–
50 Hz 600 VΔ, 60 Hz 690 VΔ	4	4	–	–	–	O. R.	✓	O. R.	✓	O. R.	✓	✓
50 Hz 660 VΔ	4	6	–	–	–	✓	✓	✓	✓	✓	✓	✓
Voltage at 60 Hz and required power												
380 VΔ/660 VY; 50 Hz power	9	0	M2B	✓	✓	–	–	–	–	–	–	–
380 VΔ; 50 Hz power				✓	✓	–	–	–	–	–	–	–
440 VΔ; 50 Hz power	9	0	M2D	✓	✓	✓	✓	O. R.	O. R.	O. R.	O. R.	✓
440 VΔ; 60 Hz power	9	0	M1D	–	–	✓	✓	O. R.	O. R.	O. R.	O. R.	✓
460 VΔ; 50 Hz power	9	0	M2F	✓	✓	✓	✓	O. R.	O. R.	O. R.	O. R.	✓
460 VΔ; 60 Hz power	9	0	M1F	–	–	✓	✓	O. R.	O. R.	O. R.	O. R.	✓
575 VΔ; 50 Hz power	9	0	M2H	✓	✓	✓	✓	✓	✓	O. R.	✓	✓
575 VΔ; 60 Hz power	9	0	M1H	–	–	✓	✓	✓	✓	O. R.	✓	✓
400 VΔ/690 VY; 50 Hz power	9	0	M2J	✓	✓	O. R.	✓	O. R.	O. R.	O. R.	O. R.	✓
400 VΔ; 50 Hz power				✓	✓	–	–	–	–	–	–	–
400 VΔ/690 VY; 60 Hz power	9	0	M1J	–	–	O. R.	✓	O. R.	O. R.	O. R.	O. R.	✓
480 VΔ; 50 Hz power	9	0	M2L	✓	✓	✓	✓	O. R.	O. R.	O. R.	O. R.	✓
480 VΔ; 60 Hz power	9	0	M1L	–	–	✓	✓	O. R.	O. R.	O. R.	O. R.	✓
Non-standard voltage and/or frequencies												
Non-standard winding ^{2) 3)}	9	0	M1Y • and customer specifications	✓	✓	✓	✓	✓	✓	✓	✓	✓

- Standard version
- Without additional charge
- This order code only determines the price of the version – Additional plain text is required.
- O. R. Possible on request
- ✓ With additional charge

¹⁾ Without additional measures not possible for converter operation at 690 VY and 660 VΔ (valid for 1LE5504, 1LE5604, 1LE5534, 1LE5634, 1LE5503, 1LE5603, 1LE5533 and 1LE5633).

²⁾ Plain text must be specified in the order: Voltage between 200 and 690 V (voltages outside the range are available on request), frequency, circuit, rated power.

³⁾ 2-pole version, frame size 450 for 60 Hz operation on request.









SIMOTICS SD standard motors next generation

Article No. supplements and special versions · Types of construction

Cast-iron series SIMOTICS SD 1LE55, 1LE56

Selection and ordering data





Types of construction	Article No. supplement Type of construction code letter 14th position of the Article No.	For types of construction with order code(s) Article No. with additional identification code -Z	Frame size				Motor version	
			315	355	400	450	IEC	IE4
			1LE55.4 Basic Line		1LE5534			
			1LE56.4 Performance Line					
			1LE55.3 Basic Line		1LE55.3			IE3
			1LE56.3 Performance Line					
	1LE5 (-Z)	Order code					
Without flange								
IM B3 ^{1) 2)}		A	-	□	□	□	□	
IM B6 ²⁾		T	-	○	○	-	-	
IM B7 ²⁾		U	-	○	○	-	-	
IM B8 ²⁾		V	-	○	○	-	-	
IM V6 ²⁾		D	-	○	○	O. R. ⁷⁾	O. R. ⁷⁾	
IM V5 without protective cover ²⁾		C	-	○	○	O. R. ⁷⁾	O. R. ⁷⁾	
IM V5 with protective cover ^{2) 3) 4)}		C	H00	✓	✓	O. R. ⁷⁾	O. R. ⁷⁾	

4

SIMOTICS SD standard motors next generation

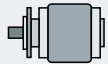
Article No. supplements and special versions · Types of construction

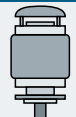
Cast-iron series SIMOTICS SD 1LE55, 1LE56

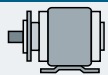
Types of construction	Article No. supplement		Frame size				Motor version	
	Type of construction code letter 14th position of the Article No.	For types of construction with order code(s) Article No. with additional identification code -Z	315	355	400	450	IEC	IE4
1LE5 ■ (-Z)		Order code	1LE55.4 Basic Line		1LE5534		IEC	IE4
			1LE56.4 Performance Line					
			1LE55.3 Basic Line		1LE55.3		IE3	
			1LE56.3 Performance Line					
With flange	EN 50347 DIN 42948		FF740 A 800	FF840 A 900	FF940 A 1000	FF1080 A 1150		
IM B5 ^{2) 5) 6)}		F	-	✓	✓	✓	✓	
IM V1 without protective cover ²⁾		G	-	✓	✓	✓ ⁷⁾	✓ ⁷⁾	
IM V1 with protective cover ^{2) 3) 4)}		G	H00	✓	✓	✓ ⁷⁾	✓ ⁷⁾	
IM V3 ⁴⁾		H	-	✓	✓	-	-	
IM B35 ³⁾		J	-	✓	✓	✓	✓	

- Standard version
- Without additional charge
- ✓ With additional charge

- 1) The types of construction IM B6/7/8, IM V6 and IM V5 with/without protective cover are also possible as long as no stamping of these types of construction on the rating plate is required. As standard the type of construction IM B3 is then stamped on the rating plate. With type of construction IM V5 with protective cover, the protective cover has to be additionally ordered with order code **H00**. The protective cover is not stamped on the rating plate.
- 2) The type of construction is stamped on the rating plate. If mounted in a different position, the position must be specified to ensure that the condensation drainage holes are positioned correctly.
- 3) In combination with an encoder, it is not necessary to order the protective cover (order code **H00**), as this is delivered as a protection for the encoder as standard. In this case the protective cover is standard design (without additional charge).
- 4) The "Standard cylindrical shaft extension (second shaft extension)" option (order code **L05**) is not possible.
- 5) The types of construction IM V3 and IM V1 with/without protective cover are also possible as long as no stamping of these types of construction on the rating plate is required. As standard the type of construction IM B5 is then stamped on the rating plate. With type of construction IM V1 with protective cover, the protective cover has to be additionally ordered with order code **H00**. The protective cover is not stamped on the rating plate.
- 6) For machines, type of construction IM B5, provide an additional support foot at the NDE. The support foot is not included in the scope of supply. Use an appropriately sized support foot with the appropriate rigidity. The support foot must be able to support the total weight of the machine.
- 7) Not possible for 2-pole 1LE55..-4BA motors.

SIMOTICS SD standard motors next generation

Article No. supplements and special versions · Motor protection

Cast-iron series SIMOTICS SD 1LE55, 1LE56

Selection and ordering data

Motor protection	Article No. supplement		Frame size				Motor version	
	Motor protection code letter 15th position of the Article No.	Additional identification code with order code and plain text, if required	315	355	400	450	IEC	IE4
			1LE55.4 Basic Line		1LE5534			
			1LE56.4 Performance Line					
			1LE55.3 Basic Line		1LE55.3			IE3
			1LE56.3 Performance Line					
	1LE5 ... - ... - ...	Order code						

Motor protection	Article No.	Additional identification code with order code and plain text, if required	315	355	400	450	Motor version
Without (standard) ¹⁾	A	-	□	□	□	□	Only for: 1LE55.4, 1LE55.3
1 or 3 PTC thermistors – for tripping (2 terminals) ^{1) 2)}	B	-	✓	✓	✓	✓	Only for: 1LE55.4, 1LE55.3
2 or 6 PTC thermistors – for alarm and tripping (4 terminals) ²⁾	C	-	✓	✓	✓	✓	Only for: 1LE56.4, 1LE56.3
1 KTY84-130 temperature sensor (2 terminals) ²⁾	F	-	✓	✓	✓	✓	
2 KTY84-130 temperature sensor (4 terminals) ²⁾	G	-	✓	✓	✓	✓	
3 Pt100 resistance thermometers – 2-wire input (6 terminals)	H	-	✓	✓	✓	✓	
6 Pt100 resistance thermometers – 2-wire input (12 terminals)	J	-	✓	✓	✓	✓	
1 Pt1000 resistance thermometer (2 terminals) ²⁾	K	-	✓	✓	✓	✓	
2 Pt1000 resistance thermometers (4 terminals) ²⁾	L	-	✓	✓	✓	✓	
1 Pt100 resistance thermometer – 2-wire input (2 terminals) ²⁾	P	-	✓	✓	✓	✓	
3 Pt100 resistance thermometers – 3-wire input (9 terminals) ²⁾	Q	-	✓	✓	✓	✓	
6 Pt100 resistance thermometers – 3-wire input (18 terminals) ²⁾	R	-	✓	✓	✓	✓	
3 bimetal sensors (NC contacts) for tripping (2 terminals) ²⁾	Z	Q3A	✓	✓	✓	✓	
6 bimetal sensors (NC contacts) for alarm and tripping (4 terminals) ²⁾	Z	Q9A	✓	✓	✓	✓	

- Standard version
- ✓ With additional charge

Note:

Options are available specifically for bearing protection – for order codes and descriptions, see from page 4/26.

¹⁾ For the Performance Line, motor protection by means of PTC thermistors with 3 built-in temperature sensors for tripping (motor protection code letter B) is already included in the basic price. For the Performance Line, the option "without motor protection" (motor protection code A) is not possible.

²⁾ Evaluation with associated tripping unit (see Catalog IC 10) is recommended.

SIMOTICS SD standard motors next generation

Article No. supplements and special versions · Terminal box position

Cast-iron series SIMOTICS SD 1LE55, 1LE56

Selection and ordering data

Terminal box position	Article No. supplement		Frame size				Motor version	
	Terminal box position code with order code and plain text, if required	Additional identification code with order code and plain text, if required	315	355	400	450	IEC	IE4
			1LE55.4 Basic Line		1LE5534			
			1LE56.4 Performance Line					
			1LE55.3 Basic Line		1LE55.3			IE3
			1LE56.3 Performance Line					
	1LE5	Order code						

Terminal box position							
Terminal box base left with terminal box at the top ⁶⁾	0	–	✓	✓	✓	✓	
Terminal box base right with terminal box at the top ⁶⁾	1	–	✓	✓	✓	✓	
Terminal box base left with oblique terminal box 45° ⁶⁾	2	–	○	○	○	○	
Terminal box base right with oblique terminal box 45° ⁶⁾	3	–	□	□	□	□	
Terminal box top ⁷⁾	4	–	□	□	□	□	
Terminal box right-hand side ¹⁾	5	–	✓	✓	✓	✓	
Terminal box left-hand side ¹⁾	6	–	✓	✓	✓	✓	
Terminal box left-hand side (base below) ^{2) 6)}	9	R5L	✓	✓	✓	✓	
Terminal box right-hand side (base below) ^{2) 6)}	9	R6R	✓	✓	✓	✓	
Terminal box bottom left ^{2) 6)}	9	R7L	✓	✓	✓	✓	
Terminal box bottom right ^{2) 6)}	9	R7R	✓	✓	✓	✓	

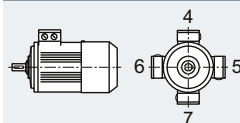

Terminal box position							
	1LE5	Order code					
Terminal box top ⁴⁾	0	–	✓	–	–	–	Only for: 11th position of Article No. 0, 2, 4, 5 (2- ... 8-pole) 6 (6- and 8-pole)
Terminal box right-hand side ⁴⁾	5	–	✓	–	–	–	Only for: 11th position of Article No. 0, 2, 4, 5 (2- ... 8-pole) 6 (6- and 8-pole)
Terminal box left-hand side	6	–	✓	–	–	–	Only for: 11th position of Article No. 0, 2, 4, 5 (2- ... 8-pole) 6 (6- and 8-pole)
Terminal box bottom ⁵⁾	9	R7R	✓	–	–	–	

- Standard version
- Without additional charge
- ✓ With additional charge

Note:

On the motors
 1LE5583-4AA3, 1LE5583-4AA5,
 1LE5583-4BA3, 1LE5583-4BA5, 1LE5583-4BA7,
 1LE5583-4AC7, 1LE5583-4BC3,
 1LE5583-4BD7,
 terminal box type 1XB1631 is mounted.

- ¹⁾ For types of construction with feet and flange-mounted with feet, cast feet are standard. Screwed-on feet are available on request.
- ²⁾ Only possible in combination with type of construction IM B5.
- ³⁾ Only possible for Frame sizes 400 and 450 in combination with IM V1 type of construction.
- ⁴⁾ For types of construction with feet and flange-mounted with feet, cast feet are standard. Screwed-on feet are available with order code **H01**.
- ⁵⁾ Not generally possible for motors with feet.
- ⁶⁾ Only for frame size 315 if 11th position of Article No. for 2-, 4-pole motors **6, 7**, for 6-, 8-pole motors **7, 8** and for shaft height 355 to 450.
- ⁷⁾ Only for frame size 315 if 11th position of Article No. for all poles **0, 2, 4, 5**; for 6-, 8-pole motors **6**.

SIMOTICS SD standard motors next generation

Article No. supplements and special versions · Options

Cast-iron series SIMOTICS SD 1LE55, 1LE56

Selection and ordering data

Special versions	Additional identification code -Z with order code and plain text if required	Frame size				Motor version	
		315	355	400	450	IEC	IE4
		1LE55.4 Basic Line		1LE55.34		IEC	IE4
		1LE56.4 Performance Line					
		1LE55.3 Basic Line		1LE55.3			IE3
		1LE56.3 Performance Line					
1LE5 - - -Z		Order code					
Motor protection							
1 or 3 PTC thermistors – for tripping (2 terminals) ¹⁾	Q11	✓	✓	✓	✓	Not for:	Combination with motor protection code letter B (15th position of the Article No.)
2 or 6 PTC thermistors – for alarm and tripping (4 terminals) ¹⁾	Q12	✓	✓	✓	✓	Not for:	Combination with motor protection code letter C (15th position of the Article No.)
1 KTY84-130 temperature sensor (2 terminals) ¹⁾	Q23	✓	✓	✓	✓	Not for:	Combination with motor protection code letter F (15th position of the Article No.)
2 KTY84-130 temperature sensors (4 terminals) ¹⁾	Q25	✓	✓	✓	✓	Not for:	Combination with motor protection code letter G (15th position of the Article No.)
3 bimetal sensors (NC contacts) for tripping (2 terminals)	Q31	✓	✓	✓	✓		
6 bimetal sensors (NC contacts) for alarm and tripping (4 terminals)	Q32	✓	✓	✓	✓		
3 bimetal sensors (NC contacts) for tripping (6 terminals)	Q33	✓	✓	✓	✓		
6 bimetal sensors (NC contacts) for alarm and tripping (12 terminals)	Q34	✓	✓	✓	✓		
1 Pt1000 resistance thermometer (2 terminals)	Q35	✓	✓	✓	✓		
2 Pt1000 resistance thermometers (4 terminals)	Q36	✓	✓	✓	✓		
3 Pt100 resistance thermometers – 2-wire input (6 terminals) ¹⁾	Q60	✓	✓	✓	✓	Not for:	Combination with motor protection code letter H (15th position of the Article No.)
6 Pt100 resistance thermometers – 2-wire input (12 terminals) ¹⁾	Q61	✓	✓	✓	✓	Not for:	Combination with motor protection code letter J (15th position of the Article No.)
1 Pt100 resistance thermometer – 2-wire input (2 terminals)	Q62	✓	✓	✓	✓		
3 Pt100 resistance thermometers – 3-wire input (9 terminals)	Q63	✓	✓	✓	✓		
6 Pt100 resistance thermometers – 3-wire input (18 terminals)	Q64	✓	✓	✓	✓		
2 Pt100 resistance thermometers in basic configuration for bearings (2 terminals)	Q72	✓	✓	✓	✓		
2 Pt100 resistance thermometers in 3-wire input for bearings (6 terminals)	Q78	✓	✓	✓	✓		
2 Pt100 double resistance thermometers in 3-wire input for bearings (12 terminals)	Q79	✓	✓	✓	✓	Not for:	Motors in combination with order codes F40 and F41
Motor connection and terminal box							
External grounding		–	–	□	□		
Terminal box at NDE	H08	✓	✓	✓	✓		
Two terminal boxes at NDE ⁴²⁾	H09	–	–	✓	✓		
Second external grounding	H70	✓	✓	✓	✓		
Subsequently rotatable main terminal box	R09	–	–	✓	✓		
Rotation of the terminal box through 90°, entry from DE ³⁵⁾	R10	✓	✓	✓	✓	Not for:	Combination with type of construction code letters F, G, H, J (14th position of the Article No.)
Rotation of the terminal box through 90°, entry from NDE	R11	✓	✓	✓	✓		
Rotation of the terminal box through 180°	R12	✓	✓	✓	✓		

For legends and footnotes, see page 4/34.

SIMOTICS SD standard motors next generation

Article No. supplements and special versions · Options

Cast-iron series SIMOTICS SD 1LE55, 1LE56

Special versions	Additional identification code -Z with order code and plain text if required	Frame size				Motor version	
		315	355	400	450	IEC	IE4
		1LE55.4 Basic Line		1LE5534		IEC	IE4
		1LE56.4 Performance Line					
		1LE55.3 Basic Line		1LE55.3			IE3
		1LE56.3 Performance Line					
1LE5 - - - Z Order code							
Motor connection and terminal box (continued)							
One EMC cable gland	R14	✓	✓	–	–	Not for:	Combination with order codes R51, R53
One metal cable gland	R15	✓	✓	–	–	Not for:	Combination with order codes R51, R53
EMC cable gland, maximum configuration	R16	✓	✓	✓	✓	Not for:	Combination with order codes R51, R53 (frame sizes 315 and 355)
Stud terminal for cable connection, accessories pack (3 items)	R17	✓	✓	–	–	Not for:	Combination with order codes R51, R53
Metal cable gland, maximum configuration	R18	✓	✓	✓	✓	Not for:	Combination with order codes R51, R53 (frame sizes 315 and 355)
Saddle terminal for connection without cable lug, accessories pack	R19	✓	✓	✓	✓	Not for:	Combination with order codes R51, R53 (frame sizes 315 and 355)
3 cables protruding, 1.5 m long	R21	O. R.	O. R.	O. R.	O. R.	Not for:	Combination with order codes R17, R19, R50 (frame sizes 315 and 355)
6 cables protruding, 1.5 m long	R23	O. R.	O. R.	O. R.	O. R.	Not for:	Combination with order codes R17, R19, R50 (frame sizes 315 and 355)
6 cables protruding, 3 m long	R24	O. R.	O. R.	O. R.	O. R.	Not for:	Combination with order codes R17, R19, R50 (frame sizes 315 and 355)
Larger terminal box ³⁶⁾	R50	✓	–	✓	✓	Not for:	Combination with order codes R21, R23, R24 (frame sizes 315 and 355)
Terminal box without cable entry opening	R51	○	○	–	–	Not for:	Combination with order code R14, R15, R16, R18
Drilled removable entry plate	R52	✓	✓	□	□		
Undrilled removable entry plate	R53	✓	✓	○	○	Not for:	Combination with order codes R14, R15, R16, R18 (frame sizes 315 and 355)
Cast-iron auxiliary terminal box (small)	R62	✓	✓	✓	✓		
Cast-iron auxiliary terminal box (large)	R63	✓	✓	✓	✓		
Stainless steel auxiliary terminal box (large)	R65	–	–	✓	✓		
Non-standard threaded through hole (NPT or G thread) ^{2) 28)}	Y61 • and customer specifications	✓	✓	✓	✓		
Windings and insulation							
Temperature class 155 (F), utilized acc. to 155 (F), with service factor ³⁷⁾	N01	✓	✓	□	□	Not for:	1LE5583, 1LE5683 (frame sizes 315 and 355)
Temperature class 155 (F), utilized acc. to 155 (F), with increased power ³⁷⁾	N02	✓	✓	✓	✓	Not for:	1LE5583, 1LE5683 (frame sizes 315 and 355)
Temperature class 155 (F), utilized acc. to 155 (F), with increased coolant temperature ³⁷⁾	N03	✓	✓	✓	✓	Not for:	1LE5583, 1LE5683 (frame sizes 315 and 355)
Temperature class 155 (F), used acc. to 130 (B), coolant temperature 45 °C, derating approx. 4 % ^{37) 40)}	N05	✓	✓	✓	✓		
Temperature class 155 (F), used acc. to 130 (B), coolant temperature 50 °C, derating approx. 8 % ^{37) 40)}	N06	✓	✓	✓	✓		
Temperature class 155 (F), used acc. to 130 (B), coolant temperature 55 °C, derating approx. 13 % ^{37) 40)}	N07	✓	✓	✓	✓		
Temperature class 155 (F), used acc. to 130 (B), coolant temperature 60 °C, derating approx. 18 % ^{37) 40)}	N08	✓	✓	✓	✓		
Temperature class 180 (H) ³⁸⁾	N10	✓	✓	✓	✓		
Temperature class 180 (H) at rated power and max. CT 60 °C ⁴⁾	N11	✓	✓	O. R.	O. R.		
Increased air humidity/temperature with 30 to 60 g water per m ³ of air	N30	✓	✓	✓	✓		

For legends and footnotes, see page 4/34.

SIMOTICS SD standard motors next generation

Article No. supplements and special versions · Options

Cast-iron series SIMOTICS SD 1LE55, 1LE56

Special versions	Additional identification code -Z with order code and plain text if required	Frame size				Motor version	
		315	355	400	450	IEC	IE4
		1LE55.4 Basic Line		1LE55.34		IEC	IE4
		1LE56.4 Performance Line					
		1LE55.3 Basic Line		1LE55.3			IE3
		1LE56.3 Performance Line					
1LE5 -Z Order code							
Windings and insulation (continued)							
Increased air humidity/temperature with 60 to 100 g water per m ³ of air	N31		✓	✓	✓	✓	
Temperature class 155 (F), utilized acc. to 130 (B), with higher coolant temperature and/or installation altitude	Y50 • CT .. °C or IA m above sea level		✓	✓	✓	✓	Not for: 1LE5583, 1LE5683 (frame sizes 315 and 355)
Temperature class 155 (F), utilized acc. to 155 (F), other requirements ⁴⁾	Y52 • CT .. °C or IA m above sea level		✓	✓	✓	✓	
Temperature class 180 (H), utilized acc. to 155 (F)	Y75 • CT .. °C or IA m above sea level		✓	✓	O. R.	O. R.	
Colors and paint finish							
Standard paint finish C2 in RAL 7030 stone gray			□	□	□	□	Only for: Frame sizes 315 and 355 – Basic Line
Unpainted (only cast-iron parts primed)	S00		○	○	○	○	
Unpainted, only primed	S01		✓	✓	✓	✓	
Special paint finish C3			□	□	✓	✓	Only for: Frame sizes 315 and 355 – Performance Line
	S02		✓	–			Only for: Frame sizes 315 and 355 – Basic Line
Special paint finish sea air resistant C4 ³⁹⁾	S03		✓	✓	✓	✓	
Special paint finish for use offshore C5 ³⁹⁾	S04		✓	✓	✓	✓	
Internal coating	S05		✓	✓	✓	✓	
Top coat polyurethane ²⁵⁾	S06		✓	✓	□	□	
Special paint finish C5mid with medium durability	S08		✓	✓	–	–	
Special paint finish CX for offshore with high durability	S09		✓	✓	–	–	
Paint finish in other standard RAL colors: RAL 1015, 3000, 5002, 5009, 5010, 5012, 5015, 6011, 7001, 7011, 7016, 7031, 7032, 7035, 7037, 8012, 9005, 9010 (see Catalog Section 1 "Introduction")	Y53 • and paint finish RAL....		✓	✓	✓	✓	
Paint finish in special RAL colors: For RAL colors, see "Special paint finish in special RAL colors" (see Catalog Section 1 "Introduction")	Y56 • and paint finish RAL....		✓	✓	✓	✓	
Non-standard colors Colors see "Paint finish in non-standard colors" (see Catalog Section 1 "Introduction")	Y66 • and paint finish		✓	✓	✓	✓	
Modular technology – Basic versions ⁵⁾							
Mounting of holding brake (standard assignment) ^{5) 6) 23) 24) 28)}	F01		✓	✓	✓	✓	Only for: 4-pole motors for frame sizes 315 and 355
			–	–			Only for: Combination with order codes D02, F40, F41, L05, L30, L52
Mounting of separately driven fan ³¹⁾	F70		✓	✓	✓	✓	Not for: Combination with order codes L05, Y59 (frame sizes 315 and 355)
Mounting of Kübler Sendix 5020 HTL, 1024 I rotary pulse encoder ⁵⁾	G11		✓	✓	–	–	Not for: Combination with order codes D02, L05
Mounting of Kübler Sendix 5020 TTL, 1024 I rotary pulse encoder ⁵⁾	G12		✓	O. R.	–	–	
Modular technology – Additional versions							
Brake supply voltage 24 V DC	F10		✓	✓	–	–	Only for: 4-pole motors for frame sizes 315 and 355
			–	–			Only for: Combination with order codes D02, F40, F41, L05, L30, L52

For legends and footnotes, see page 4/34.

SIMOTICS SD standard motors next generation

Article No. supplements and special versions · Options

Cast-iron series SIMOTICS SD 1LE55, 1LE56

Special versions	Additional identification code -Z with order code and plain text if required	Frame size				Motor version	
		315	355	400	450	IEC	IE4
		1LE55.4 Basic Line		1LE5534		IEC	IE4
		1LE56.4 Performance Line					
		1LE55.3 Basic Line		1LE55.3		IE3	
		1LE56.3 Performance Line					
1LE5 -Z Order code							
Modular technology – Additional versions (continued)							
Brake supply voltage 230 V AC, 50/60 Hz	F11	○	○	–	–	Only for: 4-pole motors for frame sizes 315 and 355	Only for: Combination with order codes D02, F40, F41, L05, L30, L52
		–	–	○	○		
Brake supply voltage 400 V AC, 50/60 Hz	F12	✓	✓	✓	✓	Only for: 4-pole motors for frame sizes 315 and 355	Only for: Combination with order codes D02, F40, F41, L05, L30, L52
		–	–				
Backstop, counterclockwise motion blocked, clockwise direction of rotation	F40	✓	✓	–	–	Not for: Combination with order codes F01, F10, F11, F12	
Backstop, clockwise motion blocked, counterclockwise direction of rotation	F41	✓	✓	–	–		
Special technology ⁵⁾							
Mounting of LL 861 900 220 rotary pulse encoder ^{5) 9)}	G04	✓	✓	✓	✓	Not for: Combination with order codes D02, L05 (frame sizes 315 and 355)	
Mounting of HOG 9 DN 1024 I rotary pulse encoder ^{5) 9)}	G05	✓	✓	✓	✓		
Mounting of HOG 10 D 1024 I rotary pulse encoder ^{5) 9)}	G06	✓	✓	✓	✓		
Mounting of POG 10 DN rotary pulse encoder (only in combination with separately driven fan or brake) ^{5) 10)}	G07	✓	✓	–	–	Not for: Combination with order codes D02, L05	
Mounting of POG 9 rotary pulse encoder (only in combination with separately driven fan or brake) ^{5) 10)}	G08	✓	✓	–	–		
Mounting of HOG 10 DN 1024 I rotary pulse encoder, terminal box moisture protection ⁵⁾	G15	✓	✓	✓	✓	Not for: Combination with order codes D02, L05 (frame sizes 315 and 355)	Not for: Combination with order codes D02, L04, L05 (frame sizes 315 and 355)
Mounting of HOG 10 DN 1024 I rotary pulse encoder, terminal box dust protection ⁵⁾	G16	✓	✓	✓	✓		
Anbau Drehimpulsgeber Kübler Sendix 5834FS2 1024, SIL-2	G21	✓	✓	–	–		
Anbau Drehimpulsgeber Kübler Sendix 5834FS3 1024, SIL-3	G22	✓	✓	–	–		
Anbau Drehimpulsgeber HOGS100S-B76.626.01024.1	G25	✓	✓	✓	✓		
Anbau Drehimpulsgeber LL FSI 862-184560-1024, SIL-2	G27	✓	✓	✓	✓		
Anbau Drehimpulsgeber XSI 850 Over-speed	G93	✓	✓	✓	✓		
Anbau Drehimpulsgeber XHI 861 Over-speed	G94	✓	✓	✓	✓		
Mounting of a special type of rotary pulse encoder	Y70 • and customer specifications	–	–	O. R.	O. R.	Not for: Combination with order codes D02, L05 (frame sizes 315 and 355)	
Mounting of rotary pulse encoder HOG 10 DN 1024 I + FSL, (integrated centrifugal switch, speed rpm) ⁵⁾ terminal box moisture protection ⁵⁾	Y74 • and spec. speed rpm	✓	✓	✓	✓		
Mounting of rotary pulse encoder HOG 10 DN 1024 I + FSL, (integrated centrifugal switch, speed rpm), terminal box dust protection ⁵⁾	Y76 • and spec. speed rpm	✓	✓	✓	✓	Not for: Combination with order codes D02, L05 (frame sizes 315 and 355)	
Mounting of rotary pulse encoder HOG 10 DN 1024 I + ESL 93, (integrated electronic speed switch, speed rpm), terminal box dust protection ⁵⁾	Y79 • and spec. speed (max 3) rpm	✓	✓	✓	✓		

For legends and footnotes, see page 4/34.

SIMOTICS SD standard motors next generation

Article No. supplements and special versions · Options

Cast-iron series SIMOTICS SD 1LE55, 1LE56

Special versions	Additional identification code -Z with order code and plain text if required	Frame size				Motor version	
		315	355	400	450	IEC	IE4
		1LE55.4 Basic Line		1LE55.34		IEC	IE4
		1LE56.4 Performance Line					
		1LE55.3 Basic Line		1LE55.3		IE3	
		1LE56.3 Performance Line					
1LE5 -Z Order code							
Mechanical version and degrees of protection							
Low-noise version for 2-pole motors with clockwise direction of rotation	F77	✓	✓	□	□	Only for:	2-pole motors for frame sizes 315 and 355
		–	–			Not for:	Combination with order codes L05, F90
Low-noise version for 2-pole motors with counterclockwise direction of rotation	F78	✓	✓	○	○	Only for:	2-pole motors for frame sizes 315 and 355
		–	–			Not for:	Combination with order codes L05, F90
Prepared for mounted components, centering hole only	G40	–	–	□	□		
Prepared for mountings with D12 shaft	G41	✓	✓	–	–	Not for:	Combination with order codes D02, L05
Prepared for mountings with D16 shaft	G42	✓	✓	✓	✓	Not for:	Combination with order code L05 (frame sizes 315 and 355)
Mechanical protection for encoder ^{7) 9)}	G43	✓	✓	✓	✓	Not for:	Combination with order code L05 (frame sizes 315 and 355)
Protective cover ^{7) 9) 11)}	H00	✓	✓	✓	✓		
Vibration-proof version; vibration resistance to Class 3M4 acc. to IEC 60721-3-3:1994	H02	✓	✓	–	–		
Condensation drainage holes		□	□	□	□		
Rust-resistant screws (externally)	H07	✓	✓	✓	✓		
Degree of protection IP66	H19	✓	✓	–	–		
Degree of protection IP65 ¹³⁾	H20	✓	✓	✓	✓		
Degree of protection IP54 ³³⁾	H21	✓	✓	–	–		
Degree of protection IP56 ¹⁴⁾	H22	✓	✓	✓	✓		
Drive-end seal for flange-mounting motors, oil-tight to 0.1 bar ^{12) 22)}	H23	✓	✓	–	–	Not for:	Combination with type of construction code letters T, U, V (14th position of the Article No.)
Sealing ring made of fluoroelastomer (FKM)	H25	✓	✓	✓	✓	Not for:	Combination with order codes D02, D03, D04 (frame sizes 315 and 355)
Increased corrosion protection for external components ²⁸⁾	H90	–	–	✓	✓		
Grounding brush for converter operation ^{29) 44)}	L52	✓	✓	✓	✓	Not for:	Combination with order codes F01, F10, F11, F12 (frame sizes 315 and 355)
Coolant temperature and installation altitude							
Coolant temperature –50 to +40 °C ^{15) 32)}	D02	✓	✓	✓	✓	Not for:	Combination with order codes F01, F10, F11, F12, G04, G05, G06, G07, G11, G12, G15, G16; H25, Y74, Y76, Y79 (frame sizes 315 and 355)
Coolant temperature –40 to +40 °C ¹⁵⁾	D03	✓	✓	✓	✓	Not for:	Combination with order code H25 (frame sizes 315 and 355)
Coolant temperature –30 to +40 °C ¹⁵⁾	D04	✓	✓	✓	✓		
Versions in accordance with standards and specifications							
VIK version ⁴⁴⁾	C02	–	–	O. R.	O. R.	In combination with order codes F01, F10, F11, F12, G01, G02, G11 or G12 on request	
Chemstar version chemical industry	C03	✓	✓	–	–		
Chemstar version Oil & Gas industry	C04	✓	✓	–	–		
Motor without CE marking for export outside EEA (see EU Regulation 640/2009)	D22	○	○	–	–		
Motor exclusively for use in transportation equipment for passenger and freight transportation corresponding to EVPG §1 dated February 27, 2008	D23	○	○	–	–		
Electrical acc. to NEMA MG1-12 ¹⁷⁾	D30	✓	✓	□	□	Only for:	1LE5504, 1LE5604, 1LE5503, 1LE5603 for frame sizes 315 and 355
Design acc. to UL with "Recognition Mark" ¹⁷⁾	D31	✓	✓	□	□		
China Energy Efficiency Label	D34	○	○	–	–		

For legends and footnotes, see page 4/34.

SIMOTICS SD standard motors next generation

Article No. supplements and special versions · Options

Cast-iron series SIMOTICS SD 1LE55, 1LE56

Special versions	Additional identification code -Z with order code and plain text if required	Frame size				Motor version	
		315	355	400	450	IEC	IE4
		1LE55.4 Basic Line		1LE55.34			
		1LE56.4 Performance Line					
		1LE55.3 Basic Line		1LE55.3			IE3
1LE56.3 Performance Line							
1LE5 . . . - - -Z Order code							
Versions in accordance with standards and specifications (continued)							
Canadian regulations (CSA) ¹⁶⁾	D40	✓	✓	□	□	Only for: 1LE5504, 1LE5604, 1LE5503, 1LE5603 for frame sizes 315 and 355	
TR CU product safety certificate EAC for Eurasian Customs Union	D47	✓	✓	✓	✓		
MEPS Australia	D70	✓	–	–	–	Only for: 1LE5533, 1LE5633, 1LE5583, 1LE5683	
Bearings and lubrication							
Regreasing device with M10 × 1 grease nipple acc. to DIN 71412-A	L19	○	○	○	○		
Located bearing DE	L20	✓	✓	□	□		
Located bearing NDE ³⁴⁾	L21	–	–	✓	✓		
Bearing design for increased cantilever forces ^{26) 27)}	L22	✓	✓	O. R.	O. R.		
Regreasing device		–	–	□	□		
Hot bearing grease	L24	O. R.	O. R.	–	–		
Drainage for used grease		□	□	O. R.	O. R.	Only for: Frame sizes 315 and 355 – Performance Line	
	L30	✓	–			Only for: Frame sizes 315 and 355 – Basic Line	
Special version with higher speeds	L37	O. R.	O. R.	O. R.	O. R.		
Bearing insulation DE ⁴⁴⁾	L50	✓	✓	✓	✓		
Bearing insulation NDE ^{29) 44)}	L51	✓	✓	✓	✓		
Measuring nipple for SPM shock pulse measurement for bearing inspection	Q01	✓	✓	✓	✓		
Balance and vibration severity							
Vibration severity grade A		□	□	□	□		
Vibration severity grade B ¹⁸⁾	L00	✓	✓	✓	✓	Only for: 4-pole motors for frame sizes 315 and 355	
Half-key balancing (standard)		□	□	□	□		
Balancing without feather key ⁴¹⁾	L01	✓	✓	✓	✓	Not for: Combination with order code L04 (frame sizes 315 and 355)	
Full-key balancing ⁴¹⁾	L02	✓	✓	✓	✓		
Shaft and rotor							
Shaft extension with standard dimensions, without feather keyway	L04	✓	✓	✓	✓	Not for: Combination with order codes L01, L02 (frame sizes 315 and 355)	
Standard, cylindrical shaft extension (second shaft extension) NDE acc. to EN 50347	L05	✓	✓	✓	✓	Not for: Combination with order codes F01, F10, F11, F12, F70, F77, F78, G04, G05, G06, G07, G15, G16, G41, G42, G43, H00, Y74, Y76, Y79 (frame sizes 315 and 355)	
Standard shaft made of stainless steel (e.g. 1.4021)	L06	✓	✓	–	–		
Shaft extension run-out in accordance with IEC 60072-1 precision class	L07	✓	✓	✓	✓		
Shaft extension run-out, concentricity and perpendicularity in accordance with IEC 60072-1 precision class for flange-mounted motors	L08	✓	✓	✓	✓	Not for: Combination with type of construction code letters A, T, U, V (14th position of the Article No.) for frame sizes 315 and 355	
Non-standard cylindrical shaft extension, DE ¹⁹⁾	Y58 • and customer specifications	✓	✓	✓	✓		
Non-standard cylindrical shaft extension, NDE ¹⁹⁾	Y59 • and customer specifications	✓	✓	✓	✓	Not for: Combination with order code F70 (frame sizes 315 and 355)	
Special shaft steel	Y60 • and customer specifications	O. R.	O. R.	O. R.	O. R.		

For legends and footnotes, see page 4/34.

SIMOTICS SD standard motors next generation

Article No. supplements and special versions · Options

Cast-iron series SIMOTICS SD 1LE55, 1LE56

Special versions	Additional identification code -Z with order code and plain text if required	Frame size				Motor version	
		315	355	400	450	IEC	IE4
		1LE55.4 Basic Line		1LE55.34		IEC	IE4
		1LE56.4 Performance Line					
		1LE55.3 Basic Line		1LE55.3			IE3
		1LE56.3 Performance Line					
1LE5 . . . - -Z Order code							
Heating and ventilation							
Sheet metal fan cover	F74	<input type="checkbox"/>	<input type="checkbox"/>	<input type="checkbox"/>	<input type="checkbox"/>	Only for: Frame sizes 315 and 355 – Performance Line	
		<input checked="" type="checkbox"/>	<input type="checkbox"/>			Only for: Frame sizes 315 and 355 – Basic Line	
Metal external fan	F76	<input type="checkbox"/>	<input type="checkbox"/>	<input checked="" type="checkbox"/>	<input checked="" type="checkbox"/>		
Without external fan and without fan cover	F90	<input checked="" type="checkbox"/>	<input checked="" type="checkbox"/>	<input checked="" type="checkbox"/>	<input checked="" type="checkbox"/>	Not for: Combination with order codes F74, F77, F78 (frame sizes 315 and 355)	
Anti-condensation heating for 230 V (2 terminals)	Q02	<input checked="" type="checkbox"/>	<input checked="" type="checkbox"/>	<input checked="" type="checkbox"/>	<input checked="" type="checkbox"/>	Not for: Combination with order codes Q03, Q06	
Anti-condensation heating for 115 V (2 terminals)	Q03	<input checked="" type="checkbox"/>	<input checked="" type="checkbox"/>	<input checked="" type="checkbox"/>	<input checked="" type="checkbox"/>	Not for: Combination with order codes Q02, Q06	
Anti-condensation heating for 400 V (2 terminals)	Q06	<input checked="" type="checkbox"/>	<input checked="" type="checkbox"/>	<input checked="" type="checkbox"/>	<input checked="" type="checkbox"/>	Not for: Combination with order codes Q02, Q03	
Separately driven fan with non-standard voltage and/or frequency	Y81 • and customer specifications	<input checked="" type="checkbox"/>	<input checked="" type="checkbox"/>	<input checked="" type="checkbox"/>	<input checked="" type="checkbox"/>		
Rating plate and additional rating plates							
Additional rating plate for voltage tolerance	B07	<input checked="" type="checkbox"/>	<input checked="" type="checkbox"/>	<input checked="" type="checkbox"/>	<input checked="" type="checkbox"/>		
Second rating plate, loose	M10	<input checked="" type="checkbox"/>	<input checked="" type="checkbox"/>	<input checked="" type="checkbox"/>	<input checked="" type="checkbox"/>		
Rating plate, stainless steel	M11	<input checked="" type="checkbox"/>	<input type="checkbox"/>	<input type="checkbox"/>	<input type="checkbox"/>	Only for: Basic Line	
		<input type="checkbox"/>	<input type="checkbox"/>			Only for: Frame sizes 315 and 355 – Performance Line	
Additional rating plate with deviating rating plate data ⁴³⁾	Y80 • and customer specifications	<input checked="" type="checkbox"/>	<input checked="" type="checkbox"/>	<input checked="" type="checkbox"/>	<input checked="" type="checkbox"/>		
Additional rating plate with customer specifications	Y82 • and customer specifications	<input checked="" type="checkbox"/>	<input checked="" type="checkbox"/>	<input checked="" type="checkbox"/>	<input checked="" type="checkbox"/>		
Additional information on rating plate and on package label (max. 20 characters)	Y84 • and customer specifications	<input checked="" type="checkbox"/>	<input checked="" type="checkbox"/>	<input checked="" type="checkbox"/>	<input checked="" type="checkbox"/>		
Adhesive label, supplied loose (printed with: Article No., Serial No.: 2 lines of text)	Y85 • and customer specifications	<input checked="" type="checkbox"/>	<input checked="" type="checkbox"/>	<input type="checkbox"/>	<input type="checkbox"/>		
Extension of the liability for defects							
Extension of the liability for defects by 12 months to a total of 24 months (2 years) from delivery ²⁰⁾	Q80	<input checked="" type="checkbox"/>	<input checked="" type="checkbox"/>	<input checked="" type="checkbox"/>	<input checked="" type="checkbox"/>		
Extension of the liability for defects by 18 months to a total of 30 months (2.5 years) from delivery ²⁰⁾	Q81	<input checked="" type="checkbox"/>	<input checked="" type="checkbox"/>	<input checked="" type="checkbox"/>	<input checked="" type="checkbox"/>		
Extension of the liability for defects by 24 months to a total of 36 months (3 years) from delivery ²⁰⁾	Q82	<input checked="" type="checkbox"/>	<input type="checkbox"/>	<input checked="" type="checkbox"/>	<input checked="" type="checkbox"/>		
Extension of the liability for defects by 30 months to a total of 42 months (3.5 years) from delivery ²⁰⁾	Q83	<input checked="" type="checkbox"/>	<input checked="" type="checkbox"/>	<input checked="" type="checkbox"/>	<input checked="" type="checkbox"/>		
Extension of the liability for defects by 36 months to a total of 48 months (4 years) from delivery ²⁰⁾	Q84	<input checked="" type="checkbox"/>	<input checked="" type="checkbox"/>	<input checked="" type="checkbox"/>	<input checked="" type="checkbox"/>		
Extension of the liability for defects by 48 months to a total of 60 months (5 years) from delivery ²⁰⁾	Q85	<input checked="" type="checkbox"/>	<input checked="" type="checkbox"/>	<input checked="" type="checkbox"/>	<input checked="" type="checkbox"/>		
Packaging, safety notes, documentation and test certificates							
Inspection certificate 3.1 acc. to EN 10204 ²⁰⁾	B02	<input checked="" type="checkbox"/>	<input checked="" type="checkbox"/>	<input checked="" type="checkbox"/>	<input checked="" type="checkbox"/>		
Printed German/English Operating Instructions enclosed ²¹⁾	B04	<input checked="" type="checkbox"/>	<input checked="" type="checkbox"/>	<input checked="" type="checkbox"/>	<input checked="" type="checkbox"/>		
Without "Made in manufacturing country" marking	B13	<input type="checkbox"/>	<input type="checkbox"/>	<input type="checkbox"/>	<input type="checkbox"/>		
Starting curves (torque-speed and current-speed)	B50	<input checked="" type="checkbox"/>	<input checked="" type="checkbox"/>	<input checked="" type="checkbox"/>	<input checked="" type="checkbox"/>		
Equivalent circuit diagram	B51	<input checked="" type="checkbox"/>	<input checked="" type="checkbox"/>	<input checked="" type="checkbox"/>	<input checked="" type="checkbox"/>		
Starting diagram (torque vs. speed and current vs. speed)	B52	<input checked="" type="checkbox"/>	<input checked="" type="checkbox"/>	<input checked="" type="checkbox"/>	<input checked="" type="checkbox"/>		

For legends and footnotes, see page 4/34.

SIMOTICS SD standard motors next generation

Article No. supplements and special versions · Options

Cast-iron series SIMOTICS SD 1LE55, 1LE56

Special versions	Additional identification code -Z with order code and plain text if required	Frame size				Motor version	
		315	355	400	450	IEC	IE4
		1LE55.4 Basic Line		1LE5534		IEC	IE4
		1LE56.4 Performance Line					
		1LE55.3 Basic Line		1LE55.3			IE3
		1LE56.3 Performance Line					
1LE5 . . . - -Z Order code							

Packaging, safety notes, documentation and test certificates (continued)						
Document - Electrical datasheet	B60	✓	✓	✓	✓	
Document - Order dimensional drawing	B61	✓	✓	✓	✓	
Standard test (routine test) with acceptance	B65	✓	✓	✓	✓	
Temperature test without acceptance	B67	✓	✓	✓	✓	
Temperature test with acceptance	B68	✓	✓	✓	✓	
Type test with heat run for horizontal motors, without acceptance	B82	✓	✓	✓	✓	
Type test with heat run for horizontal motors, with acceptance	B83	✓	✓	✓	✓	
"Basic" documentation package	B90	✓	✓	✓	✓	
"Advanced" documentation package	B91	✓	✓	✓	✓	
"Projects" documentation package	B92	✓	✓	✓	✓	
Connected in star for dispatch	M01	✓	✓	✓	O.R.	
Connected in delta for dispatch	M02	✓	✓	✓	O.R.	

SIMOTICS SD standard motors next generation

Article No. supplements and special versions · Options

Cast-iron series SIMOTICS SD 1LE55, 1LE56

- Standard version
- Without additional charge
- This order code only determines the price of the version – Additional plain text is required.
- ✓ With additional charge
- O. R. Possible on request
- Not possible

- 1) Evaluation with associated tripping unit (see Catalog IC 10) is recommended.
- 2) Parallel Whitworth threaded pipe DIN ISO 228 (DIN 259) BSPP (British Standard Pipe Parallel), threaded pipe for connections not sealed in the thread (cylindrical), external = G.
- 3) The grease lifetime specified in Catalog Section 1 "Introduction" refers to CT 40 °C. If the coolant temperature is increased by 10 K, the grease lifetime and regreasing interval are halved.
- 4) Not possible for 1LE5 motors with increased power.
- 5) A second shaft extension is not possible. Please inquire for mounted brakes.
- 6) For order codes **F10**, **F11**, and **F12**, the brake supply voltage must be specified or ordered.
- 7) The 1XP8 rotary pulse encoders are fitted with a protective cover as standard. The protective cover is omitted at the factory when a rotary pulse encoder is combined with a separately driven fan, because in this case the rotary pulse encoder is installed under the fan cover.
- 8) In combination with a separately driven fan (order code **F70**) the 1XP8032-10 rotary pulse encoder is used instead of 1XP8012-10 or 1XP8032-20 is used instead of 1XP8012-20.
- 9) For frame sizes 315 and 355, LL and HOG rotary pulse encoders are fitted with a protective cover as standard. The protective cover is omitted at the factory when a rotary pulse encoder is combined with a separately driven fan, because in this case the rotary pulse encoder is installed under the fan cover. Protective cover (order code **G43**) possible.
- 10) Option (encoder mounting) is only possible for motors with a mounted separately driven fan or for naturally cooled motors (without an external fan). This option can be used in combination with brakes of type KFB and SFB. This option cannot be used in combination with brakes of type BFK458!
- 11) Order code **H00** provides mechanical protection for encoders.
- 12) Not possible for type of construction IM V3.
- 13) Not possible in combination with HOG 9 D 1024l rotary pulse encoder (order code **G05**) and/or BFK458 brake (order code **F01**).
- 14) Not possible in combination with brake BFK458 (order code **F01**).
- 15) In connection with mountings, the respective technical specifications must be observed, please inquire before ordering.
- 16) The rated voltage is indicated on the rating plate without voltage range.
- 17) Possible up to 600 V max. The rated voltage is indicated on the rating plate without voltage range. Order codes D30 does not authorize importing into USA and Mexico.
- 18) On request for 2-pole motors
- 19) When motors are ordered that have a longer or shorter shaft extension than normal, the required position and length of the feather keyway must be specified in a sketch. It must be ensured that only feather keys in accordance with EN 50347 are used. The feather keyway is positioned centrally on the shaft extension. The length is defined by the manufacturer in accordance with the appropriate standard. Not valid for: Conical shafts, non-standard threaded journals, non-standard shaft tolerances, friction welded journals, extremely "thin" shafts, special geometry dimensions (e.g. square journals), hollow shafts. Valid for non-standard shaft extensions DE or NDE. The feather keys are supplied in every case. For order codes **Y58**, **Y59** and **L05** the following applies:
 - Dimensions D and DA ≤ ball bearing inner diameter (see dimension tables for "Dimensions")
 - Dimensions E and EA ≤ 2 × length E (standard) of the shaft extension.
- 20) The delivery time for the manufacturer's test certificate may differ from the delivery time for the motor.
- 21) The Operating Instructions (Compact) are available in PDF format for all official EU languages at <http://support.automation.siemens.com/WWW/view/en/10803948/133300>
- 22) Not possible in combination with order codes **Q72** and **Q78**.
- 23) Not possible in combination with order codes **N05**, **N06**, **N07**, **N08** and **N11**.
- 24) When order codes **F01** and **F12** are combined, the rectifier for the brake will be supplied separately as a single part.
- 25) Order code **S06** cannot be combined with order code **S00** and **S01**. It can be combined with **Y53** on request.
- 26) A minimum cantilever force F_{min} of $0.5 \cdot F_{max}$ is required for NU bearings (cylindrical roller bearings) in contrast to ball bearings. Cylindrical roller bearings are not suitable for coupling output or for brief periods of no-load operation without cantilever force.
- 27) Supplied with the condensation drainage holes sealed at the drive end DE and non-drive end NDE (IP55, IP56, IP65). If the condensation drainage holes are required for motors of the IM B6, IM B7 or IM B8 type of construction (feet on side or top), the motors must be ordered in the respective type of construction and with order code **H03**, so that the condensation drainage holes will be placed in the correct position.
- 28) For frame sizes 400 and 450, permissible cantilever forces for motors with reinforced bearings are available on request. Please specify cantilever force and lever arm.
- 29) For insulated bearings at the DE, and non-insulated bearings at the NDE, the motor coupling must be insulated.
- 30) For insulated bearings at the DE and NDE, a grounding brush (**L52**) is essential if no grounding is provided in the drive train. Otherwise, it should be omitted.
- 31) Only possible for line operation.
- 32) The separately driven fan motor is implemented with voltage code **34** (400 V/50 Hz; 460 V/60 Hz).
- 33) For frame sizes 400 to 450, the degree of protection changes to IP54.
- 34) For frame size 450, not possible in the vertical type of construction.
- 35) For motors with flange (IM B5, IM B35, IM V1), only possible in conjunction with order code **H08**.
- 36) Restrictions can apply when mounting the terminal box.
- 37) Only possible in conjunction with SIMOTICS SD Add motors (6th position of the Article No.: **3**).
- 38) When compared to utilization, temperature class 155 (F), the power is increased by 5 %.
- 39) Only available for 1LE5 and 1MB551 (Ex tc for Zone 21) and 1MB552 (Ex tc for Zone 22). Not available for 1MB553 (Ex ec for Zone 2).
- 40) Not available for 8-pole motors, frame size 450.
- 41) Not possible in combination with order code **C02**.
- 42) Not possible in combination with order code **R50**.
- 43) Customer specifications: Voltage between 380 and 690 V (voltages outside this range are available on request), frequency, circuit, required rated power in kW.
- 44) For 1LE5, only available for line operation (DOL). For 1LE5 in combination with order code **L50** or **L51** on request (converter operation).

Overview

Couplings

The motor from Siemens is connected to the machine or gear unit through a coupling. Flender is an important coupling manufacturer with a wide range of products.

For standard applications, Siemens recommends that flexible couplings, types N-EUPEX and RUPEX or torsionally rigid couplings, types ARPEX and ZAPEX are used. For special applications, FLUDEX and ELPEX-S couplings are recommended.

Available from:

Siemens contact partner - ordering from catalog
Siemens MD 10.1 "FLENDER Standard Couplings"

or

Flender GmbH
Kupplungswerk Mussum
Industriepark Bocholt
Schlavenhorst 100
46395 Bocholt, Germany
Phone +49 (2871) 922185
Fax +49 (2871) 922579

www.flender.com

Email: flender-kupplungen-2.pd.de@siemens.com

Taper pins according to DIN 258 with threaded ends and constant taper lengths

Taper pins are used for components that are repeatedly removed. The drilled hole is conically ground using a conical reamer until the pin can be pushed in by hand until the cone shoulder lies approx. 3 to 4 mm above the rim of the hole.

It can then be driven in using a hammer until it is correctly seated. The pin is removed from the drilled hole by screwing on the nut and tightening it.

Standardized taper pins are commercially available.

For instance, available from:

Otto Roth GmbH & Co. KG
Rutesheimer Strasse 22
70499 Stuttgart, Germany
Phone +49 (711) 1388-0
Fax. +49 (711) 1388-233

www.ottoroth.de

Email: info@ottoroth.de

Foundation blocks according to DIN 799

The foundation blocks are inserted into the stone foundation and embedded in concrete. They are used for fixing machines of medium size, slide rails, pedestal bearings, base frames, etc. After the fixing bolts have been unscrewed, the machines can be shifted without them having to be lifted.

When the machine is initially installed, the foundation blocks that are bolted to the machine (without washers) and fitted with taper pins are not embedded with concrete until the machine has been fully aligned. In this case, the machine is positioned 2 to 3 mm lower. The difference in shaft height is compensated by inserting shims on final installation. The taper pins safeguard the exact position of the machine when it is repeatedly removed and replaced without the need for realignment.

Available from:

Lütgert & Co. GmbH
Postfach 42 51
33276 Gütersloh, Germany
Phone +49 (5241) 7407-0
Fax +49 (5241) 7407-90

www.luetgert-antriebe.de

Email: info@luetgert-antriebe.de

Slide rails with fixing bolts and tensioning screws according to DIN 42923

Slide rails are used to tension the belt of a machine easily and conveniently when there is no belt-tensioning pulley. They are fixed to the base using stone bolts or foundation blocks.

The assignment of slide rails to motor size can be found in DIN 42923. For motors of frame sizes 355 to 450, there are no standardized slide rails (please inquire).

Available from:

Lütgert & Co. GmbH
Postfach 42 51
33276 Gütersloh, Germany
Phone +49 (5241) 7407-0
Fax +49 (5241) 7407-90

www.luetgert-antriebe.de

Email: info@luetgert-antriebe.de

SIMOTICS SD standard motors next generation

Article No. supplements and special versions · Accessories

More information

Spare motors and repair parts

- Commitment to provide replacement motors and repair parts following delivery of the motor:
 - For up to 3 years after delivery of the original motor, in the event of total motor failure, Siemens will supply a comparable replacement motor with regard to the mounting dimensions and functions (the type series may vary).
 - If a replacement motor is supplied within the 3-year period, this does not mean that the warranty restarts.
 - Replacement motors delivered after the active production of the machine series are also identified as spare motors on the rating plate.
 - Spare parts are offered only for these spare motors on request; repair and replacement are not possible.
 - After a period of 3 years (after the delivery of the original motor), it is only possible to repair these motors (depending on the availability of the spare parts required).
 - For up to 5 years after the delivery of the original motor, spare parts will be available and for a further 5 years, Siemens will provide information about spare parts and will supply documents when required.
- When repair parts are ordered, the following details must be provided:
 - Designation and part number
 - Article No. and factory number of the motor.
- For bearing types, see Catalog Section 1 "Introduction".
- For standard components, a commitment to supply repaired parts does not apply.
- Support hotline
In Germany
Phone +49 (180) 5050448

You will find telephone numbers for other countries on our Internet site:

www.siemens.com/automation/service&support

Overview

- Dimensional designations according to EN 50347 and IEC 60072.
- Fits
The shaft extensions specified in the dimension tables (DIN 748) and centering spigot diameters (EN 50347) are machined with the following fits:

Dimension designation	ISO fit	DIN ISO 286-2
D, DA	to 30	j6
	over 30 to 50	k6
	over 50	m6
N	to 250	j6
	over 250	h6
F, FA		h9
K		H17
S	flange (FF)	H17

The drilled holes of couplings and belt pulleys should have an ISO fit of at least H7.

- Dimensional tolerances
For the following dimensions, the admissible deviations are given below:

Dimension designation	Dimension	Admissible deviation
H	to 250	- 0.5
	over 250	- 1.0
E, EA		- 0.5

- Keyways and feather keyways (dimensions GA, GC, F, and FA) are made in compliance with DIN 6885 Part 1.
- All dimensions are specified in mm.

Dimension sheet generator (within the DT Configurator)

Overview

A dimensional drawing can be created in the "Drive Technology Configurator" (DT Configurator) for every configurable motor. A dimensional drawing can be requested for every other motor.

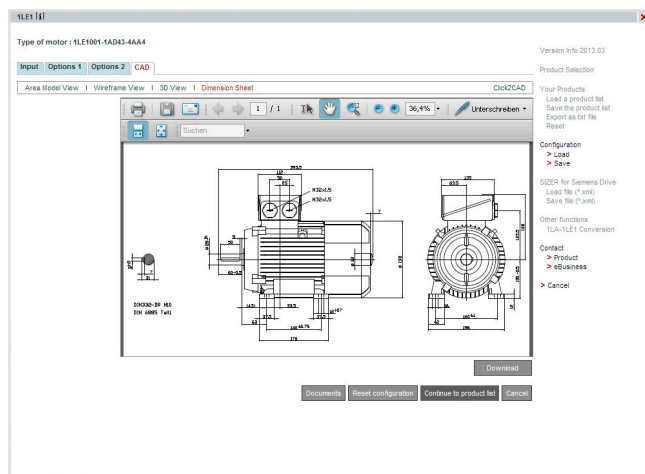

When a complete Article No. is entered with or without order codes, a dimensional drawing can be called up under the "Documentation" tab.

These dimensional drawings can be presented in different views and sections and printed.

The corresponding dimension sheets can be exported, saved and processed further in DXF format (interchange/import format for CAD systems) or as bitmap graphics.

Online access in the Siemens Industry Mall

The DT Configurator is integrated into the Siemens Industry Mall and can be used on the Internet without installation.

German: www.siemens.de/dt-konfigurator
English: www.siemens.com/dt-konfigurator

SIMOTICS SD standard motors next generation

Dimensions · Cast-iron series SIMOTICS SD

IE4, IE3 – self-ventilated · Frame sizes 315 L to 355 L

Dimensional drawings

Type of construction IM B3

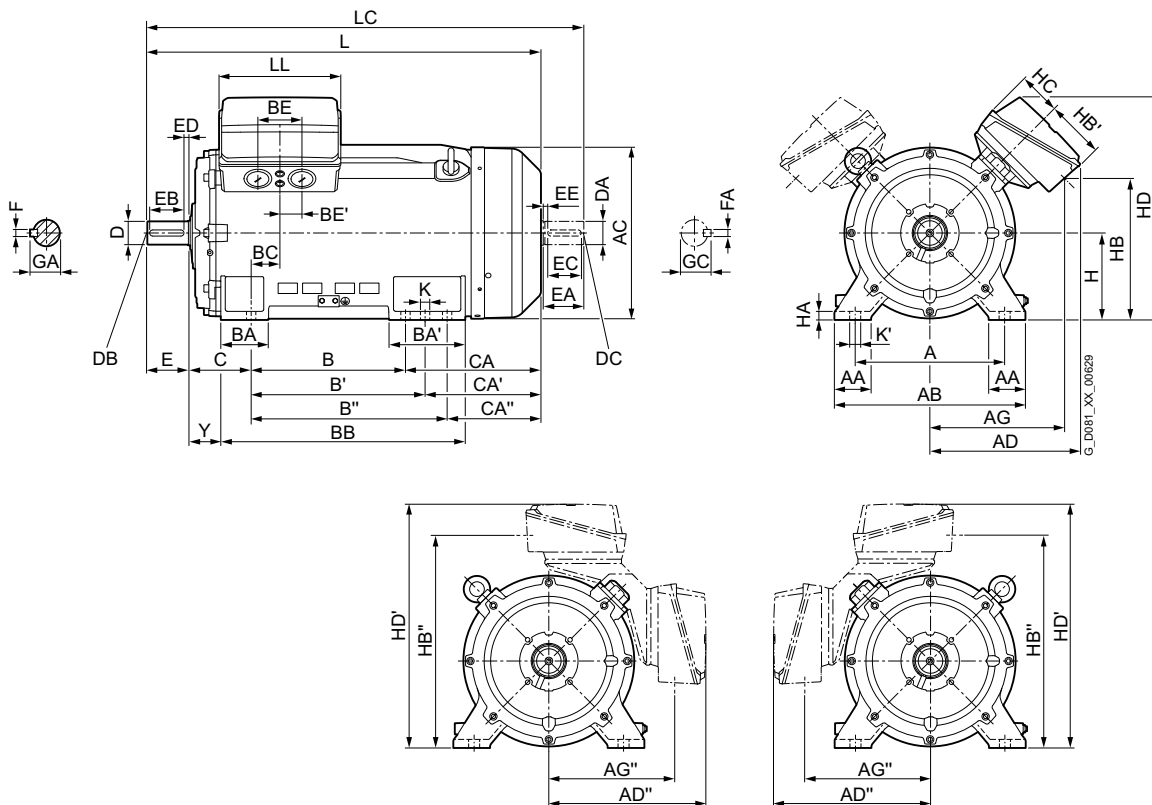

Types of construction IM B5 and IM V1

For flange dimensions, see page 1/48 (Z = the number of retaining holes)

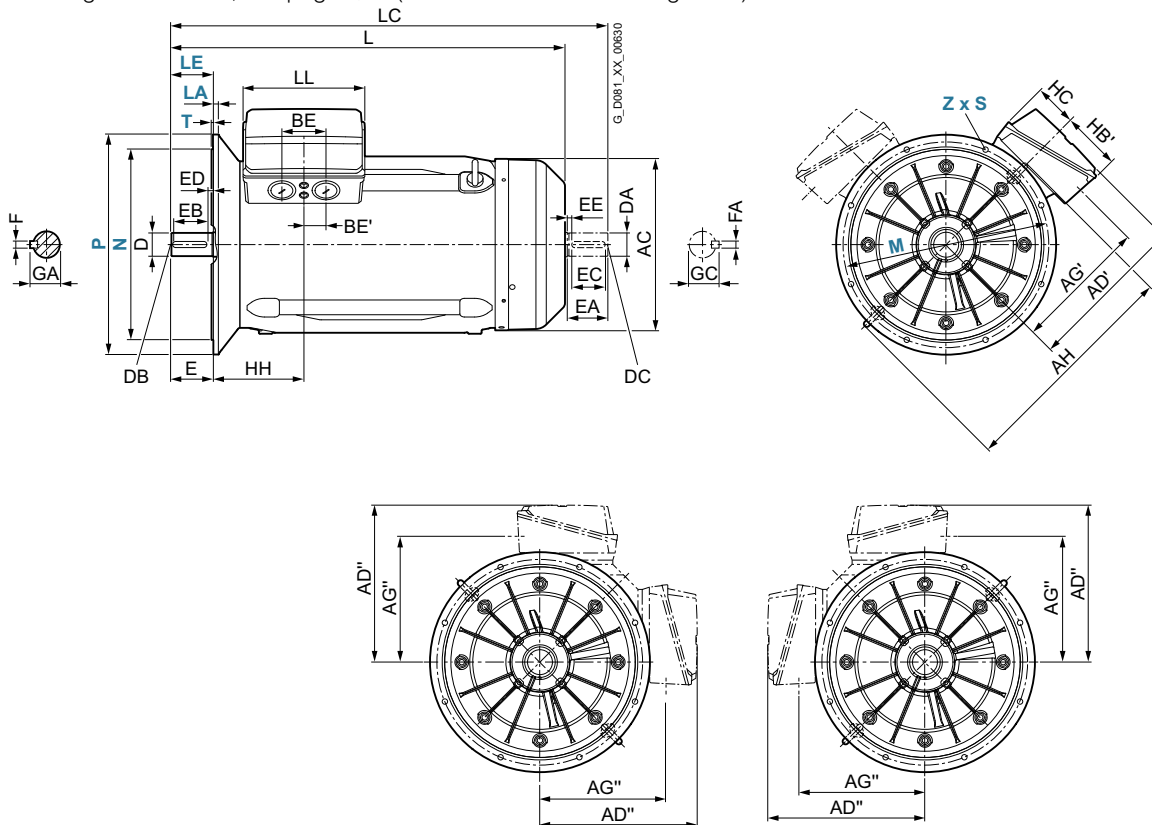

SIMOTICS SD standard motors next generation

Dimensions · Cast-iron series SIMOTICS SD

IE4, IE3 – self-ventilated · Frame sizes 315 L to 355 L

Dimensional drawings

Type of construction IM B35

For flange dimensions, see page 1/48 (Z = the number of retaining holes)

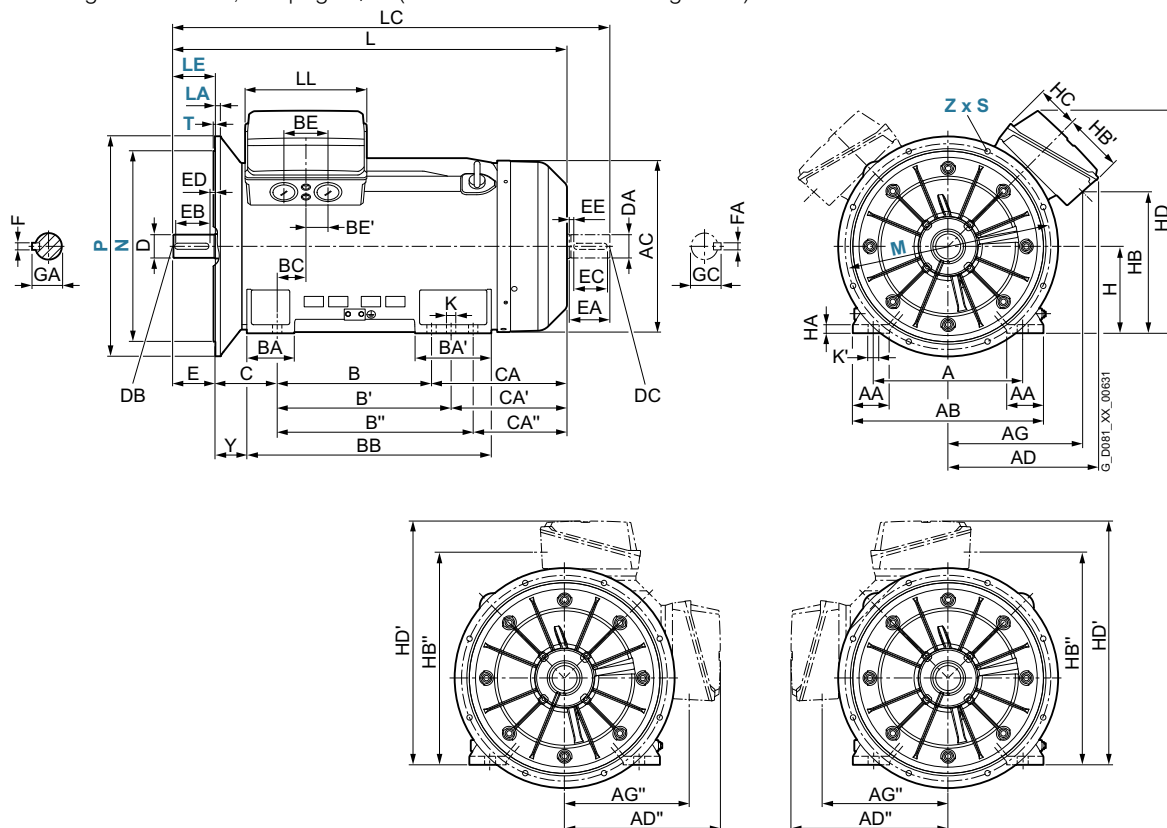

For motor	Dimension designation acc. to IEC	No. of A	AA	AB	AC	AD	AD'	AD''	AG	AG'	AG''	AH	B	B'	B''	BA	BA'	BB	BC	BE	BE'	C	CA	CA'	CA''	H	HA	HB	
315 L	3AA6	2	508	120	610	641	590	565	540	553	459	434	890	457	508	-	176	227	648	139	120	60	216	469	418	-	315	50	412
	3AB6	4																											
	3AA7	2												508	560	630		298	770								498	446	376
	3AB7	4																									528	476	406
	3AC7	6				542			491	473	448									135	67.5								491
	3AC8	6				590			553	459	434									120	60					618	566	496	412
	3AD7	8				543			491	473	448									135	67.5					528	476	406	491
	3AD8	8																								618	566	496	
355 L	3BA3, 3BA4, 3BA5	2	610	150	780	718	620	657	644	550	542	530	940	630	710	800	198	315	998	116	240	120	254	553	473	383	355	49	574
	3BB., 3BC., 3BD.	4, 6, 8															194	311											35

For motor	Dimension designation acc. to IEC	No. of HB'	HB'	HB''	HC	HD	HD'	HH	Y	K	K'	L	LC ¹⁾	LL	DE shaft extension	NDE shaft extension	D	DB	E	EB	ED	F	GA	DA	DC	EA	EC	EE	FA	GC
315 L	3AA6	2	336	749	167	800	855	355	146	28	35	1282	1427	327	65	M20	140	125	10	18	69	60	M20	140	125	10	18	64	64	
	3AB6	4										1312	1457		85		170	140	25	22	90	70						20	74.5	
	3AA7	2										1362	1507		65		140	125	10	18	69	60						18	64	
	3AB7	4										1422	1567		85		170	140	25	22	90	70						20	74.5	
	3AC7	6	225	763																										
	3AC8	6	336	749								1512	1657																	
	3AD7	8	225	763								1422	1567																	
	3AD8	8										1512	1657																	
355 L	3BA3, 3BA4, 3BA5	2	247	885	188	911	999	370	130	35	42	1577	1722	519	75	M20	140	125	10	20	79.5	60	M20	140	125	10	18	64		
	3BB., 3BC., 3BD.	4, 6, 8										1607	1782		95	M24	170	140	25	25	100	80			170	140	25	22	85.5	

¹⁾ In the low-noise version, a second shaft extension and/or mounted encoder is not possible.



SIMOTICS SD standard motors next generation

Dimensions · Cast-iron series SIMOTICS SD Add

IE4, IE3 – self-ventilated · Frame sizes 315 L to 355 L

Dimensional drawings

Type of construction IM B3

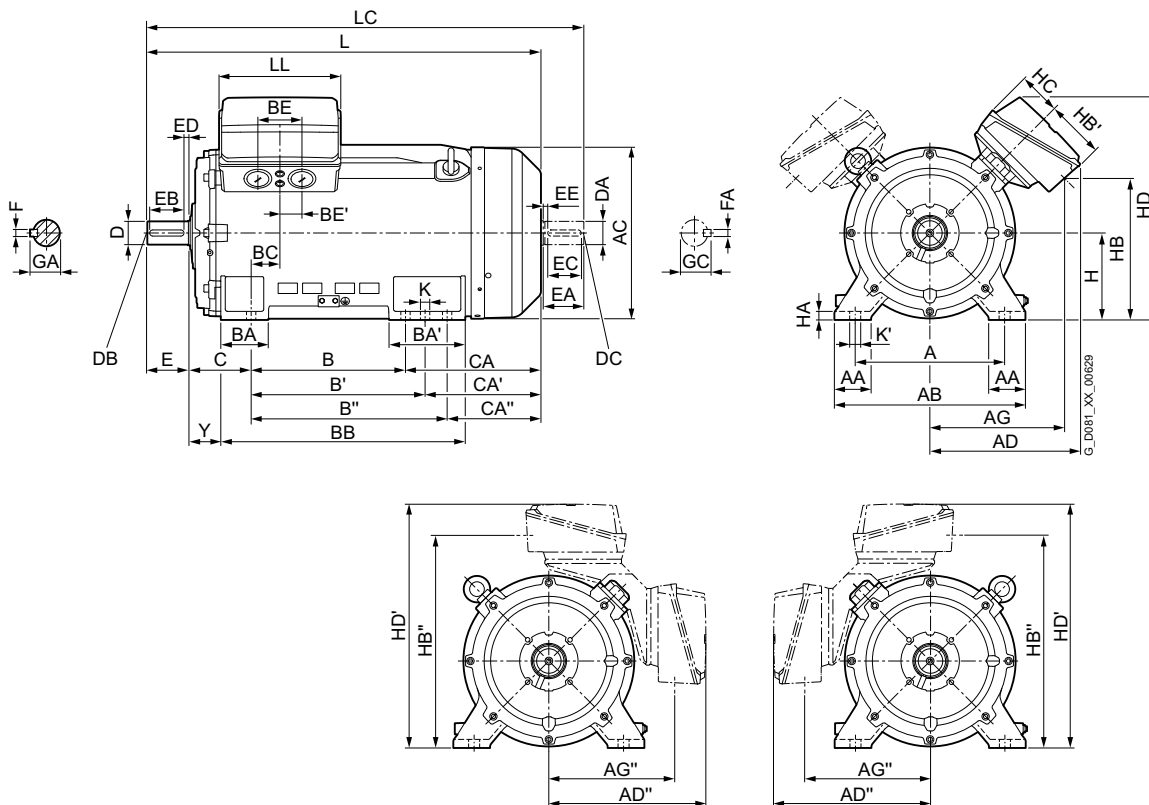

Types of construction IM B5 and IM V1

For flange dimensions, see page 1/48 (Z = the number of retaining holes)

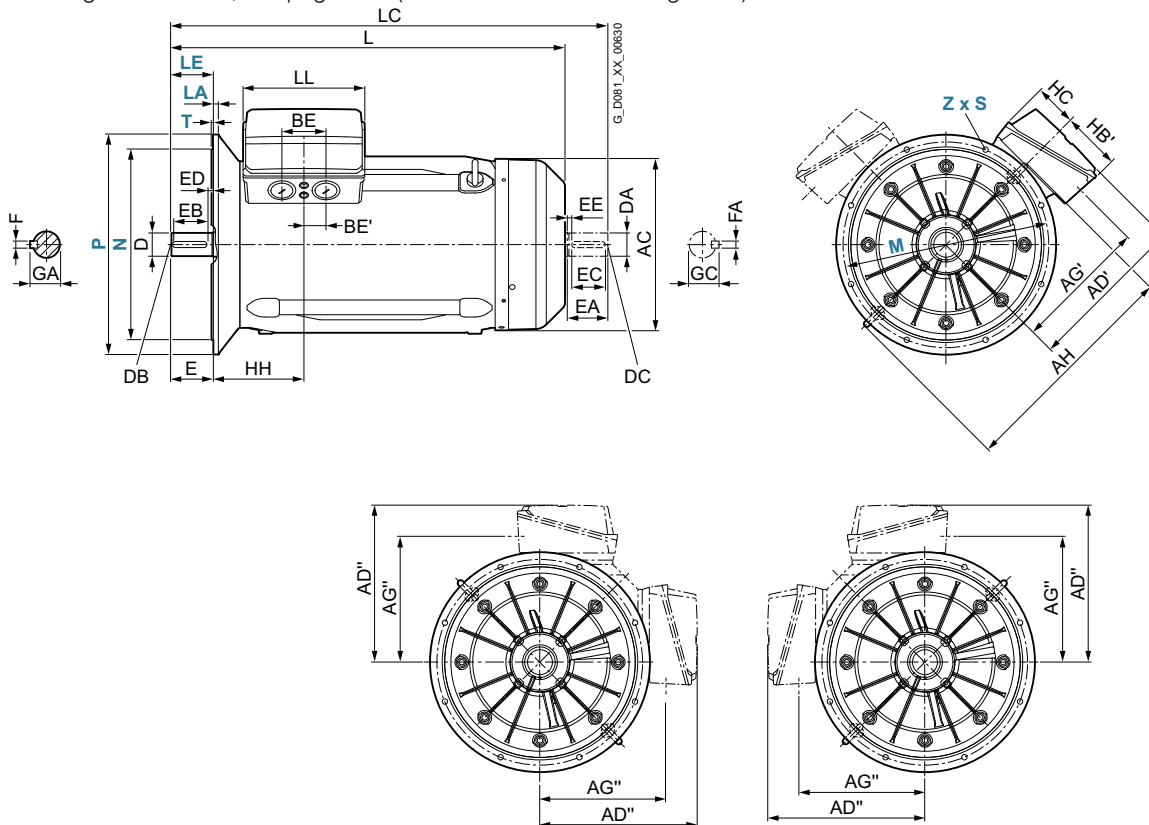

SIMOTICS SD standard motors next generation

Dimensions · Cast-iron series SIMOTICS SD Add

IE4, IE3 – self-ventilated · Frame sizes 315 L to 355 L

Dimensional drawings

Type of construction IM B35

For flange dimensions, see page 1/48 (Z = the number of retaining holes)

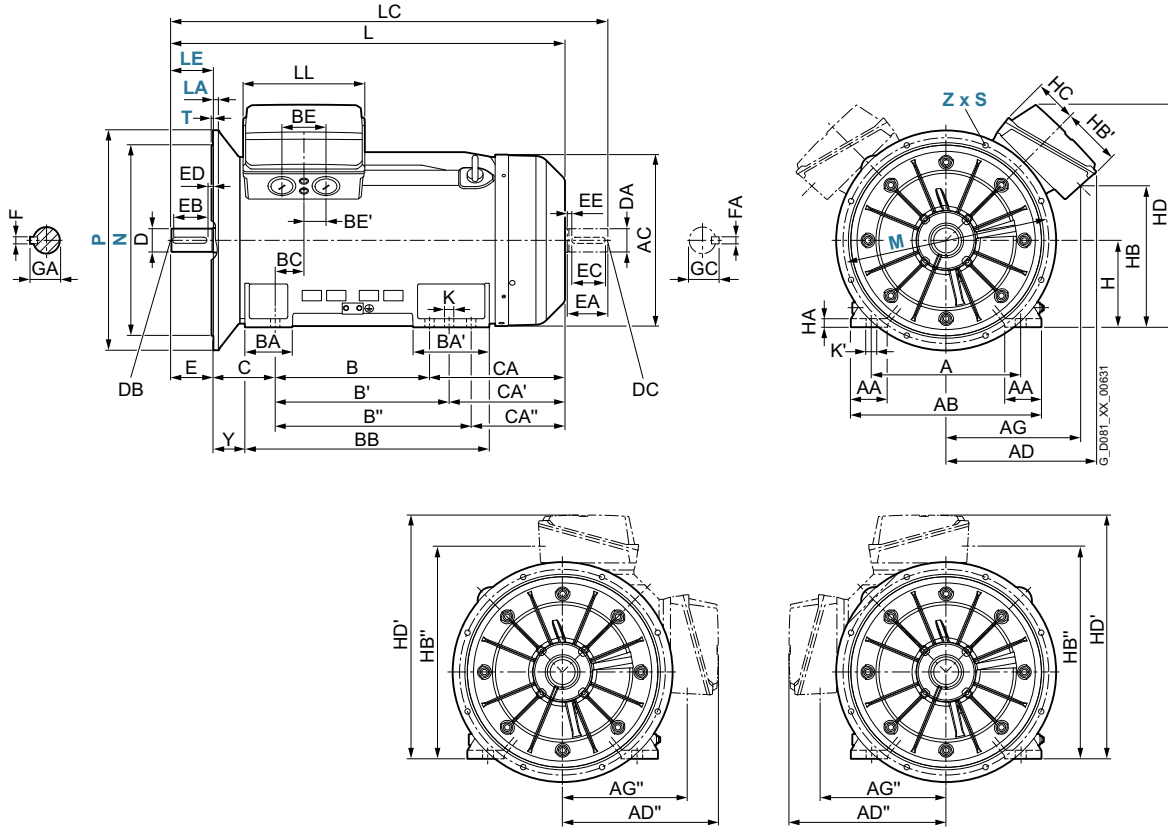

For motor	Dimension designation acc. to IEC	No. of A	AA	AB	AC	AD	AD'	AD''	AG	AG'	AG''	AH	B	B'	B''	BA	BA'	BB	BC	BE	BE'	C	CA	CA'	CA''	H	HA	HB		
315 L	3AA6	2	508	120	610	641	590	565	540	553	459	434	890	457	508	-	176	227	648	139	120	60	216	469	418	-	315	50	412	
	3AB6, 3AB7	4											508	560	630			298	770											
	3AA7	2																												
	3AC8	6																												
	3AC7, 3AD7	6					543		491	473	448										135	67.5							491	
	3AD8	8																												
355 L	3BA3, 3BA4, 3BA5	2	610	150	780	718	620	657	644	550	542	530	940	630	710	800	198	315	998	116	240	120	254	553	473	383	355	49	574	
	3BB., 3BC., 3BD.	4, 6, 8																194	311										35	

For motor	Dimension designation acc. to IEC	No. of HB'	HB''	HC	HD	HD'	HH	Y	K	K'	L	LC ¹⁾	LL	D	DB	E	EB	ED	F	GA	DA	DC	EA	EC	EE	FA	GC		
315 L	3AA6	2	336	749	167	800	855	355	146	28	35	1282	1427	327	65	M20	140	125	10	18	69	60	M20	140	125	10	18	64	
	3AB6, 3AB7	4										1422	1567	85		170	140	25	22	90	70						20	74.5	
	3AA7	2										1362	1507	65		140	125	10	18	69	60							18	64
	3AC8	6										1512	1657	85		170	140	25	22	90	70							20	74.5
	3AC7, 3AD7	6, 8	225	763								1422	1567																
	3AD8	8										1512	1657																
355 L	3BA3, 3BA4, 3BA5	2	247	885	188	911	999	370	130	35	42	1577	1722	519	75	M20	140	125	10	20	79.5	60	M20	140	125	10	18	64	
	3BB., 3BC., 3BD.	4, 6, 8										1607	1782	95	M24	170	140	25	25	100	80			170	140	25	22	85.5	

¹⁾ In the low-noise version, a second shaft extension and/or mounted encoder is not possible.

SIMOTICS SD standard motors next generation

Dimensions · Cast-iron series SIMOTICS SD Pro

IE3 – self-ventilated · Frame sizes 315 L to 355 L

Dimensional drawings

Type of construction IM B3

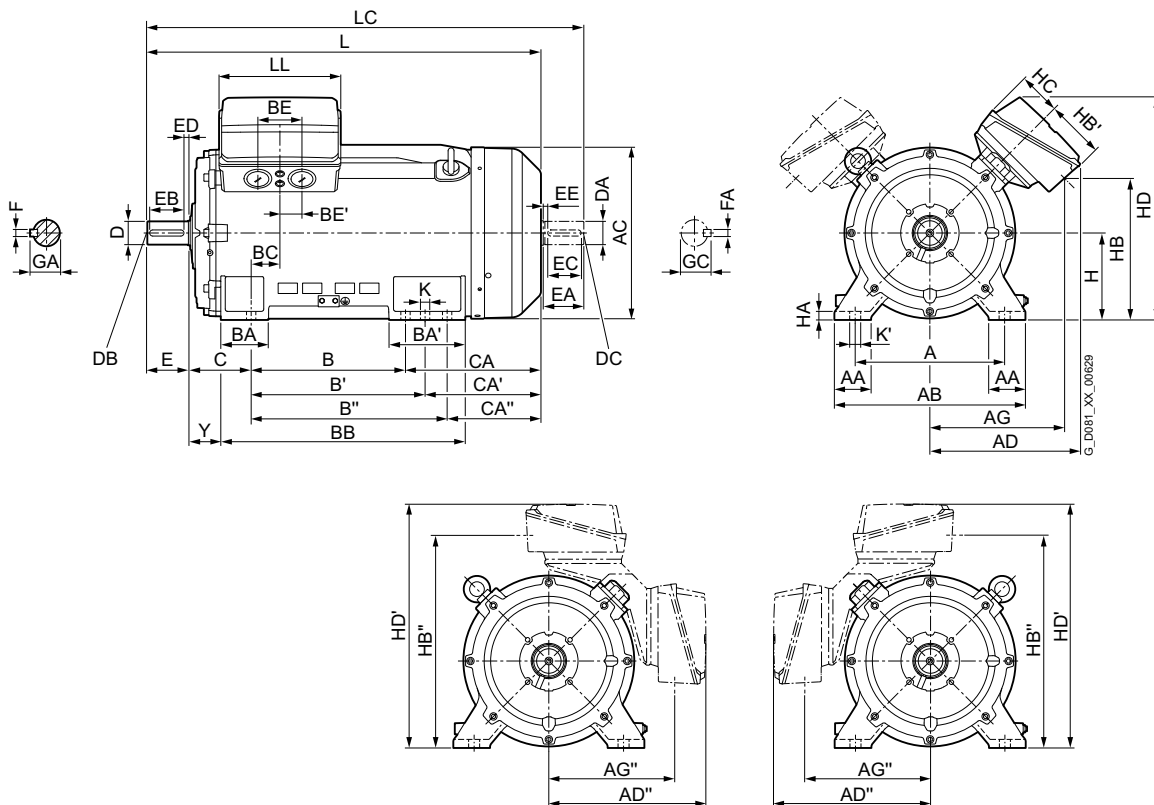

Types of construction IM B5 and IM V1

For flange dimensions, see page 1/48 (Z = the number of retaining holes)

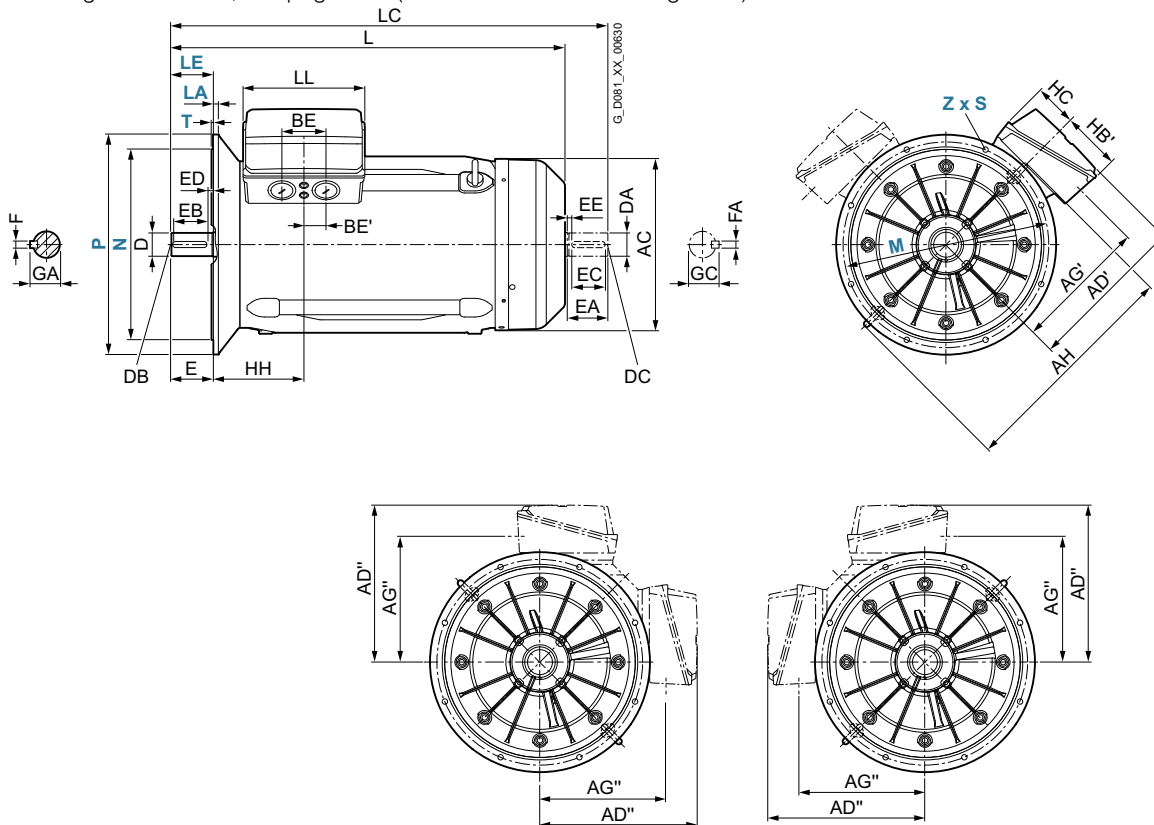

SIMOTICS SD standard motors next generation

Dimensions · Cast-iron series SIMOTICS SD Pro

IE3 – self-ventilated · Frame sizes 315 L to 355 L

Dimensional drawings

Type of construction IM B35

For flange dimensions, see page 1/48 (Z = the number of retaining holes)

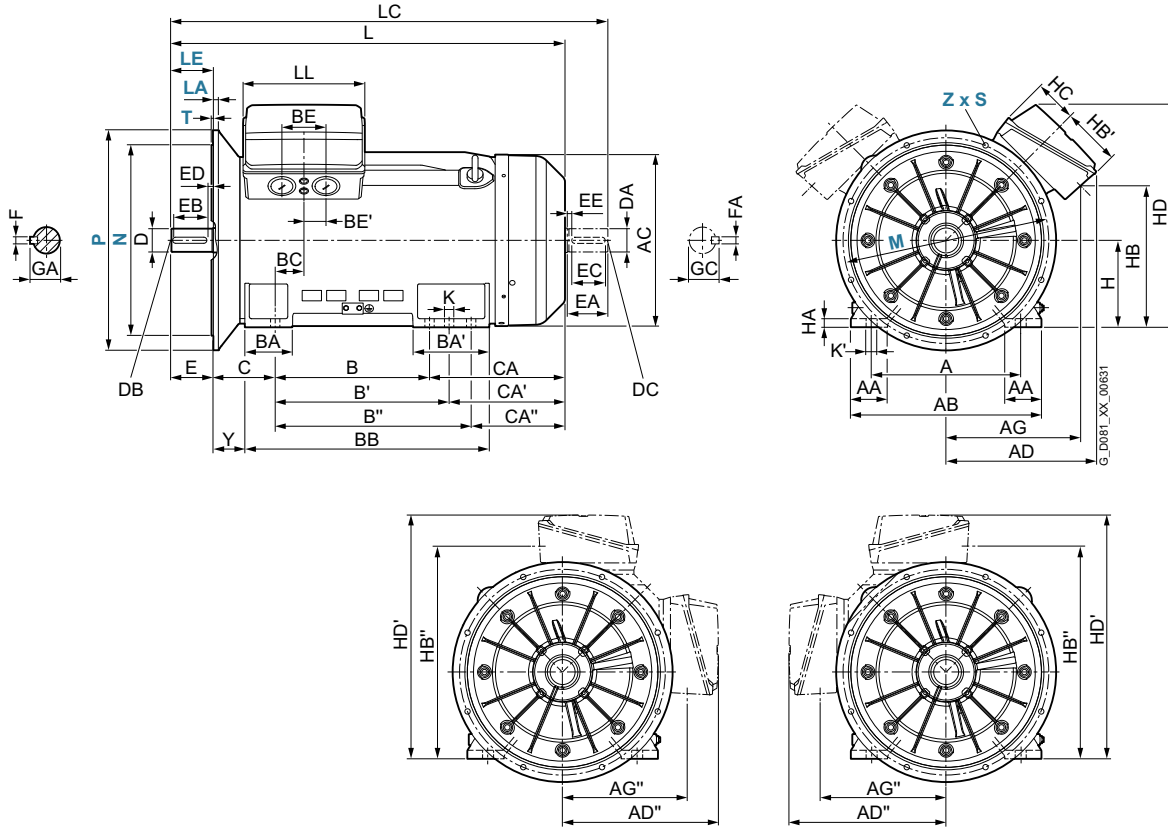

For motor	Dimension designation acc. to IEC	No. of A	AA	AB	AC	AD	AD'	AD''	AG	AG'	AG''	AH	B	B'	B''	BA	BA'	BB	BC	BE	BE'	C	CA	CA'	CA''	H	HA	HB		
315 L	3AA6	2	508	120	610	641	590	565	540	553	459	434	890	457	508	-	176	227	648	139	120	60	216	469	418	-	315	50	412	
	3AB6	4												508	560	630		298	770											
	3AA7	2																												
	3AB8	6																												
	3AC7	6				543			491	473	448									135	67.5								491	
	3AC8	6				590			553	459	434									120	60				618	566	496		412	
355 L	3BA.	2	610	150	780	718	620	657	644	550	542	530	940	630	710	800	198	315	998	116	240	120	254	553	473	383	355	49	574	
	3BB3, 3BB4	4															194	311											35	
	3BB5	4																												
	3BC2, 3BC3	6																												
	3BC4	6																												

For motor	Dimension designation acc. to IEC	No. of HB'	HB''	HC	HD	HD'	HH	Y	K	K'	L	LC ¹⁾	LL	DE shaft extension	NDE shaft extension	D	DB	E	EB	ED	F	GA	DA	DC	EA	EC	EE	FA	GC
315 L	3AA6	2	336	749	167	800	855	355	146	28	35	1282	1427	327	65	M20	140	125	10	18	69	60	M20	140	125	10	18	64	
	3AB6	4										1362	1507																
	3AA7	2										1422	1567	85		170	140	25	22	90	70						20	74.5	
	3AB8	6										1512	1657																
	3AC7	6, 8	225	763								1422	1567																
	3AC8	8	336	749								1512	1657																
355 L	3BA.	2	247	247	188	911	999	370	130	35	42	1577	1722	519	75	M20	140	125	10	20	79.5	60	M20	140	125	10	18	64	
	3BB3, 3BB4	4										1607	1782	95	M24	170	140	25	25	100	80			170	140	25	22	85.5	
	3BB5	4										1702	1877																
	3BC2, 3BC3	6										1607	1782																
	3BC4	6										1702	1877																

¹⁾ In the low-noise version, a second shaft extension and/or mounted encoder is not possible.

SIMOTICS SD standard motors next generation

Dimensions · Cast-iron series SIMOTICS SD Pro

IE3 – self-ventilated · Frame sizes 400 and 450

Dimensional drawings

Type of construction IM B3

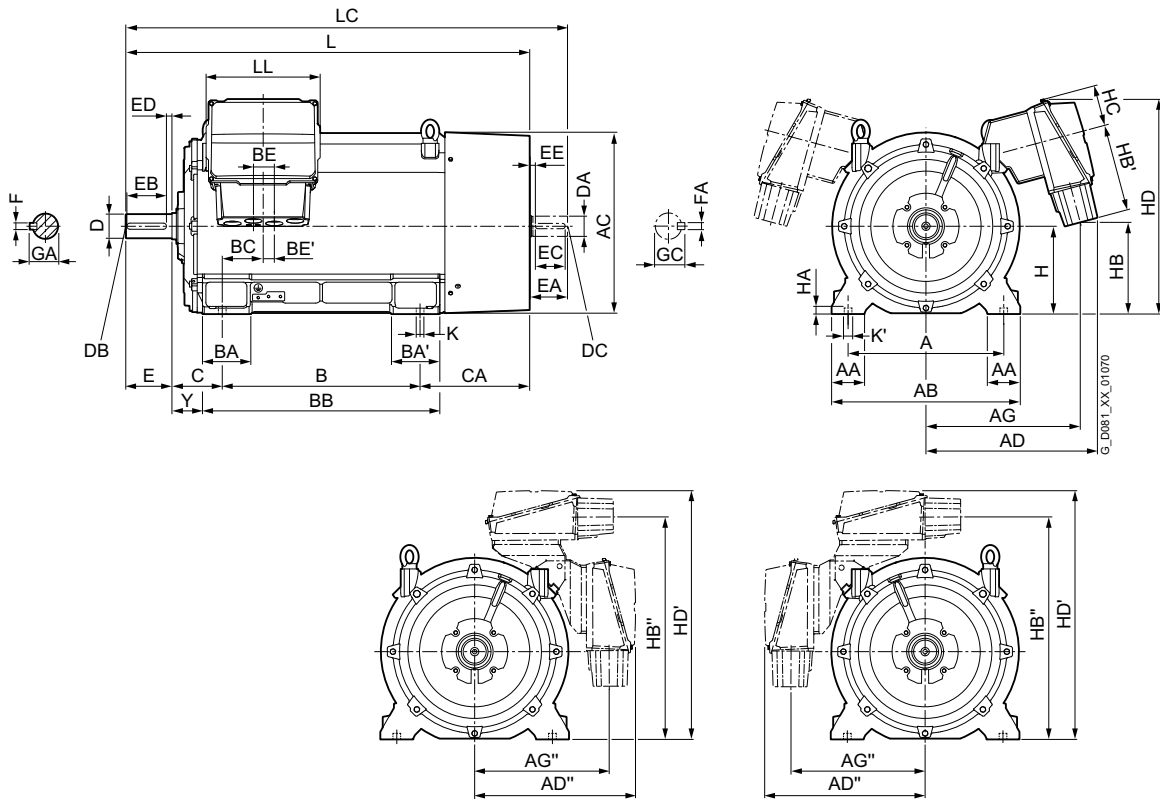

4

Types of construction IM B5 and IM V1

For flange dimensions, see page 1/48 (Z = the number of retaining holes)

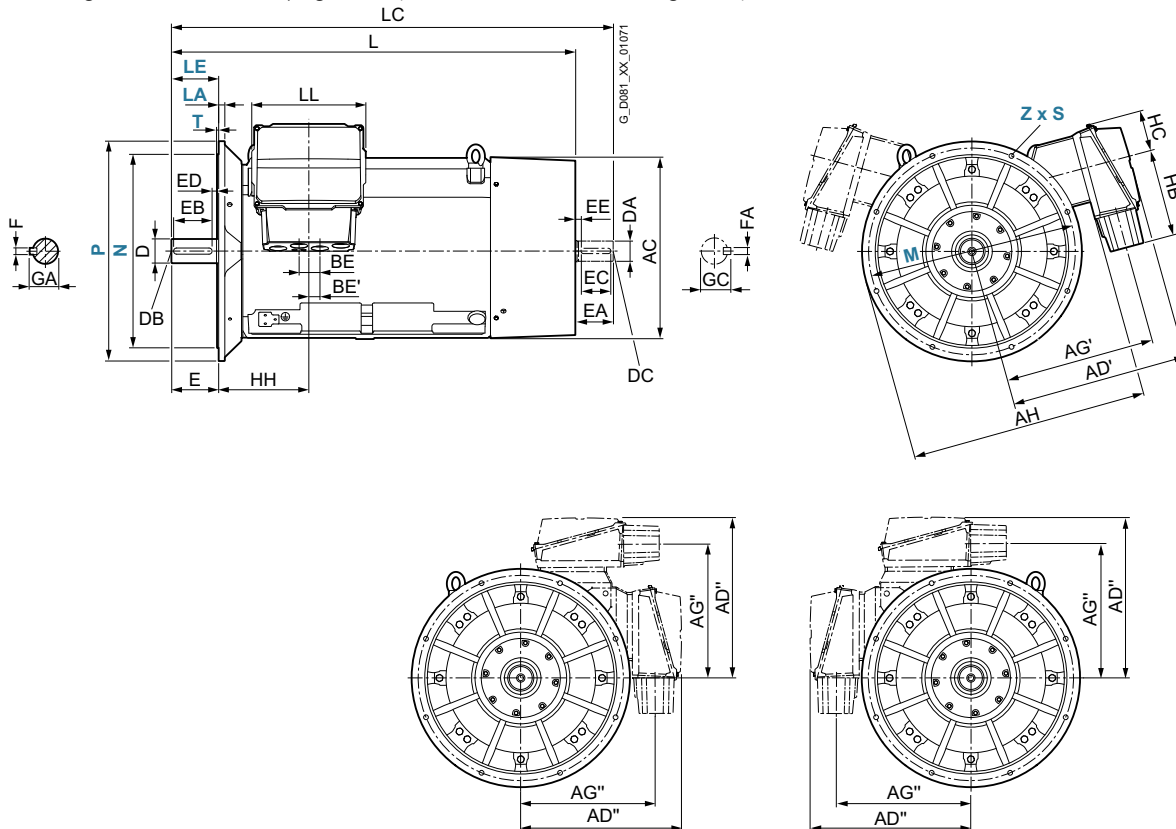

SIMOTICS SD standard motors next generation

Dimensions · Cast-iron series SIMOTICS SD Pro

IE3 – self-ventilated · Frame sizes 400 and 450

Dimensional drawings

Type of construction IM B35

For flange dimensions, see page 1/48 (**Z** = the number of retaining holes)

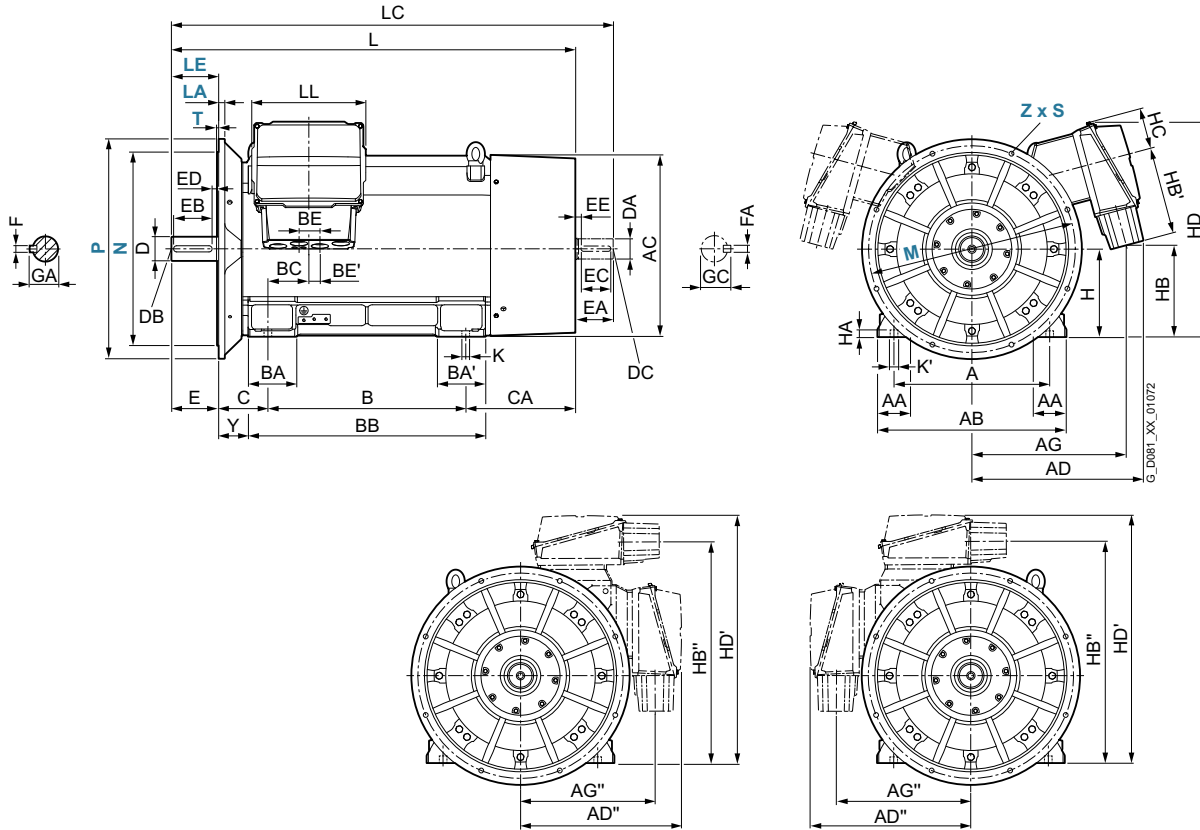

For motor	Dimension designation acc. to IEC																																
Frame size	Motor type	No. of poles	A	AA	AB	AC	AD	AD'	AD''	AG	AG'	AG''	AH	B	B'	B''	BA	BA'	BB	BC	BE	BE'	C	CA	C A'	C A''	H	H A	HB	HB A			
400	4AA	2	710	150	860	880	785	845	740	705	720	620	1110	900	-	-	220	220	1080	186	87.5	43.5	224	501	-	-	400	35	420				
	4AB	4																															
	4AC	6																															
	4AD	8																															
450	4BA	2	800	180	980	970	820	895	775	740	770	655	1235	1000	-	-	260	260	1220	170	87.5	43.5	250	535	-	-	450	42	505				
	4BB	4																															
	4BC	6																															
	4BD	8																															

For motor	Dimension designation acc. to IEC											DE shaft extension				NDE shaft extension												
Frame size	Motor type	No. of poles	HB'	HB''	HC	HD	HD'	HH	Y	K	K'	L	LC ¹⁾	LL	D	DB	E	EB	ED	F	GA	DA	DC	EA	EC	EE	FA	GC
400	4AA	2	400	1020	190	980	1140	410	134	35	42	1795	1940	519	80	M20	170	140	25	22	85	70	M20	140	125	10	20	74.5
	4AB	4										1835	2010		110	M24	210	180		28	116	90	M24	170	140	25	25	95
	4AC	6																										
	4AD	8																										
450	4BA	2	400	1105	190	1065	1225	420	140	42	50	1955	2100	519	90	M24	170	140	25	25	95	75	M20	140	125	10	20	79.5
	4BB	4										1995	2210		120		210	180		32	127	100	M24	210	180	25	28	106
	4BC	6																										
	4BD	8																										

¹⁾ In the low-noise version, a second shaft extension and/or mounted encoder is not possible.

SIMOTICS SD standard motors next generation

Dimensions · Cast-iron series SIMOTICS SD Pro

IE3 – self-ventilated · Frame sizes 400 and 450

SIMOTICS VSD motors for converter operation

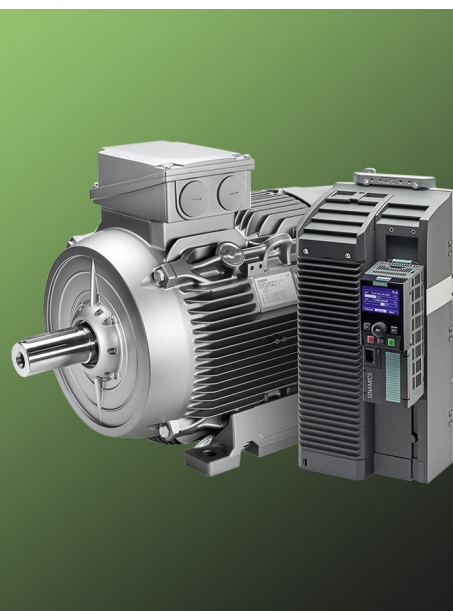

5/2	Introduction
5/2	Overview
5/2	Application
5/2	Design
5/3	Technical specifications
5/4	Synchronous reluctance motors for SINAMICS converters – VSD4000 line
5/4	Orientation
5/44	<u>Article number code</u>
5/46	Super Premium Efficiency
5/46	<u>Aluminum series SIMOTICS GP 1FP1014</u>
5/46	• Line voltage 400 V, 50 Hz/480 V, 60 Hz/400 V, 87 Hz – self-ventilated, enclosed
5/48	<u>Cast-iron series SIMOTICS SD 1FP1514</u>
5/48	• Line voltage 400 V, 50 Hz/460 V, 60 Hz/400 V, 87 Hz – self-ventilated, enclosed
5/52	Article No. supplements and special versions
	<u>Voltages</u>
5/52	• Aluminum series SIMOTICS GP 1FP1014
5/53	• Cast-iron series SIMOTICS SD 1FP1514
	<u>Types of construction</u>
5/54	• Aluminum series SIMOTICS GP 1FP1014
5/57	• Cast-iron series SIMOTICS SD 1FP1514
	<u>Motor protection</u>
5/62	• Aluminum series SIMOTICS GP 1FP1014
5/61	• Cast-iron series SIMOTICS SD 1FP1514
	<u>Terminal box position</u>
5/62	• Aluminum series SIMOTICS GP 1FP1014
5/63	• Cast-iron series SIMOTICS SD 1FP1514
	<u>Options</u>
5/64	• Aluminum series SIMOTICS GP 1FP1014
5/68	• Cast-iron series SIMOTICS SD 1FP1514
5/73	<u>Accessories</u>
5/74	Dimensions
5/74	Notes on the dimensions
5/75	Dimension sheet generator
	<u>Aluminum series SIMOTICS GP</u>
5/76	• Super Premium Efficiency – self-ventilated · Frame sizes 80 M, 90 S, 90 L, 112 M to 200 L
	<u>Cast-iron series SIMOTICS SD</u>
5/78	• Super Premium Efficiency – self-ventilated · Frame sizes 80 M, 90 S, 90 L, 112 M to 160 L
5/80	• Super Premium Efficiency – self-ventilated · Frame sizes 180 M to 200 L

5/82	Standard induction motors optimized for converter operation – VSD10 line
5/82	Orientation
5/90	<u>Article number code</u>
5/92	Standard Efficiency
5/92	<u>Aluminum series SIMOTICS GP 1LE1092</u>
5/92	• Line voltage 400 V, 50 Hz/460 V, 60 Hz/400 V, 87 Hz – self-ventilated, enclosed
5/94	• Line voltage 500 V, 50 Hz/575 V, 60 Hz/500 V, 87 Hz – self-ventilated, enclosed
5/96	• Line voltage 690 V, 50 Hz/690 V, 87 Hz – self-ventilated, enclosed
	<u>Cast-iron series SIMOTICS SD 1LE1592</u>
5/98	• Line voltage 400 V, 50 Hz/460 V, 60 Hz/400 V, 87 Hz – self-ventilated, enclosed
5/102	• Line voltage 500 V, 50 Hz/575 V, 60 Hz/500 V, 87 Hz – self-ventilated, enclosed
5/106	• Line voltage 690 V, 50 Hz/690 V, 87 Hz – self-ventilated, enclosed
5/108	Article No. supplements and special versions
	<u>Voltages</u>
5/108	• Aluminum series 1LE1092
5/109	• Cast-iron series 1LE1592
	<u>Types of construction</u>
5/110	• Aluminum series 1LE1092
5/114	• Cast-iron series 1LE1592
	<u>Motor protection</u>
5/118	• Aluminum series 1LE1092
5/119	• Cast-iron series 1LE1592
	<u>Terminal box position</u>
5/120	• Aluminum series 1LE1092
5/121	• Cast-iron series 1LE1592
	<u>Options</u>
5/122	• Aluminum series 1LE1092
5/126	• Cast-iron series 1LE1592
5/131	<u>Accessories</u>
5/133	Dimensions
5/133	<u>Notes on the dimensions</u>
5/133	Dimension sheet generator
	<u>Aluminum series SIMOTICS GP</u>
5/134	• Standard Efficiency – self-ventilated · Frame sizes 100 L to 160 L – self-ventilated
	<u>Cast-iron series SIMOTICS SD</u>
5/136	• Standard Efficiency – self-ventilated · Frame sizes 100 L to 160 L – self-ventilated
5/138	• Standard Efficiency – self-ventilated · Frame sizes 180 M to 250 M – self-ventilated
5/140	• Standard Efficiency – self-ventilated · Frame sizes 280 S to 315 L – self-ventilated

SIMOTICS VSD motors for converter operation

Introduction

Overview

SIMOTICS GP/SD VSD motors optimized for converter operation (VSD = *Variable Speed Drive*)

In addition to the standard motors optimized for line operation, Siemens also offers two motor lines optimized for converters for variable-speed operation on a frequency converter:

- SIMOTICS VSD10 line – induction motors for converter operation
- SIMOTICS VSD4000 line – reluctance motors for operation with SINAMICS G120/S120 converters

The motors are optionally available with an aluminum housing (SIMOTICS GP) or with a rugged cast-iron housing (SIMOTICS SD).

SIMOTICS VSD motors are characterized by the following features:

- **High energy efficiency:**
Because the SIMOTICS VSD motors are optimized for operation with SINAMICS converters, the system power losses are low and the energy efficiency therefore high. In particular, the SIMOTICS VSD4000 line synchronous reluctance motors in conjunction with optimized control algorithms result in excellent loss-optimized operation in the speed setting range with a full and partial load, and are superior to an induction motor system that has comparable nominal efficiency, especially in the partial-load range.
- **Optimized investment costs:**
The optimized motor active part/power module allocation results in low capital investment costs. The motors and frequency converters are optimally harmonized and coordinated with one another. No power unit upgrade is therefore required. This applies in particular to the SIMOTICS VSD10 line motors on account of their optimized motor design.

- **Low space requirement, low weight:**
The high power density and compact design ensure low space requirements combined with low weight.
- **Very rugged and reliable:**
High availability using the standard protection functions for converter operation (KTY84-130 temperature sensors). As a result of the optimized insulation system, a high degree of reliability is obtained for four-quadrant operation with SINAMICS converters. SIMOTICS VSD10 motors also have insulated bearings at the non-drive end (NDE) in frame sizes 280 and 315.
- **Fast and simple commissioning** by transferring a motor code on the frequency converter.
- **Flexible in use:**
SIMOTICS VSD line motors are designed as standard for operation with a 50 Hz, 60 Hz and 87 Hz characteristic.
- **Wide range of options:**
By consistently utilizing the 1LE1 standard motor platform, almost all options of the 1LE1 line motors can also be used for the SIMOTICS VSD line motors.
- **High level of compatibility:**
Line and converter motors can be easily interchanged due to their identical dimensions and customer interfaces. The connection and operating philosophy is exactly the same as for 1LE1 line motors.
- **International applicability:**
The motors are not subject to any minimum efficiency requirements for specific countries.

Application

The SIMOTICS GP/SD VSD motors can be deployed in all industries and sectors, e.g. paper, steel, energy, chemistry, water/waste water.

The wide field of applications that can be addressed includes, for example, the following:

- Pumps
- Fans
- Compressors
- Cranes
- Conveyor belts

Design

The SIMOTICS GP/SD VSD motors are based on the platform of the SIMOTICS 1LE1 motor type series. For this reason, the principal design is the same as for the 1LE1 line motors – the mechanical parts are identical.

The motors are adapted to the converter by appropriately dimensioning the active part and VSD-specific rating plate data.

Moreover, a large number of the variations available in the SIMOTICS 1LE1 motors (types of construction, motor protection, terminal box position, and options) are also available for the VSD motors.

SIMOTICS VSD4000 line	SIMOTICS VSD10 line
Use in VSD applications with high dynamic requirements	Use in VSD applications
Focus on low operating costs	Focus on low investment costs
Very low system power losses due to the reluctance principle and optimum coordination of the motor with the converter	Low system power losses due to optimum coordination of the motor with the converter
Optimized for operation with SINAMICS G120 and S120	Optimized for use with SINAMICS G120, G130, G150
36 month warranty	<ul style="list-style-type: none"> • 12 month warranty for SIMOTICS GP • 24 month warranty for SIMOTICS SD (optionally expandable)

Technical specifications

Brief overview of the general technical specifications for SIMOTICS VSD4000 line reluctance motors

Air-cooled, enclosed version with self-ventilation ¹⁾	
Operation	Converter operation – VSD
Power at 50 Hz ²⁾	0.55 ... 45 kW
Rated speed	1500 rpm, 1800 rpm and 2610 rpm 3000 rpm, 3600 rpm
Voltages	50 Hz line supplies: 400 V 60 Hz line supplies: 460 V
Cooling method	IC411, self-ventilated
Frame size	SIMOTICS GP: 80/112 ... 200 SIMOTICS SD: 80/112 ... 225
Degree of protection ³⁾	IP55
Housing	Aluminum or cast-iron version
Load characteristic	$T \sim n^2$, $T = \text{const.}$
Motor type	SIMOTICS GP: 1FP10.4 SIMOTICS SD: 1FP15.4

Brief overview of the general technical specifications for SIMOTICS VSD10 line standard motors for converter operation

Air-cooled, enclosed version with self-ventilation ¹⁾	
Operation	Converter operation – VSD
Power at 50 Hz	2.2 ... 200 kW (1500 rpm) 3 ... 90 kW (3000 rpm)
Rated speed	1500 rpm, 1800 rpm and 2610 rpm ⁴⁾ 3000 rpm, 3600 rpm and 5220 rpm ⁴⁾
Voltages	50 Hz line supplies: 400 V, 500 V, 690 V 60 Hz line supplies: 460 V, 600 V
Cooling method	IC411, self-ventilated
Frame size	SIMOTICS GP: 100 ... 160 SIMOTICS SD: 100 ... 315
Degree of protection ³⁾	IP55
Housing	Aluminum or cast-iron version
Load characteristic	$T \sim n^2$, $T = \text{const.}$
Motor type	SIMOTICS GP: 1LE1092 SIMOTICS SD: 1LE1592

¹⁾ Forced ventilation optionally available.

²⁾ Rated speed 1500 rpm.

³⁾ Other degrees of protection optionally available.

⁴⁾ 87 Hz characteristic not available for all frame sizes.

Synchronous reluctance motors for SINAMICS converters – VSD4000 line

Orientation

Overview

SIMOTICS GP/SD VSD4000 line motor series: 1FP10, 1FP15



As a result of their flexibility and the wide range of versions, SIMOTICS GP/SD VSD4000 line motors are especially suitable for sectors and industries, where the focus is on minimum lifecycle costs (TCO) and/or operation with a high dynamic performance.

Versions of the SIMOTICS GP/SD VSD4000 line motor series: 1FP10, 1FP15

The motors have compact dimensions in a surface-cooled, enclosed version with self-ventilation. They have been specifically designed for converter operation.

1FP10 General Purpose for converter operation

- Four-quadrant converter operation, optimally harmonized with the SINAMICS G120, PM240-2 and S120 (ALM, BLM) drive system.
- IP55 degree of protection
- IC411 cooling method, self-ventilated (IC416 cooling method, force-ventilated version optional)
- Housing: Aluminum
- Frame sizes: 80/112 to 200 ¹⁾

1FP15 Severe Duty for converter operation

- Four-quadrant converter operation, optimally harmonized with the SINAMICS G120, PM240-2 and S120 (ALM, BLM) drive system.
- IP55 degree of protection
- IC411 cooling method, self-ventilated (IC416 cooling method, force-ventilated version optional)
- Housing: Cast iron
- Frame sizes: 80/112 to 200

Benefits

The SIMOTICS GP/SD VSD4000 line motor series has been specifically developed for operation with SINAMICS G120 converters.

- The synchronous-reluctance motors in conjunction with optimized closed-loop control algorithms result in an excellent, loss-optimized operating behavior in the speed control range at full and partial load. This system is superior to an induction motor-based system with comparable nominal efficiencies, especially in the partial load range.
- As a result of their low intrinsic moment of inertia, synchronous-reluctance motors are also especially suitable for operating modes demanding a high dynamic performance.
- The optimized motor active part/power module allocation results in low capital investment costs.
- The high power density and compact design ensure low space requirements combined with low weight.
- The motors and converters are optimally harmonized and coordinated with one another. It is not therefore necessary to upgrade the power unit.
- SIMOTICS GP motors with aluminum housing or SIMOTICS SD motors with rugged cast-iron housing are available.
- High availability using the standard protection functions for converter operation (KTY84-130 temperature sensors, Pt100/Pt1000 resistance thermometers).
- As a result of the optimized insulation system, a high degree of reliability is obtained for four-quadrant operation with SINAMICS converters.
- Fast and simple commissioning by transferring a motor code into the converter.
- Standard warranty period for synchronous-reluctance motors 36 months.

More power ratings

SIMOTICS GP/SD VSD4000 line motors are designed as standard for operation with a 50 Hz, 60 Hz, and 87 Hz characteristic ²⁾. No special ordering option is required.

Optimized for converter operation

The new motor series has been optimized for operation with SINAMICS G120 converters with regard to converter output currents and voltage utilization. Four-quadrant operation is possible with the SINAMICS G120, PM240-2, and S120 (ALM, BLM) converter families (for line voltages up to 480 V 3 AC).

High degree of flexibility

By consistently utilizing the 1LE1 standard motor platform, almost all options of the 1LE1 line motors can also be used for the SIMOTICS GP/SD VSD4000 line series.

Known and established design

Line and converter motors can be easily interchanged due to their identical dimensions and customer interfaces. The connection and operating philosophy is exactly the same as for 1LE1 line motors.

International applications

The motors are not subject to any minimum efficiency requirements for specific countries. As a consequence, they can be operated without additional MEPS certificates, also in the USA, for example.

System components

System components required:

- SIMOTICS 1FP1 synchronous-reluctance motor
- SINAMICS G120 converter PM240-2 Power Module or SINAMICS S120 (ALM, BLM) converter

¹⁾ For the motor type 1FP10 of the SIMOTICS GP series, frame sizes 180 and 200 on request.

²⁾ With firmware V4.7 SP3, only 1500 rpm can be programmed.

Synchronous reluctance motors for SINAMICS converters – VSD4000 line

Orientation

Benefits

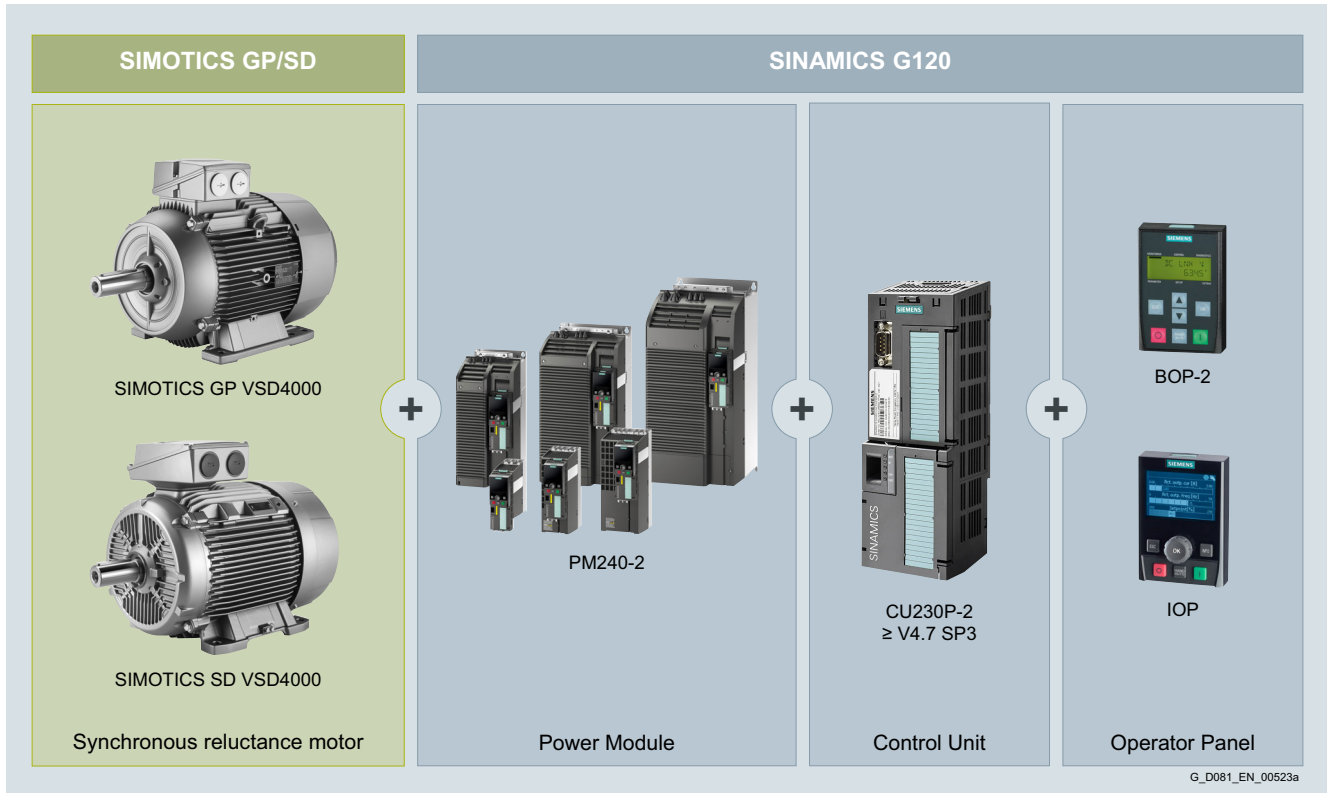

Example configuration SIMOTICS GP/SD VSD4000 with SINAMICS G120

Application

As a result of the wide range of options, the SIMOTICS GP/SD VSD4000 line motor series can be used in all industrial areas and sectors. Paper, steel, energy, chemical, water/waste water are examples of some typical sectors.

Various flange and foot-mounted designs according to EN 60034-7 are available. IP55 is the standard degree of protection (other degrees of protection optionally available).

The wide field of applications that can be addressed includes, for example, the following:

- Pumps
- Fans
- Compressors
- Cranes
- Conveyor belts
- Processing machines that require synchronous operation (e.g. in the textile industry)

Design

The SIMOTICS GP/SD VSD4000 line motors are based on the 1LE1 platform. The basic design of the SIMOTICS GP/SD VSD4000 line motors therefore corresponds to the 1LE1 line motors. The mechanical parts are identical. The motors are adapted to the converter by appropriately dimensioning the active part.

Synchronous reluctance motors for SINAMICS converters – VSD4000 line

Orientation

Technical specifications

Overview of technical specifications

This table lists the most important technical specifications.

Type of motor	IEC low-voltage three-phase synchronous-reluctance motors
Connection types	Star/delta connection The connection used depends on the particular load characteristic.
No. of poles	4
Frame sizes	80/112 ... 225
Rated power	4-pole: 0.55 ... 45 kW (50 Hz characteristic); 0.63 ... 52 kW (60 Hz characteristic), 0.9 ... 78 kW (87 Hz characteristic)
Frequencies	Characteristics for 50 Hz, 60 Hz and 87 Hz
Versions	Air-cooled, enclosed version: <ul style="list-style-type: none"> • with self ventilation • with forced ventilation (optional) SIMOTICS GP motors in an aluminum version, frame sizes 80/112 ... 200 SIMOTICS SD motors in a cast-iron version, frame sizes 80/112 ... 225
System efficiency	IES2 in accordance with EN 50598 (system with SINAMICS G120 converter, PM240-2)
Marking	Only permitted for converter operation. As converter motors, IE classification according to IEC 60034-30-1 is not required.
Rated speed	1500 rpm, 1800 rpm and 2610 rpm (up to frame size 200) 3000 rpm, 3600 rpm (frame sizes 180 and 200)
Rated torque	3.5 ... 191 Nm (50 Hz characteristic); 3.3 ... 183 Nm (60 Hz characteristic), 3.3 ... 176 Nm (87 Hz characteristic)
Insulation of the stator winding in accordance with EN 60034-1 (IEC 60034-1)	Temperature class F, utilized acc. to B Reinforced insulation system (Advanced)
Degree of protection according to EN 60034-5 (IEC 60034-5)	IP55 as standard Air-cooled, enclosed version
Cooling according to EN 60034-6 (IEC 60034-6)	<ul style="list-style-type: none"> • Standard: Self-ventilated (IC411) • Optional: Forced-air cooled (IC416) (132 ... 200)
Permissible coolant temperature and installation altitude	-20 ... +40 °C as standard, installation altitude up to 1000 m above sea level
Standard voltages according to EN 60038 (IEC 60038)	50 Hz line supplies: 400 V, 60 Hz line supplies: 480 V The rated motor voltage required is listed in the "Selection and ordering data" for the required motor.
Type of construction according to EN 60034-7 (IEC 60034-7)	<ul style="list-style-type: none"> • Without flange: IM B3, IM B6, IM B7, IM B8, IM V5, IM V6 • With flange: IM B35, IM V1, IM V3
Paint finish Suitability of paint finish for climate group according to IEC 60721, Part 2-1	As standard: color RAL 7030 stone gray
Vibration severity grade according to EN 60034-14 (IEC 60034-14)	Grade A (normal)
Shaft extension according to DIN 748 (IEC 60072)	Balancing type: half-key balancing as standard
Sound pressure level according to EN ISO 1680 (tolerance +3 dB)	The corresponding sound pressure level is listed in the "Selection and ordering data" for the required motor.
Weights	The corresponding weight is listed in the "Selection and ordering data" for the required motor.
Modular mounting concept	Optional brake and separately driven fan according to ordering data
Options	See "Article No. supplements and special versions"

Synchronous reluctance motors for SINAMICS converters – VSD4000 line

Orientation

Technical specifications

Rating plate

In accordance with EN 60034-1, the approximate total weight is specified on the rating plate. The standard version of the rating plate is the international version in English.

For straightforward and fast commissioning with SINAMICS G converters, a motor code number is stamped on the rating plate (CODE).

SIEMENS									
Made in Czech Rep.		D-90441 Nürnberg							
3~Mot. 1RV4164B		1FP10141DB421AA4-Z				UD 1701/1234567 001 001			
IEC/EN 60034 160L IMB3		IP55							
90kg	Th.Cl. 155(F)	-20°C ≤ TAMB ≤ 40°C							
Bearing									
DE	6209-2ZC3								
NE	6209-2ZC3								
CONVERTER DUTY ONLY VPWM SINAMICS G120 Nmax 4200 1/min									
V	Hz	A	kW	cos φ	Nm	1/min	EFF	CODE	
380 Y	50	33.5	15.0	0.72	95	1500	93.9	60004	
220 Δ	50	58	15.0	0.72	95	1500	93.9		
440 Y	60	33.0	17.3	0.73	92	1800	94.5		
380 Δ	87	59	26.0	0.72	95	2610	93.3		

Example of a SIMOTICS GP VSD4000 line rating plate, 1FP10

Motors specially designed for converter operation

These motors have been specifically designed for converter operation. The catalog data is applicable for operation on the converter of the SINAMICS G120 series (PM240-2/PM240P-2) and SINAMICS S120 (PM240-2 and Booksize Motor Modules).

SINAMICS G120 system requirements:

- SINAMICS G120, PM240-2/PM240P-2 Power Module, CU230P-2 Control Unit
- V4.7.6 and higher
- The converter is operated with a rated pulse frequency of at least 4 kHz.
- The converter can provide the rated voltage as listed in the catalog.

For SINAMICS G120 converters (from firmware version 4.7) the SIMOTICS GP/SD VSD4000 line series can be selected in the SINAMICS converter via the STARTER software or the operator panel at the converter (Basic Operator Panel (BOP), Intelligent Operator Panel (IOP)) as motor category and can be addressed using the motor code number.

SINAMICS S120 system requirements:

- SINAMICS S120, PM240-2 Power Module and CU310
- SINAMICS S120 Booksize Motor Module and CU320-2
- FW 4.8 and higher

Rated voltage

The tolerance for the rated voltage is in accordance with EN 60034-1. A rated voltage range is not specified. The rated motor voltages are selected so that when operated with a SINAMICS G120 converter, the available voltage is optimally utilized.

Insulation

The motors can be operated with SINAMICS G/S converters up to line voltages of 480 V when the permissible voltage peaks are complied with ($\hat{U}_{LL} \leq 3200 \text{ V}$, $\hat{U}_{LE} \leq 2800 \text{ V}$).

For converter operation with the power ratings specified in the catalog, the motors can be utilized corresponding to thermal class 155 (F) (service factor 1.2).

Preferred supply system configurations are TT systems and TN systems with neutral-point grounding. In the case of a fault when connected to an IT system (ground fault), the insulation is excessively stressed. In this case, the process should be terminated as quickly as possible ($t < 2 \text{ h}$), and the fault resolved. We do not recommend operation in corner-grounded TN systems.

Noise

The maximum sound pressure levels should be taken from the "Selection and ordering data".

Synchronous reluctance motors for SINAMICS converters – VSD4000 line

Orientation

Technical specifications

Separately driven fan

For the technical specifications of the separately driven fans, see page 1/80 "Technical specifications of separately driven fans".

Bearings

For converter operation, as a result of the basic principle employed, electrical bearing stress is created through the bearing lubricant film due to a voltage that is capacitively coupled in.

The physical cause of this is the common-mode voltage at the converter output that is inherent in the control method for a converter:

The sum of the three phase voltages is – in contrast to pure line operation – not equal to zero at every point in time.

In order to apply currents to the motor which are sinusoidal as far as possible (resulting in smoother running, lower oscillation torques, and lower stray losses), a high pulse frequency is required for the converter's output voltage. The related (very steep) switching edges of the converter output voltage (and also, therefore, of the common-mode voltage) cause correspondingly high capacitive currents and voltages on the machine's internal capacitances.

In the worst-case scenario, the capacitive voltage induced via the bearing can lead to random arcing through the bearing lubricating film, thus causing premature bearing aging or damage.

This physical effect, which occurs in isolated cases, has mostly been observed in connection with larger motors.

EMC-compliant installation of the drive system is a basic prerequisite for preventing premature bearing damage via bearing currents.

The most important measures for reducing bearing currents are:

- Insulated motor bearing at the NDE.

Recommended from frame size 225 and higher:

- Use cables with a symmetrical cable cross-section:

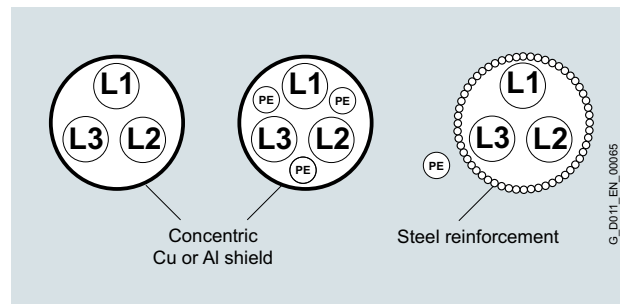

- Preference given to a line supply with isolated neutral point (IT system).
- Using grounding cables with low impedance over a wide frequency range (DC up to approximately 70 MHz): for example, braided copper ribbon cables, HF finely stranded wires.
- Separate HF equipotential-bonding cable between motor housing and driven machine.
- Separate HF equipotential-bonding cable between motor housing and converter PE busbar.
- 360° HF contacting of the cable shield on the motor housing and the converter PE busbar. This can be achieved using EMC screwed glands on the motor side and EMC shield clips on the converter side, for example.

Technical specifications

Torque limits (continuous duty)

The thermal torque limit characteristics of the SIMOTICS GP/SD VSD4000 line define the maximum load torque for uninterrupted duty (S1) over the complete speed control range. The characteristics are different for all of the cooling methods. The speed control range is limited by the mechanical speed limit, which depends on the motor's mechanical design.

The following statements are valid for the following diagrams:

- Thermally, from $1/10$ of the rated speed up to the full rated speed, the rated torque and the curve of the suitable power unit are possible, utilizing the thermal class 155 (temperature class F).
- The curves of the next largest power unit and the maximum power curve can be achieved in continuous-operation periodic duty (S6 - x %), and briefly in S9 duty, provided that $P_{2(S9)} = P_{2N}$ is not exceeded.

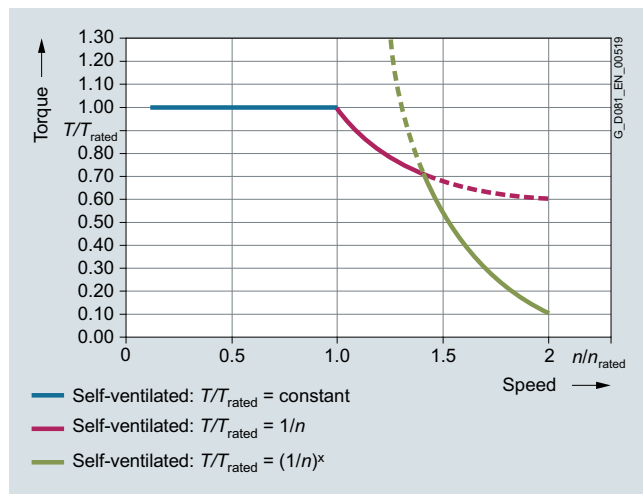

Torque limit for SIMOTICS GP/SD VSD4000 line self-ventilated

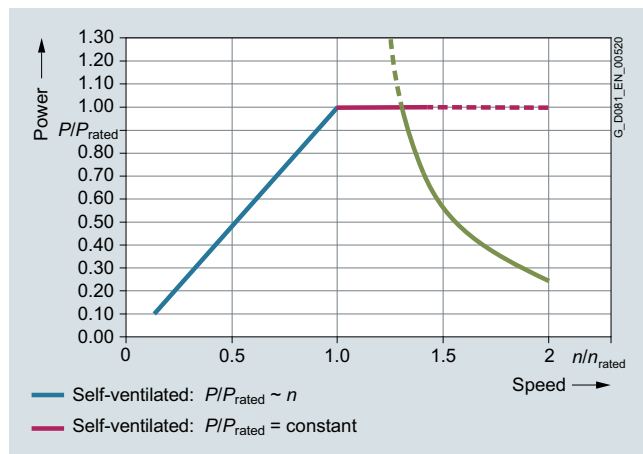

Power limit for SIMOTICS GP/SD VSD4000 line self-ventilated

Maximum overload torques/thermal limit characteristic

The short-time maximum overload torque output from the motor is defined by the limit characteristic and the available converter output current.

Thermally, the motors can be permanentl overloaded according to the F/F characteristic, see limit torque characteristics in the following catalog pages. The speed control range is limited by the mechanical speed limit, which depends on the motor's mechanical design.

Synchronous reluctance motors for SINAMICS converters – VSD4000 line

Orientation

Technical specifications

The torque and power characteristics for converter configuration for the SIMOTICS GP/SD 1FP1.14-0DB2 motor, frame size 80 with the particular motor voltage and circuit:

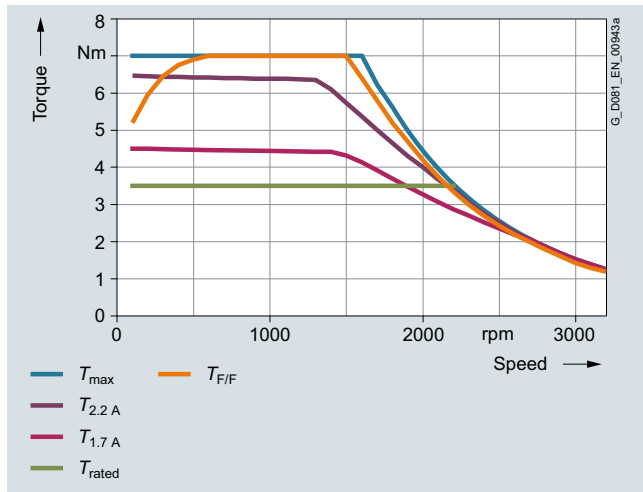

Torque limit for 380 VY (50 Hz characteristic)

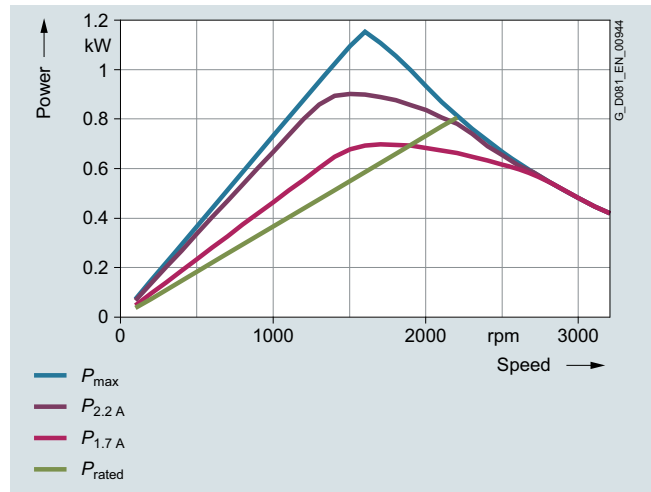

Power limit for 380 VY (50 Hz characteristic)

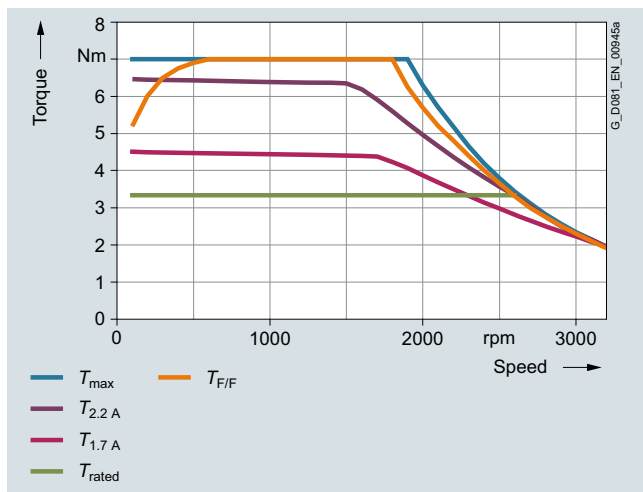

Torque limit for 440 VY (60 Hz characteristic)

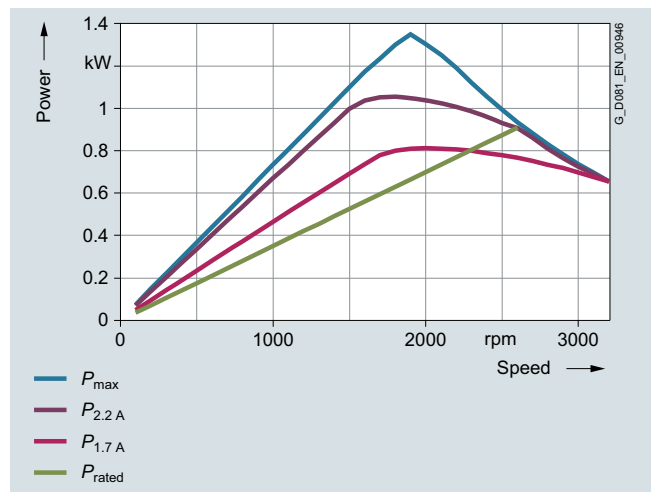

Power limit for 440 VY (60 Hz characteristic)

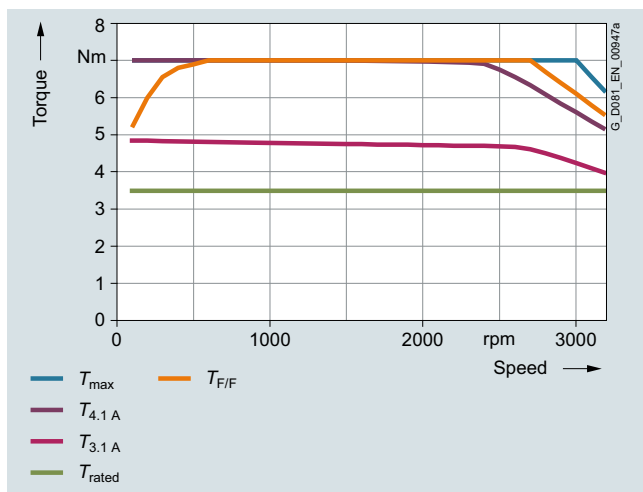

Torque limit for 380 VΔ (87 Hz characteristic)

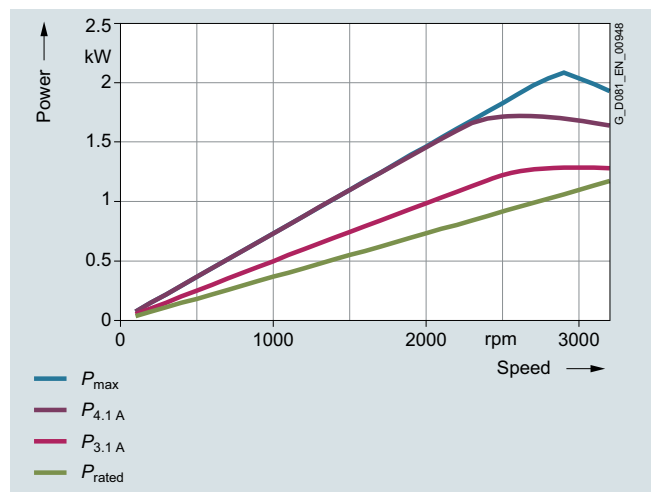

Power limit for 380 VΔ (87 Hz characteristic)

5

Synchronous reluctance motors for SINAMICS converters – VSD4000 line Orientation

Technical specifications

The torque and power characteristics for converter configuration for the SIMOTICS GP/SD 1FP1.14-0DB3 motor, frame size 80 with the particular motor voltage and circuit:

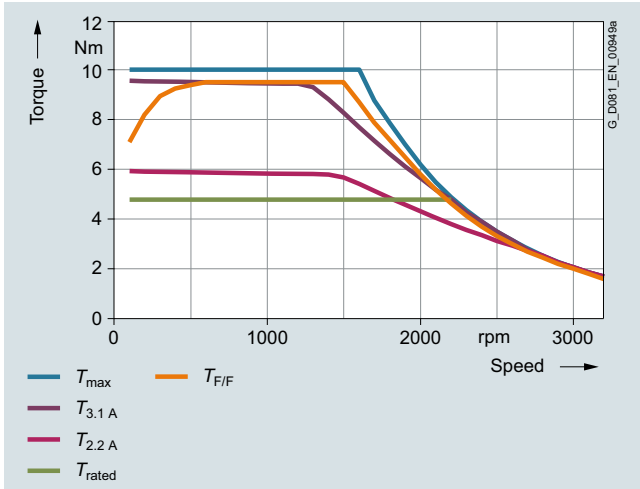

Torque limit for 380 VY (50 Hz characteristic)

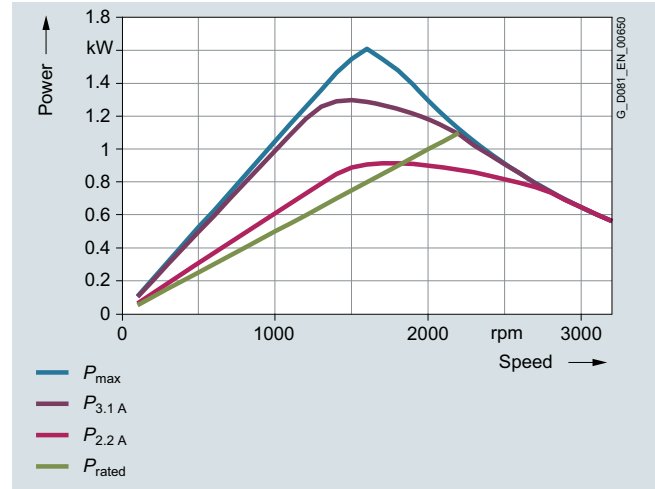

Power limit for 380 VY (50 Hz characteristic)

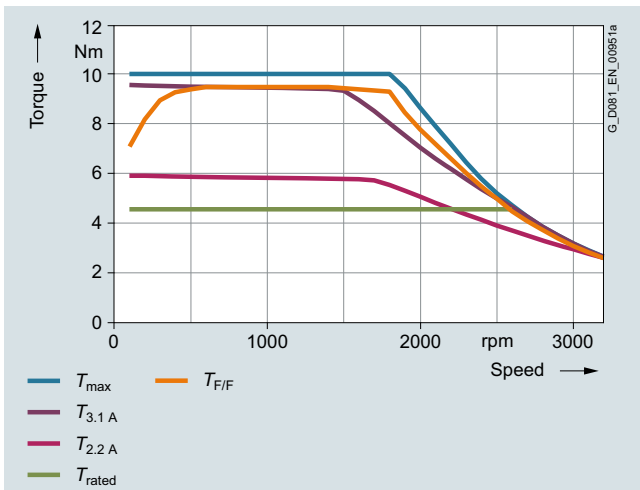

Torque limit for 440 VY (60 Hz characteristic)

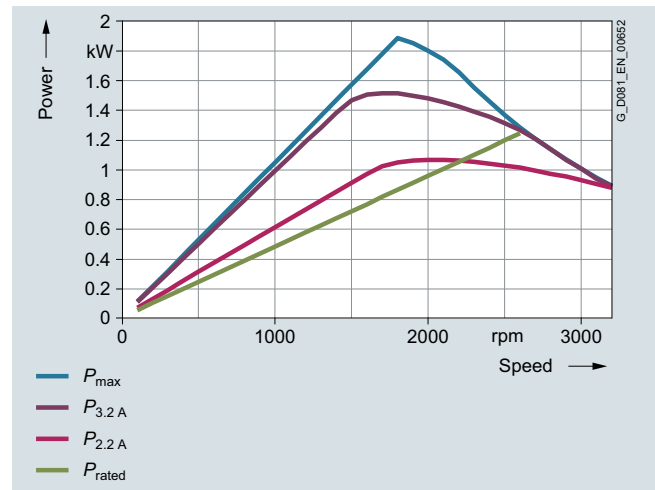

Power limit for 440 VY (60 Hz characteristic)

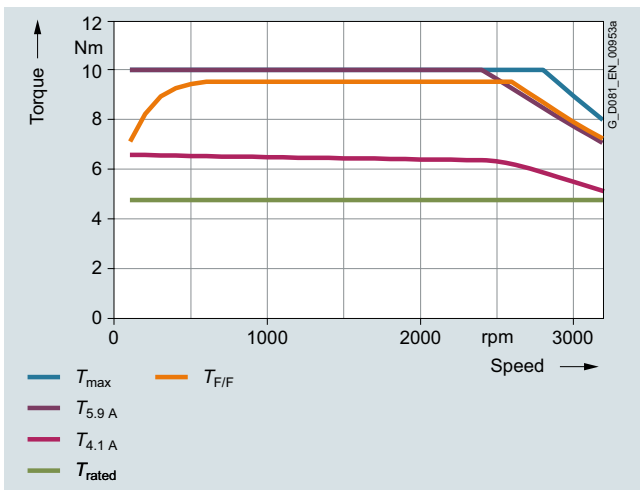

Torque limit for 380 VΔ (87 Hz characteristic)

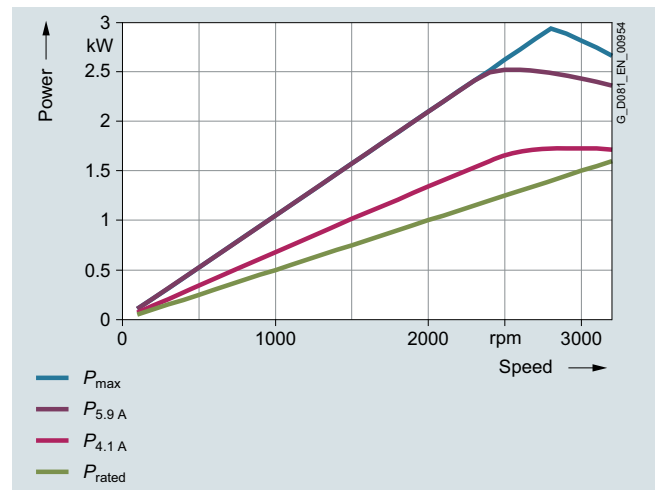

Power limit for 380 VΔ (87 Hz characteristic)

Synchronous reluctance motors for SINAMICS converters – VSD4000 line

Orientation

Technical specifications

The torque and power characteristics for converter configuration for the SIMOTICS GP/SD 1FP1.14-0DF2 motor, frame size 80 with the particular motor voltage and circuit:

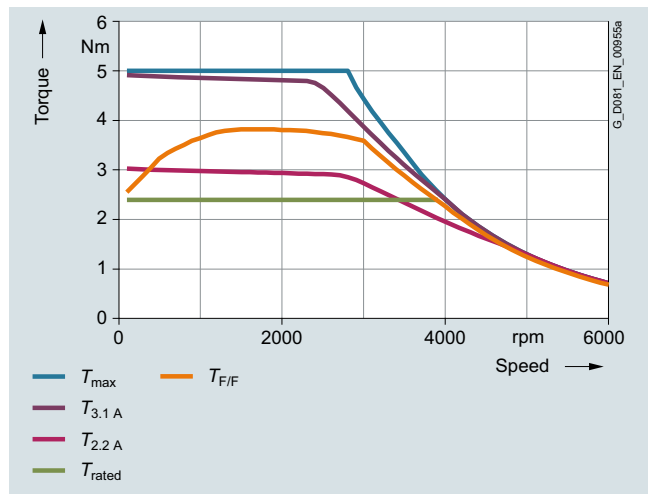

Torque limit for 380 VY (100 Hz characteristic)

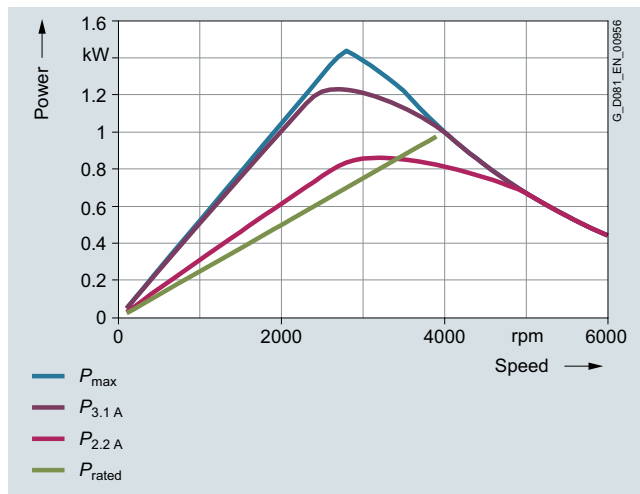

Power limit for 380 VY (100 Hz characteristic)

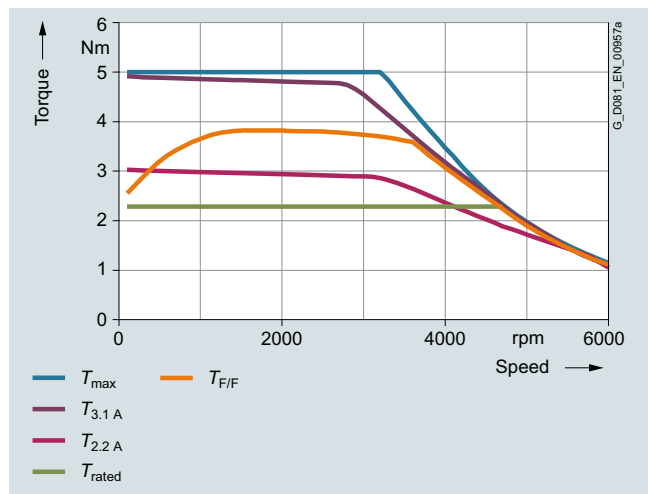

Torque limit for 440 VY (120 Hz characteristic)

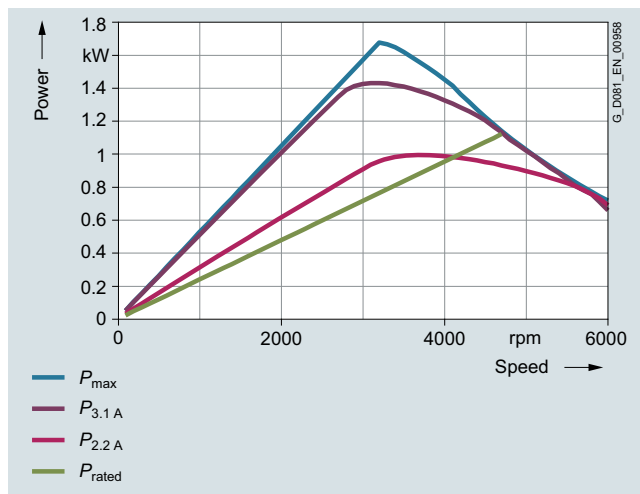

Power limit for 440 VY (120 Hz characteristic)

5

Synchronous reluctance motors for SINAMICS converters – VSD4000 line

Orientation

Technical specifications

The torque and power characteristics for converter configuration for the SIMOTICS GP/SD 1FP1.14-0DF3 motor, frame size 80 with the particular motor voltage and circuit:

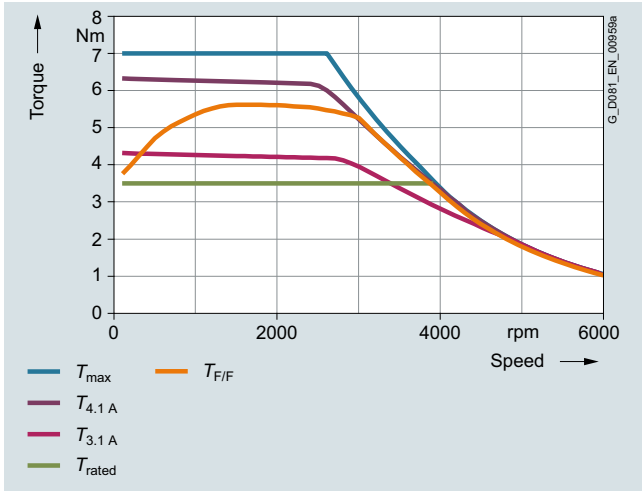

Torque limit for 380 VY (100 Hz characteristic)

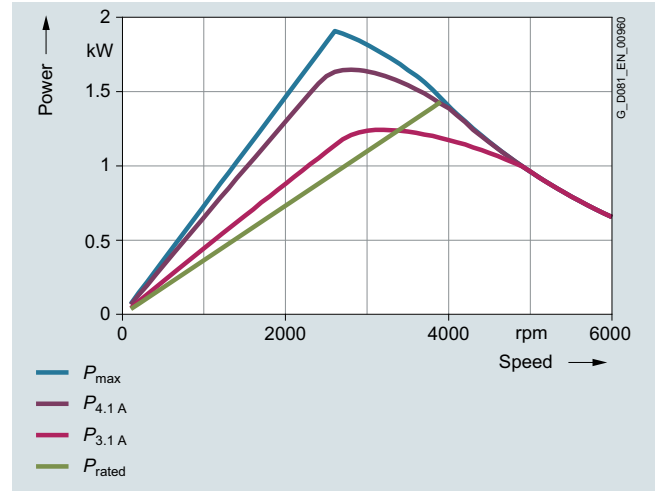

Power limit for 380 VY (100 Hz characteristic)

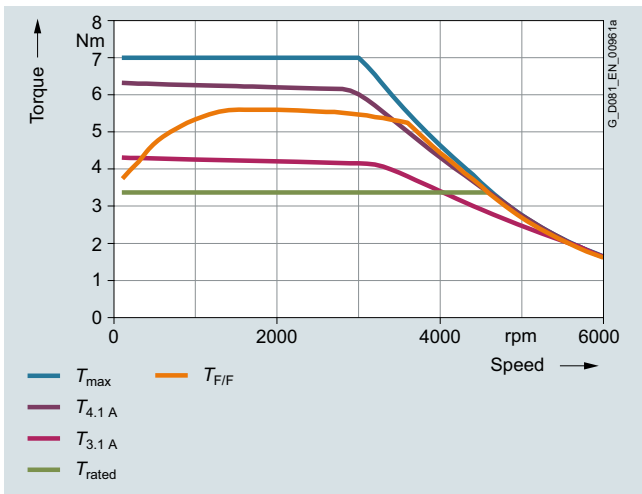

Torque limit for 440 VY (120 Hz characteristic)

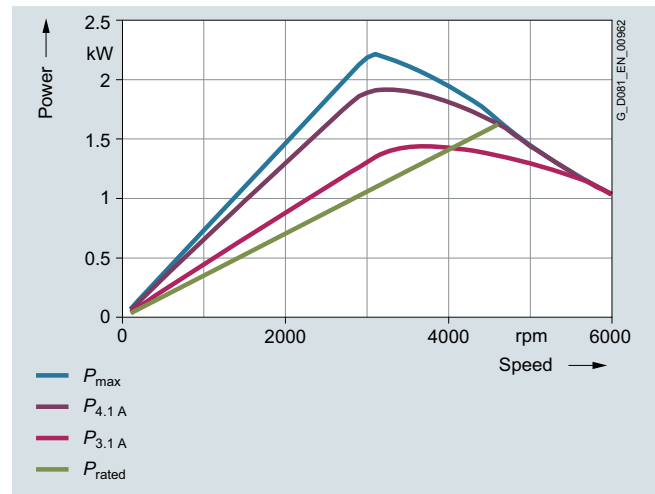

Power limit for 440 VY (120 Hz characteristic)

Synchronous reluctance motors for SINAMICS converters – VSD4000 line

Orientation

Technical specifications

The torque and power characteristics for converter configuration for the SIMOTICS GP/SD 1FP1.14-0EB0 motor, frame size 90 with the particular motor voltage and circuit:

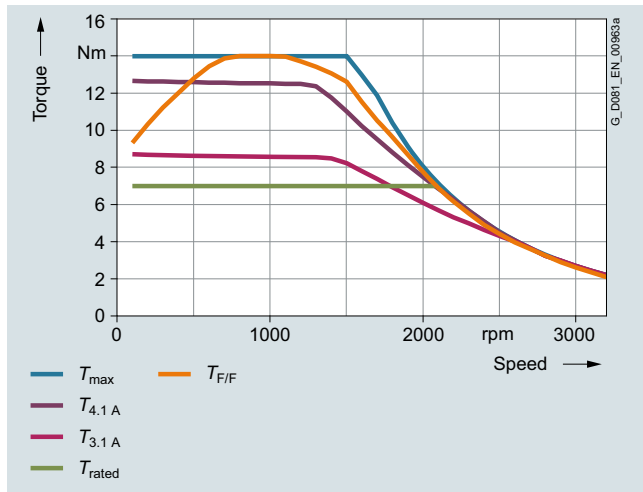

Torque limit for 380 VY (50 Hz characteristic)

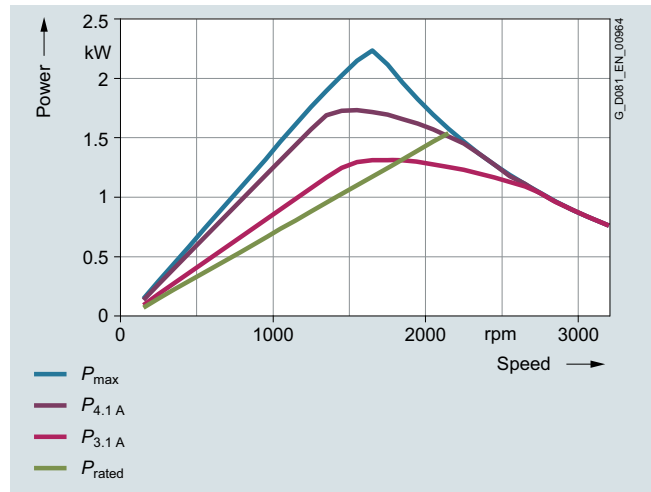

Power limit for 380 VY (50 Hz characteristic)

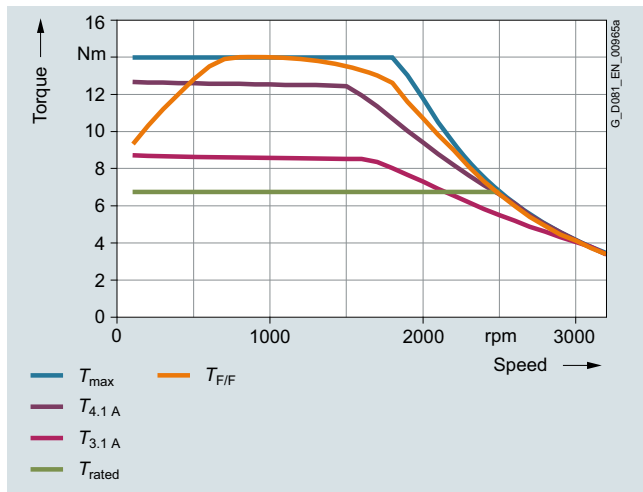

Torque limit for 440 VY (60 Hz characteristic)

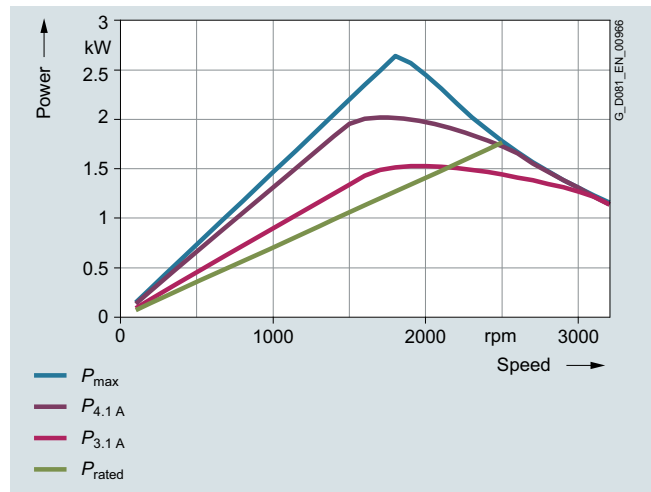

Power limit for 440 VY (60 Hz characteristic)

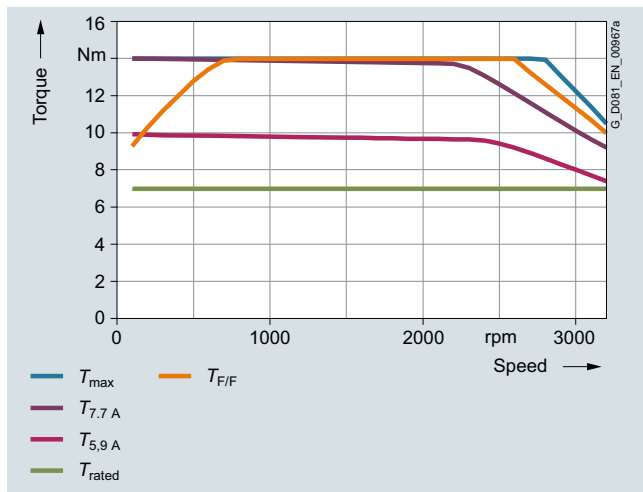

Torque limit for 380 VΔ (87 Hz characteristic)

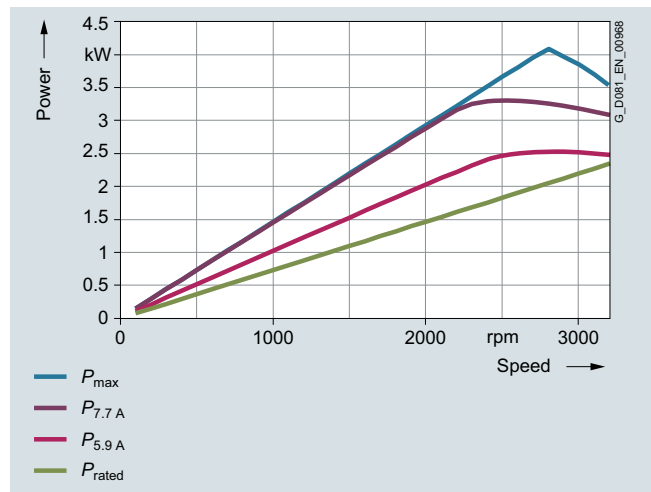

Power limit for 380 VΔ (87 Hz characteristic)

5

Synchronous reluctance motors for SINAMICS converters – VSD4000 line Orientation

Technical specifications

The torque and power characteristics for converter configuration for the SIMOTICS GP/SD 1FP1.14-0EB4 motor, frame size 90 with the particular motor voltage and circuit:

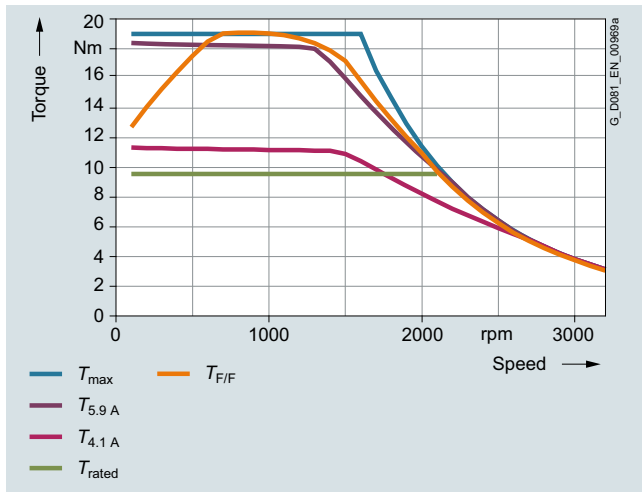

Torque limit for 380 VY (50 Hz characteristic)

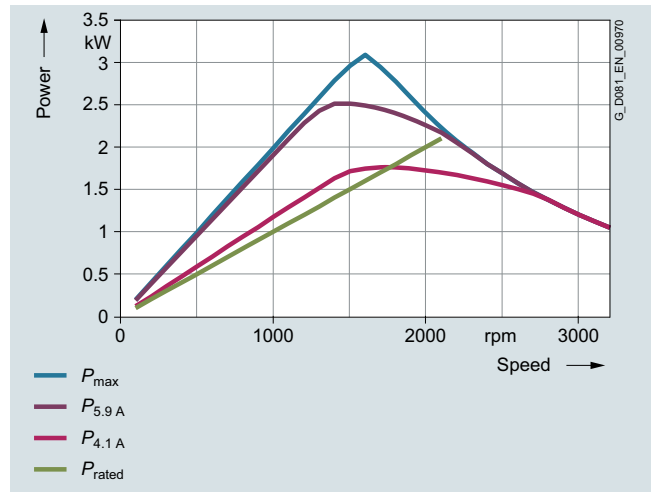

Power limit for 380 VY (50 Hz characteristic)

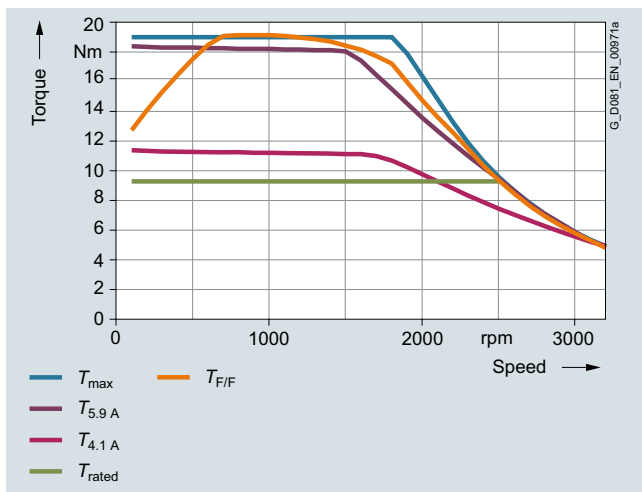

Torque limit for 440 VY (60 Hz characteristic)

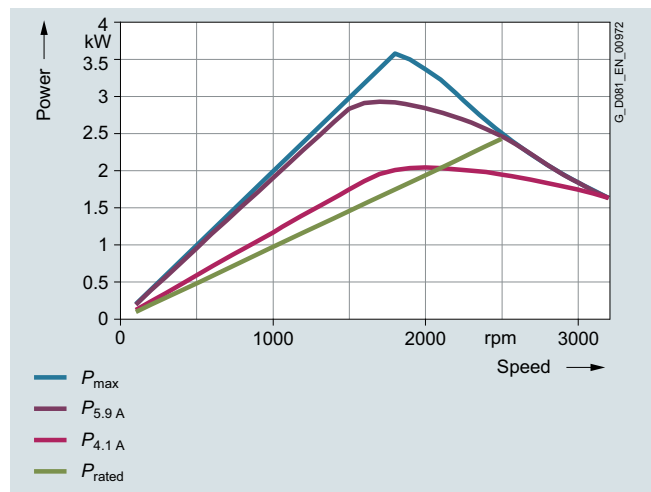

Power limit for 440 VY (60 Hz characteristic)

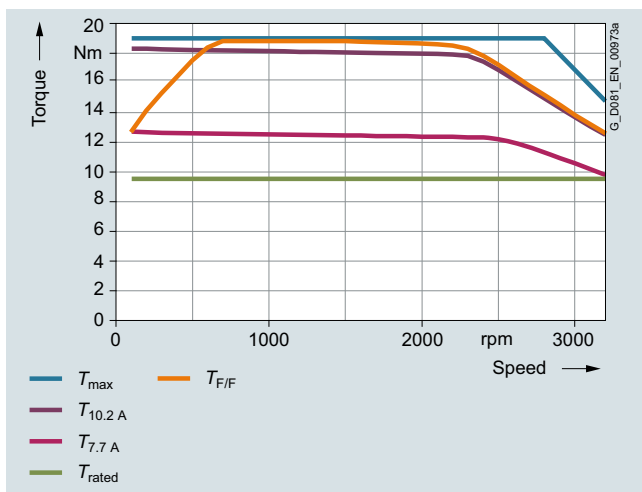

Torque limit for 380 VΔ (87 Hz characteristic)

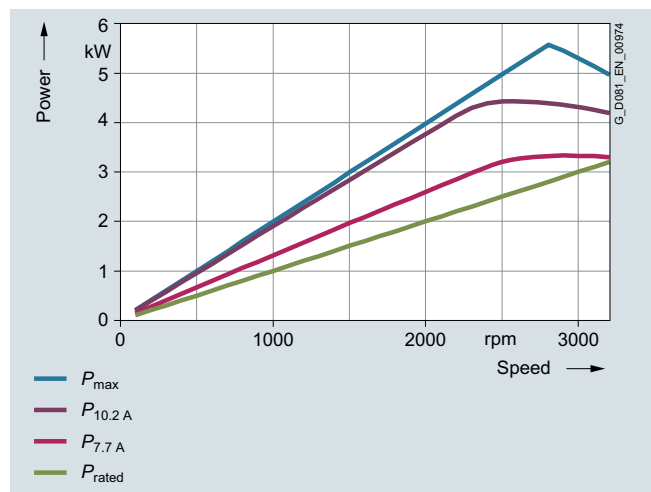

Power limit for 380 VΔ (87 Hz characteristic)

Synchronous reluctance motors for SINAMICS converters – VSD4000 line

Orientation

Technical specifications

The torque and power characteristics for converter configuration for the SIMOTICS GP/SD 1FP1.14-0EF0 motor, frame size 90 with the particular motor voltage and circuit:

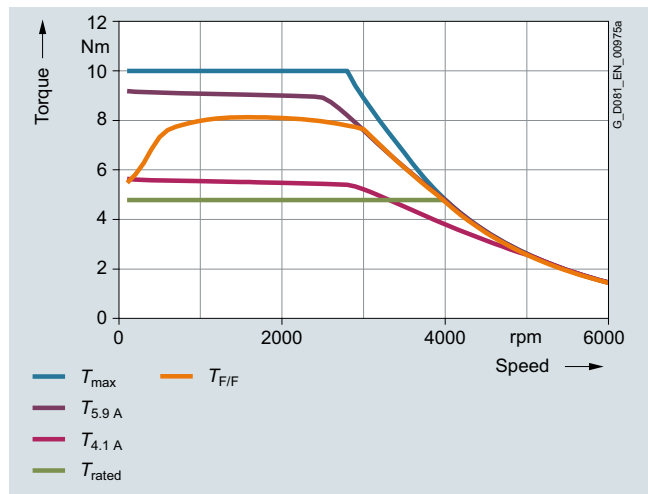

Torque limit for 380 VY (100 Hz characteristic)

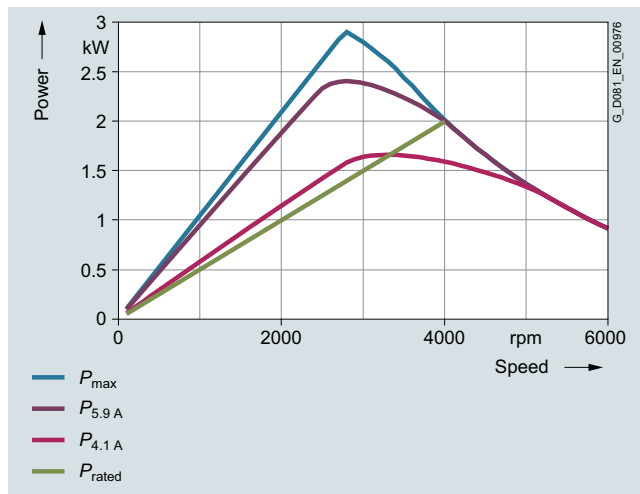

Power limit for 380 VY (100 Hz characteristic)

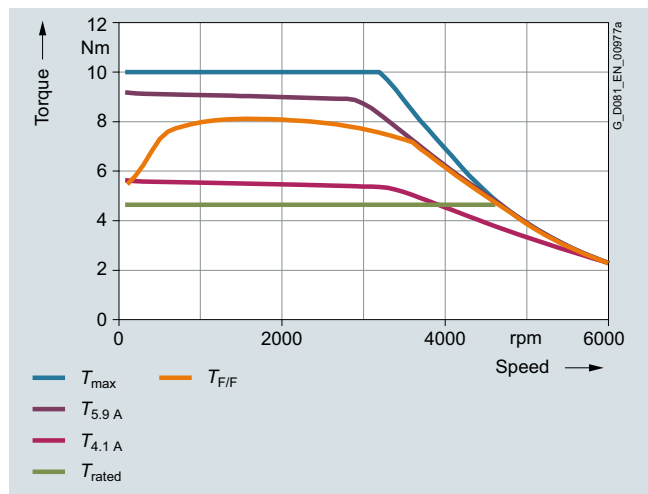

Torque limit for 440 VY (120 Hz characteristic)

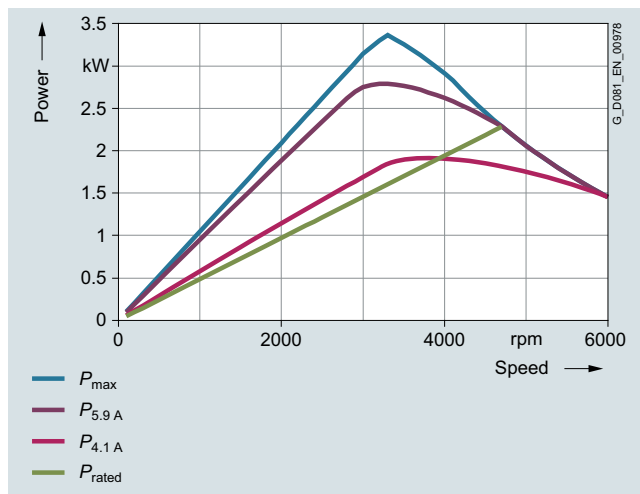

Power limit for 440 VY (120 Hz characteristic)

5

Synchronous reluctance motors for SINAMICS converters – VSD4000 line

Orientation

Technical specifications

The torque and power characteristics for converter configuration for the SIMOTICS GP/SD 1FP1.14-0EF4 motor, frame size 90 with the particular motor voltage and circuit:

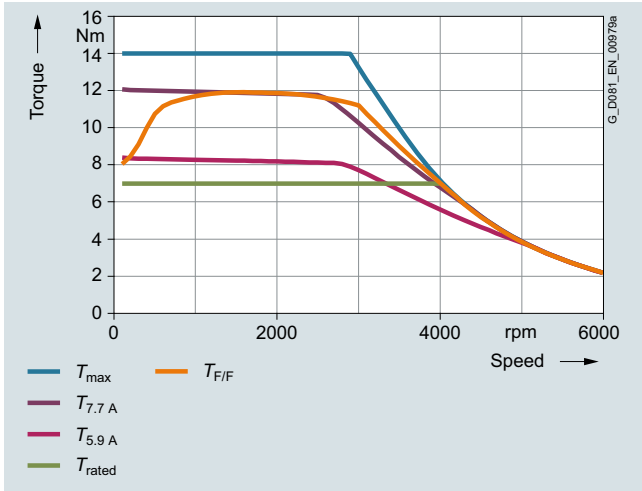

Torque limit for 380 VY (100 Hz characteristic)

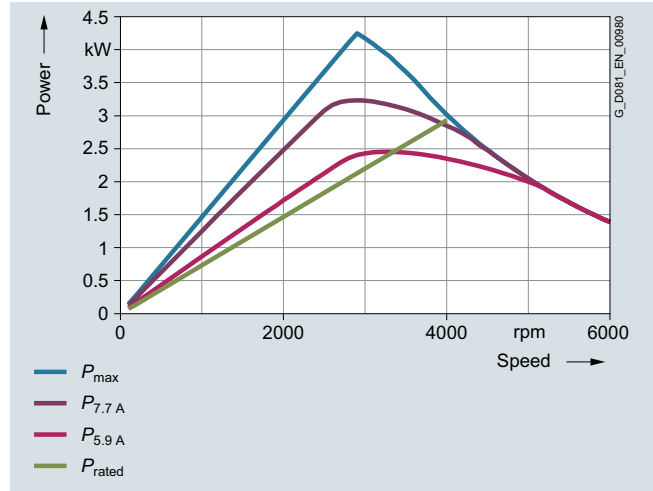

Power limit for 380 VY (100 Hz characteristic)

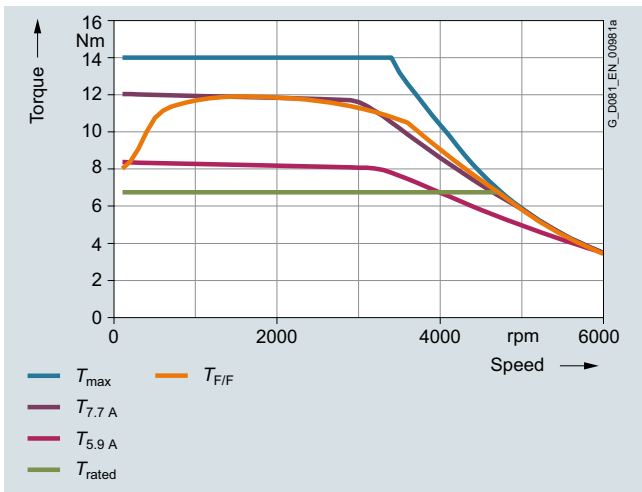

Torque limit for 440 VY (120 Hz characteristic)

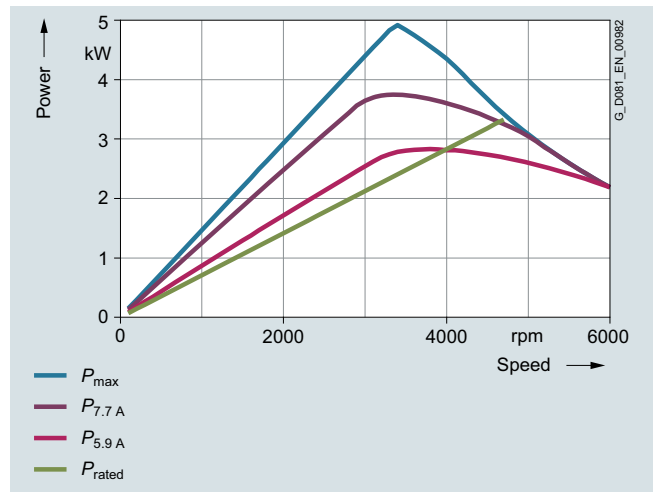

Power limit for 440 VY (120 Hz characteristic)

Synchronous reluctance motors for SINAMICS converters – VSD4000 line

Orientation

Technical specifications

The torque and power characteristics for converter configuration for the SIMOTICS GP/SD 1FP1.14-1BB0 motor, frame size 112 with the particular motor voltage and circuit:

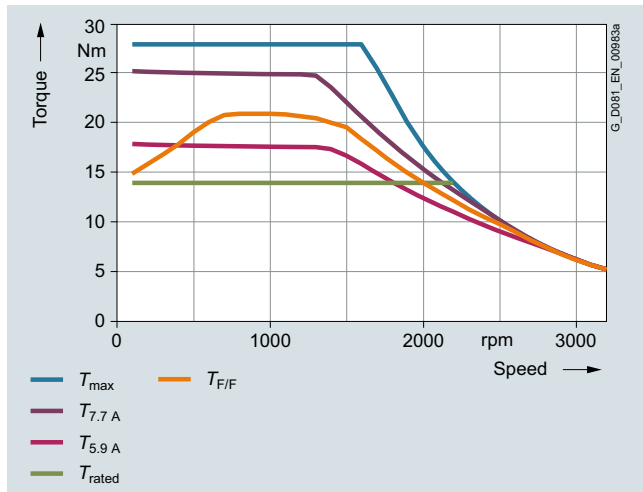

Torque limit for 380 VY (50 Hz characteristic)

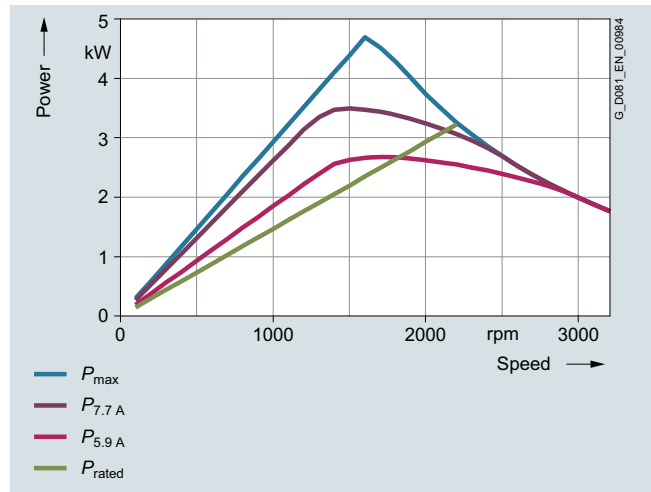

Power limit for 380 VY (50 Hz characteristic)

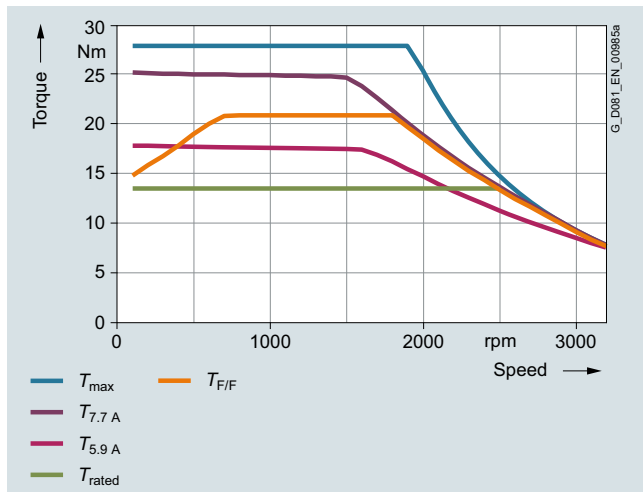

Torque limit for 440 VY (60 Hz characteristic)

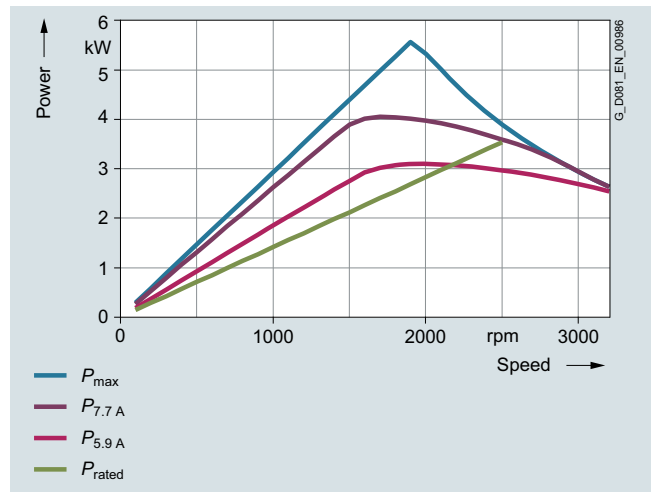

Power limit for 440 VY (60 Hz characteristic)

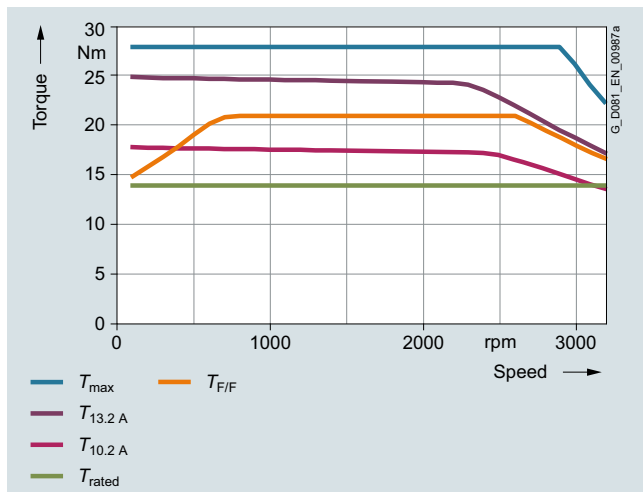

Torque limit for 380 VΔ (87 Hz characteristic)

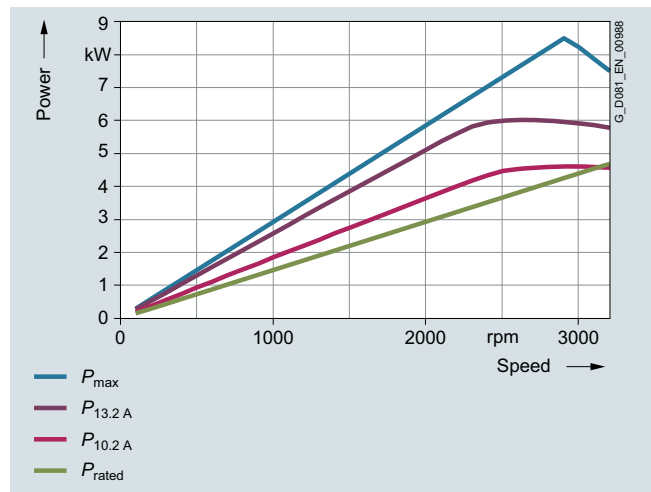

Power limit for 380 VΔ (87 Hz characteristic)

5

Synchronous reluctance motors for SINAMICS converters – VSD4000 line Orientation

Technical specifications

The torque and power characteristics for converter configuration for the SIMOTICS GP/SD 1FP1.14-1BB1 motor, frame size 112 with the particular motor voltage and circuit:

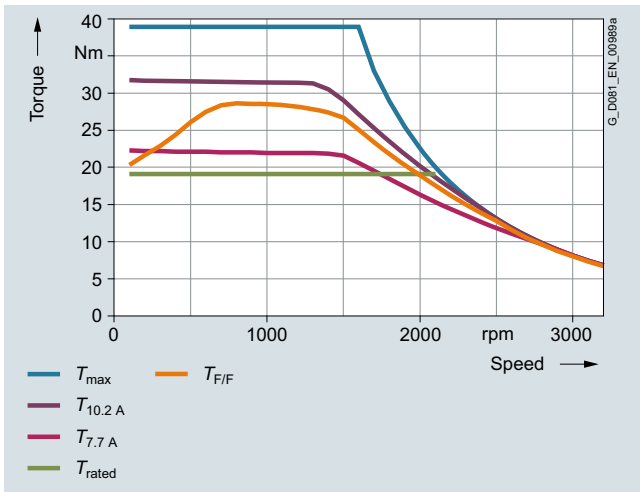

Torque limit for 380 VY (50 Hz characteristic)

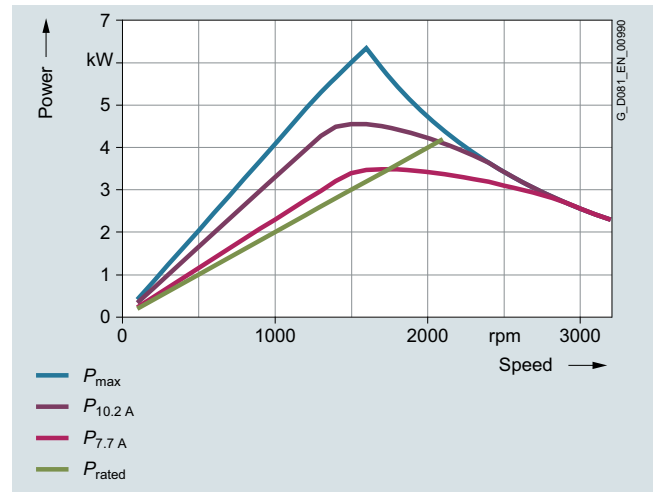

Power limit for 380 VY (50 Hz characteristic)

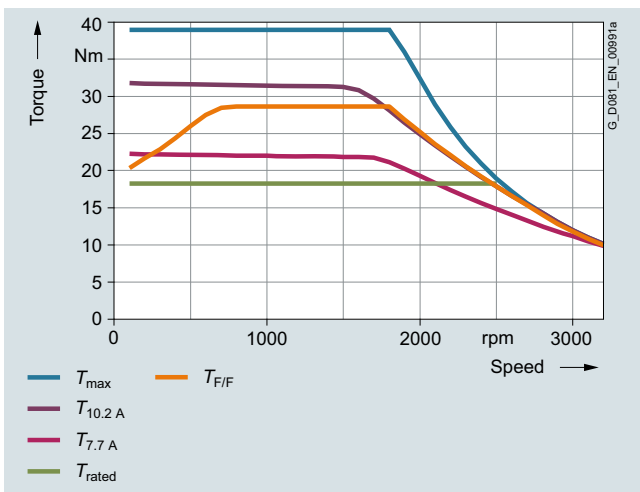

Torque limit for 440 VY (60 Hz characteristic)

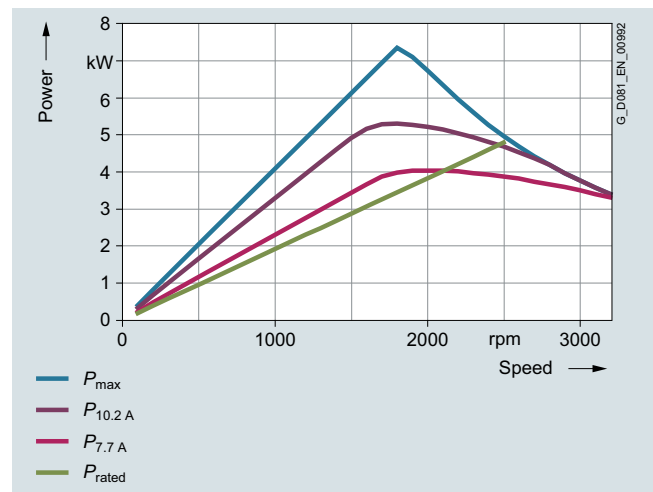

Power limit for 440 VY (60 Hz characteristic)

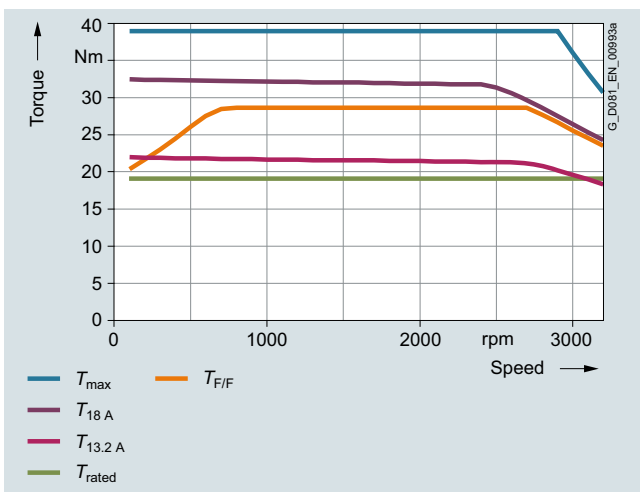

Torque limit for 380 VΔ (87 Hz characteristic)

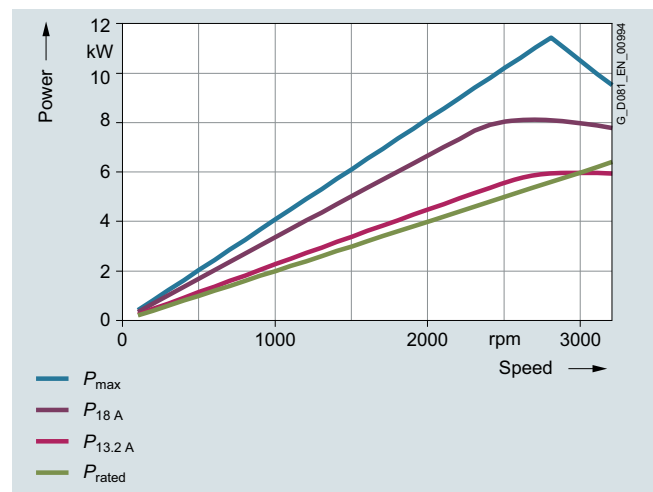

Power limit for 380 VΔ (87 Hz characteristic)

Synchronous reluctance motors for SINAMICS converters – VSD4000 line

Orientation

Technical specifications

The torque and power characteristics for converter configuration for the SIMOTICS GP/SD 1FP1.14-1BB2 motor, frame size 112 with the particular motor voltage and circuit:

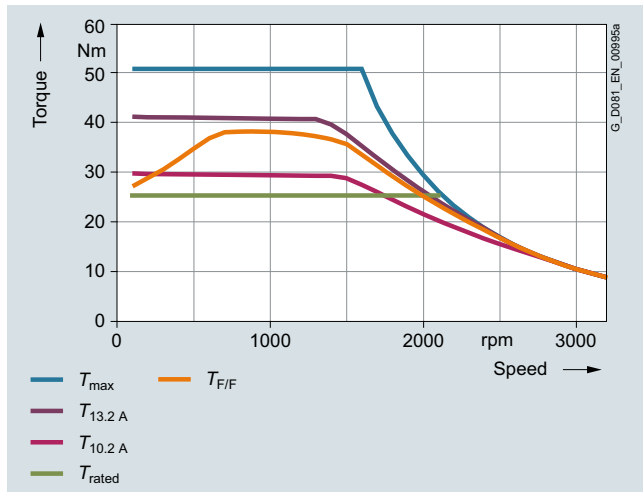

Torque limit for 380 VY (50 Hz characteristic)

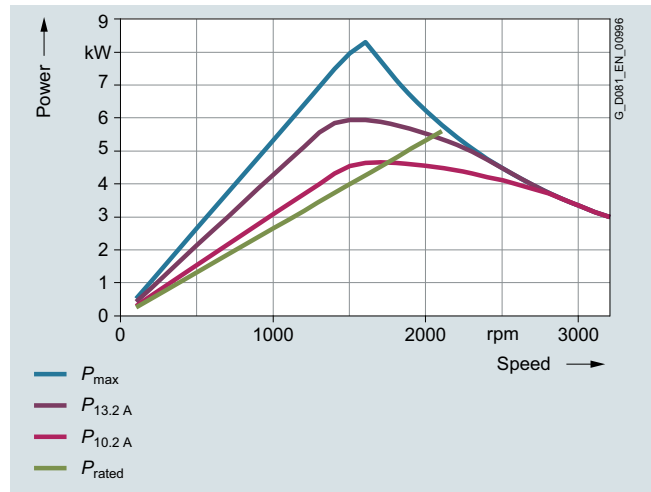

Power limit for 380 VY (50 Hz characteristic)

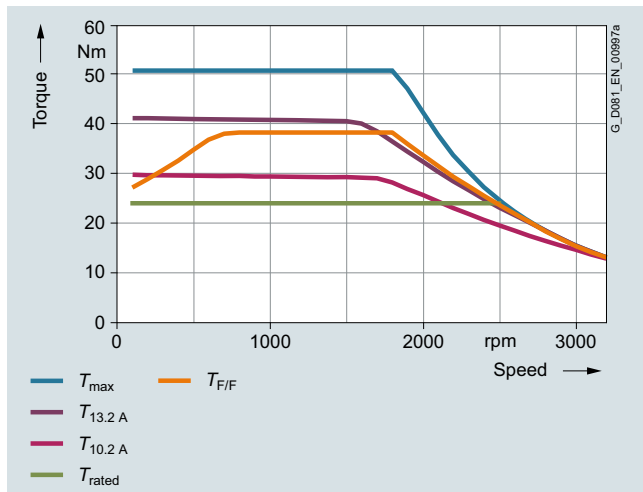

Torque limit for 440 VY (60 Hz characteristic)

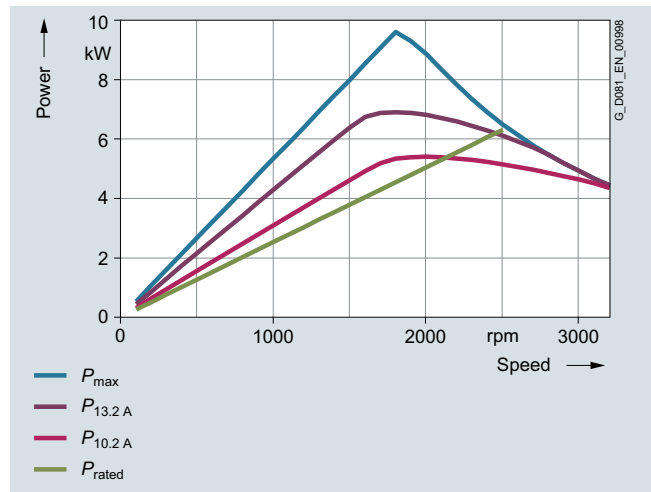

Power limit for 440 VY (60 Hz characteristic)

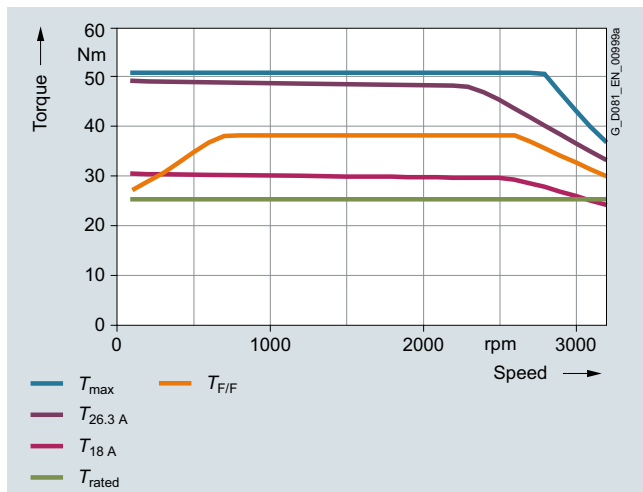

Torque limit for 380 VΔ (87 Hz characteristic)

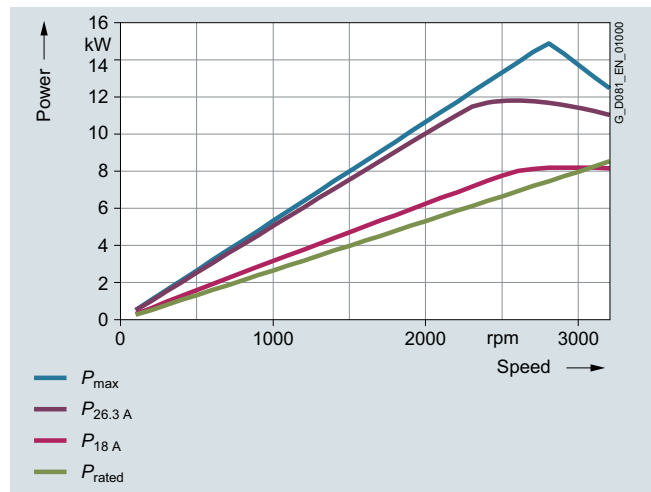

Power limit for 380 VΔ (87 Hz characteristic)

5

Synchronous reluctance motors for SINAMICS converters – VSD4000 line

Orientation

Technical specifications

The torque and power characteristics for converter configuration for the SIMOTICS SD 1FP1514-1BF1 motor, frame size 112 with the particular motor voltage and circuit:

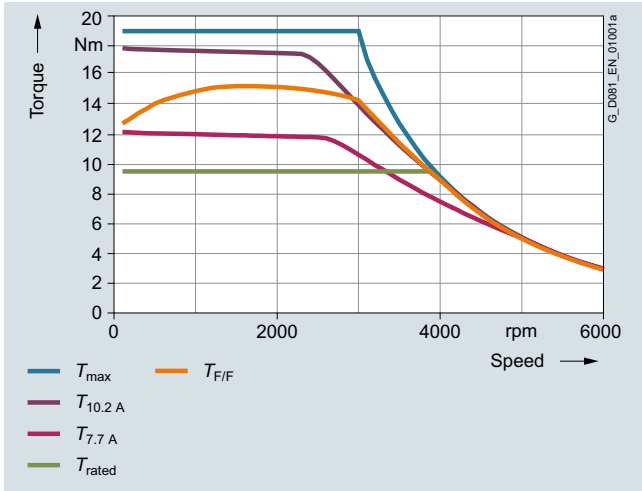

Torque limit for 380 VY (100 Hz characteristic)

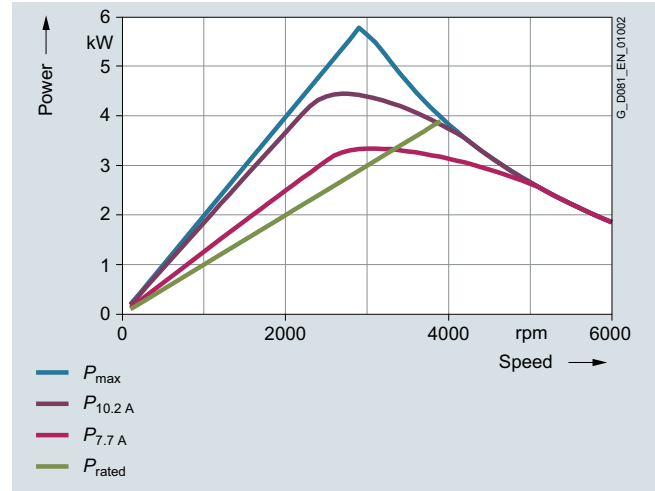

Power limit for 380 VY (100 Hz characteristic)

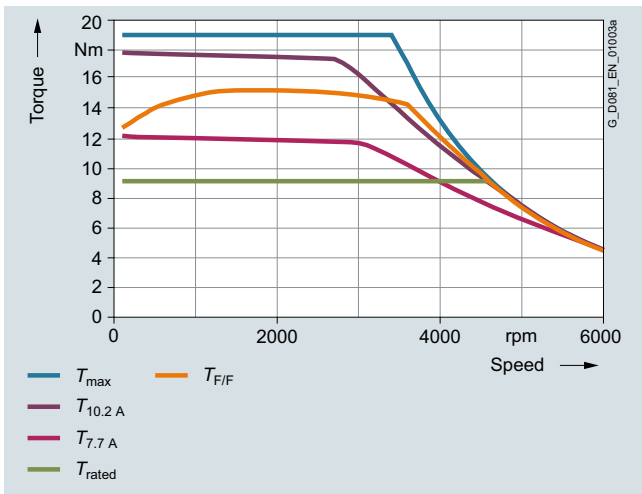

Torque limit for 440 VY (120 Hz characteristic)

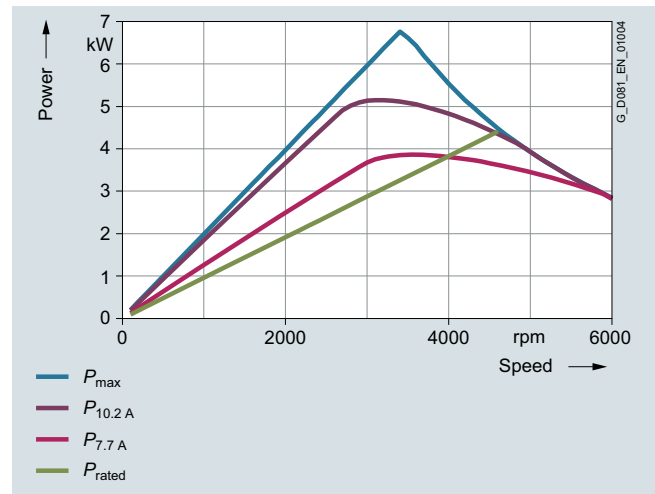

Power limit for 440 VY (120 Hz characteristic)

Synchronous reluctance motors for SINAMICS converters – VSD4000 line

Orientation

Technical specifications

The torque and power characteristics for converter configuration for the SIMOTICS GP/SD 1FP1.14-1BF2 motor, frame size 112 with the particular motor voltage and circuit:

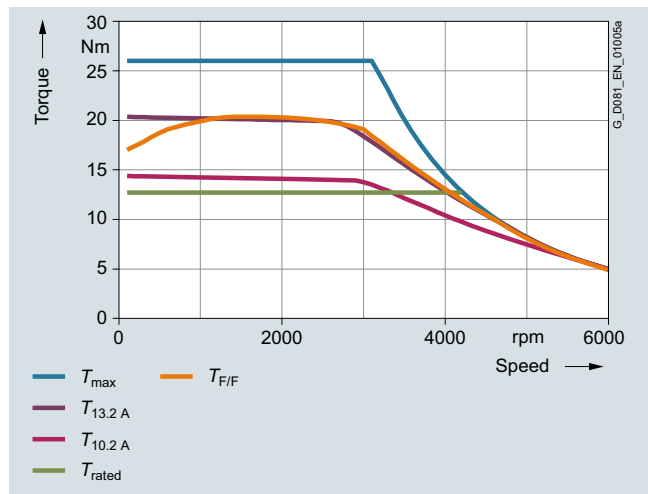

Torque limit for 380 VY (100 Hz characteristic)

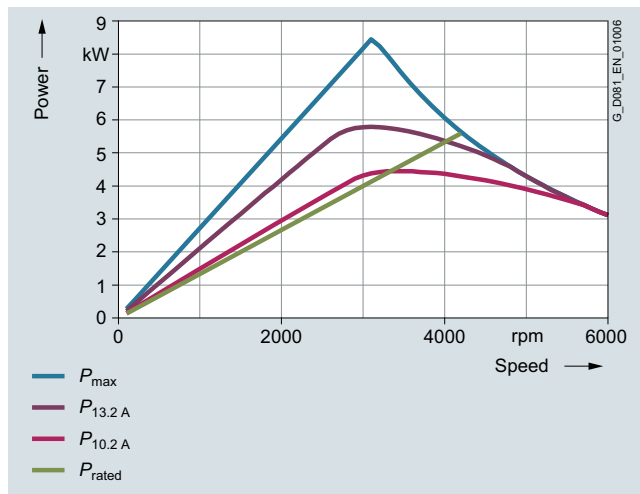

Power limit for 380 VY (100 Hz characteristic)

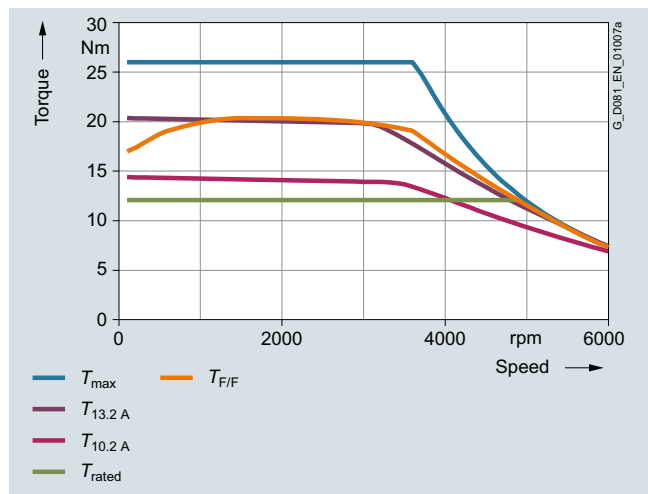

Torque limit for 440 VY (120 Hz characteristic)

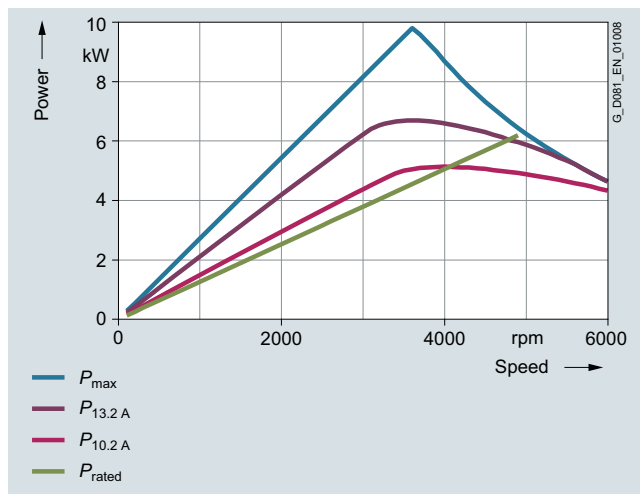

Power limit for 440 VY (120 Hz characteristic)

5

Synchronous reluctance motors for SINAMICS converters – VSD4000 line Orientation

Technical specifications

The torque and power characteristics for converter configuration for the SIMOTICS GP/SD 1FP1.14-1CB0 motor, frame size 132 with the particular motor voltage and circuit:

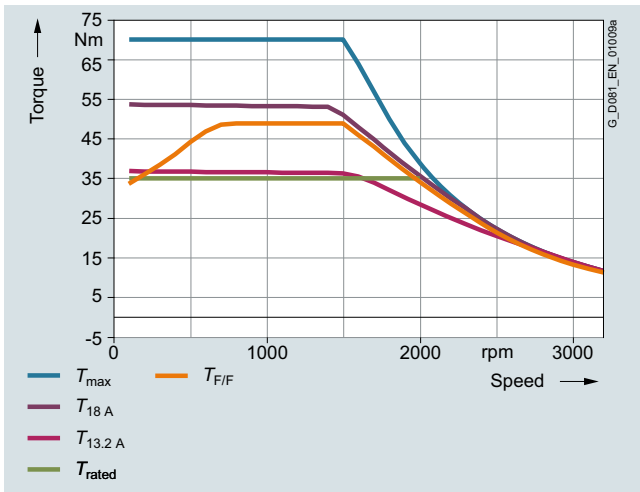

Torque limit for 380 VY (50 Hz characteristic)

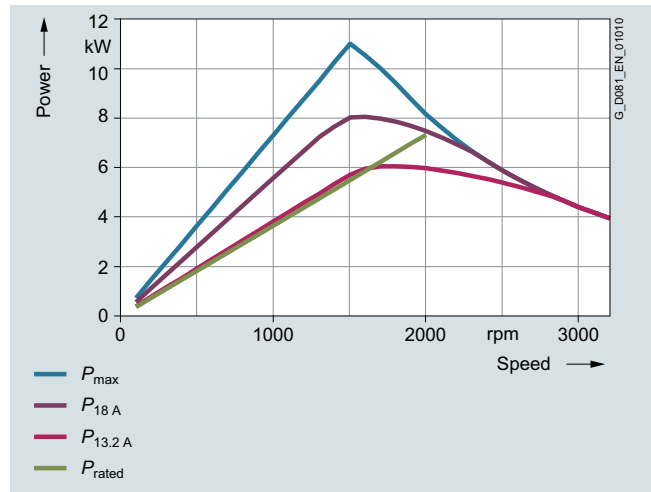

Power limit for 380 VY (50 Hz characteristic)

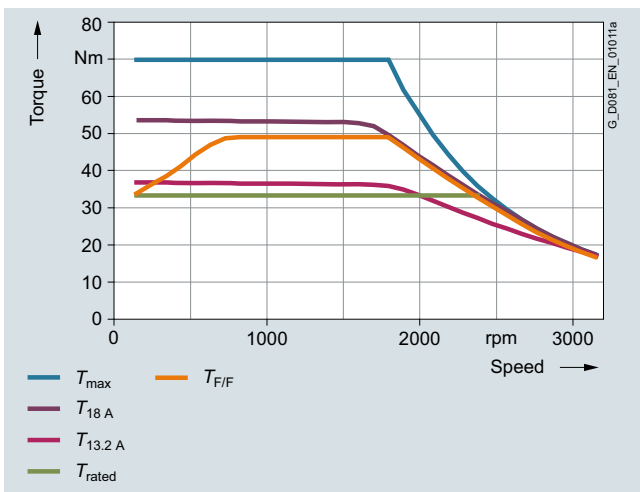

Torque limit for 440 VY (60 Hz characteristic)

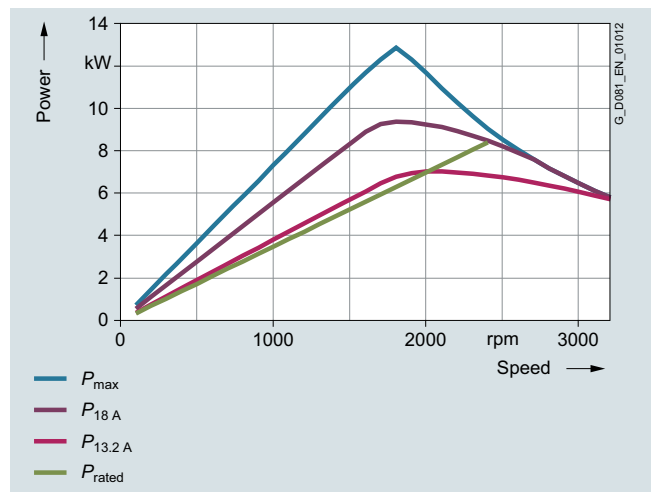

Power limit for 440 VY (60 Hz characteristic)

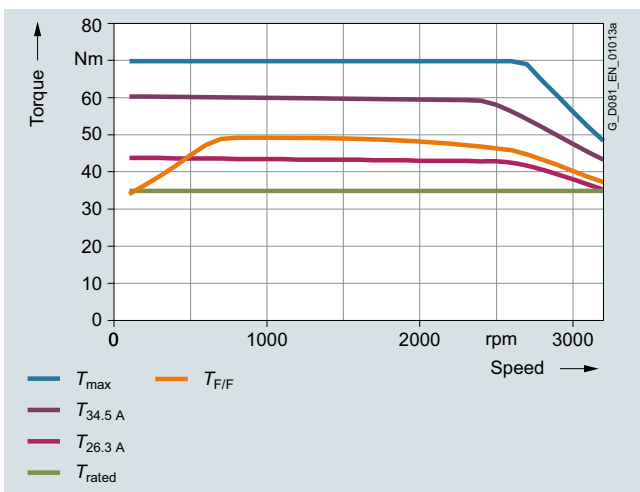

Torque limit for 380 VΔ (87 Hz characteristic)

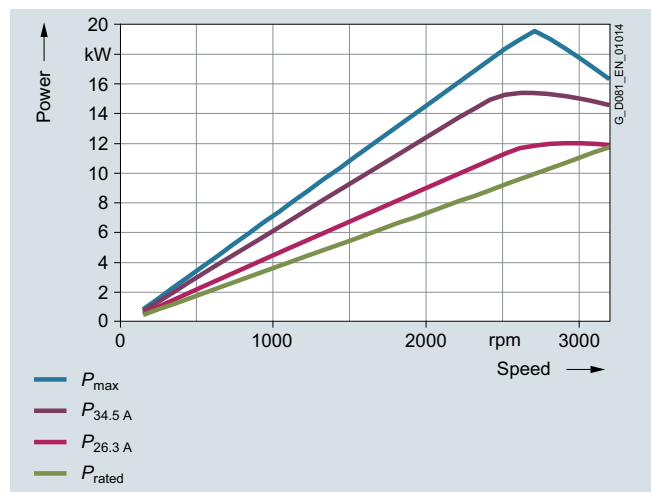

Power limit for 380 VΔ (87 Hz characteristic)

Synchronous reluctance motors for SINAMICS converters – VSD4000 line

Orientation

Technical specifications

The torque and power characteristics for converter configuration for the SIMOTICS GP/SD 1FP1.14-1CB2 motor, frame size 132 with the particular motor voltage and circuit:

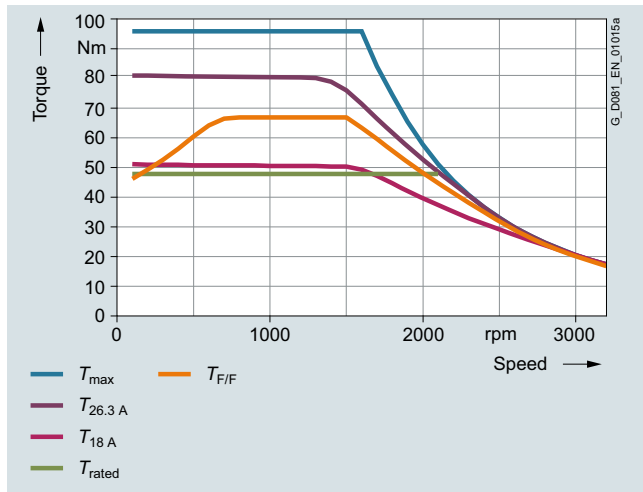

Torque limit for 380 VY (50 Hz characteristic)

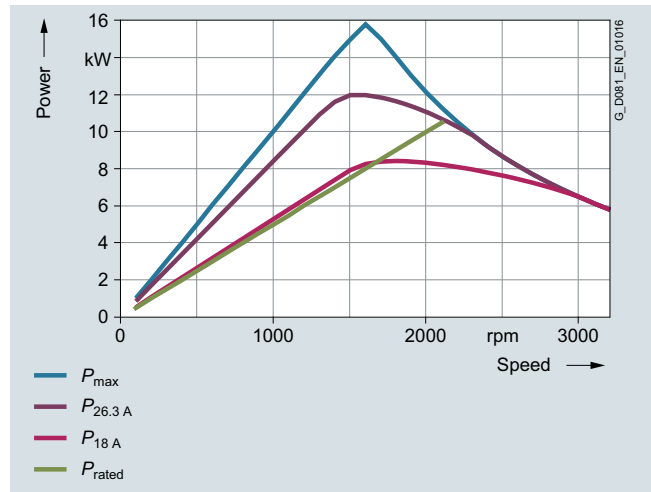

Power limit for 380 VY (50 Hz characteristic)

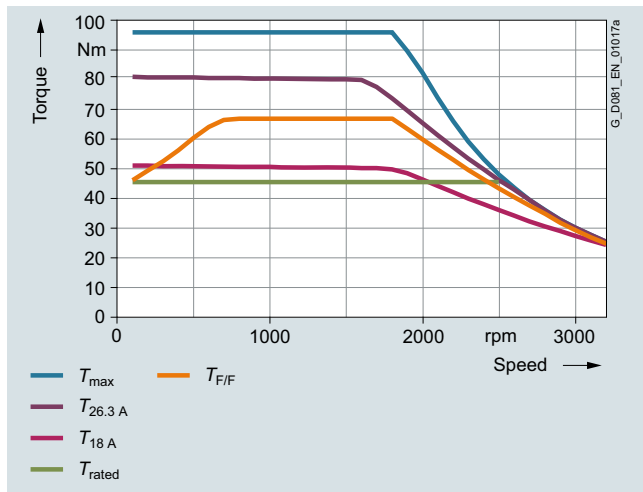

Torque limit for 440 VY (60 Hz characteristic)

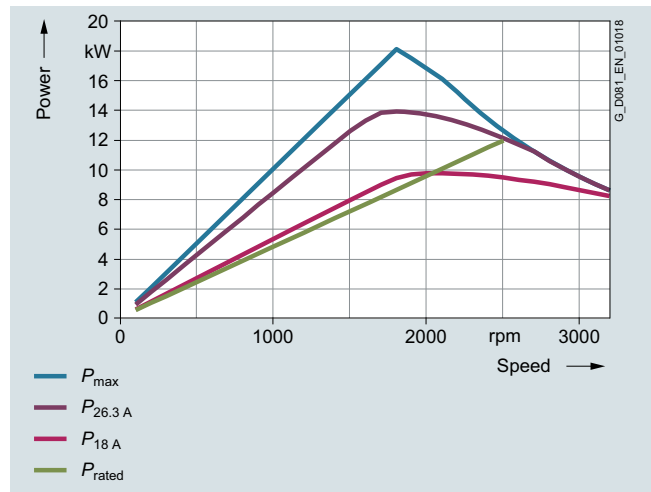

Power limit for 440 VY (60 Hz characteristic)

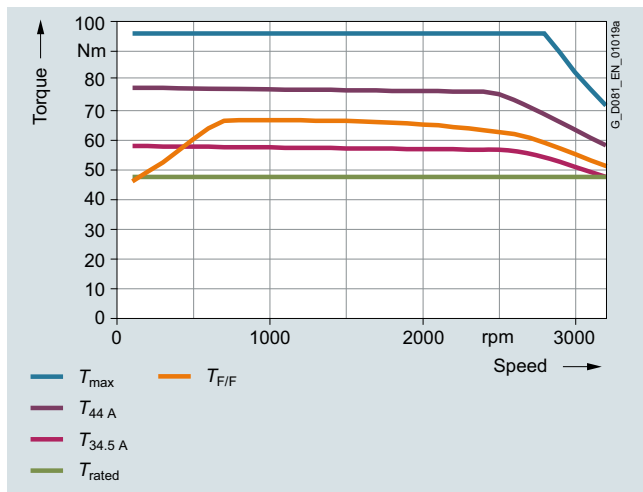

Torque limit for 380 VΔ (87 Hz characteristic)

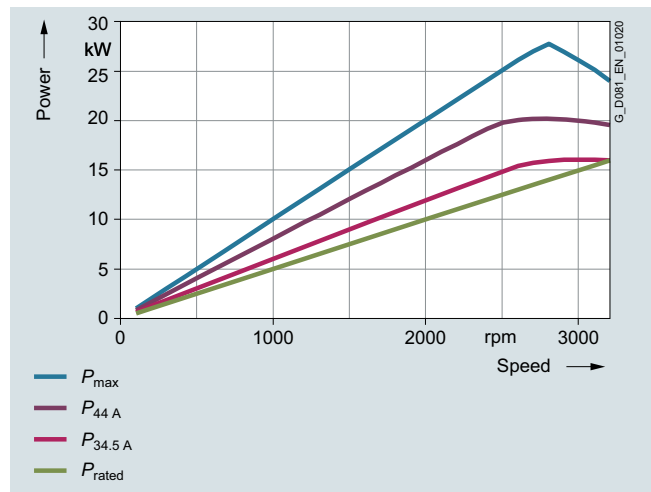

Power limit for 380 VΔ (87 Hz characteristic)

5

Synchronous reluctance motors for SINAMICS converters – VSD4000 line

Orientation

Technical specifications

The torque and power characteristics for converter configuration for the SIMOTICS GP/SD 1FP1.14-1CF0 motor, frame size 132 with the particular motor voltage and circuit:

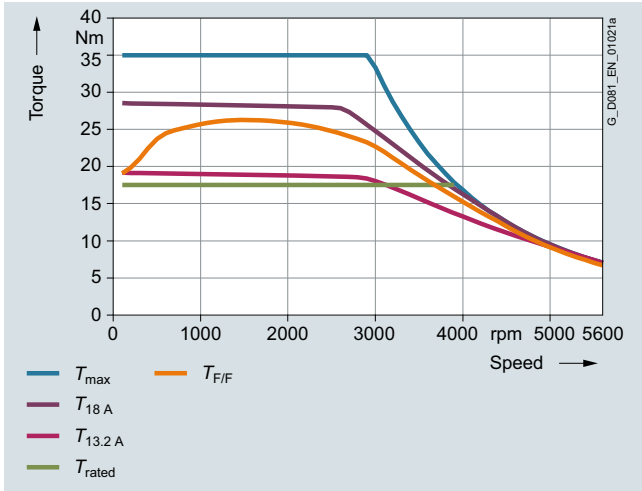

Torque limit for 380 VY (100 Hz characteristic)

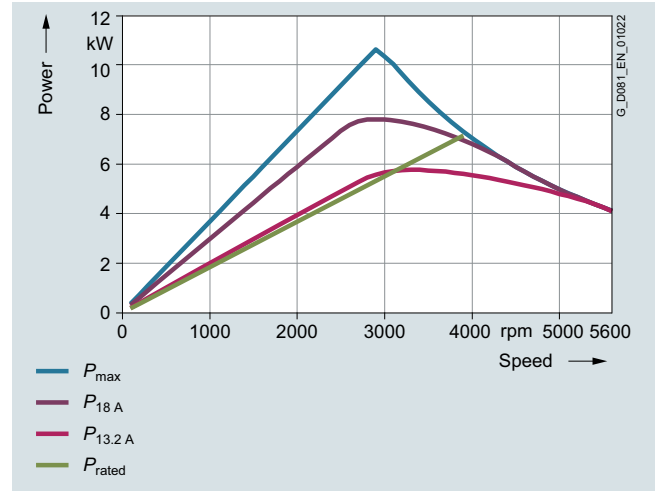

Power limit for 380 VY (100 Hz characteristic)

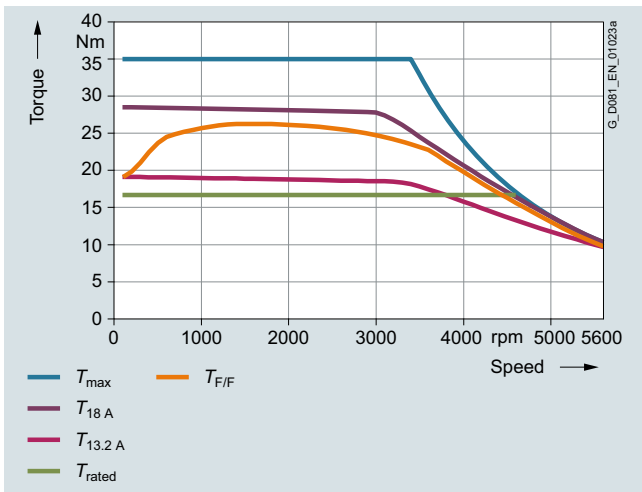

Torque limit for 440 VY (120 Hz characteristic)

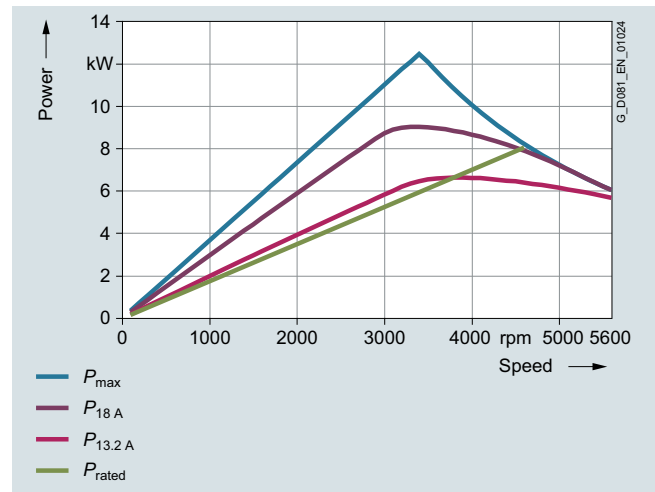

Power limit for 440 VY (120 Hz characteristic)

Synchronous reluctance motors for SINAMICS converters – VSD4000 line

Orientation

Technical specifications

The torque and power characteristics for converter configuration for the SIMOTICS GP/SD 1FP1.14-1CF1 motor, frame size 132 with the particular motor voltage and circuit:

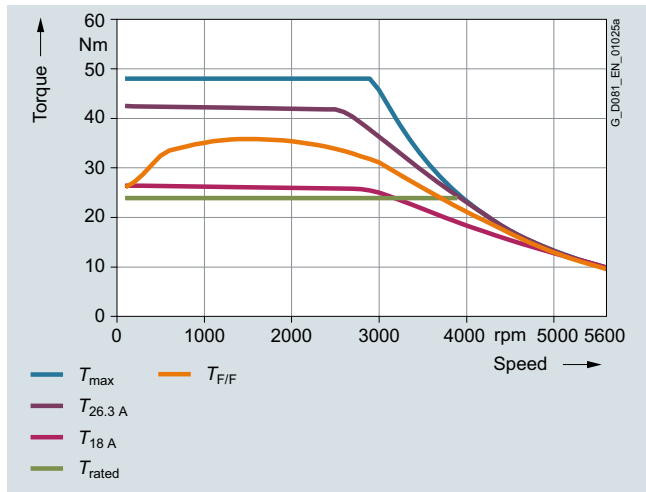

Torque limit for 380 VY (100 Hz characteristic)

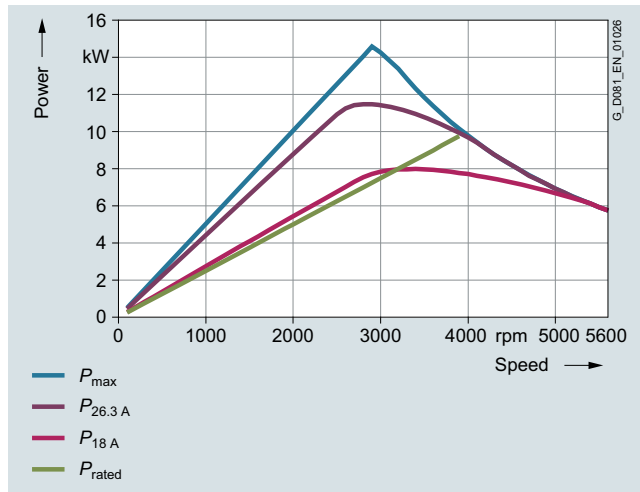

Power limit for 380 VY (100 Hz characteristic)

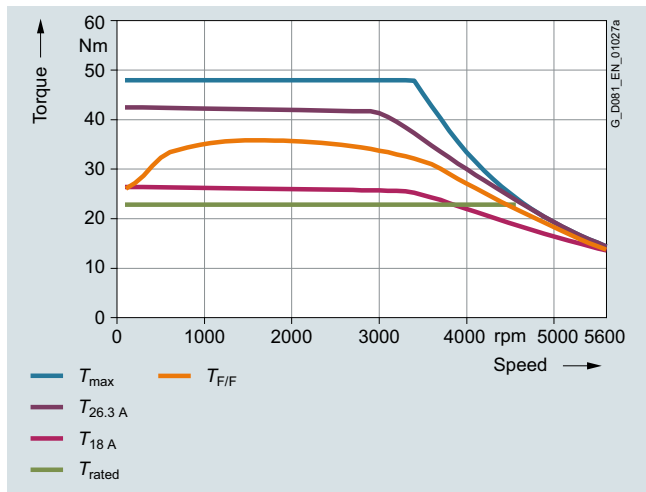

Torque limit for 440 VY (120 Hz characteristic)

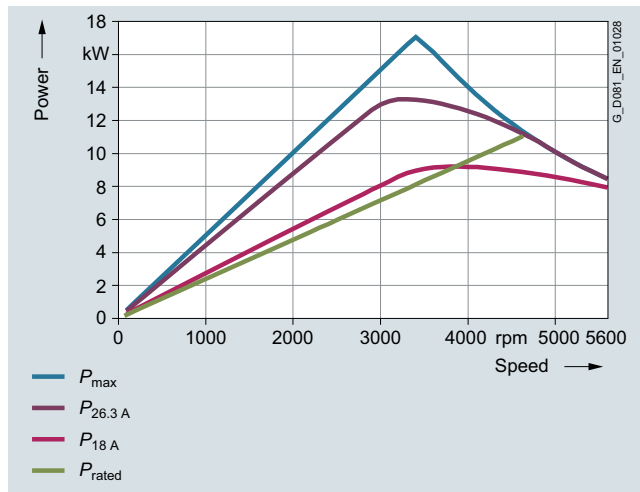

Power limit for 440 VY (120 Hz characteristic)

Synchronous reluctance motors for SINAMICS converters – VSD4000 line Orientation

Technical specifications

The torque and power characteristics for converter configuration for the SIMOTICS GP/SD 1FP1.14-1DB2 motor, frame size 160 with the particular motor voltage and circuit:

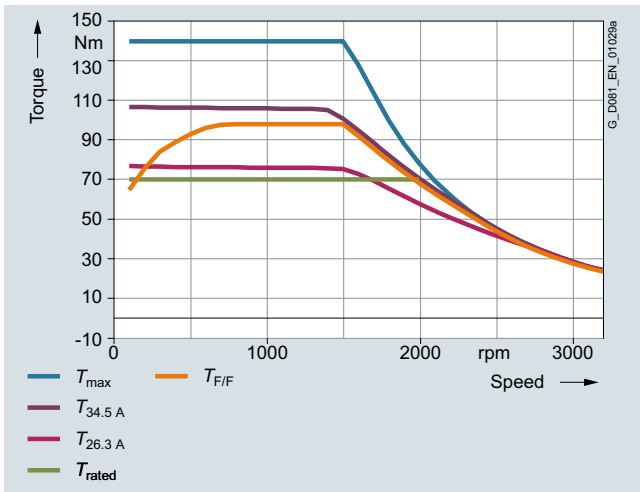

Torque limit for 380 VY (50 Hz characteristic)

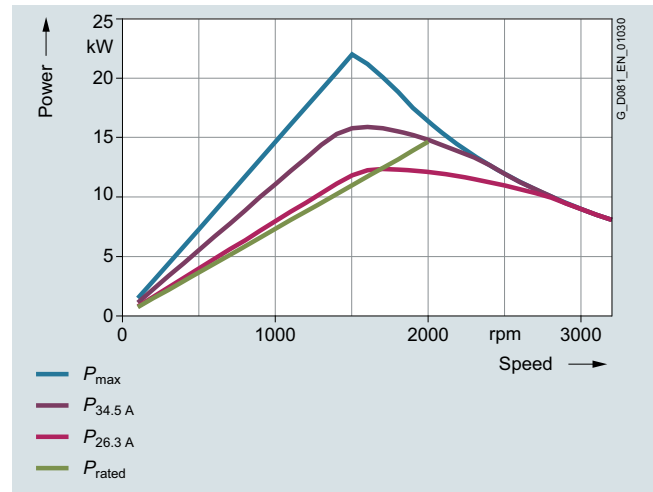

Power limit for 380 VY (50 Hz characteristic)

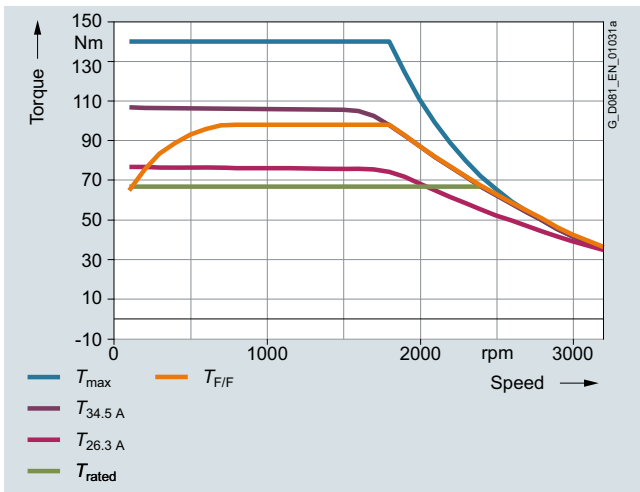

Torque limit for 440 VY (60 Hz characteristic)

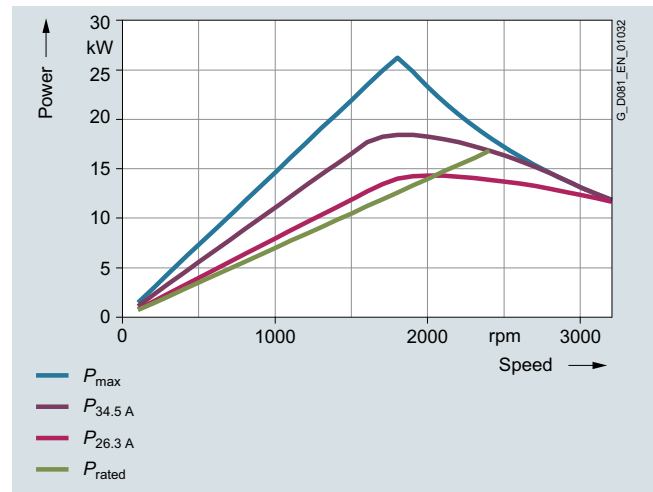

Power limit for 440 VY (60 Hz characteristic)

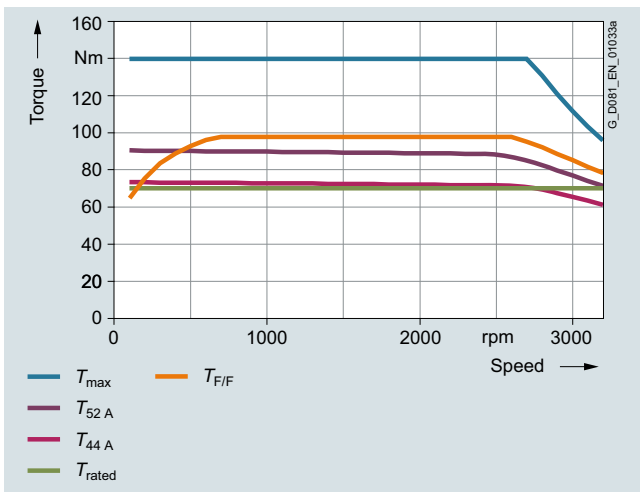

Torque limit for 380 VΔ (87 Hz characteristic)

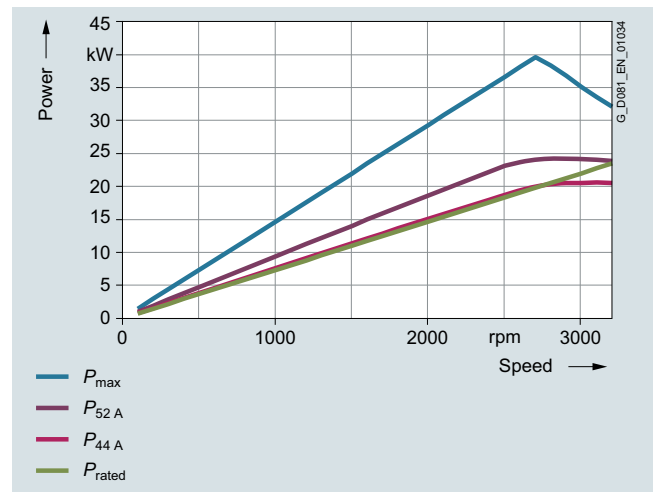

Power limit for 380 VΔ (87 Hz characteristic)

Synchronous reluctance motors for SINAMICS converters – VSD4000 line

Orientation

Technical specifications

The torque and power characteristics for converter configuration for the SIMOTICS GP/SD 1FP1.14-1DB4 motor, frame size 160 with the particular motor voltage and circuit:

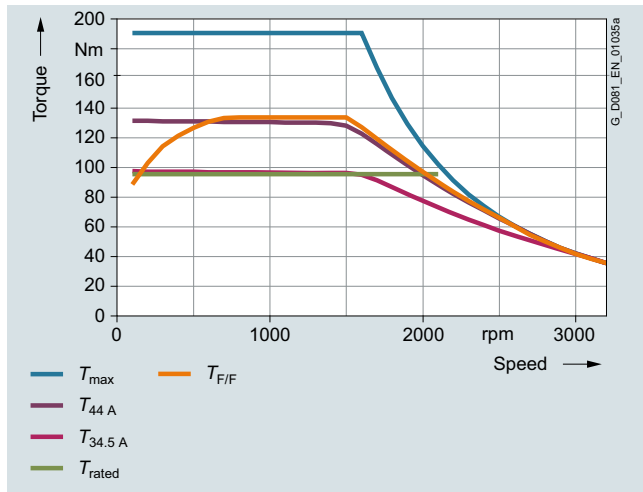

Torque limit for 380 VY (50 Hz characteristic)

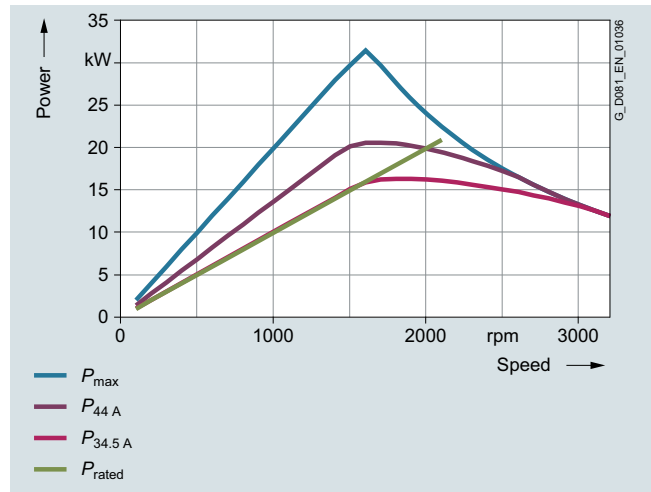

Power limit for 380 VY (50 Hz characteristic)

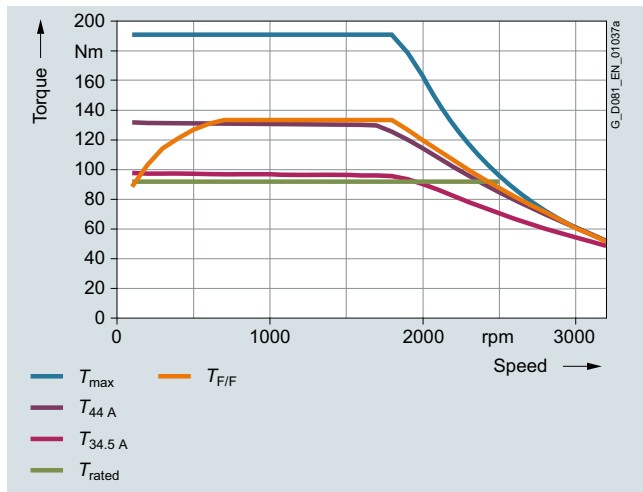

Torque limit for 440 VY (60 Hz characteristic)

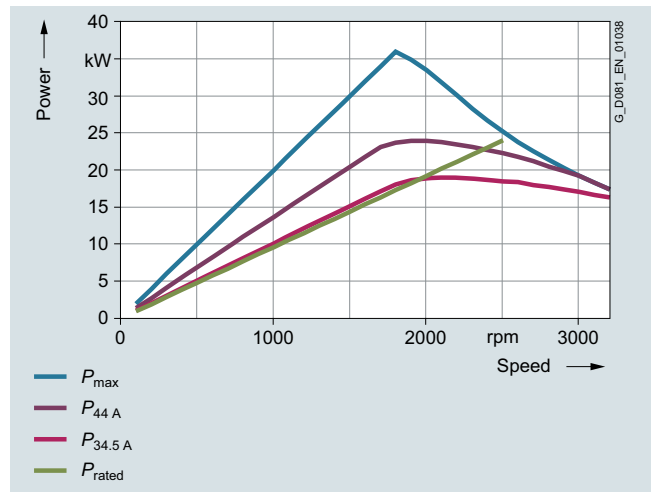

Power limit for 440 VY (60 Hz characteristic)

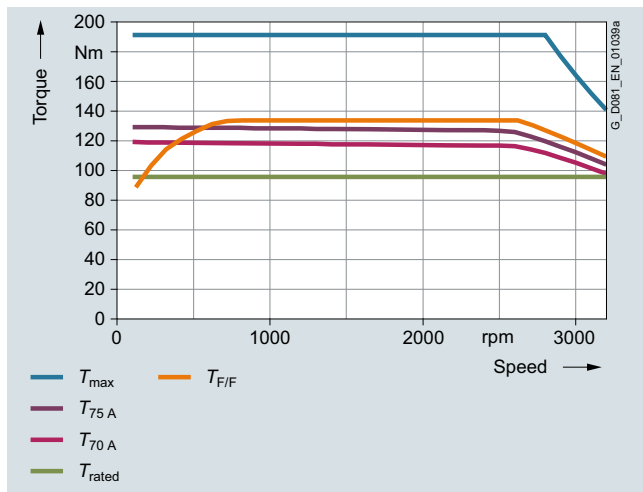

Torque limit for 380 VΔ (87 Hz characteristic)

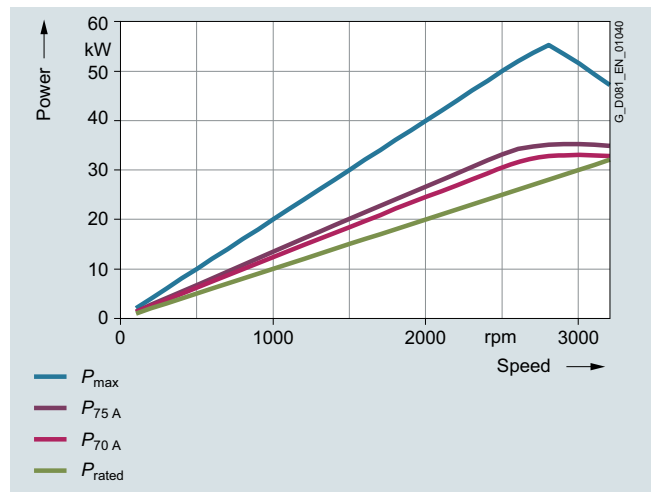

Power limit for 380 VΔ (87 Hz characteristic)

5

Synchronous reluctance motors for SINAMICS converters – VSD4000 line Orientation

Technical specifications

The torque and power characteristics for converter configuration for the SIMOTICS GP/SD 1FP1.14-1DF2 motor, frame size 160 with the particular motor voltage and circuit:

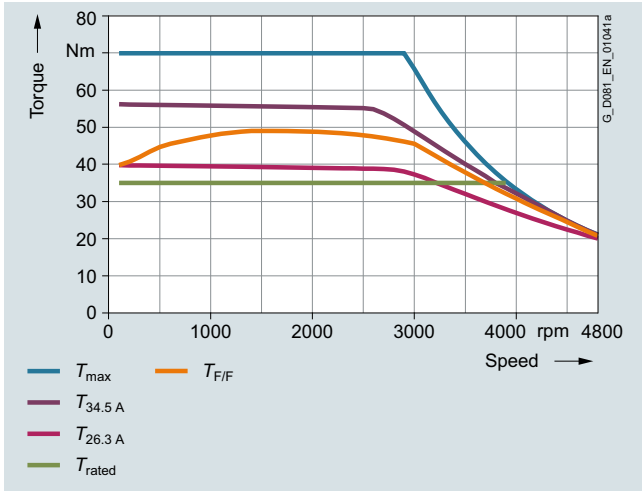

Torque limit for 380 VY (100 Hz characteristic)

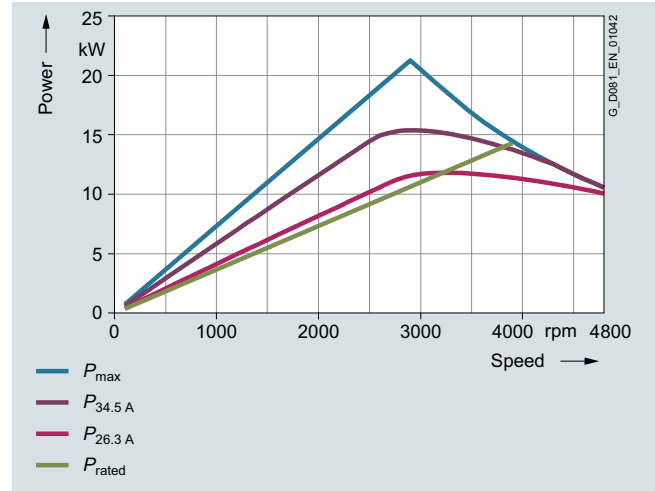

Power limit for 380 VY (100 Hz characteristic)

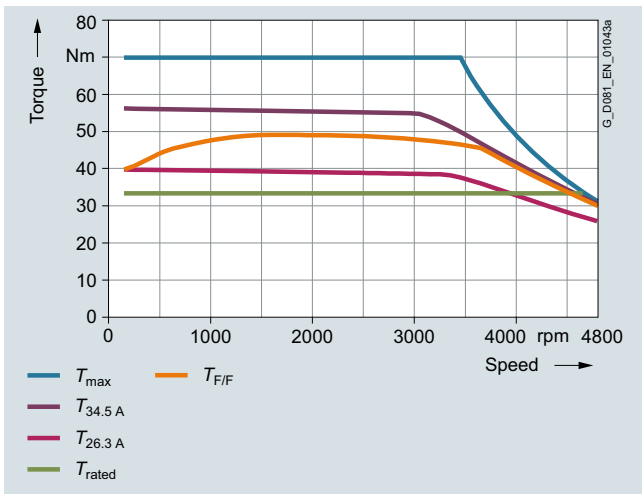

Torque limit for 440 VY (120 Hz characteristic)

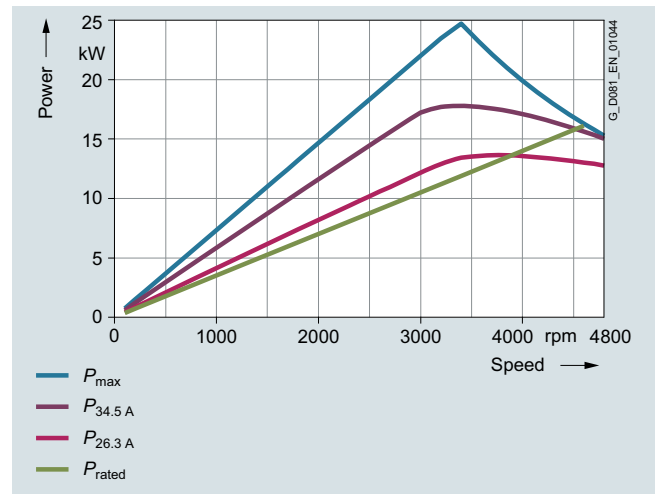

Power limit for 440 VY (120 Hz characteristic)

Synchronous reluctance motors for SINAMICS converters – VSD4000 line

Orientation

Technical specifications

The torque and power characteristics for converter configuration for the SIMOTICS GP/SD 1FP1.14-1DF3 motor, frame size 160 with the particular motor voltage and circuit:

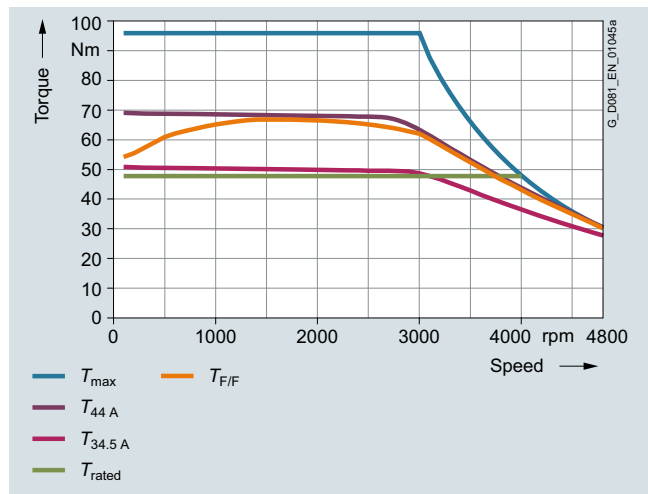

Torque limit for 380 VY (100 Hz characteristic)

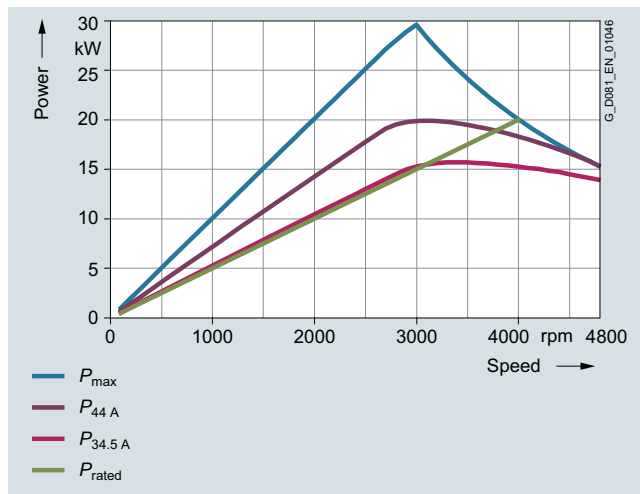

Power limit for 380 VY (100 Hz characteristic)

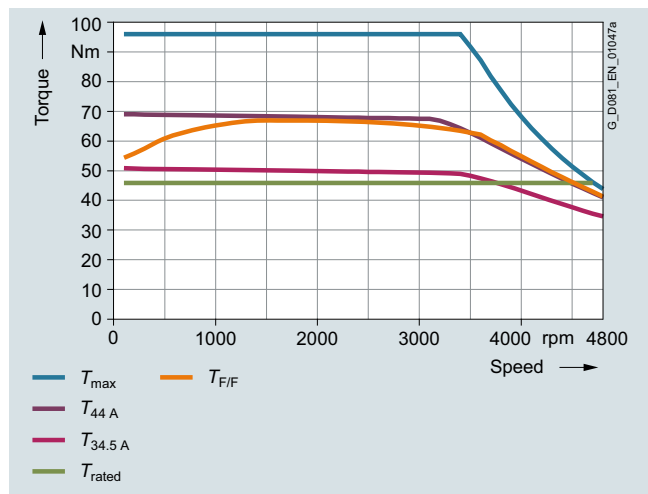

Torque limit for 440 VY (120 Hz characteristic)

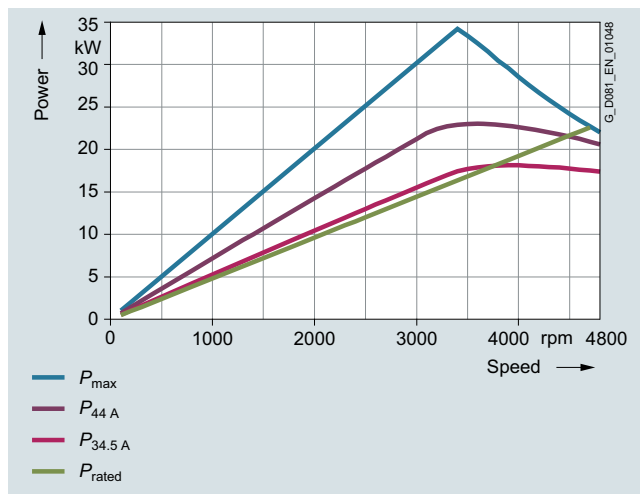

Power limit for 440 VY (120 Hz characteristic)

5

Synchronous reluctance motors for SINAMICS converters – VSD4000 line Orientation

Technical specifications

The torque and power characteristics for converter configuration for the SIMOTICS GP/SD 1FP1.14-1DF4 motor, frame size 160 with the particular motor voltage and circuit:

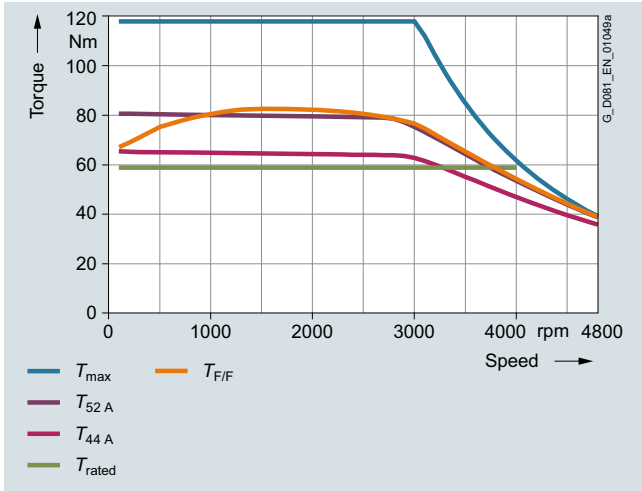

Torque limit for 380 VY (100 Hz characteristic)

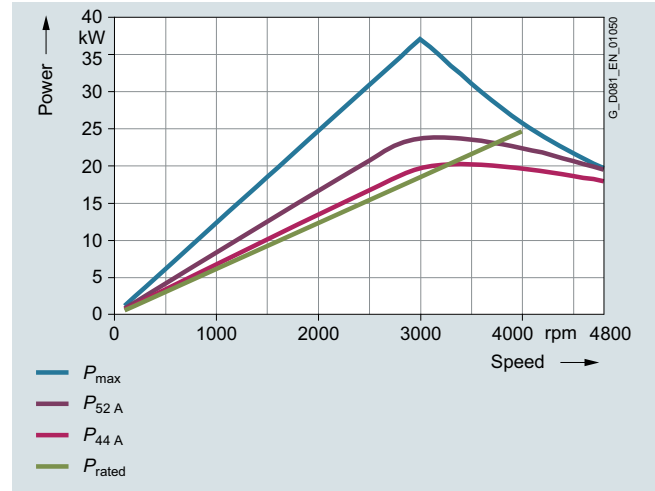

Power limit for 380 VY (100 Hz characteristic)

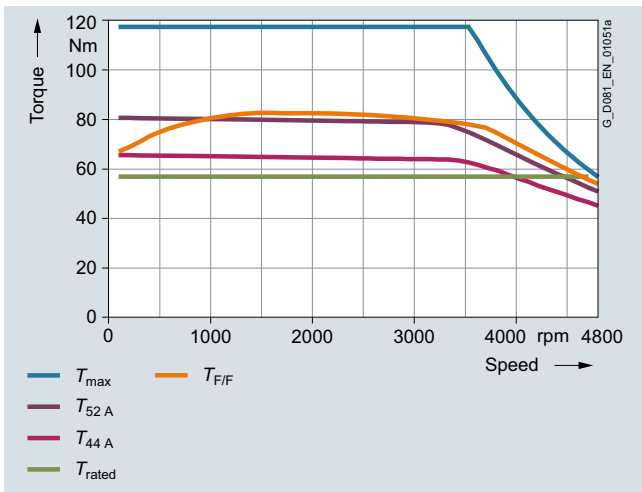

Torque limit for 440 VY (120 Hz characteristic)

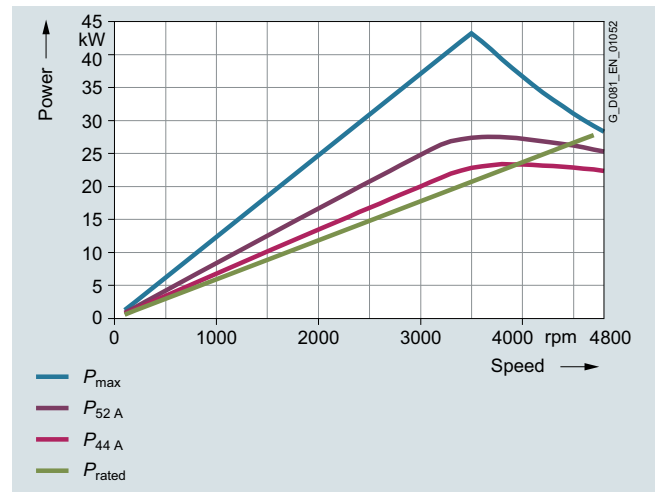

Power limit for 440 VY (120 Hz characteristic)

Synchronous reluctance motors for SINAMICS converters – VSD4000 line

Orientation

Technical specifications

The torque and power characteristics for converter configuration for the SIMOTICS SD 1FP1514-1EB2 motor, frame size 180 with the particular motor voltage and circuit:

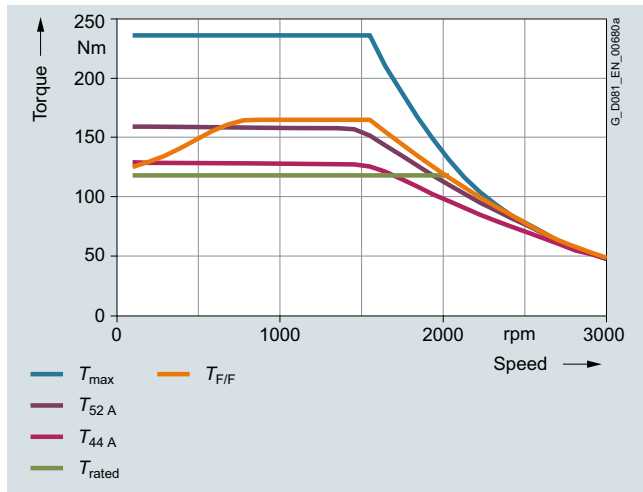

Torque limit for 380 VY (50 Hz characteristic)

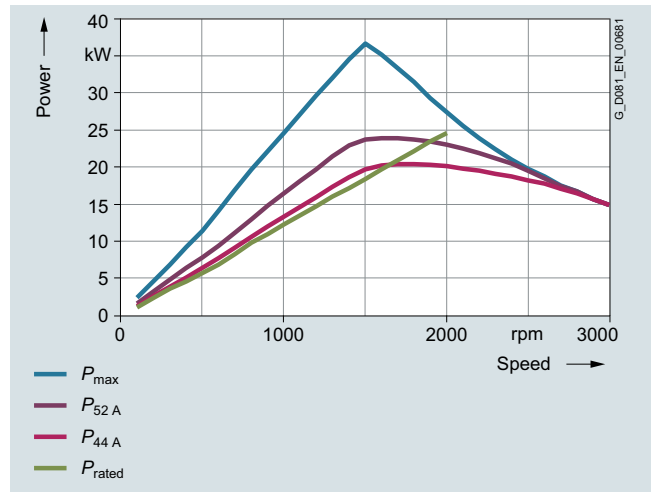

Power limit for 380 VY (50 Hz characteristic)

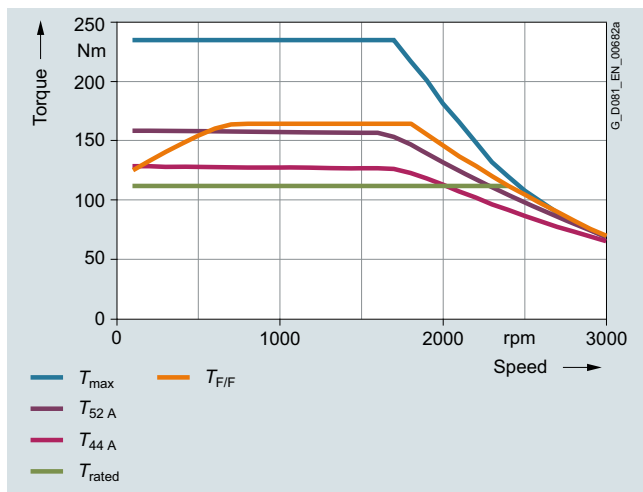

Torque limit for 440 VY (60 Hz characteristic)

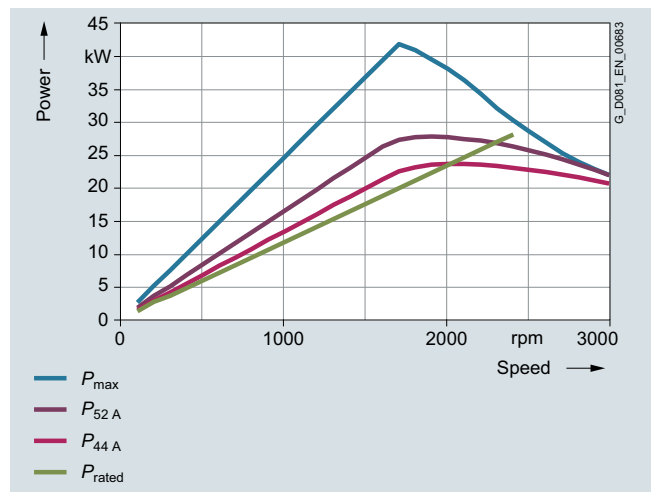

Power limit for 440 VY (60 Hz characteristic)

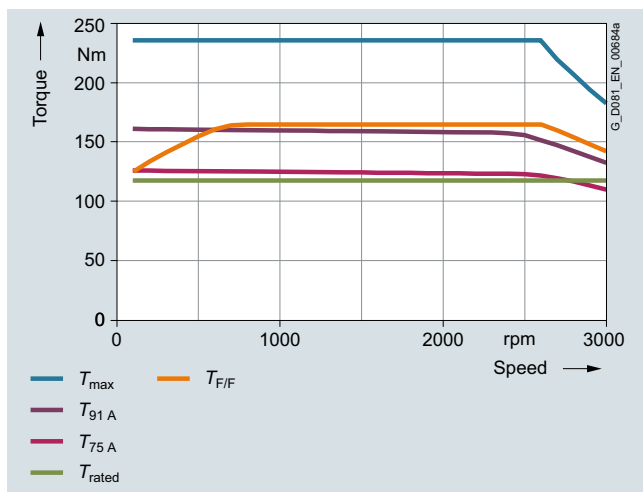

Torque limit for 380 VΔ (87 Hz characteristic)

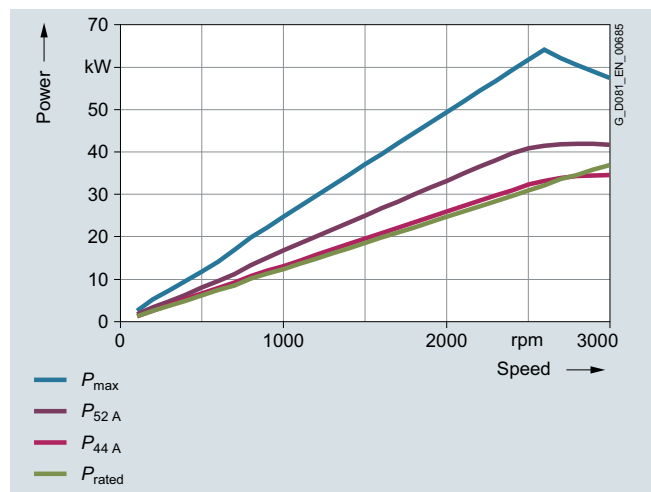

Power limit for 380 VΔ (87 Hz characteristic)

5

Synchronous reluctance motors for SINAMICS converters – VSD4000 line

Orientation

Technical specifications

The torque and power characteristics for converter configuration for the SIMOTICS SD 1FP1514-1EB4 motor, frame size 180 with the particular motor voltage and circuit:

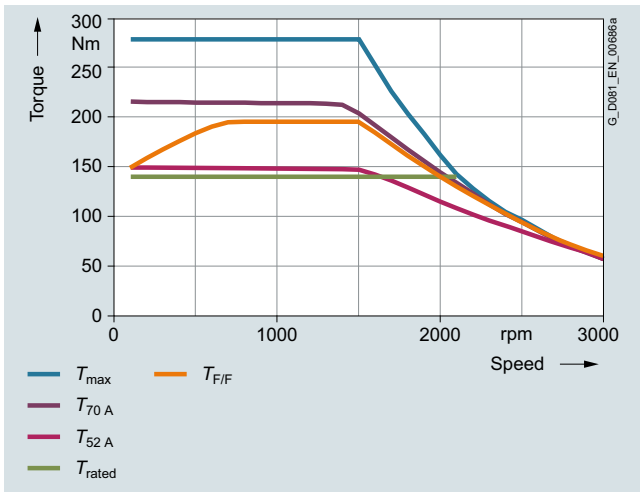

Torque limit for 380 VY (50 Hz characteristic)

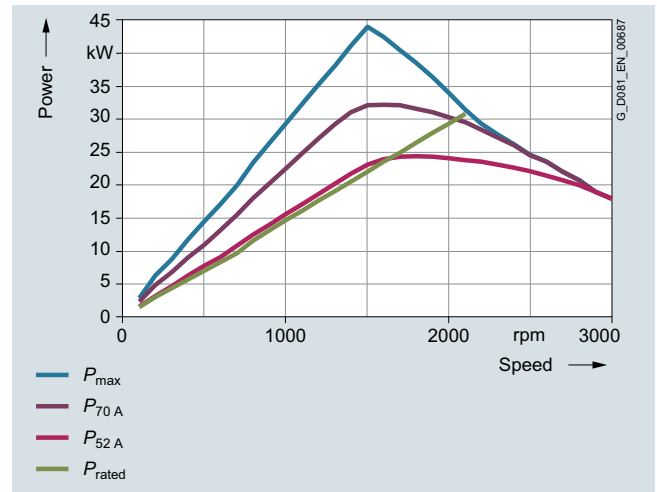

Power limit for 380 VY (50 Hz characteristic)

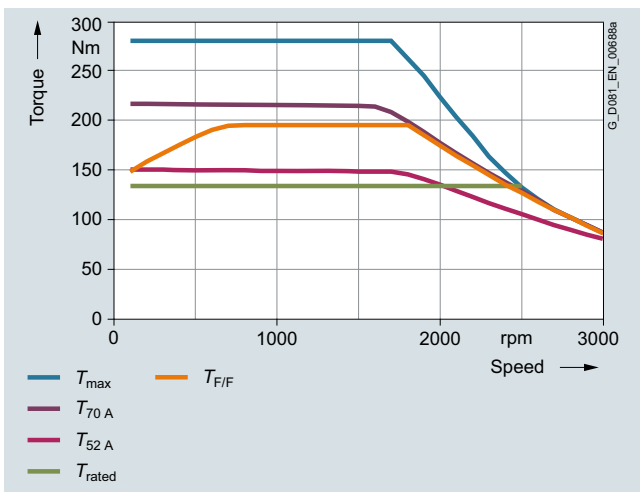

Torque limit for 440 VY (60 Hz characteristic)

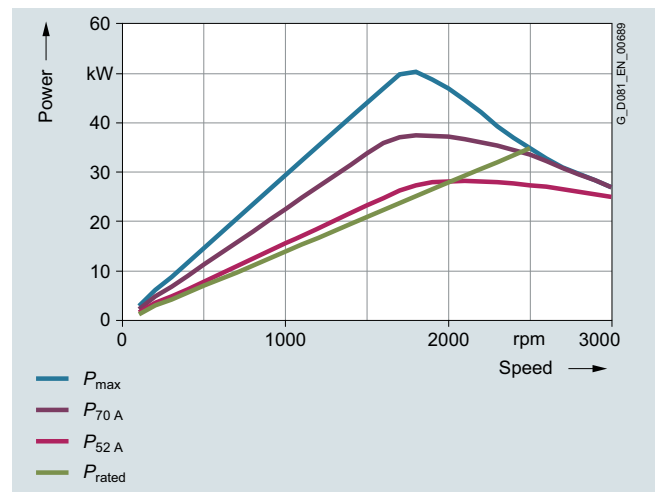

Power limit for 440 VY (60 Hz characteristic)

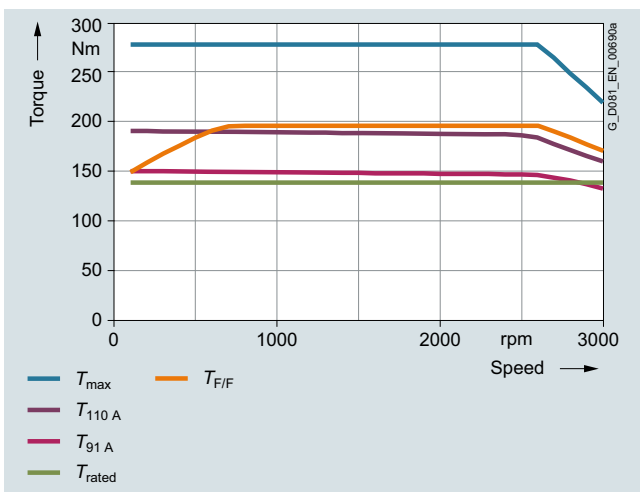

Torque limit for 380 VΔ (87 Hz characteristic)

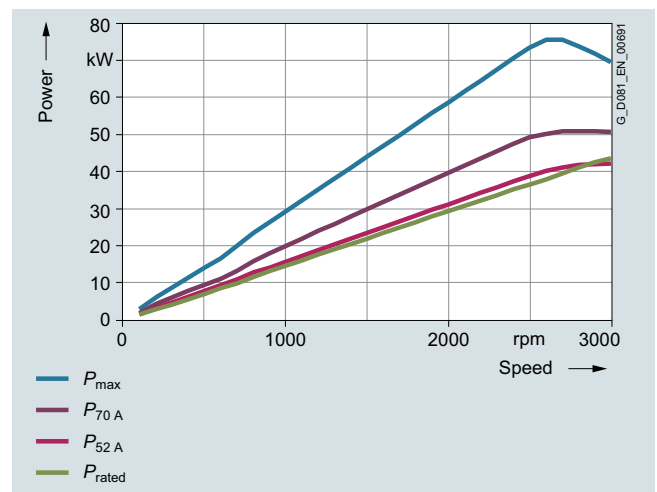

Power limit for 380 VΔ (87 Hz characteristic)

Synchronous reluctance motors for SINAMICS converters – VSD4000 line

Orientation

Technical specifications

The torque and power characteristics for converter configuration for the SIMOTICS SD 1FP1514-1EF2 motor, frame size 180 with the particular motor voltage and circuit:

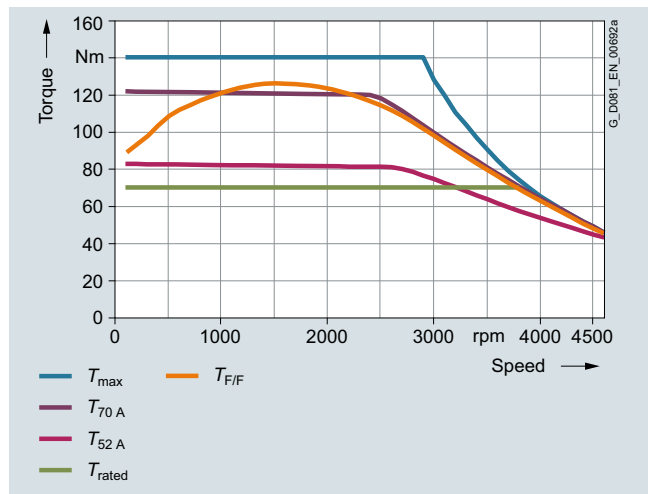

Torque limit for 380 VY (50 Hz characteristic)

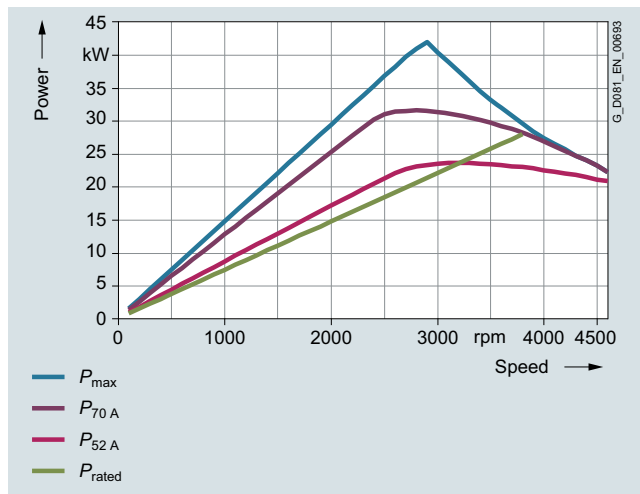

Power limit for 380 VY (50 Hz characteristic)

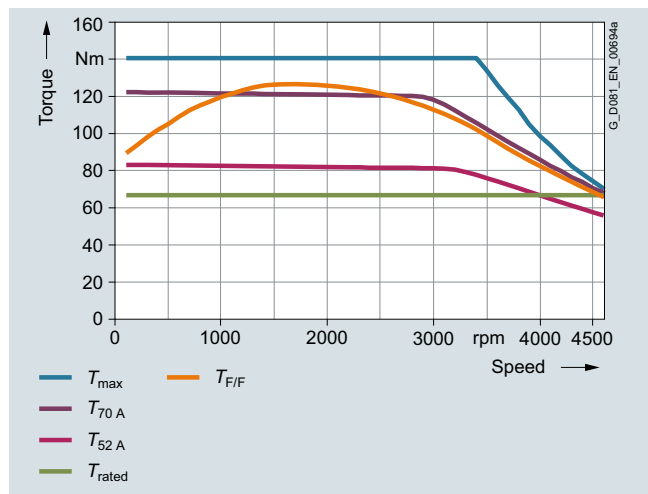

Torque limit for 440 VY (60 Hz characteristic)

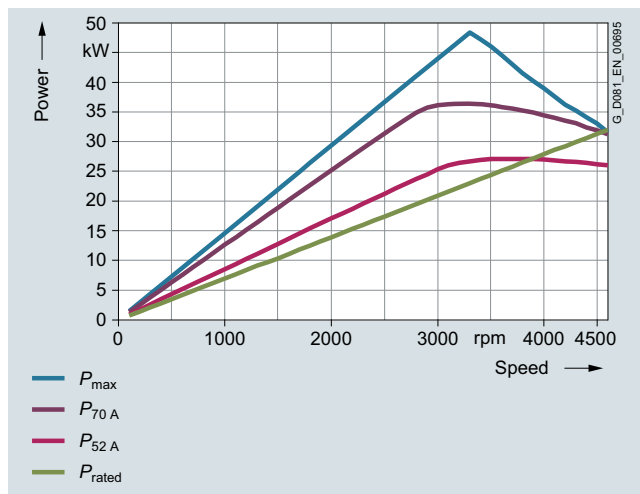

Power limit for 440 VY (60 Hz characteristic)

5

Synchronous reluctance motors for SINAMICS converters – VSD4000 line

Orientation

Technical specifications

The torque and power characteristics for converter configuration for the SIMOTICS SD 1FP1514-2AB5 motor, frame size 200 with the particular motor voltage and circuit:

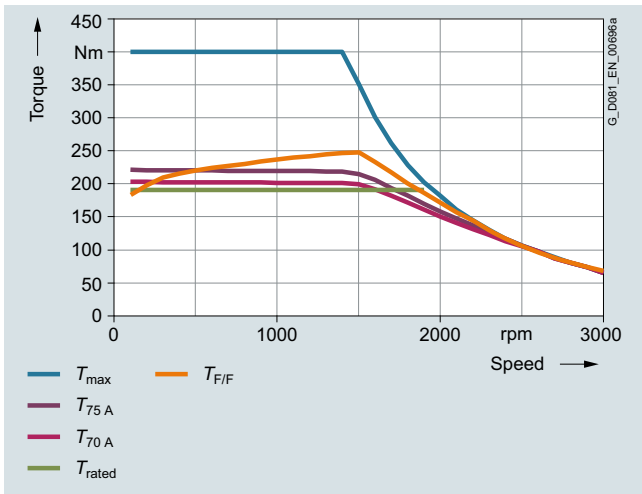

Torque limit for 380 VY (50 Hz characteristic)

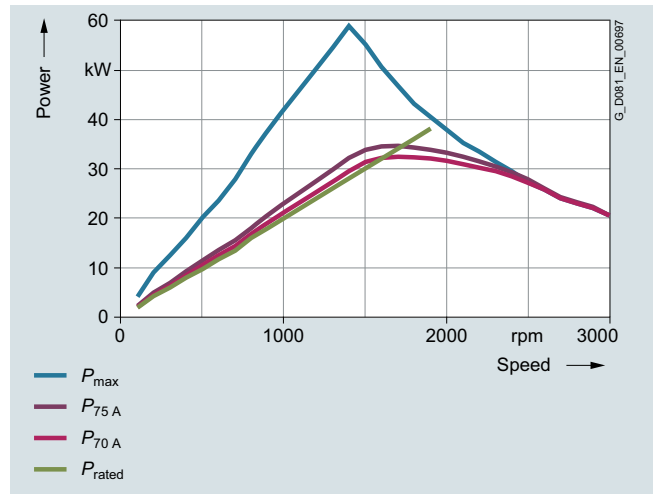

Power limit for 380 VY (50 Hz characteristic)

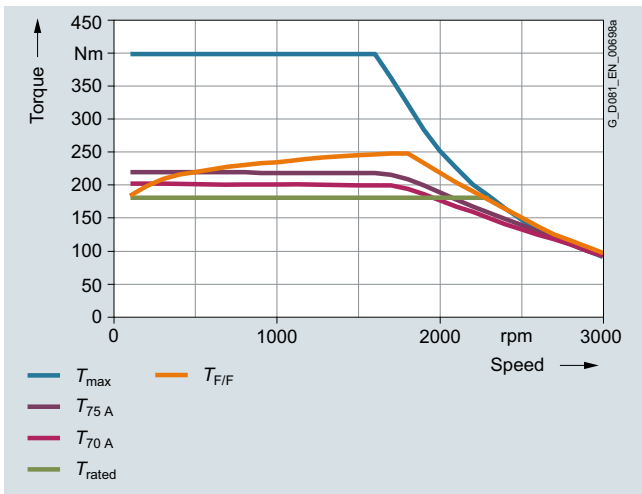

Torque limit for 440 VY (60 Hz characteristic)

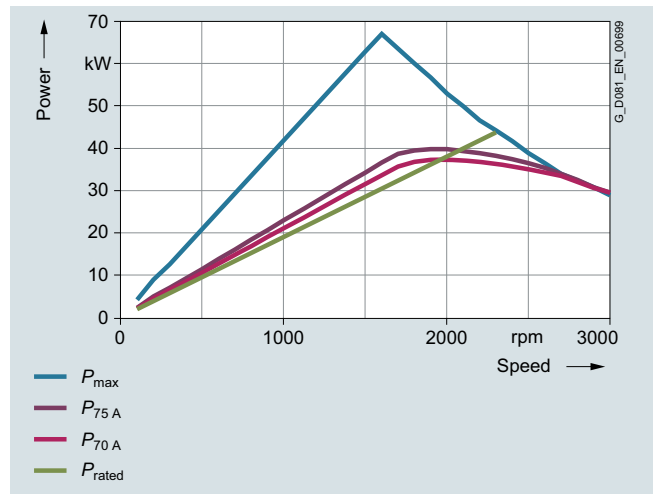

Power limit for 440 VY (60 Hz characteristic)

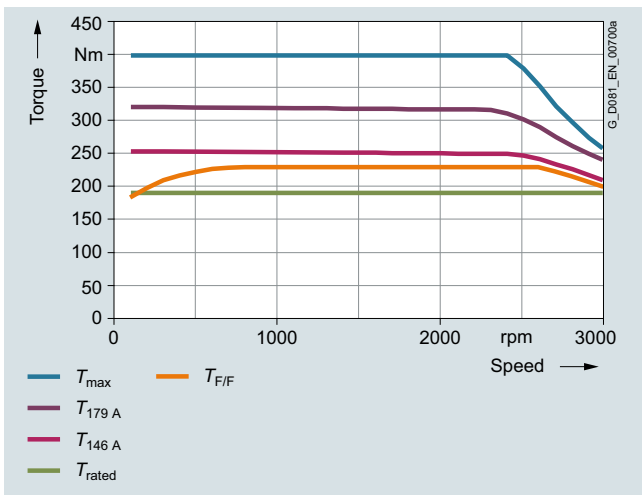

Torque limit for 380 VΔ (87 Hz characteristic)

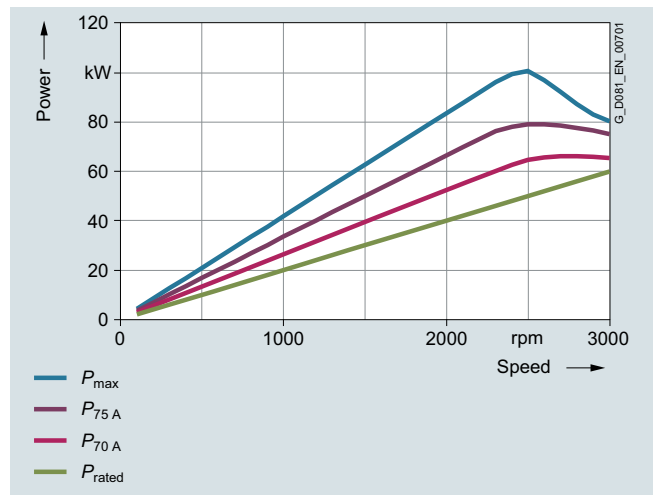

Power limit for 380 VΔ (87 Hz characteristic)

Synchronous reluctance motors for SINAMICS converters – VSD4000 line

Orientation

Technical specifications

The torque and power characteristics for converter configuration for the SIMOTICS SD 1FP1514-2AF4 motor, frame size 200 with the particular motor voltage and circuit:

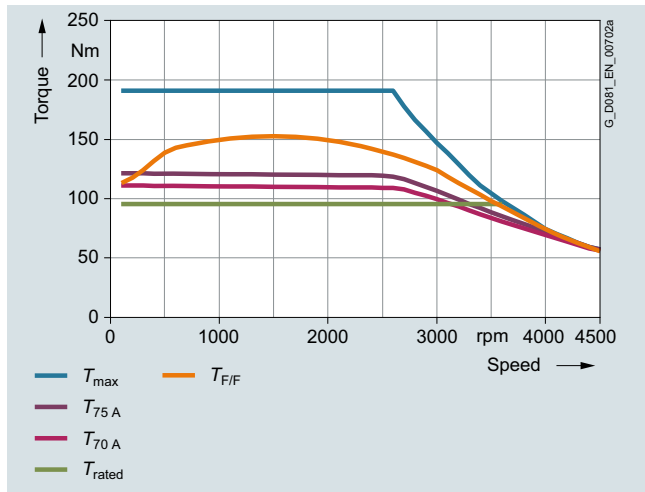

Torque limit for 380 VY (50 Hz characteristic)

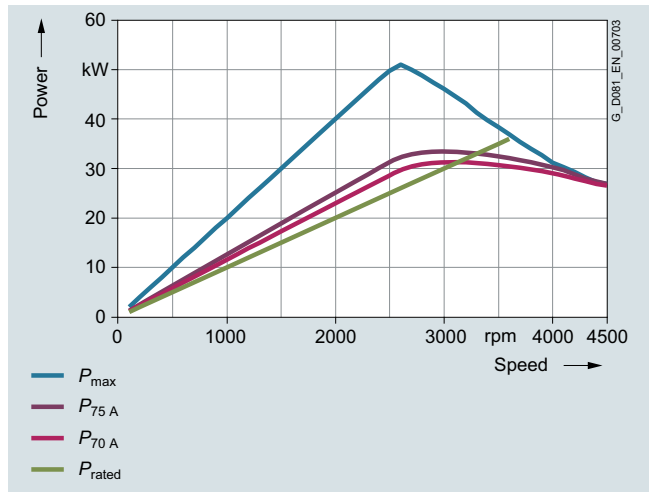

Power limit for 380 VY (50 Hz characteristic)

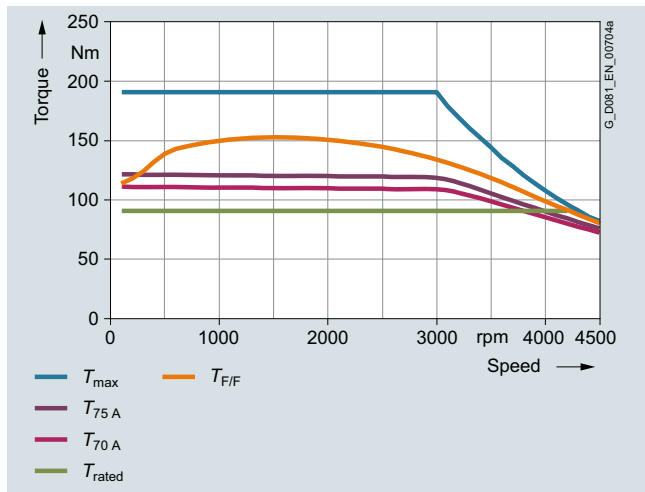

Torque limit for 440 VY (60 Hz characteristic)

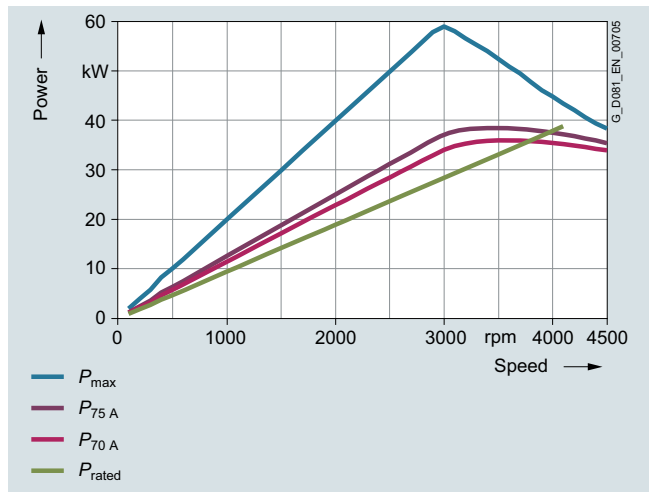

Power limit for 440 VY (60 Hz characteristic)

Synchronous reluctance motors for SINAMICS converters – VSD4000 line

Orientation

Technical specifications

The torque and power characteristics for converter configuration for the SIMOTICS SD 1FP1514-2AF5 motor, frame size 200 with the particular motor voltage and circuit:

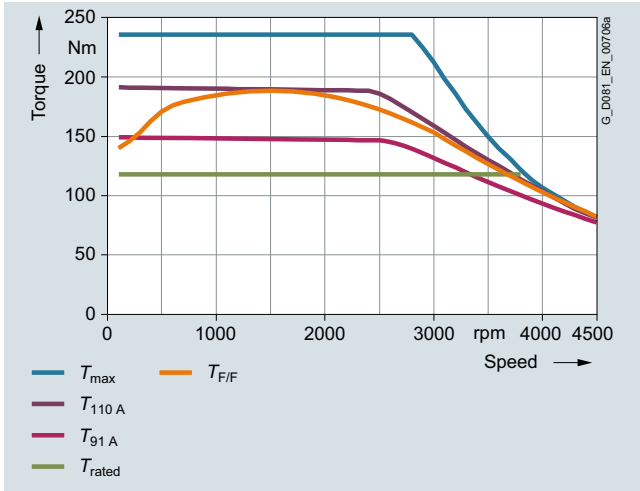

Torque limit for 380 VY (50 Hz characteristic)

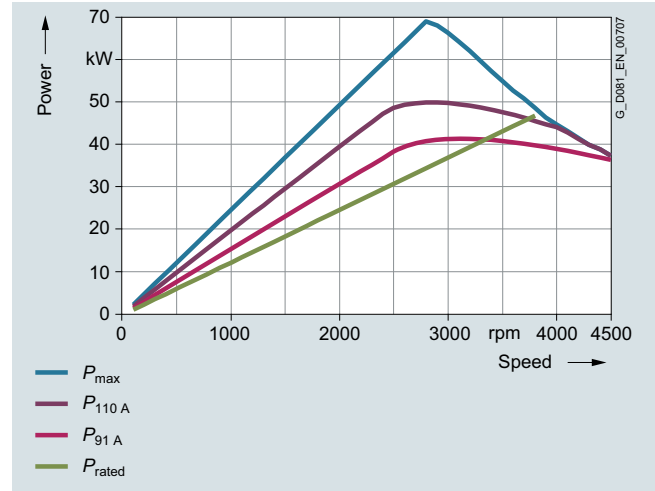

Power limit for 380 VY (50 Hz characteristic)

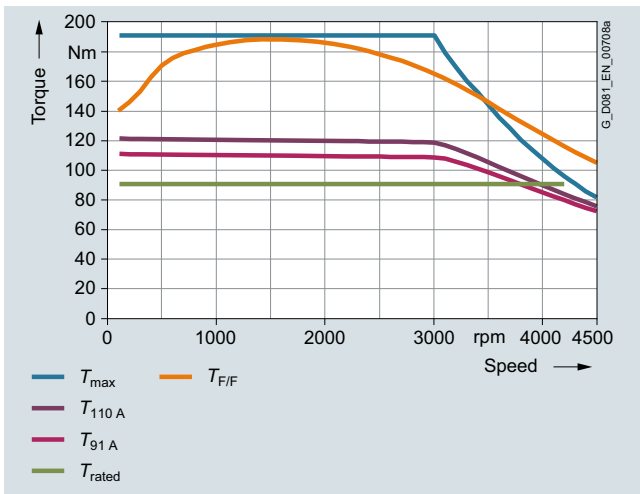

Torque limit for 440 VY (60 Hz characteristic)

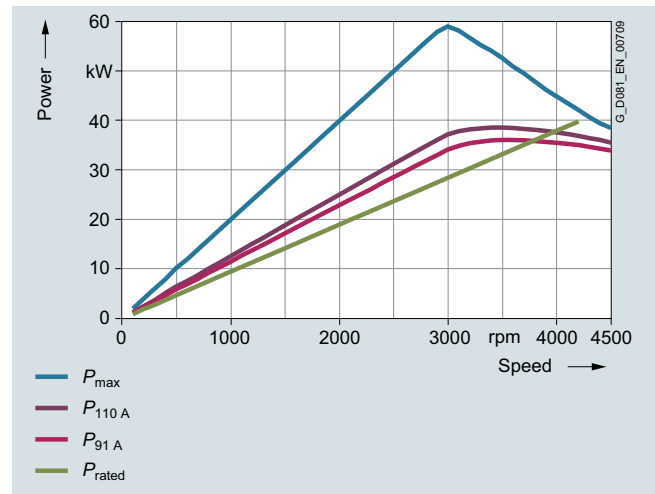

Power limit for 440 VY (60 Hz characteristic)

Synchronous reluctance motors for SINAMICS converters – VSD4000 line

Orientation

Technical specifications

The torque and power characteristics for converter configuration for the SIMOTICS SD 1FP1514-2BB0 motor, frame size 225 with the particular motor voltage and circuit:

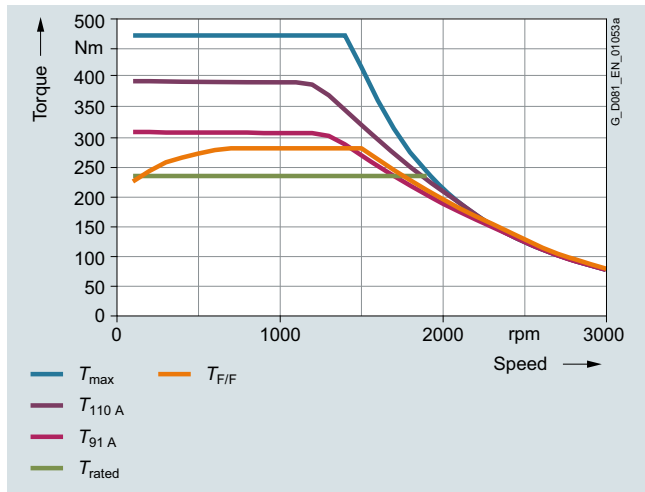

Torque limit for 380 VY (50 Hz characteristic)

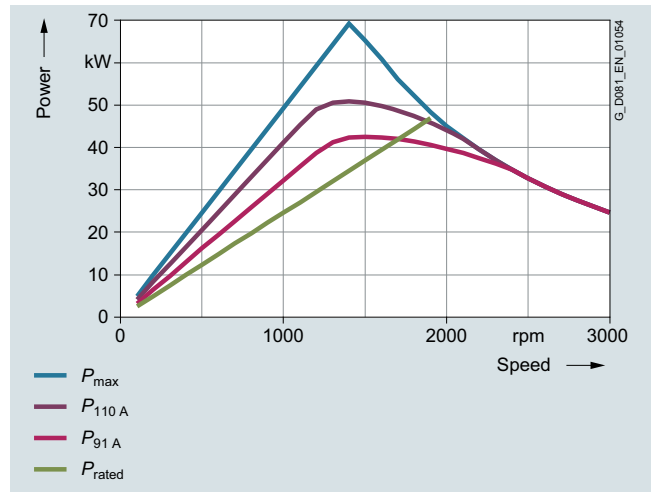

Power limit for 380 VY (50 Hz characteristic)

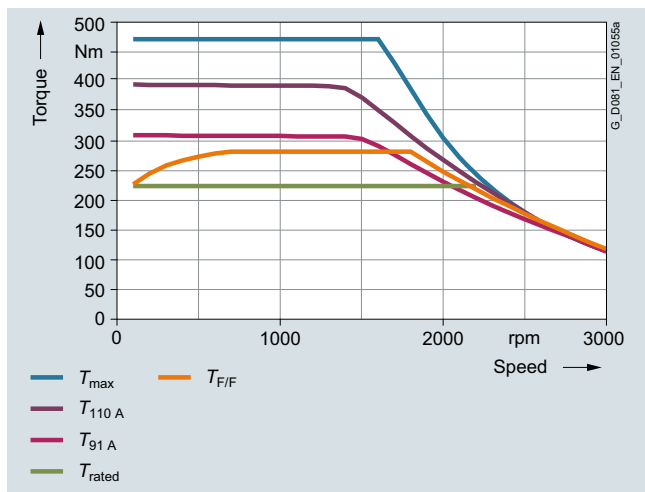

Torque limit for 440 VY (60 Hz characteristic)

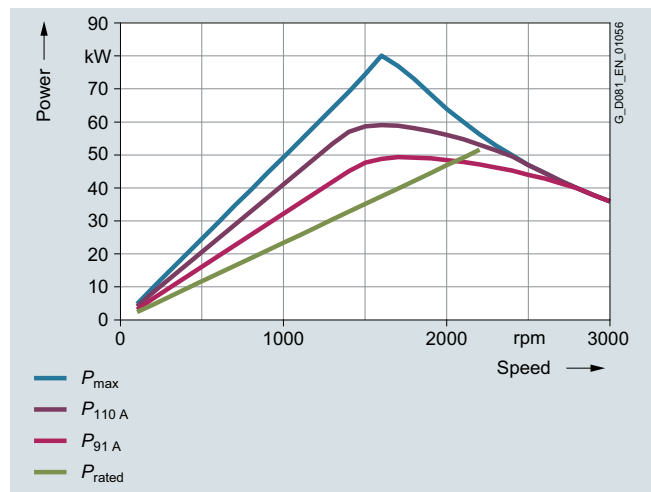

Power limit for 440 VY (60 Hz characteristic)

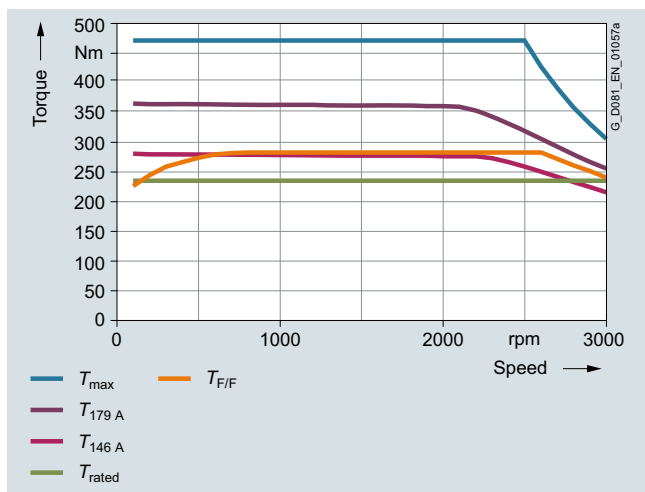

Torque limit for 380 VΔ (87 Hz characteristic)

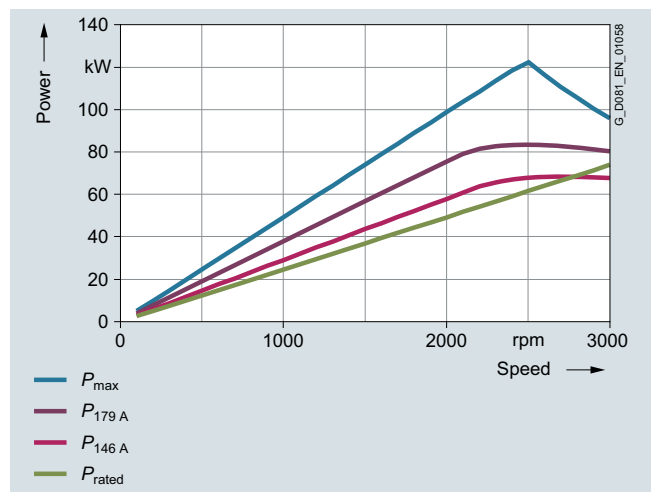

Power limit for 380 VΔ (87 Hz characteristic)

Synchronous reluctance motors for SINAMICS converters – VSD4000 line Orientation

Technical specifications

The torque and power characteristics for converter configuration for the SIMOTICS SD 1FP1514-2BB2 motor, frame size 225 with the particular motor voltage and circuit:

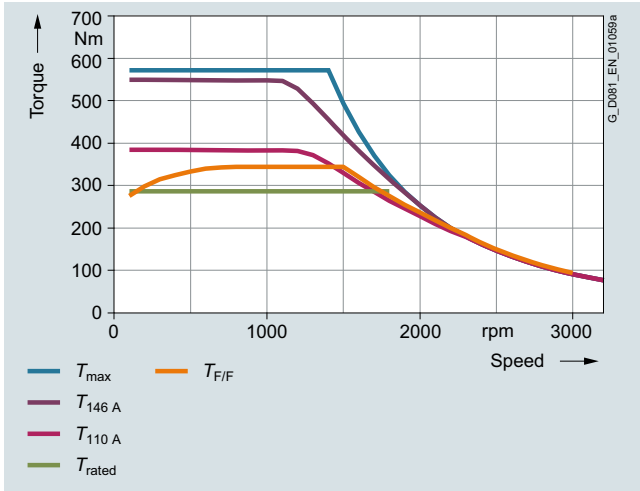

Torque limit for 380 VY (50 Hz characteristic)

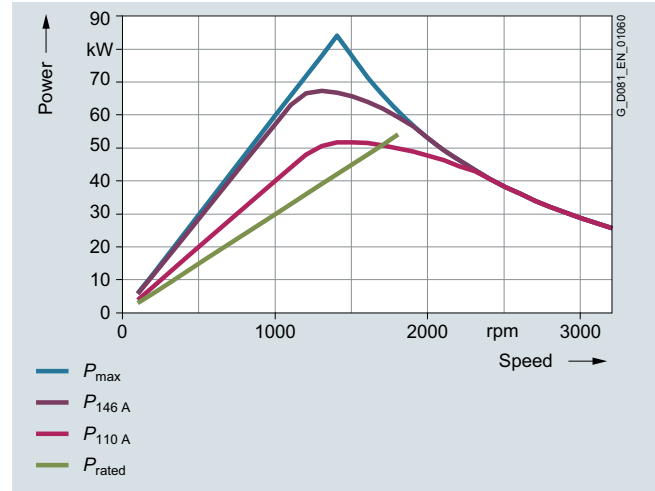

Power limit for 380 VY (50 Hz characteristic)

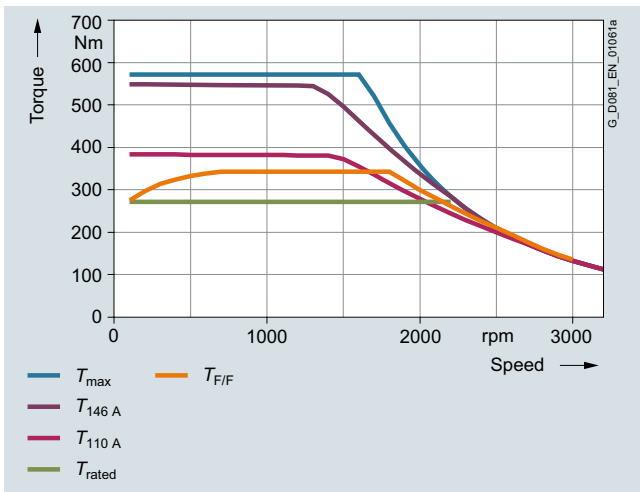

Torque limit for 440 VY (60 Hz characteristic)

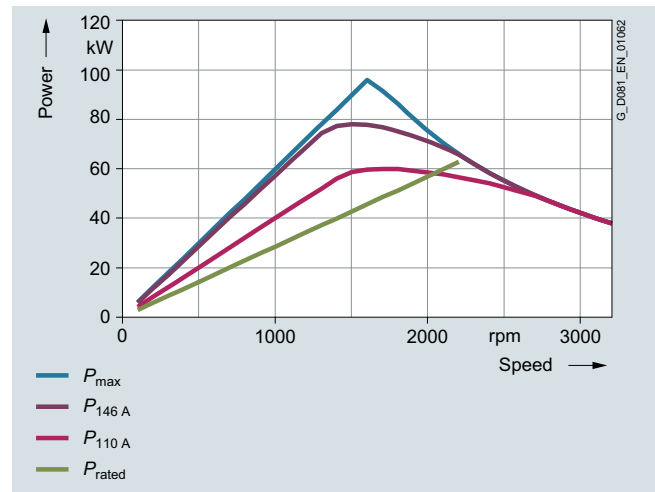

Power limit for 440 VY (60 Hz characteristic)

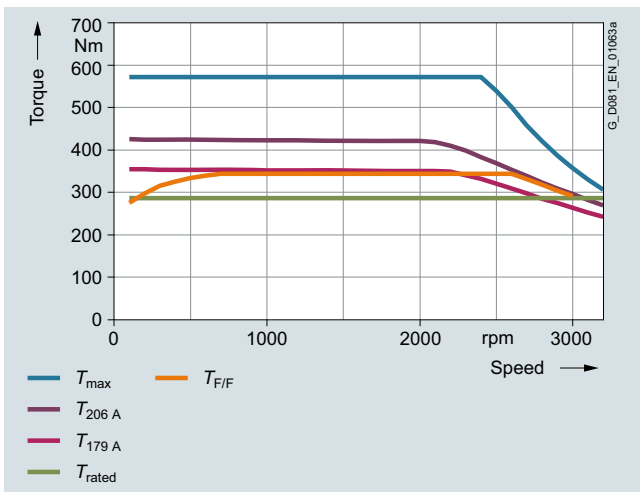

Torque limit for 380 VΔ (87 Hz characteristic)

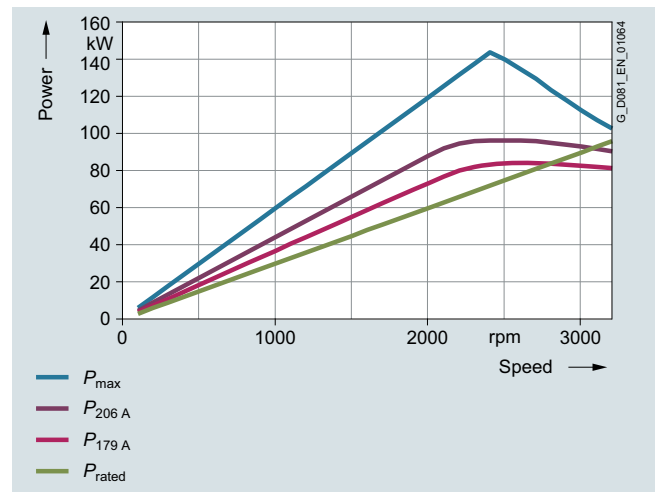

Power limit for 380 VΔ (87 Hz characteristic)

Synchronous reluctance motors for SINAMICS converters – VSD4000 line

Orientation

Technical specifications

The torque and power characteristics for converter configuration for the SIMOTICS SD 1FP1514-2BF2 motor, frame size 225 with the particular motor voltage and circuit:

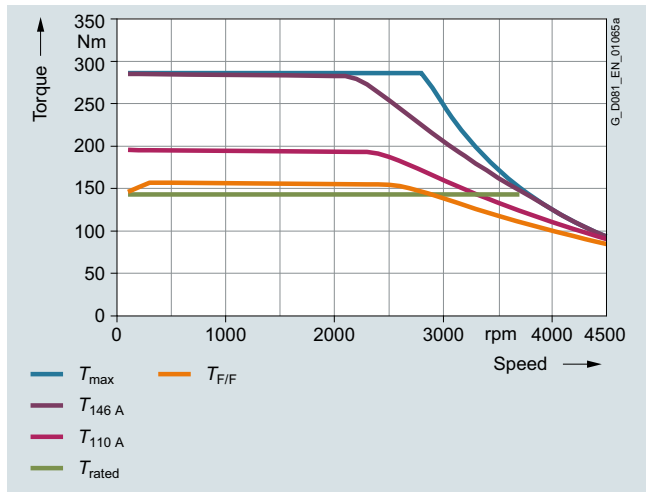

Torque limit for 380 VY (50 Hz characteristic)

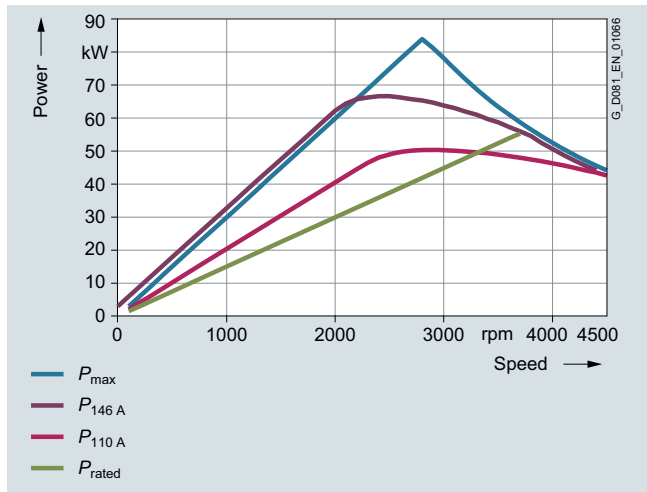

Power limit for 380 VY (50 Hz characteristic)

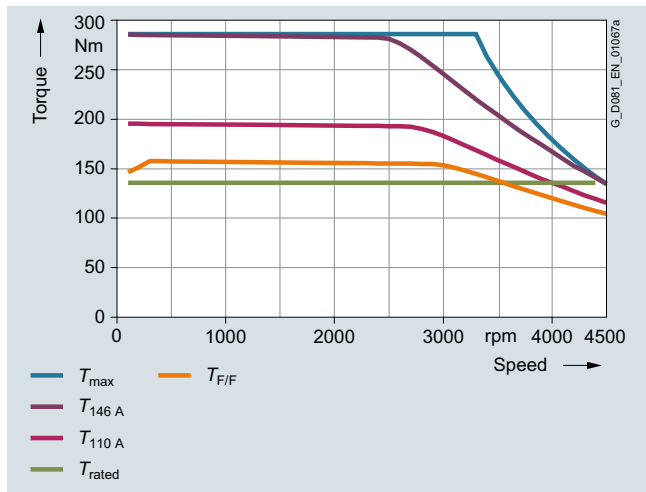

Torque limit for 440 VY (60 Hz characteristic)

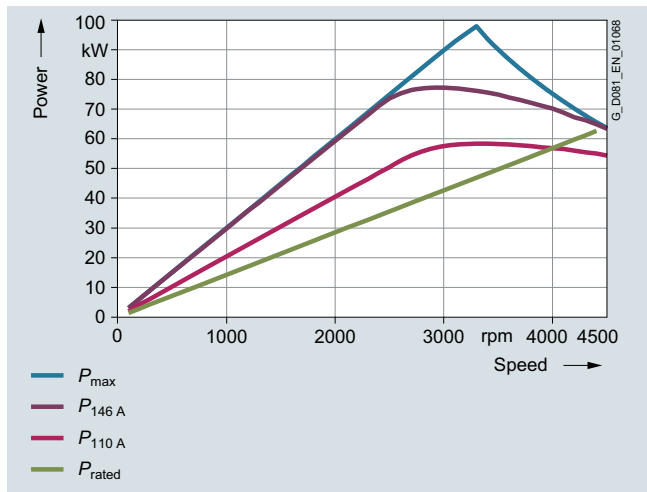

Power limit for 440 VY (60 Hz characteristic)

Synchronous reluctance motors for SINAMICS converters – VSD4000 line

Orientation

Technical specifications

Additional information

Mechanical stress and grease lifetime

When motors are operated at speeds above the rated speed, the mechanical smooth running operation and the bearings are subjected to greater mechanical stress. This reduces the grease lifetime and the bearing lifetime.

Above 100 Hz, the motors must be balanced for twice the rated frequency; it can be expected that the lubrication intervals and bearing lifetime are significantly reduced.

Motor protection

A motor protection function can be implemented using the P_t sensing function implemented in the converter software. If required, more precise motor protection can be afforded by direct temperature measurement using KTY84 sensors (standard scope of delivery) or PTC thermistors in the motor winding. Some converters from Siemens determine the motor temperature using the resistance of the temperature sensor. They can be set to a required temperature for alarm and tripping. When ordering PTC thermistors or other temperature sensors to monitor the cooling temperature, the KTY84 sensors, otherwise provided as standard, are eliminated. As described above, KTY84 sensors are evaluated in the SINAMICS converters.

Motor connection

When connecting the motors, it is important to consider the restrictions for 1LE1 line motors as well as the maximum conductor cross-sections permitted for the converter.

Operating data for 50 Hz/60 Hz/87 Hz characteristics

SIMOTICS GP/SD VSD4000 line motors are designed for operation with 50 Hz, 60 Hz and 87 Hz characteristics (87 Hz characteristic up to frame size 200).

Operation with the 50/60 Hz characteristic requires Y (star or wye) connection; operation with the 87 Hz characteristic requires Δ connection.

The corresponding performance data are stamped on the rating plate as standard. An ordering option is not required.

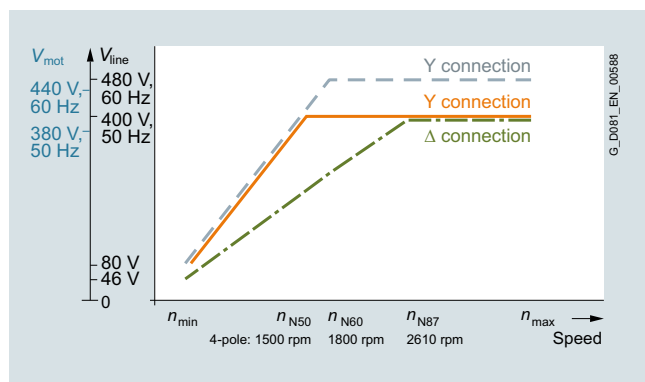

Operating characteristics of SIMOTICS GP/SD VSD4000 line motors ¹⁾

Maximum operating speed

The maximum operating speed is limited by the mechanical speed limit of the motors as well as the available converter output frequency.

A significant increase in the sound pressure level can be expected when operating the motor above its rated speed (field weakening range).

Mechanical speed limits SIMOTICS GP/SD VSD4000 line:

Frame size	Mechanical speed limit		
	50 Hz SIMOTICS GP n_{max} rpm	SD n_{max} rpm	100 Hz SIMOTICS SD n_{max} rpm
80	3200	3200	6000
90	3200	3200	6000
112	3200	3200	6000
132	3200	3200	5600
160	3000	3200	4800
180	2610	3000	4600
200	2610	3000	4500
225		3000	4500

International use

As special converter motors, SIMOTICS GP/SD VSD4000 line motors are presently not subject to any minimum efficiency requirements in the EU and USA/Canada. However, other national certificates may be required (e.g. CSA-S safety in Canada).

¹⁾ With V4.7 SP3, only a 50 Hz characteristic is possible.

Synchronous reluctance motors for SINAMICS converters – VSD4000 line

Orientation

Technical specifications

Load characteristics for the line supply voltage: 400 V 3 AC, 50 Hz

Load characteristic							SIMOTICS GP/SD VSD4000 line motors	SINAMICS G120 converters Operating mode: Low overload
$T \sim n^2$	$T = \text{const.}$							
	Speed control range							
	1:2		1:4		1:10			
P	P	T	P	T	P	T	Motor type	Converter type
kW	kW	kW	kW	kW	kW	kW		
Rated speed 1500 rpm								
at 1500 rpm	from 750 rpm	from 750 rpm to 1500 rpm	from 375 rpm	from 375 rpm to 1500 rpm	from 150 rpm	from 150 rpm to 1500 rpm		
0.55	0.28	3.5	0.14	3.5	0.06	3.5	1FP1.14-0DB2-.....	6SL3210-1PE11-8.L0
0.75	0.38	4.8	0.19	4.8	0.08	4.8	1FP1.14-0DB3-.....	6SL3210-1PE12-3.L0
1.1	0.55	7	0.28	7	0.11	7	1FP1.14-0EB0-.....	6SL3210-1PE13-2.L1
1.5	0.75	9.5	0.38	9.5	0.15	9.5	1FP1.14-0EB4-.....	6SL3210-1PE14-3.L1
2.2	1.1	14	0.55	14	0.22	14	1FP1.14-1BB0-.....	6SL3210-1PE16-1.L1
3	1.5	19.1	0.75	19.1	0.3	19.1	1FP1.14-1BB1-.....	6SL3210-1PE18-0.L1
4	2	25.5	1	25.5	0.4	25.5	1FP1.14-1BB2-.....	6SL3210-1PE21-1.L0
5.5	2.75	35	1.38	35	0.55	35	1FP1.14-1CB0-.....	6SL3210-1PE21-4.L0
7.5	3.75	47.5	1.88	47.5	0.75	47.5	1FP1.14-1CB2-.....	6SL3210-1PE21-8.L0
11	5.5	70	2.75	70	1.1	70	1FP1.14-1DB2-.....	6SL3210-1PE22-7.L0
15	7.5	95	3.75	95	1.5	95	1FP1.14-1DB4-.....	6SL3210-1PE23-3.L0
18.5	9.25	118	4.63	118	1.85	118	1FP1.14-1EB2-.....	6SL3210-1PE23-8.L0
22	11	140	5.5	140	2.2	140	1FP1.14-1EB4-.....	6SL3210-1PE24-5.L0
30	15	191	7.5	191	3	191	1FP1.14-2AB5-.....	6SL3210-1PE26-0.L0
37	18.5	236	9.25	236	3.7	236	1FP1514-2BB0-.....	6SL3210-1PE28-8.L0
45	22.5	286	11.25	286	4.5	286	1FP1514-2BB2-.....	6SL3210-1PE31-1.L0
Rated speed 3000 rpm								
at 3000 rpm	from 1500 rpm	from 1500 rpm to 3000 rpm	from 750 rpm	from 750 rpm to 3000 rpm	from 300 rpm	from 300 rpm to 3000 rpm		
0.75	0.38	2.4	0.19	2.4	0.08	2.4	1FP1514-0DF2-.....	6SL3210-1PE12-3.L0
1.1	0.55	3.5	0.28	3.5	0.11	3.5	1FP1514-0DF3-.....	6SL3210-1PE13-2.L1
1.5	0.75	4.8	0.38	4.8	0.15	4.8	1FP1514-0EF0-.....	6SL3210-1PE14-3.L1
2.2	1.1	7	0.55	7	0.22	7	1FP1514-0EF4-.....	6SL3210-1PE16-1.L1
3	1.5	9.5	0.75	9.5	0.3	9.5	1FP1514-1BF1-.....	6SL3210-1PE18-0.L1
4	2	12.7	1	12.7	0.4	12.7	1FP1514-1BF2-.....	6SL3210-1PE21-1.L0
5.5	2.75	17.5	1.38	17.5	0.55	17.5	1FP1514-1CF0-.....	6SL3210-1PE21-4.L0
7.5	3.75	24	1.88	24	0.75	24	1FP1514-1CF1-.....	6SL3210-1PE21-8.L0
11	5.5	35	2.75	35	1.1	35	1FP1514-1DF2-.....	6SL3210-1PE22-7.L0
15	7.5	48	3.75	48	1.5	48	1FP1514-1DF3-.....	6SL3210-1PE23-3.L0
18.5	9.25	58	4.63	58	1.85	58	1FP1514-1DF4-.....	6SL3210-1PE23-8.L0
22	11	70	5.5	70	2.2	70	1FP1514-1EF2-.....	6SL3210-1PE24-5.L0
30	15	96	7.5	96	3	96	1FP1514-2AF4-.....	6SL3210-1PE26-0.L0
37	18.5	118	9.25	118	3.7	118	1FP1514-2AF5-.....	6SL3210-1PE28-8.L0
45	22.5	143	11.25	143	4.5	143	1FP1514-2BF2-.....	6SL3210-1PE31-1.L0

Note:

The converter recommendation applies to standard ambient conditions (40 °C; 1000 m above sea level).

If, as a result of different ambient conditions, the rated motor power is significantly reduced, under certain circumstances, another converter is the optimum solution. Here, please use the configuration options for converters in the DT Configurator.

Synchronous reluctance motors for SINAMICS converters – VSD4000 line

Orientation

Technical specifications

System power loss acc. to IEC 61800-9-2: 2017

The drive system comprising SIMOTICS GP/SD VSD4000 line synchronous-reluctance motors and SINAMICS G120 converters is, as a result of the minimal system power losses, especially suitable for applications in the full and partial load range that are optimized to achieve minimum lifecycle costs.

General conditions:

- CU230P-2 Control Unit
- Line voltage: 400 V 3 AC 50/60 Hz
- Output voltage: Up to 0.95 x line supply input voltage
- Inverter pulse frequency:
4 kHz to 90 kW; 2 kHz from 110 kW
- In the standby mode, the converter does not supply any power to the motor (the inverter pulses are inhibited)
- In the standby operating mode, the Control Unit is operated from the internal or external 24 V DC electronics power supply
- Converters with vector control for synchronous-reluctance motors and flux reduction
- The operating points defined in the subsequent table already take into account the standby portions

SIMOTICS GP/SD VSD4000 line synchronous-reluctance motors with SINAMICS G120 PM240-2 Power Modules

Rated power kW	SIMOTICS GP/SD VSD4000 1FP10/1FP15 Type	Frame size	PM240-2 Power Module Type	Frame size	System power loss, relative $P_{V,rel}$ as a % referred to P_{rated} Operating points at partial load ¹⁾								IES class acc. to IEC 61800-9-2: 2017
					0/25 %	0/50 %	0/100 %	50/25 %	50/50 %	50/100 %	100/50 %	100/100 %	
Line voltage 400 V 3 AC, 50/60 Hz, rated speed 1500 rpm													
0.55	1FP1.14-0DB2-.....	80 M	6SL3210-1PE11-8.L0	FSA	10.62	12.52	19.12	10.38	13.76	21.42	15.05	23.16	IES2
0.75	1FP1.14-0DB3-.....	80 M	6SL3210-1PE12-3.L1	FSA	8.59	10.28	15.78	8.38	11.32	17.78	12.64	19.59	IES2
1.1	1FP1.14-0EB0-.....	90 S	6SL3210-1PE13-2.L1	FSA	6.45	8.14	13.66	6.47	9.23	15.40	10.58	17.13	IES2
1.5	1FP1.14-0EB4-.....	90 L	6SL3210-1PE14-3.L1	FSA	5.72	7.31	12.70	5.55	8.21	14.26	9.61	16.03	IES2
2.2	1FP1.14-1BB0-.....	112 M	6SL3210-1PE16-1.L1	FSA	3.91	5.01	8.71	4.17	6.10	10.45	7.62	12.43	IES2
3	1FP1.14-1BB1-.....	112 M	6SL3210-1PE18-0.L1	FSA	3.63	4.90	9.45	3.81	5.84	11.09	7.36	12.99	IES2
4	1FP1.14-1BB2-.....	112 M	6SL3210-1PE21-1.L0	FSA	3.21	4.41	8.65	3.31	5.21	10.04	6.45	11.75	IES2
5.5	1FP1.14-1CB0-.....	132 S	6SL3210-1PE21-4.L0	FSB	2.68	3.85	7.61	2.91	4.61	9.40	5.97	10.87	IES2
7.5	1FP1.14-1CB2-.....	132 M	6SL3210-1PE21-8.L0	FSB	2.42	3.43	6.71	2.62	4.13	8.22	5.33	9.68	IES2
11	1FP1.14-1DB2-.....	160 M	6SL3210-1PE22-7.L0	FSC	2.26	3.17	6.20	2.25	3.64	7.55	4.75	9.14	IES2
15	1FP1.14-1DB4-.....	160 L	6SL3210-1PE23-3.L0	FSC	2.09	2.89	5.73	2.08	3.42	6.89	4.31	8.13	IES2
18.5	1FP1.14-1EB2-.....	180 M	6SL3210-1PE23-8.L0	FSD	1.76	2.42	4.65	1.86	3.01	6.00	3.99	7.56	IES2
22	1FP1.14-1EB4-.....	180 L	6SL3210-1PE24-5.L0	FSD	1.67	2.34	4.46	1.74	2.84	5.73	3.82	7.15	IES2
30	1FP1.14-2AB5-.....	200 L	6SL3210-1PE26-0.L0	FSD	1.65	2.41	4.82	1.53	2.60	5.58	3.36	6.80	IES2
37	1FP1514-2BB0-.....	225 S	6SL3210-1PE28-8.L0	FSE	1.29	2.02	4.49	1.64	2.73	5.54	3.49	6.74	IES2
45	1FP1514-2BB2-.....	225 M	6SL3210-1PE31-1.L0	FSE	1.18	1.91	4.41	1.51	2.63	5.38	3.34	6.72	IES2
Line voltage 400 V 3 AC, 50/60 Hz, rated speed 3000 rpm													
0.75	1FP1514-0DF2-.....	80 M	6SL3210-1PE12-3.L1	FSA	8.28	10.08	15.81	8.93	11.98	18.36	14.49	21.79	IES2
1.1	1FP1514-0DF3-.....	80 M	6SL3210-1PE13-2.L1	FSA	6.39	8.17	13.83	7.08	9.91	16.17	12.44	19.32	IES2
1.5	1FP1514-0EF0-.....	90 S	6SL3210-1PE14-3.L1	FSA	5.73	7.05	11.43	5.99	8.45	13.83	11.44	17.34	IES2
2.2	1FP1514-0EF4-.....	90 L	6SL3210-1PE16-1.L1	FSA	4.72	5.79	9.34	4.99	7.10	11.51	9.81	14.67	IES2
3	1FP1514-1BF1-.....	112 M	6SL3210-1PE18-0.L1	FSA	3.00	4.06	6.11	3.74	5.51	9.51	7.79	12.49	IES2
4	1FP1514-1BF2-.....	112 M	6SL3210-1PE21-1.L0	FSA	3.04	3.91	6.86	3.53	5.16	8.74	7.56	11.62	IES2
5.5	1FP1514-1CF0-.....	132 S	6SL3210-1PE21-4.L0	FSB	2.72	3.55	6.82	3.19	4.71	8.48	7.21	11.67	IES2
7.5	1FP1514-1CF1-.....	132 S	6SL3210-1PE21-8.L0	FSB	2.21	3.07	6.27	2.72	4.20	8.00	6.21	10.71	IES2
11	1FP1514-1DF2-.....	160 M	6SL3210-1PE22-7.L0	FSC	1.83	2.58	5.12	2.40	3.66	6.74	5.79	9.53	IES2
15	1FP1514-1DF3-.....	160 M	6SL3210-1PE23-3.L0	FSC	1.84	2.58	5.18	2.32	3.54	6.77	5.43	9.10	IES2
18.5	1FP1514-1DF4-.....	160 L	6SL3210-1PE23-8.L0	FSD	1.76	2.49	4.99	2.20	3.48	6.66	5.21	9.06	IES2
22	1FP1514-1DF1-.....	180 M	6SL3210-1PE24-5.L0	FSD	1.39	1.93	3.72	1.90	2.95	5.24	4.69	7.67	IES2
30	1FP1514-2AF4-.....	200 L	6SL3210-1PE26-0.L0	FSD	1.25	1.78	3.78	1.80	2.81	5.28	4.28	7.58	IES2
37	1FP1514-2AF5-.....	200 L	6SL3210-1PE28-8.L0	FSD	1.26	1.69	3.09	1.71	2.58	4.38	3.82	6.17	IES2
45	1FP1514-2BF2-.....	225 M	6SL3210-1PE31-1.L0	FSD	1.16	1.70	3.46	1.63	2.55	4.59	3.66	6.29	IES2

¹⁾ Output frequency, rel. [%] referred to the rated speed/
torque, rel. [%] referred to the rated torque T_{rated} .

Synchronous reluctance motors for SINAMICS converters – VSD4000 line

Orientation

Article number code

Selection and ordering data

The article number consists of a combination of digits and letters and is divided into three hyphenated blocks to provide a better overview, e.g.:

**1FP1514-1DB42-1GF4-Z
H00**

The first block (positions 1 to 7) identifies the motor type. The second block (positions 8 to 12) defines the motor frame size and length, the number of poles and power and in some cases the frequency/voltage. In the third block (positions 13 to 16), the frequency/voltage, type of construction and further design features are encoded.

For deviations in the second and third block from the catalog codes either **Z** or **90** should be used as appropriate.

Ordering data:

- Complete Article No. and order code(s) or plain text
- If a quotation has been requested, please specify the quotation number in addition to the Article No.
- When ordering a complete motor as a spare part, please specify the works serial No. for the previously supplied motor as well as the Article No.

Structure of the Article No.:		Position:	1	2	3	4	5	6	7	-	8	9	10	11	12	-	13	14	15	16	
1st to 4th position:	Three-phase synchronous-reluctance motor																				
Digit, letter, letter, digit	Self-ventilated by fan mounted on and driven by the rotor		1	F	P	1															
5th position:	SIMOTICS GP – aluminum housing						0														
Digit	SIMOTICS SD – cast-iron housing						5														
6th position:	Standard version Gen 2							1													
Digit																					
7th position:	Efficiency class																				
Digit	Super Premium Efficiency								4												
8th and 9th position:	Motor frame size										0	A									
Digit, letter	(frame size as a combination of shaft height and overall length, encoded)																		
											2	E									
10th position:	No. of poles												B								
Letter	B, F: 4-pole												F								
11th position:	Laminated core length													0							
Digit														2							
														4							
														5							
12th and 13th position:	Motor voltage and frequency															2		1			
2 digits	380 V 3 AC, 50 Hz/440 V 3 AC, 60 Hz/380 V 3 AC, 87 Hz																				
14th position:	Type of construction																		A		
Letter	(encoded with A ... V)																		...		
																			V		
15th position:	Motor protection																			B	
Letter	(encoded with B ... Z; Z requires order code Q.. (e.g. Q3A); F = standard version with integrated KTY84 temperature sensor)																			...	
																				Z	
16th position:	Terminal box position																				4
Digit	4: Terminal box top (normal version), 5: Terminal box right, 6: Terminal box left																				...
																					6
	Special order versions: encoded – additional order code required not encoded – additional plain text required																				-
																					Z

Synchronous reluctance motors for SINAMICS converters – VSD4000 line

Orientation

Article number code

Selection and ordering data

Ordering example:

Selection criteria	Requirement	Structure of the Article No.
1FP10 motor type	Standard motor for converter operation SIMOTICS GP VSD4000 line, aluminum version, rated power at $P_{rated 50}$ with 15 kW, $P_{rated 60}$ with 17.3 kW or $P_{rated 87}$ with 23.5 kW	1FP1014-■■■■■-■■■■■
Motor frame size	160 L	1FP1014-1D■4■-■■■■■
No. of poles	4-pole	1FP1014-1DB4■-■■■■■
Motor voltage and frequency	380 V 3 AC, 50 Hz/440 V 3 AC, 60 Hz/380 V 3 AC, 87 Hz	1FP1014-1DB42-1■■■■■
Type of construction with special version	IM V5 with protective cover ¹⁾	1FP1014-1DB42-1C■■■-Z H00
Motor protection	Motor protection with PTC thermistors with 1 or 3 embedded temperature sensors for tripping	1FP1014-1DB42-1CB■-Z H00
Terminal box position	Terminal box right (viewed from DE)	1FP1014-1DB42-1CB5-Z H00

¹⁾ Standard without protective cover – the protective cover is defined with order code **H00** and must be ordered in addition to the Article No. with **-Z** and this order code.

Synchronous reluctance motors for SINAMICS converters – VSD4000 line

Super Premium Efficiency

Aluminum series SIMOTICS GP 1FP1014, line voltage 400 V, 50 Hz/480 V, 60 Hz/400 V, 87 Hz – self-ventilated

Selection and ordering data

P _{rated} , 50 Hz, 400 V	P _{rated} , 60 Hz, 480 V	P _{rated} , 87 Hz, 400 V	Frame size	Connection	Operating values at rated power					Article No.
					f _{rated}	T _{rated}	η _{rated} , 4/4 for converter operation	cos φ _{rated} , 4/4	I _{rated}	
kW	kW	kW			Hz	Nm	%		A	
<ul style="list-style-type: none"> Insulation: Thermal class 155 (temperature class F), IP55 degree of protection, utilization in accordance with thermal class F according to B Operation with a SINAMICS G120 converter with uncontrolled infeed – rated voltage 380 V, 50 Hz/440 V, 60 Hz/380 V, 87 Hz 										
1500 rpm	1800 rpm	2610 rpm	4-pole							
0.55			80 M	Y	50	3.5	83.9	0.67	1.49	1FP1014-0DB2 ■-■■■■■
	0.63			Y	60	3.4	84.0	0.66	1.49	
		0.95		Δ	87	3.5	87.5	0.65	2.55	
0.75			80 M	Y	50	4.8	85.7	0.67	1.98	1FP1014-0DB3 ■-■■■■■
	0.86			Y	60	4.6	85.5	0.66	2.0	
		1.3		Δ	87	4.8	89.0	0.64	3.45	
1.1			90 S	Y	50	7.0	87.2	0.69	2.8	1FP1014-0EB0 ■-■■■■■
	1.27			Y	60	6.7	87.5	0.69	2.75	
		1.9		Δ	87	7.0	89.0	0.68	4.8	
1.5			90 M	Y	50	9.5	88.2	0.69	3.75	1FP1014-0EB4 ■-■■■■■
	1.75			Y	60	9.0	88.5	0.68	3.8	
		2.6		Δ	87	9.5	90.5	0.67	6.5	
2.2			112 M	Y	50	14	89.5	0.71	5.3	1FP1014-1BB0 ■-■■■■■
	2.55			Y	60	13.3	91.0	0.71	5.2	
		3.85		Δ	87	14	92.0	0.69	9.2	
3			112 M	Y	50	19.1	90.4	0.71	7.1	1FP1014-1BB1 ■-■■■■■
	3.45			Y	60	18.1	91.0	0.72	6.9	
		5.2		Δ	87	19.1	91.8	0.70	12.3	
4			112 M	Y	50	25.5	91.1	0.72	9.3	1FP1014-1BB2 ■-■■■■■
	4.55			Y	60	24.0	91.0	0.73	9.0	
		6.9		Δ	87	25.5	92.3	0.71	16.0	
5.5			132 S	Y	50	35	91.9	0.72	12.6	1FP1014-1CB0 ■-■■■■■
	6.3			Y	60	33.5	92.4	0.73	12.3	
		9.6		Δ	87	35	92.8	0.71	22	
7.5			132 M	Y	50	47.5	92.6	0.72	17.1	1FP1014-1CB2 ■-■■■■■
	8.6			Y	60	45.5	92.4	0.73	16.7	
		13.1		Δ	87	47.5	93.3	0.70	30.5	
11			160 M	Y	50	70	93.3	0.72	25.0	1FP1014-1DB2 ■-■■■■■
	12.6			Y	60	67	93.6	0.73	24.0	
		19.1		Δ	87	70	93.6	0.71	43.5	
15			160 L	Y	50	95	93.9	0.71	34.0	1FP1014-1DB4 ■-■■■■■
	17.3			Y	60	90	94.5	0.72	33.5	
		26		Δ	87	95	94.1	0.71	59.0	
18.5			180 M	Y	50	118.0	94.2	0.71	42.0	1FP1014-1EB2 ■-■■■■■
	21.3			Y	60	113.0	94.5	0.72	41.0	
		32		Δ	87	118.0	95.0	0.71	73.0	
22			180 L	Y	50	140.0	94.5	0.71	50.0	1FP1014-1EB4 ■-■■■■■
	25.3			Y	60	134.0	94.5	0.72	49.0	
		38.1		Δ	87	140.0	93.9	0.70	87.0	
30			200 L	Y	50	191.0	95.2	0.71	68.0	1FP1014-2AB5 ■-■■■■■
	34.5			Y	60	183.0	95.4	0.72	66.0	
		52		Δ	87	191.0	94.4	0.71	118.0	

For versions, see Article No. supplements and special versions. ■-■■■■■

All technical specifications refer to converter operation.

Synchronous reluctance motors for SINAMICS converters – VSD4000 line

Super Premium Efficiency

Aluminum series SIMOTICS GP 1FP1014, line voltage 400 V, 50 Hz/480 V, 60 Hz/400 V, 87 Hz – self-ventilated

Motor type	$m_{IM B3}$	J	L_{pfA} , tolerance +3 dB(A) load	L_{WA} , tolerance +3 dB(A) load	Mech. speed limit	Terminal box	Converter	Frame size	IES class acc. to EN 50598-2
							SINAMICS G120 – PM240-2 Operating mode: Low overload		
	kg	kgm ²	dB(A)	dB(A)	rpm	Type	Type ¹⁾		
1FP1014-0DB2.-.....	12	0.0019	66.0	78.0	3200	TB1D00	6SL3210-1PE11-8.L0	FSA	IES 2
			67.0	79.0			6SL3210-1PE11-8.L0	FSA	IES 2
			69.0	81.0			6SL3210-1PE13-2.L0	FSA	IES 2
1FP1014-0DB3.-.....	15	0.0025	66.0	78.0	3200	TB1D00	6SL3210-1PE12-3.L0	FSA	IES 2
			67.0	79.0			6SL3210-1PE12-3.L0	FSA	IES 2
			69.0	81.0			6SL3210-1PE14-3.L0	FSA	IES 2
1FP1014-0EB0.-.....	18	0.0034	58.0	70.0	3200	TB1D00	6SL3210-1PE13-2.L1	FSA	IES 2
			59.0	71.0			6SL3210-1PE13-2.L1	FSA	IES 2
			69.0	81.0			6SL3210-1PE16-1.L1	FSA	IES 2
1FP1014-0EB4.-.....	22	0.0043	58.0	70.0	3200	TB1D00	6SL3210-1PE14-3.L1	FSA	IES 2
			59.0	71.0			6SL3210-1PE14-3.L1	FSA	IES 2
			69.0	81.0			6SL3210-1PE18-0.L1	FSA	IES 2
1FP1014-1BB0.-.....	34	0.0092	58.0	70.0	3200	TB1F00	6SL3210-1PE16-1.L1	FSA	IES 2
			58.0	70.0			6SL3210-1PE16-1.L1	FSA	IES 2
			65.0	77.0			6SL3210-1PE21-1.L0	FSA	IES 2
1FP1014-1BB1.-.....	34	0.0092	59.0	71.0	3200	TB1F00	6SL3210-1PE18-0.L1	FSA	IES 2
			59.0	71.0			6SL3210-1PE18-0.L1	FSA	IES 2
			65.0	77.0			6SL3210-1PE21-4.L0	FSA	IES 2
1FP1014-1BB2.-.....	39	0.0114	59.0	71.0	3200	TB1F00	6SL3210-1PE21-1.L0	FSA	IES 2
			60.0	72.0			6SL3210-1PE21-1.L0	FSA	IES 2
			69.0	81.0			6SL3210-1PE21-8.L0	FSB	IES 2
1FP1014-1CB0.-.....	52	0.0200	69.0	81.0	3200	TB1H00	6SL3210-1PE21-4.L0	FSB	IES 2
			68.0	80.0			6SL3210-1PE21-4.L0	FSB	IES 2
			69.0	81.0			6SL3210-1PE22-7.L0	FSC	IES 2
1FP1014-1CB2.-.....	66	0.0277	62.0	74.0	3200	TB1H00	6SL3210-1PE21-8.L0	FSB	IES 2
			64.0	76.0			6SL3210-1PE21-8.L0	FSB	IES 2
			68.0	80.0			6SL3210-1PE23-3.L0	FSC	IES 2
1FP1014-1DB2.-.....	86	0.0485	69.0	81.0	3000	TB1J00	6SL3210-1PE22-7.L0	FSC	IES 2
			70.0	82.0			6SL3210-1PE22-7.L0	FSC	IES 2
			75.0	87.0			6SL3210-1PE23-8.L0	FSD	IES 2
1FP1014-1DB4.-.....	104	0.0624	71.0	83.0	3000	TB1J00	6SL3210-1PE23-3.L0	FSC	IES 2
			72.0	84.0			6SL3210-1PE23-3.L0	FSC	IES 2
			76.0	88.0			6SL3210-1PE26-0.L0	FSD	IES 2
1FP1014-1EB2.-.....	132	0.1155	69.0	82.0	2610	TB1J00	6SL3210-1PE23-8.L0	FSD	IES 2
			70.0	83.0			6SL3210-1PE24-5.L0	FSD	IES 2
			76.0	89.0			6SL3210-1PE27-5.L0	FSE	IES 2
1FP1014-1EB4.-.....	144	0.1315	69.0	82.0	2610	TB1J00	6SL3210-1PE24-5.L0	FSD	IES 2
			70.0	83.0			6SL3210-1PE26-0.L0	FSD	IES 2
			76.0	89.0			6SL3210-1PE28-8.L0	FSE	IES 2
1FP1014-2AB5.-.....	171	0.1884	68.0	81.0	2610	TB1L00	6SL3210-1PE26-0.L0	FSE	IES 2
			70.0	83.0			6SL3210-1PE27-5.L0	FSD	IES 2
			73.0	86.0			6SL3210-1PE31-5.L0	FSF	IES 2

¹⁾ In addition to the Power Module, a CU230P-2 Control Unit and an Operator Panel are required (see Catalog D 31 and/or D 35).

Synchronous reluctance motors for SINAMICS converters – VSD4000 line

Super Premium Efficiency

Cast-iron series SIMOTICS SD 1FP1514, line voltage 400 V, 50 Hz/460 V, 60 Hz/400 V, 87 Hz – self-ventilated

Selection and ordering data

P _{rated} , 50 Hz, 400 V	P _{rated} , 60 Hz, 480 V	P _{rated} , 87 Hz, 400 V	Frame size	Connection	Operating values at rated power				I _{rated}	Article No.
					f _{rated}	T _{rated}	η _{rated} , 4/4 for converter operation	cos φ _{rated} , 4/4		
kW	kW	kW			Hz	Nm	%	A		
<ul style="list-style-type: none"> Insulation: Thermal class 155 (temperature class F), IP55 degree of protection, utilization in accordance with thermal class F according to B Operation with a SINAMICS G120 converter with uncontrolled infeed – rated voltage 380 V, 50 Hz/440 V, 60 Hz/380 V, 87 Hz 										
3000 rpm	3600 rpm		4-pole							
0.75			80 M	Y	100	2.4	0.65	83.5	2.1	1FP1514-0DF2 ■-■■■■■
	0.86			Y	120	2.3	0.65	82.5	2.1	
1.1			80 M	Y	100	3.5	0.66	85.2	2.95	1FP1514-0DF3 ■-■■■■■
	1.27			Y	120	6.7	0.66	85.5	2.95	
1.5			90 S	Y	100	4.8	0.66	86.5	4	1FP1514-0EF0 ■-■■■■■
	1.75			Y	120	4.6	0.67	86.5	3.95	
2.2			90 L	Y	100	7	0.66	88	5.8	1FP1514-0EF4 ■-■■■■■
	2.55			Y	120	13.5	0.68	88.5	5.6	
3.0			112 M	Y	100	9.5	0.71	89.1	7.2	1FP1514-1BF1 ■-■■■■■
	3.45			Y	120	9.2	0.71	89.5	7.1	
4.0			112 M	Y	100	12.7	0.69	90	9.8	1FP1514-1BF2 ■-■■■■■
	4.55			Y	120	12.1	0.7	89.5	9.5	
5.5			132 S	Y	100	17.5	90.9	0.71	12.9	1FP1514-1CF0 ■-■■■■■
	6.3			Y	120	16.7	90.2	0.72	12.7	
7.5			132 S	Y	100	24.0	91.7	0.72	17.3	1FP1514-1CF1 ■-■■■■■
	8.6			Y	120	23.0	91.7	0.72	17.1	
11			160 M	Y	100	35	92.6	0.73	24.5	1FP1514-1DF2 ■-■■■■■
	12.6			Y	120	33.5	91.4	0.73	24.5	
15			160 M	Y	100	48.0	93.3	0.72	34	1FP1514-1DF3 ■-■■■■■
	17.3			Y	120	46.0	93.0	0.73	33.5	
18.5			160 L	Y	100	58	93.7	0.72	41.5	1FP1514-1DF4 ■-■■■■■
	21.3			Y	120	56.5	93.0	0.73	41.0	
22			180 M	Y	100	70	94.0	0.71	50	1FP1514-1EF2 ■-■■■■■
	25.3			Y	120	67	93.0	0.71	50	
30			200 L	Y	100	96	94.5	0.72	67	1FP1514-2AF4 ■-■■■■■
	34.5			Y	120	91	94.1	0.72	67	
37			200 L	Y	100	118	94.8	0.72	82	1FP1514-2AF5 ■-■■■■■
	42.5			Y	120	112	94.5	0.73	81	
45			225 M	Y	100	143	95.0	0.73	99	1FP1514-2BF2 ■-■■■■■
	52			Y	120	136	94.4	0.73	99	

For versions, see Article No. supplements and special versions.

■-■■■■■

All technical specifications refer to converter operation.

Synchronous reluctance motors for SINAMICS converters – VSD4000 line

Super Premium Efficiency

Cast-iron series SIMOTICS SD 1FP1514, line voltage 400 V, 50 Hz/460 V, 60 Hz/400 V, 87 Hz – self-ventilated

Motor type	$m_{IM B3}$	J	L_{pA} , tolerance +3 dB(A) load	L_{WA} , tolerance +3 dB(A) load	Mech. speed limit	Terminal box	Converter	Frame size	IES class acc. to EN 50598-2
							SINAMICS G120 – PM240-2 Operating mode: Low overload		
	kg	kgm ²	dB(A)	dB(A)	rpm	Type	Type ¹⁾		
1FP1514-0DF2.-.....	17	0.0013	68.0	80.0	6000	TB1D00	6SL3210-1PE12-3.L0	FSA	IES 2
							6SL3210-1PE12-3.L0	FSA	IES 2
1FP1514-0DF3.-.....	18	0.0015	68.0	80.0	6000	TB1D00	6SL3210-1PE13-2.L1	FSA	IES 2
							6SL3210-1PE13-2.L1	FSA	IES 2
1FP1514-0EF0.-.....	24	0.0022	66.0	78.0	6000	TB1D00	6SL3210-1PE14-3.L1	FSA	IES 2
			70.0	82.0			6SL3210-1PE14-3.L1	FSA	IES 2
1FP1514-0EF4.-.....	27	0.0031	66.0	78.0	6000	TB1D00	6SL3210-1PE16-1.L1	FSA	IES 2
			70.0	82.0			6SL3210-1PE16-1.L1	FSA	IES 2
1FP1514-1BF1.-.....	39	0.0064	63.0	75.0	6000	TB1F00	6SL3210-1PE18-0.L1	FSA	IES 2
			67.0	79.0			6SL3210-1PE18-0.L1	FSA	IES 2
1FP1514-1BF2.-.....	41	0.0071	69.0	81.0	6000	TB1F00	6SL3210-1PE21-1.L0	FSA	IES 2
							6SL3210-1PE21-1.L0	FSA	IES 2
1FP1514-1CF0.-.....	53	0.0133	70.0	82.0	5600	TB1H01	6SL3210-1PE21-4.L0	FSB	IES 2
			72.0	84.0			6SL3210-1PE21-4.L0	FSB	IES 2
1FP1514-1CF1.-.....	56	0.0160	70.0	82.0	5600	TB1H01	6SL3210-1PE21-8.L0	FSB	IES 2
			72.0	84.0			6SL3210-1PE21-8.L0	FSB	IES 2
1FP1514-1DF2.-.....	89	0.0323	72.0	84.0	4800	TB1J01	6SL3210-1PE22-7.L0	FSC	IES 2
			76.0	88.0			6SL3210-1PE22-7.L0	FSC	IES 2
1FP1514-1DF3.-.....	96	0.0377	72.0	84.0	4800	TB1J01	6SL3210-1PE23-3.L0	FSC	IES 2
			76.0	88.0			6SL3210-1PE23-3.L0	FSC	IES 2
1FP1514-1DF4.-.....	102	0.0444	75.0	87.0	4800	TB1J01	6SL3210-1PE23-8.L0	FSC	IES 2
			76.0	88.0			6SL3210-1PE24-5.L0	FSC	IES 2
1FP1514-1EF2.-.....	144	0.087	73.0	86.0	4600	TB1J00	6SL3210-1PE24-5.L0		IES 2
			75.0	88.0			6SL3210-1PE26-0.L0		IES 2
1FP1514-2AF4.-.....	187	0.1277	73.0	86.0	4500	TB1L01	6SL3210-1PE26-0.L0		IES 2
			76.0	89.0			6SL3210-1PE27-5.L0		IES 2
1FP1514-2AF5.-.....	222	0.1884	73.0	86.0	4500	TB1L01	6SL3210-1PE28-8.L0		IES 2
			76.0	89.0			6SL3210-1PE28-8.L0		IES 2
1FP1514-2BF2.-.....	286	0.3599	78.0	92.0	4500	TB1L01	6SL3210-1PE31-1.L0		IES 2
			81.0	95.0			6SL3210-1PE31-1.L0		IES 2

¹⁾ In addition to the Power Module, a CU230P-2 Control Unit and an Operator Panel are required (see Catalog D 31 and/or D 35).

Synchronous reluctance motors for SINAMICS converters – VSD4000 line

Super Premium Efficiency

Cast-iron series SIMOTICS SD 1FP1514, line voltage 400 V, 50 Hz/460 V, 60 Hz/400 V, 87 Hz – self-ventilated

Selection and ordering data

P _{rated} , 50 Hz, 400 V	P _{rated} , 60 Hz, 480 V	P _{rated} , 87 Hz, 400 V	Frame size	Connection	Operating values at rated power				Article No.	
					f _{rated}	T _{rated}	η _{rated} , 4/4 for converter operation	cos φ _{rated} , 4/4		I _{rated}
kW	kW	kW			Hz	Nm	%	A		
<ul style="list-style-type: none"> Insulation: Thermal class 155 (temperature class F), IP55 degree of protection, utilization in accordance with thermal class F according to B Operation with a SINAMICS G120 converter with uncontrolled infeed – rated voltage 380 V, 50 Hz/440 V, 60 Hz/380 V, 87 Hz 										
1500 rpm	1800 rpm	2610 rpm	4-pole							
0.55			80 M	Y	50	3.5	83.9	0.67	1.49	1FP1514-0DB2 ■■■■■
	0.63			Y	60	3.4	84.0	0.66	1.49	
		0.95		Δ	87	3.5	87.5	0.65	2.55	
0.75			80 M	Y	50	4.8	85.7	0.67	1.98	1FP1514-0DB3 ■■■■■
	0.86			Y	60	4.6	85.5	0.66	2.0	
		1.3		Δ	87	4.8	89.0	0.64	3.45	
1.1			90 S	Y	50	7.0	87.2	0.69	2.8	1FP1514-0EB0 ■■■■■
	1.27			Y	60	6.7	87.5	0.69	2.75	
		1.9		Δ	87	7.0	89.0	0.68	4.8	
1.5			90 M	Y	50	9.5	88.2	0.69	3.75	1FP1514-0EB4 ■■■■■
	1.75			Y	60	9.0	88.5	0.68	3.8	
		2.6		Δ	87	9.5	90.5	0.67	6.5	
2.2			112 M	Y	50	14	89.5	0.71	5.3	1FP1514-1BB0 ■■■■■
	2.55			Y	60	13.3	91.0	0.71	5.2	
		3.85		Δ	87	14	92.0	0.69	9.2	
3			112 M	Y	50	19.1	90.4	0.71	7.1	1FP1514-1BB1 ■■■■■
	3.45			Y	60	18.1	91.0	0.72	6.9	
		5.2		Δ	87	19.1	91.8	0.70	12.3	
4			112 M	Y	50	25.5	91.1	0.72	9.3	1FP1514-1BB2 ■■■■■
	4.55			Y	60	24.0	91.0	0.73	9.0	
		6.9		Δ	87	25.5	92.3	0.71	16.2	
5.5			132 S	Y	50	35	91.9	0.72	12.6	1FP1514-1CB0 ■■■■■
	6.3			Y	60	33.5	92.4	0.73	12.3	
		9.6		Δ	87	35	92.8	0.71	22	
7.5			132 M	Y	50	47.5	92.6	0.72	17.1	1FP1514-1CB2 ■■■■■
	8.6			Y	60	45.5	92.4	0.73	16.7	
		13.1		Δ	87	47.5	93.3	0.70	30.5	
11			160 M	Y	50	70	93.3	0.72	25.0	1FP1514-1DB2 ■■■■■
	12.6			Y	60	67	93.6	0.73	24.0	
		19.1		Δ	87	70	93.6	0.71	43.5	
15			160 L	Y	50	95	93.9	0.71	34.0	1FP1514-1DB4 ■■■■■
	17.3			Y	60	90	94.5	0.72	33.5	
		26		Δ	87	95	94.1	0.71	59.0	
18.5			180 M	Y	50	118.0	94.2	0.71	42.0	1FP1514-1EB2 ■■■■■
	21.3			Y	60	113.0	94.5	0.72	41.0	
		32		Δ	87	118.0	95.0	0.71	73.0	
22			180 L	Y	50	140.0	94.5	0.71	50.0	1FP1514-1EB4 ■■■■■
	25.3			Y	60	134.0	94.5	0.72	49.0	
		38.1		Δ	87	140.0	93.9	0.70	87.0	
30			200 L	Y	50	191.0	95.2	0.71	68.0	1FP1514-2AB5 ■■■■■
	34.5			Y	60	183.0	95.4	0.72	66.0	
		52		Δ	87	191.0	94.4	0.71	118.0	
37			225 S	Y	50	236	95.2	0.75	79	1FP1514-2BB0 ■■■■■
	42.5			Y	60	225	95.4	0.75	78	
		64		Δ	87	236	95.4	0.75	136	
45			225 M	Y	50	286	95.4	0.75	96	1FP1514-2BB2 ■■■■■
	52			Y	60	276	95.8	0.75	95	
		78		Δ	87	286	95.6	0.75	165	

For versions, see Article No. supplements and special versions.



All technical specifications refer to converter operation.

Synchronous reluctance motors for SINAMICS converters – VSD4000 line

Super Premium Efficiency

Cast-iron series SIMOTICS SD 1FP1514, line voltage 400 V, 50 Hz/460 V, 60 Hz/400 V, 87 Hz – self-ventilated

Motor type	m_{IMB3}	J	L_{pFA} , tolerance +3 dB(A) load	L_{WA} , tolerance +3 dB(A) load	Mech. speed limit	Terminal box	Converter	Frame size	IES class acc. to EN 50598-2
							SINAMICS G120 – PM240-2 Operating mode: Low overload		
	kg	kgm ²	dB(A)	dB(A)	rpm	Type	Type ¹⁾		
1FP1514-0DB2-.....	19	0.0019	66.0	78.0	3200	TB1D01	6SL3210-1PE11-8.L0	FSA	IES 2
			67.0	79.0			6SL3210-1PE11-8.L0	FSA	IES 2
			69.0	81.0			6SL3210-1PE13-2.L0	FSA	IES 2
1FP1514-0DB3-.....	22.5	0.0025	66.0	78.0	3200	TB1D01	6SL3210-1PE12-3.L0	FSA	IES 2
			67.0	79.0			6SL3210-1PE12-3.L0	FSA	IES 2
			69.0	81.0			6SL3210-1PE14-3.L0	FSA	IES 2
1FP1514-0EB0-.....	18	0.0034	58.0	70.0	3200	TB1D01	6SL3210-1PE13-2.L1	FSA	IES 2
			59.0	71.0			6SL3210-1PE13-2.L1	FSA	IES 2
			69.0	81.0			6SL3210-1PE16-1.L1	FSA	IES 2
1FP1514-0EB4-.....	26	0.0043	58.0	70.0	3200	TB1D01	6SL3210-1PE14-3.L1	FSA	IES 2
			59.0	71.0			6SL3210-1PE14-3.L1	FSA	IES 2
			69.0	81.0			6SL3210-1PE18-0.L1	FSA	IES 2
1FP1514-1BB0-.....	46	0.0092	58.0	70.0	3200	TB1F01	6SL3210-1PE16-1.L1	FSA	IES 2
			58.0				6SL3210-1PE16-1.L1	FSA	IES 2
			65.0	77.0			6SL3210-1PE21-1.L0	FSA	IES 2
1FP1514-1BB1-.....	46	0.0092	59.0	71.0	3200	TB1F01	6SL3210-1PE18-0.L1	FSA	IES 2
			59.0				6SL3210-1PE18-0.L1	FSA	IES 2
			65.0	77.0			6SL3210-1PE21-4.L0	FSA	IES 2
1FP1514-1BB2-.....	51	0.0114	59.0	71.0	3200	TB1F01	6SL3210-1PE21-1.L0	FSA	IES 2
			60.0	72.0			6SL3210-1PE21-1.L0	FSA	IES 2
			69.0	81.0			6SL3210-1PE21-8.L0	FSA	IES 2
1FP1514-1CB0-.....	68	0.0200	69.0	81.0	3200	TB1H01	6SL3210-1PE21-4.L0	FSB	IES 2
			68.0	80.0			6SL3210-1PE21-4.L0	FSB	IES 2
			69.0	81.0			6SL3210-1PE22-7.L0	FSC	IES 2
1FP1514-1CB2-.....	80	0.0277	62.0	74.0	3200	TB1H01	6SL3210-1PE21-8.L0	FSB	IES 2
			64.0	76.0			6SL3210-1PE21-8.L0	FSB	IES 2
			68.0	80.0			6SL3210-1PE23-3.L0	FSC	IES 2
1FP1514-1DB2-.....	105	0.0485	69.0	81.0	3200	TB1J01	6SL3210-1PE22-7.L0	FSC	IES 2
			70.0	82.0			6SL3210-1PE22-7.L0	FSC	IES 2
			75.0	87.0			6SL3210-1PE23-8.L0	FSD	IES 2
1FP1514-1DB4-.....	120	0.0624	71.0	83.0	3200	TB1J01	6SL3210-1PE23-3.L0	FSC	IES 2
			72.0	84.0			6SL3210-1PE23-3.L0	FSC	IES 2
			76.0	88.0			6SL3210-1PE26-0.L0	FSD	IES 2
1FP1514-1EB2-.....	166	0.1155	69.0	82.0	3000	TB1J01	6SL3210-1PE23-8.L0	FSD	IES 2
			70.0	83.0			6SL3210-1PE24-5.L0	FSD	IES 2
			76.0	89.0			6SL3210-1PE27-5.L0	FSE	IES 2
1FP1514-1EB4-.....	182	0.1315	69.0	82.0	3000	TB1J01	6SL3210-1PE24-5.L0	FSD	IES 2
			70.0	83.0			6SL3210-1PE26-0.L0	FSD	IES 2
			76.0	89.0			6SL3210-1PE28-8.L0	FSE	IES 2
1FP1514-2AB5-.....	220	0.1884	68.0	81.0	3000	TB1L01	6SL3210-1PE26-0.L0	FSE	IES 2
			70.0	83.0			6SL3210-1PE27-5.L0	FSD	IES 2
			73.0	86.0			6SL3210-1PE31-5.L0	FSF	IES 2
1FP1514-2BB0-.....	320	0.442	70.0	84.0	3000	TB1L01	6SL3210-1PE28-8.L0	FSE	IES 2
			71.0	85.0			6SL3210-1PE28-8.L0	FSE	IES 2
			77.0	91.0			6SL3210-1PE31-5.L0	FSF	IES 2
1FP1514-2BB2-.....	365	0.518	70.0	84.0	3000	TB1L01	6SL3210-1PE31-1.L0	FSE	IES 2
			71.0	85.0			6SL3210-1PE31-1.L0	FSE	IES 2
			77.0	91.0			6SL3210-1PE31-8.L0	FSF	IES 2

¹⁾ In addition to the Power Module, a CU230P-2 Control Unit and an Operator Panel are required (see Catalog D 31 and/or D 35).

Synchronous reluctance motors for SINAMICS converters – VSD4000 line

Article No. supplements and special versions · Voltages

Aluminum series SIMOTICS GP 1FP1014

Selection and ordering data

Voltages	Article No.	supplement	Frame size						Motor version
			80	90	112	132	160	180	
	Voltage code	Additional identification code with order code and plain text if required	1FP1014						Super Premium Efficiency
	12th and 13th position of the Article No.								
	1FP1014-	- - . . .							
		Order code							
Voltage at 50 Hz or 60 Hz									
Line voltage:	2	1	-	<input type="checkbox"/>	<input type="checkbox"/>	<input type="checkbox"/>	<input type="checkbox"/>	<input type="checkbox"/>	<input type="checkbox"/>
50 Hz, 400 V									
60 Hz, 480 V									

Standard version

Synchronous reluctance motors for SINAMICS converters – VSD4000 line

Article No. supplements and special versions · Voltages

Cast-iron series SIMOTICS SD 1FP1514

Selection and ordering data

Voltages	Article No. supplement	Voltage code 12th and 13th posi- tion of the Article No.	Additional identifica- tion code with order code and plain text if required	Frame size							Motor version	
				80	90	112	132	160	180	200		225
				1FP1514								Super Premium Efficiency
1FP1514-....				■ - ■ ...								
Order code												
Voltage at 50 Hz or 60 Hz												
Line voltage:	2	1	-	<input type="checkbox"/>	<input type="checkbox"/>	<input type="checkbox"/>	<input type="checkbox"/>	<input type="checkbox"/>	<input type="checkbox"/>	<input type="checkbox"/>	<input type="checkbox"/>	
50 Hz, 400 V												
60 Hz, 480 V												













Standard version

Synchronous reluctance motors for SINAMICS converters – VSD4000 line

Article No. supplements and special versions · Types of construction

Aluminum series SIMOTICS GP 1FP1014

Selection and ordering data



Types of construction	Article No. supplement		Frame size							Motor version
	Type of construction code letter 14th position of the Article No.	For types of construction with order code(s) Article No. with additional identification code -Z	80	90	112	132	160	180	200	
			1FP1014							Super Premium Efficiency
1FP1014- (-Z)	Order code								
Without flange										
IM B3 ^{1) 2)}		A	-	□	□	□	□	□	□	□
IM B6 ²⁾		T	-	□	□	□	□	□	□	□
IM B7 ²⁾		U	-	□	□	□	□	□	□	□
IM B8 ²⁾		V	-	□	□	□	□	□	□	□
IM V6 ²⁾		D	-	□	□	□	□	□	□	□
IM V5 without protective cover ²⁾		C	-	□	□	□	□	□	□	□
IM V5 with protective cover ^{2) 3) 4)}		C	H00	✓	✓	✓	✓	✓	✓	✓
With flange										
		Acc. to EN 50347 Acc. to DIN 42948		FF165 A 200	FF165 A 200	FF215 A 250	FF265 A 300	FF300 A 350	FF300 A 350	FF350 A 400
IM B5 ^{2) 5)}		F	-	✓	✓	✓	✓	✓	✓	✓
IM V1 without protective cover ²⁾		G	-	✓	✓	✓	✓	✓	✓	✓
IM V1 with protective cover ^{2) 4)}		G	H00	✓	✓	✓	✓	✓	✓	✓
IM V3 ³⁾		H	-	✓	✓	✓	✓	✓	✓	✓
IM B35		J	-	✓	✓	✓	✓	✓	✓	✓

For legends and footnotes, see page 5/56.

Synchronous reluctance motors for SINAMICS converters – VSD4000 line

Article No. supplements and special versions · Types of construction

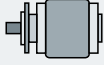
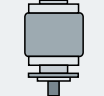
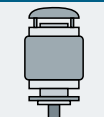
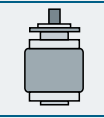
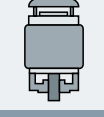
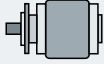
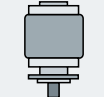
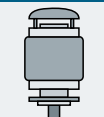
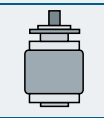
Aluminum series SIMOTICS GP 1FP1014

Types of construction	Article No. supplement	Frame size	Motor version							
			80	90	112	132	160	180	200	
	Type of construction code letter 14th position of the Article No.	For types of construction with order code(s) Article No. with additional identification code -Z	1FP1014							Super Premium Efficiency
1FP1014-.....-.. (-Z)	.. (-Z)	Order code								
With flange next largest	Acc. to EN 50347	–	FF215	FF265	FF300	–	–	–		
	Acc. to DIN 42948	–	A 250	A 300	A 350	–	–	–		
IM B5 ^{2) 5)}	F	P01	–	✓	✓	✓	–	–	–	
										
IM V1 without protective cover ²⁾	G	P01	–	✓	✓	✓	–	–	–	
										
IM V1 with protective cover ^{2) 4) 5) 6)}	G	P01+H00	–	✓	✓	✓	–	–	–	
										
IM V3 ⁴⁾	H	P01	–	✓	✓	✓	–	–	–	
										
IM V18 with protective cover ^{2) 3) 4) 5)}	M	H00	–	✓	✓	✓	–	–	–	
										
With flange next smallest	Acc. to EN 50347	FF130	–	FF165	FF215	FF265	FF265	FF300		
	Acc. to DIN 42948	A 160	–	A 200	A 250	A 300	A 300	A 350		
IM B5 ^{2) 6)}	F	P02	✓	–	✓	✓	✓	✓	✓	
										
IM V1 without protective cover ²⁾	G	P02	✓	–	✓	✓	✓	✓	✓	
										
IM V1 with protective cover ^{2) 4) 5) 6)}	G	P02+H00	✓	–	✓	✓	✓	✓	✓	
										
IM V3 ⁴⁾	H	P02	✓	–	✓	✓	✓	✓	✓	
										
IM B35 ³⁾	J	P02	✓	–	✓	✓	✓	✓	✓	
										

Synchronous reluctance motors for SINAMICS converters – VSD4000 line

Article No. supplements and special versions · Types of construction

Aluminum series SIMOTICS GP 1FP1014

Types of construction	Article No. supplement	Frame size	Motor version						
			80	90	112	132	160	180	200
	Type of construction code letter 14th position of the Article No.	For types of construction with order code(s) Article No. with additional identification code -Z	1FP1014						
	Order code		Super Premium Efficiency						
1FP1014-.....-..-..(-Z)									
With flange	Acc. to EN 50347 Acc. to DIN 42948	FT100 C 120	FT115 C 140	FT130 C 160	FT165 C 200	FT215 C 250	-	-	-
IM B14 ^{2) 6)}	K	✓	✓	✓	✓	✓	-	-	-
IM V19 ²⁾	L	✓	✓	✓	✓	✓	-	-	-
IM V18 without protective cover ²⁾	M	✓	✓	✓	✓	✓	-	-	-
IM V18 with protective cover ^{2) 4) 5) 6)}	M	H00	✓	✓	✓	✓	-	-	-
IM B34 ³⁾	N	✓	✓	✓	✓	✓	-	-	-
With flange next largest	Acc. to EN 50347 Acc. to DIN 42948	FT130 C 160	FT130 C 160	FT165 C 200	FT215 C 250	-	-	-	-
IM B14 ^{2) 6)}	K	P01	✓	✓	✓	✓	-	-	-
IM V19 ²⁾	L	P01	✓	✓	✓	✓	-	-	-
IM V18 without protective cover ²⁾	M	P01	✓	✓	✓	✓	-	-	-
IM V18 with protective cover ^{2) 4) 5) 6)}	M	P01+H00	✓	✓	✓	✓	-	-	-
IM B34 ³⁾	N	P01	✓	✓	✓	✓	-	-	-

- Standard version
- ✓ With additional charge
- O. R. Possible on request
- Not possible

- 1) The types of construction IM B6/7/8, IM V6, and IM V5 with/without protective cover are also possible as long as no condensation drainage holes (order code **H03**) and no stamping of these types of construction on the rating plate are required. As standard the type of construction IM B3 is then stamped on the rating plate. With type of construction IM V5 with protective cover, the protective cover has to be additionally ordered with order code **H00**. The protective cover is not stamped on the rating plate.
- 2) The type of construction is stamped on the rating plate. For orders with condensation drainage holes (order code **H03**), if mounted in a different position, the position must be specified to ensure that the condensation drainage holes are positioned correctly.
- 3) The "Second shaft extension" option (order code **L05**) is not possible.
- 4) In combination with an encoder, it is not necessary to order the protective cover (order code **H00**), as this is delivered as a protection for the encoder as standard. In this case the protective cover is standard version (without additional charge).













- 5) The types of construction IM V3 and IM V1 with/without protective cover are also possible as long as no condensation drainage holes (order code **H03**) and no stamping of these types of construction on the rating plate are required. As standard the type of construction IM B5 is then stamped on the rating plate. With type of construction IM V1 with protective cover, the protective cover has to be additionally ordered with order code **H00**. The protective cover is not stamped on the rating plate.
- 6) The types of construction IM V19 and IM V18 with/without protective cover are also possible as long as no condensation drainage holes (order code **H03**) and no stamping of these types of construction on the rating plate are required. As standard the type of construction IM B14 is then stamped on the rating plate. With type of construction IM V18 with protective cover, the protective cover has to be additionally ordered with order code **H00**. The protective cover is not stamped on the rating plate.

Synchronous reluctance motors for SINAMICS converters – VSD4000 line

Article No. supplements and special versions · Types of construction

Cast-iron series SIMOTICS SD 1FP1514



Selection and ordering data

Types of construction	Article No. supplement	Type of construction code letter 14th position of the Article No.	For types of construction with order code(s) Article No. with additional identification code -Z Order code	Frame size								Motor version
				80	90	112	132	160	180	200	225	
1FP1514-.....-...(-Z)				1FP1514								Super Premium Efficiency
Without flange												
IM B3 ^{1) 2)}		A	-	<input type="checkbox"/>	<input type="checkbox"/>	<input type="checkbox"/>	<input type="checkbox"/>	<input type="checkbox"/>	<input type="checkbox"/>	<input type="checkbox"/>	<input type="checkbox"/>	
IM B6 ²⁾		T	-	<input type="checkbox"/>	<input type="checkbox"/>	<input type="checkbox"/>	<input type="checkbox"/>	<input type="checkbox"/>	<input type="checkbox"/>	<input type="checkbox"/>	<input type="checkbox"/>	
IM B7 ²⁾		U	-	<input type="checkbox"/>	<input type="checkbox"/>	<input type="checkbox"/>	<input type="checkbox"/>	<input type="checkbox"/>	<input type="checkbox"/>	<input type="checkbox"/>	<input type="checkbox"/>	
IM B8 ²⁾		V	-	<input type="checkbox"/>	<input type="checkbox"/>	<input type="checkbox"/>	<input type="checkbox"/>	<input type="checkbox"/>	<input type="checkbox"/>	<input type="checkbox"/>	<input type="checkbox"/>	
IM V6 ²⁾		D	-	<input type="checkbox"/>	<input type="checkbox"/>	<input type="checkbox"/>	<input type="checkbox"/>	<input type="checkbox"/>	<input type="checkbox"/>	<input type="checkbox"/>	<input type="checkbox"/>	
IM V5 without protective cover ²⁾		C	-	<input type="checkbox"/>	<input type="checkbox"/>	<input type="checkbox"/>	<input type="checkbox"/>	<input type="checkbox"/>	<input type="checkbox"/>	<input type="checkbox"/>	<input type="checkbox"/>	
IM V5 with protective cover ^{2) 3) 4)}		C	H00	<input checked="" type="checkbox"/>	<input checked="" type="checkbox"/>	<input checked="" type="checkbox"/>	<input checked="" type="checkbox"/>	<input checked="" type="checkbox"/>	<input checked="" type="checkbox"/>	<input checked="" type="checkbox"/>	<input checked="" type="checkbox"/>	
With flange				FF165	FF165	FF215	FF265	FF300	FF300	FF350	FF400	
				A 200	A 200	A 250	A 300	A 350	A 350	A 400	A 450	
IM B5 ^{2) 5)}		F	-	<input checked="" type="checkbox"/>	<input checked="" type="checkbox"/>	<input checked="" type="checkbox"/>	<input checked="" type="checkbox"/>	<input checked="" type="checkbox"/>	<input checked="" type="checkbox"/>	<input checked="" type="checkbox"/>	<input checked="" type="checkbox"/>	
IM V1 without protective cover ²⁾		G	-	<input checked="" type="checkbox"/>	<input checked="" type="checkbox"/>	<input checked="" type="checkbox"/>	<input checked="" type="checkbox"/>	<input checked="" type="checkbox"/>	<input checked="" type="checkbox"/>	<input checked="" type="checkbox"/>	<input checked="" type="checkbox"/>	
IM V1 with protective cover ^{2) 3) 4)}		G	H00	<input checked="" type="checkbox"/>	<input checked="" type="checkbox"/>	<input checked="" type="checkbox"/>	<input checked="" type="checkbox"/>	<input checked="" type="checkbox"/>	<input checked="" type="checkbox"/>	<input checked="" type="checkbox"/>	<input checked="" type="checkbox"/>	
IM V3 ⁴⁾		H	-	<input checked="" type="checkbox"/>	<input checked="" type="checkbox"/>	<input checked="" type="checkbox"/>	<input checked="" type="checkbox"/>	<input checked="" type="checkbox"/>	<input checked="" type="checkbox"/>	<input checked="" type="checkbox"/>	<input checked="" type="checkbox"/>	
IM B35		J	-	<input checked="" type="checkbox"/>	<input checked="" type="checkbox"/>	<input checked="" type="checkbox"/>	<input checked="" type="checkbox"/>	<input checked="" type="checkbox"/>	<input checked="" type="checkbox"/>	<input checked="" type="checkbox"/>	<input checked="" type="checkbox"/>	

Synchronous reluctance motors for SINAMICS converters – VSD4000 line

Article No. supplements and special versions · Types of construction

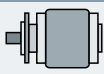
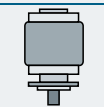
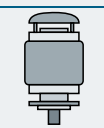
Cast-iron series SIMOTICS SD 1FP1514

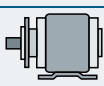
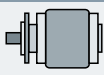
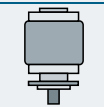
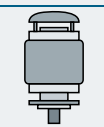
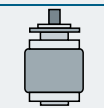
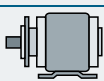
Types of construction	Article No. supplement	Frame size	Motor version							
			80	90	112	132	160	180	200	225
	Type of construction code letter 14th position of the Article No.	For types of construction with order code(s) Article No. with additional identification code -Z Order code	1FP1514							Super Premium Efficiency
1FP1514-.....-...(-Z)										
With flange next largest	Acc. to EN 50347	–	FF215	FF265	FF300	–	–	–	–	
	Acc. to DIN 42948	–	A 250	A 300	A 350	–	–	–	–	
IM B5 ^{2) 6)}	 F	P01	–	✓	✓	✓	–	–	–	–
IM V1 without protective cover ²⁾	 G	P01	–	✓	✓	✓	–	–	–	–
IM V1 with protective cover ^{2) 4) 5)}	 G	P01+H00	–	✓	✓	✓	–	–	–	–
IM V3 ³⁾	 H	P01	–	✓	✓	✓	–	–	–	–
IM B35 ³⁾	 J	P01	–	✓	✓	✓	–	–	–	–
With flange next smallest	Acc. to EN 50347	FF130	–	FF165	FF215	FF265	FF265	FF300	–	
	Acc. to DIN 42948	A 160	–	A 200	A 250	A 300	A 300	A 350	–	
IM B5 ^{2) 6)}	 F	P02	✓	–	✓	✓	✓	✓	✓	–
IM V1 without protective cover ²⁾	 G	P02	✓	–	✓	✓	✓	✓	✓	–
IM V1 with protective cover ^{2) 4) 5)}	 G	P02+H00	✓	–	✓	✓	✓	✓	✓	–
IM V3 ⁴⁾	 H	P02	✓	–	✓	✓	✓	✓	✓	–
IM B35 ³⁾	 J	P02	✓	–	✓	✓	✓	✓	✓	–











5

For legends and footnotes, see page 5/59.

Synchronous reluctance motors for SINAMICS converters – VSD4000 line

Article No. supplements and special versions · Types of construction

Cast-iron series SIMOTICS SD 1FP1514

Types of construction	Article No. supplement	Frame size	Motor version							
			80	90	112	132	160	180	200	225
	Type of construction code letter 14th position of the Article No.	For types of construction with order code(s) Article No. with additional identification code -Z	1FP1514							Super Premium Efficiency
1FP1514-.....-..-Z	..(-Z)	Order code								
With flange	Acc. to EN 50347 Acc. to DIN 42948	FT100 C 120	FT130 C 160	FT165 C 200	FT215 C 250	-	-	-	-	
IM B14 ^{2) 6)}	 K	-	-	✓	✓	✓	-	-	-	
IM V19 ²⁾	 L	-	-	✓	✓	✓	-	-	-	
IM V18 without protective cover ²⁾	 M	-	-	✓	✓	✓	-	-	-	
IM V18 with protective cover ^{2) 3) 4)}	 M	H00	-	-	✓	✓	✓	-	-	
IM B34	 N	-	✓	✓	✓	✓	✓	-	-	
With flange next largest	Acc. to EN 50347 Acc. to DIN 42948	FT130 C 160	FT130 C 160	FT165 C 200	FT215 C 250	-	-	-	-	
IM B14 ^{2) 6)}	 K	P01	✓	✓	✓	✓	-	-	-	
IM V19 ²⁾	 L	P01	✓	✓	✓	✓	-	-	-	
IM V18 without protective cover ²⁾	 M	P01	✓	✓	✓	✓	-	-	-	
IM V18 with protective cover ^{2) 3) 4)}	 M	P01+H00	✓	✓	✓	✓	-	-	-	
IM B34	 N	P01	✓	✓	✓	✓	-	-	-	

- Standard version
- ✓ With additional charge
- O. R. Possible on request
- Not possible

¹⁾ The types of construction IM B6/7/8, IM V6 and IM V5 with/without protective cover are also possible as long as no stamping of these types of construction on the rating plate is required. As standard the type of construction IM B3 is then stamped on the rating plate. With type of construction IM V5 with protective cover, the protective cover has to be additionally ordered with order code **H00**. The protective cover is not stamped on the rating plate.

²⁾ The type of construction is stamped on the rating plate. If mounted in a different position, the position must be specified to ensure that the condensation drainage holes are positioned correctly.

³⁾ In combination with an encoder, it is not necessary to order the protective cover (order code **H00**), as this is delivered as a protection for the encoder as standard. In this case the protective cover is standard design (without additional charge).

⁴⁾ The "Second shaft extension" option (order code **L05**) is not possible.

⁵⁾ The types of construction IM V3 and IM V1 with/without protective cover are also possible as long as no stamping of these types of construction on the rating plate is required. As standard the type of construction IM B5 is then stamped on the rating plate. With type of construction IM V1 with protective cover, the protective cover has to be additionally ordered with order code **H00**. The protective cover is not stamped on the rating plate.

⁶⁾ The types of construction IM V19 and IM V18 with/without protective cover are also possible as long as no stamping of these types of construction on the rating plate is required. As standard the type of construction IM B14 is then stamped on the rating plate. With type of construction IM V18 with protective cover, the protective cover has to be additionally ordered with order code **H00**. The protective cover is not stamped on the rating plate.

Synchronous reluctance motors for SINAMICS converters – VSD4000 line

Article No. supplements and special versions · Motor protection

Aluminum series SIMOTICS GP 1FP1014

Selection and ordering data

Motor protection	Article No. supplement		Frame size							Motor version
	Motor protection code letter 15th position of the Article No.	Additional identification code with order code and plain text if required	80	90	112	132	160	180	200	
			1FP1014							Super Premium Efficiency
	1FP1014-.....	■ .								
Motor protection										
1 or 3 PTC thermistors – for tripping (2 terminals) ¹⁾	B	–	✓	✓	✓	✓	✓	✓	✓	✓
2 or 6 PTC thermistors – for alarm and tripping (4 terminals) ¹⁾	C	–	✓	✓	✓	✓	✓	✓	✓	✓
1 KTY84-130 temperature sensor (2 terminals) ¹⁾	F	–	✓	✓	✓	✓	✓	✓	✓	✓
2 KTY84-130 temperature sensors (4 terminals) ¹⁾	G	–	✓	✓	✓	✓	✓	✓	✓	✓
3 Pt100 resistance thermometers 2-wire input (6 terminals) ¹⁾	H	–	–	–	✓	✓	✓	✓	✓	✓
1 Pt1000 resistance thermometer (2 terminals) ²⁾	K	–	✓	✓	✓	✓	✓	✓	✓	✓
2 Pt1000 resistance thermometers (4 terminals) ²⁾	L	–	✓	✓	✓	✓	✓	✓	✓	✓
1 Pt100 resistance thermometer 2-wire input (2 terminals)	P	–	–	–	✓	✓	✓	✓	✓	✓
3 Pt100 resistance thermometers 3-wire input (9 terminals)	Q	–	–	–	✓	✓	✓	✓	✓	✓
6 Pt100 resistance thermometers 3-wire input (18 terminals) ¹⁾	R	–	–	–	✓	✓	✓	✓	✓	✓
3 bimetal sensors (NC contacts) for tripping (2 terminals) ¹⁾	Z	Q3A	✓	✓	✓	✓	✓	✓	✓	✓

- Without additional charge
- ✓ With additional charge
- Not possible

¹⁾ Evaluation with associated tripping unit (see Catalog IC 10) is recommended.

²⁾ Not UL-certified. Not in combination with option **D39**.

Synchronous reluctance motors for SINAMICS converters – VSD4000 line

Article No. supplements and special versions · Motor protection

Cast-iron series SIMOTICS SD 1FP1514

Selection and ordering data

Motor protection	Article No. supplement		Frame size								Motor version
	Motor protection code letter 15th position of the Article No.	Additional identification code with order code and plain text if required	80	90	112	132	160	180	200	225	
			1FP1514								Super Premium Efficiency
	1FP1514-.....	■ .									
Motor protection											
1 or 3 PTC thermistors – for tripping (2 terminals) ¹⁾	B	–	✓	✓	✓	✓	✓	✓	✓	✓	
2 or 6 PTC thermistors – for alarm and tripping (4 terminals) ¹⁾	C	–	✓	✓	✓	✓	✓	✓	✓	✓	
1 KTY84-130 temperature sensor (2 terminals) ¹⁾	F	–	✓	✓	✓	✓	✓	✓	✓	✓	
2 KTY84-130 temperature sensors (4 terminals) ¹⁾	G	–	✓	✓	✓	✓	✓	✓	✓	✓	
3 Pt100 resistance thermometers 2-wire input (6 terminals) ¹⁾	H	–	✓	✓	✓	✓	✓	✓	✓	✓	
1 Pt1000 resistance thermometer (2 terminals) ²⁾	K	–	✓	✓	✓	✓	✓	✓	✓	✓	
2 Pt1000 resistance thermometers (4 terminals) ²⁾	L	–	–	–	✓	✓	✓	✓	✓	✓	
1 Pt100 resistance thermometer – 2-wire input (2 terminals)	P	–	–	–	✓	✓	✓	✓	✓	✓	
3 Pt100 resistance thermometers – 3-wire input (9 terminals)	Q	–	–	–	✓	✓	✓	✓	✓	✓	
6 Pt100 resistance thermometers – 3-wire input (18 terminals)	R	–	–	–	✓	✓	✓	✓	✓	✓	
3 NTC thermistors – for tripping (6 terminals) ²⁾	Z	Q2A	✓	✓	✓	✓	✓	–	–	–	
3 bimetal sensors (NC contacts) for tripping (2 terminals) ¹⁾	Z	Q3A	✓	✓	✓	✓	✓	✓	✓	✓	
6 × bimetal sensors (NC contacts) for alarm and tripping (4 terminals) ¹⁾	Z	Q9A	–	–	✓	✓	✓	✓	✓	✓	

- Without additional charge
- ✓ With additional charge
- Not possible

¹⁾ Evaluation with associated tripping unit (see Catalog IC 10) is recommended.

²⁾ Not UL-certified. Not in combination with option **D39**.

Synchronous reluctance motors for SINAMICS converters – VSD4000 line

Article No. supplements and special versions · Terminal box position

Aluminum series SIMOTICS GP 1FP1014

Selection and ordering data

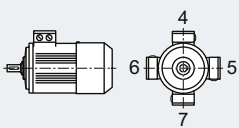
Terminal box position	Article No. supplement	Frame size	Motor version
 1FP1014-.....-....	Terminal box position code 16th position of the Article No.	80 90 112 132 160 180 200	Super Premium Efficiency
	Additional identification code with order code and plain text if required	1FP1014	
	Order code		

Terminal box position		80	90	112	132	160	180	200
Terminal box top ¹⁾	4	☐	☐	☐	☐	☐	☐	☐
Terminal box right-hand side ²⁾	5	✓	✓	✓	✓	✓	✓	✓
Terminal box left-hand side ²⁾	6	✓	✓	✓	✓	✓	✓	✓
Terminal box bottom ²⁾	7	–	–	✓	✓	–	–	–

- ☐ Standard version
 ✓ With additional charge

¹⁾ For types of construction with feet, cast feet are standard. Screwed-on feet are available with order code **H01**.

²⁾ For types of construction with feet, screwed-on feet are standard.

Synchronous reluctance motors for SINAMICS converters – VSD4000 line

Article No. supplements and special versions · Terminal box position

Cast-iron series SIMOTICS SD 1FP1514

Selection and ordering data

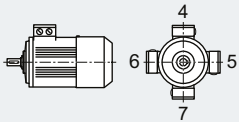
Terminal box position	Article No. supplement	Frame size							Motor version
		80	90	112	132	160	180	200	
 1FP1514-.....-....	Terminal box position code 16th position of the Article No.	1FP1514							Super Premium Efficiency
	Additional identification code with order code and plain text if required								
	Order code								

Terminal box position											
Terminal box top ¹⁾	4	–	☐	☐	☐	☐	☐	☐	☐	☐	☐
Terminal box right-hand side ²⁾	5	–	✓	✓	✓	✓	✓	✓	✓	✓	✓
Terminal box left-hand side ²⁾	6	–	✓	✓	✓	✓	✓	✓	✓	✓	✓
Terminal box bottom ²⁾	7	–	–	–	✓	✓	✓	–	–	–	–

- ☐ Standard version
 ✓ With additional charge

¹⁾ For types of construction with feet, cast feet are standard. Screwed-on feet are available with order code **H01**.

²⁾ For types of construction with feet, screwed-on feet are standard.

Synchronous reluctance motors for SINAMICS converters – VSD4000 line

Article No. supplements and special versions · Options

Aluminum series SIMOTICS GP 1FP1014

Selection and ordering data

Special versions	Additional identification code -Z with order code and plain text if required	Frame size							Motor version
		80	90	112	132	160	180	200	
		1FP1014							Super Premium Efficiency
1FP1014-.....-.....-Z	Order code								
Motor protection									
1 or 3 PTC thermistors – for tripping (2 terminals) ^{2) 3)}	Q11	✓	✓	✓	✓	✓	✓	✓	
2 or 6 PTC thermistors – for alarm and tripping (4 terminals) ³⁾	Q12	✓	✓	✓	✓	✓	✓	✓	
1 KTY84-130 temperature sensor (2 terminals) ³⁾	Q23	✓	✓	✓	✓	✓	✓	✓	
2 KTY84-130 temperature sensor (4 terminals) ³⁾	Q25	✓	✓	✓	✓	✓	✓	✓	
3 bimetal sensors (NC contacts) for tripping (2 terminals) ³⁾	Q31	✓	✓	✓	✓	✓	✓	✓	
6 bimetal sensors (NC contacts) for alarm and tripping (4 terminals)	Q32	✓	✓	✓	✓	✓	✓	✓	
3 bimetal sensors (NC contacts) for tripping (6 terminals)	Q33	–	–	–	–	–	✓	✓	
6 bimetal sensors (NC contacts) for alarm and tripping (12 terminals)	Q34	–	–	–	–	–	✓	✓	
1 Pt1000 resistance thermometer (2 terminals) ¹⁹⁾	Q35	✓	✓	✓	✓	✓	✓	✓	
2 Pt1000 resistance thermometers (4 terminals) ¹⁹⁾	Q36	✓	✓	✓	✓	✓	✓	✓	
3 Pt100 resistance thermometers – 2-wire input (6 terminals)	Q60	–	–	✓	✓	✓	✓	✓	
6 Pt100 resistance thermometers – 2-wire input (12 terminals)	Q61	–	–	✓	✓	✓	✓	✓	
1 Pt100 resistance thermometer – 2-wire input (2 terminals)	Q62	–	–	✓	✓	✓	✓	✓	
3 Pt100 resistance thermometers – 3-wire input (9 terminals)	Q63	–	–	✓	✓	✓	✓	✓	
6 Pt100 resistance thermometers – 3-wire input (18 terminals)	Q64	–	–	✓	✓	✓	✓	–	
2 Pt100 resistance thermometers in basic configuration for bearings (2 terminals)	Q72	–	–	O. R.	O. R.	O. R.	✓	✓	
2 Pt100 resistance thermometers in 3-wire input for bearings (6 terminals)	Q78	–	–	O. R.	O. R.	O. R.	✓	✓	
2 Pt100 double resistance thermometers in 3-wire input for bearings (12 terminals)	Q79	–	–	O. R.	O. R.	O. R.	✓	✓	
Motor connection and terminal box									
External grounding	H04	✓	✓	✓	✓	✓	✓	✓	
Terminal box on NDE ¹⁾	H08	✓	✓	✓	✓	✓	✓	✓	
Rotation of the terminal box through 90°, entry from DE ²⁾	R10	○	○	○	○	○	✓	✓	
Rotation of the terminal box through 90°, entry from NDE	R11	○	○	○	○	○	✓	✓	
Rotation of the terminal box through 180°	R12	○	○	○	○	○	✓	✓	
Terminal box in position 0°; connection from right ²⁰⁾	R13	○	○	○	○	–	–	–	
One metal cable gland	R15	✓	✓	✓	✓	✓	✓	✓	
Metal cable gland, maximum configuration	R18	✓	✓	✓	✓	✓	✓	✓	
3 cables protruding, 0.5 m long	R20	✓	✓	✓	✓	✓	–	–	
3 cables protruding, 1.5 m long	R21	✓	✓	✓	✓	✓	O. R.	O. R.	
6 cables protruding, 0.5 m long	R22	✓	✓	✓	✓	✓	O. R.	O. R.	
6 cables protruding, 1.5 m long	R23	✓	✓	✓	✓	✓	O. R.	O. R.	
6 cables protruding, 3 m long	R24	✓	✓	✓	✓	✓	O. R.	O. R.	
Larger terminal box	R50	✓	✓	✓	✓	✓	✓	✓	
Motor connector Han-Drive 10e for 230 VΔ/400 VY	R70	✓	✓	✓	✓	–	–	–	
Motor connector EMC Han-Drive 10e for 230 VΔ/400 VY	R71	✓	✓	✓	✓	–	–	–	

For legends and footnotes, see page 5/67.

Synchronous reluctance motors for SINAMICS converters – VSD4000 line

Article No. supplements and special versions · Options

Aluminum series SIMOTICS GP 1FP1014

Special versions	Additional identification code -Z with order code and plain text if required	Frame size							Motor version
		80	90	112	132	160	180	200	
		1FP1014							Super Premium Efficiency
1FP1014-.....-.....-Z	Order code								
Windings and insulation									
Temperature class 180 (H) at rated power and max. CT 60 °C ³⁾	N11	✓	✓	✓	✓	✓	✓	✓	
Increased air humidity/temperature with 30 to 60 g water per m ³ of air	N30	✓	✓	✓	✓	✓	✓	✓	
Increased air humidity/temperature with 60 to 100 g water per m ³ of air	N31	✓	✓	✓	✓	✓	✓	✓	
Colors and paint finish									
Standard paint finish C2 in RAL 7030 stone gray		□	□	□	□	□	□	□	
Unpainted (only cast-iron parts primed)	S00	○	○	○	○	○	○	○	
Unpainted, only primed	S01	✓	✓	✓	✓	✓	✓	✓	
Special paint finish C3	S02	✓	✓	✓	✓	✓	✓	✓	
Special paint finish sea air resistant C4	S03	✓	✓	✓	✓	✓	✓	✓	
Internal coating	S05	✓	✓	✓	✓	✓	✓	✓	
Paint finish in other standard RAL colors: RAL 1RAL 1015, 3000, 5002, 5009, 5010, 5012, 5015, 6011, 7001, 7011, 7016, 7031, 7032, 7035, 7037, 8012, 9005, 9010 (see Catalog Section 1 "Introduction")	Y53 • and paint finish RAL....	✓	✓	✓	✓	✓	✓	✓	
Paint finish in special RAL colors: For RAL colors, see "Special paint finish in special RAL colors" (see Catalog Section 1 "Introduction")	Y56 • and paint finish RAL....	✓	✓	✓	✓	✓	✓	✓	
Non-standard colors Colors see "Paint finish in non-standard colors" (see Catalog Section 1 "Introduction")	Y66 • and paint finish	✓	✓	✓	✓	✓	✓	✓	
Modular technology – Basic versions⁴⁾									
Mounting of holding brake (standard assignment) ⁵⁾	F01	✓	✓	✓	✓	✓	✓	✓	
Mounting of brake for higher switching frequency (operating brake)	F02	O. R.	O. R.	O. R.	O. R.	O. R.	–	–	
Mounting of PRECIMA brake	F04	–	–	✓	✓	✓	✓	✓	
Mounting of Kübler Sendix 5020 HTL, 1024 l rotary pulse encoder	G11	✓	✓	✓	✓	✓	✓	✓	
Mounting of Kübler Sendix 5020 TTL, 1024 l rotary pulse encoder	G12	✓	✓	✓	✓	✓	✓	✓	
Modular technology – Additional versions									
Brake supply voltage 24 V DC	F10	✓	✓	✓	✓	✓	✓	✓	
Brake supply voltage 230 V AC, 50/60 Hz	F11	✓	✓	○	○	○	○	○	
Brake supply voltage 400 V AC, 50/60 Hz	F12	✓	✓	✓	✓	✓	✓	✓	
Brake supply voltage 180 V DC	F17	✓	✓	✓	✓	✓	✓	✓	Only for: Combination with F01
Brake supply voltage 205 V DC	F18	✓	✓	✓	✓	✓	✓	✓	Only for: Combination with F01
Mechanical manual brake release with lever (no locking)	F50	✓	✓	✓	✓	✓	✓	✓	
Special technology³⁾									
Mounting of LL 861 900 220 rotary pulse encoder ⁶⁾	G04	–	–	✓	✓	✓	✓	✓	
Mounting of HQG 9 DN 1024 l rotary pulse encoder ⁶⁾	G05	–	–	✓	✓	✓	✓	✓	
Mounting of HQG 10 D 1024 l rotary pulse encoder ⁶⁾	G06	–	–	✓	✓	✓	✓	✓	
Mounting of Kübler Sendix 5834FS2 1024, SIL-2 rotary pulse encoder	G21	–	–	–	–	–	✓	✓	
Mounting of Kübler Sendix 5834FS3 1024, SIL-3 rotary pulse encoder	G22	–	–	–	–	–	✓	✓	
Mounting of HOGS100S-B76.626.01024.1 rotary pulse encoder	G25	–	–	–	–	–	✓	✓	
Mounting of LL FSI 862-184560-1024, SIL-2 rotary pulse encoder	G27	–	–	–	–	–	✓	✓	
Mechanical version and degrees of protection									
Prepared for mountings, centering hole only ⁷⁾	G40	✓	✓	✓	✓	✓	□	□	
Prepared for mountings with D12 shaft ¹²⁾	G41	✓	✓	✓	✓	✓	✓	✓	
Prepared for mountings with D16 shaft ¹²⁾	G42	O. R.	O. R.	✓	✓	✓	✓	✓	

For legends and footnotes, see page 5/67.

Synchronous reluctance motors for SINAMICS converters – VSD4000 line

Article No. supplements and special versions · Options

Aluminum series SIMOTICS GP 1FP1014

Special versions	Additional identification code -Z with order code and plain text if required	Frame size							Motor version
		80	90	112	132	160	180	200	
		1FP1014							Super Premium Efficiency
1FP1014-.....-.....-Z	Order code								
Mechanical design and degrees of protection (continued)									
Mechanical protection for encoder	G43	✓	✓	✓	✓	✓	✓	✓	
Protective cover ^{6) 8)}	H00	✓	✓	✓	✓	✓	✓	✓	
Screwed-on (instead of cast) feet	H01	✓	✓	✓	✓	✓	□	□	
Vibration-proof version; vibration resistance to Class 3M4 according to IEC 60721-3-3:1994	H02	✓	✓	✓	✓	✓	✓	✓	
Condensation drainage holes ⁹⁾	H03	✓	✓	✓	✓	✓	✓	✓	
Rust-resistant screws (externally)	H07	✓	✓	✓	✓	✓	✓	✓	
Housing with screw mounting	H10	✓	✓	–	–	–	✓	✓	
IP66 degree of protection	H19	✓	✓	✓	✓	✓	✓	✓	Not for:
IP65 degree of protection ¹⁰⁾	H20	✓	✓	✓	✓	✓	✓	✓	
IP56 degree of protection ¹¹⁾	H22	✓	✓	✓	✓	✓	✓	✓	
Drive-end seal for flange-mounted motors, oil-tight to 0.1 bar ⁸⁾	H23	✓	✓	✓	✓	✓	✓	✓	
Coolant temperature and installation altitude									
Coolant temperature –40 to +40 °C ¹³⁾	D03	✓	✓	✓	✓	✓	✓	✓	
Coolant temperature –30 to +40 °C ¹³⁾	D04	✓	✓	✓	✓	✓	✓	✓	
Versions in accordance with standards and specifications									
Version according to UL and CSA (Canadian regulation)	D39	✓	✓	✓	✓	✓	✓	✓	
TR CU product safety certificate EAC for Eurasian Customs Union	D47	✓	✓	✓	✓	✓	✓	✓	
Bearings and lubrication									
Located bearing DE	L20	✓	✓	✓	✓	✓	✓	✓	
Located bearing NDE	L21	✓	✓	✓	✓	□	□	□	
Bearing design for increased cantilever forces	L22	✓	✓	✓	✓	✓	✓	✓	
Regreasing device ¹⁴⁾	L23	–	–	✓	✓	✓	✓	✓	
Bearings reinforced at both ends for DE and NDE, bearing size 63	L25	✓	✓	✓	✓	✓	✓	✓	
Bearing insulation NDE	L51	–	–	✓	✓	✓	✓	✓	
Measuring nipple for SPM shock pulse measurement for bearing inspection ¹⁴⁾	Q01	–	–	✓	✓	✓	✓	✓	
Balance and vibration severity									
Half-key balancing (standard)		□	□	□	□	□	□	□	
Balancing without feather key	L01	✓	✓	✓	✓	✓	✓	✓	
Full-key balancing	L02	✓	✓	✓	✓	✓	✓	✓	
Shaft and rotor									
Shaft extension with standard dimensions, without feather keyway	L04	✓	✓	✓	✓	✓	✓	✓	
Standard, cylindrical shaft extension (second shaft extension) NDE acc. to EN 50347	L05	✓	✓	✓	✓	✓	✓	✓	
Standard shaft made of stainless steel (e.g. 1.4021)	L06	✓	✓	–	✓	✓	✓	✓	
Shaft extension run-out in accordance with IEC 60072-1 precision class	L07	✓	✓	✓	✓	✓	✓	✓	
Shaft extension run-out, concentricity and perpendicularity in accordance with IEC 60072-1 precision class for flange-mounted motors	L08	✓	✓	✓	✓	✓	✓	✓	
Non-standard cylindrical shaft extension, DE ¹⁵⁾	Y58 • and customer specifications	✓	✓	✓	✓	✓	✓	✓	
Non-standard cylindrical shaft extension, NDE ¹⁵⁾	Y59 • and customer specifications	✓	✓	✓	✓	✓	✓	✓	
Heating and ventilation									
Mounted separately driven fan	F70	✓	✓	✓	✓	✓	✓	✓	
Sheet metal fan cover	F74	✓	✓	✓	✓	✓	✓	✓	
Fan cover for textile industry ¹⁶⁾	F75	✓	✓	✓	✓	✓	✓	✓	
Metal external fan	F76	✓	✓	✓	✓	✓	✓	✓	
Without external fan and without fan cover	F90	✓	✓	✓	✓	✓	✓	✓	
Anti-condensation heating for 230 V (2 terminals)	Q02	✓	✓	✓	✓	✓	✓	✓	
Anti-condensation heating for 115 V (2 terminals)	Q03	✓	✓	✓	✓	✓	✓	✓	

For legends and footnotes, see page 5/67.

Synchronous reluctance motors for SINAMICS converters – VSD4000 line

Article No. supplements and special versions · Options

Aluminum series SIMOTICS GP 1FP1014

Special versions	Additional identification code -Z with order code and plain text if required	Frame size							Motor version
		80	90	112	132	160	180	200	
		1FP1014							Super Premium Efficiency
1FP1014-.....-.....-Z	Order code								
Rating plate and additional rating plates									
Second rating plate, loose	M10	✓	✓	✓	✓	✓	✓	✓	
Rating plate, stainless steel	M11	✓	✓	✓	✓	✓	✓	✓	
Additional rating plate with customer specifications	Y82 • and customer specifications	✓	✓	✓	✓	✓	✓	✓	
Additional information on rating plate and on package label (max. 20 characters)	Y84 • and customer specifications	✓	✓	✓	✓	✓	✓	✓	
Adhesive label, supplied loose (printed with: Article No., Serial No.; 2 lines of text)	Y85 • and customer specifications	–	–	✓	✓	✓	✓	✓	
Extension of the liability for defects									
Extension of the liability for defects by 24 months to a total of 36 months (3 years) from delivery ²¹⁾		□	□	□	□	□	□	□	
Packaging, safety notes, documentation and test certificates									
A printed version of the safety notes in German/English and safety notes in the language of the country of use is supplied in each wire-lattice pallet ¹⁷⁾	B01	○	○	○	○	○	○	○	
Inspection certificate 3.1 according to EN 10204 ¹⁸⁾	B02	✓	✓	✓	✓	✓	✓	✓	
Document - Electrical datasheet	B60	✓	✓	✓	✓	✓	✓	✓	
Document - Order dimensional drawing	B61	✓	✓	✓	✓	✓	✓	✓	
Type test with heat run for horizontal motors, with acceptance	B83	✓	✓	✓	✓	✓	✓	✓	
"Basic" documentation package	B90	✓	✓	✓	✓	✓	✓	✓	
"Advanced" documentation package	B91	✓	✓	✓	✓	✓	✓	✓	
"Projects" documentation package	B92	✓	✓	✓	✓	✓	✓	✓	
Wire-lattice pallet packaging	B99	○	○	○	○	○	○	○	
Connected in star for dispatch	M01	–	–	✓	✓	✓	✓	✓	
Connected in delta for dispatch	M02	–	–	✓	✓	✓	✓	✓	

- Standard version
- Without additional charge
- ✓ With additional charge
- O. R. Possible on request

- Not possible
- This order code only determines the price of the version – Additional plain text is required.

1) For order code **H08**, feet dimensions differing from EN 50347. Further information is available in the DT Configurator (see Appendix, "Tools and engineering").

2) With IM B5 flange, only possible in combination with order code **H08**.

3) The grease lifetime specified in Catalog Section 1 "Introduction" refers to CT 40 °C. If the coolant temperature is increased by 10 K, the grease lifetime and regreasing interval are halved.

4) A second shaft extension is not possible. Please inquire for mounted brakes.

5) The brake supply voltage must be specified or ordered with order codes **F10**, **F11**, **F12**, **F17**, and **F18**.

6) In combination with a separately driven fan (order code **F70**) the 1XP8032-10 rotary pulse encoder is used instead of 1XP8012-10 or 1XP8032-20 is used instead of 1XP8012-20.

7) As standard, motors that are prepared for additional mounted components (order codes **G40**, **G41**, **G42**) are shipped without protective cover. If a protective cover is requested as a cover or mechanical protection for mounted components provided by the customer, this can be ordered with order code **G43**. Not possible in combination with order code **L00** vibration severity grade B. In combination with a separately driven fan (order code **F70**) the 1XP8032-10 rotary pulse encoder is used instead of 1XP8012-10 or 1XP8032-20 is used instead of 1XP8012-20.

8) Order code **H00** provides mechanical protection for encoders.

9) Supplied with the condensation drainage holes sealed at the drive end DE and non-drive end NDE (IP55, IP56, IP65). If the condensation drainage holes are required for motors of the IM B6, IM B7 or IM B8 type of construction (feet on side or top), the motors must be ordered in the respective type of construction and with order code **H03**, so that the condensation drainage holes will be placed in the correct position.

10) Not possible in combination with HOG 9 DN 1024 I rotary pulse encoder (order code **G05**) and/or brake BFK458 (order code **F01**).

11) Not possible in combination with brake BFK458 (order code **F01**).

12) As standard, motors that are prepared for additional mounted components (order codes **G40**, **G41**, **G42**) are shipped without protective cover. If a protective cover is requested as a cover or mechanical protection for mounted components provided by the customer, this can be ordered with order code **G43**. Not possible in combination with order code **L00** vibration severity grade B.

13) Not possible for type of construction IM V3.

14) Not possible when brake is mounted.

15) When motors are ordered that have a longer or shorter shaft extension than normal, the required position and length of the feather keyway must be specified in a sketch. It must be ensured that only feather keys in accordance with DIN 6885, Form A are permitted to be used. The feather keyway is positioned centrally on the shaft extension. The length is defined by the manufacturer in accordance with the appropriate standard. Not valid for: Conical shafts, non-standard threaded journals, non-standard shaft tolerances, friction welded journals, extremely "thin" shafts, special geometry dimensions (e.g. square journals), hollow shafts. Valid for non-standard shaft extensions DE or NDE. The feather keys are supplied in every case. For order codes **Y58**, **Y59** and **L05** the following applies:
 - Dimensions D and DA ≤ ball bearing inner diameter (see dimension tables for "Dimensions")
 - Dimensions E and EA ≤ 2 × length E (standard) of the shaft extension. For an explanation of the order codes, see Catalog Section 1 "Introduction".

16) The special requirements of the textile industry regarding the sheet metal cover open up the possibility that a finger may be inserted between the cover and housing. The customer must implement appropriate measures to ensure that the installed system is "finger-safe".

17) The Operating Instructions (Compact) are available in PDF format for all official EU languages at <http://support.automation.siemens.com/WWW/view/en/40761976>

18) The delivery time for the manufacturer's test certificate may differ from the delivery time for the motor and will be dispatched by e-mail.

19) Not UL-certified. Not in combination with option **D31**.

20) Only possible in combination with order codes **R70** and **R71**.

Synchronous reluctance motors for SINAMICS converters – VSD4000 line

Article No. supplements and special versions · Options

Cast-iron series SIMOTICS SD 1FP1514

Selection and ordering data

Special versions	Additional identification code -Z with order code and plain text if required	Frame size								Motor version
		80	90	112	132	160	180	200	225	Super Premium Efficiency
		1FP15.4								
1FP15.4-.....-.....-Z	Order code									
Motor protection										
1 or 3 PTC thermistors – for tripping (2 terminals) ^{2) 3)}	Q11	✓	✓	✓	✓	✓	✓	✓	✓	
2 or 6 PTC thermistors – for alarm and tripping (4 terminals) ³⁾	Q12	✓	✓	✓	✓	✓	✓	✓	✓	
1 KTY84-130 temperature sensor (2 terminals) ³⁾	Q23	✓	✓	✓	✓	✓	✓	✓	✓	
2 KTY84-130 temperature sensor (4 terminals) ³⁾	Q25	✓	✓	✓	✓	✓	✓	✓	✓	
3 bimetal sensors (NC contacts) for tripping (2 terminals) ³⁾	Q31	✓	✓	✓	✓	✓	✓	✓	✓	
6 bimetal sensors (NC contacts) for alarm and tripping (4 terminals)	Q32	–	–	–	–	✓	✓	✓	✓	
3 bimetal sensors (NC contacts) for tripping (6 terminals)	Q33	–	–	✓	✓	✓	✓	✓	✓	
6 bimetal sensors (NC contacts) thermostat for alarm and tripping (12 terminals)	Q34	–	–	✓	✓	✓	✓	✓	✓	
1 Pt1000 resistance thermometer (2 terminals) ¹⁹⁾	Q35	✓	✓	✓	✓	✓	✓	✓	✓	
2 Pt1000 resistance thermometers (4 terminals) ¹⁹⁾	Q36	✓	✓	✓	✓	✓	✓	✓	✓	
3 Pt100 resistance thermometers – 2-wire input (6 terminals)	Q60	–	–	✓	✓	✓	✓	✓	✓	
1 Pt100 resistance thermometer – 2-wire input (2 terminals)	Q62	–	–	✓	✓	✓	✓	✓	✓	
3 Pt100 resistance thermometers – 3-wire input (9 terminals)	Q63	–	–	✓	✓	✓	✓	✓	✓	
6 Pt100 resistance thermometers – 3-wire input (18 terminals)	Q64	–	–	✓	✓	✓	✓	✓	✓	
2 Pt100 resistance thermometers in basic configuration for bearings (2 terminals) ¹⁾	Q72	–	–	–	–	–	✓	✓	✓	
2 Pt100 resistance thermometers in 3-wire input for bearings (6 terminals)	Q78	–	–	–	–	–	✓	✓	✓	
2 Pt100 double resistance thermometers in 3-wire input for bearings (12 terminals)	Q79	–	–	–	–	–	✓	✓	✓	
Motor connection and terminal box										
External grounding	H04	✓	✓	✓	✓	✓	□	□	□	
Terminal box on NDE ²⁾	H08	✓	✓	✓	✓	✓	✓	✓	✓	
Second external grounding	H70	–	–	✓	✓	✓	✓	✓	✓	
Rotation of the terminal box through 90°, entry from DE	R10	○	○	○	○	○	✓	✓	✓	
Rotation of the terminal box through 90°, entry from NDE	R11	○	○	○	○	○	✓	✓	✓	
Rotation of the terminal box through 180°	R12	○	○	○	○	○	✓	✓	✓	
One EMC cable gland	R14	✓	✓	✓	✓	✓	✓	✓	✓	
One metal cable gland	R15	✓	✓	✓	✓	✓	✓	✓	✓	
EMC cable gland, maximum configuration	R16	✓	✓	✓	✓	✓	✓	✓	✓	
Larger terminal box	R50	✓	✓	✓	✓	✓	✓	✓	✓	
Terminal box without cable entry opening	R51	–	–	○	○	○	○	○	○	
Drilled removable entry plate	R52	–	–	–	–	–	✓	✓	✓	
Undrilled removable entry plate	R53	–	–	–	–	–	✓	✓	✓	
Cast-iron auxiliary terminal box (small)	R62	–	–	✓	✓	✓	✓	✓	✓	
Silicone-free version		–	–	□	□	□	□	□	□	
Non-standard threaded through hole (NPT or G thread)	Y61 • and customer specifications	–	–	✓	✓	✓	✓	✓	✓	

For legend, see page 5/71 and for footnotes, see page 5/72.

Synchronous reluctance motors for SINAMICS converters – VSD4000 line

Article No. supplements and special versions · Options

Cast-iron series SIMOTICS SD 1FP1514

Special versions	Additional identification code -Z with order code and plain text if required	Frame size								Motor version
		80	90	112	132	160	180	200	225	
		1FP15.4								Super Premium Efficiency
1FP15.4-.....-.....-Z	Order code									
Windings and insulation										
Temperature class 180 (H) at rated power and max. CT 60 °C ³⁾	N11	✓	✓	✓	✓	✓	✓	✓	✓	
Increased air humidity/temperature with 30 to 60 g water per m ³ of air	N30	✓	✓	✓	✓	✓	✓	✓	✓	
Increased air humidity/temperature with 60 to 100 g water per m ³ of air	N31	✓	✓	✓	✓	✓	✓	✓	✓	
Colors and paint finish										
Standard paint finish C2 in RAL 7030 stone gray		□	□	□	□	□	□	□	□	
Unpainted (only cast-iron parts primed)	S00	○	○	○	○	○	○	○	○	
Unpainted, only primed	S01	✓	✓	✓	✓	✓	✓	✓	✓	
Special paint finish C3	S02	✓	✓	✓	✓	✓	✓	✓	✓	
Special paint finish sea air resistant C4	S03	✓	✓	✓	✓	✓	✓	✓	✓	
Special paint finish for use offshore C5	S04	✓	✓	✓	✓	✓	✓	✓	✓	
Internal coating	S05	–	–	✓	✓	✓	✓	✓	✓	
Special paint finish C5mid with medium durability	S08	–	–	✓	✓	✓	✓	✓	✓	
Special paint finish CX for offshore with high durability	S09	–	–	✓	✓	✓	✓	✓	✓	
Paint finish in other standard RAL colors: RAL 1RAL 1015, 3000, 5002, 5009, 5010, 5012, 5015, 6011, 7001, 7011, 7016, 7031, 7032, 7035, 7037, 8012, 9005, 9010 (see Catalog Section 1 "Introduction")	Y53 • and paint finish RAL....	✓	✓	✓	–	✓	✓	✓	✓	
Paint finish in special RAL colors: For RAL colors, see "Special paint finish in special RAL colors" (see Catalog Section 1 "Introduction")	Y56 • and paint finish RAL....	✓	✓	✓	✓	✓	✓	✓	✓	
Non-standard colors Colors see "Paint finish in non-standard colors" (see Catalog Section 1 "Introduction")	Y66 • and paint finish	✓	✓	✓	✓	✓	✓	✓	✓	
Modular technology – Basic versions⁴⁾										
Mounting of holding brake (standard assignment) ⁵⁾	F01	–	–	✓	✓	✓	✓	✓	✓	
Mounting of Kübler Sendix 5020 HTL, 1024 l rotary pulse encoder	G11	✓	✓	✓	✓	✓	✓	✓	✓	
Mounting of Kübler Sendix 5020 TTL, 1024 l rotary pulse encoder	G12	✓	✓	✓	✓	✓	✓	✓	✓	
Modular technology – Additional versions										
Brake supply voltage 24 V DC	F10	–	–	✓	✓	✓	✓	✓	✓	
Brake supply voltage 230 V AC, 50/60 Hz	F11	–	–	○	○	○	○	○	○	
Brake supply voltage 400 V AC, 50/60 Hz	F12	–	–	✓	✓	✓	✓	✓	✓	
Brake supply voltage 180 V DC	F17	–	–	✓	✓	✓	✓	✓	✓	Only for: Combination with F01
Brake supply voltage 205 V DC	F18	–	–	✓	✓	✓	✓	✓	✓	Only for: Combination with F01
Backstop, counterclockwise motion blocked, clockwise direction of rotation	F40	–	–	–	✓	✓	✓	✓	✓	
Backstop, clockwise motion blocked, counterclockwise direction of rotation	F41	–	–	–	✓	✓	✓	✓	✓	
Mechanical manual brake release with lever (no locking)	F50	–	–	✓	✓	✓	✓	✓	✓	
Special technology⁵⁾										
Mounting of LL 861 900 220 rotary pulse encoder ⁸⁾	G04	–	–	✓	✓	✓	✓	✓	✓	
Mounting of HQG 9 DN 1024 l rotary pulse encoder ⁸⁾	G05	–	–	✓	✓	✓	✓	✓	✓	
Mounting of HQG 10 D 1024 l rotary pulse encoder ⁸⁾	G06	–	–	✓	✓	✓	✓	✓	✓	
Mounting of POG 10 DN rotary pulse encoder (only in combination with separately driven fan or brake) ¹⁸⁾	G07	–	–	–	–	–	✓	✓	✓	
Mounting of POG 9 rotary pulse encoder (only in combination with separately driven fan or brake) ¹⁸⁾	G08	–	–	–	–	–	✓	✓	✓	

For legend, see page 5/71 and for footnotes, see page 5/72.

Synchronous reluctance motors for SINAMICS converters – VSD4000 line

Article No. supplements and special versions · Options

Cast-iron series SIMOTICS SD 1FP1514

Special versions	Additional identification code -Z with order code and plain text if required	Frame size								Motor version
		80	90	112	132	160	180	200	225	
		1FP15.4								Super Premium Efficiency
1FP15.4-.....-.....-Z	Order code									
Special technology (continued) ⁵⁾										
Mounting of Kübler Sendix 5834FS2 1024, SIL-2 rotary pulse encoder	G21	✓	✓	✓	✓	✓	✓	✓	✓	
Mounting of Kübler Sendix 5834FS3 1024, SIL-3 rotary pulse encoder	G22	✓	✓	✓	✓	✓	✓	✓	✓	
Mounting of HOGS100S-B76.626.01024.1 rotary pulse encoder	G25	-	-	-	-	-	✓	✓	✓	
Mounting of LL FSI 862-184560-1024, SIL-2 rotary pulse encoder	G27	-	-	-	-	-	✓	✓	✓	
Mounting of a special type of rotary pulse encoder	Y70 • and customer specifications	-	-	-	-	-	O.R.	O.R.	O.R.	
Mechanical version and degrees of protection										
Prepared for mountings, centering hole only	G40	✓	✓	✓	✓	✓	□	□	□	
Prepared for mountings with D12 shaft	G41	✓	✓	✓	✓	✓	✓	✓	✓	
Prepared for mountings with D16 shaft	G42	✓	✓	✓	✓	✓	✓	✓	✓	
Mechanical protection for encoder	G43	✓	✓	✓	✓	✓	✓	✓	✓	
Protective cover ^{6) 8) 9)}	H00	✓	✓	✓	✓	✓	✓	✓	✓	
Screwed-on (instead of cast) feet	H01	-	-	✓	✓	✓	✓	✓	✓	
Vibration-proof version; vibration resistance to Class 3M4 according to IEC 60721-3-3:1994	H02	✓	✓	✓	✓	✓	✓	✓	✓	
Condensation drainage holes		✓	✓	□	□	□	□	□	□	
Rust-resistant screws (externally)	H07	✓	✓	✓	✓	✓	✓	✓	✓	
IP66 degree of protection	H19	✓	✓	✓	✓	✓	✓	✓	✓	
IP65 degree of protection ¹⁰⁾	H20	✓	✓	✓	✓	✓	✓	✓	✓	
IP54 degree of protection	H21	-	-	-	-	-	✓	✓	✓	
IP56 degree of protection ¹¹⁾	H22	✓	✓	✓	✓	✓	✓	✓	✓	
Drive-end seal for flange-mounted motors, oil-tight to 0.1 bar ¹²⁾	H23	✓	✓	✓	✓	✓	✓	✓	✓	
Coolant temperature and installation altitude										
Coolant temperature -50 to +40 °C	D02	-	-	✓	✓	✓	✓	✓	✓	
Coolant temperature -40 to +40 °C ¹³⁾	D03	✓	✓	✓	✓	✓	✓	✓	✓	
Coolant temperature -30 to +40 °C	D04	✓	✓	✓	✓	✓	✓	✓	✓	
Versions in accordance with standards and specifications										
Version according to UL and CSA (Canadian regulation)	D39	✓	✓	✓	✓	✓	✓	✓	✓	
TR CU product safety certificate EAC for Eurasian Customs Union	D47	✓	✓	✓	✓	✓	✓	✓	✓	
Bearings and lubrication										
Regreasing device with M10 x 1 grease nipple according to DIN 71412 A ¹⁴⁾	L19	-	-	-	-	-	✓	✓	✓	
Located bearing DE	L20	✓	✓	✓	✓	✓	✓	✓	✓	
Located bearing NDE	L21	✓	✓	✓	✓	□	□	□	□	
Bearing design for increased cantilever forces	L22	✓	✓	✓	✓	✓	✓	✓	✓	
Regreasing device ¹⁴⁾	L23	-	-	✓	✓	✓	✓	✓	✓	
Bearings reinforced at both ends for DE and NDE, bearing size 63	L25	✓	✓	✓	✓	✓	✓	✓	✓	
Reinforced bearings at both DE and NDE, DE bearing for increased cantilever forces	L28	-	-	-	-	-	✓	✓	✓	
Bearing insulation NDE	L51	-	-	✓	✓	✓	✓	✓	✓	
Measuring nipple for SPM shock pulse measurement for bearing inspection ¹⁴⁾	Q01	-	-	✓	✓	✓	✓	✓	✓	
Balance and vibration severity										
Half-key balancing (standard)		□	□	□	□	□	□	□	□	
Balancing without feather key	L01	✓	✓	✓	✓	✓	✓	✓	✓	
Full-key balancing	L02	✓	✓	✓	✓	✓	✓	✓	✓	
Shaft and rotor										
Shaft extension with standard dimensions, without feather keyway	L04	✓	✓	✓	✓	✓	✓	✓	✓	
Standard, cylindrical shaft extension (second shaft extension) NDE acc. to EN 50347	L05	✓	✓	✓	✓	✓	✓	✓	✓	

For legend, see page 5/71 and for footnotes, see page 5/72.

Synchronous reluctance motors for SINAMICS converters – VSD4000 line

Article No. supplements and special versions · Options

Cast-iron series SIMOTICS SD 1FP1514

Special versions	Additional identification code -Z with order code and plain text if required	Frame size								Motor version
		80	90	112	132	160	180	200	225	
		1FP15.4								Super Premium Efficiency
1FP15.4-.....-.....-Z	Order code									
Shaft and rotor (continued)										
Standard shaft made of stainless steel (e.g. 1.4021)	L06	✓	✓	✓	✓	✓	✓	✓	✓	
Shaft extension run-out in accordance with IEC 60072-1 precision class	L07	✓	✓	✓	✓	✓	✓	✓	✓	
Shaft extension run-out, concentricity and perpendicularity in accordance with IEC 60072-1 precision class for flange-mounted motors	L08	✓	✓	✓	✓	✓	✓	✓	✓	
Non-standard cylindrical shaft extension, DE ¹⁵⁾	Y58 • and customer specifications	✓	✓	✓	✓	✓	✓	✓	✓	
Non-standard cylindrical shaft extension, NDE ¹⁵⁾	Y59 • and customer specifications	✓	✓	✓	✓	✓	✓	✓	✓	
Special shaft steel	Y60 • and customer specifications	–	–	O. R.	O. R.	O. R.	O. R.	O. R.	O. R.	
Heating and ventilation										
Mounted separately driven fan	F70	–	–	–	✓	✓	✓	✓	✓	
Sheet metal fan cover	F74	□	□	✓	✓	✓	✓	✓	✓	
Metal external fan	F76	✓	✓	✓	✓	✓	✓	✓	✓	
Anti-condensation heating for 230 V (2 terminals)	Q02	✓	✓	✓	✓	✓	✓	✓	✓	
Anti-condensation heating for 115 V (2 terminals)	Q03	✓	✓	✓	✓	✓	✓	✓	✓	
Rating plate and additional rating plates										
Second rating plate, loose	M10	✓	✓	✓	✓	✓	✓	✓	✓	
Rating plate, stainless steel	M11	✓	✓	✓	✓	✓	✓	✓	✓	
Additional rating plate with customer specifications	Y82 • and customer specifications	✓	✓	✓	✓	✓	✓	✓	✓	
Additional information on rating plate and on package label (max. 20 characters)	Y84 • and customer specifications	✓	✓	✓	✓	✓	✓	✓	✓	
Adhesive label, supplied loose (printed with: Article No., Serial No.; 2 lines of text)	Y85 • and customer specifications	–	–	✓	✓	✓	✓	✓	✓	
Extension of the liability for defects										
Extension of the liability for defects by 24 months to a total of 36 months (3 years) from delivery ¹⁶⁾		□	□	□	□	□	□	□	□	
Packaging, safety notes, documentation and test certificates										
Inspection certificate 3.1 according to EN 10204 ¹⁷⁾	B02	✓	✓	✓	✓	✓	✓	✓	✓	
Document - Electrical datasheet	B60	✓	✓	✓	✓	✓	✓	✓	✓	
Document - Order dimensional drawing	B61	✓	✓	✓	✓	✓	✓	✓	✓	
Standard test (routine test) with acceptance	B65	–	–	✓	✓	✓	✓	✓	✓	
Type test with heat run for horizontal motors, with acceptance	B83	✓	✓	✓	✓	✓	✓	✓	✓	
"Basic" documentation package	B90	✓	✓	✓	✓	✓	✓	✓	✓	
"Advanced" documentation package	B91	✓	✓	✓	✓	✓	✓	✓	✓	
"Projects" documentation package	B92	✓	✓	✓	✓	✓	✓	✓	✓	
Connected in star for dispatch	M01	✓	✓	✓	✓	✓	✓	✓	✓	
Connected in delta for dispatch	M02	✓	✓	✓	✓	✓	✓	✓	✓	

- Standard version
- Without additional charge
- This order code only determines the price of the version – Additional plain text is required.
- ✓ With additional charge
- O. R. Possible on request
- Not possible

Synchronous reluctance motors for SINAMICS converters – VSD4000 line

Article No. supplements and special versions · Options

Cast-iron series SIMOTICS SD 1FP1514

5

- 1) Evaluation with associated tripping unit (see Catalog IC 10) is recommended.
- 2) For order code **H08**, feet dimensions differing from EN 50347 Further information is available in the DT Configurator (see Appendix, "Tools and engineering").
- 3) The grease lifetime specified in Catalog Section 1 "Introduction" refers to CT 40 °C. If the coolant temperature is increased by 10 K, the grease lifetime and regreasing interval are halved.
- 4) A second shaft extension is not possible. Please inquire for mounted brakes.
- 5) The brake supply voltage must be specified or ordered with order codes **F10**, **F11**, **F12**, **F17**, and **F18**.
- 6) The 1XP8 rotary pulse encoders are fitted with a protective cover as standard. The protective cover is omitted at the factory when a rotary pulse encoder is combined with a separately driven fan, because in this case the rotary pulse encoder is installed under the fan cover.
- 7) In combination with a separately driven fan (order code **F70**) the 1XP8032-10 rotary pulse encoder is used instead of 1XP8012-10 or 1XP8032-20 is used instead of 1XP8012-20.
- 8) LL and HOG rotary pulse encoders up to frame size 160 are fitted with a protective cover as standard. The protective cover is omitted at the factory when a rotary pulse encoder is combined with a separately driven fan, because in this case the rotary pulse encoder is installed under the fan cover.
- 9) Order code **H00** provides mechanical protection for encoders.
- 10) Not possible in combination with HOG 9 DN 1024 I rotary pulse encoder (order code **G05**) and/or brake BFK458 (order code **F01**).
- 11) Not possible in combination with brake BFK458 – order code **F01**.
- 12) Not possible for type of construction IM V3.
- 13) In connection with mountings, the respective technical specifications must be observed, please inquire before ordering.
- 14) Up to frame size 160 not possible when brake is mounted.
- 15) When motors are ordered that have a longer or shorter shaft extension than normal, the required position and length of the feather keyway must be specified in a sketch. It must be ensured that only feather keys in accordance with DIN 6885, Form A are permitted to be used. The feather keyway is positioned centrally on the shaft extension. The length is defined by the manufacturer in accordance with the appropriate standard. Not valid for: Conical shafts, non-standard threaded journals, non-standard shaft tolerances, friction welded journals, extremely "thin" shafts, special geometry dimensions (e.g. square journals), hollow shafts. Valid for non-standard shaft extensions DE or NDE. The feather keys are supplied in every case. For order codes **Y58**, **Y59** and **L05** the following applies:
 - Dimensions D and DA ≤ ball bearing inner diameter (see dimension tables for "Dimensions")
 - Dimensions E and EA ≤ 2 × length E (standard) of the shaft extension. For an explanation of the order codes, see Catalog Section 1 "Introduction".
- 16) Wearing parts (bearings) are excluded from the warranty extension.
- 17) The delivery time for the manufacturer's test certificate may differ from the delivery time for the motor.
- 18) Option (encoder mounting) is only possible for motors with a mounted separately driven fan or for naturally cooled motors (without an external fan). This option can be used in combination with brakes of type KFB. This option cannot be used in combination with brakes of type BFK458!
- 19) Not UL and CSA certified. Not available in combination with order code **D31**.

Synchronous reluctance motors for SINAMICS converters – VSD4000 line

Article No. supplements and special versions · Accessories

Overview

Slide rails with fixing bolts and tensioning screws according to DIN 42923

Slide rails are used to tension the belt of a machine easily and conveniently when there is no belt-tensioning pulley. They are fixed to the base using stone bolts or foundation blocks.

The assignment of slide rails to motor size can be found in DIN 42923. For motors of frame sizes 355 to 450, there are no standardized slide rails (please inquire).

Available from:

Lütgert & Co. GmbH
Postfach 42 51
33276 Gütersloh, Germany
Phone +49 (5241) 7407-0
Fax +49 (5241) 7407-90

www.luetgert-antriebe.de
Email: info@luetgert-antriebe.de

Taper pins according to DIN 258 with threaded ends and constant taper lengths

Taper pins are used for components that are repeatedly removed. The drilled hole is conically ground using a conical reamer until the pin can be pushed in by hand until the cone shoulder lies approx. 3 to 4 mm above the rim of the hole.

It can then be driven in using a hammer until it is correctly seated. The pin is removed from the drilled hole by screwing on the nut and tightening it.

Standardized taper pins are commercially available.

For instance, available from:

Otto Roth GmbH & Co. KG
Rutesheimer Strasse 22
70499 Stuttgart, Germany
Phone +49 711 1388-0
Fax +49 711 1388-233

www.ottoroth.de
Email: info@ottoroth.de

Foundation blocks according to DIN 799

The foundation blocks are inserted into the stone foundation and embedded in concrete. They are used for fixing machines of medium size, slide rails, pedestal bearings, base frames, etc. After the fixing bolts have been unscrewed, the machines can be shifted without them having to be lifted.

When the machine is initially installed, the foundation blocks that are bolted to the machine (without washers) and fitted with taper pins are not embedded with concrete until the machine has been fully aligned. In this case, the machine is positioned 2 to 3 mm lower. The difference in shaft height is compensated by inserting shims on final installation. The taper pins safeguard the exact position of the machine when it is repeatedly removed and replaced without the need for realignment.

Available from:

Lütgert & Co. GmbH
Postfach 42 51
33276 Gütersloh, Germany
Phone +49 (5241) 7407-0
Fax +49 (5241) 7407-90

www.luetgert-antriebe.de
Email: info@luetgert-antriebe.de

More information

Replacement motors and repair parts

- Commitment to provide replacement motors and repair parts following delivery of the motor:
 - for up to 3 years after delivery of the original motor, in the event of total motor failure, Siemens will supply a comparable spare motor with regard to the mounting dimensions and functions (the type series may vary).
 - if a spare motor is provided within the 3-year period, this will not mean that the warranty restarts.
 - Replacement motors delivered after the active production of the motor series are also identified as spare motors on the rating plate.
 - Spare parts are offered only for these spare motors on request; repair and replacement are not possible.
 - after a period of 3 years (after the delivery of the original motor), it is only possible to repair these motors (depending on the availability of the spare parts required).
 - for up to 5 years after the delivery of the original motor, spare parts will be available and for a further 5 years, Siemens will provide information about spare parts and will supply documents when required.

- When repair parts are ordered, the following details must be provided:
 - Designation and part number
 - Article No. and factory number of the motor.
- For bearing types, see Catalog Section 1 "Introduction".
- For standard components, a commitment to supply repaired parts does not apply.
- Support hotline
In Germany
Phone +49 911 895 7 222

You will find telephone numbers for other countries on our Internet site:

www.siemens.com/automation/service&support

Synchronous reluctance motors for SINAMICS converters – VSD4000 line

Dimensions

Notes on the dimensions

Overview

- Dimension designations according to EN 50347 and IEC 60072.

- Fits

The shaft extensions specified in the dimension tables (DIN 748) and centering spigot diameters (EN 50347) are machined with the following fits:

Dimension designation	ISO fit EN ISO 286-2	
D, DA	to 30	j6
	over 30 to 50	k6
	over 50	m6
N	to 250	j6
	over 250	h6
F, FA		h9
K		H17
S	flange (FF)	H17

The drilled holes of couplings and belt pulleys should have an ISO fit of at least H7.

- Dimensional tolerances

For the following dimensions, the admissible deviations are given below:

Dimension designation	Dimension	Admissible deviation
H	to 250	– 0.5
	over 250	– 1.0
E, EA		– 0.5

Keyways and feather keyways (dimensions GA, GC, F and FA) are made in compliance with DIN 6885 Part 1.

- All dimensions are specified in mm.

Synchronous reluctance motors for SINAMICS converters – VSD4000 line

Dimensions

Dimension sheet generator (within the DT Configurator)

Overview

A dimensional drawing can be created in the "Drive Technology Configurator" (DT Configurator) for every configurable motor. A dimensional drawing can be requested for every other motor.

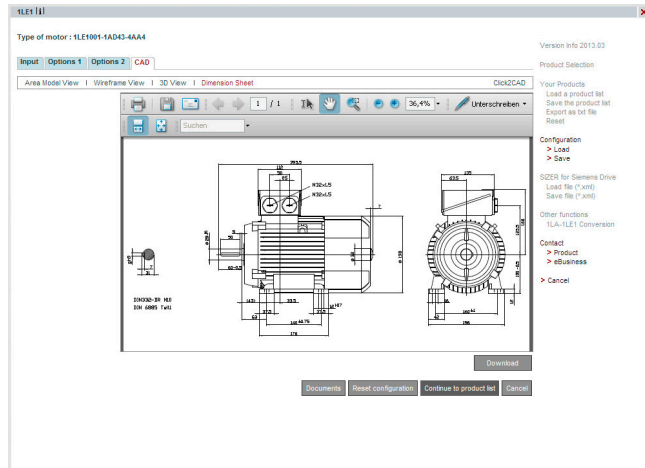

When a complete Article No. is entered with or without order codes, a dimensional drawing can be called up under the "Documentation" tab.

These dimensional drawings can be presented in different views and sections and printed.

The corresponding dimension sheets can be exported, saved and processed further in DXF format (interchange/import format for CAD systems) or as bitmap graphics.

Online access in the Siemens Industry Mall

The DT Configurator is integrated in the Siemens Industry Mall and can be used on the Internet without installation.

German: www.siemens.de/dt-konfigurator
English: www.siemens.com/dt-configurator

Synchronous reluctance motors for SINAMICS converters – VSD4000 line

Dimensions · Aluminum series SIMOTICS GP

Super Premium Efficiency – self-ventilated · Frame sizes 80 M, 90 S, 90 L, 112 M to 200 L

Dimensional drawings

Type of construction IM B3

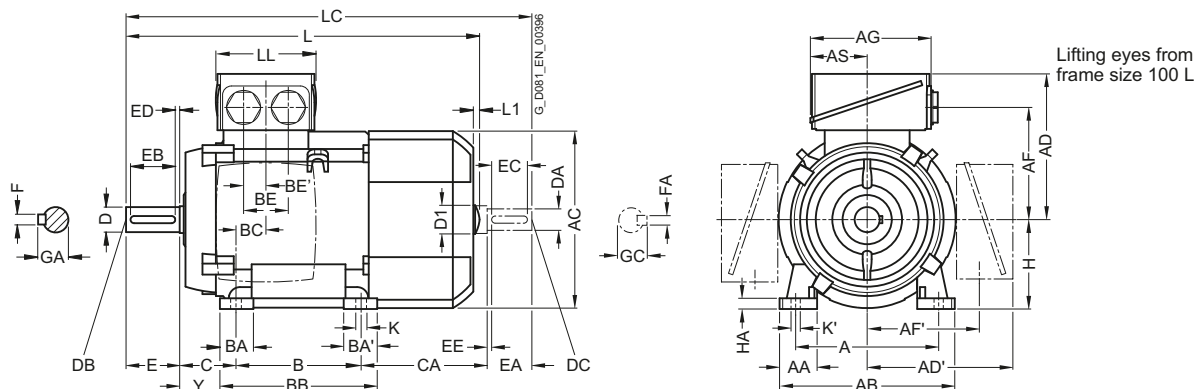

Types of construction IM B5 and IM V1

For flange dimensions, see page 1/48 (Z = the number of retaining holes)

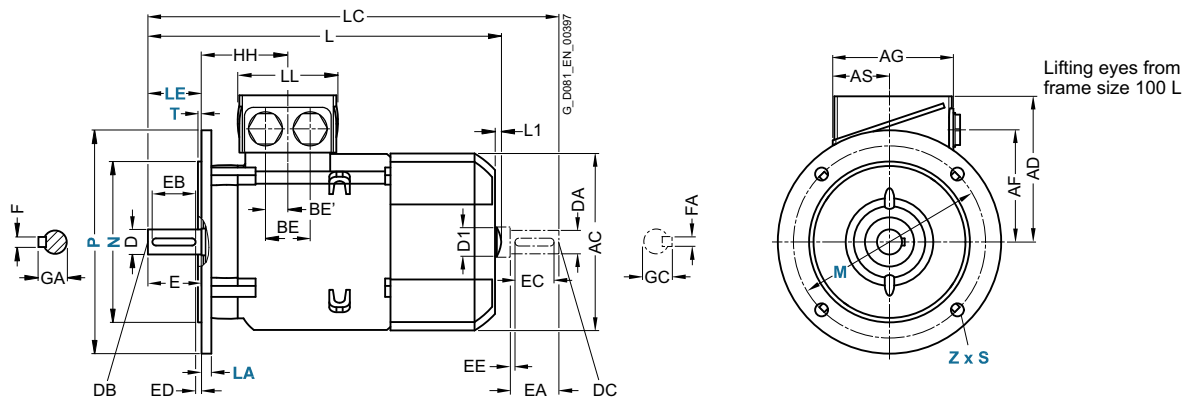

5

For motor			Dimension designation acc. to IEC																					
Frame size	Motor type 1FP1014-	No. of poles	A	AA	AB	AC	AD	AD'	AF	AF'	AG	AS	B	BA	BA'	BB	BC	BE	BE'	C	CA	H	HA	Y
80 M	0DB2, 0DB3	4	125	30.5	150	159	121.5	121.5	96.5	96.5	93	43	100	32	32	118	23	-	18 ¹⁾	50	113	80	8	41
90 S	0EB0	4	140	30.5	165	178	126	126	101.5	101.5	93	43	100	33	-	143	22.5	- ¹⁾	18 ¹⁾	56	159	90	10	47
90 L	0EB4	4	140	30.5	165	178	126	126	101.5	101.5	93	43	125	33	-	143	22.5	- ¹⁾	18 ¹⁾	56	154	90	10	47
112 M	1BB0, 1BB1, 1BB2	4	190	46	226	222	177	177	136.5	136.5	135	63.5	140	37.5	37.5	176	26	50	25	70	155	112	12	52
132 S	1CB0	4	216	53	256	262	202	202	159.5	159.5	155	70.5	140	38	76 ²⁾	218 ⁴⁾	26.5	48	24	89	166.5	132	15	69
132 M	1CB2	4	216	53	256	262	202	202	159.5	159.5	155	70.5	178	38	76	218	26.5	48	24	89	178.5	132	15	69
160 M	1DB2	4	254	60	300	314	236.5	236.5	190	190	175	77.5	210	44	89 ³⁾	300 ⁵⁾	47	57	28.5	108	192	160	18	85
160 L	1DB4	4	254	60	300	314	236.5	236.5	190	190	175	77.5	254	44	89	300	47	57	28.5	108	208	160	18	85
180 M	1EB2	4	279	65	339	356	259	259	212.5	212.5	175	77.5	241	80	100	328	30	57	28.5	121	232	180	20	95
180 L	1EB4	4	279	65	339	356	259	259	212.5	212.5	175	77.5	279	80	100	328	30	57	28.5	121	194	180	20	95
200 L	2AB5	4	318	70	378	396	296	296	238	238	225	102.5	305	90	100	355	45	75	37.5	133	202	200	25	108

1) Connecting hole for terminal box is on the side at the rear of the terminal box.

2) With screwed-on feet, dimension BA' is 38 mm.

3) With screwed-on feet, dimension BA' is 44 mm.

4) With screwed-on feet, dimension BB is 180 mm.

5) With screwed-on feet, dimension BB is 256 mm.

Synchronous reluctance motors for SINAMICS converters – VSD4000 line

Dimensions · Aluminum series SIMOTICS GP

Super Premium Efficiency – self-ventilated · Frame sizes 80 M, 90 S, 90 L, 112 M to 200 L

Dimensional drawings

Type of construction IM B35

For flange dimensions, see page 1/48 (**Z** = the number of retaining holes)

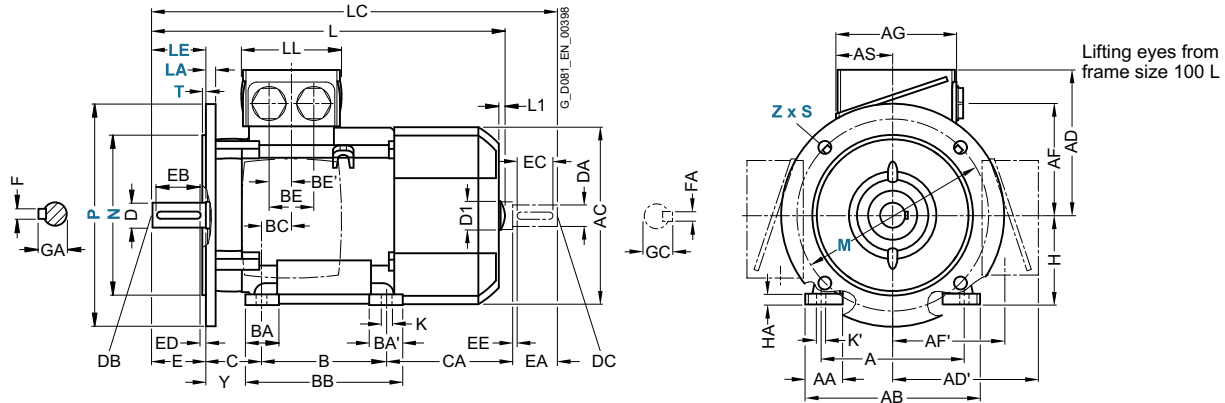

Type of construction IM B14

For flange dimensions, see page 1/48 (**Z** = the number of retaining holes)

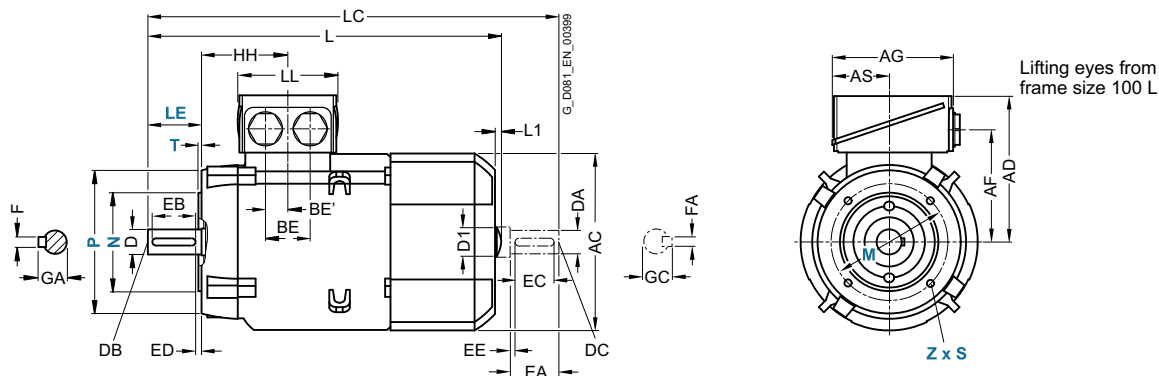

For motor		Dimension designation acc. to IEC										DE shaft extension					NDE shaft extension							
Frame size	Motor type 1FP10.4-	No. of poles	HH	K	K'	L ¹⁾	L1	D1	LC	LL	D	DB	E	EB	ED	F	GA	DA	DC	EA	EC	EE	FA	GC
80 M	0DB2,	4	73	9.5	13.5	292	-	-	343	79	19	M6	40	32	4	6	21.5	19	M6	40	32	4	6	21.5
	0DB3					327																		
90 S	0EB0	4	78.5	10	14	347	-	-	405	79	24	M8	50	40	5	8	27	19	M6	40	32	4	6	21.5
90 L	0EB4	4	78.5	10	14	387	-	-	445	79	24	M8	50	40	5	8	27	19	M6	40	32	4	6	21.5
112 M	1BB0,	4	96	12	16	464	7	32	475	112	28	M10	60	50	5	8	31	24	M8	50	40	5	8	27
	1BB1,																							
	1BB2																							
132 S	1CB0	4	115.5	12	16	465	8.5	39	535.5	130	38	M12	80	70	5	10	41	28	M10	60	50	5	8	31
132 M	1CB2	4	115.5	12	16	515	8.5	39	585.5	130	38	M12	80	70	5	10	41	28	M10	60	50	5	8	31
160 M	1DB2	4	155	15	19	606	10	45	730	145	42	M16	110	90	10	12	45	42	M16	110	90	10	12	45
160 L	1DB4	4	155	15	19	666	10	45	790	145	42	M16	110	90	10	12	45	42	M16	110	90	10	12	45
180 M	1EB2	4	151	14.5	19	698	-	-	814	145	48	M16	110	100	5	14	52	48	M16	110	100	5	14	52
180 L	1EB4	4	151	14.5	19	698	-	-	814	145	48	M16	110	100	5	14	52	48	M16	110	100	5	14	52
200 L	2AB5	4	178	18.5	25	746	-	-	860	185	55	M20	110	100	5	16	59	55	M20	110	100	5	16	59

¹⁾ The length is specified as far as the tip of the fan cover.

Synchronous reluctance motors for SINAMICS converters – VSD4000 line

Dimensions · Cast-iron series SIMOTICS SD

Super Premium Efficiency – self-ventilated · Frame sizes 80 M, 90 S, 90 L, 112 M to 160 L

Dimensional drawings

Type of construction IM B3

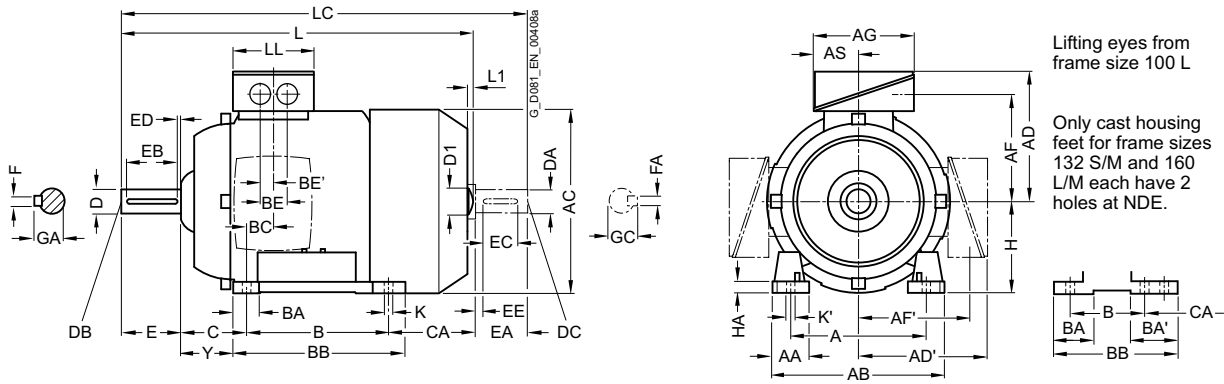

Types of construction IM B5 and IM V1

For flange dimensions, see page 1/48 (Z = the number of retaining holes)

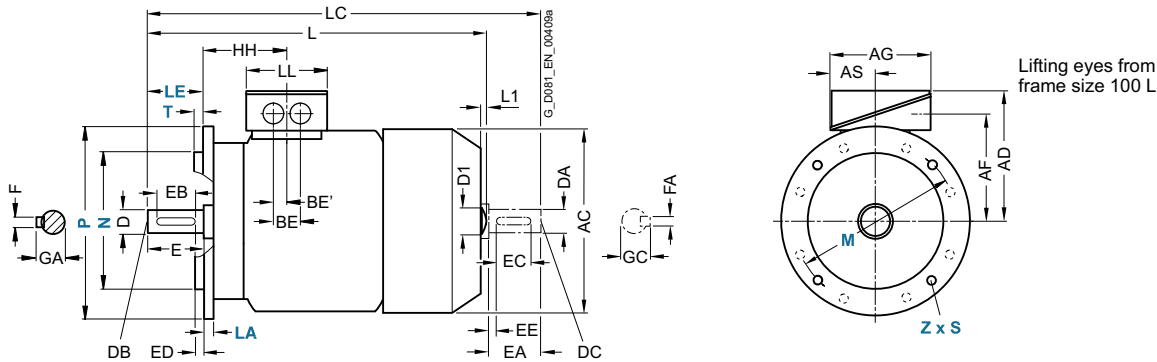

5

For motor			Dimension designation acc. to IEC																					
Frame size	Motor type 1FP15.4-	No. of poles	A	AA	AB	AC	AD	AD'	AF	AF'	AG	AS	B	BA	BA'	BB	BC	BE	BE'	C	CA	H	HA	Y
80 M	0DB2, 0DF2, 0DF3, 0DB3	4	125	30.5	150	162	159	159	122	122	126	62	100	32	32	118	22.5	36	18	50	112.5	80	8	41
90 S	0EB0, 0EF0,	4	140	30.5	165	180	164	164	127	127	126	62	100	33	54	143	24.5	36	18	56	159	90	11	47
90 L	0EF4, 0EB4	4	140	30.5	165	180	164	164	127	127	126	62	125	33	54	143	24.5	36	18	56	159 134	90	11	47
112 M	1BB0, 1BB1, 1BF1, 1BF2, 1BB2	4	190	46	226	239	195	195	150	150	163	80.5	140	48	48	176	30	48	24	70	130	112	12	52
132 S	1CB0, 1CF0, 1CF1	4	216	53	256	281	214.5	214.5	169	169	163	80.5	140	52 ¹⁾	89 ³⁾	218 ⁵⁾	26.5	48	24	89	166.5	132	15	69
132 M	1CB2	4	216	53	256	281	214.5	214.5	169	169	163	80.5	140	52 ¹⁾	–	218 ⁵⁾	26.5	48	24	89	178.5	132	15	69
160 M	1DB2, 1DF2, 1DF3	4	254	60	300	333.5	261	261	213	213	190	92	210	73 ²⁾	117 ⁴⁾	300 ⁶⁾	37	60	30	108	192	160	18	85
160 L	1DF4, 1DB4	4	254	60	300	333.5	261	261	213	213	190	92	254	73 ²⁾	117 ⁴⁾	300 ⁶⁾	37	60	30	108	192 208	160	18	85

1) With screwed-on feet, dimension BA is 41 mm.
 2) With screwed-on feet, dimension BA is 51 mm.
 3) With screwed-on feet, dimension BA' is 41 mm.

4) With screwed-on feet, dimension BA' is 51 mm.
 5) With screwed-on feet, dimension BB is 180 mm.
 6) With screwed-on feet, dimension BB is 256 mm.

Synchronous reluctance motors for SINAMICS converters – VSD4000 line

Dimensions · Cast-iron series SIMOTICS SD

Super Premium Efficiency – self-ventilated · Frame sizes 80 M, 90 S, 90 L, 112 M to 160 L

Dimensional drawings

Type of construction IM B35

For flange dimensions, see page 1/48 (**Z** = the number of retaining holes)

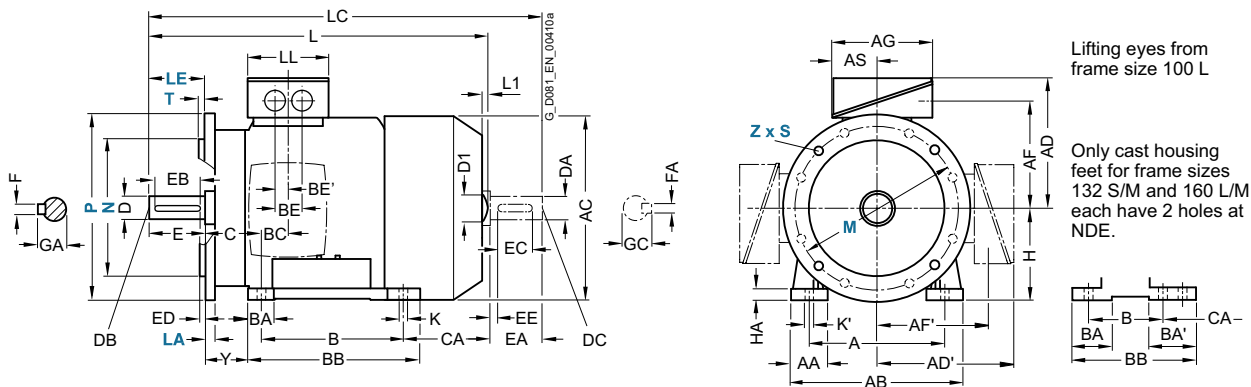

Type of construction IM B14

For flange dimensions, see page 1/48 (**Z** = the number of retaining holes)

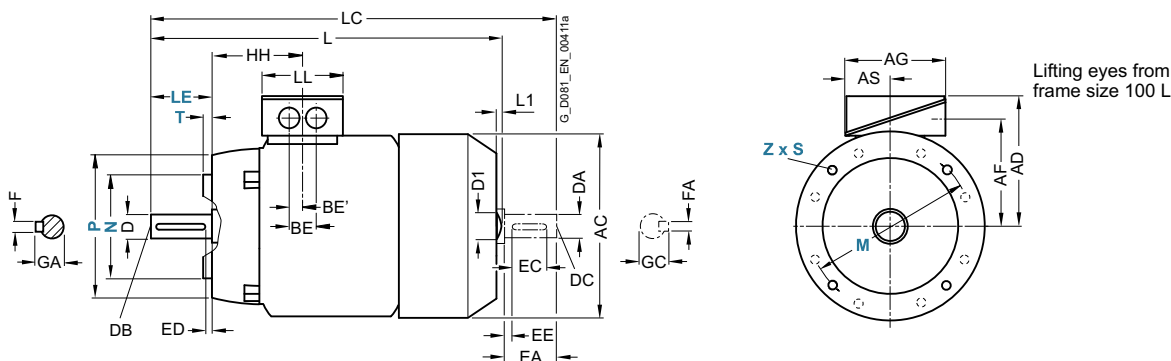

For motor	Motor type	No. of poles	Dimension designation acc. to IEC										DE shaft extension				NDE shaft extension							
			HH	K	K'	L	L1	D1	LC	LL	D	DB	E	EB	ED	F	GA	DA	DC	EA	EC	EE	FA	GC
80 M	0DB2, 0DF2, 0DF3, 0DB3	4	71.5	10	10	292 327	-	-	343 378	102	19	M6	40	32	4	6	21.5	19	M6	40	32	4	6	21.5
90 S	0EB0, 0EF0,	4	79.5	10	10	347	-	-	405	102	24	M8	50	40	5	8	27	19	M6	40	27	4	6	21.5
90 L	0EF4, 0EB4	4	79.5	10	10	347 387	-	-	445	102	24	M8	50	40	5	8	27	19	M6	40	27	4	6	21.5
112 M	1BB0, 1BB1, 1BF1, 1BF2, 1BB2	4	100.5	12	16	415.5 465.5	7	32	475	134	28	M10	60	50	5	8	31	24	M8	50	40	5	8	27
132 S	1CB0, 1CF0, 1CF1	4	115.5	12	16	466.5	8.5	39	535.5	134	38	M12	80	70	5	10	41	28	M10	60	50	5	8	31
132 M	1CB2	4	115.5	12	16	516.5	8.5	39	585.5	134	38	M12	80	70	5	10	41	28	M10	60	50	5	8	31
160 M	1DB2, 1DF2, 1DF3	4	145	14.	18	606	10	45	730	165	42	M16	110	90	10	12	45	42	M16	110	90	10	12	45
160 L	1DF4, 1DB4	4	145	14.	18	606 666	10	45	730 790	165	42	M16	110	90	10	12	45	42	M16	110	90	10	12	45

Synchronous reluctance motors for SINAMICS converters – VSD4000 line

Dimensions · Cast-iron series SIMOTICS SD

Super Premium Efficiency – self-ventilated · Frame sizes 180 M to 200 L

Dimensional drawings

Type of construction IM B3

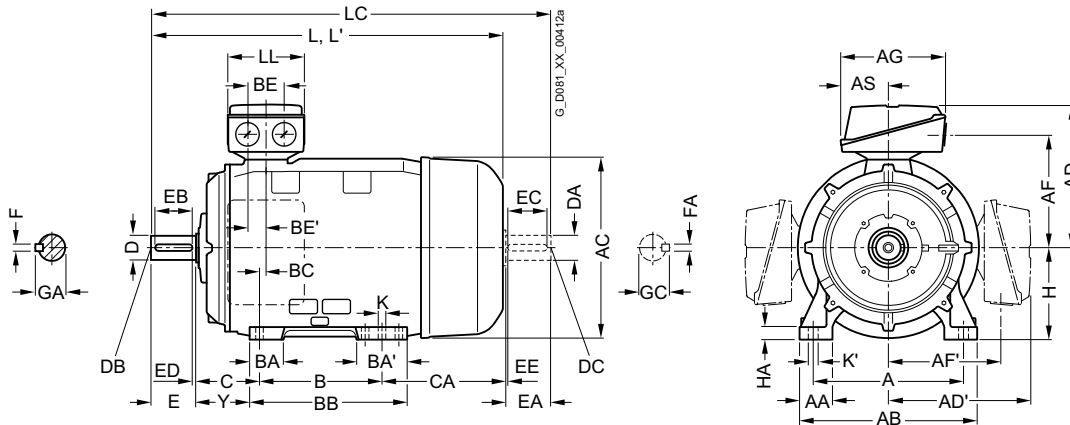

Types of construction IM B5 and IM V1

For flange dimensions, see page 1/48 (Z = the number of retaining holes)

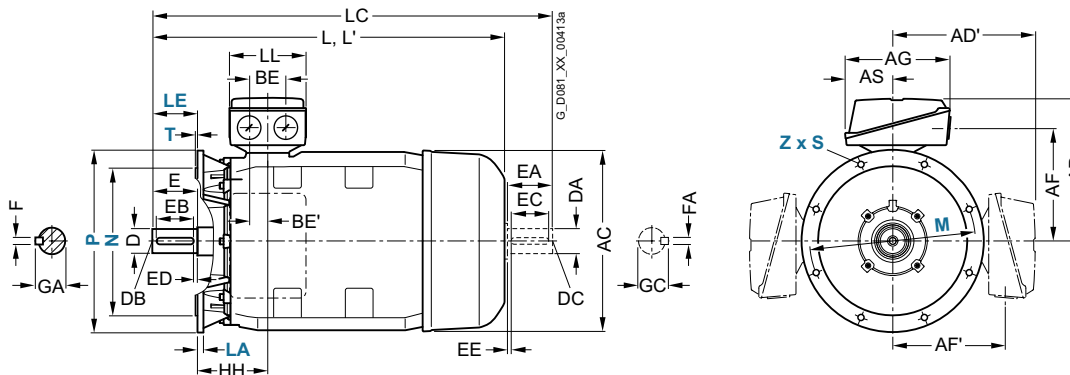

5

For motor			Dimension designation acc. to IEC																		
Frame size	Motor type	No. of poles	A	AA	AB	AC	AD	AD'	AF	AF'	AG	AS	B	BA	BA'	BB	BC	BE	BE'	C	CA
180 M/ 180 L	1EB2, 1EF2 1EB4	4	279	65	339	356	286	286	234	234	190	92	241	85	120	328	34	60	30	121	202
200 L	2AF4, 2AF5, 2AB5	4	318	70	378	396	315	315	259	259	266	112	305	104	104	355	31	85	42.5	133	177
225 S	2BB0	4	356	80	436	449	338	338	282	282	266	112	286	92	117	361	15	85	42.5	149	273
225 M	2BF2 2BB2	4	356	80	436	449	338	338	282	282	266	112	311	92	117	361	15	85	42.5	149	248

Synchronous reluctance motors for SINAMICS converters – VSD4000 line

Dimensions · Cast-iron series SIMOTICS SD

Cast-iron series, self-ventilated – Super Premium Efficiency · Frame sizes 180 M to 200 L

Dimensional drawings

Type of construction IM B35

For flange dimensions, see page 1/48 (**Z** = the number of retaining holes)

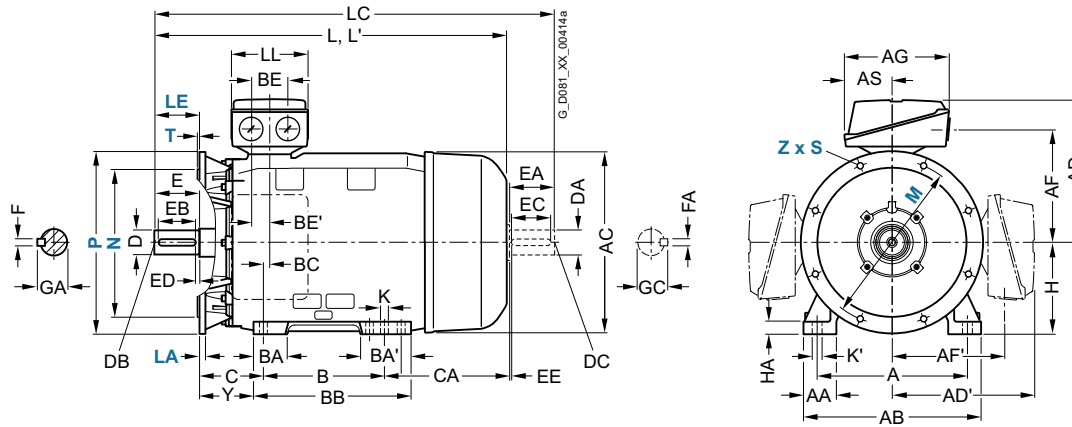

For motor		Dimension designation acc. to IEC										DE shaft extension					NDE shaft extension								
Frame size	Motor type 1FP15.4-	No. of poles	H	HA	Y	HH	K	K'	L	LC ¹⁾	LL	D	DB	E	EB	ED	F	GA	DA	DC	EA	EC	EE	FA	GC
180 M/ 180 L	1EB2, 1EF2 1EB4	4	180	20	95	155	15	19	668 698	784 814	164	48	M16	110	100	5	14	51.5	48	M16	110	100	5	14	51.5
200 L	2AF4, 2AF5, 2AB5	4	200	25	108	164	19	25	721	835	197	55	M20	110	100	5	16	59	55	M20	110	100	5	16	59
225 S	2BB0	4	225	34	124	164	19	25	848	903	197	60	M20	140	125	10	18	64	55	M20	110	100	5	16	59
225 M	2BF2 2BB2	4	225	34	124	164	19	25	848 928	903 963	197 60	55	M20	110 140	100 125	5 10	16 18	59 64	48 55	M16 M20	110	100	5	14 16	51.5 59

¹⁾ In the low-noise version, a second shaft extension and/or mounted encoder is not possible.

Standard induction motors optimized for converter operation – VSD10 line

Orientation

Overview

SIMOTICS GP/SD VSD10 line motor series: 1LE109, 1LE159



SIMOTICS GP/SD VSD10 line motors are suitable for all sectors of industry as a result of their flexibility and the wide range of versions available.

Versions of the SIMOTICS GP/SD VSD10 line motor series: 1LE109, 1LE159

The motors are squirrel-cage induction motors with compact dimensions in a surface-cooled, enclosed version with self-ventilation. They have been specifically designed for converter operation.

1LE109 General Purpose for converter operation

- Four-quadrant operation with a converter, optimally coordinated to the SINAMICS G drive system. Can be operated with SINAMICS S (ALM, SLM) in four-quadrant operation.
- IP55 degree of protection
- IC411 cooling method, self-ventilated (IC416 cooling method, force-ventilated version optional)
- Housing: Aluminum
- Frame sizes 100 to 160

1LE159 Severe Duty for converter operation

- Four-quadrant operation with a converter, optimally coordinated to the SINAMICS G drive system. Can be operated with SINAMICS S (ALM, SLM) in four-quadrant operation.
- IP55 degree of protection
- IC411 cooling method, self-ventilated (IC416 cooling method, force-ventilated version optional)
- Housing: Cast iron
- Frame sizes 100 to 315

Benefits

The SIMOTICS GP/SD VSD10 line motor series has been specifically developed for operation with SINAMICS G converters.

- Optimizing the assignment of the motor active part to the Power Module results in low capital investment costs.
- The high power density and compact design ensure low space requirements combined with low weight.
- An optimally harmonized drive system is created as the motor is optimally coordinated and harmonized with the converter. For instance, the converter does not have to be derated or there is low temperature rise.
- Optionally, SIMOTICS GP motors with an aluminum housing (frame sizes 100 to 160) or SIMOTICS SD motors with a rugged cast-iron housing (frame sizes 100 to 315) are available.
- High degree of availability based on standard protection functions for converter operation – KTY 84-130 temperature sensors, Pt1000 resistance thermometers (all frame sizes) and NDE insulated bearings (frame sizes 280 and 315).
- As a result of the optimized insulation system, a high degree of reliability is obtained for four-quadrant operation with SINAMICS converters.
- Fast and simple commissioning by transferring a motor code into the converter.

More power ratings

SIMOTICS GP/SD VSD10 line motors are designed as standard for operation with a 50 Hz, 60 Hz, and 87 Hz characteristic (up to frame size 200). No special ordering option is required.

Optimized for converter operation

The new motor series has been optimized for operation with SINAMICS G120, G130, and G150 converters with regard to converter output currents and voltage utilization. Four-quadrant operation is possible without restrictions with the SINAMICS G120 and SINAMICS S120 converter families. The motors can also be operated on other SINAMICS converters (SINAMICS G120P, SINAMICS G120C, SINAMICS G120D).

High degree of flexibility

By consistently utilizing the 1LE1 standard motor platform, almost all options of the 1LE1 line motors can also be used for the SIMOTICS GP/SD VSD10 line series.

Known and established design

Line and converter motors can be easily interchanged due to their identical dimensions and customer interfaces. The connection and operating philosophy is exactly the same as for 1LE1 line motors.

International applications

The motors are not subject to any minimum efficiency requirements for specific countries. As a consequence, they can be operated without additional MEPS certificates, also in the USA, for example.

Standard induction motors optimized for converter operation – VSD10 line

Orientation

Application

As a result of the wide range of options, the SIMOTICS GP/SD VSD10 line motor series can be deployed in all industrial areas and sectors. Paper, steel, energy, chemical, water/waste water are examples of some typical sectors.

Various flange and foot-mounted designs according to EN 60034-7 are available. IP55 is the standard degree of protection (other degrees of protection optionally available).

The wide field of applications that can be addressed includes, for example, the following:

- Pumps
- Fans
- Compressors
- Cranes
- Conveyor belts

Design

The SIMOTICS GP/SD VSD10 line motors are based on the 1LE1 platform. The principle design of the SIMOTICS GP/SD VSD10 line motors therefore corresponds to the 1LE1 line motors.

The mechanical parts are identical. The motors are adapted to the converter by appropriately dimensioning the active part and VSD-specific rating plate data.

Technical specifications

Overview of technical specifications

This table lists the most important technical specifications.

Type of motor	SIMOTICS GP/SD VSD10 line IEC Low-Voltage Motors; three-phase induction motors
Connection types	Star/delta connection The connection used depends on the particular load characteristic.
No. of poles	2, 4
Frame sizes	100 ... 315
Rated power	<ul style="list-style-type: none"> • 2-pole: 3 ... 90 kW (50 Hz characteristic); 3.45 ... 101 kW (60 Hz characteristic), 4.5 ... 12.5 kW (87 Hz characteristic) • 4-pole: 2.2 ... 200 kW (50 Hz characteristic); 2.55 ... 230 kW (60 Hz characteristic), 3.7 ... 48 kW (87 Hz characteristic)
Frequencies	Characteristics for 50 Hz, 60 Hz and 87 Hz
Versions	Air-cooled, enclosed version: <ul style="list-style-type: none"> • with self ventilation • with forced ventilation (optional) SIMOTICS GP motors in an aluminum version, frame sizes 100 ... 160 SIMOTICS SD motors in a cast-iron version, frame sizes 100 ... 315
Marking	Only permitted for converter operation. As converter motors, IE classification according to IEC 60034-30-1 is not required.
Rated speed	<ul style="list-style-type: none"> • 1500 rpm, 1800 rpm (up to frame size 315), and 2610 rpm (up to frame size 200) • 3000 rpm, 3600 rpm (up to frame size 280), and 5220 rpm (up to frame size 112)
Rated torque	9.6 ... 1273 Nm (50 Hz characteristic); 9.2 ... 1220 Nm (60 Hz characteristic), 8.2 ... 176 Nm (87 Hz characteristic)
Insulation of the stator winding in accordance with EN 60034-1 (IEC 60034-1)	Temperature class F Reinforced insulation system (Advanced) up to 440 V motor connection voltage Special insulation system (Premium) up to 480 V motor connection voltage
Degree of protection acc. to EN 60034-5 (IEC 60034-5)	Standard IP55 optionally IP56 and IP65 Air-cooled, enclosed version
Cooling acc. to EN 60034-6 (IEC 60034-6)	<ul style="list-style-type: none"> • Standard: Self-ventilated (IC411) • Optional: Forced-air cooled (IC416)
Permissible coolant temperature and installation altitude	-20 ... +40 °C as standard, installation altitude up to 1000 m above sea level
Standard voltages acc. to EN 60038 (IEC 60038)	50 Hz line supplies: 400 V, 500 V, 690 V 60 Hz line supplies: 460 V, 600 V The rated motor voltage required is listed in the "Selection and ordering data" for the required motor.
Type of construction acc. to EN 60034-7 (IEC 60034-7)	<ul style="list-style-type: none"> • Without flange: IM B3, IM B6, IM B7, IM B8, IM V5, IM V6 • With flange: IM B5, IM B35, IM V1, IM V3
Paint finish Suitability of paint finish for climate group acc. to IEC 60721, Part 2-1	As standard: color RAL 7030 stone gray
Vibration severity grade acc. to EN 60034-14 (IEC 60034-14)	Grade A (normal)
Shaft extension acc. to DIN 748 (IEC 60072)	Balancing type: half-key balancing as standard
Sound pressure level acc. to EN ISO 1680 (tolerance +3 dB)	The corresponding sound pressure level is listed in the "Selection and ordering data" for the required motor.
Weights	The corresponding weight is listed in the "Selection and ordering data" for the required motor.
Modular mounting concept	Optional pulse encoder, brake, and separately driven fan according to ordering data
Options	See "Article No. supplements and special versions"

Standard induction motors optimized for converter operation – VSD10 line

Orientation

Technical specifications

Rating plate

In accordance with EN 60034-1, the approximate total weight is specified on the rating plate. The standard version of the rating plate is the international version in English.

For straightforward and fast commissioning with SINAMICS G converters, a motor code number is stamped on the rating plate (CODE). The rated frequencies deviate, depending on the slip, from 50 Hz, 60 Hz, and 87 Hz.

SIEMENS									
Made in Czech Rep.		D-90441 Nürnberg							
3-Mot. 1AV1164B		1LE10921DB421AF4				UD 1701/1234567 001 001			
IEC/EN 60034		160L IMB3		IP55					
73kg		Th.Cl. 155(F)		-20°C ≤ TAMB ≤ 40°C					
Bearing									
DE 6209-2ZC3									
NE 6209-2ZC3									
CONVERTER DUTY ONLY VPWM SINAMICS G120 Nmax 4200 1/min									
V	Hz	A	kW	cos φ	Nm	1/min	EFF	CODE	
380 Y	51.4	31.5	15.0	0.82	95	1500	88.7	17026	
220 Δ	51.4	54	15.0	0.82	95	1500	88.7		
440 Y	61.4	30.5	17.3	0.82	92	1800	90.5		
380 Δ	88.2	51	23.5	0.77	86	2610	90.5		

Example of a rating plate for SIMOTICS GP VSD10 line

Motors specially designed for converter operation

These motors have been specifically designed for converter operation. The catalog data apply for operation with Siemens SINAMICS G and SINAMICS S converters.

When operated with an alternative converter, the catalog data apply (thermal torque limits, maximum overload torques), approximately for the following general conditions:

- Minimum rated pulse frequencies:
 - 4 kHz at 400 V, up to 90 kW
 - 2 kHz at 500 V to 690 V, up to 132 kW
 - 1.25 kHz at 500 V to 690 V, 160 and 200 kW
- The converter can provide the rated voltage as listed in the catalog.
- Permissible voltage peaks for reinforced insulation system (Advanced):

$$\hat{U}_{\text{phase-to-phase}} \leq 1600 \text{ V}, \hat{U}_{\text{phase-to-ground}} \leq 1400 \text{ V}, t_s > 0.1 \mu\text{s}$$
- Permissible voltage peaks for special insulation system (Premium):

$$\hat{U}_{\text{phase-to-phase}} \leq 2200 \text{ V}, \hat{U}_{\text{phase-to-ground}} \leq 1500 \text{ V}, t_s > 0.1 \mu\text{s}$$

For SINAMICS G120 converters (from firmware version 4.7 and higher), the SIMOTICS GP/SD VSD10 line can be selected as the motor category and addressed using the motor code No. in the SINAMICS converter using the STARTER software or at the converter operator panel (Advanced Operator Panel (AOP), Basic Operator Panel (BOP)).

Rated voltage

The tolerance for the rated voltage is in accordance with EN 60034-1. A rated voltage range is not specified. The rated motor voltages are selected so that when operated with a SINAMICS G120 converter, the available voltage is optimally utilized.

Insulation

The motors can be operated with line voltages up to 690 V 3 AC with SINAMICS G converters and SINAMICS S converters (uncontrolled and controlled infeed) when maintaining the permissible peak voltages specified above.

Depending on the selected motor connection voltage, a special insulation system is used for converter operation.

- Up to 440 V motor voltage (480 V line voltage) reinforced insulation system (Advanced)
- From 480 V motor voltage (500 V line voltage) special insulation system (Premium)

For converter operation with the power ratings specified in the catalog, the motors can be utilized corresponding to thermal class 155 (F) (service factor 1.0).

Preferred supply system configurations are TT systems and TN systems with neutral-point grounding. In the case of a fault when connected to an IT system (ground fault), the insulation is excessively stressed. In this case, the process should be terminated as quickly as possible ($t < 2 \text{ h}$), and the fault resolved. We do not recommend operation in corner-grounded TN systems.

Noise

The maximum sound pressure levels should be taken from the selection and ordering data.

Technical specifications

Separately driven fan

For the technical specifications of the separately driven fans, see page 1/80 "Technical specifications of separately driven fans".

Bearings

To prevent bearing current damage, converter motors are equipped with insulated bearing cartridges at the NDE, available as standard for frame sizes 280 and 315.

Insulated NDE bearings are optionally available for frame sizes 100 to 250. We recommend their use depending on the particular plant or system.

For converter operation, as a result of the basic principle employed, electrical bearing stress is created through the bearing lubricant film due to a voltage that is capacitively coupled in.

The physical cause of this is the common-mode voltage at the converter output that is inherent in the control method for a converter:

The sum of the three phase voltages is – in contrast to pure line operation – not equal to zero at every point in time.

In order to apply currents to the motor which are sinusoidal as far as possible (resulting in smoother running, lower oscillation torques, and lower stray losses), a high pulse frequency is required for the converter's output voltage. The related (very steep) switching edges of the converter output voltage (and also, therefore, of the common-mode voltage) cause correspondingly high capacitive currents and voltages on the machine's internal capacitances.

In the worst-case scenario, the capacitive voltage induced via the bearing can lead to random arcing through the bearing lubricating film, thus causing premature bearing aging or damage.

This physical effect, which occurs in isolated cases, has mostly been observed in connection with larger motors.

EMC-compliant installation of the drive system is a basic prerequisite for preventing premature bearing damage via bearing currents.

The most important measures for reducing bearing currents are:

- Insulated motor bearing at the NDE.
- Use cables with a symmetrical cable cross-section:

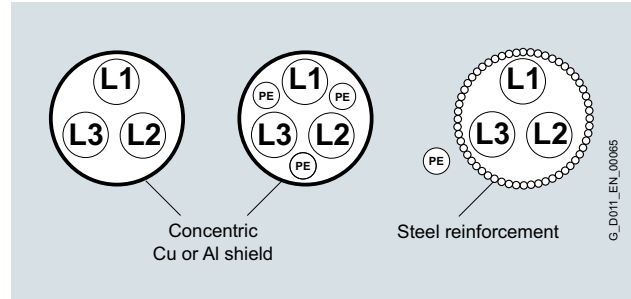

- Preference given to a line supply with isolated neutral point (IT system).
- Using grounding cables with low impedance over a wide frequency range (DC up to approximately 70 MHz): for example, braided copper ribbon cables, HF finely stranded wires.
- Separate HF equipotential-bonding cable between motor housing and driven machine.
- Separate HF equipotential-bonding cable between motor housing and converter PE busbar.
- 360° HF contacting of the cable shield on the motor housing and the converter PE busbar. This can be achieved using EMC screwed glands on the motor side and EMC shield clips on the converter side, for example.

Standard induction motors optimized for converter operation – VSD10 line

Orientation

Technical specifications

Torque limits (continuous duty)

The thermal torque limit characteristics of the SIMOTICS GP/SD VSD10 line define the maximum load torque for uninterrupted duty (S1) over the complete speed control range. The characteristics are different for all of the cooling methods. The speed control range is limited by the mechanical speed limit, which depends on the motor's mechanical design.

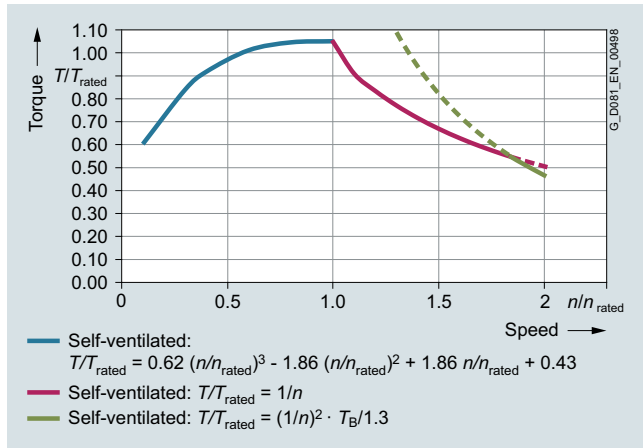

Torque limit characteristic for SIMOTICS GP/SD VSD10 line, self-ventilated

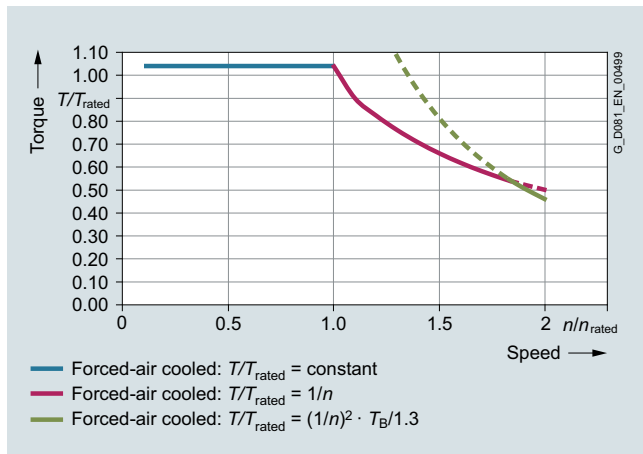

Torque limit characteristic for SIMOTICS GP/SD VSD10 line, forced-air cooled

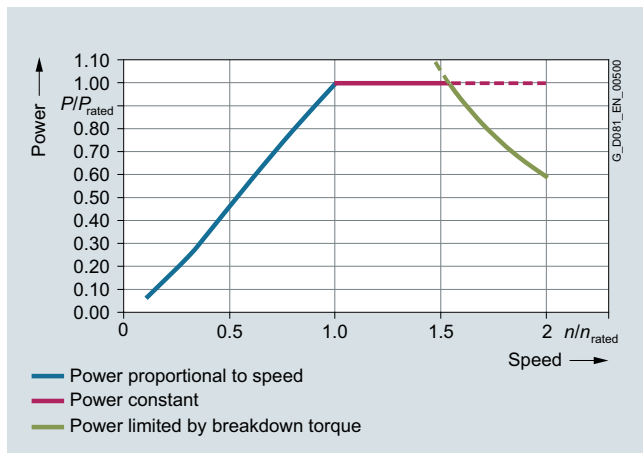

Power limit for SIMOTICS GP/SD VSD10 line, self-ventilated

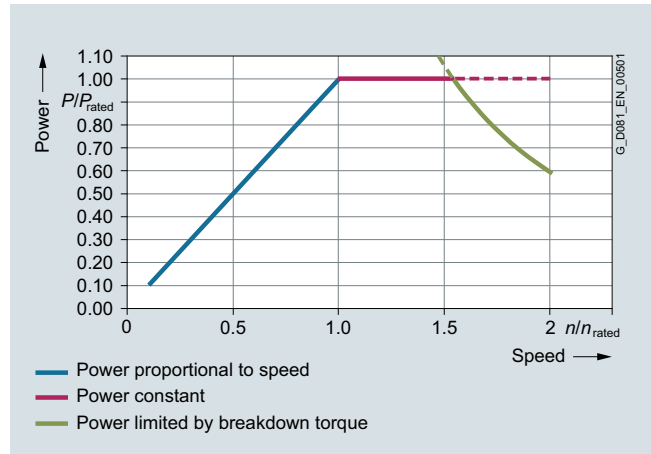

Power limit for SIMOTICS GP/SD VSD10 line, forced-air cooled

Maximum overload torques

The maximum overload torque output from the motor is defined by the overload torque characteristic over the complete speed control range. The reference variable is the breakdown torque at rated speed. The breakdown torque is calculated from the breakdown torque ratio and the rated torque. Operation at the maximum overload torque is only briefly permissible, for instance, when accelerating. The speed control range is limited by the mechanical speed limit, which depends on the motor's mechanical design.

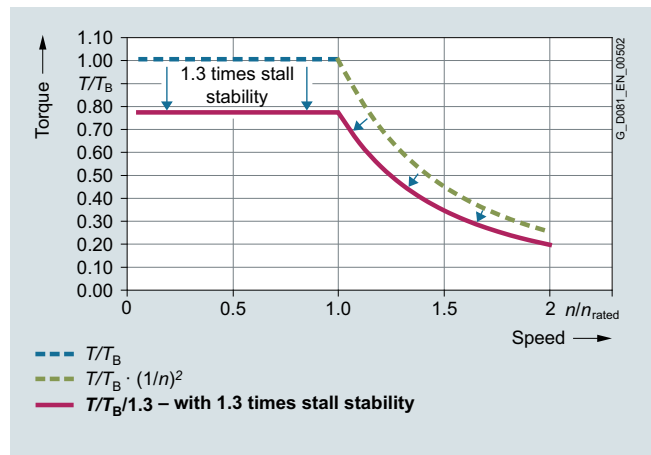

Overload torque characteristic for SIMOTICS GP/SD VSD10 line

Standard induction motors optimized for converter operation – VSD10 line

Orientation

Technical specifications

Additional information

Mechanical stress and grease lifetime

When motors are operated at speeds above the rated speed, the mechanical smooth running operation and the bearings are subjected to greater mechanical stress. This reduces the grease lifetime and the bearing lifetime.

Above 100 Hz, the motors must be balanced for twice the rated frequency.

Motor protection

A motor protection function can be implemented using the Rt sensing function implemented in the converter software. If required, more precise motor protection can be afforded by direct temperature measurement using KTY84 sensors, PTC thermistors, or Pt100/1000 resistance thermometers in the motor winding. Some converters from Siemens determine the motor temperature using the resistance of the temperature sensor. They can be set to a required temperature for alarm and tripping. When ordering PTC thermistors, Pt100 resistance thermistors or other temperature sensors to monitor the cooling temperature, the KTY84 sensors, otherwise provided as standard, are omitted. As described above, KTY84 sensors are evaluated in the SINAMICS converters.

Motor connection

When connecting the motors, it is important to consider the restrictions for 1LE1 line motors as well as the maximum conductor cross-sections permitted for the converter.

Operating data for 50 Hz/60 Hz/87 Hz characteristics

SIMOTICS GP/SD VSD10 line motors are designed for operation with 50 Hz, 60 Hz and 87 Hz characteristics (87 Hz characteristic up to frame size 200).

Operation with the 50/60 Hz characteristic requires Y (star or wye) connection; operation with the 87 Hz characteristic requires Δ connection.

The corresponding power data are stamped on the rating plate as standard. An ordering option is not required.

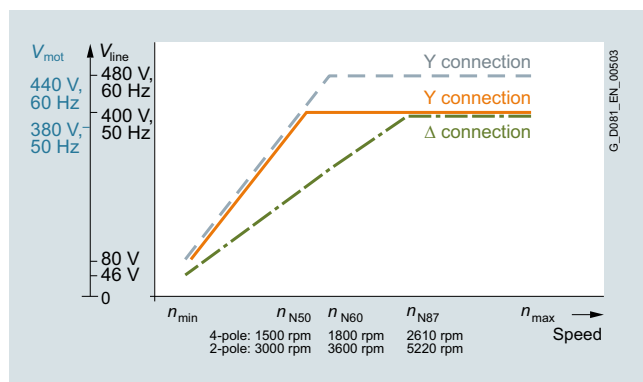

Operating characteristics of SIMOTICS GP/SD VSD10 line motors

Maximum operating speed

The maximum operating speed is limited by the mechanical speed limit of the motors as well as the available converter output frequency.

A significant increase in the sound pressure level can be expected when operating the motor above its rated speed (field weakening range).

Mechanical speed limits SIMOTICS GP/SD VSD10 line:

Frame size	Mechanical speed limits for 1LE1.92 motors	
	2-pole	4-pole
	n_{max} rpm	n_{max} rpm
100	5500	4200
112	5500	4200
132	4500	4200
160	4500	4200
180	4500	4200
200	4500	4200
225	4500	4500
250	3900	3700
280	3600	3000
315	–	2600

International use:

As special converter motors, SIMOTICS GP/SD VSD10 line motors are presently not subject to any minimum efficiency requirements in the EU and USA/Canada. However, other national certificates may be required (e.g. CSA-S safety in Canada).

Therefore, for use in USA, Canada and Mexico, we recommend:

Ordering with order code **D39** (version according to UL and CSA-S).

Note:

At the present time, national Chinese regulations regarding converter motors are being revised. A conclusive interpretation relating to the design still cannot be made. As a consequence, until further notice, for China we recommend that line motors suitable for converter operation are used with CEL (China Energy Label) (e.g. 1LE100. with order code **D34**).

Standard induction motors optimized for converter operation – VSD10 line

Orientation

Technical specifications

Load characteristics for the line supply voltage: 400 V 3 AC, 50 Hz

Rated speed 3000 rpm				SIMOTICS GP/SD VSD10 line motors	SINAMICS G120 converters
Load characteristic $T \sim n^2$					
Speed control range					
	from 1500 rpm 1 : 2	from 750 rpm 1 : 4	from 300 rpm 1 : 10		
P_{max}	P_{max}	P_{max}	P_{max}	Motor type	Converter type
kW	kW	kW	kW		
3	1.47	0.63	0.21	1LE1.92-1AA42-1...	6SL3210-1PE18-0.L1
4	1.97	0.84	0.27	1LE1.92-1BA22-1...	6SL3210-1PE21-1.L0
5.5	2.69	1.17	0.39	1LE1.92-1CA02-1...	6SL3210-1PE21-4.L0
7.5	3.64	1.59	0.54	1LE1.92-1CA12-1...	6SL3210-1PE21-8.L0
11	5.38	2.34	0.79	1LE1.92-1DA22-1...	6SL3210-1PE22-7.L0
15	7.33	3.19	1.08	1LE1.92-1DA32-1...	6SL3210-1PE23-3.L0
18.5	9.05	3.93	1.32	1LE1.92-1DA42-1...	6SL3210-1PE23-8.L0
22	10.77	4.69	1.59	1LE1592-1EA22-1...	6SL3210-1PE24-5.L0
30	14.64	6.37	2.13	1LE1592-2AA42-1...	6SL3210-1PE26-0.L0
37	18.08	7.86	2.66	1LE1592-2AA52-1...	6SL3210-1PE27-5.L0
45	21.99	9.54	3.21	1LE1592-2BA22-1...	6SL3210-1PE28-8.L0
55	26.86	11.65	3.91	1LE1592-2CA22-1...	6SL3210-1PE31-1.L0
75	36.63	15.85	5.33	1LE1592-2DA02-1...	6SL3210-1PE31-5.L0
90	43.91	19.00	6.38	1LE1592-2DA22-1...	6SL3210-1PE31-8.L0

Rated speed 1500 rpm				SIMOTICS GP/SD VSD10 line motors	SINAMICS converters
Load characteristic $T \sim n^2$					
Speed control range					
	from 750 rpm 1:2	from 375 rpm 1:4	from 150 rpm 1:10		
P_{max}	P_{max}	P_{max}	P_{max}	Motor type	Converter type
kW	kW	kW	kW		
2.2	1.06	0.43	0.13	1LE1.92-1AB42-1...	6SL3210-1PE16-1.L1
3	1.45	0.59	0.18	1LE1.92-1AB52-1...	6SL3210-1PE18-0.L1
4	1.93	0.78	0.24	1LE1.92-1BB22-1...	6SL3210-1PE21-1.L0
5.5	2.65	1.07	0.33	1LE1.92-1CB02-1...	6SL3210-1PE21-4.L0
7.5	3.60	1.45	0.45	1LE1.92-1CB22-1...	6SL3210-1PE21-8.L0
11	5.31	2.14	0.66	1LE1.92-1DB22-1...	6SL3210-1PE22-7.L0
15	7.20	2.91	0.90	1LE1.92-1DB42-1...	6SL3210-1PE23-3.L0
18.5	8.94	3.61	1.11	1LE1592-1EB22-1...	6SL3210-1PE23-8.L0
22	10.61	4.29	1.32	1LE1592-1EB42-1...	6SL3210-1PE24-5.L0
30	14.48	5.85	1.80	1LE1592-2AB52-1...	6SL3210-1PE26-0.L0
37	17.89	7.23	2.22	1LE1592-2BB02-1...	6SL3210-1PE27-5.L0
45	21.68	8.76	2.70	1LE1592-2BB22-1...	6SL3210-1PE28-8.L0
55	26.53	10.72	3.30	1LE1592-2CB22-1...	6SL3210-1PE31-1.L0
75	36.15	14.61	4.50	1LE1592-2DB02-1...	6SL3210-1PE31-5.L0
90	43.43	17.55	5.40	1LE1592-2DB22-1...	6SL3210-1PE31-8.L0
106	53.05	21.44	6.60	1LE1592-3AB02-1...	6SL3210-1PE32-1.L0
130	63.66	25.73	7.92	1LE1592-3AB22-1...	6SL3210-1PE32-5.L0
160	77.23	31.21	9.60	1LE1592-3AB42-1...	6SL3224-OXE41-3.A0
200	96.48	38.99	12.00	1LE1592-3AB52-1...	6SL3224-OXE41-6.A0

Note:

The converter recommendation applies to standard ambient conditions (40 °C; 1000 m above sea level).

If, as a result of different ambient conditions, the rated motor power is significantly reduced, under certain circumstances, another converter is the optimum solution. Here, please use the configuration options for converters in the DT Configurator.

Standard induction motors optimized for converter operation – VSD10 line

Orientation

Technical specifications

SIMOTICS GP/SD VSD10 line standard motors for converter operation with converter SINAMICS G120 Power Modules PM240-2

Rated power kW	SIMOTICS GP/SD VSD10 1LE109/1LE159	Frame size	SINAMICS G120 Power Module PM240-2	Pulse fre- quency kHz	Frame size	System power loss, relative $P_{V,rel}$ as a % referred to P_{rated}										IES class acc. to EN 50598-2
						Operating points at partial load ¹⁾					at rated load ¹⁾					
Type	Type	Type	Type	Type	Type	0/25 %	0/50 %	0/100 %	50/25 %	50/50 %	50/100 %	100/50 %	100/100 %			
Line voltage 400 V 3 AC, 50/60 Hz, rated speed 3000 rpm																
3	1LE1.92-1AA42-1...	100 L	6SL3210-1PE18-0.L1	4	FSA	3.433	6.367	17.333	5.4	8.533	21.433	13.567	27.833	IES 1		
4	1LE1.92-1BA22-1...	112 M	6SL3210-1PE21-1.L0	4	FSB	3.775	5.8	14.35	5.65	8.025	17.6	13.375	24.45	IES 1		
5.5	1LE1.92-1CA02-1...	132 S	6SL3210-1PE21-4.L0	4	FSB	3.109	5.218	13.836	4.109	6.564	16.6	10.309	21.6	IES 1		
7.5	1LE1.92-1CA12-1...	132 S	6SL3210-1PE21-8.L0	4	FSB	2.56	4.333	11.587	3.653	5.693	13.84	9.093	18.533	IES 2		
11	1LE1.92-1DA22-1...	160 M	6SL3210-1PE22-7.L0	4	FSC	2.664	4.364	11.2	3.973	5.936	13.845	10.255	19.555	IES 1		
15	1LE1.92-1DA32-1...	160 M	6SL3210-1PE23-3.L0	4	FSC	1.96	3.68	10.227	3.153	5.04	12.693	8.547	17.4	IES 1		
18.5	1LE1592-1DA42-1...	160 L	6SL3210-1PE23-8.L0	4	FSD	2.308	3.649	8.854	3.53	5.022	10.865	8.059	15.07	IES 2		
22	1LE1592-1EA22-1...	180 M	6SL3210-1PE24-5.L0	4	FSD	1.695	3.027	8.345	2.586	4.073	9.741	6.482	13.255	IES 2		
30	1LE1592-2AA42-1...	200 L	6SL3210-1PE26-0.L0	4	FSD	1.33	2.703	7.327	2.233	3.737	8.88	6.233	12.797	IES 2		
37	1LE1592-2AA52-1...	200 L	6SL3210-1PE27-5.L0	4	FSD	1.276	2.3	6.238	2.108	3.276	7.611	5.257	10.678	IES 2		
45	1LE1592-2BA22-1...	225 M	6SL3210-1PE28-8.L0	4	FSE	1.127	2.093	5.749	2.044	3.144	7.016	5.538	10.471	IES 2		
55	1LE1592-2CA22-1...	250 M	6SL3210-1PE31-1.L0	4	FSE	1.056	1.991	5.467	1.869	2.945	6.771	5.396	10.253	IES 2		
75	1LE1592-2DA02-1...	280 S	6SL3210-1PE31-5.L0	4	FSF	1.064	1.847	4.784	2.064	2.971	6.207	5.564	9.799	IES 2		
90	1LE1592-2DA22-1...	280 M	6SL3210-1PE31-8.L0	4	FSF	0.932	1.643	4.241	1.696	2.527	5.473	4.523	8.412	IES 2		
Line voltage 400 V 3 AC, 50/60 Hz, rated speed 1500 rpm																
2.2	1LE1.92-1AB42-1...	100 L	6SL3210-1PE16-1.L1	4	FSA	5.273	8.273	19.273	6.682	10.364	27.682	14.364	32.091	IES 1		
3	1LE1.92-1AB52-1...	100 L	6SL3210-1PE18-0.L1	4	FSA	4.433	7.233	16.4	5.867	9	22.367	12.433	27	IES 1		
4	1LE1.92-1BB22-1...	112 M	6SL3210-1PE21-1.L0	4	FSB	4.45	6.9	16.1	5.675	8.425	20.025	11.5	24.3	IES 1		
5.5	1LE1.92-1CB02-1...	132 S	6SL3210-1PE21-4.L0	4	FSB	3.618	6	15.618	4.764	7.455	18.818	10.545	23.036	IES 1		
7.5	1LE1.92-1CB22-1...	132 M	6SL3210-1PE21-8.L0	4	FSB	3.413	5.24	12.533	4.787	6.84	15.24	10.013	19.733	IES 1		
11	1LE1.92-1DB22-1...	160 M	6SL3210-1PE22-7.L0	4	FSC	3.255	4.918	11.445	4.482	6.355	13.936	9.418	18.336	IES 1		
15	1LE1.92-1DB42-1...	160 L	6SL3210-1PE23-3.L0	4	FSC	2.94	4.387	10.073	4.013	5.627	12.06	8.14	15.8	IES 2		
18.5	1LE1592-1EB22-1...	180 M	6SL3210-1PE23-8.L0	4	FSD	2.205	3.665	9.092	3.465	5.076	11.292	7.514	14.843	IES 2		
22	1LE1592-1EB42-1...	180 L	6SL3210-1PE24-5.L0	4	FSD	2.232	3.527	8.5	3.1	4.545	10.145	6.15	12.841	IES 2		
30	1LE1592-2AB52-1...	200 L	6SL3210-1PE26-0.L0	4	FSD	1.99	3.167	7.903	2.877	4.197	9.32	6.06	12.26	IES 2		
37	1LE1592-2BB02-1...	225 S	6SL3210-1PE27-5.L0	4	FSD	1.53	2.635	6.938	2.551	3.797	8.568	6.051	11.924	IES 2		
45	1LE1592-2BB22-1...	225 M	6SL3210-1PE28-8.L0	4	FSE	1.413	2.493	6.644	2.291	3.504	8.053	5.447	10.982	IES 2		
55	1LE1592-2CB22-1...	250 M	6SL3210-1PE31-1.L0	4	FSE	1.298	2.427	7.129	2.104	3.36	8.082	5.3	11.051	IES 2		
75	1LE1592-2DB02-1...	280 S	6SL3210-1PE31-5.L0	4	FSF	1.317	2.135	5.216	2.441	3.373	6.811	5.909	10.315	IES 2		
90	1LE1592-2DB22-1...	280 M	6SL3210-1PE31-8.L0	4	FSF	1.224	2.033	5.132	2.002	2.92	6.357	4.579	8.95	IES 2		
106	1LE1592-3AB02-1...	315 S	6SL3210-1PE32-1.L0	2	FSF	1.021	1.711	4.398	1.959	2.765	5.781	4.811	8.863	IES 2		
130	1LE1592-3AB22-1...	315 M	6SL3210-1PE32-5.L0	2	FSF	0.947	1.543	3.828	1.754	2.468	5.094	4.256	7.9	IES 2		
160	1LE1592-3AB42-1...	315 L	6SL3224-OXE41-3.A0	2	FSGX	1.343	1.981	4.441	2.224	2.974	5.771	4.762	8.614	IES 2		
200	1LE1592-3AB52-1...	315 L	6SL3224-OXE41-6.A0	2	FSGX	1.149	1.879	4.737	1.871	2.703	5.838	4.154	8.251	IES 2		

¹⁾ Output frequency, rel. [%] referred to the rated speed/
Torque, rel. [%] referred to the rated torque T_{rated}

Standard induction motors optimized for converter operation – VSD10 line

Orientation

Article number code

Selection and ordering data

The article number consists of a combination of digits and letters and is divided into three hyphenated blocks to provide a better overview, e.g.:

**1LE1592-1DB42-1GF4-Z
H00**

The first block (positions 1 to 7) identifies the motor type. The second block (positions 8 to 12) defines the motor frame size and length, the number of poles and power and in some cases the frequency/voltage. In the third block (positions 13 to 16), the frequency/voltage, type of construction and further design features are encoded.

For deviations in the second and third block from the catalog codes either **Z** or **90** should be used as appropriate.

Ordering data:

- Complete Article No. and order code(s) or plain text
- If a quotation has been requested, please specify the quotation number in addition to the Article No.
- When ordering a complete motor as a spare part, please specify the works serial No. for the previously supplied motor as well as the Article No.

Structure of the Article No.:		Position:	1	2	3	4	5	6	7	-	8	9	10	11	12	-	13	14	15	16	
1st to 4th position: Digit, letter, letter, digit	Self-ventilated by fan mounted on and driven by the rotor		1	L	E	1															
5th position: Digit	SIMOTICS GP – aluminum housing SIMOTICS SD – cast-iron housing						0 5														
6th position: Digit	VSD10 line motor (motor for converter operation)							9													
7th position: Digit	Standard efficiency class								2												
8th and 9th position: Digit, letter	Motor frame size (frame size as a combination of shaft height and overall length, encoded)										1 ...	A ...									
10th position: Letter	No. of poles A: 2-pole B: 4-pole												A B								
11th position: Digit	Laminated core length												0 1 2 3 4 5								
12th and 13th position: 2 digits	Voltage and frequency ¹⁾ 380 V 3 AC, 50 Hz/440 V 3 AC, 60 Hz/380 V 3 AC, 87Hz 480 V 3 AC, 50 Hz/550 V 3 AC, 60 Hz/480 V 3 AC, 87Hz 660 V 3 AC, 50 Hz/660 V 3 AC, 87 Hz Non-standard winding, requires order code M.. (e.g. M1Y)												2 2 3 9		1 6 3 0						
14th position: Letter	Type of construction (encoded with A ... V)																	A ...	V		
15th position: Letter	Motor protection (encoded with B ... Z; Z requires order code Q.. (e.g. Q3A); F = standard version with integrated KTY 84 temperature sensor)																		B ...	Z	
16th position: Digit	Terminal box position 4: Terminal box top (normal version), 5: Terminal box right, 6: Terminal box left																			4 ...	
	Special order versions: encoded – additional order code required not encoded – additional plain text required																				- Z

¹⁾ Depending on slip, the rated frequency is above 50 Hz, 60 Hz, or 87 Hz (see Technical specifications).

Standard induction motors optimized for converter operation – VSD10 line

Orientation

Article number code

Selection and ordering data

Ordering example:

Selection criteria	Requirement	Structure of the Article No.
Motor type 1LE1	Standard motor for converter operation SIMOTICS GP VSD10 line, aluminum version	1LE1092-■■■■■-■■■■■
Motor frame size	160 L	1LE1092-1DB■■■-■■■■■
No. of poles	4-pole	1LE1092-1DB4■-■■■■■
Rated power	$P_{\text{rated } 50}$: 15 kW $P_{\text{rated } 60}$: 17.3 kW $P_{\text{rated } 87}$: 23.5 kW	
Voltage and frequency	380 V 3 AC, 50 Hz/440 V 3 AC, 60 Hz/380 V 3 AC, 87 Hz	1LE1092-1DB42-1■■■■■
Type of construction with special version	IM V5 with protective cover ¹⁾	1LE1092-1DB42-1C■■■-Z H00
Motor protection	Motor protection with PTC thermistors with 1 or 3 embedded temperature sensors for tripping	1LE1092-1DB42-1CB■-Z H00
Terminal box position	Terminal box right (viewed from DE)	1LE1092-1DB42-1CB5-Z H00

¹⁾ Standard without protective cover – the protective cover is defined with order code **H00** and must be ordered in addition to the Article No. with **-Z** and this order code.

Standard induction motors optimized for converter operation – VSD10 line

Standard Efficiency

Aluminum series SIMOTICS GP 1LE1092, line voltage 400 V, 50 Hz/460 V, 60 Hz/400 V, 87 Hz – self-ventilated

Selection and ordering data

$P_{\text{rated, 50 Hz}}$ 400 V	$P_{\text{rated, 60 Hz}}$ 460 V	$P_{\text{rated, 87 Hz}}$ 400 V	Frame size	Connection	Operating values at rated power				I_{rated}	1LE1092 aluminum series Version specifically for converter operation
					f_{rated}	T_{rated}	$\eta_{\text{rated, 4/4}}$ for converter operation	$\cos\phi_{\text{rated, 4/4}}$		
kW	kW	kW			Hz	Nm	%	A	Article No.	
<ul style="list-style-type: none"> Insulation: Thermal class 155 (temperature class F), IP55 degree of protection, utilization in accordance with thermal class 155 (temperature class F) Operation with a SINAMICS G converter with uncontrolled infeed – rated motor voltage 380 V, 50 Hz/440 V, 60 Hz/380 V, 87 Hz 										
3000 rpm	3600 rpm	5220 rpm	2-pole							
3			100 L	Y	52.9	9.6	81.5	0.87	6.4	1LE1092-1AA42-1 ■■■
	3.45			Y	62.8	9.2	84.5	0.88	6.1	
		4.5		Δ	89.4	8.2	84.5	0.82	9.9	
4			112 M	Y	51.2	12.7	83.1	0.86	8.5	1LE1092-1BA22-1 ■■■
	4.55			Y	61.2	12.1	84.5	0.88	8	
		6.6		Δ	88.2	12.1	84.5	0.83	14.2	
5.5			132 S	Y	51.4	17.5	84.7	0.89	11.1	1LE1092-1CA02-1 ■■■
	6.3			Y	61.4	16.7	86.0	0.90	10.7	
7.5			132 S	Y	51.2	23.9	86.0	0.87	15.2	1LE1092-1CA12-1 ■■■
	8.6			Y	61.2	22.8	88.7	0.88	14.7	
11			160 M	Y	51.3	35.0	87.6	0.85	22.5	1LE1092-1DA22-1 ■■■
	12.6			Y	61.2	33.4	87.5	0.86	22	
15			160 M	Y	51.4	47.8	88.7	0.84	30.5	1LE1092-1DA32-1 ■■■
	17.3			Y	61.4	45.9	89.5	0.86	29.5	
18.5			160 L	Y	51.1	58.9	89.3	0.86	36.5	1LE1092-1DA42-1 ■■■
	21.3			Y	61.1	56.5	89.5	0.87	36	
1500 rpm	1800 rpm	2610 rpm	4-pole							
2.2			100 L	Y	52.9	14.0	79.7	0.81	5.2	1LE1092-1AB42-1 ■■■
	2.55			Y	62.8	13.5	83.0	0.82	4.9	
		3.7		Δ	89.3	13.5	83.0	0.79	8.6	
3			100 L	Y	52.7	19.1	81.5	0.85	6.6	1LE1092-1AB52-1 ■■■
	3.45			Y	62.6	18.3	85.0	0.86	6.2	
		5		Δ	89.3	18.3	85.0	0.79	11.3	
4			112 M	Y	52.3	25.5	83.1	0.85	8.6	1LE1092-1BB22-1 ■■■
	4.55			Y	62.2	24.0	85.0	0.85	8.3	
		6.6		Δ	89.0	24.0	85.0	0.81	14.6	
5.5			132 S	Y	52.1	35.0	84.7	0.82	12	1LE1092-1CB02-1 ■■■
	6.3			Y	62.0	33.5	87.0	0.84	11.3	
		9		Δ	88.8	33.0	87.0	0.81	19.4	
7.5			132 M	Y	51.7	47.5	86.0	0.82	16.2	1LE1092-1CB22-1 ■■■
	8.6			Y	61.7	45.5	87.5	0.84	15.4	
		12.5		Δ	88.8	45.5	87.5	0.80	27.1	
11			160 M	Y	51.5	70.0	87.6	0.82	23.5	1LE1092-1DB22-1 ■■■
	12.6			Y	61.4	67.0	88.5	0.82	23	
		17		Δ	88.3	62.0	88.5	0.78	37.5	
15			160 L	Y	51.4	95.0	88.7	0.82	31.5	1LE1092-1DB42-1 ■■■
	17.3			Y	61.4	92.0	90.5	0.82	30.5	
		23.5		Δ	88.2	86.0	90.5	0.77	51	

For versions, see Article No. supplements and special versions.

All technical specifications refer to converter operation.

Standard induction motors optimized for converter operation – VSD10 line

Standard Efficiency

Aluminum series SIMOTICS GP 1LE1092, line voltage 400 V, 50 Hz/460 V, 60 Hz/400 V, 87 Hz – self-ventilated

Motor type	$m_{IM\ B3}$	J	L_{pfA} , tolerance +3 dB(A) load	L_{WA} , tolerance +3 dB(A) load	Mech. speed limit	Terminal box	Preferred SINAMICS G120 – PM240(-2) Other SINAMICS converters also possible Operating mode: Low overload Type ¹⁾	Frame size	IES class acc. to EN 50598-2
	kg	kgm ²	dB(A)	dB(A)	rpm				
1LE1092-1AA42-1...	20	0.0034	79.0	91.1	5500	TB1F00	6SL3210-1PE18-0.L1	FSA	IES 1
	20	0.0034	79.0	91.1	5500		6SL3210-1PE18-0.L1	FSA	IES 1
	20	0.0034	83.0	95.1	5500		6SL3210-1PE21-4.L0	FSB	IES 1
1LE1092-1BA22-1...	25	0.0067	78.0	90.1	5500	TB1F00	6SL3210-1PE21-1.L0	FSB	IES 1
	25	0.0067	78.0	90.1	5500		6SL3210-1PE21-1.L0	FSB	IES 1
	25	0.0067	83.0	95.2	5500		6SL3210-1PE21-8.L0	FSB	IES 1
1LE1092-1CA02-1...	35	0.013	76.0	88.3	4500	TB1F00	6SL3210-1PE21-4.L0	FSB	IES 1
	35	0.013	76.0	88.3	4500		6SL3210-1PE21-4.L0	FSB	IES 1
1LE1092-1CA12-1...	40	0.016	76.0	88.4	4500	TB1H00	6SL3210-1PE21-8.L0	FSB	IES 2
	40	0.016	76.0	88.4	4500		6SL3210-1PE21-8.L0	FSB	IES 2
1LE1092-1DA22-1...	60	0.03	79.0	91.4	4500	TB1H00	6SL3210-1PE22-7.L0	FSC	IES 1
	60	0.03	78.0	90.4	4500		6SL3210-1PE22-7.L0	FSC	IES 1
1LE1092-1DA32-1...	68	0.036	79.0	91.8	4500	TB1J00	6SL3210-1PE23-3.L0	FSC	IES 1
	68	0.036	78.0	90.8	4500		6SL3210-1PE23-3.L0	FSC	IES 1
1LE1092-1DA42-1...	78	0.044	79.0	91.8	4500	TB1J00	6SL3210-1PE23-8.L0	FSD	IES 2
	78	0.044	78.0	90.8	4500		6SL3210-1PE23-8.L0	FSD	IES 2
1LE1092-1AB42-1...	15	0.0059	79.0	91.0	4200	TB1F00	6SL3210-1PE16-1.L1	FSA	IES 1
	15	0.0059	79.0	91.0	4200		6SL3210-1PE16-1.L1	FSA	IES 1
	15	0.0059	81.0	93.0	4200		6SL3210-1PE21-1.L0	FSB	IES 1
1LE1092-1AB52-1...	21	0.0078	79.0	91.0	4200	TB1F00	6SL3210-1PE18-0.L1	FSA	IES 1
	21	0.0078	79.0	91.0	4200		6SL3210-1PE18-0.L1	FSA	IES 1
	21	0.0078	81.0	93.0	4200		6SL3210-1PE21-4.L0	FSB	IES 1
1LE1092-1BB22-1...	27	0.01	77.4	89.4	4200	TB1F00	6SL3210-1PE21-1.L0	FSB	IES 1
	27	0.01	77.2	89.2	4200		6SL3210-1PE21-1.L0	FSB	IES 1
	27	0.01	78.4	90.4	4200		6SL3210-1PE21-8.L0	FSB	IES 1
1LE1092-1CB02-1...	39	0.019	76.0	88.0	4200	TB1H00	6SL3210-1PE21-4.L0	FSB	IES 1
	39	0.019	76.0	88.0	4200		6SL3210-1PE21-4.L0	FSB	IES 1
	39	0.019	83.0	95.0	4200		6SL3210-1PE22-7.L0	FSC	IES 1
1LE1092-1CB22-1...	43	0.024	76.0	88.0	4200	TB1H00	6SL3210-1PE21-8.L0	FSB	IES 1
	43	0.024	76.0	88.0	4200		6SL3210-1PE21-8.L0	FSB	IES 1
	43	0.024	83.0	95.0	4200		6SL3210-1PE23-3.L0	FSC	IES 1
1LE1092-1DB22-1...	67	0.044	83.5	95.5	4200	TB1J00	6SL3210-1PE22-7.L0	FSC	IES 1
	67	0.044	82.3	94.3	4200		6SL3210-1PE22-7.L0	FSC	IES 1
	67	0.044	85.8	97.8	4200		6SL3210-1PE24-5.L0	FSD	IES 1
1LE1092-1DB42-1...	75	0.056	83.5	95.5	4200	TB1J00	6SL3210-1PE23-3.L0	FSC	IES 2
	75	0.056	82.3	94.3	4200		6SL3210-1PE23-3.L0	FSC	IES 2
	75	0.056	85.8	97.8	4200		6SL3210-1PE26-0.L0	FSD	IES 2

¹⁾ In addition to the Power Module, a Control Unit and an Operator Panel are required (see Catalog D 31 and/or D 35).

Standard induction motors optimized for converter operation – VSD10 line

Standard Efficiency

Aluminum series SIMOTICS GP 1LE1092, line voltage 500 V, 50 Hz/575 V, 60 Hz/500 V, 87 Hz – self-ventilated

Selection and ordering data

$P_{\text{rated, 50 Hz}}$ 500 V	$P_{\text{rated, 60 Hz}}$ 575 V	$P_{\text{rated, 87 Hz}}$ 500 V	Frame size	Connection	Operating values at rated power				I_{rated}	1LE1092 aluminum series Version specifically for converter operation
					f_{rated}	T_{rated}	$\eta_{\text{rated, 4/4}}$ for converter operation	$\cos\phi_{\text{rated, 4/4}}$		
kW	kW	kW			Hz	Nm	%	A	Article No.	
<ul style="list-style-type: none"> Insulation: Thermal class 155 (temperature class F), IP55 degree of protection, utilization in accordance with thermal class 155 (temperature class F) Operation with a SINAMICS G converter with uncontrolled infeed – rated motor voltage 480 V, 50 Hz/550 V, 60 Hz/480 V, 87 Hz 										
3000 rpm	3600 rpm	5220 rpm	2-pole							
3			100 L	Y	52.9	9.6	81.5	0.87	5.1	1LE1092-1AA42-6 ■■■
	3.45			Y	63.0	9.2	84.5	0.88	4.85	
		5		Δ	89.6	9.1	84.5	0.85	8.4	
4			112 M	Y	51.3	12.7	83.1	0.86	6.7	1LE1092-1BA22-6 ■■■
	4.55			Y	61.3	12.1	84.5	0.88	6.4	
		6.6		Δ	88.2	12.1	84.5	0.84	11.1	
5.5			132 S	Y	51.6	17.5	84.7	0.89	8.8	1LE1092-1CA02-6 ■■■
	6.3			Y	61.6	16.7	86.0	0.90	8.5	
7.5			132 S	Y	51.2	23.9	86.0	0.87	12.1	1LE1092-1CA12-6 ■■■
	8.6			Y	61.2	22.8	88.7	0.88	11.7	
11.0			160 M	Y	51.3	35.0	87.6	0.85	17.8	1LE1092-1DA22-6 ■■■
	12.6			Y	61.3	33.4	87.5	0.86	17.6	
14			160 M	Y	51.1	44.6	88.7	0.84	22.5	1LE1092-1DA32-6 ■■■
	16.5			Y	61.2	43.8	89.5	0.86	22.5	
17			160 L	Y	51.1	54.1	89.3	0.85	27	1LE1092-1DA42-6 ■■■
	19.5			Y	61.1	51.7	89.5	0.86	26.5	
1500 rpm	1800 rpm	2610 rpm	4-pole							
2.2			100 L	Y	52.8	14.0	79.7	0.81	4.1	1LE1092-1AB42-6 ■■■
	2.55			Y	62.8	13.5	83.0	0.82	3.95	
		3.7		Δ	89.6	13.5	83.0	0.79	6.8	
3			100 L	Y	52.6	19.1	81.5	0.85	5.2	1LE1092-1AB52-6 ■■■
	3.45			Y	62.6	18.3	85.0	0.86	4.95	
		5		Δ	89.3	18.3	85.0	0.79	8.7	
4			112 M	Y	52.4	25.5	83.1	0.85	6.8	1LE1092-1BB22-6 ■■■
	4.55			Y	62.3	24.1	85.0	0.85	6.6	
		6.6		Δ	89.1	24.1	85.0	0.81	12	
5.5			132 S	Y	52.0	35.0	84.7	0.82	9.5	1LE1092-1CB02-6 ■■■
	6.3			Y	62.0	33.4	87.0	0.84	9	
		9		Δ	88.8	32.9	87.0	0.81	15.4	
7.5			132 M	Y	51.9	47.8	86.0	0.82	12.8	1LE1092-1CB22-6 ■■■
	8.6			Y	61.9	45.6	87.5	0.84	12.3	
		12.5		Δ	88.7	45.7	87.5	0.80	21.5	
11			160 M	Y	51.5	70.0	87.6	0.82	18.4	1LE1092-1DB22-6 ■■■
	12.6			Y	61.5	66.9	88.5	0.82	18.2	
		17		Δ	88.4	62.2	88.5	0.78	29.5	
13.5			160 L	Y	51.2	86.0	88.7	0.79	23	1LE1092-1DB42-6 ■■■
	15.6			Y	61.2	82.8	90.5	0.81	22.5	
		23.5		Δ	88.3	86.0	90.5	0.77	40.5	

For versions, see Article No. supplements and special versions.

All technical specifications refer to converter operation.



Standard induction motors optimized for converter operation – VSD10 line

Standard Efficiency

Aluminum series SIMOTICS GP 1LE1092, line voltage 500 V, 50 Hz/575 V, 60 Hz/500 V, 87 Hz – self-ventilated

Motor type	m_{IMB3} kg	J kgm ²	L_{pFA} , tolerance +3 dB(A) load dB(A)	L_{WA} , tolerance +3 dB(A) load dB(A)	Mech. speed limit rpm	Terminal box	Preferred SINAMICS G120 – PM240(-2) Other SINAMICS converters also possible Operating mode: Low overload Type ¹⁾	Frame size	IES class acc. to EN 50598-2
1LE1092-1AA42-6...	20	0.0034	80.0	92.1	5500	TB1F00			
	20	0.0034	80.0	92.1	5500				
	20	0.0034	85.0	92.1	5500				
1LE1092-1BA22-6...	25	0.0067	79.0	91.1	5500	TB1F00			
	25	0.0067	79.0	91.1	5500				
	25	0.0067	85.0	91.1	5500		6SL3210-1PH21-4.L0	FSD	
1LE1092-1CA02-6...	35	0.013	77.0	89.3	4500	TB1F00	6SL3210-1PH21-4.L0	FSD	
	35	0.013	77.0	89.3	4500		6SL3210-1PH21-4.L0	FSD	
1LE1092-1CA12-6...	40	0.016	77.0	89.4	4500	TB1H00	6SL3210-1PH21-4.L0	FSD	
	40	0.016	77.0	89.4	4500		6SL3210-1PH21-4.L0	FSD	
1LE1092-1DA22-6...	60	0.03	80.0	92.4	4500	TB1H00	6SL3210-1PH22-0.L0	FSD	
	60	0.03	80.0	92.4	4500		6SL3210-1PH22-0.L0	FSD	
1LE1092-1DA32-6...	68	0.036	80.0	92.8	4500	TB1J00	6SL3210-1PH22-3.L0	FSD	
	68	0.036	80.0	92.8	4500		6SL3210-1PH22-3.L0	FSD	
1LE1092-1DA42-6...	78	0.044	80.0	92.8	4500	TB1J00	6SL3210-1PH22-7.L0	FSD	
	78	0.044	80.0	92.8	4500		6SL3210-1PH22-7.L0	FSD	
1LE1092-1AB42-6...	18	0.0059	80.0	92.1	4200	TB1F00			
	18	0.0059	80.0	92.1	4200				
	18	0.0059	81.0	93.1	4200				
1LE1092-1AB52-6...	22	0.0078	80.0	92.1	4200	TB1F00			
	22	0.0078	80.0	92.1	4200				
	22	0.0078	81.0	93.1	4200				
1LE1092-1BB22-6...	27	0.01	79.0	91.3	4200	TB1F00			
	27	0.01	79.0	91.3	4200				
	27	0.01	80.0	92.3	4200		6SL3210-1PH21-4.L0	FSD	
1LE1092-1CB02-6...	38	0.019	77.0	89.4	4200	TB1H00	6SL3210-1PH21-4.L0	FSD	
	38	0.019	77.0	89.4	4200		6SL3210-1PH21-4.L0	FSD	
	38	0.019	83.0	95.4	4200		6SL3210-1PH22-0.L0	FSD	
1LE1092-1CB22-6...	44	0.024	77.0	89.4	4200	TB1H00	6SL3210-1PH21-4.L0	FSD	
	44	0.024	77.0	89.4	4200		6SL3210-1PH21-4.L0	FSD	
	44	0.024	83.0	95.4	4200		6SL3210-1PH22-3.L0	FSD	
1LE1092-1DB22-6...	62	0.044	85.0	97.8	4200	TB1J00	6SL3210-1PH22-0.L0	FSD	
	62	0.044	85.0	97.8	4200		6SL3210-1PH22-0.L0	FSD	
	62	0.044	85.0	97.8	4200		6SL3210-1PH23-5.L0	FSD	
1LE1092-1DB42-6...	73	0.056	85.0	97.8	4200	TB1J00	6SL3210-1PH22-3.L0	FSD	
	73	0.056	85.0	97.8	4200		6SL3210-1PH22-3.L0	FSD	
	73	0.056	85.0	97.8	4200		6SL3210-1PH24-2.L0	FSD	

¹⁾ In addition to the Power Module, a Control Unit and an Operator Panel are required (see Catalog D 31 and/or D 35).

Standard induction motors optimized for converter operation – VSD10 line

Standard Efficiency

Aluminum series SIMOTICS GP 1LE1092, line voltage 690 V, 50 Hz/690 V, 87 Hz – self-ventilated

Selection and ordering data

$P_{\text{rated, 50 Hz, 690 V}}$	$P_{\text{rated, 60 Hz}}$	$P_{\text{rated, 87 Hz, 690 V}}$	Frame size	Connection	Operating values at rated power					Article No.
					f_{rated}	T_{rated}	$\eta_{\text{rated, 4/4}}$ for converter operation	$\cos\varphi_{\text{rated, 4/4}}$	I_{rated}	
kW	kW	kW			Hz	Nm	%		A	
<ul style="list-style-type: none"> Insulation: Thermal class 155 (temperature class F), IP55 degree of protection, utilization in accordance with thermal class 155 (temperature class F) Operation with a SINAMICS G converter with uncontrolled infeed – rated motor voltage 660 V/50 Hz/660 V, 87 Hz 										
3000 rpm	3600 rpm	5220 rpm	2-pole							
3			100 L	Y	52.7	9.6	81.5	0.87	3.7	1LE1092-1AA43-3 ■■■
	5			Δ	89.5	9.1	84.5	0.81	6.4	
4			112 M	Y	51.2	12.7	83.1	0.86	4.9	1LE1092-1BA23-3 ■■■
	6.6			Δ	88.2	12.1	84.5	0.83	8.2	
5.5			132 S	Y	51.6	17.5	84.7	0.89	6.4	1LE1092-1CA03-3 ■■■
7.5			132 S	Y	51.2	23.9	86.0	0.87	8.8	1LE1092-1CA13-3 ■■■
11			160 M	Y	51.3	35.0	87.6	0.85	12.9	1LE1092-1DA23-3 ■■■
15			160 M	Y	51.4	47.8	88.7	0.84	17.6	1LE1092-1DA33-3 ■■■
18.5			160 L	Y	51.3	58.9	89.3	0.86	20.5	1LE1092-1DA43-3 ■■■
1500 rpm	1800 rpm	2610 rpm	4-pole							
2.2			100 L	Y	52.9	14.0	79.7	0.81	3	1LE1092-1AB43-3 ■■■
	3.7			Δ	89.5	13.5	83.0	0.79	4.95	
3			100 L	Y	52.5	19.1	81.5	0.85	3.8	1LE1092-1AB53-3 ■■■
	5			Δ	89.5	18.3	85.0	0.79	6.5	
4			112 M	Y	52.5	25.5	83.1	0.85	5	1LE1092-1BB23-3 ■■■
	6.6			Δ	89.2	24.1	85.0	0.81	8.4	
5.5			132 S	Y	52.0	35.0	84.7	0.82	6.9	1LE1092-1CB03-3 ■■■
	9			Δ	88.7	32.9	87.0	0.81	11.2	
7.5			132 M	Y	51.7	47.8	86.0	0.82	9.3	1LE1092-1CB23-3 ■■■
	12.5			Δ	88.6	45.7	87.5	0.80	15.6	
11			160 M	Y	51.5	70.0	87.6	0.82	13.4	1LE1092-1DB23-3 ■■■
	17			Δ	88.3	62.2	88.5	0.78	21.5	
15			160 L	Y	51.4	95.5	88.7	0.82	18	1LE1092-1DB43-3 ■■■
	23.5			Δ	88.2	86.0	90.5	0.77	29.5	

For versions, see Article No. supplements and special versions. ■■■

All technical specifications refer to converter operation.

Standard induction motors optimized for converter operation – VSD10 line

Standard Efficiency

Aluminum series SIMOTICS GP 1LE1092, line voltage 690 V, 50 Hz/690 V, 87 Hz – self-ventilated

Motor type	$m_{IM B3}$ kg	J kgm ²	L_{pA} , tolerance +3 dB(A) load dB(A)	L_{WA} , tolerance +3 dB(A) load dB(A)	Mech. speed limit rpm	Terminal box	Preferred SINAMICS G120 – PM240(-2) Other SINAMICS converters also possible Operating mode: Low overload Type ¹⁾	Frame size	IES class acc. to EN 50598-2
1LE1092-1AA43-3...	20	0.0034	80.0	92.1	5500	TB1F00			
	20	0.0034	85.0	97.1	5500				
1LE1092-1BA23-3...	25	0.0067	79.0	91.1	5500	TB1F00			
	25	0.0067	85.0	97.2	5500		6SL3210-1PH21-4.L0	FSD	
1LE1092-1CA03-3...	35	0.013	77.0	89.3	4500	TB1F00	6SL3210-1PH21-4.L0	FSD	
1LE1092-1CA13-3...	40	0.016	77.0	89.4	4500	TB1H00	6SL3210-1PH21-4.L0	FSD	
1LE1092-1DA23-3...	60	0.03	80.0	92.4	4500	TB1H00	6SL3210-1PH21-4.L0	FSD	
1LE1092-1DA33-3...	68	0.036	80.0	92.8	4500	TB1J00	6SL3210-1PH22-0.L0	FSD	
1LE1092-1DA43-3...	78	0.044	80.0	92.8	4500	TB1J00	6SL3210-1PH22-3.L0	FSD	
1LE1092-1AB43-3...	18	0.0059	80.0	92.1	4200	TB1F00			
	18	0.0059	81.0	93.1	4200				
1LE1092-1AB53-3...	22	0.0078	80.0	92.1	4200	TB1F00			
	22	0.0078	81.0	93.1	4200				
1LE1092-1BB23-3...	27	0.01	79.0	91.3	4200	TB1F00			
	27	0.01	80.0	92.3	4200		6SL3210-1PH21-4.L0	FSD	
1LE1092-1CB03-3...	38	0.019	77.0	89.4	4200	TB1H00	6SL3210-1PH21-4.L0	FSD	
	38	0.019	83.0	95.4	4200		6SL3210-1PH21-4.L0	FSD	
1LE1092-1CB23-3...	44	0.024	77.0	89.4	4200	TB1H00	6SL3210-1PH21-4.L0	FSD	
	44	0.024	83.0	95.4	4200		6SL3210-1PH22-0.L0	FSD	
1LE1092-1DB23-3...	62	0.044	85.0	97.8	4200	TB1J00	6SL3210-1PH21-4.L0	FSD	
	62	0.044	85.0	97.8	4200		6SL3210-1PH22-7.L0	FSD	
1LE1092-1DB43-3...	73	0.056	85.0	97.8	4200	TB1J00	6SL3210-1PH22-0.L0	FSD	
	73	0.056	85.0	97.8	4200		6SL3210-1PH23-5.L0	FSD	

¹⁾ In addition to the Power Module, a Control Unit and an Operator Panel are required (see Catalog D 31 and/or D 35).

Standard induction motors optimized for converter operation – VSD10 line

Standard Efficiency

Cast-iron series SIMOTICS SD 1LE1592, line voltage 400 V, 50 Hz/460 V, 60 Hz/400 V, 87 Hz – self-ventilated

Selection and ordering data

$P_{\text{rated, 50 Hz}}$ 400 V	$P_{\text{rated, 60 Hz}}$ 460 V	$P_{\text{rated, 87 Hz}}$ 400 V	Frame size	Connection	Operating values at rated power					1LE1592 cast-iron series Version specifically for converter operation
					f_{rated}	T_{rated}	$\eta_{\text{rated, 4/4}}$ for converter operation	$\cos\phi_{\text{rated, 4/4}}$	I_{rated}	
kW	kW	kW			Hz	Nm	%		A	
<ul style="list-style-type: none"> Insulation: Thermal class 155 (temperature class F), IP55 degree of protection, utilization in accordance with thermal class 155 (temperature class F) Operation with a SINAMICS G converter with uncontrolled infeed – rated motor voltage 380 V, 50 Hz/440 V, 60 Hz/380 V, 87 Hz 										
3000 rpm	3600 rpm	5220 rpm	2-pole							
3			100 L	Y	52.9	9.6	81.5	0.87	6.4	1LE1592-1AA42-1 ■■■
	3.45			Y	62.8	9.2	84.5	0.88	6.1	
		4.5		Δ	89.4	8.2	84.5	0.82	9.9	
4.0			112 M	Y	51.2	12.7	83.1	0.86	8.5	1LE1592-1BA22-1 ■■■
	4.6			Y	61.2	12.1	84.5	0.88	8	
		6.6		Δ	88.2	12.1	84.5	0.83	14.2	
5.5			132 S	Y	51.4	17.5	84.7	0.89	11.1	1LE1592-1CA02-1 ■■■
	6.3			Y	61.4	16.7	86.0	0.90	10.7	
7.5			132 S	Y	51.2	23.9	86.0	0.87	15.2	1LE1592-1CA12-1 ■■■
	8.6			Y	61.2	22.8	88.7	0.88	14.7	
11			160 M	Y	51.3	35.0	87.6	0.85	22.5	1LE1592-1DA22-1 ■■■
	12.6			Y	61.2	33.4	87.5	0.86	22	
15.0			160 M	Y	51.4	47.8	88.7	0.84	30.5	1LE1592-1DA32-1 ■■■
	17.3			Y	61.4	45.9	89.5	0.86	29.5	
18.5			160 L	Y	51.1	58.9	89.3	0.86	36.5	1LE1592-1DA42-1 ■■■
	21.3			Y	61.1	56.5	89.5	0.87	36	
22			180 M	Y	51.0	70	89.9	0.87	42.5	1LE1592-1EA22-1 ■■■
	24.5			Y	60.9	65.0	89.5	0.87	41.5	
30			200 L	Y	50.9	96	90.7	0.84	60	1LE1592-2AA42-1 ■■■
	33.5			Y	60.9	88.9	91.5	0.84	57	
37			200 L	Y	50.8	118	91.2	0.88	70	1LE1592-2AA52-1 ■■■
	41.5			Y	60.7	110.1	91.7	0.89	67	
45			225 M	Y	50.7	143	91.7	0.88	85	1LE1592-2BA22-1 ■■■
	51			Y	60.7	135.0	92.4	0.88	82	
55			250 M	Y	50.6	175	92.1	0.88	103	1LE1592-2CA22-1 ■■■
	62			Y	60.6	164.0	92.4	0.88	100	
75			280 S	Y	50.5	239	92.7	0.87	141	1LE1592-2DA02-1 ■■■
	84			Y	60.5	223.0	93.0	0.87	136	
90			280 M	Y	50.4	286	93.0	0.88	167	1LE1592-2DA22-1 ■■■
	101			Y	60.4	268	93.0	0.88	162	

For versions, see Article No. supplements and special versions. ■■■

All technical specifications refer to converter operation.

Standard induction motors optimized for converter operation – VSD10 line

Standard Efficiency

Cast-iron series SIMOTICS SD 1LE1592, line voltage 400 V, 50 Hz/460 V, 60 Hz/400 V, 87 Hz – self-ventilated

Motor type	m_{IMB3} kg	J kgm ²	L_{pA} , tolerance +3 dB(A) load dB(A)	L_{WA} , tolerance +3 dB(A) load dB(A)	Mech. speed limit rpm	Terminal box	Preferred SINAMICS G120 – PM240(-2) Other SINAMICS converters also possible Operating mode: Low overload Type ¹⁾	Frame size	IES class acc. to EN 50598-2
1LE1592-1AA42-1...	31	0.0034	79.0	91.1	5500	TB1F01	6SL3210-1PE18-0.L1	FSA	IES 1
	31	0.0034	79.0	91.1	5500		6SL3210-1PE18-0.L1		
	31	0.0034	83.0	95.1	5500		6SL3210-1PE21-4.L0		
1LE1592-1BA22-1...	36	0.0067	78.0	90.1	5500	TB1F01	6SL3210-1PE21-4.L0	FSB	IES 1
	36	0.0067	78.0	90.1	5500		6SL3210-1PE21-4.L0		
	36	0.0067	83.0	95.2	5500		6SL3210-1PE22-7.L0		
1LE1592-1CA02-1...	53	0.013	76.0	88.3	4500	TB1H01	6SL3210-1PE21-8.L0	FSB	IES 1
	53	0.013	76.0	88.3	4500		6SL3210-1PE21-8.L0		
1LE1592-1CA12-1...	58	0.016	76.0	88.4	4500	TB1H01	6SL3210-1PE22-7.L0	FSC	IES 2
	58	0.016	76.0	88.4	4500		6SL3210-1PE22-7.L0		
1LE1592-1DA22-1...	87	0.03	79.0	91.4	4500	TB1J01	6SL3210-1PE23-3.L0	FSC	IES 1
	87	0.03	78.0	90.4	4500		6SL3210-1PE23-3.L0		
1LE1592-1DA32-1...	95	0.036	79.0	91.8	4500	TB1J01	6SL3210-1PE23-8.L0	FSD	IES 1
	95	0.036	78.0	90.8	4500		6SL3210-1PE23-8.L0		
1LE1592-1DA42-1...	105	0.044	79.0	91.8	4500	TB1J01	6SL3210-1PE23-8.L0	FSD	IES 2
	105	0.044	78.0	90.8	4500		6SL3210-1PE23-8.L0		
1LE1592-1EA22-1...	150	0.069	79.0	92.0	4500	TB1J01	6SL3210-1PE24-5.L0	FSD	IES 2
	150	0.069	78.0	91.0	4500		6SL3210-1PE24-5.L0		
1LE1592-2AA42-1...	195	0.124	78.0	91.0	4500	TB1L01	6SL3210-1PE26-0.L0	FSD	IES 2
	195	0.124	78.0	91.0	4500		6SL3210-1PE26-0.L0		
1LE1592-2AA52-1...	230	0.15	76.0	89.1	4500	TB1L01	6SL3210-1PE27-5.L0	FSD	IES 2
	230	0.15	76.0	89.1	4500		6SL3210-1PE27-5.L0		
1LE1592-2BA22-1...	280	0.22	78.0	90.0	4500	TB1L01	6SL3210-1PE28-8.L0	FSE	IES 2
	280	0.22	80.0	93.0	4500		6SL3210-1PE28-8.L0		
1LE1592-2CA22-1...	360	0.4	78.0	92.0	3900	TB1N01	6SL3210-1PE31-1.L0	FSE	IES 2
	360	0.4	82.0	96.0	3900		6SL3210-1PE31-1.L0		
1LE1592-2DA02-1...	470	0.72	78.0	92.0	3600	TB1N01	6SL3210-1PE31-5.L0	FSF	IES 2
	470	0.72	82.0	96.0	3600		6SL3210-1PE31-5.L0		
1LE1592-2DA22-1...	530	0.83	78.0	92.0	3600	TB1N01	6SL3210-1PE31-8.L0	FSF	IES 2
	530	0.83	82.0	96.0	3600		6SL3210-1PE31-8.L0		

¹⁾ In addition to the Power Module, a Control Unit and an Operator Panel are required (see Catalog D 31 and/or D 35).

Standard induction motors optimized for converter operation – VSD10 line

Standard Efficiency

Cast-iron series SIMOTICS SD 1LE1592, line voltage 400 V, 50 Hz/460 V, 60 Hz/400 V, 87 Hz – self-ventilated

Selection and ordering data

P _{rated} , 50 Hz, 400 V	P _{rated} , 60 Hz, 460 V	P _{rated} , 87 Hz, 400 V	Frame size	Connection	Operating values at rated power				I _{rated}	1LE1592 cast-iron series Version specifically for converter operation
					f _{rated}	T _{rated}	η _{rated} , 4/4 for converter operation	cos φ _{rated} , 4/4		
kW	kW	kW			Hz	Nm	%	A	Article No.	
<ul style="list-style-type: none"> Insulation: Thermal class 155 (temperature class F), IP55 degree of protection, utilization in accordance with thermal class 155 (temperature class F) Operation with a SINAMICS G converter with uncontrolled infeed – rated motor voltage 380 V, 50 Hz/440 V, 60 Hz/380 V, 87 Hz 										
1500 rpm	1800 rpm	2610 rpm	4-pole							
2.2			100 L	Y	52.9	14.0	79.7	0.81	5.2	1LE1592-1AB42-1 ■■■
	2.55			Y	62.8	13.5	83.0	0.82	4.9	
		3.7		Δ	89.3	13.5	83.0	0.79	8.6	
3			100 L	Y	52.7	19.1	81.5	0.85	6.6	1LE1592-1AB52-1 ■■■
	3.45			Y	62.6	18.3	85.0	0.86	6.2	
		5		Δ	89.3	18.3	85.0	0.79	11.3	
4			112 M	Y	52.3	25.5	83.1	0.85	8.6	1LE1592-1BB22-1 ■■■
	4.55			Y	62.2	24.0	85.0	0.85	8.3	
		6.6		Δ	89.0	24.0	85.0	0.81	14.6	
5.5			132 S	Y	52.1	35.0	84.7	0.82	12	1LE1592-1CB02-1 ■■■
	6.3			Y	62.0	33.5	87.0	0.84	11.3	
		9		Δ	88.8	33.0	87.0	0.81	19.4	
7.5			132 M	Y	51.7	47.5	86.0	0.82	16.2	1LE1592-1CB22-1 ■■■
	8.6			Y	61.7	45.5	87.5	0.84	15.4	
		12.5		Δ	88.8	45.5	87.5	0.80	27.1	
11			160 M	Y	51.5	70.0	87.6	0.82	23.5	1LE1592-1DB22-1 ■■■
	12.6			Y	61.4	67.0	88.5	0.82	23	
		17		Δ	88.3	62.0	88.5	0.78	37.5	
15			160 L	Y	51.4	95.0	88.7	0.82	31.5	1LE1592-1DB42-1 ■■■
	17.3			Y	61.4	92.0	90.5	0.82	30.5	
		23.5		Δ	88.2	86.0	90.5	0.77	51	
18.5			180 M	Y	51.1	118	89.3	0.85	37	1LE1592-1EB22-1 ■■■
	21.3			Y	61.1	113	91.0	0.85	36	
		31		Δ	88.1	113	91.0	0.84	62	
22			180 L	Y	51.1	140	89.9	0.83	45	1LE1592-1EB42-1 ■■■
	25.3			Y	61.1	134	91.0	0.84	43.5	
		36.5		Δ	88.0	134	91.0	0.82	74	
30			200 L	Y	50.9	191	90.7	0.83	60	1LE1592-2AB52-1 ■■■
	34.5			Y	60.9	183	92.4	0.84	58	
		48		Δ	87.8	176	92.4	0.81	97	
37			225 S	Y	50.9	236	91.4	0.85	72	1LE1592-2BB02-1 ■■■
	42.5			Y	60.9	225	92.4	0.86	70	
45			225 M	Y	50.9	286	92.4	0.88	84	1LE1592-2BB22-1 ■■■
	52			Y	60.9	276	93.0	0.83	84	
55			250 M	Y	50.8	350	92.3	0.86	105	1LE1592-2CB22-1 ■■■
	63			Y	60.8	334	93.0	0.86	103	
75			280 S	Y	50.6	477	92.7	0.86	143	1LE1592-2DB02-1 ■■■
	86			Y	60.6	456	93.2	0.87	139	
90			280 M	Y	50.6	573	93.0	0.87	169	1LE1592-2DB22-1 ■■■
	104			Y	60.6	552	93.2	0.87	168	
106			315 S	Y	50.4	675	94.0	0.84	205	1LE1592-3AB02-1 ■■■
	125			Y	60.4	663	94.2	0.85	205	
130			315 M	Y	50.4	828	94.4	0.84	250	1LE1592-3AB22-1 ■■■
	152			Y	60.4	806	94.8	0.85	250	
160			315 L	Y	50.4	1019	95.0	0.87	295	1LE1592-3AB42-1 ■■■
	184			Y	60.4	976	95.0	0.87	290	
200			315 L	Y	50.5	1273	95.5	0.89	360	1LE1592-3AB52-1 ■■■
	230			Y	60.5	1220	95.0	0.89	355	

For versions, see Article No. supplements and special versions. ■■■

All technical specifications refer to converter operation.

Standard induction motors optimized for converter operation – VSD10 line

Standard Efficiency

Cast-iron series SIMOTICS SD 1LE1592, line voltage 400 V, 50 Hz/460 V, 60 Hz/400 V, 87 Hz – self-ventilated

Motor type	m_{IMB3} kg	J kgm ²	L_{pA} , tolerance +3 dB(A) load dB(A)	L_{WA} , tolerance +3 dB(A) load dB(A)	Mech. speed limit rpm	Terminal box	Preferred SINAMICS G120 – PM240(-2) Other SINAMICS converters also possible Operating mode: Low overload Type ¹⁾	Frame size	IES class acc. to EN 50598-2
1LE1592-1AB42-1...	29	0.0059	79.0	91.0	4200	TB1F01	6SL3210-1PE16-1.L1	FSA	IES 1
	29	0.0059	79.0	91.0	4200		6SL3210-1PE16-1.L1	FSA	IES 1
	29	0.0059	81.0	93.0	4200		6SL3210-1PE21-1.L0	FSB	IES 1
1LE1592-1AB52-1...	33	0.0078	79.0	91.0	4200	TB1F01	6SL3210-1PE18-0.L1	FSA	IES 1
	33	0.0078	79.0	91.0	4200		6SL3210-1PE18-0.L1	FSA	IES 1
	33	0.0078	81.0	93.0	4200		6SL3210-1PE21-4.L0	FSB	IES 1
1LE1592-1BB22-1...	38	0.01	77.4	89.4	4200	TB1F01	6SL3210-1PE21-1.L0	FSB	IES 1
	38	0.01	77.2	89.2	4200		6SL3210-1PE21-1.L0	FSB	IES 1
	38	0.01	78.4	90.4	4200		6SL3210-1PE21-8.L0	FSB	IES 1
1LE1592-1CB02-1...	60	0.019	76.0	88.0	4200	TB1H01	6SL3210-1PE21-4.L0	FSB	IES 1
	60	0.019	76.0	88.0	4200		6SL3210-1PE21-4.L0	FSB	IES 1
	60	0.019	83.0	95.0	4200		6SL3210-1PE22-7.L0	FSC	IES 1
1LE1592-1CB22-1...	62	0.024	76.0	88.0	4200	TB1H01	6SL3210-1PE21-8.L0	FSB	IES 1
	62	0.024	76.0	88.0	4200		6SL3210-1PE21-8.L0	FSB	IES 1
	62	0.024	83.0	95.0	4200		6SL3210-1PE23-3.L0	FSC	IES 1
1LE1592-1DB22-1...	89	0.044	83.5	95.5	4200	TB1J01	6SL3210-1PE22-7.L0	FSC	IES 1
	89	0.044	82.3	94.3	4200		6SL3210-1PE22-7.L0	FSC	IES 1
	89	0.044	85.8	97.8	4200		6SL3210-1PE24-5.L0	FSD	IES 1
1LE1592-1DB42-1...	100	0.056	83.5	95.5	4200	TB1J01	6SL3210-1PE23-3.L0	FSC	IES 2
	100	0.056	82.3	94.3	4200		6SL3210-1PE23-3.L0	FSC	IES 2
	100	0.056	85.8	97.8	4200		6SL3210-1PE26-0.L0	FSD	IES 2
1LE1592-1EB22-1...	170	0.13	71.0	83.0	4200	TB1J01	6SL3210-1PE23-8.L0	FSD	IES 2
	170	0.13	73.0	85.0	4200		6SL3210-1PE23-8.L0	FSD	IES 2
	170	0.13	84.0	96.0	4200		6SL3210-1PE27-5.L0	FSD	IES 2
1LE1592-1EB42-1...	170	0.13	71.0	83.0	4200	TB1J01	6SL3210-1PE24-5.L0	FSD	IES 2
	170	0.13	73.0	85.0	4200		6SL3210-1PE24-5.L0	FSD	IES 2
	170	0.13	84.0	96.0	4200		6SL3210-1PE28-8.L0	FSE	IES 2
1LE1592-2AB52-1...	220	0.2	76.3	88.3	4200	TB1L01	6SL3210-1PE26-0.L0	FSD	IES 2
	220	0.2	77.7	89.7	4200		6SL3210-1PE26-0.L0	FSD	IES 2
	220	0.2	83.1	95.1	4200		6SL3210-1PE31-1.L0	FSE	IES 2
1LE1592-2BB02-1...	260	0.37	67.0	83.0	4500	TB1L01	6SL3210-1PE27-5.L0	FSD	IES 2
	260	0.37	70.0	86.0	4500		6SL3210-1PE27-5.L0	FSD	IES 2
1LE1592-2BB22-1...	290	0.45	70.0	83.0	4500	TB1L01	6SL3210-1PE28-8.L0	FSE	IES 2
	290	0.45	72.0	86.0	4500		6SL3210-1PE28-8.L0	FSE	IES 2
1LE1592-2CB22-1...	360	0.69	70.0	83.0	3700	TB1N01	6SL3210-1PE31-1.L0	FSE	IES 2
	360	0.69	72.0	86.0	3700		6SL3210-1PE31-1.L0	FSE	IES 2
1LE1592-2DB02-1...	540	1.2	75.0	90.0	3000	TB1N01	6SL3210-1PE31-5.L0	FSF	IES 2
	540	1.2	76.0	91.0	3000		6SL3210-1PE31-5.L0	FSF	IES 2
1LE1592-2DB22-1...	560	1.4	75.0	90.0	3000	TB1N01	6SL3210-1PE31-8.L0	FSF	IES 2
	560	1.4	76.0	91.0	3000		6SL3210-1PE31-8.L0	FSF	IES 2
1LE1592-3AB02-1...	730	1.9	79.0	94.0	2600	TB1Q01	6SL3210-1PE32-1.L0	FSF	IES 2
	730	1.9	82.0	96.0	2600		6SL3210-1PE32-1.L0	FSF	IES 2
1LE1592-3AB22-1...	760	2.2	79.0	94.0	2600	TB1Q01	6SL3210-1PE32-5.L0	FSF	IES 2
	760	2.2	82.0	96.0	2600		6SL3210-1PE32-5.L0	FSF	IES 2
1LE1592-3AB42-1...	940	2.8	79.0	94.0	2600	TB1Q01	6SL3224-0XE41-3.A0	FSGX	IES 2
	940	2.8	80.0	95.0	2600		6SL3224-0XE41-3.A0	FSGX	IES 2
1LE1592-3AB52-1...	1140	3.5	81.0	96.0	2600	TB1Q01	6SL3224-0XE41-6.A0	FSGX	IES 2
	1140	3.5	82.0	96.0	2600		6SL3224-0XE41-6.A0	FSGX	IES 2

¹⁾ In addition to the Power Module, a Control Unit and an Operator Panel are required (see Catalog D 31 and/or D 35).

Standard induction motors optimized for converter operation – VSD10 line

Standard Efficiency

Cast-iron series SIMOTICS SD 1LE1592, line voltage 500 V, 50 Hz/575 V, 60 Hz/500 V, 87 Hz – self-ventilated

Selection and ordering data

$P_{\text{rated, 50 Hz}}$ 500 V	$P_{\text{rated, 60 Hz}}$ 575 V	$P_{\text{rated, 87 Hz}}$ 500 V	Frame size	Connection	Operating values at rated power					1LE1592 cast-iron series Version specifically for converter operation
					f_{rated}	T_{rated}	$\eta_{\text{rated, 4/4}}$ for converter operation	$\cos\varphi_{\text{rated, 4/4}}$	I_{rated}	
kW	kW	kW			Hz	Nm	%		A	
<ul style="list-style-type: none"> Insulation: Thermal class 155 (temperature class F), IP55 degree of protection, utilization in accordance with thermal class 155 (temperature class F) Operation with a SINAMICS G converter with uncontrolled infeed – rated motor voltage 480 V, 50 Hz/550 V, 60 Hz/480 V, 87 Hz 										
3000 rpm	3600 rpm	5220 rpm	2-pole							
3			100 L	Y	52.9	9.6	81.5	0.87	5.1	1LE1592-1AA42-6 ■■■
	3.45			Y	63.0	9.2	84.5	0.88	4.85	
		5		Δ	89.6	9.1	84.5	0.85	8.4	
4			112 M	Y	51.3	12.7	83.1	0.86	6.7	1LE1592-1BA22-6 ■■■
	4.55			Y	61.3	12.1	84.5	0.88	6.4	
		6.6		Δ	88.2	12.1	84.5	0.84	11.1	
5.5			132 S	Y	51.6	17.5	84.7	0.89	8.8	1LE1592-1CA02-6 ■■■
	6.3			Y	61.6	16.7	86.0	0.90	8.5	
7.5			132 S	Y	51.2	23.9	86.0	0.87	12.1	1LE1592-1CA12-6 ■■■
	8.6			Y	61.2	22.8	88.7	0.88	11.7	
11			160 M	Y	51.3	35.0	87.6	0.85	17.8	1LE1592-1DA22-6 ■■■
	12.6			Y	61.3	33.4	87.5	0.86	17.6	
14			160 M	Y	51.1	44.6	88.7	0.84	22.5	1LE1592-1DA32-6 ■■■
	16.5			Y	61.2	43.8	89.5	0.86	22.5	
17			160 L	Y	51.1	54.1	89.3	0.85	27	1LE1592-1DA42-6 ■■■
	19.5			Y	61.1	51.7	89.5	0.86	26.5	
22			180 M	Y	50.9	70	89.9	0.87	34	1LE1592-1EA22-6 ■■■
	24.5			Y	60.9	65	89.5	0.87	33	
30			200 L	Y	50.8	96	90.7	0.82	48.5	1LE1592-2AA42-6 ■■■
	33.5			Y	60.8	89	91.5	0.82	47	
34			200 L	Y	50.7	108	91.2	0.87	52	1LE1592-2AA52-6 ■■■
	40			Y	60.8	106	91.7	0.89	51	
41			225 M	Y	50.6	131	91.7	0.88	61	1LE1592-2BA22-6 ■■■
	48			Y	60.6	127	91.7	0.88	62	
53			250 M	Y	50.5	169	92.1	0.88	79	1LE1592-2CA22-6 ■■■
	60			Y	60.5	159	92.4	0.88	77	
75			280 S	Y	50.5	239	92.7	0.87	112	1LE1592-2DA02-6 ■■■
	84			Y	60.5	223	93.0	0.87	109	
90			280 M	Y	50.4	286	93.0	0.88	132	1LE1592-2DA22-6 ■■■
	101			Y	60.4	268	93.0	0.88	130	

For versions, see Article No. supplements and special versions. ■■■

All technical specifications refer to converter operation.

Standard induction motors optimized for converter operation – VSD10 line

Standard Efficiency

Cast-iron series SIMOTICS SD 1LE1592, line voltage 500 V, 50 Hz/575 V, 60 Hz/500 V, 87 Hz – self-ventilated

Motor type	m_{IMB3}	J	L_{pFA} , tolerance +3 dB(A) load dB(A)	L_{WA} , tolerance +3 dB(A) load dB(A)	Mech. speed limit rpm	Terminal box	Preferred SINAMICS G120 – PM240(-2) Other SINAMICS converters also possible Operating mode: Low overload Type ¹⁾	Frame size	IES class acc. to EN 50598-2
	kg	kgm ²							
1LE1592-1AA42-6...	31	0.0034	80.0	92.1	5500	TB1F01			
	31	0.0034	80.0	92.1	5500				
	31	0.0034	85.0	97.1	5500				
1LE1592-1BA22-6...	36	0.0067	79.0	91.1	5500	TB1F01			
	36	0.0067	79.0	91.1	5500				
	36	0.0067	85.0	97.2	5500		6SL3210-1PH21-4.L0	FSD	
1LE1592-1CA02-6...	53	0.013	77.0	89.3	4500	TB1H01	6SL3210-1PH21-4.L0	FSD	
	53	0.013	77.0	89.3	4500		6SL3210-1PH21-4.L0	FSD	
1LE1592-1CA12-6...	58	0.016	77.0	89.4	4500	TB1H01	6SL3210-1PH21-4.L0	FSD	
	58	0.016	77.0	89.4	4500		6SL3210-1PH21-4.L0	FSD	
1LE1592-1DA22-6...	87	0.03	80.0	92.4	4500	TB1J01	6SL3210-1PH22-0.L0	FSD	
	87	0.03	80.0	92.4	4500		6SL3210-1PH22-0.L0	FSD	
1LE1592-1DA32-6...	95	0.036	80.0	92.8	4500	TB1J01	6SL3210-1PH22-3.L0	FSD	
	95	0.036	80.0	92.8	4500		6SL3210-1PH22-3.L0	FSD	
1LE1592-1DA42-6...	105	0.044	80.0	92.8	4500	TB1J01	6SL3210-1PH22-7.L0	FSD	
	105	0.044	80.0	92.8	4500		6SL3210-1PH22-7.L0	FSD	
1LE1592-1EA22-6...	150	0.069	80.0	93.0	4500	TB1J01	6SL3210-1PH23-5.L0	FSD	
	150	0.069	80.0	93.0	4500		6SL3210-1PH23-5.L0	FSD	
1LE1592-2AA42-6...	195	0.124	79.0	92.0	4500	TB1L01	6SL3210-1PH25-2.L0	FSE	
	195	0.124	79.0	92.0	4500		6SL3210-1PH25-2.L0	FSE	
1LE1592-2AA52-6...	230	0.15	77.0	90.1	4500	TB1L01	6SL3210-1PH25-2.L0	FSE	
	230	0.15	77.0	90.1	4500		6SL3210-1PH25-2.L0	FSE	
1LE1592-2BA22-6...	280	0.22	78.0	90.0	4500	TB1L01	6SL3210-1PH26-2.L0	FSE	
	280	0.22	80.0	93.0	4500		6SL3210-1PH26-2.L0	FSE	
1LE1592-2CA22-6...	360	0.4	78.0	92.0	3900	TB1N01	6SL3210-1PH28-0.L0	FSF	
	360	0.4	82.0	96.0	3900		6SL3210-1PH28-0.L0	FSF	
1LE1592-2DA02-6...	470	0.72	78.0	92.0	3600	TB1N01	6SL3210-1PH31-2.L0	FSF	
	470	0.72	82.0	96.0	3600		6SL3210-1PH31-2.L0	FSF	
1LE1592-2DA22-6...	530	0.83	78.0	92.0	3600	TB1N01	6SL3210-1PH31-4.L0	FSF	
	530	0.83	82.0	96.0	3600		6SL3210-1PH31-4.L0	FSF	

¹⁾ In addition to the Power Module, a Control Unit and an Operator Panel are required (see Catalog D 31 and/or D 35).

Standard induction motors optimized for converter operation – VSD10 line

Standard Efficiency

Cast-iron series SIMOTICS SD 1LE1592, line voltage 500 V, 50 Hz/575 V, 60 Hz/500 V, 87 Hz – self-ventilated

Selection and ordering data

P _{rated, 50 Hz} 500 V	P _{rated, 60 Hz} 575 V	P _{rated, 87 Hz} 500 V	Frame size	Connection	Operating values at rated power				Article No.	
					f _{rated}	T _{rated}	η _{rated, 4/4} for converter operation	cos φ _{rated, 4/4}		I _{rated}
kW	kW	kW			Hz	Nm	%	A		
<ul style="list-style-type: none"> Insulation: Thermal class 155 (temperature class F), IP55 degree of protection, utilization in accordance with thermal class 155 (temperature class F) Operation with a SINAMICS G converter with uncontrolled infeed – rated motor voltage 480 V, 50 Hz/550 V, 60 Hz/480 V, 87 Hz 										
1500 rpm	1800 rpm	2610 rpm	4-pole							
2.2			100 L	Y	52.8	14.0	79.7	0.81	4.1	1LE1592-1AB42-6 ■■■
	2.55			Y	62.8	13.5	83.0	0.82	3.95	
		4		Δ	89.6	13.5	83.0	0.79	6.8	
3			100 L	Y	52.6	19.1	81.5	0.85	5.2	1LE1592-1AB52-6 ■■■
	3.45			Y	62.6	18.3	85.0	0.86	4.95	
		5		Δ	89.3	18.3	85.0	0.79	8.7	
4			112 M	Y	52.4	25.5	83.1	0.85	6.8	1LE1592-1BB22-6 ■■■
	4.55			Y	62.3	24.1	85.0	0.85	6.6	
		7		Δ	89.1	24.1	85.0	0.81	12	
5.5			132 S	Y	52.0	35.0	84.7	0.82	9.5	1LE1592-1CB02-6 ■■■
	6.3			Y	62.0	33.4	87.0	0.84	9	
		9		Δ	88.8	32.9	87.0	0.81	15.4	
7.5			132 M	Y	51.9	47.8	86.0	0.82	12.8	1LE1592-1CB22-6 ■■■
	8.6			Y	61.9	45.6	87.5	0.84	12.3	
		13		Δ	88.7	45.7	87.5	0.80	21.5	
11			160 M	Y	51.5	70.0	87.6	0.82	18.4	1LE1592-1DB22-6 ■■■
	12.6			Y	61.5	66.9	88.5	0.82	18.2	
		17		Δ	88.4	62.2	88.5	0.78	29.5	
13.5			160 L	Y	51.2	86.0	88.7	0.79	23	1LE1592-1DB42-6 ■■■
	15.6			Y	61.2	82.8	90.5	0.81	22.5	
		24		Δ	88.3	86.0	90.5	0.77	40.5	
16.7			180 M	Y	51.0	106	89.3	0.84	27	1LE1592-1EB22-6 ■■■
	19.2			Y	61.0	102	91.0	0.84	26.5	
		31		Δ	88.0	113	91.0	0.84	49	
21.5			180 L	Y	51.1	137	89.9	0.83	34.5	1LE1592-1EB42-6 ■■■
	25.3			Y	61.2	134	91.0	0.84	34.5	
		37		Δ	88.1	134	91.0	0.82	59	
30			200 L	Y	51.0	191	90.7	0.83	48	1LE1592-2AB52-6 ■■■
	34.5			Y	61.0	183	92.4	0.84	46.5	
		48		Δ	87.9	176	92.4	0.81	77	
33			225 S	Y	50.6	210	92.0	0.84	51	1LE1592-2BB02-6 ■■■
	38			Y	60.6	202	92.4	0.84	51	
41			225 M	Y	50.7	261	92.4	0.87	61	1LE1592-2BB22-6 ■■■
	47			Y	60.7	249	93.0	0.87	61	
52			250 M	Y	50.7	331	92.3	0.85	80	1LE1592-2CB22-6 ■■■
	59			Y	60.7	313	93.0	0.85	78	
75			280 S	Y	50.5	477	92.7	0.85	114	1LE1592-2DB02-6 ■■■
	86			Y	60.5	456	93.2	0.86	113	
90			280 M	Y	50.6	573	93.0	0.87	134	1LE1592-2DB22-6 ■■■
	102			Y	60.6	541	93.2	0.87	132	
110			315 S	Y	50.4	700	94.0	0.84	168	1LE1592-3AB02-6 ■■■
	127			Y	60.4	674	94.2	0.84	168	
132			315 M	Y	50.4	840	94.4	0.85	198	1LE1592-3AB22-6 ■■■
	152			Y	60.4	806	94.8	0.85	198	
160			315 L	Y	50.3	1019	95.0	0.86	235	1LE1592-3AB42-6 ■■■
	184			Y	60.3	976	95.0	0.86	235	
200			315 L	Y	50.4	1273	95.0	0.88	290	1LE1592-3AB52-6 ■■■
	230			Y	60.4	1220	95.0	0.88	290	

For versions, see Article No. supplements and special versions. ■■■

All technical specifications refer to converter operation.

Standard induction motors optimized for converter operation – VSD10 line

Standard Efficiency

Cast-iron series SIMOTICS SD 1LE1592, line voltage 500 V, 50 Hz/575 V, 60 Hz/500 V, 87 Hz – self-ventilated

Motor type	m_{IMB3}	J	L_{pFA} , tolerance +3 dB(A) load	L_{WA} , tolerance +3 dB(A) load	Mech. speed limit	Terminal box	Preferred SINAMICS G120 – PM240(-2) Other SINAMICS converters also possible Operating mode: Low overload Type ¹⁾	Frame size	IES class acc. to EN 50598-2
	kg	kgm ²	dB(A)	dB(A)	rpm				
1LE1592-1AB42-6...	29	0.0059	80.0	92.1	4200	TB1F01			
	29	0.0059	80.0	92.1	4200				
	29	0.0059	81.0	93.1	4200				
1LE1592-1AB52-6...	33	0.0078	80.0	92.1	4200	TB1F01			
	33	0.0078	80.0	92.1	4200				
	33	0.0078	81.0	93.1	4200				
1LE1592-1BB22-6...	38	0.01	79.0	91.3	4200	TB1F01			
	38	0.01	79.0	91.3	4200				
	38	0.01	80.0	92.3	4200		6SL3210-1PH21-4.L0	FSD	
1LE1592-1CB02-6...	60	0.019	77.0	89.4	4200	TB1H01	6SL3210-1PH21-4.L0	FSD	
	60	0.019	77.0	89.4	4200		6SL3210-1PH21-4.L0	FSD	
	60	0.019	83.0	95.4	4200		6SL3210-1PH22-0.L0	FSD	
1LE1592-1CB22-6...	62	0.024	77.0	89.4	4200	TB1H01	6SL3210-1PH21-4.L0	FSD	
	62	0.024	77.0	89.4	4200		6SL3210-1PH21-4.L0	FSD	
	62	0.024	83.0	95.4	4200		6SL3210-1PH22-3.L0	FSD	
1LE1592-1DB22-6...	89	0.044	85.0	97.8	4200	TB1J01	6SL3210-1PH22-0.L0	FSD	
	89	0.044	85.0	97.8	4200		6SL3210-1PH22-0.L0	FSD	
	89	0.044	85.0	97.8	4200		6SL3210-1PH23-5.L0	FSD	
1LE1592-1DB42-6...	100	0.056	85.0	97.8	4200	TB1J01	6SL3210-1PH22-3.L0	FSD	
	100	0.056	85.0	97.8	4200		6SL3210-1PH22-3.L0	FSD	
	100	0.056	85.0	97.8	4200		6SL3210-1PH24-2.L0	FSD	
1LE1592-1EB22-6...	170	0.13	72.0	85.0	4200	TB1J01	6SL3210-1PH22-7.L0	FSD	
	170	0.13	72.0	85.0	4200		6SL3210-1PH22-7.L0	FSD	
	170	0.13	84.0	97.0	4200		6SL3210-1PH25-2.L0	FSE	
1LE1592-1EB42-6...	170	0.13	72.0	85.0	4200	TB1J01	6SL3210-1PH23-5.L0	FSD	
	170	0.13	72.0	85.0	4200		6SL3210-1PH23-5.L0	FSD	
	170	0.13	84.0	97.0	4200		6SL3210-1PH26-2.L0	FSE	
1LE1592-2AB52-6...	220	0.2	78.0	91.3	4200	TB1L01	6SL3210-1PH25-2.L0	FSE	
	220	0.2	78.0	91.3	4200		6SL3210-1PH25-2.L0	FSE	
	220	0.2	84.0	97.3	4200		6SL3210-1PH31-0.L0	FSF	
1LE1592-2BB02-6...	260	0.37	70.0	84.0	4500	TB1L01	6SL3210-1PH25-2.L0	FSE	
	260	0.37	70.0	84.0	4500		6SL3210-1PH25-2.L0	FSE	
1LE1592-2BB22-6...	290	0.45	71.0	84.0	4500	TB1L01	6SL3210-1PH26-2.L0	FSE	
	290	0.45	71.0	84.0	4500		6SL3210-1PH26-2.L0	FSE	
1LE1592-2CB22-6...	360	0.69	71.0	84.0	3700	TB1N01	6SL3210-1PH28-0.L0	FSF	
	360	0.69	71.0	84.0	3700		6SL3210-1PH28-0.L0	FSF	
1LE1592-2DB02-6...	540	1.2	76.0	91.0	3000	TB1N01	6SL3210-1PH31-2.L0	FSF	
	540	1.2	76.0	91.0	3000		6SL3210-1PH31-2.L0	FSF	
1LE1592-2DB22-6...	560	1.4	76.0	91.0	3000	TB1N01	6SL3210-1PH31-4.L0	FSF	
	560	1.4	76.0	91.0	3000		6SL3210-1PH31-4.L0	FSF	
1LE1592-3AB02-6...	730	1.9	80.0	95.0	2600	TB1Q01	6SL3710-1GF31-8.A3	–	
	730	1.9	80.0	95.0	2600		6SL3710-1GF31-8.A3	–	
1LE1592-3AB22-6...	760	2.2	80.0	95.0	2600	TB1Q01	6SL3710-1GF32-2.A3	–	
	760	2.2	80.0	95.0	2600		6SL3710-1GF32-2.A3	–	
1LE1592-3AB42-6...	940	2.8	80.0	95.0	2600	TB1Q01	6SL3710-1GF32-6.A3	–	
	940	2.8	80.0	95.0	2600		6SL3710-1GF32-6.A3	–	
1LE1592-3AB52-6...	1140	3.5	82.0	96.0	2600	TB1Q01	6SL3710-1GF33-3.A3	–	
	1140	3.5	82.0	96.0	2600		6SL3710-1GF33-3.A3	–	

¹⁾ In addition to the Power Module, a Control Unit and an Operator Panel are required (see Catalog D 31 and/or D 35).

Standard induction motors optimized for converter operation – VSD10 line

Standard Efficiency

Cast-iron series SIMOTICS SD 1LE1592, line voltage 690 V, 50 Hz/690 V, 87 Hz – self-ventilated

Selection and ordering data

$P_{\text{rated, 50 Hz}}$ 690 V	$P_{\text{rated, 60 Hz}}$ 690 V	$P_{\text{rated, 87 Hz}}$ 690 V	Frame size	Connection	Operating values at rated power				$\cos\varphi_{\text{rated, 4/4}}$	I_{rated}	1LE1592 cast-iron series Version specifically for converter operation
					f_{rated}	T_{rated}	$\eta_{\text{rated, 4/4}}$ for converter operation	$\cos\varphi_{\text{rated, 4/4}}$			
kW	kW	kW			Hz	Nm	%		A		
<ul style="list-style-type: none"> Insulation: Thermal class 155 (temperature class F), IP55 degree of protection, utilization in accordance with thermal class 155 (temperature class F) Operation with a SINAMICS G converter with uncontrolled infeed – rated motor voltage 660 V, 50 Hz/660 V, 87 Hz 											
3000 rpm	3600 rpm	5220 rpm	2-pole								
3			100 L	Y	52.7	9.6	81.5	0.87	3.7	1LE1592-1AA43-3 ■■■	
	5			Δ	89.5	9.1	84.5	0.81	6.4		
4			112 M	Y	51.2	12.7	83.1	0.86	4.9	1LE1592-1BA23-3 ■■■	
	6.6			Δ	88.2	12.1	84.5	0.83	8.2		
5.5			132 S	Y	51.6	17.5	84.7	0.89	6.4	1LE1592-1CA03-3 ■■■	
7.5			132 S	Y	51.2	23.9	86.0	0.87	8.8	1LE1592-1CA13-3 ■■■	
11			160 M	Y	51.3	35.0	87.6	0.85	12.9	1LE1592-1DA23-3 ■■■	
15			160 M	Y	51.4	47.8	88.7	0.84	17.6	1LE1592-1DA33-3 ■■■	
18.5			160 L	Y	51.3	58.9	89.3	0.86	20.5	1LE1592-1DA43-3 ■■■	
22			180 M	Y	51.0	70	89.9	0.87	24.5	1LE1592-1EA23-3 ■■■	
30			200 L	Y	50.9	96	90.7	0.84	34.5	1LE1592-2AA43-3 ■■■	
37			200 L	Y	50.9	118	91.2	0.88	40.5	1LE1592-2AA53-3 ■■■	
45			225 M	Y	50.7	143	91.7	0.88	49	1LE1592-2BA23-3 ■■■	
55			250 M	Y	50.6	175	92.1	0.88	59	1LE1592-2CA23-3 ■■■	
75			280 S	Y	50.5	239	92.7	0.88	80	1LE1592-2DA03-3 ■■■	
90			280 M	Y	50.4	286	93.0	0.88	96	1LE1592-2DA23-3 ■■■	
1500 rpm	1800 rpm	2610 rpm	4-pole								
2.2			100 L	Y	52.9	14.0	79.7	0.81	3	1LE1592-1AB43-3 ■■■	
	3.7			Δ	89.5	13.5	83.0	0.79	4.95		
3			100 L	Y	52.5	19.1	81.5	0.85	3.8	1LE1592-1AB53-3 ■■■	
	5			Δ	89.5	18.3	85.0	0.79	6.5		
4			112 M	Y	52.5	25.5	83.1	0.85	5	1LE1592-1BB23-3 ■■■	
	6.6			Δ	89.2	24.1	85.0	0.81	8.4		
5.5			132 S	Y	52.0	35.0	84.7	0.82	6.9	1LE1592-1CB03-3 ■■■	
	9			Δ	88.7	32.9	87.0	0.81	11.2		
7.5			132 M	Y	51.7	47.8	86.0	0.82	9.3	1LE1592-1CB23-3 ■■■	
	12.5			Δ	88.6	45.7	87.5	0.80	15.6		
11			160 M	Y	51.5	70.0	87.6	0.82	13.4	1LE1592-1DB23-3 ■■■	
	17			Δ	88.3	62.2	88.5	0.78	21.5		
15			160 L	Y	51.4	95.5	88.7	0.82	18	1LE1592-1DB43-3 ■■■	
	23.5			Δ	88.2	86.0	90.5	0.77	29.5		
18.5			180 M	Y	51.1	117.8	89.3	0.85	21.5	1LE1592-1EB23-3 ■■■	
	31			Δ	88.0	112	91.0	0.84	35		
22			180 L	Y	51.2	140	89.9	0.85	25	1LE1592-1EB43-3 ■■■	
	36.5			Δ	88.2	134	91.0	0.84	42		
30			200 L	Y	51.0	191	90.7	0.83	35	1LE1592-2AB53-3 ■■■	
	48			Δ	87.9	176	92.4	0.81	56		
37			225 S	Y	50.8	236	91.4	0.85	41.5	1LE1592-2BB03-3 ■■■	
45			225 M	Y	50.8	286	92.4	0.88	48.5	1LE1592-2BB23-3 ■■■	
55			250 M	Y	50.8	350	92.3	0.86	61	1LE1592-2CB23-3 ■■■	
72			280 S	Y	50.5	458	92.7	0.85	80	1LE1592-2DB03-3 ■■■	
90			280 M	Y	50.6	573	93.0	0.87	97	1LE1592-2DB23-3 ■■■	
105			315 S	Y	50.4	668	94.0	0.85	115	1LE1592-3AB03-3 ■■■	
130			315 M	Y	50.4	828	94.4	0.85	142	1LE1592-3AB23-3 ■■■	
160			315 L	Y	50.3	1019	95.0	0.87	169	1LE1592-3AB43-3 ■■■	
200			315 L	Y	50.4	1273	95.0	0.89	205	1LE1592-3AB53-3 ■■■	

For versions, see Article No. supplements and special versions.

All technical specifications refer to converter operation.

Standard induction motors optimized for converter operation – VSD10 line

Standard Efficiency

Cast-iron series SIMOTICS SD 1LE1592, line voltage 690 V, 50 Hz/690 V, 87 Hz – self-ventilated

Motor type	$m_{IM\ B3}$	J	L_{pFA} , tolerance +3 dB(A) load	L_{WA} , tolerance +3 dB(A) load	Mech. speed limit	Terminal box	Preferred SINAMICS G120 – PM240(-2) Other SINAMICS converters also possible Operating mode: Low overload Type ¹⁾	Frame size	IES class acc. to EN 50598-2
	kg	kgm ²	dB(A)	dB(A)	rpm				
1LE1592-1AA43-3...	31	0.0034	80.0	92.1	5500	TB1F01			
	31	0.0034	85.0	97.1	5500				
1LE1592-1BA23-3...	36	0.0067	79.0	91.1	5500	TB1F01			
	36	0.0067	85.0	97.2	5500		6SL3210-1PH21-4.L0	FSD	
1LE1592-1CA03-3...	53	0.013	77.0	89.3	4500	TB1H01	6SL3210-1PH21-4.L0	FSD	
1LE1592-1CA13-3...	58	0.016	77.0	89.4	4500	TB1H01	6SL3210-1PH21-4.L0	FSD	
1LE1592-1DA23-3...	87	0.03	80.0	92.4	4500	TB1J01	6SL3210-1PH21-4.L0	FSD	
1LE1592-1DA33-3...	95	0.036	80.0	92.8	4500	TB1J01	6SL3210-1PH22-0.L0	FSD	
1LE1592-1DA43-3...	105	0.044	80.0	92.8	4500	TB1J01	6SL3210-1PH22-3.L0	FSD	
1LE1592-1EA23-3...	150	0.069	80.0	93.0	4500	TB1J01	6SL3210-1PH22-7.L0	FSD	
1LE1592-2AA43-3...	195	0.124	79.0	92.0	4500	TB1L01	6SL3210-1PH23-5.L0	FSD	
1LE1592-2AA53-3...	230	0.15	77.0	90.1	4500	TB1L01	6SL3210-1PH24-2.L0	FSD	
1LE1592-2BA23-3...	280	0.22	78.0	90.0	4500	TB1L01	6SL3210-1PH25-2.L0	FSE	
1LE1592-2CA23-3...	360	0.4	78.0	92.0	3900	TB1N01	6SL3210-1PH26-2.L0	FSE	
1LE1592-2DA03-3...	470	0.72	78.0	92.0	3600	TB1N01	6SL3210-1PH28-0.L0	FSF	
1LE1592-2DA23-3...	530	0.83	78.0	92.0	3600	TB1N01	6SL3210-1PH31-0.L0	FSF	
1LE1592-1AB43-3...	29	0.0059	80.0	92.1	4200	TB1F01			
	29	0.0059	81.0	93.1	4200				
1LE1592-1AB53-3...	33	0.0078	80.0	92.1	4200	TB1F01			
	33	0.0078	81.0	93.1	4200				
1LE1592-1BB23-3...	38	0.01	79.0	91.3	4200	TB1F01			
	38	0.01	80.0	92.3	4200		6SL3210-1PH21-4.L0	FSD	
1LE1592-1CB03-3...	60	0.019	77.0	89.4	4200	TB1H01	6SL3210-1PH21-4.L0	FSD	
	60	0.019	83.0	95.4	4200		6SL3210-1PH21-4.L0	FSD	
1LE1592-1CB23-3...	62	0.024	77.0	89.4	4200	TB1H01	6SL3210-1PH21-4.L0	FSD	
	62	0.024	83.0	95.4	4200		6SL3210-1PH22-0.L0	FSD	
1LE1592-1DB23-3...	89	0.044	85.0	97.8	4200	TB1J01	6SL3210-1PH21-4.L0	FSD	
	89	0.044	85.0	97.8	4200		6SL3210-1PH22-7.L0	FSD	
1LE1592-1DB43-3...	100	0.056	85.0	97.8	4200	TB1J01	6SL3210-1PH22-0.L0	FSD	
	100	0.056	85.0	97.8	4200		6SL3210-1PH23-5.L0	FSD	
1LE1592-1EB23-3...	170	0.13	72.0	85.0	4200	TB1J01	6SL3210-1PH22-3.L0	FSD	
	170	0.13	84.0	97.0	4200		6SL3210-1PH24-2.L0	FSD	
1LE1592-1EB43-3...	170	0.13	72.0	85.0	4200	TB1J01	6SL3210-1PH22-7.L0	FSD	
	170	0.13	84.0	97.0	4200		6SL3210-1PH25-2.L0	FSE	
1LE1592-2AB53-3...	220	0.2	78.0	91.3	4200	TB1L01	6SL3210-1PH23-5.L0	FSD	
	220	0.2	84.0	97.3	4200		6SL3210-1PH26-2.L0	FSE	
1LE1592-2BB03-3...	260	0.37	70.0	84.0	4500	TB1L01	6SL3210-1PH24-2.L0	FSD	
1LE1592-2BB23-3...	290	0.45	71.0	84.0	4500	TB1L01	6SL3210-1PH25-2.L0	FSE	
1LE1592-2CB23-3...	360	0.69	71.0	84.0	3700	TB1N01	6SL3210-1PH26-2.L0	FSE	
1LE1592-2DB03-3...	540	1.2	76.0	91.0	3000	TB1N01	6SL3210-1PH28-0.L0	FSF	
1LE1592-2DB23-3...	560	1.4	76.0	91.0	3000	TB1N01	6SL3210-1PH31-0.L0	FSF	
1LE1592-3AB03-3...	730	1.9	80.0	95.0	2600	TB1Q01	6SL3710-1GH31-2.A3	–	
1LE1592-3AB23-3...	760	2.2	80.0	95.0	2600	TB1Q01	6SL3710-1GH31-5.A3	–	
1LE1592-3AB43-3...	940	2.8	80.0	95.0	2600	TB1Q01	6SL3710-1GH31-8.A3	–	
1LE1592-3AB53-3...	1140	3.5	82.0	96.0	2600	TB1Q01	6SL3710-1GH32-2.A3	–	

¹⁾ In addition to the Power Module, a Control Unit and an Operator Panel are required (see Catalog D 31 and/or D 35).

Standard induction motors optimized for converter operation – VSD10 line

Article No. supplements and special versions · Voltages

Aluminum series SIMOTICS GP 1LE1092

Selection and ordering data

Voltages	Article No.		supplement	Frame size				Motor version
	Voltage code	12th and 13th position of the Article No.		100	112	132	160	
			Additional identification code with order code and plain text if required	1LE1092				Standard Efficiency
	1LE1092-	■ - ■ . . .	Order code					
Voltage at 50 Hz or 60 Hz								
Line voltage: 50 Hz, 400 V 60 Hz, 480 V	2	1	–	<input type="checkbox"/>	<input type="checkbox"/>	<input type="checkbox"/>	<input type="checkbox"/>	
Line voltage: 50 Hz, 690 V	3	3	–	<input checked="" type="checkbox"/>	<input checked="" type="checkbox"/>	<input checked="" type="checkbox"/>	<input checked="" type="checkbox"/>	
Non-standard voltage and/or frequencies								
Non-standard winding Reinforced insulation system (Advanced)	9	0	M1Y • and customer specifications	<input checked="" type="checkbox"/>	<input checked="" type="checkbox"/>	<input checked="" type="checkbox"/>	<input checked="" type="checkbox"/>	
Non-standard winding Special insulation system (Premium)	9	0	M2Y • and customer specifications	<input checked="" type="checkbox"/>	<input checked="" type="checkbox"/>	<input checked="" type="checkbox"/>	<input checked="" type="checkbox"/>	

- Standard version
- With additional charge
- This order code only determines the price of the version – Additional plain text is required.

Standard induction motors optimized for converter operation – VSD10 line

Article No. supplements and special versions · Voltages

Cast-iron series SIMOTICS SD 1LE1592

Selection and ordering data

Voltages	Article No.		supplement	Frame size											Motor version
	Voltage code	12th and 13th position of the Article No.		100	112	132	160	180	200	225	250	280	315		
			Additional identification code with order code and plain text if required	1LE1592											Standard Efficiency
	1LE1592-	- ■ - ■ . . .	Order code												
Voltage at 50 Hz or 60 Hz															
Line voltage: 50 Hz, 400 V 60 Hz, 480 V	2	1	–	<input type="checkbox"/>	<input type="checkbox"/>	<input type="checkbox"/>	<input type="checkbox"/>	<input type="checkbox"/>	<input type="checkbox"/>	<input type="checkbox"/>	<input type="checkbox"/>	<input type="checkbox"/>	<input type="checkbox"/>		
Line voltage: 50 Hz, 500 V 60 Hz, 600 V	2	6	–	✓	✓	✓	✓	✓	✓	✓	✓	✓	✓		
Line voltage: 50 Hz, 690 V	3	3	–	✓	✓	✓	✓	✓	✓	✓	✓	✓	✓		
Non-standard voltage and/or frequencies															
Non-standard winding Reinforced insulation system (Advanced)	9	0	M1Y • and customer specifications	✓	✓	✓	✓	✓	✓	✓	✓	✓	✓		
Non-standard winding Special insulation system (Premium)	9	0	M2Y • and customer specifications	✓	✓	✓	✓	✓	✓	✓	✓	✓	✓		













- Standard version
- ✓ With additional charge
- This order code only determines the price of the version – Additional plain text is required.

Standard induction motors optimized for converter operation – VSD10 line

Article No. supplements and special versions · Types of construction

Aluminum series SIMOTICS GP 1LE1092

Selection and ordering data

Types of construction	Article No. supplement Type of construction code letter 14th position of the Article No.	For types of construction with order code(s) Article No. with additional identification code -Z Order code	Frame size				Motor version
			100 1LE1092	112	132	160	
Without flange							Standard Efficiency
IM B3 ^{1) 2)} 	A	–	<input type="checkbox"/>	<input type="checkbox"/>	<input type="checkbox"/>	<input type="checkbox"/>	
IM B6 ²⁾ 	T	–	<input type="checkbox"/>	<input type="checkbox"/>	<input type="checkbox"/>	<input type="checkbox"/>	
IM B7 ²⁾ 	U	–	<input type="checkbox"/>	<input type="checkbox"/>	<input type="checkbox"/>	<input type="checkbox"/>	
IM B8 ²⁾ 	V	–	<input type="checkbox"/>	<input type="checkbox"/>	<input type="checkbox"/>	<input type="checkbox"/>	
IM V6 ²⁾ 	D	–	<input type="checkbox"/>	<input type="checkbox"/>	<input type="checkbox"/>	<input type="checkbox"/>	
IM V5 without protective cover ²⁾ 	C	–	<input type="checkbox"/>	<input type="checkbox"/>	<input type="checkbox"/>	<input type="checkbox"/>	
IM V5 with protective cover ^{2) 3) 4) 5)} 	C	H00	<input checked="" type="checkbox"/>	<input checked="" type="checkbox"/>	<input checked="" type="checkbox"/>	<input checked="" type="checkbox"/>	
With flange							
	Acc. to EN 50347		FF215 A 250	FF215 A 250	FF265 A 300	FF300 A 350	
	Acc. to DIN 42948						
IM B5 ^{2) 6)} 	F	–	<input checked="" type="checkbox"/>	<input checked="" type="checkbox"/>	<input checked="" type="checkbox"/>	<input checked="" type="checkbox"/>	
IM V1 without protective cover ²⁾ 	G	–	<input checked="" type="checkbox"/>	<input checked="" type="checkbox"/>	<input checked="" type="checkbox"/>	<input checked="" type="checkbox"/>	
IM V1 with protective cover ^{2) 3) 4) 5)} 	G	H00	<input checked="" type="checkbox"/>	<input checked="" type="checkbox"/>	<input checked="" type="checkbox"/>	<input checked="" type="checkbox"/>	
IM V3 ³⁾ 	H	–	<input checked="" type="checkbox"/>	<input checked="" type="checkbox"/>	<input checked="" type="checkbox"/>	<input checked="" type="checkbox"/>	
IM B35 	J	–	<input checked="" type="checkbox"/>	<input checked="" type="checkbox"/>	<input checked="" type="checkbox"/>	<input checked="" type="checkbox"/>	







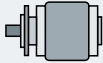

5

For legends and footnotes, see page 5/113.

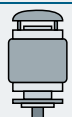
Standard induction motors optimized for converter operation – VSD10 line

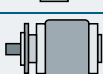
Article No. supplements and special versions · Types of construction



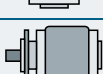







Aluminum series SIMOTICS GP 1LE1092

Types of construction	Article No. supplement		Frame size				Motor version
	Type of construction code letter	For types of construction with order code(s) Article No. with additional identification code -Z	100	112	132	160	
			1LE1092				Standard Efficiency
1LE1092-.....-...(-Z)		Order code					
With flange next largest	Acc. to EN 50347		FF265	FF265	FF300	FF350	
	Acc. to DIN 42948		A 300	A 300	A 350	A 400	
IM B5 ^{2) 6)} 	F	P01	✓	✓	✓	–	
IM V1 without protective cover ²⁾ 	G	P01	✓	✓	✓	–	
IM V1 with protective cover ^{2) 3) 4) 5)} 	G	P01+H00	✓	✓	✓	–	
IM V3 ³⁾ 	H	P01	✓	✓	✓	–	
IM B35 	J	P01	✓	✓	✓	–	
With flange next smallest	Acc. to EN 50347		FF165	FF165	FF215	FF265	
	Acc. to DIN 42948		A 200	A 200	A 250	A 300	
IM B5 ^{2) 6)} 	F	P02	✓	✓	✓	✓	
IM V1 without protective cover ²⁾ 	G	P02	✓	✓	✓	✓	
IM V1 with protective cover ^{2) 3) 4) 5)} 	G	P02+H00	✓	✓	✓	✓	
IM V3 ³⁾ 	H	P02	✓	✓	✓	✓	
IM B35 	J	P02	✓	✓	✓	✓	

Standard induction motors optimized for converter operation – VSD10 line

Article No. supplements and special versions · Types of construction

Aluminum series SIMOTICS GP 1LE1092

Types of construction	Article No. supplement		Frame size				Motor version
	Type of construction code letter	For types of construction with order code(s) Article No. with additional identification code -Z	100	112	132	160	
			1LE1092				Standard Efficiency
1LE1092-.....-...(-Z)		Order code					
With flange	Acc. to EN 50347		FT130	FT130	FT165	-	
	Acc. to DIN 42948		C 160	C 160	C 200	-	
IM B14 2) 7)		K	-	✓	✓	✓	✓
IM V19 ²⁾		L	-	✓	✓	✓	✓
IM V18 without protective cover ²⁾		M	-	✓	✓	✓	✓
IM V18 with protective cover 2) 3) 4) 5)		M	-	✓	✓	✓	✓
IM B34		N	-	✓	✓	✓	✓
With flange next largest	Acc. to EN 50347		FT165	FT165	FT215	-	
	Acc. to DIN 42948		C 200	C 200	C 250	-	
IM B14 2) 7)		K	P01	✓	✓	✓	-
IM V19 ²⁾		L	P01	✓	✓	✓	-
IM V18 without protective cover ²⁾		M	P01	✓	✓	✓	-
IM V18 with protective cover 2) 3) 4) 5)		M	P01+H00	✓	✓	✓	-
IM B34		N	P01	✓	✓	✓	-

5

For legends and footnotes, see page 5/113.

Standard induction motors optimized for converter operation – VSD10 line

Article No. supplements and special versions · Types of construction

Aluminum series SIMOTICS GP 1LE1092

Types of construction	Article No. supplement		Frame size				Motor version
	Type of construction code letter	For types of construction with order code(s) Article No. with additional identification code -Z	100	112	132	160	
1LE1092-.....	..(-Z)	Order code	1LE1092				Standard Efficiency
With flange next smallest	Acc. to EN 50347	FT115	FT115	FT115	FT130	–	
	Acc. to DIN 42948	C 140	C 140	C 140	C 160	–	
IM B14 2) 7)	K	P02	✓	O. R.	O. R.	–	
IM V19 ²⁾	L	P02	✓	O. R.	O. R.	–	
IM V18 without protective cover ²⁾	M	P02	✓	O. R.	O. R.	–	
IM V18 with protective cover ^{2) 3) 4) 5)}	M	P02+H00	✓	O. R.	O. R.	–	
IM B34	N	P02	✓	O. R.	O. R.	–	

- Standard version
- ✓ With additional charge
- Not possible
- O. R. Possible on request







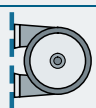
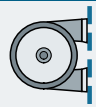

- 1) The types of construction IM B6/7/8, IM V6 and IM V5 with/without protective cover are also possible as long as there are no condensation drainage holes (order code **H03**) and these types of construction do not have to be stamped on the rating plate. As standard the type of construction IM B3 is then stamped on the rating plate. With type of construction IM V5 with protective cover, the protective cover has to be additionally ordered with order code **H00**. The protective cover is not stamped on the rating plate.
- 2) The type of construction is stamped on the rating plate. For orders with condensation drainage holes (order code **H03**), if mounted in a different position, the position must be specified to ensure that the condensation drainage holes are positioned correctly.
- 3) The "Second shaft extension" option (order code **L05**) is not possible.
- 4) In combination with an encoder, it is not necessary to order the protective cover (order code **H00**), as this is delivered as a protection for the encoder as standard. In this case the protective cover is standard version (without additional charge).
- 5) Not possible for forced-air cooled motors with order code **F90** without external fan and fan cover.
- 6) The types of construction IM V3 and IM V1 with/without protective cover are also possible as long as there are no condensation drainage holes (order code **H03**) and these types of construction do not have to be stamped on the rating plate. As standard the type of construction IM B5 is then stamped on the rating plate. With type of construction IM V1 with protective cover, the protective cover has to be additionally ordered with order code **H00**. The protective cover is not stamped on the rating plate.
- 7) The types of construction IM V19 and IM V18 with/without protective cover are also possible as long as there are no condensation drainage holes (order code **H03**) and these types of construction do not have to be stamped on the rating plate. As standard the type of construction IM B14 is then stamped on the rating plate. With type of construction IM V18 with protective cover, the protective cover has to be additionally ordered with order code **H00**. The protective cover is not stamped on the rating plate.

Standard induction motors optimized for converter operation – VSD10 line

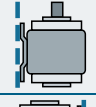
Article No. supplements and special versions · Types of construction

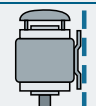
Cast-iron series SIMOTICS SD 1LE1592

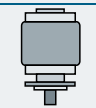
Selection and ordering data

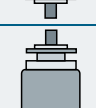
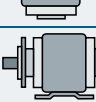
Types of construction	Article No. supplement Type of construction code letter 14th position of the Article No.	For types of construction with order code(s) Article No. with additional identification code -Z Order code	Frame size												Motor version	
			100	112	132	160	180	200	225	250	280	315 S/M	315 L			
1LE1592-.....-...(-Z)			1LE1592												Standard Efficiency	
Without flange																
IM B3 ^{1) 2)}	 A	-	<input type="checkbox"/>	<input type="checkbox"/>	<input type="checkbox"/>	<input type="checkbox"/>	<input type="checkbox"/>	<input type="checkbox"/>	<input type="checkbox"/>	<input type="checkbox"/>	<input type="checkbox"/>	<input type="checkbox"/>	<input type="checkbox"/>	<input type="checkbox"/>		
IM B6 ²⁾	 T	-	<input type="checkbox"/>	<input type="checkbox"/>	<input type="checkbox"/>	<input type="checkbox"/>	<input type="checkbox"/>	<input type="checkbox"/>	<input type="checkbox"/>	<input type="checkbox"/>	<input type="checkbox"/>	<input type="checkbox"/>	<input type="checkbox"/>	<input type="checkbox"/>		
IM B7 ²⁾	 U	-	<input type="checkbox"/>	<input type="checkbox"/>	<input type="checkbox"/>	<input type="checkbox"/>	<input type="checkbox"/>	<input type="checkbox"/>	<input type="checkbox"/>	<input type="checkbox"/>	<input type="checkbox"/>	<input type="checkbox"/>	<input type="checkbox"/>	<input type="checkbox"/>		
IM B8 ²⁾	 V	-	<input type="checkbox"/>	<input type="checkbox"/>	<input type="checkbox"/>	<input type="checkbox"/>	<input type="checkbox"/>	<input type="checkbox"/>	<input type="checkbox"/>	<input type="checkbox"/>	<input type="checkbox"/>	<input type="checkbox"/>	<input type="checkbox"/>	<input type="checkbox"/>		
IM V6 ²⁾	 D	-	<input type="checkbox"/>	<input type="checkbox"/>	<input type="checkbox"/>	<input type="checkbox"/>	<input type="checkbox"/>	<input type="checkbox"/>	<input type="checkbox"/>	<input type="checkbox"/>	<input type="checkbox"/>	<input type="checkbox"/>	<input type="checkbox"/>	<input type="checkbox"/>		
IM V5 without protective cover ²⁾	 C	-	<input type="checkbox"/>	<input type="checkbox"/>	<input type="checkbox"/>	<input type="checkbox"/>	<input type="checkbox"/>	<input type="checkbox"/>	<input type="checkbox"/>	<input type="checkbox"/>	<input type="checkbox"/>	<input type="checkbox"/>	<input type="checkbox"/>	<input type="checkbox"/>		
IM V5 with protective cover ^{2) 3) 4)}	 C	H00	<input checked="" type="checkbox"/>	<input checked="" type="checkbox"/>	<input checked="" type="checkbox"/>	<input checked="" type="checkbox"/>	<input checked="" type="checkbox"/>	<input checked="" type="checkbox"/>	<input checked="" type="checkbox"/>	<input checked="" type="checkbox"/>	<input checked="" type="checkbox"/>	<input checked="" type="checkbox"/>	<input checked="" type="checkbox"/>	<input checked="" type="checkbox"/>		
With flange			Acc. to EN 50347 Acc. to DIN 42948		FF215	FF215	FF265	FF300	FF300	FF350	FF400	FF500	FF500	FF600	-	
IM B5 ^{2) 5)}	 F	-	<input checked="" type="checkbox"/>	<input checked="" type="checkbox"/>	<input checked="" type="checkbox"/>	<input checked="" type="checkbox"/>	<input checked="" type="checkbox"/>	<input checked="" type="checkbox"/>	<input checked="" type="checkbox"/>	<input checked="" type="checkbox"/>	<input checked="" type="checkbox"/>	<input checked="" type="checkbox"/>	<input checked="" type="checkbox"/>	<input checked="" type="checkbox"/>	<input checked="" type="checkbox"/>	
IM V1 without protective cover ²⁾	 G	-	<input checked="" type="checkbox"/>	<input checked="" type="checkbox"/>	<input checked="" type="checkbox"/>	<input checked="" type="checkbox"/>	<input checked="" type="checkbox"/>	<input checked="" type="checkbox"/>	<input checked="" type="checkbox"/>	<input checked="" type="checkbox"/>	<input checked="" type="checkbox"/>	<input checked="" type="checkbox"/>	<input checked="" type="checkbox"/>	<input checked="" type="checkbox"/>	<input checked="" type="checkbox"/>	
IM V1 with protective cover ^{2) 3) 4)}	 G	H00	<input checked="" type="checkbox"/>	<input checked="" type="checkbox"/>	<input checked="" type="checkbox"/>	<input checked="" type="checkbox"/>	<input checked="" type="checkbox"/>	<input checked="" type="checkbox"/>	<input checked="" type="checkbox"/>	<input checked="" type="checkbox"/>	<input checked="" type="checkbox"/>	<input checked="" type="checkbox"/>	<input checked="" type="checkbox"/>	<input checked="" type="checkbox"/>	<input checked="" type="checkbox"/>	
IM V3 ⁴⁾	 H	-	<input checked="" type="checkbox"/>	<input checked="" type="checkbox"/>	<input checked="" type="checkbox"/>	<input checked="" type="checkbox"/>	<input checked="" type="checkbox"/>	<input checked="" type="checkbox"/>	<input checked="" type="checkbox"/>	<input checked="" type="checkbox"/>	<input checked="" type="checkbox"/>	<input checked="" type="checkbox"/>	<input checked="" type="checkbox"/>	<input checked="" type="checkbox"/>	<input checked="" type="checkbox"/>	
IM B35	 J	-	<input checked="" type="checkbox"/>	<input checked="" type="checkbox"/>	<input checked="" type="checkbox"/>	<input checked="" type="checkbox"/>	<input checked="" type="checkbox"/>	<input checked="" type="checkbox"/>	<input checked="" type="checkbox"/>	<input checked="" type="checkbox"/>	<input checked="" type="checkbox"/>	<input checked="" type="checkbox"/>	<input checked="" type="checkbox"/>	<input checked="" type="checkbox"/>	<input checked="" type="checkbox"/>	

For legends and footnotes, see page 5/117.

Standard induction motors optimized for converter operation – VSD10 line

Article No. supplements and special versions · Types of construction











Cast-iron series SIMOTICS SD 1LE1592

Types of construction	Article No. supplement	Frame size	Motor version										
			100	112	132	160	180	200	225	250	280	315 S/M	315 L
	Type of construction code letter 14th position of the Article No.	For types of construction with order code(s) Article No. with additional identification code -Z Order code	1LE1592										Standard Efficiency
1LE1592-.....-...(-Z)													
With flange next largest	Acc. to EN 50347 Acc. to DIN 42948	FF265 FF265 FF300 – – – – – – – – – –	A 300	A 300	A 350	–	–	–	–	–	–	–	–
IM B5 2) 5)	F	P01	✓	✓	✓	–	–	–	–	–	–	–	–
IM V1 without protective cover 2)	G	P01	✓	✓	✓	–	–	–	–	–	–	–	–
IM V1 with protective cover 2) 3) 4)	G	P01+H00	✓	✓	✓	–	–	–	–	–	–	–	–
IM V3 4)	H	P01	✓	✓	✓	–	–	–	–	–	–	–	–
IM B35	J	P01	✓	✓	✓	–	–	–	–	–	–	–	–
With flange next smallest	Acc. to EN 50347 Acc. to DIN 42948	FF165 FF215 FF215 FF265 FF265 FF300 – – – – –	A 200	A 250	A 250	A 300	A 300	A 350	–	–	–	–	–
IM B5 2) 5)	F	P02	✓	✓	✓	✓	✓	✓	–	–	–	–	–
IM V1 without protective cover 2)	G	P02	✓	✓	✓	✓	✓	✓	–	–	–	–	–
IM V1 with protective cover 2) 3) 4)	G	P02+H00	✓	✓	✓	✓	✓	✓	–	–	–	–	–
IM V3 4)	H	P02	✓	✓	✓	✓	✓	✓	–	–	–	–	–
IM B35	J	P02	✓	✓	✓	✓	✓	✓	–	–	–	–	–

Standard induction motors optimized for converter operation – VSD10 line

Article No. supplements and special versions · Types of construction

Cast-iron series SIMOTICS SD 1LE1592

Types of construction	Article No. supplement		Frame size										Motor version
	Type of construction code letter	For types of construction with order code(s) Article No. with additional identification code -Z	100	112	132	160	180	200	225	250	280	315 S/M	
			1LE1592										Standard Efficiency
1LE1592-.....-...(-Z)		Order code											
With flange		Acc. to EN 50347	FT130	FT130	FT165	FT215	-	-	-	-	-	-	-
		Acc. to DIN 42948	C 160	C 160	C 200	C 250	-	-	-	-	-	-	-
IM B14 2) 6)		K	-	✓	✓	✓	✓	-	-	-	-	-	-
IM V19 ²⁾		L	-	✓	✓	✓	✓	-	-	-	-	-	-
IM V18 without protective cover ²⁾		M	-	✓	✓	✓	✓	-	-	-	-	-	-
IM V18 with protective cover ^{2) 3) 4)}		M	H00	✓	✓	✓	✓	-	-	-	-	-	-
IM B34		N	-	✓	✓	✓	✓	-	-	-	-	-	-
With flange next largest		Acc. to EN 50347	FT165	FT165	FT215	-	-	-	-	-	-	-	-
		Acc. to DIN 42948	C 200	C 200	C 250	-	-	-	-	-	-	-	-
IM B14 2) 6)		K	P01	✓	✓	✓	-	-	-	-	-	-	-
IM V19 ²⁾		L	P01	✓	✓	✓	-	-	-	-	-	-	-
IM V18 without protective cover ²⁾		M	P01	✓	✓	✓	-	-	-	-	-	-	-
IM V18 with protective cover ^{2) 3) 4)}		M	P01+H00	✓	✓	✓	-	-	-	-	-	-	-
IM B34		N	P01	✓	✓	✓	-	-	-	-	-	-	-





5

For legends and footnotes, see page 5/117.

Standard induction motors optimized for converter operation – VSD10 line

Article No. supplements and special versions · Types of construction

Cast-iron series SIMOTICS SD 1LE1592

Types of construction	Article No. supplement		Frame size											Motor version
	Type of construction code letter	For types of construction with order code(s) Article No. with additional identification code -Z	100	112	132	160	180	200	225	250	280	315 S/M	315 L	
			1LE1592											Standard Efficiency
1LE1592-.....	..(-Z)	Order code												
With flange next smallest	Acc. to EN 50347	FT115	-	-	-	-	-	-	-	-	-	-	-	-
	Acc. to DIN 42948	C 140	-	-	-	-	-	-	-	-	-	-	-	-
IM B14 2) 6)	 K	P02	✓	-	-	-	-	-	-	-	-	-	-	-
IM V19 ²⁾	 L	P02	✓	-	-	-	-	-	-	-	-	-	-	-
IM V18 without protective cover ²⁾	 M	P02	✓	-	-	-	-	-	-	-	-	-	-	-
IM V18 with protective cover ^{2) 3) 4)}	 M	P02+H00	✓	-	-	-	-	-	-	-	-	-	-	-
IM B34	 N	P02	✓	-	-	-	-	-	-	-	-	-	-	-

- Standard version
- ✓ With additional charge
- Not possible

- 1) The types of construction IM B6/7/8, IM V6 and IM V5 with/without protective cover are also possible as long as no stamping of these types of construction on the rating plate is required. As standard the type of construction IM B3 is then stamped on the rating plate. With type of construction IM V5 with protective cover, the protective cover has to be additionally ordered with order code **H00**. The protective cover is not stamped on the rating plate.
- 2) The type of construction is stamped on the rating plate. If mounted in a different position, the position must be specified to ensure that the condensation drainage holes are positioned correctly.
- 3) In combination with an encoder, it is not necessary to order the protective cover (order code **H00**), as this is delivered as a protection for the encoder as standard. In this case the protective cover is standard design (without additional charge).
- 4) The "Second shaft extension" option (order code **L05**) is not possible.
- 5) The types of construction IM V3 and IM V1 with/without protective cover are also possible as long as no stamping of these types of construction on the rating plate is required. As standard the type of construction IM B5 is then stamped on the rating plate. With type of construction IM V1 with protective cover, the protective cover has to be additionally ordered with order code **H00**. The protective cover is not stamped on the rating plate.
- 6) The types of construction IM V19 and IM V18 with/without protective cover are also possible as long as no stamping of these types of construction on the rating plate is required. As standard the type of construction IM B14 is then stamped on the rating plate. With type of construction IM V18 with protective cover, the protective cover has to be additionally ordered with order code **H00**. The protective cover is not stamped on the rating plate.

Standard induction motors optimized for converter operation – VSD10 line

Article No. supplements and special versions · Motor protection

Aluminum series SIMOTICS GP 1LE1092

Selection and ordering data

Motor protection	Article No. Motor protection code letter 15th position of the Article No.	supplement Additional identifica- tion code with order code and plain text if required Order code	Frame size				Motor version
			100	112	132	160	
			1LE1092				Standard Efficiency
1LE1092- -							
Motor protection							
1 or 3 PTC thermistors – for tripping (2 terminals) ¹⁾	B	–	✓	✓	✓	✓	
2 or 6 PTC thermistors – for alarm and tripping (4 terminals) ¹⁾	C	–	✓	✓	✓	✓	
1 KTY84-130 temperature sensor (2 terminals) ¹⁾	F	–	✓	✓	✓	✓	
2 KTY84-130 temperature sensors (4 terminals) ¹⁾	G	–	✓	✓	✓	✓	
3 Pt100 resistance thermometers – 2-wire input (6 terminals) ¹⁾	H	–	✓	✓	✓	✓	
1 Pt1000 resistance thermometer (2 terminals) ²⁾	K	–	✓	✓	✓	✓	
2 Pt1000 resistance thermometers (4 terminals) ²⁾	L	–	✓	✓	✓	✓	
1 Pt100 resistance thermometers – 2-wire input (2 terminals) ¹⁾	P	–	✓	✓	✓	✓	
3 Pt100 resistance thermometers – 3-wire input (9 terminals) ¹⁾	Q	–	✓	✓	✓	✓	
6 Pt100 resistance thermometers – 3-wire input (18 terminals) ¹⁾	R	–	✓	✓	✓	✓	
3 bimetal sensors (NC contacts) for tripping (2 terminals) ¹⁾	Z	Q3A	✓	✓	✓	✓	Only for: Voltage code 2-1 (12th and 13th position of the Article No.)

- Without additional charge
 ✓ With additional charge

¹⁾ Evaluation with associated tripping unit (see Catalog IC 10) is recommended.

²⁾ Not UL-certified. Not in combination with option **D39**.

Standard induction motors optimized for converter operation – VSD10 line

Article No. supplements and special versions · Motor protection

Cast-iron series SIMOTICS SD 1LE1592

Selection and ordering data

Motor protection	Article No. supplement	Motor protection code letter 15th position of the Article No.	Additional identification code with order code and plain text if required	Frame size										Motor version		
				100	112	132	160	180	200	225	250	280	315			
				1LE1592										Standard Efficiency		
	1LE1592- -		Order code													
Motor protection																
1 or 3 PTC thermistors – for tripping (2 terminals) ¹⁾	B	–		✓	✓	✓	✓	✓	✓	✓	✓	✓	✓	✓	✓	
2 or 6 PTC thermistors – for alarm and tripping (4 terminals) ¹⁾	C	–		✓	✓	✓	✓	✓	✓	✓	✓	✓	✓	✓	✓	
1 KTY84-130 temperature sensor (2 terminals) ¹⁾	F	–		✓	✓	✓	✓	✓	✓	✓	✓	✓	✓	✓	✓	
2 KTY84-130 temperature sensors (4 terminals) ¹⁾	G	–		✓	✓	✓	✓	✓	✓	✓	✓	✓	✓	✓	✓	
3 Pt100 resistance thermometers – 2-wire input (6 terminals)	H	–		✓	✓	✓	✓	✓	✓	✓	✓	✓	✓	✓	✓	
1 Pt1000 resistance thermometers (2 terminals) ³⁾	K	–		✓	✓	✓	✓	✓	✓	✓	✓	✓	✓	✓	✓	
2 Pt1000 resistance thermometers (4 terminals) ³⁾	L	–		✓	✓	✓	✓	✓	✓	✓	✓	✓	✓	✓	✓	
1 Pt100 resistance thermometer – 2-wire input (2 terminals)	P	–		✓	✓	✓	✓	✓	✓	✓	✓	✓	✓	✓	✓	
3 Pt100 resistance thermometers – 3-wire input (9 terminals)	Q	–		✓	✓	✓	✓	✓	✓	✓	✓	✓	✓	✓	✓	
6 Pt100 resistance thermometers – 3-wire input (18 terminals)	R	–		✓	✓	✓	✓	✓	✓	✓	✓	✓	✓	✓	✓	
3 bimetal sensors (NC contacts) for tripping (2 terminals) ²⁾	Z	Q3A		✓	✓	✓	✓	✓	✓	✓	✓	✓	✓	✓	✓	Only for: Voltage code 2-1 (12th and 13th position of the Article No.)

- Without additional charge
 ✓ With additional charge

¹⁾ Evaluation with associated tripping unit (see Catalog IC 10) is recommended.

²⁾ Only applicable for voltage code (12th and 13th position of the Article No.) 2-1.

³⁾ Not possible in combination with UL.

Standard induction motors optimized for converter operation – VSD10 line

Article No. supplements and special versions · Terminal box position

Aluminum series SIMOTICS GP 1LE1092

Selection and ordering data

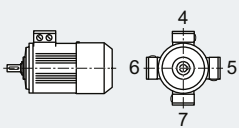
Terminal box position	Article No.	supplement	Frame size				Motor version
			100	112	132	160	
 1LE1092- -	Terminal box position code 16th position of the Article No.	Additional identification code with order code and plain text if required	1LE1092				Standard Efficiency
		Order code					

Terminal box position							
Terminal box top ¹⁾	4	–	<input type="checkbox"/>	<input type="checkbox"/>	<input type="checkbox"/>	<input type="checkbox"/>	
Terminal box right-hand side ²⁾	5	–	<input checked="" type="checkbox"/>	<input checked="" type="checkbox"/>	<input checked="" type="checkbox"/>	<input checked="" type="checkbox"/>	
Terminal box left-hand side ²⁾	6	–	<input checked="" type="checkbox"/>	<input checked="" type="checkbox"/>	<input checked="" type="checkbox"/>	<input checked="" type="checkbox"/>	
Terminal box bottom ²⁾	7	–	<input checked="" type="checkbox"/>	<input checked="" type="checkbox"/>	<input checked="" type="checkbox"/>	<input checked="" type="checkbox"/>	

- Standard version
 With additional charge

¹⁾ For types of construction with feet, cast feet are standard. Screwed-on feet are available with order code **H01**.

²⁾ For types of construction with feet, screwed-on feet are standard.

Standard induction motors optimized for converter operation – VSD10 line

Article No. supplements and special versions · Terminal box position

Cast-iron series SIMOTICS SD 1LE1592

Selection and ordering data

Terminal box position	Article No.	supplement	Frame size										Motor version	
	Terminal box position code	Additional identification code with order code and plain text if required	100	112	132	160	180	200	225	250	280	315	Standard Efficiency	
	16th position of the Article No.		1LE1592											
	1LE1592-.....-....	Order code												

Terminal box position													
Terminal box top ¹⁾	4	–	<input type="checkbox"/>	<input type="checkbox"/>	<input type="checkbox"/>	<input type="checkbox"/>	<input type="checkbox"/>	<input type="checkbox"/>	<input type="checkbox"/>	<input type="checkbox"/>	<input type="checkbox"/>	<input type="checkbox"/>	<input type="checkbox"/>
Terminal box right-hand side ²⁾	5	–	<input checked="" type="checkbox"/>	<input checked="" type="checkbox"/>	<input checked="" type="checkbox"/>	<input checked="" type="checkbox"/>	<input checked="" type="checkbox"/>	<input checked="" type="checkbox"/>	<input checked="" type="checkbox"/>	<input checked="" type="checkbox"/>	<input checked="" type="checkbox"/>	<input checked="" type="checkbox"/>	<input checked="" type="checkbox"/>
Terminal box left-hand side ²⁾	6	–	<input checked="" type="checkbox"/>	<input checked="" type="checkbox"/>	<input checked="" type="checkbox"/>	<input checked="" type="checkbox"/>	<input checked="" type="checkbox"/>	<input checked="" type="checkbox"/>	<input checked="" type="checkbox"/>	<input checked="" type="checkbox"/>	<input checked="" type="checkbox"/>	<input checked="" type="checkbox"/>	<input checked="" type="checkbox"/>
Terminal box bottom ²⁾	7	–	<input checked="" type="checkbox"/>	<input checked="" type="checkbox"/>	<input checked="" type="checkbox"/>	<input checked="" type="checkbox"/>	<input type="checkbox"/>	<input type="checkbox"/>	<input type="checkbox"/>	<input type="checkbox"/>	<input type="checkbox"/>	<input type="checkbox"/>	<input type="checkbox"/>

- Standard version
 With additional charge

¹⁾ For types of construction with feet, cast feet are standard. Screwed-on feet are available with order code **H01**.

²⁾ For types of construction with feet, screwed-on feet are standard.

Standard induction motors optimized for converter operation – VSD10 line

Article No. supplements and special versions · Options

Aluminum series SIMOTICS GP 1LE1092

Selection and ordering data

Special versions	Additional identification code -Z with order code and plain text if required	Frame size				Motor version
		100	112	132	160	
		1LE1092				Standard Efficiency
1LE1092- -Z	Order code					
Motor protection						
1 or 3 PTC thermistors – for tripping (2 terminals) ^{2) 3)}	Q11	✓	✓	✓	✓	
2 or 6 PTC thermistors – for alarm and tripping (4 terminals) ³⁾	Q12	✓	✓	✓	✓	
1 KTY84-130 temperature sensor (2 terminals) ³⁾	Q23	✓	✓	✓	✓	
2 KTY84-130 temperature sensor (4 terminals) ³⁾	Q25	✓	✓	✓	✓	
3 bimetal sensors (NC contacts) for tripping (2 terminals) ³⁾	Q31	✓	✓	✓	✓	
6 bimetal sensors (NC contacts) for alarm and tripping (4 terminals)	Q32	✓	✓	✓	✓	
3 bimetal sensors (NC contacts) for tripping (6 terminals)	Q33	O. R.	O. R.	O. R.	O. R.	
1 Pt1000 resistance thermometer (2 terminals) ²⁰⁾	Q35	✓	✓	✓	✓	
2 Pt1000 resistance thermometers (4 terminals) ²⁰⁾	Q36	✓	✓	✓	✓	
3 Pt100 resistance thermometers – 2-wire input (6 terminals)	Q60	✓	✓	✓	✓	
6 Pt100 resistance thermometers – 2-wire input (12 terminals)	Q61	✓	✓	✓	✓	
1 Pt100 resistance thermometer – 2-wire input (2 terminals)	Q62	✓	✓	✓	✓	
3 Pt100 resistance thermometers – 3-wire input (9 terminals)	Q63	✓	✓	✓	✓	
6 Pt100 resistance thermometers – 3-wire input (18 terminals)	Q64	✓	✓	✓	✓	
2 Pt100 resistance thermometers in basic configuration for bearings (2 terminals)	Q72	O. R.	O. R.	O. R.	O. R.	
2 Pt100 resistance thermometers in 3-wire input for bearings (6 terminals)	Q78	O. R.	O. R.	O. R.	O. R.	
2 Pt100 double resistance thermometers in 3-wire input for bearings (12 terminals)	Q79	O. R.	O. R.	O. R.	O. R.	Not for: Motors in combination with order codes F40 and F41 (frame sizes 225 to 315)
Motor connection and terminal box						
External grounding	H04	✓	✓	✓	✓	
Terminal box on NDE ¹⁾	H08	✓	✓	✓	✓	
Rotation of the terminal box through 90°, entry from DE ²⁾	R10	○	○	○	○	
Rotation of the terminal box through 90°, entry from NDE	R11	○	○	○	○	
Rotation of the terminal box through 180°	R12	○	○	○	○	
Terminal box in position 0°; connection from right ²¹⁾	R13	○	○	○	–	
One metal cable gland	R15	✓	✓	✓	✓	
Metal cable gland, maximum configuration	R18	✓	✓	✓	✓	
3 cables protruding, 0.5 m long	R20	✓	✓	✓	✓	
6 cables protruding, 0.5 m long	R22	✓	✓	✓	✓	
Larger terminal box	R50	✓	✓	✓	✓	
Motor connector Han-Drive 10e for 230 VΔ/400 VY	R70	✓	✓	✓	–	
Motor connector EMC Han-Drive 10e for 230 VΔ/400 VY	R71	✓	✓	✓	–	
Windings and insulation						
Increased air humidity/temperature with 30 to 60 g water per m ³ of air	N30	✓	✓	✓	✓	

For legends and footnotes, see page 5/125.

Standard induction motors optimized for converter operation – VSD10 line

Article No. supplements and special versions · Options

Aluminum series SIMOTICS GP 1LE1092

Special versions	Additional identification code -Z with order code and plain text if required	Frame size				Motor version
		100	112	132	160	
		1LE1092				Standard Efficiency
1LE1092-.....-.....-Z	Order code					
Colors and paint finish						
Standard paint finish C2 in RAL 7030 stone gray		□	□	□	□	
Unpainted (only cast-iron parts primed)	S00	○	○	○	○	
Unpainted, only primed	S01	✓	✓	✓	✓	
Special paint finish C3	S02	✓	✓	✓	✓	
Special paint finish sea air resistant C4	S03	✓	✓	✓	✓	
Internal coating	S05	✓	✓	✓	✓	
Paint finish in other standard RAL colors: RAL 1015, 3000, 5002, 5009, 5010, 5012, 5015, 6011, 7001, 7011, 7016, 7031, 7032, 7035, 7037, 8012, 9005, 9010 (see Catalog Section 1 "Introduction")	Y53 • and paint finish RAL....	✓	✓	✓	✓	
Paint finish in special RAL colors: For RAL colors, see "Special paint finish in special RAL colors" (see Catalog Section 1 "Introduction")	Y56 • and paint finish RAL....	✓	✓	✓	✓	
Non-standard colors Colors see "Paint finish in non-standard colors" (see Catalog Section 1 "Introduction")	Y66 • and paint finish	✓	✓	✓	✓	
Modular technology – Basic versions ⁴⁾						
Mounting of holding brake (standard assignment) ⁵⁾	F01	✓	✓	✓	✓	
Mounting of brake for higher switching frequency (operating brake)	F02	O. R.	O. R.	O. R.	O. R.	
Mounting of Kübler Sendix 5020 HTL, 1024 I rotary pulse encoder	G11	✓	✓	✓	✓	
Mounting of Kübler Sendix 5020 TTL, 1024 I rotary pulse encoder	G12	✓	✓	✓	✓	
Modular technology – Additional versions						
Brake supply voltage 24 V DC	F10	✓	✓	✓	✓	
Brake supply voltage 230 V AC, 50/60 Hz	F11	○	○	○	○	
Brake supply voltage 400 V AC, 50/60 Hz	F12	✓	✓	✓	✓	
Brake supply voltage 180 V DC	F17	✓	✓	✓	✓	Only for: Combination with F01
Brake supply voltage 205 V DC	F18	✓	✓	✓	✓	Only for: Combination with F01
Mechanical manual brake release with lever (no locking)	F50	✓	✓	✓	✓	
Special technology ³⁾						
Mounting of LL 861 900 220 rotary pulse encoder ⁶⁾	G04	✓	✓	✓	✓	
Mounting of HOG 9 DN 1024 I rotary pulse encoder ⁶⁾	G05	✓	✓	✓	✓	
Mounting of HOG 10 D 1024 I rotary pulse encoder ⁶⁾	G06	✓	✓	✓	✓	
Mounting of Kübler Sendix 5834FS2 1024, SIL-2 rotary pulse encoder	G21	✓	✓	✓	✓	
Mounting of Kübler Sendix 5834FS3 1024, SIL-3 rotary pulse encoder	G22	✓	✓	✓	✓	
Mechanical version and degrees of protection						
Prepared for mountings, centering hole only ⁷⁾	G40	✓	✓	✓	✓	
Prepared for mountings with D12 shaft ¹²⁾	G41	✓	✓	✓	✓	
Prepared for mountings with D16 shaft ¹²⁾	G42	✓	✓	✓	✓	
Mechanical protection for encoder	G43	✓	✓	✓	✓	
Protective cover ^{6) 8)}	H00	✓	✓	✓	✓	
Screwed-on (instead of cast) feet	H01	✓	✓	✓	✓	
Vibration-proof version; vibration resistance to Class 3M4 according to IEC 60721-3-3:1994	H02	✓	✓	✓	✓	
Condensation drainage holes ⁹⁾	H03	✓	✓	✓	✓	
Rust-resistant screws (externally)	H07	✓	✓	✓	✓	
IP66 degree of protection	H19	✓	✓	✓	✓	
IP65 degree of protection ¹⁰⁾	H20	✓	✓	✓	✓	

For legends and footnotes, see page 5/125.

Standard induction motors optimized for converter operation – VSD10 line

Article No. supplements and special versions · Options

Aluminum series SIMOTICS GP 1LE1092

Special versions	Additional identification code -Z with order code and plain text if required	Frame size				Motor version
		100	112	132	160	
		1LE1092				Standard Efficiency
1LE1092- -Z	Order code					
Mechanical version and degrees of protection (continued)						
IP56 degree of protection ¹¹⁾	H22	✓	✓	✓	✓	
Drive-end seal for flange-mounted motors, oil-tight to 0.1 bar ¹³⁾	H23	✓	✓	✓	✓	
Coolant temperature and installation altitude						
Coolant temperature –40 to +40 °C ¹⁹⁾	D03	✓	✓	✓	✓	
Coolant temperature –30 to +40 °C ¹⁹⁾	D04	✓	✓	✓	✓	
Versions in accordance with standards and specifications						
Version according to UL and CSA (Canadian regulation)	D39	✓	✓	✓	✓	
TR CU product safety certificate EAC for Eurasian Customs Union	D47	✓	✓	✓	✓	
Bearings and lubrication						
Located bearing DE	L20	✓	✓	✓	✓	
Located bearing NDE	L21	✓	✓	✓	□	
Bearing design for increased cantilever forces	L22	✓	✓	✓	✓	
Regreasing device ¹⁴⁾	L23	✓	✓	✓	✓	
Bearings reinforced at both ends for DE and NDE, bearing size 63	L25	✓	✓	✓	✓	
Bearing insulation NDE	L51	✓	✓	✓	✓	
Measuring nipple for SPM shock pulse measurement for bearing inspection ¹⁴⁾	Q01	✓	✓	✓	✓	
Balance and vibration severity						
Vibration severity grade A		□	□	□	□	
Half-key balancing (standard)		□	□	□	□	
Balancing without feather key	L01	✓	✓	✓	✓	
Full-key balancing	L02	✓	✓	✓	✓	
Shaft and rotor						
Shaft extension with standard dimensions, without feather keyway	L04	✓	✓	✓	✓	
Standard, cylindrical shaft extension (second shaft extension) NDE acc. to EN 50347	L05	✓	✓	✓	✓	
Standard shaft made of stainless steel (e.g. 1.4021)	L06	✓	✓	✓	✓	
Shaft extension run-out in accordance with IEC 60072-1 precision class	L07	✓	✓	✓	✓	
Shaft extension run-out, concentricity and perpendicularity in accordance with IEC 60072-1 precision class for flange-mounted motors	L08	✓	✓	✓	✓	
Non-standard cylindrical shaft extension, DE ¹⁵⁾	Y58 • and customer specifications	✓	✓	✓	✓	
Non-standard cylindrical shaft extension, NDE ¹⁵⁾	Y59 • and customer specifications	✓	✓	✓	✓	
Heating and ventilation						
Mounted separately driven fan	F70	✓	✓	✓	✓	
Sheet metal fan cover	F74	✓	✓	✓	✓	
Fan cover for textile industry ¹⁶⁾	F75	✓	✓	✓	✓	
Metal external fan	F76	✓	✓	✓	✓	
Without external fan and without fan cover	F90	✓	✓	✓	✓	
Anti-condensation heating for 230 V (2 terminals)	Q02	✓	✓	✓	✓	
Anti-condensation heating for 115 V (2 terminals)	Q03	✓	✓	✓	✓	
Rating plate and additional rating plates						
Second rating plate, loose	M10	✓	✓	✓	✓	
Rating plate, stainless steel	M11	✓	✓	✓	✓	
Additional rating plate with customer specifications	Y82 • and customer specifications	✓	✓	✓	✓	

For legends and footnotes, see page 5/125.

Standard induction motors optimized for converter operation – VSD10 line

Article No. supplements and special versions · Options

Aluminum series SIMOTICS GP 1LE1092

Special versions	Additional identification code -Z with order code and plain text if required	Frame size				Motor version
		100	112	132	160	
		1LE1092				Standard Efficiency
1LE1092- -Z	Order code					
Rating plate and additional rating plates (continued)						
Additional information on rating plate and on package label (max. 20 characters)	Y84 • and customer specifications	✓	✓	✓	✓	
Adhesive label, supplied loose (printed with: Article No., Serial No.; 2 lines of text)	Y85 • and customer specifications	✓	✓	✓	✓	
Packaging, safety notes, documentation and test certificates						
A printed version of the safety notes in German/English and safety notes in the language of the country of use is supplied in each wire-lattice pallet ¹⁷⁾	B01	○	○	○	○	
Inspection certificate 3.1 according to EN 10204 ¹⁸⁾	B02	✓	✓	✓	✓	
Document - Electrical datasheet	B60	✓	✓	✓	✓	
Document - Order dimensional drawing	B61	✓	✓	✓	✓	
Type test with heat run for horizontal motors, with acceptance	B83	✓	✓	✓	✓	
"Basic" documentation package	B90	✓	✓	✓	✓	
"Advanced" documentation package	B91	✓	✓	✓	✓	
"Projects" documentation package	B92	✓	✓	✓	✓	
Wire-lattice pallet packaging	B99	○	○	○	○	
Connected in star for dispatch	M01	✓	✓	✓	✓	
Connected in delta for dispatch	M02	✓	✓	✓	✓	

- Standard version
- Without additional charge
- This order code only determines the price of the version – Additional plain text is required.
- ✓ With additional charge
- O. R. Possible on request
- Not possible

- 1) For order code **H08** mounting feet dimensions deviate from EN 50347. Further information is available in the DT Configurator (see Appendix, "Tools and engineering").
- 2) With IM B5 flange, only possible in combination with order code **H08**.
- 3) The grease lifetime specified in Catalog Section 1 "Introduction" refers to CT 40 °C. If the coolant temperature is increased by 10 K, the grease life-time and regreasing interval are halved.
- 4) A second shaft extension is not possible. Please inquire for mounted brakes.
- 5) The brake supply voltage must be specified or ordered with order codes **F10, F11, F12, F17**, and **F18**.
- 6) In combination with a separately driven fan (order code **F70**) the 1XP8032-10 rotary pulse encoder is used instead of 1XP8012-10 or 1XP8032-20 is used instead of 1XP8012-20.
- 7) As standard, motors that are prepared for additional mounted components (order codes **G40, G41, G42**) are shipped without protective cover. If a protective cover is requested as a cover or mechanical protection for mounted components provided by the customer, this can be ordered with order code **G43**. In combination with a separately driven fan (order code **F70**) the 1XP8032-10 rotary pulse encoder is used instead of 1XP8012-10 or 1XP8032-20 is used instead of 1XP8012-20.
- 8) Order code **H00** provides mechanical protection for encoders.
- 9) Supplied with the condensation drainage holes sealed at the drive end DE and non-drive end NDE (IP55, IP56, IP65). If the condensation drainage holes are required for motors of the IM B6, IM B7 or IM B8 type of construction (feet on side or top), the motors must be ordered in the respective type of construction and with order code **H03**, so that the condensation drainage holes will be placed in the correct position.
- 10) Not possible in combination with HOG 9 DN 1024 I rotary pulse encoder (order code **G05**) and/or brake BFK458 (order code **F01**).
- 11) Not possible in combination with brake BFK458 (order code **F01**).
- 12) As standard, motors that are prepared for additional mounted components (order codes **G40, G41, G42**) are shipped without protective cover. If a protective cover is requested as a cover or mechanical protection for mountings provided by the customer, this can be ordered with order code **G43**.
- 13) Not possible for type of construction IM V3.
- 14) Not possible when a brake is mounted.
- 15) When motors are ordered that have a longer or shorter shaft extension than normal, the required position and length of the feather keyway must be specified in a sketch. It must be ensured that only feather keys in accordance with DIN 6885, Form A are permitted to be used. The feather keyway is positioned centrally on the shaft extension. The length is defined by the manufacturer in accordance with the appropriate standard. Not valid for: Conical shafts, non-standard threaded journals, non-standard shaft tolerances, friction welded journals, extremely "thin" shafts, special geometry dimensions (e.g. square journals), hollow shafts. Valid for non-standard shaft extensions DE or NDE. The feather keys are supplied in every case. For order codes **Y58, Y59** and **L05** the following applies:
 - Dimensions D and DA ≤ ball bearing inner diameter (see dimension tables for "Dimensions")
 - Dimensions E and EA ≤ 2 × length E (standard) of the shaft extension. For an explanation of the order codes, see Catalog Section 1 "Introduction".
- 16) The special requirements of the textile industry regarding the sheet metal cover open up the possibility that a finger may be inserted between the cover and housing. The customer must implement appropriate measures to ensure that the installed system is "finger-safe".
- 17) The Operating Instructions (compact) are available in PDF format for all official EU languages at <http://support.automation.siemens.com/WWW/view/en/40761976>.
- 18) The delivery time for the manufacturer's test certificate may differ from the delivery time for the motor and will be dispatched by e-mail.
- 19) In connection with mountings, the respective technical specifications must be observed, please inquire before ordering.
- 20) Not possible in combination with UL.
- 21) Only possible in combination with order codes **R70** and **R71**.

Standard induction motors optimized for converter operation – VSD10 line

Article No. supplements and special versions · Options

Cast-iron series SIMOTICS SD 1LE1592

Selection and ordering data

Special versions	Additional identification code -Z with order code and plain text if required	Frame size										Motor version
		100	112	132	160	180	200	225	250	280	315	Standard Efficiency
1LE1592-.....-.....-Z	Order code	1LE1592										
Motor protection												
1 or 3 PTC thermistors – for tripping (2 terminals) ^{2) 3)}	Q11	✓	✓	✓	✓	✓	✓	✓	✓	✓	✓	
2 or 6 PTC thermistors – for alarm and tripping (4 terminals) ³⁾	Q12	✓	✓	✓	✓	✓	✓	✓	✓	✓	✓	
1 KTY84-130 temperature sensor (2 terminals) ³⁾	Q23	✓	✓	✓	✓	✓	✓	✓	✓	✓	✓	
2 KTY84-130 temperature sensor (4 terminals) ³⁾	Q25	✓	✓	✓	✓	✓	✓	✓	✓	✓	✓	
3 bimetal sensors (NC contacts) for tripping (2 terminals) ³⁾	Q31	✓	✓	✓	✓	✓	✓	✓	✓	✓	✓	
6 bimetal sensors (NC contacts) for alarm and tripping (4 terminals)	Q32	✓	✓	✓	✓	✓	✓	✓	✓	✓	✓	Only for: Voltage code 2-1 (12th and 13th position of the Article No.)
3 bimetal sensors (NC contacts) for tripping (6 terminals)	Q33	✓	✓	✓	✓	✓	✓	✓	✓	✓	✓	
6 bimetal sensors (NC contacts) thermostat for alarm and tripping (12 terminals)	Q34	✓	✓	✓	✓	✓	✓	✓	✓	✓	✓	
1 Pt1000 resistance thermometer (2 terminals) ²⁰⁾	Q35	✓	✓	✓	✓	✓	✓	✓	✓	✓	✓	
2 Pt1000 resistance thermometers (4 terminals) ²⁰⁾	Q36	✓	✓	✓	✓	✓	✓	✓	✓	✓	✓	
3 Pt100 resistance thermometers – 2-wire input (6 terminals)	Q60	✓	✓	✓	✓	✓	✓	✓	✓	✓	✓	
1 Pt100 resistance thermometer – 2-wire input (2 terminals)	Q62	✓	✓	✓	✓	✓	✓	✓	✓	✓	✓	
3 Pt100 resistance thermometers – 3-wire input (9 terminals)	Q63	✓	✓	✓	✓	✓	✓	✓	✓	✓	✓	
6 Pt100 resistance thermometers – 3-wire input (18 terminals)	Q64	✓	✓	✓	✓	✓	✓	✓	✓	✓	✓	
2 Pt100 resistance thermometers in basic configuration for bearings (2 terminals) ¹⁾	Q72	–	–	–	–	✓	✓	✓	✓	✓	✓	
2 Pt100 resistance thermometers in 3-wire input for bearings (6 terminals)	Q78	–	–	–	–	✓	✓	✓	✓	✓	✓	
2 Pt100 double resistance thermometers in 3-wire input for bearings (12 terminals)	Q79	–	–	–	–	✓	✓	✓	✓	✓	✓	
Motor connection and terminal box												
External grounding	H04	✓	✓	✓	✓	□	□	□	□	□	□	
Terminal box on NDE ²⁾	H08	✓	✓	✓	✓	✓	✓	✓	✓	✓	✓	
Second external grounding	H70	✓	✓	✓	✓	✓	✓	✓	✓	✓	✓	
Rotation of the terminal box through 90°, entry from DE	R10	✓	✓	✓	✓	✓	✓	✓	✓	✓	✓	
Rotation of the terminal box through 90°, entry from NDE	R11	✓	✓	✓	✓	✓	✓	✓	✓	✓	✓	
Rotation of the terminal box through 180°	R12	○	○	○	○	✓	✓	✓	✓	✓	✓	
One EMC cable gland	R14	–	–	–	–	✓	✓	✓	✓	✓	✓	
One metal cable gland	R15	✓	✓	✓	✓	✓	✓	✓	✓	✓	✓	
EMC cable gland, maximum configuration	R16	–	–	–	–	✓	✓	✓	✓	✓	✓	
Stud terminal for cable connection, accessories pack (3 items)	R17	–	–	–	–	–	–	✓	✓	✓	✓	
Saddle terminal for connection without cable lug, accessories pack	R19	–	–	–	–	–	–	✓	✓	✓	✓	
Larger terminal box	R50	✓	✓	✓	✓	✓	✓	✓	✓	✓	✓	
Terminal box without cable entry opening	R51	○	○	○	○	○	○	○	○	○	○	
Drilled removable entry plate	R52	–	–	–	–	✓	✓	✓	✓	✓	✓	
Undrilled removable entry plate	R53	–	–	–	–	✓	✓	✓	✓	✓	✓	
Cast-iron auxiliary terminal box (small)	R62	✓	✓	✓	✓	✓	✓	✓	✓	✓	✓	
Non-standard threaded through hole (NPT or G thread)	Y61 • and customer specifications	✓	✓	✓	✓	✓	✓	✓	✓	✓	✓	

For legend, see page 5/129, for footnotes, see page 5/130.

Standard induction motors optimized for converter operation – VSD10 line

Article No. supplements and special versions · Options

Cast-iron series SIMOTICS SD 1LE1592

Special versions	Additional identification code -Z with order code and plain text if required	Frame size										Motor version
		100	112	132	160	180	200	225	250	280	315	
		1LE1592										Standard Efficiency
1LE1592-.....-.....-Z	Order code											
Windings and insulation												
Increased air humidity/temperature with 30 to 60 g water per m ³ of air	N30	✓	✓	✓	✓	✓	✓	✓	✓	✓	✓	✓
Increased air humidity/temperature with 60 to 100 g water per m ³ of air	N31	✓	✓	✓	✓	✓	✓	✓	✓	✓	✓	✓
Colors and paint finish												
Standard paint finish C2 in RAL 7030 stone gray		□	□	□	□	□	□	□	□	□	□	□
Unpainted (only cast-iron parts primed)	S00	○	○	○	○	○	○	○	○	○	○	○
Unpainted, only primed	S01	✓	✓	✓	✓	✓	✓	✓	✓	✓	✓	✓
Special paint finish C3	S02	✓	✓	✓	✓	✓	✓	✓	✓	✓	✓	✓
Special paint finish sea air resistant C4	S03	✓	✓	✓	✓	✓	✓	✓	✓	✓	✓	✓
Special paint finish for use offshore C5	S04	✓	✓	✓	✓	✓	✓	✓	✓	✓	✓	✓
Internal coating	S05	✓	✓	✓	✓	✓	✓	✓	✓	✓	✓	✓
Special paint finish C5mid with medium durability	S08	✓	✓	✓	✓	✓	✓	✓	✓	✓	✓	✓
Special paint finish CX for offshore with high durability	S09	✓	✓	✓	✓	✓	✓	✓	✓	✓	✓	✓
Paint finish in other standard RAL colors: RAL 11015, 3000, 5002, 5009, 5010, 5012, 5015, 6011, 7001, 7011, 7016, 7031, 7032, 7035, 7037, 8012, 9005, 9010 (see Catalog Section 1 "Introduction")	Y53 • and paint finish RAL....	✓	✓	✓	✓	✓	✓	✓	✓	✓	✓	✓
Paint finish in special RAL colors: For RAL colors, see "Special paint finish in special RAL colors" (see Catalog Section 1 "Introduction")	Y56 • and paint finish RAL....	✓	✓	✓	✓	✓	✓	✓	✓	✓	✓	✓
Non-standard colors Colors see "Paint finish in non-standard colors" (see Catalog Section 1 "Introduction")	Y66 • and paint finish	✓	✓	✓	✓	✓	✓	✓	✓	✓	✓	✓
Modular technology – Basic versions ⁴⁾												
Mounting of holding brake (standard assignment) ⁵⁾	F01	✓	✓	✓	✓	✓	✓	✓	✓	✓	✓	✓
Mounting of Kübler Sendix 5020 HTL, 1024 I rotary pulse encoder	G11	✓	✓	✓	✓	✓	✓	✓	✓	✓	✓	✓
Mounting of Kübler Sendix 5020 TTL, 1024 I rotary pulse encoder	G12	✓	✓	✓	✓	✓	✓	✓	✓	✓	✓	✓
Modular technology – Additional versions												
Brake supply voltage 24 V DC	F10	✓	✓	✓	✓	✓	✓	✓	✓	✓	✓	✓
Brake supply voltage 230 V AC, 50/60 Hz	F11	○	○	○	○	○	○	○	○	○	○	○
Brake supply voltage 400 V AC, 50/60 Hz	F12	✓	✓	✓	✓	✓	✓	✓	✓	✓	✓	✓
Brake supply voltage 180 V DC	F17	✓	✓	✓	✓	✓	✓	✓	✓	✓	✓	✓
Brake supply voltage 205 V DC	F18	✓	✓	✓	✓	✓	✓	✓	✓	✓	✓	✓
Mechanical manual brake release with lever (no locking)	F50	✓	✓	✓	✓	✓	✓	✓	✓	✓	✓	✓
Special technology ⁵⁾												
Mounting of LL 861 900 220 rotary pulse encoder ⁸⁾	G04	✓	✓	✓	✓	✓	✓	✓	✓	✓	✓	✓
Mounting of HOG 9 DN 1024 I rotary pulse encoder ⁸⁾	G05	✓	✓	✓	✓	✓	✓	✓	✓	✓	✓	✓
Mounting of HOG 10 D 1024 I rotary pulse encoder ⁸⁾	G06	✓	✓	✓	✓	✓	✓	✓	✓	✓	✓	✓
Mounting of POG 10 DN rotary pulse encoder (only in combination with separately driven fan or brake) ⁹⁾	G07	-	-	-	-	✓	✓	✓	✓	✓	✓	✓
Mounting of POG 9 rotary pulse encoder (only in combination with separately driven fan or brake) ⁹⁾	G08	-	-	-	-	✓	✓	✓	✓	✓	✓	✓
Mounting of Kübler Sendix 5834FS2 1024, SIL-2 rotary pulse encoder	G21	✓	✓	✓	✓	✓	✓	✓	✓	✓	✓	✓
Mounting of Kübler Sendix 5834FS3 1024, SIL-3 rotary pulse encoder	G22	✓	✓	✓	✓	✓	✓	✓	✓	✓	✓	✓
Mounting of HOGS100S-B76.626.01024.1 rotary pulse encoder	G25	-	-	-	-	✓	✓	✓	✓	✓	✓	✓
Mounting of LL FSI 862-184560-1024, SIL-2 rotary pulse encoder	G27	-	-	-	-	✓	✓	✓	✓	✓	✓	✓

For legend, see page 5/129, for footnotes, see page 5/130.

Standard induction motors optimized for converter operation – VSD10 line

Article No. supplements and special versions · Options

Cast-iron series SIMOTICS SD 1LE1592

Special versions	Additional identification code -Z with order code and plain text if required	Frame size										Motor version
		100	112	132	160	180	200	225	250	280	315	
		1LE1592										Standard Efficiency
1LE1592-.....-.....-Z	Order code											
Special technology (continued) ⁵⁾												
Mounting of a special type of rotary pulse encoder	Y70 • and customer specifications	-	-	-	-	O.R.	O.R.	O.R.	O.R.	O.R.	O.R.	
Mechanical version and degrees of protection												
Prepared for mountings, centering hole only	G40	✓	✓	✓	✓	□	□	□	□	□	□	
Prepared for mountings with D12 shaft	G41	✓	✓	✓	✓	✓	✓	✓	✓	✓	✓	
Prepared for mountings with D16 shaft	G42	✓	✓	✓	✓	✓	✓	✓	✓	✓	✓	
Mechanical protection for encoder	G43	✓	✓	✓	✓	✓	✓	✓	✓	✓	✓	
Protective cover ^{6) 8) 10)}	H00	✓	✓	✓	✓	✓	✓	✓	✓	✓	✓	
Screwed-on (instead of cast) feet	H01	✓	✓	✓	✓	✓	✓	✓	✓	✓	✓	
Vibration-proof version; vibration resistance to Class 3M4 according to IEC 60721-3-3:1994	H02	✓	✓	✓	✓	✓	✓	✓	✓	✓	✓	
Condensation drainage holes		□	□	□	□	□	□	□	□	□	□	
Rust-resistant screws (externally)	H07	✓	✓	✓	✓	✓	✓	✓	✓	✓	✓	
IP66 degree of protection	H19	✓	✓	✓	✓	✓	✓	✓	✓	✓	✓	
IP65 degree of protection ¹¹⁾	H20	✓	✓	✓	✓	✓	✓	✓	✓	✓	✓	
IP54 degree of protection	H21	-	-	-	-	✓	✓	✓	✓	✓	✓	
IP56 degree of protection ¹²⁾	H22	✓	✓	✓	✓	✓	✓	✓	✓	✓	✓	
Drive-end seal for flange-mounted motors, oil-tight to 0.1 bar ¹³⁾	H23	✓	✓	✓	✓	✓	✓	✓	✓	✓	✓	
Grounding brush for converter operation	L52	-	-	-	-	-	-	-	-	✓	✓	
Coolant temperature and installation altitude												
Coolant temperature -50 to +40 °C	D02	✓	✓	✓	✓	✓	✓	✓	✓	✓	✓	
Coolant temperature -40 to +40 °C ¹⁴⁾	D03	✓	✓	✓	✓	✓	✓	✓	✓	✓	✓	
Coolant temperature -30 to +40 °C	D04	✓	✓	✓	✓	✓	✓	✓	✓	✓	✓	
Versions in accordance with standards and specifications												
Version according to UL and CSA (Canadian regulation)	D39	✓	✓	✓	✓	✓	✓	✓	✓	✓	✓	
TR CU product safety certificate EAC for Eurasian Customs Union	D47	✓	✓	✓	✓	✓	✓	✓	✓	✓	✓	
Bearings and lubrication												
Regreasing device with M10 × 1 grease nipple according to DIN 71412 A	L19	-	-	-	-	✓	✓	✓	○	○		
Located bearing DE	L20	✓	✓	✓	✓	✓	✓	✓	✓	✓	✓	
Located bearing NDE	L21	✓	✓	✓	□	□	□	□	□	□	□	
Bearing design for increased cantilever forces	L22	✓	✓	✓	✓	✓	✓	✓	✓	✓	✓	
Regreasing device ¹⁵⁾	L23	✓	✓	✓	✓	✓	✓	✓	□	□		
Bearings reinforced at both ends for DE and NDE, bearing size 63 ¹⁶⁾	L25	✓	✓	✓	✓	✓	✓	✓	□	□		
Reinforced bearings at both DE and NDE, DE bearing for increased cantilever forces	L28	-	-	-	-	✓	✓	✓	-	-		
Bearing insulation DE	L50	-	-	-	-	-	✓	✓	✓	✓		
Bearing insulation NDE	L51	✓	✓	✓	✓	✓	✓	✓	□	□		
Measuring nipple for SPM shock pulse measurement for bearing inspection ¹⁵⁾	Q01	✓	✓	✓	✓	✓	✓	✓	✓	✓	✓	
Balance and vibration severity												
Vibration severity grade A		□	□	□	□	□	□	□	□	□	□	
Half-key balancing (standard)		□	□	□	□	□	□	□	□	□	□	
Balancing without feather key	L01	✓	✓	✓	✓	✓	✓	✓	✓	✓	✓	
Full-key balancing	L02	✓	✓	✓	✓	✓	✓	✓	✓	✓	✓	
Shaft and rotor												
Shaft extension with standard dimensions, without feather keyway	L04	✓	✓	✓	✓	✓	✓	✓	✓	✓	✓	
Standard, cylindrical shaft extension (second shaft extension) NDE acc. to EN 50347	L05	✓	✓	✓	✓	✓	✓	✓	✓	✓	✓	
Standard shaft made of stainless steel (e.g. 1.4021)	L06	✓	✓	✓	✓	✓	✓	✓	✓	✓	✓	

For legend, see page 5/129, for footnotes, see page 5/130.

Standard induction motors optimized for converter operation – VSD10 line

Article No. supplements and special versions · Options

Cast-iron series SIMOTICS SD 1LE1592

Special versions	Additional identification code -Z with order code and plain text if required	Frame size										Motor version
		100	112	132	160	180	200	225	250	280	315	
		1LE1592										Standard Efficiency
1LE1592-.....-.....-Z	Order code											
Shaft and rotor (continued)												
Shaft extension run-out in accordance with IEC 60072-1 precision class	L07	✓	✓	✓	✓	✓	✓	✓	✓	✓	✓	✓
Shaft extension run-out, concentricity and perpendicularity in accordance with IEC 60072-1 precision class for flange-mounted motors	L08	✓	✓	✓	✓	✓	✓	✓	✓	✓	✓	✓
Non-standard cylindrical shaft extension, DE ¹⁷⁾	Y58 • and customer specifications	✓	✓	✓	✓	✓	✓	✓	✓	✓	✓	✓
Non-standard cylindrical shaft extension, NDE ¹⁷⁾	Y59 • and customer specifications	✓	✓	✓	✓	✓	✓	✓	✓	✓	✓	✓
Special shaft steel	Y60 • and customer specifications	O. R.	O. R.	O. R.	O. R.	O. R.	O. R.	O. R.	O. R.	O. R.	O. R.	O. R.
Heating and ventilation												
Mounted separately driven fan	F70	✓	✓	✓	✓	✓	✓	✓	✓	✓	✓	✓
Sheet metal fan cover	F74	✓	✓	✓	✓	✓	✓	✓	✓	✓	✓	✓
Metal external fan	F76	✓	✓	✓	✓	✓	✓	✓	✓	✓	✓	✓
Anti-condensation heating for 230 V (2 terminals)	Q02	✓	✓	✓	✓	✓	✓	✓	✓	✓	✓	✓
Anti-condensation heating for 115 V (2 terminals)	Q03	✓	✓	✓	✓	✓	✓	✓	✓	✓	✓	✓
Separately driven fan with non-standard voltage and/or frequency	Y81 • and customer specifications	-	-	-	-	-	-	✓	✓	✓	✓	✓
Rating plate and additional rating plates												
Second rating plate, loose	M10	✓	✓	✓	✓	✓	✓	✓	✓	✓	✓	✓
Rating plate, stainless steel	M11	✓	✓	✓	✓	✓	✓	✓	✓	✓	✓	✓
Additional rating plate with customer specifications	Y82 • and customer specifications	✓	✓	✓	✓	✓	✓	✓	✓	✓	✓	✓
Additional information on rating plate and on package label (max. 20 characters)	Y84 • and customer specifications	✓	✓	✓	✓	✓	✓	✓	✓	✓	✓	✓
Adhesive label, supplied loose (printed with: Article No., Serial No., 2 lines of text)	Y85 • and customer specifications	✓	✓	✓	✓	✓	✓	✓	✓	✓	✓	✓
Extension of the liability for defects												
Extension of the liability for defects by 12 months to a total of 24 months (2 years) from delivery ¹⁸⁾	Q80	-	-	-	-	✓	✓	✓	✓	✓	✓	✓
Extension of the liability for defects by 24 months to a total of 36 months (3 years) from delivery ¹⁸⁾	Q82	-	-	-	-	✓	✓	✓	✓	✓	✓	✓
Packaging, safety notes, documentation and test certificates												
Inspection certificate 3.1 according to EN 10204 ¹⁹⁾	B02	✓	✓	✓	✓	✓	✓	✓	✓	✓	✓	✓
Document - Electrical datasheet	B60	✓	✓	✓	✓	✓	✓	✓	✓	✓	✓	✓
Document - Order dimensional drawing	B61	✓	✓	✓	✓	✓	✓	✓	✓	✓	✓	✓
Standard test (routine test) with acceptance	B65	✓	✓	✓	✓	✓	✓	✓	✓	✓	✓	✓
Type test with heat run for horizontal motors, with acceptance	B83	✓	✓	✓	✓	✓	✓	✓	✓	✓	✓	✓
"Basic" documentation package	B90	✓	✓	✓	✓	✓	✓	✓	✓	✓	✓	✓
"Advanced" documentation package	B91	✓	✓	✓	✓	✓	✓	✓	✓	✓	✓	✓
"Projects" documentation package	B92	✓	✓	✓	✓	✓	✓	✓	✓	✓	✓	✓
Connected in star for dispatch	M01	✓	✓	✓	✓	✓	✓	✓	✓	✓	✓	✓
Connected in delta for dispatch	M02	✓	✓	✓	✓	✓	✓	✓	✓	✓	✓	✓

- Standard version
- Without additional charge
- This order code only determines the price of the version – Additional plain text is required.
- ✓ With additional charge
- O. R. Possible on request
- Not possible

For footnotes, see page 5/130.

Standard induction motors optimized for converter operation – VSD10 line

Article No. supplements and special versions · Options

Cast-iron series SIMOTICS SD 1LE1592

5

- 1) Evaluation with associated tripping unit (see Catalog IC 10) is recommended.
- 2) For order code **H08** mounting feet dimensions deviate from EN 50347. Further information is available in the DT Configurator (see Appendix, "Tools and engineering").
- 3) The grease lifetime specified in Catalog Section 1 "Introduction" refers to CT 40 °C. If the coolant temperature is increased by 10 K, the grease life-time and regreasing interval are halved.
- 4) A second shaft extension is not possible. Please inquire for mounted brakes.
- 5) The brake supply voltage must be specified or ordered with order codes **F10, F11, F12, F17, and F18**.
- 6) The 1XP8 rotary pulse encoders are fitted with a protective cover as standard. The protective cover is omitted at the factory when a rotary pulse encoder is combined with a separately driven fan, because in this case the rotary pulse encoder is installed under the fan cover.
- 7) In combination with a separately driven fan (order code **F70**) the 1XP8032-10 rotary pulse encoder is used instead of 1XP8012-10 or 1XP8032-20 is used instead of 1XP8012-20.
- 8) LL and HOG rotary pulse encoders up to frame size 160 are fitted with a protective cover as standard. The protective cover is omitted at the factory when a rotary pulse encoder is combined with a separately driven fan, because in this case the rotary pulse encoder is installed under the fan cover.
- 9) Option (encoder mounting) is only possible for motors with a mounted separately driven fan or for naturally cooled motors (without an external fan). This option can be used in combination with brakes of type KFB! This option cannot be used in combination with brakes of type BFK458!
- 10) Order code **H00** provides mechanical protection for encoders.
- 11) Not possible in combination with HOG 9 DN 1024 I rotary pulse encoder (order code **G05**) and/or brake BFK458 (order code **F01**).
- 12) Not possible in combination with brake BFK458 (order code **F01**).
- 13) Not possible for type of construction IM V3.
- 14) In connection with mountings, the respective technical specifications must be observed, please inquire before ordering.
- 15) Up to frame size 160 not possible when brake is mounted.
- 16) Standard version for motors from frame size 280 and higher.
- 17) When motors are ordered that have a longer or shorter shaft extension than normal, the required position and length of the feather keyway must be specified in a sketch. It must be ensured that only feather keys in accordance with DIN 6885, Form A are permitted to be used. The feather keyway is positioned centrally on the shaft extension. The length is defined by the manufacturer in accordance with the appropriate standard. Not valid for: Conical shafts, non-standard threaded journals, non-standard shaft tolerances, friction welded journals, extremely "thin" shafts, special geometry dimensions (e.g. square journals), hollow shafts. Valid for non-standard shaft extensions DE or NDE. The feather keys are supplied in every case. For order codes **Y58, Y59** and **L05** the following applies:
 - Dimensions D and DA ≤ ball bearing inner diameter (see dimension tables for "Dimensions")
 - Dimensions E and EA ≤ 2 × length E (standard) of the shaft extension. For an explanation of the order codes, see Catalog Section 1 "Introduction".
- 18) Wearing parts (bearings) are excluded from the warranty extension.
- 19) The delivery time for the manufacturer's test certificate may differ from the delivery time for the motor.
- 20) Not possible in combination with UL.

Standard induction motors optimized for converter operation – VSD10 line

Article No. supplements and special versions · Accessories

Overview**Slide rails with fixing bolts and tensioning screws according to DIN 42923**

Slide rails are used to tension the belt of a machine easily and conveniently when there is no belt-tensioning pulley. They are fixed to the base using stone bolts or foundation blocks.

The assignment of slide rails to motor size can be found in DIN 42923. For motors of frame sizes 355 to 450, there are no standardized slide rails (please inquire).

Available from:

Lütgert & Co. GmbH
Postfach 42 51
33276 Gütersloh, Germany
Phone +49 (5241) 7407-0
Fax +49 (5241) 7407-90

www.luetgert-antriebe.de
Email: info@luetgert-antriebe.de

Foundation blocks according to DIN 799

The foundation blocks are inserted into the stone foundation and embedded in concrete. They are used for fixing machines of medium size, slide rails, pedestal bearings, base frames, etc. After the fixing bolts have been unscrewed, the machines can be shifted without them having to be lifted.

When the machine is initially installed, the foundation blocks that are bolted to the machine (without washers) and fitted with taper pins are not embedded with concrete until the machine has been fully aligned. In this case, the machine is positioned 2 to 3 mm lower. The difference in shaft height is compensated by inserting shims on final installation. The taper pins safeguard the exact position of the machine when it is repeatedly removed and replaced without the need for realignment.

Available from:

Lütgert & Co. GmbH
Postfach 42 51
33276 Gütersloh, Germany
Phone +49 (5241) 7407-0
Fax +49 (5241) 7407-90

www.luetgert-antriebe.de
Email: info@luetgert-antriebe.de

Taper pins according to DIN 258 with threaded ends and constant taper lengths

Taper pins are used for components that are repeatedly removed. The drilled hole is conically ground using a conical reamer until the pin can be pushed in by hand until the cone shoulder lies approx. 3 to 4 mm above the rim of the hole.

It can then be driven in using a hammer until it is correctly seated. The pin is removed from the drilled hole by screwing on the nut and tightening it.

Standardized taper pins are commercially available.

For instance, available from:

Otto Roth GmbH & Co. KG
Rutesheimer Strasse 22
70499 Stuttgart, Germany
Phone +49 (711) 1388-0
Fax +49 (711) 1388-233

www.ottoroth.de
Email: info@ottoroth.de

Couplings

The motor from Siemens is connected to the machine or gear unit through a coupling. Flender is an important coupling manufacturer with a wide range of products.

For standard applications, Siemens recommends that flexible couplings, types N-EUPEX and RUPEX or torsionally rigid couplings, types ARPEX and ZAPEX are used. For special applications, FLUDEX and ELPEX-S couplings are recommended.

Available from:

Siemens contact partner - ordering from catalog
Siemens MD 10.1 "FLENDER Standard Couplings"

or

Flender GmbH
Kupplungswerk Mussum
Industriepark Bocholt
Schlavenhorst 100
46395 Bocholt, Germany
Phone +49 (2871) 922185
Fax +49 (2871) 922579

www.flender.com
Email: flender-kupplungen-2.pd.de@siemens.com

Standard induction motors optimized for converter operation – VSD10 line

Article No. supplements and special versions · Accessories

More information

Replacement motors and repair parts

- Commitment to provide replacement motors and repair parts following delivery of the motor:
 - For up to 3 years after delivery of the original motor, in the event of total motor failure, Siemens will supply a comparable spare motor with regard to the mounting dimensions and functions (the type series may vary).
 - If a spare motor is provided within the 3-year period, this will not mean that the warranty restarts.
 - Replacement motors delivered after the active production of the motor series are also identified as spare motors on the rating plate.
 - Spare parts are offered only for these spare motors on request; repair and replacement are not possible.
 - After a period of 3 years (after the delivery of the original motor), it is only possible to repair these motors (depending on the availability of the spare parts required).
 - For up to 5 years after the delivery of the original motor, spare parts will be available and for a further 5 years, Siemens will provide information about spare parts and will supply documents when required.
- When repair parts are ordered, the following details must be provided:
 - Designation and part number
 - Article No. and factory number of the motor.
- For bearing types, see Catalog Section 1 "Introduction".
- For standard components, a commitment to supply repaired parts does not apply.
- Support hotline
In Germany
Phone +49 (0) 911 895 7222

You will find telephone numbers for other countries on our Internet site:

www.siemens.com/automation/service&support

Standard induction motors optimized for converter operation – VSD10 line

Dimensions

Notes on the dimensions

Overview

- Dimensional designations according to EN 50347 and IEC 60072.

Fits

The shaft extensions specified in the dimension tables (DIN 748) and centering spigot diameters (EN 50347) are machined with the following fits:

Dimension designation	ISO fit	DIN	ISO 286-2
D, DA	to 30	j6	
	over 30 to 50	k6	
	over 50	m6	
N	to 250	j6	
	over 250	h6	
F, FA		h9	
K		H17	
S	flange (FF)	H17	

The drilled holes of couplings and belt pulleys should have an ISO fit of at least H7.

- Dimensional tolerances

For the following dimensions, the admissible deviations are given below:

Dimension designation	Dimension	Admissible deviation
H	to 250	- 0.5
	over 250	- 1.0
E, EA		- 0.5

Keyways and feather keyways (dimensions GA, GC, F, and FA) are made in compliance with DIN 6885 Part 1.

- All dimensions are specified in mm.

Dimension sheet generator (within the DT Configurator)

Overview

A dimensional drawing can be created in the "Drive Technology Configurator" (DT Configurator) for every configurable motor. A dimensional drawing can be requested for every other motor.

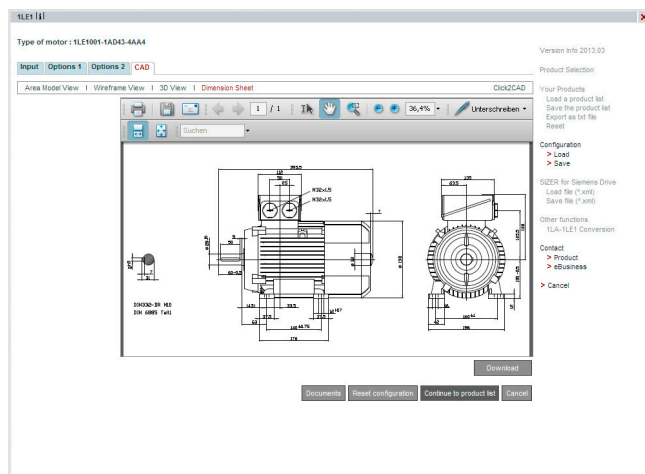

When a complete Article No. is entered with or without order codes, a dimensional drawing can be called up under the "Documentation" tab.

These dimensional drawings can be presented in different views and sections and printed.

The corresponding dimension sheets can be exported, saved and processed further in DXF format (interchange/import format for CAD systems) or as bitmap graphics.

Online access in the Siemens Industry Mall

The DT Configurator is integrated into the Siemens Industry Mall and can be used on the Internet without installation.

German: www.siemens.de/dt-konfigurator
English: www.siemens.com/dt-konfigurator

Standard induction motors optimized for converter operation – VSD10 line

Dimensions · Aluminum series SIMOTICS GP

Standard Efficiency – self-ventilated · Frame sizes 100 L to 160 L

Dimensional drawings

Type of construction IM B3

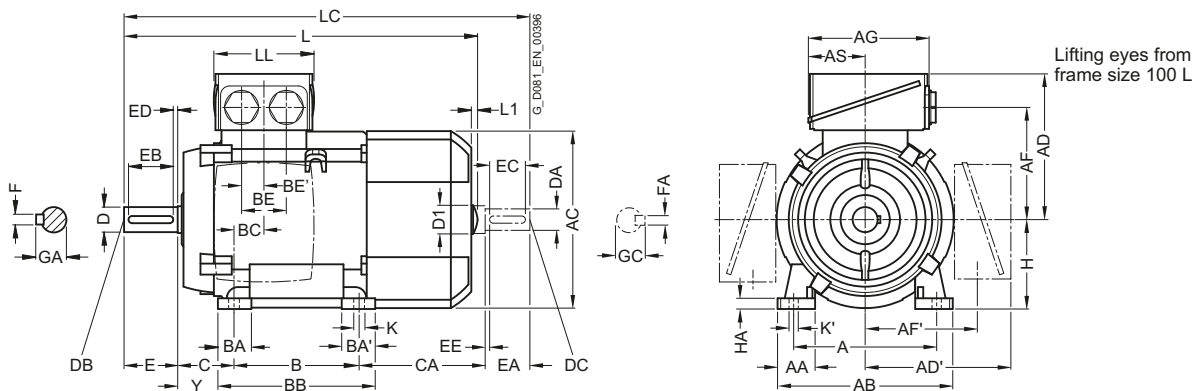

Types of construction IM B5 and IM V1

For flange dimensions, see page 1/48 (Z = the number of retaining holes)

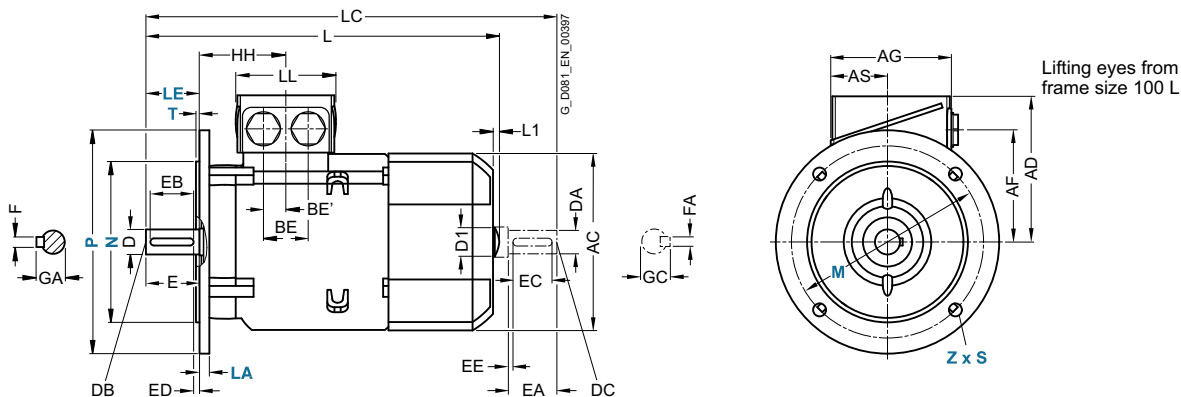

5

For motor		Dimension designation acc. to IEC																						
Frame size	Motor type 1LE1092	No. of poles	A	AA	AB	AC	AD	AD'	AF	AF'	AG	AS	B	BA	BA'	BB	BC	BE	BE'	C	CA	H	HA	Y
100 L	All	2, 4	160	42	196	198	166	166	125.5	125.5	135	63.5	140	37.5	37.5	176	33.5	50	25	63	141	100	12	45
112 M	All	2, 4	190	46	226	222	177	177	136.5	136.5	135	63.5	140	37.5	37.5	176	26	50	25	70	129.7	112	12	52
132 S	All	2, 4	216	53	256	262	202	202	159.5	159.5	155	70.5	140	38	76	218	26.5	48	24	89	128.5	132	15	69
132 M	All	2, 4	216	53	256	262	202	202	159.5	159.5	155	70.5	178	38	76	218	26.5	48	24	89	128.5	132	15	69
160 M	All	2, 4	254	60	300	314	236.5	236.5	190	190	175	77.5	210	44	89	300	47	57	28.5	108	148	160	18	85
160 L	All	2, 4	254	60	300	314	236.5	236.5	190	190	175	77.5	254	44	89	300	47	57	28.5	108	148	160	18	85

Standard induction motors optimized for converter operation – VSD10 line

Dimensions · Aluminum series SIMOTICS GP

Standard Efficiency – self-ventilated · Frame sizes 100 L to 160 L

Dimensional drawings

Type of construction IM B35

For flange dimensions, see page 1/48 (Z = the number of retaining holes)

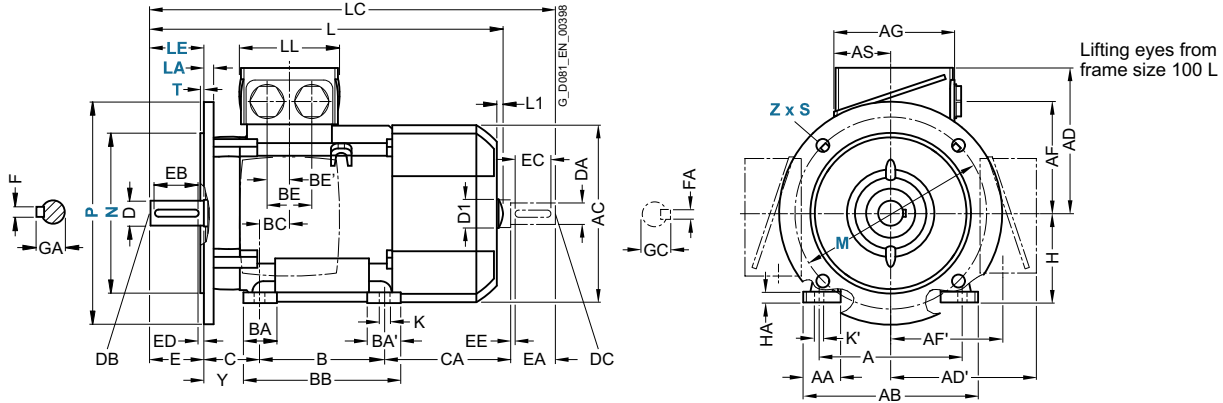

Type of construction IM B14

For flange dimensions, see page 1/48 (Z = the number of retaining holes)

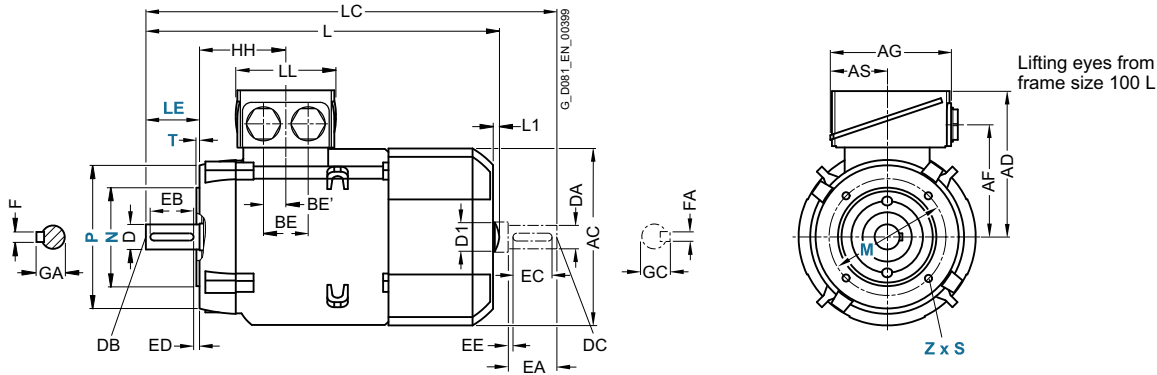

For motor Frame size	Motor type 1LE1092	No. of poles	Dimension designation acc. to IEC				DE shaft extension						NDE shaft extension											
			HH	K	K'	L ¹⁾	L1	D1	LC	LL	D	DB	E	EB	ED	F	GA	DA	DC	EA	EC	EE	FA	GC
100 L	All	2, 4	96.5	12	16	395.5	7	32	454	112	28	M10	60	50	5	8	31	24	M8	50	40	5	8	27
112 M	All	2, 4	96	12	16	389	7	32	450	112	28	M10	60	50	5	8	31	24	M8	50	40	5	8	27
132 S	All	2, 4	115.5	12	16	465	8.5	39	535.5	130	38	M12	80	70	5	10	41	28	M10	60	50	5	8	31
132 M	All	2, 4	115.5	12	16	465	8.5	39	535.5	130	38	M12	80	70	5	10	41	28	M10	60	50	5	8	31
160 M	All	2, 4	155	15	19	604	10	45	730	145	42	M16	110	90	10	12	45	42	M16	110	90	10	12	45
160 L	All	2, 4	155	15	19	604	10	45	730	145	42	M16	110	90	10	12	45	42	M16	110	90	10	12	45

¹⁾ The length is specified as far as the tip of the fan cover.

Standard induction motors optimized for converter operation – VSD10 line

Dimensions · Cast-iron series SIMOTICS SD

Standard Efficiency – self-ventilated · Frame sizes 100 L to 160 L

Dimensional drawings

Type of construction IM B3

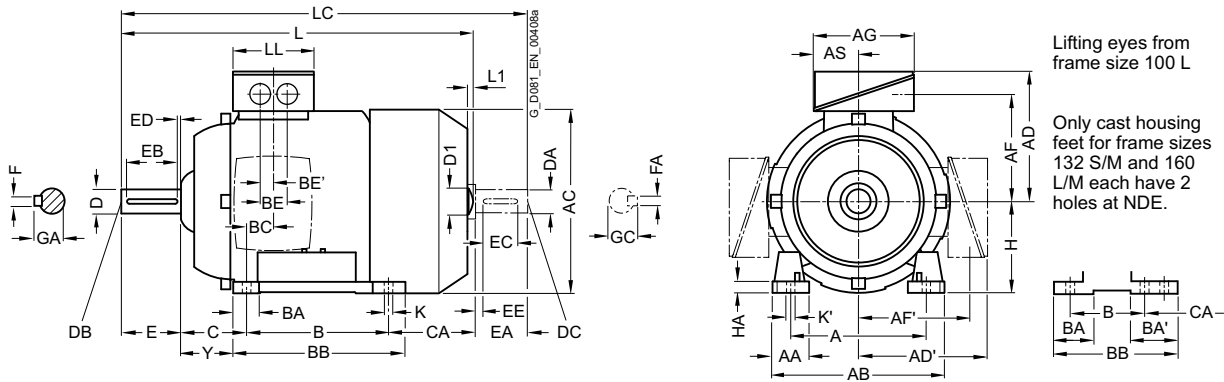

Types of construction IM B5 and IM V1

For flange dimensions, see page 1/48 (Z = the number of retaining holes)

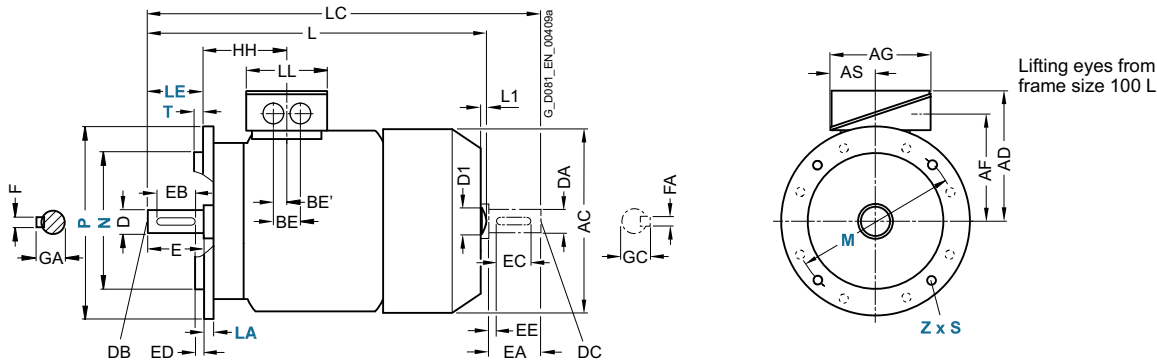

5

For motor	Dimension designation acc. to IEC																							
Frame size	Motor type 1LE1592	No. of poles	A	AA	AB	AC	AD	AD'	AF	AF'	AG	AS	B	BA	BA'	BB	BC	BE	BE'	C	CA	H	HA	Y
100 L	All	2, 4	160	42	196	217	193	193	147	147	163	80.5	140	48	48	176	37.5	48	24	63	141	100	12	45
112 M	All	2, 4	190	46	226	239	195	195	150	150	163	80.5	140	48	48	176	30	48	24	70	130	112	12	52
132 S	All	2, 4	216	53	256	281	214.5	214.5	169	169	163	80.5	140	52 ¹⁾	89 ¹⁾	218 ²⁾	26.5	48	24	89	166.5	132	15	69
132 M	All	2, 4	216	53	256	281	214.5	214.5	169	169	163	80.5	178	52 ¹⁾	89 ³⁾	218	26.5	48	24	89	128.5	132	15	69
160 M	All	2, 4	254	60	300	333.5	265	265	213	213	190	92	210	73 ⁴⁾	117 ⁴⁾	300 ⁵⁾	37	60	30	108	192	160	18	85
160 L	All	2, 4	254	60	300	333.5	265	265	213	213	190	92	254	73 ⁴⁾	117 ⁶⁾	300	37	60	30	108	148	160	18	85

1) With screwed-on feet, this dimension is 41 mm.
 2) With screwed-on feet, this dimension is 180 mm.
 3) With screwed-on feet, this dimension is 79 mm.

4) With screwed-on feet, this dimension is 51 mm.
 5) With screwed-on feet, this dimension is 256 mm.
 6) With screwed-on feet, this dimension is 95 mm.

Standard induction motors optimized for converter operation – VSD10 line

Dimensions · Cast-iron series SIMOTICS SD

Standard Efficiency – self-ventilated · Frame sizes 100 L to 160 L

Dimensional drawings

Type of construction IM B35

For flange dimensions, see page 1/48 (**Z** = the number of retaining holes)

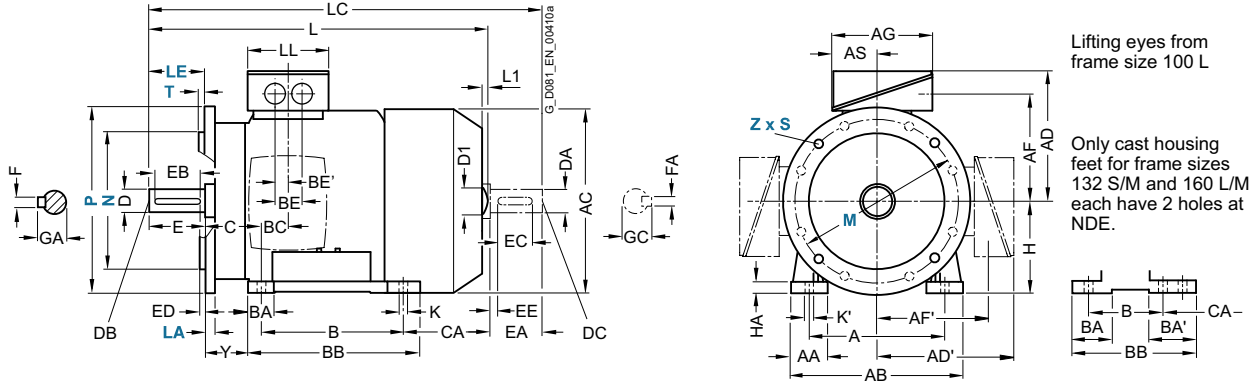

Type of construction IM B14

For flange dimensions, see page 1/48 (**Z** = the number of retaining holes)

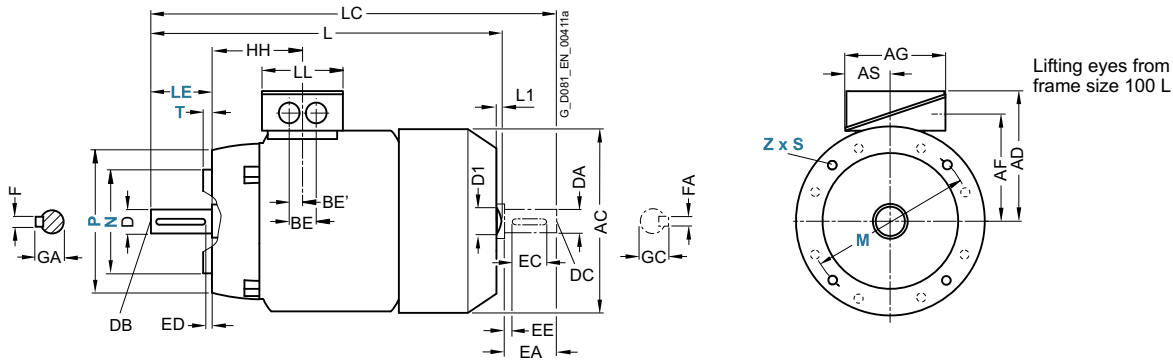

For motor Frame size	Motor type 1LE1592	No. of poles	Dimension designation acc. to IEC							DE shaft extension						NDE shaft extension								
			HH	K	K'	L	L1	D1	LC	LL	D	DB	E	EB	ED	F	GA	DA	DC	EA	EC	EE	FA	GC
100 L	All	2, 4	100.5	12	16	397.5	7	32	454	134	28	M10	60	50	5	8	31	24	M8	50	40	5	8	27
112 M	All	2, 4	100.5	12	16	390.5	7	32	450	134	28	M10	60	50	5	8	31	24	M8	50	40	5	8	27
132 S	All	2, 4	115.5	12	16	466.5	8.5	39	535.5	134	38	M12	80	70	5	10	41	28	M10	60	50	5	8	31
132 M	All	2, 4	115.5	12	16	466.5	8.5	39	535.5	134	38	M12	80	70	5	10	41	28	M10	60	50	5	8	31
160 M	All	2, 4	145	14.5	18	606	10	45	730	165	42	M16	110	90	10	12	45	42	M16	110	90	10	12	45
160 L	All	2, 4	145	14.5	18	606	10	45	730	165	42	M16	110	90	10	12	45	42	M16	110	90	10	12	45

Standard induction motors optimized for converter operation – VSD10 line

Dimensions · Cast-iron series SIMOTICS SD

Standard Efficiency – self-ventilated · Frame sizes 180 M to 250 M

Dimensional drawings

Type of construction IM B3

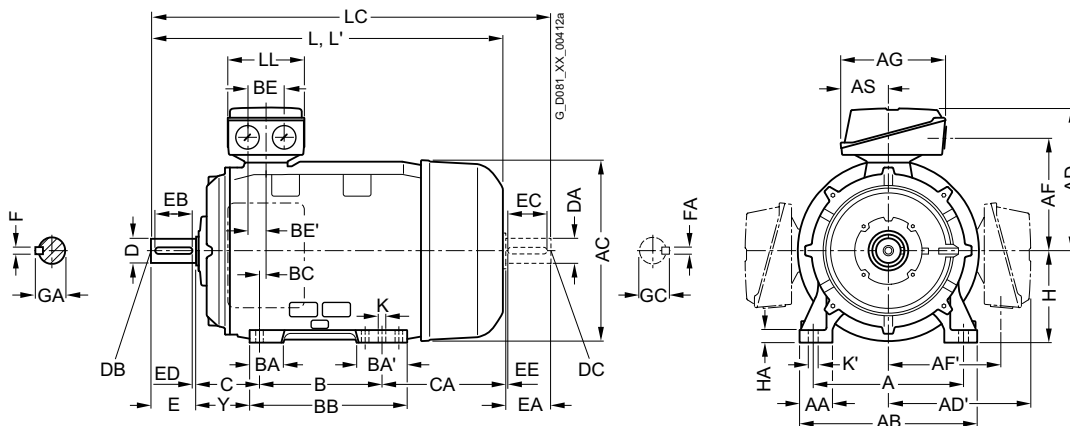

Types of construction IM B5 and IM V1

For flange dimensions, see page 1/48 (Z = the number of retaining holes)

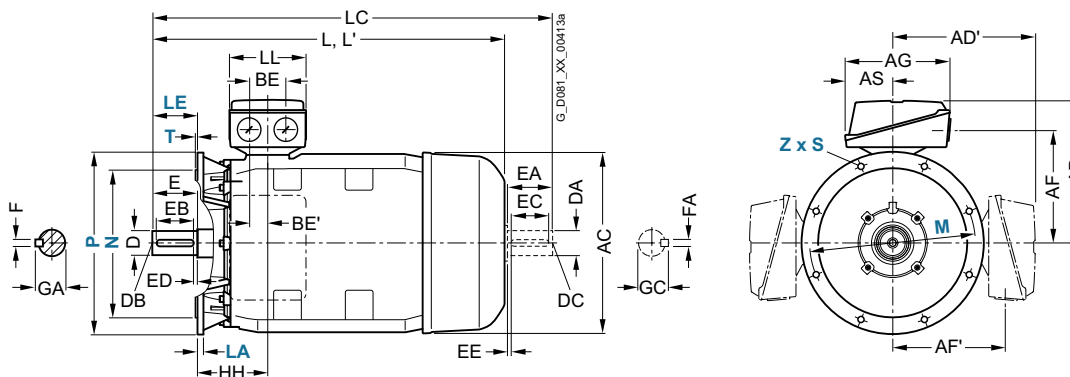

5

For motor			Dimension designation acc. to IEC																		
Frame size	Motor type	No. of poles	A	AA	AB	AC	AD	AD'	AF	AF'	AG	AS	B	BA	BA'	BB	BC	BE	BE'	C	CA
180 M	1EA2	2	279	65	339	356	286	286	234	234	190	92	241	85	120	328	34	60	30	121	202
	1EB2	4											279								
180 L	1EB4	4																			
200 L	2AA4	2	318	70	378	396	315	315	259	259	266	112	305	104	104	355	31	85	42.5	133	177
	2AA5	2																			
	2AB5	4																			
225 S	2BB0	4	356	80	436	449	338	338	282	282	266	112	311	92	117	361	15	85	42.5	149	253
225 M	2BA2	2																			
	2BB2	4																			
250 M	2CA2	2	406	100	490	497	410	410	322	322	319	145	349	102	102	409	24	110	55	168	230
	2CB2	4																			

Standard induction motors optimized for converter operation – VSD10 line

Dimensions · Cast-iron series SIMOTICS SD

Standard Efficiency – self-ventilated · Frame sizes 180 M to 250 M

Dimensional drawings

Type of construction IM B35

For flange dimensions, see page 1/48 (**Z** = the number of retaining holes)

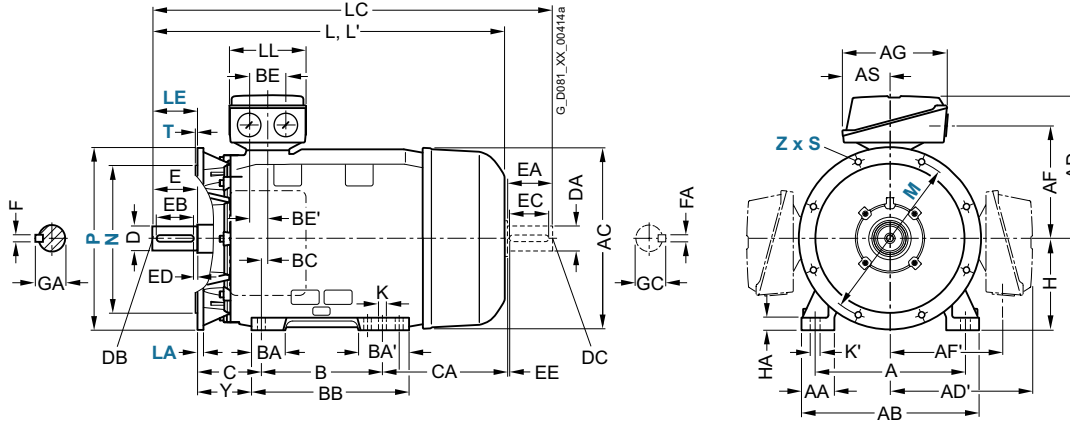

For motor			Dimension designation acc. to IEC										DE shaft extension					NDE shaft extension																		
Frame size	Motor type 1LE1592-	No. of poles	H	HA	Y	HH	K	K'	L	L'	LC	LL	D	DB	E	EB	ED	F	GA	DA	DC	EA	EC	EE	FA	GC										
180 M	1EA2	2	180	20	95	155	15	19	668	668	784	165	48	M16	110	100	5	14	52	48	M16	110	100	5	14	51.5										
	1EB2	4							698	698	814																									
180 L	1EB4	4																																		
200 L	2AA4	2	200	25	108	164	19	25	721	755	835	197	55	M20	110	100	5	16	59	55	M20	110	100	5	16	59										
	2AA5	2																																		
	2AB5	4																																		
225 S	2BB0	4	225	34	124	164	19	25	788	–	903	197	60	M20	140	125	10	18	64	55	M20	110	100	5	16	59										
225 M	2BA2	2							818	852	933																55	110	100	5	16	59	48	M16	14	51.5
	2BB2	4							848	–	963																60	140	125	10	18	64	55	M20	16	59
250 M	2CA2	2	250	40	138	192	24	30	887	924	1002	233	60	M20	140	125	10	18	64	55	M20	110	100	5	16	59										
	2CB2	4							–	–	1032																65	69	60	140	125	10	18	64		

Standard induction motors optimized for converter operation – VSD10 line

Dimensions · Cast-iron series SIMOTICS SD

Standard Efficiency – self-ventilated · Frame sizes 280 S to 315 L

Dimensional drawings

Type of construction IM B3

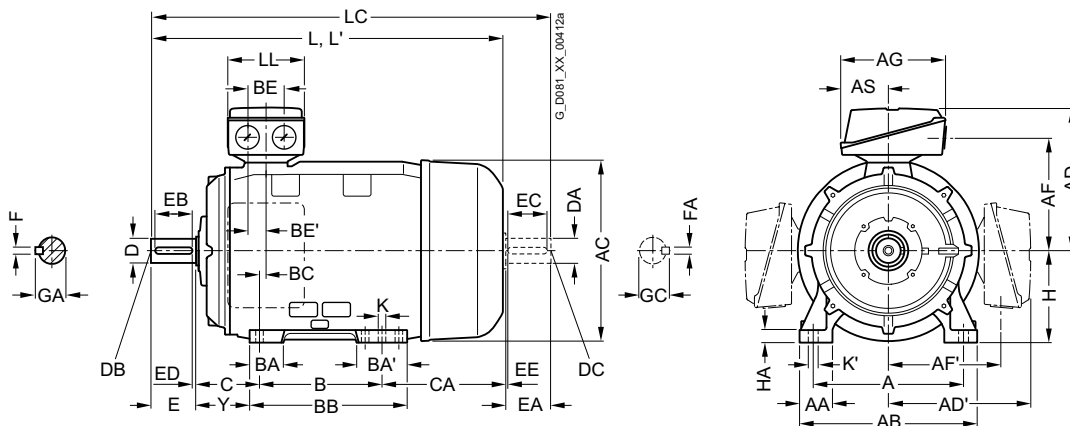

Types of construction IM B5 and IM V1

For flange dimensions, see page 1/48 (Z = the number of retaining holes)

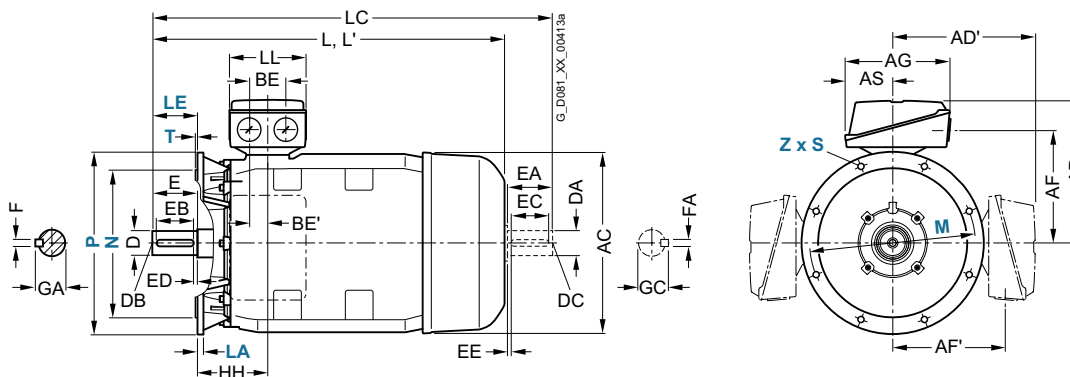

5

For motor			Dimension designation acc. to IEC																		
Frame size	Motor type	No. of poles	A	AA	AB	AC	AD	AD'	AF	AF'	AG	AS	B	BA	BA'	BB	BC	BE	BE'	C	CA
280 S	2DA0	2	457	100	540	551	433	433	345	345	319	145	368	101	152	479	20	110	55	190	267
	2DB0	4																			
280 M	2DA2	2	457	100	540	551	433	433	345	345	319	145	419	101	152	479	20	110	55	190	216
	2DB2	4																			
315 S	3AB0	4	508	120	610	616	515	515	404	404	374	164	406	113	170	527	22	110	55	216	295
315 M	3AB2 ¹⁾	4	508	120	610	616	515	515	404	404	374	164	457	113	170	578	22	110	55	216	409
315 L ¹⁾	3AB4	4	508	120	610	616	515	515	404	404	374	164	508	113	170	578	22	110	55	216	358
	3AB5	4																			

¹⁾ For orders with screwed-on feet (order code **H01**), these screwed-on feet have 3 drilled holes on the NDE side with the dimension B 406 mm, 457 mm, and 508 mm respectively; the dimension BB is 666 mm.

Standard induction motors optimized for converter operation – VSD10 line

Dimensions · Cast-iron series SIMOTICS SD

Standard Efficiency – self-ventilated · Frame sizes 280 S to 315 L

Dimensional drawings

Type of construction IM B35

For flange dimensions, see page 1/48 (Z = the number of retaining holes)

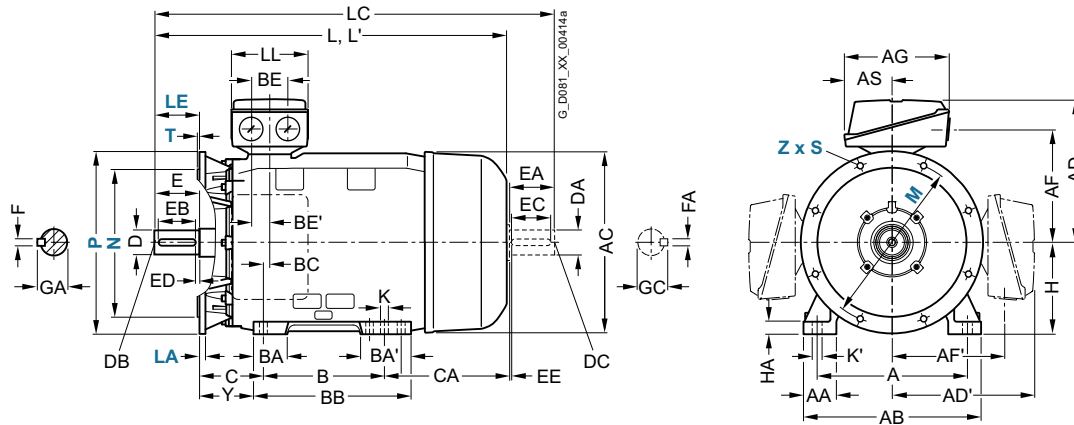

For motor			Dimension designation acc. to IEC										DE shaft extension					NDE shaft extension								
Frame size	Motor type 1LE1592-	No. of poles	H	HA	Y	HH	K	K'	L	L'	LC	LL	D	DB	E	EB	ED	F	GA	DA	DC	EA	EC	EE	FA	GC
280 S	2DA0	2	280	40	160	210	24	30	960	998	1105	233	65	M20	140	125	10	18	69	60	M20	140	125	10	18	64
	2DB0	4																								
280 M	2DA2	2	280	40	160	210	24	30	960	998	1105	233	65	M20	140	125	10	18	69	60	M20	140	125	10	18	64
	2DB2	4																								
315 S	3AB0	4	315	50	181	238	28	35	1082	–	1227	299	80	M20	170	140	25	22	85	70	M20	140	125	10	20	74.5
315 M	3AB2 ¹⁾	4	315	50	181	238	28	35	1247	–	1392	299	80	M20	170	140	25	22	85	70	M20	140	125	10	20	74.5
315 L ¹⁾	3AB4	4	315	50	146	238	28	35	1247	–	1547	299	80	M20	170	140	25	22	85	70	M20	140	125	10	20	74.5
	3AB5	4																								

¹⁾ For orders with screwed-on feet (order code **H01**), these screwed-on feet have 3 drilled holes on the NDE side with the dimension B 406 mm, 457 mm, and 508 mm respectively; the dimension BB is 666 mm.

Standard induction motors optimized for converter operation – VSD10 line

Dimensions · Cast-iron series SIMOTICS SD

Notes



6/2	Orientation
6/25	Article number code
6/27	Zones 21, 22, and 2 with types of protection Ex tb, Ex tc, Ex ec
6/27	IE4 Super Premium Efficiency
6/27	<ul style="list-style-type: none"> • Cast-iron series 1MB55 – self-ventilated
6/29	IE3 Premium Efficiency
6/29	<ul style="list-style-type: none"> • Aluminum series 1MB10 – self-ventilated
6/31	<ul style="list-style-type: none"> • Cast-iron series 1MB15, 1MB16 – self-ventilated
6/35	<ul style="list-style-type: none"> • Cast-iron series 1MB55, 1MB58 – self-ventilated
6/38	IE2 High Efficiency
6/38	<ul style="list-style-type: none"> • Aluminum series 1MB10 – self-ventilated
6/40	<ul style="list-style-type: none"> • Cast-iron series 1MB15, 1MB16 – self-ventilated
6/44	IE1 Standard Efficiency
6/44	<ul style="list-style-type: none"> • Aluminum series 1MB10 – self-ventilated
6/46	Zone 1 with type of protection Ex eb
6/46	IE3 Premium Efficiency
6/46	<ul style="list-style-type: none"> • Cast-iron series 1MB1543, 1MB1643, 1MB5543, 1MB5643 – self-ventilated
6/52	Zone 1 with types of protection Ex db, Ex db eb
6/52	IE3 Premium Efficiency
6/52	<ul style="list-style-type: none"> • Cast-iron series 1MB15.3, 1MB55.3 self-ventilated
6/56	<ul style="list-style-type: none"> • Cast-iron series 1MB15.6, 1MB55.6 self-ventilated
6/59	<ul style="list-style-type: none"> • Cast-iron series 1MB15.7, 1MB55.37 self-ventilated
6/62	<ul style="list-style-type: none"> • Cast-iron series 1MB18.3, 1MB58.3 self-ventilated
6/66	Article No. supplements and special versions
6/66	Voltages
6/71	Types of construction
6/84	Motor protection
6/89	Terminal box position
6/94	Options
6/119	Accessories

6/120	Dimensions
6/120	Notes on the dimensions
6/121	Dimension sheet generator
6/122	Dimensions · Aluminum series SIMOTICS XP
6/122	IE3 – 1MB1 with types of protection Ex tb, Ex tc, Ex ec – self-ventilated
6/122	<ul style="list-style-type: none"> • Frame sizes 80 M to 160 L
6/124	IE2, IE1 – 1MB1 with types of protection Ex tb, Ex tc, Ex ec – self-ventilated
6/124	<ul style="list-style-type: none"> • Frame sizes 80 M to 160 L
6/126	Dimensions · Cast-iron series SIMOTICS XP
6/126	IE4, IE3 – 1MB5 with types of protection Ex tb, Ex tc, Ex ec – self-ventilated
6/126	<ul style="list-style-type: none"> • Frame sizes 315 bis 450
6/126	IE3 – 1MB1 with types of protection Ex tb, Ex tc, Ex ec – self-ventilated
6/130	<ul style="list-style-type: none"> • Frame sizes 71 M to 160 L
6/132	<ul style="list-style-type: none"> • Frame sizes 180 M to 315 L
6/132	IE3 – 1MB1 with type of protection Ex eb – self-ventilated
6/134	<ul style="list-style-type: none"> • Frame sizes 71 M to 160 L
6/136	<ul style="list-style-type: none"> • Frame sizes 180 M to 280 M
6/136	IE3 – 1MB5 with type of protection Ex eb – self-ventilated
6/138	<ul style="list-style-type: none"> • Frame sizes 315 S to 315 L
6/138	IE3 – 1MB1 with type of protection Ex db, Ex db eb – self-ventilated
6/140	<ul style="list-style-type: none"> • Frame sizes 71 M to 160 L
6/142	<ul style="list-style-type: none"> • Frame sizes 180 M to 280 M
6/142	IE3 – 1MB5 with type of protection Ex db, Ex db eb – self-ventilated
6/144	<ul style="list-style-type: none"> • Frame sizes 315 S to 355 L
6/144	IE2 – 1MB1 with types of protection Ex tb, Ex tc, Ex ec – self-ventilated
6/146	<ul style="list-style-type: none"> • Frame sizes 71 M to 160 L
6/148	<ul style="list-style-type: none"> • Frame sizes 180 M to 250 M
6/150	<ul style="list-style-type: none"> • Frame sizes 280 S to 315 L

SIMOTICS XP 1MB1, 1MB5 explosion-protected motors

Orientation

Overview

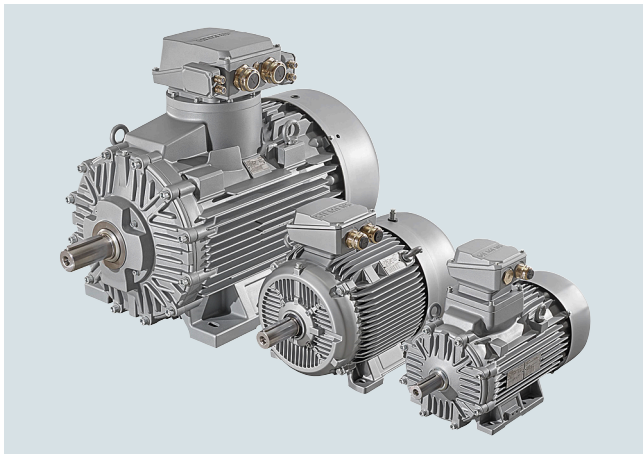

In many industrial and public sectors, explosion protection or explosion hazards are ever-present, e.g. in the chemicals industry, in refineries, on drilling platforms, at gas stations, in feed manufacturing and in sewage treatment plants.

The risk of explosion is always present when gases, fumes, mist or dust are mixed with oxygen in the air in an explosive ratio close to sources of ignition that are able to release the so-called minimum ignition energy.

In the chemical and petrochemical industries in particular, when crude oil and natural gas are transported, or in mining, milling (e.g. grain and granular solids), this can result in serious injury to persons and damage to equipment.

To ensure maximum safety in these areas, legislators in most countries have implemented appropriate stipulations in the form of laws and regulations based on national and international standards.

Explosion-protected equipment is designed such that an explosion can be prevented when it is used properly.

The explosion-protected equipment can be designed in accordance with various types of protection.

The local conditions must be subdivided into specified zones by the user with the assistance of the responsible authorities in accordance with the frequency of occurrence of an explosion hazard. Device (equipment) categories are assigned to these zones. The zones are then subdivided into possible types of protection and therefore into possible equipment (product) types.

Classification of zones

Areas subject to explosion hazard are divided into zones. Division into zones depends on the chronological and geographical probability of the presence of a hazardous, potentially explosive atmosphere. Information and specifications for classification of the zones are laid down in the following standards:

- IEC/EN 60079-10-1 for gas atmospheres
- IEC/EN 60079-10-2 for dust atmospheres

Further, a distinction is made between various explosion groups as well as temperature classes and these are included in the hazard assessment.

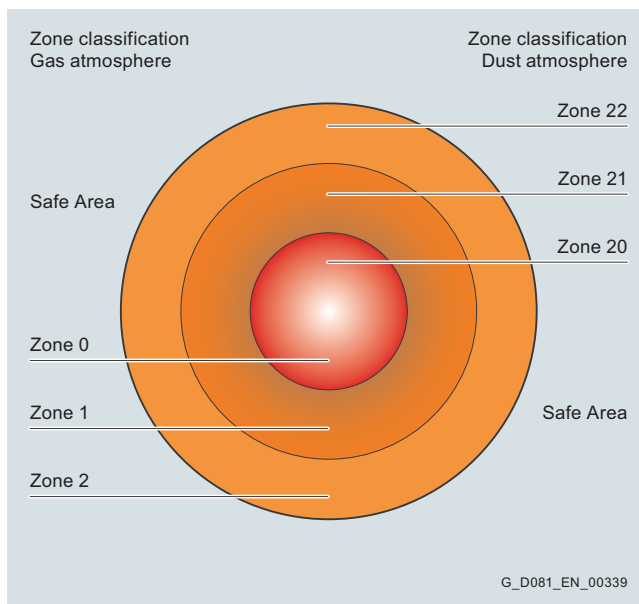

Depending on the particular zone and therefore the associated hazard, operating equipment must comply with defined minimum requirements regarding the type of protection. The different types of protection require corresponding measures to prevent ignition that should be implemented at the motor in order to prevent a surrounding explosive atmosphere from being ignited.

SIMOTICS XP 1MB1, 1MB5 explosion-protected motors

Orientation

Overview

Zone	Zone definition acc. to	Assigned types of protection	Category according to 2014/34/EU	Equipment protection level acc. to IEC/EN 60079-0
Gas 1) 2) Dust 1) 2)	IEC/EN 60079-10-1 for gas atmospheres IEC/EN 60079-10-2 for dust atmospheres			
0	- An area in which an explosive gas atmosphere is present continuously, over a long period or frequently .	Low-voltage motors not permitted	1	Ga
1	- An area in which it is expected that an explosive gas atmosphere will be present occasionally during normal operation.	Ex eb, Ex db eb; Ex db	2	Gb
2	- An area in which it is expected that an explosive gas atmosphere will be present only rarely and then only for a short period during normal operation.	Ex ec	3	Gc
- 20	An area in which there is an explosive gas atmosphere comprising a dust-air mixture continuously, over long periods or frequently .	Low-voltage motors not permitted	1	Da
- 21	An area in which it is expected that an explosive gas atmosphere comprising a dust-air mixture will be present occasionally during normal operation.	Ex tb ³⁾	2	Db
- 22	An area in which it is expected that an explosive gas atmosphere in the form of a cloud of combustible dust in air will be present only rarely and then only for a short period during normal operation.	Ex tc ⁴⁾	3	Dc

Overview of standards for explosion protection

The explosion-protected three-phase motors comply with European standards. The European standards are recognized by all member states of CENELEC (European Committee for Electrotechnical Standardization). The national electrotechnical committees of Austria, Belgium, Czech Republic, Denmark, Finland, France, Germany, Greece, Iceland, Ireland, Italy, Luxembourg, Netherlands, Norway, Spain, Sweden, Switzerland, Portugal, and United Kingdom (UK) are members of CENELEC.

Title	European standard
General provisions	EN 60079-0
Flameproof enclosure "d"	EN 60079-1
Increased safety "e"	EN 60079-7
Zone classification (gases, vapors, mist)	EN 60079-10-1
Zone classification (dust)	EN 60079-10-2
Intrinsic safety "i"	EN 60079-11
Electrical equipment in potentially explosive atmospheres (gases, vapors, mist)	EN 60079-14
Maintenance of Ex equipment	EN 60079-17
Intrinsically safe electrical systems	EN 60079-25
Equipment "Dust" (dust explosion protection by housing) "t"	EN 60079-31
Basic concepts and methodology	EN 1127-1

1) Motors of
- Zone 1 can also be used in Zone 2
- Zone 21 can also be used in Zone 22

2) Motors that are certified for gas or dust protection must not be used in hybrid mixtures! Hybrid mixtures are mixtures of flammable dusts with explosive gas/air atmospheres which can together create a dangerous explosive atmosphere if they occur at the same time. It is necessary for a competent assessor to determine and release in the individual case whether the parameters determining ignition are unfavorably affected in a particular hybrid mixture.
Information on operation in hybrid mixtures is provided in IEC 60079-14.

3) SIMOTICS XP motors with type of protection Ex tb are intended for group IIIC as a general rule, i.e. they are permitted for operation in environments with conductive and non-conductive dust.

4) SIMOTICS XP motors with type of protection Ex tc are intended for group IIIB as a general rule, i.e. they are not permitted for operation in environments with conductive dust.

SIMOTICS XP 1MB1, 1MB5 explosion-protected motors

Orientation

Overview

Temperature classes and groups

Combustible gases and vapors are divided into temperature classes according to their ignitability and into groups according to their spark ignition capacity. The marking of a three-phase motor with the codes for the type of protection, group and temperature class specifies that it can be used without danger in hazardous areas depending on the zone classification. The numerical sequence of the codes for the group and temperature class has been selected so that motors that satisfy the requirements for a certain group and temperature class also satisfy the requirements for lower groups and classes.

Temperature classes

Temperature class of electrical equipment	Maximum surface temperature of electrical equipment	Ignition temperature of gases or vapors
T1	450 °C	> 450 °C
T2	300 °C	> 300 °C
T3	200 °C	> 200 °C
T4	135 °C	> 135 °C
T5	100 °C	> 100 °C
T6	85 °C	> 85 °C

Examples of the assignment of combustible gases and vapors

Group	Temperature classes												
	T1		T2		T3		T4		T5		T6		
	Material designation	Ignition temperature °C	Material designation	Ignition temperature °C	Material designation	Ignition temperature °C	Material designation	Ignition temperature °C	Material designation	Ignition temperature °C	Material designation	Ignition temperature °C	
IIA ¹⁾	Acetone	540	i-Amyl acetate	380	Naphthas		Acetaldehyde	140					
	Ethane	515	n-Butane	365	Petrol fuels ²⁾								
	Ethyl acetate	460	n-Butyl alcohol	340	Mineral spirits								
	Ethyl chloride	510	Cyclohexanone	430	Diesel fuels ²⁾								
	Ammonia	630	1,2-Dichloroethane	440	Heating oils ²⁾								
	Benzene	555	Acetic anhydride	330	n-Hexane	240							
	Acetic acid	485											
	Carbon monoxide	605											
	Methane	595											
	Methanol	455											
	Methyl chloride	625											
	Naphtalene	520											
	Phenol	595											
	Propane	470											
Toluene	535												
IIB ¹⁾	Coal gas (town gas)	560	Ethanol	425	Hydrogen sulfide	270	Ethyl ether	180					
			Ethylene	425									
			Ethylene oxide	440									
IIC ¹⁾	Hydrogen	560	Acetylene	305					Carbon disulfide	95			

Explosion Protection Directive 2014/34/EU

Explosion protection has been fully harmonized by Directive 2014/34/EU in Germany and in the other member states of the European Union. The requirements of the new law came into force on April 20, 2016. Since then only those devices and protection systems that comply with Directive 2014/34/EU are permitted to be placed on the market.

Directive 2014/34/EU and Directive 1999/92/EC specify that only specific electrical equipment and devices are permitted to be used in the zones. The devices are assigned to equipment groups and categories.

Use of electrical equipment in accordance with EN 60079-14

Electrical equipment used in potentially explosive workshops and storage areas must comply with EN 60079-14/ VDE 0165-1 "Explosive atmospheres - Part 14: Electrical installations design, selection and erection". All other general regulations issued by the responsible supervisory authorities and the Employer's Liability Insurance Association or any specifically issued for individual case are also applicable. A plant or system subject to inspection is not permitted to be commissioned initially or following a significant modification until the plant or system has been inspected by an approved inspection agency for correctness of assembly, installation, site conditions and safe operation, taking into account the intended mode of operation. Devices compliant with Directive 2014/34/EU are permitted to be commissioned in accordance with the responsible supervisory authority. (cf. German Health and Safety at Work Regulations (BetrSichV), section 3, § 14)

¹⁾ Subgroups IIA, IIB and IIC must be specified for the types of protection Ex db, Ex eb and Ex ec described in this list in accordance with EN 60079-0.

²⁾ The minimum ignition temperature depends on the composition and lies between 220 to 300 °C, over 300 °C in special cases.

Overview

Device marking

The equipment group and category are specified in the device marking.

The device marking is defined as follows:

e.g. CE 1026 $\langle Ex \rangle$ II 2G Ex eb IIC T3 Gb

- **CE** conformity marking
CE stands for "Communautés Européennes" (European Communities)
The manufacturer of the explosion-protected devices declares by means of CE marking that the relevant product has been manufactured in accordance with all applicable regulations and requirements of the EU and the requirements laid down in Directive 2014/34/EU and the product has been subjected to the relevant conformity evaluation process.
- **0158** identification number of the inspecting authority (DEKRA)
- $\langle Ex \rangle$ Marking for prevention of explosions in accordance with Directive 2014/34/EU

Example "increased safety":

	CE	1026	$\langle Ex \rangle$	II	3	G	Ex	ec	IIC	T3	Gc
CE marking											
Number of the certifying "notified" body (1026 = FTZÚ)											
Explosion protection marking											
Equipment group: I = Underground II = All other areas											
Category: 2 (Zone 1/21) 3 (Zone 2/22)											
Ex atmosphere G = Gas D = Dust											
Explosion-protected equipment											
Type of protection Ex db, db eb, eb, ec, tb or tc (db eb = motor housing Ex db with terminal box Ex eb)											
Explosion group and explosion subgroup II = Gas (IIA, IIB or IIC) III = Dust (IIIA, IIIB or IIIC)											
Temperature class with max. surface temperature T1 = 450 °C T4 = 135 °C T2 = 300 °C T5 = 100 °C T3 = 200 °C T6 = 85 °C											
Equipment protection level (G = Gas; D = Dust): Ga = Very high protection, Da = Very high protection, Gb = High protection, Db = High protection, Gc = Increased protection, Dc = Increased protection											

SIMOTICS XP 1MB1, 1MB5 explosion-protected motors

Orientation

Overview

Overview of SIMOTICS XP 1MB1, 1MB5 explosion-protected motors

The table below contains a complete overview of our products, their types of protection and the assignment of motor types to categories. It is important to note that depending on whether the

motor is used for converter operation or line operation, different order codes are required for unique selection of the required product.

Sector	Category	Zone	Frequency of occurrence of the Ex atmosphere	Type of protection	Temperature class	Equipment protection level	Degree of protection	Motor type and if applicable order code	Operation	Order code	Utilization according to temperature class	Standard
Gases and vapors (G)	1G	0	constantly or long-term	Not admissible with low-voltage motors								
	2G	1	occasionally	Ex db eb IIC ¹⁾ (flameproof enclosure)	T1 – T4	Gb	IP55	1MB1.5, 1MB5.5	Line	–	130 (B)	IEC/EN 60079-0
				1MB1.6, 1MB5.6	Converter			B43 B44	130 (B) 155 (F)	IEC/EN 60079-1 IEC/EN 60079-7		
	3G	2	rarely or for a short period	Ex eb IIC ¹⁾ (increased safety)	T1 – T3	Gc		1MB1.4, 1MB5.4	Line	–	130 (B)/ 155 (F) ²⁾	IEC/EN 60079-0 IEC/EN 60079-7
Ex ec IIC ¹⁾ (increased safety)					1MB103, 1MB153, 1MB163			Converter	B40 B41+ B43	130 (B)		
Dust (D)	1D	20	constantly or long-term	Not admissible with low-voltage motors								
	2D	21	occasionally	Ex tb IIIC ¹⁾ : Conductive and non-conductive dust	Max. housing temperature T120 °C ⁴⁾	Db	IP65	1MB101, 1MB151, 1MB161	Line	–	130 (B)	IEC/EN 60079-0 IEC/EN 60079-31
	3D	22	rarely or for a short period	Ex tc IIIB ¹⁾ : non-conductive dust		Dc	IP55	1MB102, 1MB152, 1MB162	Converter	B40 B41+ B43		
Gases and vapors (G) and dusts (D) ³⁾	2G 2D	1 or 21	occasionally	Ex db eb IIC ¹⁾ Ex db eb IIB +B32 (flameproof enclosure)/ Ex tb IIIC ¹⁾ : Conductive and non-conductive dust	T1 – T4/ Max. housing temperature T130 °C	Gb Db	IP65	1MB1.5 +B32, 1MB5.5 +B32	Line	–	130 (B)	IEC/EN 60079-0 IEC/EN 60079-1 IEC/EN 60079-31
	2G 3D	1 or 22	Gas: occasionally dust: rarely or for a short period	Ex db eb IIC lamproof enclosure)/ Ex tb IIIB: Non-conductive dust		Gb Dc	IP55	1MB1.5 + B30 1MB5.5 + B30	Line	–	130 (B)	
				Ex db eb IIB lamproof enclosure)/ Ex tb IIIB: Non-conductive dust			1MB1.6 + B30 1MB5.6 + B30	Converter	B43 B44	130 (B) 155 (F)		
	2G 2D	1 or 21	occasionally	Ex eb IIC (increased safety)/ Ex tb IIIC: Conductive and non-conductive dust	T1 – T3/ Max. housing temperature T130 °C	gb Db	IP65	1MB1.4 + B32	Line	–	130 (B)	
	3G 3D	2 or 22	rarely or for a short period	Ex ec IIC ¹⁾ (increased safety)/ Ex tc IIIB: non-conductive dust	T1 – T3/ Max. housing temperature T120 °C ⁴⁾	Gc Dc	IP55	1MB103 +B30 1MB153 +B30 1MB163 +B30	Line	–	130 (B)	IEC/EN 60079-0 IEC/EN 60079-7 IEC/EN 60079-31
				Converter	B40 B41+ B43							

¹⁾ Highest explosion group IIC includes IIB and IIA. IIIA stands for lint, IIIB for non-conductive dust and IIIC for conductive dust. 1MB1.5, 1MB5.5 motors optionally with Ex db terminal box.

²⁾ See EU type-examination certificate.

³⁾ Motors that are certified for gas or dust protection must not be used in hybrid mixtures! Hybrid mixtures are mixtures of flammable dusts with explosive gas/air atmospheres which can together create a dangerous explosive atmosphere if they occur at the same time. It is necessary for a competent assessor to determine and release in the individual case whether the parameters determining ignition are unfavorably affected in a particular hybrid mixture. Information on operation in hybrid mixtures is provided in IEC 60079-14.

⁴⁾ For 1MB1 IE1: T140 °C
IE2: T120 °C (except T130 °C for 1MB1.11-1AD5,
1MB1.11-3AD6, 1MB1.21-1AD5 and 1MB1.21-3AD6)
IE3: T120 °C.

For 1MB5 frame sizes 400 and 450: T125 °C.

Benefits

The explosion-protected motors from Siemens offer the user numerous advantages:

- The motors are designed and constructed in accordance with Directive 2014/34/EU. As product supplier, Siemens accepts responsibility for compliance with the applicable product standards for the selected equipment.
- By using this product, the plant operating company complies with Directive 1999/92/EC in accordance with Appendix II B (ATEX 137 previously ATEX 118a). The plant manufacturer or plant operating company is responsible for correct selection and proper usage of the equipment.
- Comprehensive series of Ex motors for protection against gas and dust.
- Individual versions of motors are possible thanks to the numerous catalog options.
- Further special versions are possible on request.
- Declarations of compliance with the order 2.1 are available for a defined spectrum of Siemens motors/converters.
- The operating instructions are available in all official EU languages as well as Russian, Turkish and Chinese.
- Certificates: ATEX, IECEx, CCC-Ex, EACEx
- VIK design (see chapter 1 page 1/22)

For applications in harsh environments: SIMOTICS XP motors with a cast-iron housing

The right motor for various challenges

The following motor series are available with cast-iron housings for applications in harsh, hazardous environments:

- **Basic Line:**
Rugged, reliable motors for machine construction
- **Performance Line:**
Motors for the process industry with reinforced bearings and a more rugged coating – for requirements that extend beyond the Basic Line

Comparison: Basic Line versus Performance Line

Function	Basic Line – 1MB15	Performance Line – 1MB16
Bearing size	62, 63 from frame size 280 upwards	63
Relubrication	Optional, standard from frame size 280 upwards	Standard from frame size 160 upwards, optional for frame sizes 100 to 132
Paint system	Standard paint finish, corrosivity category C2	Special paint finish, corrosivity category C3
Drainage	Drain plug from frame size 100 upwards	Drain plug from frame size 100 upwards
Rating plate made of stainless steel	Standard from frame size 225 upwards, optional for frame sizes 71 to 200	Standard from frame size 100 upwards
Motor protection	Optional	PTC
Fan cover	Steel	Steel
Warranty	12 months	36 months

Application

The explosion-protected motors are used in the following sectors to prevent explosion hazards that result in serious injury to persons and severe damage to equipment.

- Chemical and petrochemical industry
- Production of mineral oil and gas
- Gas works
- Gas utility companies
- Gas stations
- Coking plants
- Mills (e.g. grain, solids)
- Sewage treatment plants
- Wood processing (e.g. sawdust, tree resin)
- Other industries subject to explosion hazards

SIMOTICS XP CHEMSTAR - industry-specific motor solution for Chemie, Petrochemie, Oil & Gas

see chapter 1 page 1/23

Technical specifications

General information

Ex motors are suitable for operation in electrical power systems with a voltage tolerance of $\pm 10\%$.

Ex motors in vertical type of construction with shaft extension pointing down must have a protective cover.

Standard certificate: EU type-examination certificate (ATEX), installation declaration and EU declaration of conformity, optionally IECEx, CCC-Ex and EACEx.

Note:

For all explosion-protected motors, designs according to UL and CSA are not possible.

Operating instructions are supplied as standard with explosion-protected motors in English and German. Translations are also available in all the other official EU languages as well as in Russian, Turkish, and Chinese online and on DVD.

Ambient temperature

- Standard: -20 to $+40$ °C
- Optional: -40 to $+40$ °C (order code **D03**)
- Optional: -20 to $+60$ °C (order codes **N05, N06, N07, N08**)

From 40 °C, the power is reduced. Other temperatures are available on request.

Note on Ex eb (1MB1.4):

Order codes **N05, N06, N07, N08** currently on request.

Motor connection

1MB1 and 1MB5 motors must be sealed with certified cable glands or sealing plugs.

The certificates for the motors for hazardous areas are stored with the documentation in the DT Configurator.

Certified motor protection switches/tripping units must always be used for motor protection, see Catalog IC 10.

SIMOTICS XP 1MB1, 1MB5 explosion-protected motors

Orientation

Technical specifications

Type of protection "Dust explosion protection" Ex tb, Ex tc acc. to IEC/EN 60079-31 for use in Zone 21, Zone 22.

The types of protection **Ex tb** and **Ex tc** apply to electrical equipment protected using a housing and with limited surface temperature for use in areas in which combustible dust can be present in concentration levels that could cause a fire or an explosion.

Measures are taken to prevent impermissibly high temperatures and to prevent sparks or arcs from occurring on external components of the motor.

Ex tb motors are used in areas where it is expected that an explosive atmosphere comprising dust/air mixtures will be present occasionally and for a short period.

These motors are assigned to Equipment Group II – Category 2D (corresponding to Zone 21). SIMOTICS XP motors with type of protection Ex tb are intended for group IIIC, i.e. they are permitted for operation in environments with conductive and non-conductive dust.

Ex tc motors are used in areas where it is expected that a potentially-explosive atmosphere will be caused by dust that is stirred up. If this does occur, in all probability rarely and for a short period. These motors are assigned to Equipment Group II – Category 3D (corresponding to Zone 22). SIMOTICS XP motors with type of protection Ex tc are intended for group IIIB as a general rule, i.e. they are permitted for operation in environments with non-conductive dust.

Ex tb IIIC T120 °C Gb for use in Zone 21:

Design for Zone 21, as well as Zone 22 for conductive dust (degree of protection: IP65) equipment category 2D. Motors Ex tb IIIC T120 °C Db ¹⁾: 1MB1.1 and 1MB5.1 are suitable for use in explosive dust atmospheres with conductive or non-conductive dust that are present occasionally (Zone 21) or rarely (Zone 22). For rated operation, the surface temperature is 120 °C ¹⁾.



Ex tc IIIB T120 °C Gc for use in Zone 22:

Version for Zone 22 with non-conductive dust (degree of protection IP55) equipment category 3D. Motors Ex tc IIIB T120 °C Dc ¹⁾: 1MB1.2 and 1MB5.2 are suitable for use in explosive dust atmospheres with non-conductive dust that are present rarely (Zone 22). For rated operation, the surface temperature is 120 °C ¹⁾.

For use in Zone 22 and in combination with conductive dust (e.g. carbon dust), the motor for Zone 21 must be selected.

The motors have a terminal box, a sealing system, an external grounding terminal, a metal fan cover and a metal external fan according to standard IEC/EN 60079-0.

Identification on the rating plate:

- Zone 21:  II 2D Ex tb IIIC T120 °C Db ¹⁾
- Zone 22:  II 3D Ex tc IIIB T120 °C Dc ¹⁾

Number of the EU type-examination certificate

Pole-changing versions:

- Ex tb (Zone 21): Not possible
- Ex tc (Zone 22): Possible on request.

Type of protection "increased safety" Ex ec acc. to IEC/EN 60079-7 for use in Zone 2

Type of protection **Ex ec** ensures that a motor in normal operation as well as when operated under deviating conditions as specified in the standard is not able to ignite a surrounding explosive gas atmosphere. The maximum surface temperature that can occur during operation must be below the limit temperature of the temperature class marked on the motor, e.g. T3.

Measures are taken to prevent impermissibly high temperatures and to prevent sparks or arcs from occurring on the inside and on external components of the motor.

Motors with type of protection **Ex ec** are used in an explosive atmosphere where this atmosphere is expected to reach a level that poses a risk **only rarely** and then also **only for a short period**. These motors are assigned to Equipment Group II – Category 3G (corresponding to Zone 2).

Ex ec motors can additionally optionally have type of protection Ex tc with Group IIIB (non-conductive dust) acc. to IEC/EN 60079-31 for use in Zone 22 (present rarely).

Ex ec IIC T3 Gc

➔ Standard version for paint film thicknesses < 200 µm.

Optional Ex ec IIB T3 Gc (order code B31)

➔ Optional version for paint film thicknesses > 200 µm to < 2 mm.

For further information about paint and paint film thicknesses, see page 1/14 onwards.

Optional type of protection **Ex ec/Ex tc** for use in Zone 2/22 ²⁾

The motors must be ordered with:

Version additionally for dust Ex tc - Zone 22 – order code **B30** ²⁾



Motors

- Ex ec IIC T3 Gc: 1MB1.3 and 1MB5.3
- Ex ec IIB T3 Gc: 1MB1.3 and 1MB5.3 (order code **B31**) have a terminal box (similar to Ex eb), a sealing system, an external grounding terminal and a metal fan cover according to standard IEC/EN 60079-0. The temperature class is T1-T3.

With optional order with order code **B30** additionally a metal external fan.

The combination **B30+B31** is possible.

identification on the rating plate:

- Zone 2:  II 3G Ex ec IIC T3 Gc
- Zone 2/22:  II 3G Ex ec IIB T3 Gc
-  II 3D Ex tc IIIB T120 °C Dc ²⁾

Number of the EU type-examination certificate

Please inquire in the case of:

- Utilization according to temperature class 155 (F)
- For pole-changing versions

¹⁾ IE1: T140 °C
IE2: T120 °C (except T130 °C for 1MB1.11-1AD5, 1MB1.11-3AD6, 1MB1.21-1AD5 and 1MB1.21-3AD6)
IE3: T120 °C

²⁾ Motors that are certified for gas or dust protection must not be used in hybrid mixtures! Hybrid mixtures are mixtures of flammable dusts with explosive gas/air atmospheres which can together create a dangerous explosive atmosphere if they occur at the same time. It is necessary for a competent assessor to determine and release in the individual case whether the parameters determining ignition are unfavorably affected in a particular hybrid mixture. Information on operation in hybrid mixtures is provided in IEC 60079-14.

Technical specifications

Type of protection "increased safety" Ex eb acc. to IEC/EN 60079-7 for use in Zone 1

With type of protection **Ex eb**, additional measures are taken to prevent the possibility of high temperatures and to prevent sparks or arcs from occurring on the inside and on external components of the motor.

In case of a malfunction, the drive must be switched off within the time t_E . This ensures that none of the motor's components reaches the ignition temperature of the surrounding gas in the event of a malfunction. The t_E time is the time interval in seconds within which an AC rotor or the stator winding heats up to its limit temperature through the locked-rotor current I_A from the temperature in the rated operation with the highest permissible ambient temperature.

Motors with type of protection **Ex eb** are used in an explosive atmosphere where a hazardous explosive atmosphere is expected occasionally to reach a level that poses a risk. These motors are assigned to Equipment Group II – Category 2G (corresponding to Zone 1). They ensure a high degree of safety.

Optionally Ex eb motors can additionally have type of protection Ex tb with Group IIIC (conductive and non-conductive dust) acc. to IEC/EN 60079-31 for use in Zone 21 (occasionally present).

Ex eb IIC T3 Gb

→ Standard version for paint film thicknesses < 200 µm.

Optional Ex eb IIB T3 Gb (order code **B31**)

→ Optional version for paint film thicknesses > 200 µm to < 2 mm.

For further information about paint and paint film thicknesses, see page 1/14 onwards.

Optional type of protection Ex eb/Ex tb for use in Zone 1/21²⁾

The motors must be ordered with:

Version additionally for dust Ex tb - Zone 21 – order code **B32**²⁾

Motors



- Ex eb IIC T3 Gb: 1MB1.4 and 1MB5.4
- Ex eb IIB T3 Gb: 1MB1.4 and 1MB5.4 (order code **B31**)

have a terminal box (Ex eb), a sealing system, an external grounding terminal and a metal fan cover according to standard IEC/EN 60079-0. The winding is specially designed and tested for the temperature class T1/T2 or T3.

With optional order with order code **B32** additionally a metal external fan.

The combination **B32+B31** is possible.

Identification on the rating plate:

- Zone 1:  II 2G Ex eb IIC T3 Gb
- Zone 1/21:  II 2G Ex eb IIC T3 Gb
-  II 2D Ex tb IIIC T120 °C Db¹⁾

Number of the EU type-examination certificate

Please inquire in the case of:

- Increased coolant temperatures
- Marine certificates

¹⁾ IE1: T140 °C

IE2: T120 °C (except T130 °C for 1MB1.11-1AD5, 1MB1.11-3AD6, 1MB1.21-1AD5 and 1MB1.21-3AD6)

IE3: T120 °C

²⁾ Motors that are certified for gas or dust protection must not be used in hybrid mixtures! Hybrid mixtures are mixtures of flammable dusts with explosive gas/air atmospheres which can together create a dangerous explosive atmosphere if they occur at the same time. It is necessary for a competent assessor to determine and release in the individual case whether the parameters determining ignition are unfavorably affected in a particular hybrid mixture.

Information on operation in hybrid mixtures is provided in IEC 60079-14.

Type of protection "flameproof enclosure" Ex db eb and Ex db acc. to IEC/EN 60079-1 for use in Zone 1

Type of protection **Ex db** is achieved by ensuring that any explosion is contained within the motor. The housing must resist the pressure of the explosion and also prevent ignition from the internal to the external atmospheres.

Motors with type of protection **Ex db** are used in an explosive atmosphere where a hazardous explosive atmosphere is expected occasionally to reach a level that poses a risk. These motors are assigned to Equipment Group II – Category 2G (corresponding to Zone 1). They ensure a high degree of safety.

To define the risk posed by a potentially explosive gas, the minimum ignition temperature of a dust cloud is required as well as details of the possibility of a flame exiting through a narrow slit in the motor housing. This is achieved by classification in explosion groups IIA, IIB and IIC, whereby IIC represents the highest requirements (see the table "Assignment of combustible gases and vapors").

Ex db eb IIC T4 Gb

→ Standard version for paint film thicknesses < 200 µm.

Ex db eb IIB T4 Gb or Ex db eb IIC with order code **B31**
→ Optional version for paint film thicknesses > 200 µm to < 2 mm.

Alternatively, a paint finish certified in accordance with the Ex Directive can be used. For further information about paint and paint film thicknesses, see page 1/14 onwards.

Optional type of protection

- **Ex db eb/Ex tb** for use in Zone 1/21²⁾
- **Ex db eb/Ex tc** for use in Zone 1/22²⁾

The motors must be ordered with:

- Version additionally for dust Ex tb IIIC - Zone 21 – order code **B32**²⁾
- Version additionally for dust Ex tb IIB - Zone 22 – order code **B30**²⁾

Motors

- Ex db eb IIC T4 Gb: 1MB1.5 and 1MB5.5
- Ex db eb IIB T4 Gb: 1MB1.5 and 1MB5.5 with order code **B31**
- Ex db eb IIB T4 Gb: 1MB1.6 and 1MB5.6

are suitable for use in explosive gas atmospheres with occasionally present gases or vapors in Zone 1 for temperature classes T1 to T4. The maximum surface temperature that can occur during operation must lie below the limit temperature of the respective temperature class.



The motors have a terminal box (Ex eb), optional Ex db (order code **R48**), a sealing system, an external grounding terminal and a metal fan cover according to standard IEC/EN 60079-0. The motor housing is designed with type of protection "flameproof enclosure" and has temperature class T4.



The 1MB1.6 and 1MB5.6 Ex db eb IIB motors are supplied without cable inlet as standard.

With optional order with order code **B32** additionally a metal external fan.

The combination **B32+B31** is possible.

Example of identification on the rating plate:

Zone 1:  II 2G Ex db eb IIC T4 Gb or  II 2G Ex db IIC T4 Gb (R48)

Zone 1/21:  II 2G Ex db eb IIC T4 Gb  II 2D Ex tb IIIC T130 °C Db²⁾

Number of the EU type-examination certificate

SIMOTICS XP 1MB1, 1MB5 explosion-protected motors

Orientation

Technical specifications

Line operation

Insulation system

The insulation system of SIMOTICS XP 1MB1 and 1MB5 motors is suitable for line voltages up to 690 V. The connection system (terminal box, terminals) is also designed for this rated voltage.

The motors are equipped with 6 terminals. They can therefore be operated in any star or delta connection. If a voltage variant with dual voltage e.g. 400VΔ/690VY is selected, the rated data of all voltage levels will be stamped on the rating plate.

SIMOTICS XP 1MB1 and 1MB5 motors have an insulation system with a thermal class of 155 °C (F). Utilization at rated operation corresponds to thermal class 130 °C (B).

For deviations in use for frame sizes 400 and 450, see "Winding and insulation version with regard to temperature class", on page 1/28.

Voltage tolerances

The motors are suitable for operation with voltage and frequency tolerances according to EN 60034-1.

In addition, tests are to be performed to ensure that the permissible temperature limits for the inner and outer surfaces of the motor according to the relevant standard are not exceeded during continuous operation at the voltage limits ($\pm 10\%$). For 8-pole motors of frame size 450, continuous duty is only possible with $\pm 5\%$.

Note:

Tolerances according to EN 60034-1;
max. combined voltage and frequency tolerance $\pm 10\%$

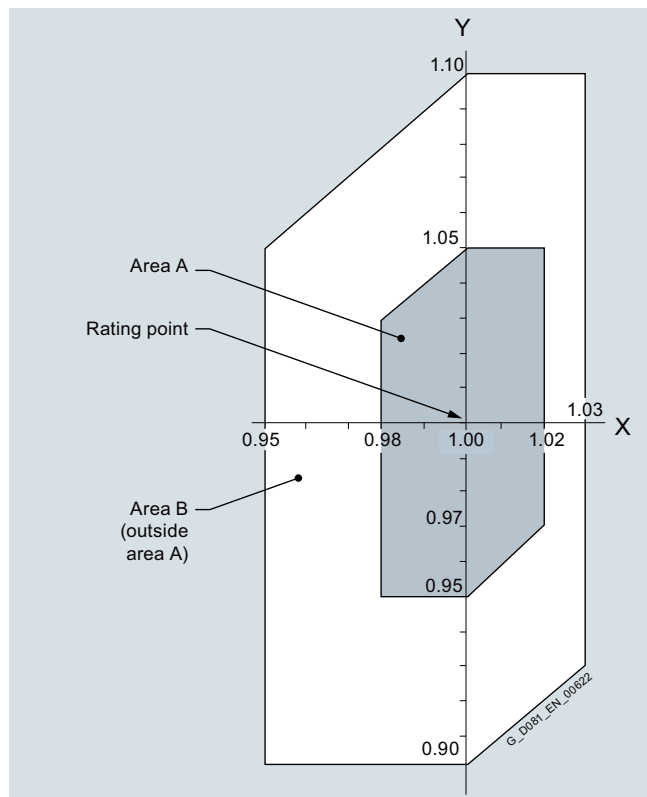

Y-axis: Voltage tolerance
Z-axis: Frequency tolerance

Motor protection

Motor protection must always be realized with a certified motor circuit breaker, see Catalog IC 10, taking into account the inrush current ratio and the maximum startup time.

Note:

For Ex eb motors in line operation, motor protection is alternatively possible as protection by PTC thermistors only, taking into account the inrush current ratio $I_{\text{startup}}/I_{\text{rated}}$ and time t_E . When the motor shaft is locked, the motor circuit breaker must disconnect the motor from the line supply within time t_E so that the maximum ignition temperature of the specific temperature class is not exceeded. Optionally on some motors up to frame size 200, full motor protection with a PTC thermistor is possible. The information about full motor protection with a PTC thermistor is documented in the EU type-examination certificate. The tripping devices required for this purpose, see Catalog IC 10, must always be certified.

Operation on a frequency converter

General information

Basically, explosion-protected motors (except for Ex eb) can be fed from converters. Particular attention must be paid to the interaction between the motor and converter system, especially with regard to the following aspects:

- The harmonic content of the supply voltage raises the motor temperature, so the motor power must be reduced
- Less cooling of the motor at speeds below the rated speed
- Voltage stress on the motor winding
- Bearing currents

The general use of high-quality insulation systems enables converter operation. When operated with a converter, the motor with explosion protection must be fitted with order code **B40**, **B41**, **B43** or **B44** and with PTC thermistors. These are installed in the stator winding and, in combination with an ex-certified trip unit (EU type-examination certificate), they perform sole motor protection in the case of converter operation.

The permissible speed and torque range is stamped on an additional rating plate.

These rated operating points stamped on the additional rating plate apply for both constant torque drives and fluid-flow machines with a square-law load torque. For constant torque drives, the resulting thermal motor torques in the positioning range must be taken into account.

During converter operation, the reduced torques for constant torque and drives for fans, pumps and compressors must be observed due to the harmonic content of the supply.

This data is available in the "Drive Technology Configurator" (DT Configurator) at

www.siemens.com/dtconfigurator

Technical specifications

Higher noise levels must be expected than for 50 Hz line operation for motors operating with converters due to the harmonic content of the supply.

Maximum voltage stress on the motor winding in converter operation:

Frame sizes: 71 to 355:

- $\hat{U}_{\text{phase-to-phase}} \leq 1500 \text{ V}$ (3000 V peak-peak values ($V_{\text{pk/pk}}$))
- $\hat{U}_{\text{phase-to-ground}} \leq 1100 \text{ V}$ (2200 V peak-peak values ($V_{\text{pk/pk}}$))

The following generally applies to motor-converter systems:

- $U_{\text{line}} = 480 \text{ V} \pm 10 \%$ (BLM = Basic Line Module; DFE = Direct Front End)
- $U_{\text{line}} \leq 460 \text{ V} \pm 10 \%$ (ALM = Active Line Module; AFE = Active Front End); $U_{\text{dc}} < 750 \text{ V}$
- $U_{\text{line}} = 500 \text{ V}$ to $690 \text{ V} \pm 10 \%$
Ex db, Ex ec, Ex tb, Ex tc with measures to reduce peak voltages to a maximum of 1500 V (3000 V peak-to-peak values ($V_{\text{pk/pk}}$)) permissible; e.g. by means of suitable filters, valid for SINAMICS (**B40/B41**) and without reference to the converter make (**B43/B44**)

Motors of the 1MB55 series with frame sizes 400 and 450 with the IVIC-C advanced insulation system:

- $\hat{U}_{\text{phase-to-phase}} \leq 1600 \text{ V}$ (3200 V peak-peak values ($V_{\text{pk/pk}}$))
- $\hat{U}_{\text{phase-to-ground}} \leq 1400 \text{ V}$ (2800 V peak-peak values ($V_{\text{pk/pk}}$))

Motors of the 1MB.8 series with frame sizes 71 to 450 with the IVIC-C premium insulation system:

- $\hat{U}_{\text{phase-to-phase}} \leq 2200 \text{ V}$ (4400 V peak-peak values ($V_{\text{pk/pk}}$))
- $\hat{U}_{\text{phase-to-ground}} \leq 1500 \text{ V}$ (3000 V peak-peak values ($V_{\text{pk/pk}}$))
- $U_{\text{line}} \leq 690 \text{ V} \pm 10 \%$ without filter

Motors with the advanced insulation system can be operated on the converter without an additional dv/dt or sine-wave filter if the following limits are observed:

- $U_{\text{line}} \leq 480 \text{ V}$
- $U_{\text{DC}} \leq 720 \text{ V}$

Converter operation requires a dv/dt or sine-wave filter or a motor with PREMIUM insulation system (motor types 1MB18. or 1MB58.) if at least the following limit is exceeded:

- $\hat{U}_{\text{phase-to-phase}} \leq 1500 \text{ V}$ (3000 V peak-peak values ($V_{\text{pk/pk}}$))

The voltage limits are chosen such that safe operation is ensured without knowledge of the converter or the converter infeed. If it is ensured that the motor is powered through a converter with uncontrolled infeed (e.g. SINAMICS G), the 1MB15 and 1MB55 motors can be operated up to $U_{\text{line}} = 480 \text{ V}$ because the limits $U_{\text{DC}} \leq 720 \text{ V}$ are then observed.

In configuration of the drive system, it must be considered that the DC-link voltage U_{DC} exceeds the limit of $U_{\text{DC, max}} = 720 \text{ V}$ (continuous duty) during braking where converters without energy recovery capability, such as SINAMICS G, are used. Exceeding this limit is permissible for a short time, for example, if the $U_{\text{DC, max}}$ controller or braking chopper ensures that the DC-link voltage does not exceed the following limits:

- 1MB.5 (advanced): $U_{\text{DC, max}} = 890 \text{ V}$ (short-time duty)
- 1MB.8 (premium): $U_{\text{DC, max}} = 1225 \text{ V}$ (short-time duty)

Further configuration notes are documented in the declaration of compliance with the order 2.1 and in the EU type-examination certificates.

Order processing of 1MB1, 1MB5 motors with Ex db, Ex ec, Ex tb and Ex tc for converter operation

PTC thermistor

For converter operation, Ex motors must always be monitored using PTC thermistors. The motors must therefore be ordered with the 15th position of the Article No.

- **B** – PTC thermistor for tripping – or alternatively
- **C** – PTC thermistor for alarm and tripping.

General information regarding the PTC thermistors:

- **B** in 15th position of the Article No.:
The motors are equipped with 3 PTC thermistors for tripping in the motor winding.
- **C** in 15th position of the Article No.:
The motors are equipped with 3 PTC thermistors for alarm and 3 PTC thermistors for tripping in the motor winding.

Certified tripping units are required for this purpose, see Catalog IC 10.

To ensure unambiguous order handling for the voltage, each approved voltage code/voltage order code is assigned only "one" voltage/frequency, as seen below:

Voltage code 12th and 13th position of the Article No.	Order code	Line frequency	Line voltage
22	–	50 Hz	230 VΔ/400 VY, 50-Hz power ²⁾
34	–	50 Hz	400 VΔ/690 VY, 50-Hz power ²⁾
27	–	50 Hz	500 VY, 50 Hz power
40	–	50 Hz	500 VΔ, 50 Hz power
90	M4A	50 Hz	400 VY, 50 Hz power
90	M4B	50 Hz	400 VΔ, 50 Hz power
90	M4E	50 Hz	690 VY, 50 Hz power
90	M4F	50 Hz	690 VΔ, 50 Hz power
90	M2C	60 Hz	440 VY, 50 Hz power
90	M1C	60 Hz	440 VY, 60 Hz power
90	M2D	60 Hz	440 VΔ, 50 Hz power
90	M1D	60 Hz	440 VΔ, 60 Hz power
90	M2E	60 Hz	460 VY, 50 Hz power
90	M1E	60 Hz	460 VY, 60 Hz power
90	M2F	60 Hz	460 VΔ, 50 Hz power
90	M1F	60 Hz	460 VΔ, 60 Hz power
90	M2G	60 Hz	575 VY, 50 Hz power
90	M1G	60 Hz	575 VY, 60 Hz power
90	M2H	60 Hz	575 VΔ, 50 Hz power
90	M1H	60 Hz	575 VΔ, 60 Hz power
90	M2K	60 Hz	480 VY; 50 Hz power
90	M1K	60 Hz	480 VY; 60 Hz power
90	M2L	60 Hz	480 VΔ, 50 Hz power
90	M1L	60 Hz	480 VΔ, 60 Hz power
90	M1Y (non-standard winding)	50 or 60 Hz	Plain text (observe max. voltage stress)
90	M3A ¹⁾	87 Hz	At 87 Hz, 400 VΔ: (4-pole to 8-pole)

Minimum pulse frequency for operation without derating

Power (kW)	Minimum pulse frequency
$P_N < 90$	$\geq 4 \text{ kHz}$
$90 \geq P_N \leq 250$	$\geq 2 \text{ kHz}$
$250 \geq P_N \leq 460$	$\geq 1.25 \text{ kHz}$
$P_N > 400$ (FS400/450)	$\geq 2.5 \text{ kHz}$

¹⁾ The motor contains winding version 50 Hz 230 VΔ.

²⁾ Stamp data for converter operation are indicated for 400 V.

SIMOTICS XP 1MB1, 1MB5 explosion-protected motors

Orientation

Technical specifications

Converter operation specially for motors in type of protection "Ex ec" (Zone 2) and VIK-Ex ec version

IEC/EN 60079-7 specifies that the motor and converter must be tested as a unit (individual test). The individual test is available for motors of "Ex ec" type of protection on the specified converters SINAMICS G, SINAMICS S and SINAMICS V20.

For details, see declaration of compliance with the order 2.1. Not possible for frame sizes 400 and 450.

Individual testing can be performed for non-Siemens converters on request (additional charge). The customer may be required to supply the external converter for individual tests.

The test will cost more when using non-Siemens converters (especially on commissioning). Commissioning personnel must be provided by the customer for setup and operation during the test, if required.

Converter operation specially for motors in type of protection "Ex tb" (Zone 21) and "Ex tc" (Zone 22)¹⁾

The drive system comprising motors protected against dust explosions operating on SINAMICS G, SINAMICS S and SINAMICS V20 converters has been tested. For details, see declaration of compliance with the order 2.1. Please inquire about operation with non-Siemens converters. Not possible for frame sizes 400 and 450.

Converter operation specially for motors with type of protection "Ex ec/Ex tc" (Zone 2/22)²⁾

For the 1MB..3 Ex ec motors, the order code **B30** version (IP55) for Zones 2 and 22 must also be specified in the case of non-conductive dust. Declaration of compliance with the order 2.1 analogous to that for Zones 2, 21 and 22.

Please inquire about non-Siemens converters.

1MB1, 1MB5 in Ex ec, Ex tb and Ex tc:

Selection of the frequency converters

The SINAMICS frequency converters are categorized into 2 product groups (order code **B40** and **B41**). Each product group is a data record with motor operating data each assigned to one frequency converter. The converter type is stamped on the rating plate. Alternative, approved SINAMICS converters can be selected, by adding the order code **Y68**.

Product group 1 (basic version):

Order code **B40** - version for converter operation in basic version with operating data SINAMICS G120 with PM240-2

Product group 1 (alternative SINAMICS converter):

Order codes **B40** + **Y68**

Operating data such as the **B40** order code with alternative SINAMICS converter on the rating plate:

- **Y68** with plain text (C-text) G120 with PM230
- **Y68** with plain text (C-text) G120 with PM240
- **Y68** with plain text (C-text) G120C
- **Y68** with plain text (C-text) G120P with PM230
- **Y68** with plain text (C-text) G120P with PM240-2
- **Y68** with plain text (C-text) G120P with PM240P-2
- **Y68** with plain text (C-text) G120P with PM330
- **Y68** with plain text (C-text) G130
- **Y68** with plain text (C-text) G150
- **Y68** with plain text (C-text) G180
- **Y68** with plain text (C-text) S120 (BLM/SLM)
- **Y68** with plain text (C-text) V20

Product group 2 (basic version):

Order code **B41** - version for converter operation in basic version with operating data SINAMICS S150.

Product group 2 (alternative SINAMICS converter):

Order codes **B41** + **Y68**

Operating data such as the **B41** order code with alternative SINAMICS converter on the rating plate:

- Order code **Y68** with plain text (C-text) S120 (ALM)

1MB1.5 and 1MB5.5 with Ex db, Ex db eb: Selection of the frequency converter

The SIMOTICS 1MB..5 and 1MB..6 motors are suitable and certified for operation on the PWM frequency converter. The only distinction made is whether the maximum permitted temperature rise of the winding is 130(B) – order code **B43** or 155(F) – order code **B44**. The power with utilization of 155(F) is approx. 10 % higher than with utilization 130(B) and the order code **B43** is usually approximately equal to the line power.

Combination with SINAMICS converters as stated in the list under Ex ec has been pretested and is recommended. For other converter types and non-Siemens converters, operation according to the Ex specifications is possible if the requirements of the certificate are met.

Defining the power for converter operation

The optimum power data are marked on the motors. These data are universally valid and can be viewed in the "Drive Technology Configurator" (DT Configurator) and used as the basis for configuration.

In specific applications, e.g. for very long motor cables, if a sine-wave filter is being used - or for converter types that cannot reach the full rated voltage at rated frequency as a result of the inherent design, then at rated voltage there is a voltage drop at the motor terminals. Under this operating condition, in order that the motor temperature rise is not inadmissibly high, at the maximum permissible current, it is possible that the motor power is reduced (derating). For example, for use of sine-wave filters and the consequential reduction of the motor voltage by 10 to 15 %, the permissible power ratings for converter operation must be similarly reduced by 10 to 15 % at rated frequency because the corner frequency for determining the power is reduced accordingly. Operation below the reduced corner frequency is possible without reducing the torque.

¹⁾ Zone 21 includes conductive and non-conductive dust.

²⁾ Motors that are certified for gas or dust protection must not be used in hybrid mixtures! Hybrid mixtures are mixtures of flammable dusts with explosive gas/air atmospheres which can together create a dangerous explosive atmosphere if they occur at the same time. It is necessary for a competent assessor to determine and release in the individual case whether the parameters determining ignition are unfavorably affected in a particular hybrid mixture.

SIMOTICS XP 1MB1, 1MB5 explosion-protected motors

Orientation

Technical specifications

Rating plate

The operating data for line operation is specified on the rating plate - on an additional rating plate, according to the selected product, 4 rated operating points are possible in the following variants:

Possible variants	Rated operating points in Hz				Additional identification code voltage code 12th and 13th position of the Article No. and order code
	5	25	50	f_{max}	
50 Hz field weakening range	5	25	50	f_{max}	50 Hz voltage: e.g. '90' and M4A
60 Hz field weakening range	6	30	60	f_{max}	60 Hz voltage: e.g. '90' and M1E
87 Hz characteristic	5	25	87	f_{max}	87 Hz at 400 VΔ: '90' and M3A

f_{max} see page 6/17 "Mechanical limit speeds of the SIMOTICS XP explosion-protected motors".

Other voltages can be selected with the voltage code **90** (12th, 13th position of the Article No.) and order code **M1Y** Special winding.

Special case: Line operation data in two voltage levels plus converter data in one voltage level: **M1Y + Y80** e.g. 400 VΔ/690 VY 50Hz DOL + 400 VΔ VSD

Insulated bearings

Frame sizes 225 and 250:

For converter operation it is recommended that an "insulated bearing cartridge NDE" – order code **L51** be used.

Frame sizes 280 to 355:

For ordering with order codes **B40/B41/B43/B44**, the "insulated bearing cartridge NDE" is included as standard.

Frame sizes 400 and 450:

For ordering with order codes **B40/B41/B43**, the "insulated bearing cartridge NDE" is included as standard.

The data on the separate rating plate for converter operation apply to both constant torque drives and pump/fan/compressor drives. For a constant torque drive, the resulting thermal motor torques in the positioning range must be taken into account.

Example motor ID:

Motor rating plate with line operation data and additional rating plate with converter operation data:

Increased safety motor Ex ec (Zone 2) for operation on SINAMICS G180:

1MB15331CB002AB4-Z
M4A+B40+Y68

Plain text Y68: SINAMICS G180

SIEMENS		IE3 H CE	
D-90441 Nürnberg		Made in Czech Rep.	
3-Mot. 1CV3130B 1MB15331CB002AB4-Z		UD 1701/1234567 001 001 0158	
IEC/EN 60034 132S IMB3 IP55		II 3 G	
67kg	Th.Cl. 155(F)	-20°C <=TAMB<=40°C	
Bearing		Ex ec IIC T3 Gc	
DE	6208-2ZC3	FTZU 13 ATEX 0055	
NE	6208-2ZC3		
V	Hz	A	kW
400 Y	50	10.8	5.5
cos φ	NOM.EFF	1/min	IE-CL
0.82	89.6	1470	IE3

SIEMENS		IE3 H CE	
D-90441 Nürnberg		Made in Czech Rep.	
3-Mot. 1CV3130B 1MB15331CB002AB4-Z		UD 1701/1234567 001 001	
IEC/EN 60034			
For converter supply			
Converter parameter settings according to DOL plate!			
Duty S9 SINAMICS G180			
CONVERTER INPUT: 400V VPWM Fp ≥ 4 kHz			
V	Hz	A	kW
49 Y	5	10.6	0.29
205 Y	25	9.2	2.35
380 Y	50	8.9	4.40
380 Y	100	8.4	4.10
cos φ	Nm	1/min	
0.84	20.5	134	
0.81	30.5	730	
0.81	28.0	1475	
0.85	13.1	2955	

For all motors, an additional rating plate complete with the operating data for the motor on the converter is fitted.

The converter type and the associated operating data are on the rating plate.

The reasons for stamping the converter type on the additional rating plate are the different control levels for the converter output voltage, pulse frequency, output frequency, harmonic content and the associated derating for the motor.

For compliance with the permissible temperature class 130 (B), derating is necessary for converter operation below the power for direct line operation! The reduction in torque depends on the choice of converter type. The data can be viewed in the "Drive Technology Configurator" (DT Configurator) and used as the basis for configuration.

The declaration of compliance with the order 2.1 for the specified converters is stored with the documentation for low-voltage motors in the "Drive Technology Configurator" (DT Configurator).

SIMOTICS XP 1MB1, 1MB5 explosion-protected motors

Orientation

Technical specifications

Configuration notes for converter operation

Permissible voltage stress

More stress is placed on the insulation of the motor winding with converter operation than with line operation. The voltage stress also depends on the type of converter used.

Voltage stress on a converter with pulse width modulation (PWM)

The PWM converter subjects the motor windings to wear and tear mainly by quickly applying voltage pulses. Each switching process of the converter releases a voltage wave onto the motor supply cable that can result in excessive motor voltages due to reflection (see diagram).

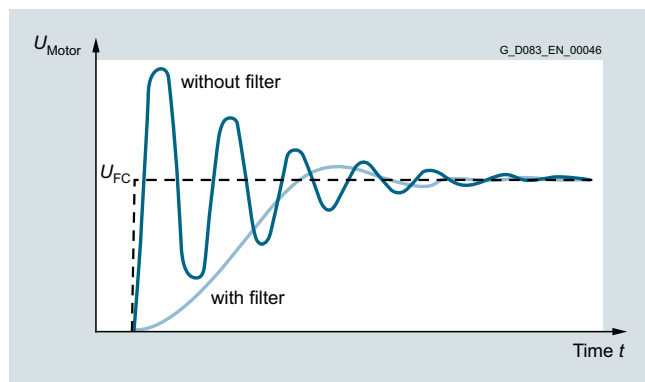

The maximum voltage is influenced by the rise time of the pulses and by the length of cable used between motor and converter. A dv/dt output filter at the converter can reduce the maximum motor voltage to uncritical values. If the permitted limits of the peak voltage for standard insulation $1500 V_{peak}$ or for premium insulation $2200 V_{peak}$ is exceeded in operation, premature motor failures can occur.

For SIMOTICS XP motors, the limits according to the certificate apply additionally and take precedence.

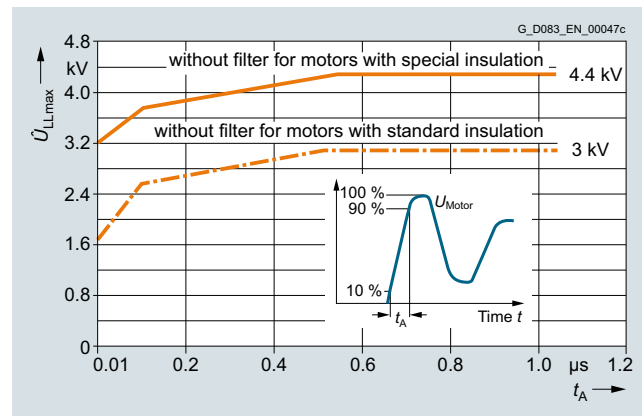

SIMOTICS XP 1MB1, 1MB5 explosion-protected motors

Orientation

Technical specifications

Individual drive check of variable speed drive (VSD) systems (IC411 self-ventilated motors) with configuration characteristics for converter operation – 1MB1/1MB5 motors (all types of protection).

Limits for example control ranges are listed in the power tables on the following pages. For individual drive checks, the following configuration characteristics apply to frame sizes 71 to 355.

For driven machine power or torque less than or equal to rated data, operation up to f_{max} in accordance with the power tables is possible. This applies to configurations with any load torques and control ranges.

The maximum admissible speed in field weakening can be calculated by dividing $f_{max} \times 120$ by the motor's number of poles.

Checking the feasibility of the required operating point

To do this, (derived from reference point A)

- The desired load/power P_2 must be divided by the VSD power P_{VSD}
- The desired control speed n must be divided by the VSD asynchronous speed $n_{asyn VSD}$
- The desired load/torque T_D must be divided by the VSD torque T_{VSD} .

These calculated values should be checked afterwards against the following diagrams to determine whether the desired operating point is below the VSD load/torque limit T_D/T_{VSD} and the load/power limit P_2/P_{VSD} .

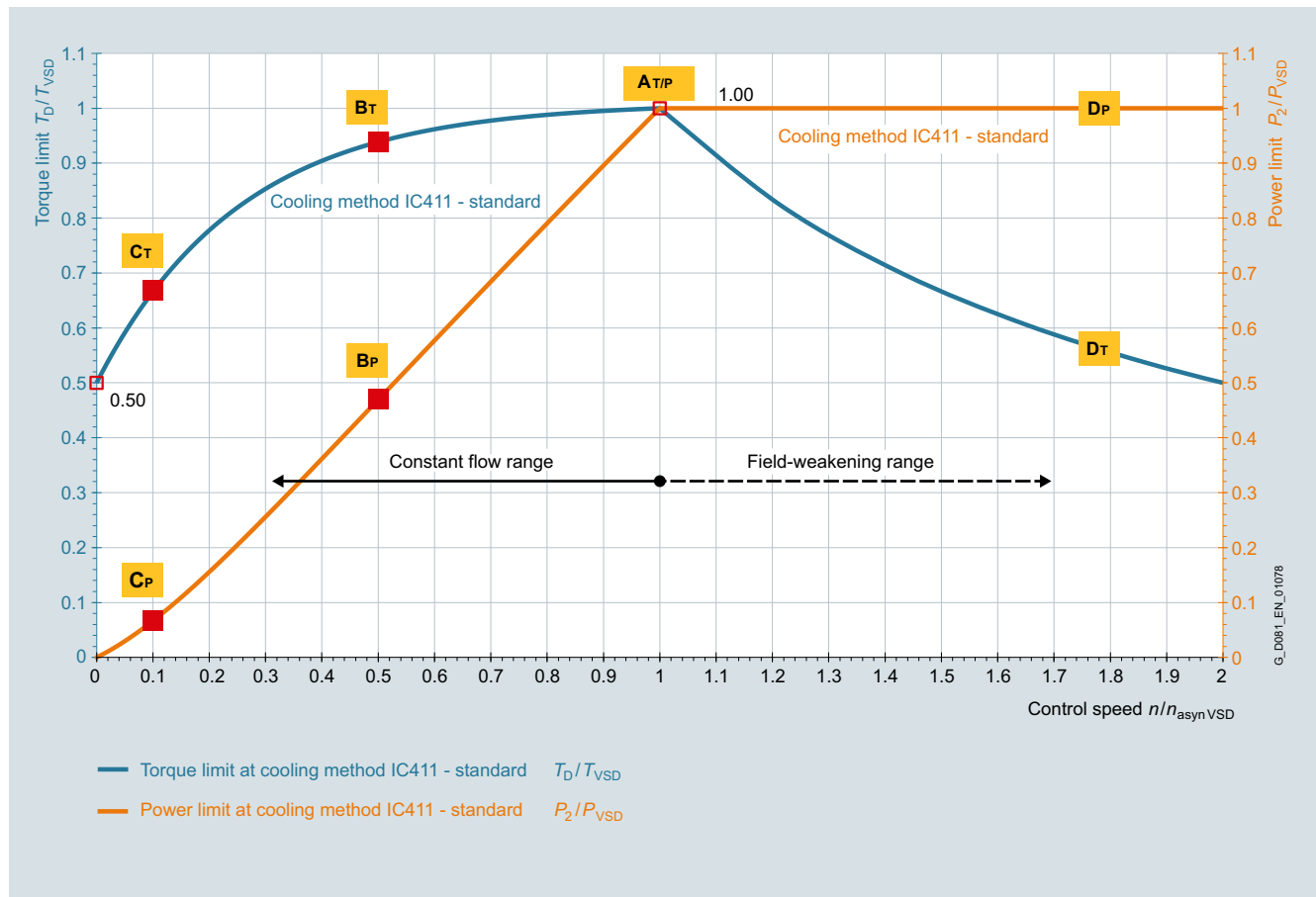

Configuration characteristics for frame sizes 71 to 200

- AM/P: Reference point for general selecting/dimensioning
- AP: Typical load point for applications with square-law load torque, e.g. fans and pumps
- BM/CM: Typical load point for applications with constant load torque, e.g. hoisting gear, conveyor belts etc.
- DM/DP: Typical load point for applications with increased speed/frequency

SIMOTICS XP 1MB1, 1MB5 explosion-protected motors

Orientation

Technical specifications

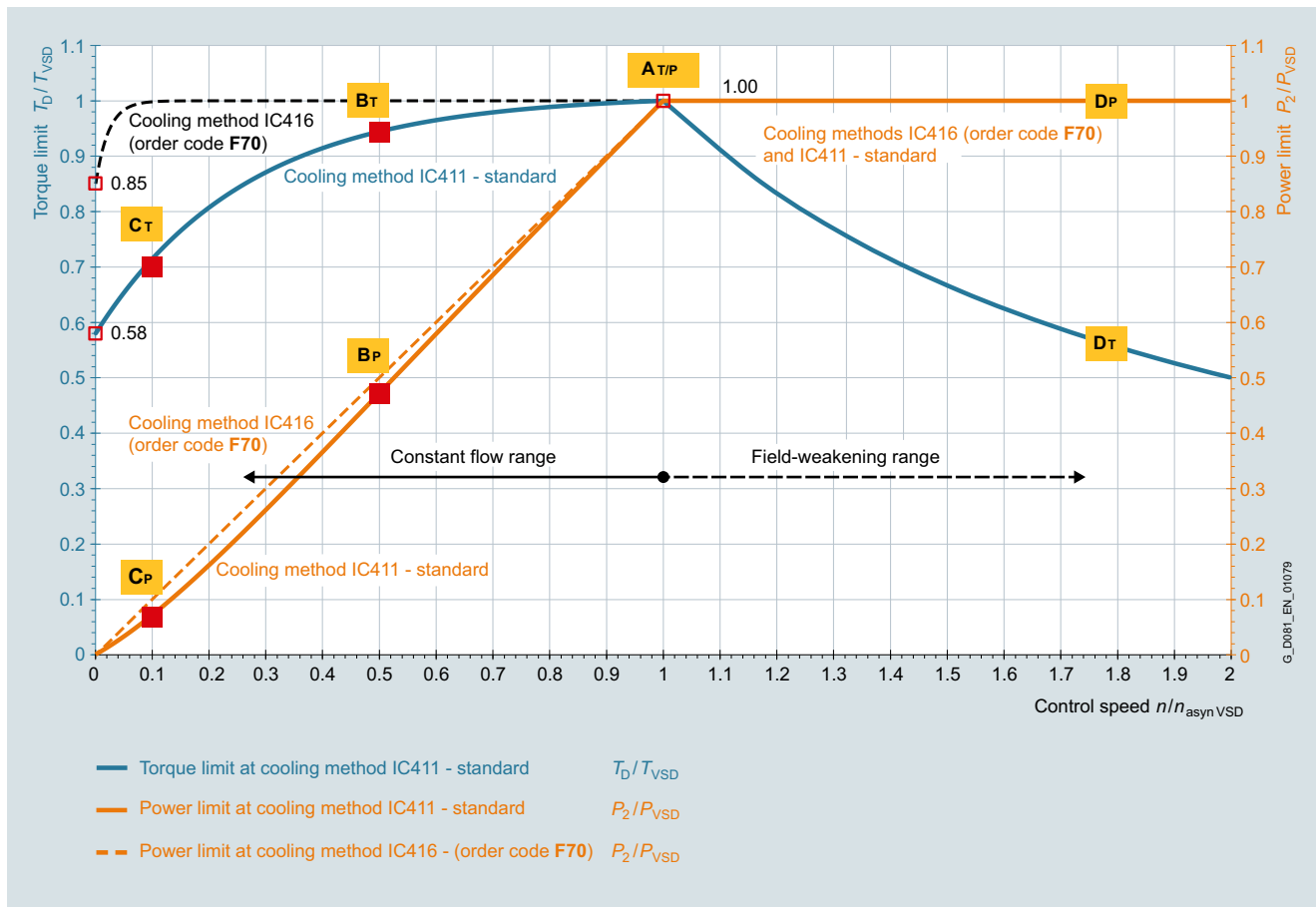

Configuration characteristics for frame sizes 225 to 355

AM/P: Reference point for general selecting/dimensioning

AP: Typical load point for applications with square-law load torque, e.g. fans and pumps

BM/CM: Typical load point for applications with constant load torque, e.g. hoisting gear, conveyor belts etc.

DM/DP: Typical load point for applications with increased speed/frequency

6

Fan

For version of the fan

Motor series	Frame size	Type of protection			
		Ex tb, Ex tc	Ex ec	Ex eb	Ex db eb
1MB1	63	Aluminum	Plastic	-	-
	71 ... 90	Aluminum	Plastic	Plastic	Plastic
	100 ... 160	Aluminum	Plastic ¹⁾	Plastic	Plastic
	180 ... 280	Sheet steel	Plastic	Plastic	Plastic
	315	Sheet steel	Plastic	-	-
1MB5	315	Sheet steel	Sheet steel	Plastic	Plastic ²⁾
	355 (2-pole)	Sheet steel	Sheet steel	-	Sheet steel
	355 (4- ... 8-pole)	Sheet steel	Sheet steel	-	Sheet steel
	400 ... 450	Cast iron	Cast iron	-	-

Note: For Ex ec, Ex eb and Ex db eb motors in combination with order code

- **B30** – Version additionally for dust Ex tc – Zone 22
 - **B32** – Version additionally for dust Ex tb – Zone 21
- Fan material as for Ex tb, Ec tc.

Low-noise version

Clockwise rotation: Order code **F77**
 Counterclockwise rotation: Order code **F78**

Low-noise version			
Motor series	Frame size	2-pole motors	
		LpfA db (A)	LWA db (A)
1MB..5	160	70	82
	180	65	78
1MB..6	200	67	80
	225	69	83
	250	72	86
	280	73	87
	315	73	88
355	80	95	

A version with a second shaft extension is not possible.

¹⁾ The fan material for 1MB1032 (IE1) is aluminum.

²⁾ Fan material may require sheet steel in relation to the motor type.

Technical specifications

Mechanical limit speeds

Mechanical limit speeds of the SIMOTICS XP 1MB10, 1MB15, 1MB16 Ex ec, Ex tb and Ex tc explosion-protected motors

Motor frame size	Motor type	2-pole ¹⁾ n_{max} rpm	f_{max} Hz	4-pole n_{max} rpm	f_{max} Hz	6-pole n_{max} rpm	f_{max} Hz	8-pole n_{max} rpm	f_{max} Hz
1MB10, 1MB15, 1MB16									
63 M	1MB15	6000	100	3000	100	2000	100	1500	100
71 M	1MB15	6000	100	3000	100	2000	100	1500	100
80 M	1MB15	6000	100	3000	100	2000	100	1500	100
90 L	1MB15	6000	100	3000	100	2000	100	1500	100
100 L	1MB10, 1MB15, 1MB16	5100	85	3000	100	2000	100	1500	100
112 M	1MB10, 1MB15, 1MB16	5100	85	3000	100	2000	100	1500	100
132 S/M	1MB10, 1MB15, 1MB16	3800	63.3	3000	100	2000	100	1500	100
160 M/L	1MB10, 1MB15, 1MB16	4500	75	3000	100	2000	100	1500	100
180 M/L	1MB15, 1MB16	4500	75	3000	100	2000	100	1500	100
200 L	1MB15, 1MB16	4500	75	3000	100	2000	100	1500	100
225 S/M	1MB15, 1MB16	3600	60	3000	100	2000	100	1500	100
250 M	1MB15, 1MB16	3600	60	3000	100	2000	100	1500	100
280 S/M	1MB15, 1MB16	3600	60	3000	100	2000	100	1500	100
315 S/M/L	1MB15, 1MB16	– ²⁾	– ²⁾	2600	87	2000	100	1500	100

Mechanical limit speeds of the SIMOTICS XP 1MB..5 Ex db, Ex db eb explosion-protected motors ³⁾

Motor frame size	Motor type	2-pole ¹⁾ n_{max} rpm	f_{max} Hz	4-pole n_{max} rpm	f_{max} Hz	6-pole n_{max} rpm	f_{max} Hz	8-pole n_{max} rpm	f_{max} Hz
1MB1.5, 1MB5.5, 1MB1.6, 1MB5.6									
71 M	1MB1.5	6000	100	3000	100	2000	100	1500	100
80 M	1MB1.5	6000	100	3000	100	2000	100	1500	100
90 L	1MB1.5	6000	100	3000	100	2000	100	1500	100
100 L	1MB1.5	6000	100	3000	100	2000	100	1500	100
112 M	1MB1.5	6000	100	3000	100	2000	100	1500	100
132 S/M	1MB1.5	5400	90	3000	100	2000	100	1500	100
160 M/L	1MB1.5	4800	80	3000	100	2000	100	1500	100
180 M/L	1MB1.5	4560	76	3000	100	2000	100	1500	100
200 L	1MB1.5	4500	75	3000	100	2000	100	1500	100
225 S/M	1MB1.5	4500	75	2610	87	2000	100	1500	100
250 M	1MB1.5	3900	65	2400	80	2000	100	1500	100
280 S/M	1MB1.5	3600	60	2250	75	2000	100	1500	100
315 S/M/L	1MB5.5	3600	60	1950	65	2000	100	1500	100
355 M/L	1MB5.5	3600	60	1800	60	2000	100	1500	100

SIMOTICS XP 1MB1.6 (frame sizes 100 to 280) and 1MB5.6 (frame sizes 315 to 355) in type of protection Ex db eb IIB are optionally available with special bearing arrangement for high axial loads.

Bearings for axial tension forces - order code L34
(frame sizes 100 ... 355):

On the drive end, there is a mounted angular-contact ball bearing for increased tension forces from the motor in the direction of the driven equipment. The bearing in frame sizes 100 to 132 is lubricated for life. For frame sizes 160 to 355, the bearings are equipped with a regreasing device.

Bearings for axial tension and thrust forces - order code L35
(frame sizes 160 ... 225):

On the non-drive end, there are two mounted angular-contact ball bearings for increased tension and thrust forces in O arrangement. The bearings are located on the non-drive end and are designed with a regreasing device.

Frame size	Δl in mm
63 M/L	25
80 M/L	24
200 L	30
225 S/M	24

Note: When ordering, the maximum radial and axial forces must also be specified for subsequent checks.

Grounding on the housing of 1MB..5 and 1MB..6 motors

Frame size	Thread size for the grounding conductor
71 ... 112	1 x M5
132 ... 160	2 x M6
180 ... 280	2 x M8
315 ... 355	2 x M12

Grounding on the housing of 1MB..1, 1MB..2 and 1MB..3 motors

Frame size	Thread size for the grounding conductor
63 ... 160	1 x M5
180	1 x M6
200	2 x M6
225 ... 280	1 x M8
315 ... 355	2 x M12

¹⁾ For continuous operation in the range f_{max} (n_{max}), an inquiry is required.

²⁾ For frame size 315, converter operation is not permissible with 2 poles.

³⁾ For converter operation, the maximum tested and certified frequency may differ.

SIMOTICS XP 1MB1, 1MB5 explosion-protected motors

Orientation

Technical specifications

Special technology

"Special technology" comprises technology that is compatible with explosion-protected motors.

Explosion-protected motors can be implemented in a broader range of applications when explosion-protected rotary pulse encoders or explosion-protected separately driven fans are mounted.

The use of a separately driven fan is recommended to increase motor utilization at low speeds and to limit noise generation at speeds significantly higher than the synchronous speed.

The following explosion-protected motor versions are available with explosion-protected rotary pulse encoders:

Type of protection	Motor type + order code	Frame size	Order code for explosion-protected rotary pulse encoder
Ex tb (Zone 21)	1MB101...	100 L ... 160 L	G30: Mounting of LL 841 (HTL); 1024 explosion-protected rotary pulse encoder
	1MB151...	100 L ... 315 L	
	1MB161...	100 L ... 315 L	
	1MB551...	400 ... 450	
	1MB581...	400 ... 450	
Ex tc (Zone 22)	1MB102...	100 L ... 160 L	
	1MB152...	100 L ... 315 L	
	1MB162...	100 L ... 315 L	
	1MB552...	400 ... 450	
	1MB582...	400 ... 450	
Ex ec (Zone 2)	1MB103...	100 L ... 160 L	
	1MB153...	100 L ... 315 L	
	1MB163...	100 L ... 315 L	
	1MB553...	400 ... 450	
	1MB583...	400 ... 450	
Ex ec or Ex tc (Zone 2/22)	1MB103... + B30	100 L ... 160 L	
	1MB153... + B30	100 L ... 315 L	
	1MB163... + B30	100 L ... 315 L	
	1MB553... + B30	400 ... 450	
	1MB583... + B30	400 ... 450	
Ex db or Ex db eb (Zone 1)	1MB..5...	100 L ... 355 L	
	1MB..6...		
Ex db or Ex db eb (Zone 1/21)	1MB..5... + B32	100 L ... 355 L	
	1MB..6... + B32		
Ex db bzw. Ex db eb (Zone 1/22)	1MB..5... + B30	100 L ... 355 L	
	1MB..6... + B30		

Note:

The maximum speed of the rotary pulse encoder is limited to $n_{\max} = 4200$ rpm.

The following explosion-protected motor versions are available with explosion-protected separately driven fans:

Type of protection	Motor type + order code	Frame size	Order code for explosion-protected separately driven fan
Ex tb (Zone 21)	1MB151...	225 S ... 315 L	F70: "Mounted separately driven fan".
	1MB161...	225 S ... 315 L	
	1MB551...	400 ... 450	
	1MB581...	400 ... 450	
Ex tc (Zone 22)	1MB102...	100 L ... 160 L	
	1MB152...	100 L ... 315 L	
	1MB162...	100 L ... 315 L	
	1MB552...	400 ... 450	
	1MB582...	400 ... 450	
Ex ec (Zone 2)	1MB103...	100 L ... 160 L	
	1MB153...	100 L ... 315 L	
	1MB163...	100 L ... 315 L	
	1MB553...	400 ... 450	
	1MB583...	400 ... 450	
Ex ec or Ex tc (Zone 2/22)	1MB103... + B30	100 L ... 160 L	
	1MB153... + B30	100 L ... 315 L	
	1MB163... + B30	100 L ... 315 L	
	1MB553... + B30	400 ... 450	
	1MB583... + B30	400 ... 450	
Ex db or Ex db eb (Zone 1)	1MB..5...	225 S ... 355 L	
	1MB..6...		
Ex db or Ex db eb (Zone 1/21)	1MB..5... + B32	225 S ... 355 L	
	1MB..6... + B32		

Notes:

- The motor operating data with the explosion-protected separately driven fan is available in the "Drive Technology Configurator" (DT Configurator).
- Alternatively, explosion-protected separately driven fans can also be used in line operation for special applications.

Technical specifications

Explosion-protected rotary pulse encoder

The rotary pulse encoder can only be mounted on a standard non-drive end (NDE), i.e. a second shaft extension cannot be supplied.

By virtue of its design, the explosion-protected rotary pulse encoder does not have insulated bearings (please inquire).

The degree of protection of the rotary pulse encoder must be observed. The relevant data are stamped on the rating plate of the rotary pulse encoder.

Attaching an explosion-protected rotary pulse encoder increases the length of the motor by Δl .

For an explanation of the additional dimensions and weights, see "Dimensions and weights of explosion-protected rotary pulse encoders".

LL 841 910 013 rotary pulse encoder (HTL version)

This encoder has a rugged construction and is therefore also suitable for difficult operating conditions. It is resistant to shock and vibration and is suitable up to corrosivity category C4.

The LL 841 910 013 explosion-protected rotary pulse encoder is supplied with the already mounted ADS diagnostic system for early detection of errors in the encoder.

Order code **G30**

Technical specifications for LL 841 910 013 (HTL version)

Supply voltage U_B	+9 ... +30 V
Current input without load	max. 80 mA
Admissible load current per output	40 mA
Pulses per revolution	1024
Outputs	6 short-circuit proof square-wave pulses A, A', B, B', O, O', high current HTL Floating switching output for ADS signal
Pulse offset between the two outputs	90° ±2.5° el.
Output amplitude	$U_{\text{High}} > U_B - 4 \text{ V}$ $U_{\text{Low}} < 2.5 \text{ V}$
Mark space ratio	1:1 ± 10 %
Maximum frequency	100 kHz with 350 m cable length
Maximum speed	4200 rpm (the maximum permissible speed must be observed during the configuration)
Temperature range	-40 ... +60 °C
Degree of protection	IP65
Maximum adm. radial cantilever force	150 N
Maximum adm. axial force	100 N
Connection system	Terminal strips in encoder/cable connection M20 x 1.5 radial (screw terminals)
Weight, approx.	1.7 kg

Manufacturer:
Leine und Linde AG
Olivehällsvägen 8
64542 Strängnäs, Sweden
Phone: +46 152 265 00
Fax +46 152 265 05

www.leinelinde.com
Email: info@leinelinde.de

Dimensions and weights of the explosion-protected rotary pulse encoders

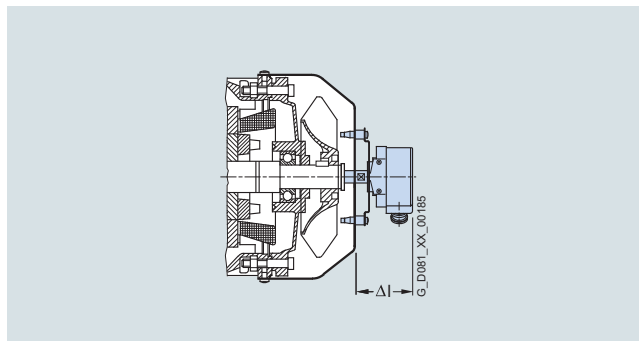

Explosion-protected rotary pulse encoder (on cover), order code **G30**

1MB10, 1MB15, 1MB16, 1MB55, 1MB56, 1MB58 motors

Frame size	Δl	Weight approx.
	mm	kg
100	110	2
112	110	2
132	110	2
160	110	2
180	110	2
200	110	2
225	100	3
250	100	3
280	100	3
315	100	3
355	100	3
400	100	3
450	100	3

A protective cover of non-corrosive sheet steel is available for the explosion-protected rotary pulse encoders from the "special technology".

For motors in the shaft heights

- 100 to 200: a protective cover is always provided
- 225 to 450: Order code **G43** – "Mechanical protection for encoder" (protective cover analogous to order code **H00**)

The length of the motor is also increased in the case of the following shaft heights:

- 100 to 200 by up to 146 mm
- 225 to 315 by up to 25 mm

SIMOTICS XP 1MB1, 1MB5 explosion-protected motors

Orientation

Technical specifications

Explosion-protected separately driven fan

The use of a separately driven fan is recommended to increase motor utilization at low speeds or to limit noise generation at speeds significantly higher than the synchronous speed. Both of these results can only be achieved with converter operation. Please inquire about traction and vibratory operation.

In the case of explosion-protected motors, the explosion-protected separately driven fan is available already mounted. Order code **F70**

Notes:

- The order code **F70** applies to all types of protection because the type of protection is already defined by the article number of the motor. Order code **F70** determines the additional charge for the separately driven fan in the assigned type of protection.
- The motor operating data with the explosion-protected separately driven fan is available in the "Drive Technology Configurator" (DT Configurator).
- The separately driven fan motor for frame sizes 225 to 355 is made of aluminum for protection types Ex ec, Ex tc, Ex tb and made of cast iron for type Ex db.

The supply voltage for the explosion-protected motors with separately driven fan is specified as follows:

Type 2CW2 has a wide-range voltage winding (see page 6/21 "Technical specifications of separately driven fans for 1MB1 explosion-protected motors (frame sizes 100 to 200) in the Ex tc (Zone 22) and Ex ec (Zone 2) versions").

These explosion-protected motors with separately driven fan up to frame size 200 have a rated voltage (rated voltage range) with tolerances according to IEC/EN 60034-1, range A.

Technical specifications of separately driven fans for 1MB..5 and 1MB..6 explosion-protected motors (frame sizes 225 to 355) in the Ex db eb (Zone 1) versions

Frame size	Voltage V	Frequency Hz	P_{\max} kW	I_{\max} A
225	400	50	0.55	1.34
250				
280	460	60		1.23
315				
355	400	50	1.1	2.25
	460	60		1.98

A rating plate with the operating data is fitted to each explosion-protected motor with separately driven fan.

The type of protection of the explosion-protected motor corresponds to that of the associated explosion-protected basic motor. Please note the direction of rotation of the separately driven fan (axial-flow fan) when connecting it.

Please inquire regarding coolant temperatures outside the range -20 to $+40$ °C.

The Ex ec/Ex tc motor with separately driven fan has the degree of protection IP55 as standard; Ex tb: IP65 (higher degrees of protection with Ex ec are available on request).

Motors with a separately driven fan must be equipped with a PTC thermistor as motor protection (15th position of the Article No.): In the event of a fault in the separately driven fan, the PTC thermistor must reliably trip the 1MB1 or 1MB5 explosion-protected motors.

For assignments and article numbers, see the tables "Technical specifications of separately driven fans for explosion-protected motors 1MB1..." on the following pages. A rating plate listing all the important data is fitted to the separately driven fan. Please inquire in the case of supply voltages outside of the rated voltage range. Please note the direction of rotation of the separately driven fan (axial-flow fan) when connecting it. The permissible coolant temperatures are $CT_{\min} -20$ °C and $CT_{\max} +40$ °C. Lower coolant temperatures are available on request.

When the separately driven fan is mounted, the length of the motor increases by Δl . For an explanation of the additional dimensions and weights, see "Dimensions and weights of explosion-protected separately driven fans".

SIMOTICS XP 1MB1, 1MB5 explosion-protected motors

Orientation

Technical specifications

Technical specifications of separately driven fans for 1MB1 explosion-protected motors (frame sizes 100 to 200) in the Ex tc (Zone 22) and Ex ec (Zone 2) versions

Technical specifications of separately driven fans (according to tolerances of EN 60034-1)				
Frame size	Rated voltage range V	Frequency Hz	Power consumption kW	Rated current A
100	3 AC 200 ... 303 Δ	50	0.097	0.40
	3 AC 346 ... 525 Y	50	0.097	0.23
	3 AC 220 ... 332 Δ	60	0.096	0.35
	3 AC 380 ... 575 Y	60	0.096	0.20
112	3 AC 200 ... 303 Δ	50	0.104	0.40
	3 AC 346 ... 525 Y	50	0.104	0.23
	3 AC 220 ... 332 Δ	50	0.114	0.34
	3 AC 380 ... 575 Y	60	0.114	0.20
132	3 AC 200 ... 303 Δ	50	0.167	0.67
	3 AC 346 ... 525 Y	50	0.167	0.39
	3 AC 220 ... 332 Δ	50	0.183	0.58
	3 AC 380 ... 575 Y	60	0.183	0.33
160 ... 200	3 AC 200 ... 303 Δ	50	0.327	1.36
	3 AC 346 ... 525 Y	50	0.327	0.79
	3 AC 220 ... 332 Δ	50	0.405	1.14
	3 AC 380 ... 575 Y	60	0.405	0.66

Technical specifications of separately driven fans for 1MB1 explosion-protected motors (frame sizes 225 to 315) in the Ex tb (Zone 21), Ex tc (Zone 22) and Ex ec (Zone 2) versions

Frame size	Rated voltage range V	Frequency Hz	Power consumption kW	Rated current for rated voltage A
225 ... 315	3 AC 230 Δ	50	0.75	2.7
	3 AC 400 Y	50	0.75	1.56
	3 AC 460 Y	60	0.86	1.63

SIMOTICS XP 1MB1, 1MB5 explosion-protected motors

Orientation

Technical specifications

Dimensions and weights of the explosion-protected separately driven fans (order code **F70**)

1MB102, 1MB152, 1MB162, 1MB103, 1MB153, 1MB163 Frame sizes 100 to 200

Explosion-protected separately driven fans
Ex tc, Ex ec

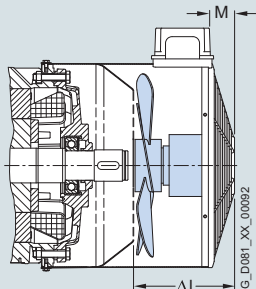

Type of protection/motor type
Ex tc (Zone 22)/1MB102, 1MB152, 1MB162
Ex ec (Zone 2)/1MB103, 1MB153, 1MB163

Frame size	Δl	Weight approx.
	mm	kg
100	141	4
112	158	4.5
132	177	5.5
160	227	7
180	269	10
200	272	11

1MB151, 1MB161, 1MB152, 1MB162, 1MB153, 1MB163 Frame sizes 225 to 315

Explosion-protected separately driven fans
Ex tb, Ex tc, Ex ec

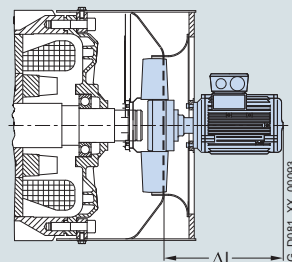

Type of protection/motor type
Ex tb (Zone 21)/1MB151, 1MB161
Ex tc (Zone 22)/1MB152, 1MB162
Ex ec (Zone 2)/1MB153, 1MB163

Frame size	Δl	Weight approx.
	mm	kg
225	259	27
250	264	30
280	260	33
315 ¹⁾	312	44,8
315 ²⁾	274	41

1MB1.5, 1MB1.6, 1MB5.5, 1MB5.6 Baugrößen 225 bis 355

Ex-Fremdlüfter
Ex db eb

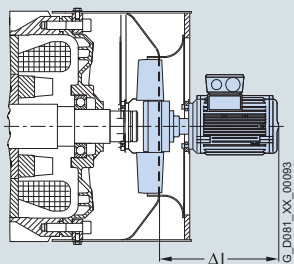

Type of protection/motor type
Ex db eb (Zone 1)/1MB155, 1MB555

Frame size	Δl	Weight approx.
	mm	kg
225	375	46
250	376	51
280	377	55
315	373	65
355	390	77

1MB1.5, 1MB1.6, 1MB5.5, 1MB5.6 Baugrößen 225 bis 355

Ex-Fremdlüfter + Ex-Drehimpulsgeber (G30)
Ex db eb

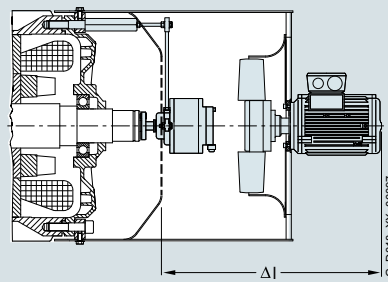

Type of protection/motor type
Ex db eb (Zone 1)/1MB1.5, 1MB1.6, 1MB5.5, 1MB5.6

Frame size	Δl	Weight approx.
	mm	kg
225	520	51
250	521	56
280	532	61
315	518	73
355	535	86

Technical specifications

Version 1MB..5, 1MB..6 motors (Ex db, Ex db eb) with mounted brake

The brake is located at drive-end of the motor and can be mounted with flange B5 or B14 depending on the motor – 14th position of the Article No. **F** (flange B5); **K** (flange B14).

The shaft extension is implemented in the same way as the standard shaft extension of the motor. A special shaft extension or special bearings are not possible.

The motor, including the brake, is available ATEX-certified as standard and optionally with IECEx (order code **D37**) and EACEx (order code **D35**).

The spring-operated brake (order code **F20**) is a single-disk brake with two friction surfaces. The compression springs produce the braking torque by means of friction that opposes the disk. The brake is released electromagnetically.

The degree of protection of the brake is IP66 (IEC/EN 60034-5 and IEC/EN 60079-0).

The braking voltage supply 24 V DC (order code **F10**), 230 V AC (order code **F11**) and 400 V AC (order code **F12**) have to be ordered together with order code **F20**.

In the standard version, the brake is equipped with a bimetal protection device for thermal protection with a limit value for the temperature class of the brake.

Dynamic application of the brake in accordance with the permissible energy and frequency of braking (duty cycles) can be determined by the formula "Calculation of the slipping time of the friction disk" and table "Frequency of braking".

For special operating characteristics in accordance with the permissible energy and the frequency of braking (braking cycles), calculation of new values by Siemens is necessary.

The possibility of manual release of the brake can be ordered optionally (order code **F50**). In this case, the brake can be released in the de-energized state (no lock).

Further options for controlling the brake, such as a PTC thermistor for monitoring the brake temperature, are available on request

Overview of the brake selection for 1MB..5, 1MB..6 motors, 2 to 8-pole

		Frame size							
		80	90	100	112	132	160 ¹⁾	180 ²⁾	200 ²⁾
Flange of the brake system with B5 flange at DE ³⁾		FF165	FF165	FF215	FF215	FF265	FF300	FF300	FF350
Flange of the brake system with B14 flange at DE ³⁾		FT100	FT115	FT130	FT130	FT165	FT215	–	–
Max. diameter of the shaft extension	mm	19 j6	24 j6	28 j6	28 j6	38 k6	42 k6	48 k6	55 m6
Brake type		VIS80	VIS90	VIS100	VIS112	VIS132	VIS160	VIS180	VIS200
Permissible radial force of the point of application $x = 0.5$ ⁴⁾	N	380	380	550	550	790	790	1700	1700
Rated braking torque (T_T) ⁵⁾ (static torque)	Nm	12	20	40	50	100	160	260	350
Possible range of the torque (on request)	Nm	12 ... 22	12 ... 22	24 ... 40	30 ... 60	70 ... 150	100 ... 160	180 ... 350	300 ... 460
Maximum speed n_{max} - (S1 duty)	rpm	3600	3600	3600	3600	3600	2900	2500	2500
Maximum speed n_{max} - (S3-40 % load)	rpm	4320	4320	4000	4000	4000	3600	2800	2800
Power supply unit power	W	50	50	80	80	105	105	180	180
Current at 24 V DC	A	2.7	2.7	2.1	2.1	2.8	2.8	3.5	3.5
Current at 230 V AC – (207 V DC coil voltage) ⁶⁾	A	0.45	0.45	0.2	0.2	0.35	0.35	0.6	0.6
Current at 400 V AC – (180 V DC coil voltage) ⁷⁾	A	0.22	0.22	0.18	0.18	0.2	0.2	0.35	0.35
Weight, approx.	kg	32	34	50	50	78	82	135	150
Brake engagement time t_1 ⁸⁾	ms	40	40	90	90	180	180	230	230
Disengagement time t_2 ⁹⁾	ms	18	18	18	18	23	23	30	30
VIS brake moment of inertia	kgm ²	0.00088	0.00088	0.00323	0.00323	0.00831	0.00885	0.0385	0.0397
Lifetime of the brake lining (time to inspection)	kJ	50000	50000	75000	75000	90000	90000	120000	120000

Dynamic application of the brake

Due to dynamic application of the brake, the permissible energy is limited by the maximum frequency of brake application and the maximum slipping time of the friction disk for one brake application.

- 1) Due to the limited maximum braking velocity, 2-pole motors are not suitable for S1 duty.
- 2) Due to the limited maximum braking velocity, 2-pole motors are not possible.
- 3) The brake is mounted at the drive-end. The motor with brake can be mounted with a B5 or B14 flange, depending on the motor. Flange B5 (14th position of the Article No. **F**) mounting of types of construction IM B5, IM V1, IM B35, IM V15; Flange B14 (14th position of the Article No. **K**) mounting of types of construction IM B14, IM V18, IM B34). It is not possible to mount IM V3 and IM V35.
- 4) The bearing lifetime of the brake is the same as the bearing lifetime of the motor.

- 5) The dynamic braking torque is lower because the rated braking torque depends on the speed. (The technical specifications must be stated for the dynamic braking torque.)
- 6) For a voltage of 230 V AC, a bridge rectifier is used, which is contained in the scope of supply.
- 7) For a voltage of 400 V AC, a half-wave rectifier is used, which is contained in the scope of supply.
- 8) Time until the braking torque is reached after the voltage supply is switched off.
- 9) Time until the braking torque has decayed after the voltage supply is switched on.

SIMOTICS XP 1MB1, 1MB5 explosion-protected motors

Orientation

Technical specifications

Calculation of the slipping time t_3 of the friction disk ¹⁾

$$t_3 = \frac{J_{\text{total}} \cdot n}{9.55 \cdot (T_f \pm T_{\text{load}})}$$

J_{total}	Total moment of inertia on the motor shaft $J_{\text{brake}} + J_{\text{motor}} + J_{\text{load}}$ in kgm^2
n	Motor speed in rpm
T_f	Rated braking torque in Nm
T_{load}	Instantaneous load torque in Nm positive or negative, depending on the conformity with the braking torque
t_3	Slipping time in s

Frequency and slipping time t_3 (duty cycles)

Brake type	Frequency of operations per cycle (1/h) ²⁾	
	Slipping time t_3 ≤ 0.5 s	Slipping time t_3 ≥ 0.5 s to ≤ 0.8 s
VIS80	1800	900
VIS90	1800	900
VIS100	1300	650
VIS112	1300	650
VIS132	900	450
VIS160	900	450
VIS180	600	300
VIS200	600	300

VIK version

VIK = *Verband der Industriellen Energie- und Kraftwirtschaft e.V.* (German Association of the Energy and Power Supply Industry)

- **VIK standard version** –
1LE1, 1LE5 + order code **C02**
"VIK" identification on rating plate.
→ Product range in Catalog Section 2.
- **VIK-Ex ec version for line operation** –
1MB1.3, 1MB5 + order code **C02**
"VIK" and "Ex ec IIC T3 Gc" marking on the rating plate according to Directive 2014/34/EU (ATEX).
→ Product range in this Catalog Section.
- **VIK Ex ec version for converter operation** –
1MB1.3, 1MB5 + order code **C02+B40/B41+...**
"VIK" and "Ex ec IIC T3 Gc" markings on the rating plate and motor operating data for converter operation on the additional rating plate according to Directive 2014/34/EU (ATEX).

VIK standard version and VIK Ex ec versions include technology for Zone 2 with type of protection Ex ec IIC T3 Gc. Motors up to frame size 355 can be supplied in accordance with the technical requirements of the VIK recoDesign features for VIK version:

Ausführungsmerkmale VIK:

- Rating plate made of stainless steel
- Fan cover made of sheet steel
- Vertical motors with protective cover (order code H00 must be ordered)
- Terminal box with silicone seal
- Certified connection system in the terminal box
- Terminal box with certified sealing plugs
- External grounding
- Painting according to corrosivity category C3
- Second rating plate supplied loose

Minimum efficiency class:

For VIK standard, VIK Ex ec and VIK-Ex db version, the minimum efficiency class IE3 for line operation and converter operation must be complied with according to EU Regulation 2019/1781. For the VIK Ex eb version, the minimum efficiency class is IE2.

Ex certification EAC for the Eurasian Customs Union (Russia, Belarus, and Kazakhstan, Armenia, Kyrgyzstan) EAC = Eurasian Conformity

For the import and commissioning of explosion-protected motors in the Eurasian Customs Union, approval is required from a named Russian testing authority.

"Ex certificate EAC for the Eurasian Customs Union"
Order code **D35**

When motors are ordered with order code **D35**, they are fitted with an additional rating plate displaying the logo "EAC Ex" and the Russian Ex marking.

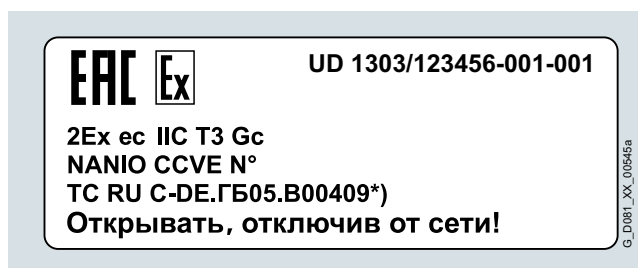

Example: Additional rating plate

The "EAC Ex" logo can also be found on the package label. The motor must have an "EAC Ex certificate", although the certificate does not generally have to be shipped with the motor. The customs authorities use the motor article number to check the motor certification.

A copy of the EAC Ex certificate must be in the customer's possession before the motor is commissioned.

The certificates are available from the SIOS (Siemens Industry Online Support) portal
<https://support.industry.siemens.com/cs/ww/en/>
as well as the "Drive Technology Configurator" (DT Configurator) www.siemens.com/dt-configurator

Coolant temperature

Coolant temperature –40 to +40 °C for explosion-protected motor

For all SIMOTICS XP 1MB. motors of frame sizes 71 to 450, the operating temperature can optionally be extended up to –40 °C. Extensive technical measures are necessary in this case.

Order code **D03**

¹⁾ The slipping time t_3 is the friction time until the motor stops (≤ 0.8 s); slipping time > 0.8 s on request.

²⁾ Maximum frequency of braking (duty cycles) per hour (> 0.8 s on request).

SIMOTICS XP 1MB1, 1MB5 explosion-protected motors

Orientation

Article number code

Selection and ordering dataOrdering example

Selection criteria	Requirement	Structure of the Article No.
Motor type 1MB1	Self-ventilated motor with explosion protection of type Ex tb IIIC (Ex Zone 21), cast-iron version, with IE2 High Efficiency, IP65 degree of protection	1MB1511-■■■■■-■■■■■
Motor frame size/No. of poles/Speed	160 M/4-pole/1500 rpm	1MB1511-1DB2■-■■■■■
Rated power	11 kW	
Voltage and frequency	230 VΔ/400 VY, 50 Hz	1MB1511-1DB22-2■■■■■
Type of construction with special version	IM B3	1MB1511-1DB22-2A■■■■■
Motor protection	Motor protection with PTC thermistor with 3 embedded temperature sensors for tripping	1MB1511-1DB22-2AB■
Terminal box position	Terminal box at top	1MB1511-1DB22-2AB4
Special version	Rotation of the terminal box through 90°, entry from DE	1MB1511-1DB22-2AB4-Z R10



SIMOTICS XP 1MB1, 1MB5 explosion-protected motors

Zones 21, 22, and 2 with types of protection Ex tb, Ex tc, Ex ec · IE4 Super Premium Efficiency

Cast-iron series 1MB5.4 – self-ventilated or forced-air cooled

Selection and ordering data

P _{rated} , 50 Hz	Frame size	Operating values at rated power										Cast-iron series 1MB5.4	m _{IM B3}	J			
		n _{rated}	T _{rated}	η _{rated} , 4/4	η _{rated} , 3/4	η _{rated} , 2/4	cosφ _{rated} , 4/4	I _{rated}	T _{LR} /T _{rated}	I _{LR} /I _{rated}	T _B /T _{rated}				L _{pFA}	L _{WA}	Article No.
kW	FS	rpm	Nm	%	%	%	A					dB(A)	dB(A)	▲ New	kg	kgm ²	
2-pole: 3000 rpm at 50 Hz																	
250	315	2982	800	96.5	96.6	96.4	0.91	410	2.6	7.5	3	80	95	▲ 1MB55 4-3AA6	1340	2.82	
315	315	2980	1010	96.5	96.7	96.5	0.91	520	2.4	7.5	2.9	81	96	▲ 1MB55 4-3AA7	1490	3.11	
355	355	2984	1136	96.5	96.7	95.9	0.9	590	2.3	8.4	3.1	83	98	▲ 1MB55 4-3BA3	2170	5.09	
400	355	2986	1279	96.5	96.5	96	0.91	660	2.3	7.7	3.1	83	98	▲ 1MB55 4-3BA4	2240	5.46	
500	355	2988	1598	96.5	96.4	95.8	0.89	840	2.8	8.5	3.7	83	98	▲ 1MB55 4-3BA5	2340	5.76	
560 ⁽¹⁾²⁾	400	2988	1790	97	96.9	96.5	0.89	940	1.6	7.3	3.2	74	90	1MB55 4-4AA3	2850	8.9	
630 ⁽¹⁾²⁾	400	2988	2000	97	97.1	96.8	0.9	1040	1.6	7.3	3	74	90	1MB55 4-4AA5	3000	9.8	
710 ⁽³⁾	400	2990	2250	97.2	97.3	96.9	0.89	680	2	7.8	3.1	74	90	1MB55 4-4AA7	3200	10.8	
800 ⁽¹⁾²⁾³⁾⁴⁾	450	2991	2550	97.5	97.4	97.1	0.87	790	1.6	8	4	75	91	1MB55 4-4BA3	4000	12.3	
900 ⁽¹⁾²⁾³⁾⁴⁾	450	2988	2900	97.5	97.6	97.4	0.88	870	1.9	7.8	3.8	75	91	1MB55 4-4BA5	4250	13.5	
1000 ⁽¹⁾²⁾³⁾⁴⁾	450	2988	3200	97.5	97.7	97.6	0.89	950	1.7	6.8	3.3	75	91	1MB55 4-4BA7	4450	14.7	
4-pole: 1500 rpm at 50 Hz																	
250	315	1488	1600	96.7	97	97	0.86	435	2.3	6.5	2.6	75	90	▲ 1MB55 4-3AB6	1520	5.09	
315	315	1488	2000	96.7	96.9	96.8	0.85	550	2.2	7.2	2.8	75	90	▲ 1MB55 4-3AB7	1530	5.28	
355	355	1491	2274	96.7	96.8	96.5	0.85	620	2.2	7.5	3.2	78	93	▲ 1MB55 4-3BB3	1960	6.26	
400	355	1491	2562	96.7	96.9	96.6	0.85	700	2.3	7.3	3.2	79	95	▲ 1MB55 4-3BB4	2080	7.06	
500	355	1493	3600	96.9	97	96.6	0.86	970	2.2	7.5	3.1	72	88	▲ 1MB55 4-3BB5	2370	8.52	
560 ⁽¹⁾²⁾	400	1493	3600	96.9	97	96.6	0.86	970	2.2	7.5	3.1	72	88	1MB55 4-4AB3	3050	14.9	
630 ⁽¹⁾²⁾	400	1492	4050	96.8	96.6	96.6	0.87	1080	2.2	6.9	2.8	74	90	1MB55 4-4AB5	3150	15.6	
710 ⁽³⁾	400	1491	4550	96.9	97	96.9	0.88	700	2	6.4	2.6	74	90	1MB55 4-4AB7	3250	16.9	
800 ⁽³⁾	450	1492	5100	96.9	97.1	96.9	0.87	790	1.5	6.5	2.4	79	95	1MB55 4-4BB3	4000	24.0	
900 ⁽³⁾	450	1493	5800	97.1	97.2	96.9	0.87	880	1.7	7.2	2.7	79	95	1MB55 4-4BB5	4150	25.4	
1000 ⁽¹⁾³⁾	450	1492	6400	97.1	97.2	97.1	0.88	980	1.8	6.8	2.5	79	95	1MB55 4-4BB7	4350	28.0	
Zones																	
Zone 21 (conductive and non-conductive dust occasionally) Ex tb IIIC														1			
Zone 22 (non-conductive dust rarely or for a short period) Ex tc IIIB														2			
Zone 2 (explosive gases rarely or for a short period) Ex ec IIC														3			
Voltages																	
50 Hz 400 VΔ/690 VY														Standard		3 4	Order code
50 Hz 500 VΔ														Without additional charge		4 0	–
50 Hz 690 VΔ														Without additional charge		4 7	–
For other voltages and more information, see from page 6/70																	
Types of construction																	
Without flange														Standard		A	Order code
With flange														With additional charge		F	–
For other types of construction and more information, see from page 6/82																	
Motor protection																	
Without														Standard		A	Order code
PTC thermistor with 3 temperature sensors														With additional charge		B	–
For other motor protection and more information, see from page 6/88																	
Terminal box position																	
Terminal box base left with terminal box 45°														Without additional charge		2	Order code
Terminal box base right with terminal box 45°														Standard		3	–
For other terminal box positions and more information, see from page 6/93																	
Special versions																	
Forced-air cooled (IC416)														1MB55 4-...-Z		F90+...+...+...	Order code(s)
For options and information, see from page 6/113																	



SIMOTICS XP 1MB1, 1MB5 explosion-protected motors

Zones 21, 22, and 2 with types of protection Ex tb, Ex tc, Ex ec · IE4 Super Premium Efficiency



Cast-iron series 1MB5.4 – self-ventilated or forced-air cooled

Selection and ordering data

P _{rated} , 50 Hz	Frame size	Operating values at rated power											Cast-iron series 1MB5.4 Article No.	m _{IM B3}	J		
		n _{rated}	T _{rated}	η _{rated} , 4/4	η _{rated} , 3/4	η _{rated} , 2/4	cosφ _{rated} , 4/4	I _{rated}	T _{LR} /T _{rated}	I _{LR} /I _{rated}	T _B /T _{rated}	L _{pFA}				L _{WA}	
kW	FS	rpm	Nm	%	%	%	A					dB(A)	dB(A)	▲ New	kg	kgm ²	
6-pole: 1000 rpm at 50 Hz																	
200	315	992	1925	96.3	96.5	96.3	0.81	370	2.8	7	3	68	83	▲ 1MB55 4-3AC7	1410	6.39	
250	315	992	2407	96.5	96.6	96.3	0.81	460	2.9	7.3	3	68	83	▲ 1MB55 4-3AC8	1640	8.1	
315	355	992	3032	96.6	96.9	96.9	0.86	550	2.4	6.8	2.8	75	90	▲ 1MB55 4-3BC2	2150	12.9	
355	355	993	3414	96.6	96.7	96.4	0.84	630	2.6	7.4	3.2	76	91	▲ 1MB55 4-3BC3	2250	13.8	
400	355	994	3843	96.6	96.7	96.5	0.84	710	2.7	7.7	2.9	75	90	▲ 1MB55 4-3BC4	2240	13.4	
450	400	994	4300	96.6	96.8	96.4	0.85	790	2.2	7.2	2.7	70	86	1MB55 4-4AC3	3100	25.5	
500 ¹⁾	400	994	4800	96.7	96.8	96.5	0.85	880	2.3	7.3	2.8	70	86	1MB55 4-4AC5	3250	27.4	
560	400	994	5400	96.7	96.8	96.4	0.84	1000	2.4	7.5	2.9	70	86	1MB55 4-4AC7	3300	28.6	
630 ¹⁾²⁾	450	995	6000	96.8	97.0	96.7	0.83	1130	2.0	7.0	2.8	72	88	1MB55 4-4BC3	4050	38.6	
710 ³⁾	450	994	6800	96.8	97.0	96.9	0.84	730	1.8	6.6	2.5	72	88	1MB55 4-4BC5	4200	41.0	
800 ¹⁾³⁾	450	994	7700	96.8	97.0	96.8	0.84	820	1.8	6.6	2.4	74	90	1MB55 4-4BC7	4300	43.3	
8-pole: 750 rpm at 50 Hz																	
160	315	741	2050	95.1	95.5	95.5	0.79	305	2.4	6.2	2.4	67	82	▲ 1MB55 4-3AD7	1420	6.78	
200	315	742	2550	95.4	95.6	95.4	0.78	390	2.9	6.7	2.8	72	86	▲ 1MB55 4-3AD8	1660	8.6	
250	355	744	3209	95.4	95.8	95.8	0.8	475	2.4	7.1	2.7	73	88	▲ 1MB55 4-3BD1	2280	13.3	
300	355	744	1420	95.4	95.7	95.4	0.8	600	2.4	7	2.9	73	88	▲ 1MB55 4-3BD2	2310	13.8	
355	400	744	4550	95.8	96.1	95.8	0.80	670	2.0	6.5	2.6	64	80	1MB55 4-4AD3	2850	21.9	
400	400	744	5100	96.0	96.2	95.9	0.80	750	2.1	6.8	2.7	64	80	1MB55 4-4AD5	3050	24.5	
450	400	744	5800	96.0	96.3	96.0	0.80	850	2.1	6.8	2.7	64	80	1MB55 4-4AD7	3250	27.5	
500 ⁵⁾	450	745	6400	96.2	96.4	96.1	0.79	950	2.0	6.8	2.5	67	83	1MB55 4-4BD3	3800	34.0	
560 ⁵⁾	450	745	7200	96.3	96.5	96.1	0.79	1060	2.0	6.9	2.6	67	83	1MB55 4-4BD5	4000	38.0	
630 ¹⁾⁵⁾	450	745	8100	96.4	96.6	96.3	0.80	1180	2.0	6.9	2.5	67	83	1MB55 4-4BD7	4250	42.5	
Zones																	
Zone 21 (conductive and non-conductive dust occasionally) Ex tb IIIC															1		
Zone 22 (non-conductive dust rarely or for a short period) Ex tc IIIB															2		
Zone 2 (explosive gases rarely or for a short period) Ex ec IIC															3		
Voltages																	
50 Hz 400 VΔ/690 VY		60 Hz 460 VΔ		Version		Standard										Order code	
50 Hz 500 VΔ		60 Hz 575 VΔ		Without additional charge		4 0										-	
50 Hz 690 VΔ				Without additional charge		4 7										-	
For other voltages and more information, see from page 6/70																	
Types of construction																	
Without flange		IM B3		Version		Standard										Order code	
With flange		IM B5		With additional charge		A F										-	
For other types of construction and more information, see from page 6/82																	
Motor protection																	
Without				Version		Standard										Order code	
PTC thermistor with 3 temperature sensors				With additional charge		A B										-	
For other motor protection and more information, see from page 6/88																	
Terminal box position																	
Terminal box base left with terminal box 45°				Version		Without additional charge										Order code	
Terminal box base right with terminal box 45°				Standard		2 3										-	
For other terminal box positions and more information, see from page 6/93																	
Special versions																	
Forced-air cooled (IC416)						1MB55 4-...-Z F90+...+...+...											
For options and information, see from page 6/113																	
						1MB55 4-...-Z ...+...+...+...											

6

1) Terminal box 1XB1631.
 2) Terminal box position NDE can only be ordered using order code **H09** (2 × terminal box TB3R61). Order code **H08** not available.
 3) The standard version is 50 Hz 690 VΔ (voltage code **4-7**) or 60 Hz 575 VΔ (voltage code **4-0**).
 4) In the series version, the maximum speed is n_{max} = 3000 rpm. Converter operation at higher speeds on request for an additional charge.
 5) Utilization with sinusoidal supply in accordance with thermal class 155 (temperature class F).



SIMOTICS XP 1MB1, 1MB5 explosion-protected motors

Zones 21, 22, and 2 with types of protection Ex tb, Ex tc, Ex ec · IE3 Premium Efficiency

Aluminum series 1MB10 – self-ventilated

Selection and ordering data

Operating values at rated power														Aluminum series		$m_{IM B3}$	J		
P_{rated} 50 Hz	P_{rated} 60 Hz	Frame size	n_{rated} 50 Hz	T_{rated} 50 Hz	Different IE class 60 Hz/P60	η_{rated} 50 Hz, 4/4	η_{rated} 50 Hz, 3/4	η_{rated} 50 Hz, 2/4	$\cos\phi_{rated}$ 50 Hz, 4/4	I_{rated} 50 Hz, 400 V	T_{LR}/I_{rated}	I_{LR}/I_{rated}	T_B/I_{rated}	L_{pFA} 50 Hz	L_{WA} 50 Hz			1MB1	Article No.
kW	kW	FS	rpm	Nm		%	%	%		A									
<ul style="list-style-type: none"> • Cooling: self-ventilated (IC411) • Efficiency according to IEC 60034-30: IE3 Premium Efficiency • Insulation: Thermal class 155 (temperature class F), IP55 degree of protection, utilization in accordance with thermal class 130 (temperature class B) 																			
2-pole: 3000 rpm at 50 Hz, 3600 rpm at 60 Hz ¹⁾																			
0.75	0.86	80 M	2850	2.5		80.7	82.2	81.9	0.86	1.56	2.6	6.2	3	60	71	1MB10 3-0DA2	-	11	0.0011
1.1	1.27	80 M	2885	3.65		82.7	83.9	83.1	0.85	2.25	3	7.1	3.3	60	71	1MB10 3-0DA3	-	12	0.0013
1.5	1.75	90 S	2910	4.9		84.2	84.6	83.2	0.86	3	2.7	8.1	4.2	65	77	1MB10 3-0EA0	-	15	0.0021
2.2	2.55	90 L	2910	7.2		85.9	86.8	86.1	0.88	4.2	2.6	8.3	4	65	77	1MB10 3-0EA4	-	19	0.0031
3	3.45	100 L	2920	9.8		87.1	87.9	87.5	0.88	5.6	3.2	8.1	4.6	67	79	1MB10 3-1AA4	-	26	0.0054
4	4.55	112 M	2950	12.9		88.1	88.7	88.2	0.89	7.4	2.5	8.7	4	69	81	1MB10 3-1BA2	-	34	0.012
5.5	6.3	132 S	2950	17.8		89.2	90.1	89.7	0.9	9.9	1.9	7.3	3.7	68	80	1MB10 3-1CA0	-	43	0.024
7.5	8.6	132 S	2950	24.5		90.1	90.9	90.7	0.92	13.1	2.1	8.3	4	68	80	1MB10 3-1CA1	-	57	0.031
11	12.6	160 M	2955	35.5		91.2	91.3	90.2	0.87	20	2.5	7.6	3.8	70	82	1MB10 3-1DA2	-	75	0.053
15	17.3	160 M	2960	48.5		91.9	91.9	91	0.87	27	2.8	8.8	4.3	70	82	1MB10 3-1DA3	-	84	0.061
18.5	21.3	160 L	2955	60		92.4	92.8	92.3	0.9	32	2.8	8.3	3.9	70	82	1MB10 3-1DA4	-	94	0.068
4-pole: 1500 rpm at 50 Hz, 1800 rpm at 60 Hz ¹⁾																			
0.55	0.63	80 M	1440	3.65		80.8	81.1	79.3	0.78	1.26	2.1	5.9	3.1	53	64	1MB10 3-0DB2	-	11	0.0021
0.75	0.86	80 M	1450	4.95		82.5	82.3	79.9	0.75	1.75	2.7	7.1	3.9	53	64	1MB10 3-0DB3	-	14	0.0029
1.1	1.27	90 S	1440	7.3		84.1	84.7	83.4	0.78	2.4	2.9	6.9	3.6	56	68	1MB10 3-0EB0	-	16	0.0036
1.5	1.75	90 L	1445	9.9		85.3	86	85.2	0.8	3.15	2.9	7.3	3.5	60	68	1MB10 3-0EB4	-	19	0.0049
2.2	2.55	100 L	1465	14.3		86.7	87	85.9	0.83	4.4	3.2	8.4	4.4	60	72	1MB10 3-1AB4	-	30	0.014
3	3.45	100 L	1460	19.6		87.7	88.5	87.9	0.83	5.9	2.5	8.3	3.9	60	72	1MB10 3-1AB5	-	30	0.014
4	4.55	112 M	1460	26		88.6	89.2	88.6	0.82	7.9	2.4	7.1	3.7	58	70	1MB10 3-1BB2	-	34	0.017
5.5	6.3	132 S	1470	35.5		89.6	90	89.4	0.82	10.8	2.9	8.5	3.7	64	76	1MB10 3-1CB0	-	64	0.046
7.5	8.6	132 M	1465	49		90.4	91.1	90.8	0.84	14.3	2.6	8.2	3.7	64	76	1MB10 3-1CB2	-	64	0.046
11	12.6	160 M	1475	71		91.4	91.8	91.2	0.84	20.5	2.6	7.6	3.4	65	77	1MB10 3-1DB2	-	83	0.083
15	17.3	160 L	1475	97		92.1	92.3	91.5	0.82	28.5	2.5	8.5	3.8	65	77	1MB10 3-1DB4	-	100	0.099
Zones																	1		
Zone 21 (conductive and non-conductive dust occasionally) Ex tb IIIC																	2		
Zone 22 (non-conductive dust rarely or for a short period) Ex tc IIIB																	3		
Zone 2 (explosive gases rarely or for a short period) Ex ec IIC																			
Voltages																	Version		Order code
50 Hz 230 VΔ/400 VY				60 Hz ¹⁾ 460 VY				Standard		2	2	-							
50 Hz 400 VΔ/690 VY				60 Hz ¹⁾ 460 VΔ				Standard		3	4	-							
50 Hz 500 VY								Without additional charge		2	7	-							
50 Hz 500 VΔ								Without additional charge		4	0	-							
For other voltages ¹⁾ and more information, see from page 6/66																	9	0	...
Types of construction																	Version		Order code
Without flange				IM B3 ²⁾				Standard		A		-							
With flange				IM B5 ²⁾				With additional charge		F		-							
With flange				IM B14 ²⁾				With additional charge		K		-							
For other types of construction and more information, see from page 6/71																			...
Motor protection																	Version		
Without								Standard		A									
3 temperature sensors (frame sizes 80, 90 or 100 to 200)								With additional charge		B									
For other motor protection and more information, see from page 6/84																			
Terminal box position																	Version		
Terminal box at top								Standard		4									
For other terminal box positions and more information, see from page 6/89																			
Special versions																			Order code(s)
For options, see from page 6/94																	1MB10 3-... -Z		...+...+...+...

SIMOTICS XP 1MB1, 1MB5 explosion-protected motors

Zones 21, 22, and 2 with types of protection Ex tb, Ex tc, Ex ec · IE3 Premium Efficiency



Aluminum series 1MB10 – self-ventilated

Selection and ordering data

Operating values at rated power														Aluminum series				
P_{rated} 50 Hz	P_{rated} 60 Hz	Frame size	n_{rated} 50 Hz	T_{rated} 50 Hz	Different IE class	η_{rated} 50 Hz, 4/4	η_{rated} 50 Hz, 3/4	η_{rated} 50 Hz, 2/4	$\cos\phi_{rated}$ 50 Hz, 4/4	I_{rated} 50 Hz, 400 V	T_{LR}/I_{rated}	I_{LR}/I_{rated}	T_B/I_{rated}	L_{pfA} 50 Hz	L_{WA} 50 Hz	1MB1	$m_{IM B3}$	J
kW	kW	FS	rpm	Nm		%	%	%		A						Article No.	kg	kgm ²
<ul style="list-style-type: none"> • Cooling: self-ventilated (IC411) • Efficiency according to IEC 60034-30: IE3 Premium Efficiency • Insulation: Thermal class 155 (temperature class F), IP55 degree of protection, utilization in accordance with thermal class 130 (temperature class B) 																		
6-pole: 1000 rpm at 50 Hz, 1200 rpm at 60 Hz ¹⁾																		
0.37	0.43	80 M	940	3.75		73.5	73.1	69.4	0.66	1.1	2.3	4.2	2.7	42	53	1MB10 3-0DC2	12	0.0025
0.55	0.63	80 M	935	5.6		77.2	77	73.9	0.67	1.53	2.5	4.5	2.8	42	53	1MB10 3-0DC3	14	0.0031
0.75	0.86	90 S	945	7.6		78.9	80	78.8	0.7	1.96	2.2	4.6	2.6	43	55	1MB10 3-0EC0	16	0.004
1.1	1.27	90 L	950	11.1	IE1	81	81.4	79.3	0.66	2.95	2.8	5	3	60	68	1MB10 3-0EC4	19	0.0052
1.5	1.75	100 L	970	14.8	IE2	82.5	83.1	81.5	0.73	3.6	1.9	5.2	2.8	59	71	1MB10 3-1AC4	30	0.014
2.2	2.55	112 M	970	21.5	IE2	84.3	85	83.9	0.75	5	2.2	5.6	2.8	65	74	1MB10 3-1BC2	39	0.014
3	3.45	132 S	975	29.5		85.6	86.1	84.9	0.73	6.9	2.3	6.6	3.2	58	66	1MB10 3-1CC0	42	0.034
4	4.55	132 M	975	39		86.8	87.1	86.2	0.73	9.1	2.2	6.2	3	67	75	1MB10 3-1CC2	46	0.039
5.5	6.3	132 M	975	54		88	88.3	87.2	0.72	12.5	2.7	6.8	3.4	64	72	1MB10 3-1CC3	58	0.05
7.5	8.6	160 M	985	73		89.1	89.5	88.6	0.81	15	2.3	7.9	3.2	71	79	1MB10 3-1DC2	95	0.132
11	12.6	160 L	980	107		90.3	90.8	90.2	0.8	22	2.9	6.8	2.8	66	74	1MB10 3-1DC4	106	0.164
8-pole: 750 rpm at 50 Hz, 900 rpm at 60 Hz ¹⁾																		
0.75	0.86	100 L	710	10.1		75	75.7	73.1	0.67	2.1	1.5	3.7	2.1	62	69	▲ 1MB10 3-1AD4	20	0.0096
1.1	1.27	100 L	710	14.8		77.7	76.4	75.1	0.67	3.05	1.8	4.1	2.3	62	70	▲ 1MB10 3-1AD5	26	0.013
1.5	1.75	112 M	720	19.9		79.7	85.6	77.3	0.63	4.15	2.6	5.1	3.1	62	70	▲ 1MB10 3-1BD2	34	0.028
2.2	2.55	132 S	725	29		81.9	82.5	80.9	0.71	5.3	1.9	5	2.5	65	73	▲ 1MB10 3-1CD0	42	0.046
3	3.45	132 M	725	39.5		83.5	83.8	82.2	0.72	7.1	2	5.2	2.5	70	78	▲ 1MB10 3-1CD2	58	0.061
4	4.55	160 M	730	52		84.5	85.5	84.7	0.74	9.1	1.6	4.7	2.1	68	76	▲ 1MB10 3-1DD2	67	0.076
5.5	6.3	160 M	730	72		86.2	87	86.3	0.73	12.4	2	5.5	2.4	68	76	▲ 1MB10 3-1DD3	78	0.1
7.5	8.6	160 L	730	98		87.3	87.9	86.9	0.73	16.9	2.3	5.8	2.7	70	78	▲ 1MB10 3-1DD4	86	0.13
Zones																		
Zone 21 (conductive and non-conductive dust occasionally) Ex tb IIIC ⁵⁾																		
Zone 22 (non-conductive dust rarely or for a short period) Ex tc IIIB																		
Zone 2 (explosive gases rarely or for a short period) Ex ec IIC																		
Voltages																		
50 Hz 230 VΔ/400 VY														Version		Order code		
60 Hz ¹⁾ 460 VY														Standard		2 2		
50 Hz 400 VΔ/690 VY														Standard		3 4		
50 Hz 500 VY														Without additional charge		2 7		
50 Hz 500 VΔ														Without additional charge		4 0		
For other voltages ¹⁾ and more information, see from page 6/66																9 0		
Types of construction																		
Without flange														Version		Order code		
IM B3 ²⁾														Standard		A		
With flange														With additional charge		F		
IM B5 ²⁾														With additional charge		K		
With flange																...		
IM B14 ²⁾																...		
For other types of construction and more information, see from page 6/71																		
Motor protection																		
Without														Version		Order code		
Standard																A		
3 temperature sensors (frame sizes 80, 90 or 100 to 200)														With additional charge		B		
For other motor protection and more information, see from page 6/84																		
Terminal box position																		
Terminal box at top														Version		Order code(s)		
Standard																4		
For other terminal box positions and more information, see from page 6/89																		
Special versions																		
For options, see from page 6/94														1MB10 3-		-Z		

6

For footnotes, see page 6/45

SIMOTICS XP 1MB1, 1MB5 explosion-protected motors

Zones 21, 22, and 2 with types of protection Ex tb, Ex tc, Ex ec · IE3 Premium Efficiency



Cast-iron series 1MB15, 1MB16 – self-ventilated

Selection and ordering data

Operating values at rated power															Cast-iron series		$m_{IM\ B3}$	J						
$P_{rated, 50\ Hz}$	$P_{rated, 60\ Hz}$	Frame size	$n_{rated, 50\ Hz}$	$T_{rated, 50\ Hz}$	Different IE class	$\eta_{rated, 50\ Hz}$	$\eta_{rated, 50\ Hz}$	$\eta_{rated, 50\ Hz}$	$\cos\phi_{rated, 50\ Hz}$	$I_{rated, 50\ Hz}$	T_{LR}/T_{rated}	I_{LR}/I_{rated}	T_B/T_{rated}	$L_{pFA, 50\ Hz}$	$L_{WA, 50\ Hz}$	Article No.								
kW	kW	FS	rpm	Nm		%	%	%		A							kg	kgm ²						
<ul style="list-style-type: none"> • Cooling: self-ventilated (IC411) • Efficiency according to IEC 60034-30: IE3 Premium Efficiency • Insulation: Thermal class 155 (temperature class F), IP55 degree of protection, utilization in accordance with thermal class 130 (temperature class B) 																								
4-pole: 1500 rpm at 50 Hz, 1800 rpm at 60 Hz ¹⁾																								
0.25	0.29	71 M	1395	1.71		73.5	73.7	70.4	0.72	0.68	2.5	4.2	2.6	44	55	1MB15-3-0CB2	13	0.0095						
0.37	0.43	71 M	1410	2.5		77.3	76.8	73.2	0.7	0.99	3.1	4.8	3.1	56	67	1MB15-3-0CB3	16	0.0014						
0.55	0.63	80 M	1440	3.65		80.8	81.1	79.3	0.78	1.26	2.1	5.9	3.1	53	64	1MB15-3-0DB2	18.5	0.0021						
0.75	0.88	80 M	1450	4.95		82.5	82.3	79.9	0.75	1.75	2.7	7.1	3.9	53	64	1MB15-3-0DB3	22.5	0.0029						
1.1	1.27	90 S	1440	7.3		84.1	84.7	83.4	0.78	2.4	2.9	6.9	3.6	56	68	1MB15-3-0EB0	25	0.0036						
1.5	1.75	90 L	1445	9.9		85.3	86	85.2	0.8	3.15	2.9	7.3	3.5	60	68	1MB15-3-0EB4	31	0.0049						
2.2	2.55	100 L	1465	14.3		86.7	87	85.9	0.83	4.4	3.2	8.4	4.4	60	72	1MB1-3-1AB4	40	0.014						
3	3.45	100 L	1460	19.6		87.7	88.5	87.9	0.83	5.9	2.5	8.3	3.9	60	72	1MB1-3-1AB5	40	0.014						
4	4.55	112 M	1460	26		88.6	89.2	88.6	0.82	7.9	2.4	7.1	3.7	58	70	1MB1-3-1BB2	46	0.017						
5.5	6.3	132 S	1470	35.5	IE2	89.6	90	89.4	0.82	10.8	2.9	8.5	3.7	64	76	1MB1-3-1CB0	74	0.046						
7.5	8.6	132 M	1465	49	IE2	90.4	91.1	90.8	0.84	14.3	2.6	8.2	3.7	64	76	1MB1-3-1CB2	80	0.046						
11	12.6	160 M	1475	71	IE2	91.4	91.8	91.2	0.84	20.5	2.6	7.6	3.4	65	77	1MB1-3-1DB2	109	0.083						
15	17.3	160 L	1475	97	IE2	92.1	92.3	91.5	0.82	28.5	2.5	8.5	3.8	65	77	1MB1-3-1DB4	127	0.099						
18.5	21.3	180 M	1470	120	IE2	92.6	93.1	93	0.82	35	2.5	7.2	3.3	66	73	1MB1-3-1EB2	165	0.13						
22	25.3	180 L	1470	143	IE2	93	93.6	93.6	0.83	41	2.3	6.8	3.3	68	75	1MB1-3-1EB4	170	0.14						
30	34.5	200 L	1470	195	IE2	93.6	94.2	94.2	0.84	55	2.6	7.3	3.1	65	72	1MB1-3-2AB5	240	0.22						
37	42.5	225 S	1478	240	IE2	93.9	94.5	94.4	0.86	66	2.5	6.4	2.7	65	78	1MB1-3-2BB0	285	0.42						
45	52	225 M	1478	290	IE2	94.2	94.9	95	0.86	80	2.6	6.6	2.6	66	79	1MB1-3-2BB2	340	0.52						
55	63	250 M	1482	355	IE2	94.6	95.1	95	0.87	96	2.5	6.8	2.9	66	79	1MB1-3-2CB2	420	0.85						
75	86	280 S	1485	480	IE2	95	95.3	95	0.86	133	2.5	6.9	3	69	83	1MB1-3-2DB0	570	1.4						
90	104	280 M	1485	580	IE2	95.2	95.5	95.3	0.87	157	2.6	7.2	3	70	84	1MB1-3-2DB2	670	1.7						
110	127	315 S	1488	710	IE2	95.4	95.8	95.5	0.87	191	2.6	6.8	2.9	70	84	1MB1-3-3AB0	760	2.2						
132	152	315 M	1490	850	IE2	95.6	95.9	95.9	0.87	230	2.8	7.3	3	73	87	1MB1-3-3AB2	960	2.9						
160	184	315 L	1490	1030	IE2	95.8	96.1	96.1	0.87	275	2.9	7.3	3.1	73	87	1MB1-3-3AB4	990	3.1						
200	230	315 L	1488	1280	IE2	96	96.3	96.1	0.88	340	3.2	7.4	3	73	87	1MB1-3-3AB5	1190	3.7						
Basic Line															5									
Performance Line															6									
Zones																								
Zone 21 (conductive and non-conductive dust occasionally) Ex tb IIIC															1									
Zone 22 (non-conductive dust rarely or for a short period) Ex tc IIIB															2									
Zone 2 (explosive gases rarely or for a short period) Ex ec IIC															3									
Voltages ³⁾																								
Version																			Order code					
50 Hz 230 VΔ/400 VY 60 Hz ¹⁾ 460 VY																			Standard	2 2			-	
50 Hz 400 VΔ/690 VY 60 Hz ¹⁾ 460 VΔ																			Standard	3 4			-	
50 Hz 500 VY																			Without additional charge	2 7			-	
50 Hz 500 VΔ																			Without additional charge	4 0			-	
For other voltages ¹⁾ and more information, see from page 6/67																				9 0			...	
Types of construction																							Order code	
Version																								
Without flange IM B3 ²⁾																			Standard	A			-	
With flange IM B5 ²⁾																			With additional charge	F			-	
With flange IM B14 ²⁾																			With additional charge	K			-	
For other types of construction and more information, see from page 6/74																							...	
Motor protection																							Order code	
Version																								
Without																			Only possible for Basic Line	Standard	A			-
PTC thermistor with 3 temperature sensors																			Basic Line	With additional charge	B			-
For other motor protection and more information, see from page 6/85																			Performance Line	Standard	B			-
Terminal box position																							Order code(s)	
Version																								
Terminal box at top																			Standard	4				
For other terminal box positions and more information, see from page 6/90																								
Special versions																							Order code(s)	
For options, see from page 6/99																								
																							1MB1-3-...-Z-...+...+...+...	

6

For footnotes, see page 6/45



SIMOTICS XP 1MB1, 1MB5 explosion-protected motors

Zones 21, 22, and 2 with types of protection Ex tb, Ex tc, Ex ec · IE3 Premium Efficiency

Cast-iron series 1MB15, 1MB16 – self-ventilated

Selection and ordering data

Operating values at rated power															Cast-iron series		$m_{IM\ B3}$	J
P_{rated} 50 Hz	P_{rated} 60 Hz	Frame size	n_{rated} 50 Hz	T_{rated} 50 Hz	Different IE class 60 Hz/P60	η_{rated} 50 Hz, 4/4	η_{rated} 50 Hz, 3/4	η_{rated} 50 Hz, 2/4	$\cos\phi_{rated}$ 50 Hz, 4/4	I_{rated} 50 Hz, 400 V	T_{LR}/I_{rated}	I_{LR}/I_{rated}	T_{β}/I_{rated}	L_{pfA} 50 Hz	L_{WA} 50 Hz	Article No.		
kW	kW	FS	rpm	Nm		%	%	%		A								

- Cooling: self-ventilated (IC411)
- Efficiency according to IEC 60034-30: IE3 Premium Efficiency
- Insulation: Thermal class 155 (temperature class F), IP55 degree of protection, utilization in accordance with thermal class 130 (temperature class B)

6-pole: 1000 rpm at 50 Hz, 1200 rpm at 60 Hz ¹⁾																		
0.18	0.21	71 M	885	1.94		63.9	64.8	60.8	0.69	0.59	2.3	2.8	2.3	39	50	1MB15-3-0CC2	12.5	0.001
0.25	0.29	71 M	885	2.7		68.6	69.5	66.2	0.69	0.76	2.6	3.2	2.6	46	57	1MB15-3-0CC3	15.5	0.0015
0.37	0.43	80 M	940	3.75		73.5	73.1	69.4	0.66	1.1	2.3	4.2	2.7	42	53	1MB15-3-0DC2	18.5	0.0025
0.55	0.63	80 M	935	5.6		77.2	77	73.9	0.67	1.53	2.5	4.5	2.8	42	53	1MB15-3-0DC3	22.5	0.0031
0.75	0.88	90 S	945	7.6		78.9	80	78.8	0.7	1.96	2.2	4.6	2.6	43	55	1MB15-3-0EC0	26.5	0.004
1.1	1.27	90 L	950	11.1	IE1	81	81.4	79.3	0.66	2.95	2.8	5	3	60	68	1MB15-3-0EC4	32	0.0052
1.5	1.75	100 L	970	14.8	IE2	82.5	83.1	81.5	0.73	3.6	1.9	5.2	2.8	59	71	1MB1-3-1AC4	36	0.011
2.2	2.55	112 M	970	21.5	IE2	84.3	85	83.9	0.75	5	2.2	5.6	2.8	65	74	1MB1-3-1BC2	53	0.017
3	3.45	132 S	975	29.5		85.6	86.1	84.9	0.73	6.9	2.3	6.6	3.2	58	66	1MB1-3-1CC0	60	0.034
4	4.55	132 M	975	39		86.8	87.1	86.2	0.73	9.1	2.2	6.2	3	67	75	1MB1-3-1CC2	64	0.039
5.5	6.3	132 M	975	54		88	88.3	87.2	0.72	12.5	2.7	6.8	3.4	64	72	1MB1-3-1CC3	76	0.05
7.5	8.6	160 M	985	73		89.1	89.5	88.6	0.81	15	2.3	7.9	3.2	71	79	1MB1-3-1DC2	124	0.132
11	12.6	160 L	980	107		90.3	90.8	90.2	0.8	22	2.9	6.8	2.8	66	74	1MB1-3-1DC4	138	0.164
15	18	180 L	975	147	IE2	91.2	91.9	91.9	0.8	29.5	2.3	5.9	2.8	61	68	1MB1-3-1EC4	180	0.19
18.5	22	200 L	978	181	IE2	91.7	92.5	92.5	0.79	37	2.5	5.6	2.6	64	71	1MB1-3-2AC4	215	0.28
22	26.5	200 L	978	215	IE2	92.2	93.1	93.2	0.79	43.5	2.5	5.6	2.6	61	68	1MB1-3-2AC5	230	0.32
30	36	225 M	982	290	IE2	92.9	93.6	93.5	0.83	56	2.6	6.6	3	64	77	1MB1-3-2BC2	325	0.67
37	44.5	250 M	985	360	IE2	93.3	94	94	0.85	67	2.7	7	2.9	62	75	1MB1-3-2CC2	405	1
45	54	280 S	988	435	IE2	93.7	94.3	94.2	0.85	82	3	6.8	2.8	60	74	1MB1-3-2DC0	510	1.4
55	66	280 M	988	530	IE2	94.1	94.5	94.4	0.85	99	3.3	7.2	3	65	79	1MB1-3-2DC2	560	1.64
75	90	315 S	990	720		94.6	94.9	94.4	0.84	136	2.6	7.5	3.1	63	78	1MB1-3-3AC0	750	2.6
90	108	315 M	991	870	IE2	94.9	95.2	94.9	0.85	161	2.5	6.7	2.8	63	78	1MB1-3-3AC2	890	3.1
110	132	315 L	991	1060	IE2	95.1	95.5	95.3	0.84	199	2.8	7.2	3	63	78	1MB1-3-3AC4	990	3.9
132	158	315 L	992	1270	IE2	95.4	95.7	95.4	0.82	245	3.3	8	3.3	66	81	1MB1-3-3AC5	1130	4.48
160	192	315 L	992	1540	IE2	95.6	95.8	95.5	0.82	295	3.5	8.5	3.6	66	81	1MB1-3-3AC6	1260	5.41

Basic Line		5																
Performance Line		6																
Zones																		
Zone 21 (conductive and non-conductive dust occasionally) Ex tb IIIC																		
Zone 22 (non-conductive dust rarely or for a short period) Ex tc IIIB																		
Zone 2 (explosive gases rarely or for a short period) Ex ec IIC																		
Voltages ³⁾																		
50 Hz 230 VΔ/400 VY										Version				Order code				
60 Hz ¹⁾ 460 VY										Standard				2 2				
50 Hz 400 VΔ/690 VY										Standard				3 4				
50 Hz 500 VY										Without additional charge				2 7				
50 Hz 500 VΔ										Without additional charge				4 0				
For other voltages ¹⁾ and more information, see from page 6/67																		
Types of construction																		
Without flange										Version				Order code				
IM B3 ²⁾										Standard				A				
With flange										With additional charge				F				
IM B5 ²⁾										With additional charge				K				
With flange										With additional charge				...				
For other types of construction and more information, see from page 6/74																		
Motor protection																		
Without										Line				Version				
PTC thermistor with 3 temperature sensors										Only possible for Basic Line				Standard				
										Basic Line				With additional charge				
										Performance Line				Standard				
For other motor protection and more information, see from page 6/85																		
Terminal box position																		
Terminal box at top										Version				Order code(s)				
										Standard				4				
For other terminal box positions and more information, see from page 6/90																		
Special versions																		
For options, see from page 6/99																		
1MB1-3-...-Z-...+...+...+...																		



For footnotes, see page 6/45

SIMOTICS XP 1MB1, 1MB5 explosion-protected motors

Zones 21, 22, and 2 with types of protection Ex tb, Ex tc, Ex ec · IE3 Premium Efficiency



Cast-iron series 1MB15, 1MB16 – self-ventilated

Selection and ordering data

Operating values at rated power														Cast-iron series		$m_{IM B3}$	J		
P_{rated} 50 Hz	P_{rated} 60 Hz	Frame size	n_{rated} 50 Hz	T_{rated} 50 Hz	Different IE class 60 Hz/P60	η_{rated} 50 Hz	η_{rated} 50 Hz	η_{rated} 50 Hz	$\cos\phi_{rated}$ 50 Hz	I_{rated} 50 Hz	T_{LR}/I_{rated}	I_{LR}/I_{rated}	T_B/I_{rated}	L_{pFA} 50 Hz	L_{WA} 50 Hz			1MB15.3 – Basic Line	1MB16.3 – Performance Line
kW	kW	FS	rpm	Nm	%	%	%	%	A									kg	kgm ²

- Cooling: self-ventilated (IC411)
- Efficiency according to IEC 60034-30: IE3 Premium Efficiency
- Insulation: Thermal class 155 (temperature class F), IP55 degree of protection, utilization in accordance with thermal class 130 (temperature class B)

8-pole: 750 rpm at 50 Hz, 900 rpm at 60 Hz ¹⁾																		
0.09	0.1	71 M	650	1.32		44.1	42.8	37.3	0.64	0.46	1.9	2.2	1.9	46	53	▲ 1MB15.3-0CD2	13	0.0098
0.12	0.1	71 M	660	1.74		50.7	49.9	44.8	0.63	0.54	2.1	2.5	2.1	46	53	▲ 1MB15.3-0CD3	16	0.0014
0.18	0.2	80 M	705	2.45		58.7	55.8	49.2	0.49	0.9	2.3	3	2.8	48	61	▲ 1MB15.3-0DD2	18	0.0021
0.25	0.3	80 M	695	3.45		64.1	62.7	57.8	0.57	0.93	1.8	2.9	2.1	52	59	▲ 1MB15.3-0DD3	22	0.003
0.37	0.4	90 S	685	5.2		69.3	68.3	63.7	0.68	1.13	1.7	2.9	1.8	56	53	▲ 1MB15.3-0ED0	26	0.0045
0.55	0.6	90 L	695	7.6		73	71.2	66.5	0.67	1.62	2	3.5	2.3	61	68	▲ 1MB15.3-0ED4	26	0.0045
0.75	0.9	100 L	710	10.1		75	75.7	73.1	0.67	2.1	1.5	3.7	2.1	61	69	▲ 1MB1.3-1AD4	31	0.0096
1.1	1.27	100 L	710	14.8		77.7	76.4	75.1	0.67	3.05	1.8	4.1	2.3	62	70	▲ 1MB1.3-1AD5	36	0.013
1.5	1.75	112 M	720	19.9		79.7	85.6	77.3	0.63	4.15	2.6	5.1	3.1	62	70	▲ 1MB1.3-1BD2	46	0.028
2.2	2.55	132 S	725	29		81.9	82.5	80.9	0.71	5.3	1.9	5	2.5	65	73	▲ 1MB1.3-1CD0	60	0.046
3	3.45	132 M	725	39.5		83.5	83.8	82.2	0.72	7.1	2	5.2	2.5	70	78	▲ 1MB1.3-1CD2	78	0.061
4	4.55	160 M	730	52		84.5	85.5	84.7	0.74	9.1	1.6	4.7	2.1	68	76	▲ 1MB1.3-1DD2	98	0.076
5.5	6.3	160 M	730	72		86.2	87	86.3	0.73	12.4	2	5.5	2.4	68	76	▲ 1MB1.3-1DD3	109	0.1
7.5	8.6	160 L	730	98		87.3	87.9	86.9	0.73	16.9	2.3	5.8	2.7	70	78	▲ 1MB1.3-1DD4	117	0.13
11	13.2	180 L	725	145		88.6	89.7	89.6	0.74	24	2.1	5.1	2.4	61	74	▲ 1MB1.3-1ED4	190	0.26
15	18	200 L	730	196		89.6	90.1	89.4	0.73	33.5	3	6.8	3.7	57	70	▲ 1MB1.3-2AD5	255	0.4
18.5	22	225 S	732	240		90.1	90.6	90	0.75	39.5	2.5	5.9	3	56	70	▲ 1MB1.3-2BD0	270	0.5
22	26.5	225 M	732	285		90.6	91.4	91.2	0.77	45.5	2.6	5.9	2.9	56	70	▲ 1MB1.3-2BD2	280	0.55
30	36	250 M	735	390		91.3	91.8	91.5	0.79	60	2.6	6.1	3	60	74	▲ 1MB1.3-2CD2	370	0.86
37	44.5	280 S	736	480		91.8	92.5	92.4	0.78	75	2.3	5.4	2.4	63	77	▲ 1MB1.3-2DD0	460	1.1
45	54	280 M	738	580		92.2	92.8	92.6	0.8	88	2.5	5.9	2.5	65	79	▲ 1MB1.3-2DD2	550	1.6
55	66	315 S	740	710		92.5	92.9	92.6	0.81	106	2.3	6	2.7	66	81	▲ 1MB1.3-3AD0	650	2
75	90	315 M	738	970		93.1	93.5	93.3	0.81	144	2.3	5.9	2.7	69	84	▲ 1MB1.3-3AD2	720	2.5
90	108	315 L	740	1160		93.4	94.2	94.3	0.83	168	2.2	5.8	2.5	71	85	▲ 1MB1.3-3AD4	860	3.1
110	132	315 L	740	1420		93.7	94.2	94.1	0.82	205	2.7	6.7	2.9	74	88	▲ 1MB1.3-3AD5	980	3.9
132	158	315 L	740	1700		94	94.4	94.1	0.81	250	2.9	7.2	3.3	76	90	▲ 1MB1.3-3AD6	1070	4.5

Basic Line																			
Performance Line																			
Zones																			
Zone 21 (conductive and non-conductive dust occasionally) Ex tb IIIC ⁵⁾																			
Zone 22 (non-conductive dust rarely or for a short period) Ex tc IIIB																			
Zone 2 (explosive gases rarely or for a short period) Ex ec IIC																			
Voltages ³⁾																			
50 Hz 230 VΔ/400 VY	60 Hz ¹⁾ 460 VY																		Order code
50 Hz 400 VΔ/690 VY	60 Hz ¹⁾ 460 VΔ																		Standard
50 Hz 500 VY																			Without additional charge
50 Hz 500 VΔ																			Without additional charge
For other voltages ¹⁾ and more information, see from page 6/67																			
Types of construction																			
Without flange	IM B3 ²⁾																		Standard
With flange	IM B5 ²⁾																		With additional charge
With flange	IM B14 ²⁾																		With additional charge
For other types of construction and more information, see from page 6/74																			
Motor protection																			
Without	Line	Only possible for Basic Line																	Standard
PTC thermistor with 3 temperature sensors	Basic Line																		With additional charge
	Performance Line																		Standard
For other motor protection and more information, see from page 6/85																			
Terminal box position																			
Terminal box at top																			Standard
For other terminal box positions and more information, see from page 6/90																			
Special versions																			
For options, see from page 6/99																	Order code(s)		
																	1MB1.3-...-Z ...+...+...+...		

For footnotes, see page 6/45



SIMOTICS XP 1MB1, 1MB5 explosion-protected motors

Zones 21, 22, and 2 with types of protection Ex tb, Ex tc, Ex ec · IE3 Premium Efficiency

Cast-iron series 1MB5.3 – self-ventilated or forced-air cooled – Advanced insulation system

Selection and ordering data

P _{rated} , 50 Hz kW	Frame size FS	Operating values at rated power										L _{WA} dB(A)	L _{pfA} dB(A)	Cast-iron series 1MB5.3 Article No.	m _{IM B3} kg	J kgm ²	
		n _{rated} rpm	T _{rated} Nm	η _{rated} %	η _{rated} %	η _{rated} %	cosφ _{rated} %	I _{rated} A	T _{LR} /T _{rated}	I _{LR} /I _{rated}	T _B /T _{rated}						
2-pole: 3000 rpm at 50 Hz																	
250	315	2982	800	95.8	95.9	95.6	0.91	415	2.8	7.2	3	80	94	▲ 1MB55 3-3AA6	1340	2.82	
315	315	2980	1010	95.8	96	95.8	0.91	520	2.4	7.5	2.9	81	96	▲ 1MB55 3-3AA7	1490	3.11	
355	355	2982	1136	95.8	95.9	95.6	0.91	415	2.8	7.2	3	80	94	▲ 1MB55 3-3BA3	2170	5.09	
400	355	2980	1009	95.8	96	95.8	0.91	520	2.4	7.5	2.9	81	96	▲ 1MB55 3-3BA4	2240	5.46	
500	355	2984	1136	95.8	95.7	95.2	0.9	590	2.3	8.4	3.1	83	98	▲ 1MB55 3-3BA5	2340	5.76	
560 ⁽¹⁾²⁾	400	2986	1279	95.8	95.8	95.3	0.91	660	2.3	7.7	3.1	83	98	1MB55 3-4AA3	2850	8.9	
630 ⁽¹⁾²⁾	400	2988	1598	95.8	95.7	95.1	0.89	850	2.8	8.5	3.7	83	98	1MB55 3-4AA5	3000	9.8	
710 ⁽³⁾	400	2988	2250	96.9	97	96.7	0.9	670	2	7.4	3.1	74	90	1MB55 3-4AA7	3200	10.8	
800 ⁽¹⁾²⁾³⁾⁴⁾	450	2990	2550	97	96.9	96.6	0.88	780	1.5	7.6	3.8	75	91	1MB55 3-4BA3	4000	12.3	
900 ⁽¹⁾²⁾³⁾⁴⁾	450	2986	2900	97	97.1	96.9	0.89	860	1.7	7.4	3.6	75	91	1MB55 3-4BA5	4250	13.5	
1000 ⁽¹⁾²⁾³⁾⁴⁾	450	2984	3200	97	97.2	97.1	0.9	950	1.6	6.4	3.1	75	91	1MB55 3-4BA7	4450	14.7	
4-pole: 1500 rpm at 50 Hz																	
250	315	1490	1600	96	96.2	95.9	0.87	430	2.1	7.2	2.8	75	91	▲ 1MB55 3-3AB6	1400	4.55	
315	315	1488	2000	96	96.2	96.1	0.85	560	2.2	7.2	2.8	75	90	▲ 1MB55 3-3AB7	1530	5.28	
355	355	1490	1602	96	96.2	95.9	0.87	430	2.1	7.2	2.8	75	91	▲ 1MB55 3-3BB3	2070	6.36	
400	355	1488	2022	96	96.2	96.1	0.85	560	2.2	7.2	2.8	75	90	▲ 1MB55 3-3BB4	2100	7.06	
500	355	1491	2274	96	96.1	95.8	0.88	610	2.2	7.5	3.1	81	95	▲ 1MB55 3-3BB5	2370	8.52	
560	400	1491	2562	96	96.1	95.9	0.87	690	2.1	7.3	3	80	95	1MB55 3-4AB3	2800	12.8	
630 ⁽¹⁾²⁾	400	1491	3202	96.0	96.2	96.0	0.86	870	3.2	8.9	3.3	80	94	1MB55 3-4AB5	3000	14.4	
710 ⁽³⁾	400	1492	4550	96.6	96.7	96.3	0.88	700	1.8	6.9	2.7	78	94	1MB55 3-4AB7	3200	16.5	
800 ⁽³⁾	450	1491	5100	96.5	96.6	96.2	0.87	790	1.6	6.4	2.5	81	97	1MB55 3-4BB3	3850	22.2	
900 ⁽³⁾	450	1492	5800	96.6	96.7	96.2	0.87	900	1.6	6.9	2.7	81	97	1MB55 3-4BB5	4100	24.8	
1000 ⁽¹⁾³⁾	450	1491	6400	96.6	96.7	96.4	0.88	970	1.9	6.5	2.5	81	97	1MB55 3-4BB7	4300	27.4	
Zones																	
Zone 21 (conductive and non-conductive dust occasionally) Ex tb IIIC															1		
Zone 22 (non-conductive dust rarely or for a short period) Ex tc IIIB															2		
Zone 2 (explosive gases rarely or for a short period) Ex ec IIC															3		
Voltages																	
50 Hz 400 VΔ/690 VY															Version		Order code
60 Hz 460 VΔ															Standard		3 4
50 Hz 500 VΔ															Without additional charge		4 0
50 Hz 690 VΔ															Without additional charge		4 7
For other voltages and more information, see from page 6/70																	
Types of construction																	
Without flange															Version		Order code
IM B3															Standard		A
With flange															With additional charge		F
For other types of construction and more information, see from page 6/82																	
Motor protection																	
Without															Version		Order code
PTC thermistor with 3 temperature sensors															Standard		A
															With additional charge		B
For other motor protection and more information, see from page 6/88																	
Terminal box position																	
Terminal box base left with terminal box 45°															Version		Order code
															Without additional charge		2
Terminal box base right with terminal box 45°															Standard		3
For other terminal box positions and more information, see from page 6/93																	
Special versions																	
Forced-air cooled (IC416)																	Order code(s)
															1MB55 3- ...		-Z F90+...+...+...
For options and information, see from page 6/113																	
															1MB55 3- ...		-Z ...+...+...+...



SIMOTICS XP 1MB1, 1MB5 explosion-protected motors

Zones 21, 22, and 2 with types of protection Ex tb, Ex tc, Ex ec · IE3 Premium Efficiency



Cast-iron series 1MB5.3 – self-ventilated or forced-air cooled – Advanced insulation system

Selection and ordering data

P _{rated} , 50 Hz	Frame size	Operating values at rated power											Cast-iron series 1MB5.3 Article No.	m _{IM B3}	J			
		n _{rated}	T _{rated}	η _{rated} , 4/4	η _{rated} , 3/4	η _{rated} , 2/4	cosφ _{rated} , 4/4	I _{rated}	T _{LR} /T _{rated}	I _{LR} /I _{rated}	T _B /T _{rated}	L _{pfA}				L _{WA}		
kW	FS	rpm	Nm	%	%	%	A								kg	kgm ²		
<ul style="list-style-type: none"> • Cooling: self-ventilated (IC411) • Efficiency: IE3 Premium Efficiency • Insulation: Thermal class 155 (temperature class F), IP55 degree of protection, utilization with sinusoidal supply in accordance with thermal class 130 (temperature class B) • Optional and suitable for converter operation with insulated bearings (L51) for f_p ≥ 2.5 kHz; U_{line} ≤ 480 V; U_{motor} ≤ 500 V; U_{DC} ≤ 720 V - IVIC-C advanced insulation system 																		
6-pole: 1000 rpm at 50 Hz																		
200	315	992	1930	95.8	96	95.8	0.81	370	2.8	7	3	68	83	▲ 1MB55 3-3AC7	1410	6.39		
250	315	992	2400	95.8	95.9	95.6	0.81	465	2.9	7.2	3	68	83	▲ 1MB55 3-3AC8	1640	8.1		
315	355	992	3032	95.8	96.1	96.1	0.86	550	2.4	6.8	2.8	75	90	▲ 1MB55 3-3BC2	2150	12.9		
355	355	993	3414	95.8	95.9	95.6	0.84	640	2.6	7.4	3.2	76	91	▲ 1MB55 3-3BC3	2250	13.8		
400	355	994	3843	95.8	96	95.8	0.84	720	2.7	7.7	2.9	75	90	▲ 1MB55 3-3BC4	2240	13.4		
450	400	992	4350	96	96.1	95.8	0.84	790	1.9	6.5	2.8	72	88	1MB55 3-4AC3	2900	22.0		
500	400	992	4800	96	96.1	95.8	0.85	870	2	6.5	2.7	72	88	1MB55 3-4AC5	3050	24.7		
560 ¹⁾	400	992	5400	96.2	96.3	96	0.86	980	2.1	6.5	2.8	72	88	1MB55 3-4AC7	3250	27.8		
630 ¹⁾	450	993	6100	96.3	96.4	96.2	0.84	1110	2	6.5	2.6	74	90	1MB55 3-4BC3	3800	34.4		
710 ³⁾	450	993	6800	96.3	96.4	96.3	0.85	730	2.1	6.2	2.6	74	90	1MB55 3-4BC5	4050	38.5		
800 ^{1) 3)}	450	993	7700	96.5	96.7	96.5	0.85	820	2.1	6.7	2.6	74	90	1MB55 3-4BC7	4300	43.1		
8-pole: 750 rpm at 50 Hz																		
160	315	741	2050	94.3	94.7	94.7	0.79	310	2.4	6.2	2.4	67	82	▲ 1MB55 3-3AD7	1420	6.78		
200	315	742	2550	94.6	94.8	94.6	0.78	390	2.9	6.7	2.8	72	86	▲ 1MB55 3-3AD8	1660	8.6		
250	355	744	3209	94.6	95	95	0.8	475	2.4	7.1	2.7	73	88	▲ 1MB55 3-3BD1	2280	13.3		
315	355	744	4043	94.6	94.9	94.6	0.8	600	2.4	7	2.9	73	88	▲ 1MB55 3-3BD2	2310	13.8		
355	400	742	4550	95.6	95.7	95.5	0.81	660	1.9	6.2	2.5	64	80	▲ 1MB55 3-3BB5	2850	21.9		
400	400	742	5100	95.7	95.8	95.5	0.81	740	2	6.5	2.6	64	80	1MB55 3-4AD3	3050	24.5		
450	400	742	5800	95.8	95.9	95.8	0.81	840	2	6.5	2.6	64	80	1MB55 3-4AD5	3250	27.5		
500 ⁵⁾	450	744	6400	95.9	96	95.7	0.8	940	1.9	6.5	2.4	67	83	1MB55 3-4AD7	3800	34.0		
560 ⁵⁾	450	744	7200	96	96.1	95.8	0.8	1050	1.9	6.5	2.4	67	83	1MB55 3-4BD3	4000	38.0		
630 ^{1) 5)}	450	744	8100	96.1	96.2	95.9	0.81	1170	1.9	6.5	2.4	67	83	1MB55 3-4BD5	4250	42.5		
Zones																		
Zone 21 (conductive and non-conductive dust occasionally) Ex tb IIC															1			
Zone 22 (non-conductive dust rarely or for a short period) Ex tc IIIB															2			
Zone 2 (explosive gases rarely or for a short period) Ex ec IIC															3			
Voltages																		
50 Hz 400 VΔ/690 VY															60 Hz 460 VΔ	Standard	3 4	Order code
50 Hz 500 VΔ															60 Hz 575 VΔ	Without additional charge	4 0	–
50 Hz 690 VΔ																Without additional charge	4 7	–
For other voltages and more information, see from page 6/70																		
Types of construction																		
Without flange															IM B3	Standard	A	Order code
With flange															IM B5	With additional charge	F	–
For other types of construction and more information, see from page 6/82																		
Motor protection																		
Without																Standard	A	Order code
PTC thermistor with 3 temperature sensors																With additional charge	B	–
For other motor protection and more information, see from page 6/88																		
Terminal box position																		
Terminal box base left with terminal box 45°																Without additional charge	2	Order code
Terminal box base right with terminal box 45°																Standard	3	–
For other terminal box positions and more information, see from page 6/93																		
Special versions																		
Forced-air cooled (IC416)																	1MB55 3-...-Z	F90+...+...+...
For options and information, see from page 6/113																		

6

1) Terminal box 1XB1631.
 2) Terminal box position NDE can only be ordered using order code **H09** (2 × terminal box TB3R61). Order code **H08** not available.
 3) The standard version is 50 Hz 690 VΔ (voltage code **4-7**) or 60 Hz 575 VΔ (voltage code **4-0**).
 4) In the series version, the maximum speed is n_{max} = 3000 rpm. Converter operation at higher speeds on request for an additional charge.
 5) Utilization with sinusoidal supply in accordance with thermal class 155 (temperature class F).



SIMOTICS XP 1MB1, 1MB5 explosion-protected motors

Zones 21, 22, and 2 with types of protection Ex tb, Ex tc, Ex ec · IE3 Premium Efficiency

Cast-iron series 1MB58.3 – self-ventilated or forced-air cooled – Premium insulation system

Selection and ordering data

P _{rated} , 50 Hz kW	Frame size FS	Operating values at rated power										Cast-iron series 1MB58.3		m _{IM B3} kg	J kgm ²		
		n _{rated} rpm	T _{rated} Nm	η _{rated} , 4/4 %	η _{rated} , 3/4 %	η _{rated} , 2/4 %	cosφ _{rated} , 4/4	I _{rated} A	T _{LR} /T _{rated}	I _{LR} /I _{rated}	T _B /T _{rated}	L _{pfA} dB(A)	L _{WA} dB(A)			Article No.	
2-pole: 3000 rpm at 50 Hz																	
545 ¹⁾	400	2988	1740	96.9	96.9	96.4	0.90	900	1.6	7.3	3.1	74	90	1MB58 3-4AA3	2850	8.9	
610 ¹⁾	400	2988	1950	97.0	97.0	96.7	0.91	1000	1.6	7.3	3.1	74	90	1MB58 3-4AA5	3000	9.8	
680 ²⁾	400	2988	2150	97.0	97.1	96.8	0.91	640	1.7	7.3	3	74	90	1MB58 3-4AA7	3200	10.8	
775 ^{1) 2) 3)}	450	2990	2500	97.4	97.4	97.0	0.88	760	1.2	7.7	3.4	75	91	1MB58 3-4BA3	4000	12.3	
875 ^{1) 2) 3)}	450	2988	2800	97.4	97.5	97.3	0.90	840	1.2	7.2	3	75	91	1MB58 3-4BA5	4250	13.5	
970 ^{1) 2) 3)}	450	2986	3100	97.4	97.5	97.4	0.91	920	1.2	7.0	2.8	75	91	1MB58 3-4BA7	4450	14.7	
4-pole: 1500 rpm at 50 Hz																	
545	400	1492	3500	96.4	96.4	96.0	0.87	940	1.8	6.7	2.7	78	94	1MB58 3-4AB3	2800	12.8	
615	400	1492	3950	96.6	96.6	96.2	0.87	1060	1.9	6.9	2.8	78	94	1MB58 3-4AB5	3000	14.4	
690 ²⁾	400	1492	4400	96.6	96.7	96.4	0.88	680	2.0	7.0	2.7	78	94	1MB58 3-4AB7	3200	16.5	
785 ²⁾	450	1492	5000	96.6	96.6	96.1	0.88	770	1.6	7.2	2.7	81	97	1MB58 3-4BB3	3850	22.2	
880 ²⁾	450	1492	5600	96.8	96.8	96.3	0.87	870	1.5	7.2	2.6	81	97	1MB58 3-4BB5	4100	24.8	
980 ²⁾	450	1492	6300	96.9	96.9	96.5	0.89	950	1.7	7.1	2.6	81	97	1MB58 3-4BB7	4300	27.4	
6-pole: 1000 rpm at 50 Hz																	
435	400	993	4200	96.2	96.3	96.0	0.85	770	2.1	6.7	2.8	72	88	1MB58 3-4AC3	2900	22.0	
485	400	993	4650	96.2	96.4	96.1	0.86	850	2.2	6.7	2.8	72	88	1MB58 3-4AC5	3050	24.7	
545 ¹⁾	400	993	5200	96.3	96.5	96.2	0.86	950	2.2	6.7	2.7	72	88	1MB58 3-4AC7	3250	27.8	
615 ¹⁾	450	993	5900	96.5	96.7	96.4	0.84	1100	2.1	6.6	2.7	74	90	1MB58 3-4BC3	3800	34.4	
690 ²⁾	450	993	6600	96.6	96.8	96.6	0.85	700	2.0	6.8	2.5	74	90	1MB58 3-4BC5	4050	38.5	
780 ²⁾	450	993	7500	96.7	96.9	96.7	0.85	790	2.0	6.7	2.6	74	90	1MB58 3-4BC7	4300	43.1	
8-pole: 750 rpm at 50 Hz																	
335	400	744	4300	95.8	96.0	95.6	0.80	630	2.0	6.9	2.6	64	80	1MB58 3-4AD3	2850	21.9	
375	400	744	4800	95.9	96.1	95.7	0.80	710	2.1	7.2	2.8	64	80	1MB58 3-4AD5	3050	24.5	
425	400	744	5500	96.1	96.2	95.8	0.80	800	2.1	7.2	2.7	64	80	1MB58 3-4AD7	3250	27.5	
485 ⁴⁾	450	745	6200	96.1	96.2	95.9	0.79	920	2.0	7.0	2.6	67	83	1MB58 3-4BD3	3800	34.0	
545 ⁴⁾	450	745	7000	96.2	96.4	96.0	0.79	1040	2.0	7.0	2.6	67	83	1MB58 3-4BD5	4000	38.0	
600 ^{1) 4)}	450	745	7700	96.3	96.5	96.1	0.80	1120	2.1	7.3	2.6	67	83	1MB58 3-4BD7	4250	42.5	
Zones																	
Zone 21 (conductive and non-conductive dust occasionally) Ex tb IIIC																	
Zone 22 (non-conductive dust rarely or for a short period) Ex tc IIIB																	
Zone 2 (explosive gases rarely or for a short period) Ex ec IIC																	
Voltages																	
50 Hz 400 VΔ/690 VY		60 Hz 460 VΔ		Version												Order code	
				Standard												-	
50 Hz 500 VΔ		60 Hz 575 VΔ		Without additional charge												-	
50 Hz 690 VΔ				Without additional charge												-	
For other voltages and more information, see from page 6/70																	
Types of construction																	
Without flange		IM B3		Version												Order code	
				Standard												-	
With flange		IM B5		With additional charge												-	
For other types of construction and more information, see from page 6/82																	
Motor protection																	
Without				Version												Order code	
				Standard												-	
PTC thermistor with 3 temperature sensors				With additional charge												-	
For other motor protection and more information, see from page 6/88																	
Terminal box position																	
Terminal box base left with terminal box 45°				Version												Order code	
				Without additional charge												-	
Terminal box base right with terminal box 45°				Standard												-	
For other terminal box positions and more information, see from page 6/93																	
Special versions																	
Forced-air cooled (IC416)				1MB58 3- -Z												F90+ +	
For options and information, see from page 6/113																	
				1MB58 3- -Z											 + +	



1) Terminal box 1XB1631.
 2) The standard version is 50 Hz 690 VΔ (voltage code 4-7) or 60 Hz 575 VΔ (voltage code 4-0).
 3) In the series version, the maximum speed is n_{max} = 3000 rpm. Converter operation at higher speeds on request for an additional charge.
 4) Utilization with sinusoidal supply in accordance with thermal class 155 (temperature class F).



SIMOTICS XP 1MB1, 1MB5 explosion-protected motors

Zones 21, 22, and 2 with types of protection Ex tb, Ex tc, Ex ec · IE2 High Efficiency **IE2**

Aluminum series 1MB10 – self-ventilated

Selection and ordering data

Operating values at rated power														Aluminum series		m _{IM B3}	J			
P _{rated} 50 Hz	P _{rated} 60 Hz	Frame size	n _{rated} 50 Hz	T _{rated} 50 Hz	Different IE class 60 Hz/P60	η _{rated} 50 Hz	η _{rated} 50 Hz	η _{rated} 50 Hz	cosφ _{rated} 50 Hz	I _{rated} 50 Hz	T _{LR} /I _{rated}	I _{LR} /I _{rated}	T _p /I _{rated}	L _{ptA} 50 Hz	L _{WA} 50 Hz			1MB10.1	Article No.	kg
kW	kW	FS	rpm	Nm		%	%	%		A						▲ New				
• Cooling: self-ventilated (IC411) • Efficiency according to IEC 60034-30: IE2 High Efficiency • Insulation: Thermal class 155 (temperature class F), IP55 degree of protection, utilization in accordance with thermal class 130 (temperature class B)																				
2-pole: 3000 rpm at 50 Hz, 3600 rpm at 60 Hz ¹⁾																				
0.18	0.21	63 M	2850	0.6	²⁾	60.4	59.4	53.7	0.78	0.55	2.2	4.5	2.7	57	64	▲	1MB10 1-0BA2	4	0.0022	
0.25	0.29	63 M	2835	0.84	²⁾	64.8	63.5	57.3	0.81	0.69	1.9	4.1	2.5	57	64	▲	1MB10 1-0BA2	5	0.0026	
0.37	0.43	71 M	2770	1.28	²⁾	69.5	70.5	67.9	0.81	0.95	2.5	4.1	2.5	58	69	▲	1MB10 1-0CA2	6	0.0035	
0.55	0.63	71 M	2780	1.89	²⁾	74.1	75.2	72.9	0.8	1.34	2.6	4.6	2.6	58	69	▲	1MB10 1-0CA2	7	0.0045	
0.75	0.86	80 M	2805	2.55		77.4	80	80.1	0.84	1.67	1.9	4.9	2.3	60	71	▲	1MB10 1-0DA2	9	0.0008	
1.1	1.27	80 M	2835	3.7		79.6	81.3	80.9	0.83	2.4	2.7	6	3.1	60	71	▲	1MB10 1-0DA3	11	0.0011	
1.5	1.75	90 S	2900	4.95		81.3	81.7	79.7	0.84	3.15	2.7	6.9	3.6	65	77	▲	1MB10 1-0EA0	13	0.0017	
2.2	2.55	90 L	2890	7.3		83.2	83.7	82	0.85	4.5	2.5	7.1	3.7	65	77	▲	1MB10 1-0EA4	15	0.0021	
3	3.45	100 L	2905	9.9		84.6	85.5	84.6	0.84	6.1	2.3	7	3.3	67	79	▲	1MB10 1-1AA4	21	0.0044	
4	4.55	112 M	2945	13		85.8	86.2	85.1	0.85	7.9	2.1	8	3.6	69	81	▲	1MB10 1-1BA2	27	0.0092	
5.5	6.3	132 S	2950	17.8		87	88	87.6	0.87	10.5	1.8	6.6	2.9	68	80	▲	1MB10 1-1CA0	39	0.02	
7.5	8.6	132 S	2950	24.5		88.1	88.5	87.6	0.87	14.1	2.2	7.5	3.1	68	80	▲	1MB10 1-1CA1	43	0.024	
11	12.6	160 M	2955	35.5		89.4	89.3	88	0.87	20.5	2.1	7.4	3.2	70	82	▲	1MB10 1-1DA2	67	0.045	
15	17.3	160 M	2955	48.5		90.3	90.7	90	0.88	27	2.4	7.6	3.4	70	82	▲	1MB10 1-1DA3	75	0.053	
18.5	21.3	160 M	2955	60		90.9	91.2	90.6	0.88	33.5	2.9	7.9	3.6	70	82	▲	1MB10 1-1DA4	84	0.061	
4-pole: 1500 rpm at 50 Hz, 1800 rpm at 60 Hz ¹⁾																				
0.12	0.14	63 M	1390	0.82	²⁾	59.1	56.4	49	0.66	0.44	2.4	3.1	2.5	50	58	▲	1MB10 1-0BB2	5	0.00037	
0.18	0.21	63 M	1385	1.24	²⁾	64.7	62.4	55.7	0.65	0.62	2.6	3.3	2.6	57	64	▲	1MB10 1-0BB2	5	0.00045	
0.25	0.29	71 M	1395	1.71	²⁾	68.5	68.4	64.2	0.69	0.76	2.4	3.7	2.5	50	61	▲	1MB10 1-0CB2	6	0.00076	
0.37	0.43	71 M	1380	2.55	²⁾	72.7	73.2	69.9	0.72	1.02	2.5	4	2.5	59	67	▲	1MB10 1-0CB2	7	0.00095	
0.55	0.63	80 M	1440	3.65		77.1	76.8	73.7	0.74	1.39	2.2	5.3	3.1	53	64	▲	1MB10 1-0DB2	10	0.0017	
0.75	0.86	80 M	1440	4.95		79.6	79.9	77.5	0.76	1.79	2.2	5.6	3.1	53	64	▲	1MB10 1-0DB3	11	0.0021	
1.1	1.27	90 S	1425	7.4		81.4	81.8	80	0.78	2.5	2.3	5.6	2.9	56	68	▲	1MB10 1-0EB0	13	0.0028	
1.5	1.75	90 L	1435	10		82.8	83.5	82.2	0.79	3.3	2.6	6.4	3.4	56	68	▲	1MB10 1-0EB4	16	0.0036	
2.2	2.55	100 L	1455	14.4		84.3	85.1	84.2	0.81	4.65	2.1	6.9	3.3	60	72	▲	1MB10 1-1AB4	21	0.0086	
3	3.45	100 L	1455	19.7		85.5	86.4	85.6	0.82	6.2	2	6.9	3.1	60	72	▲	1MB10 1-1AB5	25	0.011	
4	4.55	112 M	1460	26		86.6	87.3	86.4	0.81	8.2	2.5	7.1	3.2	58	70	▲	1MB10 1-1BB2	29	0.014	
5.5	6.3	132 S	1465	36		87.7	88.4	87.6	0.8	11.3	2.3	6.9	2.9	64	76	▲	1MB10 1-1CB0	42	0.027	
7.5	8.6	132 M	1465	49		88.7	89.8	89.8	0.83	14.7	2.3	6.9	2.9	64	76	▲	1MB10 1-1CB2	49	0.034	
11	12.6	160 M	1470	71		89.8	91	90.9	0.85	21	2.1	6.7	2.8	65	77	▲	1MB10 1-1DB2	71	0.065	
15	17.3	160 M	1475	97		90.6	91.2	90.8	0.85	28	2.3	7.3	3	65	77	▲	1MB10 1-1DB4	83	0.083	
Zones																		1		
Zone 21 (conductive and non-conductive dust occasionally) Ex tb IIIC																		2		
Zone 22 (non-conductive dust rarely or for a short period) Ex tc IIIB																		3		
Zone 2 (explosive gases rarely or for a short period) Ex ec IIIC																				
Voltages																			Order code	
50 Hz 230 VΔ/400 VY			60 Hz ¹⁾ 460 VY			Standard												2	2	-
50 Hz 400 VΔ/690 VY			60 Hz ¹⁾ 460 VΔ			Standard												3	4	-
50 Hz 500 VY						Without additional charge												2	7	-
50 Hz 500 VΔ						Without additional charge												4	0	-
For other voltages ¹⁾ and more information, see from page 6/66																		9	0	...
Types of construction																			Order code	
Without flange			IM B3 ²⁾			Standard												A		-
With flange			IM B5 ²⁾			With additional charge												F		-
With flange			IM B14 ²⁾			With additional charge												K		-
For other types of construction and more information, see from page 6/71																				...
Motor protection																			Order code	
Without						Standard												A		-
3 temperature sensors (frame sizes 80, 90 or 100 to 200)						With additional charge												B		-
For other motor protection and more information, see from page 6/84																				-
Terminal box position																			Order code	
Terminal box at top						Standard												4		-
For other terminal box positions and more information, see from page 6/89																				-
Special versions																			Order code(s)	
For options, see from page 6/94																				1MB10 1-...-Z ...+...+...+...

6



IE2

SIMOTICS XP 1MB1, 1MB5 explosion-protected motors

Zones 21, 22, and 2 with types of protection Ex tb, Ex tc, Ex ec · IE2 High Efficiency

Aluminum series 1MB10 – self-ventilated

Selection and ordering data

Operating values at rated power														Aluminum series						
P_{rated} 50 Hz	P_{rated} 60 Hz	Frame size	n_{rated} 50 Hz	T_{rated} 50 Hz	Different IE class	η_{rated} 50 Hz	η_{rated} 50 Hz	η_{rated} 50 Hz	$\cos\phi_{rated}$ 50 Hz	I_{rated} 50 Hz	T_{LR}/I_{rated}	I_{LR}/I_{rated}	T_p/I_{rated}	L_{pA} 50 Hz	L_{WA} 50 Hz	Article No.	$m_{IM B3}$	J		
kW	kW	FS	rpm	Nm		%	%	%		A						kg	kgm ²			
<ul style="list-style-type: none"> • Cooling: self-ventilated (IC411) • Efficiency according to IEC 60034-30: IE2 High Efficiency • Insulation: Thermal class 155 (temperature class F), IP55 degree of protection, utilization in accordance with thermal class 130 (temperature class B) 																				
6-pole: 1000 rpm at 50 Hz, 1200 rpm at 60 Hz ¹⁾																				
0.09	0.11	63 M	895	0.96	²⁾	42.7	38.5	30.4	0.63	0.48	1.8	2	1.9	56	62	▲ 1MB10-1-0BC2-	4	0.0037		
0.18	0.21	71 M	875	1.96	²⁾	56.6	56.9	52.7	0.68	0.68	2.2	2.5	2.3	46	57	▲ 1MB10-1-0CC2-	6	0.0080		
0.25	0.29	71 M	870	2.75	²⁾	61.6	62.7	59.2	0.7	0.84	2.3	2.6	2.3	46	57	▲ 1MB10-1-0CC3-	7	0.0100		
0.37	0.43	80 M	925	3.8		67.6	67.9	64.4	0.69	1.14	2.1	4	2.4	42	53	1MB10-1-0DC2-	9	0.0017		
0.55	0.63	80 M	935	5.6		73.1	73.8	70.8	0.66	1.65	2.5	4.4	2.9	42	53	1MB10-1-0DC3-	12	0.0025		
0.75	0.86	90 S	935	7.7		75.9	76.8	74.5	0.7	2.05	2	4.1	2.5	43	55	1MB10-1-0EC0-	13	0.003		
1.1	1.27	90 L	935	11.2	IE1	78.1	79.3	77.7	0.7	2.9	2.2	4.4	2.6	43	55	1MB10-1-0EC4-	16	0.004		
1.5	1.75	100 L	970	14.8		79.8	80.5	79	0.73	3.7	2	5.4	2.8	59	71	1MB10-1-1AC4-	25	0.011		
2.2	2.55	112 M	965	22		81.8	82.7	81.7	0.75	5.2	2	5	2.8	62	74	1MB10-1-1BC2-	29	0.014		
3	3.45	132 S	970	29.5		83.3	83.4	81	0.72	7.2	1.6	5	2.5	63	75	1MB10-1-1CC0-	38	0.024		
4	4.55	132 M	970	39.5		84.6	85.5	84.3	0.75	9.1	1.6	5	2.3	63	75	1MB10-1-1CC2-	43	0.029		
5.5	6.3	132 M	970	54		86	87.1	86.4	0.76	12.1	1.9	5.6	2.6	63	75	1MB10-1-1CC3-	52	0.037		
7.5	8.6	160 M	975	73		87.2	87.9	87.2	0.74	16.8	1.9	4.7	2.2	67	79	1MB10-1-1DC2-	77	0.075		
11	12.6	160 M	975	108		88.7	89.7	89.3	0.76	23.5	1.9	4.8	2.2	67	79	1MB10-1-1DC4-	93	0.098		
8-pole: 750 rpm at 50 Hz, 900 rpm at 60 Hz ¹⁾																				
0.09	0.11	71 M	630	1.36	²⁾	40.1	40.6	35.8	0.67	0.5	1.7	1.6	1.7	59	63	▲ 1MB10-1-1AD4-	21	0.0086		
0.12	0.14	71 M	640	1.79	²⁾	39.8	39.3	34.5	0.66	0.66	1.8	1.8	1.8	48	59	▲ 1MB10-1-1AD5-	25	0.011		
0.75	0.86	100 L	705	10.2		66.2	65.7	61.5	0.61	2.7	1.5	3.2	2.1	60	72	1MB10-1-1BD2-	34	0.017		
1.1	1.27	100 L	695	15.1		70.8	72.3	69.6	0.65	3.45	1.4	3.2	1.9	60	72	1MB10-1-1CD0-	46	0.034		
1.5	1.75	112 M	725	19.8		74.1	73.9	71.2	0.63	4.65	1.6	4	2.4	63	75	1MB10-1-1CD2-	52	0.037		
2.2	2.55	132 S	725	29		77.6	78.2	76.6	0.62	6.6	1.4	3.5	2	63	75	1MB10-1-1DD2-	69	0.065		
3	3.45	132 M	720	40	IE1	80	80.7	79.2	0.62	8.7	1.4	3.7	2	63	75	1MB10-1-1DD3-	82	0.083		
4	4.55	160 M	730	52		81.9	82.6	81.4	0.67	10.5	1.6	3.7	1.9	63	75	1MB10-1-1DD4-	94	0.098		
Zones																				
Zone 21 (conductive and non-conductive dust occasionally) Ex tb IIC																	1			
Zone 22 (non-conductive dust rarely or for a short period) Ex tc IIIB																	2			
Zone 2 (explosive gases rarely or for a short period) Ex ec IIC																	3			
Voltages																				
50 Hz 230 VΔ/400 VY																	Version		Order code	
60 Hz ¹⁾ 460 VY																	Standard		2 2	-
50 Hz 400 VΔ/690 VY																	Standard		3 4	-
50 Hz 500 VY																	Without additional charge		2 7	-
50 Hz 500 VΔ																	Without additional charge		4 0	-
For other voltages ¹⁾ and more information, see from page 6/66																			9 0	...
Types of construction																				
Without flange																	Version		Order code	
IM B3 ²⁾																	Standard		A	-
With flange																	With additional charge		F	-
IM B5 ²⁾																	With additional charge		K	-
With flange																	With additional charge			...
IM B14 ²⁾																				
For other types of construction and more information, see from page 6/71																				
Motor protection																				
Without																	Version		Order code	
Standard																	Standard		A	-
3 temperature sensors (frame sizes 80, 90 or 100 to 200)																	With additional charge		B	-
For other motor protection and more information, see from page 6/84																				
Terminal box position																				
Terminal box at top																	Version		Order code	
Standard																	Standard		4	-
For other terminal box positions and more information, see from page 6/89																				
Special versions																				
For options, see from page 6/94																			Order code(s)	
																			1MB10-1-...-Z-...+...+...+...	





IE2

SIMOTICS XP 1MB1, 1MB5 explosion-protected motors Zones 21, 22, and 2 with types of protection Ex tb, Ex tc, Ex ec · IE2 High Efficiency

Cast-iron series 1MB15, 1MB16 – self-ventilated

Selection and ordering data

Operating values at rated power														Cast-iron series		m _{IM B3}	J		
P _{rated} 50 Hz	P _{rated} 60 Hz	Frame size	n _{rated} 50 Hz	T _{rated} 50 Hz	Different IE class 60 Hz/P60	η _{rated} 4/4	η _{rated} 3/4	η _{rated} 2/4	cosφ _{rated} 50 Hz	I _{rated} 400 V	T _{LR} /I _{rated}	I _{LR} /I _{rated}	T _B /I _{rated}	L _{pFA} 50 Hz	L _{WA} 50 Hz			1MB15.1 – Basic Line	1MB16.1 – Performance Line
kW	kW	FS	rpm	Nm		%	%	%		A				dB(A)	dB(A)	Article No.		kg	kgm ²

- Cooling: self-ventilated (IC411)
- Efficiency according to IEC 60034-30: IE2 High Efficiency
- Insulation: Thermal class 155 (temperature class F), IP55 degree of protection, utilization in accordance with thermal class 130 (temperature class B)

4-pole: 1500 rpm at 50 Hz, 1800 rpm at 60 Hz ¹⁾																			
0.25	0.29	71 M	1395	1.71		68.5	68.4	64.2	0.69	0.76	2.4	3.7	2.5	50	61	1MB1 5 ■ 1-0CB2	12	0.00076	
0.37	0.43	71 M	1380	2.55		72.7	73.2	69.9	0.72	1.02	2.5	4	2.5	59	67	1MB1 5 ■ 1-0CB3	13	0.00095	
0.55	0.63	80 M	1440	3.65		77.1	76.8	73.7	0.74	1.39	2.2	5.3	3.1	53	64	1MB1 5 ■ 1-0DB2	17	0.0017	
0.75	0.86	80 M	1440	4.95		79.6	79.9	77.5	0.76	1.79	2.2	5.6	3.1	53	64	1MB1 5 ■ 1-0DB3	18.5	0.0021	
1.1	1.27	90 S	1425	7.4		81.4	81.8	80	0.78	2.5	2.3	5.6	2.9	56	68	1MB1 5 ■ 1-0EB0	23	0.0028	
1.5	1.75	90 L	1435	10		82.8	83.5	82.2	0.79	3.3	2.6	6.4	3.4	56	68	1MB1 5 ■ 1-0EB4	25	0.0036	
2.2	2.55	100 L	1455	14.4		84.3	85.1	84.2	0.81	4.65	2.1	6.9	3.3	60	72	1MB1 ■ 1-1AB4	32	0.0086	
3	3.45	100 L	1455	19.7		85.5	86.4	85.6	0.82	6.2	2	6.9	3.1	60	72	1MB1 ■ 1-1AB5	37	0.011	
4	4.55	112 M	1460	26		86.6	87.3	86.4	0.81	8.2	2.5	7.1	3.2	58	70	1MB1 ■ 1-1BB2	46	0.014	
5.5	6.3	132 S	1465	36		87.7	88.4	87.6	0.8	11.3	2.3	6.9	2.9	64	76	1MB1 ■ 1-1CB0	61	0.027	
7.5	8.6	132 M	1465	49		88.7	89.8	89.8	0.83	14.7	2.3	6.9	2.9	64	76	1MB1 ■ 1-1CB2	75	0.034	
11	12.6	160 M	1470	71		89.8	91	90.9	0.85	21	2.1	6.7	2.8	65	77	1MB1 ■ 1-1DB2	96	0.065	
15	17.3	160 M	1475	97		90.6	91.2	90.8	0.85	28	2.3	7.3	3	65	77	1MB1 ■ 1-1DB4	104	0.083	
18.5	21.3	180 M	1465	121		91.2	92	91.9	0.84	35	2.5	7.2	3.4	61	74	1MB1 ■ 1-1EB2	160	0.12	
22	25.3	180 L	1465	143		91.6	92.2	91.9	0.84	41.5	2.6	7.3	3.5	69	76	1MB1 ■ 1-1EB4	170	0.13	
30	34.5	200 L	1470	195		92.3	92.8	92.5	0.84	56	2.5	6.7	3.7	70	77	1MB1 ■ 1-2AB5	230	0.2	
37	42.5	225 S	1470	240		92.7	93.5	93.5	0.88	65	2.3	6.6	2.9	66	79	1MB1 ■ 1-2BB0	280	0.42	
45	52	225 M	1475	290		93.1	93.8	93.7	0.87	80	2.5	6.9	3.1	66	79	1MB1 ■ 1-2BB2	305	0.46	
55	63	250 M	1480	355		93.5	93.9	93.5	0.85	100	2.7	6.8	3	66	79	1MB1 ■ 1-2CB2	385	0.75	
75	86	280 S	1485	480		94	94.2	93.8	0.87	132	2.5	6.8	3	71	85	1MB1 ■ 1-2DB0	550	1.3	
90	104	280 M	1486	580		94.2	94.3	93.6	0.87	159	2.6	7.3	3.1	71	85	1MB1 ■ 1-2DB2	570	1.4	
110	127	315 S	1490	700		94.5	94.6	94	0.86	195	2.7	7.4	3	72	86	1MB1 ■ 1-3AB0	740	2	
132	152	315 M	1490	850		94.7	94.9	94.6	0.87	230	2.7	7.1	2.9	75	89	1MB1 ■ 1-3AB2	870	2.3	
160	184	315 L	1490	1030		94.9	95	94.5	0.87	280	2.8	7.2	3.1	76	91	1MB1 ■ 1-3AB4	940	2.8	
200	230	315 L	1490	1280		95.1	95.3	94.7	0.87	350	3.1	7.5	3.2	77	92	1MB1 ■ 1-3AB5	1140	3.5	

Basic Line			5
Performance Line			6
Zones			
Zone 21 (conductive and non-conductive dust occasionally) Ex tb IIC			1
Zone 22 (non-conductive dust rarely or for a short period) Ex tc IIIB			2
Zone 2 (explosive gases rarely or for a short period) Ex ec IIC			3
Voltages ³⁾		Version	Order code
50 Hz 230 VΔ/400 VY	60 Hz ¹⁾ 460 VY	Standard	2 2
50 Hz 400 VΔ/690 VY	60 Hz ¹⁾ 460 VΔ	Standard	3 4
50 Hz 500 VY		Without additional charge	2 7
50 Hz 500 VΔ		Without additional charge	4 0
For other voltages ¹⁾ and more information, see from page 6/67			9 0
...			...
Types of construction		Version	Order code
Without flange	IM B3 ²⁾	Standard	A
With flange	IM B5 ²⁾	With additional charge	F
With flange	IM B14 ²⁾	With additional charge	K
For other types of construction and more information, see from page 6/74			...
Motor protection		Line	Version
Without	Only possible for Basic Line	Standard	A
PTC thermistor with 3 temperature sensors	Basic Line	With additional charge	B
	Performance Line	Standard	B
For other motor protection and more information, see from page 6/85			...
Terminal box position		Version	Order code(s)
Terminal box at top		Standard	4
For other terminal box positions and more information, see from page 6/85			...
Special versions			Order code(s)
For options, see from page 6/99			1MB1 ■ 1-... -Z ...+...+...+...

For footnotes, see page 6/45



SIMOTICS XP 1MB1, 1MB5 explosion-protected motors

Zones 21, 22, and 2 with types of protection Ex tb, Ex tc, Ex ec · IE2 High Efficiency

IE2



Cast-iron series 1MB15, 1MB16 – self-ventilated

Selection and ordering data

Operating values at rated power															Cast-iron series		m _{IM B3}	J	
P _{rated} 50 Hz	P _{rated} 60 Hz	Frame size	n _{rated} 50 Hz	T _{rated} 50 Hz	Different IE class	η _{rated} 50 Hz	η _{rated} 50 Hz	η _{rated} 50 Hz	cosφ _{rated} 50 Hz	I _{rated} 50 Hz	T _{LR} /T _{rated}	I _{LR} /I _{rated}	T _B /T _{rated}	L _{pfA} 50 Hz	L _{WA} 50 Hz	1MB15.1 – Basic Line			1MB16.1 – Performance Line
kW	kW	FS	rpm	Nm		%	%	%		A						Article No.		kg	kgm ²
• Cooling: self-ventilated (IC411) • Efficiency according to IEC 60034-30: IE2 High Efficiency • Insulation: Thermal class 155 (temperature class F), IP55 degree of protection, utilization in accordance with thermal class 130 (temperature class B)																			
6-pole: 1000 rpm at 50 Hz, 1200 rpm at 60 Hz ¹⁾																			
0.18	0.21	71 M	875	1.96		56.6	56.9	52.7	0.68	0.68	2.2	2.5	2.3	46	57	1MB15-1-1-0CC2		11.5	0.0008
0.25	0.29	71 M	870	2.75		61.6	62.7	59.2	0.7	0.84	2.3	2.6	2.3	46	57	1MB15-1-1-0CC3		12.5	0.0010
0.37	0.43	80 M	925	3.8		67.6	67.9	64.4	0.69	1.14	2.1	4	2.4	42	53	1MB15-1-1-0DC2		16.5	0.0017
0.55	0.63	80 M	935	5.6		73.1	73.8	70.8	0.66	1.65	2.5	4.4	2.9	42	53	1MB15-1-1-0DC3		18.5	0.0025
0.75	0.86	90 S	935	7.7		75.9	76.8	74.5	0.7	2.05	2	4.1	2.5	43	55	1MB15-1-1-0EC0		23	0.003
1.1	1.27	90 L	935	11.2	IE1	78.1	79.3	77.7	0.7	2.9	2.2	4.4	2.6	43	55	1MB15-1-1-0EC4		26.5	0.004
1.5	1.75	100 L	970	14.8		79.8	80.5	79	0.73	3.7	2	5.4	2.8	59	71	1MB1-1-1-1AC4		36	0.011
2.2	2.55	112 M	965	22		81.8	82.7	81.7	0.75	5.2	2	5	2.8	62	74	1MB1-1-1-1BC2		41	0.014
3	3.45	132 S	970	29.5		83.3	83.4	81	0.72	7.2	1.6	5	2.5	63	75	1MB1-1-1-1CC0		56	0.024
4	4.55	132 M	970	39.5		84.6	85.5	84.3	0.75	9.1	1.6	5	2.3	63	75	1MB1-1-1-1CC2		61	0.029
5.5	6.3	132 M	970	54		86	87.1	86.4	0.76	12.1	1.9	5.6	2.6	63	75	1MB1-1-1-1CC3		70	0.037
7.5	8.6	160 M	975	73		87.2	87.9	87.2	0.74	16.8	1.9	4.7	2.2	67	79	1MB1-1-1-1DC2		106	0.075
11	12.6	160 M	975	108		88.7	89.7	89.3	0.76	23.5	1.9	4.8	2.2	67	79	1MB1-1-1-1DC4		122	0.098
15	18	180 L	975	147		89.7	90.1	89.5	0.78	31	2.5	6	3.1	57	70	1MB1-1-1-1EC4		155	0.17
18.5	22	200 L	978	181	IE1	90.4	91.3	91.2	0.82	36	2.4	5.8	2.6	63	76	1MB1-1-1-2AC4		200	0.25
22	26.5	200 L	978	215	IE1	90.9	91.7	91.4	0.82	42.5	2.5	6.2	2.6	63	76	1MB1-1-1-2AC5		220	0.3
30	36	225 M	980	290	IE1	91.7	92.5	92.3	0.83	57	2.5	5.6	2.7	65	78	1MB1-1-1-2BC2		300	0.58
37	44.5	250 M	982	360	IE1	92.2	93.1	93.1	0.83	70	2.8	6	2.5	62	77	1MB1-1-1-2CC2		370	0.86
45	54	280 S	985	435	IE1	92.7	93.4	93.2	0.84	83	2.7	6.3	2.6	65	79	1MB1-1-1-2DC0		460	1.1
55	66	280 M	985	530	IE1	93.1	93.9	94	0.86	99	2.5	6.4	2.6	65	79	1MB1-1-1-2DC2		510	1.4
75	90	315 S	988	720	IE1	93.7	94	93.6	0.84	138	2.5	6.7	2.8	65	79	1MB1-1-1-3AC0		660	2.1
90	108	315 M	988	870	IE1	94	94.3	93.6	0.84	165	2.6	6.9	2.8	65	79	1MB1-1-1-3AC2		730	2.5
110	132	315 L	988	1060	IE1	94.3	94.6	94.5	0.86	196	2.7	7	2.8	68	82	1MB1-1-1-3AC4		940	3.6
132	158	315 L	988	1280		94.6	94.9	94.7	0.86	235	3	7.5	2.9	69	84	1MB1-1-1-3AC5		990	4.0
160	192	315 L	988	1550		94.8	94.7	94.4	0.86	285	3.1	7.7	3.3	69	84	1MB1-1-1-3AC6		1160	4.7

Basic Line		5							
Performance Line		6							
Zones									
Zone 21 (conductive and non-conductive dust occasionally) Ex tb IIIC		1							
Zone 22 (non-conductive dust rarely or for a short period) Ex tc IIIB		2							
Zone 2 (explosive gases rarely or for a short period) Ex ec IIC		3							
Voltages ³⁾		Version		Order code					
50 Hz 230 VΔ/400 VY	60 Hz ¹⁾ 460 VY	Standard	2	2	-				
50 Hz 400 VΔ/690 VY	60 Hz ¹⁾ 460 VΔ	Standard	3	4	-				
50 Hz 500 VY		Without additional charge	2	7	-				
50 Hz 500 VΔ		Without additional charge	4	0	-				
For other voltages ¹⁾ and more information, see from page 6/67			9	0	...				
Types of construction		Version		Order code					
Without flange	IM B3 ²⁾	Standard	A	-					
With flange	IM B5 ²⁾	With additional charge	F	-					
With flange	IM B14 ²⁾	With additional charge	K	-					
For other types of construction and more information, see from page 6/74				...					
Motor protection		Line		Version					
Without	Only possible for Basic Line	Standard	A	-					
PTC thermistor with 3 temperature sensors	Basic Line	With additional charge	B	-					
	Performance Line	Standard	B	-					
For other motor protection and more information, see from page 6/85				...					
Terminal box position		Version		Order code(s)					
Terminal box at top		Standard	4	-					
For other terminal box positions and more information, see from page 6/90				...					
Special versions				Order code(s)					
For options, see from page 6/99				1MB1-1-1-...-Z-...+...+...+...					

6



IE2

SIMOTICS XP 1MB1, 1MB5 explosion-protected motors

Zones 21, 22, and 2 with types of protection Ex tb, Ex tc, Ex ec · IE2 High Efficiency

Cast-iron series 1MB15, 1MB16 – self-ventilated

Selection and ordering data

Operating values at rated power															Cast-iron series		$m_{IM\ B3}$	J
P_{rated} 50 Hz	P_{rated} 60 Hz	Frame size	n_{rated} 50 Hz	T_{rated} 50 Hz	Different IE class	η_{rated} 50 Hz	η_{rated} 50 Hz	η_{rated} 50 Hz	$\cos\phi_{rated}$ 50 Hz	I_{rated} 50 Hz	T_{LR}/T_{rated}	I_{LR}/I_{rated}	T_B/T_{rated}	L_{pFA} 50 Hz	L_{WA} 50 Hz	Article No.		
kW	kW	FS	rpm	Nm		%	%	%		A							kg	kgm ²
<ul style="list-style-type: none"> Cooling: self-ventilated (IC411) Efficiency according to IEC 60034-30: IE2 High Efficiency Insulation: Thermal class 155 (temperature class F), IP55 degree of protection, utilization in accordance with thermal class 130 (temperature class B) 																		
8-pole: 750 rpm at 50 Hz, 900 rpm at 60 Hz ¹⁾																		
0.09	0.11	71 M	630	1.36	⁵⁾	40.1	40.6	35.8	0.67	0.5	1.7	1.6	1.7	59	63	1MB1 5 ■ 1-0CD2 ■ - ■ ■ ■ ■ ■	11.5	0.0077
0.12	0.14	71 M	640	1.79		39.8	39.3	34.5	0.66	0.66	1.8	1.8	1.8	48	59	1MB1 5 ■ 1-0CD3 ■ - ■ ■ ■ ■ ■	12.5	0.0100
0.18	0.21	80 M	690	2.5		45.9	43.6	37.8	0.6	0.93	1.7	2.2	2.1	51	62	1MB1 5 ■ 1-0DD2 ■ - ■ ■ ■ ■ ■	16.5	0.0175
0.25	0.29	80 M	705	3.4		50.6	48.1	41.9	0.55	1.3	2	2.5	2.5	51	62	1MB1 5 ■ 1-0DD3 ■ - ■ ■ ■ ■ ■	18.5	0.0246
0.37	0.43	90 S	675	5.2		56.1	55.6	49.6	0.71	1.34	1.4	2.6	1.7	53	65	1MB1 5 ■ 1-0ED0 ■ - ■ ■ ■ ■ ■	20	0.0225
0.55	0.63	90 L	665	7.9		61.7	63.4	59.8	0.74	1.74	1.5	2.7	1.7	53	65	1MB1 5 ■ 1-0ED4 ■ - ■ ■ ■ ■ ■	21.5	0.0305
0.75	0.86	100 L	705	10.2		66.2	65.7	61.5	0.61	2.7	1.5	3.2	2.1	60	72	1MB1 ■ 1-1AD4 ■ - ■ ■ ■ ■ ■	32	0.0086
1.1	1.27	100 L	695	15.1		70.8	72.3	69.6	0.65	3.45	1.4	3.2	1.9	60	72	1MB1 ■ 1-1AD5 ■ - ■ ■ ■ ■ ■	36	0.011
1.5	1.75	112 M	725	19.8		74.1	73.9	71.2	0.63	4.65	1.6	4	2.4	63	75	1MB1 ■ 1-1BD2 ■ - ■ ■ ■ ■ ■	53	0.017
2.2	2.55	132 S	725	29		77.6	78.2	76.6	0.62	6.6	1.4	3.5	2	63	75	1MB1 ■ 1-1CD0 ■ - ■ ■ ■ ■ ■	64	0.034
3	3.45	132 M	720	40	IE1	80	80.7	79.2	0.62	8.7	1.4	3.7	2	63	75	1MB1 ■ 1-1CD2 ■ - ■ ■ ■ ■ ■	67	0.037
4	4.55	160 M	730	52		81.9	82.6	81.4	0.67	10.5	1.6	3.7	1.9	63	75	1MB1 ■ 1-1DD2 ■ - ■ ■ ■ ■ ■	98	0.065
5.5	6.3	160 M	730	72		83.8	84.2	83	0.67	14.1	1.7	3.9	2	63	75	1MB1 ■ 1-1DD3 ■ - ■ ■ ■ ■ ■	111	0.083
7.5	8.6	160 M	725	99		85.3	86.4	86	0.7	18.1	1.6	3.8	1.9	63	75	1MB1 ■ 1-1DD4 ■ - ■ ■ ■ ■ ■	123	0.098
11	13.2	180 L	720	146	IE1	86.9	88	87.6	0.7	26	2.3	4.9	2.6	72	80	1MB1 ■ 1-1ED4 ■ - ■ ■ ■ ■ ■	155	0.195
15	18	200 L	718	199		88	89.5	89.9	0.76	32.5	2.4	5.4	2.8	58	65	1MB1 ■ 1-2AD5 ■ - ■ ■ ■ ■ ■	220	0.344
18.5	22	225 S	730	240	IE1	89	89.9	89.5	0.78	38.5	2.2	5.4	2.7	59	72	1MB1 ■ 1-2BD0 ■ - ■ ■ ■ ■ ■	250	0.43
22	26.5	225 M	730	290		90.3	91.3	91.1	0.8	44	2.3	5.5	2.7	58	71	1MB1 ■ 1-2BD2 ■ - ■ ■ ■ ■ ■	270	0.5
30	36	250 M	732	390		91.3	92.2	92	0.8	59	2.4	5.6	2.7	60	73	1MB1 ■ 1-2CD2 ■ - ■ ■ ■ ■ ■	370	0.86
37	44.5	280 S	736	480		91.9	92.5	92.1	0.78	75	2.3	5.4	2.4	63	77	1MB1 ■ 1-2DD0 ■ - ■ ■ ■ ■ ■	460	1.1
45	54	280 M	738	580		92.4	92.8	92.4	0.79	89	2.5	5.7	2.5	66	80	1MB1 ■ 1-2DD2 ■ - ■ ■ ■ ■ ■	510	1.4
55	66	315 S	740	710		92.9	93.3	92.9	0.8	107	2.2	5.8	2.6	69	83	1MB1 ■ 1-3AD0 ■ - ■ ■ ■ ■ ■	640	2
75	90	315 M	738	970		93.5	94.4	94.5	0.81	143	2.3	5.9	2.7	69	84	1MB1 ■ 1-3AD2 ■ - ■ ■ ■ ■ ■	720	2.5
90	108	315 L	740	1160		93.5	94.3	94.4	0.83	167	2.2	5.8	2.5	69	84	1MB1 ■ 1-3AD4 ■ - ■ ■ ■ ■ ■	860	3.1
110	132	315 L	740	1420		94.2	95	95.1	0.82	205	2.7	6.7	2.9	74	88	1MB1 ■ 1-3AD5 ■ - ■ ■ ■ ■ ■	980	3.9
132	158	315 L	740	1700		94.4	94.8	94.4	0.81	250	2.9	7.2	3.3	76	90	1MB1 ■ 1-3AD6 ■ - ■ ■ ■ ■ ■	1070	4.5

Basic Line	5
Performance Line	6
Zones	
Zone 21 (conductive and non-conductive dust occasionally) Ex tb IIC	1
Zone 22 (non-conductive dust rarely or for a short period) Ex tc IIIB	2
Zone 2 (explosive gases rarely or for a short period) Ex ec IIC	3
Voltages ³⁾	
50 Hz 230 VΔ/400 VY	2
60 Hz ¹⁾ 460 VY	2
50 Hz 400 VΔ/690 VY	3
60 Hz ¹⁾ 460 VΔ	4
50 Hz 500 VY	2
Without additional charge	7
50 Hz 500 VΔ	4
Without additional charge	0
For other voltages ¹⁾ and more information, see from page 6/67	9
	0
Types of construction	
Without flange	A
IM B3 ²⁾	Standard
With flange	F
IM B5 ²⁾	With additional charge
With flange	K
IM B14 ²⁾	With additional charge
For other types of construction and more information, see from page 6/74	
Motor protection	
Without	A
Only possible for Basic Line	Standard
PTC thermistor with 3 temperature sensors	B
Basic Line	With additional charge
Performance Line	Standard
For other motor protection and more information, see from page 6/85	
Terminal box position	
Terminal box at top	4
Standard	Standard
For other terminal box positions and more information, see from page 6/90	
Special versions	
For options, see from page 6/99	
	Z



For footnotes, see page 6/45



SIMOTICS XP 1MB1, 1MB5 explosion-protected motors

Zones 21, 22, and 2 with types of protection Ex tb, Ex tc, Ex ec · IE1 Standard Efficiency

Aluminum series 1MB10 – self-ventilated

Selection and ordering data

Operating values at rated power														Aluminum series		m _{IM B3}	J			
P _{rated} 50 Hz	P _{rated} 60 Hz	Frame size	n _{rated} 50 Hz	T _{rated} 50 Hz	η _{rated} 50 Hz, 4/4	η _{rated} 50 Hz, 3/4	η _{rated} 50 Hz, 2/4	cos φ _{rated} 50 Hz, 4/4	I _{rated} 50 Hz, 400 V	T _{LR} /T _{rated}	I _{LR} /I _{rated}	T _B /T _{rated}	L _{pfA} 50 Hz	L _{WA} 50 Hz	1MB10.2			Article No.	kg	kgm ²
kW	kW	FS	rpm	Nm	%	%	%		A				dB(A)	dB(A)						
<ul style="list-style-type: none"> Cooling: self-ventilated (IC411) Efficiency according to IEC 60034-30: IE1 Standard Efficiency Insulation: Thermal class 155 (temperature class F), IP55 degree of protection, utilization in accordance with thermal class 130 (temperature class B) 																				
2-pole: 3000 rpm at 50 Hz, 3600 rpm at 60 Hz ¹⁾																				
3	3.45	100 L	2835	10.1	81.5	83.2	82.7	0.87	6.1	3.2	6.4	3.5	66	80	1MB10-2-1AA4	-	20	0.0034		
4	4.55	112 M	2935	13	83.1	82.9	80.5	0.85	8.2	3.3	8.3	4.2	70	83	1MB10-2-1BA2	-	25	0.0067		
5.5	6.3	132 S	2910	18	84.7	85.8	85.3	0.88	10.7	1.8	5.7	2.6	68	82	1MB10-2-1CA0	-	35	0.013		
7.5	8.6	132 S	2925	24.5	86	86.6	86.1	0.88	14.3	2.2	6.8	3.1	68	82	1MB10-2-1CA1	-	40	0.016		
11	12.6	160 M	2925	36	87.6	88.2	87	0.86	21	2	5.7	2.7	79	86	1MB10-2-1DA2	-	60	0.03		
15	17.3	160 M	2935	49	88.7	88.9	87.2	0.85	28.5	2.4	6.8	3.2	78	85	1MB10-2-1DA3	-	68	0.036		
18.5	21.3	160 M	2935	60	89.3	89.7	88.5	0.87	34.5	2.7	7.6	3.4	78	85	1MB10-2-1DA4	-	78	0.044		
4-pole: 1500 rpm at 50 Hz, 1800 rpm at 60 Hz ¹⁾																				
2.2	2.55	100 L	1425	14.7	79.7	80.3	78.1	0.81	4.9	2.3	5.1	2.7	60	72	1MB10-2-1AB4	-	18	0.0059		
3	3.45	100 L	1425	20	81.5	82.6	81.5	0.85	6.3	2.4	5.4	2.6	60	72	1MB10-2-1AB5	-	22	0.0078		
4	4.55	112 M	1435	26.5	83.1	84.3	84	0.83	8.4	2.5	6.1	2.9	57	70	1MB10-2-1BB2	-	27	0.010		
5.5	6.3	132 S	1450	36	84.7	85.3	84.2	0.82	11.4	2.3	5.7	2.7	64	76	1MB10-2-1CB0	-	38	0.019		
7.5	8.6	132 M	1450	49.5	86	86.5	85.4	0.82	15.4	2.6	6.6	3.1	64	76	1MB10-2-1CB2	-	44	0.024		
11	12.6	160 M	1460	72	87.6	87.9	86.7	0.81	22.5	2.7	6.9	3.3	70	82	1MB10-2-1DB2	-	62	0.044		
15	17.3	160 M	1460	98	88.7	89	87.8	0.82	30	3	7.5	3.6	70	82	1MB10-2-1DB4	-	73	0.056		
Zones																	1			
Zone 21 (conductive and non-conductive dust occasionally) Ex tb IIIC																	2			
Zone 22 (non-conductive dust rarely or for a short period) Ex tc IIIB																	3			
Zone 2 (explosive gases rarely or for a short period) Ex ec IIC																				
Voltages														Version		Order code				
50 Hz 230 VΔ/400 VY				60 Hz ¹⁾ 460 VY				Standard				2	2	-						
50 Hz 400 VΔ/690 VY				60 Hz ¹⁾ 460 VΔ				Standard				3	4	-						
50 Hz 500 VY								Without additional charge				2	7	-						
50 Hz 500 VΔ								Without additional charge				4	0	-						
For other voltages ¹⁾ and more information, see from page 6/66																	9	0	...	
Types of construction														Version		Order code				
Without flange				IM B3 ²⁾				Standard				A		-						
With flange				IM B5 ²⁾				With additional charge				F		-						
With flange				IM B14 ²⁾				With additional charge				K		-						
For other types of construction and more information, see from page 6/71																			...	
Motor protection														Version		Order code				
Without								Standard				A								
PTC thermistor with 3 temperature sensors								With additional charge				B								
For other motor protection and more information, see from page 6/84																				
Terminal box position														Version		Order code				
Terminal box at top								Standard				4								
For other terminal box positions and more information, see from page 6/90																				
Special versions																Order code(s)				
For options, see from page 6/94																	1MB10-2- ... -Z		...+...+...+...	

6

For footnotes, see page 6/45



SIMOTICS XP 1MB1, 1MB5 explosion-protected motors

Zones 21, 22, and 2 with types of protection Ex tb, Ex tc, Ex ec · IE1 Standard Efficiency

Aluminum series 1MB10 – self-ventilated

Selection and ordering data

Operating values at rated power															Aluminum series		m _{IM B3}	J
P _{rated} 50 Hz	P _{rated} 60 Hz	Frame size	n _{rated} 50 Hz	T _{rated} 50 Hz	η _{rated} 50 Hz, 4/4	η _{rated} 50 Hz, 3/4	η _{rated} 50 Hz, 2/4	cos φ _{rated} 50 Hz, 4/4	I _{rated} 50 Hz, 400 V	T _{LR} /I _{rated}	I _{LR} /I _{rated}	T _B /I _{rated}	L _{pfA} 50 Hz	L _{WA} 50 Hz	Article No.	kg		
kW	kW	FS	rpm	Nm	%	%	%		A				dB(A)	dB(A)				
<ul style="list-style-type: none"> Cooling: self-ventilated (IC411) Efficiency according to IEC 60034-30: IE1 Standard Efficiency Insulation: Thermal class 155 (temperature class F), IP55 degree of protection, utilization in accordance with thermal class 130 (temperature class B) 																		
6-pole: 1000 rpm at 50 Hz, 1200 rpm at 60 Hz ¹⁾																		
1.5	1.75	100 L	940	15	75.2	75.6	72.3	0.74	3.9	2	4	2.2	59	71	1MB10 2-1AC4	19	0.0065	
2.2	2.55	112 M	940	22	77.7	78.5	76.3	0.72	5.7	2.6	4.6	2.7	57	69	1MB10 2-1BC2	25	0.0092	
3	3.45	132 S	955	30	79.7	79.9	77.1	0.74	7.3	2	4.6	2.6	63	75	1MB10 2-1CC0	34	0.017	
4	4.55	132 M	955	40	81.4	82.6	81.9	0.76	9.3	2.3	5.2	2.6	63	75	1MB10 2-1CC2	39	0.021	
5.5	6.3	132 M	955	55	83.1	84	83	0.75	12.7	2.7	5.7	3	63	75	1MB10 2-1CC3	48	0.027	
7.5	8.6	160 M	970	74	84.7	84.8	83.2	0.73	17.5	2.1	5.5	2.9	67	79	1MB10 2-1DC2	72	0.056	
11	12.6	160 L	965	109	86.4	86.8	85.9	0.77	24	1.9	5.9	2.7	67	79	1MB10 2-1DC4	92	0.078	
8-pole: 750 rpm at 50 Hz, 900 rpm at 60 Hz ¹⁾																		
0.75	0.86	100 L	705	10	61.2	58.1	50.5	0.62	2.85	1.9	3	2.2	60	72	1MB10 2-1AD4	17	0.0056	
1.1	1.27	100 L	690	15	66.5	66	61.8	0.61	3.9	2	3.2	2.3	60	72	1MB10 2-1AD5	22	0.0078	
1.5	1.75	112 M	700	20	70.2	71.1	68.7	0.66	4.65	1.9	3.5	2.1	63	75	1MB10 2-1BD2	29	0.0094	
2.2	2.55	132 S	715	29	74.2	74.1	71.4	0.66	6.5	1.7	3.9	2.4	63	75	1MB10 2-1CD0	37	0.019	
3	3.45	132 M	715	40	77	77.4	75.2	0.68	8.3	1.8	3.9	2.2	63	75	1MB10 2-1CD2	44	0.024	
4	4.55	160 M	720	53	79.2	79.3	76.3	0.67	10.9	1.6	4.1	2.3	63	75	1MB10 2-1DD2	60	0.044	
5.5	6.3	160 M	720	73	81.4	81.9	80.3	0.68	14.3	1.6	4	2.2	63	75	1MB10 2-1DD3	72	0.056	
7.5	8.6	160 L	715	100	83.1	83.7	82.4	0.69	18.9	1.7	3.8	2.2	63	75	1MB10 2-1DD4	91	0.077	
Zones																		
Zone 21 (conductive and non-conductive dust occasionally) Ex tb IIIC																		
Zone 22 (non-conductive dust rarely or for a short period) Ex tc IIIB																		
Zone 2 (explosive gases rarely or for a short period) Ex ec IIC																		
Voltages																		
Version															Order code			
50 Hz 230 VΔ/400 VY															Standard		2 2	-
60 Hz ¹⁾ 460 VY															Standard		3 4	-
50 Hz 400 VΔ/690 VY															Without additional charge		2 7	-
60 Hz ¹⁾ 460 VΔ															Without additional charge		4 0	-
50 Hz 500 VY																	9 0	...
50 Hz 500 VΔ																		
For other voltages ¹⁾ and more information, see from page 6/66																		
Types of construction																		
Version															Order code			
Without flange IM B3 ²⁾															Standard		A	-
With flange IM B5 ²⁾															With additional charge		F	-
With flange IM B14 ²⁾															With additional charge		K	-
For other types of construction and more information, see from page 6/71																		
Motor protection																		
Version															Order code			
Without															Standard		A	-
PTC thermistor with 3 temperature sensors															With additional charge		B	-
For other motor protection and more information, see from page 6/84																		
Terminal box position																		
Version															Order code			
Terminal box at top															Standard		4	-
For other terminal box positions and more information, see from page 6/89																		
Special versions																		
															Order code(s)		1MB10 2-... -Z ...+...+...+...	
For options, see from page 6/94																		



1) Operating values at rated power for 60 Hz are stored in the Drive Technology Configurator (DT Configurator; see Appendix, "Tools and engineering").

2) Types derived from IM B3 (IM B6/7/8, IM V6 and IM V5), from IM B5 (IM V3 and IM V1) and from IM B14 (IM V19 and IM V18) are possible, provided that no requirements exist for condensation drainage holes (H03) or stamping of the type on the rating plate. The basic type IM B3, IM B5 or IM B14 is stamped as standard on the rating plate. For orders with condensation drainage holes (H03), the type must be specified.

3) Parallel supply lines are required in the case of connection to ≤ 240 V. For frame size 315 with connection to ≤ 240 V, due to the high current, a drilled, removable entry plate (order code **R52**) or a larger terminal box (order code **R50**) can be used. Order codes **R52** and **R50** alter the motor dimensions.

4) No IE class for 50 and 60 Hz because the motor is outside the validity for the efficiency classes according to IEC 60034-30-1:2014.

5) Not possible for 8-pole motors.

SIMOTICS XP 1MB1, 1MB5 explosion-protected motors

Zone 1 with type of protection Ex eb · IE3 Premium Efficiency



Aluminum series 1MB1042; Cast-iron series 1MB1543, 1MB1643, 1MB5543, 1MB5643 – self-ventilated

Selection and ordering data

P _{rated} 50 Hz kW	Tem- perature class	Frame size	Operating values at rated power													Cast-iron series		m _{IM B3} J kg kg ^{m2}	
			n _{rated} 50 Hz rpm	T _{rated} 50 Hz Nm	η _{rated} 50 Hz, 4/4 %	η _{rated} 50 Hz, 3/4 %	η _{rated} 50 Hz, 2/4 %	cosφ _{rated} 4/4	I _{rated} 50 Hz, 400 V A	T _{LR} /I _{rated} 50 Hz	I _{LR} /I _{rated} 50 Hz	T _β /I _{rated} 50 Hz	t _E 50 Hz, T1/T2	t _E 50 Hz, T3	L _{pfA} 50 Hz 1)	L _{WA} 50 Hz 1)	Article No.		
<ul style="list-style-type: none"> Cooling: self-ventilated (IC411) Efficiency according to IEC 60034-30: IE3 Premium Efficiency Insulation: Thermal class 155 (temperature class F), IP55 degree of protection, utilization in accordance with thermal class 130 (temperature class B) 																			
2-pole: 3000 rpm at 50 Hz, temperature classes T1 to T3																			
0.18	T1, T2, T3	63 M	2810	0.61	52.8	51.9	48.6	0.83	0.55	2.3	4.4	2.3	30	27	52	60	▲ 1MB1 0 42-0BA2	4	0.00018
0.25	T1, T2, T3	63 M	2800	0.85	58.2	57.3	53.7	0.85	0.7	2.2	4.4	2.3	19	16	52	65	▲ 1MB1 0 42-0BA3	4	0.00022
2-pole: 3000 rpm at 50 Hz, temperature classes T1 to T3																			
0.37	T1, T2, T3	71 M	2775	1.3	73.8	74.4	72.4	0.83	0.91	2.7	5	2.7	42	37	63	70 ²⁾	1MB1 5 43-0CA2	13	0.00045
0.55	T1, T2, T3	71 M	2845	1.8	77.8	77	73.8	0.76	1.33	3.9	6.7	3.8	25	22	63	70 ²⁾	1MB1 5 43-0CA3	15	0.00056
0.75	T1, T2, T3	80 M	2840	2.5	80.7	81.7	80.8	0.86	1.7	2.6	5.7	2.8	22	19	64	71 ²⁾	1MB1 5 43-0DA2	18	0.0011
1.1	T1, T2, T3	80 M	2845	3.7	82.7	83.7	82.7	0.85	2.4	3.1	6.7	3.2	22	14	65	73 ²⁾	1MB1 5 43-0DA3	21	0.0013
1.3	T1, T2, T3	90 S	2900	4.3	83.5	84.2	83	0.89	2.7	2.7	7.4	3.4	9	8	68	75	1MB1 5 43-0EA0	26	0.0021
1.85	T1, T2, T3	90 L	2890	6.1	85.1	86	85.9	0.92	3.7	2.7	7.8	3.2	8	7	68	75	1MB1 5 43-0EA4	32	0.0031
2.5	T1, T2, T3	100 L	2895	8.2	86.4	87.5	86.9	0.92	4.9	2.7	7.7	3.3	10	9	68	75	1MB1 43-1AA4	37	0.0054
3.3	T1, T2, T3	112 M	2940	10.7	87.4	87.6	87.3	0.92	6.5	1.9	7.3	2.9	10	9	70	77	1MB1 43-1BA2	43	0.012
4.6	T1, T2, T3	132 S	2950	15	88.6	89.8	90.1	0.91	8.7	1.7	7.5	3.1	16	13	72	79	1MB1 43-1CA0	61	0.024
5.5	T3	132 S	2950	18	89.2	90.3	90.4	0.93	10.2	1.9	7.7	3	16	14	72	79	1MB1 43-1CA1	75	0.031
7.5	T3	160 M	2955	24	90.1	90.2	88.6	0.9	13.7	2.3	8.2	3.2	37	21	78	85 ²⁾	1MB1 43-1DA2	100	0.053
10	T3	160 M	2955	32.5	90.9	91.1	90.6	0.91	18	2.3	8	3.1	29	15	78	85 ²⁾	1MB1 43-1DA3	110	0.061
12.5	T3	160 M	2945	40.5	91.5	91.9	91.7	0.92	22.5	2.2	7.6	2.8	26	13	78	85 ²⁾	1MB1 43-1DA4	125	0.068
15	T3	180 M	2955	48.5	91.9	92.3	91.2	0.89	27.5	2.6	8.3	3.6	21	8	74	81	1MB1 43-1EA2	165	0.08
20	T3	200 L	2970	64	92.5	92.7	91.7	0.84	38	1.9	7	3.1	42	7 ³⁾	76	83	1MB1 43-2AA4	220	0.12
24	T3	200 L	2970	77	92.9	93.1	92.8	0.86	44.5	2	7.1	3	39	11	75	82	1MB1 43-2AA5	245	0.15
28	T3	225 M	2960	90	93.2	93.7	93.5	0.9	52	2.4	5.9	2.6	30	11	76	90	1MB1 43-2BA2	330	0.266
36	T3	250 M	2975	116	93.7	93.8	93.1	0.91	65	2.4	6.2	2.7	35	17	75	88	1MB1 43-2CA2	420	0.466
47	T3	280 S	2975	151	94.1	94.2	93.5	0.9	84	2.7	6.4	2.6	21	9	75	89	1MB1 43-2DA0	530	0.826
58	T3	280 M	2975	186	94.4	94.5	94	0.91	103	2.6	6.5	2.6	20	8 ³⁾	75	89	1MB1 43-2DA2	620	0.934
68	T3	315 S	2982	220	94.6	94.6	93.8	0.92	119	2.2	6.6	2.8	33	15	75	89	1MB5 43-3AA0	950	1.67
80	T3	315 M	2982	255	94.8	94.9	94.3	0.93	140	2.2	6.4	2.6	28	15	75	89	1MB5 43-3AA2	1020	1.95
100	T3	315 L	2982	320	95.1	95.1	94.6	0.93	172	2.4	6.7	2.7	23	10	75	89	1MB5 43-3AA4	1190	2.32
125	T3	315 L	2980	400	95.3	95.4	94.9	0.92	215	2.3	6.6	2.7	19	10	76	91	1MB5 43-3AA5	1210	2.34

Basic Line	Version	Order code
Performance Line	5	
Voltages	Standard	2 2
50 Hz 230 VΔ/400 VY 60 Hz 460 VY	Standard	3 4
50 Hz 400 VΔ/690 VY 60 Hz 460 VA	Without additional charge	2 7
50 Hz 500 VY	Without additional charge	4 0
50 Hz 500 VΔ		9 0
For other voltages and more information, see from page 6/68		...
Types of construction	Standard	A
Without flange IM B3 ⁴⁾	With additional charge	F
With flange IM B5 ⁴⁾	With additional charge	K
With flange IM B14 ⁴⁾		...
For other types of construction and more information, see from page 6/77		
Motor protection	Standard	A
Without	With additional charge	B
PTC thermistor with 3 temperature sensors		
For other motor protection and more information, see from page 6/86		
Terminal box position	Standard	4
Terminal box at top		
For other terminal box positions and more information, see from page 6/91		
Special versions		Order code(s)
For options, see from page 6/104	1MB 43- ...	-Z ...+...+...

1) Noise values for line operation under load, tolerance + 3dB(A).
 2) The tE time T3 of
 - 1MB1543-1EB4 at 7s falls below the set value of 7.2s from the
 - 1MB1543-2AB5 at 6s falls below the set value of 7.1s from the
 VIK recommendation. These differences must be agreed between the
 manufacturer and the operator.
 3) These sound power levels are above the set values in the VIK recommen-
 dation in the "standard" version. This difference must be agreed between
 the manufacturer and the operator.
 4) Types derived from IM B3 (IM B6/7/8, IM V6 and IM V5), from IM B5 (IM V3
 and IM V1) and from IM B14 (IM V19 and IM V18) are possible.
 The basic type IM B3, IM B5 or IM B14 is stamped as standard on the
 rating plate.



SIMOTICS XP 1MB1, 1MB5 explosion-protected motors

Zone 1 with type of protection Ex eb · IE3 Premium Efficiency

Aluminum series 1MB1042; Cast-iron series 1MB1543, 1MB1643, 1MB5543, 1MB5643 – self-ventilated

Selection and ordering data

P _{rated} , 50 Hz kW	Tem- pera- ture class	Frame size FS	Operating values at rated power													Cast-iron series		m _{IM B3} J	
			η _{rated} , 50 Hz rpm	T _{rated} , 50 Hz Nm	η _{rated} , 50 Hz %	η _{rated} , 50 Hz %	η _{rated} , 50 Hz %	cosφ _{rated} , 50 Hz %	I _{rated} , 400 V A	T _{LR} / I _{rated} , 50 Hz	I _{LR} / I _{rated} , 50 Hz	T _B / I _{rated} , 50 Hz	t _E , 50 Hz T1/T2	t _E , 50 Hz T3	L _{pfA} , 50 Hz dB(A)	L _{WA} , 50 Hz dB(A)	1MB1543 – Basic Line		1MB1643 – Performance Line
<ul style="list-style-type: none"> Cooling: self-ventilated (IC411) Efficiency according to IEC 60034-30: IE3 Premium Efficiency Insulation: Thermal class 155 (temperature class F), IP55 degree of protection, utilization in accordance with thermal class 130 (temperature class B) 																			
2-pole: 3000 rpm at 50 Hz, temperature classes T1 and T2 with second rating plate (T1/T2 and T3)																			
5.5 ²⁾	T1, T2	132 S	2945	17.8	89.2	90.3	90.4	0.93	10.2	1.9	7.7	3	13	–	72	79	1MB1 43-1CA1	75	0.031
7.5	T1, T2	160 M	2955	24	90.1	90.2	88.6	0.9	13.7	2.3	8.2	3.2	32	–	78	85 ³⁾	1MB1 43-1DA2	100	0.053
10 ²⁾	T1, T2	160 M	2955	32.5	90.9	91.1	90.6	0.91	18	2.3	8	3.1	22	–	78	85 ³⁾	1MB1 43-1DA3	110	0.061
12.5 ²⁾	T1, T2	160 M	2945	40.5	91.5	91.9	91.7	0.92	22.5	2.2	7.6	2.8	17	–	78	85 ³⁾	1MB1 43-1DA4	125	0.068
15	T1, T2	180 M	2955	48.5	91.9	92.3	91.2	0.9	27.5	2.6	8.3	3.6	16	–	74	81	1MB1 43-1EA2	165	0.08
20	T1, T2	200 L	2970	64	92.5	92.7	91.7	0.84	38	1.9	7	3.1	21	–	76	83	1MB1 43-2AA4	220	0.12
24	T1, T2	200 L	2970	77	92.9	93.1	92.8	0.86	44.5	2	7.1	3	23	–	75	82	1MB1 43-2AA5	245	0.15
Basic Line																			
Performance Line																			
Voltages																			
50 Hz 230 VΔ/400 VY 60 Hz 460 VY													Version		Order code				
50 Hz 400 VΔ/690 VY 60 Hz 460 VΔ													Standard		2 2				
50 Hz 500 VY													Standard		3 4				
50 Hz 500 VΔ													Without additional charge		2 7				
													Without additional charge		4 0				
For other voltages and more information, see from page 6/68															9 0				
Types of construction																			
Without flange IM B3 ⁴⁾													Standard		A				
With flange IM B5 ⁴⁾													With additional charge		F				
With flange IM B14 ⁴⁾													With additional charge		K				
For other types of construction and more information, see from page 6/77															...				
Motor protection																			
Without													Standard		A				
PTC thermistor with 3 temperature sensors													With additional charge		B				
For other motor protection and more information, see from page 6/86															...				
Terminal box position																			
Terminal box at top													Standard		4				
For other terminal box positions and more information, see from page 6/91															...				
Special versions																			
For options, see from page 6/104															1MB1 43- ... -Z ...+...+...				

1) Noise values for line operation under load, tolerance + 3dB(A).
 2) Only complies with efficiency classification IE2.
 3) These sound power levels are above the set values in the VIK recommendation in the "standard" version. This difference must be agreed between the manufacturer and the operator.
 4) Types derived from IM B3 (IM B6/7/8, IM V6 and IM V5), from IM B5 (IM V3 and IM V1) and from IM B14 (IM V19 and IM V18) are possible. The basic type IM B3, IM B5 or IM B14 is stamped as standard on the rating plate.

SIMOTICS XP 1MB1, 1MB5 explosion-protected motors

Zone 1 with type of protection Ex eb · IE3 Premium Efficiency



Aluminum series 1MB1042; Cast-iron series 1MB1543, 1MB1643, 1MB5543, 1MB5643 – self-ventilated

Selection and ordering data

P _{rated} 50 Hz kW	Tem- perature class	Frame size FS	Operating values at rated power													Cast-iron series		m _{IM B3} J	kg	kgm ²		
			n _{rated} 50 Hz rpm	T _{rated} 50 Hz Nm	η _{rated} 50 Hz %	η _{rated} 50 Hz %	η _{rated} 50 Hz %	cosφ _{rated} 50 Hz 4/4	I _{rated} 50 Hz A	T _{LP} /I _{rated} 50 Hz	I _{LR} /I _{rated} 50 Hz	T _p /I _{rated} 50 Hz	t _E 50 Hz T1/T2	t _E 50 Hz T3	L _{p1A} 50 Hz dB(A)	L _{WA} 50 Hz dB(A)	1MB.543 – Basic Line				1MB.543 – Performance Line	
<ul style="list-style-type: none"> • Cooling: self-ventilated (IC411) • Efficiency according to IEC 60034-30: IE3 Premium Efficiency • Insulation: Thermal class 155 (temperature class F), IP55 degree of protection, utilization in accordance with thermal class 130 (temperature class B) 																						
4-pole: 1500 rpm at 50 Hz. temperature classes T1 to T3																						
0.12	T1. T2. T3	63 M	1375	0.83	50	48.6	44.3	0.66	0.52	1.9	2.6	1.9	35	30	45	53	▲	1MB1 0 42-0BB2	4	0.00029		
0.18	T1. T2. T3	63 M	1330	1.3	57	55.4	50.7	0.75	0.62	1.9	2.7	1.9	30	25	45	53	▲	1MB1 0 42-0BB3	4	0.00037		
4-pole: 1500 rpm at 50 Hz. temperature classes T1 to T3																						
0.25	T1. T2. T3	71 M	1385	1.72	73.5	72.7	68.3	0.72	0.75	2.4	4.1	2.6	73	65	59	66 ³⁾		1MB1 5 43-0CB2	13	0.00095		
0.37	T1. T2. T3	71 M	1400	2.5	77.3	76.7	73	0.7	1.02	3.3	4.9	3.1	66	59	56	63 ³⁾		1MB1 5 43-0CB3	16	0.0014		
0.55	T1. T2. T3	80 M	1435	3.7	80.8	80.7	77.7	0.77	1.37	2.2	5.4	2.8	34	30	57	64 ³⁾		1MB1 5 43-0DB2	18	0.0021		
0.75	T1. T2. T3	80 M	1440	4.95	82.5	82.6	80.8	0.76	1.8	2.7	6.4	3.2	28	25	60	67 ³⁾		1MB1 5 43-0DB3	22	0.0029		
1	T1. T2. T3	90 S	1435	6.7	83.7	84.3	82.8	0.78	2.3	3	6.7	3.4	35	31	57	64 ³⁾		1MB1 5 43-0EB0	25	0.0036		
1.35	T1. T2. T3	90 L	1440	9	84.9	85.1	83.7	0.78	3.05	3	7	3.6	30	27	62	69 ³⁾		1MB1 5 43-0EB4	31	0.0049		
2	T1. T2. T3	100 L	1455	13.1	86.3	86.7	86	0.85	4	2.4	7.7	3.3	28	25	61	68		1MB1 5 43-1AB4	40	0.014		
2.5	T1. T2. T3	100 L	1455	16	87.1	88.1	87.6	0.85	5.1	2.4	7.9	3.2	18	16	63	70 ³⁾		1MB1 5 43-1AB5	40	0.014		
3.6	T1. T2. T3	112 M	1460	24	88.3	88.8	88	0.83	7.3	2.2	8	3.4	14	13	59	66		1MB1 5 43-1BB2	43	0.017		
5	T1. T2. T3	132 S	1470	32	89.3	90.1	89.8	0.84	9.8	2.1	7.5	3	27	23	62	69		1MB1 5 43-1CB0	67	0.034		
6.8	T1. T2. T3	132 M	1470	44	90.2	90.7	90.4	0.84	13.4	2.2	7.7	3.1	26	23	66	73		1MB1 5 43-1CB2	82	0.046		
10	T1. T2. T3	160 M	1475	65	91.2	91.6	90.9	0.84	19.6	1.7	6.6	2.8	28	21	66	73		1MB1 5 43-1DB2	110	0.083		
13.5	T1. T2. T3	160 L	1475	87	91.9	92.1	91.4	0.84	26.5	2.7	7.4	3.1	23	11	66	73		1MB1 5 43-1DB4	130	0.099		
15	T3	180 M	1470	97	92.1	92.5	92.5	0.82	30	2.4	7.6	3.4	22	8	67	74		1MB1 5 43-1EB2	165	0.13		
17.5	T3	180 L	1470	114	92.5	93	93	0.83	34.5	2.3	7.5	3.3	23	7 ²⁾	69	76		1MB1 5 43-1EB4	180	0.14		
24	T3	200 L	1475	155	93.1	93.4	93	0.84	46.5	2.4	7.6	3.3	20	6 ²⁾	65	72		1MB1 5 43-2AB5	240	0.22		
30	T3	225 S	1485	193	93.6	93.7	93.1	0.84	57	3	7.3	3.1	32	13	66	79		1MB1 5 43-2BB0	300	0.417		
36	T3	225 M	1482	230	93.9	94.3	94.2	0.85	67	3	7.1	2.9	31	11	66	79		1MB1 5 43-2BB2	370	0.545		
44	T3	250 M	1486	285	94.2	94.5	94.2	0.86	80	3.1	7.6	3.1	37	18	69	83		1MB1 5 43-2CB2	480	0.975		
58	T3	280 S	1488	370	94.6	94.8	94.3	0.87	106	2.8	7.2	3	45	20	68	82		1MB1 5 43-2DB0	680	1.7		
70	T3	280 M	1490	450	94.9	95.1	94.9	0.86	129	3.1	7.6	2.9	29	13	69	83		1MB1 5 43-2DB2	670	1.61		
84	T3	315 S	1492	540	95.1	95.1	94.6	0.85	156	2.2	7.1	2.8	22	9	69	84		1MB5 43-3AB0	900	2.38		
100	T3	315 M	1491	640	95.3	95.4	94.9	0.86	184	2.2	7	2.7	33	16	70	85		1MB5 43-3AB2	980	2.88		
115	T3	315 L	1492	740	95.5	95.5	95	0.85	215	2.5	7.1	3	35	15	72	86		1MB5 43-3AB4	1110	3.18		
135	T3	315 L	1492	860	95.7	95.8	95.3	0.85	250	2.4	7.1	2.9	22	9	70	85		1MB5 43-3AB5	1190	3.67		

Basic Line	Performance Line	Order code
Voltagages		
50 Hz 230 VΔ/400 VY	60 Hz 460 VY	2 2
50 Hz 400 VΔ/690 VY	60 Hz 460 VA	3 4
50 Hz 500 VY		2 7
50 Hz 500 VΔ		4 0
For other voltagages and more information, see from page 6/68		
Types of construction		
Without flange	IM B3 ⁴⁾	A
With flange	IM B5 ⁴⁾	F
With flange	IM B14 ⁴⁾	K
For other types of construction and more information, see from page 6/77		
Motor protection		
Without		A
PTC thermistor with 3 temperature sensors		B
For other motor protection and more information, see from page 6/86		
Terminal box position		
Terminal box at top		4
For other terminal box positions and more information, see from page 6/91		
Special versions		
For options, see from page 6/104		
		Order code(s)
1MB . 43- - - Z		

1) Noise values for line operation under load, tolerance + 3dB(A).
 2) The tE time T3 of
 – 1MB1543-1EB4 at 7s falls below the set value of 7.2s from the
 – 1MB1543-2AB5 at 6s falls below the set value of 7.1s from the
 VIK recommendation. These differences must be agreed between the
 manufacturer and the operator.
 3) These sound power levels are above the set values in the VIK recommen-
 dation in the "standard" version. This difference must be agreed between
 the manufacturer and the operator.
 4) Types derived from IM B3 (IM B6/7/8, IM V6 and IM V5), from IM B5 (IM V3
 and IM V1) and from IM B14 (IM V19 and IM V18) are possible.
 The basic type IM B3, IM B5 or IM B14 is stamped as standard on the
 rating plate.



SIMOTICS XP 1MB1, 1MB5 explosion-protected motors

Zone 1 with type of protection Ex eb · IE3 Premium Efficiency

Aluminum series 1MB1042; Cast-iron series 1MB1543, 1MB1643, 1MB5543, 1MB5643 – self-ventilated

Selection and ordering data

P _{rated} , 50 Hz kW	Tem- perature class	Frame size FS	Operating values at rated power													Cast-iron series		m _{IM B3} J	kg	kgm ²															
			n _{rated} , 50 Hz rpm	T _{rated} , 50 Hz Nm	η _{rated} , 50 Hz, 4/4 %	η _{rated} , 50 Hz, 3/4 %	η _{rated} , 50 Hz, 2/4 %	η _{rated} , 50 Hz, 4/4 %	cosφ _{rated} , 50 Hz, 400 V A	I _{rated} , 50 Hz, 400 V A	T _{LP} / I _{rated} , 50 Hz °C/A	I _{LP} / I _{rated} , 50 Hz °C/A	T _p / I _{rated} , 50 Hz °C/A	t _E , 50 Hz, T1/T2 T3	t _E , 50 Hz, T3	L _{pfA} , 50 Hz dB(A)	L _{WA} , 50 Hz dB(A)				1MB.543 – Basic Line	1MB.643 – Performance Line	Article No.												
<ul style="list-style-type: none"> Cooling: self-ventilated (IC411) Efficiency according to IEC 60034-30: IE3 Premium Efficiency Insulation: Thermal class 155 (temperature class F), IP55 degree of protection, utilization in accordance with thermal class 130 (temperature class B) 																																			
4-pole: 1500 rpm at 50 Hz, temperature classes T1 and T2 with second rating plate (T1/T2 and T3)																																			
17	T1, T2	180 M	1475	97	92.1	92.5	92.5	0.82	30	2.4	7.6	3.4	19	–	67	74	1MB1	43-1EB2	165	0.13															
20	T1, T2	180 L	1470	114	92.5	93	93	0.83	34.5	2.3	7.5	3.3	18	–	69	76	1MB1	43-1EB4	180	0.14															
27	T1, T2	200 L	1475	155	93.1	93.4	93	0.84	46.5	2.4	7.6	3.3	16	–	65	72	1MB1	43-2AB5	240	0.22															
33	T1, T2	225 S	1485	193	93.6	93.7	93.1	0.84	57	3	7.3	3.1	30	–	66	79	1MB1	43-2BB0	300	0.417															
40	T1, T2	225 M	1482	230	93.9	94.3	94.2	0.85	67	3	7.1	2.9	27	–	66	79	1MB1	43-2BB2	370	0.545															
50	T1, T2	250 M	1486	285	94.2	94.5	94.2	0.86	80	3.1	7.6	3.1	35	–	69	83	1MB1	43-2CB2	480	0.975															
68	T1, T2	280 S	1488	370	94.6	94.8	94.3	0.87	106	2.8	7.2	3	40	–	68	82	1MB1	43-2DB0	680	1.7															
80	T1, T2	280 M	1490	450	94.9	95.1	94.9	0.86	129	3.1	7.6	2.9	23	–	69	83	1MB1	43-2DB2	670	1.61															
100	T1, T2	315 S	1492	540	95.1	95.1	94.6	0.85	156	2.2	7.1	2.8	19	–	69	84	1MB5	43-3AB0	900	2.38															
120	T1, T2	315 M	1491	640	95.3	95.4	94.9	0.86	184	2.2	7	2.7	28	–	70	85	1MB5	43-3AB2	980	2.88															
135	T1, T2	315 L	1492	740	95.5	95.5	95	0.85	215	2.5	7.1	3	23	–	72	86	1MB5	43-3AB4	1110	3.18															
165	T1, T2	315 L	1492	860	95.7	95.8	95.3	0.85	250	2.4	7.1	2.9	17	–	70	85	1MB5	43-3AB5	1190	3.67															
Basic Line Performance Line																	5	6																	
Voltages																	Version		Order code																
50 Hz 230 VΔ/400 VY 60 Hz 460 VY																	Standard		2 2		–														
50 Hz 400 VΔ/690 VY 60 Hz 460 VΔ																	Standard		3 4		–														
50 Hz 500 VY																	Without additional charge		2 7		–														
50 Hz 500 VΔ																	Without additional charge		4 0		–														
For other voltages and more information, see from page 6/68																			9 0		...														
Types of construction																	Version		Order code																
Without flange IM B3 ²⁾																	Standard		A		–														
With flange IM B5 ²⁾																	With additional charge		F		–														
With flange IM B14 ²⁾																	With additional charge		K		–														
For other types of construction and more information, see from page 6/77																					...														
Motor protection																	Version		Order code																
Without																	Standard		A		–														
PTC thermistor with 3 temperature sensors																	With additional charge		B		–														
For other motor protection and more information, see from page 6/86																																			
Terminal box position																	Version		Order code																
Terminal box at top																	Standard		4		–														
For other terminal box positions and more information, see from page 6/91																																			
Special versions																			Order code(s)																
For options, see from page 6/104																			1MB. 43- -Z																



1) Noise values for line operation under load, tolerance + 3dB(A).

2) Types derived from IM B3 (IM B6/7/8, IM V6 and IM V5), from IM B5 (IM V3 and IM V1) and from IM B14 (IM V19 and IM V18) are possible. The basic type IM B3, IM B5 or IM B14 is stamped as standard on the rating plate.

SIMOTICS XP 1MB1, 1MB5 explosion-protected motors

Zone 1 with type of protection Ex eb · IE3 Premium Efficiency



Aluminum series 1MB1042; Cast-iron series 1MB1543, 1MB1643, 1MB5543, 1MB5643 – self-ventilated

Selection and ordering data

P _{rated} 50 Hz kW	Tem- perature class	Frame size FS	Operating values at rated power													Cast-iron series		m _{IM B3} J kg	J kgm ²			
			n _{rated} 50 Hz rpm	T _{rated} 50 Hz Nm	η _{rated} 50 Hz %	η _{rated} 50 Hz %	η _{rated} 50 Hz %	cosφ _{rated} 50 Hz 4/4	I _{rated} 50 Hz A	T _{LP} /I _{rated} 50 Hz	I _{LP} /I _{rated} 50 Hz	T _P /I _{rated} 50 Hz	t _E 50 Hz T1/T2	t _E 50 Hz T3	L _{pfA} 50 Hz 1)	L _{WA} 50 Hz 1)	1MB.543 – Basic Line			1MB.643 – Performance Line	Article No.	
<ul style="list-style-type: none"> • Cooling: self-ventilated (IC411) • Efficiency according to IEC 60034-30: IE3 Premium Efficiency • Insulation: Thermal class 155 (temperature class F), IP55 degree of protection, utilization in accordance with thermal class 130 (temperature class B) 																						
6-pole: 1000 rpm at 50 Hz, temperature classes T1 to T3																						
0.25	T1, T2, T3	71 M	875	2.75	68.6	69.8	67.9	0.72	0.72	2.4	3.4	2.4	500	233	58	65 ²⁾	1MB1 5 43-0CC3	16	0.00015			
0.37	T1, T2, T3	80 M	935	3.8	73.5	72.6	68	0.64	1.16	2.3	4.2	2.7	73	65	55	62 ²⁾	1MB1 5 43-0DC2	19	0.00025			
0.55	T1, T2, T3	80 M	925	5.7	77.2	77.1	74.3	0.65	1.65	2.6	4.4	2.9	94	82	60	67 ²⁾	1MB1 5 43-0DC3	22	0.0031			
0.65	T1, T2, T3	90 S	940	6.6	78.3	79.3	77.8	0.7	1.8	1.8	4.2	2.4	87	77	61	68 ²⁾	1MB1 5 43-0EC0	26	0.004			
0.95	T1, T2, T3	90 L	935	9.7	80.2	81.3	79.9	0.71	2.5	2.2	4.7	2.5	64	56	60	67 ²⁾	1MB1 5 43-0EC4	31	0.0048			
1.3	T1, T2, T3	100 L	945	13.1	81.8	82.5	80.5	0.71	3.4	2.5	5.3	2.8	63	55	58	65	1MB1 43-1AC4	36	0.011			
1.9	T1, T2, T3	112 M	960	18.9	83.6	84.5	83.7	0.74	4.5	2.6	6.6	3.2	45	40	60	67	1MB1 43-1BC2	46	0.017			
2.6	T1, T2, T3	132 S	980	25.5	85	85.8	85.3	0.75	5.8	2.1	6.5	2.8	54	48	63	70	1MB1 43-1CC0	70	0.029			
3.5	T1, T2, T3	132 M	975	34.5	86.3	87.4	87.3	0.76	7.8	1.8	5.8	2.5	31	27	68	75	1MB1 43-1CC2	70	0.037			
4.8	T1, T2, T3	132 M	975	47	87.5	88.4	88.3	0.76	10.5	2.1	6.2	2.7	34	30	69	76	1MB1 43-1CC3	82	0.046			
6.6	T1, T2, T3	160 M	980	64	88.6	88.7	87.8	0.8	13.8	2.4	6.8	2.8	37	33	67	74	1MB1 43-1DC2	120	0.098			
9.7	T1, T2, T3	160 M	980	95	89.9	90	89	0.79	20.5	2.7	7.1	2.9	22	19	70	77	1MB1 43-1DC4	145	0.12			
13.2	T1, T2, T3	180 L	975	129	90.8	91.4	91.6	0.77	28	2.1	6.2	2.8	38	17	66	73	1MB1 43-1EC4	180	0.19			
16.5	T1, T2, T3	200 L	975	162	91.4	92.3	92.5	0.8	34.5	2	5.4	2.3	52	12	60	67	1MB1 43-2AC4	215	0.28			
20	T1, T2, T3	200 L	980	195	91.9	92.1	91.3	0.75	43	1.7	6.5	3	40	16	69	76	1MB1 43-2AC5	265	0.33			
27	T1, T2, T3	225 M	985	260	92.7	93.2	93.1	0.82	52	2.8	6.9	3.1	61	24	64	77	1MB1 43-2BC2	390	0.845			
33	T1, T2, T3	250 M	985	320	93.1	93.9	94	0.85	63	2.4	6.3	2.6	61	22	65	78	1MB1 43-2CC2	480	1.27			
40	T1, T2, T3	280 S	988	385	93.5	94.1	94	0.86	75	2.8	6.3	2.5	47	13	66	80	1MB1 43-2DC0	570	1.64			
46	T3	280 M	990	445	93.8	94.2	94.1	0.84	87	3.4	7.5	3	28	13	63	77	1MB1 43-2DC2	570	1.64			
64	T3	315 S	992	620	94.4	94.6	94.1	0.86	118	2.4	7.5	3.3	32	15	65	79	1MB5 43-3AC0	870	3.25			
76	T3	315 M	992	730	94.6	94.9	94.6	0.87	139	2.3	7.4	3.2	28	11	65	79	1MB5 43-3AC2	900	3.54			
92	T3	315 L	991	890	94.9	95.2	95.1	0.88	167	2.3	6.9	3	37	13	69	83	1MB5 43-3AC4	1090	4.52			
110	T3	315 L	992	1060	95.1	95.3	95.1	0.87	198	2.5	7.6	3.3	26	9	71	86	1MB5 43-3AC5	1170	5.16			
125	T3	315 L	992	1200	95.3	95.5	95.1	0.85	230	2.4	6.7	2.7	28	9	70	84	1MB5 43-3AC6	1180	4.89			
Basic Line																	5					
Performance Line																	6					
Voltages																	Version		Order code			
50 Hz 230 VΔ/400 VY 60 Hz 460 VY																	Standard		2 2		-	
50 Hz 400 VΔ/690 VY 60 Hz 460 VA																	Standard		3 4		-	
50 Hz 500 VY																	Without additional charge		2 7		-	
50 Hz 500 VΔ																	Without additional charge		4 0		-	
For other voltages and more information, see from page 6/68																			9 0		...	
Types of construction																	Version		Order code			
Without flange IM B3 ³⁾																	Standard		A		-	
With flange IM B5 ³⁾																	With additional charge		F		-	
With flange IM B14 ³⁾																	With additional charge		K		-	
For other types of construction and more information, see from page 6/77																					...	
Motor protection																	Version		Order code			
Without																	Standard		A			
PTC thermistor with 3 temperature sensors																	With additional charge		B			
For other motor protection and more information, see from page 6/86																						
Terminal box position																	Version		Order code			
Terminal box at top																	Standard		4			
For other terminal box positions and more information, see from page 6/91																						
Special versions																	Order code(s)					
For options, see from page 6/104																	1MB. 43- -Z					

6

1) Noise values for line operation under load, tolerance + 3dB(A).

2) These sound power levels are above the set values in the VIK recommendation in the "standard" version. This difference must be agreed between the manufacturer and the operator.

3) Types derived from IM B3 (IM B6/7/8, IM V6 and IM V5), from IM B5 (IM V3 and IM V1) and from IM B14 (IM V19 and IM V18) are possible. The basic type IM B3, IM B5 or IM B14 is stamped as standard on the rating plate.



SIMOTICS XP 1MB1, 1MB5 explosion-protected motors

Zone 1 with type of protection Ex eb · IE3 Premium Efficiency

Aluminum series 1MB1042; Cast-iron series 1MB1543, 1MB1643, 1MB5543, 1MB5643 – self-ventilated

Selection and ordering data

Operating values at rated power															Cast-iron series		m _{IM B3} J			
P _{rated} 50 Hz	Tem- perature class	Frame size	n _{rated} 50 Hz	T _{rated} 50 Hz	η _{rated} 50 Hz, 4/4	η _{rated} 50 Hz, 3/4	η _{rated} 50 Hz, 2/4	η _{rated} 50 Hz, 4/4	cosφ _{rated} 50 Hz, 400 V	I _{rated} 50 Hz	T _{LP} / I _{rated} 50 Hz	I _{LP} / I _{rated} 50 Hz	T _P / I _{rated} 50 Hz	t _E 50 Hz, T1/T2 T3	t _E 50 Hz, T1/T2 T3	L _{pfA} 50 Hz 1)	L _{WA} 50 Hz 1)	Article No.	kg	kgm ²
kW	FS	rpm	Nm	%	%	%	%	A	V	A	A	A	A	s	s	dB(A)	dB(A)		kg	kgm ²
<ul style="list-style-type: none"> • Cooling: self-ventilated (IC411) • Efficiency according to IEC 60034-30: IE3 Premium Efficiency • Insulation: Thermal class 155 (temperature class F), IP55 degree of protection, utilization in accordance with thermal class 130 (temperature class B) 																				
6-pole: 1000 rpm at 50 Hz, temperature classes T1 and T2 with second rating plate (T1/T2 and T3)																				
46	T1, T2	280 M	990	445	93.8	94.2	94.1	0.84	87	3.4	7.5	3	27	-	63	77		1MB1 43-2DC2	570	1.64
64	T1, T2	315 S	992	620	94.4	94.6	94.1	0.86	118	2.4	7.5	3.3	31	-	66	80		1MB5 43-3AC0	870	3.25
76	T1, T2	315 M	992	730	94.6	94.9	94.6	0.87	139	2.3	7.4	3.2	25	-	65	79		1MB5 43-3AC2	900	3.54
92	T1, T2	315 L	991	890	94.9	95.2	95.1	0.88	167	2.3	6.9	3	34	-	69	84		1MB5 43-3AC4	1090	4.52
110	T1, T2	315 L	992	1060	95.1	95.3	95.1	0.87	198	2.5	7.6	3.3	23	-	71	86		1MB5 43-3AC5	1170	5.16
125	T1, T2	315 L	992	1200	95.3	95.5	95.1	0.85	230	2.4	6.7	2.7	24	-	70	85		1MB5 43-3AC6	1180	4.89
Basic Line Performance Line																		5		
Voltages															Version		Order code			
50 Hz 230 VΔ/400 VY			60 Hz 460 VY			Standard			2 2		-									
50 Hz 400 VΔ/690 VY			60 Hz 460 VΔ			Standard			3 4		-									
50 Hz 500 VY						Without additional charge			2 7		-									
50 Hz 500 VΔ						Without additional charge			4 0		-									
For other voltages and more information, see from page 6/68																				
Types of construction															Version		Order code			
Without flange			IM B3 ²⁾			Standard			A		-									
With flange			IM B5 ²⁾			With additional charge			F		-									
With flange			IM B14 ²⁾			With additional charge			K		-									
For other types of construction and more information, see from page 6/77																				
Motor protection															Version		Order code			
Without						Standard			A		-									
PTC thermistor with 3 temperature sensors						With additional charge			B		-									
For other motor protection and more information, see from page 6/86																				
Terminal box position															Version		Order code			
Terminal box at top						Standard			4		-									
For other terminal box positions and more information, see from page 6/91																				
Special versions															Order code(s)					
For options, see from page 6/104																				
1MB . ■43- ■-■■■■■-Z . . . +																				



¹⁾ Noise values for line operation under load, tolerance + 3dB(A).

²⁾ Types derived from IM B3 (IM B6/7/8, IM V6 and IM V5), from IM B5 (IM V3 and IM V1) and from IM B14 (IM V19 and IM V18) are possible. The basic type IM B3, IM B5 or IM B14 is stamped as standard on the rating plate.

SIMOTICS XP 1MB1, 1MB5 explosion-protected motors

Zone 1 with types of protection Ex db, Ex db eb · IE3 Premium Efficiency



Cast-iron series 1MB553/1MB.563 – self-ventilated

Selection and ordering data

Operating values at rated power														Cast-iron series			
P_{rated} 50 Hz	P_{rated} 60 Hz	Frame size	n_{rated} 50 Hz	T_{rated} 50 Hz	η_{rated} 50 Hz, 4/4	η_{rated} 50 Hz, 3/4	η_{rated} 50 Hz, 2/4	$\cos\phi_{rated}$ 50 Hz, 4/4	I_{rated} 50 Hz, 400 V	$T_{LR}/$ T_{rated}	$I_{LR}/$ I_{rated}	$T_B/$ T_{rated}	$L_{pfA,1}$ 50 Hz	$L_{WA,1}$ 50 Hz	1MB15 3/1MB55 3	$m_{IM B3}$	J
kW	kW	FS	rpm	Nm	%	%	%		A				dB(A)	dB(A)	Article-No.	kg	kgm ²
<ul style="list-style-type: none"> Cooling: self-ventilated (IC411) Efficiency according to IEC 60034-30: IE3 Premium Efficiency Insulation: Thermal class 155 (temperature class F), IP55 degree of protection, utilization in accordance with thermal class 130 (temperature class B) 																	
2-pole: 3000 rpm at 50 Hz, 3600 rpm at 60 Hz																	
0,37	0,37	71 M	2850	1.24	73.8	73.3	69.7	0.76	0.95	3.5	5.8	3.5	52	63	1MB15 3-0CA2	24	0.0004
0,55	0,55	71 M	2850	1.84	77.8	77.5	74.5	0.76	1.34	3.7	6.1	3.7	57	68	1MB15 3-0CA3	25	0.0005
0,75	0,75	80 M	2850	2.5	80.7	82.2	81.9	0.86	1.56	2.6	6.2	3	60	71	1MB15 3-0DA2	30	0.0011
1,1	1,1	80 M	2885	3.65	82.7	83.9	83.1	0.85	2.25	3	7.1	3.3	60	71	1MB15 3-0DA3	32	0.0014
1,5	1,5	90 S	2910	4.9	84.2	84.6	83.2	0.86	3	2.7	8.1	4.2	65	77	1MB15 3-0EA0	41	0.0024
2,2	2,2	90 L	2910	7.2	85.9	86.8	86.1	0.88	4.2	2.6	8.3	4	65	77	1MB15 3-0EA4	45	0.0032
3	3	100 L	2920	9.8	87.1	87.9	87.5	0.88	5.6	3.2	8.1	4.2	74	82	1MB15 3-1AA4	64	0.0048
4	4	112 M	2950	12.9	88.1	88.7	88.2	0.89	7.4	2.5	8.7	4	69	81	1MB15 3-1BA2	74	0.0099
5,5	5,5	132 S	2950	17.8	89.2	90.1	89.7	0.9	9.9	1.9	7.3	3.7	68	80	1MB15 3-1CA0	95	0.0201
7,5	7,5	132 S	2950	24.5	90.1	90.9	90.7	0.92	13.1	2.1	8.3	4	68	80	1MB15 3-1CA1	106	0.0272
11	11	160 M	2955	35.5	91.2	91.3	90.2	0.87	20	2.5	7.6	3.8	70	82	1MB15 3-1DA2	169	0.0457
15	15	160 M	2960	48.5	91.9	91.9	91	0.87	27	2.8	8.8	4.3	70	82	1MB15 3-1DA3	179	0.0532
18,5	18,5	160 M	2955	60	92.4	92.8	92.3	0.9	32	2.8	8.3	3.9	70	82	1MB15 3-1DA4	190	0.0637
22	22	180 M	2950	71	92.7	93	92.4	0.89	38.5	2.3	7.5	3.5	67	80	1MB15 3-1EA2	238	0.0889
30	30	200 L	2955	97	93.3	93.6	93.3	0.87	53	2.5	7	3.3	67	80	1MB15 3-2AA4	315	0.150
37	37	200 L	2955	120	93.7	93.9	93.5	0.88	65	2.5	7.1	3.2	67	80	1MB15 3-2AA5	348	0.178
45	45	225 M	2960	145	94	94.4	94	0.89	78	2.5	7	3	73	87	1MB15 3-2BA2	447	0.263
55	55	250 M	2975	177	94.3	94.5	94.1	0.89	95	2.4	7	3	75	89	1MB15 3-2CA2	532	0.454
75	75	280 S	2975	240	94.7	94.8	94.3	0.89	128	2.5	7.3	3	76	90	1MB15 3-2DA0	729	0.816
90	90	280 M	2975	290	95	95.2	94.8	0.9	152	2.5	7.5	3.1	79	93	1MB15 3-2DA2	763	0.924
110	110	315 S	2982	350	95.2	95.3	94.7	0.91	183	2.5	7.6	3	77	92	1MB55 3-3AA0	1130	1.76
132	132	315 M	2982	425	95.4	95.3	94.7	0.91	220	2.3	7.4	2.9	77	92	1MB55 3-3AA2	1290	1.99
160	160	315 L	2980	510	95.6	95.6	95.2	0.91	265	2.3	6.9	2.8	78	92	1MB55 3-3AA4	1360	2.29
200	200	315 L	2980	640	95.8	95.9	95.5	0.92	330	2.4	6.7	2.6	78	93	1MB55 3-3AA5	1490	2.65
250	250	315 L	2986	1010	95.8	95.8	95.3	0.91	520	2.1	7.8	3	79	95	1MB55 3-3AA6	1590	2.85
315	315	355 L	2986	1010	95.8	95.8	95.3	0.91	520	2.1	7.8	3	79	95	1MB55 3-3BA2	1830	4.31
355	355	355 L	2975	1140	95.8	96.1	96	0.92	580	2.4	6.6	2.5	83	98	1MB55 3-3BA3	2620	5.84
400	400	355 L	2986	1280	95.8	95.8	95.5	0.92	660	2.2	7.6	3	81	96	1MB55 3-3BA4	2610	5.89
460	460	355 L	2990	1470	95.8	95.7	95	0.89	780	2.8	9.5	4.2	81	96	1MB55 3-3BA5	2620	5.89
Zones															Order code		
Zone 1 (explosive gases occasionally or frequently) Ex db IIC															5	-	
Zone 1 (explosive gases occasionally or frequently) Ex db IIB															6	-	
Voltages															Order code		
50 Hz 230 VΔ/400 VY 60 Hz 460 VY															2	2	
50 Hz 400 VΔ/690 VY 60 Hz 460 VΔ															3	4	
50 Hz 500 VY															2	7	
50 Hz 500 VΔ															4	0	
For other voltages and more information, see from page 6/69															9	0	
...																	
Types of construction															Order code		
Without flange IM B3 ²⁾															A	-	
With flange IM B5 ²⁾															F	-	
With flange IM B14 ²⁾															K	-	
For other types of construction and more information, see from page 6/80																...	
Motor protection															Order code		
Without															A	-	
PTC thermistor with 3 temperature sensors															B	-	
For other motor protection and more information, see from page 6/87																...	
Terminal box position															Order code		
Terminal box at top															4	-	
For other terminal box positions and more information, see from page 6/92																...	
Special versions															Order code(s)		
For options, see from page 6/108															1MB.5 3-...-Z ...+...+...+...		

6

For footnotes, see page 6/55



SIMOTICS XP 1MB1, 1MB5 explosion-protected motors

Zone 1 with type of protection Ex db, Ex db eb · IE3 Premium Efficiency

Cast-iron series 1MB553/1MB.563 – self-ventilated

Selection and ordering data

Operating values at rated power														Cast-iron series			
P_{rated} 50 Hz	P_{rated} 60 Hz	Frame size	n_{rated} 50 Hz	T_{rated} 50 Hz	η_{rated} 50 Hz, 4/4	η_{rated} 50 Hz, 3/4	η_{rated} 50 Hz, 2/4	$\cos\phi_{rated}$ 50 Hz, 4/4	I_{rated} 50 Hz, 400 V	T_{LR}/T_{rated}	I_{LR}/I_{rated}	T_B/T_{rated}	$L_{p(A,1)}$ 50 Hz	$L_{WA,1}$ 50 Hz	1MB15 ■ 3/1MB55 ■ 3	$m_{IM B3}$	J
kW	kW	FS	rpm	Nm	%	%	%		A				dB(A)	dB(A)	Article-No.	kg	kgm ²
<ul style="list-style-type: none"> • Cooling: self-ventilated (IC411) • Efficiency according to IEC 60034-30: IE3 Premium Efficiency • Insulation: Thermal class 155 (temperature class F), IP55 degree of protection, utilization in accordance with thermal class 130 (temperature class B) 																	
4-pole: 1500 rpm at 50 Hz, 1800 rpm at 60 Hz																	
0.25	0.25	71 M	1395	1.71	73.5	73.7	70.4	0.72	0.68	2.5	4.2	2.6	44	55	1MB15 ■ 3-0CB2 ■ -■■■■■	25	0.0010
0.37	0.37	71 M	1410	2.5	77.3	76.8	73.2	0.7	0.99	3.1	4.8	3.1	56	67	1MB15 ■ 3-0CB3 ■ -■■■■■	27	0.0013
0.55	0.55	80 M	1440	3.65	80.8	81.1	79.3	0.78	1.26	2.1	5.9	3.1	53	64	1MB15 ■ 3-0DB2 ■ -■■■■■	30	0.0022
0.75	0.75	80 M	1450	4.95	82.5	82.3	79.9	0.75	1.75	2.7	7.1	3.9	53	64	1MB15 ■ 3-0DB3 ■ -■■■■■	33	0.0030
1.1	1.1	90 S	1440	7.3	84.1	84.7	83.4	0.78	2.4	2.9	6.9	3.6	56	68	1MB15 ■ 3-0EB0 ■ -■■■■■	42	0.0038
1.5	1.5	90 L	1445	9.9	85.3	86	85.2	0.8	3.15	2.9	7.3	3.5	60	68	1MB15 ■ 3-0EB4 ■ -■■■■■	45	0.0050
2.2	2.2	100 L	1465	14	86.7	87	85.9	0.83	4.4	3.2	8.4	4.4	57	65	1MB15 ■ 3-1AB4 ■ -■■■■■	68	0.0124
3	3	100 L	1460	19.6	87.7	88.5	87.9	0.83	5.9	2.5	8.3	3.9	60	72	1MB15 ■ 3-1AB5 ■ -■■■■■	68	0.0124
4	4	112 M	1460	26	88.6	89.2	88.6	0.82	7.9	2.4	7.1	3.7	58	70	1MB15 ■ 3-1BB2 ■ -■■■■■	76	0.0146
5.5	5.5	132 S	1470	35.5	89.6	90	89.4	0.82	10.8	2.9	8.5	3.7	64	76	1MB15 ■ 3-1CB0 ■ -■■■■■	105	0.0352
7.5	7.5	132 M	1465	49	90.4	91.1	90.8	0.84	14.3	2.6	8.2	3.7	64	76	1MB15 ■ 3-1CB2 ■ -■■■■■	120	0.0404
11	11	160 M	1475	71	91.4	91.8	91.2	0.84	20.5	2.6	7.6	3.4	65	77	1MB15 ■ 3-1DB2 ■ -■■■■■	168	0.0733
15	15	160 M	1475	97	92.1	92.3	91.5	0.82	28.5	2.5	8.5	3.8	65	77	1MB15 ■ 3-1DB4 ■ -■■■■■	191	0.0877
18.5	18.5	180 M	1470	120	92.6	93.1	93	0.82	35	2.5	7.2	3.3	66	73	1MB15 ■ 3-1EB2 ■ -■■■■■	240	0.145
22	22	180 L	1470	143	93	93.6	93.6	0.83	41	2.3	6.8	3.3	68	75	1MB15 ■ 3-1EB4 ■ -■■■■■	249	0.158
30	30	200 L	1470	195	93.6	94.2	94.2	0.84	55	2.6	7.3	3.1	65	72	1MB15 ■ 3-2AB5 ■ -■■■■■	346	0.248
37	37	225 S	1480	240	93.9	94.3	93.9	0.86	66	2.6	6.5	2.6	65	79	1MB15 ■ 3-2BB0 ■ -■■■■■	449	0.469
45	45	225 M	1480	290	94.2	94.7	94.6	0.86	80	2.6	6.4	2.7	64	78	1MB15 ■ 3-2BB2 ■ -■■■■■	466	0.521
55	55	250 M	1482	355	94.6	95	94.8	0.86	98	2.5	6.8	2.9	67	81	1MB15 ■ 3-2CB2 ■ -■■■■■	563	0.842
75	75	280 S	1486	480	95	95.3	95.1	0.86	133	2.6	7.3	3	69	84	1MB15 ■ 3-2DB0 ■ -■■■■■	782	1.37
90	90	280 M	1486	580	95.2	95.5	95.4	0.87	157	2.7	7.5	3	73	87	1MB15 ■ 3-2DB2 ■ -■■■■■	818	1.70
110	110	315 S	1490	700	95.4	95.6	95.3	0.86	194	2.4	6.7	2.5	69	84	1MB55 ■ 3-3AB0 ■ -■■■■■	1150	2.48
132	132	315 M	1490	850	95.6	95.9	95.7	0.86	230	2.1	6.9	2.5	72	88	1MB55 ■ 3-3AB2 ■ -■■■■■	1270	2.79
160	160	315 L	1490	1030	95.8	95.9	95.6	0.85	285	2.4	7.5	3	80	94	1MB55 ■ 3-3AB4 ■ -■■■■■	1330	3.17
200	200	315 L	1490	1280	96	96.3	96.2	0.86	350	2.3	7.6	2.9	76	91	1MB55 ■ 3-3AB5 ■ -■■■■■	1480	3.79
250	250	315 L	1488	1600	96	96.2	95.9	0.86	435	2.2	7	2.7	78	93	1MB55 ■ 3-3AB6 ■ -■■■■■	1660	4.57
315	315	355 L	1492	2000	96	96	95.5	0.86	550	2.3	7.9	3.4	75	91	1MB55 ■ 3-3BB2 ■ -■■■■■	2140	5.60
355	355	355 L	1491	2250	96	96.2	95.9	0.85	630	2.2	7.5	2.9	78	94	1MB55 ■ 3-3BB3 ■ -■■■■■	2240	6.3
400	400	355 L	1491	2550	96	96.1	95.8	0.87	690	2.1	7.3	3	79	94	1MB55 ■ 3-3BB4 ■ -■■■■■	2420	7.02
460	460	355 L	1492	2950	96	96.1	95.7	0.83	830	3.4	8	3.1	79	95	1MB55 ■ 3-3BB5 ■ -■■■■■	2720	8.48
Zones																Order code	
Zone 1 (explosive gases occasionally or frequently) Ex db IIC																5	-
Zone 1 (explosive gases occasionally or frequently) Ex db IIB																6	-
Voltages																Order code	
50 Hz 230 VΔ/400 VY 60 Hz 460 VY																2	2
50 Hz 400 VΔ/690 VY 60 Hz 460 VΔ																3	4
50 Hz 500 VY																2	7
50 Hz 500 VΔ																4	0
For other voltages and more information, see from page 6/69																9	0
...																	
Types of construction																Order code	
Without flange IM B3 ²⁾																A	-
With flange IM B5 ²⁾																F	-
With flange IM B14 ²⁾																K	-
For other types of construction and more information, see from page 6/80																	...
Motor protection																Order code	
Without																A	-
PTC thermistor with 3 temperature sensors																B	-
For other motor protection and more information, see from page 6/87																	...
Terminal box position																Order code	
Terminal box at top																4	-
For other terminal box positions and more information, see from page 6/92																	...
Special versions																Order code(s)	
For options, see from page 6/108																1MB.5 ■ 3-... ■ -■■■■■ -Z ...+...+...+...	



SIMOTICS XP 1MB1, 1MB5 explosion-protected motors

Zone 1 with type of protection Ex db, Ex db eb · IE3 Premium Efficiency



Cast-iron series 1MB553/1MB.563 – self-ventilated

Selection and ordering data

Operating values at rated power														Cast-iron series			
P_{rated} 50 Hz	P_{rated} 60 Hz	Frame size	n_{rated} 50 Hz	T_{rated} 50 Hz	η_{rated} 50 Hz, 4/4	η_{rated} 50 Hz, 3/4	η_{rated} 50 Hz, 2/4	$\cos\phi_{rated}$ 50 Hz, 4/4	I_{rated} 50 Hz, 400 V	T_{LR}/T_{rated}	I_{LR}/I_{rated}	T_B/T_{rated}	$L_{pf(A,1)}$ 50 Hz	$L_{WA,1}$ 50 Hz	1MB15 3/1MB55 3	$m_{IM B3}$	J
kW	kW	FS	rpm	Nm	%	%	%		A						Article-No.	kg	kgm ²
<ul style="list-style-type: none"> • Cooling: self-ventilated (IC411) • Efficiency according to IEC 60034-30: IE3 Premium Efficiency • Insulation: Thermal class 155 (temperature class F), IP55 degree of protection, utilization in accordance with thermal class 130 (temperature class B) 																	
6-pole: 1000 rpm at 50 Hz, 1200 rpm at 60 Hz																	
0.18	0.18	71 M	885	1.94	63.9	64.8	60.8	0.69	0.59	2.3	2.8	2.3	39	50	1MB15 3-0CC2	24	0.0010
0.25	0.25	71 M	885	2.7	68.6	69.5	66.2	0.69	0.76	2.6	3.2	2.6	46	57	1MB15 3-0CC3	26	0.0014
0.37	0.37	80 M	940	3.75	73.5	73.1	69.4	0.66	1.1	2.3	4.2	2.7	42	53	1MB15 3-0DC2	31	0.0025
0.55	0.55	80 M	935	5.6	77.2	77	73.9	0.67	1.53	2.5	4.5	2.8	42	53	1MB15 3-0DC3	34	0.0031
0.75	0.75	90 S	945	7.6	78.9	80	78.8	0.7	1.96	2.2	4.6	2.6	43	55	1MB15 3-0EC0	43	0.0041
1.1	1.1	100 L	975	10.8	81	81	79	0.71	2.75	2.2	5.6	2.9	59	71	1MB15 3-1AC3	67	0.0104
1.5	1.5	112 M	975	14.7	82.5	82.8	81.2	0.76	3.45	2	5.7	2.8	62	74	1MB15 3-1BC1	75	0.0199
2.2	2.2	132 S	975	21.5	84.3	84.7	83.7	0.74	5.1	2.1	6.5	3.1	57	65	1MB15 3-1CC1	98	0.0348
3	3	132 S	975	29.5	85.6	86.1	84.9	0.73	6.9	2.3	6.6	3.2	58	66	1MB15 3-1CC0	98	0.0348
4	4	132 M	975	39	86.8	87.1	86.2	0.73	9.1	2.2	6.2	3	67	75	1MB15 3-1CC2	101	0.0400
5.5	5.5	132 M	975	54	88	88.3	87.2	0.72	12.5	2.7	6.8	3.4	64	72	1MB15 3-1CC3	115	0.0519
7.5	7.5	160 M	985	73	89.1	89.5	88.6	0.81	15	2.3	7.9	3.2	71	79	1MB15 3-1DC2	184	0.136
11	11	160 M	980	107	90.3	90.8	90.2	0.8	22	2.9	6.8	2.8	66	74	1MB15 3-1DC4	200	0.168
15	15	180 L	975	147	91.2	91.9	91.9	0.8	29.5	2.3	5.9	2.8	61	68	1MB15 3-1EC4	236	0.210
18.5	18.5	200 L	978	181	91.7	92.5	92.5	0.79	37	2.5	5.6	2.6	64	71	1MB15 3-2AC4	325	0.315
22	22	200 L	978	215	92.2	93.1	93.2	0.79	43.5	2.5	5.6	2.6	61	68	1MB15 3-2AC5	339	0.352
30	30	225 M	980	290	92.9	93.4	93.2	0.83	56	2.7	6.6	2.9	62	76	1MB15 3-2BC2	458	0.671
37	37	250 M	984	360	93.3	93.9	93.8	0.84	68	2.8	7.2	2.9	58	72	1MB15 3-2CC2	533	1.00
45	45	280 S	988	435	93.7	94.3	94.4	0.85	82	2.7	7.5	2.8	62	76	1MB15 3-2DC0	689	1.34
55	55	280 M	988	530	94.1	94.6	94.4	0.85	99	3.2	7.2	2.9	61	76	1MB15 3-2DC2	748	1.63
75	75	315 S	992	720	94.6	94.7	94.3	0.8	143	2.4	7	2.8	68	84	1MB55 3-3AC0	1070	2.98
90	90	315 M	992	870	94.9	95	94.6	0.83	165	2.5	7.3	2.8	64	79	1MB55 3-3AC2	1130	3.54
110	110	315 L	992	1060	95.1	95.3	95.1	0.83	200	2.4	7.4	2.8	68	83	1MB55 3-3AC4	1320	4.25
132	132	315 L	992	1270	95.4	95.7	95.5	0.83	240	2.5	7.8	2.9	68	83	1MB55 3-3AC5	1380	4.89
160	160	315 L	992	1540	95.6	95.8	95.6	0.82	295	2.6	7.3	2.9	72	87	1MB55 3-3AC6	1520	5.74
200	200	315 L	991	1930	95.8	96	95.8	0.81	370	2.7	7	3	67	82	1MB55 3-3AC7	1670	6.41
250	250	355 L	993	2400	95.8	96	95.7	0.87	435	2.4	7.3	2.8	75	91	1MB55 3-3BC1	2360	11.3
315	315	355 L	992	3050	95.8	96.2	96.2	0.87	550	2.4	6.8	2.7	71	86	1MB55 3-3BC2	2630	13.8
355	355	355 L	994	3400	95.8	95.9	95.4	0.84	640	2.9	7.7	3.2	74	89	1MB55 3-3BC3	2650	13.8
380	380	355 L	993	3650	95.8	95.9	95.6	0.84	680	2.9	7.7	3.2	76	90	1MB55 3-3BC4	2650	13.5

Zones	Order code
Zone 1 (explosive gases occasionally or frequently) Ex db IIC	5
Zone 1 (explosive gases occasionally or frequently) Ex db IIB	6
Voltages	Order code
50 Hz 230 VΔ/400 VY 60 Hz 460 VY	2 2
50 Hz 400 VΔ/690 VY 60 Hz 460 VΔ	3 4
50 Hz 500 VY	2 7
50 Hz 500 VΔ	4 0
For other voltages and more information, see from page 6/69	9 0
...	...
Types of construction	Order code
Without flange IM B3 ²⁾	A
With flange IM B5 ²⁾	F
With flange IM B14 ²⁾	K
...	...
Motor protection	Order code
Without	A
PTC thermistor with 3 temperature sensors	B
For other motor protection and more information, see from page 6/87	4
Terminal box position	Order code
Terminal box at top	4
For other terminal box positions and more information, see from page 6/92	...
Special versions	Order code(s)
For options, see from page 6/108	1MB.5 3-...-Z ...+...+...+...

6



SIMOTICS XP 1MB1, 1MB5 explosion-protected motors

Zone 1 with type of protection Ex db, Ex db eb · IE3 Premium Efficiency

Cast-iron series 1MB553/1MB.563 – self-ventilated

Selection and ordering data

Operating values at rated power													Cast-iron series		$m_{IM\ B3}$	J		
P_{rated} 50 Hz	P_{rated} 60 Hz	Frame size	n_{rated} 50 Hz	T_{rated} 50 Hz	η_{rated} 50 Hz, 4/4	η_{rated} 50 Hz, 3/4	η_{rated} 50 Hz, 2/4	$\cos\phi_{rated}$ 50 Hz, 4/4	I_{rated} 50 Hz, 400 V	T_{LR}/T_{rated}	I_{LR}/I_{rated}	T_B/T_{rated}	$L_{p(A,1)}$ 50 Hz	$L_{WA,1}$ 50 Hz			1MB15 ■ 3/1MB55 ■ 3	Article-No.
kW	kW	FS	rpm	Nm	%	%	%		A				dB(A)	dB(A)				
<ul style="list-style-type: none"> • Cooling: self-ventilated (IC411) • Efficiency according to IEC 60034-30: IE3 Premium Efficiency • Insulation: Thermal class 155 (temperature class F). IP55 degree of protection. utilization in accordance with thermal class 130 (temperature class B) 																		
8-pole: 750 rpm at 50 Hz. 900 rpm at 60 Hz																		
0.09	0.09	71 M	650	1.32	44.1	42.8	37.3	0.64	0.46	1.9	2.2	1.9	46	53	1MB15 ■ 3-0CD2 ■■■■■■	25	0.0010	
0.12	0.12	71 M	660	1.74	50.7	49.9	44.8	0.63	0.54	2.1	2.5	2.1	46	53	1MB15 ■ 3-0CD3 ■■■■■■	27	0.0014	
0.18	0.18	80 M	705	2.45	58.7	55.7	49	0.49	0.9	2.3	3	2.8	53	61	1MB15 ■ 3-0DD2 ■■■■■■	30	0.0022	
0.25	0.25	80 M	695	3.45	64.1	62.7	57.8	0.57	0.93	1.8	2.9	2.1	52	59	1MB15 ■ 3-0DD3 ■■■■■■	33	0.0031	
0.37	0.37	90 S	685	5.2	69.3	68.3	63.7	0.68	1.13	1.7	2.9	1.8	56	53	1MB15 ■ 3-0ED0 ■■■■■■	42	0.0041	
0.55	0.55	90 L	695	7.6	73	71.2	66.5	0.67	1.62	2	3.5	2.3	61	68	1MB15 ■ 3-0ED4 ■■■■■■	42	0.0049	
0.75	0.75	100 L	700	10.2	75	76.2	74.5	0.71	2.05	1.5	3.7	2.1	54	62	1MB15 ■ 3-1AD4 ■■■■■■	59	0.0090	
1.1	1.1	100 L	705	14.9	77.7	80.1	79.7	0.7	2.9	1.9	3.7	2.1	59	67	1MB15 ■ 3-1AD5 ■■■■■■	64	0.0124	
1.5	1.5	112 M	720	19.9	79.7	80.1	78.6	0.68	4	2.4	4.9	2.7	57	65	1MB15 ■ 3-1BD2 ■■■■■■	74	0.0267	
2.2	2.2	132 S	725	29	81.9	82.5	80.9	0.71	5.5	1.9	5	2.5	62	70	1MB15 ■ 3-1CD0 ■■■■■■	96	0.0480	
3	3	132 M	725	39.5	83.5	83.8	82.2	0.72	7.2	2.2	5.6	2.7	68	76	1MB15 ■ 3-1CD2 ■■■■■■	104	0.0686	
4	4	160 M	730	52	84.5	85.5	84.7	0.73	9.4	1.6	4.7	2.1	65	73	1MB15 ■ 3-1DD2 ■■■■■■	157	0.0782	
5.5	5.5	160 M	730	72	86.2	87	86.3	0.73	12.6	2	5.5	2.4	63	71	1MB15 ■ 3-1DD3 ■■■■■■	169	0.103	
7.5	7.5	160 M	730	98	87.3	87.9	86.9	0.71	17.5	2.3	5.8	2.7	61	69	1MB15 ■ 3-1DD4 ■■■■■■	183	0.132	
11	11	180 L	725	145	88.6	89.7	89.6	0.74	24	2.1	5.1	2.4	61	74	1MB15 ■ 3-1ED4 ■■■■■■	259	0.264	
15	15	200 L	730	196	89.6	90.1	89.4	0.73	33.5	3	6.8	3.7	57	70	1MB15 ■ 3-2AD5 ■■■■■■	357	0.417	
18.5	18.5	225 S	734	240	90.1	90.7	90.2	0.76	39	2.5	5.9	3	56	70	1MB15 ■ 3-2BD0 ■■■■■■	417	0.499	
22	22	225 M	732	285	90.6	91.3	90.9	0.77	45.5	2.6	5.9	2.9	56	70	1MB15 ■ 3-2BD2 ■■■■■■	425	0.547	
30	30	250 M	734	390	91.3	91.9	91.6	0.79	60	2.6	6.1	3	60	74	1MB15 ■ 3-2CD2 ■■■■■■	512	0.842	
37	37	280 S	736	480	91.8	92.5	92.4	0.8	73	2.3	5.4	2.3	60	74	1MB15 ■ 3-2DD0 ■■■■■■	680	1.08	
45	45	280 M	738	580	92.2	92.8	92.5	0.81	87	2.5	5.9	2.5	60	74	1MB15 ■ 3-2DD2 ■■■■■■	743	1.62	
55	55	315 S	744	710	92.5	92.8	92.4	0.81	106	2.4	6.4	2.6	67	82	1MB55 ■ 3-3AD0 ■■■■■■	1020	3.15	
75	75	315 M	742	970	93.1	93.3	92.8	0.8	145	2.5	6.3	2.6	69	84	1MB55 ■ 3-3AD2 ■■■■■■	1090	3.15	
90	90	315 L	742	1160	93.4	93.9	93.7	0.82	170	2.6	6.6	2.7	67	82	1MB55 ■ 3-3AD4 ■■■■■■	1290	4.49	
110	110	315 L	742	1420	93.7	94	93.6	0.82	205	2.6	6.6	2.6	68	83	1MB55 ■ 3-3AD5 ■■■■■■	1290	4.49	
132	132	315 L	741	1700	94	94.4	94.2	0.82	245	2.4	6.4	2.5	65	80	1MB55 ■ 3-3AD6 ■■■■■■	1370	5.15	
160	160	315 L	741	2050	94.3	94.7	94.7	0.79	310	2.6	6.2	2.5	72	87	1MB55 ■ 3-3AD7 ■■■■■■	1650	6.77	
200	200	355 L	744	2550	94.6	95	95	0.8	380	2.3	7.1	2.7	73	88	1MB55 ■ 3-3BD0 ■■■■■■	2340	11.3	
250	250	355 L	744	3200	94.6	94.9	94.8	0.82	465	2.4	7.2	2.7	72	88	1MB55 ■ 3-3BD1 ■■■■■■	2650	13.8	
300	300	355 L	744	3850	94.6	94.8	94.4	0.78	590	3.2	7.4	3	73	88	1MB55 ■ 3-3BD2 ■■■■■■	2630	13.8	

Zones	Order code
Zone 1 (explosive gases occasionally or frequently) Ex db IIC	5
Zone 1 (explosive gases occasionally or frequently) Ex db IIB	6
Voltages	Order code
50 Hz 230 VΔ/400 VY 60 Hz 460 VY	2 2
50 Hz 400 VΔ/690 VY 60 Hz 460 VΔ	3 4
50 Hz 500 VY	2 7
50 Hz 500 VΔ	4 0
For other voltages and more information, see from page 6/69	9 0
...	...
Types of construction	Order code
Without flange IM B3 ²⁾	A
With flange IM B5 ²⁾	F
With flange IM B14 ²⁾	K
For other types of construction and more information, see from page 6/80	...
Motor protection	Order code
Without	A
PTC thermistor with 3 temperature sensors	B
For other motor protection and more information, see from page 6/87	...
Terminal box position	Order code
Terminal box at top	4
For other terminal box positions and more information, see from page 6/92	...
Special versions	Order code(s)
For options, see from page 6/108	1MB.5 ■ 3-... ■■■■■■ -Z ...+...+...+...

¹⁾ Noise values for line operation under load, tolerance +3dB(A).

²⁾ Types derived from IM B3 (IM B6/7/8, IM V6 and IM V5), from IM B5 (IM V3 and IM V1) and from IM B14 (IM V19 and IM V18) are possible. The basic type IM B3, IM B5 or IM B14 is stamped as standard on the rating plate.



SIMOTICS XP 1MB1, 1MB5 explosion-protected motors

Zone 1 with types of protection Ex db, Ex db eb · IE2 High Efficiency

IE2



Cast-iron series 1MB.556/1MB.566 - self-ventilated

Selection and ordering data

P _{rated} 50 Hz	P _{rated} 60 Hz	Frame size	Operating values at rated power											Cast-iron series		m _{IM B3}	J
			n _{rated} 50 Hz	T _{rated} 50 Hz	η _{rated} 50 Hz, 4/4	η _{rated} 50 Hz, 3/4	η _{rated} 50 Hz, 2/4	cos-φ _{rated} 50 Hz, 4/4	I _{rated} 50 Hz, 400 V	T _{L/R} T _{rated}	I _{L/R} I _{rated}	T _B T _{rated}	L _{p(A,1)} 50 Hz	L _{WA,1)} 50 Hz	1MB15 6/1MB55 6		
kW	BG	min ⁻¹	Nm	%	%	%		A							▲ News	kg	kgm ²

• Cooling: self-ventilated (IC411)
 • Efficiency according to IEC 60034-30-1: IE2 High Efficiency
 • Line operation (DOL) 2)
 • Starting current maximal 600% without plus tolerance
 • Insulation: Thermal class 155 (temperature class F), utilization in accordance with thermal class 130 (temperature class B), IVIC C
 • Standard version and stamping -20 to +40°C; increased ambient temperature can be ordered with Y50, to max. +55°C without derating.

2-pole: 3000 rpm at 50 Hz

0.25	71 M	2852	0.84	64.8	75.7	72.9	0.8	0.7	2.3	6	3.3	59	67	▲ 1MB15 6-0CA2	24	0.0004
0.37	71 M	2828	1.25	69.5	78.3	76.5	0.81	0.95	2.4	6	3.3	60	68	▲ 1MB15 6-0CA3	25	0.0005
0.55	80 M	2840	1.85	74.1	82.6	82.3	0.87	1.23	2	6	2.8	64	72	▲ 1MB15 6-0DA2	30	0.0011
0.75	80 M	2848	2.5	80.7	83.3	83.3	0.87	1.54	2.3	6	3.2	70	78	▲ 1MB15 6-0DA3	32	0.0014
1.1	90 S	2865	3.65	79.6	84.1	84.3	0.9	2.2	1.6	6	2.7	66	74	▲ 1MB15 6-0EA0	41	0.0024
1.5	90 L	2845	5	81.3	85.2	86.4	0.93	2.86	2	6	2.3	65	73	▲ 1MB15 6-0EA4	45	0.0032
2.2	100 L	2865	7.3	83.2	86	87.4	0.92	4.05	1.9	6	2.5	70	78	▲ 1MB15 6-1AA4	64	0.0048
3	112 M	2920	10.1	84.6	86.9	87.5	0.92	5.6	1.7	6	2.1	71	79	▲ 1MB15 6-1BA2	74	0.0099
4	132 S	2925	13.1	85.8	87.4	88.5	0.94	7.2	1.3	6	2.4	72	80	▲ 1MB15 6-1CA0	106	0.0272
5.5	132 S	2930	17.9	87	89	90.1	0.93	9.8	1.5	6	2.3	70	78	▲ 1MB15 6-1CA1	120	0.0278
7.5	160 M	2933	24.5	88.1	89.2	88.9	0.91	13.5	1.3	6	2.5	77	85	▲ 1MB15 6-1DA2	169	0.0457
11	160 M	2932	36	89.4	91	91.3	0.92	19.3	1.4	6	2.5	77	85	▲ 1MB15 6-1DA3	190	0.0637
15	160 L	2925	49	90.3	92	92.8	0.93	26	1.7	6	2.2	77	85	▲ 1MB15 6-1DA4	206	0.0772
18.5	180 M	2920	61	90.9	93.7	94.4	0.91	32.5	1.5	6	2.4	72	80	▲ 1MB15 6-1EA2	247	0.0953
22	200 L	2940	71	91.3	91.6	91	0.89	39	2	6	2.6	74	82	▲ 1MB15 6-2AA4	315	0.150
30	200 L	2940	97	92	92.4	92	0.89	53	2.2	6	2.5	74	82	▲ 1MB15 6-2AA5	378	0.178
37	225 M	2947	120	92.5	93.4	94	0.87	66	1.7	6	2	73	87	▲ 1MB15 6-2BA2	447	0.263
45	250 M	2965	145	92.9	93.8	94	0.88	79	1.5	6	1.9	73	87	▲ 1MB15 6-2CA2	532	0.454
55	280 M	2965	177	93.2	93.8	93.5	0.88	97	1.6	6	1.8	79	93	▲ 1MB15 6-2DA2	763	0.924
75	315 S	2982	240	93.8	94.1	93.7	0.9	128		6	2.2			▲ 1MB55 6-3AA0	1130	1.76
90	315 M	2982	288	94.1	94.2	93.5	0.9	154		6	2.3			▲ 1MB55 6-3AA2	1290	1.99
110	315 L	2975	353	94.3	94.6	94.3	0.9	188		6	2			▲ 1MB55 6-3AA4	1360	2.29
132	315 L	2980	423	94.6	94.8	94.3	0.92	219		6	2.3			▲ 1MB55 6-3AA5	1490	2.65
160	315 L	2980	513	94.8	95.2	95.1	0.9	271		6	2			▲ 1MB55 6-3AA6	1590	2.85
200	355 L	2986	640	95	95.2	94.9	0.9	339		6	2.2			▲ 1MB55 6-3BA2	1830	4.31
250	355 L	2982	801	95	95.3	95.1	0.89	427		6	2.1			▲ 1MB55 6-3BA4	2620	5.84
300	355 L	2990	958	95	95.3	95.1	0.88	518		6	2.4			▲ 1MB55 6-3BA5	2620	5.89

Zones																	Order code	
Zone 1 (explosive gases occasionally or frequently) Ex db IIC																		-
Zone 1 (explosive gases occasionally or frequently) Ex db IIB																		-
Voltages																		Order code
50 Hz 230 VΔ/400 VY		60 Hz 460 VY																-
50 Hz 400 VΔ/690 VY		60 Hz 460 VΔ																-
50 Hz 500 VY																		-
50 Hz 500 VΔ																		-
For other voltages and more information, see from page 6/69																		...
Types of construction																		Order code
Without flange IM B3 ³⁾																		-
With flange IM B5 ³⁾																		-
With flange IM B14 ³⁾																		-
For other types of construction and more information, see from page 6/80																		...
Motor protection																		Order code
Without																		-
PTC thermistor with 3 temperature sensors																		-
For other motor protection and more information, see from page 6/87																		...
Terminal box position																		Order code
Terminal box at top																		-
For other terminal box positions and more information, see from page 6/92																		...
Special versions																		Order code(s)
For options, see from page 6/108																		1MB.5 6-...-Z ...+...+...+...

6

For footnotes see page 6/58



IE2

SIMOTICS XP 1MB1, 1MB5 explosion-protected motors
Zone 1 with types of protection Ex db, Ex db eb · IE2 High Efficiency

Cast-iron series 1MB.556/1MB.566 - self-ventilated

Selection and ordering data

P _{rated} 50 Hz	P _{rated} 60 Hz	Frame size	Operating values at rated power													Cast-iron series		m _{IM B3}	J
			n _{rated} 50 Hz	T _{rated} 50 Hz	η _{rated} 50 Hz, 4/4	η _{rated} 50 Hz, 3/4	η _{rated} 50 Hz, 2/4	cos-φ _{rated} 50 Hz, 4/4	I _{rated} 50 Hz, 400 V	T _{L/R} / T _{rated}	I _{L/R} / I _{rated}	T _B / T _{rated}	L _{p(A,1)} 50 Hz	L _{WA,1)} 50 Hz	1MB15 ■ 6/1MB55 ■ 6	Article-No.			
kW	kW	FS	rpm	Nm	%	%	%	A								▲ New	kg	kgm ²	
• Cooling: self-ventilated (IC411) • Efficiency according to IEC 60034-30-1: IE2 High Efficiency • Line operation (DOL) ²⁾ • Starting current maximal 600% without plus tolerance • Insulation: Thermal class 155 (temperature class F), utilization in accordance with thermal class 130 (temperature class B), IVIC C • Standard version and stamping -20 to +40°C; increased ambient temperature can be ordered with Y50, to max. +55°C without derating.																			
4-pole: 1500 rpm at 50 Hz																			
0.18	71 M	1410	1.22	69.9	74.3	71	0.72	0.52	2.3	6	2.6	57	65	▲ 1MB15 ■ 6-0CB2 ■ -■■■■■	25	0.0010			
0.25	71 M	1433	1.67	68.5	72.5	67.3	0.64	0.82	3.6	6	4.5	62	70	▲ 1MB15 ■ 6-0CB3 ■ -■■■■■	27	0.0013			
0.37	80 M	1433	2.45	72.7	78.6	78	0.81	0.91	1.6	6	2.7	62	70	▲ 1MB15 ■ 6-0DB2 ■ -■■■■■	30	0.0022			
0.55	80 M	1440	3.6	77.1	77.5	75.6	0.8	1.29	2.1	6	2.7	54	62	▲ 1MB15 ■ 6-0DB3 ■ -■■■■■	33	0.0030			
0.75	90 S	1418	5.1	79.6	82.9	83.3	0.83	1.64	2	6	2.9	58	66	▲ 1MB15 ■ 6-0EB0 ■ -■■■■■	42	0.0038			
1.1	90 L	1425	7.4	81.4	84.9	85.2	0.84	2.3	2	6	2.6	55	63	▲ 1MB15 ■ 6-0EB4 ■ -■■■■■	45	0.0050			
1.5	100 M	1431	10	82.8	86	87.4	0.88	2.95	1.7	6	2.7	57	65	▲ 1MB15 ■ 6-1AB4 ■ -■■■■■	68	0.0124			
2.2	100 L	1440	14.6	84.3	87	88.6	0.88	4.3	1.7	6	2.6	62	70	▲ 1MB15 ■ 6-1AB5 ■ -■■■■■	68	0.0124			
3	112 M	1445	19.8	85.5	87.4	88	0.87	5.8	1.6	6	2.4	74	82	▲ 1MB15 ■ 6-1BB2 ■ -■■■■■	76	0.0146			
4	132 S	1460	26	86.6	88	88.4	0.87	7.7	1.6	6	2.2	57	65	▲ 1MB15 ■ 6-1CB0 ■ -■■■■■	105	0.0352			
5.5	132 M	1449	36	87.7	90.2	91.5	0.88	10.3	1.7	6	2.7	68	76	▲ 1MB15 ■ 6-1CB2 ■ -■■■■■	120	0.0404			
7.5	160 M	1470	49	88.7	89.5	89.5	0.85	14	1.8	6	2.3	64	72	▲ 1MB15 ■ 6-1DB2 ■ -■■■■■	168	0.0733			
11	160 L	1470	71	89.8	90.7	91.2	0.85	20.5	2.2	6	2.3	60	68	▲ 1MB15 ■ 6-1DB4 ■ -■■■■■	191	0.0877			
15	180 M	1455	98	90.6	91.9	92.5	0.86	28	1.6	6	2.3	66	74	▲ 1MB15 ■ 6-1EB2 ■ -■■■■■	240	0.145			
18.5	180 L	1455	121	91.2	92.5	93.1	0.84	35	1.8	6	2.5	69	77	▲ 1MB15 ■ 6-1EB4 ■ -■■■■■	249	0.158			
22	200 L	1455	144	91.6	92.8	93.6	0.87	40	1.7	6	2.1	67	75	▲ 1MB15 ■ 6-2AB5 ■ -■■■■■	346	0.248			
30	225 S	1472	195	92.3	93	93.2	0.86	54	2	6	2	63	77	▲ 1MB15 ■ 6-2BB0 ■ -■■■■■	449	0.469			
37	225 M	1472	240	92.7	93.4	93.5	0.86	66	2.2	6	2.2	64	78	▲ 1MB15 ■ 6-2BB2 ■ -■■■■■	466	0.521			
45	250 M	1478	290	93.1	93.9	94.1	0.87	79	1.9	6	2.3	66	79	▲ 1MB15 ■ 6-2CB2 ■ -■■■■■	563	0.842			
55	280 S	1480	355	93.5	94	93.9	0.88	95	1.9	6	2.1	72	86	▲ 1MB15 ■ 6-2DB0 ■ -■■■■■	782	1.37			
75	280 M	1480	485	94	94.5	94.5	0.88	129	1.9	6	2.2	70	84	▲ 1MB15 ■ 6-2DB2 ■ -■■■■■	818	1.70			
90	315 S	1480	580	92.3	93.1	93.2	0.87	162	2	6	2			▲ 1MB55 ■ 6-3AB0 ■ -■■■■■	1150	2.48			
110	315 M	1480	240	92.7	93.5	93.7	0.87	195	1.8	6	2.3			▲ 1MB55 ■ 6-3AB2 ■ -■■■■■	1270	2.79			
132	315 L	1480	291	93.1	93.8	93.9	0.88	234	1.4	6	1.9			▲ 1MB55 ■ 6-3AB5 ■ -■■■■■	1480	3.79			
160	315 L	1480	355	93.5	94.2	94.3	0.89	280	1.7	6	2.2			▲ 1MB55 ■ 6-3AB6 ■ -■■■■■	1660	4.57			
200	355 L	1480	484	94	94.7	91.9	0.89	345	1.6	6	2.3			▲ 1MB55 ■ 6-3BB2 ■ -■■■■■	2140	5.60			
250	355 L	1480	573	94.2	94.7	94.6	0.85	436	1.4	6	2.1			▲ 1MB55 ■ 6-3BB4 ■ -■■■■■	2420	7.02			
315	355 L	1480	700	94.5	95	95	0.86	556	2.1	6	2.3			▲ 1MB55 ■ 6-3BB5 ■ -■■■■■	2720	8.48			
Zones																			
Zone 1 (explosive gases occasionally or frequently) Ex db IIC																			
Zone 1 (explosive gases occasionally or frequently) Ex db IIB																			
Voltages																			
Version																			
50 Hz 230 VΔ/400 VY 60 Hz 460 VY																			
Standard																			
50 Hz 400 VΔ/690 VY 60 Hz 460 VΔ																			
Standard																			
50 Hz 500 VY																			
Without additional charge																			
50 Hz 500 VΔ																			
Without additional charge																			
For other voltages and more information, see from page 6/69																			
Types of construction																			
Version																			
Without flange IM B3 ²³																			
Standard																			
With flange IM B5 ³⁾																			
With additional charge																			
With flange IM B14 ³⁾																			
With additional charge																			
For other types of construction and more information, see from page 6/80																			
Motor protection																			
Version																			
Without																			
Standard																			
PTC thermistor with 3 temperature sensors																			
With additional charge																			
For other motor protection and more information, see from page 6/87																			
Terminal box position																			
Version																			
Terminal box at top																			
Standard																			
For other terminal box positions and more information, see from page 6/92																			
Special versions																			
Order code(s)																			
For options, see from page 6/108																			
1MB.5 ■ 6-... ■ -■■■■■ -Z ...+...+...+...																			



SIMOTICS XP 1MB1, 1MB5 explosion-protected motors

Zone 1 with types of protection Ex db, Ex db eb · IE2 High Efficiency

IE2



Cast-iron series 1MB.556/1MB.566 - self-ventilated

Selection and ordering data

Operating values at rated power														Cast-iron series				
P_{rated} 50 Hz	P_{rated} 60 Hz	Frame size	n_{rated} 50 Hz	T_{rated} 50 Hz	η_{rated} 50 Hz, 4/4	η_{rated} 50 Hz, 3/4	η_{rated} 50 Hz, 2/4	$\cos\phi_{rated}$ 50 Hz, 4/4	I_{rated} 50 Hz, 400 V	T_{LR}/T_{rated}	I_{LR}/I_{rated}	T_{β}/T_{rated}	$L_{p(A,1)}$ 50 Hz	$L_{WA,1}$ 50 Hz	1MB15 ■ 6/1MB55 ■ 6	$m_{IM B3}$	J	
kW	kW	FS	rpm	Nm	%	%	%		A				dB(A)	dB(A)	▲ New	kg	kgm ²	
<ul style="list-style-type: none"> Cooling: self-ventilated (IC411) Efficiency according to IEC 60034-30-1: IE2 High Efficiency Line operation (DOL) ²⁾ Starting current maximal 600% without plus tolerance Insulation: Thermal class 155 (temperature class F), utilization in accordance with thermal class 130 (temperature class B), IVIC C Standard version and stamping -20 to +40°C; increased ambient temperature can be ordered with Y50, to max. +55°C without derating. 																		
6-pole: 1000 rpm at 50 Hz																		
0.12	71 M	936	1.22	50.6	58.9	51.6	0.57	0.6	3	6	3.4	61	69	▲ 1MB15 ■ 6-0CC2 ■ -■■■■■	24	0.0010		
0.18	71 M	925	1.86	56.6	65.7	59.8	0.59	0.78	3.6	6	3.7	53	61	▲ 1MB15 ■ 6-0CC3 ■ -■■■■■	26	0.0014		
0.25	80 M	964	2.5	61.6	68.3	62	0.54	1.08	2.9	6	4.3	59	67	▲ 1MB15 ■ 6-0DC2 ■ -■■■■■	31	0.0025		
0.37	80 M	964	3.65	67.6	72.3	66.6	0.54	1.46	3.5	6	4.9	61	69	▲ 1MB15 ■ 6-0DC3 ■ -■■■■■	34	0.0031		
0.55	90 S	955	5.5	73.1	78.8	76.7	0.7	1.55	2.1	6	2.6	58	66	▲ 1MB15 ■ 6-0EC0 ■ -■■■■■	43	0.0041		
0.75	100 L	960	7.5	75.9	82.8	82.1	0.72	1.98	2.1	6	2.8	61	69	▲ 1MB15 ■ 6-1AC3 ■ -■■■■■	67	0.0104		
1.1	112 L	955	11	78.1	86.2	86.4	0.78	2.6	1.8	6	2.3	57	65	▲ 1MB15 ■ 6-1BC1 ■ -■■■■■	75	0.0199		
1.5	132 S	975	14.7	79.8	87.9	87.4	0.75	3.6	1.8	6	2.7	54	62	▲ 1MB15 ■ 6-1CC1 ■ -■■■■■	98	0.0348		
2.2	132 S	970	21.5	81.8	87.4	87.2	0.76	5.1	1.8	6	2.6	60	68	▲ 1MB15 ■ 6-1CC0 ■ -■■■■■	98	0.0348		
3	132 M	970	29.5	83.3	87.4	87.3	0.75	6.9	1.8	6	2.6	65	73	▲ 1MB15 ■ 6-1CC2 ■ -■■■■■	101	0.0400		
4	132 M	970	39.5	84.6	85	83.4	0.73	9.3	2	6	2.9	57	65	▲ 1MB15 ■ 6-1CC3 ■ -■■■■■	115	0.0519		
5.5	160 M	980	54	86	89.6	90.4	0.85	10.9	1.6	6	2.2	59	67	▲ 1MB15 ■ 6-1DC2 ■ -■■■■■	184	0.136		
7.5	160 L	975	73	87.2	90.3	91.2	0.85	14.6	1.5	6	2.2	62	70	▲ 1MB15 ■ 6-1DC4 ■ -■■■■■	200	0.168		
11	180 L	969	108	88.7	91.4	92.2	0.8	22.5	1.6	6	2.8	60	68	▲ 1MB15 ■ 6-1EC4 ■ -■■■■■	236	0.210		
15	200 L	975	147	89.7	92.3	92.8	0.8	30	1.8	6	2.5	60	68	▲ 1MB15 ■ 6-2AC4 ■ -■■■■■	325	0.315		
18.5	200 L	975	181	90.4	92.5	93.1	0.79	37.5	1.9	6	2.5	65	73	▲ 1MB15 ■ 6-2AC5 ■ -■■■■■	339	0.352		
22	225 M	980	215	90.9	91.8	92	0.83	42	1.8	6	2.3	64	77	▲ 1MB15 ■ 6-2BC2 ■ -■■■■■	458	0.671		
30	250 M	980	290	91.7	92.6	92.8	0.85	56	1.7	6	2.1	58	72	▲ 1MB15 ■ 6-2CC2 ■ -■■■■■	533	1.00		
37	280 S	985	360	92.2	93	93	0.85	68	1.8	6	2.1	60	75	▲ 1MB15 ■ 6-2DC0 ■ -■■■■■	689	1.34		
45	280 M	985	430	92.7	93.7	94.1	0.86	81	2.4	6	2.2			▲ 1MB15 ■ 6-2DC2 ■ -■■■■■	748	1.63		
55	315 S	985	525	93.1	93.7	93.8	0.8	107	1.8	6	2.1			▲ 1MB55 ■ 6-3AC0 ■ -■■■■■	1070	2.98		
75	315 M	985	716	93.7	94.3	94.3	0.82	141	1.8	6	2.2			▲ 1MB55 ■ 6-3AC2 ■ -■■■■■	1130	3.54		
132	315 L	985	1261	94.6	95.4	95.8	0.83	243	1.8	6	2.1			▲ 1MB55 ■ 6-3AC7 ■ -■■■■■	1670	6.41		
200	355 L	985	1910	95	95.7	96	0.86	353	1.7	6	2			▲ 1MB55 ■ 6-3BC2 ■ -■■■■■	2630	13.8		
280	355 L	985	2674	95	95.6	95.9	0.86	495	1.9	6	2.2			▲ 1MB55 ■ 6-3BC4 ■ -■■■■■	2650	13.5		
Zones															Order code			
Zone 1 (explosive gases occasionally or frequently) Ex db IIC															5	-		
Zone 1 (explosive gases occasionally or frequently) Ex db IIB															6	-		
Voltages															Order code			
50 Hz 230 VΔ/400 VY 60 Hz 460 VY															Standard		2 2	-
50 Hz 400 VΔ/690 VY 60 Hz 460 VΔ															Standard		3 4	-
50 Hz 500 VY															Without additional charge		2 7	-
50 Hz 500 VΔ															Without additional charge		4 0	-
For other voltages and more information, see from page 6/69																	9 0	...
Types of construction															Order code			
Without flange IM B3 ³⁾															Standard		A	-
With flange IM B5 ³⁾															With additional charge		F	-
With flange IM B14 ³⁾															With additional charge		K	-
For other types of construction and more information, see from page 6/80																		...
Motor protection															Order code			
Without															Standard		A	-
PTC thermistor with 3 temperature sensors															With additional charge		B	-
For other motor protection and more information, see from page 6/87																		-
Terminal box position															Order code			
Terminal box at top															Standard		4	-
For other terminal box positions and more information, see from page 6/92																		-
Special versions															Order code(s)			
For options, see from page 6/108															1MB.5 ■ 6-... ■ -■■■■■ -Z ...+...+...+...			

6

1) Noise values for line operation under load, tolerance + 3dB(A).
 2) In combination with B43 / B44 on request.

3) Types derived from IM B3 (IM B6/7/8, IM V6 and IM V5), from IM B5 (IM V3 and IM V1) and from IM B14 (IM V19 and IM V18) are possible. The basic type IM B3, IM B5 or IM B14 is stamped as standard on the rating plate.



SIMOTICS XP 1MB1, 1MB5 explosion-protected motors

Zone 1 with types of protection Ex db, Ex db eb · IE3 Premium Efficiency

Cast-iron series 1MB.557/1MB.567 - self-ventilated

Selection and ordering data

Operating values at rated power														Cast-iron series			
P_{rated} 50 Hz	P_{rated} 60 Hz	Frame size	n_{rated} 50 Hz	T_{rated} 50 Hz	η_{rated} 50 Hz, 4/4	η_{rated} 50 Hz, 3/4	η_{rated} 50 Hz, 2/4	$\cos\phi_{rated}$ 50 Hz, 4/4	I_{rated} 50 Hz, 400 V	T_{LR}/T_{rated}	I_{LR}/I_{rated}	T_{β}/T_{rated}	$L_{p(A,1)}$ 50 Hz	$L_{WA,1}$ 50 Hz	1MB15 7/1MB55X6	$m_{IM B3}$	J
kW	kW	FS	rpm	Nm	%	%	%		A				dB(A)	dB(A)	Article-No.	kg	kgm ²
<ul style="list-style-type: none"> Cooling: self-ventilated (IC411) Efficiency according to IEC 60034-30-1: IE3 PremiumEfficiency Line operation (DOL) ²⁾ Starting current maximal 700% without plus tolerance Insulation: Thermal class 155 (temperature class F), utilization in accordance with thermal class 130 (temperature class B), IVIC C Standard version and stamping -20 to +40°C; increased ambient temperature can be ordered with Y50, to max. +55°C without derating. 																	
2-pole: 3000 rpm at 50 Hz																	
0.25	71 M	2917	0.82	69.7	74.5	70.3	0.76	0.68	2.8	7	4.1	59	67	▲ 1MB15 7-7-0CA2	24	0.0004	
0.37	71 M	2871	1.23	73.8	77.3	74	0.77	0.94	2.9	7	4	60	68	▲ 1MB15 7-7-0CA3	25	0.0005	
0.55	80 M	2864	1.83	77.8	82.5	81.7	0.86	1.19	2.3	7	3.3	64	72	▲ 1MB15 7-7-0DA2	30	0.0011	
0.75	80 M	2855	2.5	80.7	84.7	84	0.86	1.56	2.3	7	3.3	70	78	▲ 1MB15 7-7-0DA3	32	0.0014	
1.1	90 S	2877	3.65	82.7	85.1	85.2	0.9	2.15	1.9	7	3	66	74	▲ 1MB15 7-7-0EA0	41	0.0024	
1.5	90 L	2870	5	84.2	86.9	87.3	0.91	2.85	2.4	7	2.8	65	73	▲ 1MB15 7-7-0EA4	45	0.0032	
2.2	100 L	2883	7.3	85.9	88	88.7	0.93	3.95	1.9	7	3.1	75	83	▲ 1MB15 7-7-1AA4	64	0.0048	
3	112 M	2930	9.8	87.1	88.4	89	0.92	5.4	1.7	7	2.7	70	78	▲ 1MB15 7-7-1BA2	74	0.0099	
4	132 S	2945	13	88.1	89.2	89.4	0.93	7	1.7	7	2.5	69	77	▲ 1MB15 7-7-1CA0	120	0.0278	
5.5	132 S	2945	17.8	89.2	90.5	90.8	0.93	9.6	1.8	7	2.6	75	83	▲ 1MB15 7-7-1CA1	120	0.0278	
7.5	160 M	2950	24.5	90.1	90	89.5	0.9	13.3	1.8	7	2.9	77	85	▲ 1MB15 7-7-1DA2	179	0.0532	
11	160 M	2940	35.5	91.2	91.4	90.9	0.91	19.1	2	7	2.8	77	85	▲ 1MB15 7-7-1DA3	179	0.0532	
15	160 L	2940	48.5	91.9	92.2	92.1	0.92	25.5	2.2	7	2.8	79	87	▲ 1MB15 7-7-1DA4	206	0.0772	
18.5	180 M	2943	60	92.4	93	92.7	0.9	32	1.7	7	3	72	80	▲ 1MB15 7-7-1EA2	238	0.0889	
22	200 L	2952	71	92.7	93.8	93.4	0.88	39	1.7	7	2.8	76	84	▲ 1MB15 7-7-2AA4	315	0.150	
30	200 L	2950	97	93.3	93.6	93	0.9	52	2.4	7	3	79	87	▲ 1MB15 7-7-2AA5	370	0.198	
37	225 M	2960	119	93.7	93.9	93.3	0.89	64	2.3	7	2.7	73	87	▲ 1MB15 7-7-2BA2	447	0.263	
45	250 M	2975	144	94	94.4	94.1	0.89	78	2.1	7	2.6	73	87	▲ 1MB15 7-7-2CA2	532	0.454	
55	280 S	2975	177	94.3	94.5	94	0.9	94	2.1	7	2.6	78	92	▲ 1MB15 7-7-2DA0	729	0.816	
75	280 M	2975	240	94.7	95.1	95	0.9	127	2.1	7	2.6	79	93	▲ 1MB15 7-7-2DA0	763	0.924	
90	315 S	2982	290	95	95.3	94.8	0.91	151	2	7	2.6	80	94	▲ 1MB55 7-3-AA0	1130	1.76	
110	315 M	2980	350	95.2	95.4	94.8	0.9	185	1.8	7	2.4	80	94	▲ 1MB55 7-3-AA2	1290	1.99	
132	315 L	2982	425	95.4	95.6	95.2	0.91	220	2.1	7	2.5	80	94	▲ 1MB55 7-3-AA4	1360	2.29	
160	315 L	2980	510	95.6	95.8	95.3	0.92	260	2.2	7	2.5	80	94	▲ 1MB55 7-3-AA5	1490	2.65	
200	315 L	2980	640	95.8	96.1	95.9	0.91	330	2.3	7	2.6	80	94	▲ 1MB55 7-3-AA6	1590	2.85	
Zones															Order code		
Zone 1 (explosive gases occasionally or frequently) Ex db IIC															5	-	
Zone 1 (explosive gases occasionally or frequently) Ex db IIB															6	-	
Voltages															Order code		
50 Hz 230 VΔ/400 VY															2	2	
50 Hz 400 VΔ/690 VY															3	4	
50 Hz 500 VY															2	7	
50 Hz 500 VΔ															4	0	
For other voltages and more information, see from page 6/69															9	0	
Types of construction															Order code		
Without flange IM B3 ³⁾															A	-	
With flange IM B5 ³⁾															F	-	
With flange IM B14 ³⁾															K	-	
For other types of construction and more information, see from page 6/80																...	
Motor protection															Order code		
Without															A	-	
PTC thermistor with 3 temperature sensors															B	-	
For other motor protection and more information, see from page 6/87																...	
Terminal box position															Order code		
Terminal box at top															4	-	
For other terminal box positions and more information, see from page 6/92																...	
Special versions															Order code(s)		
For options, see from page 6/108															1MB.5	7-...-Z ...+...+...+...	



SIMOTICS XP 1MB1, 1MB5 explosion-protected motors

Zone 1 with types of protection Ex db, Ex db eb · IE3 Premium Efficiency



Cast-iron series 1MB.557/1MB.567 - self-ventilated

Selection and ordering data

Operating values at rated power														Cast-iron series			
$P_{rated, 50 Hz}$	$P_{rated, 60 Hz}$	Frame size	$n_{rated, 50 Hz}$	$T_{rated, 50 Hz}$	$\eta_{rated, 50 Hz, 4/4}$	$\eta_{rated, 50 Hz, 3/4}$	$\eta_{rated, 50 Hz, 2/4}$	$\cos\phi_{rated, 50 Hz, 4/4}$	$I_{rated, 50 Hz, 400 V}$	T_{LR}/T_{rated}	I_{LR}/I_{rated}	T_B/T_{rated}	$L_{p(A,1)} 50 Hz$	$L_{WA,1)} 50 Hz$	1MB15 7/1MB55 7	$m_{IM B3}$	J
kW	kW	FS	rpm	Nm	%	%	%		A				dB(A)	dB(A)	Article-No.	kg	kgm ²
<ul style="list-style-type: none"> Cooling: self-ventilated (IC411) Efficiency according to IEC 60034-30-1: IE3 PremiumEfficiency Line operation (DOL) ²⁾ Starting current maximal 700% without plus tolerance Insulation: Thermal class 155 (temperature class F), utilization in accordance with thermal class 130 (temperature class B), IVIC C Standard version and stamping -20 to +40°C; increased ambient temperature can be ordered with Y50, to max. +55°C without derating. 																	
4-pole: 1500 rpm at 50 Hz																	
0.18	71 M	1410	1.22	69.9	74.3	71	0.72	0.52	2.2	7	3.6	57	65	▲ 1MB15 7-0CB2	25	0.0010	
0.25	71 M	1442	1.66	73.5	71.5	65.6	0.59	0.83	2.5	7	3.6	62	70	▲ 1MB15 7-0CB3	27	0.0013	
0.37	80 M	1455	2.2	77.3	77.8	74.8	0.74	0.93	2.4	7	3.1	62	70	▲ 1MB15 7-0DB2	30	0.0022	
0.55	80 M	1450	3.6	80.8	80.6	78.1	0.77	1.28	2.4	7	3.1	55	63	▲ 1MB15 7-0DB3	33	0.0030	
0.75	90 S	1438	5	82.5	84	83.2	0.8	1.64	1.7	7	2.9	58	66	▲ 1MB15 7-0EB0	42	0.0038	
1.1	90 L	1440	7.3	84.1	86.1	85.5	0.83	2.25	1.9	7	3	55	63	▲ 1MB15 7-0EB4	45	0.0050	
1.5	100 M	1445	9.9	85.3	87.5	87.9	0.86	2.95	1.8	7	3	57	65	▲ 1MB15 7-1AB4	68	0.0124	
2.2	100 L	1450	14.5	86.7	88	89	0.86	4.25	2	7	3.2	62	70	▲ 1MB15 7-1AB5	68	0.0124	
3	112 M	1455	19.7	87.7	89	89.2	0.85	5.8	2	7	2.8	57	65	▲ 1MB15 7-1BB2	76	0.0146	
4	132 S	1465	26	88.6	89.8	89.9	0.86	7.6	1.9	7	2.5	66	74	▲ 1MB15 7-1CB0	105	0.0352	
5.5	132 M	1465	36	89.6	90.7	90.8	0.86	10.3	2	7	2.7	67	75	▲ 1MB15 7-1CB2	120	0.0404	
7.5	160 M	1475	48.5	90.4	90.3	89.4	0.86	13.8	2.4	7	2.6	65	73	▲ 1MB15 7-1DB2	168	0.0733	
11	160 L	1470	71	91.4	92.1	91.7	0.86	20	2.4	7	2.6	60	68	▲ 1MB15 7-1DB4	191	0.0877	
15	180 M	1470	97	92.1	92.9	93	0.84	28	2.2	7	3	64	72	▲ 1MB15 7-1EB2	240	0.145	
18.5	180 L	1465	121	92.6	93.6	93.8	0.84	34.5	2.5	7	2.5	69	77	▲ 1MB15 7-1EB4	249	0.158	
22	200 L	1470	143	93	93.6	94.1	0.86	39.5	2.1	7	2.5	60	68	▲ 1MB15 7-2AB5	346	0.248	
30	225 S	1480	194	93.6	94.2	94	0.87	54	2.1	7	2.4	63	77	▲ 1MB15 7-2BB0	449	0.469	
37	225 M	1480	240	93.9	94.5	94.5	0.86	66	2.1	7	2.4	64	78	▲ 1MB15 7-2BB2	466	0.521	
45	250 M	1482	290	94.2	94.8	94.9	0.87	79	2.2	7	2.3	66	79	▲ 1MB15 7-2CB2	563	0.842	
55	280 S	1486	355	94.6	95.1	95.1	0.88	94	1.8	7	2.3	72	86	▲ 1MB15 7-2DB0	782	1.37	
75	280 M	1486	480	95	95.6	95.7	0.89	128	2.0	7	2.5	70	84	▲ 1MB15 7-2DB2	818	1.70	
90	315 S	1490	580	95.2	95.5	95.2	0.87	157	1.8	7	2.4	75	91	▲ 1MB55 7-3AB0	1150	2.48	
110	315 M	1490	700	95.4	95.8	95.7	0.86	194	1.9	7	2.4	75	91	▲ 1MB55 7-3AB2	1270	2.79	
132	315 L	1490	850	95.6	95.9	95.7	0.85	230	1.8	7	2.6	75	91	▲ 1MB55 7-3AB4	1330	3.17	
160	315 L	1490	1030	95.8	96.3	96.3	0.87	280	1.7	7	2.5	75	91	▲ 1MB55 7-3AB5	1480	3.79	
200	315 L	1488	1280	96	96.4	96.4	0.88	346	2.2	7	2.4	75	91	▲ 1MB55 7-3AB6	1660	4.57	
250	355 L	1492	1600	96	96.3	96	0.88	425	2.2	7	3.6	81	95	▲ 1MB55 7-3BB2	2140	5.60	
315	355 L	1491	2562	96	96.3	96.2	0.89	530	2.4	7	3.1	80	95	▲ 1MB55 7-3BB4	2420	7.02	
355	355 L	1492	2944	96	96.4	96.5	0.86	599		7		80	96	▲ 1MB55 7-3BB5	2720	8.48	

Zones	Order code
Zone 1 (explosive gases occasionally or frequently) Ex db IIC	5
Zone 1 (explosive gases occasionally or frequently) Ex db IIB	6

Voltages	Version	Order code
50 Hz 230 VΔ/400 VY	Standard	2 2
50 Hz 400 VΔ/690 VY	Standard	3 4
50 Hz 500 VY	Without additional charge	2 7
50 Hz 500 VA	Without additional charge	4 0
For other voltages and more information, see from page 6/69		9 0

Types of construction	Version	Order code
Without flange	Standard	A
With flange	With additional charge	F
With flange	With additional charge	K
For other types of construction and more information, see from page 6/80		

Motor protection	Version	Order code
Without	Standard	A
PTC thermistor with 3 temperature sensors	With additional charge	B
For other motor protection and more information, see from page 6/87		

Terminal box position	Version	Order code
Terminal box at top	Standard	4
For other terminal box positions and more information, see from page 6/92		

Special versions	Order code(s)
For options, see from page 6/108	1MB.5 7-... -Z ...+...+...+...

6



SIMOTICS XP 1MB1, 1MB5 explosion-protected motors

Zone 1 with types of protection Ex db, Ex db eb · IE3 Premium Efficiency

Cast-iron series 1MB.557/1MB.567 - self-ventilated

Selection and ordering data

Operating values at rated power														Cast-iron series			
P_{rated} 50 Hz	P_{rated} 60 Hz	Frame size	n_{rated} 50 Hz	T_{rated} 50 Hz	η_{rated} 50 Hz, 4/4	η_{rated} 50 Hz, 3/4	η_{rated} 50 Hz, 2/4	$\cos\phi_{rated}$ 50 Hz, 4/4	I_{rated} 50 Hz, 400 V	T_{LR}/T_{rated}	I_{LR}/I_{rated}	T_B/T_{rated}	$L_{p(A,1)}$ 50 Hz	$L_{WA,1}$ 50 Hz	1MB15 7/1MB55 7	$m_{IM B3}$	J
kW	kW	FS	rpm	Nm	%	%	%		A				dB(A)	dB(A)	Article-No.	kg	kgm ²
<ul style="list-style-type: none"> Cooling: self-ventilated (IC411) Efficiency according to IEC 60034-30-1: IE3 PremiumEfficiency Line operation (DOL) ²⁾ Starting current maximal 700% without plus tolerance Insulation: Thermal class 155 (temperature class F), utilization in accordance with thermal class 130 (temperature class B), IVIC C Standard version and stamping -20 to +40°C; increased ambient temperature can be ordered with Y50, to max. +55°C without derating. 																	
6-pole: 1000 rpm at 50 Hz																	
0.12	71 M	936	1.22	57.7	58.9	51.6	0.57	0.53	3	7	3.4	61	69	▲ 1MB15 7-7-0CC2	24	0.0010	
0.18	71 M	925	1.86	63.9	65.7	59.8	0.59	0.69	3.6	7	3.7	53	61	▲ 1MB15 7-7-0CC3	26	0.0014	
0.25	80 M	964	2.5	68.6	68.3	62	0.54	0.97	2.9	7	4.3	59	67	▲ 1MB15 7-7-0DC2	31	0.0025	
0.37	80 M	964	3.65	73.5	74.5	68.7	0.52	1.4	3.5	7	4.9	61	69	▲ 1MB15 7-7-0DC3	34	0.0031	
0.55	90 S	955	5.5	77.2	78.8	76.7	0.7	1.47	2.1	7	2.6	58	66	▲ 1MB15 7-7-0EC0	43	0.0041	
0.75	100 L	970	7.4	78.9	82.4	79.3	0.66	2.1	2.7	7	3.7	61	69	▲ 1MB15 7-7-1AC3	67	0.0104	
1.1	112 L	965	10.9	81	85.5	84.8	0.76	2.6	2.1	7	2.8	57	65	▲ 1MB15 7-7-1BC1	75	0.0199	
1.5	132 S	975	14.7	82.5	87.9	86.9	0.74	3.55	2.1	7	3	54	62	▲ 1MB15 7-7-1CC1	98	0.0348	
2.2	132 S	975	21.5	84.3	84.7	83	0.75	5	1.8	7	2.8	54	62	▲ 1MB15 7-7-1CC0	98	0.0348	
3	132 M	975	29.5	85.6	88	87.3	0.74	6.8	2.1	7	2.9	65	73	▲ 1MB15 7-7-1CC2	98	0.0348	
4	132 M	975	39	86.8	88.9	88.3	0.73	9.1	2.2	7	3	58	66	▲ 1MB15 7-7-1CC3	98	0.0348	
5.5	160 M	980	54	88	90.6	90.7	0.83	10.9	1.8	7	2.6	59	67	▲ 1MB15 7-7-1DC2	184	0.136	
7.5	160 L	980	73	89.1	91.3	91.2	0.82	14.8	2	7	2.7	62	70	▲ 1MB15 7-7-1DC4	184	0.136	
11	180 L	975	108	90.3	92.4	92.5	0.79	22.5	1.9	7	3.3	60	68	▲ 1MB15 7-7-1EC4	236	0.210	
15	200 L	980	146	91.2	93	92.8	0.78	30.5	2.2	7	3.1	60	68	▲ 1MB15 7-7-2AC4	325	0.315	
18.5	200 L	981	180	91.7	93.3	93	0.77	38	2.6	7	3.2	65	73	▲ 1MB15 7-7-2AC5	339	0.352	
22	225 M	980	214	92.2	93	93	0.83	41	2.3	7	2.6	64	77	▲ 1MB15 7-7-2BC2	458	0.671	
30	250 M	980	292	92.9	93.8	93.8	0.85	55	2.3	7	2.5	58	72	▲ 1MB15 7-7-2CC2	533	1.00	
37	280 S	985	359	93.3	94.4	94.7	0.85	67	2.2	7	2.4	60	75	▲ 1MB15 7-7-2DC0	689	1.34	
45	280 M	985	430	93.7	94.5	94.6	0.86	81	2.7	7	2.5			▲ 1MB15 7-7-2DC2	748	1.63	
55	315 S	985	525	94.1	94.5	94.3	0.8	105	2.1	7	2.5			▲ 1MB55 7-3-AC0	1070	2.98	
75	315 M	985	716	94.6	95.1	95	0.82	140	2.3	7	2.4			▲ 1MB55 7-3-AC2	1130	3.54	
160	315 L	985	1528	95.6	96.2	96.5	0.81	290	2.1	7	2.5			▲ 1MB55 7-3-AC7	1670	6.41	
250	355 L	985	2387	95.8	96.3	96.3	0.86	429	2.2	7	2.6			▲ 1MB55 7-3-BC2	2630	13.8	
315	355 L	985	3008	95.8	96.3	96.5	0.83	552	2.3	7	2.6			▲ 1MB55 7-3-BC4	2650	13.5	
Zones															Order code		
Zone 1 (explosive gases occasionally or frequently) Ex db IIC															5	-	
Zone 1 (explosive gases occasionally or frequently) Ex db IIB															6	-	
Voltages															Order code		
50 Hz 230 VΔ/400 VY 60 Hz 460 VY															Standard	2 2	
50 Hz 400 VΔ/690 VY 60 Hz 460 VΔ															Standard	3 4	
50 Hz 500 VY															Without additional charge	2 7	
50 Hz 500 VΔ															Without additional charge	4 0	
For other voltages and more information, see from page 6/69															9 0	...	
Types of construction															Order code		
Without flange IM B3 ³⁾															Standard	A	
With flange IM B5 ³⁾															With additional charge	F	
With flange IM B14 ³⁾															With additional charge	K	
For other types of construction and more information, see from page 6/80																...	
Motor protection															Order code		
Without															Standard	A	
PTC thermistor with 3 temperature sensors															With additional charge	B	
For other motor protection and more information, see from page 6/87																	
Terminal box position															Order code		
Terminal box at top															Standard	4	
For other terminal box positions and more information, see from page 6/92																	
Special versions															Order code(s)		
For options, see from page 6/108															1MB.5	7-...-Z ...+...+...+...	



1) Noise values for line operation under load, tolerance + 3dB(A).
 2) In combination with B43 / B44 on request.

3) Types derived from IM B3 (IM B6/7/8, IM V6 and IM V5), from IM B5 (IM V3 and IM V1) and from IM B14 (IM V19 and IM V18) are possible. The basic type IM B3, IM B5 or IM B14 is stamped as standard on the rating plate.

SIMOTICS XP 1MB1, 1MB5 explosion-protected motors

Zone 1 with types of protection Ex db, Ex db eb · IE3 Premium Efficiency



Cast-iron series 1MB.853/1MB.863 - self-ventilated

Selection and ordering data

P _{rated} 50 Hz	P _{rated} 60 Hz	Frame size	Operating values at rated power											Cast-iron series 1MB18 3/1MB58 3	m _{IM B3}	J	
			n _{rated} 50 Hz	T _{rated} 50 Hz	η _{rated} 50 Hz, 4/4	η _{rated} 50 Hz, 3/4	η _{rated} 50 Hz, 2/4	cos-φ _{rated} 50 Hz, 4/4	I _{rated} 50 Hz, 400 V	T _{L/R} T _{rated}	I _{L/R} I _{rated}	T _B T _{rated}	L _{p(A,1)} 50 Hz				L _{WA,1)} 50 Hz
kW	kW	FS	rpm	Nm	%	%	%	A									
<ul style="list-style-type: none"> Cooling: self-ventilated (IC411) Efficiency according to IEC 60034-30-1: IE3 Premium Efficiency Insulation: Thermal class 155 (temperature class F), utilization in accordance with thermal class 130 (temperature class B), IVIC C Optionally for converter operation up to ULine . 690 V . IVIC-C premium insulation system 																	
2-pole: 3000 rpm at 50 Hz, 3600 rpm at 60 Hz																	
3	3	100 L	2920	9.8	87.1	87.9	87.5	0.88	5.6	3.2	8.1	4.2	74	82	▲ 1MB18 3-1AA4	64	0.0048
4	4	112 M	2950	12.9	88.1	88.7	88.2	0.89	7.4	2.5	9.2	3.4	69	81	▲ 1MB18 3-1BA2	74	0.0099
5.5	5.5	132 S	2960	17.7	89.2	89.6	88.9	0.91	9.8	2.1	9.7	3.6	72	79	▲ 1MB18 3-1CA0	95	0.0201
7.5	7.5	132 S	2950	24.5	90.1	90.9	90.7	0.91	13.2	2.1	9	3.3	68	80	▲ 1MB18 3-1CA1	106	0.0272
11	11	160 M	2955	35.5	91.2	91.5	90.7	0.9	19.3	2.5	8.5	3.4	79	86	▲ 1MB18 3-1DA2	169	0.0457
15	15	160 M	2960	48.5	91.9	91.9	91	0.86	27.5	2.8	9.5	4	70	82	▲ 1MB18 3-1DA3	179	0.0532
18.5	18.5	160 M	2960	60	92.4	92.9	92.6	0.92	31.5	2.8	9.7	3.8	78	85	▲ 1MB18 3-1DA4	190	0.0637
22	22	180 M	2950	71	92.7	93	92.4	0.89	38.5	2.3	7.5	3.5	67	80	▲ 1MB18 3-1EA2	238	0.0889
30	30	200 L	2955	97	93.3	93.6	93.3	0.86	54	2.6	7.5	3.3	68	81	▲ 1MB18 3-2AA4	315	0.150
37	37	200 L	2950	120	93.7	93.9	93.5	0.88	65	2.6	7.8	3.4	68	81	▲ 1MB18 3-2AA5	348	0.175
45	45	225 M	2960	145	94	94.4	94.1	0.88	79	2.5	7.4	2.9	73	87	▲ 1MB18 3-2BA2	447	0.263
55	55	250 M	2975	177	94.3	94.6	94.2	0.88	96	2.4	7.3	3	73	87	▲ 1MB18 3-2CA2	532	0.454
75	75	280 S	2970	240	94.7	95.1	94.9	0.9	127	2.2	7.2	2.8	79	93	▲ 1MB18 3-2DA0	729	0.816
85	85	280 M	2970	275	94.9	95.2	94.8	0.89	145	2.7	8.5	3.3	79	93	▲ 1MB18 3-2DA2	763	0.924
110	110	315 S	2975	355	95.2	95.4	95	0.91	183	2.4	8	3	77	92	▲ 1MB58 3-3AA0	1130	1.76
132	132	315 M	2982	425	95.4	95.5	94.9	0.91	220	2.3	7.5	2.9	77	92	▲ 1MB58 3-3AA2	1290	1.99
160	160	315 L	2982	510	95.6	95.8	95.4	0.9	270	2.2	7.2	2.7	78	92	▲ 1MB58 3-3AA4	1360	2.29
200	200	315 L	2980	640	95.8	96	95.8	0.92	330	2.3	6.8	2.6	83	98	▲ 1MB58 3-3AA5	1490	2.65
240	240	315 L	2982	770	95.8	96	95.8	0.91	395	2.7	8	3.1	80	94	▲ 1MB58 3-3AA6	1590	2.85
315	315	355 L	2986	1010	95.8	96	95.7	0.9	530	2	7.7	3	83	98	▲ 1MB58 3-3BA2	1830	4.31
355	355	355 L	2986	1140	95.8	95.9	95.6	0.89	600	2.1	8.2	3	83	98	▲ 1MB58 3-3BA3	2620	5.84
400	400	355 L	2986	1280	95.8	96	95.8	0.92	660	2.1	7.6	3	83	98	▲ 1MB58 3-3BA4	2610	5.89
450	450	355 L	2990	1440	95.8	95.8	95.3	0.88	770	2.9	10	4.3	83	98	▲ 1MB58 3-3BA5	2620	5.89
Zones																	
Zone 1 (explosive gases occasionally or frequently) Ex db IIC															5	-	
Zone 1 (explosive gases occasionally or frequently) Ex db IIB															6	-	
Voltages																	
50 Hz 230 VΔ/400 VY			60 Hz 460 VY			Version			Standard			2 2		-			
50 Hz 400 VΔ/690 VY			60 Hz 460 VΔ			Version			Standard			3 4		-			
50 Hz 500 VY						Without additional charge			2 7			-					
50 Hz 500 VΔ						Without additional charge			4 0			-					
For other voltages and more information, see from page 6/69																	
Types of construction																	
Without flange			IM B3 ²⁾			Version			Standard			A		-			
With flange			IM B5 ²⁾			With additional charge			F			-					
With flange			IM B14 ²⁾			With additional charge			K			-					
For other types of construction and more information, see from page 6/80																	
Motor protection																	
Without						Version			Standard			A		-			
PTC thermistor with 3 temperature sensors						With additional charge			B			-					
For other motor protection and more information, see from page 6/87																	
Terminal box position																	
Terminal box at top						Version			Standard			4		-			
For other terminal box positions and more information, see from page 6/92																	
Special versions																	
For options, see from page 6/108															1MB.8 3-... -Z ...+...+...+...		

6



SIMOTICS XP 1MB1, 1MB5 explosion-protected motors

Zone 1 with types of protection Ex db, Ex db eb · IE3 Premium Efficiency

Cast-iron series 1MB.853/1MB.863 - self-ventilated

Selection and ordering data

Operating values at rated power														Cast-iron series				
P_{rated} 50 Hz	P_{rated} 60 Hz	Frame size	n_{rated} 50 Hz	T_{rated} 50 Hz	η_{rated} 50 Hz, 4/4	η_{rated} 50 Hz, 3/4	η_{rated} 50 Hz, 2/4	$\cos\phi_{rated}$ 50 Hz, 4/4	I_{rated} 50 Hz, 400 V	T_{LR}/T_{rated}	I_{LR}/I_{rated}	T_{β}/T_{rated}	$L_{p(A,1)}$ 50 Hz	$L_{WA,1}$ 50 Hz	1MB18 3/1MB58 3	$m_{IM B3}$	J	
kW	kW	FS	rpm	Nm	%	%	%		A				dB(A)	dB(A)	Article-No.	kg	kgm ²	
<ul style="list-style-type: none"> Cooling: self-ventilated (IC411) Efficiency according to IEC 60034-30-1: IE3 Premium Efficiency Insulation: Thermal class 155 (temperature class F), utilization in accordance with thermal class 130 (temperature class B), IVIC C Optionally for converter operation up to ULine . 690 V . IVIC-C premium insulation system 																		
4-pole: 1500 min ⁻¹ bei 50 Hz, 1800 min ⁻¹ bei 60 Hz																		
2.2	2.2	100 L	1465	14.3	86.7	87	85.9	0.83	4.4	2.5	9.2	3.8	60	72	▲ 1MB18 3-1AB4	68	0.0124	
3	3	100 L	1460	19.6	87.7	88.4	87.8	0.84	5.9	2.4	8.5	3.4	68	75	▲ 1MB18 3-1AB5	68	0.0124	
4	4	112 M	1460	26	88.6	89.2	88.6	0.82	7.9	2.4	7.1	3.7	58	70	▲ 1MB18 3-1BB2	76	0.0146	
5.5	5.5	132 S	1470	35.5	89.6	90.1	89.7	0.82	10.8	2.5	8.3	3.6	64	76	▲ 1MB18 3-1CB0	105	0.0352	
7.5	7.5	132 M	1465	49	90.4	91.1	90.8	0.84	14.3	2.6	8.2	3.7	64	76	▲ 1MB18 3-1CB2	120	0.0404	
11	11	160 M	1475	71	91.4	91.8	91.2	0.84	20.5	2.3	7.2	3	65	77	▲ 1MB18 3-1DB2	168	0.0733	
15	15	160 M	1480	97	92.1	92.4	92	0.85	27.5	2.9	8.1	3.3	67	74	▲ 1MB18 3-1DB4	191	0.0877	
18.5	18.5	180 M	1470	120	92.6	93.1	93	0.82	35	2.5	7.2	3.3	66	73	▲ 1MB18 3-1EB2	240	0.145	
22	22	180 L	1470	143	93	93.4	93.1	0.82	41.5	2.6	7.7	3.3	62	75	▲ 1MB18 3-1EB4	249	0.158	
30	30	200 L	1470	195	93.6	94.3	94.5	0.84	55	2.6	7.3	3.1	59	72	▲ 1MB18 3-2AB5	346	0.248	
37	37	225 M	1482	240	93.9	94.2	93.8	0.84	68	2.6	8	3	64	78	▲ 1MB18 3-2BB2	466	0.521	
45	45	250 M	1486	290	94.2	94.6	94.3	0.85	81	2.6	7.9	3.1	66	79	▲ 1MB18 3-2CB2	563	0.842	
55	55	280 S	1486	355	94.6	94.9	94.7	0.87	96	2.5	7.8	2.9	72	86	▲ 1MB18 3-2DB0	782	1.37	
75	75	280 M	1485	480	95	95.4	95.3	0.88	129	2.6	7.2	3	70	84	▲ 1MB18 3-2DB2	818	1.70	
90	90	315 S	1490	580	95.2	95.5	95.3	0.86	159	2.2	6.8	2.4	67	82	▲ 1MB58 3-3AB0	1150	2.48	
110	110	315 M	1490	700	95.4	95.8	95.6	0.86	194	2	7	2.5	75	91	▲ 1MB58 3-3AB2	1270	2.79	
132	132	315 L	1491	850	95.6	95.9	95.8	0.85	235	2.2	7.9	2.8	75	91	▲ 1MB58 3-3AB4	1330	3.17	
160	160	315 L	1491	1020	95.8	96.1	96	0.86	280	2.3	8.2	2.9	75	91	▲ 1MB58 3-3AB5	1480	3.79	
200	200	315 L	1491	1280	96	96.2	95.9	0.87	350	2.4	8.1	2.8	75	91	▲ 1MB58 3-3AB6	1660	4.57	
250	250	355 L	1492	1600	96	96.2	95.8	0.88	425	2.1	7.7	3.1	81	95	▲ 1MB58 3-3BB2	2140	5.60	
315	315	355 L	1491	2000	96	96.2	95.9	0.88	540	2	7.5	2.8	81	95	▲ 1MB58 3-3BB3	2420	6.3	
355	355	355 L	1490	2300	96	96.3	96.1	0.88	610	1.9	7.1	2.8	80	95	▲ 1MB58 3-3BB4	2720	7.02	
Zones															Order code			
Zone 1 (explosive gases occasionally or frequently) Ex db IIC															5	-		
Zone 1 (explosive gases occasionally or frequently) Ex db IIB															6	-		
Voltages															Order code			
50 Hz 230 VΔ/400 VY															Standard		2 2	-
50 Hz 400 VΔ/690 VY															Standard		3 4	-
50 Hz 500 VY															Without additional charge		2 7	-
50 Hz 500 VΔ															Without additional charge		4 0	-
For other voltages and more information, see from page 6/69																	9 0	...
Types of construction															Order code			
Without flange IM B3 ²⁾															Standard		A	-
With flange IM B5 ²⁾															With additional charge		F	-
With flange IM B14 ²⁾															With additional charge		K	-
For other types of construction and more information, see from page 6/80																		...
Motor protection															Order code			
Without															Standard		A	-
PTC thermistor with 3 temperature sensors															With additional charge		B	-
For other motor protection and more information, see from page 6/87																		
Terminal box position															Order code			
Terminal box at top															Standard		4	-
For other terminal box positions and more information, see from page 6/92																		
Special versions															Order code(s)			
For options, see from page 6/108															1MB.8 3-...-Z		...+...+...+...	



SIMOTICS XP 1MB1, 1MB5 explosion-protected motors

Zone 1 with types of protection Ex db, Ex db eb · IE3 Premium Efficiency



Cast-iron series 1MB.853/1MB.863 - self-ventilated

Selection and ordering data

P _{rated} 50 Hz	P _{rated} 60 Hz	Frame size	Operating values at rated power											Cast-iron series		m _{IM B3}	J	
			η _{rated} 50 Hz	T _{rated} 50 Hz	η _{rated} 50 Hz, 4/4	η _{rated} 50 Hz, 3/4	η _{rated} 50 Hz, 2/4	cos- φ _{rated} 50 Hz, 4/4	I _{rated} 50 Hz, 400 V	T _{L/R} / T _{rated}	I _{L/R} / I _{rated}	T _B / T _{rated}	L _{p(A,1)} 50 Hz	L _{WA,1)} 50 Hz	1MB18 ■ 3/1MB58 ■ 3			Article-No.
kW	kW	FS	rpm	Nm	%	%	%	A								▲ New	kg	kgm ²
<ul style="list-style-type: none"> • Cooling: self-ventilated (IC411) • Efficiency according to IEC 60034-30-1: IE3 Premium Efficiency • Insulation: Thermal class 155 (temperature class F), utilization in accordance with thermal class 130 (temperature class B), IVIC C • Optionally for converter operation up to ULine . 690 V . IVIC-C premium insulation system 																		
6-pole: 1000 rpm at 50 Hz, 1200 rpm at 60 Hz																		
15	15	180 L	975	147	91,2	91,6	91,2	0,77	31	2,3	6,4	3	55	68	▲ 1MB18 ■ 3-1EC4 ■ -■■■■■	236	0,210	
18,5	18,5	200 L	978	181	91,7	92,1	91,9	0,79	37	2,5	5,6	2,6	58	71	▲ 1MB18 ■ 3-2AC4 ■ -■■■■■	325	0,315	
22	22	200 L	978	215	92,2	93,3	93,5	0,79	43,5	2,5	5,6	2,6	55	68	▲ 1MB18 ■ 3-2AC5 ■ -■■■■■	339	0,352	
25	25	225 M	986	240	92,5	92,8	92,1	0,8	49	3,1	8,4	3,4	64	77	▲ 1MB18 ■ 3-2BC2 ■ -■■■■■	458	0,671	
30	30	250 M	986	290	92,9	93,5	93,4	0,83	56	2,7	7,9	3	58	72	▲ 1MB18 ■ 3-2CC2 ■ -■■■■■	533	1,00	
37	37	280 S	988	360	93,3	94	94	0,84	68	2,7	8,2	2,9	60	75	▲ 1MB18 ■ 3-2DC0 ■ -■■■■■	689	1,34	
45	45	280 M	988	435	93,7	94,2	94	0,85	82	3,2	7,9	3	60	74	▲ 1MB18 ■ 3-2DC2 ■ -■■■■■	748	1,63	
55	55	315 S	992	530	94,1	94,6	94,4	0,81	104	2	6,5	2,5	68	83	▲ 1MB58 ■ 3-3AC0 ■ -■■■■■	1070	2,98	
75	75	315 M	992	720	94,6	95	94,7	0,83	138	2,2	6,9	2,6	68	83	▲ 1MB58 ■ 3-3AC2 ■ -■■■■■	1130	3,54	
90	90	315 L	992	870	94,9	95,4	95,3	0,83	165	2,1	6,9	2,5	68	83	▲ 1MB58 ■ 3-3AC4 ■ -■■■■■	1320	4,25	
110	110	315 L	992	1060	95,1	95,4	95,2	0,83	200	2,1	7,1	2,5	68	83	▲ 1MB58 ■ 3-3AC5 ■ -■■■■■	1380	4,89	
132	132	315 L	991	1270	95,4	96	96,1	0,84	240	2,1	6,6	2,4	73	88	▲ 1MB58 ■ 3-3AC6 ■ -■■■■■	1520	5,74	
160	160	315 L	992	1540	95,6	96	95,9	0,82	295	2,6	7,6	2,9	68	83	▲ 1MB58 ■ 3-3AC7 ■ -■■■■■	1670	6,41	
200	200	355 L	992	1930	95,8	96,2	96,1	0,88	340	2	6,4	2,4	76	91	▲ 1MB58 ■ 3-3BC1 ■ -■■■■■	2360	11,3	
250	250	355 L	992	2400	95,8	96,3	96,4	0,87	435	2,2	6,6	2,5	75	90	▲ 1MB58 ■ 3-3BC2 ■ -■■■■■	2630	13,8	
315	315	355 L	992	3050	95,8	96,1	96,1	0,86	550	2,2	6,6	2,5	75	90	▲ 1MB58 ■ 3-3BC3 ■ -■■■■■	2650	13,8	
355	355	355 L	994	3400	95,8	96,1	95,9	0,84	640	2,9	8,2	3,2	75	90	▲ 1MB58 ■ 3-3BC4 ■ -■■■■■	2650	13,5	
Zones																Order code		
Zone 1 (explosive gases occasionally or frequently) Ex db IIC																5	-	
Zone 1 (explosive gases occasionally or frequently) Ex db IIB																6	-	
Voltages																Order code		
50 Hz 230 VΔ/400 VY 60 Hz 460 VY																Standard	2 2	
50 Hz 400 VΔ/690 VY 60 Hz 460 VΔ																Standard	3 4	
50 Hz 500 VY																Without additional charge	2 7	
50 Hz 500 VΔ																Without additional charge	4 0	
For other voltages and more information, see from page 6/69																9 0	...	
Types of construction																Order code		
Without flange IM B3 ²⁾																Standard	A	
With flange IM B5 ²⁾																With additional charge	F	
With flange IM B14 ²⁾																With additional charge	K	
For other types of construction and more information, see from page 6/80																	...	
Motor protection																Order code		
Without																Standard	A	
PTC thermistor with 3 temperature sensors																With additional charge	B	
For other motor protection and more information, see from page 6/87																		
Terminal box position																Order code		
Terminal box at top																Standard	4	
For other terminal box positions and more information, see from page 6/92																		
Special versions																Order code(s)		
For options, see from page 6/108																1MB.8 ■ 3- ■ -■■■■■	-Z . . . + . . . + . . .	

6



SIMOTICS XP 1MB1, 1MB5 explosion-protected motors

Zone 1 with types of protection Ex db, Ex db eb · IE3 Premium Efficiency

Cast-iron series 1MB.853/1MB.863 - self-ventilated

Selection and ordering data

P _{rated} 50 Hz		P _{rated} 60 Hz		Frame size	Operating values at rated power										Cast-iron series		m _{IM B3}		J
kW	kW	FS	rpm	Nm	%	%	%	cos φ _{rated}	I _{rated}	T _{L/R} /T _{rated}	I _{L/R} /I _{rated}	T _B /T _{rated}	L _{pl(A, 1)}	L _{WA, 1)}	1MB18	3/1MB58	kg	kgm ²	
50 Hz	60 Hz		50 Hz	50 Hz	50 Hz	50 Hz	50 Hz	50 Hz	50 Hz	400 V			50 Hz	50 Hz	3	3			
<ul style="list-style-type: none"> Cooling: self-ventilated (IC411) Efficiency according to IEC 60034-30-1: IE3 Premium Efficiency Insulation: Thermal class 155 (temperature class F), utilization in accordance with thermal class 130 (temperature class B), IVIC C Optionally for converter operation up to ULine . 690 V . IVIC-C premium insulation system 																			
8-pole: 750 rpm at 50 Hz, 900 rpm at 60 Hz																			
11	11	180 L	725	145	88,6	89,5	89,2	0,74	24	2,1	5,4	2,6	62	75	▲ 1MB18	■ 3-1ED4	259	0,264	
15	15	200 L	730	196	89,6	89,8	89,1	0,73	33	3	6,8	3,7	57	70	▲ 1MB18	■ 3-2AD5	357	0,417	
18,5	18,5	225 S	736	240	90,1	91	90,7	0,74	40	2,5	6,5	3,1	56	70	▲ 1MB18	■ 3-2BD0	417	0,499	
22	22	225 M	736	285	90,6	91,3	90,7	0,73	48	2,9	7	3,4	56	70	▲ 1MB18	■ 3-2BD2	425	0,547	
28	28	250 M	736	365	91,2	92,1	92	0,78	57	2,7	7	3,1	60	74	▲ 1MB18	■ 3-2CD2	512	0,842	
37	37	280 S	736	480	91,8	92,8	92,9	0,79	74	2,2	5,5	2,3	63	77	▲ 1MB18	■ 3-2DD0	680	1,08	
45	45	280 M	738	580	92,2	93,2	93,5	0,81	87	2,3	6	2,4	65	79	▲ 1MB18	■ 3-2DD2	743	1,62	
55	55	315 S	744	710	92,5	92,9	92,5	0,81	106	2,4	6,4	2,6	67	82	▲ 1MB58	■ 3-3AD0	1020	3,15	
75	75	315 M	742	970	93,1	93,5	93,2	0,79	147	2,5	6,4	2,5	67	82	▲ 1MB58	■ 3-3AD2	1090	3,15	
90	90	315 L	742	1160	93,4	94	93,9	0,82	170	2,5	6,6	2,7	67	82	▲ 1MB58	■ 3-3AD4	1290	4,49	
110	110	315 L	742	1420	93,7	94,2	94,1	0,81	210	2,5	6,7	2,6	67	82	▲ 1MB58	■ 3-3AD5	1290	4,49	
132	132	315 L	743	1700	94	94,3	93,9	0,78	260	2,9	7,3	2,9	56	70	▲ 1MB58	■ 3-3AD6	1370	5,15	
150	150	315 L	742	1930	94,2	94,8	94,8	0,78	295	2,6	6,8	2,8	67	82	▲ 1MB58	■ 3-3AD7	1650	6,77	
200	200	355 L	744	2550	94,6	95,1	95,1	0,8	380	2,3	7,1	2,7	73	88	▲ 1MB58	■ 3-3BD0	2340	11,3	
250	250	355 L	744	3200	94,6	95,1	95,1	0,8	475	2,4	7,2	2,9	73	88	▲ 1MB58	■ 3-3BD1	2650	13,8	
280	280	355 L	745	3600	94,6	94,8	94,4	0,77	550	3,4	8,3	3,2	73	88	▲ 1MB58	■ 3-3BD2	2630	13,8	
Zones																Order code			
Zone 1 (explosive gases occasionally or frequently) Ex db IIC																5	-		
Zone 1 (explosive gases occasionally or frequently) Ex db IIB																6	-		
Voltages																Order code			
50 Hz 230 VΔ/400 VY																Standard		2 2	-
50 Hz 400 VΔ/690 VY																Standard		3 4	-
50 Hz 500 VY																Without additional charge		2 7	-
50 Hz 500 VΔ																Without additional charge		4 0	-
For other voltages and more information, see from page 6/69																9 0		...	
Types of construction																Order code			
Without flange																Standard		A	-
With flange																With additional charge		F	-
With flange																With additional charge		K	-
For other types of construction and more information, see from page 6/80																...			
Motor protection																Order code			
Without																Standard		A	-
PTC thermistor with 3 temperature sensors																With additional charge		B	-
For other motor protection and more information, see from page 6/87																...			
Terminal box position																Order code			
Terminal box at top																Standard		4	-
For other terminal box positions and more information, see from page 6/92																...			
Special versions																Order code(s)			
For options, see from page 6/108																1MB.8 ■ 3-... ■-■■■■■-Z		...+...+...+...	



1) Types derived from IM B3 (IM B6/7/8, IM V6 and IM V5), from IM B5 (IM V3 and IM V1) and from IM B14 (IM V19 and IM V18) are possible. The basic type IM B3, IM B5 or IM B14 is stamped as standard on the rating plate.

2) Noise values for line operation under load, tolerance + 3dB(A).

SIMOTICS XP 1MB1, 1MB5 explosion-protected motors

Article No. supplements and special versions · Voltages

Aluminum series 1MB10

Selection and ordering data

Voltages	Article No. Voltage code 12th and 13th position of the Article No.	supplement Additional identification code with order code and plain text if required	Frame size								Motor version		
			63	71	80	90	100	112	132	160			
					1MB10.3						IEC	Ex tb (Zone 21), Ex tc (Zone 22), Ex ec (Zone 2)	IE3 IE2 IE1
			1MB10.1					1MB10.2					
	1MB10	Order code											
Voltage at 50 Hz or 60 Hz (50 Hz power)													
50 Hz 230 VΔ/400 VY, 60 Hz 460 VY	2 2	–	□	□	□	□	□	□	□	□			
50 Hz 400 VΔ/690 VY, 60 Hz 460 VΔ	3 4	–	□	□	□	□	□	□	□	□			
50 Hz 500 VY	2 7	–	○	○	○	○	○	○	○	○			
50 Hz 500 VΔ	4 0	–	○	✓	–	–	○	○	○	○			
50 Hz 220 VΔ/380 VY, 60 Hz 440 VY	2 1	–	✓	✓	✓	✓	✓	✓	✓	✓			
50 Hz 380 VΔ/660 VY, 60 Hz 440 VΔ	3 3	–	✓	✓	✓	✓	✓	✓	✓	✓			
50 Hz 240 VΔ/415 VY, 60 Hz 480 VY	2 3	–	✓	✓	✓	✓	✓	✓	✓	✓			
50 Hz 415 VΔ, 60 Hz 480 VΔ	3 5	–	✓	✓	✓	✓	✓	✓	✓	✓			
50 Hz 400 VY, 60 Hz 460 VY ¹⁾	0 2	–	○	○	○	○	○	○	○	○			
50 Hz 400 VΔ, 60 Hz 460 VΔ ²⁾	0 4	–	○	○	○	○	○	○	○	○			
60 Hz 220 VΔ/380 VY	1 7	–	✓	✓	✓	✓	✓	✓	✓	✓			Not for: Only for: 1MB10.2 1MB10.3 in combination with order code D22
60 Hz 230 VΔ/400 VY	1 8	–	✓	✓	✓	✓	✓	✓	✓	✓			
60 Hz 380 VΔ/660 VY	3 0	–	✓	✓	✓	✓	✓	✓	✓	✓			
60 Hz 400 VΔ/690 VY	3 1	–	✓	✓	✓	✓	✓	✓	✓	✓			
50 Hz 400 VY	9 0	M4A	○	○	○	○	○	○	○	○			
50 Hz 400 VΔ	9 0	M4B	○	○	○	○	○	○	○	○			
Voltage at 60 Hz (50 Hz power)													
220 VΔ/380 VY; 50 Hz power ³⁾	9 0	M2A	✓	✓	✓	✓	✓	✓	✓	✓			
220 VΔ/380 VY; 60 Hz power ⁶⁾	9 0	M1A	✓	✓	✓	✓	✓	✓	✓	✓			
380 VΔ/660 VY; 50 Hz power ³⁾	9 0	M2B	✓	✓	✓	✓	✓	✓	✓	✓			
380 VΔ/660 VY; 60 Hz power ⁶⁾	9 0	M1B	✓	✓	✓	✓	✓	✓	✓	✓			
440 VY; 50 Hz power ³⁾	9 0	M2C	✓	✓	✓	✓	✓	✓	✓	✓			
440 VY; 60 Hz power ⁶⁾	9 0	M1C	✓	✓	✓	✓	✓	✓	✓	✓			
440 VΔ; 50 Hz power ³⁾	9 0	M2D	✓	✓	✓	✓	✓	✓	✓	✓			
440 VΔ; 60 Hz power ⁶⁾	9 0	M1D	✓	✓	✓	✓	✓	✓	✓	✓			
460 VY; 50 Hz power ³⁾	9 0	M2E	✓	✓	✓	✓	✓	✓	✓	✓			
460 VY; 60 Hz power ⁶⁾	9 0	M1E	○	○	○	○	○	○	○	○			
460 VΔ; 50 Hz power ³⁾	9 0	M2F	✓	✓	✓	✓	✓	✓	✓	✓			
460 VΔ; 60 Hz power ⁶⁾	9 0	M1F	○	○	○	○	○	○	○	○			
575 VY; 50 Hz power ³⁾	9 0	M2G	✓	✓	✓	✓	✓	✓	✓	✓			
575 VY; 60 Hz power ⁶⁾	9 0	M1G	✓	✓	✓	✓	✓	✓	✓	✓			
575 VΔ; 50 Hz power ³⁾	9 0	M2H	✓	✓	✓	✓	✓	✓	✓	✓			
575 VΔ; 60 Hz power ⁶⁾	9 0	M1H	✓	✓	✓	✓	✓	✓	✓	✓			
400 VΔ/690 VY; 50 Hz power ³⁾	9 0	M2J	✓	✓	✓	✓	✓	✓	✓	✓			
400 VΔ/690 VY; 60 Hz power ⁶⁾	9 0	M1J	✓	✓	✓	✓	✓	✓	✓	✓			
480 VY; 50 Hz power ³⁾	9 0	M2K	✓	✓	✓	✓	✓	✓	✓	✓			
480 VY; 60 Hz power ⁶⁾	9 0	M1K	✓	✓	✓	✓	✓	✓	✓	✓			
480 VΔ; 50 Hz power ³⁾	9 0	M2L	✓	✓	✓	✓	✓	✓	✓	✓			
480 VΔ; 60 Hz power ⁶⁾	9 0	M1L	✓	✓	✓	✓	✓	✓	✓	✓			
230 VΔ/400 VY; 50 Hz power ³⁾	9 0	M2M	✓	✓	✓	✓	✓	✓	✓	✓			
230 VΔ/400 VY; 60 Hz power ⁶⁾	9 0	M1M	✓	✓	✓	✓	✓	✓	✓	✓			
Voltage at 87 Hz (87 Hz power)													
400 VΔ ⁵⁾	9 0	M3A	○	○	○	○	○	○	○	○			
Non-standard voltage and/or frequencies													
Non-standard winding ⁴⁾	9 0	M1Y • and cus- tomer speci- fications	✓	✓	✓	✓	✓	✓	✓	✓			

□ Standard version
○ Without additional charge
✓ With additional charge

– Not possible
• This order code only determines the price of the version
– Additional plain text is required.

1) Delta connection is not possible.

2) Star connection is not possible.

3) A power of 3.7 kW is stamped on the rating plate for versions 1MB1... - 1BA2, 1MB1... - 1BB2, 1MB1... - 1CC2 and 1MB1... - 1DD2 at 60 Hz with 50 Hz power in accordance with the international efficiency classification to IEC 60034-30.

4) Plain text must be specified in the order: Voltage between 200 and 690 V (voltages outside this range are available on request), frequency, circuit, for 60 Hz additionally required rated power in kW.

5) Only possible for 4-pole, 6-pole and 8-pole motors and in combination with the order codes **B40** and **B41**. The operating data for converter operation is also provided in a table on the additional rating plate. The motor contains winding version 50 Hz 230 VΔ.

6) Order code M1A, M1B, M1C, M1D, M1E, M1F, M1G, M1H, M1K, M1L, and M1M in combination with order code B40, B41, B43 and B44 only on request.

SIMOTICS XP 1MB1, 1MB5 explosion-protected motors

Article No. supplements and special versions · Voltages

Cast-iron series 1MB15 Basic Line, 1MB16 Performance Line

Selection and ordering data

Voltages	Article No. supplement		Frame size													Motor version		
	Voltage code 12th and 13th position of the Article No.	Additional identification code with order code and plain text if required	71	80	90	100	112	132	160	180	200	225	250	280	315	IEC	Ex tb (Zone 21), Ex tc (Zone 22), Ex ec (Zone 2)	IE3 IE2
			1MB15.3 Basic Line													IEC	Ex tb (Zone 21), Ex tc (Zone 22), Ex ec (Zone 2)	IE3 IE2
			1MB16.3 Performance Line															
			1MB15.1 Basic Line															
			1MB16.1 Performance Line															
	1MB15																	
	1MB16	Order code																
Voltage at 50 Hz or 60 Hz																		
50 Hz 230 VΔ/400 VY, 60 Hz 460 VY	2 2	–	□	□	□	□	□	□	□	□	□	□	□	□	□	□	□	□
50 Hz 400 VΔ/690 VY, 60 Hz 460 VΔ	3 4	–	□	□	□	□	□	□	□	□	□	□	□	□	□	□	□	□
50 Hz 400 VY, 60 Hz 460 VY ¹⁾	0 2	–	○	○	○	○	○	○	○	○	○	○	○	○	○	○	○	○
50 Hz 400 VΔ, 60 Hz 460 VΔ ²⁾	0 4	–	○	○	○	○	○	○	○	○	○	○	○	○	○	○	○	○
50 Hz 500 VY	2 7	–	○	○	○	○	○	○	○	○	○	○	○	○	○	○	○	○
50 Hz 500 VΔ	4 0	–	–	–	–	○	○	○	○	○	○	○	○	○	○	○	○	○
50 Hz 220 VΔ/380 VY, 60 Hz 440 VY	2 1	–	✓	✓	✓	✓	✓	✓	✓	✓	✓	✓	✓	✓	✓	✓	✓	✓
50 Hz 380 VΔ/660 VY, 60 Hz 440 VΔ	3 3	–	✓	✓	✓	✓	✓	✓	✓	✓	✓	✓	✓	✓	✓	✓	✓	✓
50 Hz 240 VΔ/415 VY, 60 Hz 480 VY	2 3	–	✓	✓	✓	✓	✓	✓	✓	✓	✓	✓	✓	✓	✓	✓	✓	✓
50 Hz 415 VΔ, 60 Hz 480 VΔ	3 5	–	✓	✓	✓	✓	✓	✓	✓	✓	✓	✓	✓	✓	✓	✓	✓	✓
60 Hz 220 VΔ/380 VY	1 7	–	✓	✓	✓	✓	✓	✓	✓	✓	✓	✓	✓	✓	✓	✓	✓	✓
60 Hz 230 VΔ/400 VY	1 8	–	✓	✓	✓	✓	✓	✓	✓	✓	✓	✓	✓	✓	✓	✓	✓	✓
60 Hz 380 VΔ/660 VY	3 0	–	✓	✓	✓	✓	✓	✓	✓	✓	✓	✓	✓	✓	✓	✓	✓	✓
60 Hz 400 VΔ/690 VY	3 1	–	✓	✓	✓	✓	✓	✓	✓	✓	✓	✓	✓	✓	✓	✓	✓	✓
50 Hz 400 VY	9 0	M4A	○	○	○	○	○	○	○	○	○	○	○	○	○	○	○	○
50 Hz 400 VΔ	9 0	M4B	○	○	○	○	○	○	○	○	○	○	○	○	○	○	○	○
Voltage at 60 Hz and required power																		
220 VΔ/380 VY; 50 Hz power ³⁾	9 0	M2A	✓	✓	✓	✓	✓	✓	✓	✓	✓	✓	✓	✓	✓	✓	✓	✓
220 VΔ/380 VY; 60 Hz power	9 0	M1A	✓	✓	✓	✓	✓	✓	✓	✓	✓	✓	✓	✓	✓	✓	✓	✓
380 VΔ/660 VY; 50 Hz power ³⁾	9 0	M2B	–	–	–	✓	✓	✓	✓	✓	✓	✓	✓	✓	✓	✓	✓	✓
380 VΔ/660 VY; 60 Hz power	9 0	M1B	–	–	–	✓	✓	✓	✓	✓	✓	✓	✓	✓	✓	✓	✓	✓
440 VY; 50 Hz power ³⁾	9 0	M2C	–	–	–	✓	✓	✓	✓	✓	✓	✓	✓	✓	✓	✓	✓	✓
440 VY; 60 Hz power	9 0	M1C	–	–	–	✓	✓	✓	✓	✓	✓	✓	✓	✓	✓	✓	✓	✓
440 VΔ; 50 Hz power ³⁾	9 0	M2D	–	–	–	✓	✓	✓	✓	✓	✓	✓	✓	✓	✓	✓	✓	✓
440 VΔ; 60 Hz power	9 0	M1D	–	–	–	✓	✓	✓	✓	✓	✓	✓	✓	✓	✓	✓	✓	✓
460 VY; 50 Hz power ³⁾	9 0	M2E	–	–	–	✓	✓	✓	✓	✓	✓	✓	✓	✓	✓	✓	✓	✓
460 VY; 60 Hz power	9 0	M1E	–	–	–	○	○	○	○	○	○	○	○	○	○	○	○	○
460 VΔ; 50 Hz power ³⁾	9 0	M2F	–	–	–	✓	✓	✓	✓	✓	✓	✓	✓	✓	✓	✓	✓	✓
460 VΔ; 60 Hz power	9 0	M1F	–	–	–	○	○	○	○	○	○	○	○	○	○	○	○	○
575 VY; 50 Hz power ³⁾	9 0	M2G	–	–	–	✓	✓	✓	✓	✓	✓	✓	✓	✓	✓	✓	✓	✓
575 VY; 60 Hz power	9 0	M1G	–	–	–	✓	✓	✓	✓	✓	✓	✓	✓	✓	✓	✓	✓	✓
575 VΔ; 50 Hz power ³⁾	9 0	M2H	–	–	–	✓	✓	✓	✓	✓	✓	✓	✓	✓	✓	✓	✓	✓
575 VΔ; 60 Hz power	9 0	M1H	–	–	–	✓	✓	✓	✓	✓	✓	✓	✓	✓	✓	✓	✓	✓
400 VΔ/690 VY; 50 Hz power ³⁾	9 0	M2J	✓	✓	✓	✓	✓	✓	✓	✓	✓	✓	✓	✓	✓	✓	✓	✓
400 VΔ/690 VY; 60 Hz power	9 0	M1J	✓	✓	✓	✓	✓	✓	✓	✓	✓	✓	✓	✓	✓	✓	✓	✓
480 VY; 50 Hz power ³⁾	9 0	M2K	✓	✓	✓	✓	✓	✓	✓	✓	✓	✓	✓	✓	✓	✓	✓	✓
480 VY; 60 Hz power	9 0	M1K	✓	✓	✓	✓	✓	✓	✓	✓	✓	✓	✓	✓	✓	✓	✓	✓
480 VΔ; 50 Hz power ³⁾	9 0	M2L	✓	✓	✓	✓	✓	✓	✓	✓	✓	✓	✓	✓	✓	✓	✓	✓
480 VΔ; 60 Hz power	9 0	M1L	✓	✓	✓	✓	✓	✓	✓	✓	✓	✓	✓	✓	✓	✓	✓	✓
230 VΔ/400 VY; 50 Hz power ³⁾	9 0	M2M	✓	✓	✓	✓	✓	✓	✓	✓	✓	✓	✓	✓	✓	✓	✓	✓
230 VΔ/400 VY; 60 Hz power	9 0	M1M	✓	✓	✓	✓	✓	✓	✓	✓	✓	✓	✓	✓	✓	✓	✓	✓
Voltage at 87 Hz (87 Hz power)																		
400 VΔ ⁵⁾	9 0	M3A	✓	✓	✓	✓	✓	✓	✓	✓	✓	✓	✓	✓	–	–	–	–
Non-standard voltage and/or frequencies																		
Non-standard winding ⁴⁾	9 0	M1Y • and customer specifications	✓	✓	✓	✓	✓	✓	✓	✓	✓	✓	✓	✓	✓	✓	✓	✓

- Standard version
- Without additional charge
- ✓ With additional charge
- Not possible
- This order code only determines the price of the version – Additional plain text is required.

1) Delta connection is not possible.
 2) Star connection is not possible.
 3) A power of 3.7 kW is stamped on the rating plate for versions 1MB1... - 1BA2, 1MB1... - 1BB2, 1MB1... - 1CC2 and 1MB1... - 1DD2 at 60 Hz with 50 Hz power in accordance with the international efficiency classification to IEC 60034-30.
 4) Plain text must be specified in the order: Voltage between 200 and 690 V (voltages outside the range on request). Frequency, connection, for 60 Hz, additionally required rated power in kW.
 5) Only possible for 4-pole, 6-pole and 8-pole motors and in combination with the order codes **B40** and **B41**. The operating data for converter operation is also provided in a table on the additional rating plate. The motor contains winding version 50 Hz 230 VΔ.

SIMOTICS XP 1MB1, 1MB5 explosion-protected motors

Article No. supplements and special versions · Voltages

Aluminum series 1MB1042; Cast-iron series 1MB.543 Basic Line and 1MB.643 Performance Line

Selection and ordering data

Voltages	Article No. supplement		Frame size													Motor version			
	Voltage code 12th and 13th position of the Article No.	Additional identification code with order code and plain text if required	63	71	80	90	100	112	132	160	180	200	225	250	280	315	IEC	Ex eb (Zone 1)	IE1
			1MB1042																
			1MB1543 Basic Line																IE3
			1MB1643 Performance Line																
			1MB5543 Basic Line																
			1MB5643 Performance Line																
	1MB1042 -	■ - ■ .																	
	1MB.543 -	■ - ■ .																	
	1MB.643 -	■ - ■ .																	
		Order code																	
Voltage at 50 Hz or 60 Hz ³⁾																			
50 Hz 230 VΔ/400 VY	2	2	□	□	□	□	□	□	□	□	□	□	□	□	□	□	□	□	□
50 Hz 400 VΔ/690 VY	3	4	□	□	□	□	□	□	□	□	□	□	□	□	□	□	□	□	□
50 Hz 500 VY	2	7	○	○	○	○	○	○	○	○	○	○	○	○	○	○	○	○	○
50 Hz 500 VΔ ¹⁾	4	0	-	-	-	-	○	○	○	○	○	○	○	○	○	○	○	○	○
50 Hz 220 VΔ/380 VY	2	1	✓	✓	✓	✓	✓	✓	✓	✓	✓	✓	✓	✓	✓	✓	✓	✓	✓
50 Hz 230 VΔ	0	1	○	○	○	○	○	○	○	○	○	○	○	○	○	○	○	○	○
50 Hz 380 VΔ/660 VY	3	3	✓	✓	✓	✓	✓	✓	✓	✓	✓	✓	✓	✓	✓	✓	✓	✓	✓
50 Hz 240 VΔ ¹⁾	2	3	✓	✓	✓	✓	✓	✓	✓	✓	✓	✓	✓	✓	✓	✓	✓	✓	✓
50 Hz 415 VΔ	3	5	✓	✓	✓	✓	✓	✓	✓	✓	✓	✓	✓	✓	✓	✓	✓	✓	✓
50 Hz 400 VY	9	0	M4A	○	○	○	○	○	○	○	○	○	○	○	○	○	○	○	○
50 Hz 400 VΔ	9	0	M4B	○	○	○	○	○	○	○	○	○	○	○	○	○	○	○	○
Voltage at 60 Hz and required power																			
220 VΔ/380 VY; 50 Hz power	9	0	M2A	✓	✓	✓	✓	✓	✓	✓	✓	✓	✓	✓	✓	✓	✓	✓	✓
380 VΔ/660 VY; 50 Hz power ²⁾	9	0	M2B	✓	✓	✓	✓	✓	✓	✓	✓	✓	✓	✓	✓	✓	✓	✓	✓
440 VY; 50 Hz power	9	0	M2C	✓	✓	✓	✓	✓	✓	✓	✓	✓	✓	✓	✓	✓	✓	✓	✓
440 VΔ; 50 Hz power	9	0	M2D	✓	✓	✓	✓	✓	✓	✓	✓	✓	✓	✓	✓	✓	✓	✓	✓
460 VY; 50 Hz power	9	0	M2E	✓	✓	✓	✓	✓	✓	✓	✓	✓	✓	✓	✓	✓	✓	✓	✓
460 VΔ; 50 Hz power	9	0	M2F	✓	✓	✓	✓	✓	✓	✓	✓	✓	✓	✓	✓	✓	✓	✓	✓
575 VY; 50 Hz power ²⁾	9	0	M2G	✓	✓	✓	✓	✓	✓	✓	✓	✓	✓	✓	✓	✓	✓	✓	✓
575 VΔ; 50 Hz power	9	0	M2H	✓	✓	✓	✓	✓	✓	✓	✓	✓	✓	✓	✓	✓	✓	✓	✓
Non-standard voltage and/or frequencies																			
Non-standard winding ²⁾	9	0	M1Y • and customer specifications	✓	✓	✓	✓	✓	✓	✓	✓	✓	✓	✓	✓	✓	✓	✓	✓

- Standard version
- Without additional charge
- ✓ With additional charge
- Not possible
- This order code only determines the price of the version – Additional plain text is required.

¹⁾ Special certification is required for 60 Hz.

²⁾ Plain text must be specified in the order: Voltage between 200 V and 690 V (voltages outside this range are available on request), frequency, circuit, for 60 Hz additionally required rated power in kW.

³⁾ Motors in these frame sizes have a second rating plate (T1/T2 and T3) as standard. The T3 power is stamped on the rating plate as standard if the following motors are selected with PTC thermistor (protection by PTC thermistor only) or voltage code '90':
 – 2-pole motors: Frame sizes 132 to 160
 – 4-pole motors: Frame size 180
 Alternatively, with order code **B33**, the "T1/T2 power is stamped on the rating plate".
 – 2-pole motors: Frame sizes 132 to 200
 – 4-pole motors: Frame sizes 180 to 200

SIMOTICS XP 1MB1, 1MB5 explosion-protected motors

Article No. supplements and special versions · Voltages

Cast-iron series 1MB.55., 1MB.853, 1MB.56., 1MB.8633

Selection and ordering data

Voltages	Article No. supplement		Frame size													Motor version			
	Voltage code 12th and 13th position of the Article No.	Additional identification code with order code and plain text if required	71	80	90	100	112	132	160	180	200	225	250	280	315	355	IEC	Ex db, Ex db eb (Zone 1)	IE3
			1MB1.5., 1MB1.6.																
												1MB55..							
						1MB18.3													
												1MB58.3							
	1MB.55 . -																		
			Order code																
Voltage at 50 Hz or 60 Hz																			
50 Hz 230 VΔ/400 VY, 60 Hz 460 VY	2	2	–	□	□	□	□	□	□	□	□	□	□	□	□	□	–	–	
50 Hz 400 VΔ/690 VY, 60 Hz 460 VΔ	3	4	–	□	□	□	□	□	□	□	□	□	□	□	□	□	□	□	
50 Hz 500 VY	2	7	–	○	○	○	○	○	○	○	○	○	○	○	○	○	–	–	
50 Hz 500 VΔ	4	0	–	–	–	○	○	○	○	○	○	○	○	○	○	○	○	○	
50 Hz 220 VΔ/380 VY, 60 Hz 440 VY	2	1	–	✓	✓	✓	✓	✓	✓	✓	✓	✓	✓	✓	✓	✓	–	–	
50 Hz 380 VΔ/660 VY, 60 Hz 440 VΔ	3	3	–	✓	✓	✓	✓	✓	✓	✓	✓	✓	✓	✓	✓	✓	✓	✓	
50 Hz 240 VΔ/415 VY, 60 Hz 480 VY	2	3	–	✓	✓	✓	✓	✓	✓	✓	✓	✓	✓	✓	✓	✓	–	–	
50 Hz 415 VΔ, 60 Hz 480 VΔ	3	5	–	✓	✓	✓	✓	✓	✓	✓	✓	✓	✓	✓	✓	✓	✓	✓	
50 Hz 400 VY	9	0	M4A	○	○	○	○	○	○	○	○	○	○	○	○	○	–	–	
50 Hz 400 VΔ	9	0	M4B	○	○	○	○	○	○	○	○	○	○	○	○	○	○	○	
50 Hz 690 VY	9	0	M4E	–	–	–	○	○	○	○	○	○	○	○	○	○	○	○	
50 Hz 690 VΔ	9	0	M4F	–	–	–	○	○	○	○	○	○	○	○	○	○	○	○	
50 Hz 230 VΔ	0	1	–	○	○	○	○	○	○	○	○	○	○	○	○	○	–	–	
50 Hz 400 VY ¹⁾	0	2	–	○	○	○	○	○	○	○	○	○	○	○	○	○	–	–	
50 Hz 400 VΔ ²⁾	0	4	–	○	○	○	○	○	○	○	○	○	○	○	○	○	○	○	
Voltage at 60 Hz and required power																			
220 VΔ/380 VY; 50 Hz power ³⁾	9	0	M2A	✓	✓	✓	✓	✓	✓	✓	✓	✓	✓	✓	✓	✓	–	–	
380 VΔ/660 VY; 50 Hz power ³⁾	9	0	M2B	–	–	–	✓	✓	✓	✓	✓	✓	✓	✓	✓	✓	✓	✓	
440 VY; 50 Hz power ³⁾	9	0	M2C	✓	✓	✓	✓	✓	✓	✓	✓	✓	✓	✓	✓	✓	–	–	
440 VΔ; 50 Hz power ³⁾	9	0	M2D	✓	✓	✓	✓	✓	✓	✓	✓	✓	✓	✓	✓	✓	✓	✓	
460 VY; 50 Hz power ³⁾	9	0	M2E	✓	✓	✓	✓	✓	✓	✓	✓	✓	✓	✓	✓	✓	–	–	
460 VΔ; 50 Hz power ³⁾	9	0	M2F	✓	✓	✓	✓	✓	✓	✓	✓	✓	✓	✓	✓	✓	✓	✓	
575 VY; 50 Hz power ³⁾	9	0	M2G	–	–	–	✓	✓	✓	✓	✓	✓	✓	✓	✓	✓	–	–	
575 VΔ; 50 Hz power ³⁾	9	0	M2H	–	–	–	✓	✓	✓	✓	✓	✓	✓	✓	✓	✓	✓	✓	
Non-standard voltage and/or frequencies																			
Non-standard winding ⁴⁾	9	0	M1Y • and customer specifications	✓	✓	✓	✓	✓	✓	✓	✓	✓	✓	✓	✓	✓	✓	✓	

- Standard version
- Without additional charge
- ✓ With additional charge
- Not possible
- This order code only determines the price of the version
– Additional plain text is required.

¹⁾ Delta connection is not possible.

²⁾ Star connection is not possible.

³⁾ Power at 60 Hz according to the specification in the selection and ordering data of the basic motor.

⁴⁾ Plain text must be specified in the order: Voltage between 200 and 690 V (voltages outside this range are available on request), frequency, circuit, for 60 Hz additionally required rated power in kW.

SIMOTICS XP 1MB1, 1MB5 explosion-protected motors

Article No. supplements and special versions · Voltages

Cast-iron series 1MB55.4, 1MB55.3, 1MB58.3

Selection and ordering data

Voltages	Article No. supplement		Frame size				Motor version		
	Voltage code 12th and 13th position of the Article No.	Additional identification code with order code and plain text, if required	315	355	400, 450	$P_{rated} \leq 630 \text{ kW}$		$P_{rated} > 630 \text{ kW}$	
			1MB55 . 4				IEC	Ex ec, Ex tc, Ex tb (Zones 2, 22 and 21)	IE4 IE3
			1MB55 . 3						
					1MB58 . 3				
	1MB5	- -	Order code						
Voltage at 50 Hz or 60 Hz									
50 Hz 400 VΔ/690 VY, 60 Hz 460 VΔ	3	4	-	□	□	□	O. R.		
50 Hz 500 VΔ	4	0	-	○	○	○	○		
60 Hz 575 VΔ			-	-	-	○	□ ²⁾		
50 Hz 690 VΔ	4	7	-	✓	✓	✓	✓		
50 Hz 380 VΔ/660 VY, 60 Hz 440 VΔ	3	3	-	✓	✓	✓	✓		
50 Hz 415 VΔ, 60 Hz 480 VΔ	3	5	-	✓	✓	✓	✓		
50 Hz 600 VΔ, 60 Hz 690 VΔ	4	4	-	-	-	✓	✓		
50 Hz 660 VΔ	4	6	-	-	-	✓	✓		
Voltage at 50 Hz and required power									
400 VΔ; 50 Hz power	9	0	M4B	O. R.	O. R.	O. R.	O. R.		
Voltage at 60 Hz and required power									
440 VΔ; 60 Hz power	9	0	M1D	✓	✓	✓	✓		
460 VΔ; 60 Hz power	9	0	M1F	✓	✓	✓	✓		
575 VΔ; 60 Hz power	9	0	M1H	✓	✓	✓	✓ ²⁾		
400 VΔ/690 VY; 60 Hz power	9	0	M1J	-	-	✓	✓		
480 VΔ; 60 Hz power	9	0	M1L	✓	✓	✓	✓		
440 VΔ; 50 Hz power	9	0	M2D	✓	✓	✓	✓		
460 VΔ; 50 Hz power	9	0	M2F	✓	✓	✓	✓		
575 VΔ; 50 Hz power	9	0	M2H	✓	✓	✓	✓ ²⁾		
400 VΔ/690 VY; 50 Hz power	9	0	M2J	-	-	✓	✓		
480 VΔ; 50 Hz power	9	0	M2L	✓	✓	✓	✓		
Non-standard voltage and/or frequencies									
Non-standard winding ¹⁾	9	0	M1Y • and customer specifications	✓	✓	✓	✓		

- Standard version
- Without additional charge
- This order code only determines the price of the version – Additional plain text is required.
- O. R. Possible on request
- ✓ With additional charge

6

¹⁾ Plain text must be specified in the order: Voltage between 380 and 690 V (voltages outside this range are available on request), frequency, circuit, rated power in kW.

²⁾ 2-pole version, frame size 450 for 60 Hz operation on request.

SIMOTICS XP 1MB1, 1MB5 explosion-protected motors







Article No. supplements and special versions · Types of construction

Aluminum series 1MB10

Selection and ordering data

standard version

Types of construction	Article No. supplement	Frame size	Motor version							
			63	71	80	90	100	112	132	160
	Type of construction code letter	For types of construction with order code(s)	IEC Ex tb (Zone 21), Ex tc (Zone 22), Ex ec (Zone 2)							
	14th position of the Article No.	Article No. with additional identification code -Z	IE3 IE2 IE1							
1MB10 (-Z)	Order code								

Without flange											
IM B3		A	-	<input type="checkbox"/>	<input type="checkbox"/>	<input type="checkbox"/>	<input type="checkbox"/>	<input type="checkbox"/>	<input type="checkbox"/>	<input type="checkbox"/>	<input type="checkbox"/>
IM B6 ¹⁾		T	-	<input type="checkbox"/>	<input type="checkbox"/>	<input type="checkbox"/>	<input type="checkbox"/>	<input type="checkbox"/>	<input type="checkbox"/>	<input type="checkbox"/>	<input type="checkbox"/>
IM B7 ¹⁾		U	-	<input type="checkbox"/>	<input type="checkbox"/>	<input type="checkbox"/>	<input type="checkbox"/>	<input type="checkbox"/>	<input type="checkbox"/>	<input type="checkbox"/>	<input type="checkbox"/>
IM B8 ¹⁾		V	-	<input type="checkbox"/>	<input type="checkbox"/>	<input type="checkbox"/>	<input type="checkbox"/>	<input type="checkbox"/>	<input type="checkbox"/>	<input type="checkbox"/>	<input type="checkbox"/>
IM V6 ¹⁾		D	-	<input type="checkbox"/>	<input type="checkbox"/>	<input type="checkbox"/>	<input type="checkbox"/>	<input type="checkbox"/>	<input type="checkbox"/>	<input type="checkbox"/>	<input type="checkbox"/>
IM V5 with protective cover ^{1) 2)}		C	H00	<input checked="" type="checkbox"/>	<input checked="" type="checkbox"/>	<input checked="" type="checkbox"/>	<input checked="" type="checkbox"/>	<input checked="" type="checkbox"/>	<input checked="" type="checkbox"/>	<input checked="" type="checkbox"/>	<input checked="" type="checkbox"/>

For legends and footnotes, see page 6/73.

SIMOTICS XP 1MB1, 1MB5 explosion-protected motors

Article No. supplements and special versions · Types of construction

Aluminum series 1MB10

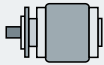
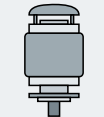
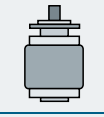
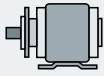
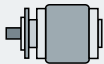
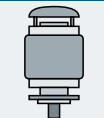
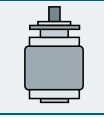
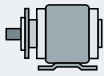
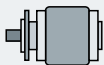
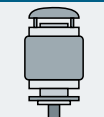
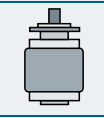
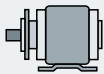
Types of construction	Article No. supplement Type of construction code letter 14th position of the Article No. Article No. with additional identification code -Z Order code	Frame size								Motor version		
		63	71	80	90	100	112	132	160	IEC	Ex tb (Zone 21), Ex tc (Zone 22), Ex ec (Zone 2)	IE3 IE2 IE1
1MB10 (-Z)				1MB10.3								
				1MB10.1								
						1MB10.2						
With flange		Acc. to EN 50347 Acc. to DIN 42 948	FF115 A 140	FF130 A 160	FF165 A 200	FF165 A 200	FF215 A 250	FF215 A 250	FF265 A 300	FF300 A 350		
IM B5		F	-	✓	✓	✓	✓	✓	✓	✓		
IM V1 with protective cover 1) 2)		G	H00	✓	✓	✓	✓	✓	✓	✓		
IM V3 1)		H	-	✓	✓	✓	✓	✓	✓	✓		
IM B35		J	-	✓	✓	✓	✓	✓	✓	✓		
With flange next largest		Acc. to EN 50347 Acc. to DIN 42 948	-	-	-	FF215 A 250	FF265 A 300	FF265 A 300	FF300 A 350	-		
IM B5		F	P01	-	-	✓	✓	✓	✓	-		
IM V1 with protective cover 1) 2)		G	P01+H00	-	-	✓	✓	✓	✓	-		
IM V3 1)		H	P01	-	-	✓	✓	✓	✓	-		
IM B35		J	P01	-	-	✓	✓	✓	✓	-		
With flange next smallest		Acc. to EN 50347 Acc. to DIN 42 948	FT100 A 120	FF115 A 140	FF130 A 160	-	FF165 A 200	FF165 A 200	FF215 A 250	-		
IM B5		F	P02	✓	✓	✓	-	✓	✓	✓		
IM V1 with protective cover 1) 2)		G	P02+H00	✓	✓	✓	-	✓	✓	✓		
IM V3 1)		H	P02	✓	✓	✓	-	✓	✓	✓		
IM B35		J	P02	✓	✓	✓	-	✓	✓	✓		

6







For legends and footnotes, see page 6/73.

SIMOTICS XP 1MB1, 1MB5 explosion-protected motors

Article No. supplements and special versions · Types of construction

Cast-iron series 1MB15 Basic Line, 1MB16 Performance Line







Selection and ordering data

Types of construction	Article No. supplement	Type of construction code letter 14th position of the Article No.	For types of construction with order code(s) Article No. with additional identification code -Z	Frame size														Motor version
				71	80	90	100	112	132	160	180	200	225	250	280	315 S/M	315 L	
				1MB15.3 Basic Line														IEC Ex tb (Zone 21), Ex tc (Zone 22), Ex ec (Zone 2) IE2
				1MB16.3 Performance Line														
				1MB15.1 Basic Line														
				1MB16.1 Performance Line														
1MB15 (-Z)																
1MB16 (-Z)	Order code															
Without flange																		
IM B3		A	-	<input type="checkbox"/>	<input type="checkbox"/>	<input type="checkbox"/>	<input type="checkbox"/>	<input type="checkbox"/>	<input type="checkbox"/>	<input type="checkbox"/>	<input type="checkbox"/>	<input type="checkbox"/>	<input type="checkbox"/>	<input type="checkbox"/>	<input type="checkbox"/>	<input type="checkbox"/>		
IM B6 1)		T	-	<input type="checkbox"/>	<input type="checkbox"/>	<input type="checkbox"/>	<input type="checkbox"/>	<input type="checkbox"/>	<input type="checkbox"/>	<input type="checkbox"/>	<input type="checkbox"/>	<input type="checkbox"/>	<input type="checkbox"/>	<input type="checkbox"/>	<input type="checkbox"/>	<input type="checkbox"/>		
IM B7 1)		U	-	<input type="checkbox"/>	<input type="checkbox"/>	<input type="checkbox"/>	<input type="checkbox"/>	<input type="checkbox"/>	<input type="checkbox"/>	<input type="checkbox"/>	<input type="checkbox"/>	<input type="checkbox"/>	<input type="checkbox"/>	<input type="checkbox"/>	<input type="checkbox"/>	<input type="checkbox"/>		
IM B8 1)		V	-	<input type="checkbox"/>	<input type="checkbox"/>	<input type="checkbox"/>	<input type="checkbox"/>	<input type="checkbox"/>	<input type="checkbox"/>	<input type="checkbox"/>	<input type="checkbox"/>	<input type="checkbox"/>	<input type="checkbox"/>	<input type="checkbox"/>	<input type="checkbox"/>	<input type="checkbox"/>		
IM V6 1)		D	-	<input type="checkbox"/>	<input type="checkbox"/>	<input type="checkbox"/>	<input type="checkbox"/>	<input type="checkbox"/>	<input type="checkbox"/>	<input type="checkbox"/>	<input type="checkbox"/>	<input type="checkbox"/>	<input type="checkbox"/>	<input type="checkbox"/>	<input type="checkbox"/>	<input type="checkbox"/>		
IM V5 with protec- tive cover 1) 2)		C	H00	<input checked="" type="checkbox"/>	<input checked="" type="checkbox"/>	<input checked="" type="checkbox"/>	<input checked="" type="checkbox"/>	<input checked="" type="checkbox"/>	<input checked="" type="checkbox"/>	<input checked="" type="checkbox"/>	<input checked="" type="checkbox"/>	<input checked="" type="checkbox"/>	<input checked="" type="checkbox"/>	<input checked="" type="checkbox"/>	<input checked="" type="checkbox"/>	<input checked="" type="checkbox"/>		

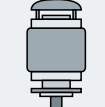
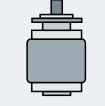
SIMOTICS XP 1MB1, 1MB5 explosion-protected motors

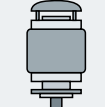
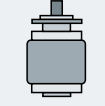
Article No. supplements and special versions · Types of construction

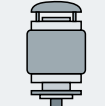
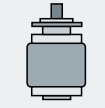









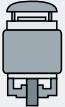

Cast-iron series 1MB15 Basic Line, 1MB16 Performance Line

Types of construction	Article No.	supplement	Frame size														Motor version	
			71	80	90	100	112	132	160	180	200	225	250	280	315 S/M	315 L		
		For types of construction with order code(s) Article No. with additional identification code -Z	1MB15.3 Basic Line														IEC Ex tb (Zone 21), Ex tc (Zone 22), Ex ec (Zone 2)	IE3 IE2
			1MB16.3 Performance Line															
			1MB15.1 Basic Line															
			1MB16.1 Performance Line															
1MB15	■ . . (-Z)																	
1MB16	■ . . (-Z)	Order code																
With flange	Acc. to EN 50347 Acc. to DIN 42 948		FF130 A 160	FF165 A 200	FF165 A 200	FF215 A 250	FF215 A 250	FF265 A 300	FF300 A 350	FF300 A 350	FF350 A 400	FF400 A 450	FF500 A 550	FF500 A 550	FF600 A 660	FF600 A 660		
IM B5 	F	-	✓	✓	✓	✓	✓	✓	✓	✓	✓	✓	✓	✓	✓	✓	-	
IM V1 with protective cover 1) 2) 	G	H00	✓	✓	✓	✓	✓	✓	✓	✓	✓	✓	✓	✓	✓	✓	✓	
IM V3 1) 	H	-	✓	✓	✓	✓	✓	✓	✓	✓	✓	✓	✓	✓	✓	✓	-	
IM B35 1) 	J	-	✓	✓	✓	✓	✓	✓	✓	✓	✓	✓	✓	✓	✓	✓	✓	
With flange next largest	Acc. to EN 50347 Acc. to DIN 42 948		-	-	FF215 A 250	FF265 A 300	FF265 A 300	FF300 A 350	-	-	-	-	-	-	-	-	-	
IM B5 	F	P01	-	-	✓	✓	✓	✓	-	-	-	-	-	-	-	-	-	
IM V1 with protective cover 1) 2) 	G	P01+H00	-	-	✓	✓	✓	✓	-	-	-	-	-	-	-	-	-	
IM V3 1) 	H	P01	-	-	✓	✓	✓	✓	-	-	-	-	-	-	-	-	-	
IM B35 1) 	J	P01	-	-	✓	✓	✓	✓	-	-	-	-	-	-	-	-	-	
With flange next smallest	Acc. to EN 50347 Acc. to DIN 42 948		-	FF130 A 160	-	FF165 A 200	FF165 A 200	FF215 A 250	FF265 A 300	FF265 A 300	FF300 A 350	-	-	-	-	-	-	
IM B5 	F	P02	-	✓	-	✓	✓	✓	✓	✓	✓	✓	-	-	-	-	-	
IM V1 with protective cover 1) 2) 	G	P02+H00	-	✓	-	✓	✓	✓	✓	✓	✓	✓	-	-	-	-	-	
IM V3 1) 	H	P02	-	✓	-	✓	✓	✓	✓	✓	✓	✓	-	-	-	-	-	
IM B35 1) 	J	P02	-	✓	-	✓	✓	✓	✓	✓	✓	✓	-	-	-	-	-	

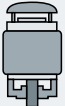
SIMOTICS XP 1MB1, 1MB5 explosion-protected motors

Article No. supplements and special versions · Types of construction

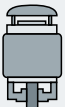
Cast-iron series 1MB15 Basic Line, 1MB16 Performance Line

Types of construction	Article No.	supplement	Frame size													Motor version		
			71	80	90	100	112	132	160	180	200	225	250	280	315 S/M	315 L	IEC	Ex tb (Zone 21), Ex tc (Zone 22), Ex ec (Zone 2)
		For types of construction with order code(s) Article No. with additional identification code -Z	1MB15.3 Basic Line													IEC	Ex tb (Zone 21), Ex tc (Zone 22), Ex ec (Zone 2)	IE3 IE2
		Order code	1MB16.3 Performance Line															
			1MB15.1 Basic Line															
			1MB16.1 Performance Line															
1MB15	■ . . (-Z)																	
1MB16	■ . . (-Z)																	
With flange	Acc. to EN 50347 Acc. to DIN 42 948		FT85 C 105	FT100 C 120	FT115 C 140	FT130 C 160	FT130 C 160	FT165 C 200	FT215 C 250	-	-	-	-	-	-	-	-	-
IM B14 1)		K	-	✓	✓	✓	✓	✓	✓	-	-	-	-	-	-	-	-	-
IM V19 1)		L	-	✓	✓	✓	✓	✓	✓	-	-	-	-	-	-	-	-	-
IM V18 with protective cover 1) 2)		M	H00	✓	✓	✓	✓	✓	✓	-	-	-	-	-	-	-	-	-
IM B34		N	-	✓	✓	✓	✓	✓	✓	-	-	-	-	-	-	-	-	-
With flange next largest	Acc. to EN 50347 Acc. to DIN 42 948		FT115 C 140	FT130 C 160	FT130 C 160	FT165 C 200	FT165 C 200	FT215 C 250	-	-	-	-	-	-	-	-	-	-
IM B14 1)		K	P01	✓	✓	✓	✓	✓	✓	-	-	-	-	-	-	-	-	-
IM V19 1)		L	P01	✓	✓	✓	✓	✓	✓	-	-	-	-	-	-	-	-	-
IM V18 with protective cover 1) 2)		M	P01+H00	✓	✓	✓	✓	✓	✓	-	-	-	-	-	-	-	-	-
IM B34		N	P01	✓	✓	✓	✓	✓	✓	-	-	-	-	-	-	-	-	-
With flange next smallest	Acc. to EN 50347 Acc. to DIN 42 948		-	-	-	FT115 C 140	-	-	-	-	-	-	-	-	-	-	-	-
IM B14 1)		K	P02	-	-	-	✓	-	-	-	-	-	-	-	-	-	-	-
IM V19 1)		L	P02+H00	-	-	-	✓	-	-	-	-	-	-	-	-	-	-	-
IM V18 with protective cover 1) 2)		M	P02	-	-	-	✓	-	-	-	-	-	-	-	-	-	-	-
IM B34		N	P02	-	-	-	✓	-	-	-	-	-	-	-	-	-	-	-

- Standard version
- ✓ With additional charge
- Not possible

1) The following applies for explosion-protected motors: In the case of the types of construction with shaft extension down, the version "with protective cover" is required. For types of construction with shaft extension pointing upwards, a suitable cover must be implemented to prevent small parts from falling into the fan cover (see the standard IEC/EN 60079-0). The cover must not block the cooling air flow.











2) The "Standard cylindrical shaft extension (second shaft extension)" option (order code **L05**) is not possible.

SIMOTICS XP 1MB1, 1MB5 explosion-protected motors

Article No. supplements and special versions · Types of construction

Aluminum series 1MB1042; Cast-iron series 1MB.543 Basic Line and 1MB.643 Performance Line

Selection and ordering data

Types of construction	Article No. supplement	For types of construction with order code(s) Article No. with additional identification code - Z	Frame size														Motor version			
			63	71	80	90	100	112	132	160	180	200	225	250	280	315 S/M	315 L	IEC	Ex eb (Zone 1)	IE1 IE3
			1MB1042																	
			1MB1543 Basic Line																	
			1MB1643 Performance Line																	
			1MB543 Basic Line																	
			1MB5643 Performance Line																	
1MB1042 - (-Z)																			
1MB.543 - (-Z)																			
1MB.643 - (-Z)	Order code																		
Without flange																				
IM B3 2)		A	-	<input type="checkbox"/>	<input type="checkbox"/>	<input type="checkbox"/>	<input type="checkbox"/>	<input type="checkbox"/>	<input type="checkbox"/>	<input type="checkbox"/>	<input type="checkbox"/>	<input type="checkbox"/>	<input type="checkbox"/>	<input type="checkbox"/>	<input type="checkbox"/>	<input type="checkbox"/>	<input type="checkbox"/>	<input type="checkbox"/>	<input type="checkbox"/>	
IM B6 1) 2)		T	-	<input type="checkbox"/>	<input type="checkbox"/>	<input type="checkbox"/>	<input type="checkbox"/>	<input type="checkbox"/>	<input type="checkbox"/>	<input type="checkbox"/>	<input type="checkbox"/>	<input type="checkbox"/>	<input type="checkbox"/>	<input type="checkbox"/>	<input type="checkbox"/>	<input type="checkbox"/>	<input type="checkbox"/>	<input type="checkbox"/>	<input type="checkbox"/>	
IM B7 1) 2)		U	-	<input type="checkbox"/>	<input type="checkbox"/>	<input type="checkbox"/>	<input type="checkbox"/>	<input type="checkbox"/>	<input type="checkbox"/>	<input type="checkbox"/>	<input type="checkbox"/>	<input type="checkbox"/>	<input type="checkbox"/>	<input type="checkbox"/>	<input type="checkbox"/>	<input type="checkbox"/>	<input type="checkbox"/>	<input type="checkbox"/>	<input type="checkbox"/>	
IM B8 1) 2)		V	-	<input type="checkbox"/>	<input type="checkbox"/>	<input type="checkbox"/>	<input type="checkbox"/>	<input type="checkbox"/>	<input type="checkbox"/>	<input type="checkbox"/>	<input type="checkbox"/>	<input type="checkbox"/>	<input type="checkbox"/>	<input type="checkbox"/>	<input type="checkbox"/>	<input type="checkbox"/>	<input type="checkbox"/>	<input type="checkbox"/>	<input type="checkbox"/>	
IM V6 1) 2)		D	-	<input type="checkbox"/>	<input type="checkbox"/>	<input type="checkbox"/>	<input type="checkbox"/>	<input type="checkbox"/>	<input type="checkbox"/>	<input type="checkbox"/>	<input type="checkbox"/>	<input type="checkbox"/>	<input type="checkbox"/>	<input type="checkbox"/>	<input type="checkbox"/>	<input type="checkbox"/>	<input type="checkbox"/>	<input type="checkbox"/>	<input type="checkbox"/>	
IM V5 with protective cover 1) 2)		C	H00	<input checked="" type="checkbox"/>	<input checked="" type="checkbox"/>	<input checked="" type="checkbox"/>	<input checked="" type="checkbox"/>	<input checked="" type="checkbox"/>	<input checked="" type="checkbox"/>	<input checked="" type="checkbox"/>	<input checked="" type="checkbox"/>	<input checked="" type="checkbox"/>	<input checked="" type="checkbox"/>	<input checked="" type="checkbox"/>	<input checked="" type="checkbox"/>	<input checked="" type="checkbox"/>	<input checked="" type="checkbox"/>	<input checked="" type="checkbox"/>	<input checked="" type="checkbox"/>	
With flange		Acc. to EN 50347 Acc. to DIN 42 948		FF130 A 160	FF130 A 160	FF165 A 200	FF165 A 200	FF215 A 250	FF215 A 250	FF265 A 300	FF300 A 350	FF300 A 350	FF350 A 400	FF400 A 450	FF500 A 550	FF500 A 550	FF600 A 660	FF600 A 660		
IM B5 2)		F	-	<input checked="" type="checkbox"/>	<input checked="" type="checkbox"/>	<input checked="" type="checkbox"/>	<input checked="" type="checkbox"/>	<input checked="" type="checkbox"/>	<input checked="" type="checkbox"/>	<input checked="" type="checkbox"/>	<input checked="" type="checkbox"/>	<input checked="" type="checkbox"/>	<input checked="" type="checkbox"/>	<input checked="" type="checkbox"/>	<input checked="" type="checkbox"/>	<input checked="" type="checkbox"/>	<input checked="" type="checkbox"/>	<input checked="" type="checkbox"/>	<input checked="" type="checkbox"/>	
IM V1 with protective cover 1) 2) 3)		G	H00	<input checked="" type="checkbox"/>	<input checked="" type="checkbox"/>	<input checked="" type="checkbox"/>	<input checked="" type="checkbox"/>	<input checked="" type="checkbox"/>	<input checked="" type="checkbox"/>	<input checked="" type="checkbox"/>	<input checked="" type="checkbox"/>	<input checked="" type="checkbox"/>	<input checked="" type="checkbox"/>	<input checked="" type="checkbox"/>	<input checked="" type="checkbox"/>	<input checked="" type="checkbox"/>	<input checked="" type="checkbox"/>	<input checked="" type="checkbox"/>	<input checked="" type="checkbox"/>	
IM V3 1) 2)		H	-	<input checked="" type="checkbox"/>	<input checked="" type="checkbox"/>	<input checked="" type="checkbox"/>	<input checked="" type="checkbox"/>	<input checked="" type="checkbox"/>	<input checked="" type="checkbox"/>	<input checked="" type="checkbox"/>	<input checked="" type="checkbox"/>	<input checked="" type="checkbox"/>	<input checked="" type="checkbox"/>	<input checked="" type="checkbox"/>	<input checked="" type="checkbox"/>	<input checked="" type="checkbox"/>	<input checked="" type="checkbox"/>	<input checked="" type="checkbox"/>	<input checked="" type="checkbox"/>	
IM B35 1) 2)		J	-	<input checked="" type="checkbox"/>	<input checked="" type="checkbox"/>	<input checked="" type="checkbox"/>	<input checked="" type="checkbox"/>	<input checked="" type="checkbox"/>	<input checked="" type="checkbox"/>	<input checked="" type="checkbox"/>	<input checked="" type="checkbox"/>	<input checked="" type="checkbox"/>	<input checked="" type="checkbox"/>	<input checked="" type="checkbox"/>	<input checked="" type="checkbox"/>	<input checked="" type="checkbox"/>	<input checked="" type="checkbox"/>	<input checked="" type="checkbox"/>	<input checked="" type="checkbox"/>	
IM V15 1) 2)		W	-	<input type="checkbox"/>	<input checked="" type="checkbox"/>	<input checked="" type="checkbox"/>	<input checked="" type="checkbox"/>	<input checked="" type="checkbox"/>	<input checked="" type="checkbox"/>	<input checked="" type="checkbox"/>	<input checked="" type="checkbox"/>	<input checked="" type="checkbox"/>	<input checked="" type="checkbox"/>	<input checked="" type="checkbox"/>	<input checked="" type="checkbox"/>	<input checked="" type="checkbox"/>	<input checked="" type="checkbox"/>	<input checked="" type="checkbox"/>	<input checked="" type="checkbox"/>	

For legends and footnotes, see page 6/79.

SIMOTICS XP 1MB1, 1MB5 explosion-protected motors

Article No. supplements and special versions · Types of construction

Aluminum series 1MB1042; Cast-iron series 1MB.543 Basic Line and 1MB.643 Performance Line

Types of construction	Article No. supplement	Frame size	Motor version																	
			63	71	80	90	100	112	132	160	180	200	225	250	280	315 S/M	315 L	IEC	Ex eb (Zone 1)	IE1 IE3
			1MB1042																	
			1MB1543 Basic Line																	
			1MB1643 Performance Line																	
			1MB5543 Basic Line																	
			1MB5643 Performance Line																	
1MB1042 - - ■ .. (-Z)																				
1MB.543 - - ■ .. (-Z)																				
1MB.643 - - ■ .. (-Z)																				
			Order code																	
With flange next largest	Acc. to EN 50347 Acc. to DIN 42 948		-	-	-	-	-	-	-	-	-	-	-	-	-	-	-	-	-	-
IM B5 2)	F	P01	-	-	-	-	-	-	-	-	-	-	-	-	-	-	-	-	-	-
IM V1 with protective cover 1) 2) 3)	G	P01+H00	-	-	-	-	-	-	-	-	-	-	-	-	-	-	-	-	-	-
IM V3 1) 2)	H	P01	-	-	-	-	-	-	-	-	-	-	-	-	-	-	-	-	-	-
IM B35 1) 2)	J	P01	-	-	-	-	-	-	-	-	-	-	-	-	-	-	-	-	-	-
IM V15 1) 2)	W	P01	-	-	-	-	-	-	-	-	-	-	-	-	-	-	-	-	-	-
With flange next smallest	Acc. to EN 50347 Acc. to DIN 42 948		-	-	-	-	-	-	-	-	-	-	-	-	-	-	-	-	-	-
IM B5 2)	F	P02	-	-	-	-	-	-	-	-	-	-	-	-	-	-	-	-	-	-
IM V1 with protective cover 1) 2) 3)	G	P02+H00	-	-	-	-	-	-	-	-	-	-	-	-	-	-	-	-	-	-
IM V3 1) 2)	H	P02	-	-	-	-	-	-	-	-	-	-	-	-	-	-	-	-	-	-
IM B35 1) 2)	J	P02	-	-	-	-	-	-	-	-	-	-	-	-	-	-	-	-	-	-
IM V15 1) 2)	W	P02	-	-	-	-	-	-	-	-	-	-	-	-	-	-	-	-	-	-











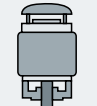

6

For legends and footnotes, see page 6/79.

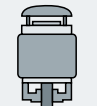
SIMOTICS XP 1MB1, 1MB5 explosion-protected motors

Article No. supplements and special versions · Types of construction

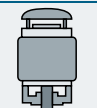
Aluminum series 1MB1042; Cast-iron series 1MB.543 Basic Line and 1MB.643 Performance Line

Types of construction	Article No.	supplement	Frame size																Motor version		
			63	71	80	90	100	112	132	160	180	200	225	250	280	315 S/M	315 L	IEC	Ex eb (Zone 1)	IE1 IE3	
			1MB1042																		
			1MB1543 Basic Line																		
			1MB1643 Performance Line																		
			1MB543 Basic Line																		
			1MB5643 Performance Line																		
1MB1042 -	■ .. (-Z)																				
1MB.543 -	■ .. (-Z)																				
1MB.643 -	■ .. (-Z)																				
		Order code																			
With flange	Acc. to EN 50347		FT75	FT85	FT100	FT115	FT130	FT130	FT165	FT215	-	-	-	-	-	-	-	-	-	-	
	Acc. to DIN 948		C 90	C 105	C 120	C 140	C 160	C 160	C 200	C 250	-	-	-	-	-	-	-	-	-	-	
IM B14 1) 2)		K	-	✓	✓	✓	✓	✓	✓	✓	-	-	-	-	-	-	-	-	-	-	
IM V19 1) 2)		L	-	✓	✓	✓	✓	✓	✓	✓	-	-	-	-	-	-	-	-	-	-	
IM V18 with protective cover 1) 2) 3)		M	H00	✓	✓	✓	✓	✓	✓	✓	-	-	-	-	-	-	-	-	-	-	
IM B34 1) 2)		N	-	✓	✓	✓	✓	✓	✓	✓	-	-	-	-	-	-	-	-	-	-	
With flange next largest	Acc. to EN 50347		FT100	FT115	FT130	FT130	FT165	FT165	FT215	-	-	-	-	-	-	-	-	-	-	-	
	Acc. to DIN 42 948		C 120	C 140	C 160	C 160	C 200	C 200	C 250	-	-	-	-	-	-	-	-	-	-	-	
IM B14 1) 2) 4)		K	P01	✓	✓	✓	✓	✓	✓	✓	-	-	-	-	-	-	-	-	-	-	
IM V19 1) 2) 4)		L	P01	✓	✓	✓	✓	✓	✓	✓	-	-	-	-	-	-	-	-	-	-	
IM V18 with protective cover 1) 2) 3) 4)		M	P01+H00	✓	✓	✓	✓	✓	✓	✓	-	-	-	-	-	-	-	-	-	-	
IM B34 1) 2) 4)		N	P01	✓	✓	✓	✓	✓	✓	✓	-	-	-	-	-	-	-	-	-	-	
With flange next smallest	Acc. to EN 50347		-	-	-	-	FT115	-	-	-	-	-	-	-	-	-	-	-	-	-	
	Acc. to DIN 42 948		-	-	-	-	C 140	-	-	-	-	-	-	-	-	-	-	-	-	-	
IM B14 1) 2) 4)		K	P02	-	-	-	✓	-	-	-	-	-	-	-	-	-	-	-	-	-	
IM V19 1) 2) 4)		L	P02	-	-	-	✓	-	-	-	-	-	-	-	-	-	-	-	-	-	
IM V18 with protective cover 1) 2) 3) 4)		M	P02+H00	-	-	-	✓	-	-	-	-	-	-	-	-	-	-	-	-	-	
IM B34 1) 2) 4)		N	P02	-	-	-	✓	-	-	-	-	-	-	-	-	-	-	-	-	-	

□ Standard version ✓ With additional charge - Not possible













- 1) The following applies for explosion-protected motors: In the case of the types of construction with shaft extension down, the version "with protective cover" is required. For types of construction with shaft extension pointing upwards, a suitable cover must be implemented to prevent small parts from falling into the fan cover (see the standard IEC/EN 60079-0). The cover must not block the cooling air flow.
- 2) The type of construction is stamped on the rating plate. For orders with condensation drainage holes (order code **H03**), if mounted in a different position, the position must be specified to ensure that the condensation drainage holes are positioned correctly.
- 3) The "Standard cylindrical shaft extension (second shaft extension)" option (order code **L05**) is not possible.
- 4) With reference to standard EN 50347, flanges that are 2 steps larger are used with option P01 in the frame sizes 71 and 80.

SIMOTICS XP 1MB1, 1MB5 explosion-protected motors

Article No. supplements and special versions · Types of construction

Cast-iron series 1MB.55., 1MB.853, 1MB.56., 1MB.863

Selection and ordering data

Types of construction	Article No. supplement		Frame size													Motor version		
	Type of construction code letter 14th position of the Article No.	For types of construction with order code(s) Article No. with additional identification code -Z Order code	71	80	90	100	112	132	160	180	200	225	250	280	315	355	IEC	Ex db, Ex db eb (Zone 1)
			1MB1.5., 1MB1.6.															
													1MB55..					
						1MB18.3												
													1MB58.3					
1MB.553 - - . . . (-Z)																		
Without flange																		
IM B3		A	-															
IM B6 1)		T	-															
IM B7 1)		U	-															
IM B8		V	-															Only for: up to frame size 315 S/M
IM V6 1)		D	-															
IM V5 with protective cover 1) 3)		C	H00	✓	✓	✓	✓	✓	✓	✓	✓	✓	✓	✓	✓	✓	-	
With flange			Acc. to EN 50347 Acc. to DIN 42 948	FF130 A 160	FF165 A 200	FF165 A 200	FF215 A 250	FF215 A 250	FF265 A 300	FF300 A 350	FF300 A 350	FF350 A 400	FF400 A 450	FF500 A 550	FF500 A 550	FF600 A 660	FF740 A 800	
IM B5 1)		F	-	✓	✓	✓	✓	✓	✓	✓	✓	✓	✓	✓	✓	✓	-	
IM V1 with protective cover 3)		G	H00	✓	✓	✓	✓	✓	✓	✓	✓	✓	✓	✓	✓	✓	✓	
IM V3		H	-	✓	✓	✓	✓	✓	✓	✓	✓	✓	✓	✓	✓	✓	-	
IM B35		J	-	✓	✓	✓	✓	✓	✓	✓	✓	✓	✓	✓	✓	✓	✓	
IM V15 with protective cover 3)		W	-	✓	✓	✓	✓	✓	✓	✓	✓	✓	✓	✓	✓	✓	-	
IM V35 2) 3)		Y	-	✓	✓	✓	✓	✓	✓	✓	✓	✓	✓	✓	✓	✓	-	











6

For legends and footnotes, see page 6/81.

SIMOTICS XP 1MB1, 1MB5 explosion-protected motors

Article No. supplements and special versions · Types of construction

Cast-iron series 1MB.55., 1MB.853, 1MB.56., 1MB.863

Types of construction	Article No. supplement		Frame size													Motor version		
	Type of construction code letter 14th position of the Article No.	For types of construction with order code(s) Article No. with additional identification code -Z Order code	71	80	90	100	112	132	160	180	200	225	250	280	315	355	IEC	Ex db, Ex db eb (Zone 1)
1MB.553 - - . . . (-Z)			1MB1.5., 1MB1.6.															
													1MB55..					
						1MB18.3												
												1MB58.3						
With flange	Acc. to EN 50347 Acc. to DIN 42 948		FT85 C 105	FT100 C 120	FT115 C 140	FT130 C 160	FT130 C 160	FT165 C 200	FT215 C 250	-	-	-	-	-	-	-	-	-
IM B14 	K	-	✓	✓	✓	✓	✓	✓	✓	-	-	-	-	-	-	-	-	-
IM V19 	L	-	✓	✓	✓	✓	✓	✓	✓	-	-	-	-	-	-	-	-	-
IM V18 with protective cover 3) 	M	H00	✓	✓	✓	✓	✓	✓	✓	-	-	-	-	-	-	-	-	-
IM B34 	N	-	✓	✓	✓	✓	✓	✓	✓	-	-	-	-	-	-	-	-	-
IM V17 3) 	X	H00	✓	✓	✓	✓	✓	✓	✓	-	-	-	-	-	-	-	-	-
With flange next largest	Acc. to EN 50347 Acc. to DIN 42 948		FT115 C 140	FT130 C 160	FT130 C 160	FT165 C 200	FT165 C 200	FT215 C 250	-	-	-	-	-	-	-	-	-	-
IM B14 	K	P01	✓	✓	✓	✓	✓	✓	✓	-	-	-	-	-	-	-	-	-
IM V19 	L	P01	✓	✓	✓	✓	✓	✓	✓	-	-	-	-	-	-	-	-	-
IM V18 with protective cover 1) 	M	P01+H00	✓	✓	✓	✓	✓	✓	✓	-	-	-	-	-	-	-	-	-
IM B34 	N	P01	✓	✓	✓	✓	✓	✓	✓	-	-	-	-	-	-	-	-	-
IM V17 3) 	X	P01+H00	✓	✓	✓	✓	✓	✓	✓	-	-	-	-	-	-	-	-	-

- Standard version
- ✓ With additional charge
- Not possible

1) Only possible for frame size 315 S/M (horizontal mounting).
 2) The "Standard cylindrical shaft extension (second shaft extension)" option (order code **L05**) is not possible.







3) The following applies for explosion-protected motors: In the case of the types of construction with shaft extension down, the version "with protective cover" is required. For types of construction with shaft extension pointing upwards, a suitable cover must be implemented to prevent small parts from falling into the fan cover (see the standard IEC/EN 60079-0). The cover must not block the cooling air flow.

SIMOTICS XP 1MB1, 1MB5 explosion-protected motors

Article No. supplements and special versions · Types of construction

Cast-iron series 1MB55.4, 1MB55.3, 1MB58.3

Selection and ordering data





Types of construction	Article No. supplement Type of construction code letter 14th position of the Article No.	For types of construction with order code(s) Article No. with additional identification code -Z Order code	Frame size				Motor version		
			315	355	400	450	IEC	Ex ec, Ex tc, Ex tb (Zones 2, 22 and 21)	IE4 IE3
1MB5 -Z			1MB55 . 4						
			1MB55 . 3						
					1MB58 . 3				
Without flange									
IM B3 ^{1) 2)}	 A	-	□	□	□	□			
IM B6 ³⁾	 T	-	○	○	-	-			
IM B7 ³⁾	 U	-	○	○	-	-			
IM B8 ³⁾	 V	-	○	○	-	-			
IM V6 ²⁾	 D	-	○	○	O. R. ⁷⁾	O. R. ⁷⁾			
IM V5 without protective cover ^{2) 3)}	 C	-	○	○	O. R. ⁷⁾	O. R. ⁷⁾			
IM V5 with protective cover ^{2) 3) 4) 5)}	 C	H00	✓	✓	O. R. ⁷⁾	O. R. ⁷⁾			

SIMOTICS XP 1MB1, 1MB5 explosion-protected motors

Article No. supplements and special versions · Types of construction

Cast-iron series 1MB55.4, 1MB55.3, 1MB58.3

Selection and ordering data

Types of construction	Article No. supplement	Motor version	Frame size			
			315	355	400	450
1MB5 -Z	Type of construction code letter 14th position of the Article No.	IEC Ex ec, Ex tc, Ex tb (Zones 2, 22 and 21) IE4 IE3	1MB55 . 4			
	For types of construction with order code(s) Article No. with additional identification code -Z Order code		1MB55 . 3		1MB58 . 3	
With flange	EN 50347 DIN 42948				FF940 A 1000	FF1080 A 1150
IM B5 ^{2) 7) 8)}	 F	-	✓	✓	✓ ⁶⁾	✓ ⁶⁾
IM V1 without protective cover ^{2) 3)}	 G	-	✓	✓	✓ ⁷⁾	✓ ⁷⁾
IM V1 with protective cover ^{2) 3) 4) 5)}	 G	H00	✓	✓	✓ ⁷⁾	✓ ⁷⁾
IM V3 ³⁾	 H	-	✓	✓	-	-
IM B35 ⁴⁾	 J	-	✓	✓	✓	✓

- Standard version
- Without additional charge
- ✓ With additional charge

¹⁾ The types of construction IM B6/7/8, IM V6 and IM V5 with/without protective cover are also possible as long as no stamping of these types of construction on the rating plate is required. As standard the type of construction IM B3 is then stamped on the rating plate. With type of construction IM V5 with protective cover, the protective cover has to be additionally ordered with order code **H00**. The protective cover is not stamped on the rating plate.

²⁾ The type of construction is stamped on the rating plate. If mounted in a different position, the position must be specified to ensure that the condensation drainage holes are positioned correctly.

³⁾ The following applies for explosion-protected motors: In the case of the types of construction with shaft extension down, the version "with protective cover" is required. For types of construction with shaft extension pointing upwards, a suitable cover must be implemented to prevent small parts from falling into the fan cover (see the standard IEC/EN 60079-0). The cover must not block the cooling air flow.

⁴⁾ In combination with an encoder, it is not necessary to order the protective cover (order code **H00**), as this is delivered as a protection for the encoder as standard. In this case the protective cover is standard design (without additional charge).

⁵⁾ The "Standard cylindrical shaft extension (second shaft extension)" option (order code **L05**) is not possible.

⁶⁾ Not available for 2-pole motors.

⁷⁾ The types of construction IM V3 and IM V1 with/without protective cover are also possible as long as no stamping of these types of construction on the rating plate is required. As standard the type of construction IM B5 is then stamped on the rating plate. With type of construction IM V1 with protective cover, the protective cover has to be additionally ordered with order code **H00**. The protective cover is not stamped on the rating plate.

⁸⁾ For machines, type of construction IM B5, provide an additional support foot at the NDE. The support foot is not included in the scope of supply. Use an appropriately sized support foot with the appropriate rigidity. The support foot must be able to support the total weight of the machine.

SIMOTICS XP 1MB1, 1MB5 explosion-protected motors

Article No. supplements and special versions · Motor protection

Aluminum series 1MB10**Selection and ordering data**

Motor protection	Article No. supplement		Frame size								Motor version		
	Motor protection code letter 15th position of the Article No.	Additional identification code with order code and plain text, if required	63	71	80	90	100	112	132	160	IEC	Ex tb (Zone 21), Ex tc (Zone 22), Ex ec (Zone 2)	IE3 IE2 IE1
1MB10 ■ .		Order code			1MB10.3								
			1MB10.1										
								1MB10.2					

Motor protection													
Motor protection	Article No.	Additional identification code with order code and plain text, if required	63	71	80	90	100	112	132	160	IEC	Ex tb (Zone 21), Ex tc (Zone 22), Ex ec (Zone 2)	IE3 IE2 IE1
None (standard)	A	–	☐	☐	☐	☐	☐	☐	☐	☐			
3 PTC thermistors – for tripping (2 terminals) ¹⁾	B	–	✓	✓	✓	✓	✓	✓	✓	✓			
6 PTC thermistors – for warning and tripping (4 terminals) ¹⁾	C	–	✓	✓	✓	✓	✓	✓	✓	✓			
1 KTY84-130 temperature sensor (2 terminals) ¹⁾	F	–	✓	✓	✓	✓	✓	✓	✓	✓			
2 KTY84-130 temperature sensors (4 terminals) ¹⁾	G	–	✓	✓	✓	✓	✓	✓	✓	✓			
3 Pt100 resistance thermometers – 2-wire input (6 terminals) ^{1) 2)}	H	–	–	–	–	–	✓	✓	✓	✓			
1 Pt1000 resistance thermometer (2 terminals) ¹⁾	K	–	✓	✓	✓	✓	✓	✓	✓	✓			
2 Pt1000 resistance thermometers (4 terminals) ¹⁾	L	–	✓	✓	✓	✓	✓	✓	✓	✓			

- ☐ Standard version
- ✓ With additional charge
- Not possible

¹⁾ Evaluation with associated tripping unit (see Catalog IC 10) is recommended. In converter operation, PTC thermistor motor protection is always required.

²⁾ In combination with the 15th position of the Article No. **'H'**, the order codes **Q02** and **Q03** are not possible for frame sizes 100 to 160. It can only be supplied with a star or delta winding for direct switch-on (3 terminals).

SIMOTICS XP 1MB1, 1MB5 explosion-protected motors

Article No. supplements and special versions · Motor protection

Cast-iron series 1MB15 Basic Line, 1MB16 Performance Line

Selection and ordering data

Motor protection	Article No. supplement		Frame size													Motor version	
	Motor protection code letter 15th position of the Article No.	Additional identification code with order code and plain text, if required	71	80	90	100	112	132	160	180	200	225	250	280	315	IEC	Ex tb (Zone 21), IE3 Ex tc (Zone 22), Ex ec (Zone 2) — IE2
			1MB15.3 Basic Line														
			1MB16.3 Performance Line														
			1MB15.1 Basic Line														
			1MB16.1 Performance Line														
1MB15																	
1MB16																	
		Order code															

Motor protection	Article No.	Additional identification code with order code and plain text, if required	71	80	90	100	112	132	160	180	200	225	250	280	315	Notes
None (standard)	A	–	□	□	□	□	□	□	□	□	□	□	□	□	□	Only for: 1MB15.. Basic Line
3 PTC thermistors – for tripping (2 terminals) ¹⁾	B	–	✓	✓	✓	✓	✓	✓	✓	✓	✓	✓	✓	✓	✓	
6 PTC thermistors – for warning and tripping (4 terminals) ²⁾	C	–	✓	✓	✓	✓	✓	✓	✓	✓	✓	✓	✓	✓	✓	Only for: 1MB15.. Basic Line
			–	–	–	□	□	□	□	□	□	□	□	□	□	Only for: MB16.. Performance Line
3 Pt100 resistance thermometers – 2-wire input (6 terminals) ^{2) 3)}	H	Q60	✓	✓	✓	✓	✓	✓	✓	✓	✓	✓	✓	✓	✓	
6 Pt100 resistance thermometers – 2-wire input (12 terminals) ²⁾	J	Q61	–	–	–	–	–	–	–	✓	✓	✓	✓	✓	✓	
1 Pt1000 resistance thermometer (2 terminals) ²⁾	K	–	✓	✓	✓	✓	✓	✓	✓	✓	✓	✓	✓	✓	✓	
2 Pt1000 resistance thermometers (4 terminals) ²⁾	L	–	✓	✓	✓	✓	✓	✓	✓	✓	✓	✓	✓	✓	✓	
3 Pt100 resistance thermometers – 3-wire input (9 terminals) ^{4) 5)}	Q	Q63	–	–	–	–	–	–	–	✓	✓	✓	✓	✓	✓	
6 Pt100 resistance thermometers – 3-wire input (18 terminals) ^{4) 5)}	R	Q64	–	–	–	–	–	–	–	✓	✓	✓	✓	✓	✓	

- Standard version
- ✓ With additional charge
- Not possible

¹⁾ For the Performance Line, motor protection by means of PTC thermistors with 3 built-in temperature sensors for tripping (motor protection code letter B) is already included in the basic price. For the Performance Line, the option "without motor protection" (motor protection code letter A) is not possible.

²⁾ Evaluation with associated tripping unit (see Catalog IC 10) is recommended. In converter operation, PTC thermistor motor protection is always required.

³⁾ In combination with the 15th position of the Article No. "H", the order codes **Q02** and **Q03** are not possible for frame sizes 100 to 160. It can only be supplied with a star or delta winding for direct switch-on (3 terminals).

⁴⁾ Maximum number of terminals for accessories, see the terminal box concept.

⁵⁾ Auxiliary terminal box required; option in Ex eb with order code **R62** or **R63**.

SIMOTICS XP 1MB1, 1MB5 explosion-protected motors

Article No. supplements and special versions · Motor protection

Cast-iron series 1MB.55., 1MB.853, 1MB.56., 1MB.863

Selection and ordering data

Motor protection	Article No. supplement		Frame size													Motor version		
	Motor protection code letter 15th position of the Article No.	Additional identification code with order code and plain text, if required	71	80	90	100	112	132	160	180	200	225	250	280	315	355	IEC	Ex db, Ex db eb (Zone 1)
			1MB1.5., 1MB1.6.															
												1MB555.						
						1MB18.3												
												1MB58.3						
		Order code																
Motor protection																		
None (standard)	A	–	☐	☐	☐	☐	☐	☐	☐	☐	☐	☐	☐	☐	☐	☐		
3 PTC thermistors – for tripping (2 terminals) ¹⁾	B	–	✓	✓	✓	✓	✓	✓	✓	✓	✓	✓	✓	✓	✓	✓		
6 PTC thermistors – for warning and tripping (4 terminals) ^{1) 2)}	C	–	✓	✓	✓	✓	✓	✓	✓	✓	✓	✓	✓	✓	✓	✓		
3 Pt100 resistance thermometers – 2-wire input (6 terminals) ²⁾	H	Q60	–	–	–	✓	✓	✓	✓	✓	✓	✓	✓	✓	✓	✓		
6 Pt100 resistance thermometers – 2-wire input (12 terminals) ^{2) 3)}	J	Q61	–	–	–	–	–	–	–	✓	✓	✓	✓	✓	✓	✓		Only for: Motors with option code R50
			–	–	–	–	–	–	–	–	–	–	–	–	–	–	–	Only for: Motors with option code R54
			–	–	–	–	–	–	–	–	–	–	–	–	–	–	–	
1 Pt1000 resistance thermometers (2 terminals)	K	Q35	✓	✓	✓	✓	✓	✓	✓	✓	✓	✓	✓	✓	✓	✓		
2 Pt1000 resistance thermometers (4 terminals) ²⁾	L	Q36	✓	✓	✓	✓	✓	✓	✓	✓	✓	✓	✓	✓	✓	✓		
3 Pt100 resistance thermometers – 3-wire input (9 terminals) ^{2) 3)}	Q	Q63	–	–	–	–	–	–	–	✓	✓	✓	✓	✓	✓	✓		
			–	–	–	–	–	–	–	–	–	–	–	–	–	–	–	Only for: Motors with option code R50 or R54
6 Pt100 resistance thermometers – 3-wire input (18 terminals) ^{2) 3)}	R	Q64	–	–	–	–	–	–	–	–	–	–	–	–	–	–		Only for: Motors with option code R50
			–	–	–	–	–	–	–	–	–	–	–	–	–	–	–	Only for: Motors with option code R54
			–	–	–	–	–	–	–	–	–	–	–	–	–	–	–	

- ☐ Standard version
 ✓ With additional charge
 – Not possible

¹⁾ Evaluation with associated tripping unit (see Catalog IC 10) is recommended. In converter operation, PTC thermistor motor protection is always required.

²⁾ Maximum number of terminals for accessories, see the terminal box concept.

³⁾ Auxiliary terminal box required; option in Ex eb with order code **R62** or **R63**.

SIMOTICS XP 1MB1, 1MB5 explosion-protected motors

Article No. supplements and special versions · Motor protection

Cast-iron series 1MB55.4, 1MB55.3, 1MB58.3

Selection and ordering data

Motor protection	Article No. supplement		Frame size				Motor version		
	Motor protection code letter 15th position of the Article No.	Additional identification code with order code and plain text, if required	315	355	400	450	IEC	Ex ec, Ex tc, Ex tb (Zones 2, 22 and 21)	IE4 IE3
			1MB55 . 4						
			1MB55 . 3						
					1MB58 . 3				
	1MB5	■ .							
Motor protection									
None (standard)	A	–			□	□			
1 or 3 PTC thermistors – for tripping (2 terminals) ¹⁾	B	–	✓	✓	✓	✓			
2 or 6 PTC thermistors – for alarm and tripping (4 terminals) ¹⁾	C	–	✓	✓	✓	✓			
1 KTY84-130 temperature sensor (2 terminals) ¹⁾	F	–	✓	✓	✓	✓			
2 KTY84-130 temperature sensors (4 terminals) ¹⁾	G	–	✓	✓	✓	✓			
3 Pt100 resistance thermometers – 2-wire input (6 terminals)	H	–	✓	✓	✓	✓			
6 Pt100 resistance thermometers – 2-wire input (12 terminals)	J	–	✓	✓	✓	✓			
1 Pt1000 resistance thermometer (2 terminals)	K	–	✓	✓	✓	✓			
2 Pt1000 resistance thermometers (4 terminals)	L	–	✓	✓	✓	✓			
1 Pt100 resistance thermometer – 2-wire input (2 terminals)	P	–	✓	✓	✓	✓			
3 Pt100 resistance thermometers – 3-wire input (9 terminals)	Q	–	✓	✓	✓	✓			
6 Pt100 resistance thermometers – 3-wire input (18 terminals)	R	–	✓	✓	✓	✓			

- Standard version
- ✓ With additional charge

Note:

Options are available specifically for bearing protection – for order codes and descriptions, see from page 6/113.

¹⁾ Evaluation with associated tripping unit (see Catalog IC 10) is recommended. In converter operation, PTC thermistor motor protection is always required.

SIMOTICS XP 1MB1, 1MB5 explosion-protected motors

Article No. supplements and special versions · Terminal box position

Aluminum series 1MB10

Selection and ordering data

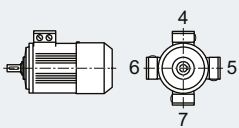
Terminal box position	Article No. supplement	Frame size	Motor version
	Terminal box position code 16th position of the Article No.	63 71 80 90 100 112 132 160	
 <p>1MB10.....</p>	Additional identification code with order code and plain text, if required	1MB10.3	IEC Ex tb (Zone 21), IE3 Ex tc (Zone 22), IE2 Ex ec (Zone 2) IE1
		1MB10.1	
		1MB10.2	
	Order code		

Terminal box position			
Terminal box top ¹⁾	4	–	<input type="checkbox"/> <input type="checkbox"/> <input type="checkbox"/> <input type="checkbox"/> <input type="checkbox"/> <input type="checkbox"/> <input type="checkbox"/> <input type="checkbox"/>
Terminal box right-hand side ²⁾	5	–	<input type="checkbox"/> <input type="checkbox"/> <input checked="" type="checkbox"/> <input checked="" type="checkbox"/> <input checked="" type="checkbox"/> <input checked="" type="checkbox"/> <input checked="" type="checkbox"/> <input checked="" type="checkbox"/>
Terminal box left-hand side ²⁾	6	–	<input type="checkbox"/> <input type="checkbox"/> <input checked="" type="checkbox"/> <input checked="" type="checkbox"/> <input checked="" type="checkbox"/> <input checked="" type="checkbox"/> <input checked="" type="checkbox"/> <input checked="" type="checkbox"/>
Terminal box at bottom ^{2) 3)}	7	–	<input type="checkbox"/> <input type="checkbox"/> <input type="checkbox"/> <input type="checkbox"/> <input checked="" type="checkbox"/> <input checked="" type="checkbox"/> <input checked="" type="checkbox"/> <input checked="" type="checkbox"/>

- Standard version
 With additional charge

¹⁾ For types of construction with feet, cast feet are standard.

²⁾ For types of construction with feet, screwed-on feet are standard.

³⁾ Not generally possible for motors with feet.

SIMOTICS XP 1MB1, 1MB5 explosion-protected motors

Article No. supplements and special versions · Terminal box position

Cast-iron series 1MB15 Basic Line, 1MB16 Performance Line**Selection and ordering data**

Terminal box position	Article No. supplement	Frame size											Motor version				
		71	80	90	100	112	132	160	180	200	225	250	280	315	IEC	Ex tb (Zone 21), Ex tc (Zone 22), Ex ec (Zone 2)	IE3 IE2
 1MB15 ■ 1MB16 ■	Terminal box position code 16th position of the Article No.	Additional identification code with order code and plain text, if required											IEC	Ex tb (Zone 21), Ex tc (Zone 22), Ex ec (Zone 2)	IE3 IE2		
		1MB15.3 Basic Line															
		1MB16.3 Performance Line															
		1MB15.1 Basic Line															
1MB16.1 Performance Line																	
Order code																	
Terminal box position																	
Terminal box top ¹⁾	4	-	□	□	□	□	□	□	□	□	□	□	□	□	□	□	□
Terminal box right-hand side ²⁾	5	-	-	✓	✓	✓	✓	✓	✓	✓	✓	✓	✓	✓	✓	✓	✓
Terminal box left-hand side ²⁾	6	-	-	✓	✓	✓	✓	✓	✓	✓	✓	✓	✓	✓	✓	✓	✓
Terminal box bottom ³⁾	7	-	-	-	✓	✓	✓	✓	-	-	-	-	-	-	-	-	-

- Standard version
- ✓ With additional charge
- Not possible

¹⁾ For types of construction with feet, cast feet are standard.

²⁾ For types of construction with feet, screwed-on feet are standard.

³⁾ Not generally possible for motors with feet.

SIMOTICS XP 1MB1, 1MB5 explosion-protected motors

Article No. supplements and special versions · Terminal box position

Aluminum series 1MB1042; Cast-iron series 1MB.543 Basic Line and 1MB.643 Performance Line

Selection and ordering data

Terminal box position	Article No. supplement		Frame size													Motor version		
	Terminal box position code 16th position of the Article No.	Additional identification code with order code and plain text, if required	63	71	80	90	100	112	132	160	180	200	225	250	280	315	IEC	Ex eb (Zone 1)
			1MB1042															
			1MB1543 Basic Line															
			1MB1643 Performance Line															
			1MB5543 Basic Line															
			1MB5643 Performance Line															
		Order code																
1MB1042 -	■																	
1MB1.43 -	■																	
1MB5.43 -	■																	

Terminal box position																			
Terminal box position	0	1	2	3	4	5	6	7	9	9	9	9	9	9	9	9	9	9	9
Terminal box base left with terminal box at the top	0	–	–	–	–	–	–	–	–	–	–	–	–	–	–	–	–	–	✓
Terminal box base right with terminal box at the top	1	–	–	–	–	–	–	–	–	–	–	–	–	–	–	–	–	–	✓
Terminal box base left with oblique terminal box 45°	2	–	–	–	–	–	–	–	–	–	–	–	–	–	–	–	–	–	○
Terminal box base right with oblique terminal box 45°	3	–	–	–	–	–	–	–	–	–	–	–	–	–	–	–	–	–	◻
Terminal box top ¹⁾	4	–	◻	◻	◻	◻	◻	◻	◻	◻	◻	◻	◻	◻	◻	◻	◻	◻	–
Terminal box right-hand side ²⁾	5	–	–	–	✓	✓	✓	✓	✓	✓	✓	✓	✓	✓	✓	✓	✓	✓	✓
Terminal box left-hand side ²⁾	6	–	–	–	✓	✓	✓	✓	✓	✓	✓	✓	✓	✓	✓	✓	✓	✓	✓
Terminal box at bottom ²⁾³⁾	7	–	–	–	–	–	–	–	–	–	–	–	–	–	–	–	–	–	–
Terminal box on left-hand side (base below)	9	R5L	–	–	–	–	–	–	–	–	–	–	–	–	–	–	–	–	✓
Terminal box on right-hand side (base below)	9	R6R	–	–	–	–	–	–	–	–	–	–	–	–	–	–	–	–	✓
Terminal box bottom left	9	R7L	–	–	–	–	–	–	–	–	–	–	–	–	–	–	–	–	✓
Terminal box bottom right	9	R7R	–	–	–	–	–	–	–	–	–	–	–	–	–	–	–	–	✓

- ◻ Standard version
- Without additional charge
- ✓ With additional charge
- Not possible

¹⁾ For types of construction with feet, cast feet are standard. Screwed-on feet are available with order code **H01**.
²⁾ For types of construction with feet, screwed-on feet are standard.
³⁾ Not generally possible for motors with feet.

SIMOTICS XP 1MB1, 1MB5 explosion-protected motors

Article No. supplements and special versions · Terminal box position

Cast-iron series 1MB.55., 1MB.853, 1MB.56., 1MB.863

Selection and ordering data

Terminal box position	Article No. supplement	Frame size	Motor version																		
			71	80	90	100	112	132	160	180	200	225	250	280	315	355					
 1MB.553 -	Terminal box position code 16th position of the Article No.	1MB1.5., 1MB1.6.																IEC	Ex db, Ex db eb	IE3 (Zone 1)	
	Additional identification code with order code and plain text, if required	1MB18.3																			
	Order code	1MB55..																			

Terminal box position																				
Terminal box top ¹⁾	4	–	□	□	□	□	□	□	□	□	□	□	□	□	□	□	□			
Terminal box right-hand side ¹⁾	5	–	–	–	–	–	–	✓	✓	✓	✓	✓	✓	✓	✓	✓	✓			
Terminal box left-hand side ¹⁾	6	–	–	–	–	–	–	✓	✓	✓	✓	✓	✓	✓	✓	✓	–			
Terminal box bottom ²⁾	7	–	–	–	–	✓	✓	✓	✓	–	–	–	–	–	–	–	–			

- Standard version
- ✓ With additional charge
- Not possible

Standard version:

Cable entry from right, as seen looking onto the shaft, with terminal box position left, entry from below, on frame size 355 and with terminal box on the right-hand side, cable entry is from the NDE.

Note:

Flange mounted motors horizontal alignment can also be mounted with connection box position on right-hand side, left-hand side or bottom during installation.

¹⁾ For types of construction with feet, cast feet are standard.

²⁾ Not generally possible for motors with feet.

SIMOTICS XP 1MB1, 1MB5 explosion-protected motors

Article No. supplements and special versions · Terminal box position

Cast-iron series 1MB55.4, 1MB55.3, 1MB58.3

Selection and ordering data

Terminal box position	Article No. supplement		Frame size				Motor version	
	Terminal box position code 16th position of the Article No.	Additional identification code with order code and plain text, if required	315	355	400	450	IEC	Ex ec, Ex tc, Ex tb (Zones 2, 22 and 21)
			1MB55 . 4					IE4
			1MB55 . 3					IE3
					1MB58 . 3			
1MB5		Order code						
Terminal box position								
Terminal box base left with terminal box at the top	0	–	✓	✓	✓	✓		
Terminal box base right with terminal box at the top	1	–	✓	✓	✓	✓		
Terminal box base left with oblique terminal box 45°	2	–			○	○		
Terminal box base right with oblique terminal box 45°	3	–			□	□		
Terminal box on right-hand side	5	–	✓	✓	✓	✓		
Terminal box on left-hand side	6	–	✓	✓	✓	✓		
Terminal box left-hand side (base below) ¹⁾	9	R5L	✓	✓	✓	✓		
Terminal box right-hand side (base below) ¹⁾	9	R6R	✓	✓	✓	✓		
Terminal box bottom left ¹⁾	9	R7L	✓	✓	✓	✓		
Terminal box bottom right ¹⁾	9	R7R	✓	✓	✓	✓		

- Standard version
- Without additional charge
- ✓ With additional charge

¹⁾ Only possible in combination with type of construction IM V1.

SIMOTICS XP 1MB1, 1MB5 explosion-protected motors

Article No. supplements and special versions · Options

Aluminum series 1MB10

Selection and ordering data

Special versions	Additional identification code -Z with order code and plain text if required	Frame size								Motor version		
		63	71	80	90	100	112	132	160	IEC	Ex tb (Zone 21), Ex tc (Zone 22), Ex ec (Zone 2)	IE3 IE2 IE1
				1MB10.3								
		1MB10.1										
						1MB10.2						
1MB10 -Z	Order code											
Explosion-protected version												
Version additionally for dust Ex tc – Zone 22 ^{1) 14) 22)}	B30	–	–	✓	✓	✓	✓	✓	✓	✓	Only for: 1MB103 – Ex ec (Zone 2)	
Version IIC with stamping of IIB ²²⁾	B31	○	○	○	○	○	○	○	○	○	Only for: 1MB103 – Ex ec (Zone 2)	
VIK version	C02	✓	✓	✓	✓	✓	✓	✓	✓	✓	Only for: 1MB1033 – Ex ec IE3 (Zone 2)	
Version for converter operation												
Version for converter operation in basic version with operating data SINAMICS G120 with PM240-2. ¹⁵⁾	B40	✓	✓	✓	✓	✓	✓	✓	✓	✓		
Version for converter operation in basic version with operating data SINAMICS S150 ¹⁵⁾	B41	✓	✓	✓	✓	✓	✓	✓	✓	✓		
Version for converter operation with power data on the PWM converter	B43	✓	✓	–	–	–	–	–	–	–		
Operating data such as the B40 order code with alternative SINAMICS converter on the rating plate • G120 with PM230 • G120 with PM240 • G120C • G120P with PM230 • G120P with PM240-2 • G120P with PM240P-2 • G120P with PM330 • G130, G150, G180 • S120 (BLM/SLM) • V20 Operating data such as order code B41 with alternative SINAMICS converters on the rating plate • S120 (ALM)	Y68 • and converter type	○	○	○	○	○	○	○	○	○		
Motor protection												
1 or 3 PTC thermistors – for tripping (2 terminals)	Q11	✓	✓	–	–	–	–	–	–	–		
2 or 6 PTC thermistors – for alarm and tripping (4 terminals)	Q12	✓	✓	–	–	–	–	–	–	–		
1 KTY84-130 temperature sensor (2 terminals)	Q23	✓	✓	–	–	–	–	–	–	–		
2 KTY84-130 temperature sensors (4 terminals)	Q25	✓	✓	–	–	–	–	–	–	–		
1 Pt1000 resistance thermometer (2 terminals)	Q35	✓	✓	✓	✓	✓	✓	✓	✓	✓		
2 Pt1000 resistance thermometers (4 terminals)	Q36	✓	✓	✓	✓	✓	✓	✓	✓	✓		
Motor connection and terminal box												
External grounding		□	□	□	□	□	□	□	□	□		
Rotation of the terminal box through 90°, entry from DE	R10	○	○	○	○	○	○	○	○	○		
Rotation of the terminal box through 90°, entry from NDE	R11	○	○	○	○	○	○	○	○	○		
Rotation of the terminal box through 180°	R12	○	○	○	○	○	○	○	○	○		
Metal cable gland, maximum configuration	R18	✓	✓	✓	✓	✓	✓	✓	✓	✓		
Larger terminal box ²⁴⁾	R50	✓	✓	□	□	–	–	–	–	–		
Windings and insulation												
Temperature class 155 (F), utilized acc. to 130 (B), coolant temperature 45 °C, derating approx. 4 % ²⁾	N05	✓	✓	✓	✓	✓	✓	✓	✓	✓		
Temperature class 155 (F), utilized acc. to 130 (B), coolant temperature 50 °C, derating approx. 8 % ²⁾	N06	✓	✓	✓	✓	✓	✓	✓	✓	✓		
Temperature class 155 (F), utilized acc. to 130 (B), coolant temperature 55 °C, derating approx. 13 % ²⁾	N07	✓	✓	✓	✓	✓	✓	✓	✓	✓		

For legends and footnotes, see page 6/98.

SIMOTICS XP 1MB1, 1MB5 explosion-protected motors

Article No. supplements and special versions · Options

Aluminum series 1MB10

Special versions	Additional identification code -Z with order code and plain text if required	Frame size								Motor version		
		63	71	80	90	100	112	132	160	IEC	Ex tb (Zone 21), Ex tc (Zone 22), Ex ec (Zone 2)	IE3 IE2 IE1
				1MB10.3								
	1MB10.1											
					1MB10.2							
	1MB10...-Z	Order code										
Windings and insulation (continued)												
Temperature class 155 (F), utilized acc. to 130 (B), coolant temperature 60 °C, derating approx. 18 %	N08		✓	✓	✓	✓	✓	✓	✓	✓		
Increased air humidity/temperature with 30 to 60 g water per m ³ of air	N30		✓	✓	✓	✓	✓	✓	✓	✓		
Increased air humidity/temperature with 60 to 100 g water per m ³ of air	N31		✓	✓	✓	✓	✓	✓	✓	✓		
Temperature class 155 (F), utilized acc. to 130 (B), with higher coolant temperature and/or installation altitude	Y50 • CT... °C or IA... m above sea level		✓	✓	✓	✓	✓	✓	✓	✓		
Colors and paint finish												
Special paint finish in RAL 7030 stone gray			□	□	□	□	□	□	□	□		
Unpainted (only cast-iron parts primed)	S00		○	○	○	○	○	○	○	○		
Unpainted, only primed	S01		✓	✓	✓	✓	✓	✓	✓	✓		
Special paint finish C3	S02		✓	✓	✓	✓	✓	✓	✓	✓		
Special paint finish sea air resistant C4	S03		✓	✓	✓	✓	✓	✓	✓	✓		
Top coat polyurethane ^{12) 23)}	S06		✓	✓	✓	✓	✓	✓	✓	✓	Only for: 1MB103. – Ex ec (Zone 2)	
Paint finish in other standard RAL colors: RAL 1015, 5002, 5009, 5010, 5012, 5015, 6011, 7001, 7011, 7016, 7031, 7032, 7035, 7037, 8012, 9005 (see Catalog Section 1 "Introduction")	Y53 • and paint finish RAL		✓	✓	✓	✓	✓	✓	✓	✓		
Paint finish in special RAL colors: For RAL colors, see "Special paint finish in special RAL colors" (see Catalog Section 1 "Introduction")	Y56 • and paint finish RAL		✓	✓	✓	✓	✓	✓	✓	✓		
Non-standard colors Colors see "Paint finish in non-standard colors" (see Catalog Section 1 "Introduction")	Y66 • und Anstrich		✓	✓	✓	✓	✓	✓	✓	✓		
Modular technology – Basic versions												
Mounting of separately driven fan ¹⁷⁾	F70		–	–	–	–	–	–	–	–	Only for: 1MB101. – Ex tb (Zone 21)	
			–	–	–	–	✓	✓	✓	✓	Only for: 1MB102. – Ex tc (Zone 22), 1MB103. – Ex ec (Zone 2)	
Special technology												
Mounting of LL 841 (HTL); 1024 I explosion-protected rotary pulse encoder ¹⁶⁾	G30		–	–	–	–	✓	✓	✓	✓		
Mechanical version and degrees of protection												
Low-noise version for 2-pole motors with clockwise direction of rotation	F77		–	–	–	–	–	–	✓	✓		
Low-noise version for 2-pole motors with counterclockwise direction of rotation	F78		–	–	–	–	–	–	✓	✓		
Mechanical protection for encoder	G43		–	–	□	□	□	□	□	□		
Protective cover	H00		✓	✓	✓	✓	✓	✓	✓	✓		
Screwed-on (instead of cast) feet	H01				✓	✓	✓	✓	✓	✓		
Vibration-proof version; vibration resistance to Class 3M4 according to IEC 60721-3-3:1994	H02		✓	✓	✓	✓	✓	✓	✓	✓		
Condensation drainage holes ⁶⁾	H03		✓	✓	✓	✓	✓	✓	✓	✓		
Rust-resistant screws (externally)	H07		✓	✓	✓	✓	✓	✓	✓	✓		
IP66 degree of protection	H19		–	✓	✓	✓	✓	✓	✓	✓		
IP65 degree of protection ⁴⁾	H20		✓	✓	✓	✓	✓	✓	✓	✓	Only for: 1MB103. – Ex ec (Zone 2)	
IP56 degree of protection ⁵⁾	H22		✓	✓	✓	✓	✓	✓	✓	✓	Only for: 1MB103. – Ex ec (Zone 2)	
Drive-end seal for flange-mounting motors, oil-tight to 0.1 bar ³⁾	H23		✓	✓	✓	✓	✓	✓	✓	✓		

SIMOTICS XP 1MB1, 1MB5 explosion-protected motors

Article No. supplements and special versions · Options

Aluminum series 1MB10

Special versions	Additional identification code -Z with order code and plain text if required	Frame size								Motor version		
		63	71	80	90	100	112	132	160	IEC	Ex tb (Zone 21), Ex tc (Zone 22), Ex ec (Zone 2)	IE3 IE2 IE1
				1MB10.3								
		1MB10.1										
						1MB10.2						
	1MB10 -Z	Order code										
Coolant temperature and installation altitude												
Coolant temperature -40 to +40 °C ²⁰⁾	D03		✓	✓	✓	✓	✓	✓	✓	✓		
Versions in accordance with standards and specifications												
Motor without CE marking for export outside EEA (see EU Regulation 640/2009)	D22		-	-	○	○	○	○	○	○	Not for: 1MB103. - Ex ec (Zone 2)	
Motor exclusively according to the Energy-related Products Law, Article 1 dated 27.2.2008, motor to be used in means of transport for persons and goods	D23		-	-	○	○	○	○	○	○	Only for: IE2, IE1	
Ex certification for China	D32		-	-	✓	✓	✓	✓	✓	✓		
China Energy Efficiency Label	D34		-	-	○	○	○	○	○	○	Only for: 1MB10.3 - Ex ec (Zone 2)	
EAC Ex certificate for the Eurasian Customs Union ¹⁸⁾	D35		-	-	✓	✓	✓	✓	✓	✓		
IECEX certification	D37		-	-	✓	✓	-	-	-	-	Only for: 1MB101. - Ex tb (Zone 21)	
			-	-	✓	✓	✓	✓	✓	✓	Only for: 1MB102. - Ex tc (Zone 22), 1MB103. - Ex ec (Zone 2)	
MEPS Australia	D70		-	-	✓	✓	✓	✓	✓	✓	Only for: 1MB1013, 1MB1023, 1MB1033	
Bearings and lubrication												
Located bearing DE	L20		✓	✓	✓	✓	✓	✓	✓	✓		
Located bearing NDE	L21		✓	✓	✓	✓	✓	✓	✓	□		
Bearing design for increased cantilever forces ¹³⁾	L22		-	-	-	-	✓	✓	✓	✓		
Regreasing device	L23		-	-	-	-	✓	✓	✓	✓		
Bearings reinforced at both ends for DE and NDE, bearing size 63	L25		-	-	-	-	✓	✓	✓	✓		
Bearing insulation NDE	L51		-	-	-	-	✓	✓	✓	✓		
Measuring nipple for SPM shock pulse measurement for bearing inspection	Q01		-	-	-	-	✓	✓	✓	✓		
Balance and vibration severity												
Vibration severity grade A			□	□	□	□	□	□	□	□		
Vibration severity grade B ¹⁹⁾	L00		✓	✓	✓	✓	✓	✓	✓	✓		
Half-key balancing			□	□	□	□	□	□	□	□		
Balancing without feather key	L01		✓	✓	✓	✓	✓	✓	✓	✓		
Full-key balancing	L02		✓	✓	✓	✓	✓	✓	✓	✓		
Shaft and rotor												
Shaft extension with standard dimensions, without feather keyway	L04		-	-	✓	✓	✓	✓	✓	✓		
Standard, cylindrical shaft extension (second shaft extension) NDE acc. to EN 50347	L05		✓	✓	✓	✓	✓	✓	✓	✓		
Standard shaft made of stainless steel (e.g. 1.4021)	L06		✓	✓	✓	✓	✓	✓	✓	✓		
Shaft extension run-out in accordance with IEC 60072-1 precision class	L07		✓	✓	✓	✓	✓	✓	✓	✓		
Shaft extension run-out, concentricity and perpendicularity in accordance with IEC 60072-1 precision class for flange-mounted motors	L08		✓	✓	✓	✓	✓	✓	✓	✓		
Non-standard cylindrical shaft extension, DE ⁷⁾	Y58 • and customer specifications		✓	✓	✓	✓	✓	✓	✓	✓		
Non-standard cylindrical shaft extension, NDE ⁷⁾	Y59 • and customer specifications		✓	✓	✓	✓	✓	✓	✓	✓		
Heating and ventilation												
Metal external fan ⁸⁾	F76		✓	✓	□	□	-	-	-	-	Only for: 1MB103. - Ex ec (Zone 2)	
			-	-	□	□	✓	✓	✓	✓	Only for: 1MB101. - Ex tb (Zone 21), 1MB102. - Ex tc (Zone 22)	

For legends and footnotes, see page 6/98.

SIMOTICS XP 1MB1, 1MB5 explosion-protected motors

Article No. supplements and special versions · Options

Aluminum series 1MB10

Special versions	Additional identification code -Z with order code and plain text if required	Frame size								Motor version		
		63	71	80	90	100	112	132	160	IEC	Ex tb (Zone 21), Ex tc (Zone 22), Ex ec (Zone 2)	IE3 IE2 IE1
				1MB10.3								
		1MB10.1										
						1MB10.2						
	1MB10 -Z	Order code										
Heating and ventilation (continued)												
Anti-condensation heating for 230 V (2 terminals) ⁹⁾	Q02	✓	✓	✓	✓	✓	✓	✓	✓	✓		
Anti-condensation heating for 115 V (2 terminals) ⁹⁾	Q03	✓	✓	✓	✓	✓	✓	✓	✓	✓		
Rating plate and additional rating plates												
Second rating plate, loose	M10	✓	✓	✓	✓	✓	✓	✓	✓	✓		
Rating plate, stainless steel	M11	✓	✓	✓	✓	✓	✓	✓	✓	✓		
Additional rating plate with deviating rating plate data	Y80 • and customer specifications	✓	✓	✓	✓	✓	✓	✓	✓	✓		
Additional rating plate with customer specifications	Y82 • and customer specifications	✓	✓	✓	✓	✓	✓	✓	✓	✓		
Additional information on rating plate and on package label (max. 20 characters)	Y84 • and customer specifications	✓	✓	✓	✓	✓	✓	✓	✓	✓		
Packaging, safety notes, documentation and test certificates												
Printed Operating Instructions in German/English and a DVD with all official EU languages as well as Norwegian, Russian, Turkish, and Chinese ¹¹⁾		□	□	□	□	□	□	□	□	□		
Inspection certificate 3.1 according to EN 10204 ¹⁰⁾	B02	✓	✓	✓	✓	✓	✓	✓	✓	✓		
Document – Electrical datasheet	B60	✓	✓	✓	✓	✓	✓	✓	✓	✓		
Document – Order dimensional drawing	B61	✓	✓	✓	✓	✓	✓	✓	✓	✓		
Type test with heat run for horizontal motors, with acceptance	B83	✓	✓	✓	✓	✓	✓	✓	✓	✓		
"Basic" documentation package	B90	✓	✓	✓	✓	✓	✓	✓	✓	✓		
"Advanced" documentation package	B91	✓	✓	✓	✓	✓	✓	✓	✓	✓		
"Projects" documentation package	B92	✓	✓	✓	✓	✓	✓	✓	✓	✓		
Wire-lattice pallet packaging	B99	○	○	○	○	○	○	○	○	○		
Connected in star for dispatch	M01	✓	✓	✓	✓	✓	✓	✓	✓	✓		
Connected in delta for dispatch	M02	✓	✓	✓	✓	✓	✓	✓	✓	✓		

- Standard version
- Without additional charge
- This order code only determines the price of the version – Additional plain text is required.
- ✓ With additional charge
- Not possible

SIMOTICS XP 1MB1, 1MB5 explosion-protected motors

Article No. supplements and special versions · Options

Aluminum series 1MB10**6**

- 1) Please inquire regarding combination with order codes **D03** and **C02**. Not possible in combination with order codes **H20** and **H22**.
- 2) There is no derating in combination with order codes **M2A, M2B, M2C, M2D, M2E, M2F, M2G, M2H**.
- 3) Not possible for type of construction IM V3.
- 4) For Zone 21, IP65 degree of protection is standard. Not possible for Zone 22, because only IP55 degree of protection is required.
- 5) Not admissible for Zone 21 (IP65 degree of protection) and Zone 22 (IP55 degree of protection).
- 6) Supplied with the condensation drainage holes sealed at the drive end DE and non-drive end NDE (IP55, IP56, IP65). If the condensation drainage holes are required for motors of the IM B6, IM B7 or IM B8 type of construction (feet on side or top), the motors must be ordered in the respective type of construction and with order code **H03**, so that the condensation drainage holes will be placed in the correct position.
- 7) When motors are ordered that have a longer or shorter shaft extension than normal, the required position and length of the feather keyway must be specified in a sketch. It must be ensured that only feather keys in accordance with DIN 6885, Form A are permitted to be used. The feather keyway is positioned centrally on the shaft extension. The length is defined by the manufacturer in accordance with the appropriate standard. Not valid for: Conical shafts, non-standard threaded journals, non-standard shaft tolerances, friction welded journals, extremely "thin" shafts, special geometry dimensions (e.g. square journals), hollow shafts. Valid for non-standard shaft extensions DE or NDE. The feather keys are supplied in every case. For order codes **Y58, Y59** and **L05** the following applies:
 - Dimensions D and DA ≤ ball bearing inner diameter (see dimension tables for "Dimensions")
 - Dimensions E and EA ≤ 2 × length E (standard) of the shaft extension
 For an explanation of the order codes, see Catalog Section 1 "Introduction".
- 8) The metal external fan is not possible in combination with the low-noise version – order code **F77** or **F78**.
- 9) In combination with the 15th position of the article number "**H**", the order codes **Q02** and **Q03** are not possible for frame sizes 100 to 160. It can only be supplied with a star or delta winding for direct switch-on (3 terminals).
- 10) The delivery time for the inspection certificate may differ from the delivery time for the motor.
- 11) The Operating Instructions are available on the Internet in PDF format for all official EU languages at <http://support.automation.siemens.com/WWW/view/en/10803948/133300>.
- 12) Order code **S06** cannot be combined with order code **B30**.
- 13) A minimum cantilever force F_{\min} of $0.5 \cdot F_{\max}$ is required for NU bearings (cylindrical roller bearings) in contrast to ball bearings. Cylindrical roller bearings are not suitable for coupling output or for brief periods of no-load operation without cantilever force.
- 14) The Ex motor is not admissible in an explosive atmosphere of dust and air (hybrid). A standard is not currently available that describes the product requirements for a hybrid mixture.
- 15) In combination with order codes **B40** and **B41**, "**B**" or "**C**" must be added to the 15th position of the Article No. . For compliance with the admissible temperature class 130 (B), derating is necessary in the case of converter operation in Zones 2, 21 and 22. The operating data for SINAMICS converters from Siemens are on the rating plate – the torque is reduced in contrast to line operation. The motor operating data for converter operation is available in the DTC selection and ordering tool (www.siemens.com/dt-configurator). For converter operation, voltage codes/order codes are only admissible with one voltage only. When used in hazardous zones, the frequency converter must have a certified trip unit for motors of equipment category 1 (Zone 21). A certified trip unit is also recommended for motors of device category 3 (Zones 2 and 22). Alternatively, an external, certified trip unit can be used (see Catalog IC 10).
- 16) Can be combined with order codes **N30, N31, L51** and **F70** on request. Not admissible in combination with order code **L05**. Combination with protective cover as standard for frame sizes 100 to 200. Protective cover not possible for frame sizes 225 to 315.
- 17) In combination with order codes **N05, N06, N07, N08, N30, N31, D03, G30, C02, H20** and **H22** on request. Not admissible with order code **L05**. The degree of protection of the separately driven fan must match that of the motor.
- 18) Not admissible in combination with anti-condensation heating (order code **Q02/Q03**). For this component, no TR CU certificate is available yet.
- 19) Vibration severity grade B not admissible in combination with converter operation (order code **B40/B41**).
- 20) Not possible in combination with order codes **Q02** or **Q03**.
- 21) Not possible in vertical version with downward shaft extension DE.
- 22) Permissible paint film thickness up to 2 mm.
- 23) Order code S06 cannot be combined with order code S00 and S01. It can be combined with Y53 and Y56 on request.
- 24) For Zone 22 the larger terminal box is standard only for motors with motor protection or anti-condensation heating. For Zone 2 the special large terminal box is standard.

SIMOTICS XP 1MB1, 1MB5 explosion-protected motors

Article No. supplements and special versions · Options

Cast-iron series 1MB15 Basic Line, 1MB16 Performance Line

Selection and ordering data

Special versions	Additional identification code - Z with order code and plain text if required	Frame size												Motor version			
		71	80	90	100	112	132	160	180	200	225	250	280	315	IEC	Ex tb (Zone 21), Ex tc (Zone 22), Ex ec (Zone 2)	IE3 IE2
		1MB15.3 Basic Line												IEC	Ex tb (Zone 21), Ex tc (Zone 22), Ex ec (Zone 2)	IE3 IE2	
		1MB16.3 Performance Line															
1MB15 -Z		1MB15.1 Basic Line															
1MB16 -Z	Order code	1MB16.1 Performance Line															
Explosion-protected version																	
Version additionally for dust Ex tc – Zone 22 ^{1) 16)}	B30	✓	✓	✓	✓	✓	✓	✓	✓	✓	✓	✓	✓	✓	✓	✓	Only for: 1MB1.3. – Ex ec (Zone 2)
Version IIC with stamping of IIB ²⁴⁾	B31	○	○	○	○	○	○	○	○	○	○	○	○	○	○	○	Only for: 1MB1.3. – Ex ec (Zone 2)
VIK version	C02	✓	✓	✓	✓	✓	✓	✓	✓	✓	✓	✓	✓	✓	✓	✓	Only for: 1MB1.33 – Ex ec (Zone 2)
Chemstar design chemical industry	C03	✓	✓	✓	✓	✓	✓	✓	✓	✓	✓	✓	✓	✓	✓	✓	
Chemstar design Oil & Gas industry	C04	✓	✓	✓	✓	✓	✓	✓	✓	✓	✓	✓	✓	✓	✓	✓	
Version for converter operation																	
Version for converter operation in basic version with operating data SINAMICS G120 with PM240-2. ^{17) 20) 21) 22)}	B40	✓	✓	✓	✓	✓	✓	✓	✓	✓	✓	✓	✓	✓	✓	✓ ²⁰⁾ ✓ ²⁰⁾	
Version for converter operation in basic version with operating data SINAMICS S150 ^{17) 20) 21)}	B41	✓	✓	✓	✓	✓	✓	✓	✓	✓	✓	✓	✓	✓	✓	✓ ²⁰⁾ ✓ ²⁰⁾	
Version for converter operation with power data on the PWM converter	B43	✓	✓	✓	✓	✓	✓	✓	✓	✓	✓	✓	✓	✓	✓	✓	
Operating data such as order code B40 with alternative SINAMICS converters on the rating plate ²⁰⁾ • G120 with PM230 • G120 with PM240 • G120C • G120P with PM230 • G120P with PM240-2 • G120P with PM240P-2 • G120P with PM330 • G130, G150, G180 • S120 (BLM/SLM) • V20 Operating data such as order code B41 with alternative SINAMICS converters on the rating plate ²⁰⁾ • S120 (ALM)	Y68 • and converter type	○	○	○	○	○	○	○	○	○	○	○	○	○	○	○	
Motor protection																	
1 Pt1000 resistance thermometer (2 terminals)	Q35	-	-	-	✓	✓	✓	✓	✓	✓	✓	✓	✓	✓	✓	✓	
2 Pt1000 resistance thermometers (4 terminals)	Q36	-	-	-	✓	✓	✓	✓	✓	✓	✓	✓	✓	✓	✓	✓	
2 Pt100 resistance thermometers in basic configuration for bearings (2 terminals) ²⁾	Q72	-	-	-	-	-	-	-	✓	✓	✓	✓	✓	✓	✓	✓	
2 Pt100 resistance thermometers in 3-wire input for bearings (6 terminals) ²⁾	Q78	-	-	-	-	-	-	-	✓	✓	✓	✓	✓	✓	✓	✓	
2 Pt100 double resistance thermometers in 3-wire input for bearings (12 terminals) ²⁾	Q79	-	-	-	-	-	-	-	-	-	-	-	-	-	✓	✓	
Motor connection and terminal box																	
External grounding		□	□	□	□	□	□	□	□	□	□	□	□	□	□	□	
Rotation of the terminal box through 90°, entry from DE	R10	○	○	○	○	○	○	○	✓	✓	✓	✓	✓	✓	✓	✓	
Rotation of the terminal box through 90°, entry from NDE	R11	○	○	○	○	○	○	○	✓	✓	✓	✓	✓	✓	✓	✓	
Rotation of the terminal box through 180°	R12	○	○	○	○	○	○	○	✓	✓	✓	✓	✓	✓	✓	✓	
Stud terminal for cable connection, accessories pack (3 items)	R17	-	-	-	-	-	-	-	-	-	-	-	-	✓	✓	✓	Only for: 1MB1.1. – Ex tb (Zone 21), 1MB1.2. – Ex tc (Zone 22)
Metal cable gland, maximum configuration	R18	✓	✓	✓	✓	✓	✓	✓	✓	✓	✓	✓	✓	✓	✓	✓	
Saddle terminal for connection without cable lug, accessories pack	R19	-	-	-	-	-	-	-	-	-	-	-	-	✓	✓	✓	Only for: 1MB1.1. – Ex tb (Zone 21), 1MB1.2. – Ex tc (Zone 22)
		□	□	□	□	□	□	□	□	□	□	□	□	□	□	□	Only for: 1MB1.3. – Ex ec (Zone 2)
Larger terminal box ¹⁵⁾	R50	✓	✓	✓	✓	✓	✓	✓	✓	✓	✓	✓	✓	✓	✓	✓	
Cast-iron auxiliary terminal box (small)	R62	-	-	-	-	-	-	-	✓	✓	✓	✓	✓	✓	✓	✓	

For legends and footnotes, see page 6/103.

SIMOTICS XP 1MB1, 1MB5 explosion-protected motors

Article No. supplements and special versions · Options

Cast-iron series 1MB15 Basic Line, 1MB16 Performance Line

Special versions	Additional identification code - Z with order code and plain text if required	Frame size												Motor version			
		71	80	90	100	112	132	160	180	200	225	250	280	315	IEC	Ex tb (Zone 21), Ex tc (Zone 22), Ex ec (Zone 2)	IE3 IE2
		1MB15.3 Basic Line												IEC	Ex tb (Zone 21), Ex tc (Zone 22), Ex ec (Zone 2)	IE3 IE2	
		1MB16.3 Performance Line															
	1MB15 - Z	1MB15.1 Basic Line															
	1MB16 - Z	1MB16.1 Performance Line															
Windings and insulation																	
Temperature class 155 (F), utilized acc. to 130 (B), coolant temperature 45 °C, derating approx. 4 % ⁴⁾	N05	✓	✓	✓	✓	✓	✓	✓	✓	✓	✓	✓	✓	✓	✓	✓	
Temperature class 155 (F), utilized acc. to 130 (B), coolant temperature 50 °C, derating approx. 8 % ⁴⁾	N06	✓	✓	✓	✓	✓	✓	✓	✓	✓	✓	✓	✓	✓	✓	✓	
Temperature class 155 (F), utilized acc. to 130 (B), coolant temperature 55 °C, derating approx. 13 % ⁴⁾	N07	✓	✓	✓	✓	✓	✓	✓	✓	✓	✓	✓	✓	✓	✓	✓	
Temperature class 155 (F), utilized acc. to 130 (B), coolant temperature 60 °C, derating approx. 18 %	N08	✓	✓	✓	✓	✓	✓	✓	✓	✓	✓	✓	✓	✓	✓	✓	
Increased air humidity/temperature with 30 to 60 g water per m ³ of air	N30	✓	✓	✓	✓	✓	✓	✓	✓	✓	✓	✓	✓	✓	✓	✓	
Increased air humidity/temperature with 60 to 100 g water per m ³ of air	N31	✓	✓	✓	✓	✓	✓	✓	✓	✓	✓	✓	✓	✓	✓	✓	
Temperature class 155 (F), utilized acc. to 130 (B), with higher coolant temperature and/or installation altitude	Y50 • CT... °C or IA m above sea level	✓	✓	✓	✓	✓	✓	✓	✓	✓	✓	✓	✓	✓	✓	✓	
Colors and paint finish																	
Standard paint finish C2 in RAL 7030 stone gray		□	□	□	□	□	□	□	□	□	□	□	□	□	□	□	Only for: 1MB15..
Unpainted (only cast-iron parts primed)	S00	○	○	○	○	○	○	○	○	○	○	○	○	○	○	○	
Unpainted, only primed	S01	✓	✓	✓	✓	✓	✓	✓	✓	✓	✓	✓	✓	✓	✓	✓	
Special paint finish C3	S02	✓	✓	✓	✓	✓	✓	✓	✓	✓	✓	✓	✓	✓	✓	✓	Only for: 1MB15..
		-	-	-	□	□	□	□	□	□	□	□	□	□	□	□	Only for: 1MB16..
Special paint finish sea air resistant C4	S03	✓	✓	✓	✓	✓	✓	✓	✓	✓	✓	✓	✓	✓	✓	✓	
Special paint finish for use offshore C5	S04	✓	✓	✓	✓	✓	✓	✓	✓	✓	✓	✓	✓	✓	✓	✓	
Top coat polyurethane ¹²⁾	S06	✓	✓	✓	✓	✓	✓	✓	✓	✓	✓	✓	✓	✓	✓	✓	Only for: 1MB1.3. – Ex ec (Zone 2)
Special paint finish C5mid with medium durability	S08	✓	✓	✓	✓	✓	✓	✓	✓	✓	✓	✓	✓	✓	✓	✓	
Special paint finish CX for offshore with high durability	S09	✓	✓	✓	✓	✓	✓	✓	✓	✓	✓	✓	✓	✓	✓	✓	
Paint finish in other standard RAL colors: RAL AL 1015, 3000, 5002, 5009, 5010, 5012, 5015, 6011, 7001, 7011, 7016, 7031, 7032, 7035, 7037, 8012, 9005, 9010 (see Catalog Section 1 "Introduction")	Y53 • and paint finish RAL	✓	✓	✓	✓	✓	✓	✓	✓	✓	✓	✓	✓	✓	✓	✓	Only for: 1MB15..
Paint finish in special RAL colors: For RAL colors, see "Special paint finish in special RAL colors" (see Catalog Section 1 "Introduction")	Y56 • and paint finish RAL	✓	✓	✓	✓	✓	✓	✓	✓	✓	✓	✓	✓	✓	✓	✓	
Non-standard colors Colors see "Paint finish in non-standard colors" (see Catalog Section 1 "Introduction")	Y66 • und Anstrich	✓	✓	✓	✓	✓	✓	✓	✓	✓	✓	✓	✓	✓	✓	✓	
Modular technology – Basic versions																	
Mounting of separately driven fan ¹⁹⁾	F70	-	-	-	-	-	-	-	-	-	✓	✓	✓	✓	✓	✓	Only for: 1MB1.1. – Ex tb (Zone 21)
		-	-	-	✓	✓	✓	✓	✓	✓	✓	✓	✓	✓	✓	✓	Only for: 1MB1.2. – Ex tc (Zone 22)
		-	-	-	✓	✓	✓	✓	✓	✓	✓	✓	✓	✓	✓	✓	✓
Special technology																	
Mounting of LL 841 (HTL); 1024 l explosion-protected rotary pulse encoder ¹⁸⁾	G30	-	-	-	✓	✓	✓	✓	✓	✓	✓	✓	✓	✓	✓	✓	
Mechanical version and degrees of protection																	
Low-noise version for 2-pole motors with clockwise direction of rotation	F77	-	-	-	-	-	✓	✓	✓	✓	✓	✓	✓	✓	✓	✓	
Low-noise version for 2-pole motors with counterclockwise direction of rotation	F78	-	-	-	-	-	✓	✓	✓	✓	✓	✓	✓	✓	✓	✓	
Mechanical protection for encoder	G43	-	-	-	□	□	□	□	□	□	✓	✓	✓	✓	✓	✓	
Protective cover	H00	✓	✓	✓	✓	✓	✓	✓	✓	✓	✓	✓	✓	✓	✓	✓	
Screwed-on (instead of cast) feet	H01	-	-	-	✓	✓	✓	✓	✓	✓	✓	✓	✓	✓	✓	✓	

For legends and footnotes, see page 6/103.

SIMOTICS XP 1MB1, 1MB5 explosion-protected motors

Article No. supplements and special versions · Options

Cast-iron series 1MB15 Basic Line, 1MB16 Performance Line

Special versions	Additional identification code - Z with order code and plain text if required	Frame size												Motor version			
		71	80	90	100	112	132	160	180	200	225	250	280	315	IEC	Ex tb (Zone 21), Ex tc (Zone 22), Ex ec (Zone 2)	IE3 <hr/> IE2
		1MB15.3 Basic Line												IEC	Ex tb (Zone 21), Ex tc (Zone 22), Ex ec (Zone 2)	IE3 <hr/> IE2	
		1MB16.3 Performance Line															
	1MB15 -Z	1MB15.1 Basic Line															
	1MB16 -Z	1MB16.1 Performance Line															
Mechanical version and degrees of protection (continued)																	
Vibration-proof version; vibration resistance to Class 3M4 according to IEC 60721-3-3:1994 ²⁷⁾	H02	✓	✓	✓	✓	✓	✓	✓	✓	✓	✓	✓	✓	✓	✓	✓	
Condensation drainage holes ⁷⁾	H03	✓	✓	✓	□	□	□	□	□	□	□	□	□	□	□	□	
Rust-resistant screws (externally)	H07	✓	✓	✓	✓	✓	✓	✓	✓	✓	✓	✓	✓	✓	✓	✓	
IP66 degree of protection	H19	✓	✓	✓	✓	✓	✓	✓	✓	✓	✓	✓	✓	✓	✓	✓	Not for: Combination with order code H20, H22
IP65 degree of protection ⁵⁾	H20	✓	✓	✓	✓	✓	✓	✓	✓	✓	✓	✓	✓	✓	✓	✓	
IP56 degree of protection ⁶⁾	H22	✓	✓	✓	✓	✓	✓	✓	✓	✓	✓	✓	✓	✓	✓	✓	
Drive-end seal for flange-mounting motors, oil-tight to 0.1 bar	H23	✓	✓	✓	✓	✓	✓	✓	✓	✓	✓	✓	✓	✓	✓	✓	Not for: Type of construction IM V3
Coolant temperature and installation altitude																	
Coolant temperature -40 to +40 °C ²⁶⁾	D03	✓	✓	✓	✓	✓	✓	✓	✓	✓	✓	✓	✓	✓	✓	✓	
Versions in accordance with standards and specifications																	
Motor without CE marking for export outside EEA (see EU Regulation 640/2009)	D22	○	○	○	○	○	○	○	○	○	○	○	○	○	○	○	
Motor exclusively according to the Energy-related Products Law, Article 1 dated 27.2.2008, motor to be used in means of transport for persons and goods	D23	○	○	○	○	○	○	○	○	○	○	○	○	○	○	○	
Ex certification for China	D32	✓	✓	✓	✓	✓	✓	✓	✓	✓	✓	✓	✓	✓	✓	✓	Only for: 1MB15..
China Energy Efficiency Label	D34	○	○	○	○	○	○	○	○	○	○	○	○	○	○	○	Only for: 1MB16..
		-	-	-	○	○	○	○	○	○	○	○	○	○	○	○	Only for: 1MB15..3
EAC Ex certificate for the Eurasian Customs Union ¹³⁾	D35	✓	✓	✓	✓	✓	✓	✓	✓	✓	✓	✓	✓	✓	✓	✓	
IECEX certification	D37	✓	✓	✓	✓	✓	✓	✓	✓	✓	✓	✓	✓	✓	✓	✓	
MEPS Australia	D70	-	✓	✓	✓	✓	✓	✓	✓	✓	✓	✓	✓	✓	✓	✓	Only for: 1MB15..3
Bearings and lubrication																	
Regreasing device with M10 x 1 grease nipple according to DIN 71412-A	L19	-	-	-	-	-	-	-	✓	✓	✓	✓	○	○			
Located bearing DE	L20	✓	✓	✓	✓	✓	✓	✓	✓	✓	✓	✓	✓	✓	✓	✓	
Located bearing NDE	L21	✓	✓	✓	✓	✓	✓	□	□	□	□	□	□	□	□	□	
Bearing design for increased cantilever forces ¹⁴⁾	L22	✓	✓	✓	✓	✓	✓	✓	✓	✓	✓	✓	✓	✓	✓	✓	
Regreasing device	L23	-	-	-	✓	✓	✓	✓	✓	✓	✓	✓	□	□		Only for: 1MB15..	
		-	-	-	✓	✓	✓	□	□	□	□	□	□	□	□		Only for: 1MB16..
Bearings reinforced at both ends for DE and NDE, bearing size 63	L25	✓	✓	✓	✓	✓	✓	✓	✓	✓	✓	✓	□	□		Only for: 1MB15..	
		-	-	-	□	□	□	□	□	□	□	□	□	□	□		Only for: 1MB16..
Bearing insulation NDE ²⁰⁾	L51	-	-	-	-	-	-	-	✓	✓	✓	✓	✓	✓	✓	✓	
Measuring nipple for SPM shock pulse measurement for bearing inspection	Q01	-	-	-	✓	✓	✓	✓	✓	✓	✓	✓	✓	✓	✓	✓	
Balance and vibration severity																	
Vibration severity grade A		□	□	□	□	□	□	□	□	□	□	□	□	□	□	□	
Vibration severity grade B ²¹⁾²²⁾²³⁾	L00	✓	✓	✓	✓	✓	✓	✓	✓	✓	✓	✓	✓	✓	✓	✓	
Half-key balancing		□	□	□	□	□	□	□	□	□	□	□	□	□	□	□	
Balancing without feather key	L01	✓	✓	✓	✓	✓	✓	✓	✓	✓	✓	✓	✓	✓	✓	✓	
Full-key balancing	L02	✓	✓	✓	✓	✓	✓	✓	✓	✓	✓	✓	✓	✓	✓	✓	
Shaft and rotor																	
Shaft extension with standard dimensions, without feather keyway	L04	-	-	-	✓	✓	✓	✓	✓	✓	✓	✓	✓	✓	✓	✓	
Standard, cylindrical shaft extension (second shaft extension) NDE acc. to EN 50347 ²⁵⁾	L05	✓	✓	✓	✓	✓	✓	✓	✓	✓	✓	✓	✓	✓	✓	✓	
Standard shaft made of stainless steel (e.g. 1.4021)	L06	✓	✓	✓	✓	✓	✓	✓	✓	✓	✓	✓	✓	✓	✓	✓	
Shaft extension run-out in accordance with IEC 60072-1 precision class	L07	✓	✓	✓	✓	✓	✓	✓	✓	✓	✓	✓	✓	✓	✓	✓	
Shaft extension run-out, concentricity and perpendicularity in accordance with IEC 60072-1 precision class for flange-mounted motors	L08	✓	✓	✓	✓	✓	✓	✓	✓	✓	✓	✓	✓	✓	✓	✓	



For legends and footnotes, see page 6/103.

SIMOTICS XP 1MB1, 1MB5 explosion-protected motors

Article No. supplements and special versions · Options

Cast-iron series 1MB15 Basic Line, 1MB16 Performance Line

Special versions	Additional identification code - Z with order code and plain text if required	Frame size												Motor version			
		71	80	90	100	112	132	160	180	200	225	250	280	315	IEC	Ex tb (Zone 21), Ex tc (Zone 22), Ex ec (Zone 2)	IE3 IE2
		1MB15.3 Basic Line												IEC	Ex tb (Zone 21), Ex tc (Zone 22), Ex ec (Zone 2)	IE3 IE2	
		1MB16.3 Performance Line															
		1MB15.1 Basic Line															
		1MB16.1 Performance Line															
Shaft and rotor (continued)																	
Non-standard cylindrical shaft extension, DE ⁸⁾	Y58 • and customer specifications	✓	✓	✓	✓	✓	✓	✓	✓	✓	✓	✓	✓	✓	✓	✓	
Non-standard cylindrical shaft extension, NDE ⁸⁾	Y59 • and customer specifications	✓	✓	✓	✓	✓	✓	✓	✓	✓	✓	✓	✓	✓	✓	✓	
Heating and ventilation																	
Metal external fan ⁹⁾	F76	✓	✓	✓	✓	✓	✓	✓	✓	✓	✓	✓	✓	✓	✓	✓	Only for: 1MB1.3. – Ex ec (Zone 2)
Anti-condensation heating for 230 V (2 terminals) ³⁾	Q02	✓	✓	✓	✓	✓	✓	✓	✓	✓	✓	✓	✓	✓	✓	✓	
Anti-condensation heating for 115 V (2 terminals) ³⁾	Q03	✓	✓	✓	✓	✓	✓	✓	✓	✓	✓	✓	✓	✓	✓	✓	
Rating plate and additional rating plates																	
Second rating plate, loose	M10	✓	✓	✓	✓	✓	✓	✓	✓	✓	✓	✓	✓	✓	✓	✓	
Rating plate, stainless steel	M11	✓	✓	✓	✓	✓	✓	✓	✓	✓	✓	✓	✓	✓	✓	✓	Only for: 1MB15..
		–	–	–	□	□	□	□	□	□	□	□	□	□	□	□	Only for: 1MB16..
Additional rating plate with deviating rating plate data	Y80 • and customer specifications	✓	✓	✓	✓	✓	✓	✓	✓	✓	✓	✓	✓	✓	✓	✓	
Additional rating plate with customer specifications	Y82 • and customer specifications	✓	✓	✓	✓	✓	✓	✓	✓	✓	✓	✓	✓	✓	✓	✓	
Additional information on rating plate and on package label (max. 20 characters)	Y84 • and customer specifications	✓	✓	✓	✓	✓	✓	✓	✓	✓	✓	✓	✓	✓	✓	✓	
Packaging, safety notes, documentation and test certificates																	
Printed Operating Instructions in German/English and a DVD with all official EU languages as well as Norwegian, Russian, Turkish, and Chinese ¹⁾		□	□	□	□	□	□	□	□	□	□	□	□	□	□	□	
Inspection certificate 3.1 according to EN 10204 ¹⁰⁾	B02	✓	✓	✓	✓	✓	✓	✓	✓	✓	✓	✓	✓	✓	✓	✓	
Document – Electrical datasheet	B60	✓	✓	✓	✓	✓	✓	✓	✓	✓	✓	✓	✓	✓	✓	✓	
Document – Order dimensional drawing	B61	✓	✓	✓	✓	✓	✓	✓	✓	✓	✓	✓	✓	✓	✓	✓	
Standard test (routine test) with acceptance	B65	✓	✓	✓	✓	✓	✓	✓	✓	✓	✓	✓	✓	✓	✓	✓	
Type test with heat run for horizontal motors, with acceptance	B83	✓	✓	✓	✓	✓	✓	✓	✓	✓	✓	✓	✓	✓	✓	✓	
"Basic" documentation package	B90	✓	✓	✓	✓	✓	✓	✓	✓	✓	✓	✓	✓	✓	✓	✓	
"Advanced" documentation package	B91	✓	✓	✓	✓	✓	✓	✓	✓	✓	✓	✓	✓	✓	✓	✓	
"Projects" documentation package	B92	✓	✓	✓	✓	✓	✓	✓	✓	✓	✓	✓	✓	✓	✓	✓	
Wire-lattice pallet packaging	B99	○	○	○	○	○	○	○	–	–	–	–	–	–	–	–	
Connected in star for dispatch	M01	✓	✓	✓	✓	✓	✓	✓	✓	✓	✓	✓	✓	✓	✓	✓	
Connected in delta for dispatch	M02	✓	✓	✓	✓	✓	✓	✓	✓	✓	✓	✓	✓	□	□	□	□

6

For legends and footnotes, see page 6/103.

SIMOTICS XP 1MB1, 1MB5 explosion-protected motors

Article No. supplements and special versions · Options

Cast-iron series 1MB15 Basic Line, 1MB16 Performance Line

- Standard version
- Without additional charge
- This order code only determines the price of the version – Additional plain text is required.
- ✓ With additional charge
- Not possible

- 1) Please inquire regarding combination with order codes **D03** and **C02**. Not possible in combination with order codes **H20** and **H22**.
- 2) Evaluation with associated tripping unit (see Catalog IC 10) is recommended. A certified tripping unit is necessary for use in hazardous areas.
- 3) In combination with the 15th position of the Article No. "**H**", the order codes **Q02** and **Q03** are not possible for frame sizes 100 to 160. It can only be supplied with a star or delta winding for direct switch-on (3 terminals).
- 4) There is no derating in combination with order codes **M2A, M2B, M2C, M2D, M2E, M2F, M2G, M2H**.
- 5) Order code **H20** (IP65 degree of protection) can only be ordered for Zone 2.
For Zone 21, IP65 degree of protection is standard. Not possible for Zone 22, because only IP55 degree of protection is required.
- 6) Order code **H22** IP56 degree of protection is only possible for Zone 2. Degree of protection IP56 is not permissible for Zone 21 (IP65 degree of protection) and Zone 22 (IP55 degree of protection).
- 7) Supplied with the condensation drainage holes sealed at the drive end DE and non-drive end NDE (IP55, IP56, IP65). If the condensation drainage holes are required for motors of the IM B6, IM B7 or IM B8 type of construction (feet on side or top), the motors must be ordered in the respective type of construction and with order code **H03**, so that the condensation drainage holes will be placed in the correct position.
- 8) When motors are ordered that have a longer or shorter shaft extension than normal, the required position and length of the feather keyway must be specified in a sketch. It must be ensured that only feather keys in accordance with DIN 6885, Form A are permitted to be used. The feather keyway is positioned centrally on the shaft extension. The length is defined by the manufacturer in accordance with the appropriate standard. Not valid for: Conical shafts, non-standard threaded journals, non-standard shaft tolerances, friction welded journals, extremely "thin" shafts, special geometry dimensions (e.g. square journals), hollow shafts. Valid for non-standard shaft extensions DE or NDE. The feather keys are supplied in every case.
For order codes **Y58, Y59** and **L05** the following applies:
– Dimensions D and DA ≤ ball bearing inner diameter (see dimension tables in "Dimensions")
– Dimensions E and EA ≤ 2 × length E (standard) of the shaft extension
For an explanation of the order codes, see Catalog Section 1 "Introduction".
- 9) The metal external fan is not possible in combination with the low-noise version – order code **F77** or **F78**.
- 10) The delivery time for the manufacturer's test certificate may differ from the delivery time for the motor.
- 11) The Operating Instructions are available on the Internet in PDF format for all official EU languages at <http://support.automation.siemens.com/WWW/view/en/10803948/133300>.
- 12) Order code **S06** not possible in combination with order code **B30**.
- 13) Not admissible in combination with anti-condensation heating (order code **Q02/Q03**). For this component, no TR CU certificate is available yet.
- 14) A minimum cantilever force F_{\min} of $0.5 \cdot F_{\max}$ is required for NU bearings (cylindrical roller bearings) in contrast to ball bearings. Cylindrical roller bearings are not suitable for coupling output or for brief periods of no-load operation without cantilever force.
- 15) A larger terminal box is the standard version in combination with the order code **Q02, Q03** and/or 15th position of the Article No. "**H**" for frame sizes 71 to 90.
- 16) The Ex motor is not admissible in an explosive atmosphere of dust and air (hybrid). A standard is not currently available that describes the product requirements for a hybrid mixture.
- 17) In combination with order codes **B40** and **B41**, "**B**" or "**C**" must be added to the 15th position of the Article No. For compliance with the admissible temperature class 130 (B), derating is necessary in the case of converter operation in Zones 2, 21 and 22. The operating data for SINAMICS converters from Siemens are on the rating plate – the torque is reduced in contrast to line operation. The motor operating data for converter operation is available in the DTC selection and ordering tool (www.siemens.com/dt-configurator).
For converter operation, voltage codes/order codes are only admissible with one voltage only. When used in hazardous zones, the frequency converter must have a certified trip unit for motors of equipment category 1 (Zone 21). A certified trip unit is also recommended for motors of device category 3 (Zones 2 and 22). Alternatively, an external, certified trip unit can be used (see Catalog IC 10).
- 18) Can be combined with order codes **N30, N31, L51** and **F70** on request. Not admissible in combination with order code **L05**. Combination with protective cover as standard for FS 100 to 200. Protective cover not possible for FS 225 to 315.
- 19) In combination with order codes **N05, N06, N07, N08, N30, N31, D03, G30, C02, H20** and **H22** on request. Not admissible with order code **L05**. The degree of protection of the separately driven fan must match that of the motor.
- 20) The frame sizes 280 and 315 in combination with order code **B40** or **B41** are equipped with "Bearing insulation NDE" as standard (order code **L51** is included in **B40/B41**).
- 21) Not admissible for frame size 315, 2-pole.
- 22) Not admissible in combination with converter operation (order code **B40, B41**).
- 23) On request for 2-pole motors for line operation (concerns frame sizes 315).
- 24) Permissible paint film thickness up to 2 mm.
- 25) Not possible in vertical version with downward shaft extension DE.
- 26) Not possible in combination with order code **Q02** or **Q03**.
- 27) Not possible in combination with order code **R50**.

SIMOTICS XP 1MB1, 1MB5 explosion-protected motors

Article No. supplements and special versions · Options

Aluminum series 1MB1042; Cast-iron series 1MB.543 Basic Line and 1MB.643 Performance Line**Selection and ordering data**

Special versions	Additional identification code -Z with order code and plain text if required	Frame size														Motor version			
		63	71	80	90	100	112	132	160	180	200	225	250	280	315	IEC	Ex eb (Zone 1)	IE3	
			1MB1042																
			1MB1543 Basic Line																
			1MB1643 Performance Line																
												1MB5543 Basic Line							
												1MB5643 Performance Line							
	1MB1042 - -Z																		
	1MB1.43 - -Z																		
	1MB5.43 - -Z	Order code																	
Explosion-protected version																			
Version IIC with stamping of IIB ¹⁾	B31		○	○	○	○	○	○	○	○	○	○	○	○	○				
Version additionally for dust Ex tb – Zone 21; IP65 ²⁾	B32		✓	✓	✓	✓	✓	✓	✓	✓	✓	✓	✓	✓	✓				
T1/T2 on rating plate ³⁾	B33		–	–	–	–	–	○	○	○	○	○	○	○	○				
VIK version ¹⁸⁾	C02		✓	✓	✓	✓	✓	✓	✓	✓	✓	✓	✓	✓	✓				
Chemstar design chemical industry	C03		✓	✓	✓	✓	✓	✓	✓	✓	✓	✓	✓	✓	✓				
Chemstar design Oil & Gas industry	C04		✓	✓	✓	✓	✓	✓	✓	✓	✓	✓	✓	✓	✓				
Motor protection																			
2 Pt100 resistance thermometers in basic configuration for bearings (2 terminals) ⁴⁾	Q72		–	–	–	–	–	–	–	–	–	–	–	–	–	–	–	–	
2 Pt100 resistance thermometers in 3-wire input for bearings (6 terminals) ⁴⁾	Q78		–	–	–	–	–	–	–	–	–	–	–	–	–	–	–	–	
2 Pt100 double resistance thermometers in 3-wire input for bearings (12 terminals) ⁴⁾	Q79		–	–	–	–	–	–	–	–	–	–	–	–	–	–	–	–	
Motor connection and terminal box																			
External grounding			□	□	□	□	□	□	□	□	□	□	□	□	□	□	□	□	
Second external grounding	H70		–	–	–	–	–	–	–	–	–	–	–	–	–	–	–	–	
Rotation of the terminal box through 90°, entry from DE	R10		○	○	○	○	○	○	○	○	○	○	○	○	○	○	○	○	
Rotation of the terminal box through 90°, entry from NDE	R11		○	○	○	○	○	○	○	○	○	○	○	○	○	○	○	○	
Rotation of the terminal box through 180°	R12		○	○	○	○	○	○	○	○	○	○	○	○	○	○	○	○	
Metal cable gland, maximum configuration	R18		✓	✓	✓	✓	✓	✓	✓	✓	✓	✓	✓	✓	✓	✓	✓	✓	
Saddle terminal for connection without cable lug, accessories pack	R19		–	–	–	–	–	–	–	–	–	–	–	–	–	–	–	–	
Larger terminal box	R50		✓	✓	✓	✓	✓	✓	✓	✓	✓	✓	✓	✓	✓	✓	✓	✓	
Drilled removable entry plate	R52		–	–	–	–	–	–	–	–	–	–	–	–	–	–	–	–	
Undrilled removable entry plate	R53		–	–	–	–	–	–	–	–	–	–	–	–	–	–	–	–	
Cast-iron auxiliary terminal box (small)	R62		–	–	–	–	–	–	–	–	–	–	–	–	–	–	–	–	
Cast-iron auxiliary terminal box (large)	R63		–	–	–	–	–	–	–	–	–	–	–	–	–	–	–	–	
2 small cast-iron auxiliary terminal boxes	R67		–	–	–	–	–	–	–	–	–	–	–	–	–	–	–	–	
Windings and insulation																			
Temperature class 155 (F), utilized acc. to 130 (B), coolant temperature 45 °C, derating approx. 4 % ⁵⁾	N05		O. R.	O. R.	O. R.	O. R.	O. R.	O. R.	O. R.	O. R.	O. R.	O. R.	O. R.	O. R.	O. R.	O. R.	O. R.	O. R.	
Temperature class 155 (F), utilized acc. to 130 (B), coolant temperature 50 °C, derating approx. 8 % ⁵⁾	N06		O. R.	O. R.	O. R.	O. R.	O. R.	O. R.	O. R.	O. R.	O. R.	O. R.	O. R.	O. R.	O. R.	O. R.	O. R.	O. R.	
Temperature class 155 (F), utilized acc. to 130 (B), coolant temperature 55 °C, derating approx. 13 % ⁵⁾	N07		O. R.	O. R.	O. R.	O. R.	O. R.	O. R.	O. R.	O. R.	O. R.	O. R.	O. R.	O. R.	O. R.	O. R.	O. R.	O. R.	
Temperature class 155 (F), utilized acc. to 130 (B), coolant temperature 60 °C, derating approx. 18 % ⁵⁾	N08		O. R.	O. R.	O. R.	O. R.	O. R.	O. R.	O. R.	O. R.	O. R.	O. R.	O. R.	O. R.	O. R.	O. R.	O. R.	O. R.	
Increased air humidity/temperature with 30 to 60 g water per m ³ of air	N30		✓	✓	✓	✓	✓	✓	✓	✓	✓	✓	✓	✓	✓	✓	✓	✓	
Increased air humidity/temperature with 60 to 100 g water per m ³ of air	N31		✓	✓	✓	✓	✓	✓	✓	✓	✓	✓	✓	✓	✓	✓	✓	✓	
Colors and paint finish																			
Standard paint finish C2 in RAL 7030 stone gray			□	□	□	□	□	□	□	□	□	□	□	□	□	□	□	□	
Unpainted (only cast-iron parts primed)	S00		○	○	○	○	○	○	○	○	○	○	○	○	○	○	○	○	
Unpainted, only primed	S01		✓	✓	✓	✓	✓	✓	✓	✓	✓	✓	✓	✓	✓	✓	✓	✓	
Special paint finish C3	S02		✓	✓	✓	✓	✓	✓	✓	✓	✓	✓	✓	✓	✓	✓	✓	✓	
			–	–	–	–	–	–	–	–	–	–	–	–	–	–	–	–	
Special paint finish sea air resistant C4	S03		✓	✓	✓	✓	✓	✓	✓	✓	✓	✓	✓	✓	✓	✓	✓	✓	
Special paint finish for use offshore C5	S04		✓	✓	✓	✓	✓	✓	✓	✓	✓	✓	✓	✓	✓	✓	✓	✓	
Internal coating	S05		–	–	–	–	–	–	–	–	–	–	–	–	–	–	–	–	
Top coat polyurethane	S06		✓	✓	✓	✓	✓	✓	✓	✓	✓	✓	✓	✓	✓	✓	✓	✓	

For legends and footnotes, see page 6/107.

SIMOTICS XP 1MB1, 1MB5 explosion-protected motors

Article No. supplements and special versions · Options

Aluminum series 1MB1042; Cast-iron series 1MB.543 Basic Line and 1MB.643 Performance Line

Special versions	Additional identification code -Z with order code and plain text if required	Frame size													Motor version			
		63	71	80	90	100	112	132	160	180	200	225	250	280	315	IEC	Ex eb (Zone 1)	IE3
			1MB1042															
			1MB1543 Basic Line															
			1MB1643 Performance Line															
			1MB5543 Basic Line															
			1MB5643 Performance Line															
	Order code																	
Colors and paint finish (continued)																		
Special paint finish C5mid with medium durability	S08	-	✓	✓	✓	✓	✓	✓	✓	✓	✓	✓	✓	✓	✓			
Special paint finish CX for offshore with high durability	S09	-	✓	✓	✓	✓	✓	✓	✓	✓	✓	✓	✓	✓	✓			
Paint finish in other standard RAL colors: RAL 1015, 3000, 5002, 5009, 5010, 5012, 5015, 6011, 7001, 7011, 7016, 7031, 7032, 7035, 7037, 8012, 9005, 9010 (see Catalog Section 1 "Introduction")	Y53 • and paint finish RAL	✓	✓	✓	✓	✓	✓	✓	✓	✓	✓	✓	✓	✓	✓		Only for: 1MB.5..	
Paint finish in special RAL colors: For RAL colors, see "Special paint finish in special RAL colors" (see Catalog Section 1 "Introduction")	Y56 • and paint finish RAL	✓	✓	✓	✓	✓	✓	✓	✓	✓	✓	✓	✓	✓	✓			
Non-standard colors Colors see "Paint finish in non-standard colors" (see Catalog Section 1 "Introduction")	Y66 • and finish	✓	✓	✓	✓	✓	✓	✓	✓	✓	✓	✓	✓	✓	✓			
Mechanical version and degrees of protection																		
Low-noise version for 2-pole motors with clockwise direction of rotation ^{6) 18)}	F77	-	-	-	-	-	-	O. R.	O. R.	O. R.	O. R.	✓	✓	✓	✓			
Low-noise version for 2-pole motors with anti-clockwise direction of rotation ^{6) 18)}	F78	-	-	-	-	-	-	O. R.	O. R.	O. R.	O. R.	✓	✓	✓	✓			
Protective cover	H00	✓	✓	✓	✓	✓	✓	✓	✓	✓	✓	✓	✓	✓	✓			
Screwed-on (instead of cast) feet	H01	-	-	-	-	✓	✓	✓	✓	✓	✓	✓	✓	✓	✓			
Vibration-proof version; vibration resistance to Class 3M4 according to IEC 60721-3-3:1994	H02	✓	✓	✓	✓	✓	✓	✓	✓	✓	✓	✓	✓	✓	✓			
Condensation drainage holes ⁷⁾	H03	✓	✓	✓	✓	□	□	□	□	□	□	□	□	□	□			
Rust-resistant screws (externally)	H07	✓	✓	✓	✓	✓	✓	✓	✓	✓	✓	✓	✓	✓	✓			
IP66 degree of protection	H19	-	✓	✓	✓	✓	✓	✓	✓	✓	✓	✓	✓	✓	✓			
IP65 degree of protection ⁸⁾	H20	✓	✓	✓	✓	✓	✓	✓	✓	✓	✓	✓	✓	✓	✓			
IP56 degree of protection ⁸⁾	H22	✓	✓	✓	✓	✓	✓	✓	✓	✓	✓	✓	✓	✓	✓			
Drive-end seal for flange-mounting motors, oil-tight to 0.1 bar Not possible for type of construction IM V3	H23	✓	✓	✓	✓	✓	✓	✓	✓	✓	✓	✓	✓	✓	✓			
Coolant temperature and installation altitude																		
Coolant temperature -40 to +40 °C ⁹⁾	D03	✓	✓	✓	✓	✓	✓	✓	✓	✓	✓	✓	✓	✓	✓			
Versions in accordance with standards and specifications																		
IECEx certification	D37	✓	✓	✓	✓	✓	✓	✓	✓	✓	✓	✓	✓	✓	✓			
Bearings and lubrication																		
Regreasing device with M10 × 1 grease nipple according to DIN 71412-A	L19	-	-	-	-	-	-	-	-	✓	✓	✓	✓	○	○			
Located bearing DE	L20	✓	✓	✓	✓	✓	✓	✓	✓	✓	✓	✓	✓	✓	✓			
Located bearing NDE	L21	✓	✓	✓	✓	✓	✓	✓	□	□	□	□	□	□	□			
Bearing design for increased cantilever forces ¹⁰⁾	L22	✓	✓	✓	✓	✓	✓	✓	✓	✓	✓	✓	✓	✓	✓			
Regreasing device	L23	-	-	-	-	✓	✓	✓	✓	✓	✓	✓	✓	✓	□		Only for: 1MB.5..	
		-	-	-	-	✓	✓	✓	□	□	□	□	□	□	□		Only for: 1MB.6..	
Bearings reinforced at both ends for DE and NDE, bearing size 63	L25	✓	✓	✓	✓	✓	✓	✓	✓	✓	✓	✓	✓	✓	□		Only for: 1MB.5..	
		-	-	-	-	□	□	□	□	□	□	□	□	□	□		Only for: 1MB.6..	
Reinforced bearings at both DE and NDE, DE bearing for increased cantilever forces	L28	-	-	-	-	-	-	-	-	✓	✓	✓	✓	-	-			
Bearing insulation DE ²²⁾	L50	-	-	-	-	-	-	-	-	-	-	✓	✓	✓	✓			
Bearing insulation NDE ²²⁾	L51	-	-	-	-	-	-	-	-	-	-	✓	✓	✓	✓			
Measuring nipple for SPM shock pulse measurement for bearing inspection	Q01	-	-	-	-	✓	✓	✓	✓	✓	✓	✓	✓	✓	✓			

For legends and footnotes, see page 6/107.

SIMOTICS XP 1MB1, 1MB5 explosion-protected motors

Article No. supplements and special versions · Options

Aluminum series 1MB1042; Cast-iron series 1MB.543 Basic Line and 1MB.643 Performance Line

Special versions	Additional identification code -Z with order code and plain text if required	Frame size													Motor version			
		63	71	80	90	100	112	132	160	180	200	225	250	280	315	IEC	Ex eb (Zone 1)	IE3
		1MB1042																
		1MB1543 Basic Line																
		1MB1643 Performance Line																
		1MB543 Basic Line																
		1MB5643 Performance Line																
	Order code																	
Balance and vibration severity																		
Vibration severity grade A ²⁰⁾		<input type="checkbox"/>	<input type="checkbox"/>	<input type="checkbox"/>	<input type="checkbox"/>	<input type="checkbox"/>	<input type="checkbox"/>	<input type="checkbox"/>	<input type="checkbox"/>	<input type="checkbox"/>	<input type="checkbox"/>	<input type="checkbox"/>	<input type="checkbox"/>	<input type="checkbox"/>	<input type="checkbox"/>			
Vibration severity grade B ²⁰⁾	L00	<input checked="" type="checkbox"/>	<input checked="" type="checkbox"/>	<input checked="" type="checkbox"/>	<input checked="" type="checkbox"/>	<input checked="" type="checkbox"/>	<input checked="" type="checkbox"/>	<input checked="" type="checkbox"/>	<input checked="" type="checkbox"/>	<input checked="" type="checkbox"/>	<input checked="" type="checkbox"/>	<input checked="" type="checkbox"/>	<input checked="" type="checkbox"/>	<input checked="" type="checkbox"/>	<input checked="" type="checkbox"/>			
Half-key balancing		<input type="checkbox"/>	<input type="checkbox"/>	<input type="checkbox"/>	<input type="checkbox"/>	<input type="checkbox"/>	<input type="checkbox"/>	<input type="checkbox"/>	<input type="checkbox"/>	<input type="checkbox"/>	<input type="checkbox"/>	<input type="checkbox"/>	<input type="checkbox"/>	<input type="checkbox"/>	<input type="checkbox"/>			
Balancing without feather key	L01	<input checked="" type="checkbox"/>	<input checked="" type="checkbox"/>	<input checked="" type="checkbox"/>	<input checked="" type="checkbox"/>	<input checked="" type="checkbox"/>	<input checked="" type="checkbox"/>	<input checked="" type="checkbox"/>	<input checked="" type="checkbox"/>	<input checked="" type="checkbox"/>	<input checked="" type="checkbox"/>	<input checked="" type="checkbox"/>	<input checked="" type="checkbox"/>	<input checked="" type="checkbox"/>	<input checked="" type="checkbox"/>			
Full-key balancing	L02	<input checked="" type="checkbox"/>	<input checked="" type="checkbox"/>	<input checked="" type="checkbox"/>	<input checked="" type="checkbox"/>	<input checked="" type="checkbox"/>	<input checked="" type="checkbox"/>	<input checked="" type="checkbox"/>	<input checked="" type="checkbox"/>	<input checked="" type="checkbox"/>	<input checked="" type="checkbox"/>	<input checked="" type="checkbox"/>	<input checked="" type="checkbox"/>	<input checked="" type="checkbox"/>	<input checked="" type="checkbox"/>			
Shaft and rotor																		
Shaft extension with standard dimensions, without feather keyway	L04	-	-	-	<input checked="" type="checkbox"/>	<input checked="" type="checkbox"/>	<input checked="" type="checkbox"/>	<input checked="" type="checkbox"/>	<input checked="" type="checkbox"/>	<input checked="" type="checkbox"/>	<input checked="" type="checkbox"/>	<input checked="" type="checkbox"/>	<input checked="" type="checkbox"/>	<input checked="" type="checkbox"/>	<input checked="" type="checkbox"/>			
Standard, cylindrical shaft extension (second shaft extension) NDE acc. to EN 50347 ¹¹⁾	L05	<input checked="" type="checkbox"/>	<input checked="" type="checkbox"/>	<input checked="" type="checkbox"/>	<input checked="" type="checkbox"/>	<input checked="" type="checkbox"/>	<input checked="" type="checkbox"/>	<input checked="" type="checkbox"/>	<input checked="" type="checkbox"/>	<input checked="" type="checkbox"/>	<input checked="" type="checkbox"/>	<input checked="" type="checkbox"/>	<input checked="" type="checkbox"/>	<input checked="" type="checkbox"/>	<input checked="" type="checkbox"/>			
Standard shaft made of stainless steel (e.g. 1.4021)	L06	<input checked="" type="checkbox"/>	<input checked="" type="checkbox"/>	<input checked="" type="checkbox"/>	<input checked="" type="checkbox"/>	<input checked="" type="checkbox"/>	<input checked="" type="checkbox"/>	<input checked="" type="checkbox"/>	<input checked="" type="checkbox"/>	<input checked="" type="checkbox"/>	<input checked="" type="checkbox"/>	<input checked="" type="checkbox"/>	<input checked="" type="checkbox"/>	<input checked="" type="checkbox"/>	<input checked="" type="checkbox"/>			
Shaft extension run-out in accordance with IEC 60072-1 precision class ¹²⁾	L07	<input checked="" type="checkbox"/>	<input checked="" type="checkbox"/>	<input checked="" type="checkbox"/>	<input checked="" type="checkbox"/>	<input checked="" type="checkbox"/>	<input checked="" type="checkbox"/>	<input checked="" type="checkbox"/>	<input checked="" type="checkbox"/>	<input checked="" type="checkbox"/>	<input checked="" type="checkbox"/>	<input checked="" type="checkbox"/>	<input checked="" type="checkbox"/>	<input checked="" type="checkbox"/>	<input checked="" type="checkbox"/>			
Shaft extension run-out, concentricity and perpendicularity in accordance with IEC 60072-1 precision class for flange-mounted motors ¹²⁾	L08	<input checked="" type="checkbox"/>	<input checked="" type="checkbox"/>	<input checked="" type="checkbox"/>	<input checked="" type="checkbox"/>	<input checked="" type="checkbox"/>	<input checked="" type="checkbox"/>	<input checked="" type="checkbox"/>	<input checked="" type="checkbox"/>	<input checked="" type="checkbox"/>	<input checked="" type="checkbox"/>	<input checked="" type="checkbox"/>	<input checked="" type="checkbox"/>	<input checked="" type="checkbox"/>	<input checked="" type="checkbox"/>			
Non-standard cylindrical shaft extension, DE ¹³⁾	Y58 • and customer specifications	<input checked="" type="checkbox"/>	<input checked="" type="checkbox"/>	<input checked="" type="checkbox"/>	<input checked="" type="checkbox"/>	<input checked="" type="checkbox"/>	<input checked="" type="checkbox"/>	<input checked="" type="checkbox"/>	<input checked="" type="checkbox"/>	<input checked="" type="checkbox"/>	<input checked="" type="checkbox"/>	<input checked="" type="checkbox"/>	<input checked="" type="checkbox"/>	<input checked="" type="checkbox"/>	<input checked="" type="checkbox"/>			
Non-standard cylindrical shaft extension, NDE ¹³⁾	Y59 • and customer specifications	<input checked="" type="checkbox"/>	<input checked="" type="checkbox"/>	<input checked="" type="checkbox"/>	<input checked="" type="checkbox"/>	<input checked="" type="checkbox"/>	<input checked="" type="checkbox"/>	<input checked="" type="checkbox"/>	<input checked="" type="checkbox"/>	<input checked="" type="checkbox"/>	<input checked="" type="checkbox"/>	<input checked="" type="checkbox"/>	<input checked="" type="checkbox"/>	<input checked="" type="checkbox"/>	<input checked="" type="checkbox"/>			
Heating and ventilation																		
Sheet metal fan cover		<input type="checkbox"/>	<input type="checkbox"/>	<input type="checkbox"/>	<input type="checkbox"/>	<input type="checkbox"/>	<input type="checkbox"/>	<input type="checkbox"/>	<input type="checkbox"/>	<input type="checkbox"/>	<input type="checkbox"/>	<input type="checkbox"/>	<input type="checkbox"/>	<input type="checkbox"/>	<input type="checkbox"/>			
Metal external fan ¹⁴⁾	F76	<input type="checkbox"/>	<input type="checkbox"/>	<input type="checkbox"/>	<input type="checkbox"/>	<input type="checkbox"/>	<input type="checkbox"/>	<input type="checkbox"/>	<input type="checkbox"/>	<input type="checkbox"/>	<input type="checkbox"/>	<input type="checkbox"/>	<input type="checkbox"/>	<input type="checkbox"/>	<input type="checkbox"/>			
Anti-condensation heating for 230 V (2 terminals) ¹⁹⁾	Q02	<input checked="" type="checkbox"/>	<input checked="" type="checkbox"/>	<input checked="" type="checkbox"/>	<input checked="" type="checkbox"/>	<input checked="" type="checkbox"/>	<input checked="" type="checkbox"/>	<input checked="" type="checkbox"/>	<input checked="" type="checkbox"/>	<input checked="" type="checkbox"/>	<input checked="" type="checkbox"/>	<input checked="" type="checkbox"/>	<input checked="" type="checkbox"/>	<input checked="" type="checkbox"/>	<input checked="" type="checkbox"/>			
Anti-condensation heating for 115 V (2 terminals) ¹⁹⁾	Q03	<input checked="" type="checkbox"/>	<input checked="" type="checkbox"/>	<input checked="" type="checkbox"/>	<input checked="" type="checkbox"/>	<input checked="" type="checkbox"/>	<input checked="" type="checkbox"/>	<input checked="" type="checkbox"/>	<input checked="" type="checkbox"/>	<input checked="" type="checkbox"/>	<input checked="" type="checkbox"/>	<input checked="" type="checkbox"/>	<input checked="" type="checkbox"/>	<input checked="" type="checkbox"/>	<input checked="" type="checkbox"/>			
Rating plate and additional rating plates																		
Second rating plate, loose	M10	<input checked="" type="checkbox"/>	<input checked="" type="checkbox"/>	<input checked="" type="checkbox"/>	<input checked="" type="checkbox"/>	<input checked="" type="checkbox"/>	<input checked="" type="checkbox"/>	<input checked="" type="checkbox"/>	<input checked="" type="checkbox"/>	<input checked="" type="checkbox"/>	<input checked="" type="checkbox"/>	<input checked="" type="checkbox"/>	<input checked="" type="checkbox"/>	<input checked="" type="checkbox"/>	<input checked="" type="checkbox"/>			
Rating plate, stainless steel	M11	<input checked="" type="checkbox"/>	<input checked="" type="checkbox"/>	<input checked="" type="checkbox"/>	<input checked="" type="checkbox"/>	<input checked="" type="checkbox"/>	<input checked="" type="checkbox"/>	<input checked="" type="checkbox"/>	<input checked="" type="checkbox"/>	<input checked="" type="checkbox"/>	<input checked="" type="checkbox"/>	<input checked="" type="checkbox"/>	<input checked="" type="checkbox"/>	<input checked="" type="checkbox"/>	<input checked="" type="checkbox"/>			
		-	-	-	-	<input type="checkbox"/>	<input type="checkbox"/>	<input type="checkbox"/>	<input type="checkbox"/>	<input type="checkbox"/>	<input type="checkbox"/>	<input type="checkbox"/>	<input type="checkbox"/>	<input type="checkbox"/>	<input type="checkbox"/>			Only for: 1MB.6..
Additional rating plate with deviating rating plate data	Y80 • and customer specifications	<input checked="" type="checkbox"/>	<input checked="" type="checkbox"/>	<input checked="" type="checkbox"/>	<input checked="" type="checkbox"/>	<input checked="" type="checkbox"/>	<input checked="" type="checkbox"/>	<input checked="" type="checkbox"/>	<input checked="" type="checkbox"/>	<input checked="" type="checkbox"/>	<input checked="" type="checkbox"/>	<input checked="" type="checkbox"/>	<input checked="" type="checkbox"/>	<input checked="" type="checkbox"/>	<input checked="" type="checkbox"/>			
Additional rating plate with customer specifications	Y82 • and customer specifications	<input checked="" type="checkbox"/>	<input checked="" type="checkbox"/>	<input checked="" type="checkbox"/>	<input checked="" type="checkbox"/>	<input checked="" type="checkbox"/>	<input checked="" type="checkbox"/>	<input checked="" type="checkbox"/>	<input checked="" type="checkbox"/>	<input checked="" type="checkbox"/>	<input checked="" type="checkbox"/>	<input checked="" type="checkbox"/>	<input checked="" type="checkbox"/>	<input checked="" type="checkbox"/>	<input checked="" type="checkbox"/>			
Additional information on rating plate and on package label (max. 20 characters)	Y84 • and customer specifications	<input checked="" type="checkbox"/>	<input checked="" type="checkbox"/>	<input checked="" type="checkbox"/>	<input checked="" type="checkbox"/>	<input checked="" type="checkbox"/>	<input checked="" type="checkbox"/>	<input checked="" type="checkbox"/>	<input checked="" type="checkbox"/>	<input checked="" type="checkbox"/>	<input checked="" type="checkbox"/>	<input checked="" type="checkbox"/>	<input checked="" type="checkbox"/>	<input checked="" type="checkbox"/>	<input checked="" type="checkbox"/>			
Extension of the liability for defects																		
Extension of the liability for defects by 12 months to a total of 24 months (2 years) from delivery ¹⁴⁾	Q80	-	-	-	-	-	-	-	-	<input checked="" type="checkbox"/>	<input checked="" type="checkbox"/>	<input checked="" type="checkbox"/>	<input checked="" type="checkbox"/>	<input checked="" type="checkbox"/>	<input checked="" type="checkbox"/>			Only for: 1MB.5..
		-	-	-	-	<input type="checkbox"/>	<input type="checkbox"/>	<input type="checkbox"/>	<input type="checkbox"/>	<input type="checkbox"/>	<input type="checkbox"/>	<input type="checkbox"/>	<input type="checkbox"/>	<input type="checkbox"/>	<input type="checkbox"/>			Only for: 1MB.6..
Extension of the liability for defects by 24 months to a total of 36 months (3 years) from delivery ¹⁵⁾	Q82	-	-	-	-	-	-	-	-	<input checked="" type="checkbox"/>	<input checked="" type="checkbox"/>	<input checked="" type="checkbox"/>	<input checked="" type="checkbox"/>	<input checked="" type="checkbox"/>	<input checked="" type="checkbox"/>			Only for: 1MB.5..
		-	-	-	-	<input type="checkbox"/>	<input type="checkbox"/>	<input type="checkbox"/>	<input type="checkbox"/>	<input type="checkbox"/>	<input type="checkbox"/>	<input type="checkbox"/>	<input type="checkbox"/>	<input type="checkbox"/>	<input type="checkbox"/>			Only for: 1MB.6..

6

For legends and footnotes, see page 6/107.

SIMOTICS XP 1MB1, 1MB5 explosion-protected motors

Article No. supplements and special versions · Options

Aluminum series 1MB1042; Cast-iron series 1MB.543 Basic Line and 1MB.643 Performance Line

Special versions	Additional identification code -Z with order code and plain text if required	Frame size													Motor version			
		63	71	80	90	100	112	132	160	180	200	225	250	280	315	IEC	Ex eb (Zone 1)	IE3
		1MB1042																
		1MB1543 Basic Line																
		1MB1643 Performance Line																
		1MB5543 Basic Line																
		1MB5643 Performance Line																
1MB1042 --Z																		
1MB1.43 --Z																		
1MB5.43 --Z	Order code																	

Packaging, safety notes, documentation and test certificates																		
Printed Operating Instructions in German/English and a DVD with all official EU languages as well as Norwegian, Russian, Turkish, and Chinese ¹⁷⁾		□	□	□	□	□	□	□	□	□	□	□	□	□	□	□	□	
Inspection certificate 3.1 according to EN 10204 ¹⁸⁾	B02	✓	✓	✓	✓	✓	✓	✓	✓	✓	✓	✓	✓	✓	✓	✓	✓	
Document – Electrical datasheet	B60	✓	✓	✓	✓	✓	✓	✓	✓	✓	✓	✓	✓	✓	✓	✓	✓	
Document – Order dimensional drawing	B61	✓	✓	✓	✓	✓	✓	✓	✓	✓	✓	✓	✓	✓	✓	✓	✓	
Standard test (routine test) with acceptance	B65	–	–	–	✓	✓	✓	✓	✓	✓	✓	✓	✓	✓	✓	✓	✓	
Type test with heat run for horizontal motors, without acceptance	B82	✓	✓	✓	✓	✓	✓	✓	✓	✓	✓	✓	✓	✓	✓	✓	✓	
Type test with heat run for horizontal motors, with acceptance	B83	O. R.	O. R.	O. R.	O. R.	O. R.	O. R.	O. R.	O. R.	O. R.	O. R.	O. R.	O. R.	O. R.	O. R.	O. R.	O. R.	
"Basic" documentation package	B90	✓	✓	✓	✓	✓	✓	✓	✓	✓	✓	✓	✓	✓	✓	✓	✓	
"Advanced" documentation package	B91	✓	✓	✓	✓	✓	✓	✓	✓	✓	✓	✓	✓	✓	✓	✓	✓	
"Projects" documentation package	B92	✓	✓	✓	✓	✓	✓	✓	✓	✓	✓	✓	✓	✓	✓	✓	✓	
Connected in star for dispatch	M01	✓	✓	✓	✓	✓	✓	✓	✓	✓	✓	✓	✓	✓	✓	✓	✓	
Connected in delta for dispatch	M02	✓	✓	✓	✓	✓	✓	✓	✓	✓	✓	✓	□	□	□	□	□	

- Standard version
- Without additional charge
- This order code only determines the price of the version – Additional plain text is required.
- ✓ With additional charge
- O. R. Possible on request
- Not possible

1) Permissible paint film thickness up to 2 mm.

2) Please inquire regarding combination with order codes **D03** and **C02**. Not possible in combination with order codes **H20** and **H22**.

3) Motors in these frame sizes have a second rating plate (T1/T2 and T3) as standard. The T3 power is stamped on the rating plate as standard if the following motors are selected with PTC thermistor (protection by PTC thermistor only) or voltage code **90**:
 – 2-pole motors: Frame sizes 132 to 160
 – 4-pole motors: Frame size 180
 Alternatively, with order code **B33**, the "T1/T2 power is stamped on the rating plate".
 – 2-pole motors: Frame sizes 132 to 200
 – 4-pole motors: Frame sizes 180 to 200

4) Evaluation with associated tripping unit (see Catalog IC 10) is recommended. A certified tripping unit is necessary for use in hazardous areas.

5) The maximum possible certified power will be supplied. For motors with T1/T2, T3 power, T3 power is supplied. The T1/T2 power must be ordered with the order code **B33**.

6) The motors are up to 80 mm longer than normal. A second shaft extension is not possible.

7) Supplied with the condensation drainage holes sealed at the drive end DE and non-drive end NDE for IP55, IP56 and IP65 degrees of protection. If condensation drainage holes are required in motors of the IM B6, IM B7 or IM B8 type of construction (feet located on side or top), it is necessary to relocate the bearing shields at the drive end (DE) and non-drive end (NDE) so that the condensation drainage holes situated between the feet on delivery are underneath.

8) Not possible in combination with version additionally for dust Ex tb – Zone 21; IP65 - order code **B32**. IP65 degree of protection is prescribed for the version for Zone 21.

9) Not possible in combination with vibration-proof version, order code **H02**.

10) Not possible for 2-pole motors, frame size 315 L in vertical frame sizes; bearings for increased cantilever forces for vibration severity grade B are available on request for motors of frame size 225 M and above. Not possible for motors of frame size 225 M and above in combination with shaft extension run-out, concentricity and perpendicularity according to DIN 42955 tolerance R for flange-mounting types.

11) For motors of frame size 180 M and above in vertical type of construction in version with second shaft extension on request. Not possible for low-noise version (2-pole) for frame sizes 132 S to 160 L. Version with protective cover not possible.

12) Can be combined with deep-groove bearings of series 60... 62... and 63... Not possible in combination with cylindrical roller bearings (e.g. bearings for increased cantilever forces, order code **L22**).

13) When motors are ordered that have a longer or shorter shaft extension than normal, the required position and length of the feather keyway must be specified in a sketch. It must be ensured that only feather keys in accordance with DIN 6885, Form A are permitted to be used. The feather keyway is positioned centrally on the shaft extension. The length is defined by the manufacturer in accordance with the appropriate standard. Not valid for: Conical shafts, non-standard threaded journals, non-standard shaft tolerances, friction welded journals, extremely "thin" shafts, special geometry dimensions (e.g. square journals), hollow shafts. Valid for non-standard shaft extensions DE or NDE. The feather keys are supplied in every case. For order codes **Y58**, **Y59** and **L05** the following applies:
 –Dimensions D and DA ≤ ball bearing inner diameter (see dimension tables in "Dimensions")
 –Dimensions E and EA ≤ 2 × length E (standard) of the shaft extension
 For an explanation of the order codes, see Catalog Section 1 "Introduction".

14) The metal external fan is not possible in combination with the low-noise version – order code **F77** or **F78**.

15) Wearing parts (bearings) are excluded from the warranty extension.

16) The Operating Instructions are available on the Internet in SIOS too: <http://support.automation.siemens.com/WWW/view/en/10803948/133300>

17) The delivery time for the manufacturer's test certificate may differ from the delivery time for the motor.

18) The motors may exceed the noise levels defined by VIK.

19) For frame sizes 71 to 90 in combination with the order codes **Q02** and **Q03**, **R50** is the standard version (the additional charge **R50** is already contained in **Q02** and **Q03**).

20) Not permissible for frame size 315, 2-pole, except for elastic installation.

21) For frame sizes 100 and 112, only permissible in combination with order code **R50**.

22) It is not permissible to combine order codes **L50** and **L51**.

SIMOTICS XP 1MB1, 1MB5 explosion-protected motors

Article No. supplements and special versions · Options

Cast-iron series 1MB.55., 1MB.853, 1MB.56., 1MB.863

Selection and ordering data

Special versions	Additional identification code -Z with order code and plain text if required	Frame size														Motor version		
		71	80	90	100	112	132	160	180	200	225	250	280	315	355	IEC	Ex db, Ex db eb (Zone 1)	IE3
		1MB1.5., 1MB1.6.																
												1MB55..						
						1MB18.3												
											1MB58.3							
1MB.553 - - -Z		Order code																
Explosion-protected version																		
Version additionally for dust Ex tc – Zone 22	B30	✓	✓	✓	✓	✓	✓	✓	✓	✓	✓	✓	✓	✓	✓	✓	Not for:	Combination with order code S00
Version IIC with stamping of IIB	B31	○	○	○	○	○	○	○	○	○	○	○	○	○	○	○		
Version additionally for dust Ex tb – Zone 21; IP65	B32	✓	✓	✓	✓	✓	✓	✓	✓	✓	✓	✓	✓	✓	✓	✓	Not for:	Combination with order code S00
VIK version ¹⁸⁾	C02	✓	✓	✓	✓	✓	✓	✓	✓	✓	✓	✓	✓	✓	✓	✓		
Chemstar chemical Industry	C03	✓	✓	✓	✓	✓	✓	✓	✓	✓	✓	✓	✓	✓	✓	✓	Only for:	1MB..5. Ex db IIC
Chemstar Oil & Gas Industry	C04	✓	✓	✓	✓	✓	✓	✓	✓	✓	✓	✓	✓	✓	✓	✓		
Version for converter operation																		
Version for converter operation with power data on the PWM converter ⁶⁾	B43	✓	✓	✓	✓	✓	✓	✓	✓	✓	✓	✓	✓	✓	✓	✓		
Version for converter operation with power data on the PWM converter, utilization in accordance with temperature class 155 (F) ⁶⁾	B44	✓	✓	✓	✓	✓	✓	✓	✓	✓	✓	✓	✓	✓	✓	✓		
Motor protection																		
2 Pt100 resistance thermometers in basic configuration for bearings (2 terminals) ¹⁾	Q72	-	-	-	-	-	-	✓	✓	✓	✓	✓	✓	✓	✓	✓		
2 Pt100 resistance thermometers in 3-wire input for bearings (6 terminals) ¹⁾	Q78	-	-	-	-	-	-	✓	✓	✓	✓	✓	✓	✓	✓	✓		
2 Pt100 double resistance thermometers in 3-wire input for bearings (12 terminals) ¹⁾	Q79	-	-	-	-	-	-	-	-	-	-	-	✓	✓	✓	✓		
Motor connection and terminal box																		
External grounding		□	□	□	□	□	□	□	□	□	□	□	□	□	□	□		
Second external grounding	H70	✓	✓	✓	✓	✓	✓	✓	✓	✓	✓	✓	✓	✓	✓	✓		
Rotation of the terminal box through 90°, entry from DE	R10	✓	✓	✓	✓	✓	✓	✓	✓	✓	✓	✓	✓	✓	✓	✓		
Rotation of the terminal box through 90°, entry from NDE	R11	✓	✓	✓	✓	✓	✓	✓	✓	✓	✓	✓	✓	✓	✓	✓		
Rotation of the terminal box through 180°	R12	✓	✓	✓	✓	✓	✓	✓	✓	✓	✓	✓	✓	✓	✓	✓		
One metal cable gland	R15	✓	✓	✓	✓	✓	✓	✓	✓	✓	✓	✓	✓	✓	✓	✓	Only for:	1MB.6. Ex db IIB
Metal cable gland, maximum configuration ¹⁷⁾	R18	✓	✓	✓	✓	✓	✓	✓	✓	✓	✓	✓	✓	✓	✓	✓		
1 cable gland, Ex eb, for armored cable, line feeder cable	R45	✓	✓	✓	✓	✓	✓	✓	✓	✓	✓	✓	✓	✓	✓	✓		
2 cable glands, Ex eb, for armored cable, line feeder cable	R46	-	-	-	✓	✓	✓	✓	✓	✓	✓	✓	✓	✓	✓	✓		
Main terminal box in Ex db ²⁴⁾	R48	✓	✓	✓	✓	✓	✓	✓	✓	✓	✓	✓	✓	✓	✓	✓	Only for:	1MB..5. Ex db IIC
Auxiliary terminal box in Ex db ²⁴⁾	R49	-	-	-	-	-	-	✓	✓	✓	✓	✓	✓	✓	✓	✓	Only for:	1MB..5. Ex db IIC
Larger terminal box ¹⁷⁾	R50	□	□	□	✓	✓	✓	✓	✓	✓	✓	✓	✓	✓	✓	-		
Enlarged connection system for main terminal box ¹⁷⁾	R54	✓	✓	✓	✓	✓	✓	✓	✓	✓	-	-	-	-	-	-		
Cast-iron auxiliary terminal box (small)	R62	✓ ²²⁾	✓ ²²⁾	✓ ²²⁾	✓ ²¹⁾	✓ ²¹⁾	✓ ²¹⁾	✓	✓	✓	✓	✓	✓	✓	✓	✓		
Cast-iron auxiliary terminal box (large)	R63	-	-	-	-	-	-	-	-	✓ ²²⁾	✓ ²¹⁾	✓	✓	✓	✓	✓		
2 small cast-iron auxiliary terminal boxes	R67	✓ ²²⁾	✓ ²²⁾	✓ ²²⁾	✓ ²¹⁾	✓ ²¹⁾	✓ ²¹⁾	✓	✓	✓	✓	✓	✓	✓	✓	✓		
2 big cast-iron auxiliary terminal boxes	R68	-	-	-	-	-	-	-	-	✓	✓	✓	✓	✓	✓	✓		
Non-standard threaded through hole (NPT or G thread)	Y61 • and customer specifications	✓	✓	✓	✓	✓	✓	✓	✓	✓	✓	✓	✓	✓	✓	✓	Not for:	Combination with order code R15 or R18
Windings and insulation																		
Temperature class 155 (F), utilized acc. to 130 (B), coolant temperature 45 °C, derating approx. 4 %	N05	✓	✓	✓	✓	✓	✓	✓	✓	✓	✓	✓	✓	✓	✓	✓		
Temperature class 155 (F), utilized acc. to 130 (B), coolant temperature 50 °C, derating approx. 8 %	N06	✓	✓	✓	✓	✓	✓	✓	✓	✓	✓	✓	✓	✓	✓	✓		
Temperature class 155 (F), utilized acc. to 130 (B), coolant temperature 55 °C, derating approx. 13 %	N07	✓	✓	✓	✓	✓	✓	✓	✓	✓	✓	✓	✓	✓	✓	✓		

For legends and footnotes, see page 6/112.

SIMOTICS XP 1MB1, 1MB5 explosion-protected motors

Article No. supplements and special versions · Options

Cast-iron series 1MB.55., 1MB.853, 1MB.56., 1MB.863

Special versions	Additional identification code -Z with order code and plain text if required	Frame size													Motor version			
		71	80	90	100	112	132	160	180	200	225	250	280	315	355	IEC	Ex db, Ex db eb (Zone 1)	IE3
		1MB1.5., 1MB1.6.																
					1MB18.3							1MB55..						
												1MB58.3						
1MB.553 - - -Z	Order code																	
Windings and insulation (continued)																		
Temperature class 155 (F), utilized acc. to 130 (B), coolant temperature 60 °C, derating approx. 18 %	N08	✓	✓	✓	✓	✓	✓	✓	✓	✓	✓	✓	✓	✓	✓			
Increased air humidity/temperature with 30 to 60 g water per m ³ of air	N30	✓	✓	✓	✓	✓	✓	✓	✓	✓	✓	✓	✓	✓	✓			
Increased air humidity/temperature with 60 to 100 g water per m ³ of air ²⁰⁾	N31	✓	✓	✓	✓	✓	✓	✓	✓	✓	✓	✓	✓	✓	✓			
Temperature class 155 (F), utilized acc. to 130 (B), with higher coolant temperature and/or installation altitude	Y50 • CT ... °C or IA m above sea level	✓	✓	✓	✓	✓	✓	✓	✓	✓	✓	✓	✓	✓	✓			
Colors and paint finish																		
Standard paint finish C2 in RAL 7030 stone gray		□	□	□	□	□	□	□	□	□	□	□	□	□	□			
Unpainted (only cast-iron parts primed)	S00	○	○	○	○	○	○	○	○	○	○	○	○	○	○			
Unpainted, only primed	S01	✓	✓	✓	✓	✓	✓	✓	✓	✓	✓	✓	✓	✓	✓			
Special paint finish C3	S02	✓	✓	✓	✓	✓	✓	✓	✓	✓	✓	✓	✓	✓	✓			
Special paint finish sea air resistant C4	S03	✓	✓	✓	✓	✓	✓	✓	✓	✓	✓	✓	✓	✓	✓			
Special paint finish for use offshore C5	S04	✓	✓	✓	✓	✓	✓	✓	✓	✓	✓	✓	✓	✓	✓			
Internal coating	S05	✓	✓	✓	✓	✓	✓	✓	✓	✓	✓	✓	✓	✓	✓			
Top coat polyurethane ¹⁶⁾	S06	✓	✓	✓	✓	✓	✓	✓	✓	✓	✓	✓	✓	✓	✓			
Special paint finish C5mid with medium durability	S08	✓	✓	✓	✓	✓	✓	✓	✓	✓	✓	✓	✓	✓	✓			
Special paint finish CX for offshore with high durability	S09	✓	✓	✓	✓	✓	✓	✓	✓	✓	✓	✓	✓	✓	✓			
Paint finish in other standard RAL colors: RAL 1015, 3000, 5002, 5009, 5010, 5012, 5015, 6011, 7001, 7011, 7016, 7031, 7032, 7035, 7037, 8012, 9005, 9010 (see Catalog Section 1 "Introduction")	Y53 • and paint finish RAL	✓	✓	✓	✓	✓	✓	✓	✓	✓	✓	✓	✓	✓	✓			
Paint finish in special RAL colors: For RAL colors, see "Special paint finish in special RAL colors" (see Catalog Section 1 "Introduction")	Y56 • and paint finish RAL	✓	✓	✓	✓	✓	✓	✓	✓	✓	✓	✓	✓	✓	✓			
Non-standard colors Colors see "Paint finish in non-standard colors" (see Catalog Section 1 "Introduction")	Y66 • and paint finish	✓	✓	✓	✓	✓	✓	✓	✓	✓	✓	✓	✓	✓	✓			
Modular technology – Basic versions																		
Mounting of separately driven fan	F70	-	-	-	-	-	-	-	-	-	✓	✓	✓	✓	✓	Not for:	Combination with order code D03	
Modular technology – Additional versions																		
Brake supply voltage 24 V DC	F10	-	○	○	○	○	○	○	○	○	-	-	-	-	-			
Brake supply voltage 230 V AC, 50/60 Hz	F11	-	○	○	○	○	○	○	○	○	-	-	-	-	-			
Brake supply voltage 400 V AC, 50/60 Hz	F12	-	○	○	○	○	○	○	○	○	-	-	-	-	-			
Mechanical manual brake release with lever (no locking)	F50	-	✓	✓	✓	✓	✓	✓	✓	✓	-	-	-	-	-			
Special technology																		
Mounting of brake in Ex db version	F20	-	✓	✓	✓	✓	✓	✓	✓	✓	-	-	-	-	-			
Mounting of LL 841 (HTL); 1024 l explosion-protected rotary pulse encoder	G30	-	-	-	✓	✓	✓	✓	✓	✓	✓	✓	✓	✓	✓			
Mechanical version and degrees of protection																		
Low-noise version for 2-pole motors with clockwise direction of rotation	F77	-	-	-	-	-	✓	✓	✓	✓	✓	✓	✓	✓	✓	Not for:	Combination with order code D03	
Low-noise version for 2-pole motors with counterclockwise direction of rotation ²⁶⁾	F78	-	-	-	-	-	✓	✓	✓	✓	✓	✓	✓	✓	✓	Not for:	Combination with order code D03	
Protective cover ⁴⁾	H00	✓	✓	✓	✓	✓	✓	✓	✓	✓	✓	✓	✓	✓	✓			
Vibration-proof version; vibration resistance to Class 3M4 according to IEC 60721-3-3:1994	H02	✓	✓	✓	✓	✓	✓	✓	✓	✓	✓	✓	✓	✓	✓	Not for:	Combination with order code F20, F70, R50, R54	
External screws, bolts and unpainted materials made of stainless steel (V4A) ⁵⁾	H06	✓	✓	✓	✓	✓	✓	✓	✓	✓	✓	✓	✓	✓	✓			
Rust-resistant screws (externally)	H07	✓	✓	✓	✓	✓	✓	✓	✓	✓	✓	✓	✓	✓	✓			

For legends and footnotes, see page 6/112.



SIMOTICS XP 1MB1, 1MB5 explosion-protected motors

Article No. supplements and special versions · Options

Cast-iron series 1MB.55., 1MB.853, 1MB.56., 1MB.863

Special versions	Additional identification code -Z with order code and plain text if required	Frame size													Motor version			
		71	80	90	100	112	132	160	180	200	225	250	280	315	355	IEC	Ex db, Ex db eb (Zone 1)	IE3
		1MB1.5., 1MB1.6.																
					1MB18.3							1MB55..						
												1MB58.3						
	1MB.553 - - -Z	Order code																
Mechanical version and degrees of protection (continued)																		
IP66 degree of protection	H19		✓	✓	✓	✓	✓	✓	✓	✓	✓	✓	✓	✓	✓	✓		
IP65 degree of protection	H20		✓	✓	✓	✓	✓	✓	✓	✓	✓	✓	✓	✓	✓	✓		
IP56 degree of protection	H22		✓	✓	✓	✓	✓	✓	✓	✓	✓	✓	✓	✓	✓	✓		
Drive-end seal for flange-mounting motors, oil-tight to 0.1 bar	H23		✓	✓	✓	✓	✓	✓	✓	✓	✓	✓	✓	✓	✓	✓	Not for:	Combination with type of construction code letters H, L, Y (14th position of the Article No.)
Adjustment screws for feet in horizontal installation ⁷⁾	H30		-	-	-	-	-	-	-	✓	✓	✓	✓	✓	✓			
Coolant temperature and installation altitude																		
Coolant temperature -40 to +40 °C	D03		✓	✓	✓	✓	✓	✓	✓	✓	✓	✓	✓	✓	✓	✓	Only for:	1MB..5. Ex db IIC
Versions in accordance with standards and specifications																		
Motor without CE marking for export outside EEA (see EU Regulation 2019/1781)	D22		○	○	○	○	○	○	○	○	○	○	○	○	○	○	Only for:	Combination with order code D37
Ex certification for China ²³⁾	D32		✓	✓	✓	✓	✓	✓	✓	✓	✓	✓	✓	✓	✓	✓	Only for:	1MB..5. Ex db IIC
China Energy Efficiency Label ²³⁾	D34		○	○	○	○	○	○	○	○	○	○	○	○	○	○	Only for:	1MB..5. Ex db IIC
EAC Ex certificate for the Eurasian Customs Union	D35		✓	✓	✓	✓	✓	✓	✓	✓	✓	✓	✓	✓	✓	✓	Only for:	1MB..5. Ex db IIC
IECEX certification	D37		✓	✓	✓	✓	✓	✓	✓	✓	✓	✓	✓	✓	✓	✓		
MEPS Australia	D70		✓	✓	✓	✓	✓	✓	✓	✓	✓	✓	✓	✓	✓	✓		
Bearings and lubrication																		
Regreasing device with M10 × 1 grease nipple according to DIN 71412-A	L19		-	-	-	-	-	✓	✓	✓	✓	✓	○	○	○			
Located bearing DE	L20		□	□	□	□	□	□	□	□	□	□	□	□	□			
Located bearing NDE	L21		✓	✓	✓	✓	✓	✓	✓	✓	✓	✓	✓	✓	✓			
Bearing design for increased cantilever forces	L22		-	-	-	-	-	✓	✓	✓	✓	✓	✓	✓	✓			
Regreasing device	L23		-	-	-	-	-	✓	✓	✓	✓	✓	□	□	□			
Bearing for high axial tension forces	L34		-	-	-	✓	✓	✓	✓	✓	✓	✓	✓	✓	✓			
Bearing for high axial tension and thrust forces	L35		-	-	-	-	-	✓	✓	✓	✓	-	-	-	-			
Bearing insulation NDE	L51		-	-	-	-	-	✓	✓	✓	✓	✓	✓	✓	✓			
Measuring nipple for SPM shock pulse measurement for bearing inspection	Q01		-	-	-	✓	✓	✓	✓	✓	✓	✓	✓	✓	✓			
Balance and vibration severity																		
Vibration severity grade A			□	□	□	□	□	□	□	□	□	□	□	□	□			
Vibration severity grade B ²⁾	L00		✓	✓	✓	✓	✓	✓	✓	✓	✓	✓	✓	✓	✓			
Half-key balancing			□	□	□	□	□	□	□	□	□	□	□	□	□			
Balancing without feather key	L01		✓	✓	✓	✓	✓	✓	✓	✓	✓	✓	✓	✓	✓			
Full-key balancing	L02		✓	✓	✓	✓	✓	✓	✓	✓	✓	✓	✓	✓	✓			
Shaft and rotor																		
Shaft extension with standard dimensions, without feather keyway	L04		✓	✓	✓	✓	✓	✓	✓	✓	✓	✓	✓	✓	✓			
Standard, cylindrical shaft extension (second shaft extension) NDE acc. to EN 50347	L05		✓	✓	✓	✓	✓	✓	✓	✓	✓	✓	✓	✓	✓	Not for:	Combination with order code F70, G30, H00	
Standard shaft made of stainless steel (e.g. 1.4021)	L06		✓	✓	✓	✓	✓	✓	✓	✓	✓	✓	✓	✓	✓			
Shaft extension run-out in accordance with IEC 60072-1 precision class	L07		✓	✓	✓	✓	✓	✓	✓	✓	✓	✓	✓	✓	✓			
Shaft extension run-out, concentricity and perpendicularity in accordance with IEC 60072-1 precision class for flange-mounted motors	L08		✓	✓	✓	✓	✓	✓	✓	✓	✓	✓	✓	✓	✓			
Non-standard cylindrical shaft extension, DE ⁸⁾	Y58 • and customer specifications		✓	✓	✓	✓	✓	✓	✓	✓	✓	✓	✓	✓	✓			
Non-standard cylindrical shaft extension, NDE ⁸⁾	Y59 • and customer specifications		✓	✓	✓	✓	✓	✓	✓	✓	✓	✓	✓	✓	✓			

For legends and footnotes, see page 6/112.

SIMOTICS XP 1MB1, 1MB5 explosion-protected motors

Article No. supplements and special versions · Options

Cast-iron series 1MB.55., 1MB.853, 1MB.56., 1MB.863

Special versions	Additional identification code -Z with order code and plain text if required	Frame size														Motor version		
		71	80	90	100	112	132	160	180	200	225	250	280	315	355	IEC	Ex db, Ex db eb (Zone 1)	IE3
		1MB1.5., 1MB1.6.																
					1MB18.3								1MB55..					
															1MB58.3			
1MB.553 - - - Z	Order code																	
Heating and ventilation																		
Metal fan cover		<input type="checkbox"/>	<input type="checkbox"/>	<input type="checkbox"/>	<input type="checkbox"/>	<input type="checkbox"/>	<input type="checkbox"/>	<input type="checkbox"/>	<input type="checkbox"/>	<input type="checkbox"/>	<input type="checkbox"/>	<input type="checkbox"/>	<input type="checkbox"/>	<input type="checkbox"/>	<input type="checkbox"/>			
Metal fan made of brass	F68	<input checked="" type="checkbox"/>	<input checked="" type="checkbox"/>	<input checked="" type="checkbox"/>	<input checked="" type="checkbox"/>	<input checked="" type="checkbox"/>	<input checked="" type="checkbox"/>	<input checked="" type="checkbox"/>	<input checked="" type="checkbox"/>	<input checked="" type="checkbox"/>	<input checked="" type="checkbox"/>	<input checked="" type="checkbox"/>	<input checked="" type="checkbox"/>	<input checked="" type="checkbox"/>	<input checked="" type="checkbox"/>	Not for:	Combination with order code F77, F78	
Metal external fan ⁹⁾	F76	<input checked="" type="checkbox"/>	<input checked="" type="checkbox"/>	<input checked="" type="checkbox"/>	<input checked="" type="checkbox"/>	<input checked="" type="checkbox"/>	<input checked="" type="checkbox"/>	<input checked="" type="checkbox"/>	<input checked="" type="checkbox"/>	<input checked="" type="checkbox"/>	<input checked="" type="checkbox"/>	<input checked="" type="checkbox"/>	<input checked="" type="checkbox"/>	<input checked="" type="checkbox"/>	<input type="checkbox"/>	Not for:	Combination with order code F77, F78	
Anti-condensation heating for 230 V (2 terminals) ^{1) 10)}	Q02	<input checked="" type="checkbox"/>	<input checked="" type="checkbox"/>	<input checked="" type="checkbox"/>	<input checked="" type="checkbox"/>	<input checked="" type="checkbox"/>	<input checked="" type="checkbox"/>	<input checked="" type="checkbox"/>	<input checked="" type="checkbox"/>	<input checked="" type="checkbox"/>	<input checked="" type="checkbox"/>	<input checked="" type="checkbox"/>	<input checked="" type="checkbox"/>	<input checked="" type="checkbox"/>	<input checked="" type="checkbox"/>			
Anti-condensation heating for 115 V (2 terminals) ^{1) 10)}	Q03	<input checked="" type="checkbox"/>	<input checked="" type="checkbox"/>	<input checked="" type="checkbox"/>	<input checked="" type="checkbox"/>	<input checked="" type="checkbox"/>	<input checked="" type="checkbox"/>	<input checked="" type="checkbox"/>	<input checked="" type="checkbox"/>	<input checked="" type="checkbox"/>	<input checked="" type="checkbox"/>	<input checked="" type="checkbox"/>	<input checked="" type="checkbox"/>	<input checked="" type="checkbox"/>	<input checked="" type="checkbox"/>			
Anti-condensation heating for 220 V (2 terminals) ^{1) 10)}	Q04	<input checked="" type="checkbox"/>	<input checked="" type="checkbox"/>	<input checked="" type="checkbox"/>	<input checked="" type="checkbox"/>	<input checked="" type="checkbox"/>	<input checked="" type="checkbox"/>	<input checked="" type="checkbox"/>	<input checked="" type="checkbox"/>	<input checked="" type="checkbox"/>	<input checked="" type="checkbox"/>	<input checked="" type="checkbox"/>	<input checked="" type="checkbox"/>	<input checked="" type="checkbox"/>	<input checked="" type="checkbox"/>			
Separately driven fan with non-standard voltage and/or frequency	Y81 • and customer specifications	-	-	-	-	-	-	-	-	-	<input checked="" type="checkbox"/>	<input checked="" type="checkbox"/>	<input checked="" type="checkbox"/>	<input checked="" type="checkbox"/>	<input checked="" type="checkbox"/>			
Rating plate and additional rating plates																		
Second rating plate, loose	M10	<input checked="" type="checkbox"/>	<input checked="" type="checkbox"/>	<input checked="" type="checkbox"/>	<input checked="" type="checkbox"/>	<input checked="" type="checkbox"/>	<input checked="" type="checkbox"/>	<input checked="" type="checkbox"/>	<input checked="" type="checkbox"/>	<input checked="" type="checkbox"/>	<input checked="" type="checkbox"/>	<input checked="" type="checkbox"/>	<input checked="" type="checkbox"/>	<input checked="" type="checkbox"/>	<input checked="" type="checkbox"/>			
Rating plate, stainless steel	M11	<input type="checkbox"/>	<input type="checkbox"/>	<input type="checkbox"/>	<input type="checkbox"/>	<input type="checkbox"/>	<input type="checkbox"/>	<input type="checkbox"/>	<input type="checkbox"/>	<input type="checkbox"/>	<input type="checkbox"/>	<input type="checkbox"/>	<input type="checkbox"/>	<input type="checkbox"/>	<input type="checkbox"/>			
Additional rating plate with deviating rating plate data	Y80 • and customer specifications	<input checked="" type="checkbox"/>	<input checked="" type="checkbox"/>	<input checked="" type="checkbox"/>	<input checked="" type="checkbox"/>	<input checked="" type="checkbox"/>	<input checked="" type="checkbox"/>	<input checked="" type="checkbox"/>	<input checked="" type="checkbox"/>	<input checked="" type="checkbox"/>	<input checked="" type="checkbox"/>	<input checked="" type="checkbox"/>	<input checked="" type="checkbox"/>	<input checked="" type="checkbox"/>	<input checked="" type="checkbox"/>			
Additional rating plate with customer specifications	Y82 • and customer specifications	<input checked="" type="checkbox"/>	<input checked="" type="checkbox"/>	<input checked="" type="checkbox"/>	<input checked="" type="checkbox"/>	<input checked="" type="checkbox"/>	<input checked="" type="checkbox"/>	<input checked="" type="checkbox"/>	<input checked="" type="checkbox"/>	<input checked="" type="checkbox"/>	<input checked="" type="checkbox"/>	<input checked="" type="checkbox"/>	<input checked="" type="checkbox"/>	<input checked="" type="checkbox"/>	<input checked="" type="checkbox"/>			
Additional information on rating plate and on package label (max. 20 characters)	Y84 • and customer specifications	<input checked="" type="checkbox"/>	<input checked="" type="checkbox"/>	<input checked="" type="checkbox"/>	<input checked="" type="checkbox"/>	<input checked="" type="checkbox"/>	<input checked="" type="checkbox"/>	<input checked="" type="checkbox"/>	<input checked="" type="checkbox"/>	<input checked="" type="checkbox"/>	<input checked="" type="checkbox"/>	<input checked="" type="checkbox"/>	<input checked="" type="checkbox"/>	<input checked="" type="checkbox"/>	<input checked="" type="checkbox"/>			
Extension of the liability for defects																		
Extension of the liability for defects period by 12 months to a total of 24 months (2 years) from delivery	Q80	<input checked="" type="checkbox"/>	<input checked="" type="checkbox"/>	<input checked="" type="checkbox"/>	<input checked="" type="checkbox"/>	<input checked="" type="checkbox"/>	<input checked="" type="checkbox"/>	<input checked="" type="checkbox"/>	<input checked="" type="checkbox"/>	<input checked="" type="checkbox"/>	<input checked="" type="checkbox"/>	<input checked="" type="checkbox"/>	<input checked="" type="checkbox"/>	<input checked="" type="checkbox"/>	<input checked="" type="checkbox"/>			
Extension of the liability for defects period by 24 months to a total of 36 months (3 years) from delivery	Q82	<input checked="" type="checkbox"/>	<input checked="" type="checkbox"/>	<input checked="" type="checkbox"/>	<input checked="" type="checkbox"/>	<input checked="" type="checkbox"/>	<input checked="" type="checkbox"/>	<input checked="" type="checkbox"/>	<input checked="" type="checkbox"/>	<input checked="" type="checkbox"/>	<input checked="" type="checkbox"/>	<input checked="" type="checkbox"/>	<input checked="" type="checkbox"/>	<input checked="" type="checkbox"/>	<input checked="" type="checkbox"/>			
Packaging, safety notes, documentation and test certificates																		
Printed Operating Instructions in German/English and a DVD with all official EU languages as well as Norwegian, Russian, Turkish, and Chinese ¹¹⁾		<input type="checkbox"/>	<input type="checkbox"/>	<input type="checkbox"/>	<input type="checkbox"/>	<input type="checkbox"/>	<input type="checkbox"/>	<input type="checkbox"/>	<input type="checkbox"/>	<input type="checkbox"/>	<input type="checkbox"/>	<input type="checkbox"/>	<input type="checkbox"/>	<input type="checkbox"/>	<input type="checkbox"/>			
Inspection certificate 3.1 according to EN 10204 ¹²⁾	B02	<input checked="" type="checkbox"/>	<input checked="" type="checkbox"/>	<input checked="" type="checkbox"/>	<input checked="" type="checkbox"/>	<input checked="" type="checkbox"/>	<input checked="" type="checkbox"/>	<input checked="" type="checkbox"/>	<input checked="" type="checkbox"/>	<input checked="" type="checkbox"/>	<input checked="" type="checkbox"/>	<input checked="" type="checkbox"/>	<input checked="" type="checkbox"/>	<input checked="" type="checkbox"/>	<input checked="" type="checkbox"/>			
Document – Electrical datasheet	B60	<input checked="" type="checkbox"/>	<input checked="" type="checkbox"/>	<input checked="" type="checkbox"/>	<input checked="" type="checkbox"/>	<input checked="" type="checkbox"/>	<input checked="" type="checkbox"/>	<input checked="" type="checkbox"/>	<input checked="" type="checkbox"/>	<input checked="" type="checkbox"/>	<input checked="" type="checkbox"/>	<input checked="" type="checkbox"/>	<input checked="" type="checkbox"/>	<input checked="" type="checkbox"/>	<input checked="" type="checkbox"/>			
Document – Order dimensional drawing	B61	<input checked="" type="checkbox"/>	<input checked="" type="checkbox"/>	<input checked="" type="checkbox"/>	<input checked="" type="checkbox"/>	<input checked="" type="checkbox"/>	<input checked="" type="checkbox"/>	<input checked="" type="checkbox"/>	<input checked="" type="checkbox"/>	<input checked="" type="checkbox"/>	<input checked="" type="checkbox"/>	<input checked="" type="checkbox"/>	<input checked="" type="checkbox"/>	<input checked="" type="checkbox"/>	<input checked="" type="checkbox"/>			
Standard test (routine test) with acceptance	B65	<input checked="" type="checkbox"/>	<input checked="" type="checkbox"/>	<input checked="" type="checkbox"/>	<input checked="" type="checkbox"/>	<input checked="" type="checkbox"/>	<input checked="" type="checkbox"/>	<input checked="" type="checkbox"/>	<input checked="" type="checkbox"/>	<input checked="" type="checkbox"/>	<input checked="" type="checkbox"/>	<input checked="" type="checkbox"/>	<input checked="" type="checkbox"/>	<input checked="" type="checkbox"/>	<input checked="" type="checkbox"/>			
Noise measurement without load with octave band analysis, without acceptance ¹³⁾	B71	<input checked="" type="checkbox"/>	<input checked="" type="checkbox"/>	<input checked="" type="checkbox"/>	<input checked="" type="checkbox"/>	<input checked="" type="checkbox"/>	<input checked="" type="checkbox"/>	<input checked="" type="checkbox"/>	<input checked="" type="checkbox"/>	<input checked="" type="checkbox"/>	<input checked="" type="checkbox"/>	<input checked="" type="checkbox"/>	<input checked="" type="checkbox"/>	<input checked="" type="checkbox"/>	<input checked="" type="checkbox"/>			
Noise measurement without load with octave band analysis, with acceptance ¹⁴⁾	B72	<input checked="" type="checkbox"/>	<input checked="" type="checkbox"/>	<input checked="" type="checkbox"/>	<input checked="" type="checkbox"/>	<input checked="" type="checkbox"/>	<input checked="" type="checkbox"/>	<input checked="" type="checkbox"/>	<input checked="" type="checkbox"/>	<input checked="" type="checkbox"/>	<input checked="" type="checkbox"/>	<input checked="" type="checkbox"/>	<input checked="" type="checkbox"/>	<input checked="" type="checkbox"/>	<input checked="" type="checkbox"/>			
Type test with heat run for horizontal motors, without acceptance ¹³⁾	B82	<input checked="" type="checkbox"/>	<input checked="" type="checkbox"/>	<input checked="" type="checkbox"/>	<input checked="" type="checkbox"/>	<input checked="" type="checkbox"/>	<input checked="" type="checkbox"/>	<input checked="" type="checkbox"/>	<input checked="" type="checkbox"/>	<input checked="" type="checkbox"/>	<input checked="" type="checkbox"/>	<input checked="" type="checkbox"/>	<input checked="" type="checkbox"/>	<input checked="" type="checkbox"/>	<input checked="" type="checkbox"/>			
Type test with heat run for horizontal motors, with acceptance ¹⁴⁾	B83	<input checked="" type="checkbox"/>	<input checked="" type="checkbox"/>	<input checked="" type="checkbox"/>	<input checked="" type="checkbox"/>	<input checked="" type="checkbox"/>	<input checked="" type="checkbox"/>	<input checked="" type="checkbox"/>	<input checked="" type="checkbox"/>	<input checked="" type="checkbox"/>	<input checked="" type="checkbox"/>	<input checked="" type="checkbox"/>	<input checked="" type="checkbox"/>	<input checked="" type="checkbox"/>	<input checked="" type="checkbox"/>			
"Basic" documentation package ¹⁵⁾	B90	<input checked="" type="checkbox"/>	<input checked="" type="checkbox"/>	<input checked="" type="checkbox"/>	<input checked="" type="checkbox"/>	<input checked="" type="checkbox"/>	<input checked="" type="checkbox"/>	<input checked="" type="checkbox"/>	<input checked="" type="checkbox"/>	<input checked="" type="checkbox"/>	<input checked="" type="checkbox"/>	<input checked="" type="checkbox"/>	<input checked="" type="checkbox"/>	<input checked="" type="checkbox"/>	<input checked="" type="checkbox"/>			
"Advanced" documentation package ¹⁵⁾	B91	<input checked="" type="checkbox"/>	<input checked="" type="checkbox"/>	<input checked="" type="checkbox"/>	<input checked="" type="checkbox"/>	<input checked="" type="checkbox"/>	<input checked="" type="checkbox"/>	<input checked="" type="checkbox"/>	<input checked="" type="checkbox"/>	<input checked="" type="checkbox"/>	<input checked="" type="checkbox"/>	<input checked="" type="checkbox"/>	<input checked="" type="checkbox"/>	<input checked="" type="checkbox"/>	<input checked="" type="checkbox"/>			
"Projects" documentation package ¹⁵⁾	B92	<input checked="" type="checkbox"/>	<input checked="" type="checkbox"/>	<input checked="" type="checkbox"/>	<input checked="" type="checkbox"/>	<input checked="" type="checkbox"/>	<input checked="" type="checkbox"/>	<input checked="" type="checkbox"/>	<input checked="" type="checkbox"/>	<input checked="" type="checkbox"/>	<input checked="" type="checkbox"/>	<input checked="" type="checkbox"/>	<input checked="" type="checkbox"/>	<input checked="" type="checkbox"/>	<input checked="" type="checkbox"/>			
Wire-lattice pallet packaging	B99	<input type="checkbox"/>	<input type="checkbox"/>	<input type="checkbox"/>	<input type="checkbox"/>	<input type="checkbox"/>	<input type="checkbox"/>	<input type="checkbox"/>	<input type="checkbox"/>	<input type="checkbox"/>	<input type="checkbox"/>	<input type="checkbox"/>	<input type="checkbox"/>	<input type="checkbox"/>	<input type="checkbox"/>			
Connected in star for dispatch	M01	<input checked="" type="checkbox"/>	<input checked="" type="checkbox"/>	<input checked="" type="checkbox"/>	<input checked="" type="checkbox"/>	<input checked="" type="checkbox"/>	<input checked="" type="checkbox"/>	<input checked="" type="checkbox"/>	<input checked="" type="checkbox"/>	<input checked="" type="checkbox"/>	<input checked="" type="checkbox"/>	<input checked="" type="checkbox"/>	<input checked="" type="checkbox"/>	<input checked="" type="checkbox"/>	<input checked="" type="checkbox"/>			
Connected in delta for dispatch	M02	<input checked="" type="checkbox"/>	<input checked="" type="checkbox"/>	<input checked="" type="checkbox"/>	<input checked="" type="checkbox"/>	<input checked="" type="checkbox"/>	<input checked="" type="checkbox"/>	<input checked="" type="checkbox"/>	<input checked="" type="checkbox"/>	<input checked="" type="checkbox"/>	<input type="checkbox"/>	<input type="checkbox"/>	<input type="checkbox"/>	<input type="checkbox"/>	<input type="checkbox"/>			

For legends and footnotes, see page 6/112.

SIMOTICS XP 1MB1, 1MB5 explosion-protected motors

Article No. supplements and special versions · Options

Cast-iron series 1MB.55., 1MB.853, 1MB.56., 1MB.863

- Standard version
- Without additional charge
- This order code only determines the price of the version – Additional plain text is required.
- ✓ With additional charge
- Not possible

- 1) Maximum number of connections for accessories, see terminal box concept.
- 2) The vibration severity grade B is maintained up to the rated frequency (DOL) during operation at the inverter. This may deviate when operating at higher frequencies..
- 3) The frame sizes 280, 315, and 355 in combination with order code **B43** or **B44** are equipped with "Bearing insulation NDE" as standard (order code **L51** is included in B43/B44).
- 4) The following applies for explosion-protected motors: In the case of the types of construction with shaft extension down, the version "with protective cover" is required. For types of construction with shaft extension pointing upwards, a suitable cover must be implemented to prevent small parts from falling into the fan cover (see the standard IEC/EN 60079-0). The cover must not block the cooling air flow.
- 5) Rating plate, screws, grounding, and options with order codes **L19**, **L23**, **Q01** made of stainless steel (V4A).
- 6) Power data in converter operation according to the VSD rating lists. Wind-ing monitoring with PTC thermistor mandatory.
- Frame size 280 and larger with insulated bearings on the fan side (NDE).
- 7) 4 threads in the motor feet; adjustment screws not in the scope of supply.
- 8) When motors are ordered that have a longer or shorter shaft extension than normal, the required position and length of the feather keyway must be specified in a sketch. It must be ensured that only feather keys in accordance with DIN 6885, Form A are permitted to be used. The feather keyway is positioned centrally on the shaft extension. The length is defined by the manufacturer in accordance with the appropriate standard. Not valid for: Conical shafts, non-standard threaded journals, non-standard shaft tolerances, friction welded journals, extremely "thin" shafts, special geometry dimensions (e.g. square journals), hollow shafts. Valid for non-standard shaft extensions DE or NDE. The feather keys are supplied in every case.
For order codes **Y58**, **Y59** and **L05** the following applies:
– Dimensions D and DA ≤ ball bearing inner diameter
(see dimension tables in "Dimensions")
– Dimensions E and EA ≤ 2 × length E (standard) of the shaft extension
For an explanation of the order codes, see Catalog Section 1 "Introduction".
- 9) The material of the fan is aluminum, for frame sizes 225 to 355 steel – metal fans are painted with paint finishes with film thickness 90 µm or more.
- 10) Connection in the main terminal box in the standard version.
- 11) The Operating Instructions are available on the Internet in PDF format for all official EU languages.
- 12) The delivery time for the inspection certificate may differ from the delivery time for the motor.
- 13) The delivery time is then approx. 20 working days longer.
- 14) The delivery time is then approx. 25 working days longer or the confirmed acceptance date.
- 15) Version and content of the documentation, see Chapter 1.
- 16) Not in combination with order codes **S00**, **S01**, and **S02**. Other colors, order codes **Y53**, **Y56** and **Y66**, on request.
- 17) Not in combination with order codes **R48** and **R49**.
- 18) For installation in a hostile and corrosive environment, paint finish with order code **S03** or better is recommended.
- 19) Cable glands in Ex e version.
- 20) Standard paint finish C2, we recommend C3 or better (e.g. order code **S02**, **S03**, **S04**).
- 21) Only possible in combination with order code **R50** or **R54**.
- 22) Only possible in combination with order code **R54**.
- 23) Not possible in combination with **1MB..56, 1MB..57** or **1MB.853** (frame size 225 to 355).
- 24) Supplied without cable gland.

SIMOTICS XP 1MB1, 1MB5 explosion-protected motors

Article No. supplements and special versions · Options

Cast-iron series 1MB55.4, 1MB55.3, 1MB58.3

Selection and ordering data

Special versions	Additional identification code -Z with order code and plain text if required	Frame size				Motor version	
		315	355	400	450	IEC	Ex ec, Ex tc, Ex tb (Zones 2, 22 and 21)
		1MB55 . 4	1MB55 . 3	1MB58 . 3	IE4 IE3		
1MB5 -Z	Order code						
Explosion-protected version							
Version additionally for dust Ex tc – Zone 22 ¹⁾¹⁶⁾	B30	✓	✓	✓	✓	Only for: 1MB553. - Ex ec (Zone 2) frame size 315 and 355	
Version IIC with stamping of IIB ²⁰⁾	B31	✓	✓	✓	✓	Only for: 1MB553. - Ex ec (Zone 2) frame size 315 and 355	
VIK version	C02	✓	✓	✓	✓	Only for: 1MB553. - Ex ec (Zone 2) frame size 315 and 355	
Version for converter operation							
Version for converter operation in the basic version with SINAMICS G120 operating data with PM240-2	B40	O. R.	O. R.	O. R.	O. R.		
Version for converter operation in the basic version with SINAMICS S150 operating data	B41	O. R.	O. R.	O. R.	O. R.		
Version for converter operation with power data on the PWM converter	B43	O. R.	O. R.	O. R.	O. R.		
Operating data such as the B40 order code with alternative SINAMICS converter on the rating plate	Y68 • and converter type	O. R.	O. R.	O	O		
<ul style="list-style-type: none"> • G120 with PM230 • G120 with PM240 • G120C • G120P with PM230 • G120P with PM240-2 • G120P with PM240P-2 • G120P with PM330 • G130, G150, G180 • S120 (BLM/SLM) • V20 Operating data such as order code B41 with alternative SINAMICS converters on the rating plate <ul style="list-style-type: none"> • S120 (ALM) 							
Motor protection							
1 or 3 PTC thermistors – for tripping (2 terminals) ¹⁾	Q11	✓	✓	✓	✓	Not for: Combination with motor protection code letter B (15th position of the Article No.)	
2 or 6 PTC thermistors – for alarm and tripping (4 terminals) ¹⁾	Q12	✓	✓	✓	✓	Not for: Combination with motor protection code letter C (15th position of the Article No.)	
3 NTC thermistors – for tripping (6 terminals)	Q21	✓	✓	✓	✓	Not for: Combination with motor protection code letter F (15th position of the Article No.)	
1 KTY84-130 temperature sensor (2 terminals) ¹⁾	Q23	✓	✓	✓	✓	Not for: Combination with motor protection code letter F (15th position of the Article No.)	
2 KTY84-130 temperature sensors (4 terminals) ¹⁾	Q25	✓	✓	✓	✓	Not for: Combination with motor protection code letter G (15th position of the Article No.)	
1 Pt1000 resistance thermometer (2 terminals)	Q35	✓	✓	✓	✓		
2 Pt1000 resistance thermometers (4 terminals)	Q36	✓	✓	✓	✓		
6 Pt1000 resistance thermometers (12 terminals)	Q37	✓	✓	✓	✓		
3 Pt100 resistance thermometers – 2-wire input (6 terminals) ¹⁾	Q60	✓	✓	✓	✓	Not for: Combination with motor protection code letter H (15th position of the Article No.)	
6 Pt100 resistance thermometers – 2-wire input (12 terminals) ¹⁾	Q61	✓	✓	✓	✓	Not for: Combination with motor protection code letter J (15th position of the Article No.)	
1 Pt100 resistance thermometer – 2-wire input (2 terminals)	Q62	✓	✓	✓	✓		
3 Pt100 resistance thermometers – 3-wire input (9 terminals)	Q63	✓	✓	✓	✓		
6 Pt100 resistance thermometers – 3-wire input (18 terminals)	Q64	✓	✓	✓	✓		
2 Pt100 resistance thermometers in basic configuration for bearings (2 terminals)	Q72	✓	✓	✓	✓		
2 Pt100 resistance thermometers in 3-wire input for bearings (6 terminals)	Q78	✓	✓	✓	✓		

For legends and footnotes, see page 6/118.

SIMOTICS XP 1MB1, 1MB5 explosion-protected motors

Article No. supplements and special versions · Options

Cast-iron series 1MB55.4, 1MB55.3, 1MB58.3

Special versions	Additional identification code -Z with order code and plain text if required	Frame size				Motor version		
		315	355	400	450	IEC	Ex ec, Ex tc, Ex tb (Zones 2, 22 and 21)	IE4 IE3
		1MB55.4	1MB55.3		1MB58.3			
1MB5 -Z	Order code							
Motor protection (continued)								
2 Pt100 double resistance thermometers in 3-wire input for bearings (12 terminals)	Q79		✓	✓	✓	✓		
Motor connection and terminal box								
External grounding			□	□	□	□		
Terminal box at NDE	H08		✓	✓	✓	✓		
Two terminal boxes at NDE ¹⁷⁾	H09		✓	✓	✓	✓		
Second external grounding	H70		✓	✓	✓	✓		
Subsequently rotatable main terminal box	R09		✓	✓	✓	✓		
Rotation of the terminal box through 90°, entry from DE ^{12) 22)}	R10		✓	✓	✓	✓	Not for: Combination with type of construction code letters F, G, J (14th position of the Article No.)	
Rotation of the terminal box through 90°, entry from NDE	R11		✓	✓	✓	✓		
Rotation of the terminal box through 180°	R12		✓	✓	✓	✓		
One metal cable gland	R15		✓	✓	-	-		
EMC cable gland, maximum configuration	R16		-	-	✓	✓		
Stud terminals for cable connection, accessories pack (3 items)	R17		✓	✓	-	-	Only for: 1MB551. - Ex ec (Zone 21) 1MB552. - Ex ec (Zone 22) frame size 315 and 355	
Metal cable gland, maximum configuration	R18		✓	✓	✓	✓		
Saddle terminal for connection without cable lug, accessories pack	R19		✓	✓	✓	✓	Only for: 1MB551. - Ex ec (Zone 21) 1MB552. - Ex ec (Zone 22) frame size 315 and 355	
			□	□	-	-	Only for: 1MB553. - Ex ec (Zone 2) frame size 315 and 355	
Larger terminal box ¹³⁾	R50		✓	✓	✓	✓		
Drilled removable entry plate	R52		✓	✓	✓	✓		
Undrilled removable entry plate			-	-	□	□		
Cast-iron auxiliary terminal box (small)	R62		✓	✓	✓	✓		
Cast-iron auxiliary terminal box (large)	R63		✓	✓	✓	✓		
Stainless steel auxiliary terminal box (large)	R65		✓	✓	✓	✓		
Non-standard threaded through hole (NPT or G thread) ²⁾	Y61 • and customer specifications		✓	✓	✓	✓		
Windings and insulation								
Temperature class 155 (F), utilized acc. to 155 (F), with service factor ⁹⁾					□	□		
Temperature class 155 (F), utilized acc. to 130 (B), coolant temperature 45 °C, derating approx. 4 % ^{15) 23)}	N05		✓	✓	✓	✓		
Temperature class 155 (F), utilized acc. to 130 (B), coolant temperature 50 °C, derating approx. 8 % ^{15) 23)}	N06		✓	✓	✓	✓		
Temperature class 155 (F), utilized acc. to 130 (B), coolant temperature 55 °C, derating approx. 13 % ^{15) 23)}	N07		✓	✓	✓	✓		
Temperature class 155 (F), utilized acc. to 130 (B), coolant temperature 60 °C, derating approx. 18 % ¹⁵⁾	N08		✓	✓	✓	✓		
Increased air humidity/temperature with 30 to 60 g water per m ³ of air	N30		✓	✓	✓	✓		
Increased air humidity/temperature with 60 to 100 g water per m ³ of air	N31		✓	✓	✓	✓		
Temperature class 155 (F), utilized acc. to 130 (B), with higher coolant temperature and/or installation altitude ⁹⁾	Y50 • CT .. °C or IA ... m above sea level		✓	✓	✓	✓		

6

For legends and footnotes, see page 6/118.

SIMOTICS XP 1MB1, 1MB5 explosion-protected motors

Article No. supplements and special versions · Options

Cast-iron series 1MB55.4, 1MB55.3, 1MB58.3

Special versions	Additional identification code -Z with order code and plain text if required	Frame size				Motor version	
		315	355	400	450	IEC	Ex ec, Ex tc, Ex tb (Zones 2, 22 and 21)
		1MB55 . 4	1MB55 . 3	1MB58 . 3	IE4 IE3		
1MB5 -Z	Order code						
Colors and paint finish							
Standard paint finish C2 in RAL 7030 stone gray		☐	☐	☐	☐		
Unpainted (only cast-iron parts primed)	S00	○	○	○	○		
Unpainted, only primed	S01	✓	✓	✓	✓		
Special paint finish C3	S02	✓	✓	✓	✓		
Special paint finish sea air resistant C4 ¹⁴⁾	S03	✓	✓	✓	✓		
Special paint finish for use offshore C5 ¹⁴⁾	S04	✓	✓	✓	✓		
Internal coating	S05	✓	✓	✓	✓		
Top coat polyurethane ⁶⁾	S06	✓	✓	☐	☐	Only for: 1MB553. - Ex ec (Zone 2) frame size 315 and 355	
Paint finish in other standard RAL colors: RAL 1015, 3000, 5002, 5009, 5010, 5012, 5015, 6011, 7001, 7011, 7016, 7031, 7032, 7035, 7037, 8012, 9005, 9010 (see Catalog Section 1 "Introduction")	Y53 • and paint finish RAL....	✓	✓	✓	✓		
Paint finish in special RAL colors: For RAL colors, see "Special paint finish in special RAL colors" (see Catalog Section 1 "Introduction")	Y56 • and paint finish RAL....	✓	✓	✓	✓		
Non-standard colors Colors see "Paint finish in non-standard colors" (see Catalog Section 1 "Introduction")	Y66 • and paint finish	✓	✓	✓	✓		
Modular technology – Basic versions							
Mounting of separately driven fan ¹⁰⁾	F70	✓	✓	✓	✓		
Special technology							
Mounting of LL 841 (HTL); 1024 I explosion-protected rotary pulse encoder ²⁴⁾	G30	✓	✓	✓	✓		
Mounting of a special type of rotary pulse encoder	Y70 • and customer specifications	O. R.	O. R.	O. R.	O. R.		
Mechanical version and degrees of protection							
Low-noise version for 2-pole motors with clockwise direction of rotation	F77	✓	✓	☐	☐	Only for: 2-pole motors combination with order code L05 and F90 frame size 315 and 355	
Low-noise version for 2-pole motors with counterclockwise direction of rotation	F78	✓	✓	○	○	Only for: 2-pole motors combination with order code L05 and F90 frame size 315 and 355	
Prepared for mounted components, centering hole only		–	–	☐	☐		
Prepared for mountings with D16 shaft	G42	–	–	✓	✓		
Mechanical protection for encoder	G43	O. R.	O. R.	✓	✓		
Protective cover	H00	✓	✓	✓	✓		
Vibration-proof version; vibration resistance to Class 3M4 according to IEC 60721-3-3:1994		☐	☐	–	–		
Condensation drainage holes		☐	☐	☐	☐		
Rust-resistant screws (externally)	H07	✓	✓	✓	✓		
IP66 degree of protection	H19	✓	✓	–	–		
IP65 degree of protection ^{19) 25)}	H20	✓	✓	✓	✓	Only for: 1MB553. - Ex ec (Zone 2) frame size 315 and 355	
IP56 degree of protection ²⁶⁾	H22	✓	✓	✓	✓	Only for: 1MB553. - Ex ec (Zone 2) frame size 315 and 355	
Drive-end seal for flange-mounting motors, oil-tight to 0.1 bar	H23	✓	✓	–	–		
Sealing ring made of fluoroelastomer (FKM)	H25	✓	✓	✓	✓	Not for: combination with order code D03 frame size 315 and 355	
Adjustment screws for feet in horizontal installation	H30	O. R.	O. R.	–	–		
Increased corrosion protection for external components	H90	–	–	✓	✓		
Coolant temperature and installation altitude							
Coolant temperature –40 to +40 °C	D03	✓	✓	✓	✓		

For legends and footnotes, see page 6/118.

SIMOTICS XP 1MB1, 1MB5 explosion-protected motors

Article No. supplements and special versions · Options

Cast-iron series 1MB55.4, 1MB55.3, 1MB58.3

Special versions	Additional identification code -Z with order code and plain text if required	Frame size				Motor version		
		315	355	400	450	IEC	Ex ec, Ex tc, Ex tb (Zones 2, 22 and 21)	IE4 IE3
		1MB55.4	1MB55.3		1MB58.3			
1MB5 -Z	Order code							
Versions in accordance with standards and specifications								
Electrical according to NEMA MG1-12 ⁷⁾		-	-	□	□			
IECEx certificate	D37	✓	✓	✓	✓			
Meps Australia	D70	✓	-	-	-			Only for: 1MB55.3
Bearings and lubrication								
Regreasing device with M10 × 1 grease nipple according to DIN 71412-A	L19	○	○	○	○			
Located bearing DE	L20	✓	✓	□	□			
Located bearing NDE ¹¹⁾	L21	□	□	✓	✓			
Bearing design for increased cantilever forces ^{7) 8)}	L22	✓	✓	O. R.	O. R.			
Regreasing device		□	□	□	□			
Bearings reinforced at both ends for DE and NDE, bearing size 63	L25	□	□	-	-			
Drainage for used grease	L30	✓	□	O. R.	O. R.			
Special version with higher speeds	L37	O. R.	O. R.	-	-			
Bearing insulation DE ²¹⁾	L50	✓	✓	✓	✓			
Bearing insulation NDE ²¹⁾	L51	✓	✓	✓	✓			
Measuring nipple for SPM shock pulse measurement for bearing inspection	Q01	✓	✓	✓	✓			
Balance and vibration severity								
Vibration severity grade A		□	□	□	□			
Vibration severity grade B	L00	✓	✓	✓	✓			Only for: 2-pole motors frame size 315 and 355
Half-key balancing (standard)		□	□	□	□			
Balancing without feather key ¹⁶⁾	L01	✓	✓	✓	✓			
Full-key balancing ¹⁶⁾	L02	✓	✓	✓	✓			
Shaft and rotor								
Shaft extension with standard dimensions, without feather keyway	L04	✓	✓	✓	✓			
Standard, cylindrical shaft extension (second shaft extension) NDE acc. to EN 50347	L05	✓	✓	✓	✓			
Standard shaft made of stainless steel (e.g. 1.4021)	L06	✓	✓	-	-			
Shaft extension run-out in accordance with IEC 60072-1 precision class	L07	✓	✓	-	-			
Shaft extension run-out, concentricity and perpendicularity in accordance with IEC 60072-1 precision class for flange-mounted motors	L08	✓	✓	✓	✓			
Non-standard cylindrical shaft extension, DE ³⁾	Y58 • and customer specifications	✓	✓	✓	✓			
Non-standard cylindrical shaft extension, NDE ³⁾	Y59 • and customer specifications	✓	✓	✓	✓			
Special shaft steel	Y60 • and customer specifications	O. R.	O. R.	O. R.	O. R.			
Heating and ventilation								
Metal fan made of brass	F68	O. R.	O. R.	-	-			
Sheet metal fan cover		□	□	□	□			
Metal external fan ²⁷⁾		□	□	□	□			
Without external fan and without fan cover	F90	-	-	✓	✓			
Anti-condensation heating for 230 V (2 terminals)	Q02	✓	✓	✓	✓			
Anti-condensation heating for 115 V (2 terminals)	Q03	✓	✓	✓	✓			
Anti-condensation heating for 400 V (2 terminals)	Q06	✓	✓	✓	✓			
Separately driven fan with non-standard voltage and/or frequency	Y81 • and customer specifications	O. R.	O. R.	O. R.	O. R.			

For legends and footnotes, see page 6/118.

SIMOTICS XP 1MB1, 1MB5 explosion-protected motors

Article No. supplements and special versions · Options

Cast-iron series 1MB55.4, 1MB55.3, 1MB58.3

Special versions	Additional identification code -Z with order code and plain text if required	Frame size				Motor version		
		315	355	400	450	IEC	Ex ec, Ex tc, Ex tb (Zones 2, 22 and 21)	IE4 IE3
		1MB55 . 4	1MB55 . 3		1MB58 . 3			
1MB5 -Z	Order code							
Rating plate and additional rating plates								
Second rating plate, loose	M10		✓	✓	✓	✓		
Rating plate, stainless steel		□	□	□	□			
Additional rating plate with deviating rating plate data ¹⁸⁾	Y80 • and customer specifications		✓	✓	✓	✓		
Additional rating plate with customer specifications	Y82 • and customer specifications		✓	✓	✓	✓		
Additional information on rating plate and on package label (max. 20 characters)	Y84 • and customer specifications		✓	✓	✓	✓		
Adhesive label, supplied loose (printed with: Article No., Serial No.: 2 lines of text)	Y85 • und Besteller-angabe		✓	✓	-	-		
Extension of the liability for defects								
Extension of the liability for defects by 12 months to a total of 24 months (2 years) from delivery ^{4) 28)}	Q80		✓	✓	✓	✓		
Extension of the liability for defects by 18 months to a total of 30 months (2.5 years) from delivery ⁴⁾	Q81		✓	✓	✓	✓		
Extension of the liability for defects by 24 months to a total of 36 months (3 years) from delivery ^{4) 28)}	Q82		✓	✓	✓	✓		
Extension of the liability for defects by 30 months to a total of 42 months (3.5 years) from delivery ⁴⁾	Q83		-	-	✓	✓		
Extension of the liability for defects by 36 months to a total of 48 months (4 years) from delivery ⁴⁾	Q84		-	-	✓	✓		
Extension of the liability for defects by 48 months to a total of 60 months (5 years) from delivery ⁴⁾	Q85		-	-	✓	✓		
Packaging, safety notes, documentation and test certificates								
Inspection certificate 3.1 according to EN 10204 ⁴⁾	B02		✓	✓	✓	✓		
Printed German/English operating instructions enclosed ⁵⁾		□	□	□	□			
Equivalent circuit diagram	B51		✓	✓	✓	✓		
Starting diagram (torque vs. speed and current vs. speed)	B52		✓	✓	✓	✓		
Document – Electrical datasheet	B60		✓	✓	✓	✓		
Document – Order dimensional drawing	B61		✓	✓	✓	✓		
Standard test (routine test) with acceptance	B65		✓	✓	✓	✓		
Temperature test without acceptance	B67		✓	✓	✓	✓		
Temperature test with acceptance	B68		✓	✓	✓	✓		
Type test with heat run for horizontal motors, without acceptance	B82		✓	✓	✓	✓		
Type test with heat run for horizontal motors, with acceptance	B83		✓	✓	✓	✓		
"Basic" documentation package	B90		✓	✓	✓	✓		
"Advanced" documentation package	B91		✓	✓	✓	✓		
"Projects" documentation package	B92		✓	✓	✓	✓		
Connected in star for dispatch	M01		✓	✓	✓	O. R		
Connected in delta for dispatch	M02		✓	✓	✓	O. R		

- Standard version
- Without additional charge
- This order code only determines the price of the version – Additional plain text is required.
- ✓ With additional charge
- O. R. Possible on request

For legends and footnotes, see page 6/118.

SIMOTICS XP 1MB1, 1MB5 explosion-protected motors

Article No. supplements and special versions · Options

Cast-iron series 1MB55.4, 1MB55.3, 1MB58.3

6

- 1) Evaluation with associated tripping unit (see Catalog IC 10) is recommended.
- 2) Parallel Whitworth threaded pipe DIN ISO 228 (DIN 259) BSPP (British Standard Pipe Parallel), threaded pipe for connections not sealed in the thread (cylindrical), external = G.
- 3) When motors are ordered that have a longer or shorter shaft extension than normal, the required position and length of the feather keyway must be specified in a sketch. It must be ensured that only feather keys in accordance with EN 50347 are used. The feather keyway is positioned centrally on the shaft extension. The length is defined by the manufacturer in accordance with the appropriate standard. Not valid for: Conical shafts, non-standard threaded journals, non-standard shaft tolerances, friction welded journals, extremely "thin" shafts, special geometry dimensions (e.g. square journals), hollow shafts. Valid for non-standard shaft extensions DE or NDE. The feather keys are supplied in every case. For order codes **Y58**, **Y59** and **L05** the following applies:
 - Dimensions D and DA ≤ ball bearing inner diameter (see dimension tables for "Dimensions")
 - Dimensions E and EA ≤ 2 × length E (standard) of the shaft extension.
- 4) The delivery time for the manufacturer's test certificate may differ from the delivery time for the motor.
- 5) The Operating Instructions (Compact) are available in PDF format for all official EU languages at <http://support.automation.siemens.com/WW/view/en/10803948/133300>
- 6) Order code **S06** cannot be combined with order codes **S00** and **S01**. Possible without restriction in combination with **Y53** for frame sizes 315 to 355 and for frame sizes 400 and 450.
- 7) A minimum cantilever force F_{\min} of $0.5 \cdot F_{\max}$ is required for NU bearings (cylindrical roller bearings) in contrast to ball bearings. Cylindrical roller bearings are not suitable for coupling output or for brief periods of no-load operation without cantilever force.
- 8) For frame sizes 400 and 450, permissible cantilever forces for motors with reinforced bearings are available on request. Please specify cantilever force and lever arm.
- 9) Only possible for line operation.
- 10) The separately driven fan motor is implemented with voltage code **34** (400 V/50 Hz; 460 V/60 Hz).
- 11) For frame sizes 400 and 450, not possible for a vertical type of construction.
- 12) For motors with flange (IM B5, IM B35, IM V1), only possible in conjunction with order code **H08**.
- 13) Restrictions can apply when mounting the terminal box.
- 14) Only available for 1MB552 (Ex tc for Zone 22). Not available for 1MB553 (Ex ec for Zone 2).
- 15) Not available for 8-pole motors, frame size 450.
- 16) Not possible in combination with order code **C02**.
- 17) Not possible in combination with order code **R50**.
- 18) Customer specifications: Voltage between 380 and 690 V (voltages outside this range are available on request), frequency, circuit, required rated power in kW.
- 19) Standard version for 1MB5.1 (Ex tb for Zone 21).
- 20) Combination with order code D03 and C02 non request. Not possible in combination with order codes H20 and H22
- 21) For IM V1-motors (frame sizes 315 and 355): (Load) tests are performed as IM B3 (horizontal) (IM-identification acc. to EN 60034-7)
- 22) Frame sizes 315 and 355: In combination with order code B40 or B41 bearing insulation BS* is standard (order code L51 is including inB40/B41
- 23) At frame sizes 315 and 355 there is no derating in combination with order codes M2A, M2B, M2C, M2D, M2E, M2F, M2G, M2H.
- 24) For frame sizes 315 and 355 applies: Can be combined with order codes N30, N31, L51 on request. Not admissible in combination with order code L05. Protective cover not possible.
- 25) Order code H20 (IP65 degree of protection) can only be ordered for zone 2. For zone 21, IP65 degree of protection is standard. Not possible for zone 22, because only IP55 degree of protection is required.
- 26) Order code H22 IP56 degree of protection is only possible for zone 2. Degree of protection IP56 is not permissible for zone 21 (IP65 degree of protection) and zone 22 (IP55 degree of protection).
- 27) Not possible with flange A800 mounting on DE side – as standard for frame size 315. Not possible with flange A900 mounting on DE side – as standard for frame size 355, combination with option H08 it is possible.
- 28) The delivery time for the factory test certificate may differ from the delivery time for the motor.
- 29) For chemical industry must be used steel fan.

SIMOTICS XP 1MB1, 1MB5 explosion-protected motors

Article No. supplements and special versions · Accessories

Overview

Couplings for use in hazardous areas

The motor from Siemens is connected to the machine or gear unit through a coupling. Flender is an important coupling manufacturer with a wide range of products.

For standard applications, Siemens recommends that flexible couplings, types N-EUPEX and RUPEX or torsionally rigid couplings, types ARPEX and ZAPEX are used. For special applications, FLUDEX and ELPEX-S couplings are recommended. These coupling types are suitable for use in areas subject to explosion hazards and are offered with declaration of conformity and EU type-examination certificate according to Directive 2014/34/EU.

Available from:

Siemens contact partner - ordering from catalog
Siemens MD 10.1 "FLENDER Standard Couplings"

or

Flender GmbH
Kupplungswerk Mussum
Industriepark Bocholt
Schlavenhorst 100
46395 Bocholt, Germany
Phone +49 (2871) 922185
Fax +49 (2871) 922579

www.flender.com

Email: flender-kupplungen-2.pd.de@siemens.com

Taper pins according to DIN 258 with threaded ends and constant taper lengths

Taper pins are used for components that are repeatedly removed. The drilled hole is conically ground using a conical reamer until the pin can be pushed in by hand until the cone shoulder lies approx. 3 to 4 mm above the rim of the hole.

It can then be driven in using a hammer until it is correctly seated. The pin is removed from the drilled hole by screwing on the nut and tightening it.

Standardized taper pins are commercially available.

For instance, available from:

Otto Roth GmbH & Co. KG
Rutesheimer Strasse 22
70499 Stuttgart, Germany
Phone +49 711 1388-0
Fax +49 711 1388-233

www.ottoroth.de

Email: info@ottoroth.de

Foundation blocks according to DIN 799

The foundation blocks are inserted into the stone foundation and embedded in concrete. They are used for fixing machines of medium size, slide rails, pedestal bearings, base frames, etc. After the fixing bolts have been unscrewed, the machines can be shifted without them having to be lifted.

When the machine is initially installed, the foundation blocks that are bolted to the machine (without washers) and fitted with taper pins are not embedded with concrete until the machine has been fully aligned. In this case, the machine is positioned 2 to 3 mm lower. The difference in shaft height is compensated by inserting shims on final installation. The taper pins safeguard the exact position of the machine when it is repeatedly removed and replaced without the need for realignment.

Available from:

Lütgert & Co. GmbH
Postfach 42 51
33276 Gütersloh, Germany
Phone +49 5241 7407-0
Fax +49 5241 7407-90

www.luetgert-antriebe.de

Email: info@luetgert-antriebe.de

Slide rails with fixing bolts and tensioning screws according to DIN 42923

Slide rails are used to tension the belt of a machine easily and conveniently when there is no belt-tensioning pulley. They are fixed to the base using stone bolts or foundation blocks.

The assignment of slide rails to motor size can be found in DIN 42923. For motors of frame sizes 355 to 450, there are no standardized slide rails (please inquire).

Available from:

Lütgert & Co. GmbH
Postfach 42 51
33276 Gütersloh, Germany
Phone +49 5241 7407-0
Fax +49 5241 7407-90

www.luetgert-antriebe.de

Email: info@luetgert-antriebe.de

More information

Replacement motors and repair parts

- Commitment to provide replacement motors and repair parts following delivery of the motor:
 - For up to 3 years after the delivery of the original motor, in the event of total motor failure – with regard to the mounting dimensions and functions – Siemens will supply a comparable replacement motor (the type series may vary).
 - If a spare motor is supplied within the 3-year period, this does not mean that the warranty restarts.
 - Replacement motors delivered after the active production of the motor series are also identified as spare motors on the rating plate.
 - Spare parts are available only on request for these spare motors. Repair or replacement is not possible.
 - After a period of 3 years (after the delivery of the original motor), it is only possible to repair these motors (depending on the availability of the spare parts required).
 - For up to 5 years after the delivery of the original motor, spare parts will be available and for a further 5 years, Siemens will provide information about spare parts and will supply documents when required.

- When repair parts are ordered, the following details must be provided:
 - Designation and part number
 - Article No. and factory number of the motor.
- For bearing types, see Catalog Section 1 "Introduction".
- Repair parts are available for 1MB1 motors on request.
- For standard components, a commitment to supply repaired parts does not apply.
- Support hotline
In Germany
Phone +49 911 895 7 222

You will find telephone numbers for other countries on our Internet site:

www.siemens.com/automation/service&support

SIMOTICS XP 1MB1, 1MB5 explosion-protected motors

Dimensions

Notes on the dimensions

Overview

- Dimension designations according to EN 50347 and IEC 60072.

- Fits**

The shaft extensions specified in the dimension tables (DIN 748) and centering spigot diameters (EN 50347) are machined with the following fits:

Dimension designation	ISO fit DIN ISO 286-2	
D, DA	to 30	j6
	over 30 to 50	k6
	over 50	m6
N	to 250	j6
	over 250	h6
F, FA		h9
K		H17
S	flange (FF)	H17

The drilled holes of couplings and belt pulleys should have an ISO fit of at least H7.

- Dimensional tolerances**

For the following dimension designations, the admissible deviations are given below:

Dimension designation	Dimension	Admissible deviation
H	to 250	- 0.5
	over 250	- 1.0
E, EA		- 0.5

Feather keyways and feather keys (dimensions GA, GC, F and FA) are made in compliance with DIN 6885 Part 1.

- All dimensions are specified in mm.

SIMOTICS XP 1MB1, 1MB5 explosion-protected motors

Dimensions

Dimension sheet generator (within the DT Configurator)

Overview

A dimensional drawing can be created in the "Drive Technology Configurator" (DT Configurator) for every configurable motor. A dimensional drawing can be requested for every other motor.

When a complete Article No. is entered with or without order codes, a dimensional drawing can be called up under the "Documentation" tab.

These dimensional drawings can be presented in different views and sections and printed.

The corresponding dimension sheets can be exported, saved and processed further in DXF format (interchange/import format for CAD systems) or as bitmap graphics.

Online access in the Siemens Industry Mall

The "DT Configurator" is integrated into the Siemens Industry Mall and can be used on the Internet without installation.

German: www.siemens.de/dt-konfigurator
English: www.siemens.com/dt-configurator

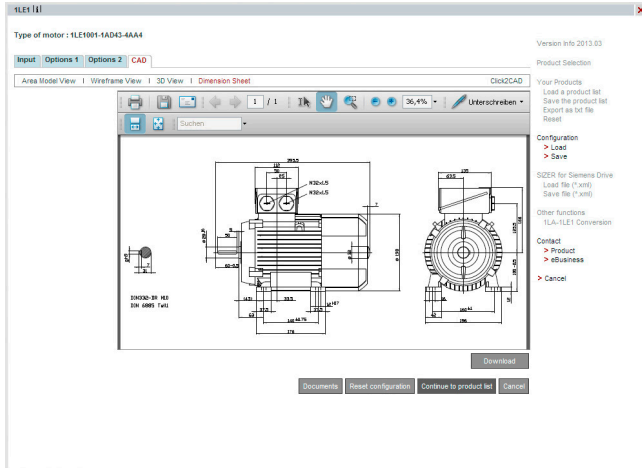

SIMOTICS XP 1MB1, 1MB5 explosion-protected motors

Dimensions · Aluminum series SIMOTICS XP

IE3 – 1MB1 with types of protection Ex tb, Ex tc, Ex ec – self-ventilated · Frame sizes 80 M to 160 L

Dimensional drawings

Type of construction IM B3

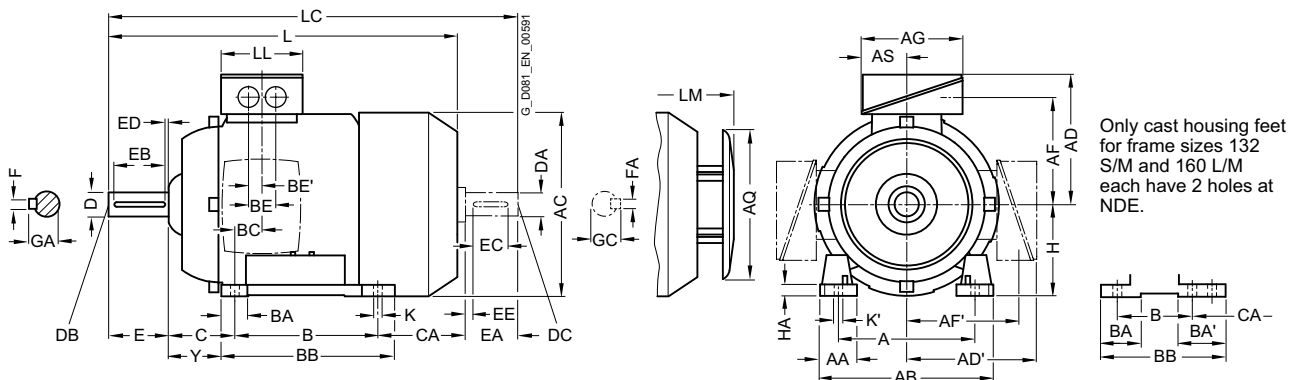

Types of construction IM B5 and IM V1

For flange dimensions, see page 1/48 (Z = the number of retaining holes)

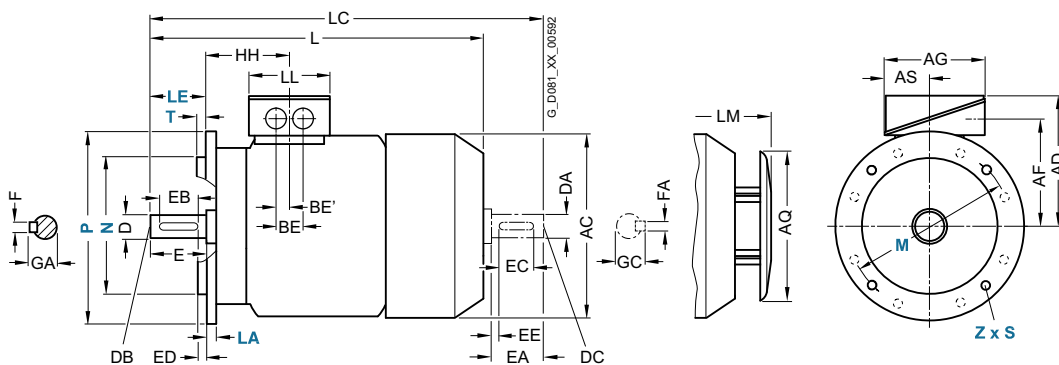

For motor			Dimension designation acc. to IEC																						
Frame size	Motor type No. of poles		A	AA	AB	AC	AD	AD'	AF	AF'	AG	AQ	AS	B	BA	BA'	BB	BC	BE	BE'	C	CA	H	HA	Y
80 M	0DA2, 0DB2, 0DC3 0DA3, 0DB3, 0DC3	2, 4, 6	125	30.5	150	159	121	121	96.5	96.5	93	155	43	100	32	32	118	23	36	18	50	113	80	8	41
90 S	All	2, 4, 6	140	30.5	165	178	126	126	101.5	101.5	93	155	43	100	33	33	143	22.5	36	18	56	159	90	10	47
90 L	All	2, 4, 6	140	30.5	165	178	126	126	101.5	101.5	93	155	43	125	33	33	143	22.5	36	18	56	199	90	10	47
100 L	All	2, 4	160	42	196	198	166	166	125.5	125.5	135	195	63.5	140	37.5	-	176	33.5	50	25	63	176	100	12	45
112 M	All	2, 4	190	46	226	222	177	177	136.5	136.5	135	195	63.5	140	35.4	-	176	26	50	25	70	155	112	12	52
132 S	1CA0, 1CC0	2, 6	216	53	256	262	202	202	159.5	159.5	155	260	70.5	140	38	-	218	26.5	48	24	89	128.5	132	15	69
	1CA1, 1CB0	2, 4															38	180				178.5			
132 M	1CC2	6	216	53	256	262	202	202	159.5	159.5	155	260	70.5	178	38	-	218	26.5	48	24	89	128.5	132	15	69
	1CB2, 1CC3	4, 6															38					178.5			
160 M	All	2, 4, 6	254	60	300	314	236.5	236.5	190	190	175	260	77.5	210	44	-	300	47	57	28.5	108	148	160	18	85
160 L	All	2, 4, 6	254	60	300	314	236.5	236.5	190	190	175	260	77.5	254	44	-	300	47	57	28.5	108	208	160	18	85

1) With screwed-on feet, dimension BA' is 43 mm.
 2) With screwed-on feet, dimension BB is 180 mm.
 3) With screwed-on feet, dimension BA' is 51 mm.

4) With screwed-on feet, dimension BB is 256 mm.

SIMOTICS XP 1MB1, 1MB5 explosion-protected motors

Dimensions · Aluminum series SIMOTICS XP

IE3 – 1MB1 with types of protection Ex tb, Ex tc, Ex ec – self-ventilated · Frame sizes 80 M to 160 L

Dimensional drawings

Type of construction IM B35

For flange dimensions, see page 1/48 (Z = the number of retaining holes)

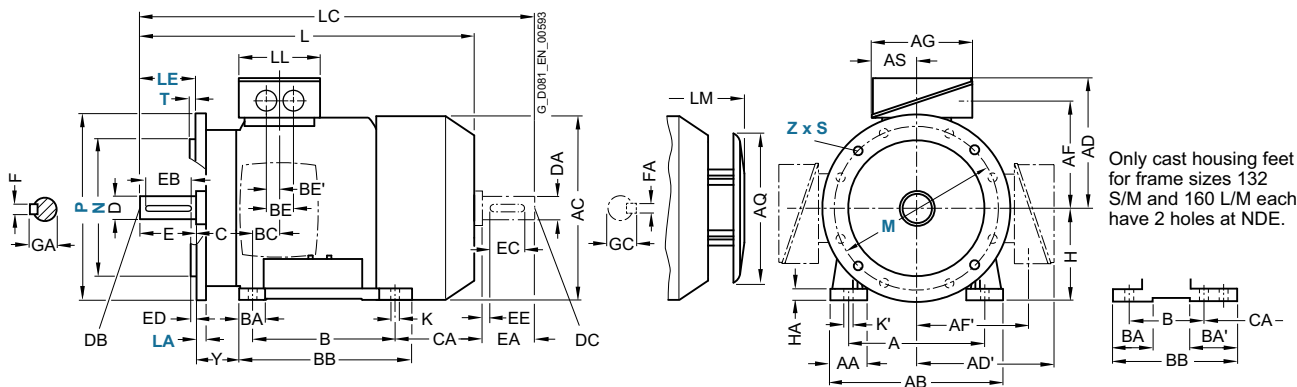

Type of construction IM B14

For flange dimensions, see page 1/48 (Z = the number of retaining holes)

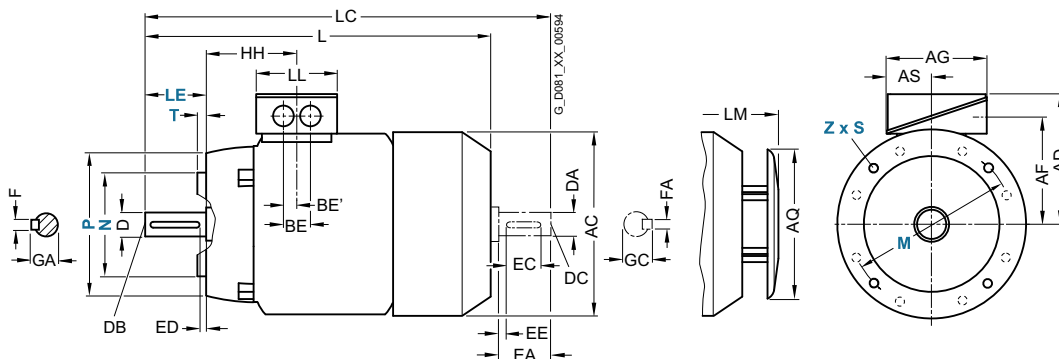

For motor			Dimension designation acc. to IEC							DE shaft extension					NDE shaft extension								
Frame size	Motor type	No. of poles	HH	K	K'	L	LC	LL	LM	D	DB	E	EB	ED	F	GA	DA	DC	EA	EC	EE	FA	GC
80 M	0DA2, 0DB2, 0DC3	2, 4, 6	73	9.5	13.5	292	343	79	328	19	M6	40	32	4	6	21.5	19	M6	40	32	4	6	21.5
	0DA3, 0DB3, 0DC3					327																	
90 S	All	2, 4, 6	78.5	10	14	347	405	79	383	24	M8	50	40	5	8	27	19	M6	40	32	4	6	21.5
90 L	All	2, 4, 6	78.5	10	14	387	445	79	383	24	M8	50	40	5	8	27	19	M6	40	32	4	6	21.5
100 L	All	2, 4	100.5	12	16	418	489	112	463.5	28	M10	60	50	5	8	31	24	M8	50	40	5	8	27
112 M	All	2, 4	100.5	12	16	401	475	112	447	28	M10	60	50	5	8	31	24	M8	50	40	5	8	27
132 S	1CA0, 1CC0	2, 6	115.5	12	16	449.5	535.5	130	516.5	38	M12	80	70	5	10	41	28	M10	60	50	5	8	31
	1CA1, 1CB0	2, 4				499.5	585.5		550.5														
132 M	1CC2	6	115.5	12	16	449.5	535.5	130	516.5	38	M12	80	70	5	10	41	28	M10	60	50	5	8	31
	1CB2, 1CC3	4, 6				499.5	585.5		550.5														
160 M	All	2, 4, 6	145	15	19	586	730	145	654	42	M16	110	90	10	12	45	42	M16	110	90	10	12	45
160 L	All	2, 4, 6	145	15	19	646	790	145	714	42	M16	110	90	10	12	45	42	M16	110	90	10	12	45

SIMOTICS XP 1MB1, 1MB5 explosion-protected motors

Dimensions · Aluminum series SIMOTICS XP

IE2, IE1 – 1MB1 with types of protection Ex tb, Ex tc, Ex ec – self-ventilated · Frame sizes 80 M to 160 L

Dimensional drawings

Type of construction IM B3

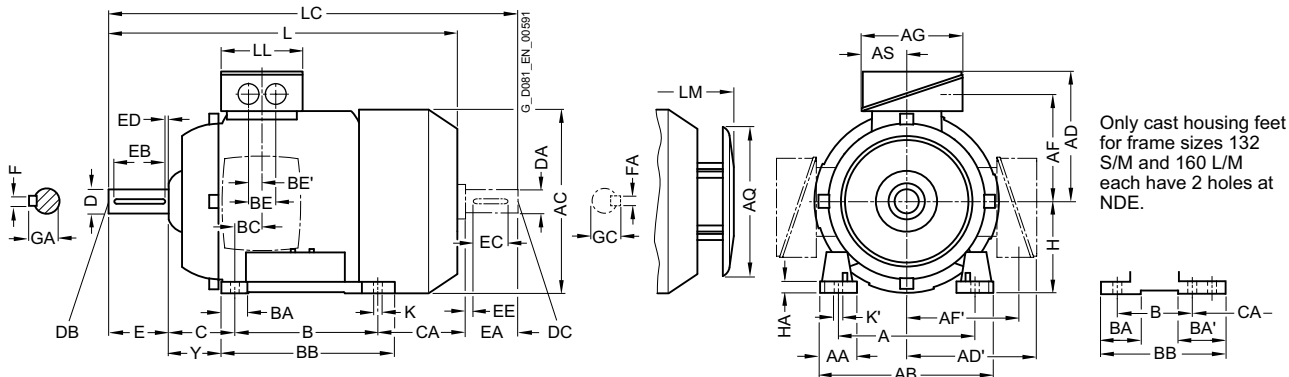

Types of construction IM B5 and IM V1

For flange dimensions, see page 1/48 (Z = the number of retaining holes)

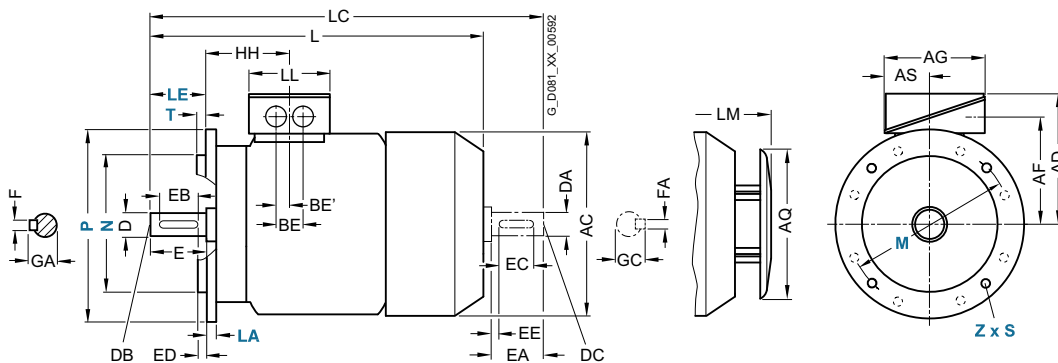

For motor			Dimension designation acc. to IEC																						
Frame size	Motor type	No. of poles	A	AA	AB	AC	AD	AD'	AF	AF'	AG	AQ	AS	B	BA	BA'	BB	BC	BE	BE'	C	CA	H	HA	Y
80 M	1MB10.1	2, 4, 6	125	30.5	150	159	149	149	96.5	112.5	119.5	155	61.5	100	32	32	118	23	36	18	50	112.5	80	8	41
90 S	1MB10.1	2, 4, 6	140	30.5	165	178	154	154	101.5	117.5	119.5	155	62.5	100	33	54	143	22.5	36	18	56	159	90	10	47
90 L	1MB10.1	2, 4, 6	140	30.5	165	178	154	154	101.5	117.7	119.5	155	62.5	125	33	54	143	22.5	36	18	56	134	90	10	47
100 L	All	2, 4, 6, 8	160	42	196	198	166	166	125.5	125.5	135	195	63.5	140	37.5	37.5	176	33.5	50	25	63	141	100	12	45
112 M	All	2, 4, 6, 8	190	46	226	222	177	177	136.5	136.5	135	195	63.5	140	35.4	37.5	176	26	50	25	70	129.7	112	12	52
132 S	All	2, 4, 6, 8	216	53	256	262	202	202	159.5	159.5	155	260	70.5	140	38	76 ¹⁾	218 ²⁾	26.5	48	24	89	128.5 ³⁾	132	15	69
132 M	All	2, 4, 6, 8	216	53	256	262	202	202	159.5	159.5	155	260	70.5	178	38	76	218	26.5	48	24	89	128.5 ³⁾	132	15	69
160 M	All	2, 4, 6, 8	254	60	300	314	236.5	236.5	190	190	175	260	77.5	210	44	89 ⁴⁾	300 ⁵⁾	47	57	28.5	108	148 ⁶⁾	160	18	85
160 L	All	2, 4, 6, 8	254	60	300	314	236.5	236.5	190	190	175	260	77.5	254	44	89	300	47	57	28.5	108	148 ⁶⁾	160	18	85

1) With screwed-on feet, dimension BA' is 38 mm.
 2) With screwed-on feet, dimension BB is 180 mm.
 3) With screwed-on feet, dimension CA is 166.5 mm.
 4) With screwed-on feet, dimension BA' is 44 mm.

5) With screwed-on feet, dimension BB is 256 mm.
 6) With screwed-on feet, dimension CA is 192 mm.

SIMOTICS XP 1MB1, 1MB5 explosion-protected motors

Dimensions · Aluminum series SIMOTICS XP

IE2, IE1 – 1MB1 with types of protection Ex tb, Ex tc, Ex ec – self-ventilated · Frame sizes 80 M to 160 L

Dimensional drawings

Type of construction IM B35

For flange dimensions, see page 1/48 (**Z** = the number of retaining holes)

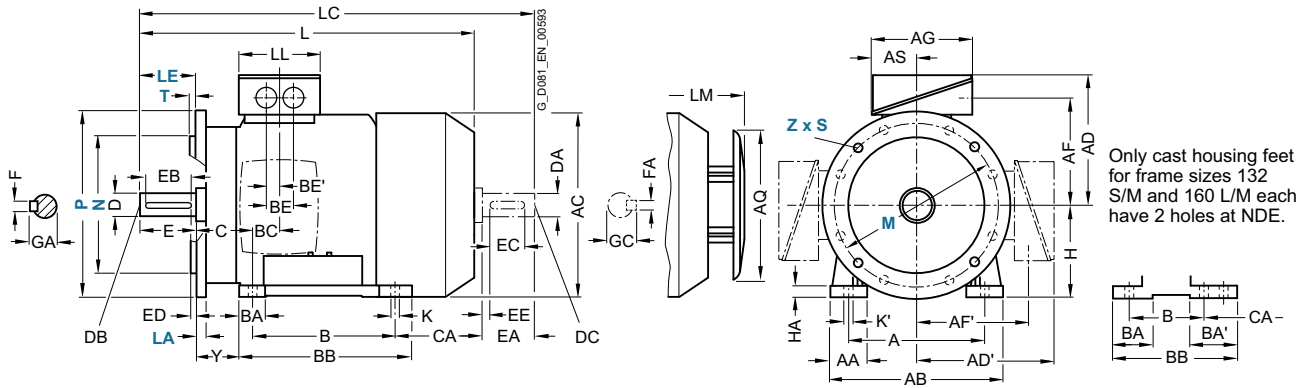

Type of construction IM B14

For flange dimensions, see page 1/48 (**Z** = the number of retaining holes)

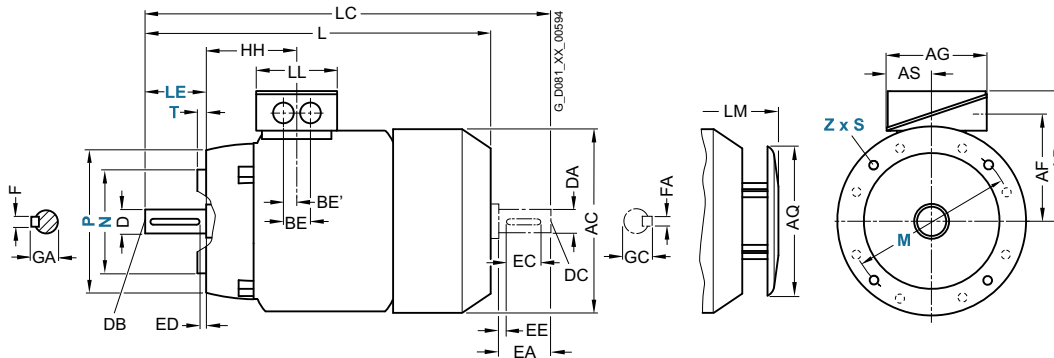

For motor Frame size	Motor type	No. of poles	Dimension designation acc. to IEC						DE shaft extension					NDE shaft extension									
			HH	K	K'	L	LC	LL	LM	D	DB	E	EB	ED	F	GA	DA	DC	EA	EC	EE	FA	GC
80 M	1MB10.1	2, 4, 6	73	9.5	13.5	253	342.5	123	328	19	M6	40	32	4	6	21.5	19	M6	40	32	4	6	21.5
90 S/L	1MB10.1	2, 4, 6	78.5	10	14	294.5	405	123	383	24	M8	50	40	5	8	27	19	M6	40	32	4	6	21.5
90 L	1MB10.1	2, 4, 6	78.5	10	14	294.5	405	123	383	24	M8	50	40	5	8	27	19	M6	40	32	4	6	21.5
100 L	All	2, 4, 6, 8	96.5	12	16	388.5	454	112	428.5	28	M10	60	50	5	8	31	24	M8	50	40	5	8	27
112 M	All	2, 4, 6, 8	96	12	16	382	450	112	422	28	M10	60	50	5	8	31	24	M8	50	40	5	8	27
132 S	All	2, 4, 6, 8	115.5	12	16	456.5	535.5	130	516.5	38	M12	80	70	5	10	41	28	M10	60	50	5	8	31
132 M	All	2, 4, 6, 8	115.5	12	16	456.5	535.5	130	516.5	38	M12	80	70	5	10	41	28	M10	60	50	5	8	31
160 M	All	2, 4, 6, 8	155	15	19	594	730	145	654	42	M16	110	90	10	12	45	42	M16	110	90	10	12	45
160 L	All	2, 4, 6, 8	155	15	19	594	730	145	654	42	M16	110	90	10	12	45	42	M16	110	90	10	12	45

SIMOTICS XP 1MB1, 1MB5 explosion-protected motors

Dimensions · Cast-iron series SIMOTICS XP

IE4, IE3 – 1MB5 with types of protection Ex tb, Ex tc, Ex ec – self-ventilated · Frame sizes 315 L to 450

Dimensional drawings

Type of construction IM B3

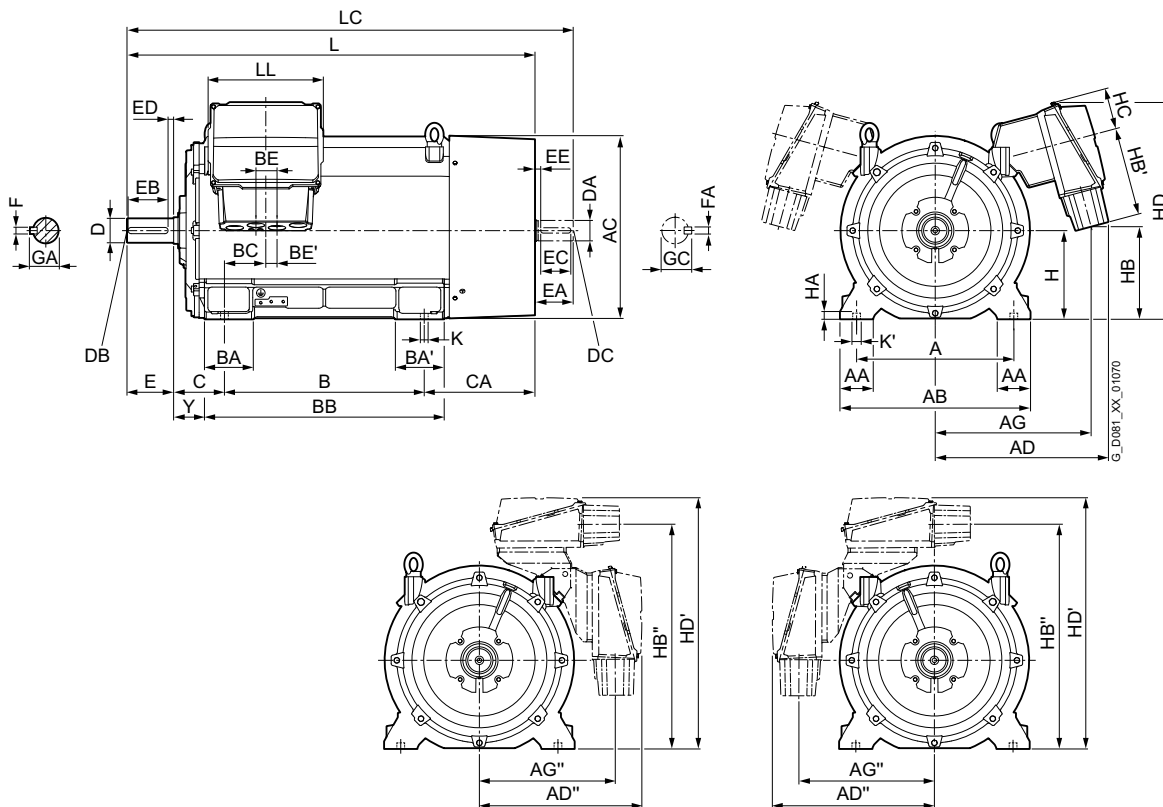

Types of construction IM B5 and IM V1

For flange dimensions, see page 1/48 (Z = the number of retaining holes)

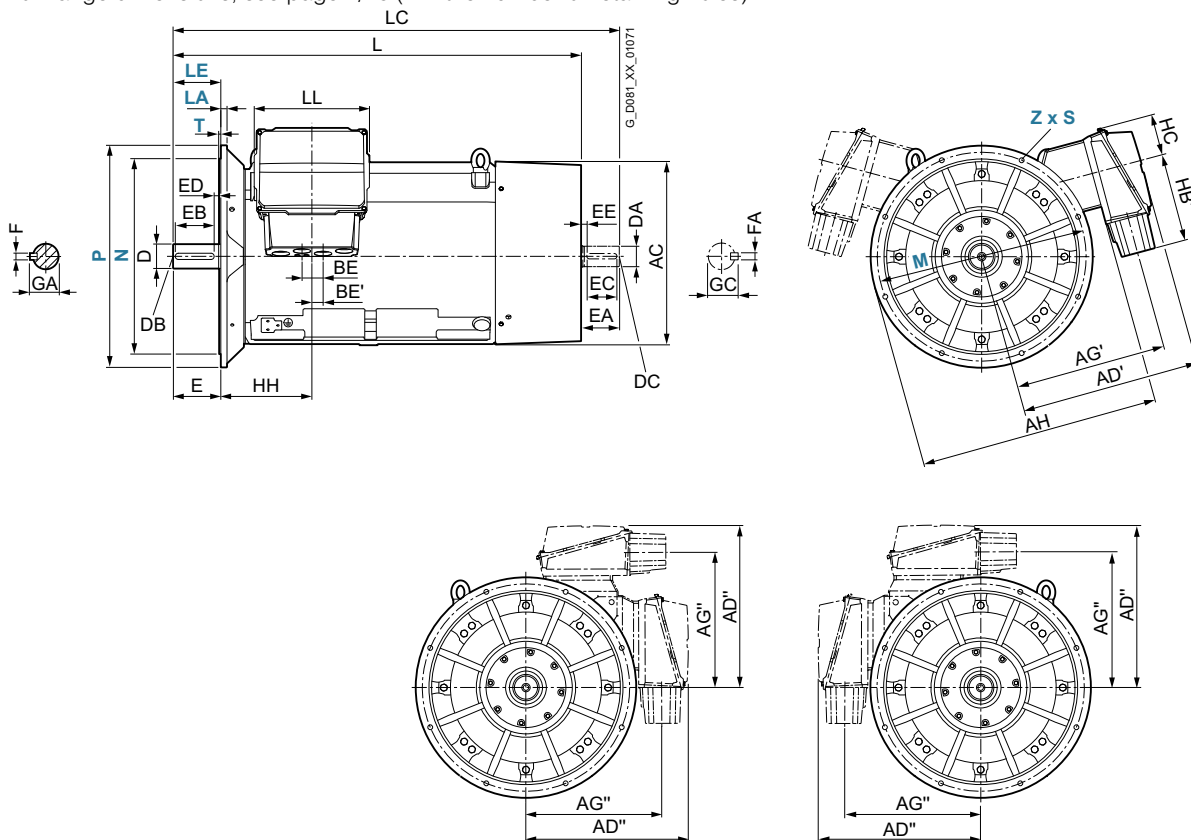

SIMOTICS XP 1MB1, 1MB5 explosion-protected motors

Dimensions · Cast-iron series SIMOTICS XP

IE4, IE3 – 1MB5 with types of protection Ex tb, Ex tc, Ex ec – self-ventilated · Frame sizes 315 L to 450

Dimensional drawings

Type of construction IM B35

For flange dimensions, see page 1/48 (Z = the number of retaining holes)

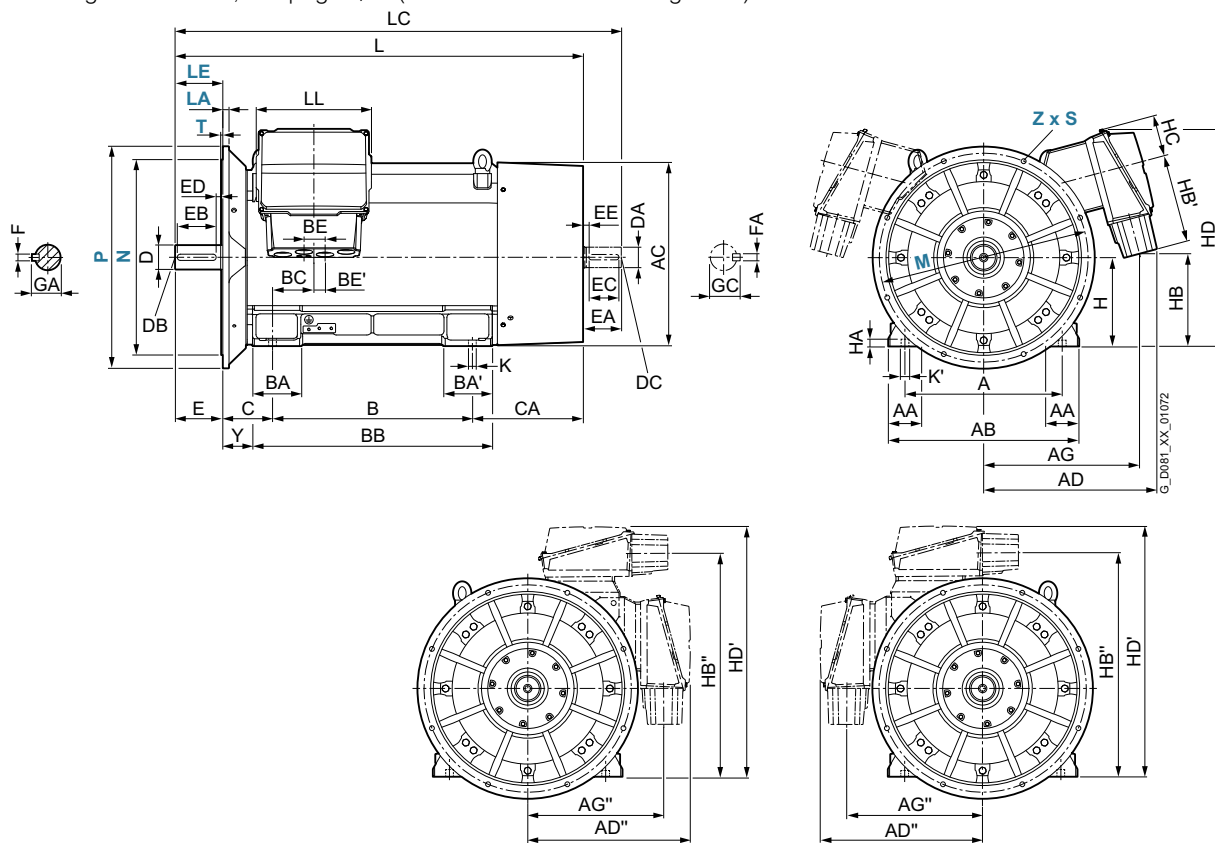

SIMOTICS XP 1MB1, 1MB5 explosion-protected motors

Dimensions · Cast-iron series SIMOTICS XP

IE4, IE3 – 1MB5 with types of protection Ex tb, Ex tc, Ex ec – self-ventilated · Frame sizes 315 L to 450

Dimensional drawings

For Motor	Dimension designation acc. to IEC	No. of poles	A	AA	AB	AC	AD	AD'	AD''	AG	AG'	AG''	AH	B	B'	B''	BA	BA'	BB	BC	BE	BE'	C	CA	CA'	CA''	H	HA	Y	
315 L	3AA6	2	508	120	610	641	590	565	540	553	459	–	890	457	508	–	176	227	648	139	120	60	216	469	418	–	315	50	146	
	3AB6, 3AB7	4												508	560	630		298	770								528	476	406	
	3AA7	2																									498	446	376	
	3AC8	6																									618	566	496	
	3AC7, 3AD7	6, 8					543				491	473										135	67,5				528	476	406	
	3AD8	8																									618	566	496	
355 S/M/L	3BA3, 3BA4, 3BA5	2	610	150	780	718	620	657	644	550	542	–	940	630	710	800	198	315	998	116	240	120	254	553	473	383	355	49	130	
	3BB3, 3BB4	4																												
	3BB5	4															194	311									648	568	478	35
	3BC2, 3BC3	6																												
	3BC4	6																												
	3BD1, 3BD2	6																												
400	4AA	2	710	150	860	880	785	845	740	705	720	620	1110	900	–	–	220	220	1080	186	87,5	43,5	224	501	–	–	400	35	134	
	4AB	4																												
	4AC	6																												
	4AD	8																												
450	4BA	2	800	180	980	970	820	895	775	740	770	655	1235	1000	–	–	260	260	1220	170	87,5	43,5	250	535	–	–	450	42	140	
	4BB	4																												
	4BC	6																												
	4BD	8																												

SIMOTICS XP 1MB1, 1MB5 explosion-protected motors

Dimensions · Cast-iron series SIMOTICS XP

IE4, IE3 – 1MB5 with types of protection Ex tb, Ex tc, Ex ec – self-ventilated · Frame sizes 315 L to 450

Dimensional drawings

For motors Frame size	Motortype 1MB5.2- 1MB5.3-	No. of poles	Dimension designation acc. to IEC													DE shaft extension						NDE shaft extension									
			HB	HB'	HB''	HC	HD	HD'	HH	K	K'	L	LC ¹⁾	LL	D	DB	E	EB	ED	F	GA	DA	DC	EA	EC	EE	FA	GC			
315 L	3AA6	2	421	336	–	167	800	–	355	35	–	1282	1427	327	65	M20	140	125	10	18	69	60	M20	140	125	10	18	64			
	3AB6, 3AB7	4										1422	1567	85		170	140	25	22	90	70						20	74,5			
	3AA7	2										1362	1507	65		140	125	10	18	69	60							18	64		
	3AC8	6										1512	1657	85		170	140	25	22	90	70							20	74,5		
	3AC7, 3AD7	6, 8	491	225								1422	1567																		
	3AD8	8										1512	1657																		
	355 S/M/L	3BA3, 3BA4, 3BA5	2	578	247	–	188	911	–	370	35	42	1577	1722	519	75	M20	140	125	10	20	79,5	60	M20	140	125	10	18	64		
		3BB3, 3BB4	4										1607	1782	95	M24	170	140	25	25	100	80			170	140	25	22	85,5		
	3BB5	4										1702	1877																		
	3BC2, 3BC3	6										1607	1782																		
	3BC4	6																													
	3BD1	8																													
	3BD2	8										1702	1877																		
400	4AA	2	420	400	1020	190	980	1140	410	35	42	1795	1940	519	80	M20	170	140	25	22	85	70	M20	140	125	10	20	74,5			
	4AB	4										1835	2010	110	M24	210	180	28	116	90	M24	170	140	25	25	95					
	4AC	6																													
	4AD	8																													
450	4BA	2	505	400	1105	190	1065	1225	420	42	50	1955	2100	519	90	M24	170	140	25	25	95	75	M20	140	125	10	20	79,5			
	4BB	4										1995	2210	120		210	180	32	127	100	M24	210	180	25	28	106					
	4BC	6																													
	4BD	8																													

¹⁾ In the low-noise version, a second shaft extension and/or mounted encoder is not possible.

SIMOTICS XP 1MB1, 1MB5 explosion-protected motors

Dimensions · Cast-iron series SIMOTICS XP

IE3 – 1MB1 with types of protection Ex tb, Ex tc, Ex ec – self-ventilated · Frame sizes 71 M to 160 L

Dimensional drawings

Type of construction IM B3

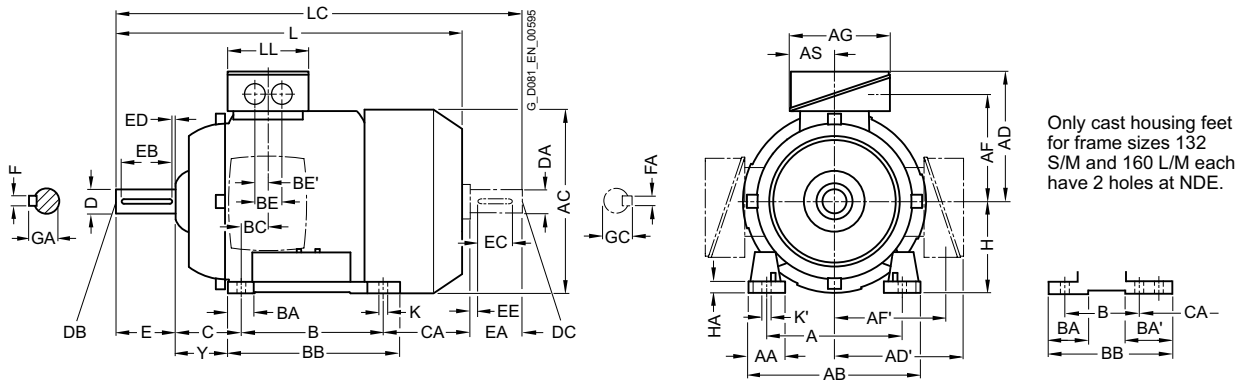

Types of construction IM B5 and IM V1

For flange dimensions, see page 1/48 (Z = the number of retaining holes)

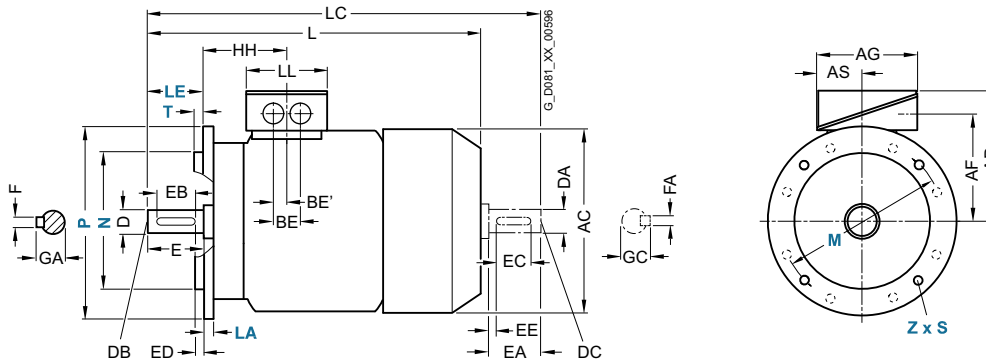

For motor Frame size	Motor type	No. of poles	Dimension designation acc. to IEC																					
			A	AA	AB	AC	AD	AD'	AF	AF'	AG	AS	B	BA	BA'	BB	BC	BE	BE' C	CA	H	HA	Y	
71 M	0CA2, 0CB2, 0CC2	2, 4, 6	112	30.5	132	145	149	149	112	112	126	62	90	32	32	106	21	36	18	45	83	71	7	37
	0CA3, 0CB3, 0CC3																							
80 M	0DA2, 0DB2, 0DC2	2, 4, 6	125	30.5	150	162	159	159	122	122	126	62	100	32	32	118	22.5	36	18	50	112.5	80	8	41
	0DA3, 0DB3, 0DC3																							
90 S	All	2, 4, 6	140	30.5	165	180	164	164	127	127	126	62	100	33	54	143	24.5	36	18	56	149	90	10	47
90 L	All	2, 4, 6	140	30.5	165	180	164	164	127	127	126	62	125	33	54	143	24.5	36	18	56	164	90	10	47
100 L	All	2, 4, 6	160	42	196	198	193	193	147	147	163	80.5	140	40	40	176	37.5	48	24	63	176	100	12	45
112 M	All	2, 4, 6	190	46	226	222	195	195	150	150	163	80.5	140	40	40	176	30	48	24	70	155	112	12	52
132 S	1CA0, 1CC0	2, 6	216	53	256	262	214.5	214.5	169	169	163	80.5	140	44	81 ¹⁾	218 ²⁾	26.5	48	24	89	128.5	132	15	69
	1CA1, 1CB0	2, 4																						
132 M	1CC2	6	216	53	256	262	214.5	214.5	169	169	163	80.5	178	44	81 ¹⁾	218	26.5	48	24	89	128.5	132	15	69
	1CB2, 1CC3	4, 6																						
160 M	All	2, 4, 6	254	60	300	314	261	261	213	213	190	92	210	73	117 ³⁾	300 ⁴⁾	37	60	30	108	148	160	18	85
160 L	All	2, 4, 6	254	60	300	314	261	261	213	213	190	92	254	73	117 ³⁾	300	37	60	30	108	208	160	18	85

1) With screwed-on feet, dimension BA' is 43 mm.
 2) With screwed-on feet, dimension BB is 180 mm.
 3) With screwed-on feet, dimension BA' is 51 mm.

4) With screwed-on feet, dimension BB is 256 mm.

SIMOTICS XP 1MB1, 1MB5 explosion-protected motors

Dimensions · Cast-iron series SIMOTICS XP

IE3 – 1MB1 with types of protection Ex tb, Ex tc, Ex ec – self-ventilated · Frame sizes 71 M to 160 L

Dimensional drawings

Type of construction IM B35

For flange dimensions, see page 1/48 (Z = the number of retaining holes)

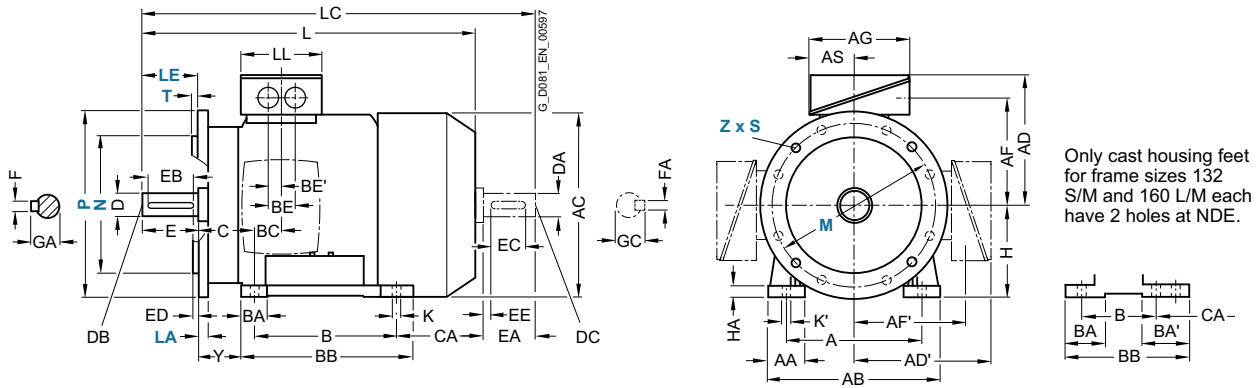

Only cast housing feet for frame sizes 132 S/M and 160 L/M each have 2 holes at NDE.

Type of construction IM B14

For flange dimensions, see page 1/48 (Z = the number of retaining holes)

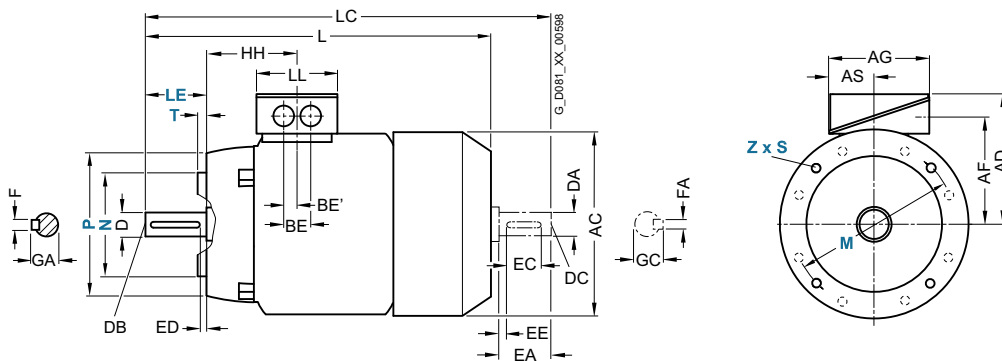

Frame size	Motor type	No. of poles	Dimension designation acc. to IEC						DE shaft extension				NDE shaft extension									
			HH	K	K'	L	LC	LL	D	DB	E	EB	ED	F	GA	DA	DC	EA	EC	EE	FA	GC
71 M	0CA2, 0CB2, 0CC2	2, 4, 6	63	7.5	7.5	240	278	102	14	M5	30	22	4	5	16	14	M5	30	22	4	5	16
	0CA3, 0CB3, 0CC3		70			280	318															
80 M	0DA2, 0DB2, 0DC2	2, 4, 6	72.5	10	13.5	292	342.5	102	19	M6	40	32	4	6	21.5	19	M6	40	32	4	6	21.5
	0DA3, 0DB3, 0DC3					327	377.5															
90 S	All	2, 4, 6	80.5	10	10	347	405	102	24	M8	50	40	5	8	27	24	M8	50	40	5	8	27
90 L	All	2, 4, 6	80.5	10	10	387	445	102	24	M8	50	40	5	8	27	24	M8	50	40	5	8	27
100 L	All	2, 4, 6	100.5	12	16	418	489	134	28	M10	60	50	5	8	31	24	M8	50	40	5	8	27
112 M	All	2, 4, 6	100.5	12	16	402	475	134	28	M10	60	50	5	8	31	24	M8	50	40	5	8	27
	1CA0, 1CC0	2, 6	115.5	12	16	449.5	536	134	38	M12	80	70	5	10	41	28	M10	60	50	5	8	31
132 S	1CA1, 1CB0	2, 4				499.5	586															
	1CC2	6	115.5	12	16	449.5	536	134	38	M12	80	70	5	10	41	28	M10	60	50	5	8	31
132 M	1CB2, 1CC3	4, 6				499.5	586															
	All	2, 4, 6	145	15	19	586	730	165	42	M16	110	90	10	12	45	42	M16	110	90	10	12	45
160 L	All	2, 4, 6	145	15	19	646	790	165	42	M16	110	90	10	12	45	42	M16	110	90	10	12	45

SIMOTICS XP 1MB1, 1MB5 explosion-protected motors

Dimensions · Cast-iron series SIMOTICS XP

IE3, IE1 – 1MB1 with type of protection Ex eb – self-ventilated · Frame sizes 63 M to 160 L

Dimensional drawings

Type of construction IM B3

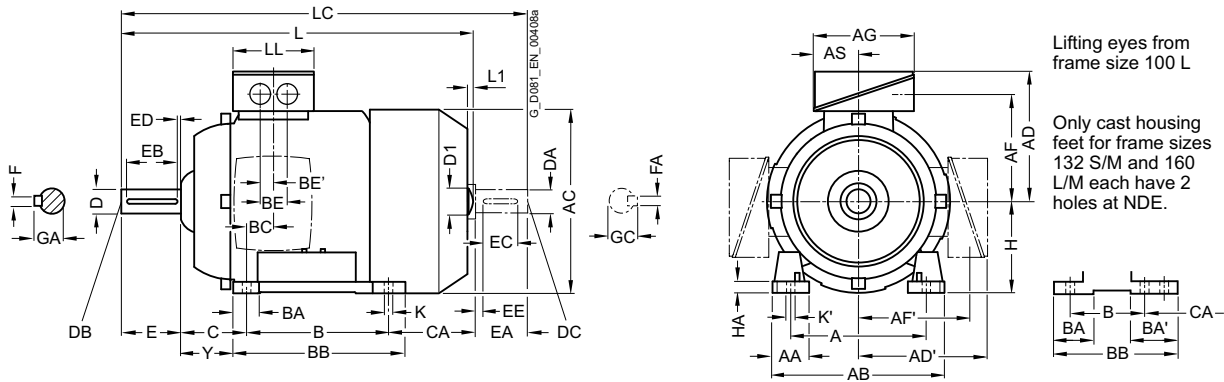

Types of construction IM B5 and IM V1

For flange dimensions, see page 1/48 (Z = the number of retaining holes)

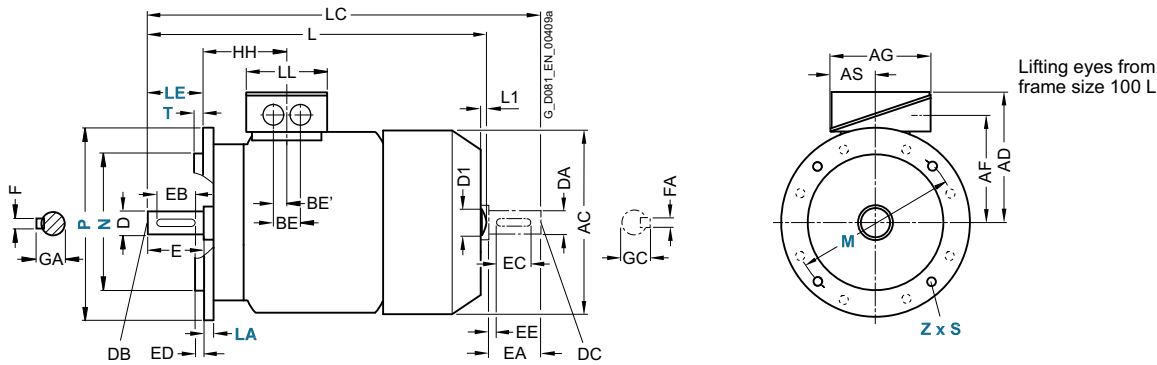

For motor			Dimension designation acc. to IEC																					
Frame size	Motor type	No. of poles	A	AA	AB	AC	AD	AD'	AF	AF'	AG	AS	B	BA	BA'	BB	BC	BE	BE'	C	CA	H	HA	Y
63M	1MB1042-0B.2 0B.3	2, 4	100	27	120	124	135	-	95	-	120	60	80	27	-	96	52	32	16	40	66	63	7	-
71 M	1MB1543-1MB1643-0C.2 0C.3	2, 4, 6	112	30.5	132	145	173	173	129	129	163	80.5	90	32	32	106	21	48	24	45	83	71	7	37
80 M	0D.2 0D.3	2, 4, 6	125	30.5	150	162	183	183	139	139	163	80.5	100	32	32	118	22.5	48	24	50	112.5	80	8	41
90 S	0E.0	2, 4, 6	140	30.5	165	180	188	188	144	144	163	80.5	100	33	54	143	24.5	48	24	56	159	90	11	47
90 L	0E.4	2, 4, 6	140	30.5	165	180	188	188	144	144	163	80.5	125	33	54	143	24.5	48	24	56	134	90	11	47
100 L	All	2, 4, 6	160	42	196	217	193	193	147	147	163	80.5	140	48	48	176	37.5	48	24	63	141	100	12	45
112 M	All	2, 4, 6	190	46	226	239	195	195	150	150	163	80.5	140	48	48	176	30	48	24	70	130	112	12	52
132 S	1CA0, 1CC0 1CA1, 1CB0	2, 6 2, 4	216	53	256	281	214.5	214.5	169	169	163	80.5	140	52	89 ¹⁾	218 ²⁾	26.5	48	24	89	128.5 178.5	132	15	69
132 M	1CC2 1CB2, 1CC3	6 4, 6	216	53	256	281	214.5	214.5	169	169	163	80.5	178	52	89 ¹⁾	218	26.5	48	24	89	128.5 178.5	132	15	69
160 M	All	2, 4, 6	254	60	300	333.5	261	261	213	213	190	92	210	73	117 ³⁾	300 ⁴⁾	37	60	30	108	192	160	18	85
160 L	All	2, 4, 6	254	60	300	333.5	261	261	213	213	190	92	254	73	117 ³⁾	300	37	60	30	108	208	160	18	85

1) With screwed-on feet, dimension BA' is 43 mm.
 2) With screwed-on feet, dimension BB is 180 mm.
 3) With screwed-on feet, dimension BA' is 51 mm.
 4) With screwed-on feet, dimension BB is 256 mm.

SIMOTICS XP 1MB1, 1MB5 explosion-protected motors

Dimensions · Cast-iron series SIMOTICS XP

IE3, IE1 – 1MB1 with type of protection Ex eb – self-ventilated · Frame sizes 63 M to 160 L

Dimensional drawings

Type of construction IM B35

For flange dimensions, see page 1/48 (Z = the number of retaining holes)

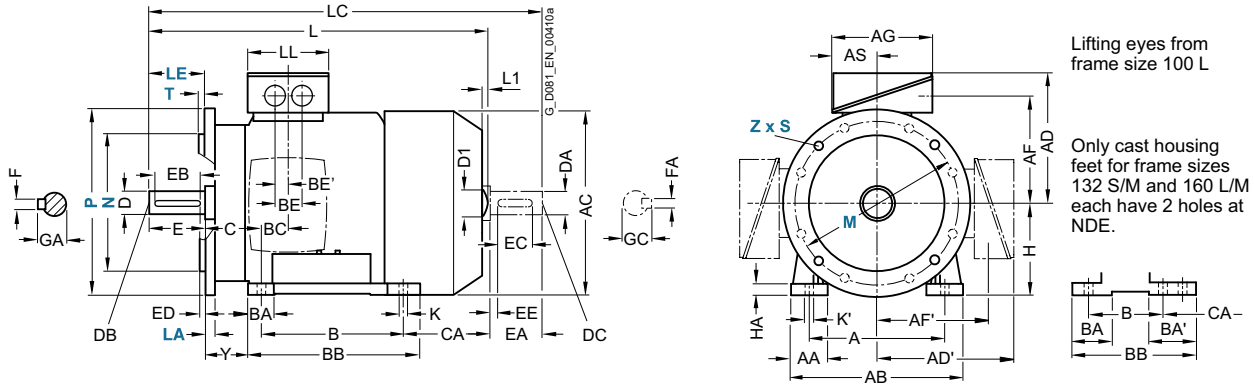

Type of construction IM B14

For flange dimensions, see page 1/48 (Z = the number of retaining holes)

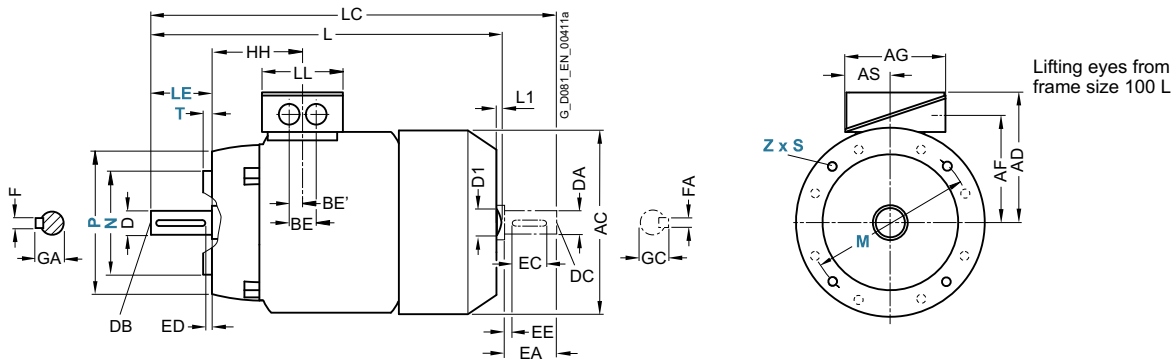

For motor			Dimension designation acc. to IEC							DE shaft extension					NDE shaft extension									
Frame size	Motor type	No. of poles	HH	K	K'	L ¹⁾	L1	D1	LC	LL	D	DB	E	EB	ED	F	GA	DA	DC	EA	EC	EE	FA	GC
63 M	1MB1042-0B.2 0B.3	2, 4	69.5	7	10	202.5	-	-	232	120	11	M4	23	16	3.5	4	12.5	11	M4	23	16	3.5	4	12.5
71 M	1MB1543-0C.2 1MB1643-0C.3	2, 4, 6	64.5	7.5	7.5	240 280	-	-	278	134	14	M5	30	22	4	5	16	14	M5	30	22	4	5	16
80 M	0D.2 0D.3	2, 4, 6	71.5	10	10	292 327	-	-	318	134	19	M6	40	32	4	6	21.5	19	M6	40	32	4	6	21.5
90 S	0E.0	2, 4, 6	79.5	10	10	347	-	-	343	134	24	M8	50	40	5	8	27	19	M6	50	40	5	8	21.5
90 L	0E.4	2, 4, 6	79.5	10	10	387	-	-	378	134	24	M8	50	40	5	8	27	19	M6	50	40	5	8	21.5
100 L	All	2, 4, 6	100.5	12	16	425.5	-	32	405	134	28	M10	M10	50	5	8	31	24	M8	M10	50	5	8	27
112 M	All	2, 4, 6	100.5	12	16	408.5	-	32	445	134	28	M10	60	50	5	8	31	24	M8	60	50	5	8	27
132 S	1CA0, 1CC0 1CA1, 1CB0	2, 6 2, 4	115.5	12	16	458	-	39	489	134	38	M12	80	70	5	10	41	28	M10	80	70	5	10	31
132 M	1CC2 1CB2, 1CC3	6 4, 6	115.5	12	16	508	-	39	342.5	134	38	M12	80	70	5	10	41	28	M10	80	70	5	10	31
160 M	All	2, 4, 6	145	14.5	18	596	-	45	475	165	42	M16	110	90	10	12	45	42	M16	110	90	10	12	45
160 L	All	2, 4, 6	145	14.5	18	656	-	45	535.5	165	42	M16	110	90	10	12	45	42	M16	110	90	10	12	45

1) For 1MB1643 motors less dimension L1.

2) Only for 1MB1543 motors.

SIMOTICS XP 1MB1, 1MB5 explosion-protected motors

Dimensions · Cast-iron series SIMOTICS XP

IE3 – 1MB1 with type of protection Ex eb – self-ventilated · Frame sizes 180 M to 280 M

Dimensional drawings

Type of construction IM B3

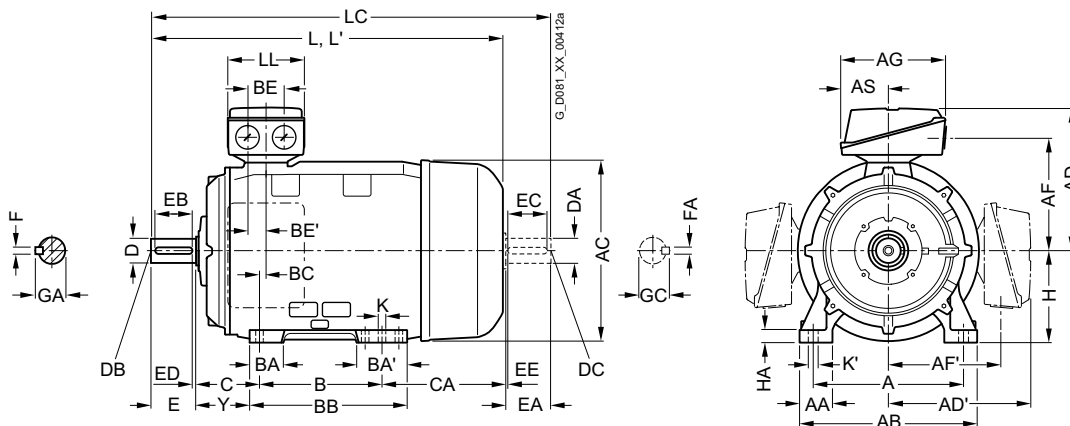

Types of construction IM B5 and IM V1

For flange dimensions, see page 1/48 (Z = the number of retaining holes)

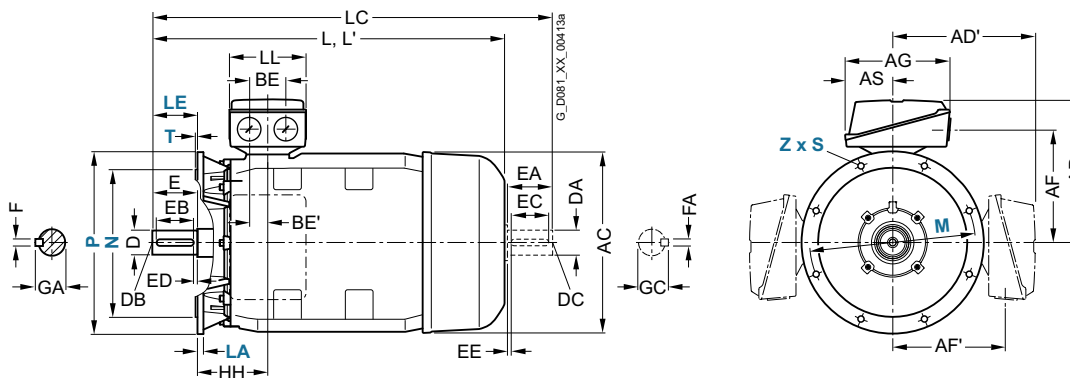

For motor Frame size	Motor type	No. of poles	Dimension designation acc. to IEC																		
			A	AA	AB	AC	AD	AD'	AF	AF'	AG	AS	B	BA	BA'	BB	BC	BE	BE'	C	CA
180 M/ 180 L	1EA2, 1EB4 1EB2, 1EC4	2, 4 4, 6	279	65	339	356	286	286	234	234	190	92	241	85	120	328	34	60	30	121	202
200 L	2AA4, 2AC4 2AA5, 2AB5, 2AC5	2, 6 2, 4, 6	318	70	378	396	315	315	259	259	266	112	305	104	104	355	31	85	42,5	133	177
225 S	2BB0	4	356	80	436	449	338	338	282	282	266	112	286	92	117	361	15	85	42,5	149	218
225 M	2BA2 2BB2, 2BC2	2 4, 6											311					85	42,5	149	253
250 M	2CA2 2CB2, 2CC2	2 4, 6	406	100	490	497	410	410	322	322	319	145	349	102	102	409	24	110	55	168	230
280 S	2DA0 2DB0, 2DC0	2 4, 6	457	100	540	551	433	433	345	345	319	145	368	101	152	479	20	110	55	190	267
280 M	2DA2 2DB2 2DC2	2 4 6											419								

6

SIMOTICS XP 1MB1, 1MB5 explosion-protected motors

Dimensions · Cast-iron series SIMOTICS XP

IE3 – 1MB5 with type of protection Ex eb – self-ventilated · Frame sizes 315 S to 315 L

Dimensional drawings

Type of construction IM B3

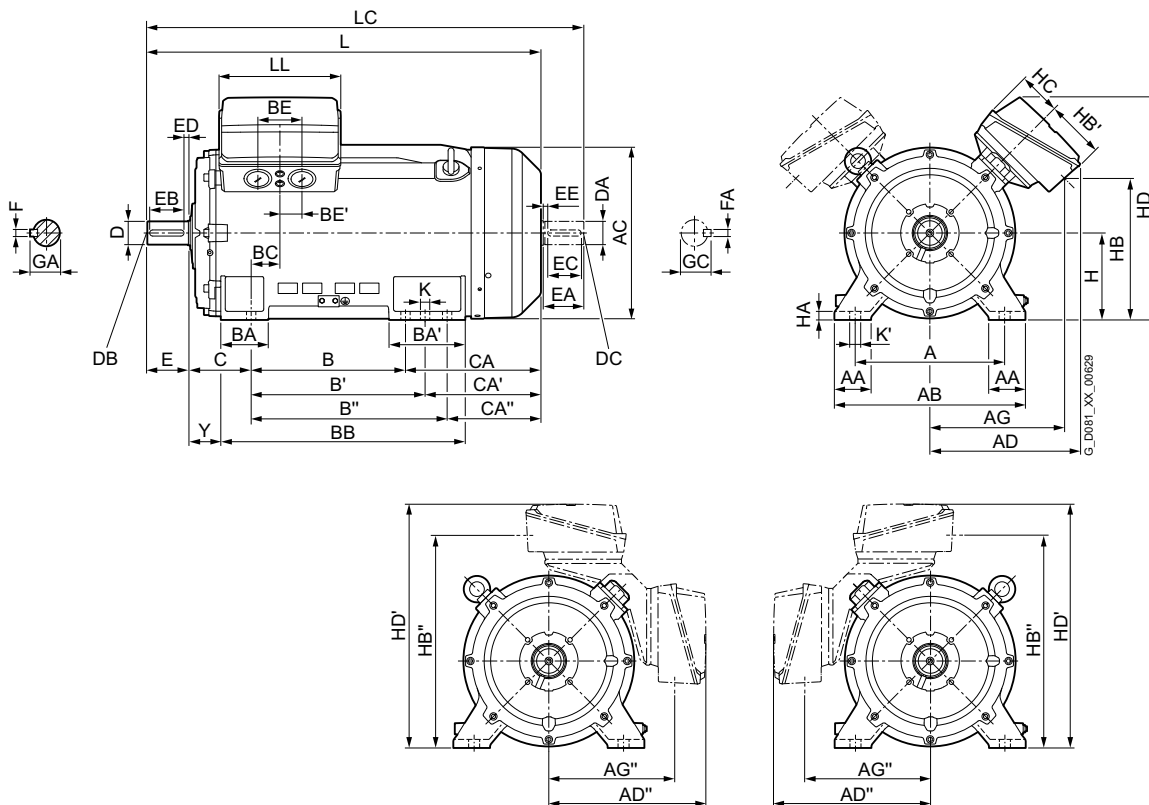

Types of construction IM B5 and IM V1

For flange dimensions, see page 1/48 (Z = the number of retaining holes)

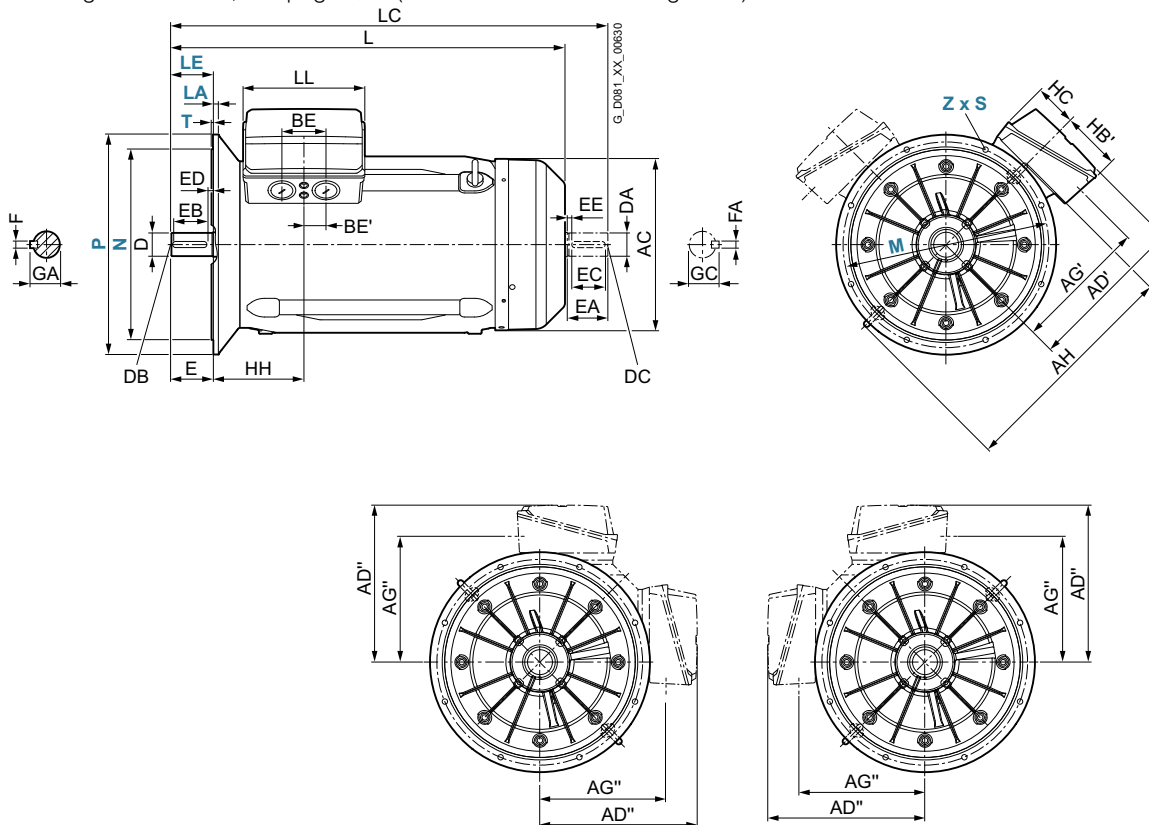

SIMOTICS XP 1MB1, 1MB5 explosion-protected motors

Dimensions · Cast-iron series SIMOTICS XP

IE3 – 1MB5 with type of protection Ex eb – self-ventilated · Frame sizes 315 S to 315 L

Dimensional drawings

Type of construction IM B35

For flange dimensions, see page 1/48 (Z = the number of retaining holes)

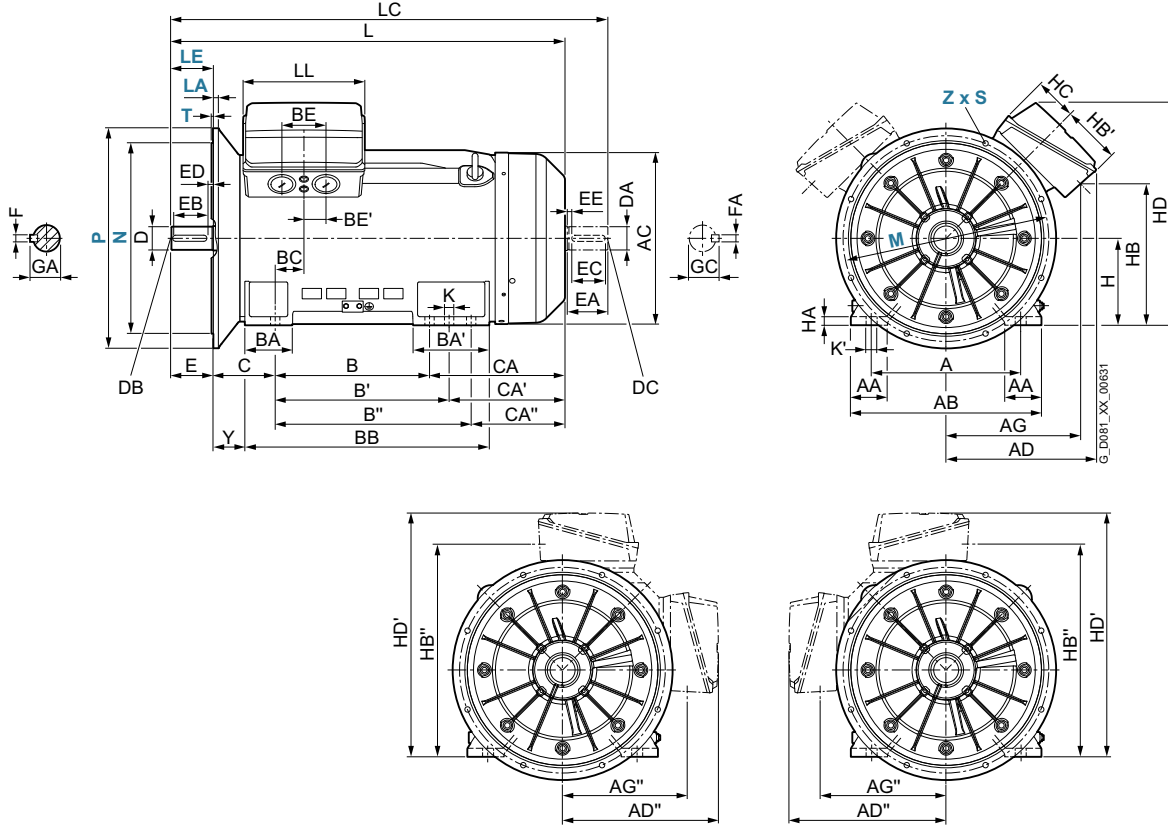

For motor		Dimension designation acc. to IEC																									
Frame size	Motor type	No. of poles	A	AA	AB	AC	AD	AD'	AD''	AG	AG'	AG''	AH	B	B'	BA	BA'	BB	BC	BE	BE'	C	CA	CA'	H	HA	HB
315 S/M	1MB5543	2	508	120	610	641	543	565	540	491	480	481	660	406	457	176	227	570	139	135	67.5	216	370	319	315	50	491
	3AB0, 3AB2, 3AC0, 3AC2		4, 6														177	226									
	315 L		3AA4, 3AA5, 3AB4, 3AB5, 3AC4, 3AC5, 3AC6	2, 4, 6	508	120	610	641	543	565	540	491	480	481	660	457	508	176	227	648	139	135	67.5	216	469	418	315

For motor		Dimension designation acc. to IEC													DE shaft extension				NDE shaft extension									
Frame size	Motor type	No. of poles	HB'	HB''	HC	HD	HD'	HH	Y	K	K'	L	LC ¹⁾	LL	D	DB	E	EB	ED	F	GA	DA	DC	EA	EC	EE	FA	GC
315 S/M	1MB5543	2	225	796	167	800	880	355	146	28	35	1132	1277	327	65	M20	140	125	10	18	69	60	M20	140	125	80	18	64
	3AB0, 3AB2, 3AC0, 3AC2		4, 6										1162	1307		80	M20	170	140	25	22	85	70				20	74
	315 L		3AA0, 3AA2, 3AB4, 3AB5, 3AC4, 3AC5, 3AC6	2, 4, 6	225	796	167	800	880	355	146	28	35	1282	1427	327	65	M20	140	125	10	18	69	60	M20	140	125	80
												1312	1457		80													

¹⁾ In the low-noise version, a second shaft extension and/or mounted encoder is not possible.

SIMOTICS XP 1MB1, 1MB5 explosion-protected motors

Dimensions · Cast-iron series SIMOTICS XP

IE3 – 1MB1 with types of protection Ex db, Ex db eb – self-ventilated · Frame sizes 71 M to 160 L

Dimensional drawings

Type of construction IM B3

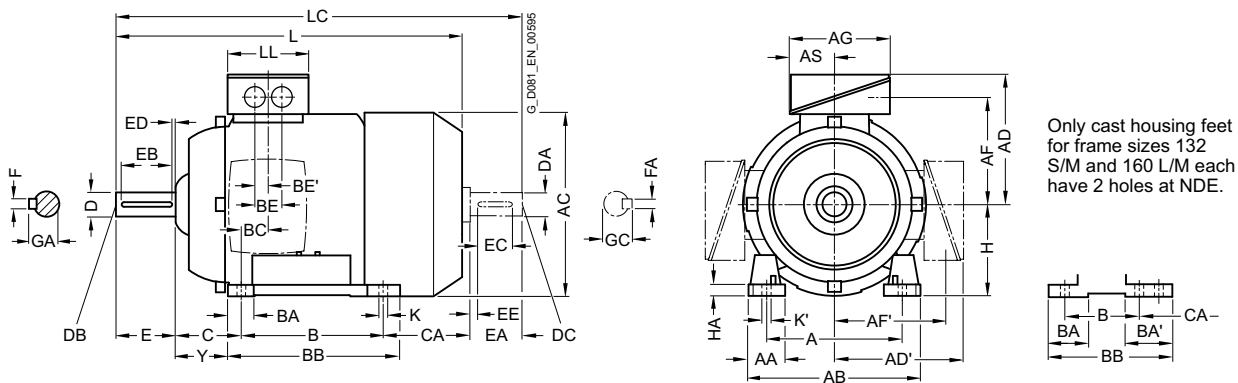

Only cast housing feet for frame sizes 132 S/M and 160 L/M each have 2 holes at NDE.

Types of construction IM B5 and IM V1

For flange dimensions, see page 1/48 (Z = the number of retaining holes)

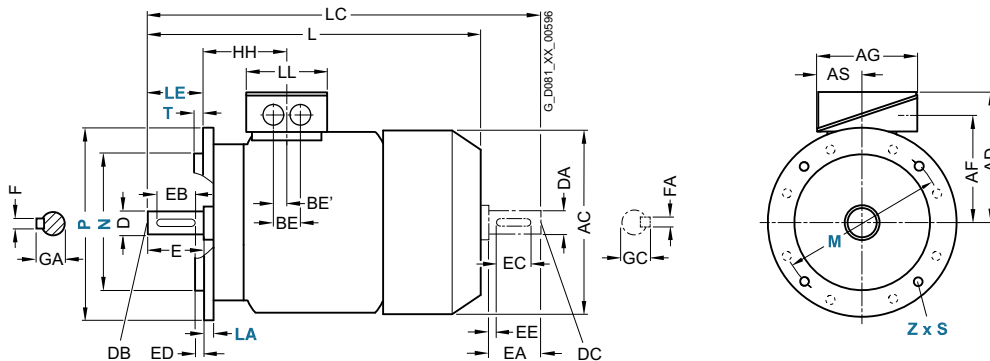

For motor		Dimension designation acc. to IEC																						
Frame size	Motor type 1MB1.5.- 1MB1.6.-	No. of poles	A	AA	AB	AC	AD	AD'	AF	AF'	AG	AS	B	BA	BA'	BB	BC	BE	BE'	C	CA	H	HA	Y
71 M	All	2, 4, 6, 8	112	25	140	169	240	-	195	-	163	81	90	30	45	125	76	36	18	45	199.5	71	10	35
80 M	All	2, 4, 6, 8	125	35	160	169	249	-	204	-	163	81	100	33	38	130	75.5	36	18	50	204	80	13	37.5
90 S/L	All	2, 4, 6, 8	140	40	180	182	261	-	216	-	163	81	125	41	40	155	80	36	18	56	239	90	13	41
100 L	All	2, 4, 6, 8	160	40	205	218	259	-	213	-	163	81	140	50	50	170	92	48	24	63	306	100	18	48
112 M	All	2, 4, 6, 8	190	45	240	230	279	-	233	-	163	81	140	50	50	170	92	48	24	70	280.5	112	18	55
132 S	All	2, 4, 6, 8	216	50	260	262	295	295	250	250	163	81	140	58	104	235	101	48	24	89	292	132	18	64
132 M	1CB2, 1CC3 1CC2, 1CD2	4, 6 6, 8	216	50	260	262	295	295	250	250	163	81	178	58	104	235	101	48	24	89	309	132	18	64
																					254			
160 M	All	2, 4, 6, 8	254	60	310	314	351	351	299	299	190	92	210	61	114	307	162.5	60	3	108	393	160	20	87.5
160 L	All	2, 4, 6, 8	254	60	310	314	351	351	299	299	190	92	254	61	114	307	162.5	60	3	108	349	160	20	87.5

6

SIMOTICS XP 1MB1, 1MB5 explosion-protected motors

Dimensions · Cast-iron series SIMOTICS XP

IE3 – 1MB1 with types of protection Ex db, Ex db eb – self-ventilated · Frame sizes 71 M to 160 L

Dimensional drawings

Type of construction IM B14

For flange dimensions, see page 1/48 (Z = the number of retaining holes)

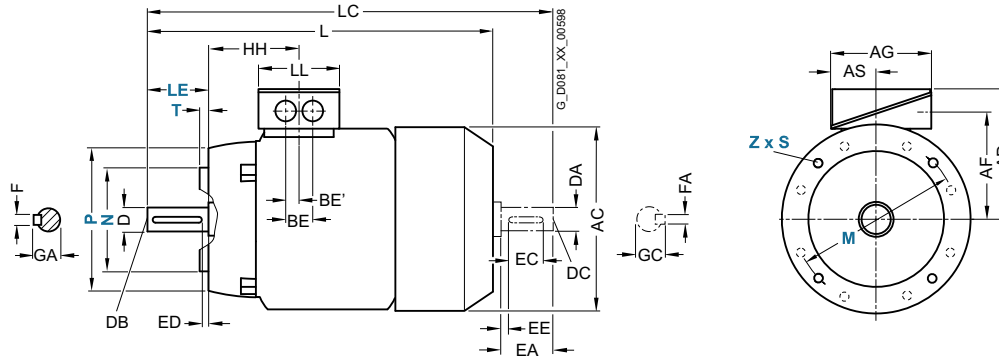

For motor Frame size	Motor type 1MB1.5.- 1MB1.6.-	No. of poles	Dimension designation acc. to IEC							DE shaft extension					NDE shaft extension							
			HH	K	K'	L	LC	LL	D	DB	E	EB	ED	F	GA	DA	DC	EA	EC	EE	FA	GC
71 M	All	2, 4, 6, 8	121	7	10	350	394.5	134	14	M5	30	22	4	5	16	14	M5	30	22	4	5	16
80 M	All	2, 4, 6, 8	125.5	10	15	374	434	134	19	M6	40	32	4	6	21.5	19	M6	40	32	4	6	21.5
90 S/L	All	2, 4, 6, 8	136	10	15	450	510	134	24	M8	50	40	5	8	27	19	M6	40	32	4	6	21.5
100 L	All	2, 4, 6, 8	155	12	19	544	619	134	28	M10	60	50	5	8	31	24	M8	50	40	5	8	27
112 M	All	2, 4, 6, 8	162	12	19	520	600.5	134	28	M10	60	50	5	8	31	24	M8	50	40	5	8	27
132 S	All	2, 4, 6, 8	190	12	19	571	661	134	38	M12	80	70	5	10	41	28	M10	60	50	5	8	31
132 M	1CB2, 1CC3	4, 6	190	12	19	626	716	134	38	M12	80	70	5	10	41	28	M10	60	50	5	8	31
	1CC2, 1CD2	6, 8				571	661															
160 M	All	2, 4, 6, 8	270.5	14.5	23	786	931	165	42	M16	110	90	10	12	45	42	M16	110	90	10	12	45
160 L	All	2, 4, 6, 8	270.5	14.5	23	786	931	165	42	M16	110	90	10	12	45	42	M16	110	90	10	12	45

SIMOTICS XP 1MB1, 1MB5 explosion-protected motors

Dimensions · Cast-iron series SIMOTICS XP

IE3 – 1MB1 with types of protection Ex db, Ex db eb – self-ventilated · Frame sizes 180 M to 280 M

Dimensional drawings

Type of construction IM B3

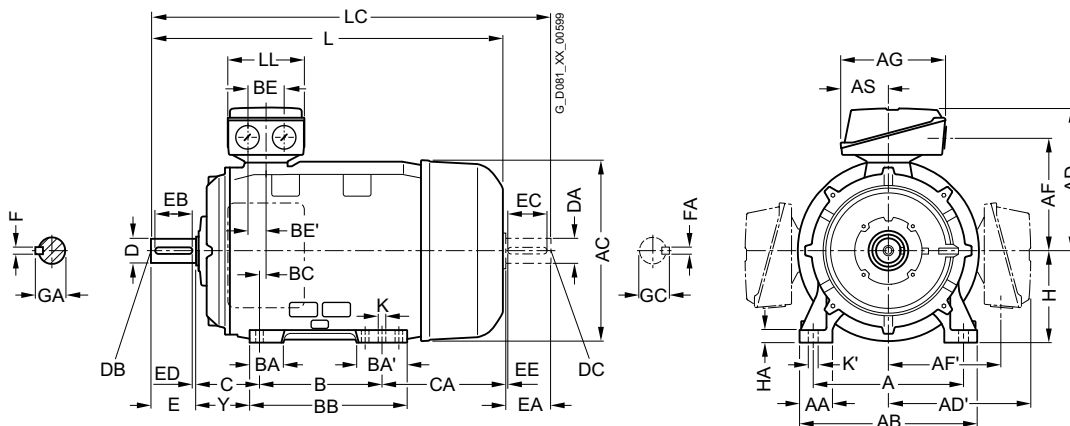

Types of construction IM B5 and IM V1

For flange dimensions, see page 1/48 (Z = the number of retaining holes)

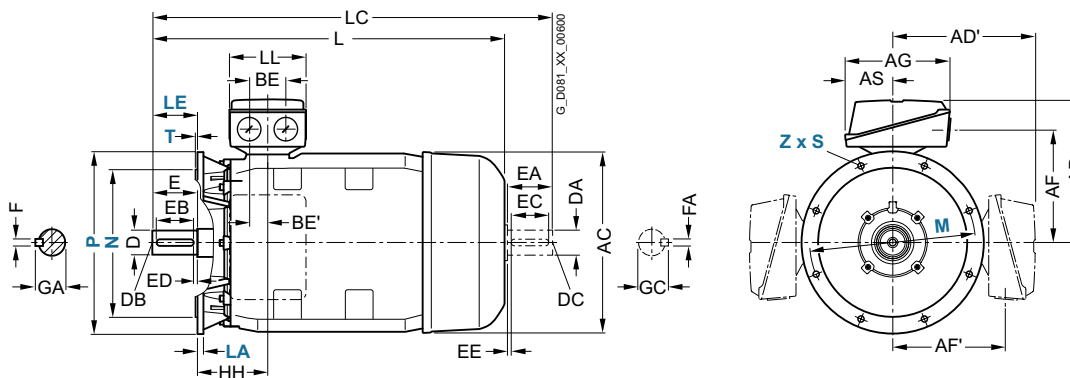

For motor			Dimension designation acc. to IEC																		
Frame size	Motor type	No. of poles	A	AA	AB	AC	AD	AD'	AF	AF'	AG	AS	B	BA	BA'	BB	BC	BE	BE'	C	CA
180 M	1EA2, 1EB2	2, 4	279	70	349	353	388	388	336	336	190	92	241	100	170	359	184	60	30	121	411
180 L	4EB4, 1EC4, 1ED4	4, 6, 8	279	70	349	353	388	388	336	336	190	92	279	100	170	359	184	60	30	121	373
200 L	All	2, 4, 6, 8	318	80	400	393	447	447	390	390	266	112	305	120	142	425	217	85	42.5	133	411
225 S	2BB0, 2BD0	4, 8	356	90	446	439	467	467	410	410	266	112	286	115	209	438	221	85	42.5	149	494
225 M	2BA2	2	356	90	446	439	467	467	410	410	266	112	311	115	209	438	221	85	42.5	149	469
	2BB2, 2BC2, 2BD2	4, 6, 8																			
250 M	2CA2	2	406	100	505	487	502	502	414	414	319	145	349	123	128	420	188	110	55	168	422
	2CB2, 2CC2, 2CD2	4, 6, 8																			
280 S	2CA0	2	457	110	570	540	524	524	436	436	319	145	368	173	177	520	252	110	55	190	496
	2DB0, 2DC0	4, 6, 8																			
280 M	2DA2	2	457	110	570	540	524	524	436	436	319	145	419	173	177	520	252	110	55	190	445
	2CB2, 2DC2, 2DD2	4, 6, 8																			

6

SIMOTICS XP 1MB1, 1MB5 explosion-protected motors

Dimensions · Cast-iron series SIMOTICS XP

IE3 – 1MB1 with types of protection Ex db, Ex db eb – self-ventilated · Frame sizes 180 M to 280 M

Dimensional drawings

Type of construction IM B35

For flange dimensions, see page 1/48 (Z = the number of retaining holes)

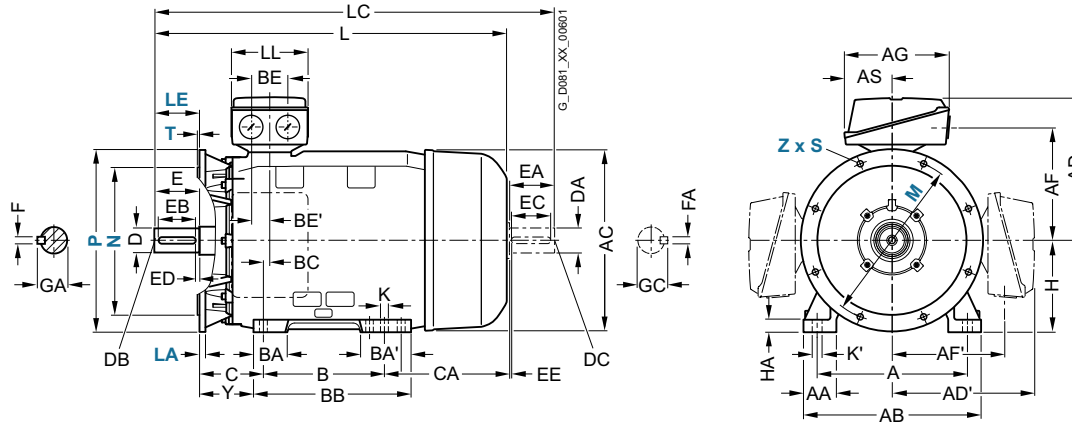

For motor Frame size	Motor type	No. of poles	Dimension designation acc. to IEC							DE shaft extension							NDE shaft extension								
			H	HA	Y	HH	K	K'	L	LC	LL	D	DB	E	EB	ED	F	GA	DA	DC	EA	EC	EE	FA	GC
180 M	1EA2, 1EB2	2, 4	180	19	97	305	14.5	22	838	993	165	48	M16	110	100	5	14	51.5	48	M16	110	100	5	14	51.5
180 L	4EB4, 1EC4, 1ED4	4, 6, 8	180	19	97	305	14.5	22	838	993	165	48	M16	110	100	5	14	51.5	48	M16	110	100	5	14	51.5
200 L	All	2, 4, 6, 8	200	25	101	350	18.5	25	899	1069	197	55	M20	110	100	5	16	59	55	M20	110	100	5	16	59
225 S	2BB0, 2BD0	4, 8	225	25.5	117	370	18.5	25	1004	1179	197	60	M20	140	125	10	18	64	55	M20	110	100	5	16	59
225 M	2BA2	2	225	25.5	117	370	18.5	25	974	1149	197	55	M20	110	100	5	16	59	48	M16	110	100	5	14	51.5
	2BB2, 2BC2, 2BD2	4, 6, 8							1004	1179		60		140	125	10	18	64	55	M20				16	59
250 M	2CA2	2	250	35	133	356	24	40	1014	1189	233	60	M20	140	125	10	18	64	55	M20	110	100	5	16	59
	2CB2, 2CC2, 2CD2	4, 6, 8								1219		65						69	60		140	125	10	18	64
280 S	2CA0	2	280	40	140	442	24	40	1124	1334	233	65	M20	140	125	10	18	69	60	M20	140	125	10	18	64
	2DB0, 2DC0, 2DCC0	4, 6, 8										75					20	79.5	65						69
280 M	2DA2	2	280	40	140	442	24	40	1124	1334	233	65	M20	140	125	10	18	69	60	M20	140	125	10	18	64
	2CB2, 2DC2, 2DD2	4, 6, 8										75					20	79.5	65						69

SIMOTICS XP 1MB1, 1MB5 explosion-protected motors

Dimensions · Cast-iron series SIMOTICS XP

IE3 – 1MB5 with types of protection Ex db, Ex db eb – self-ventilated · Frame sizes 315 S to 355 L

Dimensional drawings

Type of construction IM B3

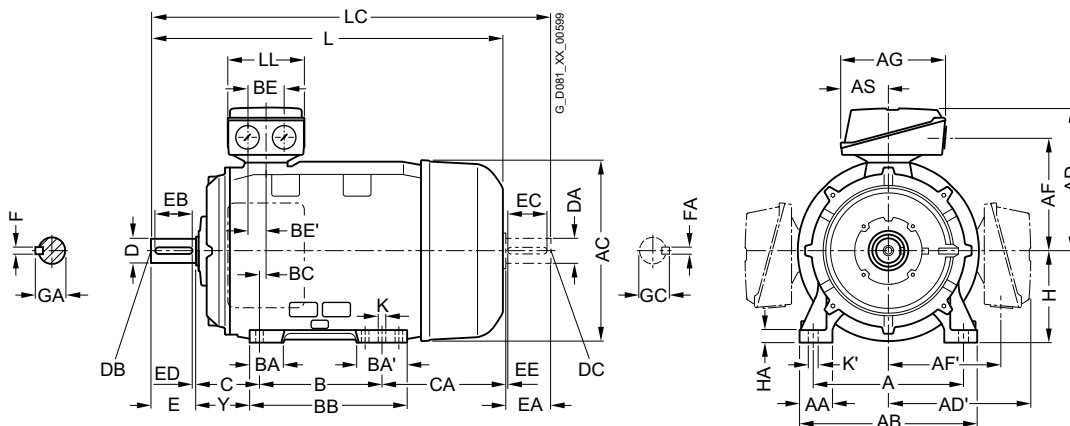

Types of construction IM B5 and IM V1

For flange dimensions, see page 1/48 (Z = the number of retaining holes)

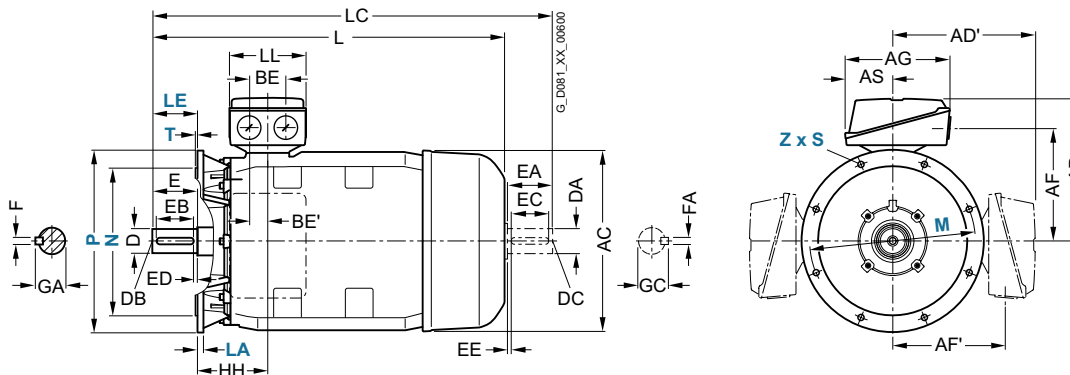

6

For motor			Dimension designation acc. to IEC																		
Frame size	Motor type	No. of poles	A	AA	AB	AC	AD	AD'	AF	AF'	AG	AS	B	BA	BA'	BB	BC	BE	BE'	C	CA
315 S	3AA0	2	508	120	610	668	603	603	509	509	509	167	406	140	196	602	169	120	60	216	497
	3AB0, 3AC0, 3AD0	4, 6, 8																			
315 M	3AA2	2	508	120	610	668	603	603	509	509	509	167	457	140	286	692	169	120	60	216	536
	3AB2	4													286	692					536
	3AC2, 3AD2	6, 8													196	602					446
315 L	3AA4	2	508	120	610	668	603	603	509	509	509	167	508	140	286	692	169	120	60	216	485
	3AA5														305	762					555
	3AA6														334	842	254				635
	3AB4, 3AC4, 3AD5, 3AD6	4, 6, 8													286	692	169				485
	3AB5, 3AC5, 3AC6	4, 6													305	762	169				555
	3AB6, 3AC7, 3AD7	4, 6, 8													334	842	254				635
	3AD4	8											457		196	602	169				446
355 S	3BD0	8	508	120	610	668	603	603	509	509	509	167	457	140	196	602	169	120	60	216	446
	3BD1																				
355 M	3BD2	8	508	120	610	668	603	603	509	509	509	167	457	140	196	602	169	120	60	216	446
355 L	3BA2	2	610	150	780	736	710	710	590	590	570	175	630	187	350	893	230	120	60	254	535
	3BA3														365	968					610
	3BA4, 3BA5														191	401	1078				720
	3BB2, 3BB3	4													187	350	893				535
	3BB4, 3BC1	4, 6													365	968					
	3BB5, 3BC2, 3BC3, 3BC4	4, 6, 8													191	401	1078				

SIMOTICS XP 1MB1, 1MB5 explosion-protected motors

Dimensions · Cast-iron series SIMOTICS XP

IE3 – 1MB5 with types of protection Ex db, Ex db eb – self-ventilated · Frame sizes 315 S to 355 L

Dimensional drawings

Type of construction IM B35

For flange dimensions, see page 1/48 (Z = the number of retaining holes)

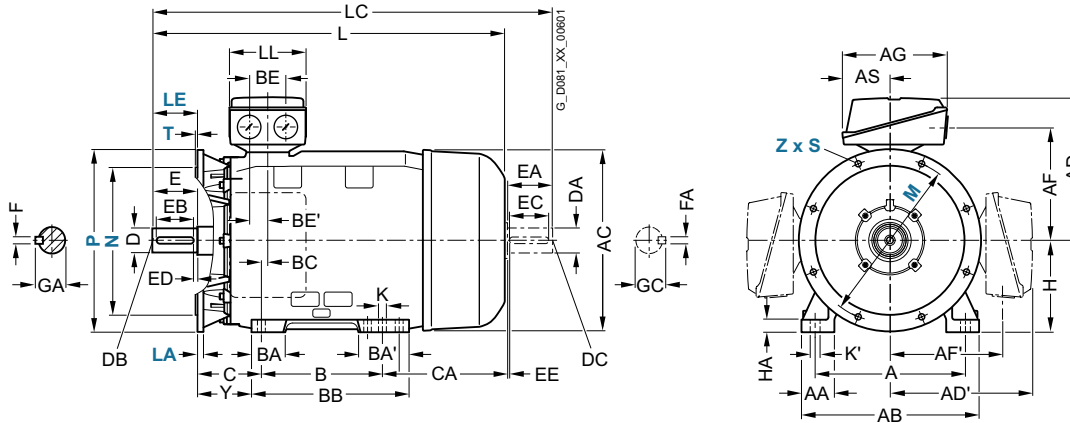

For motor		No. of poles	Dimension designation acc. to IEC							DE shaft extension					NDE shaft extension											
Frame size	Motor type		H	HA	Y	HH	K	K'	L	LC	LL	D	DB	E	EB	ED	F	GA	DA	DC	EA	EC	EE	FA	GC	
315 S	3AA0	2	315	50	146	385	28	28	1189	1399	327	65	M20	140	125	10	18	69	60	M20	140	125	10	18	64	
	3AB0, 3AC0, 3AD0	4, 6, 8							1219	1429		80	M20	170	140	25	22	85	70						20	74.5
315 M	3AA2	2	315	50	146	385	28	28	1279	1489	327	65	M20	140	125	10	18	69	60	M20	140	125	10	18	64	
	3AB2	4							1309	1519		80		170	140	25	22	85	70						20	74.5
	3AC2, 3AD2	6, 8							1219	1429																
315 L	3AA4	2	315	50	146	385	28	28	1279	1489	327	65	M20	140	125	10	18	69	60	M20	140	125	10	18	64	
	3AA5								1349	1559																
	3AA6						470		1429	1639																
	3AB4, 3AC4, 3AD5, 3AD6	4, 6, 8					385		1309	1519		80		170	140	25	22	85	70						20	74.5
	3AB5, 3AC5, 3AC6	4, 6					385		1379	1589																
	3AB6, 3AC7, 3AD7	4, 6, 8					470		1459	1669																
	3AD4	8					385		1219	1429																
355 S	3BD0	8	355	50	146	385	28	28	1584	1834	497	95	M24	170	140	25	25	100	80	M20	170	140	25	22	85	
	3BD1								1694	1944																
355 M	3BD2	8	355	50	146	385	28	28	1694	1944	497	95	M24	170	140	25	25	100	80	M20	170	140	25	22	85	
355 L	3BA2	2	355	50	139	385	35	35	1479	1699	497	75	M20	140	125	10	20	79.5	60	M20	140	125	10	18	64	
	3BA3								1554	1774																
	3BA4, 3BA5								1664	1884																
	3BB2, 3BB3	4							1509	1759		95	M24	170	140	25	25	100	80	M20	170	125	25	22	85	
	3BB4, 3BC1	4, 6							1584	1834																
	3BB5, 3BC2, 3BC3, 3BC4	4, 6, 8							1694	1944																

SIMOTICS XP 1MB1, 1MB5 explosion-protected motors

Dimensions · Cast-iron series SIMOTICS XP

IE2 – 1MB1 with types of protection Ex tb, Ex tc, Ex ec – self-ventilated · Frame sizes 71 M to 160 L

Dimensional drawings

Type of construction IM B3

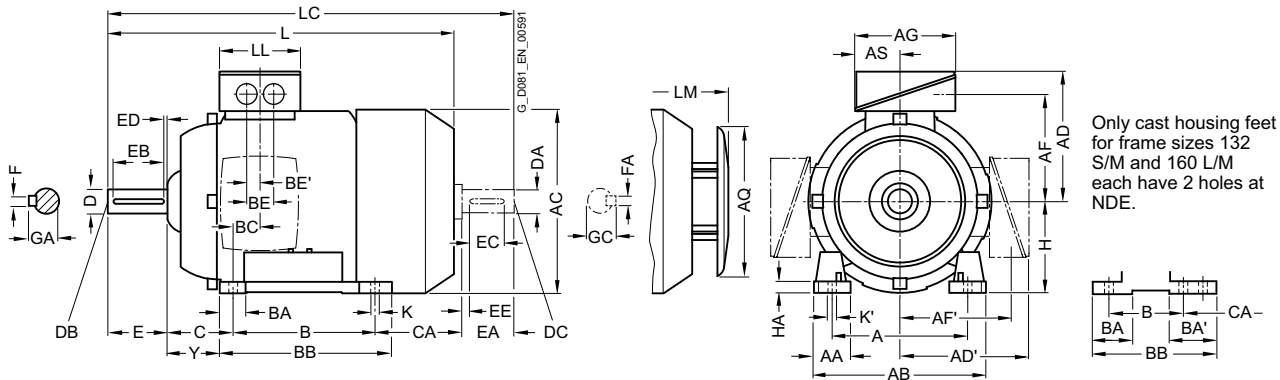

Types of construction IM B5 and IM V1

For flange dimensions, see page 1/48 (Z = the number of retaining holes)

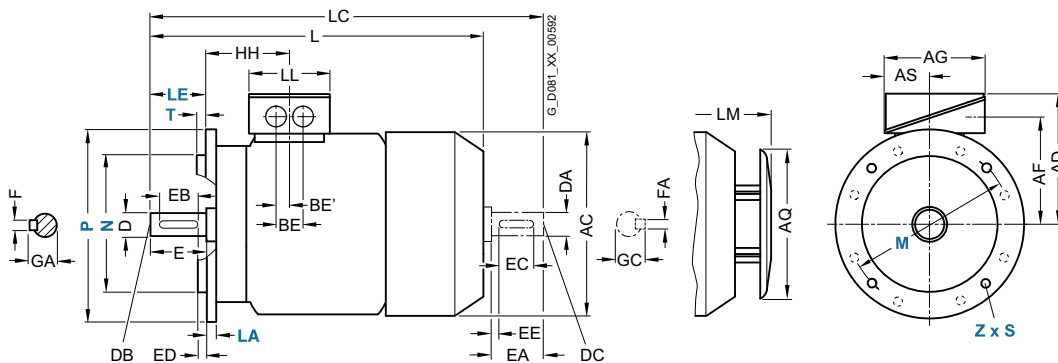

Frame size	Motor type	No. of poles	Dimension designation acc. to IEC																					
			A	AA	AB	AC	AD	AD'	AF	AF'	AG	AS	B	BA	BA'	BB	BC	BE	BE'	C	CA	H	HA	Y
71 M	OCA2, OCB2, OCC2, OCD2	2, 4, 6, 8	112	30.5	132	145	149	149	112	112	126	62	90	32	32	106	21	36	18	45	83	71	7	37
	OCA3, OCB3, OCC3, OCD3																							
80 M	ODA2, ODB2, ODC2, ODD2	2, 4, 6, 8	125	30.5	150	162	159	159	122	122	126	62	100	32	32	118	22.5	36	18	50	112.5	80	8	41
	ODA3, ODB3, ODC3, ODD3																							
90 S	All	2, 4, 6, 8	140	30.5	165	180	164	164	127	127	126	62	100	33	54	143	24.5	36	18	56	149	90	10	47
90 L	All	2, 4, 6, 8	140	30.5	165	180	164	164	127	127	126	62	125	33	54	143	24.5	36	18	56	124	90	10	47
100 L	All	2, 4, 6, 8	160	42	196	198	193	193	147	147	163	80.5	140	40	40	176	37.5	48	24	63	141	100	12	45
112 M	1BA2, 1BB2, 1BC2	2, 4, 6	190	46	226	222	195	195	150	150	163	80.5	140	40	40	176	30	48	24	70	129.7	112	12	52
	1BD2																							
132 S	All	2, 4, 6, 8	216	53	256	262	214.5	214.5	169	169	163	80.5	140	44	81 ¹⁾	218 ³⁾	26.5	48	24	89	167	132	15	69
132 M	All	2, 4, 6, 8	216	53	256	262	214.5	214.5	169	169	163	80.5	178	44	81 ¹⁾	218	26.5	48	24	89	129	132	15	69
160 M	All	2, 4, 6, 8	254	60	300	314	265	265	213	213	190	92	210	51	95 ²⁾	300 ⁴⁾	37	60	30	108	192	160	18	85
160 L	All	2, 4, 6, 8	254	60	300	314	265	265	213	213	190	92	254	51	95 ²⁾	300	37	60	30	108	148	160	18	85

1) With screwed-on feet, dimension BA' is 43 mm.
 2) With screwed-on feet, dimension BA' is 51 mm.
 3) With screwed-on feet, dimension BB is 180 mm.

4) With screwed-on feet, dimension BB is 256 mm.

SIMOTICS XP 1MB1, 1MB5 explosion-protected motors

Dimensions · Cast-iron series SIMOTICS XP

IE2 – 1MB1 with types of protection Ex tb, Ex tc, Ex ec – self-ventilated · Frame sizes 71 M to 160 L

Dimensional drawings

Type of construction IM B35

For flange dimensions, see page 1/48 (Z = the number of retaining holes)

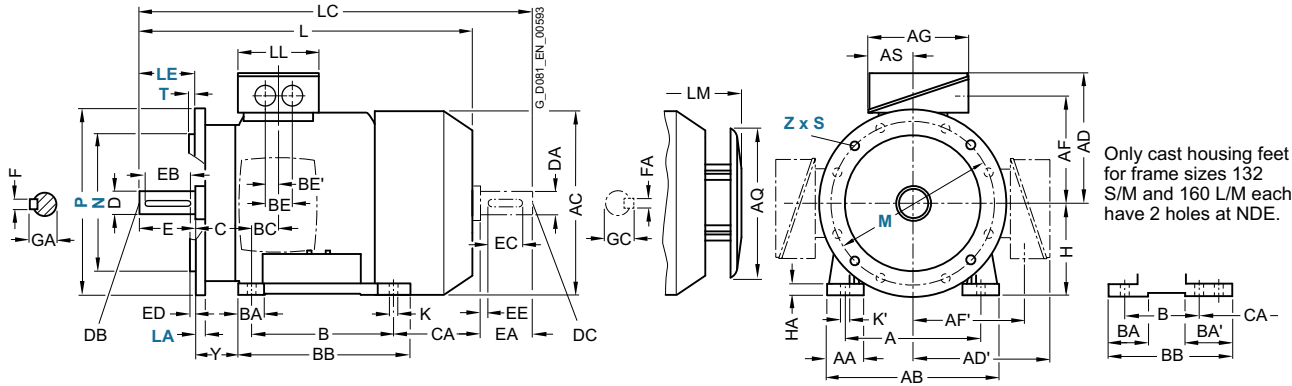

Type of construction IM B14

For flange dimensions, see page 1/48 (Z = the number of retaining holes)

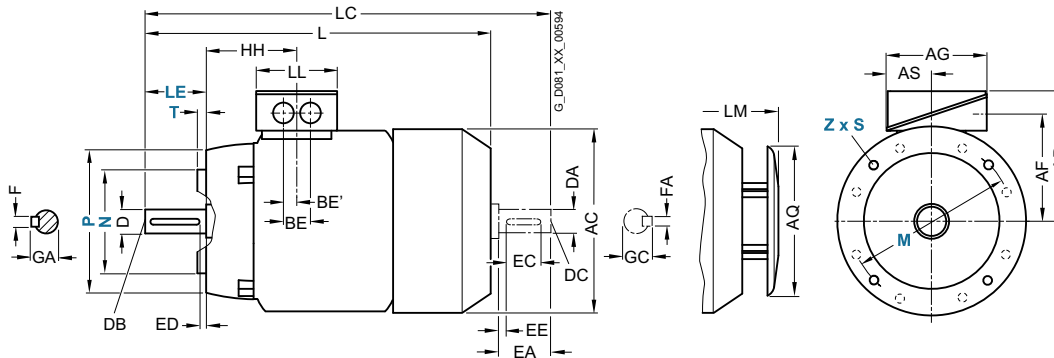

Frame size	Motor type	No. of poles	Dimension designation acc. to IEC				DE shaft extension					NDE shaft extension										
			HH	K	K'	L	LC	LL	D	DB	E	EB	ED	F	GA	DA	DC	EA	EC	EE	FA	GC
71 M	0CA2, 0CB2, 0CC2, 0CD2	2, 4, 6, 8	63	7	7	240	278	102	14	M5	30	22	4	5	16	14	M5	30	22	4	5	16
	0CA3, 0CB3, 0CC3, 0CD3		70			280	318															
80 M	0DA2, 0DB2, 0DC2, 0DD2	2, 4, 6, 8	72.5	10	13.5	292	342.5	102	19	M6	40	32	4	6	21.5	19	M6	40	32	4	6	21.5
	0DA3, 0DB3, 0DC3, 0DD3					327	377.5															
90 S	All	2, 4, 6, 8	80.5	10	10	347	405	102	24	M8	50	40	5	8	27	24	M8	50	40	5	8	27
90 L	All	2, 4, 6, 8	80.5	10	10	387	445	102	24	M8	50	40	5	8	27	24	M8	50	40	5	8	27
100 L	All	2, 4, 6, 8	100.5	12	16	390.5	454	134	28	M10	60	50	5	8	31	24	M8	50	40	5	8	27
112 M	1BA2, 1BB2, 1BC2	2, 4, 6	100.5	12	16	390.5	450	134	28	M10	60	50	5	8	31	24	M8	50	40	5	8	27
	1BD2	8				408.5	475															
132 S	All	2, 4, 6, 8	115.5	12	16	458	536	134	38	M12	80	70	5	10	41	28	M10	60	50	5	8	31
132 M	All	2, 4, 6, 8	115.5	12	16	458	536	134	38	M12	80	70	5	10	41	28	M10	60	50	5	8	31
160 M	All	2, 4, 6, 8	145	15	19	596	730	165	42	M16	110	90	10	12	45	42	M16	110	90	10	12	45
160 L	All	2, 4, 6, 8	145	15	19	596	730	165	42	M16	110	90	10	12	45	42	M16	110	90	10	12	45

SIMOTICS XP 1MB1, 1MB5 explosion-protected motors

Dimensions · Cast-iron series SIMOTICS XP

IE2 – 1MB1 with types of protection Ex tb, Ex tc, Ex ec – self-ventilated · Frame sizes 180 M to 250 M

Dimensional drawings

Type of construction IM B3

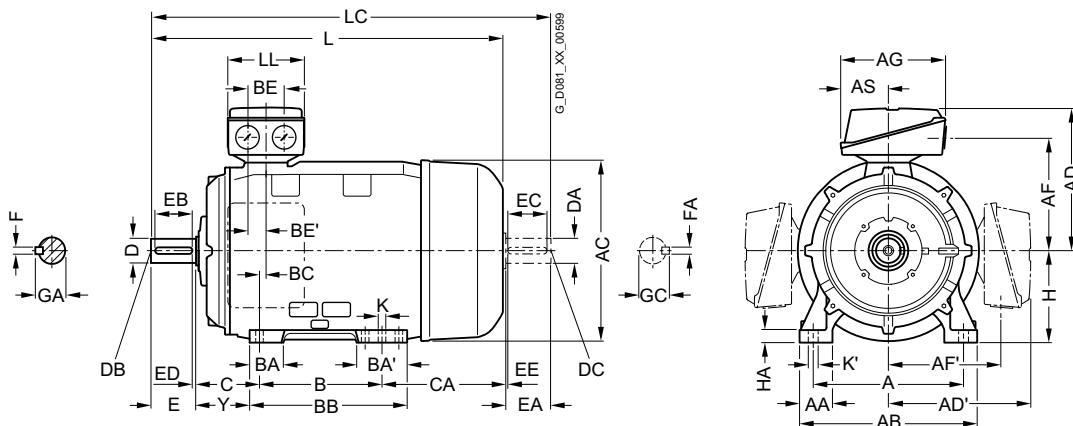

Types of construction IM B5 and IM V1

For flange dimensions, see page 1/48 (Z = the number of retaining holes)

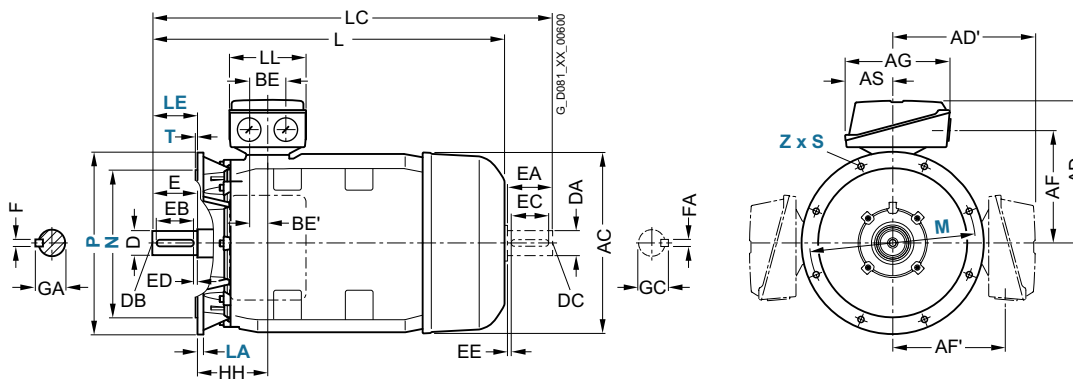

6

For motor			Dimension designation acc. to IEC																			
Frame size	Motor type	No. of poles	A	AA	AB	AC	AD	AD'	AF	AF'	AG	AH	AS	B	BA	BA'	BB	BC	BE	BE'	C	CA
180 M/ 180 L	1EA2, 1EB24 1EC4, 1ED4 1EB4	2, 4 6, 8 4	279	65	339	356	286	286	234	234	190	468	92	241	85	120	328	34	60	30	121	202
200 L	All	2, 4, 6, 8	318	60	378	396	315	315	259	259	266	533	112	305	104	104	355	31	85	42.5	133	177
225 S/ 225 M	2BB0, 2BD0, 2BB2, 2BC2, 2BD2 2BA2	4, 8 4, 6, 8 2	356	80	436	449	338	338	282	282	266	556	112	311	92	117	361	15	85	42.5	149	253
250 M	2CA2 2CB2, 2CC2, 2CD2	2 4, 6, 8	406	100	490	497	410	410	322	322	319	620	145	349	102	102	409	24	110	55	168	230

SIMOTICS XP 1MB1, 1MB5 explosion-protected motors

Dimensions · Cast-iron series SIMOTICS XP

IE2 – 1MB1 with types of protection Ex tb, Ex tc, Ex ec – self-ventilated · Frame sizes 180 M to 250 M

Dimensional drawings

Type of construction IM B35

For flange dimensions, see page 1/48 (Z = the number of retaining holes)

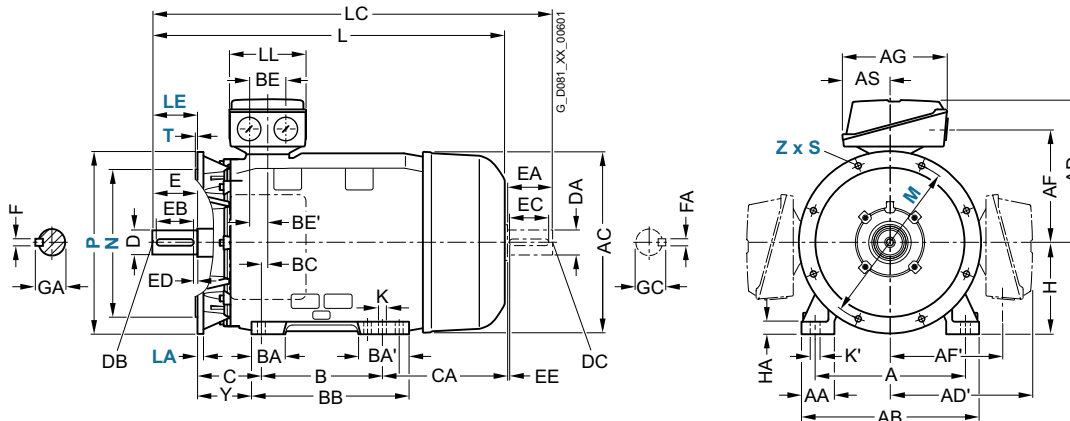

For motor		No. of poles	Dimension designation acc. to IEC										DE shaft extension					NDE shaft extension							
Frame size	Motor type 1MB15.1-, 1MB16.1-		H	HA	Y	HH	K	K'	L	LC	LL	D	DB	E	EB	ED	F	GA	DA	DC	EA	EC	EE	FA	GC
180 M/ 180 L	1EA2, 1EB2	2, 4	180	20	95	155	15	19	668	784	165	48	M16	110	100	5	14	52	48	M16	110	100	5	14	51.5
	1EC4, 1ED4	6, 8																							
	1EB4	4							698	814															
200 L	All	2, 4, 6, 8	200	25	108	164	19	25	721	835	197	55	M20	110	100	5	16	59	55	M20	110	100	5	16	59
225 S/ 225 M	2BB0, 2BD0,	4, 8	225	34	124	164	19	25	788	903	197	60	M20	140	125	10	18	64	55	M20	110	100	5	16	59
	2BB2, 2BC2, 2BD2	4, 6, 8							848	963															
	2BA2	2							818	933	55		110	100	5	16	59	48	M16				14	51.5	
250 M	2CA2	2	250	40	138	192	24	30	887	1002	233	60	M20	140	125	10	18	64	55	M20	110	100	5	16	59
	2CB2, 2CC2, 2CD2	4, 6, 8								1032	65						69	60			140	125	10	18	64



SIMOTICS XP 1MB1, 1MB5 explosion-protected motors

Dimensions · Cast-iron series SIMOTICS XP

IE2 – 1MB1 with types of protection Ex tb, Ex tc, Ex ec – self-ventilated · Frame sizes 280 S to 315 L

Dimensional drawings

Type of construction IM B3

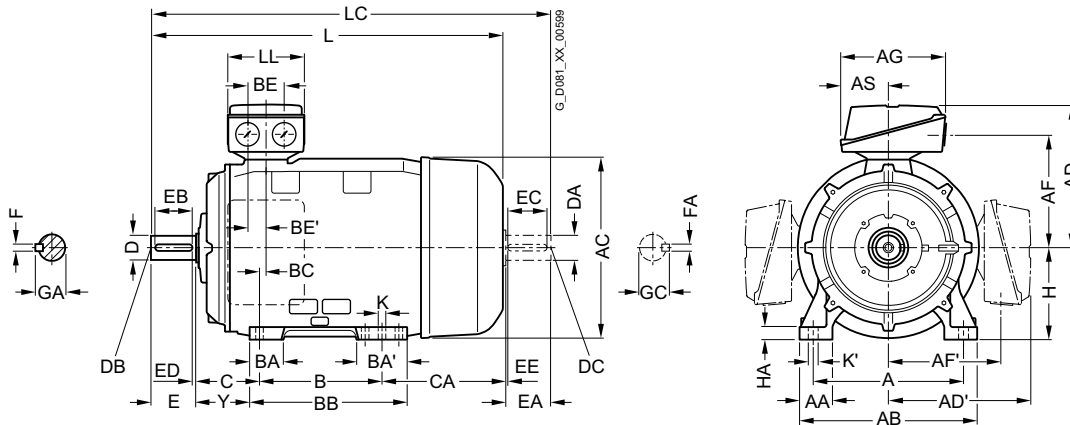

Types of construction IM B5 and IM V1

For flange dimensions, see page 1/48 (Z = the number of retaining holes)

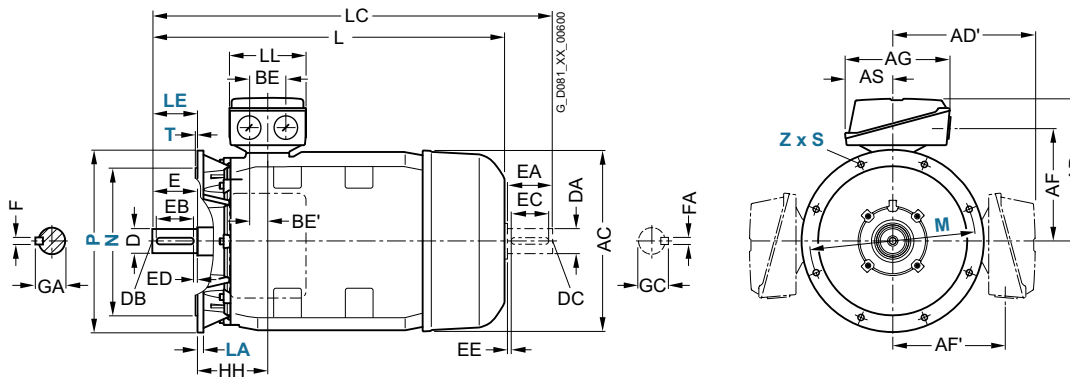

6

For motor			Dimension designation acc. to IEC																				
Frame size	Motor type	No. of poles	A	AA	AB	AC	AD	AD'	AF	AF'	AG	AH	AS	B	BA	BA'	BB	BC	BE	BE'	C	CA	
280 S	1MB15.1-, 1MB16.1-	2	457	100	540	551	433	433	345	345	319	672	145	368	101	152	479	20	110	55	190	267	
	2DB0, 2DC0, 2DD0	4, 6, 8																					
280 M	2DA2	2	457	100	540	551	433	433	345	345	319	672	145	419	101	152	479	20	110	55	190	216	
	2DB2, 2DC2, 2DD2	4, 6, 8																					
315 S	3AA0	2	508	120	610	616	515	515	404	404	374	780	164	406	113	170	527	22	110	55	216	295	
	3AB0, 3AC0, 3AD0	4, 6, 8																					
315 M	3AA2	2	508	120	610	616	515	515	404	404	374	780	164	457	113	170	578	22	110	55	216	409	
	3AB2	4																					
	3AC2, 3AD2	6, 8															327					244	
315 L	3AA4	2	508	120	610	616	515	515	404	404	374	780	164	508	113	170	578	22	110	55	216	358	
	3AB4, 3AC4, 3AD4, 3AC5, 3AD5, 3AD6	4, 6, 8																					
	3AA5	2															176	227	648				513
	3AB5 ¹⁾ , 3AC6 ¹⁾	4, 6																					

¹⁾ When ordering a terminal box positioned on the left-hand side or right-hand side, the feet are screwed on as standard. These screwed-on feet have 3 drill holes on the NDE with the respective dimension B 406, 457 and 508 mm; the dimension BB is 666 mm.

SIMOTICS XP 1MB1, 1MB5 explosion-protected motors

Dimensions · Cast-iron series SIMOTICS XP

IE2 – 1MB1 with types of protection Ex tb, Ex tc, Ex ec – self-ventilated · Frame sizes 280 S to 315 L

Dimensional drawings

Type of construction IM B35

For flange dimensions, see page 1/48 (Z = the number of retaining holes)

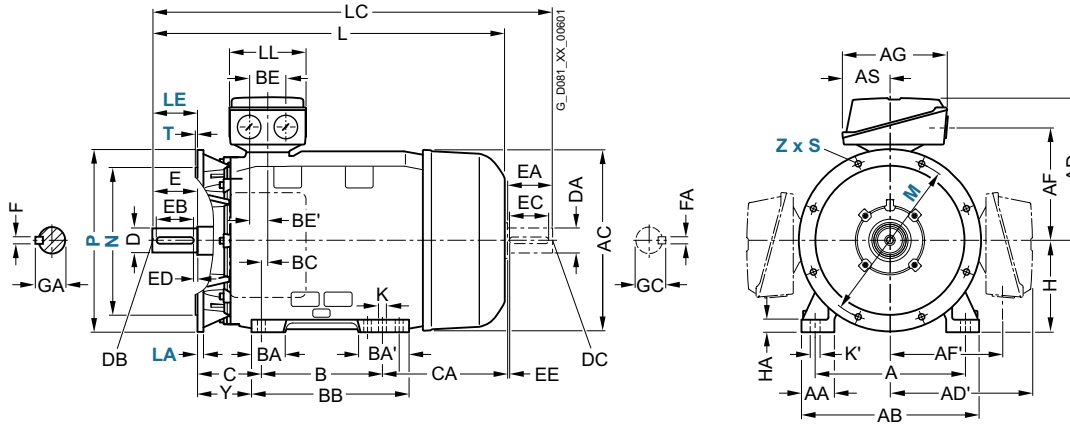

For motor		No. of poles	Dimension designation acc. to IEC										DE shaft extension					NDE shaft extension							
Frame size	Motor type		H	HA	Y	HH	K	K'	L	LC	LL	D	DB	E	EB	ED	F	GA	DA	DC	EA	EC	EE	FA	GC
280 S	2DA0	2	280	40	160	210	24	30	960	1105	233	65	M20	140	125	10	18	69	60	M20	140	125	10	18	64
	2DB0, 2DC0, 2DD0	4, 6, 8										75					20	79.5	65						69
280 M	2DA2	2	280	40	160	210	24	30	960	1105	233	65	M20	140	125	10	18	69	60	M20	140	125	10	18	64
	2DB2, 2DC2, 2DD2	4, 6, 8										75					20	79.5	65						69
315 S	3AA0	2	315	50	181	238	28	35	1052	1197	299	65	M20	140	125	10	18	69	60	M20	140	125	10	18	64
	3AB0, 3AC0, 3AD0	4, 6, 8							1082	1227		80		170	140	25	22	85	70						20 74.5
315 M	3AA2	2	315	50	181	238	28	35	1217	1362	299	65	M20	140	125	10	18	69	60	M20	140	125	10	18	64
	3AB2	4							1247	1392		80		170	140	25	22	85	70						20 74.5
	3AC2, 3AD2	6, 8							1082	1227															
315 L	3AA4	2	315	50	181	238	28	35	1217	1362	299	65	M20	140	125	10	18	69	60	M20	140	125	10	18	64
	3AB4, 3AC4, 3AD4, 3AC5, 3AD5, 3AD6	4, 6, 8							1247	1392		80		170	140	25	22	85	70						20 74.5
	3AA5	2			146				1372	1517		65		140	125	10	18	69	60						18 64
	3AB5, 3AC6	4, 6							1402	1547		80		170	140	25	22	85	70						20 74.5

SIMOTICS XP 1MB1, 1MB5 explosion-protected motors

Dimensions · Cast-iron series SIMOTICS XP

Notes

SIMOTICS DP application-specific motors

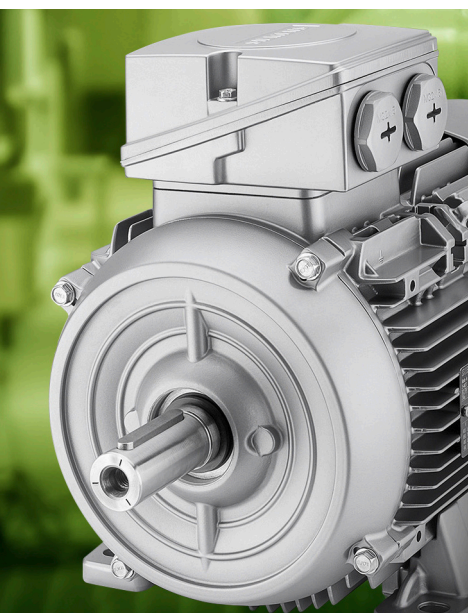

7/2	Introduction
7/3	Marine motors
7/3	Orientation
7/9	Special versions
7/9	<u>Options</u>
7/9	• Aluminum series 1LE10
7/10	• Cast-iron series 1LE15/1LE16 Basic/Performance Line
7/11	• Cast-iron series 1LE55/1LE56 Basic/Performance Line
7/12	• Aluminum series 1MB10, Cast-iron series 1MB15/1MB16/1MB55

SIMOTICS DP application-specific motors

Introduction

Overview

With the designation SIMOTICS DP, Siemens offers a number of industry and application specific (**D**efinite **P**urpose) motors that differ from standard motors in that they have special industry/application-specific features:

SIMOTICS DP marine motors

Marine motors are exposed to air humidity and other hostile conditions on the high seas and must always perform their function reliably. Our marine motors meet the standards of the leading classification companies (DNV GL, BV, LR, RS, KR, ABS, RINA) and have type test certifications up to frame size 315 L. They are basically suitable for the higher ambient temperatures in engine rooms below deck. If requested, a representative of the marine classification society can be present in our factories to formally accept equipment.

You will find more information on marine motors on the following pages.

SIMOTICS DP steel plant motors

The steel plant motors are specially designed for applications in the steel industry with stringent requirements for vibrations and shocks according to class 3M4 (EN 60721-3-3). They provide an optimized technical and economic solution for numerous transportation tasks in the steel manufacturing process or in steel manufacturing facilities, in which no scale dust occurs. Steel plant motors can be operated at a constant speed directly on the line or are used together with the SINAMICS S120 converter for dynamic processes.

The ordering data for SIMOTICS DP steel plant motors can be found in the Catalog Add On D 81.1 AO – Motors for the steel industry.

SIMOTICS DP roller table and steel plant motors

SIMOTICS DP roller table and steel plant motors are designed for directly driving the rollers of working roller tables in reversing rolling mills. They are designed as completely enclosed three-phase induction motors, with a housing made of spheroidal graphite cast iron, ring ribs, and reinforced bearing shields. This makes the motors ideal for use with typical shocks and vibrations and severe dirt due to scale dust. On account of their special mechanical design, they meet the most stringent requirements demanded by this application. Of course, the motors are also designed for variable-speed reversing operation on frequency converters of the SINAMICS S and G series.

The ordering data for SIMOTICS DP roller table and steel plant motors can be found in the Catalog ME81 – Motors for the steel industry.

SIMOTICS DP crane motors

Like marine motors, crane motors are exposed to extreme climatic conditions and must meet tough operating requirements. Our crane motors stand up to high humidity levels, salt-laden air, and high wind speeds. They are characterized by high overload capability and a large speed setting range, for example, to operate hoist mechanisms efficiently in converter operation. SIMOTICS DP crane motors are reliably protected against corrosion with especially elaborate paint finishes and sealing. The rugged cast-iron motors are especially suitable for tough operation under hostile conditions, for indoor and outdoor use, e.g. in harbor facilities for rubber-tired gantry, rail-mounted gantry, and automatic stacking cranes. Special pulse encoders and brakes round off the product to form a perfectly adapted solution.

You can obtain further information on the SIMOTICS DP crane motors from your Siemens contact and found in the catalog CR81.

SIMOTICS DP application-specific motors – Marine motors

Orientation

Overview



Low-voltage motors in the marine version can be used below deck on ships and in the offshore industry. The thermal utilization of the motors is adapted to the generally higher ambient temperatures onboard ships. If the application demands compliance with additional regulations, such as explosion protection (Directive 2014/34/EU (ATEX 95)), the appropriate motor series must be chosen.

The motors on board ships are generally subdivided into three classes of importance by the marine classification societies in cooperation with customers, depending on the field of application:

- **Essential Service for Propulsion** or also referred to as Primary Essential Service
- **Essential Service** or also referred to as Secondary Essential Service or Important Service
- **Non-Essential Service** or also referred to as Non-Important Service

The class of importance must be specified by the customer (ordering party). Retrospective certification by means of individual acceptance test or construction supervision cannot be issued.

The categories include the following requirements of the classification societies:

	Class of importance		
	Essential Service for Propulsion	Essential Service	Non-Essential Service
Typical applications	Propeller drive, thruster	Thrusters, lateral thrust units, anchor winches, bilge and ballast pumps, fire-fighting pumps	Pumps for service water
Version	In accordance with the regulations set up by the classification society		In accordance with ambient conditions set up by the classification society
Inspection certificate	Inspection certificate 3.2 in accordance with EN 10204	Inspection certificate 3.1 in accordance with EN 10204	None
Individual acceptance by classification society	Necessary if no type test certificate exists or the classification society has defined it based on the application		Not required
Type test	Not a requirement of the classification societies For standard motors up to frame size 355, a type test certificate is supplied. These motors can only be ordered with options E11 to E54 in accordance with the classification society.		
Ordering several identical motors	Differentiation between the first motor and additional ones must be realized when ordering using an order code		No distinction
Rating plate data	Information about ambient conditions of the classification society		
Stamp of the classification society	Stamp on shaft and housing		No stamp

Classification societies

Society	Abbreviation	Location
American Bureau of Shipping	ABS	USA
Bureau Veritas	BV	France
DNV Maritime	DNV	Germany
Korean Register	KR	Korea
Lloyds Register	LR	UK
Registro Italiano Navale	RINA	Italy
Russian Maritime Register of Shipping	RS	Russia

SIMOTICS DP application-specific motors – Marine motors

Orientation

Overview

Type test (type approval)

All 1LE1, 1LE5, 1MB1, 1PC1, 1PC3, 1PC4 motors are manufactured and type tested in accordance with the regulations set up by the following international classification societies:

- ABS (American Bureau of Shipping)



- BV (Bureau Veritas, France)



- DNV Maritime



- KR (Korean Register of Shipping)



- LR (Lloyds Register of Shipping)



- Registro Italiano Navale (RINA)



- Russian Maritime Register of Shipping (RS)



Special versions that differ from the range defined in the catalog are possible on request.

Benefits

The marine motors offer the user a number of advantages and benefits:

- Cast-iron versions can be supplied for corrosive atmospheres especially for high humidity levels and salty air
- Increased corrosion protection using specially designed paint finishes is available
- Certified marine motors can be supplied for use in areas to be protected against explosion (hazardous zones)
- Due to the existing type test, individual acceptance test in power ranges below the power limits defined by the classification societies is not required which means short delivery times
- In depth know-how regarding customer requirements
- Worldwide service network with 24 hour service hotline for motors and converters

Application

Our type tested marine motors are specially designed for use on board ship below deck and for the offshore industry:

- Applications on ships as main and auxiliary drives below deck, e.g.:
 - Fans (air conditioning systems, refrigeration systems)
 - Pumps (for fire-extinguishing water, fuels, oils)

- Winches (anchor winches, warping winches, lifting gear)
- Compressors
- Bow thruster drives
- Ex motors for hazardous zones
- Application in the offshore industry
 - Coastal areas, e.g. oil rigs, drilling ships

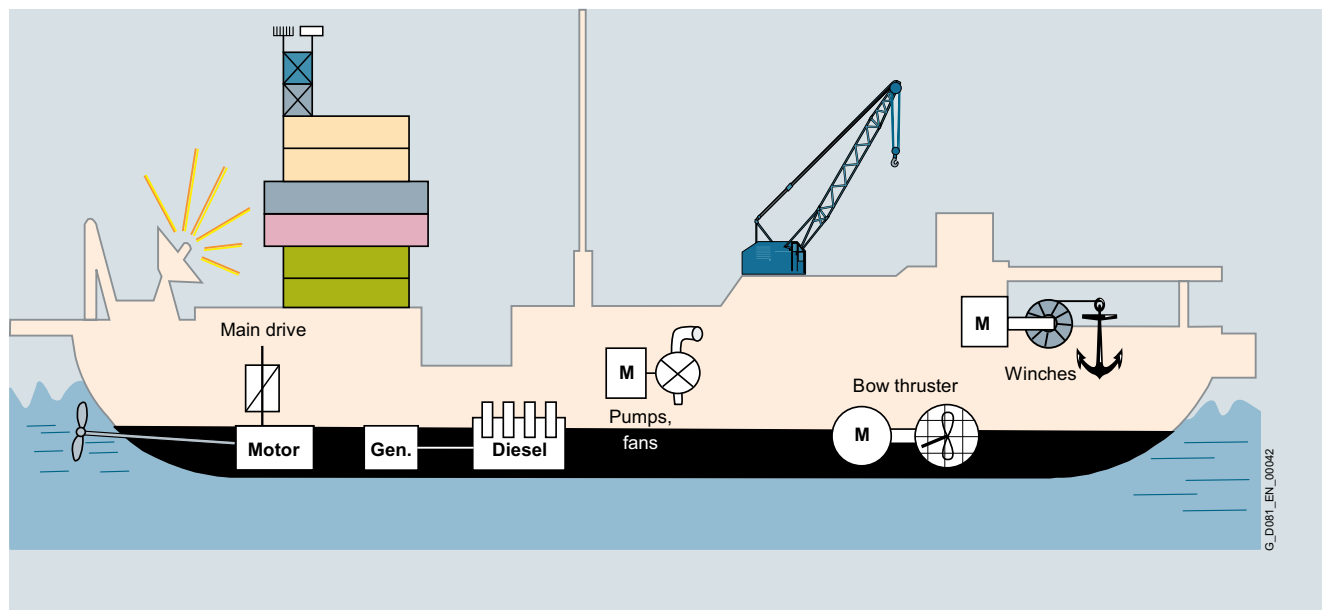

Typical below-deck applications

Technical specifications

Housing design

Motors can be supplied depending on the motor series in a corrosion-resistant aluminum housing or in a rugged low-vibration cast-iron version.

Motor connection

Cable glands are not included in the standard scope of supply with the exception of explosion-protected motors (see "Special versions").

All marine motors generally have an external grounding terminal.

Mountings (rotary pulse encoder, separately driven fan, brake)

Brakes, encoders and separately driven fans from our basic series (1LE, 1MB) are accepted as mountings without a separate certificate from the marine classification societies by the following: LR, RINA, RS, DNV, ABS and KR.

However, BV always demands separate certification for encoders. For this reason, 1LE1, 1MB1, 1PC1 and 1PC3 motors for BV can only be supplied in the "prepared for encoder mounting" condition. In this instance, the customer must bear responsibility for purchasing and installing a suitable encoder. With respect to brakes and separately driven fans, BV will also accept Siemens standard components.

Fan / fan cover

Fans and fan covers are made from the same materials as components from the basic series. BV stipulates that these components must be made of metal, and they are automatically supplied in this material when order code **E31** is specified.

SIMOTICS DP application-specific motors – Marine motors

Orientation

Technical specifications

Specifications of the individual classification societies with order codes (options) for motors in frame sizes 71M - 315 L

Classification society	Coolant temperature CT	Admissible temperature rise limit according to the classification society	Rated power limit for individual acceptance test for essential service drive	Rated power limit for construction supervision for essential service drive	Order codes for surface-cooled motors up to frame size 315 L with type test certificate	
		Temperature class				
		130 (B)	155 (F)			
	°C	K	K	kW	kW	
LR	45	70	95	≥ 100	≥ 100	E21
BV	45	75	100	≥ 100	–	E31
DNV	45	75	100	≥ 300	–	E51
ABS	50	70	95	≥ 100 ¹⁾	–	E52
RINA	45	75	100	≥ 100	–	E41
RS	45	75	95	≥ 20	–	E46
KR	45	75	95	≥ 7.5	–	E54

Type test certificates

The image displays several overlapping technical certificates and approvals for Siemens motors. Key documents include:

- ABS CERTIFICATE OF DESIGN ASSESS**: Issued to Siemens AG - D-97616 BAD NEUSTADT, certifying design plans for asynchronous low-voltage motors.
- Bureau Veritas TYPE APPROVAL CERTIFICATE**: For asynchronous machines (power below 100 kW), issued on 11 Feb 2020.
- Lloyd's Register Type Approval Certificate**: Issued on 14/2003, for asynchronous low-voltage motors with aluminum or cast iron enclosures.
- KR TYPE APPROVAL CERTIFICATE**: Issued on 19th August 2014, for electric motors.
- RINA TYPE APPROVAL CERTIFICATE**: Issued on 11 Feb 2015, for asynchronous low-voltage motors.
- RUSSIAN MARITIME REGISTER OF SHIPPING (RMRS) TYPE APPROVAL CERTIFICATE**: Issued on 13.02.2019, for asynchronous squirrel-cage motors.

¹⁾ Required for all power ranges for ATEX compliance.

SIMOTICS DP application-specific motors – Marine motors

Orientation

Technical specifications

Temperature class and coolant temperature

SIMOTICS GP/SD standard motors and SIMOTICS XP explosion-proof motors up to frame size 355

In general, marine motors are designed for a coolant temperature CT 45 °C in temperature class 155 (F) – used according to 155 (F) – with thermal reserve. When motors are used according to temperature class 130 (B) (order code **N05**), derating is required. For standard motors up to frame size 315 L, the derating is approx. 4 % (for order codes **E52** and **E21** approx. 8 %).

1MB1 motors in Zones 2, 21 and 22 are designed for temperature class 155 (F) – used according to temperature class 130 (B) – with derating of approx. 4 % (with order code **E52** approx. 8 %). Motors with increased power in temperature class 155 (F) – used according to temperature class 155 (F) – are also derated by approx. 4 % (with order code **E52** and **E21** approx. 8 %). If temperature class 155 (F) is to be used according to 130 (B), further derating of approximately 10 % is required.

Coolant temperatures that exceed CT 45 °C require derating in accordance with the following table:

	Coolant temperature CT			
	45 °C	50 °C	55 °C	60 °C
Temperature class 155 (F) used according to 155 (F)				
Derating factor for line operation	1.00	0.96	0.92	0.87
Temperature class 155 (F) used according to 130 (B)				
Derating factor for line operation	0.90	0.86	0.83	0.78

More detailed information is available on request.

Rating plate and inspection certificate

The rating plate indicates the relevant classification society and the associated coolant temperature

V	Hz	A	kW	cosφ	NOM.EFF	1/min	IE-CL
400 Δ	50	275	160	0.87	95.8	1490	IE3
690 Y	50	161	160	0.87	95.8	1490	IE3
460 Δ	60	275	184	0.88	96.2	1788	IE3
460 Δ	60	240	160	0.87	96.2	1791	IE3

Rating plate for a marine motor according to DNV

Degree of protection

The protection classes applicable here are specified in the catalog sections for basic series 1LE1/1LE5/1MB1/1MB5/1PC1. With IP56, icing must be avoided.

Winding and motor protection

For monitoring the winding and bearings, the motors can be equipped with PTC thermistors, temperature sensors and resistance thermometers. Anti-condensation heaters can also be fitted to the marine motors to prevent condensation building up on the winding.

Paint finish

The standard paint finish is suitable for indoor installations or outdoor installations which are roof-protected against weathering.

When installing the standard motors in sea air or in rooms with permanent moisture, the special paint finish climate group "worldwide" according to IEC 60721-2-1 is appropriate, because this ensures a higher degree of corrosion protection. Most marine motors are finished in this special paint finish as standard (see "Special versions").

With particularly corrosive atmospheres, the sea-air-resistant special paint finish C4 (order code **S03**) or the offshore special paint finish C5 (order code **S04**) is recommended.

Special paint colors with the order codes **Y53** and **Y56** and increased film thicknesses are available on request.

Converter operation

The standard insulation of the motors is designed such that converter operation is permissible at line voltages up to $U_{\text{rated}} \leq 500$ V. The following limit values (voltage values are peak values) must be maintained: $U_{\text{phase-to-phase}} \leq 1500$ V, $U_{\text{phase-to-ground}} \leq 1100$ V, voltage rise times of $t_s > 0.1$ μs. Operation of motors at higher voltage peaks (e.g. on converters with controlled input, e.g. AFE, ALM) requires motors with higher insulation resistance. Please inquire in this case.

During installation, the EMC guidelines must be complied with. This does not apply to motors in type of protection Ex eb according to IEC/EN 60079-2 that are certified only for line operation.

It is important to note the extent to which the converter used must also be acceptance tested by the marine classification authority.

SIMOTICS DP application-specific motors – Marine motors

Orientation

Technical specifications

Recommended special versions

- Motor protection with 1 or 3 PTC thermistors – for tripping (2 terminals) – 15th position of the Article No. **B**
- Installation of Pt100 resistance thermometers for winding temperature monitoring – 16th position of the Article No. **"H"**
- Especially for the motor series 1LE5:
Installation of 2 Pt100 resistance thermometers in basic circuit for rolling-contact bearings – order code **Q72**
- Anti-condensation heating for 230 V – order code **Q02**
- Anti-condensation heating for 115 V – order code **Q03**
- IP56 degree of protection for protection against harmful dust deposits, protection against water jets from any direction – order code **H22**
- IP65 degree of protection for complete protection against dust deposits, protection against water jets from any direction – order code **H20**
- Special bearing for drive-end (DE) and non-drive-end (NDE), bearing size 63 – order code **L25**, for non-standard motors on request
- Metal external fan for self-ventilated motors – order codes **F74** and **F76** (standard with order code **E31**)

Additional notes

Order information

The fees levied by the classification societies for individual acceptance testing are included in order code **B10** for motor types 1LE1, 1LE5, 1PC5, 1MB1, 1PC1 and 1PC3.

When ordering, add the supplement **-Z** to the Article No. and state details in plain text if required.

For information about other special versions, refer to the appropriate sections under "SIMOTICS GP/SD 1LE1/1PC1 standard motors" and "SIMOTICS XP 1MB1 explosion-protected motors".

In addition to this, for marine motors, the following special versions are the "Standard version" and therefore included in the order codes for the basic marine version.

Standard version:

Designation	Order code
Inspection certificate 3.1 in accordance with EN 10204	B02
Note: The delivery time for the manufacturer's test certificate may differ from the delivery time for the motor.	
External grounding terminal	H04

Ordering example

Selection criteria	Requirement	Structure of the Article No.
Motor type	SIMOTICS SD Basic Line, efficiency class IE3 Premium Efficiency, IP55 degree of protection, IM B3 type of construction, without winding protection, terminal box at top	1LE1503
No. of poles, speed, rated power	4-pole, 1500 rpm, 55 kW	1LE1503-2CB2
Voltage, frequency	400 VΔ/690 VY, 50 Hz	1LE1503-2CB23-4
Type of construction	IM B3	1LE1503-2CB23-4A
Motor protection	1 or 3 PTC thermistors – for tripping (2 terminals)	1LE1503-2CB23-4AB
Terminal box position	Terminal box right	1LE1503-2CB23-4AB5
Paint finish	Paint finish in "Brilliant blue" RAL 5007	1LE1503-2CB23-4AB5-Z Y53 Plain text: RAL5007
Marine version	Drive for "Essential Services" with type test certificate according to DNV Maritime with coolant temperature CT 45 °C	1LE1503-2CB23-4AB5-Z Y53+E51 Plain text: RAL5007
	Individual acceptance (by marine classification society)	1LE1503-2CB23-4AB5-Z Y53+E51+B10 Plain text: RAL5007
Motor order	Type test with temperature-rise run for horizontal motors, with acceptance	1LE1503-2CB23-4AB5-Z Y53+E51+B10+B83 Plain text: RAL5007

The ordering example is valid for an order quantity of 1 item. For larger order quantities, a type test with heat run (order code **B83**) has only to be ordered for one motor. It is not necessary to specify order code **B83** for any further identical motors (included in the same order). The order must be divided into two order items; see "Example for 5 identical motors".

Example for 5 identical motors

Order item	Quantity in units	Article No.
1	1	1LE1503-2CB23-4AB5-Z Z=Y53+E51+B10+B83 Plain text: RAL 5007
2	4	1LE1503-2CB23-4AB5-Z Z=Y53+E51+B10 Plain text: RAL 5007

SIMOTICS DP application-specific motors – Marine motors

Special versions · Options

Aluminum series 1LE10

Selection and ordering data

Special versions	Additional identification code -Z with order code and plain text if required	Frame size										Motor version		
		63	71	80	90	100	112	132	160	180	200			
						1LE1004							IEC	IE4
				1LE1003										IE3
		1LE1001												IE2
		1LE1002												IE1
				1LE1023									Eagle Line	NPE (NEMA)
				1LE1021										NEE (NEMA)
										1LE1011			Pole-changing	
										1LE1012				
1LE10 -Z		Order code												

Marine version – Basic version

		63	71	80	90	100	112	132	160	180	200		
With type test certificate according to Lloyds Register (LR), CT 45 °C, temperature class 155 (F), utilized according to 155 (F)	E21	✓	✓	✓	✓	✓	✓	✓	✓	✓	✓		
With type test certificate according to Bureau Veritas (BV), CT 45 °C, temperature class 155 (F), utilized according to 155 (F)	E31	✓	✓	✓	✓	✓	✓	✓	✓	✓	✓		
With type test certificate according to Registro Italiano Navale (RINA), CT 45 °C, temperature class 155 (F), utilized according to 155 (F)	E41	✓	✓	✓	✓	✓	✓	✓	✓	✓	✓		
With type test certificate according to Russian Maritime Register (RS), CT 45 °C, temperature class 155 (F), utilized according to 155 (F)	E46	✓	✓	✓	✓	✓	✓	✓	✓	✓	✓		
With type test certificate according to DNV GL Maritime, CT 45 °C, temperature class 155 (F), utilized according to 155 (F)	E51	✓	✓	✓	✓	✓	✓	✓	✓	✓	✓		
With type test certificate according to American Bureau of Shipping (ABS), CT 50 °C, temperature class 155 (F), utilized according to 155 (F)	E52	✓	✓	✓	✓	✓	✓	✓	✓	✓	✓		
With type test certificate according to Korean Register of Shipping (KR), CT 45 °C, temperature class 155 (F), utilized according to 155 (F)	E54	✓	✓	✓	✓	✓	✓	✓	✓	✓	✓		

Marine version – Acceptance/certification

		63	71	80	90	100	112	132	160	180	200		
Individual acceptance by marine classification society	B10	–	–	✓	✓	✓	✓	✓	✓	✓	✓		
Type test with heat run for horizontal motors, with acceptance	B83	–	✓	✓	✓	✓	✓	✓	✓	✓	✓		

- ✓ With additional charge
 – Not possible

SIMOTICS DP application-specific motors – Marine motors

Special versions · Options

Cast-iron series 1LE55/1LE56 Basic/Performance Line

Selection and ordering data

Special versions	Additional identification code -Z with order code and plain text if required	Frame size	Motor version
		315	
		355	
		1LE55.4 Basic Line	IEC IE4
		1LE56.4 Performance Line	
		1LE55.3 Basic Line	IE3
1LE5 -Z	Order code	1LE56.3 Performance Line	

Marine version – Basic version

With type test certificate according to Lloyds Register (LR), CT 45 °C, temperature class 155 (F), utilized according to 155 (F)	E21	✓	✓
With type test certificate according to Registro Italiano Navale (RINA), CT 45 °C, temperature class 155 (F), utilized according to 155 (F)	E41	✓	✓
With type test certificate according to Russian Maritime Register (RS), CT 45 °C, temperature class 155 (F), utilized according to 155 (F)	E46	✓	✓
With type test certificate according to DNV GL Maritime, CT 45 °C, temperature class 155 (F), utilized according to 155 (F)	E51	✓	✓
With type test certificate according to American Bureau of Shipping (ABS), CT 50 °C, temperature class 155 (F), utilized according to 155 (F)	E52	✓	✓

Marine version – Acceptance/certification

Individual acceptance by marine classification society	B10	✓	✓
Type test with heat run for vertical motors, with acceptance	B81	✓	✓
Type test with heat run for horizontal motors, with acceptance	B83	✓	✓

✓ With additional charge

SIMOTICS DP application-specific motors – Marine motors

Special versions · Options

Aluminum series 1MB10, cast-iron series 1MB15/1MB16/1MB55

Selection and ordering data

Special versions	Additional identification code -Z with order code and plain text if required	Frame size													Motor version			
		71	80	90	100	112	132	160	180	200	225	250	280	315	355			
Aluminum series			1MB10.3														IEC	IE3
			1MB10.1															IE2
				1MB10.2														IE1
Cast-iron series			1MB15.3 Basic Line														IE3	
			1MB16.3 Performance Line															
			1MB1553															
			1MB5553															
			1MB15.1 Basic Line														IE2	
1MB-.....-.....-Z	Order code		1MB16.1 Performance Line															
Marine version – Basic version																		
With type test certificate according to Lloyds Register (LR), CT 45 °C, temperature class 155 (F), utilized according to 155 (F)	E21	✓	✓	✓	✓	✓	✓	✓	✓	✓	✓	✓	✓	✓	✓	✓		
With type test certificate according to Bureau Veritas (BV), CT 45 °C, temperature class 155 (F), utilized according to 155 (F)	E31	✓	✓	✓	✓	✓	✓	✓	✓	✓	✓	✓	✓	✓	✓	✓		
With type test certificate according to Registro Italiano Navale (RINA), CT 45 °C, temperature class 155 (F), utilized according to 155 (F)	E41	✓	✓	✓	✓	✓	✓	✓	✓	✓	✓	✓	✓	✓	✓	✓		
With type test certificate according to Russian Maritime Register (RS), CT 45 °C, temperature class 155 (F), utilized according to 155 (F)	E46	✓	✓	✓	✓	✓	✓	✓	✓	✓	✓	✓	✓	✓	✓	✓		
With type test certificate according to DNV GL Maritime, CT 45 °C, temperature class 155 (F), utilized according to 155 (F)	E51	✓	✓	✓	✓	✓	✓	✓	✓	✓	✓	✓	✓	✓	✓	✓		
With type test certificate according to American Bureau of Shipping (ABS), CT 50 °C, temperature class 155 (F), utilized according to 155 (F)	E52	✓	✓	✓	✓	✓	✓	✓	✓	✓	✓	✓	✓	✓	✓	✓		
With type test certificate according to Korean Register of Shipping (KR), CT 45 °C, temperature class 155 (F), utilized according to 155 (F)	E54	✓	✓	✓	✓	✓	✓	✓	✓	✓	✓	✓	✓	✓	✓	✓		
Marine version – Acceptance/certification																		
Individual acceptance by marine classification society	B10	✓	✓	✓	✓	✓	✓	✓	✓	✓	✓	✓	✓	✓	✓	✓		
Type test with heat run for horizontal motors, with acceptance	B83	✓	✓	✓	✓	✓	✓	✓	✓	✓	✓	✓	✓	✓	✓	✓		

✓ With additional charge

Appendix



8/2 8/2	NEMA motors Motors according to NEMA standard
8/5 8/6 8/8	Industry Services Industry Services – Portfolio overview Online Support
8/9 8/9	Partner Partner at Siemens
8/10 8/10 8/11 8/12 8/13	Tools and engineering Drive Technology Configurator selection tool SinaSave energy efficiency tool SIZER for Siemens Drives engineering tool SIPLUS CMS Condition Monitoring Systems for the continuous condition monitoring of motors
8/14	Index of order codes
8/23	Conversion tables
8/25 8/25 8/26 8/27	Metal surcharges • Explanation of the raw material/ metal surcharges • Explanation of the raw material/ metal surcharges for dysprosium and neodym (rare earths) • Values of the metal factor
8/28 8/28 8/28 8/29	Conditions of sale and delivery • 1. General Provisions • 2. Prices • 3. Additional Terms and Conditions • 4. Export Regulations

Appendix

NEMA motors

Motors according to NEMA standard



NEMA motors (National Electrical Manufacturers Association) for the North American market distinguish themselves as a result of their new design – and especially as a result of their efficiency. Siemens offers a complete line of General Purpose motors (aluminum and cast-iron design), Severe Duty motors, IEEE 841 and XP motors with NEMA Premium or higher efficiencies. Energy-saving motors with NEMA Premium efficiency class comply with the US EISA legislation (Energy Independence and Security Act) for minimum efficiencies. Our NEMA Premium + efficiency class exceeds the efficiencies specified in the EISA standards.

The motors are mechanically and electrically compliant with NEMA MG1. In addition to the minimum efficiencies specified in the US, these motors also fulfill the minimum efficiency requirements for Canada (CSA) and Mexico (NOM).

General technical specifications

Voltage and power range	208 ... 230/460 V, 575 V, 60 Hz 1 ... 400 hp (0.75 ... 300 kW)
Frame sizes and types	NEMA frame sizes 140 ... 440
Pole number and frequencies	2, 4, 6 and 8-pole, 60 Hz
Environmental conditions	Surface-cooled with IP54/IP55 degree of protection

Customer benefits

Copper die-cast rotors optimize the efficiency

Copper die-cast rotors reduce the power loss and slightly reduce the motor length. This version reduces the motor life cycle costs as a result of the lower energy consumption.

Can be easily modified for high versatility

Unmounted feet (aluminum housing) or 8-hole foot mounting (cast-iron housing) make it easier to modify the motors, ensure a high degree of versatility and reduce inventory costs – for the OEM as well as for servicing and maintenance.

A design that fulfills each and every requirement

We offer motors suitable for any application in a lightweight aluminum design or with a rugged cast-iron housing. Both variants are available with NEMA Premium or NEMA Premium + efficiency. The perfect fit for any operating period.

Typical applications

NEMA motors are suitable throughout the industrial and commercial field, in the automotive, textile, printing and chemical industries as well as in cross-industry applications – for example in conveyor technology. The HVAC sector (Heating, Ventilating & Air Conditioning), for instance, which requires extremely light motors, provides typical applications for our so-called General Purpose motors – either with cast-iron or aluminum housings. Severe Duty motors in a fully cast-iron design are suitable for use under harsh environmental conditions – for instance in the pulp and paper industry. The Severe Duty SD100 IEEE 841 motor version even exceeds the stringent IEEE 841 standards applicable in the crude oil and chemical industries.

More information

The full range of products with all ordering data and technical information can be found in Catalog
D 81.2, US/Canada www.sea.siemens.com/motors.



General Purpose



GP100A

Power range	1 ... 20 hp (0.75 ... 15 kW)	FS 140 ... 250
Frame size (FS)	140 ... 250	
Degree of protection NEMA MG1	TEFC (totally enclosed fan cooled)	
Housing material	Die-cast aluminum	8-hole foot mounting
Efficiency	NEMA Premium NEMA Premium +	FS 140 ... 250 FS 140 ... 250
Power supply	3-phase, 60 Hz	
Voltage	208 ... 230/460 V 575 V	FS 140 ... 250 FS 140 ... 250
Service factor	1.15	Sinusoidal
Electrical design	NEMA design B	
Hazard classification	Not specified	
Insulation	Class F	NEMA MG1 Part 31
Utilization	Class B at 1.0 SF, Class F at 1.15 SF	Sinusoidal
Terminal box (oversized)	Die-cast aluminum	FS 140 ... 250
Fan cover	Plastic	FS 140 ... 250
Fan	Bi-directional - Polypropylene	
Seal	O-ring	FS 140 ... 250
Rotor material	Die-cast aluminum Die-cast copper	FS 140 ... 250 FS 140 ... 250
Stator winding	Copper – random wound	
Shaft material	High-strength carbon steel	C1045
Shaft seal/ slinger	V-ring slinger meets IP54	(DE only)
Bearing housing	Cast aluminum	FS 140 ... 250
Bearing type	Double-shielded	FS 140 ... 250
Bearing inner cap	No	
Lubrication	Polyurea	Base grease
Oil filling nozzle	Not specified	
Oil drain valve	Not specified	
Vibrations	0.15 IPS	
Rating plate	Aluminum	Engraved
Condensation drainage hole	Condensation drainage holes – lowest point (2)	
Mountings	Rust-resistant	
Lifting eye	Cast	
Paint finish	ALKYED modified	RAL7030
Warranty	18 months	
Converter operation	VT 20:1 CT 4:1 CT 10:1	FS 140 ... 250 FS 140 ... 250 FS 140 ... 250 (Cu)
Catalog	D 81.2, US/Canada	



Motors according to NEMA standard

		Severe Duty			
					
GP100		SD100		SD100 IEE 841	
1 ... 200 hp (0.75 ... 132 kW)	FS 140 ... 440	1 ... 400 hp (0.75 ... 300 kW)	FS 140 ... S440	1 ... 400 hp (0.75 ... 300 kW)	FS 140 ... S440
140 ... 440		140 ... S449		140 ... S449	
TEFC (totally enclosed fan cooled)		TEFC (totally enclosed fan cooled)		TEFC (totally enclosed fan cooled)	
Cast iron	8-hole foot	Cast iron	8-hole foot	Cast iron	8-hole foot
NEMA Premium NEMA Premium +	FS 140 ... 440 FS 140 ... 250	NEMA Premium NEMA Premium +	FS 140 ... S440 FS 140 ... 250	NEMA Premium NEMA Premium +	FS 140 ... S440 FS 140 ... 250
3-phase, 60 Hz		3-phase, 60 Hz		3-phase, 60 Hz	
208 ... 230/460 V 230/460 V 460 V 575 V	FS 140 ... 250 FS 280 ... 360 100 ... 200 hp 1 ... 200 hp	208 ... 230/460 V 460 V 575 V	1 ... 20 hp 25 ... 400 hp 1 ... 400 hp	460 V 575 V	FS 140 ... S440 FS 140 ... S440
1.15	Sinusoidal	1.15	Sinusoidal	1.15	Sinusoidal
NEMA design B		NEMA design B		NEMA design B	
Not specified		CL I Gr, C&D Div. 2	Optional	CL I Gr, C&D Div. 2	Optional
Class F	NEMA MG1 Part 31	Class F	NEMA MG1 Part 31	Class F	NEMA MG1 Part 31
Class B at 1.0 SF, Class F at 1.15 SF	Sinusoidal	Class B at 1.0 SF, Class F at 1.15 SF	Sinusoidal	Class B at 1.0 SF, Class F at 1.15 SF	Sinusoidal
Die-cast aluminum Steel Cast iron	FS 140 ... 250 FS 280 ... 400 FS 440	Cast iron		Cast iron	
Plastic Cast iron	FS 140 ... 250 FS 280 ... 440	Cast iron	FS 140 ... S440	Cast iron	FS 140 ... S440
Bi-directional - Polypropylene		Bi-directional - Polypropylene - Bronze Counterclockwise	FS 140 ... 440 FS S440 300 ... 400 hp 2P/4P	Bi-directional - Polypropylene - Bronze Counterclockwise	FS 140 ... 440 FS S440 300 ... 400 hp 2P/4P
O-ring Neoprene	FS 140 ... 250 FS 280 ... 440	Neoprene		Neoprene	
Die-cast aluminum Die-cast copper	FS 140 ... 440 FS 140 ... 250	Die-cast aluminum Die-cast copper	FS 140 ... S440 FS 140 ... 250	Die-cast aluminum Die-cast copper	FS 140 ... S440 FS 140 ... 250
Copper – random wound		Copper – random wound		Copper – random wound	
High-strength carbon steel	C1045	High-strength carbon steel	C1045	High-strength carbon steel	C1045
V-ring slinger meets IP54	(DE only)	V-ring slinger meets IP54	(DE, NDE)	Inpro/seal bearing insulation meets IP55	(DE, NDE)
Cast iron	FS 140 ... 440	Cast iron	FS 140 ... S440	Cast iron	FS 140 ... S440
Double-shielded Regreasable inlet and outlet	(FS 440 only)	Double-shielded Single-shielded Regreasable inlet and outlet	FS 140 ... 250 FS 280 ... S440	Double-shielded Single-shielded Regreasable inlet and outlet	FS 140 ... 250 FS 280 ... S440
No		Cast iron		Cast iron	
Polyurea	Base grease	Polyurea	Base grease	Polyurea	Base grease
Alemite	FS 440 only	Alemite		Alemite	
Plug	FS 440 only	Plug		Pressure relief (automatic)	
0.15 IPS		0.08 IPS		0.06 IPS	
Aluminum	Engraved	Stainless steel	Engraved	Stainless steel	Embossed
Condensation drainage holes – lowest point (2)		T discharges – lowest point (2)		T discharges – lowest point (2)	
Rust-resistant		Rust-resistant		Rust-resistant	
Included	> 75 lb (> 34.0 kg)	Included	> 75 lb (> 34.0 kg)	Included	
ALKYED modified	RAL7030	ALKYED modified	RAL7030	ALKYED modified	RAL7030
18 months		36 months		60 months	
VT 20:1 CT 4:1 CT 10:1	FS 140 ... 440 FS 140 ... 440 FS 140 ... 250 (Cu)	CT 20:1 CT 4:1 CT 10:1	FS 143 ... 365 FS 140 ... 440 FS 140 ... 250 (Cu)	CT 20:1 CT 4:1 CT 10:1	FS 143 ... 365 FS 140 ... 440 FS 140 ... 250 (Cu)
D 81.2, US/Canada		D 81.2, US/Canada		D 81.2, US/Canada	

Appendix

NEMA motors

Motors according to NEMA standard

	Explosion Protected				Definite Purpose	
						
	XP100		XP100 ID1		SD10 MS	
Power range	1 ... 300 hp (0.75 ... 200 kW)	FS 140 ... 440	1 ... 300 hp (0.75 ... 200 kW)	FS 140 ... 440	1 ... 200 hp (0.75 ... 160 kW)	4/8-pole – 1W VT
Frame size (FS)	140 ... 440		140 ... 440		140 ... 440	
Degree of protection NEMA MG1	TEFC (totally enclosed fan cooled)		TEFC (totally enclosed fan cooled)		TEFC (totally enclosed fan cooled)	
Housing material	Cast iron	8-hole foot	Cast iron	8-hole foot	Cast iron	8-hole foot
Efficiency	NEMA Premium	FS 140 ... 440	NEMA Premium	FS 140 ... 440	Standard	FS 140 ... 440
Power supply	3-phase, 60 Hz		3-phase, 60 Hz		3-phase, 60 Hz	
Voltage	208 ... 230/460 V 230/460 V 460 V 575 V	1 ... 20 hp 25 ... 100 hp 125 ... 300 hp 1 ... 300 hp	208 ... 230/460 V 230/460 V 460 V 575 V	1 ... 20 hp FS 280 ... 100 hp 125 ... 300 hp 1 ... 300 hp	460 V 575 V	FS 140 ... 440 FS 140 ... 440
Service factor	1.0	Sinusoidal	1.0	Sinusoidal	1.0	Sinusoidal
Electrical design	NEMA design B		NEMA design B		Not specified	
Hazard classification	CL I Gr. C&D, CL II F&G Div 1	Max. code T3C	CL I Gr. D, Div 1	Max. code T2A	Not specified	
Insulation	Class F	NEMA MG1 Part 31	Class F	NEMA MG1 Part 31	Class F	NEMA MG1 Part 31
Utilization	Class B at 1.0 SF, Class F at 1.15 SF	Sinusoidal	Class B at 1.0 SF, Class F at 1.15 SF	Sinusoidal not with 300, 250 hp, 4-pole	Class B at 1.0 SF, Class F at 1.15 SF	Sinusoidal not with 300, 250 hp, 4-pole
Terminal box (oversized)	Cast iron		Cast iron		Cast iron	
Fan cover	Cast iron		Cast iron		Cast iron	
Fan	Bi-directional - Polypropylene	FS 140 ... 440	Bi-directional - Polypropylene	FS 140 ... 440	Bi-directional - Polypropylene	FS 140 ... 440
Seal	Neoprene		Not specified	(lead seal)	Neoprene	
Rotor material	Die-cast aluminum		Die-cast aluminum		Die-cast aluminum	
Stator winding	Copper – random wound NC protective device	FS 140 – 440 Included	Copper – random wound NC protective device	FS 140 – 440 Not specified	Copper – random wound	
Shaft material	High-strength carbon steel		High-strength carbon steel		High-strength carbon steel	
Shaft seal/ slinger	V-ring slinger meets IP54	(DE, NDE)	V-ring slinger meets IP54	(DE, NDE)	V-ring slinger meets IP54	(DE, NDE)
Bearing housing	Cast iron		Cast iron		Cast iron	
Bearing type	Double-shielded Regreasable inlet and outlet	FS 140 ... 440	Double-shielded Regreasable inlet and outlet	FS 140 ... 440	Double-shielded Single-shielded Regreasable inlet and outlet	FS 140 ... 250 FS 280 ... S440
Bearing inner cap	Cast iron		Cast iron		Cast iron	
Lubrication	Polyurea	Base grease	Polyurea	Base grease	Polyurea	Base grease
Oil filling nozzle	Alemite		Alemite		Alemite	
Oil drain valve	Plug		Plug		Plug	
Vibrations	0.08 IPS		0.08 IPS		0.08 IPS	
Rating plate	Stainless steel	Engraved	Stainless steel	Engraved	Stainless steel	Engraved
Condensation drainage hole	UL certification	FS 280 ... 440	UL certification	FS 280 ... 440	T discharges – lowest point (2)	
Mountings	Rust-resistant		Rust-resistant		Rust-resistant	
Lifting eye	Included	> 75 lb (> 34.0 kg)	Included	> 75 lb (> 34.0 kg)	Included	> 75 lb (> 34.0 kg)
Paint finish	ALKYED modified	RAL7030	ALKYED modified	RAL7030	ALKYED modified	RAL7030
Warranty	36 months		36 months		36 months	
Converter operation	VT 20:1 CT 4:1	FS 140 ... 440 FS 140 ... 320	VT 20:1 CT 4:1	FS 140 ... 440 FS 140 ... 440	Not specified	
Catalog	D 81.2, US/Canada		D 81.2, US/Canada		D 81.2, US/Canada	

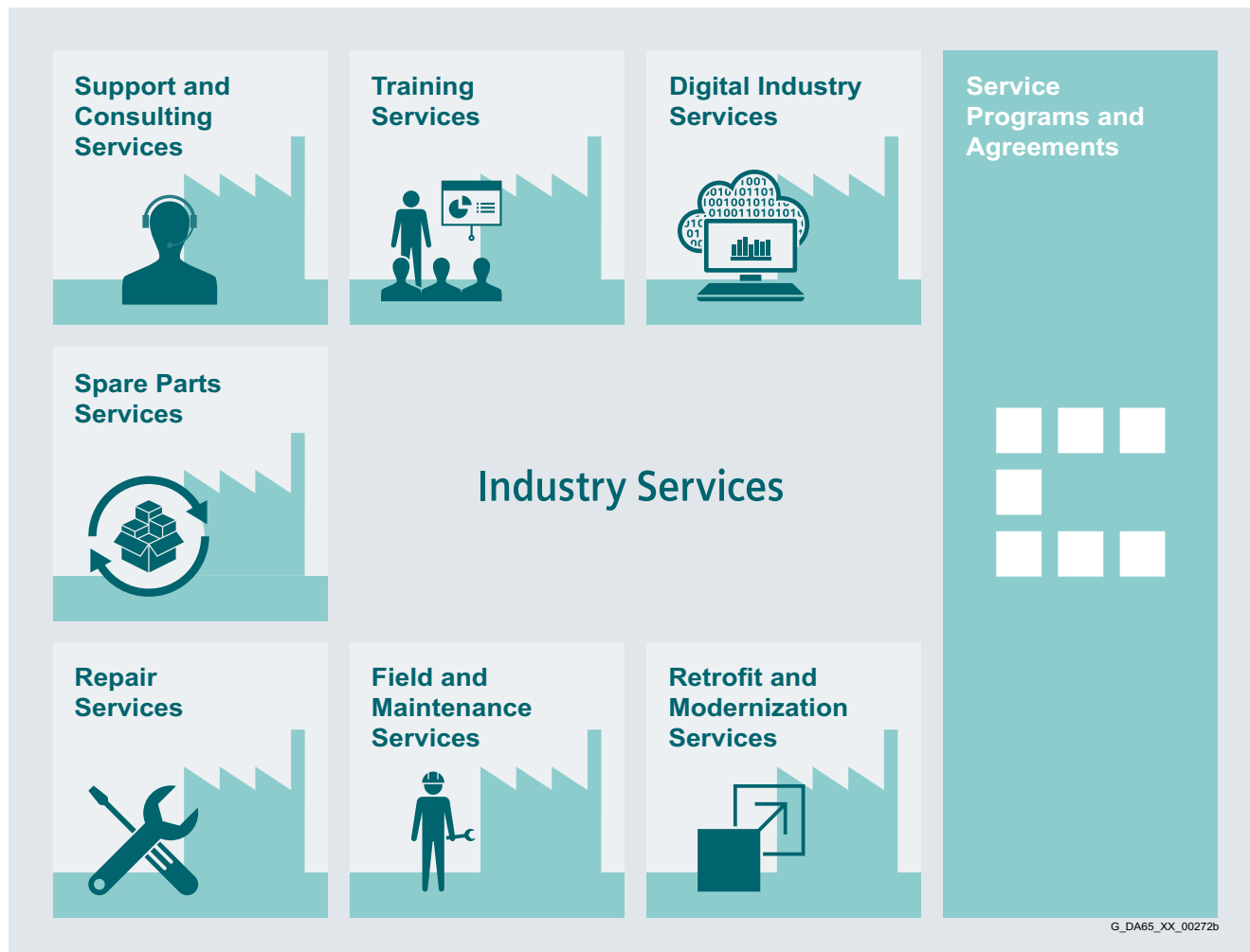
Overview

Keep your business running and shaping your digital future – with Industry Services

Optimizing the productivity of your equipment and operations can be a challenge, especially with constantly changing market conditions. Working with our service experts makes it easier. We understand your industry's unique processes and provide the services needed so that you can better achieve your business goals.

You can count on us to maximize your uptime and minimize your downtime, increasing your operations' productivity and reliability. When your operations have to be changed quickly to meet a new demand or business opportunity, our services give you the flexibility to adapt. Of course, we take care that your production is protected against cyber threats. We assist in keeping your operations as energy and resource efficient as possible and reducing your total cost of ownership. As a trendsetter, we ensure that you can capitalize on the opportunities of digitalization and by applying data analytics to enhance decision making: You can be sure that your plant reaches its full potential and retains this over the longer lifespan.

You can rely on our highly dedicated team of engineers, technicians and specialists to deliver the services you need – safely, professionally and in compliance with all regulations. We are there for you, where you need us, when you need us.

www.siemens.com/industriyservices

Appendix

Industry Services

Industry Services – Portfolio overview

Overview

Digital Industry Services



Digital Industry Services make your industrial processes transparent to gain improvements in productivity, asset availability, and energy efficiency.

Production data is generated, filtered and translated with intelligent analytics to enhance decision-making.

This is done whilst taking data security into consideration and with continuous protection against cyber-attack threats.

<https://www.siemens.com/global/en/home/products/services/industry/digital-services.html>

Support and Consulting Services



Industry Online Support site for comprehensive information, application examples, FAQs and support requests.

Technical and Engineering Support for advice and answers for all inquiries about functionality, handling, and fault clearance. The Service Card as prepaid support for value added services such as Priority Call Back or Extended Support offers the clear advantage of quick and easy purchasing.

Information & Consulting Services, e.g. SIMATIC System Audit; clarity about the state and service capability of your automation system or Lifecycle Information Services; transparency on the lifecycle of the products in your plants.

<https://support.industry.siemens.com/cs/ww/en/sc/2235>

Training Services



From the basics and advanced to specialist skills, SITRAIN courses provide expertise right from the manufacturer – and encompass the entire spectrum of Siemens products and systems for the industry.

Worldwide, SITRAIN courses are available wherever you need a training course in more than 170 locations in over 60 countries.

<https://support.industry.siemens.com/cs/ww/en/sc/2226>

Spare Parts Services



Spare Parts Services are available worldwide for smooth and fast supply of spare parts – and thus optimal plant availability. Genuine spare parts are available for up to ten years. Logistic experts take care of procurement, transport, custom clearance, storage and order management. Reliable logistics processes ensure that components reach their destination as needed.

Since not all spare parts can be kept in stock at all times, Siemens offers a preventive measure for spare parts provisioning on the customer's premises with optimized **Spare Parts Packages** for individual products, custom-assembled drive components and entire integrated drive trains – including risk consulting.

Asset Optimization Services help you design a strategy for parts supply where your investment and carrying costs are reduced and the risk of obsolescence is avoided.

<https://support.industry.siemens.com/cs/ww/en/sc/2110>

Overview

Repair Services



Repair Services are offered on-site and in regional repair centers for fast restoration of faulty devices' functionality.

Also available are extended repair services, which include additional diagnostic and repair measures, as well as emergency services.

<https://support.industry.siemens.com/cs/ww/en/sc/2154>

Retrofit and Modernization Services



Retrofit and Modernization Services provide a cost-effective solution for the expansion of entire plants, optimization of systems or upgrading existing products to the latest technology and software, e.g. migration services for automation systems.

Service experts support projects from planning through commissioning and, if desired over the entire extended lifespan, e.g. Retrofit for Integrated Drive Systems for an extended lifetime of your machines and plants.

<https://support.industry.siemens.com/cs/ww/en/sc/2286>

Field and Maintenance Services

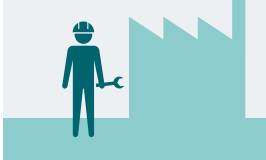

Siemens specialists are available globally to provide expert field and maintenance services, including commissioning, functional testing, preventive maintenance and fault clearance.

All services can be included in customized service agreements with defined reaction times or fixed maintenance intervals.

<https://support.industry.siemens.com/cs/ww/en/sc/2265>

Service Programs and Agreements

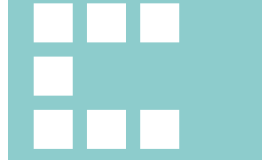

A technical Service Program or Agreement enables you to easily bundle a wide range of services into a single annual or multi-year agreement.

You pick the services you need to match your unique requirements or fill gaps in your organization's maintenance capabilities.

Programs and agreements can be customized as KPI-based and/or performance-based contracts.

<https://support.industry.siemens.com/cs/ww/en/sc/2275>

Appendix

Industry Services

Online Support

Overview

Online Support – fast, intuitive, whenever you want, wherever you need

Web
support.industry.siemens.com

App

GET IT ON Google Play | GET IT ON App Store | Microsoft Store

Scan the QR code for information on our Online Support app.

- FAQ / Application examples**
Information about industrial products, programming and configuration as well as application examples
- Technical information**
Videos, documentation, manuals, updates, product notes, compatibility tool, certificates, planning data such as dimensional drawings, product data, 3D models
- Forum**
Exchange information and experience with other users and experts

Online Support for Siemens Industry Products

Siemens Industry and Online Support with some 1.7 million visitors per month is one of the most popular web services provided by Siemens. It is the central access point for comprehensive technical know-how about products, systems and services for automation and drives applications as well as for process industries.

In connection with the challenges and opportunities related to digitalization you can look forward to continued support with innovative offerings.

SIEMENS
Ingenierie für alle

Competence: Spare parts / Repairs / Call... Products: All Products and Branches Region: All Regions

Contacts at Siemens

Please choose a city in the upper search field, if possible. Or select a city or a contact person on the map on the right. If you do not find your city in the selection, we recommend choosing the nearest city.

Siemens NVISA

Digital Factory - Process Industries and Drives
Service Shop

Address: GEZOND GEZELLESRAAT 123
1654 Beesel
Belgium

Communication data
+32 2 536 4975
+32 2 536 6851
s@repairs.be@siemens.com
http://www.siemens.be/industrie

Competences: Spare parts / Repairs... Products & Branches: Please filter... Region: Please filter...

Siemens SPA

Digital Factory - Process Industries and Drives
Service

Address: Lotissement el Kadous, Lot No 10
16035 Algier
Algeria

Communication data
+213 21 36 14 55587475/768294
+213 770 17 29 82
+213 21 36 13 79
support.automation.do@siemens.com
rahah.benamar@siemens.com
http://www.siemens.com

Competences: Spare parts / Repairs... Products & Branches: Please filter... Region: Please filter...

At your service locally, around the globe for consulting, sales, training, service, support, spare parts on the entire portfolio of Siemens.

Your partner can be found in our Personal Contacts Database at:
www.siemens.com/automation-contact

You start by selecting

- the required competence,
- products and branches,
- a country and a city

or by a

- location search or free text search.

Appendix

Tools and engineering

Drive Technology Configurator selection tool

Overview

The Drive Technology (DT) Configurator supports you when you are configuring the optimum drive technology products for your application – from gearboxes, motors, converters as well as the associated options and components through to controllers, software licenses and connection systems. With or without detailed knowledge of products: Preselected product groups, targeted navigation through selection menus and direct product selection through entry of the article number support quick, efficient and convenient configuration.

In addition, comprehensive documentation comprising technical data sheets, 2D dimensional drawings/3D CAD models, operating instructions, certificates, etc. can be selected in the DT Configurator. Immediate ordering is possible by simply transferring a parts list to the shopping cart of the Industry Mall.

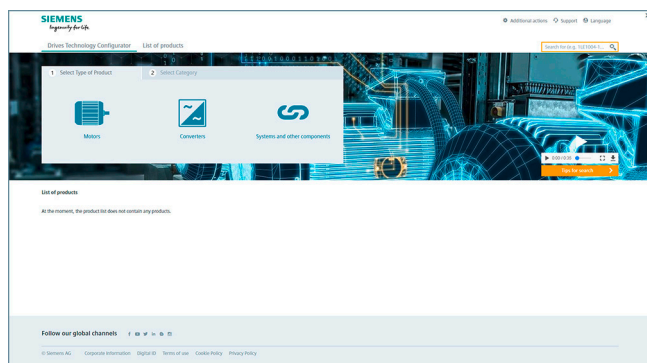

Drive Technology Configurator for efficient drive configuration with the following functions

- Quick and easy configuration of drive products and associated components – gear units, motors, converters, controllers, connection systems
- Configuration of drive systems for pump, fan and compressor applications from 1 kW to 2.6 MW
- Displayable documentation for configured products and components, such as
 - Data sheets in up to 9 languages in PDF or RTF format
 - 2D dimensional drawings/3D CAD models in various formats
 - Terminal box drawing and terminal connection diagram
 - Operating instructions
 - Certificates
 - Start-up calculation for SIMOTICS motors
 - EPLAN macros
- Support with retrofitting in conjunction with Spares On Web www.siemens.com/sow
- Ability to order products directly in the Siemens Industry Mall

Access to the Drive Technology Configurator

The Drive Technology Configurator can be called up without registration and without a login:

www.siemens.com/dt-configurator

More information

[Online access to Drive Technology Configurator](#)

More information about the Drive Technology Configurator is available on the Internet at:

www.siemens.com/dtconfigurator

Overview

The SinaSave energy efficiency tool determines energy saving potential and amortization times based on your individual conditions of use and therefore offers practical assistance in making decisions about investments in energy-efficient technologies.

In SinaSave Version 6.0 and higher, the drive systems to be compared and the relevant drive component parameters are displayed graphically. An additional expansion includes numerous comparison possibilities for different control types and comprehensive product combinations for drive solutions for pump and fan applications. In addition to SIMOTICS motors and SINAMICS converters, the product portfolio comprises SIRIUS controls, offering a comprehensive range of comparison possibilities – according to your individual requirements.



SinaSave offers numerous comparison scenarios:

- Comparison of drive systems for pump and fan applications in the power range from 0.55 kW (low voltage) to 5.5 MW (medium voltage) for
 - Reactor control (fixed speed; motor and switchgear)
 - Bypass control (fixed speed; motor and switchgear)
 - Speed control (variable speed; motor and converter)
- Comparison and evaluation of standard motors (incl. ignition protection motors) in different energy efficiency classes

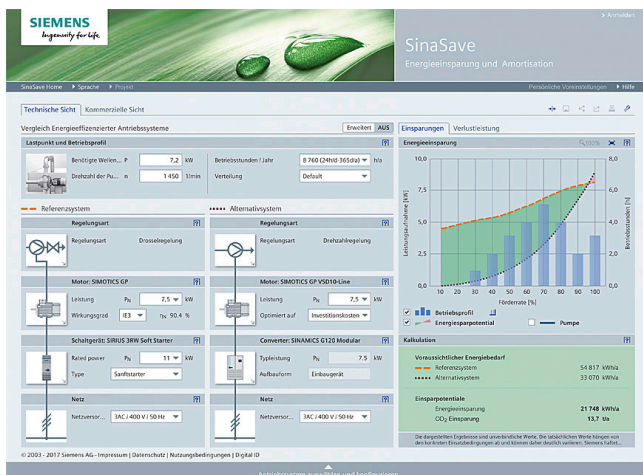

SinaSave supports the evaluation of different product and system comparisons by:

- Displaying the potential savings for energy and energy costs as well as CO₂ emissions
- Estimation of the amortization time
- Estimation of the individual total lifecycle costs
- Representation of the system power losses according to EN 50598-2 for full load and partial load
- Direct comparison of Siemens drives with the reference Power Drive System (PDS) described in EN 50598-2

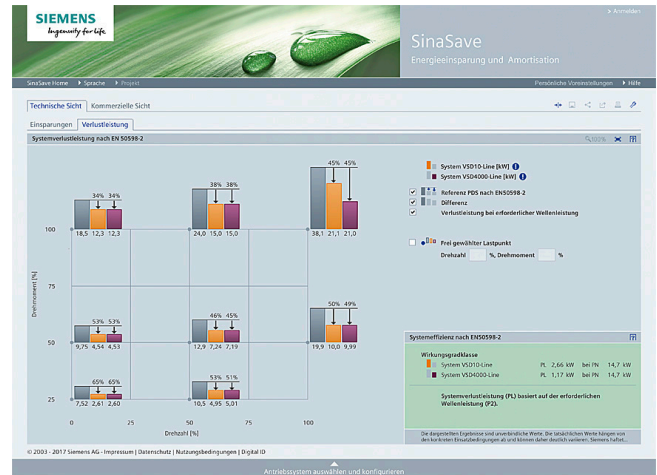

Access to the SinaSave energy efficiency tool

SinaSave can be accessed without the need for registration or logging in:

www.sinasave.siemens.com

More information

For more information about the amortization calculator for energy-efficient drive systems, visit

www.sinasave.siemens.com

More information about services for energy saving is available on the Internet at

www.siemens.com/energy-saving

Appendix

Tools and engineering

SIZER for Siemens Drives engineering tool

Overview

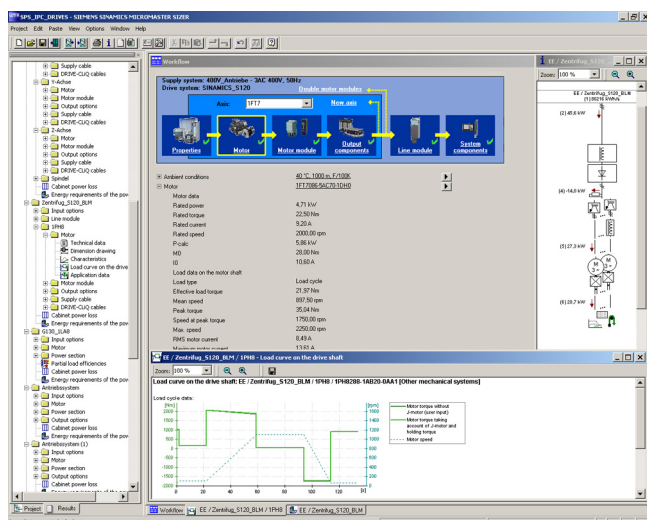

The following drives and controls can be engineered in a user-friendly way using the SIZER for Siemens Drives engineering tool:

- SIMOTICS low-voltage motors, including servo geared motors
- SIMOGEAR geared motors
- SINAMICS low-voltage drive systems
- Motor starters
- SINUMERIK CNC
- SIMOTION Motion Control controller
- SIMATIC controller

It provides support when selecting the technologies involved in the hardware and firmware components required for a drive task. SIZER for Siemens Drives covers the full range of operations required to configure a complete drive system, from basic single drives to demanding multi-axis applications.

SIZER for Siemens Drives supports all of the engineering steps in one workflow:

- Configuring the power supply
- Designing the motor and gearbox, including calculation of mechanical transmission elements
- Configuring the drive components
- Compiling the required accessories
- Selecting the line-side and motor-side power options, e.g. cables, filters, and reactors

When SIZER for Siemens Drives was being designed, particular importance was placed on a high degree of usability and a universal, function-based approach to the drive application. The extensive user guidance makes it easy to use the tool. Status information keeps you continually informed about the progress of the configuration process.

The drive configuration is saved in a project. In the project, the components and functions used are displayed in a hierarchical tree structure.

The project view permits the configuration of drive systems and the copying/inserting/modifying of drives already configured.

The configuration process produces the following results:

- A parts list of the required components (export to Excel, use of the Excel data sheet for import to SAP)
- Technical specifications of the system
- Characteristic curves
- Comments on system reactions
- Mounting arrangement of drive and control components and dimensional drawings of motors
- Energy requirements of the configured application

These results are displayed in a results tree and can be reused for documentation purposes.

Support is provided by the technological online help menu:

- Detailed technical specifications
- Information about the drive systems and their components
- Decision-making criteria for the selection of components
- Online help in English, French, German, Italian, Chinese and Japanese

System requirements

- PG or PC, Pentium™ III min. 800 MHz (recommended > 1 GHz)
- 512 MB RAM (1 GB recommended)
- At least 2 GB of free hard disk space
- An additional 100 MB of free hard disk space on Windows system drive
- Screen resolution 1024 × 768 pixels
- Operating system:
 - Windows 7 (32/64-bit) Professional, Enterprise, Ultimate, Home
 - Windows 8.1 (32/64-bit) Professional, Enterprise, Ultimate, Home
 - Microsoft Office 2003/2007/2010/2013/2016
 - Windows 365
 - Microsoft Internet Explorer V8.0
 - Microsoft .NET Framework 2.0
 - OpenGL 2.1
 - Windows 10 (64-bit) Professional, Enterprise
- Microsoft Internet Explorer from V5.5 SP2

More information

The SIZER for Siemens Drives engineering tool is available free on the Internet at www.siemens.com/sizer

SIPLUS CMS Condition Monitoring Systems for the continuous condition monitoring of motors

Overview

The SIPLUS CMS Condition Monitoring Systems continuously monitor the condition of wear-prone drive components, such as motors. Depending on the system, individual motors can be monitored as well as complete drive trains, or even the entire plant. IEPE sensors are used for acquisition of the motor vibrations for analysis, visualization and archiving by SIPLUS CMS. Information is supplied regularly and event-driven – even in remote operation. SIPLUS CMS can also be retrofitted.

More information on SIPLUS CMS is available on the Internet at www.siemens.com/siplus-cms

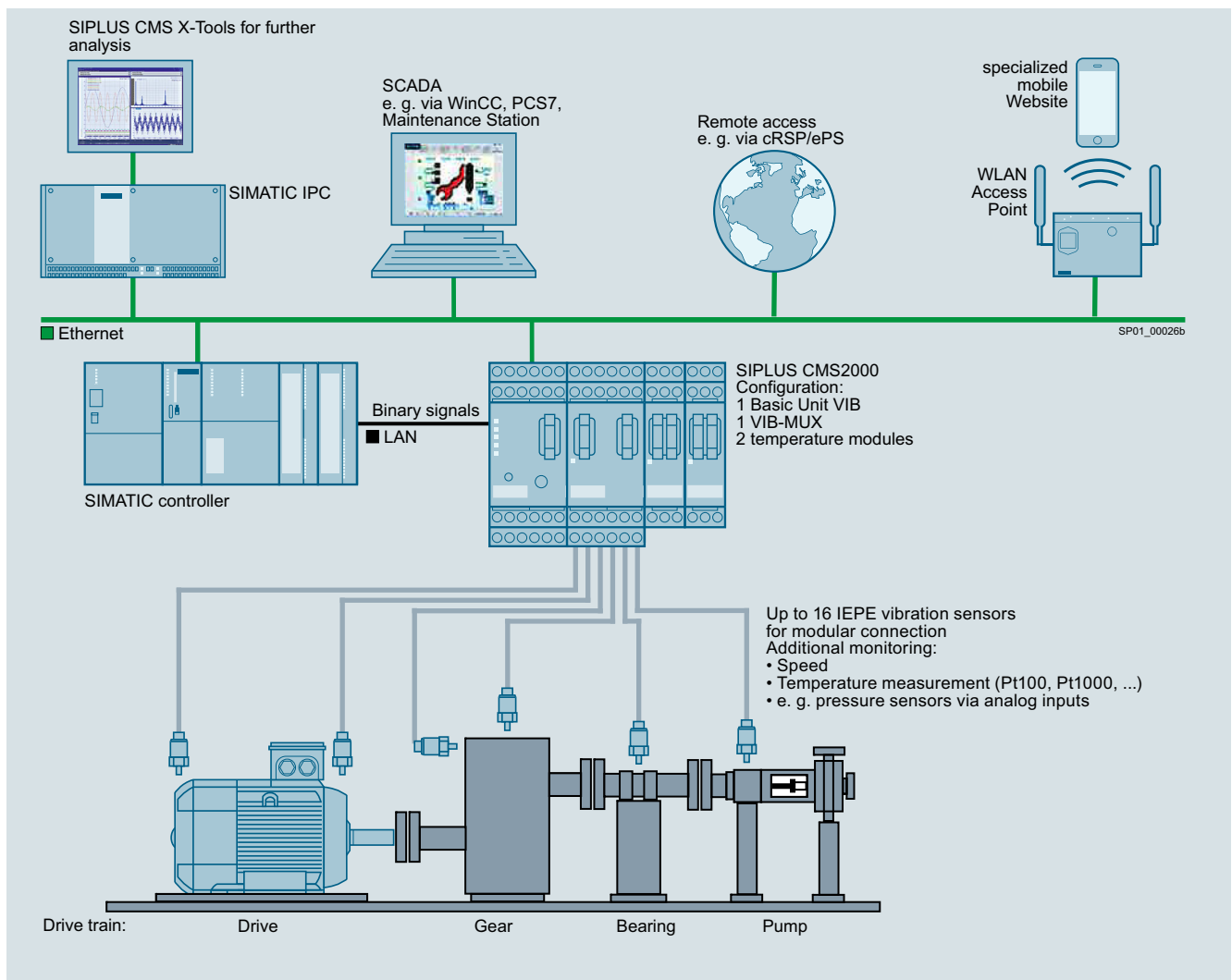
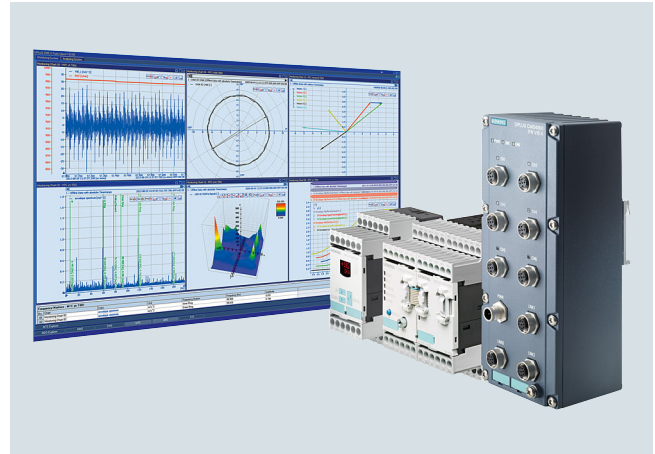

Appendix

Indexes

Index of order codes

Order codes for motors 1FP, 1LE, 1MB, 1PC

All options are listed alphanumerically according to order codes in the following table.

Order code	Special versions	Category	For further information, see page
B01	A printed version of the safety notes in German/English and safety notes in the language of the country of use is supplied in each wire-lattice pallet	Packaging, safety notes, documentation and test certificates	3/127, 5/67, 5/125,
B02	Inspection certificate 3.1 in accordance with EN 10204		3/127, 3/135, 3/142, 4/31, 5/67, 5/71, 5/125, 5/129, 6/97, 6/102, 6/107, 6/111, 6/117
B04	Printed German/English Operating Instructions enclosed		4/31
B07	Additional rating plate for voltage tolerance	Rating plate and additional rating plates	3/127, 3/135, 4/31
B10	Individual acceptance by marine classification society	Marine version – Acceptance/certification	7/9, 7/10, 7/11, 7/12
B13	Without "Made in manufacturing country" marking	Packaging, safety notes, documentation and test certificates	4/31
B30	Version additionally for dust Ex tc – Zone 22	Explosion-protected version	6/94, 6/99, 6/108, 6/113
B31	Version IIC with stamping of IIB		6/94, 6/99, 6/104, 6/108, 6/113
B32	Version additionally for dust Ex tb - Zone 21; IP65		6/104, 6/108
B33	T1/T2 on rating plate		6/104
B40	Version for converter operation in basic version with operating data SINAMICS G120 with PM240-2	Version for converter operation	6/94, 6/99, 6/113
B41	Version for converter operation in basic version with operating data SINAMICS S150		6/94, 6/99, 6/113
B43	Version for converter operation with power data on the PWM converter		6/94, 6/99, 6/108, 6/113
B44	Version for converter operation with power data on the PWM converter when used in accordance with temperature class 155 (F)		6/108
B50	Starting curves (torque-speed and current-speed)	Packaging, safety notes, documentation and test certificates	4/31
B51	Equivalent circuit diagram		4/31, 6/117
B52	Starting diagram (torque vs. speed and current vs. speed)		4/31, 6/117
B60	Document - Electrical datasheet		3/127, 3/135, 3/142, 4/32, 5/67, 5/71, 5/125, 5/129, 6/97, 6/102, 6/107, 6/111, 6/117
B61	Document - Order dimensional drawing		3/127, 3/135, 3/142, 4/32, 5/67, 5/71, 5/125, 5/129, 6/97, 6/102, 6/107, 6/111, 6/117
B65	Standard test (routine test) with acceptance		3/135, 3/142, 4/32, 5/71, 5/129, 6/102, 6/107, 6/111, 6/117
B67	Temperature test without acceptance		4/32, 6/117
B68	Temperature test with acceptance		4/32, 6/117
B71	Noise measurement without load with octave band analysis, without acceptance		6/111
B72	Noise measurement without load with octave band analysis, with acceptance		6/111
B81	Type test with heat run for vertical motors, with acceptance		7/11
B82	Type test with heat run for horizontal motors, without acceptance		3/136, 3/142, 4/32, 6/107, 6/111, 6/117
B83	Type test with heat run for horizontal motors, with acceptance		3/127, 3/136, 3/142, 4/32, 5/67, 5/71, 5/125, 5/129, 6/97, 6/102, 6/107, 6/111, 6/117
B83	Type test with heat run for horizontal motors, with acceptance	Marine version – Acceptance/certification	7/9, 7/10, 7/11, 7/12
B90	"Basic" documentation package	Packaging, safety notes, documentation and test certificates	3/127, 3/136, 4/32, 5/67, 5/71, 5/125, 5/129, 6/97, 6/102, 6/107, 6/111, 6/117
B91	"Advanced" documentation package		3/127, 3/136, 4/32, 5/67, 5/71, 5/125, 5/129, 6/97, 6/102, 6/107, 6/111, 6/117
B92	"Projects" documentation package		3/127, 3/136, 4/32, 5/67, 5/71, 5/125, 5/129, 6/97, 6/102, 6/107, 6/111, 6/117

Index of order codes

Order code	Special versions	Category	For further information, see page
B99	Wire-lattice pallet packaging	Packaging, safety notes, documentation and test certificates	3/127, 5/125, 6/97, 6/102, 6/111,
C02	VIK version	Versions in accordance with standards and specifications	3/125, 3/133, 4/29, 6/94,
C02	VIK version	Explosion-protected version	6/99, 6/104, 6/108, 6/113
C03	Chemstar chemical Industry		6/108
C04	Chemstar Oil & Gas Industry		6/108
D01	CCC China Compulsory Certification	Versions in accordance with standards and specifications	3/125, 3/133
D02	Coolant temperature –50 to +40 °C	Coolant temperature and installation altitude	3/133, 3/141, 4/29, 5/70, 5/128
D03	Coolant temperature -40 to +40 °C		3/125, 3/133, 3/141, 4/29, 5/66, 5/70, 5/124, 5/128, 6/96, 6/101, 6/105, 6/110, 6/115
D04	Coolant temperature –30 to +40 °C		3/125, 3/133, 3/141, 4/29, 5/66, 5/70, 5/124, 5/128
D22	Motor without CE marking for export outside EEA (see EU Regulation 640/2009)	Versions in accordance with standards and specifications	3/125, 3/133, 4/29, 6/96, 6/101, 6/110
D23	Motor exclusively for use in transportation equipment for passenger and freight transportation corresponding to ETPG §1 dated February 27, 2008		3/125, 3/133, 4/29, 6/96, 6/101
D30	Electrical according to NEMA MG1-12		3/125, 3/133, 4/29
D31	Design according to UL with "Recognition Mark"		3/125, 3/133, 4/29
D32	Ex certification for China		6/96, 6/101, 6/110
D33	KEMCO Korea Energy Efficiency Label		3/125, 3/133
D34	China Energy Efficiency Label		3/125, 3/134, 4/29, 6/96, 6/101, 6/110
D35	Ex certificate EAC for the Eurasian Customs Union		6/96, 6/101, 6/110
D37	IECEx certification		6/96, 6/101, 6/105, 6/110, 6/116
D39	Version according to UL and CSA (Canadian regulation)		5/66, 5/70, 5/124, 5/128
D40	Canadian regulations (CSA)		3/125, 3/134, 4/30
D41	NEMA Premium Efficient, North America version acc. to NEMA MG1, Table 12-11, incl. UL and CSA		3/125, 3/134
D47	TR CU product safety certificate EAC for Eurasian Customs Union		3/125, 3/134, 4/30, 5/66, 5/70, 5/124, 5/128
D70	MEPS Australia		3/125, 3/134, 4/30, 6/96, 6/101, 6/110, 6/116
E21	With type test certificate according to Lloyds Register (LR), CT 45 °C, temperature class 155 (F), utilized according to 155 (F)	Marine version – Basic version	7/9, 7/10, 7/11, 7/12
E31	With type test certificate according to Bureau Veritas (BV), CT 45 °C, temperature class 155 (F), utilized according to 155 (F)		7/9, 7/10, 7/12
E41	With type test certificate according to Registro Italiano Navale (RINA), CT 45 °C, temperature class 155 (F), utilized according to 155 (F)		7/9, 7/10, 7/11, 7/12
E46	With type test certificate according to Russian Maritime Register (RS), CT 45 °C, temperature class 155 (F), utilized according to 155 (F)		7/9, 7/10, 7/11, 7/12
E51	With type test certificate according to DNV GL Maritime, CT 45 °C, temperature class 155 (F), utilized according to 155 (F)		7/9, 7/10, 7/11, 7/12
E52	With type test certificate according to American Bureau of Shipping (ABS), CT 50 °C, temperature class 155 (F), utilized according to 155 (F)		7/9, 7/10, 7/11, 7/12
E54	With type test certificate according to Korean Register of Shipping (KR), CT 45 °C, temperature class 155 (F), utilized according to 155 (F)		7/9, 7/10, 7/12
F01	Mounting of holding brake (standard assignment)	Modular technology – Basic versions	3/124, 3/131, 3/140, 4/27, 5/65, 5/69, 5/123, 5/127
F02	Mounting of brake for higher switching frequency (operating brake)		3/124, 5/65, 5/123
F04	Mounting of PRECIMA brake		3/131, 3/140
F10	Brake supply voltage 24 V DC	Modular technology – Additional versions	3/124, 3/132, 3/140, 4/27, 5/65, 5/69, 5/123, 5/127, 6/109
F11	Brake supply voltage 230 V AC, 50/60 Hz		3/124, 3/132, 3/140, 4/28, 5/65, 5/69, 5/123, 5/127, 6/109
F12	Brake supply voltage 400 V AC, 50/60 Hz		3/124, 3/132, 3/140, 4/28, 5/65, 5/69, 5/123, 5/127, 6/109
F17	Brake supply voltage 180 V DC		3/124, 3/132, 3/140, 5/65, 5/69, 5/123, 5/127

Appendix

Indexes

Index of order codes

Order code	Special versions	Category	For further information, see page
F18	Brake supply voltage 205 V DC	Modular technology – Additional versions	3/124, 3/132, 3/140, 5/65, 5/69, 5/123, 5/127
F20	Mounting of brake in Ex db version	Special technology	6/109
F40	Backstop, counterclockwise motion blocked, clockwise direction of rotation	Modular technology – Additional versions	3/132, 3/140, 4/28, 5/69
F41	Backstop, clockwise motion blocked, counterclockwise direction of rotation		
F50	Mechanical manual brake release with lever (no locking)		3/124, 3/132, 3/140, 5/65, 5/69, 5/123, 5/127, 6/109
F68	Metal fan made of brass	Heating and ventilation	6/111, 6/116
F70	Mounted separately driven fan	Modular technology – Basic versions	3/124, 3/131, 3/140, 4/27, 5/66, 5/71, 5/124, 5/129, 6/95, 6/100, 6/109, 6/115
F74	Sheet metal fan cover	Heating and ventilation	3/126, 3/135, 3/142, 4/31, 5/66, 5/71, 5/124, 5/129
F75	Fan cover for textile industry		
F76	Metal external fan		3/126, 5/66, 5/124
F77	Low-noise version for 2-pole motors with clockwise direction of rotation	Mechanical design and degrees of protection	3/125, 3/133, 3/141, 4/29, 6/95, 6/100, 6/105, 6/109, 6/115
F78	Low-noise version for 2-pole motors with counterclockwise direction of rotation		
F90	Without external fan and without fan cover	Heating and ventilation	3/126, 3/135, 3/142, 4/31, 5/66, 5/124, 6/116
G04	Mounting of LL 861 900 220 rotary pulse encoder	Special technology	3/124, 3/132, 3/140, 4/28, 5/65, 5/69, 5/123, 5/127
G05	Mounting of HOG 9 DN 1024 I rotary pulse encoder		
G06	Mounting of HOG 10 D 1024 I rotary pulse encoder		3/124, 3/132, 3/140, 4/28, 5/65, 5/69, 5/123, 5/127
G07	Mounting of POG 10 DN rotary pulse encoder (only in combination with separately driven fan or brake)		3/132, 3/140, 4/28, 5/69, 5/127
G08	Mounting of POG 9 rotary pulse encoder (only in combination with separately driven fan or brake)		3/132, 3/140, 4/28, 5/69, 5/127
G11	Mounting of Kübler Sendix 5020 HTL, 1024 I rotary pulse encoder	Modular technology – Basic versions	3/124, 3/131, 3/140, 4/27, 5/65, 5/69, 5/123, 5/127
G12	Mounting of Kübler Sendix 5020 TTL, 1024 I rotary pulse encoder		
G15	Mounting of HOG 10 DN 1024 I rotary pulse encoder, terminal box moisture protection	Special technology	3/132, 3/140, 4/28
G16	Mounting of HOG 10 DN 1024 I rotary pulse encoder, terminal box dust protection		
G21	Mounting of Kübler Sendix 5834FS2 1024, SIL-2 rotary pulse encoder		3/124, 3/132, 3/140, 4/28, 5/65, 5/70, 5/123, 5/127
G22	Mounting of Kübler Sendix 5834FS3 1024, SIL-3 rotary pulse encoder		3/124, 3/132, 3/140, 4/28, 5/65, 5/70, 5/123, 5/127
G25	Mounting of HOGS100S-B76.626.01024.1 rotary pulse encoder		3/124, 3/132, 3/140, 4/28, 5/65, 5/70, 5/127
G27	Mounting of LL FSI 862-184560-1024, SIL-2 rotary pulse encoder		3/124, 3/132, 3/140, 4/28, 5/65, 5/70, 5/127
G30	Mounting of LL 841 (HTL); 1024 I explosion-protected rotary pulse encoder		6/95, 6/100, 6/109, 6/115
G40	Prepared for mounted components, centering hole only	Mechanical design and degrees of protection	3/125, 3/133, 3/141, 4/29, 5/65, 5/70, 5/123, 5/128
G41	Prepared for mountings with D12 shaft		
G42	Prepared for mountings with D16 shaft		
G43	Mechanical protection for encoder		
G93	Mounting of rotary pulse encoder XSI 850 Overspeed	Special technology	3/125, 3/132, 3/140, 4/28
G94	Mounting of rotary pulse encoder XHI 861 Overspeed		
H00	Protective cover	Mechanical design and degrees of protection	3/125, 3/133, 3/141, 4/29, 5/66, 5/70, 5/123, 5/128, 6/95, 6/100, 6/105, 6/109, 6/115

Index of order codes

Order code	Special versions	Category	For further information, see page
H01	Screwed-on (instead of cast) feet	Mechanical design and degrees of protection	3/125, 3/133, 3/141, 5/66, 5/70, 5/123, 5/128, 6/95, 6/100, 6/105
H02	Vibration-proof version; vibration resistance to Class 3M4 according to IEC 60721-3-3:1994		3/125, 3/133, 3/141, 4/29, 5/66, 5/70, 5/123, 5/128, 6/95, 6/101, 6/105, 6/109
H03	Condensation drainage holes		3/125, 3/133, 3/141, 5/66, 5/123, 6/95, 6/101, 6/105, 6/115
H04	External grounding	Motor connection and terminal boxes	3/122, 3/129, 3/138, 5/64, 5/68, 5/122, 5/126
H06	External screws, bolts and unpainted materials made of stainless steel (V4A)	Mechanical design and degrees of protection	6/109
H07	Rust-resistant screws (externally)		3/125, 3/133, 3/141, 4/29, 5/66, 5/70, 5/123, 5/128, 6/95, 6/101, 6/105, 6/109, 6/115
H08	Terminal box on NDE	Motor connection and terminal boxes	3/122, 3/129, 3/138, 4/25, 5/64, 5/68, 5/122, 5/126, 6/114
H09	Two terminal boxes on NDE		4/25, 6/114
H10	Housing with screw mounting	Mechanical design and degrees of protection	3/125, 5/66
H19	Degree of protection IP66		3/125, 3/133, 3/141, 4/29, 5/66, 5/70, 5/123, 5/128, 6/95, 6/101, 6/105, 6/110, 6/115
H20	IP65 degree of protection		3/125, 3/133, 4/29, 5/66, 5/70, 5/123, 5/128, 6/95, 6/101, 6/105, 6/110, 6/115
H21	IP54 degree of protection		3/133, 4/29, 5/70, 5/128
H22	IP56 degree of protection		3/125, 3/133, 3/141, 4/29, 5/66, 5/70, 5/124, 5/128, 6/95, 6/101, 6/105, 6/110, 6/115
H23	Drive-end seal for flange-mounted motors, oil-tight to 0.1 bar		3/125, 3/133, 3/141, 4/29, 5/66, 5/70, 5/124, 5/128, 6/95, 6/101, 6/105, 6/110, 6/115
H25	Sealing ring made of fluoroelastomer (FKM)		4/29, 6/115
H30	Adjustment screws for feet in horizontal installation		6/110, 6/115
H70	Second external grounding	Motor connection and terminal boxes	3/129, 3/138, 4/25, 5/68, 5/126, 6/104, 6/108, 6/114
H90	Increased corrosion protection for external components	Mechanical design and degrees of protection	4/29, 6/115
L00	Vibration severity grade B	Balance and vibration severity	3/126, 3/134, 3/141, 4/30, 6/96, 6/101, 6/106, 6/110, 6/116
L01	Balancing without feather key		3/126, 3/134, 3/141, 4/30, 5/66, 5/70, 5/124, 5/128, 6/96, 6/101, 6/106, 6/110, 6/116
L02	Full-key balancing		3/126, 3/134, 3/141, 4/30, 5/66, 5/70, 5/124, 5/128, 6/96, 6/101, 6/106, 6/110, 6/116
L04	Shaft extension with standard dimensions, without feather keyway	Shaft and rotor	3/126, 3/134, 3/142, 4/30, 5/66, 5/70, 5/124, 5/128, 6/96, 6/101, 6/106, 6/110, 6/116
L05	Standard, cylindrical shaft extension (second shaft extension) NDE acc. to EN 50347		3/126, 3/134, 3/142, 4/30, 5/66, 5/70, 5/124, 5/128, 6/96, 6/101, 6/106, 6/110, 6/116
L06	Standard shaft made of stainless steel (e.g. 1.4021)		3/126, 3/134, 3/142, 4/30, 5/66, 5/71, 5/124, 5/128, 6/96, 6/101, 6/106, 6/110, 6/116
L07	Shaft extension run-out in accordance with IEC 60072-1 precision class		3/126, 3/134, 3/142, 4/30, 5/66, 5/71, 5/124, 5/129, 6/96, 6/101, 6/106, 6/110, 6/116

Appendix

Indexes

Index of order codes

Order code	Special versions	Category	For further information, see page
L08	Shaft extension run-out, concentricity and perpendicularity in accordance with IEC 60072-1 precision class for flange-mounted motors	Shaft and rotor	3/126, 3/134, 3/142, 4/30, 5/66, 5/71, 5/124, 5/129, 6/96, 6/101, 6/106, 6/110, 6/116
L19	Regreasing device with M10 × 1 grease nipple according to DIN 71412-A	Bearings and lubrication	3/126, 3/134, 3/141, 4/30, 5/70, 5/128, 6/101, 6/105, 6/110, 6/116
L20	Located bearing DE		3/126, 3/134, 3/141, 4/30, 5/66, 5/70, 5/124, 5/128, 6/96, 6/101, 6/105, 6/110, 6/116
L21	Located bearing NDE		3/126, 3/134, 3/141, 4/30, 5/66, 5/70, 5/124, 5/128, 6/96, 6/101, 6/105, 6/110, 6/116
L22	Bearing design for increased cantilever forces		3/126, 3/134, 3/141, 4/30, 5/66, 5/70, 5/124, 5/128, 6/96, 6/101, 6/105, 6/110, 6/116
L23	Regreasing device		3/126, 3/134, 3/141, 5/66, 5/70, 5/124, 5/128, 6/96, 6/101, 6/105, 6/110
L24	Hot bearing grease		4/30
L25	Bearings reinforced at both ends for DE and NDE, bearing size 63		3/126, 3/134, 3/141, 5/66, 5/70, 5/124, 5/128, 6/96, 6/101, 6/105, 6/116
L28	Reinforced bearings at both DE and NDE, DE bearing for increased cantilever forces		3/134, 3/141, 5/70, 5/128, 6/105
L30	Drainage for used grease		4/30, 6/116
L34	Bearing for high axial tension forces		6/110
L35	Bearing for high axial tension and thrust forces		6/110
L37	Special version with higher speeds		4/30, 6/116
L50	Bearing insulation DE		3/134, 3/141, 4/30, 5/128, 6/105, 6/116
L51	Bearing insulation NDE		3/126, 3/134, 3/141, 4/30, 5/66, 5/70, 5/124, 5/128, 6/96, 6/101, 6/105, 6/110, 6/116
L52	Grounding brush for converter operation	Mechanical design and degrees of protection	3/133, 3/141, 4/29, 5/128
L90	Version suitable for railways IC411, EN IEC 60349, without EN 45545, with external fan and fan cover in plastic	Versions in accordance with standards and specifications	3/126
L91	Version suitable for railways IC411, EN IEC 60349, with EN 45545, with external fan and fan cover in metal		3/126
L92	Version suitable for railways IC418, EN IEC 60349, without EN 45545, without external fan and fan cover		3/126
M01	Connected in star for dispatch	Packaging, safety notes, documentation and test certificates	3/127, 3/136, 3/142, 4/32, 5/67, 5/71, 5/125, 5/129, 6/97, 6/102, 6/107, 6/111, 6/117
M02	Connected in delta for dispatch		3/127, 3/136, 3/142, 4/32, 5/67, 5/71, 5/125, 5/129, 6/97, 6/102, 6/107, 6/111, 6/117
M10	Second rating plate, loose	Rating plate and additional rating plates	3/127, 3/135, 3/142, 4/31, 5/67, 5/71, 5/124, 5/129, 6/97, 6/102, 6/106, 6/111, 6/117
M11	Rating plate, stainless steel		3/127, 3/135, 3/142, 4/31, 5/67, 5/71, 5/124, 5/129, 6/97, 6/102, 6/106, 6/111
N01	Temperature class 155 (F), utilized according to 155 (F), with service factor	Windings and insulation	3/123, 3/130, 3/139, 4/26
N02	Temperature class 155 (F), utilized acc. to 155 (F), with increased power		3/123, 3/130, 3/139, 4/26
N03	Temperature class 155 (F), utilized acc. to 155 (F), with increased coolant temperature		3/123, 3/130, 3/139, 4/26
N05	Temperature class 155 (F), utilized acc. to 130 (B), coolant temperature 45 °C, derating approx. 4 %		3/123, 3/130, 3/139, 4/26, 6/94, 6/100, 6/104, 6/108, 6/114

Index of order codes

Order code	Special versions	Category	For further information, see page
N06	Temperature class 155 (F), utilized acc. to 130 (B), coolant temperature 50 °C, derating approx. 8 %	Windings and insulation	3/123, 3/130, 3/139, 4/26, 6/94, 6/100, 6/104, 6/108, 6/114
N07	Temperature class 155 (F), utilized acc. to 130 (B), coolant temperature 55 °C, derating approx. 13 %		3/123, 3/130, 3/139, 4/26, 6/94, 6/100, 6/104, 6/108, 6/114
N08	Temperature class 155 (F), utilized acc. to 130 (B), coolant temperature 60 °C, derating approx. 18 %		3/123, 3/130, 3/139, 4/26, 6/95, 6/100, 6/104, 6/109, 6/114
N10	Temperature class 180 (H)		3/123, 3/130, 3/139, 4/26
N11	Temperature class 180 (H) at rated power and max. CT 60 °C		3/123, 3/130, 3/139, 4/26, 5/65, 5/69
N30	Increased air humidity/temperature with 30 to 60 g water per m ³ of air		3/123, 3/130, 3/139, 4/26, 5/65, 5/69, 5/122, 5/127, 6/95, 6/100, 6/104, 6/109, 6/114
N31	Increased air humidity/temperature with 60 to 100 g water per m ³ of air		3/123, 3/130, 3/139, 4/27, 5/65, 5/69, 5/127, 6/95, 6/100, 6/104, 6/109, 6/114
Q01	Measuring nipple for SPM shock pulse measurement for bearing inspection	Bearings and lubrication	3/126, 3/134, 3/141, 4/30, 5/66, 5/70, 5/124, 5/128, 6/96, 6/101, 6/105, 6/110, 6/116
Q02	Anti-condensation heating for 230 V (2 terminals)	Heating and ventilation	3/126, 3/135, 3/142, 4/31, 5/66, 5/71, 5/124, 5/129, 6/97, 6/102, 6/106, 6/111, 6/116
Q03	Anti-condensation heating for 115 V (2 terminals)		3/126, 3/135, 3/142, 4/31, 5/66, 5/71, 5/124, 5/129, 6/97, 6/102, 6/106, 6/111, 6/116
Q04	Anti-condensation heating for 220 V (2 terminals)		6/111
Q06	Anti-condensation heating for 400 V (2 terminals)		4/31, 6/116
Q11	1 or 3 PTC thermistors – for tripping (2 terminals)	Motor protection	3/122, 3/129, 3/138, 4/25, 5/64, 5/68, 5/122, 5/126, 6/94, 6/113
Q12	2 or 6 PTC thermistors – for alarm and tripping (4 terminals)		3/122, 3/129, 3/138, 4/25, 5/64, 5/68, 5/122, 5/126, 6/94, 6/113
Q21	3 NTC thermistors – for tripping (6 terminals)		6/113
Q23	1 KTY84-130 temperature sensor (2 terminals)		3/122, 3/129, 3/138, 4/25, 5/64, 5/68, 5/122, 5/126, 6/94, 6/113
Q25	2 KTY84-130 temperature sensors (4 terminals)		3/122, 3/129, 3/138, 4/25, 5/64, 5/68, 5/122, 5/126, 6/94, 6/113
Q31	3 bimetal sensors (NC contacts) for tripping (2 terminals)		3/122, 3/129, 3/138, 4/25, 5/64, 5/68, 5/122, 5/126
Q32	6 bimetal sensors (NC contacts) for alarm and tripping (4 terminals)		3/122, 3/129, 3/138, 4/25, 5/64, 5/68, 5/122, 5/126
Q33	3 bimetal sensors (NC contacts) for tripping (6 terminals)	Motor protection	3/122, 3/129, 3/138, 4/25, 5/64, 5/68, 5/122, 5/126
Q34	6 bimetal sensors (NC contacts) for alarm and tripping (12 terminals)		3/122, 3/129, 3/138, 4/25, 5/64, 5/68, 5/126
Q35	1 Pt1000 resistance thermometer (2 terminals)		3/122, 3/129, 3/138, 4/25, 5/64, 5/68, 5/122, 5/126, 6/94, 6/99, 6/113
Q36	2 Pt1000 resistance thermometers (4 terminals)		3/122, 3/129, 3/138, 4/25, 5/64, 5/68, 5/122, 5/126, 6/94, 6/99, 6/113
Q37	6 Pt1000 resistance thermometer (12 terminals)		6/113
Q60	3 Pt100 resistance thermometers – 2-wire input (6 terminals)		3/122, 3/129, 3/138, 4/25, 5/64, 5/68, 5/122, 5/126, 6/113
Q61	6 Pt100 resistance thermometers – 2-wire input (12 terminals)		3/122, 3/129, 3/138, 4/25, 5/64, 5/122, 6/113
Q62	1 Pt100 resistance thermometer – 2-wire input (2 terminals)		3/122, 3/129, 3/138, 4/25, 5/64, 5/68, 5/122, 5/126, 6/113
Q63	3 Pt100 resistance thermometers – 3-wire input (9 terminals)		3/122, 3/129, 3/138, 4/25, 5/64, 5/68, 5/122, 5/126, 6/113

Appendix

Indexes

Index of order codes

Order code	Special versions	Category	For further information, see page
Q64	6 Pt100 resistance thermometers – 3-wire input (18 terminals)	Motor protection	3/122, 3/129, 3/138, 4/25, 5/64, 5/68, 5/122, 5/126, 6/113
Q72	2 Pt100 resistance thermometers in basic configuration for bearings (2 terminals)		3/122, 3/129, 3/138, 4/25, 5/64, 5/68, 5/122, 5/126, 6/99, 6/104, 6/108, 6/113
Q78	2 Pt100 resistance thermometers in 3-wire input for bearings (6 terminals)		3/122, 3/129, 3/138, 4/25, 5/64, 5/68, 5/122, 5/126, 6/99, 6/104, 6/108, 6/113
Q79	2 Pt100 double resistance thermometers in 3-wire input for bearings (12 terminals)		3/122, 3/129, 3/138, 4/25, 5/64, 5/68, 5/122, 5/126, 6/99, 6/104, 6/108, 6/114
Q80	Extension of the liability for defects period by 12 months to a total of 24 months (2 years) from delivery	Extension of the liability for defects	3/135, 4/31, 5/129, 6/106, 6/111, 6/117
Q81	Extension of the liability for defects period by 18 months to a total of 30 months (2.5 years) from delivery		4/31, 6/117
Q82	Extension of the liability for defects period by 24 months to a total of 36 months (3 years) from delivery		3/135, 4/31, 5/129, 6/106, 6/111, 6/117
Q83	Extension of the liability for defects period by 30 months to a total of 42 months (3.5 years) from delivery		4/31, 6/117
Q84	Extension of the liability for defects period by 36 months to a total of 48 months (4 years) from delivery		4/31, 6/117
Q85	Extension of the liability for defects period by 48 months to a total of 60 months (5 years) from delivery		4/31, 6/117
R09	Subsequently rotatable main terminal box	Motor connection and terminal boxes	4/25, 6/114
R10	Rotation of the terminal box through 90°, entry from DE		3/122, 3/129, 3/138, 4/25, 5/64, 5/68, 5/122, 5/126, 6/94, 6/99, 6/104, 6/108, 6/114
R11	Rotation of the terminal box through 90°, entry from NDE		3/122, 3/129, 3/138, 4/25, 5/64, 5/68, 5/122, 5/126, 6/94, 6/99, 6/104, 6/108, 6/114
R12	Rotation of the terminal box through 180°		3/122, 3/129, 3/138, 4/25, 5/64, 5/68, 5/122, 5/126, 6/94, 6/99, 6/104, 6/108, 6/114
R13	Terminal box in position 0°; connection from right		3/122, 5/64, 5/122
R14	One EMC cable gland		3/129, 3/138, 4/26, 5/68, 5/126
R15	One metal cable gland		3/122, 3/129, 3/138, 4/26, 5/64, 5/68, 5/122, 5/126, 6/108, 6/114
R16	EMC cable gland, maximum configuration		3/129, 3/138, 4/26, 5/68, 5/126, 6/114
R17	Stud terminal for cable connection, accessories pack (3 items)		3/129, 3/138, 4/26, 5/126, 6/99, 6/114
R18	Metal cable gland, maximum configuration		3/122, 3/129, 3/138, 4/26, 5/64, 5/122, 6/94, 6/99, 6/104, 6/108, 6/114
R19	Saddle terminal for connection without cable lug, accessories pack		3/130, 3/138, 4/26, 5/126, 6/99, 6/104, 6/114
R20	3 cables protruding, 0.5 m long		3/122, 3/130, 3/138, 5/64, 5/122
R21	3 cables protruding, 1.5 m long		3/122, 3/130, 3/138, 4/26, 5/64
R22	6 cables protruding, 0.5 m long		3/122, 3/130, 3/138, 5/64, 5/122
R23	6 cables protruding, 1.5 m long		3/122, 3/130, 3/138, 4/26, 5/64
R24	6 cables protruding, 3 m long		3/123, 3/130, 3/138, 4/26, 5/64
R30	Reduction piece for M cable gland in accordance with British Standard, mounted on both cable entries		3/123, 3/130
R45	1 cable gland, Ex eb, for armored cable, line feeder cable		6/108
R46	2 cable glands, Ex eb, for armored cable, line feeder cable		6/108
R48	Main terminal box in Ex db IIC		6/108
R49	Auxiliary terminal box in Ex db IIC		6/108

Index of order codes

Order code	Special versions	Category	For further information, see page
R50	Larger terminal box	Motor connection and terminal boxes	3/123, 3/130, 3/139, 4/26, 5/64, 5/68, 5/122, 5/126, 6/94, 6/99, 6/104, 6/108, 6/114
R51	Terminal box without cable entry opening		3/130, 3/139, 4/26, 5/68, 5/126
R52	Drilled removable entry plate		3/130, 3/139, 4/26, 5/68, 5/126, 6/104, 6/114
R53	Undrilled removable entry plate		3/130, 3/139, 4/26, 5/68, 5/126, 6/104
R54	Enlarged connection system for main terminal box		6/108
R60	Auxiliary terminal box, aluminum		3/123
R62	Cast-iron auxiliary terminal box (small)		3/130, 3/139, 4/26, 5/68, 5/126, 6/99, 6/104, 6/108, 6/114
R63	Cast-iron auxiliary terminal box (large)		3/139, 4/26, 6/104, 6/108, 6/114
R65	Stainless steel auxiliary terminal box (large)		4/26, 6/114
R67	2 small cast-iron auxiliary terminal boxes		6/104, 6/108
R70	Motor connector Han-Drive 10e for 230 V Δ /400 VY		5/64, 5/122
R71	Motor connector EMC Han-Drive 10e for 230 V Δ /400 VY		3/123, 5/64, 5/122
R72	Small motor connector CQ12 with EMC		3/123
R73	Small motor connector CQ12 without EMC		3/123
S00	Unpainted (only cast-iron parts primed)	Colors and paint finish	3/124, 3/131, 3/139, 4/27, 5/65, 5/69, 5/123, 5/127, 6/95, 6/100, 6/104, 6/109, 6/115
S01	Unpainted, only primed		3/124, 3/131, 3/139, 4/27, 5/65, 5/69, 5/123, 5/127, 6/95, 6/100, 6/104, 6/109, 6/115
S02	Special paint finish C3		3/124, 3/131, 3/139, 4/27, 5/65, 5/69, 5/123, 5/127, 6/95, 6/100, 6/104, 6/109, 6/115
S03	Special paint finish sea air resistant C4		3/124, 3/131, 3/139, 4/27, 5/65, 5/69, 5/123, 5/127, 6/95, 6/100, 6/104, 6/109, 6/115
S04	Special paint finish for use offshore C5		3/131, 3/139, 4/27, 5/69, 5/127, 6/100, 6/104, 6/109, 6/115
S05	Internal coating		3/131, 3/139, 4/27, 5/65, 5/69, 5/123, 5/127, 6/104, 6/109, 6/115
S06	Top coat polyurethane		3/124, 3/131, 3/139, 4/27, 6/95, 6/100, 6/104, 6/109, 6/115
S08	C5mid Special paint system with durability "medium"		3/131, 3/139, 4/27, 5/69, 5/127, 6/100, 6/105, 6/109
S09	CX Special paint system for offshore with durability "high"		3/131, 3/139, 4/27, 5/69, 5/127, 6/100, 6/105, 6/109
Y50 • and spec. power, CT ... °C or IA m above sea level	Temperature class 155 (F), utilized acc. to 130 (B), with higher coolant temperature and/or installation altitude	Windings and insulation	3/123, 3/131, 3/139, 4/27, 6/95, 6/100, 6/109, 6/114
Y52 • and spec. power, CT ... °C or IA m above sea level	Temperature class 155 (F), utilized according to 155 (F), other requirements		3/123, 3/131, 3/139, 4/27
Y53 • and paint finish RAL	Paint finish in other standard RAL colors: RAL 1002, 1013, 1015, 1019, 2003, 2004, 3000, 3007, 5002, 5007, 5009, 5010, 5012, 5015, 5017, 5018, 5019, 6011, 6019, 6021, 7000, 7001, 7004, 7011, 7016, 7022, 7031, 7032, 7033, 7035, 9001, 9002, 9005 (see Catalog Section 1 "Introduction")	Colors and paint finish	3/124, 3/131, 3/140, 4/27, 5/65, 5/69, 5/123, 5/127, 6/95, 6/100, 6/105, 6/109, 6/115

Appendix

Indexes

Index of order codes

Order code	Special versions	Category	For further information, see page
Y56 • and paint finish RAL	Paint finish in special RAL colors: For RAL colors, see "Special paint finish in special RAL colors" (see Catalog Section 1 "Introduction")	Colors and paint finish	3/124, 3/131, 3/140, 4/27, 5/65, 5/69, 5/123, 5/127, 6/95, 6/100, 6/105, 6/109, 6/115
Y58 • and customer specifications	Non-standard cylindrical shaft extension, DE	Shaft and rotor	3/126, 3/134, 3/142, 4/30, 5/66, 5/71, 5/124, 5/129, 6/96, 6/102, 6/106, 6/110, 6/116
Y59 • and customer specifications	Non-standard cylindrical shaft extension, NDE		3/126, 3/135, 3/142, 4/30, 5/66, 5/71, 5/124, 5/129, 6/96, 6/102, 6/106, 6/110, 6/116
Y60 • and customer specifications	Special shaft steel		3/135, 3/142, 4/30, 5/71, 5/129, 6/116
Y61 • and customer specifications	Non-standard threaded through hole (NPT or G thread)	Motor connection and terminal boxes	3/130, 3/139, 4/26, 5/68, 5/126, 6/108, 6/114
Y66 • and paint finish	Non-standard colors Colors see "Paint finish in non-standard colors" (see Catalog Section 1 "Introduction")	Colors and paint finish	3/124, +D94:F251 3/131, 3/140, 4/27, 5/65, 5/69, 5/123, 5/127, 6/95, 6/100, 6/105, 6/109, 6/115
Y68 • and converter type	Operating data such as the B40 order code with alternative SINAMICS converter on the rating plate <ul style="list-style-type: none"> • G120 with PM230 • G120 with PM240 • G120C • G120P with PM230 • G120P with PM240P-2 • G120P with PM330 • G130, G150, G180 • S120 (BLM/SLM) • V20 Operating data such as the B41 order code with alternative SINAMICS converter on the rating plate <ul style="list-style-type: none"> • S120 (ALM) 	Version for converter operation	6/94, 6/99, 6/113
Y70 • and customer specifications	Mounting of a special type of rotary pulse encoder	Special technology	3/132, 4/28, 5/70, 5/128, 6/115
Y74 • and spec. speed rpm	Mounting of rotary pulse encoder HOG 10 DN 1024 I + FSL, (integrated centrifugal switch, speed ... rpm), terminal box moisture protection		3/132, 3/141, 4/28,
Y75 • and spec. power, CT ... °C or IA m above sea level	Temperature class 180 (H), utilized according to 155 (F)	Windings and insulation	3/123, 3/131, 3/139, 4/27,
Y76 • and spec. speed rpm	Mounting of rotary pulse encoder HOG 10 DN 1024 I + FSL, (integrated centrifugal switch, speed ... rpm), terminal box dust protection	Special technology	3/132, 3/141, 4/28,
Y79 • and spec. speed (max. 3) rpm	Mounting of rotary pulse encoder HOG 10 DN 1024 I + ESL 93, (integrated electronic speed switch, speed ... rpm), terminal box dust protection		3/133, 3/141, 4/28,
Y80 • and customer specifications	Additional rating plate with deviating rating plate data	Rating plate and additional rating plates	3/135, 3/142, 4/31, 6/97, 6/102, 6/106, 6/111, 6/117
Y81 • and customer specifications	Separately driven fan with non-standard voltage and/or frequency	Heating and ventilation	3/135, 3/142, 4/31, 5/129, 6/111, 6/116
Y82 • and customer specifications	Additional rating plate with customer specifications	Rating plate and additional rating plates	3/127, 3/135, 3/142, 4/31, 5/67, 5/71, 5/124, 5/129, 6/97, 6/102, 6/106, 6/111, 6/117
Y84 • and customer specifications	Additional information on rating plate and on package label (max. 20 characters)		3/127, 3/135, 3/142, 4/31, 5/67, 5/71, 5/125, 5/129, 6/97, 6/102, 6/106, 6/111, 6/117
Y85 • and customer specifications	Adhesive label, supplied loose (printed with: Article No., Serial No.; 2 lines of text)		3/127, 3/135, 3/142, 4/31, 5/67, 5/71, 5/125, 5/129, 6/117

Rotary inertia (to convert from A to B, multiply by entry in table)

A \ B	lb-in ²	lb-ft ²	lb-in-s ²	lb-ft-s ² slug-ft ²	kg-cm ²	kg-cm-s ²	gm-cm ²	gm-cm-s ²	oz-in ²	oz-in-s ²
lb-in ²	1	6.94×10^{-3}	2.59×10^{-3}	2.15×10^{-4}	2.926	2.98×10^{-3}	2.92×10^3	2.984	16	4.14×10^{-2}
lb-ft ²	144	1	0.3729	3.10×10^{-2}	421.40	0.4297	4.21×10^5	429.71	2304	5.967
lb-in-s ²	386.08	2.681	1	8.33×10^{-2}	1.129×10^3	1.152	1.129×10^6	1.152×10^3	6.177×10^3	16
lb-ft-s ² slug-ft ²	4.63×10^3	32.17	12	1	1.35×10^4	13.825	1.355×10^7	1.38×10^4	7.41×10^4	192
kg-cm ²	0.3417	2.37×10^{-3}	8.85×10^{-4}	7.37×10^{-5}	1	1.019×10^{-3}	1000	1.019	5.46	1.41×10^{-2}
kg-cm-s ²	335.1	2.327	0.8679	7.23×10^{-2}	980.66	1	9.8×10^5	1000	5.36×10^3	13.887
gm-cm ²	3.417×10^{-4}	2.37×10^{-6}	8.85×10^{-7}	7.37×10^{-8}	1×10^{-3}	1.01×10^{-6}	1	1.01×10^{-3}	5.46×10^{-3}	1.41×10^{-5}
gm-cm-s ²	0.335	2.32×10^{-3}	8.67×10^{-4}	7.23×10^{-5}	0.9806	1×10^{-3}	980.6	1	5.36	1.38×10^{-2}
oz-in ²	0.0625	4.34×10^{-4}	1.61×10^{-4}	1.34×10^{-5}	0.182	1.86×10^{-4}	182.9	0.186	1	2.59×10^{-3}
oz-in-s ²	24.13	0.1675	6.25×10^{-2}	5.20×10^{-3}	70.615	7.20×10^{-2}	7.09×10^4	72.0	386.08	1

Torque (to convert from A to B, multiply by entry in table)

A \ B	lb-in	lb-ft	oz-in	N-m	kg-cm	kg-m	gm-cm	dyne-cm
lb-in	1	8.333×10^{-2}	16	0.113	1.152	1.152×10^{-2}	1.152×10^3	1.129×10^6
lb-ft	12	1	192	1.355	13.825	0.138	1.382×10^4	1.355×10^7
oz-in	6.25×10^{-2}	5.208×10^{-3}	1	7.061×10^{-3}	7.200×10^{-2}	7.200×10^{-4}	72.007	7.061×10^4
N-m	8.850	0.737	141.612	1	10.197	0.102	1.019×10^4	1×10^7
kg-cm	0.8679	7.233×10^{-2}	13.877	9.806×10^{-2}	1	10^{-2}	1000	9.806×10^5
kg-m	86.796	7.233	1.388×10^3	9.806	100	1	1×10^5	9.806×10^7
gm-cm	8.679×10^{-4}	7.233×10^{-5}	1.388×10^{-2}	9.806×10^{-5}	1×10^{-3}	1×10^{-5}	1	980.665
dyne-cm	8.850×10^{-7}	7.375×10^{-8}	1.416×10^{-5}	10^{-7}	1.0197×10^{-6}	1.019×10^{-8}	1.019×10^{-3}	1

Length (to convert from A to B, multiply by entry in table)

A \ B	inches	feet	cm	yd	mm	m
inches	1	0.0833	2.54	0.028	25.4	0.0254
feet	12	1	30.48	0.333	304.8	0.3048
cm	0.3937	0.03281	1	1.09×10^{-2}	10	0.01
yd	36	3	91.44	1	914.4	0.914
mm	0.03937	0.00328	0.1	1.09×10^{-3}	1	0.001
m	39.37	3.281	100	1.09	1000	1

Force (to convert from A to B, multiply by entry in table)

A \ B	lb	oz	gm	dyne	N
lb	1	16	453.6	4.448×10^5	4.4482
oz	0.0625	1	28.35	2.780×10^4	0.27801
gm	2.205×10^{-3}	0.03527	1	1.02×10^{-3}	N.A.
dyne	2.248×10^{-6}	3.59×10^{-5}	980.7	1	0.00001
N	0.22481	3.5967	N.A.	100000	1

Power (to convert from A to B, multiply by entry in table)

A \ B	hp	Watts
hp (English)	1	745.7
(lb-in) (deg./s)	2.645×10^{-6}	1.972×10^{-3}
(lb-in) (rpm)	1.587×10^{-5}	1.183×10^{-2}
(lb-ft) (deg./s)	3.173×10^{-5}	2.366×10^{-2}
(lb-ft) (rpm)	1.904×10^{-4}	0.1420
Watts	1.341×10^{-3}	1

Mass (to convert from A to B, multiply by entry in table)

A \ B	lb	oz	gm	kg	slug
lb	1	16	453.6	0.4536	0.0311
oz	6.25×10^{-2}	1	28.35	0.02835	1.93×10^{-3}
gm	2.205×10^{-3}	3.527×10^{-2}	1	10^{-3}	6.852×10^{-5}
kg	2.205	35.27	10^3	1	6.852×10^{-2}
slug	32.17	514.8	1.459×10^4	14.59	1

Rotation (to convert from A to B, multiply by entry in table)

A \ B	rpm	rad/s	degrees/s
rpm	1	0.105	6.0
rad/s	9.55	1	57.30
degrees/s	0.167	1.745×10^{-2}	1

Appendix

Conversion tables

Temperature Conversion

°F	°C	°C	°F
0	-17.8	-10	14
32	0	0	32
50	10	10	50
70	21.1	20	68
90	32.2	30	86
98.4	37	37	98.4
212	100	100	212
subtract 32 and multiply by $\frac{5}{9}$		multiply by $\frac{9}{5}$ and add 32	

Mechanism Efficiencies

Acme-screw with brass nut	~0.35–0.65
Acme-screw with plastic nut	~0.50–0.85
Ball-screw	~0.85–0.95
Chain and sprocket	~0.95–0.98
Preloaded ball-screw	~0.75–0.85
Spur or bevel-gears	~0.90
Timing belts	~0.96–0.98
Worm gears	~0.45–0.85
Helical gear (1 reduction)	~0.92

Friction Coefficients

Materials	μ
Steel on steel (greased)	~0.15
Plastic on steel	~0.15–0.25
Copper on steel	~0.30
Brass on steel	~0.35
Aluminum on steel	~0.45
Steel on steel	~0.58
Mechanism	μ
Ball bushings	<0.001
Linear bearings	<0.001
Dove-tail slides	~0.2++
Gibb ways	~0.5++

Material Densities

Material	lb-in ³	gm-cm ³
Aluminum	0.096	2.66
Brass	0.299	8.30
Bronze	0.295	8.17
Copper	0.322	8.91
Hard wood	0.029	0.80
Soft wood	0.018	0.48
Plastic	0.040	1.11
Glass	0.079–0.090	2.2–2.5
Titanium	0.163	4.51
Paper	0.025–0.043	0.7–1.2
Polyvinyl chloride	0.047–0.050	1.3–1.4
Rubber	0.033–0.036	0.92–0.99
Silicone rubber, without filler	0.043	1.2
Cast iron, gray	0.274	7.6
Steel	0.280	7.75

Wire Gauges¹⁾

Cross-section mm ²	Standard Wire Gauge (SWG)	American Wire Gauge (AWG)
0.2	25	24
0.3	23	22
0.5	21	20
0.75	20	19
1.0	19	18
1.5	17	16
2.5	15	13
4	13	11
6	12	9
10	9	7
16	7	6
25	5	3
35	3	2
50	0	1/0
70	000	2/0
95	00000	3/0
120	0000000	4/0
150	–	6/0
185	–	7/0

¹⁾ The table shows approximate SWG/AWG sizes nearest to standard metric sizes; the cross-sections do not match exactly.

Explanation of the raw material/metal surcharges¹⁾

Surcharge calculation

To compensate for variations in the price of the raw materials silver, copper, aluminum, lead, gold, dysprosium²⁾ and/or neodym²⁾, surcharges are calculated on a daily basis using the so-called metal factor for products containing these raw materials. A surcharge for the respective raw material is calculated as a supplement to the price of a product if the basic official price of the raw material in question is exceeded.

The surcharges are calculated in accordance with the following criteria:

- Basic official price of the raw material
Basic official price from the day prior to receipt of the order or prior to release order (daily price) for³⁾
 - Silver (sales price, processed)
 - Gold (sales price, processed)
 and for⁴⁾
 - Copper (lower DEL notation + 1 %)
 - Aluminum (aluminum in cables)
 - Lead (lead in cables)
- Metal factor of the products
Certain products are displayed with a metal factor. The metal factor determines the official price (for those raw materials concerned) as of which the metal surcharges are applied and the calculation method used (weight or percentage method). An exact explanation is given below.

Structure of the metal factor

The metal factor consists of several digits; the first digit indicates whether the percentage method of calculation refers to the list price or a possible discounted price (customer net price) (L = list price / N = customer net price).

The remaining digits indicate the method of calculation used for the respective raw material. If no surcharge is added for a raw material, a "-" is used.

1st digit	List or customer net price using the percentage method
2nd digit	for silver (AG)
3rd digit	for copper (CU)
4th digit	for aluminum (AL)
5th digit	for lead (PB)
6th digit	for gold (AU)
7th digit	for dysprosium (Dy) ²⁾
8th digit	for neodym (Nd) ²⁾

Weight method

The weight method uses the basic official price, the daily price and the raw material weight. In order to calculate the surcharge, the basic official price must be subtracted from the daily price. The difference is then multiplied by the raw material weight.

The basic official price can be found in the table below using the number (1 to 9) of the respective digit of the metal factor. The raw material weight can be found in the respective product descriptions.

Percentage method

Use of the percentage method is indicated by the letters A-Z at the respective digit of the metal factor.

The surcharge is increased - dependent on the deviation of the daily price compared with the basic official price - using the percentage method in "steps" and consequently offers surcharges that remain constant within the framework of this "step range". A higher percentage rate is charged for each new step. The respective percentage level can be found in the table below.

Metal factor examples

LEA -----	<ul style="list-style-type: none"> Basis for % surcharge: List price Silver Basis 150 €, Step 50 €, 0.5 % Copper Basis 150 €, Step 50 €, 0.1 % No surcharge for aluminum No surcharge for lead No surcharge for gold No surcharge for dysprosium No surcharge for neodym
N-A6 -----	<ul style="list-style-type: none"> Basis for % surcharge: Customer net price No surcharge for silver Copper Basis 150 €, Step 50 €, 0.1 % Aluminum acc. to weight, basic offic. price 225 € No surcharge for lead No surcharge for gold No surcharge for dysprosium No surcharge for neodym
--- 3 -----	<ul style="list-style-type: none"> No basis necessary No surcharge for silver Copper acc. to weight, basic official price 150 € No surcharge for aluminum No surcharge for lead No surcharge for gold No surcharge for dysprosium No surcharge for neodym

1) Refer to the separate explanation on the next page regarding the raw materials dysprosium and neodym (= rare earths).

2) For a different method of calculation, refer to the separate explanation for these raw materials on the next page.

3) Source: Umicore, Hanau (www.metalsmanagement.umicore.com).

4) Source: Schutzvereinigung DEL-Notiz e.V. (www.del-notiz.org).

Appendix

Metal surcharges

Explanation of the raw material/metal surcharges for dysprosium and neodym (rare earths)

Surcharge calculation

To compensate for variations in the price of the raw materials silver¹⁾, copper¹⁾, aluminum¹⁾, lead¹⁾, gold¹⁾, dysprosium and/or neodym, surcharges are calculated on a daily basis using the so-called metal factor for products containing these raw materials. The surcharge for dysprosium and neodym is calculated as a supplement to the price of a product if the basic official price of the raw material in question is exceeded.

The surcharge is calculated in accordance with the following criteria:

- Basic official price of the raw material²⁾
Three-month basic average price (see below) in the period before the quarter in which the order was received or the release order took place (= average official price) for
 - dysprosium (Dy metal, 99 % min. FOB China; USD/kg)
 - neodym (Nd metal, 99 % min. FOB China; USD/kg)
- Metal factor of the products
Certain products are displayed with a metal factor. The metal factor indicates (for those raw materials concerned) the basic official price as of which the surcharges for dysprosium and neodym are calculated using the weight method. An exact explanation of the metal factor is given below.

Three-month average price

The prices of rare earths vary according to the foreign currency, and there is no freely accessible stock exchange listing. This makes it more difficult for all parties involved to monitor changes in price. In order to avoid continuous adjustment of the surcharges, but to still ensure fair, transparent pricing, an average price is calculated over a three-month period using the average monthly foreign exchange rate from USD to EUR (source: European Central Bank). Since not all facts are immediately available at the start of each month, a one-month buffer is allowed before the new average price applies.

Examples of calculation of the average official price:

Period for calculation of the average price:	Period during which the order/release order is effected and the average price applies:
Sep 2012 - Nov 2012	Q1 in 2013 (Jan - Mar)
Dec 2012 - Feb 2013	Q2 in 2013 (Apr - Jun)
Mar 2013 - May 2013	Q3 in 2013 (Jul - Sep)
Jun 2013 - Aug 2013	Q4 in 2013 (Oct - Dec)

Structure of the metal factor

The metal factor consists of several digits; the first digit is not relevant to the calculation of dysprosium and neodym.

The remaining digits indicate the method of calculation used for the respective raw material. If no surcharge is added for a raw material, a "-" is used.

1st digit	List or customer net price using the percentage method
2nd digit	for silver (AG) ¹⁾
3rd digit	for copper (CU) ¹⁾
4th digit	for aluminum (AL) ¹⁾
5th digit	for lead (PB) ¹⁾
6th digit	for gold (AU) ¹⁾
7th digit	for dysprosium (Dy)
8th digit	for neodym (Nd)

Weight method

The weight method uses the basic official price, the average price and the raw material weight. In order to calculate the surcharge, the basic official price must be subtracted from the average price. The difference is then multiplied by the raw material weight.

The basic official price can be found in the table below using the number (1 to 9) of the respective digit of the metal factor. Your Sales contact can inform you of the raw material weight.

Metal factor examples

-----71	No basis necessary
	No surcharge for silver
	No surcharge for copper
	No surcharge for aluminum
	No surcharge for lead
	No surcharge for gold
	Dysprosium acc. to weight, basic official price 300 €
	Neodym acc. to weight, basic official price 50 €

1) For a different method of calculation, refer to the separate explanation for these raw materials on the previous page.

2) Source: Asian Metal Ltd (www.asianmetal.com)

Values of the metal factor

Percentage method	Basic official price in €	Step range in €	% surcharge 1st step	% surcharge 2nd step	% surcharge 3rd step	% surcharge 4th step	% surcharge per additional step	
			Price in €	Price in €	Price in €	Price in €		
			150.01 - 200.00	200.01 - 250.00	250.01 - 300.00	300.01 - 350.00		
A	150	50	0.1	0.2	0.3	0.4	0.1	
B	150	50	0.2	0.4	0.6	0.8	0.2	
C	150	50	0.3	0.6	0.9	1.2	0.3	
D	150	50	0.4	0.8	1.2	1.6	0.4	
E	150	50	0.5	1.0	1.5	2.0	0.5	
F	150	50	0.6	1.2	1.8	2.4	0.6	
G	150	50	1.0	2.0	3.0	4.0	1.0	
H	150	50	1.2	2.4	3.6	4.8	1.2	
I	150	50	1.6	3.2	4.8	6.4	1.6	
J	150	50	1.8	3.6	5.4	7.2	1.8	
			175.01 - 225.00	225.01 - 275.00	275.01 - 325.00	325.01 - 375.00		
O	175	50	0.1	0.2	0.3	0.4	0.1	
P	175	50	0.2	0.4	0.6	0.8	0.2	
R	175	50	0.5	1.0	1.5	2.0	0.5	
			225.01 - 275.00	275.01 - 325.00	325.01 - 375.00	375.01 - 425.00		
S	225	50	0.2	0.4	0.6	0.8	0.2	
U	225	50	1.0	2.0	3.0	4.0	1.0	
V	225	50	1.0	1.5	2.0	3.0	1.0	
W	225	50	1.2	2.5	3.5	4.5	1.0	
			150.01 - 175.00	175.01 - 200.00	200.01 - 225.00	225.01 - 250.00		
Y	150	25	0.3	0.6	0.9	1.2	0.3	
			400.01 - 425.00	425.01 - 450.00	450.01 - 475.00	475.01 - 500.00		
Z	400	25	0.1	0.2	0.3	0.4	0.1	
Price basis (1st digit)								
L	Calculation based on the list price							
N	Calculation based on the customer net price (discounted list price)							
Weight method	Basic official price in €							
1	50	Calculation based on raw material weight						
2	100							
3	150							
4	175							
5	200							
6	225							
7	300							
8	400							
9	555							
Miscellaneous								
-	No metal surcharge							

Appendix

Conditions of sale and delivery

1. General Provisions

By using this catalog you can purchase products (hardware, software and services) described therein from Siemens Aktiengesellschaft subject to the following Terms and Conditions of Sale and Delivery (hereinafter referred to as "T&C"). Please note that the scope, the quality and the conditions for supplies and services, including software products, by any Siemens entity having a registered office outside Germany, shall be subject exclusively to the General Terms and Conditions of the respective Siemens entity. The following T&C apply exclusively for orders placed with Siemens Aktiengesellschaft, Germany.

1.1 For customers with a seat or registered office in European Union

For customers with a seat or registered office in European Union, the following terms and conditions apply subordinate to T&C:

- for products, which include specific terms and conditions in the description text, these specific terms and conditions shall apply and subordinate thereto,
- for stand-alone software products and software products forming a part of a product or project, the "General License Conditions for Software Products for Automation and Drives for Customers with a Seat or registered Office in Germany"¹⁾ and/or
- for consulting services the "Allgemeine Geschäftsbedingungen für Beratungsleistungen der Division DF – Deutschland" (available only in German) and/or
- for other services, the „Supplementary Terms and Conditions for Services ("BL")"¹⁾ and/or
- for other supplies the "General Conditions for the Supply of Products and Services of the Electrical and Electronics Industry"¹⁾.

In case such supplies should contain Open Source Software, the conditions of which shall prevail over the "General Conditions for the Supply of Products and Services of the Electrical and Electronics Industry"¹⁾, a notice will be contained in the scope of delivery in which the applicable conditions for Open Source Software are specified. This shall apply mutatis mutandis for notices referring to other third party software components.

1.2 For customers with a seat or registered office outside Germany

For customers with a seat or registered office outside European Union, the following terms and conditions apply subordinate to T&C:

- for products, which include specific terms and conditions in the description text, these specific terms and conditions shall apply and subordinate thereto,
- for consulting services the "Standard Terms and Conditions for Consulting Services of the Division DF for Customers with a Seat or Registered Office Outside of Germany"¹⁾ and/or
- for other services the "International Terms & Conditions for Services"¹⁾ supplemented by "Software Licensing Conditions"¹⁾ and/or
- for other supplies of hard- and software the "International Terms & Conditions for Products"¹⁾ supplemented by "Software Licensing Conditions"¹⁾

1.3 For customers with master or framework agreement

To the extent our supplies and/or services offered are covered by an existing master or framework agreement, the terms and conditions of that agreement shall apply instead of T&C.

2. Prices

The prices are in € (Euro) ex point of delivery, exclusive of packaging.

The sales tax (value added tax) is not included in the prices. It shall be charged separately at the respective rate according to the applicable statutory legal regulations.

Prices are subject to change without prior notice. We will charge the prices valid at the time of delivery.

To compensate for variations in the price of raw materials (e.g. silver, copper, aluminum, lead, gold, dysprosium and neodym), surcharges are calculated on a daily basis using the so-called metal factor for products containing these raw materials.

A surcharge for the respective raw material is calculated as a supplement to the price of a product if the basic official price of the raw material in question is exceeded.

The metal factor of a product indicates the basic official price (for those raw materials concerned) as of which the surcharges on the price of the product are applied, and with what method of calculation.

You will find a detailed explanation of the metal factor on the page headed "Metal surcharges".

To calculate the surcharge (except in the cases of dysprosium and neodym), the official price from the day prior to that on which the order was received or the release order was effected is used.

To calculate the surcharge applicable to dysprosium and neodym ("rare earths"), the corresponding three-month basic average price in the quarter prior to that in which the order was received or the release order was effected is used with a one-month buffer (details on the calculation can be found in the explanation of the metal factor).

3. Additional Terms and Conditions

The dimensions are in mm. In Germany, according to the German law on units in measuring technology, data in inches apply only to devices for export.

Illustrations are not binding.

Insofar as there are no remarks on the individual pages of this catalog – especially with regard to data, dimensions and weights given – these are subject to change without prior notice.

¹⁾ The text of the Terms and Conditions of Siemens AG can be downloaded at https://mall.industry.siemens.com/legal/ww/en/terms_of_trade_en.pdf

4. Export Regulations

We shall not be obligated to fulfill any agreement if such fulfillment is prevented by any impediments arising out of national or international foreign trade or customs requirements or any embargoes and/or other sanctions.

Export may be subject to license. We shall indicate in the delivery details whether licenses are required under German, European and US export lists.

Our products are controlled by the U.S. Government (when labeled with "ECCN" unequal "N") and authorized for export only to the country of ultimate destination for use by the ultimate consignee or end-user(s) herein identified. They may not be resold, transferred, or otherwise disposed of, to any other country or to any person other than the authorized ultimate consignee or end-user(s), either in their original form or after being incorporated into other items, without first obtaining approval from the U.S. Government or as otherwise authorized by U.S. law and regulations. Products labeled with "AL" unequal "N" are subject to European / national export authorization.

The export indications can be viewed in advance in the description of the respective goods on the Industry Mall, our online catalog system. Only the export labels "AL" and "ECCN" indicated on order confirmations, delivery notes and invoices are authoritative.

Products without label, with label "AL:N" / "ECCN:N", or label "AL:9X9999" / "ECCN: 9X9999" may require authorization from responsible authorities depending on the final end-use, or the destination.

If you transfer goods (hardware and/or software and/or technology as well as corresponding documentation, regardless of the mode of provision) delivered by us or works and services (including all kinds of technical support) performed by us to a third party worldwide, you shall comply with all applicable national and international (re-)export control regulations. In any event of such transfer of goods, works and services you shall comply with the (re-) export control regulations of the Federal Republic of Germany, of the European Union and of the United States of America.

Prior to any transfer of goods, works and services provided by us to a third party you shall in particular check and guarantee by appropriate measures that

- there will be no infringement of an embargo imposed by the European Union, by the United States of America and/ or by the United Nations by such transfer, by brokering of contracts concerning those goods, works and services or by provision of other economic resources in connection with those goods, works and services, also considering the limitations of domestic business and prohibitions of by-passing those embargoes;
- such goods, works and services are not intended for use in connection with armaments, nuclear technology or weapons, if and to the extent such use is subject to prohibition or authorization, unless required authorization is provided;
- the regulations of all applicable Sanctioned Party Lists of the European Union and the United States of America concerning the trading with entities, persons and organizations listed therein are considered.

If required to enable authorities or us to conduct export control checks, you, upon request by us, shall promptly provide us with all information pertaining to the particular end customer, the particular destination and the particular intended use of goods, works and services provided by us, as well as any export control restrictions existing.

You acknowledge that under the EU embargo regulations against Iran, Syria and Russia respectively the sale of certain listed goods and related services is subject to authorization by the competent export control authorities of the European Union. If (i) the goods or services ordered by you are destined for Iran, Syria or Russia, and (ii) the contract for our supplies and/or services is subject to prior authorization of the competent export control authorities of the European Union, the contract between you and us shall come into force in this respect only upon granting of such authorization.

The products listed in this catalog may be subject to European/German and/or US export regulations. Any export requiring approval is therefore subject to authorization by the relevant authorities.

Errors excepted and subject to change without prior notice.

Appendix

Conditions of sale and delivery

Notes

Selection and ordering at Siemens Industry Mall, downloading and ordering catalogs

Easy product selection and ordering: Industry Mall

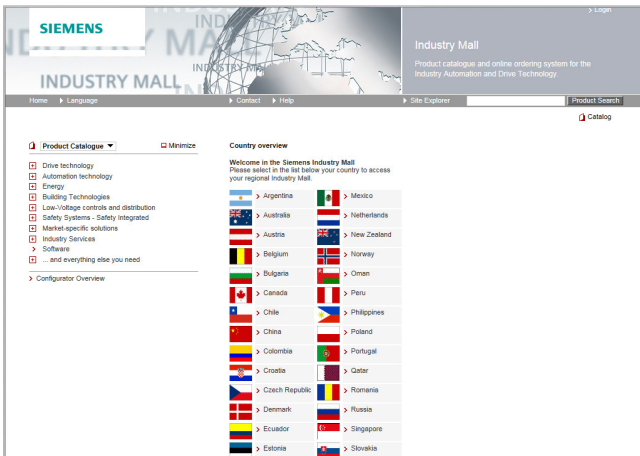

Industry Mall

The Industry Mall is a Siemens AG Internet ordering platform. It provides you with online access to a comprehensive product spectrum that is presented in an informative, well-organized way.

Powerful search functions help you select the required products, while configurators enable you to configure complex product and system components quickly and easily. CAX data are also available for you to use.

Data transfer allows the entire procedure, from selection through ordering to tracking and tracing, to be carried out online. Availability checks, individual customer discounting, and quotation preparation are also possible.

www.siemens.com/industrymall

Downloading catalogs

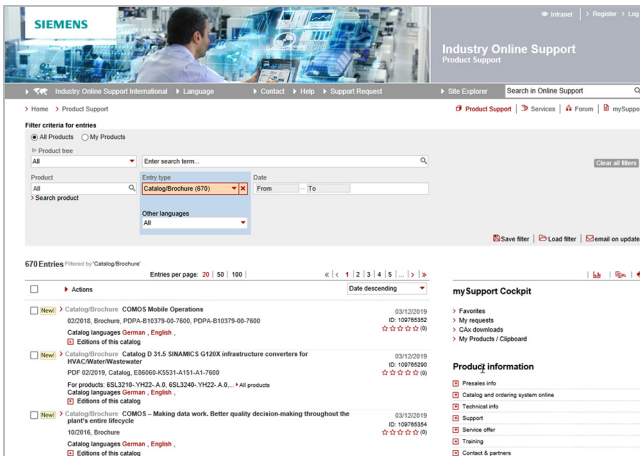

Siemens Industry Online Support

You can download catalogs and brochures in PDF format from Siemens Industry Online Support without having to register.

The filter box makes it possible to perform targeted searches.

www.siemens.com/industry-catalogs

Ordering printed catalogs



Please contact your local Siemens branch if you are interested in ordering printed catalogs.

Addresses can be found at www.siemens.com/automation-contact

Get more information

Siemens Motors:
www.siemens.com/motors

Local partners worldwide:
www.siemens.com/automation-contact

Published by
Siemens AG

For the U.S. published by
Siemens Industry Inc.

Digital Industries
Motion Control
P.O. Box 31 80
91050 Erlangen, Germany

100 Technology Drive
Alpharetta, GA 30005
United States

PDF (Article No. E86060-K5581-A111-B5-7600)
V7.MKKATA.LVM.110
KG 1221 700 En
Produced in Germany
© Siemens 2021

Subject to changes and errors. The information given in this catalog only contains general descriptions and/or performance features which may not always specifically reflect those described, or which may undergo modification in the course of further development of the products. The requested performance features are binding only when they are expressly agreed upon in the concluded contract.

All product designations may be trademarks or product names of Siemens AG or other companies whose use by third parties for their own purposes could violate the rights of the owners.

Security information

Siemens provides products and solutions with industrial security functions that support the secure operation of plants, systems, machines and networks.

In order to protect plants, systems, machines and networks against cyber threats, it is necessary to implement – and continuously maintain – a holistic, state-of-the-art industrial security concept. Siemens' products and solutions constitute one element of such a concept.

Customers are responsible for preventing unauthorized access to their plants, systems, machines and networks. Such systems, machines and components should only be connected to an enterprise network or the internet if and to the extent such a connection is necessary and only when appropriate security measures (e.g. firewalls and/or network segmentation) are in place.

For additional information on industrial security measures that may be implemented, please visit
<https://www.siemens.com/industrialsecurity>

Siemens' products and solutions undergo continuous development to make them more secure. Siemens strongly recommends that product updates are applied as soon as they are available and that the latest product versions are used. Use of product versions that are no longer supported, and failure to apply the latest updates may increase customer's exposure to cyber threats.

To stay informed about product updates, subscribe to the Siemens Industrial Security RSS Feed under
<https://www.siemens.com/industrialsecurity>

Please scan the
QR code for more
information on
Siemens Motors.

