

Instruction Manual for OCM F Measurement Device

(Original Instruction Manual – German)



ab Software-Revisionsnummer 3.13

NIVUS GmbH

Im Taele 2

75031 Eppingen, Germany

Phone +49 (0) 72 62 / 91 91 - 0

Fax +49 (0) 72 62 / 91 91 - 999

E-mail: info@nivus.com

Internet: www.nivus.com

NIVUS AG

Hauptstrasse 49
CH - 8750 Glarus
Tel.: +41 (0)55 6452066
Fax: +41 (0)55 6452014
E-Mail: swiss@nivus.com
Internet: www.nivus.de

NIVUS Sp. z o.o.

ul. Hutnicza 3 / B-18
PL - 81-212 Gdynia
Tel.: +48 (0) 58 7602015
Fax: +48 (0) 58 7602014
E-Mail: poland@nivus.com
Internet: www.nivus.pl

NIVUS Austria

Mühlbergstraße 33B
A-3382 Loosdorf
Tel.: +43 (0)2754 567 63 21
Fax: +43 (0)2754 567 63 20
E-Mail: austria@nivus.com
Internet: www.nivus.de

NIVUS Middle East (FZE)

Building Q 1-1 ap. 055
P.O. Box: 9217
Sharjah Airport International
Free Zone
Tel.: +971 6 55 78 224
Fax: +971 6 55 78 225
E-Mail: Middle-East@nivus.com
Internet: www.nivus.com

NIVUS France

14, rue de la Paix
F - 67770 Sessenheim
Tel.: +33 (0)3 88071696
Fax: +33 (0)3 88071697
E-Mail: france@nivus.com
Internet: www.nivus.com

NIVUS Korea Co. Ltd.

#411 EZEN Techno Zone,
1L EB Yangchon Industrial Complex,
Gimpo-Si
Gyeonggi-Do 415-843,
Tel. +82 31 999 5920
Fax. +82 31 999 5923
E-Mail: korea@nivus.com
Internet: www.nivus.com

NIVUS U.K. Ltd

Wedgewood Rugby Road
Weston under Wetherley
Royal Leamington Spa
CV33 9BW, Warwickshire
Tel.: +44 (0)1926 632470
E-mail: info@nivus.com
Internet: www.nivus.com

NIVUS U.K.

1 Arisaig Close
Eaglescliffe
Stockton on Tees
Cleveland, TS16 9EY
Phone: +44 (0)1642 659294
E-mail: info@nivus.com
Internet: www.nivus.com

Translation

If the device is sold to a country in the European Economic Area (EEA) this instruction handbook must be translated into the language of the country in which the device is to be used.

Should the translated text be unclear, the original instruction handbook (German) must be consulted or the manufacturer contacted for clarification.

Copyright

No part of this publication may be reproduced, transmitted, sold or disclosed without prior permission. Damages will be claimed for violations. All rights reserved.

Names

The use of general descriptive names, trade names, trademarks and the like in this handbook does not entitle the reader to assume they may be used freely by everyone. They are often protected registered trademarks even if not marked as such.

1 Contents

1.1 Table of Contents

1	Contents	4
1.1	Table of Contents	4
2	General	6
3	General Notes on Safety and Danger.....	7
3.1	General Danger Signs.....	7
3.2	Special Danger Notes	7
3.3	Turn-off procedure.....	7
3.4	Device Identification	8
4	Overview and use in accordance with the requirements .9	
4.1	Overview	9
4.2	Use in accordance with the requirements	9
4.3	Specifications	11
4.4	Installation of Spare Parts and Parts subject to Wear and Tear .	11
4.5	User's Responsibility	12
5	Function principle.....	13
5.1	General.....	13
5.2	Level Measurement using Pressure.....	14
5.3	Flow Velocity Detection	15
5.4	Unit Versions	16
6	Storing, Delivery and Transport	17
6.1	Receipt	17
6.2	Delivery	17
6.3	Storing	17
6.4	Transport.....	18
6.5	Return.....	18
7	Installation.....	19
7.1	General.....	19
7.2	Enclosure Dimensions.....	19
7.3	Transmitter Installation and Connection.....	20
7.3.1	General.....	20
7.3.2	Safety Instructions for the Cabling	20
7.3.3	Hints for the avoidance of Electrostatic Discharge (ESD).....	21
7.4	Electrical Installation.....	21
7.4.1	Transmitter Connection	22
7.4.2	KDA Sensor Connection	25
7.5	OCM F Power Supply.....	28
7.6	Overvoltage Protection Precautions.....	29
7.7	Regulator Mode.....	32
7.7.1	General.....	32
7.7.2	Construction of Measurement Section and Control Section	33
7.7.3	Connection for Controller Operation	34
7.7.4	Control Algorithm.....	35
8	Initial start-up.....	36
8.1	Notes to the User	36
8.2	General Principles	36
8.3	Keypad	37
8.4	Display.....	37
8.5	Operation Basics	39

9	Parameter Setting	40
9.1	Basics	40
9.2	Operation Mode (RUN)	41
9.3	Display Menu (EXTRA)	44
9.4	Parameter Menu (PAR)	47
9.4.1	Parameter Menu „Measurement Place“	47
9.4.2	Parameter Menu “Level“	51
9.4.3	Information on how to connect i-Series sensors	54
9.4.4	Parameter Menu „Flow Velocity“	55
9.4.5	Parameter Menu „Digital Inputs“	55
9.4.6	Parameter Menu “Analog Outputs“	57
9.4.7	8.4.6 Parameter Menu “Relays“	60
9.4.8	Parameter Menu “Control Unit“	62
9.4.9	Parameter Menu „Setup Parameter“	65
9.5	Signal Input-/Output Menu (I/O)	67
9.5.1	I/O Menu “Digital Inputs“	67
9.5.2	I/O Menu “Analog Outputs“	67
9.5.3	I/O Menu „Digital Outputs“	68
9.5.4	I/O Menu „Measurement Data“	68
9.5.5	I/O Menu “Sensor-Info“	69
9.5.6	I/O-Menu „v-Histogram“	69
9.5.7	I/O Menu “External Level“	70
9.5.8	I/O Menu “Control Unit“	71
9.5.9	I/O Menu “Test control unit – manual mode“	71
9.6	Calibration and Calculation Menu (CAL)	72
9.6.1	CAL Menu “Level“	72
9.6.2	CAL Menu “Flow Velocity“	73
9.6.3	CAL Menu “Analog Outputs“	77
9.6.4	Basic Hints on Simulation:	77
9.6.5	CAL Menu „Digital outputs“	79
9.6.6	CAL Menu „Simulation“	79
9.7	Parameter storage	80
10	Parameter tree	82
11	Troubleshooting	88
12	Verification of the Measurement System	91
12.1	General	91
12.2	Verification of Combi Sensor with Pressure Measurement Cell	91
12.3	Verification of external Level Measurement	92
12.4	Verification and Simulation of Input and Output Signals	93
12.5	Verification of Flow Velocity Measurement	93
13	Maintenance and Cleaning	94
13.1	General Maintenance	94
13.2	KDA-Sensor	94
13.3	Accessories (optional)	95
14	Table „Manning - Strickler Coefficients“	96
15	Emergency	97
16	Dismantling/Disposal	97
17	Table of Pictures	97
18	Index	100
19	Certificates and Approvals	101

2 General



Important

READ CAREFULLY BEFORE USE

KEEP IN A SAFE PLACE FOR LATER REFERENCE

This Instruction manual for the measurement transmitter OCM F is intended for the initial start-up of the unit depicted on the title page.
Read the instructions carefully prior to use.

This Instruction manual is part of the OCM F delivery and shall be available to users at any time. The safety instructions contained therein must be followed.
In case of selling the OCM F this technical description must be provided to the purchaser.

The operation of the complete system is described in the separate manual >Technical Instruction for Doppler Sensors< and >Installation Instructions for Correlation and Doppler Sensors<.

Instructions on how to connect external level sensors are provided with the standard delivery of the according sensors (e.g. NivuCompact, i-Series sensors...).

3 General Notes on Safety and Danger

3.1 General Danger Signs



Cautions

are framed and labelled with a warning triangle.

This indicates an immediate high risk threatening life and limb.



Danger by electric voltage

is framed and labelled with the Symbol on the left.



Warnings

are framed and labelled with a "STOP"-sign.

This indicates a possible risk to persons as well as possible damage to facilities and material.



Notes

are framed and labelled with a "hand"

For connection, initial start-up and operation of the OCM F the following information and higher legal regulations (e.g. in Germany VDE), such as Ex-regulations as well as safety requirements and regulations in order to avoid accidents, must be kept.

All operations, which go beyond steps to install, to connect or to program the device, must be carried out by NIVUS staff only due to reasons of safety and guarantee.

3.2 Special Danger Notes

WARNING



Germ contamination

Please note that due to the operation in the waste water field the measurement system and cables may be loaded with dangerous disease germs. Respective precautionary measures must be taken to avoid damage to one's health.

3.3 Turn-off procedure



For maintenance, cleaning and repairs (authorised staff personnel only!) the device shall be disconnected from mains.

3.4 Device Identification

The instructions in this manual apply only for the type of device indicated on the title page. The nameplate is fixed on the on the bottom of the device and contains the following:

- Name and address of manufacturer
- CE label
- Type and serial number
- Year of manufacture
- Ex-label (on Ex-version devices only) as mentioned in chapter Special Danger Notes.

It is important for enquiries and replacement part orders to specify article number as well as serial number of the respective transmitter or sensor. This ensures correct and quick processing.

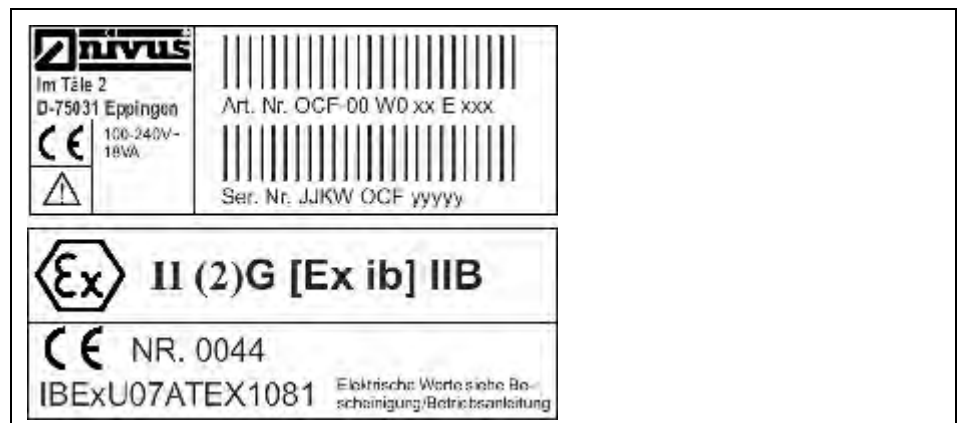


Fig. 3-1 Transmitter nameplate



This instruction manual is a part of the device and must be available for the user at any time.

The safety instructions contained within must be followed.



In addition to this instruction manual please see the "Technical Instruction of Doppler Sensors" as well as the "Installation Instruction for Correlation and Doppler Sensors" to correctly install and to operate the complete system.

WARNING



Do not disable safety devices!

It is strictly prohibited to disable safety measures or to change the way they work!

4 Overview and use in accordance with the requirements

4.1 Overview



- 1 Clear view door
- 2 Display
- 3 Keypad
- 4 Cable Glands
- 5 Terminal Clamp Housing
- 6 USB-B Interface
- 7 Pipe Sensor with retaining element
- 8 Wedge Sensor (Flow Velocity)

Fig. 4-1 Overview

4.2 Use in accordance with the requirements

WARNING



Damage due to improper use

The device is exclusively intended to be used for purposes as described above.

Modifying or using the devices for other purposes without the written consent of the manufacturer will not be considered as use in accordance with the requirements.

Damages resulting from this are left at user's risk.

The device is designed for a lifetime of approx. 10 years. After that period an inspection in addition with a general overhaul has to be made.

The measurement device type OCM F including the respective sensor technology is intended to be used for continuous flow measurement and control tasks of slight to heavy polluted media in part filled and permanent full pipes, channels or similar.

Here the allowed maximum values, as specified in chapter 4.3 shall be strictly kept. All cases which vary from these conditions and are not passed by NIVUS GmbH in writing are left at owner's risk.



Note:

For installation and initial start-up the conformity certificates and test certificates of the respective authorities as well as applicable national regulations shall be followed.



Important Note

The transmitter and the sensors always have to be installed outside of Ex-zones!

Ex Approval

The Ex-version of the transmitter is designed for use in areas featuring explosive atmosphere according to Zone 1.

Transmitter Approval:

 II(2)G [Ex ib] IIB

WARNING



The approval is only valid in connection with the respective indication on the transmitter or the sensor nameplate.

The OCM F Ex version is adjusted to the NIVUS Doppler sensors, type KDA requirements regarding the intrinsically safe system review according to EN 60079-25.

In case of using sensors from third party manufacturers the operator must carry out a system review according to EN 60079-25!

The required specifications of the OCM F Ex version can be taken from the EC-type examination certificate IBEU07ATEX1081.



Note:

The Ex approval of the active sensors is part of the "Technical Instructions for Doppler Sensors".

4.3 Specifications

Power supply	85 to 260 V AC, 47 to 63 Hz or 24 V DC $\pm 15\%$, 5 % residual fluctuation
Power consumption	max. 18 VA (7 VA typical)
Enclosure	- Material: Polycarbonate - Weight: approx. 1200 g - Protection: IP 65 - Mounting: wall or DIN rail mount
Ex-Approval (optional)	II(2)G [Ex ib] IIB
Operating temperature	-20 °C to +60 °C (-4 °F to +140 °F) Ex: -20 °C to +40 °C (-4 °F to +104 °F)
Storage temperature	-30 °C to +70 °C (-22 °F to +158 °F)
Max. humidity	90 %, non-condensing
Display	back-lit full graphic LC display, 128 x 64 pixel
Operation	6 keys, menu driven in German, English, French and Polish
Inputs	- 1 x 4 – 20 mA for external level measurement (2-wire sensor) - 2 x 0/4 – 20 mA, 122 bit resolution for external level measurement and external set points - 4 x digital input - 1 compact Doppler active sensor, type KDA, connectable
Outputs	- 3 x 0/4 – 20 mA, load 500 Ohm, 12 bit resolution, accuracy better than 0.1 % (after adjustment) - 5 switchable relays, loadable up to 230 V AC / 2 A (cos. φ 0,9)
Controller	three-step controller, quick close control, adjustable slide valve position in error case, auto-flush function in case of blocked slide valve

4.4 Installation of Spare Parts and Parts subject to Wear and Tear

We herewith particularly emphasize that replacement parts or accessories, which are not supplied by us, are not certified by us, too. Hence, the installation and/or the use of such products may possibly be detrimental to the device's ability to work.

Damages caused by using non-original parts and non-original accessories are left at user's risk. Appropriate accessories and spare parts can be found in chapter 13.3.

4.5 User's Responsibility



In the EEA (European Economic Area) national implementation of the framework directive 89/391/EEC and corresponding individual directives, in particular the directive 89/655/EEC concerning the minimum safety and health requirements for the use of work equipment by workers at work, as amended, are to be observed and adhered to.

In Germany the Industrial Safety Ordinance must be observed.

The customer must (where necessary) obtain any local **operating permits** required and observe the provisions contained therein. In addition to this, he must observe local laws and regulations on

- personnel safety (accident prevention regulations)
- safety of work materials and tools (safety equipment and maintenance)
- disposal of products (laws on wastes)
- disposal of materials (laws on wastes)
- cleaning (cleansing agents and disposal)
- environmental protection.

Connections

Before operating the device the user has to ensure, that the local regulations (e.g. for operation in channels) on installation and initial start-up are taken into account, if this is both carried out by the user.



This instruction manual is a part of the device and must be available for the user at any time.

The safety instructions contained within must be followed.



In addition to this instruction manual please see the "Technical Instruction of Doppler Sensors" as well as the "Installation Instruction for Correlation and Doppler Sensors" to correctly install and to operate the complete system.



It is strictly prohibited to disable the safety devices or to change the way they work!

5 Function principle

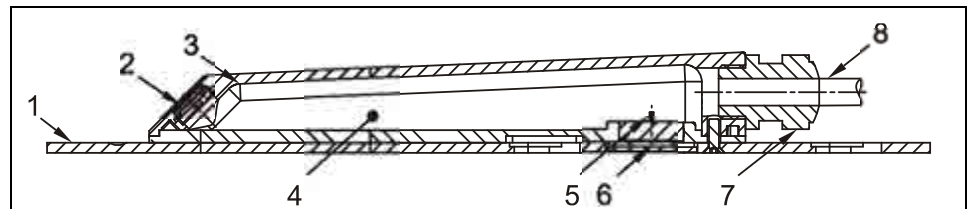
5.1 General

The OCM F is a permanent measurement system for flow measurement and flow control. The device is designed to be used primarily in slight to heavy polluted media with various compositions. It can be operated in partial and permanent filled channels and pipes with various shapes and dimensions.



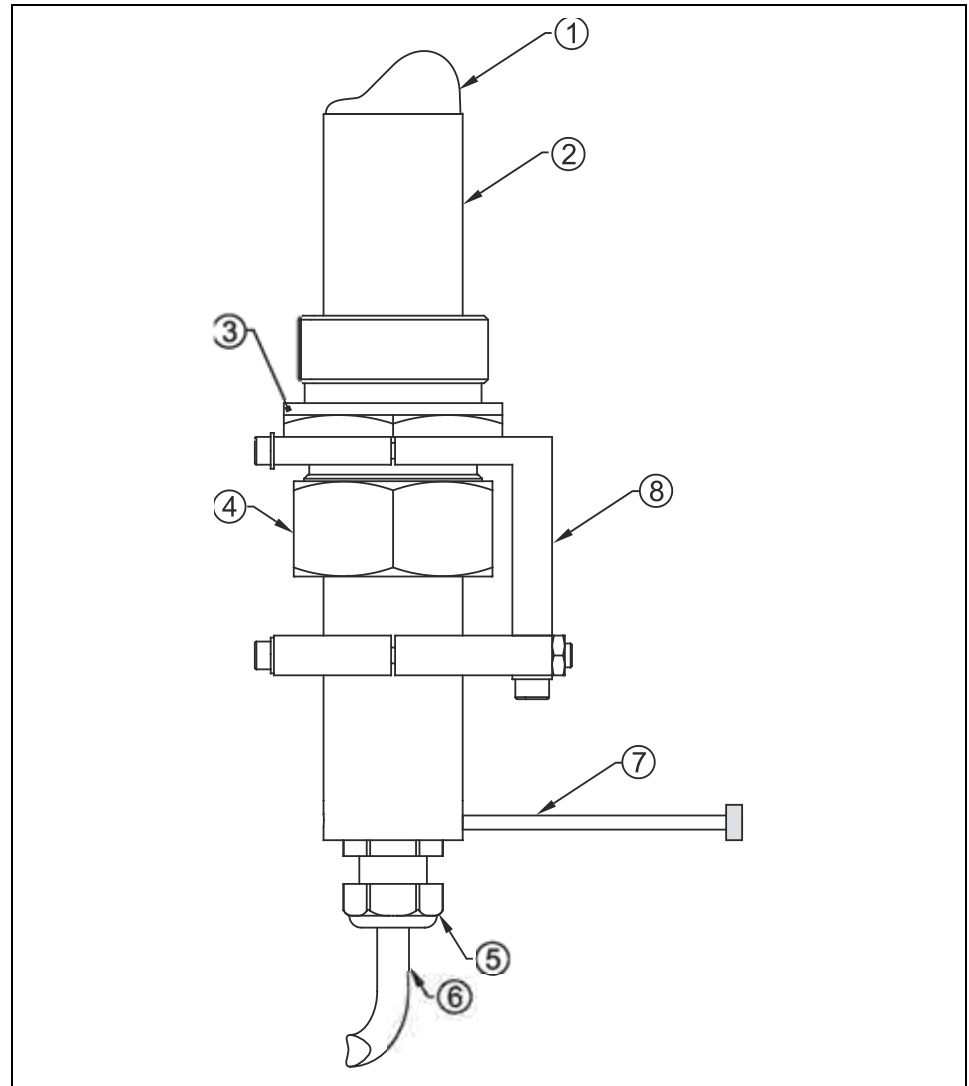
The measurement method is based on the ultrasound Doppler principle. Hence, it is indispensable for the system's capability to work that the water contains particles which are able to reflect the ultrasonic signal sent by the sensor (dirt particles, gas bubbles or similar).

The OCM F utilises an active compact Doppler sensor Type KDA (after this named >KDA sensor<). This KDA sensor is available as flow velocity and combi sensor. The combi sensor Type "KDA" can be combined with a sensor-integrated pressure measurement cell for hydrostatic level measurement.



- 1 Ground plate
- 2 Acoustic coupling layer with sonic converter behind
- 3 Temperature sensor
- 4 Electronics
- 5 Pressure measurement cell (option)
- 6 Duct to pressure measurement (option)
- 7 Cable gland
- 8 Sensor cable

Fig. 5-1 Construction of combi sensor Type "KDA" with additional pressure measurement cell



- 1 Sensor head
- 2 Sensor enclosure
- 3 Double nipple
- 4 Spigot nut
- 5 Cable gland
- 6 Sensor cable
- 7 Adjustment aid (screw M4)
- 8 Retaining element

Fig. 5-2 Construction pipe sensor, type KDA

5.2 Level Measurement using Pressure

The combi sensor type “KDA” additionally contains a hydrostatic level measurement via integrated pressure measurement cell.

The piezo-resistive pressure sensor operates according to the relative pressure principle, i.e. the pressure of the standing water column above the sensor is direct proportional to the flow level.

During initial start-up procedure, the pressure sensor is going to be adjusted by entering a manually investigated reference value.

5.3 Flow Velocity Detection

The flow velocity sensor, type "KDA" operates according to the continuous Doppler principle (CW-Doppler) using 2 built-in piezo crystals with a slope of 45°. The crystal surfaces are arranged parallel to the slope of the flow velocity sensor. One of the crystals continuously operates as ultrasonic transmitter, the other one as receiver detecting the reflected ultrasonic signal.

The sensor enclosure enables acoustic coupling of the high-frequency ultrasonic signal between piezo crystal/enclosure and enclosure/medium. Due to that reason an ultrasonic signal with an angle of 45° is sent permanently against the flow direction of the medium to be measured. As soon as the signal hits dirt particles, gas bubbles or similar a portion of the sonic energy is reflected, being converted into an electric signal by the receiving crystal subsequently.

Caused by the movement of the reflecting particles in relation to the acoustic source the frequency of the ultrasonic signal is shifted. The resulting frequency shift is directly proportional to the particles' movement within the medium and hence represents the flow velocity.

The sensor processes the received reflection signal, converting it to be sent to the transmitter.

Due to varying velocities within the flow profile, vorticity, rotation of single reflecting particles, surface waves etc. a frequency mixture is emerging. This mixture is evaluated directly within the KDA sensor regarding statistic considerations related to average flow velocity. The frequency mixture is indicated on the transmitter display in >I/O / v-Histogram< (see chapter 9.5.6).

It is recommended to verify the measurement if conditions are disadvantageous from a hydraulic standpoint. Verification should not be based on the CW-Doppler method since in this case it is not possible to spatially allocate recorded flow velocities.

In this case the VDI/VDE Directive 2640 is very helpful and important.

NIVUS recommends the portable meter Type >PVM/PD< or >PCM Pro< as calibration measurement or the NIVUS initial start-up service.

5.4 Unit Versions

The OCM F transmitter is available in different versions. The tables below give a brief overview on the various possibilities.

The transmitters primarily vary in terms of power supply and Ex-protection. The current type of device is indicated by the article number, which can be found on a weatherproof label on the bottom of the enclosure.

From this article key the type of device can be specified.

OCF-	Type			
	00	Standard version for various pipe and channel shapes. 5 relays, 3 mA outputs (galv. isolated), 1 mA input (galv. isolated with 2-wire sensor supply) or for external level measurement, integrated 3-step controller		
	Enclosure			
	W0	wall mount IP 65		
Power Supply				
	AC	85 - 265 V AC, 47-63 Hz		
	DC	20 - 28 V DC		
Approvals				
	0	non		
	E	Intrinsically safe sensor supply in Ex zone 1		
OCF-	00	W0		

Fig. 5-3 Type key for OCM F measurement transmitter

6 Storing, Delivery and Transport

6.1 Receipt

Please check your delivery if it is complete and in working order according to the delivery note immediately after receipt. Any damage resulting from transport or transit shall be reported to the carrier instantly. An immediate, written report must be sent to NIVUS GmbH Eppingen as well.

Please report any shortcoming due to delivery to your representative or directly to NIVUS Eppingen within two weeks in writing.



Mistakes cannot be rectified later!

6.2 Delivery

The standard delivery of the OCM F measurement transmitter contains:

- the instruction manual with the certificate of conformity. All required steps to correctly install and to operate the measurement system are listed herein.
- a OCM F transmitter
- a screwdriver with a 2.5 mm (0.098 in) blade for connecting the sensor inside the terminal clamp housing

Additional accessories such as sensors, pressure compensation element (in case of using sensors, type “KDA” with integrated pressure measurement cell →combi sensor), overvoltage protection, separate level measurements etc. depending on order. Please check by using the delivery note.

6.3 Storing

The following storing conditions must be strictly adhered to:

Transmitter:	min. temperature:	- 30 °C (-22 °F)
	max. temperature:	+ 70 °C (158 °F)
	max. humidity:	80 %, non-condensing

KDA-Sensor:	min. temperature:	- 30 °C (-22 °F)
	max. temperature:	+ 70 °C (158 °F)
	max. humidity:	100 %

The devices must be protected from corrosive or organic solvent vapours, radioactive radiation as well as strong electromagnetic radiation.

6.4 Transport

Sensor and Transmitter are conceived for harsh industrial conditions. Despite this do not expose them to heavy shocks or vibrations.
Transportation must be carried out in the original packaging.

6.5 Return

The units must be returned at customer cost to NIVUS Eppingen in the original packaging.
Otherwise the return cannot be accepted!

7 Installation

7.1 General

For electric installation the local regulations in the respective countries (e.g. VDE 0100 in Germany) must be referred to.



The OCM F power supply must be separately protected by a 6 A slow-blow fuse and has to be isolated from other facility parts (separate turn-off, e.g. by using an automatic cut-out with >B< characteristics).

Before feeding the rated voltage the transmitter and sensor installation must be correctly completed. The installation should be carried out by qualified personnel only. Further statutory standards, regulations and technical rulings have to be taken into account.

All outer circuits, wires and lines connected to the device must have a minimum isolation resistance of 250 V. If the voltage exceeds 42 V DC an isolation resistance with 500 kOhm min. will be required.

The cross-sectional dimension of the power supply wires must be 0.75 mm^2 (0.03 in^2) and must be in accordance to IEC 227 or IEC 245. The device protection rating is IP 65.

The maximum allowed switching voltage on the relay contacts must not exceed 250 V. According to Ex protection it must be checked if the devices power supplies must be integrated into the facility's emergency shutdown conception.

7.2 Enclosure Dimensions

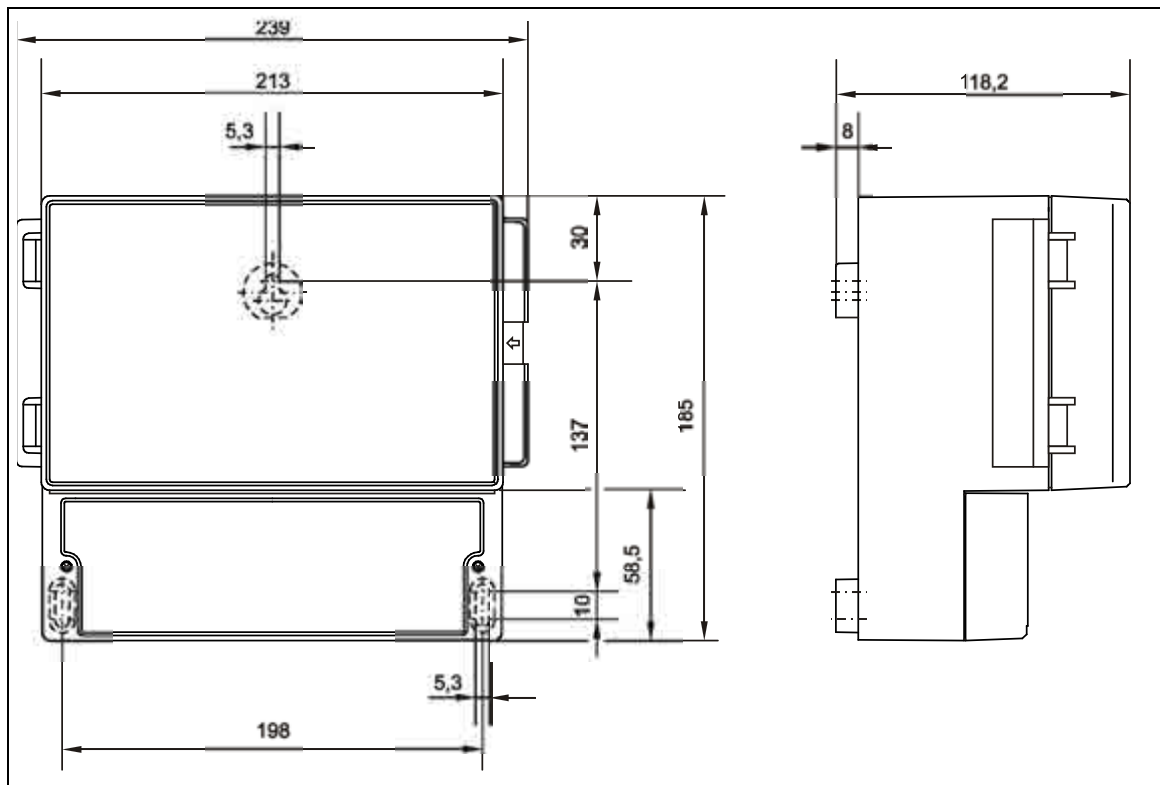


Fig. 7-1 Wall mount enclosure

7.3 Transmitter Installation and Connection



Important Note:

- Ensure the installation is completed properly!
 - Comply with the existing legal and/or operational directives!
 - Improper handling can cause injuries and/or damage to the devices!
-

7.3.1 General

The transmitters mounting place has to be selected according to certain criteria. Please strictly avoid:

- direct sunlight (use weatherproof cover if necessary)
- heat emitting objects (max. ambient temperature: +40 °C (104 °F))
- objects with strong electromagnetic fields (e.g. frequency converters, electric motors with high power consumption or similar)
- corrosive chemicals or gas
- mechanical shocks
- installation close to footpaths or travel ways
- vibrations
- radioactive radiation

The clear view door of the measurement transmitter is provided with a protection foil for protection during transport and from scratches during assembly. This protection foil has to be removed immediately after the assembly.

Clear view door

The clear view door as well as the display of the measurement transmitter is provided with a protection foil for protection during transport and from scratches during assembly. This protection foil has to be removed immediately after the assembly.



If the view door or the display protection foil has been exposed to direct solar radiation for a long period, it cannot be removed easily.

In this case view door or display can be cleaned using spirit or if necessary with car polish. If this is not successful, door or display must be replaced by NIVUS. This service is subject to charge.

7.3.2 Safety Instructions for the Cabling

If connections are placed to the OCM F, the following warnings and information must be observed, in addition to the warnings and information found in the individual chapters for installation.

7.3.3 Hints for the avoidance of Electrostatic Discharge (ESD)



Important Note:

Since the OCM F does not require any power source please disconnect the unit from mains prior to maintenance works to minimise danger and risks due to electrostatic discharge.

The sensitive electronic components inside the device can be damaged by static electricity, which can impair the device performance or even cause the device to fail. The manufacturer recommends the following steps to prevent any damage to the device caused by electrostatic discharges:

- Make sure to discharge any static electricity from your body before touching the electronic modules of the unit (such as circuit boards as well as their components). To do so touch a grounded metallic surface, such as the enclosure frame or a metal pipe.
- Avoid any unnecessary movements to prevent built-up static charges.
- Use antistatic containers or packaging to transport the static sensitive components.
- Prevent damage to internal electronics from electrostatic discharges (ESD) by discharging your body to a grounding point (e.g. use of wrist strap)
- Do not touch components sensitive to static electricity outside of antistatic working areas. Always use antistatic floor covering and working surfaces if possible.

7.4 Electrical Installation



Important Note:

All installation work, which is described in the following section, must be carried out by NIVUS staff only due to reasons of safety and guarantee.

7.4.1 Transmitter Connection



Important Note:

Each time before opening the enclosure please ensure to disconnect the measurement system from any voltage.



Important Note

Never remove the faceplate!



Important Note

Water or dirt must not leak into the terminal housing. Please seal the housing with the supplied lid and both screws respectively.

Installation Wall Mount Enclosure:

Ensure the installation is completed properly!

The most simple way to install a wall mount enclosure is to fasten a DIN rail with a length of 210 mm (8.3 in.) and then to snap-on the enclosure.

It is possible to install the enclosure by using 3 screws as well. Use a pan head screw with a head diameter of 5.5 ... 8.0 mm (0.22 ... 0.32 in.) for this. This screw must be screwed into the mounting plate protruding 4 mm (0.16 in.). Then hang the enclosure on the screw and additionally fix it with 2 more screws from the terminal clamp housing. Please observe to screw them at least 40 mm into the wall or 50 mm into appropriate dowels (to be set).

General

The wall mount enclosure can be equipped with cable glands and comes with following installation parts:

- 1 glands M16 x 1.5
- 2 glands M20 x 1.5

With the supplied glands the following outer cable cross-sections can be connected reliably:

- M16 x 1,5 3,5 mm – 10,5 mm
- M20 x 1,5 6,0 mm – 14,0 mm

To be able to use cable diameters outside of the tolerance, glands must be used which ensure IP 65 minimum protection. Unused lead-ins have to be locked with an appropriate dummy plug before the initial start-up.

In terms of electric connection please note the device configuration since unspecified inputs, outputs as well as power supply connections are not connected.



Important note

Before the first connection it is necessary to have a slight pressure on the screw of the clamping connection to ensure safe opening and a correct connection. All further clamps are tension spring clamps with screw clamps.

On power supply and relay clamps one copper wire with a maximum cross-section of 2.5 mm² (0.01 in.) can be connected per clamp. Connection is made by using terminal clamps and a screwdriver with a 3.5 mm (0.14 in.) blade.

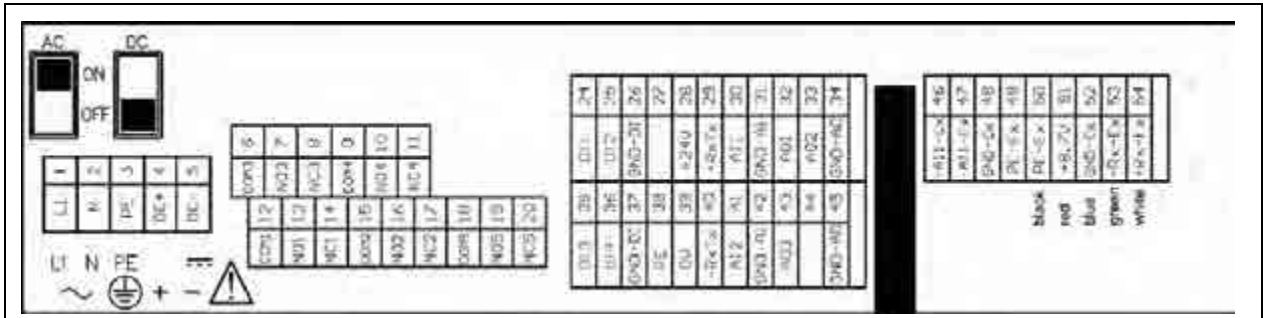


Fig. 7-2 Connection Enclosure

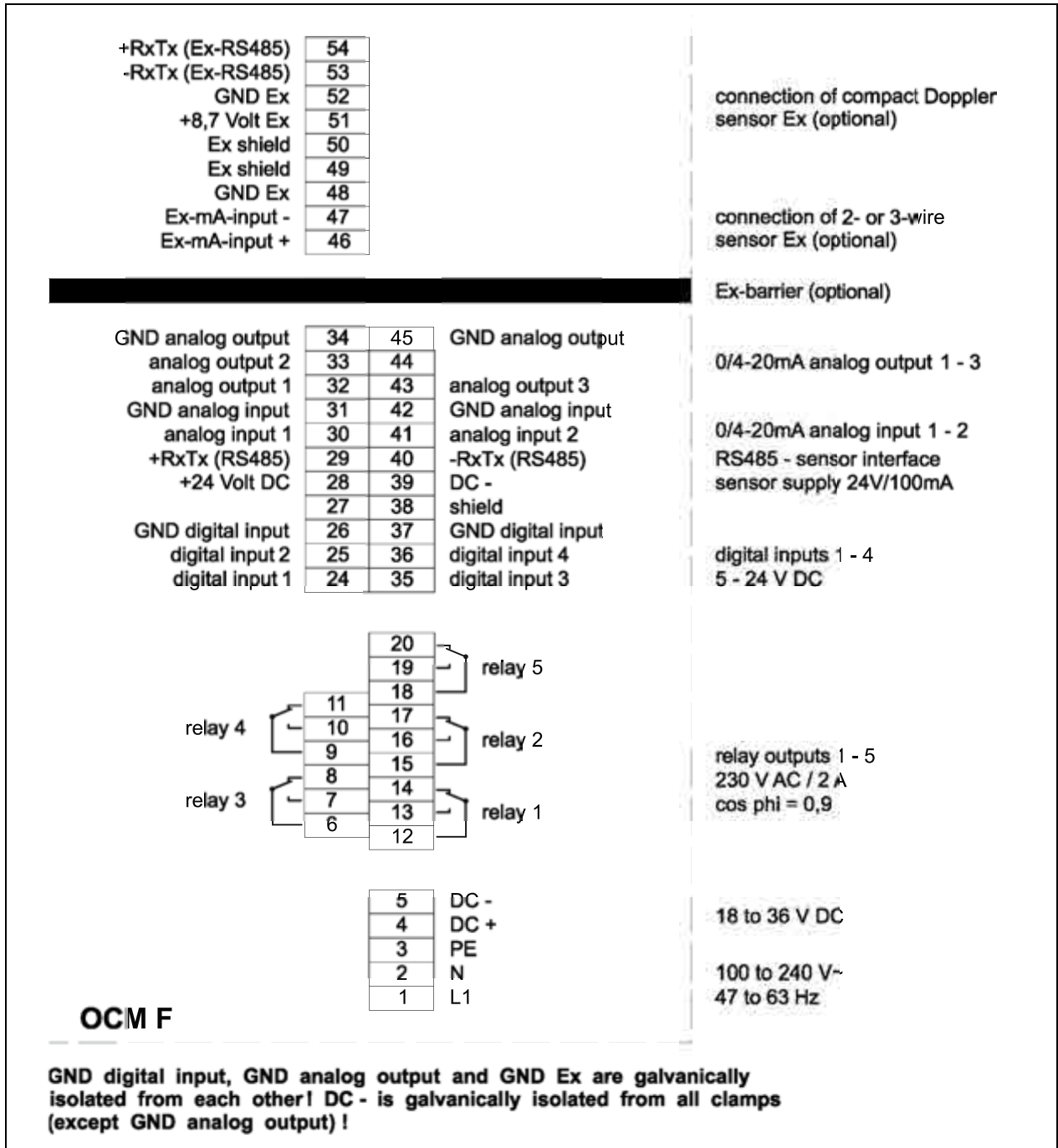


Fig. 7-3 Clamp wiring OCM F

7.4.2 KDA Sensor Connection



Important Note:

Always disconnect the measurement system from mains prior to connecting any sensors.



For use of the KDA sensors in the Ex-area, the sensor cables must not be directed past the mechanical shield between the termination blocks. Use only the two cable connections of the Ex-connection block!

The sensor cable has to be connected to the transmitter at the termination block using tension spring clamps or connectors with screw clamps depending on version.

- Lead the sensor cable from outside through the cable gland.
- Now connect the sensor cables to the connection board as described in the wiring diagram
- Tighten the cable gland to fix the sensor cable.

The diagram below applies in case of connecting a KDA flow velocity combi sensor:

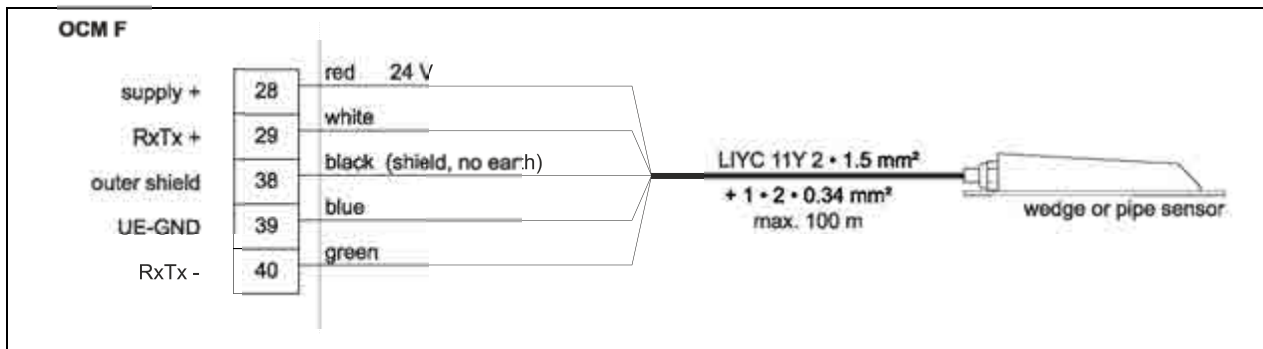


Fig. 7-4 Connection of 1 wedge or pipe sensor (no Ex), Type K0 or R0

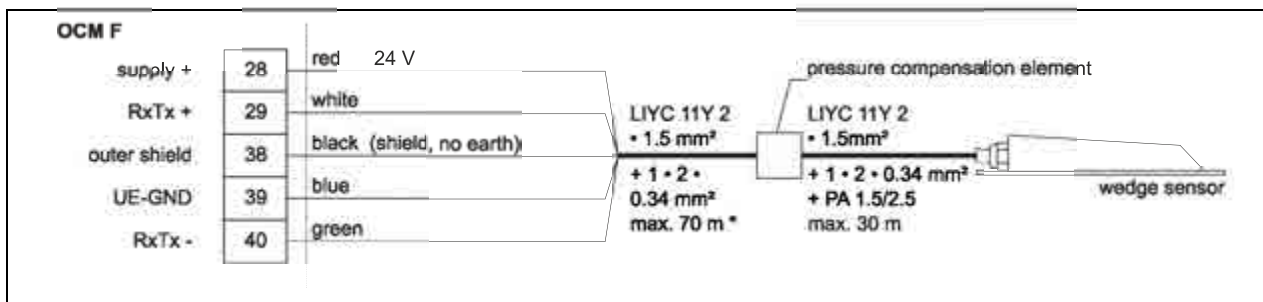


Fig. 7-5 Connection of 1 KDA combi sensor (no Ex) with integrated pressure measurement cell, Type KP

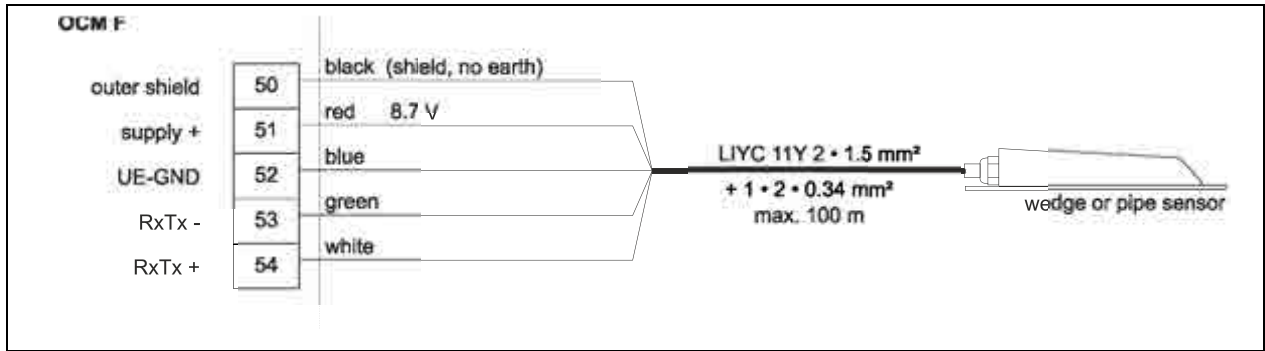


Fig. 7-6 Connection of 1 KDA wedge or pipe sensor (Ex), Type K0 or R0

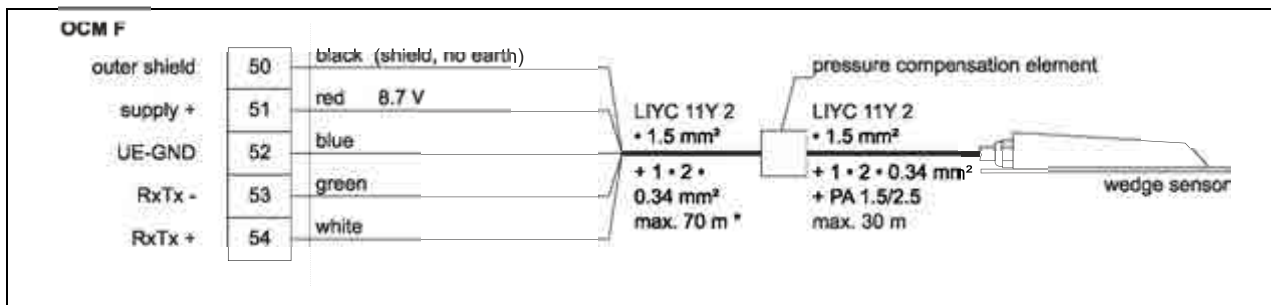


Fig. 7-7 Connection of 1 KDA combi sensor (Ex) with integrated pressure measurement cell, Type KP



The pressure compensation element serves as connection socket for cable extension at the same time.

Please observe not to exceed the maximum cable length of 250 m (820 ft) between KDA sensor and transmitter by taking the maximum permissible resistance into account.

If the level measurement is carried out by a 2-wire probe, (NivuBar, Nivu-Compact 2-wire echo sounder or similar) which is supplied by the OCM F, please follow the wiring diagram below:

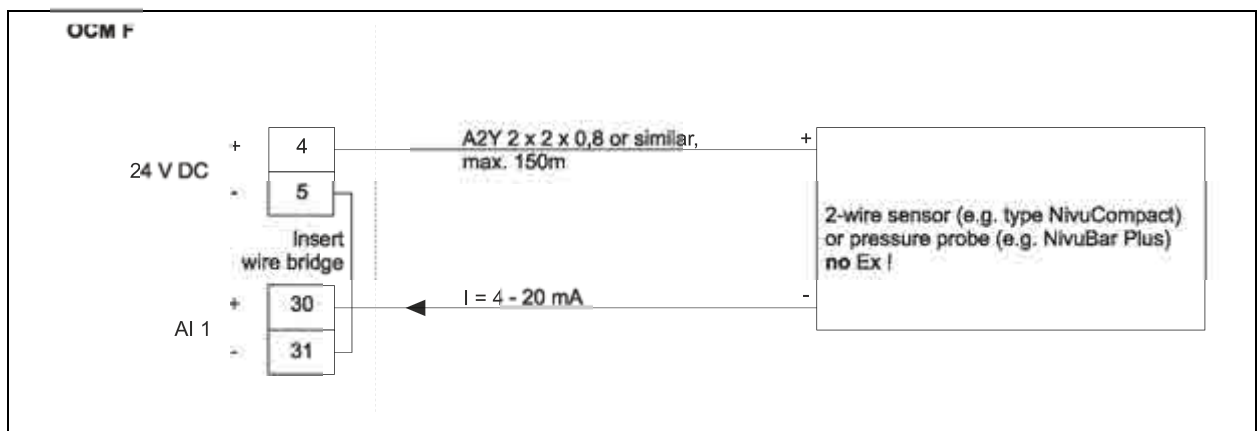


Fig. 7-8 Connecting an ext. 2-wire sensor (no Ex) for flow level measurement

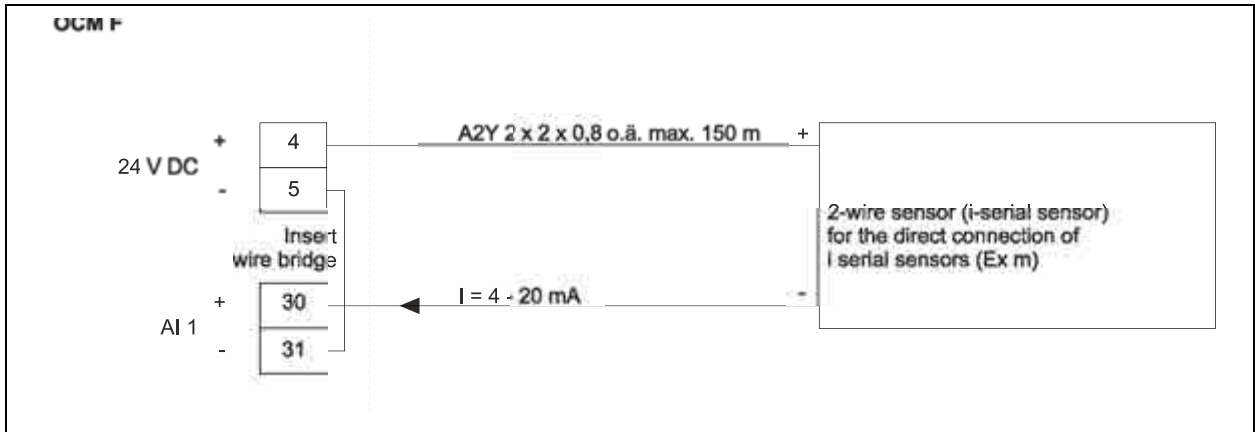


Fig. 7-9 Connecting a NIVUS i-Serial sensor for level measurement in Ex-Zone 1



Important Note

The Zone 1 Ex approval of i-Series sensors is guaranteed thanks to protection encapsulation category "Ex m". These sensors hence must not be connected to the intrinsically safe terminal clamps (Ex ia) of the transmitter.

This would cancel the protection rating of the intrinsically safe terminal clamps (47/46) of the transmitter and thus invalidate the according Ex approval.

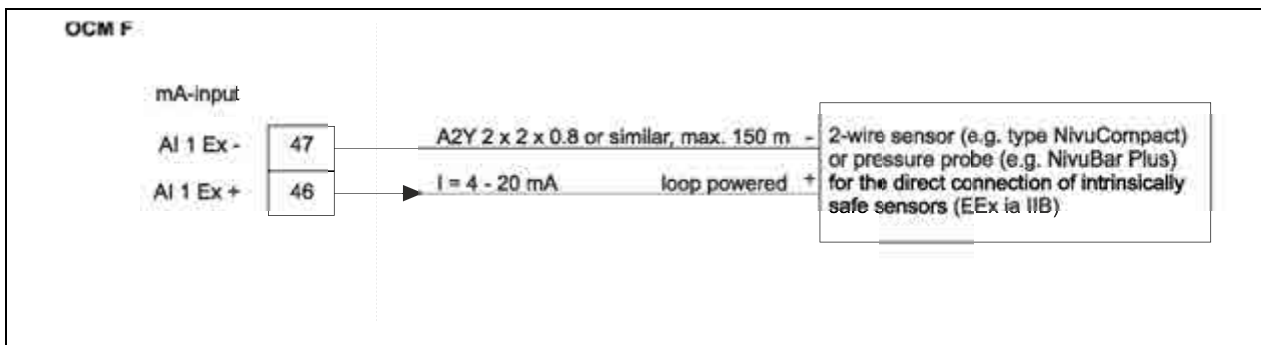


Fig. 7-10 Connecting an ext. 2-wire sensor (Ex) for flow level measurement

If the mA signal for level measurement is provided from an external transmitter (such as NivuMaster) connect to clamps as follows:

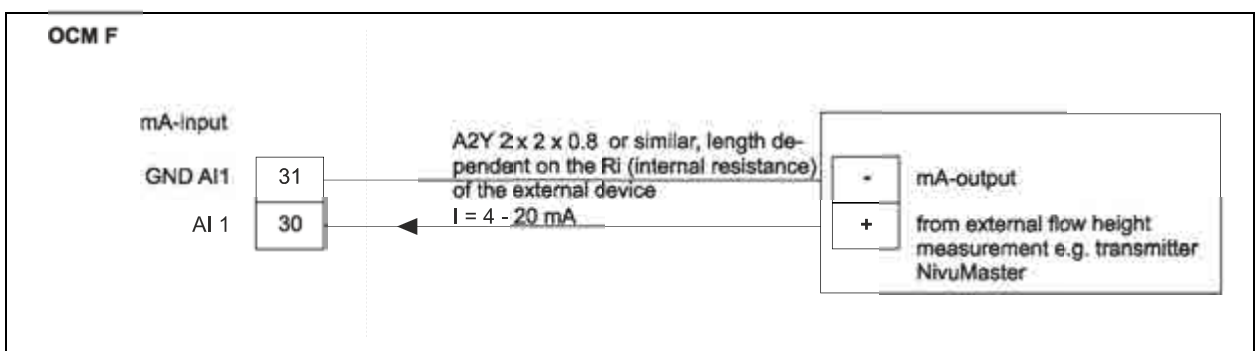


Fig. 7-11 Connecting an external flow level measurement via NivuMaster

7.5 OCM F Power Supply

Depending on the type of OCM F used, it can be supplied, with 85-260 V AC. Also possible is a 24 V DC supply. The two slide switches located above the terminals serve as additional power switch.

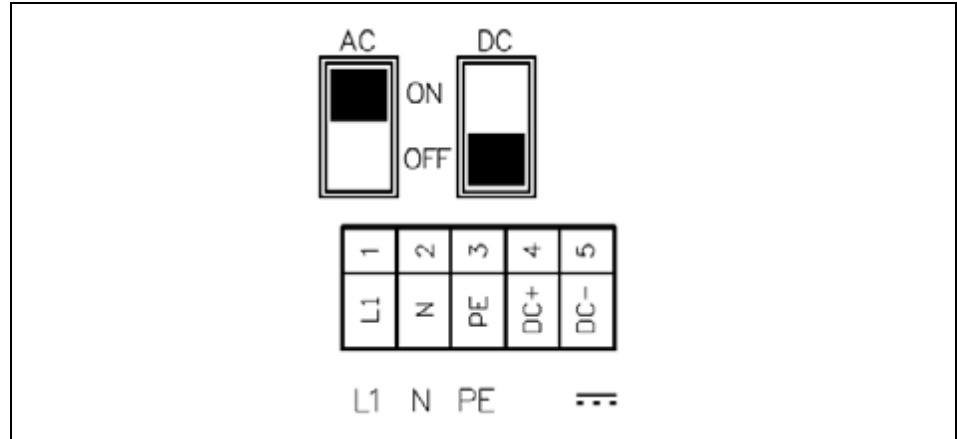


Fig. 7-12 Slide switch position in terminal clamp housing



A transmitter with 24 V DC cannot be operated with alternating current, just as it is impossible to operate a 230 V AC transmitter with direct current.

When operated with alternating current, the direct current supply clamps 4 and 5 both provide a voltage of 24 V and max. capacity of 100 mA (turn on 24 V switch!). Please note, when using this supply voltage (e.g. for digital inputs with control signals), it must not be shielded through the complete switchgear in order to maintain disturbing interferences on a low level.

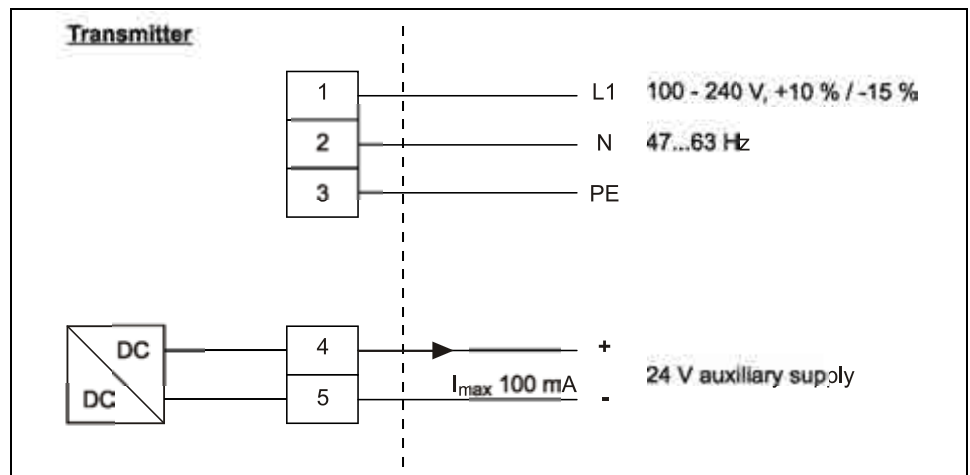


Fig. 7-13 AC model power supply

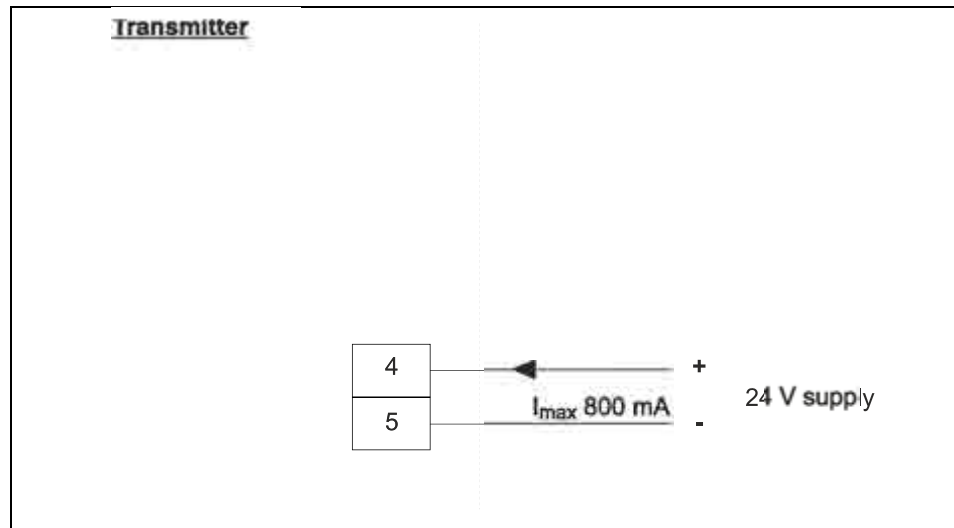


Fig. 7-14 DC model power supply

7.6 Overvoltage Protection Precautions



Using overvoltage protection elements for sensor protection reduces the possible maximum cable length.

The series resistance is 0.3 Ohm per wire and must be added to the maximum permissible total resistance (please refer to the "Technical Instruction of Doppler Sensors" manual)

For effective protection of the OCM F transmitter it is necessary to protect power supply and mA inputs and outputs.

NIVUS recommends surge arrestors type:

>EnerPro< 220 Tr< (at 230 V AC) or

>EnerPro 24 V< (at 24 V DC).

For mA outputs and inputs type:

>DataPro 2x1 24 V / 24 V<

The flow velocity sensor is internally protected against overvoltage. In case of an expected high hazard potential it is possible to protect the sensor by using a combination of the Types:

For Ex-Sensors:

>SonicPro 3x1 24 V / 24 V Ex< and >DataPro 2x1 12 V / 12 V 11 μ H Tr (N)<

For Non-Ex-Sensors:

>SonicPro 3x1 24 V / 24 V< and >DataPro 2x1 24 V / 24 V Tr<

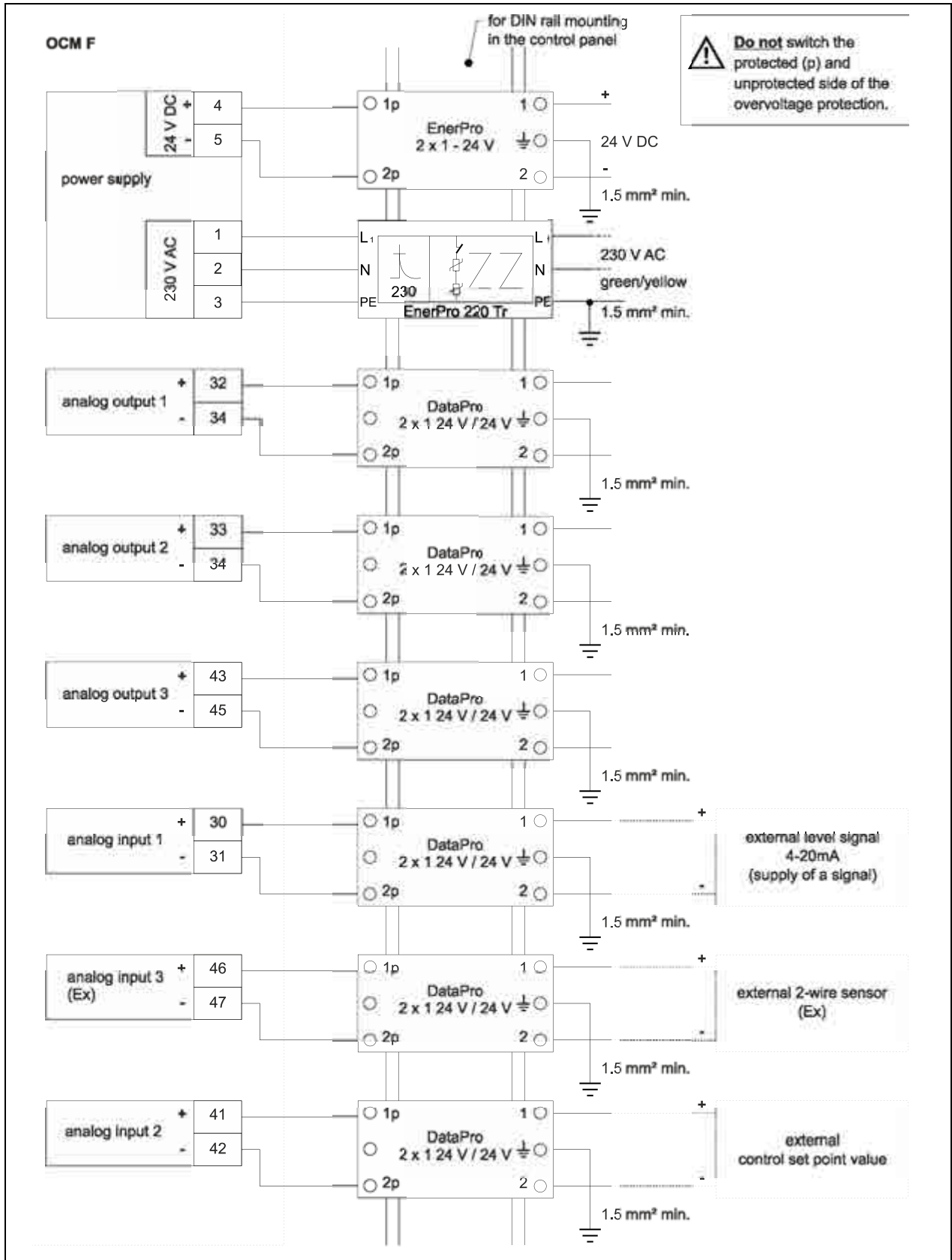


Fig. 7-15 Connecting the overvoltage protection for power supply and analog inputs and outputs

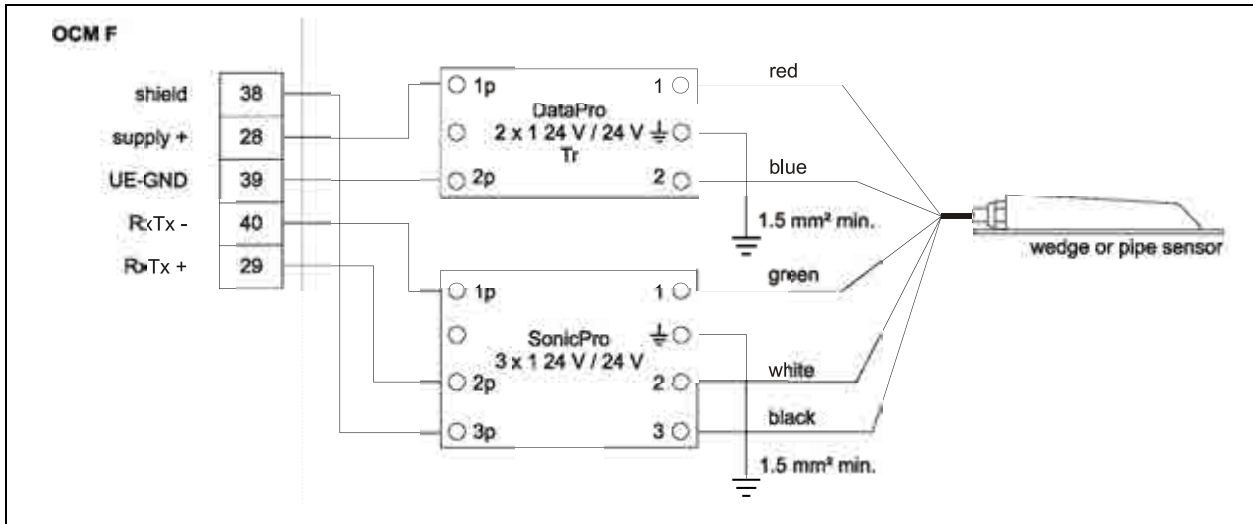


Fig. 7-16 Overvoltage protection compact Doppler active sensor

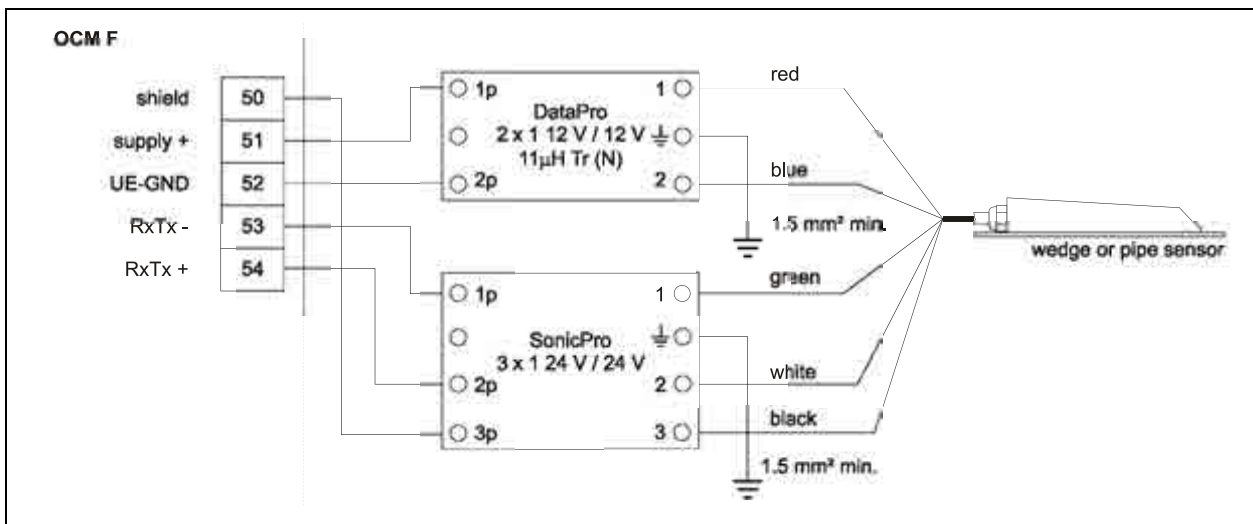


Fig. 7-17 Overvoltage protection compact Doppler active sensor (Ex)



When using the sensors in Ex areas the electrical values of overvoltage protection elements as well as capacities and inductance of the KDA sensor cable shall be considered additionally!

The NIVUS cable lengths below are allowed for use in Ex areas:

- unilateral overvoltage protection: 135 m
- double-sided overvoltage protection: 120 m



Please observe the non-reversed connection (p-side to transmitter) as well as a correct, straight wiring supply. Ground (earth) must lead to the unprotected side. Incorrect wiring will deactivate the overvoltage protection function!

7.7 Regulator Mode

7.7.1 General



Knowledge in control technologies is necessarily required to correctly and safely set the regulator!

Typically there are sluice gate valves, knife gate valves or iris gate valves with electrically driven three-step controller in use. Analog-driven slide valves cannot be used.

We recommend the following regulating times (time elapsed between valve completely open and completely closed) for the selection of gate valves:

≤ 300 mm (11.8 in) diameter: min. 60 seconds

≤ 500 mm (19.7 in) diameter: min. 120 seconds

≤ 800 mm (31.5 in) diameter: min. 240 seconds

≤ 1000 mm (39.4 in) diameter: min. 300 seconds

For the correct driving as well as for error monitoring of the slide valve, the Way-End-Switches "OPEN" and "CLOSE" as well as the torque switches "CLOSE" are a mandatory requirement. These signals have to be connected to the digital inputs 1-3 of the measurement transmitter. Please note to select gold-plated contacts in order to ensure contact reliability. Connect a signal relay between switches and measurement transmitter digital input to safely conduct the 10 mA input current.

Analog position feedback to the measurement transmitter is not planned.

The measurement transmitter OCM F operates as a three-step controller with surge detection, quick close control, slide valve monitoring and automatic flush function.

To drive the regulating unit, the relays 4 and 5 are assigned as default. Hence, relay 4 as "slide valve closed" and relay 5 as "slide valve open" are defined.

Analog input 2 is assigned for entering external setpoints (see Fig. 7-19).



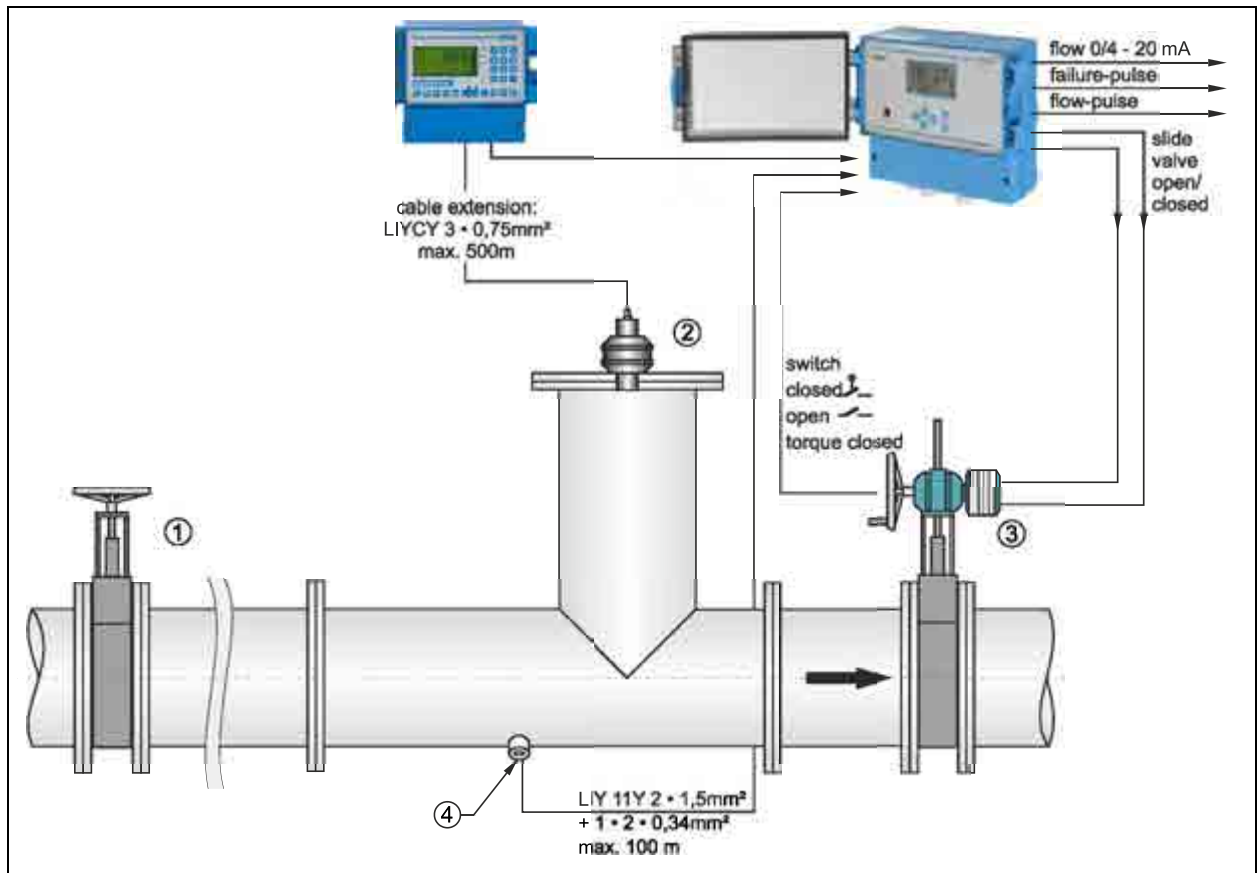
The assignment of the digital outputs for the regulator cannot be modified.



The input current on the digital inputs of the OCM F is 10 mA. Please ensure contact reliability by selecting sufficient contact materials on the end switch of the control slide valve.

7.7.2 Construction of Measurement Section and Control Section

You can find a detailed description of measurement and control sections in the "Installation Instruction for Correlation and Doppler Sensors" manual.



- 1 Hand-slide valve
- 2 Ultrasonic sensor P-Series
- 3 Regulation-slide valve
- 4 Install pipe sensor using nozzle or tapping saddle

Fig. 7-18 Setup of a controlled system such as a discharge control

7.7.3 Connection for Controller Operation

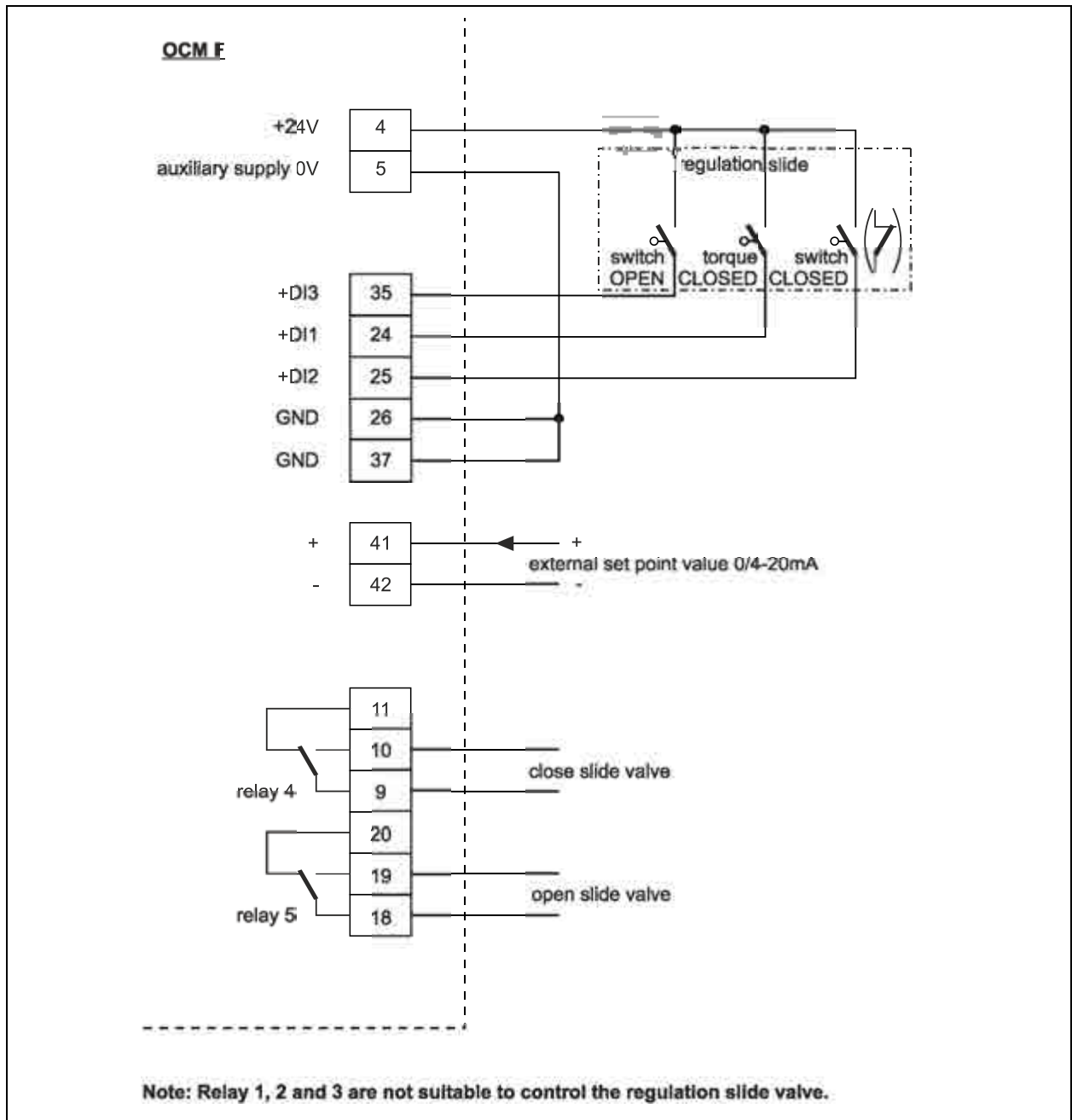


Fig. 7-19 Wiring diagram for controller operation

7.7.4 Control Algorithm

If the regulator function is selected (see also Chapter 9.4.8), relay 4 is used for "CLOSE SLIDE VALVE" and relay 5 for "OPEN SLIDE VALVE" function. This assignment cannot be modified.

The digital inputs are free programmable for position feedback. To ensure correct and failsafe slide valve drive necessarily use the messages "PATH OFF", "PATH ON" and "TORQUE CLOSED" of the slide valve drive.

The input current per digital input is 10 mA.



*In case of driving the slide valves via the digital inputs **always** use all the 3 messages. Activating one message only may result in disturbed regulator operation.*

The regulator can be operated with external or internal set point.

External setpoints have to be routed to analog input 4 (clamps 41+ and 42 GND).

In case of using a 4-20 mA signal as external setpoint, this signal can be monitored for cable breaks and short circuits. If errors should occur the OCM F is going to access the internal setpoint (→ in case of using external 4-20 mA setpoints and error monitoring always set the internal setpoint additionally!).

The following equation applies for the internal calculation of the slide valve control time:

$$\text{control time} = (\text{setpoint} - \text{flow}_{\text{actual value}}) \cdot P_factor \cdot \frac{\text{max. slide valve runtime}}{\text{max. flow}}$$

8 Initial start-up

8.1 Notes to the User



For proper start-up of the entire system it might be necessary to additionally refer to the accessories manuals below.

>Installation instructions for Correlation and Doppler sensors<

>Technical instructions for Doppler sensors<

These manuals are part of the accessories standard delivery.

Before you connect and operate the OCM F you should strictly follow the notes below!

This instruction manual contains all necessary information to program and to operate the device, addressing qualified technical staff who have appropriate knowledge about measurement technology, automation technology, information technology and waste water hydraulics.

To ensure a correct function of the OCM F this instruction manual must be read thoroughly!

It is vital to read and comply with the safety instructions!

The OCM F must be wired in accordance with the wiring diagram, see Fig. 7-3!

If any problems regarding installation, connection or programming should occur please contact our technical division or our service centre.

NIVUS GmbH

Service hotline, Phone +49 (0)7262 9191-888

or by e-Mail to: Hotline-worldwide@nivus.com

For initial start-up of the complete system, the instruction manuals of the accessories have also to be read. These manuals are included in the accessories delivery.

8.2 General Principles

The initial start-up is not allowed until the installation has been finished and checked. To exclude faulty programming this instruction manual must be read before the initial start-up. Please get familiar with the OCM F programming via display and keyboard by, reading the instruction manual before you begin to program the device.

After transmitter and sensors are connected (see chapters 7.4.1 and 7.4.2) the parameters must be set.

In the most cases all you need is:

- geometry of the measurement place and dimensions
- used sensors and positioning
- display units
- span and function of analog and digital outputs

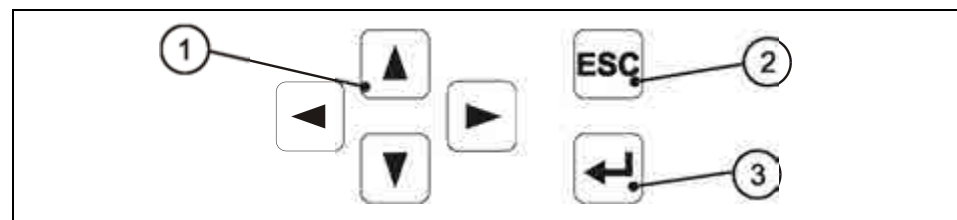
The OCM F user surface was designed in a way that even unfamiliar users are able to easily set up basic settings in dialog mode which ensure reliable device operation.

For extensive programming, difficult hydraulic conditions, in case of absence of expert staff or if a setup and error protocol is required, the programming should be carried out by the manufacturer or an expert company which is authorised by the manufacturer.

8.3 Keypad

For data input there is a comfortable 6-button keypad available.

Due to mechanic and electronic reasons the keypad has a membrane cover with abrasion-proof labelling.

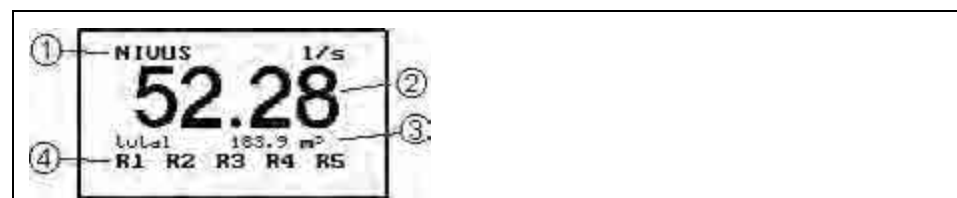


- 1 Arrow keys (control)
- 2 Escape key
- 3 Confirm key (ENTER)

Fig. 8-1 Keypad

8.4 Display

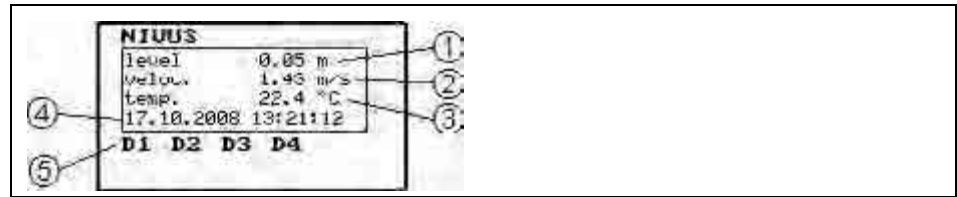
OCM F has a large back-lit graphic display with a resolution of 128 x 64 pixel. This enables convenient communication.



- 1 Name of measurement place
- 2 Flow
- 3 Total
- 4 Relay status

Fig. 8-2 Main screen

After confirming with >ENTER< the auxiliary screen appears.



- 1 Level
- 2 Velocity
- 3 Medium temperature
- 4 Current date / system time
- 5 Digital input status

Fig. 8-3 Auxiliary screen

There are 5 basic menus available for selection, programming and diagnostic options which are visible in the display headline. These menus can be accessed via the arrow buttons >left< or >right<.

- RUN** Standard operation mode. It allows to display day totals and, if available, error messages. Furthermore it is possible to set the time of 24 h-totalizing and to reset the daily totalizer.
- PAR** This menu is the most extensive of the OCM F. It is for the complete parameter setting of dimensions of the measurement place, sensors, analog and digital inputs and outputs and regulator function, damping and system reset.
- I/O** This menu includes information about internal operation of the OCM F. All current values can be displayed, as well as the values of analog and digital outputs and relays. Additionally it is possible to indicate the current flow velocity as well as the flow velocity distribution.
- CAL** Set maximum and minimum measurable flow velocity here. Calibration of analog outputs as well as simulation of analog and digital outputs and calculated volumes is possible too.
- EXTRA** This sub-menu includes basic display settings: contrast, language, units, decimal digits, system times and totalizer pre-sets.

8.5 Operation Basics

The entire operation of the OCM F is menu driven.

To navigate within the menu structure use the 4 control keys (see chapter 8.3).



>up<

- navigates upward in the respective submenu (e.g. PAR/measurement place/name)
- select pre-set values e.g. units (m, cm, l/s, m³/s etc.)
- increase values



>down<

- navigates downward in the respective submenu (e.g. PAR/measurement place/name)
- select pre-set values e.g. units (m, cm, l/s, m³/s etc.)
- decrease values,
- set decimal point



>left<

- press once ; toggle between indication mode and overview menu (main menu)
- jump across in main or submenu
- jump across between identical measurement values (e.g. span of analog outputs 1 – 3)



>right<

- press once ; toggle between indication mode and overview menu (main menu)
- jump across in main or submenu
- jump across between identical measurement values (e.g. span of analog outputs 1 – 3)



>ESC<

- delete values
- each key action in menu → jumps back one level until RUN menu



>ENTER<

- press once; toggle from RUN menu to overview menu (main menu)
 - activate a submenu
 - accept and store values, units and so on
-

9 Parameter Setting

9.1 Basics

The transmitter in the background operates with the settings which have been entered at the beginning of the parameter setting. The system will not ask to accept the modifications before the settings or modifications have been finished. Enter the PIN below in order to accept modifications.

2718 type in 2718 if prompted.



Never give the PIN code to any unauthorised persons. Even do not leave the code next to the equipment or write it down on it. The code number protects against unauthorized access.

The unit will accept modified parameters if entered correctly performing a restart subsequently. The OCM F is ready for operation after approx. 20-30 seconds.

It is possible to save modified parameters at the end of the parameter setting procedure.

Entered parameters may be saved at the end of the setting procedure (>accept changes<) or rejected by pressing >cancel<. It is also possible to jump back to the previous level using the >back< function. This enables the user to modify settings which might have been forgotten without the need to buffer previously modified settings.

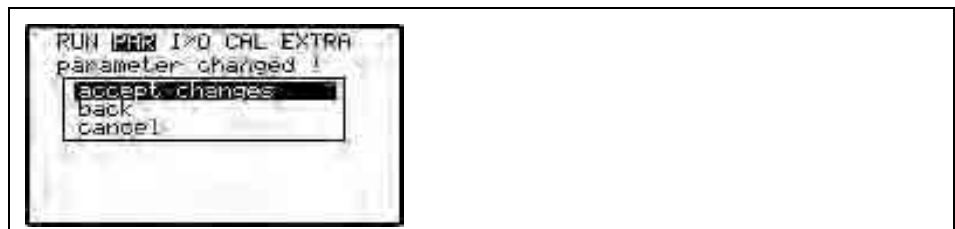


Fig. 9-1 Screen on end of parameter setting

Modifications concerning language, units and contrast do not require the PIN code to be entered as these settings influence just the way of representation and not measurement or output.

If parameter settings are not going to be modified but just verified by selecting each parameter, there will be no PIN request at the end of the dialog.

After mounting and installing sensor and transmitter (see previous chapters) activate the power supply.

On initial start-up the unit will prompt the language selection:

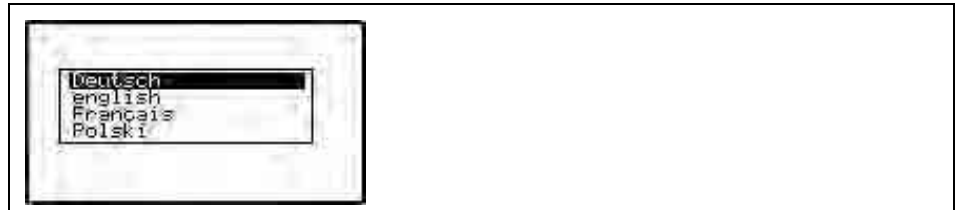


Fig. 9-2 Language selection

Select the desired language with the >up< or >down arrow keys< and confirm with >ENTER<.

9.2 Operation Mode (RUN)

This menu is a display menu for saved day totals and error messages. Containing the following submenus, it is not required for parameter setting:

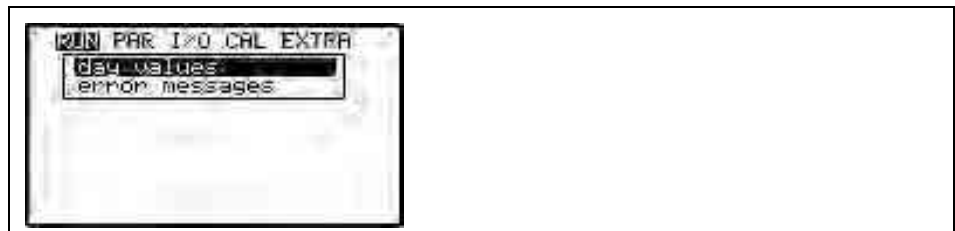


Fig. 9-3 Operation mode selection

Day values

Please select submenu >Info<. This menu contains the total flow values of the past 7 days (see Fig. 9-4).

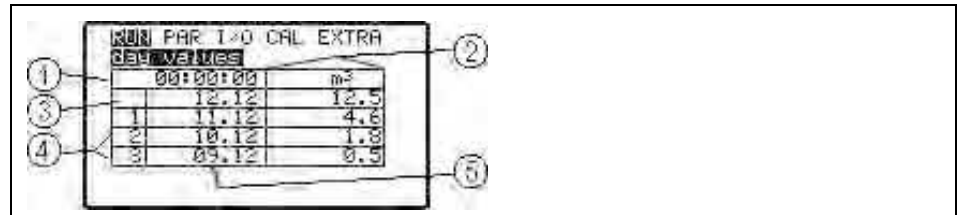
Presumed the transmitter was operated without any interruption in the past seven days. Otherwise it shows the total for the uninterrupted days of operation.

Only the first 3 days will be indicated after selecting. Browse to other days by using the arrow key >down<.

The oldest day total will be overwritten as soon as the 24h-total of the 8. day has been created des (circular memory function).

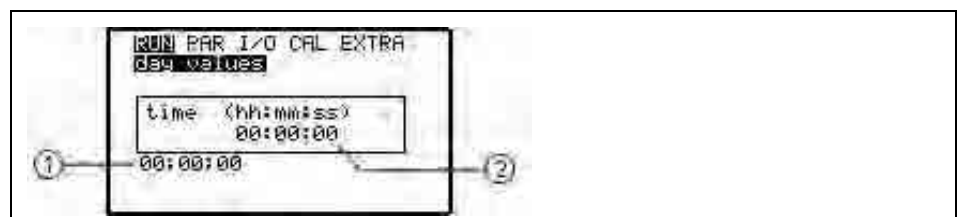
The flow totals of 24 hours will be indicated. Totalization normally is carried out at 00:00 h (midnight). If desired, this value can be modified under RUN – day values - cycle (see Fig. 9-5).

Additionally, you can erase all day counters under >erase counter<. Due to safety reasons it is required to enter the PIN >2718< and confirmation with ENTER after erasing.



- 1 Time of day totalising
- 2 Day values
- 3 Current day with cumulated total
- 4 24 h-day totals
- 5 Date

Fig. 9-4 Day values



- 1 current time of day totalising
- 2 programmable time of future totalising in <hours : minutes : seconds>

Fig. 9-5 Time of day totalising



If the transmitter is disconnected from mains at the time of totalising set, it is not possible to create or to save a total for the respective day.

If the unit has been shut down temporarily within 24 hrs. the flow rate missed during the inoperative period is not going to be considered for totalising. There will be no averaging interpolated replacing the lost flow rate!

Error messages

This menu is to monitor any interruptions in the unit function. Errors are going to be saved and ordered by type of error, date and time.

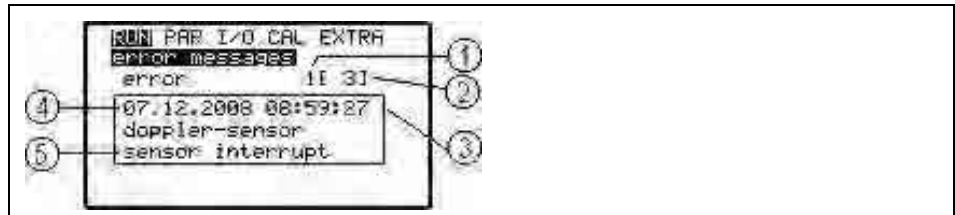
Selecting the menu will always indicate the latest/last error message. Browse through error messages using the keys >left< and >right<.

Pressing the >ENTER<-key will delete all error messages one by one.

The maximum number of stored error messages is limited to 10. The oldest of 11 error messages will be overwritten as soon as saved old error messages are not going to be erased (circular memory function).

Following error messages are possible:

- "Doppler-Sensor" - at interruption of the sensor communication or with defective KDA sensor
- "external level" - at interruption of communication to external level measurement or if value falls below the limit of 3.5 mA
- "external level short-circuit" - in case of exceeding the input signal 20 mA
- "temperature" - in case of exceeding maximum or minimum permissible temperature ranges by +/-10 °C (as from -30 or +60 °C) or if the temperature sensor should be defect
- "ext. set point" - if external set point is not available
- "control unit" - in case of error of the control unit ("Valve OPEN", "Valve CLOSED", "Valve TORQUE")



- 1 Error number
- 2 Number of stored error messages
- 3 Time of error message
- 4 Date of error message
- 5 Type of error / error message

Fig. 9-6 Error message



Remaining errors are NOT going to be written into the error memory anew if once they have been deleted. As soon as the error occurs repeatedly (or if the power supply has been interrupted for a short period) the same error will be saved into the error memory again.

9.3 Display Menu (EXTRA)

This menu allows to modify settings such as units, language, system time as well as the display itself. The following submenus are available:



Fig. 9-7 Extra-submenus

Due to reasons of limited space it is not possible to indicate the entire menu on the display. This can be seen from the black scroll bar on the right-hand side of the display.



Scroll through the menu using the up and down keys.

Info

This point provides comprehensive information on unit type, transmitter serial no. and software version (see Fig. 9-8). The menu is subdivided into 4 pages. Pressing the arrow buttons >left< or >right< will take you through the pages. Among other information these pages contain information on last parameter setting / parameter change as well as mains power failure which might have been occurred.



Fig. 9-8 System information

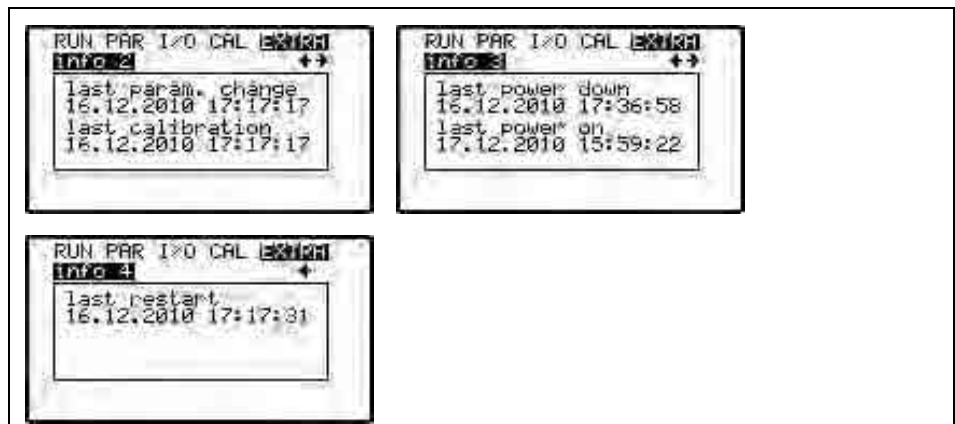


Fig. 9-9 Additional system information

Unit system

Here you can select between indication and calculation. Select from: metric system (litre, cubic meters, cm/s etc.), English system (ft, in, gal/s, etc.) and American system (fps, mgd. etc.)



Fig. 9-10 Selecting the unit system

Units

This menu contains the following sub menus:

- Flow rate
- Velocity
- Level
- Total

For each of these four measured values you can select a unit which appears on the display. Depending on the unit system selected, there are various units available.



Fig. 9-11 Selecting the units

Format

Choose display formats for velocity and totals here.

The position of the decimal point can be defined as displayed in Fig. 9-12. The unit automatically determines the decimal digit position of the current flow rate indication and hence cannot be set to a fixed position.



Fig. 9-12 Selecting the display format

Language

Select from German, English, French or Polish.

Display

Allows to adjust display settings regarding contrast. Use >down< to decrease; and >up< to increase values in 5 %-steps.

The display contrast can be adjusted on the main page of the menu as well.

System time

In order to perform various control or memory functions, the unit includes an internal clock saving dates of year, weekdays and week numbers. The clock settings can be modified if required (different time zones, summer time / winter time etc.). First select the menu point "Info":

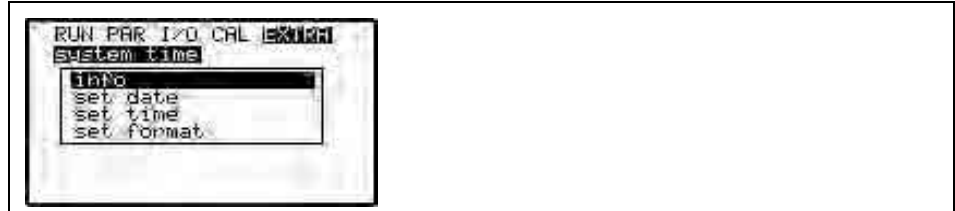


Fig. 9-13 system time - submenus

The complete system time is indicated after the settings have been confirmed:

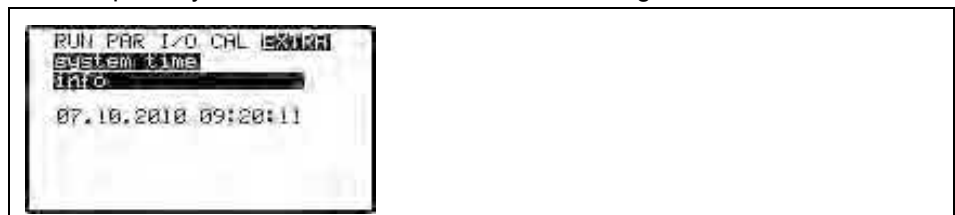


Fig. 9-14 complete system time

This menu point is for indicating purposes only. Hence the system time can-not be adjusted here. Modifications can be carried out in the individual menus >set date< and >set time< (Fig. 9-13). Select between 12 h or 24 h mode in >set format< submenu.

Totalizer

This menu allows to newly set the totalizer indicated on the main screen. This feature is normally used when replacing a transmitter which has to indicate the same value as before replacement.

After the new value has been set confirm using the "Enter"-key and type in the PIN "2718". (2 faulty entries allowed). Otherwise the modified value will not be accepted.

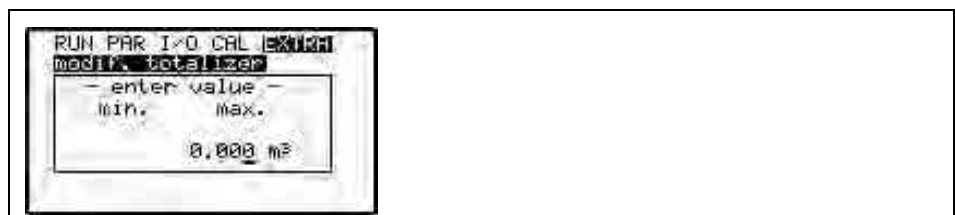


Fig. 9-15 Totalizer modification

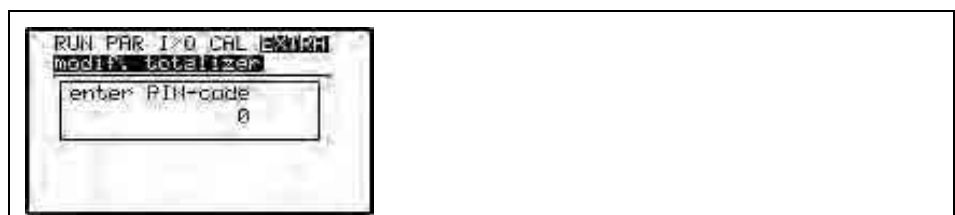


Fig. 9-16 PIN-Code request

9.4 Parameter Menu (PAR)

This menu is the most important regarding the unit settings. It nevertheless is sufficient in most cases to set only some essential parameters, which usually are:

- Channel shape
- Channel dimensions
- Sensor types
- Analog output (function, measurement range and measurement span)
- Relay output (function and values)

All other functions are additions which are required in special cases only. (Regulator mode or for special hydraulic applications). These settings are normally made with the help of our service personnel or by an authorised expert company.

The parameter menu >PAR< includes eight partially very extensive submenus which are described individually on the following pages.

9.4.1 Parameter Menu „Measurement Place“

This menu is one of the most important basic menus for parameter setting as the measurement place is going to be defined here.

The menu cannot be indicated completely due to restricted display space. Similar to many well-known PC applications, this is readily identifiable from the black bars on the right-hand side of the screen.

Name

NIVUS recommends to coordinate and to define names according to names stated in the respective documents. Names may contain up to 15 letters. After the submenu >Name< has been selected the basic setting „NIVUS“ will come up. There is a cursor blinking below the first digit.

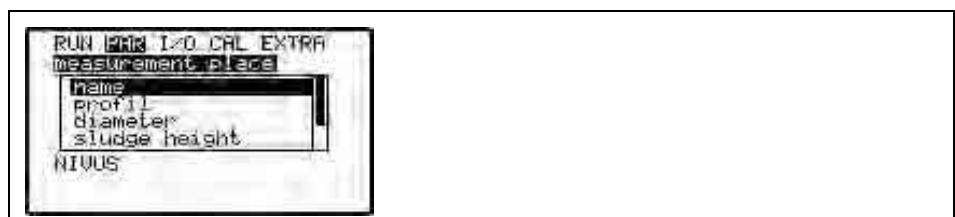


Fig. 9-17 submenu – name

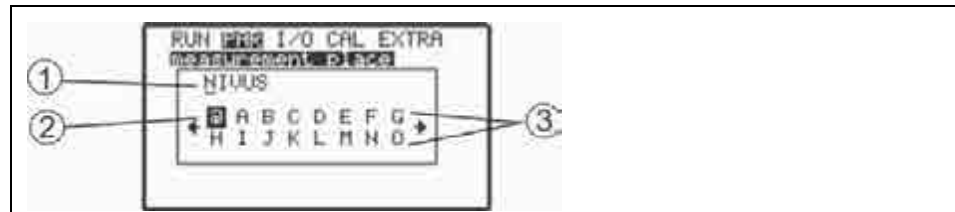


Use "Up" and "Down" keys to scroll the menu.

Underneath the measurement place name you can find a table with 20 lines containing all uppercase and lowercase letters as well as a large number of special characters (see Fig. 9-18). Use the arrow keys >up< and >down< to jump across 2 lines up or down at each key action.

To complete the name of the measurement place use the four arrow keys and confirm your selection with >ENTER<. The cursor subsequently will jump one digit to the right enabling you to choose the next character.

Delete unused characters by entering space. By pressing the both keys >right< + >down< or + >up< you can move the cursor to the right. Using the keys >left< + >down< or + >up< will move the cursor to the left.



- 1 Current name (of the measurement place)
- 2 Selected character
- 3 Selection list

Fig. 9-18 Setting the name (of the measurement place)

You can obtain the same movements as well if you move the cursor to the rightmost or leftmost edge of the table by using >left< or >right<. As soon as the cursor has reached the rightmost or leftmost edge of the table it will jump to the desired position by one step on pressing >left< or >right< again.

Exit this part of the program with ESC. Decide to accept the new name, to correct the new name (= Back) or to abort the procedure subsequently (see Fig. 9-19).

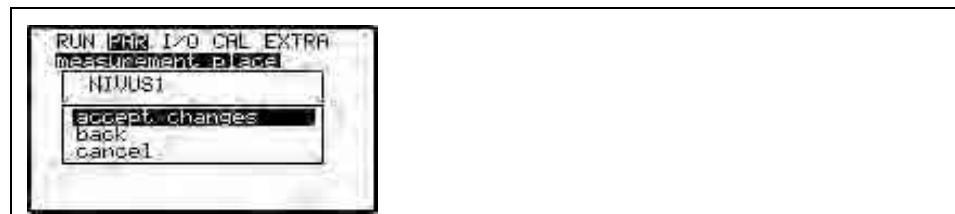


Fig. 9-19 Accepting the new name

Channel shape

You can select between following standard profiles according to ATV A110: (dimensions to be entered in brackets)

- Round pipe (diameter)
- 3er egg (diameter)
- rectangle (channel height and width)
- u-profile (channel height and radius)
- trapezoid (channel height, trapeze width bottom/top, trapeze height)
- custom shape h / A
- custom shape h / b

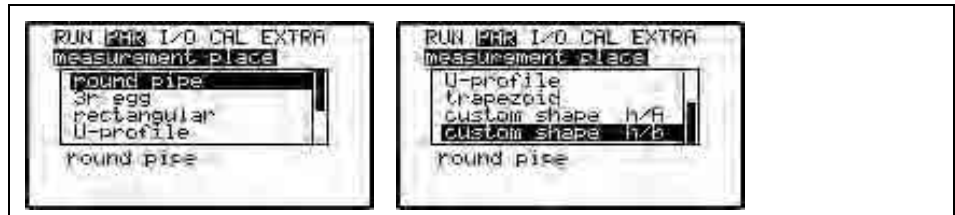


Fig. 9-20 Channel shape selection



Select channel shape with >Up< and >Down< keys.

Confirm selection with >Enter<.

The selected profile will be indicated in the bottom line of the display.

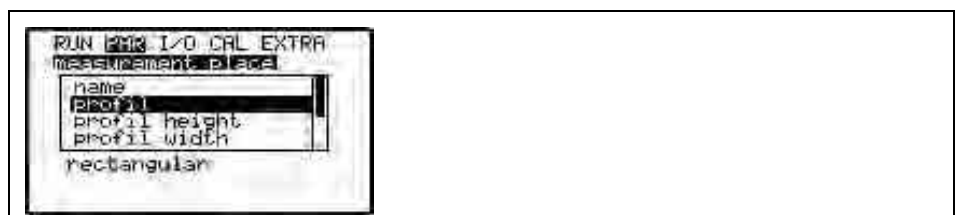


Fig. 9-21 Selected profile screen

If the existing profile does not comply with the options to select from, choose >Custom shape< in this case



Confirm with >Enter<.

After having >custom shape< selected, first choose >channel dimensions<.

Channel dimensions

Type in the respective channel dimensions depending on the profile chosen before.



Please observe indicated units!

Choosing >Custom shape< will indicate a table of 32 possible breakpoints on the display. As described above, enter the relations between height-width or height-area and enter the according value pairs.

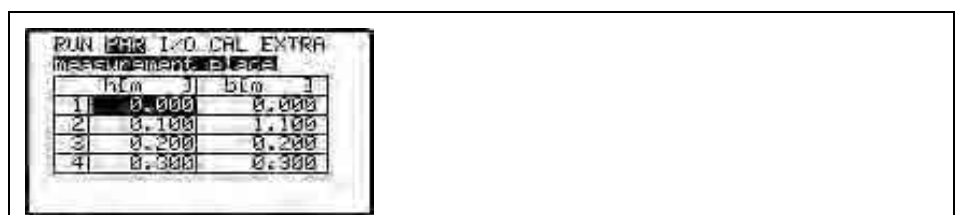


Fig. 9-22 List of breakpoints for >Custom shape<

In order to define the zero point of the channel start by entering 0 – 0 in breakpoint 1. All further breakpoint can be set freely regarding height as well as width/area.

There may be different distances between individual level points. Furthermore it is not required to use all of the 32 breakpoints possible. The OCM F however is going to use a linearization function between the breakpoints. Decrease the distance between breakpoints in case of heavy and irregular fluctuation within the area.

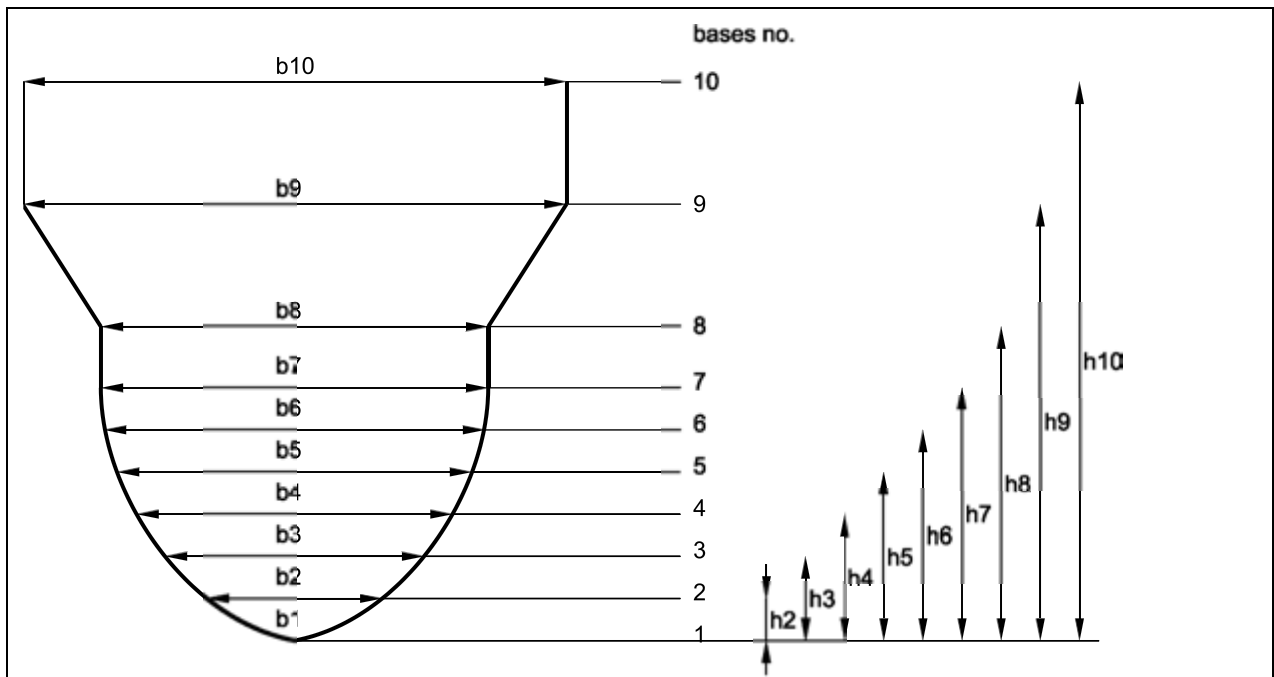


Fig. 9-23 breakpoints for >Custom shape<

Sludge level

The sludge level set is going to be calculated as non-moving channel sub-area and will be subtracted from the wetted hydraulic total area prior to performing flow calculation.

Low-flow volume
Q_{min.}

This parameter serves to suppress lowest movements or apparent volumes arising. Used mainly to measure overflow volumes in constructions which are permanently flooded by receiving water.

Q_{min.}: measurement values lower than this one will be set to >0<. Only positive values are allowed to be set. These values are going to be considered as absolute values and therefore have positive as well as negative effects.

V_{min.}: Low-flow volumes in applications with large profiles and filling levels can be suppressed by means of this parameter. Lowest velocity fluctuations within longer periods of time may cause apparently large volume fluctuations which cannot be gated by using the value of Q_{min.}

Flow velocities below this value will be set to „0“ which will set the calculated volume to „0“ as well.

Only positive values are allowed to be set. These values are going to be considered as absolute values and therefore affect positive as well as negative velocities!

Both setting options of low-flow suppression have an OR relation between each other.

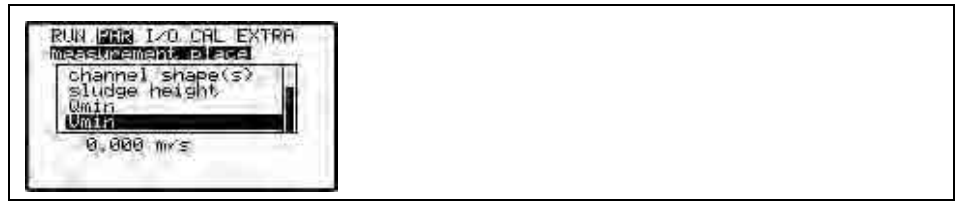


Fig. 9-24 Selection low-flow volumes



The suppression of low-flow volumes is **no** offset but a limit value.

9.4.2 Parameter Menu “Level“



Fig. 9-25 Menu level measurement

This menu defines any parameter regarding level measurement. The start screen depicted below as well as the parameters to be set may vary depending on the sensor type selected.



Fig. 9-26 Example in case of external level sensor

Basically determine the sensor type first (see Fig. 9-27).



Fig. 9-27 Determine the sensor type

Sensor type
Pressure trans.

No.

- 01** Level measurement by a KDA combi sensor which is directly connected to OCM F according Fig. 7-5. Offset installation e.g. due to sedimentation or high dirt load is possible. Level measurement in case of flooding is possible as well.

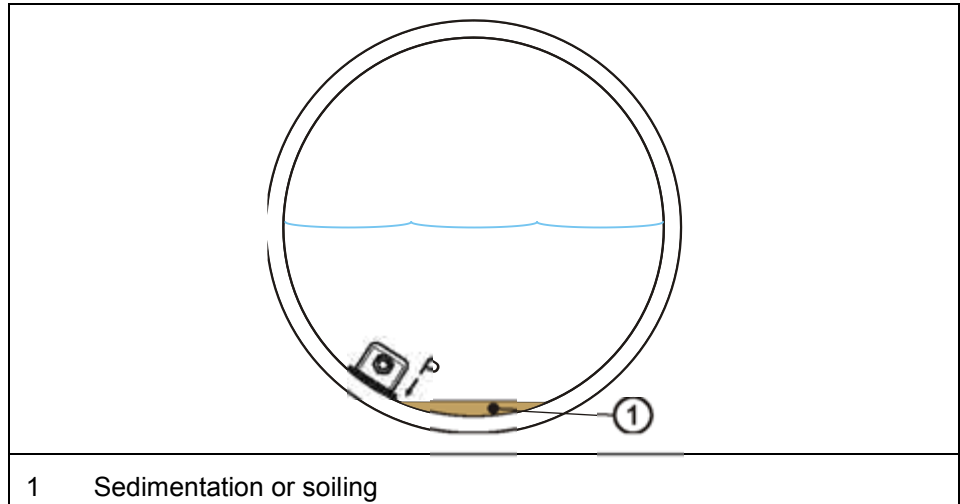


Fig. 9-28 Sensor type 1: Pressure int.

Constant level

- 02** Use this point to set parameters for constantly full filled pipes and channels. Such applications normally do not require level measurements. The constant filling level must be set under >value< and is used for flow calculation. This parameter is helpful too at initial start-up or in case of performing tests without having level values available.

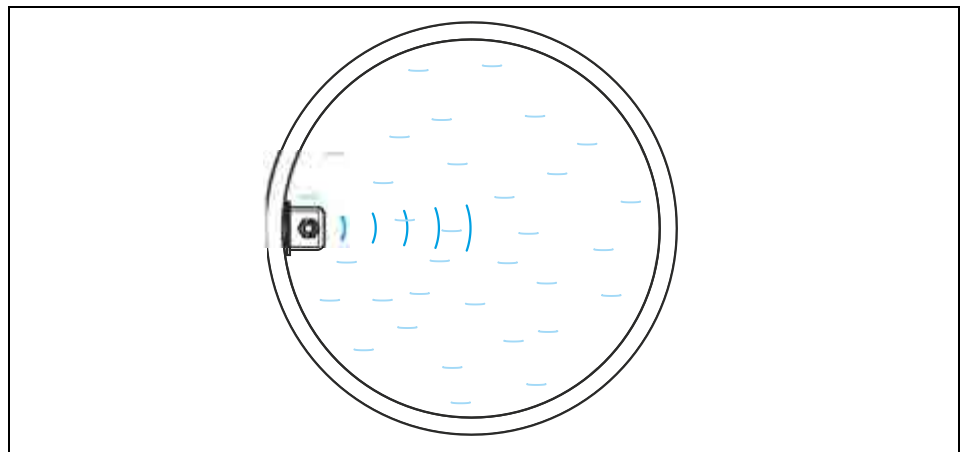


Fig. 9-29 Sensor type 2: Constant level

ext. Sensor

- 03** In this case the level is measured by using external transmitters such Type NivuMaster with echo sounder or an external 2-wire sensor such as NivuCompact (non-Ex) or i-Series sensor for Ex-Zone 1. Connect as shown in Fig. 7-8, Fig. 7-11 or i-Series connection plan Fig. 7-9.

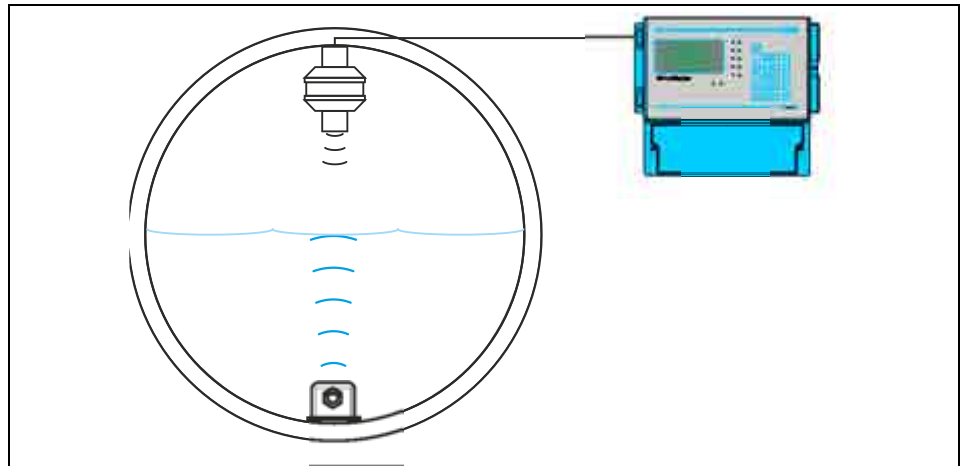


Fig. 9-30 Sensor type3: 22 wire probe

ext. Sensor (Ex)

- 04 Level measurement by external Ex 2-wire sensor supplied by OCM F e.g. a pressure probe, type NivuBar Plus or echo sounder type Nivu-Compact). Connect as described in Fig. 7-10.

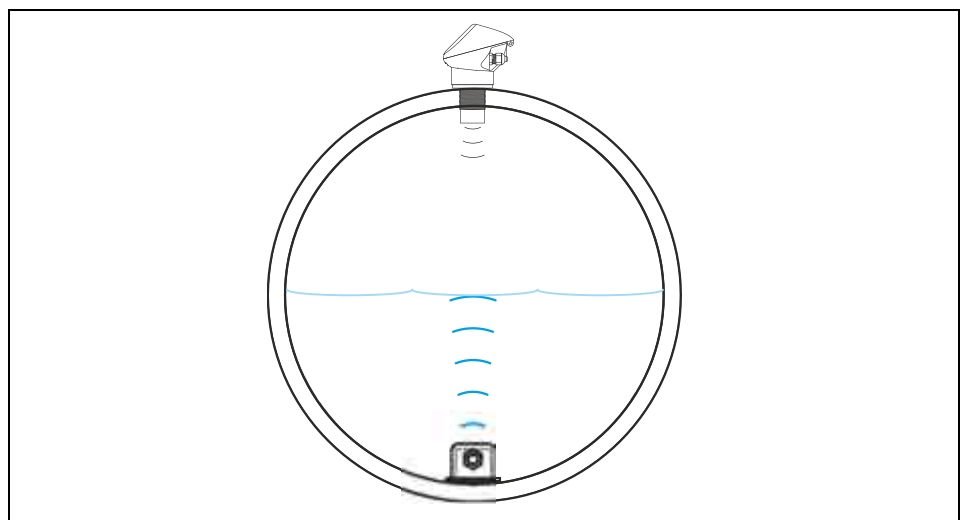


Fig. 9-31 Sensor type 4: 2-wire probe Ex

Please select the appropriate level measurement method prior to planning the facility.



The transmitter will access only the clamps which have been programmed in the menu!

Due to this reason please observe correct sensor connection (see chapter 7.4.2)

Mounting height

Only visible, if sensor type no. 1 is selected. This value is set to 5 mm (0.19 in) as KDA combi sensors in standard, which is the position of the diaphragm above the channel bottom. There is no need to modify this value unless the sensor is going to be installed **higher or lower**. If installed higher (on a block or similar) enter 5 mm (0.19 in) plus additional height, if installed lower subtract from 5 mm (0.19 in) and enter the total height.

- Value** Enter a fixed value for the level here. Only visible, if sensor type no. 2 is selected. This value is set to 0.1 m (3.9 in) as standard.
- Measurement range** Select between measurement ranges 4-20 mA or 0-20 mA. Only visible, if sensor type no. 3 is selected.
- Value at 0 mA** Enter a level value for 0 mA here.
Only visible if 0-20 mA has been selected as measurement range for sensor type no. 3. This value is set to 0 m (0.0 in) as standard.
- Value at 4 mA** Enter a level value for 4 mA here.
Only visible, if sensor type no. 3 or 4 is selected.
This value is set to 0 m (0.0 in) as standard.
- Value at 20 mA** Enter a level value for 20 mA here.
Only visible, if sensor type no. 3 or 4 is selected.
This value is set to 4 m (13.1 ft) as standard.
- Offset** This entry will move the zero point of the external sensor. Only visible, if sensor type no. 3 or 4 is selected. This value is set to 0 m (0.0 in) as standard.
- Damping** This value is to damp a fluctuating signal of an external level measurement.
Only visible, if sensor type no. 3 or 4 is selected.
This value is set to 0 s as standard and can be set to up to 10 s.

9.4.3 Information on how to connect i-Series sensors



The i-Series sensors feature pre-programmed measurement ranges. Please refer to the according instruction manual. The sensor can be operated even without HART modem.

Setting the parameter "Value at 20 mA" requires to enter the measurement span of the sensor. Depending on the installation height of the sensor a negative offset value may be additionally necessary.

	i-3	i-6	i-10	i-15
4 mA (empty) 0% span Distance to sensor face in m	3.0	6.0	10.0	15.0
20 mA (full) 100% span Distance to sensor face in m	0.125	0.300	0.300	0.500
Measurement span (value at 20 mA)	2.875	5.7	9.7	14.5

Fig. 9-32 i-Series sensors measurement range

9.4.4 Parameter Menu „Flow Velocity“

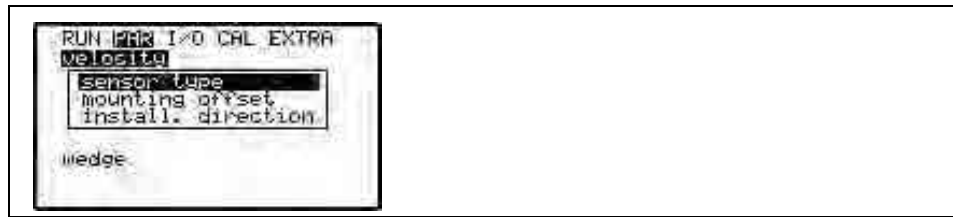


Fig. 9-33 Sensor settings

Sensor type

Select between wedge or pipe sensor. The standard setting is wedge sensor.

Mounting height

This menu point is to modify the installation height of the flow velocity sensor. The standard setting is 15 mm (0.59 in) which is equivalent to the position of the sensor centre above the channel bottom. This setting does not need to be modified unless the sensor has been installed **higher or lower**. If the sensor has been installed higher enter the additional mounting height plus 15 mm (0.59 in) and modify parameter “h-crit” (see Chap. 9.6.2) additionally, if installed lower subtract the missing height from 15 mm (0.59 in) and enter overall height.

Never countersink flow velocity sensors without pressure measurement cell deeper than 8 mm into the channel bottom (see "Installation Instruction for Correlation and Doppler Sensors")!



Never countersink flow velocity sensors with integrated pressure measurement cell into the channel bottom!!!

Otherwise the measurement might fail!

Install. direction

Installation direction is set to “positive” per default. This parameter should not be modified. It is going to be used only for special applications where the flow velocity sensor is heading upstream (unlike heading downstream towards the flow direction as in standard applications) but is to detect positive velocities however. This is the only case which requires to set “negative” here.

9.4.5 Parameter Menu „Digital Inputs“



Fig. 9-34 Digital inputs – submenu

Select from digital inputs 1 – 4 using the >left< or >right< arrow keys as long as the regulator function is active. This section enables to set and the digital input signals „switch OPEN“, „switch CLOSE“ and „torque switch“.

The OCM F requires these inputs for regulator operation.

The function >Stop v-measurement< is exclusively available for digital input 4.

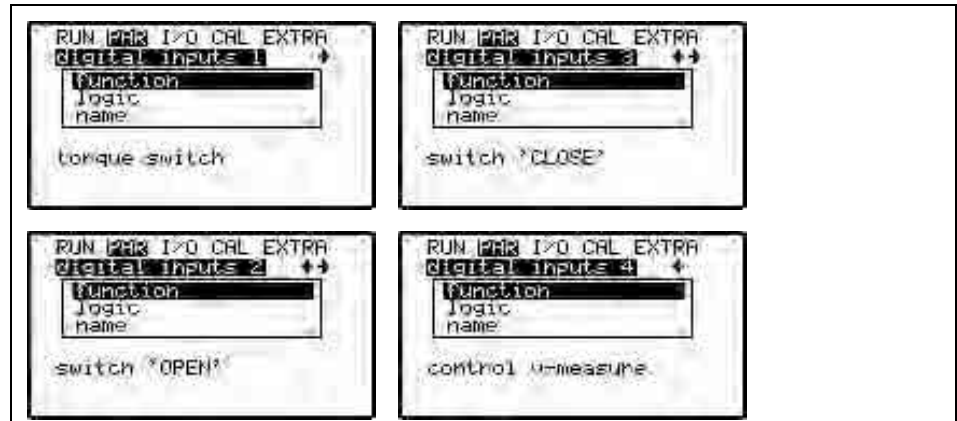


Fig. 9-35 Digital inputs functions

Function

Each digital input chosen by pressing >left< or >right< will be assigned to a certain function as long as the regulator function is active.

Select from:

- „inactive“ (The digital input has no function.)
- **DI1 „torque switch“** (the torque switch for the closed condition is connected to the selected digital input.)
- **DI2 „switch CLOSE“** (the slide end switch for closed condition is routed to the selected digital input.)
- **DI3 „switch OPEN“** (the slide end switch for open condition is wired to the selected digital input.)
- **DI4 „control v-measure“** (the digital input is used to block/release the measurement using an external signal such as flood messages or limit values for measurement start or similar. Indicated as: 0 l/s, inputs and outputs set will de-energise)

Logic

Toggle between inverse and non-inverse input by pressing >up< or >down< arrow keys. This means that e.g. slide valve signals can be configured as being normally closed and cable breaks can be detected without any problem. The default setting is „non-inverse“.

Name

The name of a digital input can have up to 3 characters. These names will be indicated in the main screen and in overview menu; see overview menu. Set the names as described in chapter 9.4.1.



*Please observe that the digital inputs are passive and therefore shall be supplied by an external 24 V DC power supply!
The signal current is 10 mA. Please ensure reliable conductivity by using relay or end switch contacts made of high quality material.*

9.4.6 Parameter Menu “Analog Outputs“



Fig. 9-36 Menü Analogausgang

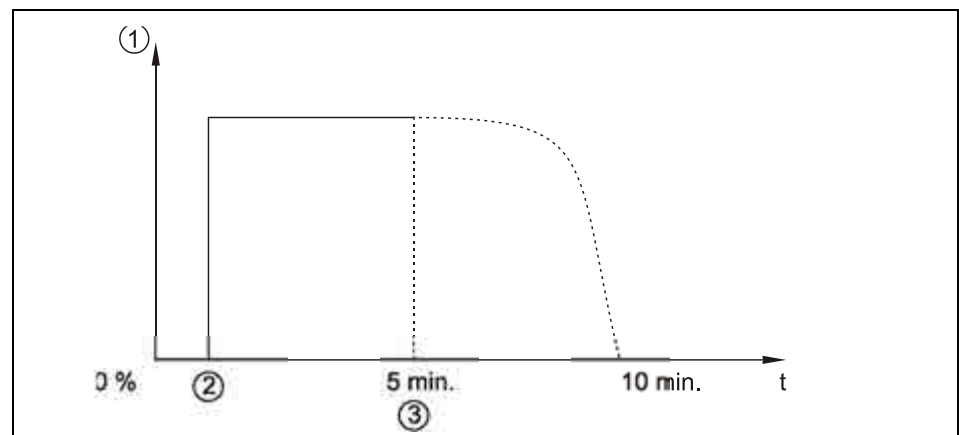
Innerhalb dieses Menüs kann zwischen den Analogausgängen 1-3 mit den Pfeiltasten >rechts< oder >links< gewählt werden.

Function

The selected analog output is going to be assigned to a function.

Select from various functions:

- Not active (no analog signal output)
- Flow rate (output of analog signal which is proportional to calculated flow volume)
- Level (output of analog signal which is proportional to measured filling level)
- Velocity (output of analog signal which is proportional to mean flow velocity averaged from measured individual velocities)
- Temperature (output of measured water temperature as analog signal)
- Constant current (calculates from the ratio between valid readings to total readings resulting from velocity measurement, output as analog signal). This function is not conceived for control purposes, but for monitoring, remote analysis and for determination of sensor cleaning intervals.



- 1 Analog output
- 2 Start measurement
- 3 Stop measurement (obstruction, standing water or no water etc.)

Fig. 9-37 Analog output signal quality

The Fig. 9-37 signal quality shows the analog output signal if the signal quality has been programmed. The signal will steeply rise at the beginning of the measurement (2).

The signal is damped in order to avoid heavy signal fluctuation.

As soon as e.g. the sensor is going to be removed from the medium or no velocity can be measured at all (3), the signal first slopes gently getting steeper subsequently.

After selecting >Function< it is possible to set “span“, “value at 0/4” or 20 mA and “error mode” for flow, filling level, velocity, temperature or signal quality (see Fig. 9-38).

Constant current (the analog output can be set to output a constant current which is independent from any readings). After choosing the function a new window comes up in order to enter the desired initial current value (max. 20.475 mA, see Fig. 9-39).

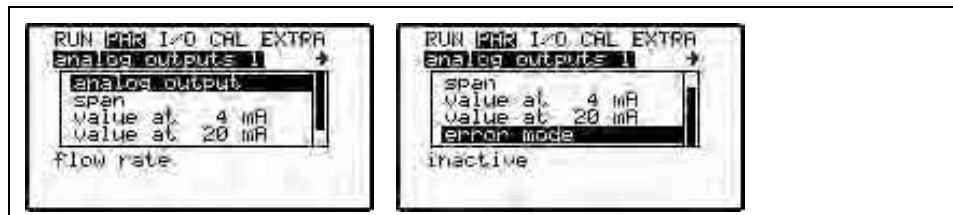


Fig. 9-38 Selection flow



Fig. 9-39 Selection constant current

Span

After having a function selected (flow, level, velocity, signal quality or temperature) toggle between measurement ranges of 0-20 mA or 4-20 mA here.

Value at 0 mA

Enter the measurement value at 0 m.

Value at 4 mA

Enter the measurement value at 4 mA.

Example:

A measurement place is partially tending to backwater formation. Negative values shall be recorded as well; the following recording or process conducting system however has only one analog input left available. In this case the analog output signal is set to have a “floating” behaviour.

This means that flow = 0 is going to output the 12 mA analog signal:

4 mA = -100 l/s

20 mA = 100 l/s

Backwater will cause the analog signal to decrease, positive flow will cause the signal to increase.

Value at 20 mA

Enter the measurement value at 20 mA.

Error mode

If this parameter has been enabled it is possible to set the analog output to a defined value in case of error. After activation the points “Error input mask” as well as “Value at errors” can be selected (see Fig. 9-40).

Error input mask

This point is accessible only if error mode has been activated. Output signals can be assigned to the respective error here. Available are Doppler-sensor, external level, temperature, external set point input and slide valve. Velocity is currently not yet available.

Choose the desired function with the >up< or >down< arrow keys and confirm by pressing ENTER. A tick will appear as soon as the function has been confirmed. Pressing ENTER once more will deactivate the function again. Leave this point by pressing ESC, see Fig. 9-41

All errors will be saved in the error memory (see Chap. 9.2 section “Error messages”).



Fig. 9-40 Extended submenu analog output

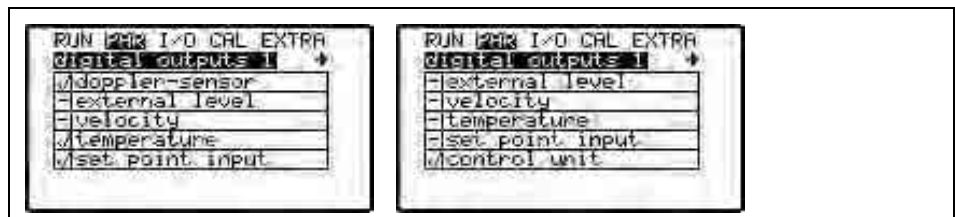


Fig. 9-41 Error input mask

Value at errors

Visible only if error mode has been enabled. This parameter is to define the desired analog output condition if an error should occur (see also Fig. 9-42)

The following functions are available:

- hold last value (holds the last value prior to error)
- constant 0.0 mA
- constant 3.6 mA
- constant 4.0 mA
- constant 20.457 mA

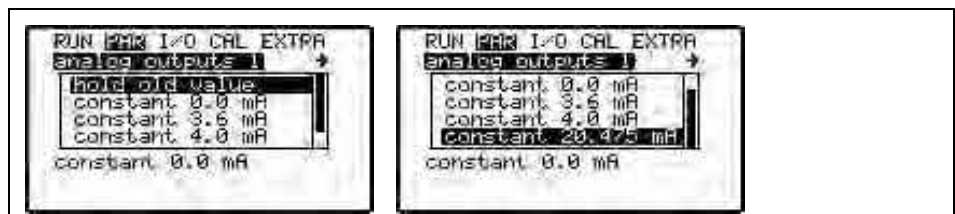


Fig. 9-42 Programming error output

9.4.7 Parameter Menu "Digital outputs"

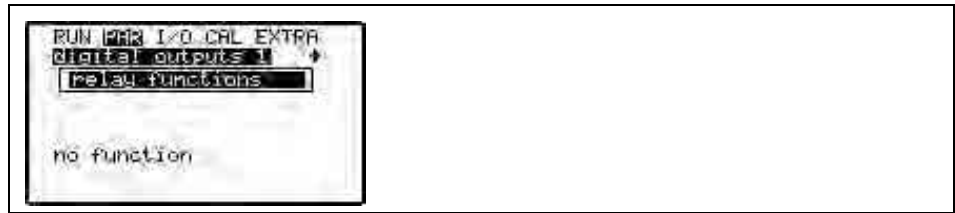


Fig. 9-43 Relay selection menu

This menu allows to select between relays 1-5 using the >right< or >left< arrow keys.



Relays 4 (close slide valve) and 5 (open slide valve) are dedicated to regulator functions if the regulator has been enabled. It is not possible to modify this assignment!

Select parameter "relay function" to indicate available functions.



Fig. 9-44 Relay outputs – submenu

Limit flow rate	Relay will energise if a flow limit value (to be set) has been exceeded and will de-energise if flow falls below a second limit value (to be set).
Limit level	Relay will energise if a level limit value (to be set) has been exceeded and will de-energise if level falls below a second limit value (to be set).
Limit velocity	Relay will energise if a velocity limit value (to be set) has been exceeded and will de-energise if velocity falls below a second limit (value to be set).
Limit temperature	Relay will energise if a temperature limit value (to be set) has been exceeded and will de-energise if medium temperature falls below a second limit (value to be set).
Volume impulse pos.	Relay will output volume-proportional impulses if the flow direction is positive. Weighting and impulse duration are free programmable
Volume impulse neg.	Relay will output volume-proportional impulses if the flow direction is negative (= backwater). Weighting and impulse duration are free programmable.
Error signalling	Error message output via relay. >Error input screen< can be selected as soon as this parameter has been activated.
Error input screen	It is possible to assign the relay output to the respective error here.

The choices are:

Doppler sensor, external fill level, temperature, external setpoint and slide valve. The velocity is not available.

Choose the desired function with the >up< or >down< arrow keys and confirm by pressing ENTER. A tick will appear as soon as the function has been confirmed. Pressing ENTER once more will deactivate the function again, pressing ESC will exit the menu (see also Fig. 9-45). All errors will be saved in the error memory (see Chap 9.2 section “Error messages”)

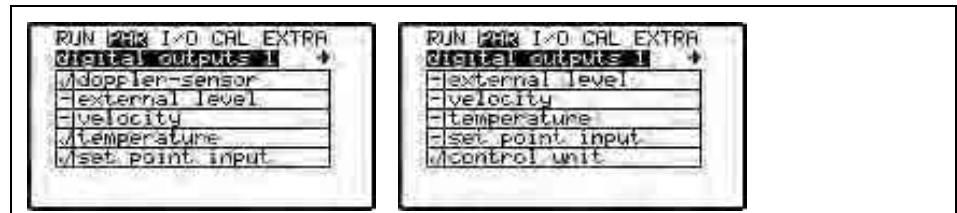


Fig. 9-45 Error input mask

After the relay function has been defined (limit flow rate, limit level, limit velocity, or limit temperature) another window will appear enabling to define the function parameters depending on the function chosen. The respective parameters are ON and OFF points, ON and OFF delays as well as modifications of the name which might come into effect on the screen (see Fig. 9-46).



Fig. 9-46 Limit value parameter

Switching mode

It is possible to select between >normally open< and >normally closed<.

The relay is going to energise if >normally open< has been selected and the according value has been reached, if >normally close< has been selected the relay will energise immediately after the parameter has been set and will de-energise as soon as the according value has been reached.

Switch point on

Defines the “ON” point for the selected limit value. This value is required for all limit functions.

Switch point off

Defines the “OFF” point for the selected limit value. This value is required for all limit functions.

Time delay on

The “ON” event in case of reaching the limit value can be delayed by up to 9999 seconds max. The relay will not energise before the time set is expired and the limit value is present yet.

If the value falls below the limit threshold for a moment the cycle will begin anew.

Time delay off

The “OFF” event in case of reaching the limit value can be delayed by up to 9999 seconds max. The relay will not de-energise before the time set is expired and the limit value is present yet. If the value falls below the limit threshold for a moment the cycle will begin anew.

Name

The relay output name may consist of 3 characters max., which will be indicated in main menu and in overview menu. Set the name as described in Chapter. 9.4.1.

If the impulse function has been selected the options below have the following functions:

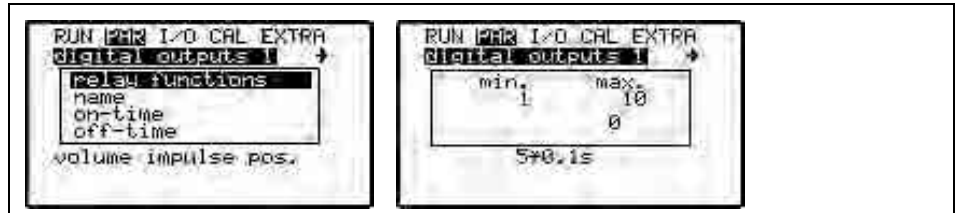


Fig. 9-47 Impulse parameters / impulse duration

Impulse duration

Set impulse duration from 0.1 to 1.0 seconds. The impulse-pause-ratio is 1:1; the default setting is 0.5 seconds.

It is useful to extend impulse duration e.g. in case of using slow SPS (PLC) inputs or sluggish mechanic counters.

Volume impulse

Defines the impulse value. The measured volume will be added internally until the value set has been reached (e.g. 1 m³). Then an impulse signal with the duration set will be output and the internal counter will be set to 0 again. The course of events will repeat again subsequently.

9.4.8 Parameter Menu “Control Unit“



Fig. 9-48 Control unit basic settings

This menu allows you to adjust the transmitter to almost any waste water application for optimum performance. It enables to execute slide valve and torque monitoring as well as quick close control or automatic flush functions. The digital inputs >PATH OFF<, >PATH ON< and >TORQUE CLOSED< have to be activated for the control unit to operate.

You can find more comprehensive information on setup and functional principle in chapter 7.7 Regulator Mode.



It is absolutely necessary to have sound knowledge on control technology to correctly and safely set the regulator!

Guideline:

$$\text{Interval} = \frac{\text{average flow velocity}}{\text{distance between regulating unit and measurement}} \cdot 1,3$$

Slide valve run time/shifter time

Use this parameter to monitor spindle breaks, slide valve gate breaks, gear defects, power failures on the regulating unit or other malfunction sources which may reveal because the regulating unit does not move although control signals are being generated.



An error message is going to be generated if the controller unit does not reach the end switch CLOSED after the slide run time has expired (see Chap. 9.2 sub item "Error messages")

Guideline:

Slide run time to be set = time between open and closed condition of slide valve during permanent operation • 1,22,0.
(the longer the slide run time the lower the factor)



*The slide run time has an effect similar to the P-factor and **has to be set!***

There will be no error message generated e.g. in case of a broken spindle if the slide run time has not been set!

Min. pulse time

This parameter can be considered as quite similar to the I-component of PID controllers. It defines a minimum regulating time of a regulating unit in order to ensure that calculated very short control impulses mechanically affect the regulating unit at all. Hence the minimum control impulse duration should be specified longer than motor start-up time + gear clearance + slide valve clearance. If 0 has been set an impulse duration of 0.25 seconds will be used.

Max. pulse time

This parameter defines the maximum control impulse duration of the regulating unit. This allows to limit the slider run time. The maximum control impulse duration should be shorter than the cycle time.

P-Factor

The proportionality factor indicates, to which degree the regulating time is going to be affected in case of a deviation Δw from setpoint w . The higher the proportionality factor, the longer the regulating time of the slide valve at the same control deviation..

Quick close function:

The quick close function is used if certain conditions such as large diameters, long slide valve run times and long dead times of the measurement section are given. In case of sudden rainfall events this function will partially close the open slide valve independent of the calculated regulating time.

During permanent operation this is going to be executed without any run time interruption. This function requires "h, Q and t-quick close" to be set.

- h-quick close** h-quick close acts as OR-parameter related to Q-quick close. This parameter defines the desired maximum flow level of the medium. "t-quick close" will be activated as soon as this value has been reached. Depending on application, this parameter shall be set approx. 60-80 % higher than the setpoint. Before setting this parameter please observe waves at the measurement place as well as the unit's regulating deviation.

- Q-quick close** Q-quick close acts as OR-parameter related to h-quick close. This parameter defines the desired maximum flow rate of the medium. "t-quick close" will be activated as soon as this value has been reached. Depending on application; this parameter shall be set approx. 10-50 % higher than the condition which makes the system go to regulator mode during dry weather operation. Before setting this parameter please observe the unit setpoint deviation tolerance.

- t-quick close** t-quick close is the time the regulating unit needs to move from open condition (end switch: PATH ON) to the position it has whilst being in normal regulator mode. "h-" or "Q-quick close" are the conditions for "t-quick close" to switch.

- t of Pos. "CLOSED"** This period is for error cases, e.g. interrupted sensor communication or defect sensor. In this case the regulating unit goes to closed condition (end switch: PATH OFF) before it opens again for the period set in this parameter t of Pos. "CLOSED".

- Time delay** This is the time to elapse before the position control comes into effect in case of errors. The adjustable range is 0-240 seconds.

9.4.9 Parameter Menu „Setup Parameter“

WARNING



Data loss due to system reset

Selecting >system reset< is going to reset the system to the basic parameter settings. The default settings are going to be restored and all customer modifications will be set to default condition (system general reset).



Fig. 9-51 Setup parameter – submenu

This menu allows to modify measurement and output damping, to reset the system to default condition as well as to modify special settings by using the service code.

System reset

Enables a general reset of the measurement transmitter. Entering the PIN-Codes >2718< will cause the OCM F to execute a general reset. The unit will be in initialising mode subsequently which requires the operation language to be set.

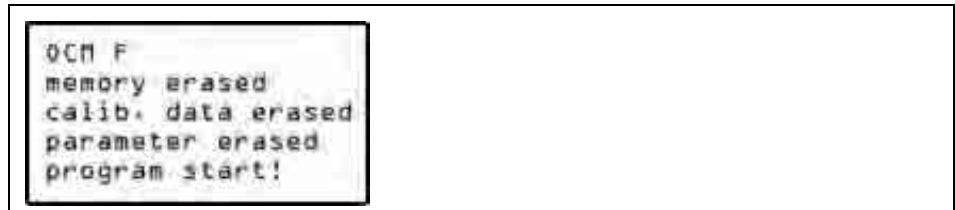


Fig. 9-52 New program start OCM F



Fig. 9-53 Choose language

The OCM F will now overwrite the flash memory restarting the program. Before restart the unit briefly indicates unit ID (see Fig. 9-52). Subsequently the desired language can be selected (see Fig. 9-53) and the unit will return to factory default condition.

Service mode

Additional system setting options are going to be revealed as soon as a special code has been entered. This parameter is reserved for NIVUS service personnel as the settings require comprehensive expert knowledge and are not needed for common applications.

Damping

Allows to adjust indication and analog output damping between 20 and 200 seconds. This means that if the calculated volume jumps from 0 to 100 % the system will need the time set here to indicate and to output this jump.

Stability

It is recommended to increase stability in case of irregular measurement drops due to poor hydraulic conditions..

9.5 Signal Input-/Output Menu (I/O)

This menu includes several submenus which both serve to assess and to check sensors as well as to control signal inputs and outputs. It allows to indicate various values (current values of inputs and outputs, relay conditions, distribution of frequency groups etc.), however does not enable to influence signals or conditions (offset, adjustment, simulation or similar). The menu therefore primarily serves in order to assess the parameter settings and for error diagnosis.



Fig. 9-54 I/O Menu

9.5.1 I/O Menu “Digital Inputs”

Digital input values routed to the transmitter input clamps can be viewed here. Select from either logically "OFF" or "ON".



Fig. 9-55 Screen digital values

9.5.2 I/O Menu “Analog Outputs”

This menu indicates the calculated values which have to be sent to the analog converter as mA signals.



Fig. 9-56 Screen analog values



The actual current on the output clamps will not be displayed. The only signal visible is the one the analog output converter is receiving for output purposes. External faulty wiring neither can be detected nor indicated in this menu.

9.5.3 I/O Menu „Digital Outputs”

Conditions which are calculated by the transmitter and routed to the relay for output purposes subsequently can be viewed here. Select from either logically "OFF" or "ON".

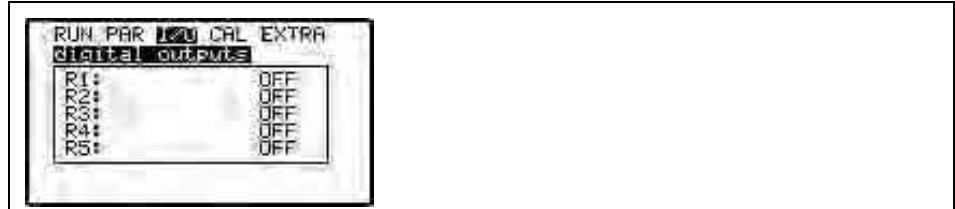


Fig. 9-57 Screen digital values



The actual output condition of the relay contacts on the output clamps will not be displayed. The only signal visible is the one the relay is receiving for output purposes.

External faulty wiring neither can be detected nor indicated in this menu.

9.5.4 I/O Menu „Measurement Data”

This menu is to recall current readings at a glance.

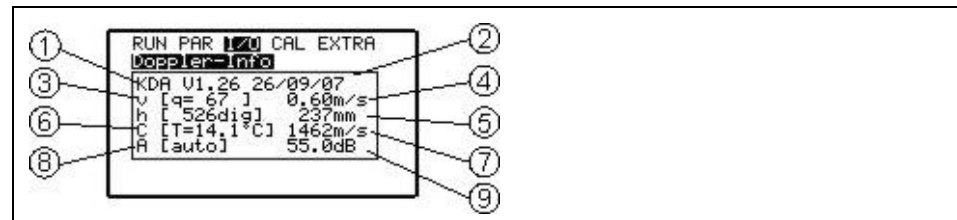


- h = Measured level
- v = Measured flow velocity
- A = Calculated area
- Q = Calculated flow rate
- t = Measured temperature
- q = Quality of velocity measurement (damped)

Fig. 9-58 Screen measurement data

9.5.5 I/O Menu “Sensor-Info”

This menu is to indicate various information regarding the sensor and is mainly for service purposes.



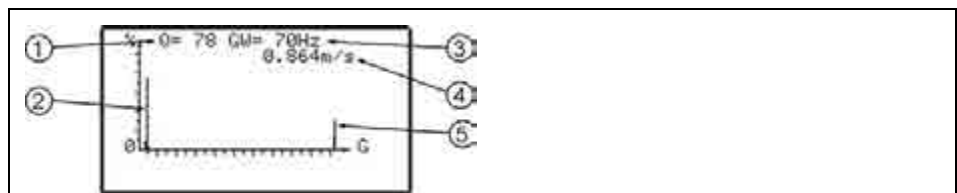
- 1 Firmware version of sensor
- 2 Creation date of sensor firmware
- 3 Quality of velocity measurement
- 4 Calculated average flow velocity
- 5 Height measured by pressure sensor
- 6 Measured medium temperature
- 7 Velocity of sound resulting from medium temperature
- 8 Amplification mode of sensor
- 9 Amplification value of sensor

Fig. 9-59 Status of sensors and velocity evaluation

9.5.6 I/O-Menu „v-Histogram”

The frequency histogram indicates the spreading of the investigated Doppler frequency. Each bar (peak) represents a frequency group.

This is particularly important to assess and to choose measurement places as well as to find a place for sensor installation.



- 1 = Quality of velocity measurement
- 2 = frequency group (peak)
- 3= Measurement frequency
- 4= Currently measured flow velocity
- 5= invalid values

Fig. 9-60 Distribution of frequency groups

The measurement quality (0-100 %) indicates the relation between the evaluated Doppler frequency and the entire frequency spectrum measured. The higher the quality, the more reliable the indicated flow velocity reading. There are no limit values for the quality (Q) since the shape of the frequency distribution has to be considered additionally. This shape is more important for hydraulic assessment than „q“.



There are cases where, despite comparatively high quality values, it is not possible to correctly investigate the flow velocity reading due to poor frequency group distribution. In such cases install the flow velocity sensor in another place. See „Installation Instruction for Correlation and Doppler Sensors“.

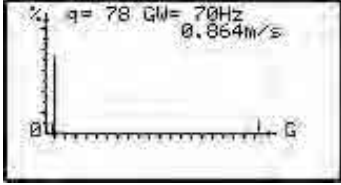
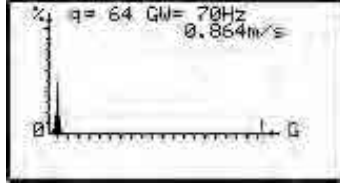

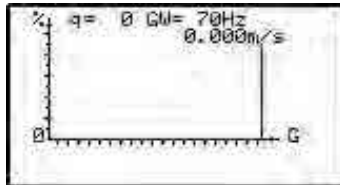

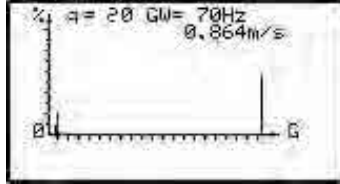
	
<p>Quality = very good Frequency distribution = very good</p>	<p>Quality = good Frequency distribution = good</p>
	
<p>Quality = satisfactory Frequency distribution = satisfactory</p>	<p>Quality = none Frequency distribution = none</p>
	
<p>Quality = very good Frequency distribution = poor</p>	<p>Quality = poor Frequency distribution = satisfactory</p>

Fig. 9-61 Flow velocity profiles

9.5.7 I/O Menu “External Level“

This menu is visible only if external level measurement is enabled. Here the prevailing currents on analog input 1 and the height of the external level measurement are indicated.

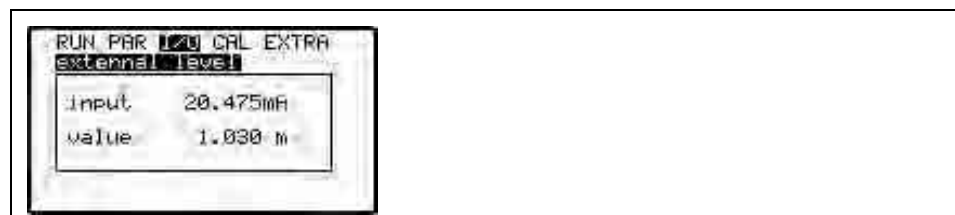
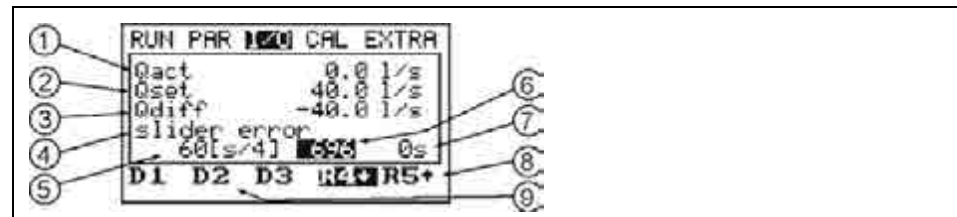


Fig. 9-62 External level selection

9.5.8 I/O Menu “Control Unit”

This menu is visible only if the controller has been enabled in the PAR menu. Having the controller enabled will bring up the screen below:



- 1 Currently measured flow rate
- 2 Set point of regulator
- 3 Difference between Q_{act} and Q_{set}
- 4 Regulator status: Normal, Quick close, Idle, Error
- 5 Current regulating time calculated from „Qdff” in sec./4
- 6 Time in seconds how long activated relay remains energised
- 7 Remaining cycle time
- 8 Status of three digital inputs
- 9 Status of both relays

Fig. 9-63 Control unit selection

9.5.9 I/O Menu “Test control unit – manual mode”

DANGER



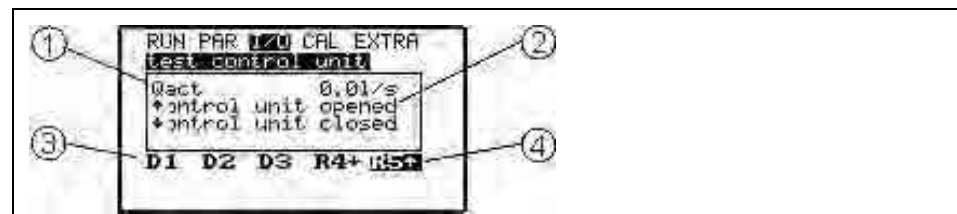
Caution – Danger of injury!

*The manual controller operation directly will access any following facility areas **without any safety locking measures!** This might result in personal injuries!*

Manual operation is for test purposes exclusively!

Safety precautions must be taken!

This menu is visible only if the controller has been enabled. The slide valve can be manually opened and closed for testing purposes. The arrow keys >up< and >down< serve as manual control elements.



- 1 currently measured flow rate
- 2 time in seconds how long activated relay remains energised manually
- 3 status of three digital inputs
- 4 status of both relays

Fig. 9-64 Control menu for test control unit

9.6 Calibration and Calculation Menu (CAL)

This menu is to adjust the level measurement, to adapt flow velocity and analog outputs to following systems and to simulate relay switching events and analog outputs.



Fig. 9-65 CAL- menu selection

9.6.1 CAL Menu "Level"

This menu allows to adjust level measurements.

Values from -1000 mm to +1000 mm (39.4 in) can be entered. This adjustment is required only if the level measurement utilises a pressure measurement cell.



Fig. 9-66 Submenu - level



Due to physical reasons the pressure measurement cell is subject to zero point drift. It is recommended to adjust the pressure sensor to the zero point regularly (recommended interval: 6 months).

Required values have to be investigated with the sensor being removed if possible or if the water level is as low as possible. The correct filling level has to be investigated as accurate as possible before adjusting by using another suitable measurement method (value = 0 if the sensor has been removed from the medium).

Enter the investigated value as reference.



Investigating the zero point of the pressure measurement cell is often carried out by measuring the current filling level with a yardstick, a ruler or similar without removing the sensor. After the ruler or similar has been held into the medium, the respective reading is entered as reference value.

*This is why the filling level for reference measurement purposes has to be measured **always** from top down (see Fig. 12-1).*

9.6.2 CAL Menu “Flow Velocity“

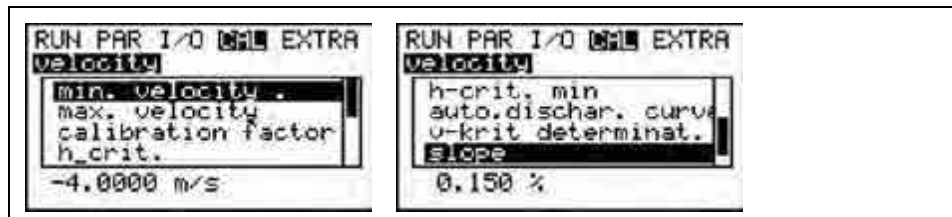


Fig. 9-67 Submenu – velocity

min. velocity

Defines the minimum flow velocity measurement range the OCM F shall measure and process. It is set to -4 m/s per default. The minimum flow velocity can be set to >0< if negative flow directions are not to be measured.

max. velocity

Defines the maximum flow velocity measurement range the OCM F shall measure and process. It is set to 4 m/s per default.



It is not possible to measure and to output positive velocity if the maximum value has been set to >0<!

It is not possible to measure and to output negative velocity if the minimum value has been set to >0<!

Calibration factor

Here the calibration factor can be modified. The calibration factor is multiplied by the measured flow velocity. The value is set to 1 per default.

h-crit.

Measuring the flow velocity is no longer possible as soon as the level falls below a certain level called h_crit.

The level h_crit is pre-determined by the construction of the sensor as well as the measurement method and is set to 0.065 m (2.56 in) per default.

After initial start-up, the OCM operates using the start values found in the Manning-Strickler table (CAL / Flow velocity / v-crit determination / Manning-Strickler) until it reaches the h-crit value set.

Going through a level range of 9-12 cm featuring a decreasing trend causes the unit to determine an application coefficient (automatic activated).

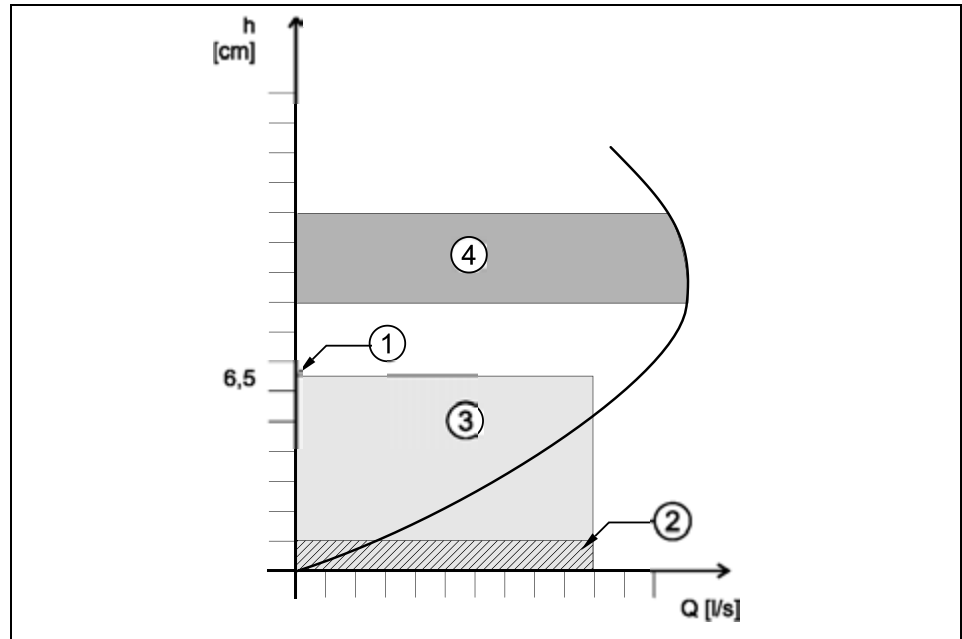
Then the OCM under h-crit operates using the investigated application coefficient.

In case of a raised sensor installation position enter + 0.065 m as installation height here.

Example: enter 0.085 m under "h-crit" in case of using a sensor installation height of 0.02 m..

h_crit min

The flow velocity will not be calculated below "h_crit min" and hence will be set to >0<.



- 1 h-critical
- 2 h_crit min
- 3 Range of automatic Q/h relation
- 4 determination of application coefficient

Fig. 9-68 Flow velocity determination graph

Auto discharge curve Depending on the selected setting, entered values are verified and corrected if necessary with the next measuring event (automatic >active<). Another option is to permanently operate using the values entered in "Manning Strickler", "manual" or "Assistant" (automatic >inactive<).

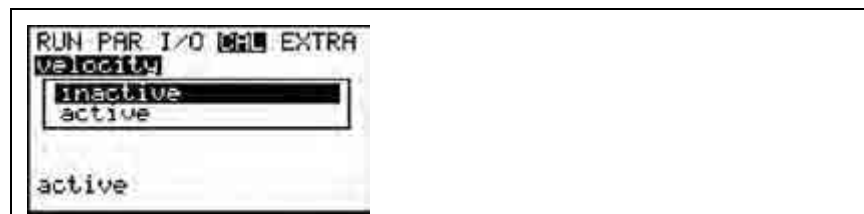


Fig. 9-69 Defining v-crit



Note

Please avoid backwater up to levels of 0.012 m if Auto discharge curve is „active“.

v-crit Determination

This menu is conceived to be used for commissioning at low filling levels lower than 6.5 cm. There are three options to determine the flow velocity:

- Manning-Strickler (if slope and roughness are known)
- Manual (if a reference value can be determined)
- Assistant (if a minimum dam-up of 6.5 cm is possible)



Comprehensive expert knowledge is required to properly utilise these parameters. We therefore recommend the NIVUS commissioning service or a thorough device training.

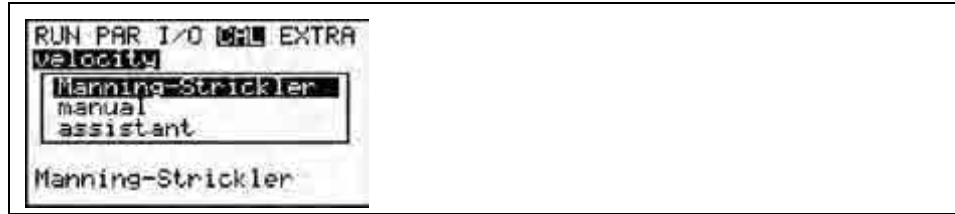


Fig. 9-70 Selecting v-crit determination

Manning Strickler

The theoretical discharge curve is calculated using the settings under >Dimensions<, >Slope< and >Roughness<.

This function may be combined with the automatic mode. The theoretical settings within the flow velocity monitoring area (see Fig. 9-68, No. 4) will be verified using this method.

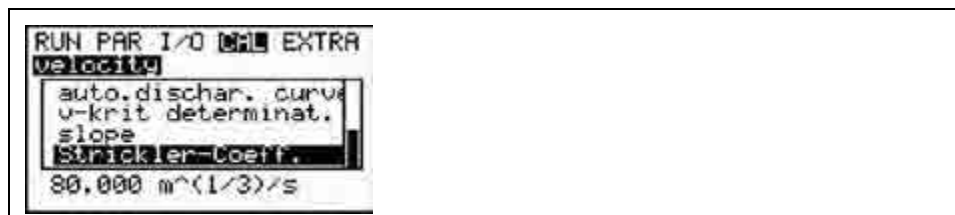


Fig. 9-71 Manning Strickler v-crit determination

Slope Enter the slope at measurement point in %
Strickler -coefficient Enter the Manning - Strickler coefficient



Please see Table „Manning - Strickler Coefficients“ in chapter 14 for more information.

Manual

Enter the current level and the current flow velocity (measured using a reference) directly. The theoretical discharge curve is calculated from these values. This function may be combined with the automatic mode. The theoretical settings within the flow velocity monitoring area (see Fig. 9-68, No. 4) will be verified using this method.



Fig. 9-72 Manually setting v-crit determination

Assistant

The OCM guides through a menu using an artificial dam-up (e.g. using a sand-bag) to determine required characteristics. The theoretical discharge curve will be generated automatically.

This function may be combined with the automatic mode. The theoretical settings within the flow velocity monitoring area (see Fig. 9-68, No. 4).

will be verified using this method.

First ensure free discharge, then start level measurement with >ENTER<.

```

RUN PAR I/O [M] EXTRA
free discharge!
h_actual: 0.000 m
start measuring [#]
    
```

Fig. 9-73 Assistant – start measuring v-crit determination

The OCM executes the first level measurement in free discharge. Measuring will take 8 seconds.

```

RUN PAR I/O [M] EXTRA
free discharge!
h_actual: 0.000 m
4
    
```

Fig. 9-74 Measuring Countdown Assistant

After the first measuring, a dam-up of minimum 6.5 cm (12 cm are recommended) must be created behind the sensor by using a sandbag or similar. The second level measurement in the dam-up cannot be started before "h-actual" shows stable values.

```

RUN PAR I/O [M] EXTRA
create dam-up!
set point> 0.120 m
h_actual: 0.000 m
start measuring [#]
    
```

Fig. 9-75 Create dam-up – start measuring

The OCM will execute a new 8-second level measurement.

```

RUN PAR I/O [M] EXTRA
create dam-up!
set point> 0.120 m
h_actual: 0.000 m
v_actual: 0.000 m/s
Q_actual: 0.000 l/s
5
    
```

Fig. 9-76 Measuring countdown for the second measuring

The readings below will be indicated after the second measurement has been finished:

- **h_{actual}**: actual level
- **h**: level before creating a dam-up
- **v**: measured flow velocity
- **Q**: investigated flow

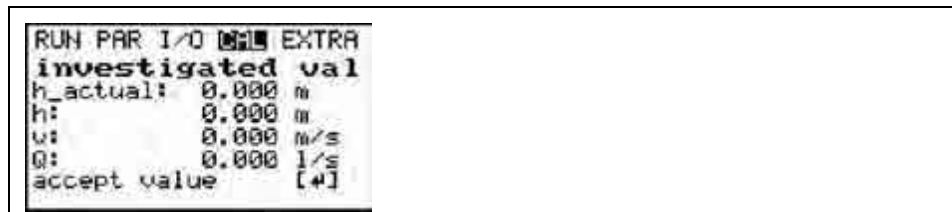


Fig. 9-77 Assistant indicating investigated values

Pressing >ENTER< determines and subsequently enters an application coefficient (factor) for the measurement point.

9.6.3 CAL Menu “Analog Outputs“

Basic Hints on Simulation:

DANGER



High risk potential during simulation

Due to the extremely high risk potential (direct access to following plant sections) as well as incalculable effects due to poor or faulty simulation, NIVUS herewith refuse to accept any responsibility for personal or material damages of any kind in advance!

Simulations must be carried out by trained expert personnel exclusively!

Adjustment

The 3 analog outputs can be adapted to following systems. Adjust between -4 mA and 4 mA (see Fig. 9-78).

These values will be added to or subtracted from the analog outputs. Adjustment is not possible as soon as the analog output has been set to “Constant value”.



Fig. 9-78 Adjustment of analog outputs

WARNING



Danger of injury!

*The simulation of OCM F outputs will access any following facility areas **without any safety locking measures!***

Simulations are allowed to be executed exclusively by NIVUS expert personnel or by expert companies trained by NIVUS in cooperation with experienced users. Be sure to always observe safety precautions!

WARNING



Make sure to have a safety person available

The simulation of analog inputs and outputs is allowed to be carried out by specialist electricians only who have sound knowledge on the control system of the facility. This requires detailed preparation.

It is absolutely necessary to have a safety person available!

The following system must be set to manual operation mode. Actuators or similar have to be disabled if possible or have to be functionally restricted in a way not to cause any damage.

Simulation

It is possible to simulate a free adjustable analog output current on the 3 analog outputs. Select the desired analog output with the >right< or >left< keys. After entering the PIN code >2718< you can increase or decrease the mA value in steps of 0.01 mA using the >up< or >down< keys during simulation. Furthermore it is possible to directly enter desired values to simulate by pressing ENTER. A maximum output current of 20.475 mA can be simulated (see Fig. 9-79).

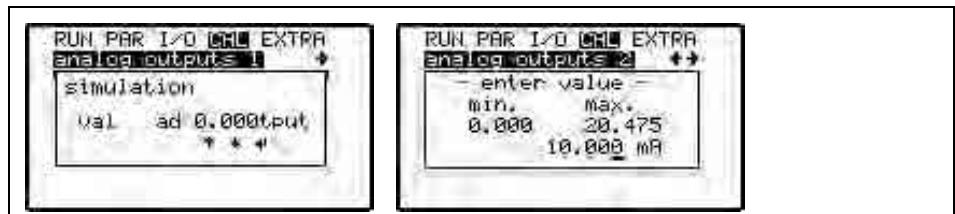


Fig. 9-79 Simulation of analog outputs

9.6.4 CAL Menu „Digital outputs“

Selecting the >Digital outputs< menu requires to enter the PIN (2718) once again. This ensures to prevent unauthorised persons from performing simulations during operation.

Choose the desired relays to be simulated by using the >up< and >down< arrow keys. Use ENTER to either turn the chosen relay ON or OFF directly. The relays will de-energise if you exit the menu

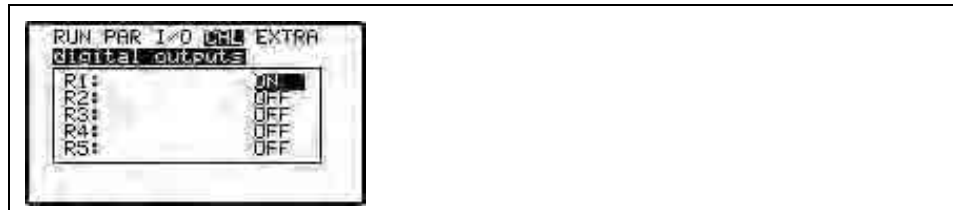


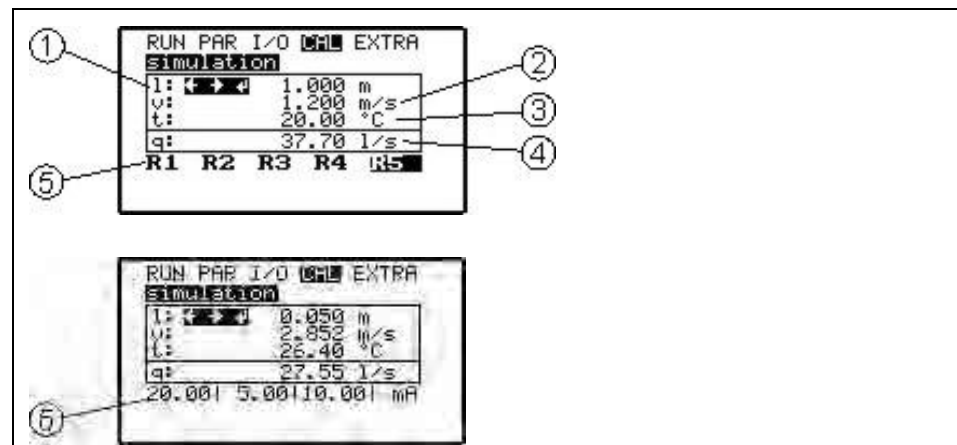
Fig. 9-80 Relay simulation

9.6.5 CAL Menu „Simulation“

After entering the PIN code >2718< select between level, velocity and medium temperature by using the >up< and >down< arrow keys. Pressing >right< or >left< will increase or decrease the simulated flow velocity or temperature value in steps of 1 cm or 0.1 °C.

Using ENTER enables to enter the desired simulation value directly.

The flow value which has been calculated by means of the simulated readings will be indicated on the bottom line of the screen. Relays which might have been set will switch and programmed mA outputs supply according current values simultaneously. Use >up< or >down< keys to indicate output values in the bottom line of the display.



- 1 Simulated height/level
- 2 Simulated flow velocity
- 3 Simulated medium temperature
- 4 Calculated simulated flow value
- 5 Programmed relay activated by simulation
- 6 Analog output signals

Fig. 9-81 Simulation mode

9.7 Parameter storage

Via the front-side USB interface, parameter can be either loaded or saved on PC or Laptop using software tool „PaDa“. This tool is free and can be down-loaded from www.nivus.com under >Download/Software<.

Connect the OCM F and PC/Laptop with an USB cable (Type A-B). The „Pa-Da“ software tool at present can be operated under Windows® XP, Vista and Windows® 7 (32-Bit version).



*If a warning should be displayed during installation click the "**Continue Anyway**" button.*

PC or Laptop are not capable of detecting the OCM F transmitter however if you select "STOP Installation" instead. In this case the software must be installed again!



Fig. 9-82 PaDa Installation Warning

After the software has been installed successfully, run the tool under Windows® XP either from „**Start – All Programs - NIVUS GmbH**“ or via the desktop icon (self-installed; German, English or French).

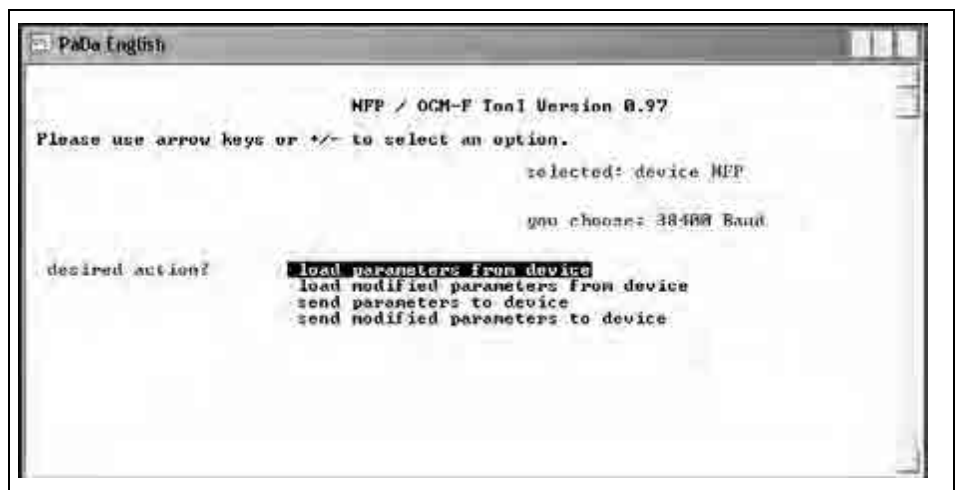


Fig. 9-83 PaDa English

Select the desired option using the >up< and >down< arrow keys and confirm with the Enter key. The standard installation routine will install the software under Windows® XP in the **C:\Programme\PaDa** directory. Parameter sets will be saved there as well. Read out or open parameters either with EXCEL or an appropriate editor application.

Load parameters from device

Downloads the complete current parameter settings of the transmitter from OCM F to PC/Laptop creating a file named "PARAM.TXT".

Load modified parameters from device

Loads only parameters which have been modified in the unit (varying from default) using a file named "CHGPARAM. TXT".

Send parameters to device

Sends previously saved parameters ("PARAM. TXT") to OCM F in case of accidental system reset, faulty modification of specific settings or device defects. Synchronises the parameters between PC/Laptop and OCM F. Copy the desired parameters into the same directory as the "PaDa.exe" before transmitting.

Send modified parameters to device

Use this function to send modified parameters to the transmitter. The file name is "CHGPARAM. TXT".

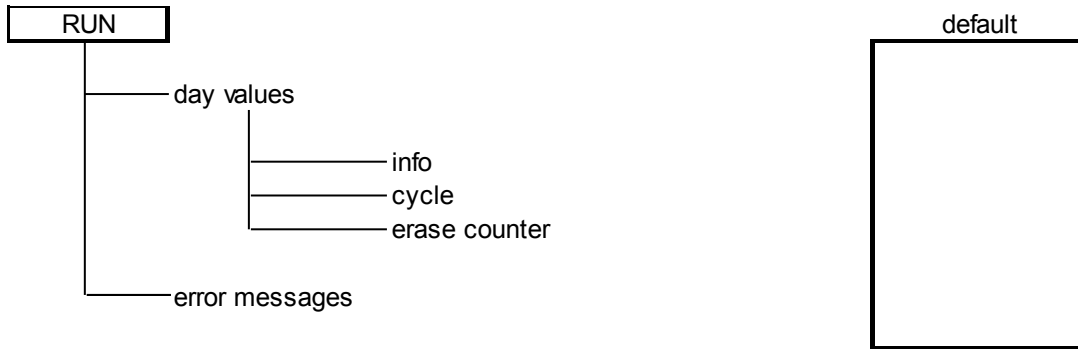
Do not close the tool window during data transmission! The window will close automatically as soon as the transmission has been finished successfully!



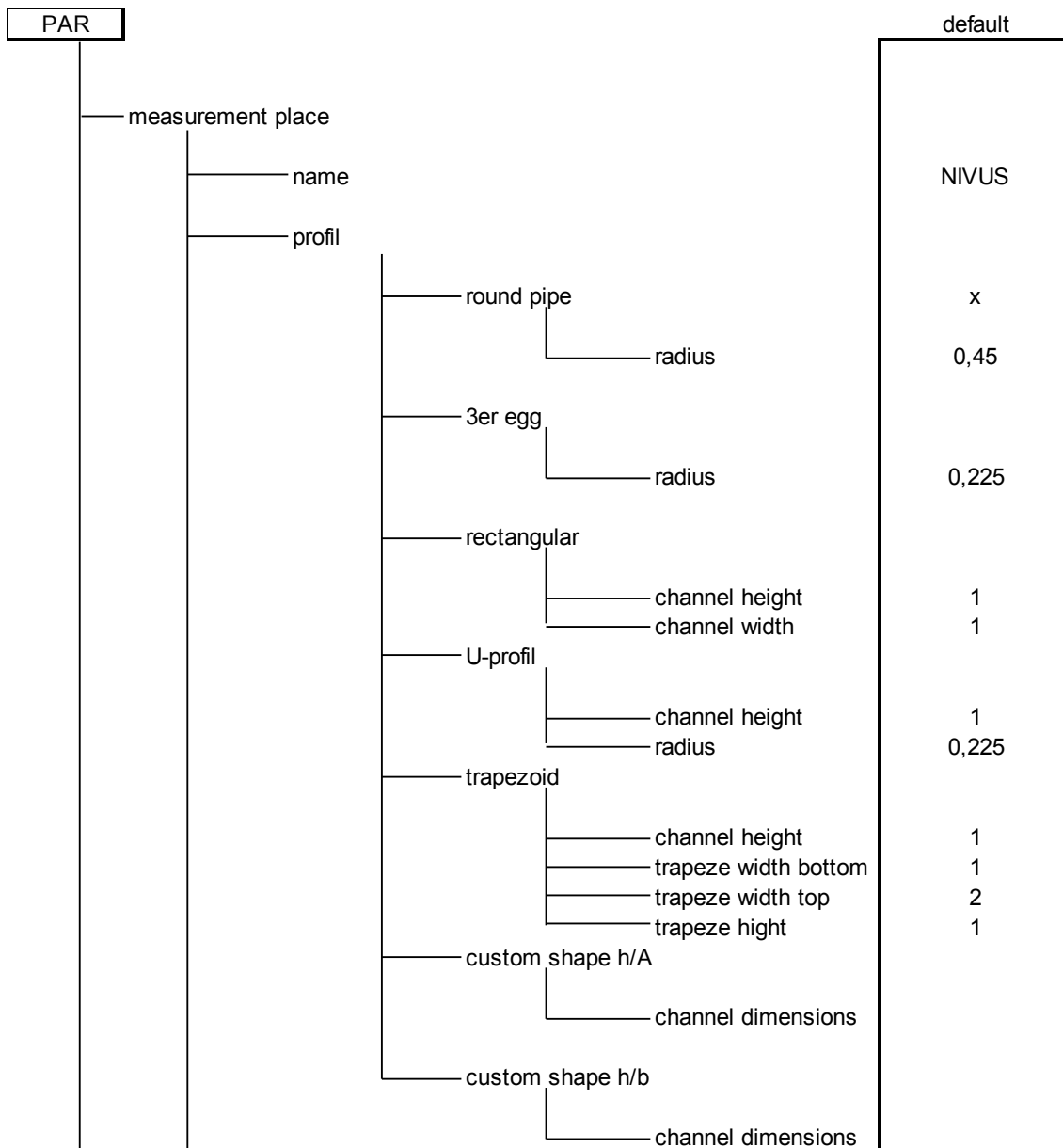
In order to prevent data from being overwritten, move parameters which have been read out before into a separate folder.

10 Parameter tree

Parameter Menu (RUN)



Parameter Menu (PAR) Part 1



Parameter Menu (PAR) Part 2

		default
level	Sludge level	0
	Low-flow volume Qmin.	0
	Low-flow volume Vmin	0
	sensor type	
	pressure trans.	x
	mounting offset	0,005
	constant level	
	value	0,1
	external sensor	
	range	4-20 mA
value at 0/4 mA	0	
value at 20 mA	4	
offset	0	
damping	3	
external sensor (Ex)		
value at 4 mA	0	
value at 20 mA	4	
offset	0	
damping	3	
velocity	sensor type	wedge
	mounting offset	0,015
	mounting direction	positive
digital input	function	
	DI 4 stop v-measurement	
	logic name	non-inverse D1
	DI 1 torque switch	
	DI 2 switch "CLOSE"	
DI 3 switch "OPEN"		

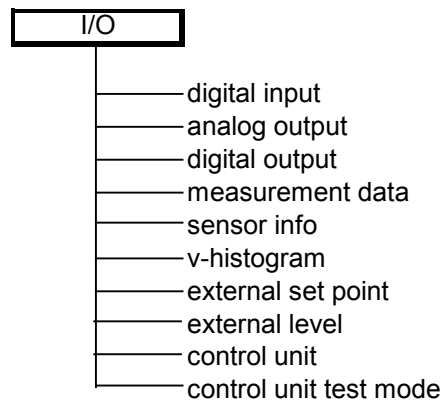
Parameter Menu (PAR) Part 3

	default
analog output	D1
function	x
inactive	
flow rate	
level	
velocity	
temperature	
constant current	
output range	x
0-20 mA	
4-20 mA	
value at 0/4 mA	1 m/s
value at 20 mA	0,8 m/s
error mode	x
inactive	
active	
error input mask	
value in error case	x
hold old value	
constant 0 mA	
constant 3,6 mA	
constant 4,0 mA	
constant 20,475 mA	
digital outputs	
relay functions	1
no function	x
limit flow rate	
limit level	
limit velocity	
limit temperature	
pos-total impulse	
neg-total impulse	
error messages	
error input mask name	R1
Par. below at active relay function only	
switching mode	x
normally open	
normally closed	

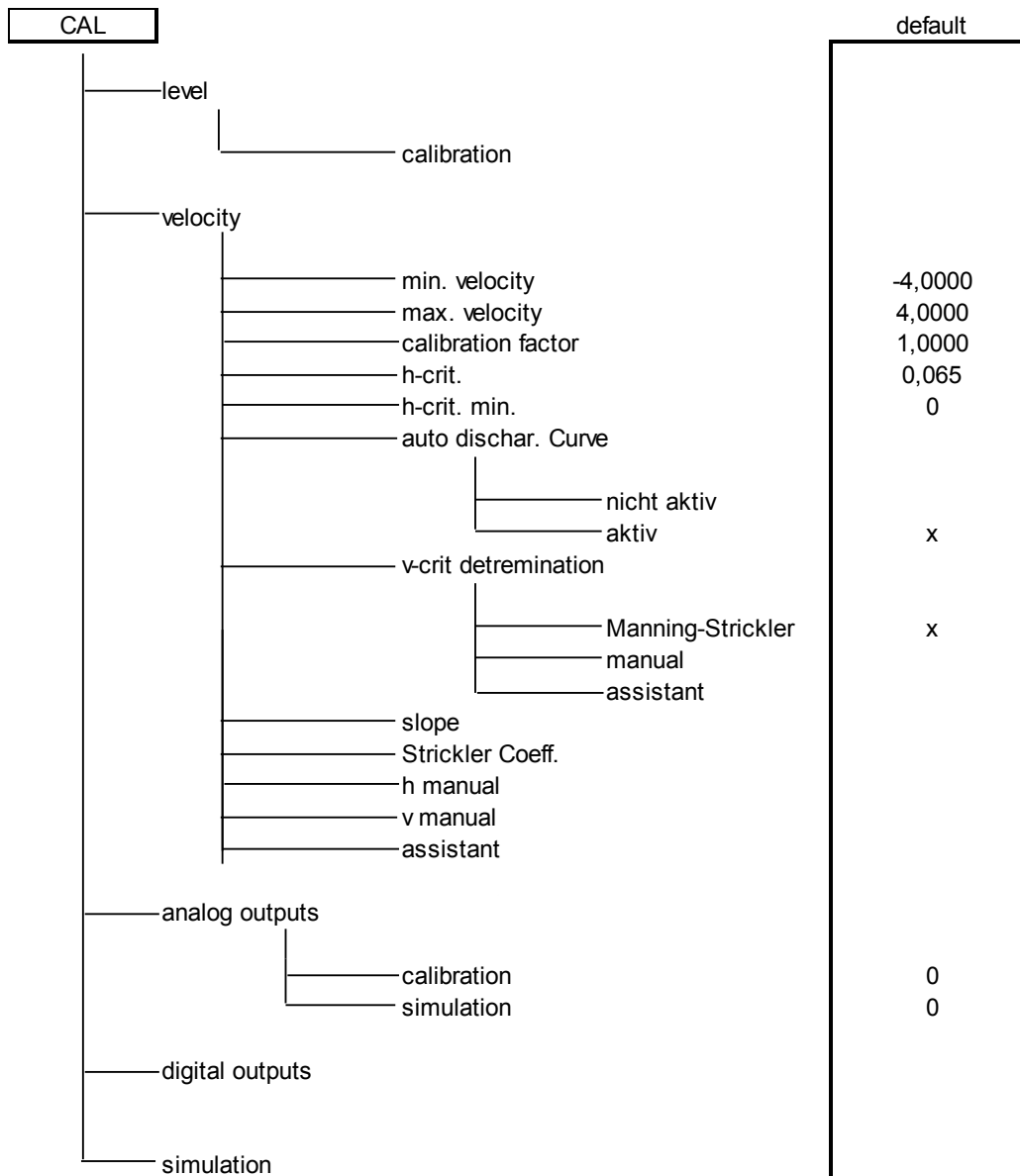
Parameter Menu (PAR) Part 4

		default
	switch point on	0
	switch point off	0
	time delay on	0
	time delay off	0
	name	R1
	only when relays function is "impulse"	
	impulse duration	5
	amount	1
control unit	function	
	not active	
	internal set point active	
	external set point active	
	external set point range at 0/4 mA	
	external set point range at 20 mA	
	max. flow rate	200
	int. set point flow	40
	control deviation	5
	cycle time	90
	shifter time	120
	min. Pulse time	1
	max. Pulse time	15
	P-factor	70
	h-Quick close function	1
	Q-Quick close function	1000
	t-Quick close function	60
	t of Pos. "CLOSED"	30
	time delay	0
setup parameter	system reset	
	service mode	
	service code	
	damping	20
	stability	60

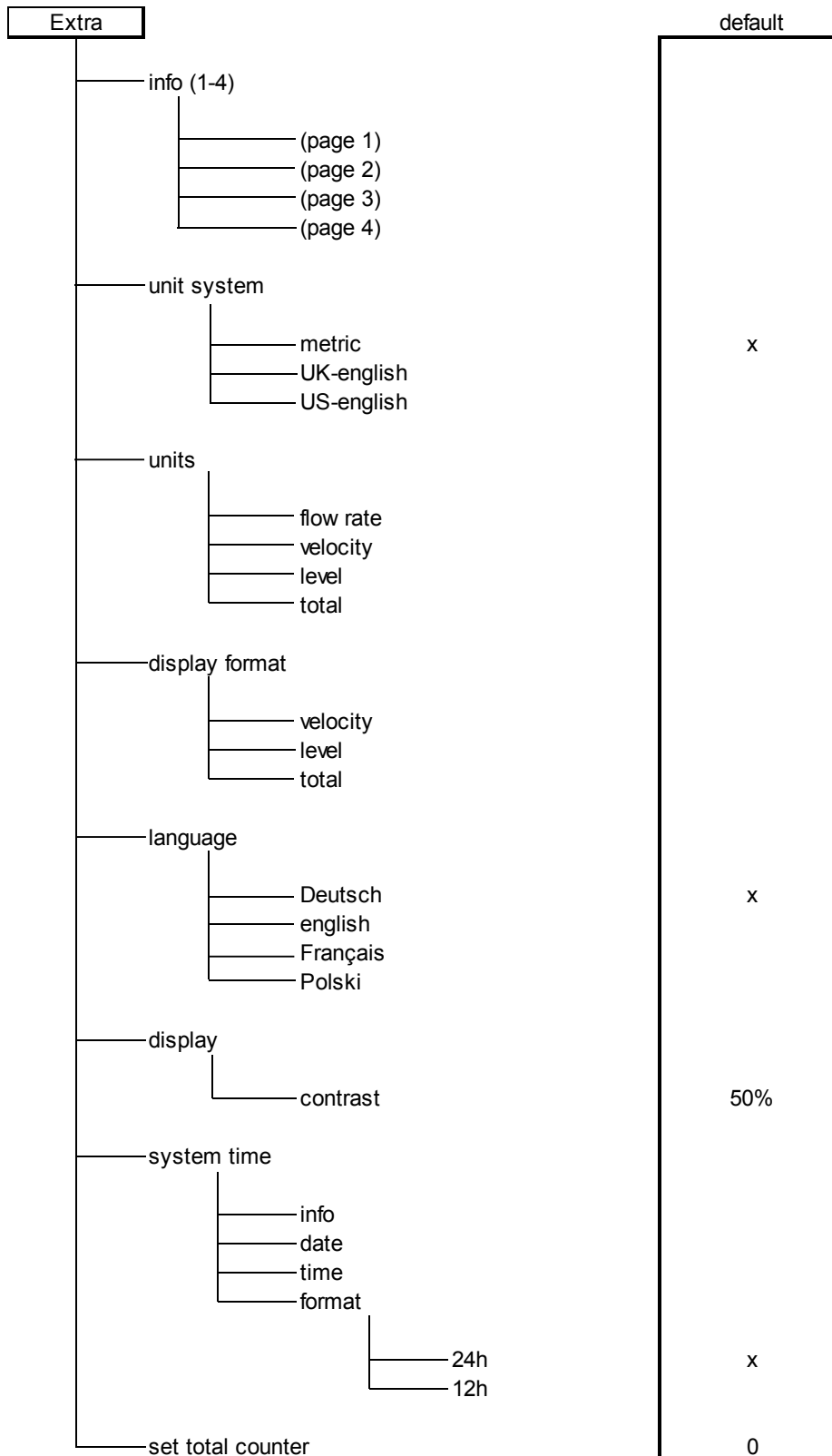
Parameter Menu (I/O)



Parameter Menu (CAL)



Parameter Menu (EXTRA)



11 Troubleshooting

Error	Possible reasons	Correction
No indication of flow (>0<or >----<)	Connection	Check connection between sensor cable and terminal strip. Check connection boxes, connections for sensor cable extension or air compensation element for correct connection or moisture. Sensor cable connected to appropriate terminal clamp strip (Ex or Non-Ex)?
	Sensor	Check sensor installation (towards flow direction, horizontal installation).
		Check sensor for soiling, sedimentation, silting (→ to be removed) or mechanical damage or sensor body and cable (→ replace sensor).
	Flow level measurement	<p>Important: no flow level → no flow velocity measurement possible!!</p> <p>In case of Doppler level measurement: check sensor for horizontal installation. Check sensor function in menu >I/O - >v-Histogram<.</p> <p>In case of external level measurement: check function and signal transmission (cables, clamp connections, short circuits and contact resistances).</p> <p>In case of measurement with pressure cell: check compensation channel at sensor body for obstructions. Remove yellow cap from filter element.</p>
		Check level measurement parameter "Fixed value" in case measuring in full channel without using level measurement.
	Transmitter	Call up error memory. Depending on error messages take the respective measures (check cables, plug and socket connections, sensor installation).
	Negative flow direction	Check installation direction of the sensor, rotate sensor if required. If the flow direction is reversed only occasionally and the measurement fails subsequently → set min. value to -6,0 m/s in menu CAL-Flow vel. – min. + max. value.
Programming	Completely check the transmitter parameter settings.	
Display >Error Doppler Sensor<	Connection	Check cable connection. Wiring on terminal strip switched? Cables firmly connected to plugs (tighten screws, pull at cable ends)? Insulation of single wires unintentionally clamped in?
	Communication	Communication to sensor disturbed. Can be checked by choosing menu I/O >Doppler-Info<. Sensor should be indicated in the first line of the following screen. Check cables for interruption or loose connection. Check sensor for mechanical damage.

Unstable measurement values	Hydraulically unsuitable measurement place	Check quality of measurement place by using the graphic frequency group distribution display. Relocate the sensor to a hydraulically more suitable place (extend calming section).
		Remove soiling, sedimentation or obstructive constructions in front of the sensor.
		Straighten the flow profile by installing appropriate baffle plates and calming elements, flow straighteners or similar upstream of measurement.
		Increase damping.
	Sensor	Check sensor installation (towards flow direction, horizontal installation). Check sensor for sedimentation or obstructions.
Implausible measurement values	Hydraulically unsuitable measurement place	See "Unstable measurement values".
	External level signals	Check for correct connection.
		Check if cables are crushed, for short circuits and improper resistive loads or current consumers without galvanic isolation.
		Check measurement range and span.
		Check input signal in I/O menu.
	Sensor	Check for correct connection.
		Check if cables are crushed / for extensions/cable types, short circuits, surge arresters or improper resistive loads.
		Check level signal, echo profile, flow velocity signal, cable parameters and temperature in I/O menu.
		Check if sensor is installed on a vibration-free place. Check sensor installation (towards flow direction, horizontal installation), check sensor for soiling.
	Programming	Check if the correct shape of measurement place has been set, check dimensions (observe units), sensor type, sensor installation height etc.
Faulty Digital output	Connection	Check connections on terminal clamp strip.
		Check power supply of external control relays.
		In I/O menu check signals to be output.
		Check output control function in calibration menu.

	Programming	<p>Check if relay outputs are enabled.</p> <p>Check if outputs are correctly assigned to respective output channels.</p> <p>Check additional values such as impulse parameters, limit values, logic etc.</p>
No controller function	Connection	Check terminal clamps (relays 4 and 5 are dedicated to controller function).
		Check power supply of external control relays.
		Check input signals from limit contacts and setpoint.
		Check output control function by using menu manual controller operation.
	Programming	Check settings. Controller enabled? Controller parameters set? Analog input set and enabled as setpoint? Relay outputs enabled? Observe controller status in I/O menu.
Faulty mA output	Connection	Check connection clamps for correct wiring and polarity.
		In case of using one or several outputs: check following systems/indicators if they are potential-free. Two analog outputs at a time have a common ground.
	Programming	Output enabled?
		Check if functions have been assigned to correct output channel.
		Check output range (0 or 4-20 mA)
		Check output span
		Check offset
		Check output signal in I/O menu
	Following systems	Check cables and connections as well as input and output clamps.
		Check input range (0 or 4-20 mA) of following system.
Check input span of following system.		
Check offset of following system.		
PC / Laptop unable to detect device	No device driver installed	Reinstall driver, on WINDOWS warning press "Continue anyway".

12 Verification of the Measurement System

12.1 General

The verification of the measurement system should be carried out by the NIVUS service if possible or by an expert company authorised by NIVUS.

In case of an initial general verification carried out by hydraulically and technically well-versed personnel, proceed according to the guidelines described below:

- Check power supply on the OCM F. The according slide switch on the board must be engaged (see Fig. 7-12). The main screen must be visible on the transmitter display.
- Check the communication between flow velocity sensor or combi sensor and transmitter at I/O/Doppler-Info
- If the sensor(s) is/are not recognised, check the connections as well as over-voltage protection elements which might have been used
- Check the level measurement
- Check the flow velocity measurement
- Check analog and digital inputs and outputs (see Chap. 9.5.1, 9.5.2 as well as Chap. 12.2 and 12.3)

For initial assessment mainly the I/O menu as well as the >I-key< on the transmitter are helpful.

Refer to chapter 11 to locate the most prominent errors.

12.2 Verification of Combi Sensor with Pressure Measurement Cell

Due to physical reasons, the level measurement using sensors with pressure measurement cell is subject to long-term drift (see >Technical Instructions of Doppler Sensors<). NIVUS therefore recommend to calibrate sensors with integrated pressure measurement cells twice per year regarding the zero point. The best calibration results can be achieved if the water level is as low as possible or by dismantling and removing the sensors from the measurement medium.

The calibration procedure is described in Chapter 9.6.1.



*Adjusting the zero point by measuring the current filling level with a yardstick, a ruler or similar in the flowing medium is tending to errors. As soon as the ruler (or yardstick) is being put into the flowing water the resulting surge will lead to measurement errors depending on the current flow velocity. This is why the filling level for reference measurement purposes has to be measured **always** from top down!*

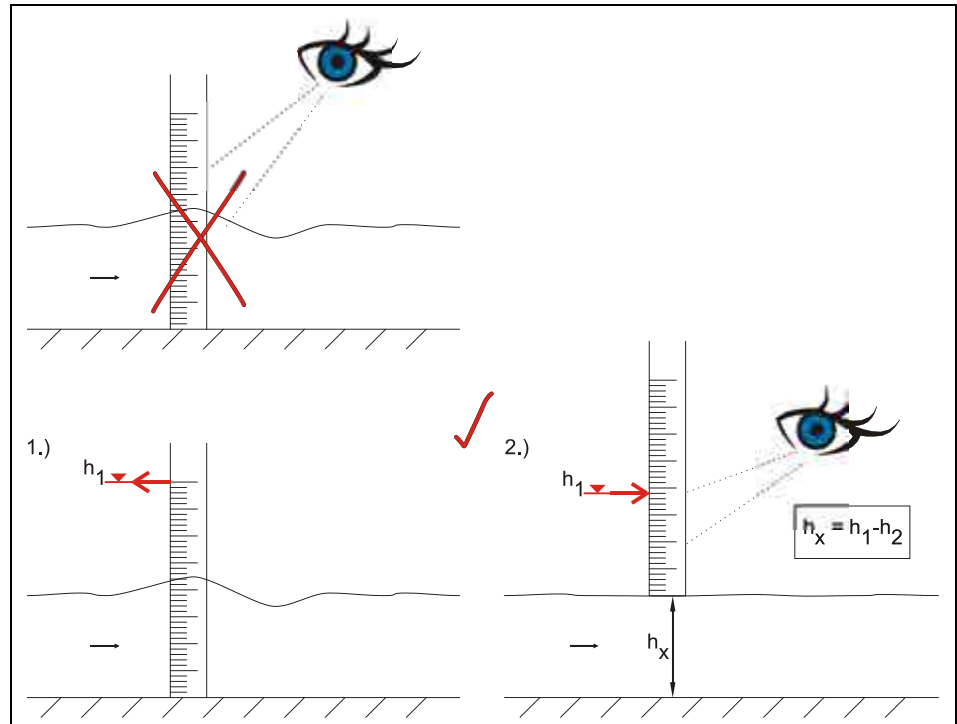


Fig. 12-1 Determination of reference level under operating conditions



Flow velocity sensors with pressure measurement sensor (Type KP) must be uninstalled as soon as the pressure level measurement fails. The sensor shall be soaked for an appropriate period and the pressure channel (see Fig. 5-1) shall be flushed carefully or shall be cleaned with a soft brush.

Do not use high pressure to flush the channel. This may lead to misadjustment of the 0-point or may even destroy the built-in pressure sensor.

Furthermore never remove the ground plate (risk of leakage or sensor destruction)!

12.3 Verification of external Level Measurement

Using an external level measurement (e.g. NivuMaster) needs to measure the filling level in the channel with a yardstick (see Fig. 12-1) and to adjust the zero point on the level transmitter if required.

Then compare output signal as well as measurement span of the external measurement with the analog input signal and the measurement span of the OCM F in PAR menu as well as in I/O menu and adjust accordingly if required.

12.4 Verification and Simulation of Input and Output Signals

The I/O menu (see Chap. 9.5) allows to verify connected sensors as well as to check signal inputs and outputs with the aid of several submenus. Various values can be indicated (current input and output values, relay conditions, echo profiles, single velocities etc.), signals or conditions however (offset, adjustment, simulation or similar) cannot be influenced. Analog output signals, relay conditions as well as the theoretical flow can be simulated in the CAL menu (see Chap. 9.6).

12.5 Verification of Flow Velocity Measurement

Use the menu I/O/v-histogram to view the frequency histogram of the V-sensor. Chapter 8.5.6 describes how to assess the histogram.

The velocity can be verified using a portable flowmeter e.g. PCM Pro, PVM-PD, hydrometric vane etc.). A calibration factor can be entered here if the deviation of the flow velocity should be strong (chapter 9.6.2)

The sensor is obstructed due to build-up or soiling (→to be removed) as soon as the histogram indicates visible disturbances.

Another reason is that the sensor may have been installed at a hydraulically unfavourable position tending to low measurement quality or measurement failure (→check installation position of sensor).

Please note, that without a working level measurement it is not possible to measure flow velocities and hence the flow cannot be computed.

If the flow velocity measurement fails, the sensor however is connected correctly and lines, clamping connections and overvoltage protection have been checked, the sensor possibly may be defective.

In various countries it may be necessary to carry out regular maintenance with comparative measurements in particular applications to comply with official regulations. If desired, NIVUS is going to carry out all required verifications, hydraulic and technical assessment, calibration, troubleshooting and repairs if an according maintenance agreement has been contracted. These services will be carried out according to DIN 19559 incl. the agreed proof of the remaining residual error, as well as according to rules in the respective countries.

13 Maintenance and Cleaning

WARNING



Germ contamination

Please note that due to the operation in the waste water field sensors and cables may be loaded with hazardous disease germs. Respective precautionary measures must be taken to avoid damage to one's health.



Important note:

To avoid damage of the instrument the measures described in this section of the instruction manual must be executed by trained expert personnel exclusively.

Please disconnect the unit from mains prior to maintenance, cleaning and/or repair works.

13.1 General Maintenance

The device Type OCM F is designed to be virtually maintenance-free and free of material wear and moreover needs no calibration.

Maintenance extents as well as the according cycles depend on the following factors:

- measurement principle of the level sensor
- material wear
- measurement medium and channel hydraulics
- general regulations for the operator of this measurement plant
- ambient conditions

To ensure reliable, accurate and error-free function of the measurement system, we recommend annual inspections of the entire measurement system by NIVUS.

If required clean the transmitter enclosure if with a dry, lint-free cloth. For heavy pollution NIVUS recommends the use of surface-active agents.

The use of abrasive cleansing agents is not allowed.

13.2 KDA-Sensor

WARNING



Damage caused by hard objects

No hard objects such as wire brushes, rods, scrapers or similar shall be used to clean the sensor. This may result in damaged sensors, lead to measurement failures and hence is prohibited in principle.

You can find a comprehensive description on sensor maintenance and cleaning in the "Technical Instructions for Doppler Sensors".

13.3 Accessories (optional)

KDA-Sensor KDA-K...	Ultrasonic Doppler sensor for flow velocity or combi sensor for flow velocity and level for connection to OCM F.
Pipe measurement section OCM0 ZDN0	for OCM Pro CF and OCM F (short)
Flange ZUB0 DN200	Flange DN 200 made of PVC with R1" thread (Pipe measurement section short)
Flange gasket set ZUB0 DN200-DISET	Flange gasket set for DN 200
Pressure compensation element ZUB0 DAE	for connection of sensors with pressure measurement cell Material: aluminium, plastic, degree of protection: IP54
Replacement filter ZUB0 FILTER02	with plug and connection hose for sensors with pressure measurement cell for connection PCM-series transmitters as well as the ZUB0 DAE pressure compensation element.
Pipe mounting system ZUB0 RMS2... ZUB0 RMS3... ZUB0 RMS4...	for temporary installation of POA, KDA, CSM and DSM wedge sensors in pipe lines with diameters between 200 and 800 mm
Stop ball valve ZUB0 HAHNR15	for removal of pipe sensors from pipes without pressure
Tapping saddles ZUB0 ABS01... ZUB0 ABS02... ZUB0 ABS03...	for installation of 1½" pipe sensors in pipe lines
Welding nozzle ZUB0 STU15...	For pipe sensors; material steel or stainless steel

You can find more accessories for sensor installation in our current price list.

14 Table „Manning - Strickler Coefficients“

Channel wall consistency		M in m ^{1/3} /s	k in mm
smooth	glass, PMMA, polished metal surfaces	> 100	0...0,003
	plastic (PVC, PE)	≥ 100	0,05
	new steel plate with protective coating; smoothened cement plaster		0,03...0,06
moderately rough	asphalt coated steel plate; concrete from steel or vacuum formwork, no joints, carefully smooth- ened; planed wood, joint-free, new; asbestos cement, new	90...100	0,1...0,3
	smoothened concrete, smooth finish; planed wood, well-joint	85...90	0,4 0,6
	concrete, good formwork, high cement contents	80	0,8
	non-planed wood; concrete pipes	75	1,5
rough	hard-burned bricks, carefully joint; well-manufactured ashlar facing; concrete from joint-free wooden formwork	70...75	1,5...2,0
	rolling-cast asphalt finish	70	2
	ashlar masonry, well-manufactured; moderately incrustated steel pipes; non-finished concrete, wooden formwork; squared stones; old and swelled wood; cement walls	65...70	3
	non-finished concrete; old wooden formwork; brickwork, no joints, finished; dry stone wall, less carefully manufactured; soil material, smooth (fine-grained)	60	6
	Rougher surfaces are difficult to measure under hydraulic aspects and hence are not described here		

15 Emergency

In case of emergency

- press the emergency-off button of the main system or
- set the slide switch (see Fig. 7-12) on the unit to OFF.

16 Dismantling/Disposal

The device shall be disposed according to the local regulations for electronic products.

17 Table of Pictures

Fig. 3-1	Transmitter nameplate	8
Fig. 4-1	Overview	9
Fig. 5-1	Construction of combi sensor Type "KDA" with additional pressure measurement cell	13
Fig. 5-2	Construction pipe sensor, type KDA	14
Fig. 5-3	Type key for OCM F measurement transmitter	16
Fig. 7-1	Wall mount enclosure	19
Fig. 7-2	Connection Enclosure	23
Fig. 7-3	Clamp wiring OCM F	24
Fig. 7-4	Connection of 1 wedge or pipe sensor (no Ex), Type K0 or R0	25
Fig. 7-5	Connection of 1 KDA combi sensor (no Ex) with integrated pressure measurement cell, Type KP	25
Fig. 7-6	Connection of 1 KDA wedge or pipe sensor (Ex), Type K0 or R0	26
Fig. 7-7	Connection of 1 KDA combi sensor (Ex) with integrated pressure measurement cell, Type KP	26
Fig. 7-8	Connecting an ext. 2-wire sensor (no Ex) for flow level measurement.....	26
Fig. 7-9	Connecting a NIVUS i-Serial sensor for level measurement in Ex-Zone 1	27
Fig. 7-10	Connecting an ext. 2-wire sensor (Ex) for flow level measurement.....	27
Fig. 7-11	Connecting an external flow level measurement via NivuMaster	27
Fig. 7-12	Slide switch position in terminal clamp housing.....	28
Fig. 7-13	AC model power supply	28
Fig. 7-14	DC model power supply	29
Fig. 7-15	Connecting the overvoltage protection for power supply and analog inputs and outputs	30
Fig. 7-16	Overvoltage protection compact Doppler active sensor	31
Fig. 7-17	Overvoltage protection compact Doppler active sensor (Ex).....	31
Fig. 7-18	Setup of a controlled system such as a discharge control.....	33
Fig. 7-19	Wiring diagram for controller operation	34
Fig. 8-1	Keypad	37
Fig. 8-2	Main screen	37
Fig. 8-3	Auxiliary screen	38
Fig. 9-1	Screen on end of parameter setting	40
Fig. 9-2	Language selection	41
Fig. 9-3	Operation mode selection	41
Fig. 9-4	Day values.....	42
Fig. 9-5	Time of day totalising	42
Fig. 9-6	Error message.....	43
Fig. 9-7	Extra-submenus	44
Fig. 9-8	System information.....	44
Fig. 9-9	Additional system information	44
Fig. 9-10	Selecting the unit system	45
Fig. 9-11	Selecting the units	45
Fig. 9-12	Selecting the display format	45
Fig. 9-13	system time - submenu	46
Fig. 9-14	complete system time	46
Fig. 9-15	Totalizer modification	46

Fig. 9-16	PIN-Code request.....	46
Fig. 9-17	submenu – name.....	47
Fig. 9-18	Setting the name (of the measurement place).....	48
Fig. 9-19	Accepting the new name.....	48
Fig. 9-20	Channel shape selection.....	49
Fig. 9-21	Selected profile screen.....	49
Fig. 9-22	List of breakpoints for >Custom shape<	49
Fig. 9-23	breakpoints for >Custom shape<	50
Fig. 9-24	Selection low-flow volumes.....	51
Fig. 9-25	Menu level measurement.....	51
Fig. 9-26	Example in case of external level sensor.....	51
Fig. 9-27	Determine the sensor type	51
Fig. 9-28	Sensor type 1: Pressure int.....	52
Fig. 9-29	Sensor type 2: Constant level	52
Fig. 9-30	Sensor type3: 22 wire probe	53
Fig. 9-31	Sensor type 4: 2-wire probe Ex.....	53
Fig. 9-32	i-Series sensors measurement range	54
Fig. 9-33	Sensor settings.....	55
Fig. 9-34	Digital inputs – submenu	55
Fig. 9-35	Digital inputs functions	56
Fig. 9-36	Menü Analogausgang	57
Fig. 9-37	Analog output signal quality	57
Fig. 9-38	Selection flow	58
Fig. 9-39	Selection constant current.....	58
Fig. 9-40	Extended submenu analog output	59
Fig. 9-41	Error input mask.....	59
Fig. 9-42	Programming error output.....	59
Fig. 9-43	Relay selection menu.....	60
Fig. 9-44	Relay outputs – submenu	60
Fig. 9-45	Error input mask.....	61
Fig. 9-46	Limit value parameter.....	61
Fig. 9-47	Impulse parameters / impulse duration	62
Fig. 9-48	Control unit basic settings	62
Fig. 9-49	Setting the external setpoint.....	63
Fig. 9-50	Control unit settings	63
Fig. 9-51	Setup parameter – submenu.....	65
Fig. 9-52	New program start OCM F	66
Fig. 9-53	Choose language	66
Fig. 9-54	I/O Menu.....	67
Fig. 9-55	Screen digital values	67
Fig. 9-56	Screen analog values.....	67
Fig. 9-57	Screen digital values	68
Fig. 9-58	Screen measurement data	68
Fig. 9-59	Status of sensors and velocity evaluation	69
Fig. 9-60	Distribution of frequency groups	69
Fig. 9-61	Flow velocity profiles	70
Fig. 9-62	External level selection	70
Fig. 9-63	Control unit selection.....	71
Fig. 9-64	Control menu for test control unit.....	71
Fig. 9-65	CAL- menu selection	72
Fig. 9-66	Submenu - level	72
Fig. 9-67	Submenu – velocity.....	73
Fig. 9-68	Flow velocity determination graph.....	74
Fig. 9-69	Defining v-crit	74
Fig. 9-70	Selecting v-crit determination.....	75
Fig. 9-71	Manning Strickler v-crit determination.....	75
Fig. 9-72	Manually setting v-crit determination.....	75
Fig. 9-73	Assistant – start measuring v-crit determination	76
Fig. 9-74	Measuring Countdown Assistant.....	76
Fig. 9-75	Create dam-up – start measuring	76
Fig. 9-76	Measuring countdown for the second measuring	76
Fig. 9-77	Assistant indicating investigated values.....	77

Fig. 9-78	Adjustment of analog outputs.....	77
Fig. 9-79	Simulation of analog outputs.....	78
Fig. 9-80	Relay simulation	79
Fig. 9-81	Simulation mode.....	79
Fig. 9-82	PaDa Installation Warning.....	80
Fig. 9-83	PaDa English.....	80
Fig. 12-1	Determination of reference level under operating conditions	92

18 Index

A			Mounting height	53
	Analog outputs	57, 67		
C			N	
	Cable Glands	22	Name of measurement place	47
	Calibration menu	72	Names	3
	Channel shape	48	O	
	Clamp wiring	24	Operating permits	12
	Connecting an i serial sensor	27	Operation basics	39
	Connection	22	Overvoltage Protection	29
	Control algorithm	35	P	
	Control unit	62	Parameter setting	40
	Copyright	3	Parameter tree	82
D			R	
	Danger by electric voltage	7	Receipt	17
	Danger Notes	7	Relay functions	61
	Day values	41	Relay menu	60
	Delivery	17	Return	18
	Device identification	8	S	
	Digital inputs	55, 67	Sensor connection	25
	Documentation	17	Sensor info menu	69
E			Setup parameter	65
	Electrostatic discharge	21	Simulation	77
	error diagnostics	67	Slide Valve	
	Error messages	42	Runtime	35
	Ex Approval	10	Sludge level	50
F			Software tool >PaDa<	80
	Flow velocity detection	15	Spare parts	11
	Function principle	13	Storing	17
G			Subject to Wear	11
	Generals	6	System information	44
	Graphic display	37	T	
I			Totalizer	46
	Initial start-up	36	Translation	3
	Installation	19	Transport	18
K			U	
	Keypad	37	Unit versions	16
L			Units	45
	Language	45	Use in accordance with the requirements	9
	Level Parameter	51	V	
M			VDI/VDE Directive 2640	15
	Maintenance	94	Verification	
	Manning-Strickler coefficients	96	Combi sensor	91
	Measurement Section	33	external level measurement	92
			I/O signals	93
			measurement system	91
			velocity measurement	93


19 Certificates and Approvals



The approvals are only valid in connection with the respective indication on the transmitter's nameplate.

The complete EC-type examination certificates (incl. supplements) can be downloaded from www.nivus.com.

IBExU Institut für Sicherheitstechnik GmbH
An-Institut der TU Bergakademie Freiberg

[1] **EG-BAUMUSTERPRÜFBESCHEINIGUNG**
gemäß Richtlinie 94/9/EG, Anhang III 

[2] Geräte und Schutzsysteme zur bestimmungsgemäßen Verwendung in explosionsgefährdeten Bereichen, Richtlinie 94/9/EG

[3] EG-Baumusterprüfbescheinigungsnummer: **IBExU07ATEX1081**

[4] Gerät: Durchflussmessumformer
Typ OCM F, OCM FR, OCM FM
NFP

[5] Hersteller: NIVUS GmbH

[6] Anschrift: Im Täle 2
75031 Eppingen
Deutschland

[7] Die Bauart des unter [4] genannten Gerätes sowie die verschiedenen zulässigen Ausführungen sind in der Anlage zu dieser EG-Baumusterprüfbescheinigung festgelegt.


[8] IBExU Institut für Sicherheitstechnik GmbH, BENANNT STELLE Nr. 0637 nach Artikel 9 der Richtlinie 94/9/EG des Europäischen Parlaments und des Rates vom 23. März 1994, bescheinigt, dass das unter [4] genannte Gerät die in Anhang II der Richtlinie festgelegten grundlegenden Sicherheits- und Gesundheitsanforderungen für die Konzeption und den Bau des Gerätes zur bestimmungsgemäßen Verwendung in explosionsgefährdeten Bereichen erfüllt. Die Prüfergebnisse sind im Prüfbericht IB-07-3-145/1 vom 03.07.2007 festgehalten.

[9] Die grundlegenden Sicherheits- und Gesundheitsanforderungen werden erfüllt durch Übereinstimmung mit EN 60079-0:2004 und EN 60079-11:2007.

[10] Falls das Zeichen „X“ hinter der Bescheinigungsnummer steht, wird auf besondere Bedingungen für die sichere Anwendung des Gerätes in der Anlage zu dieser EG-Baumusterprüfbescheinigung unter [17] hingewiesen.


[11] Diese EG-Baumusterprüfbescheinigung bezieht sich nur auf die Konzeption und den Bau des festgelegten Gerätes. Weitere Anforderungen dieser Richtlinie gelten für die Herstellung und das Inverkehrbringen dieses Gerätes.


[12] Die Kennzeichnung des unter [4] genannten Gerätes muss die folgenden Angaben enthalten



IBExU Institut für Sicherheitstechnik GmbH
Fuchsmühlenweg 7 - 09599 Freiberg, Deutschland
☎ +49 (0) 3731 3805-0 • 📠 +49 (0) 3731 23650

Zertifizierungsstelle Explosionsschutz Freiberg, 04.07.2007

Im Auftrag

(Dr. Lösch)


(Kenn-Nr. 0637)

Bescheinigungen ohne Unterschrift und ohne Siegel haben keine Gültigkeit. Bescheinigungen dürfen nur unverändert weiterverbreitet werden.

Anlage

Seite 1 von 2
IBExU07ATEX1081



EG-Konformitätserklärung

EC Declaration of Conformity

Déclaration de conformité CE

NIVUS GmbH
Im Taele 2
75031 Eppingen

Telefon: +49 07362 9191-0
Telefax: +49 07362 9191-999
E-Mail: info@nivus.com
Internet: www.nivus.de

Für das folgend bezeichnete Erzeugnis:

We hereby declare that the design of the:

Le produit désigné ci-dessous:

Bezeichnung:	"Ex" Durchflussmessumformer stationär OCM F / OCM FR / NFP
<i>Description / Désignation:</i>	<i>"Ex" permanent flow measurement transmitter / "Ex" convertisseur de mesure de débit fixe</i>
Typ / Type / Type:	OCF-00xxxxE / OCF-R0xxxxE / NFP-xxxxxxEx

wird bestätigt, dass es mit den folgenden Richtlinien übereinstimmt:

as delivered complies with the following EC directives:

Est certifié, conforme aux directives CE suivantes:

- 94/9/EG
- 2004/108/EG
- 2006/95/EG

Die Geräte stehen im Einklang mit den folgenden harmonisierten Normen oder Dokumenten:

The devices furthermore comply with the following harmonised standards or documents:

En outre, ces appareils satisfont aux normes et documents harmonisés désignés ci-après:

- EN 60079-0:2009
- EN 60079-11:2007
- EN 61326-1:2006
- EN 61010-1:2001

Ex-Kennzeichnung / *Ex-designation / Marquage Ex:*

 II (2)G [Ex b] IIB

EG-Baumusterprüfbescheinigung / *EC-Type Examination Certificate / Attestation d'examen «CE» de type:*

IBExU07ATEX1081

Benannte Stelle (Kennnummer) / *Notified Body (Identif. No.) / Organisme notifié (N° d'identification)*

IBExU Institut für Sicherheitstechnik GmbH, 09599 Freiberg, Allemagne (0637)

Qualitätssicherung ATEX / *Quality assurance ATEX / Assurance qualité ATEX:*

TÜV Nord CERT GmbH, Am TÜV 1, 30519 Hannover, Allemagne (0044)

Diese Erklärung wird verantwortlich für den Hersteller / Importeur:

This declaration is submitted on behalf of the manufacturer / importer:

Le fabricant / importateur assume la responsabilité de cette déclaration:

NIVUS GmbH • Im Taele 2 • 75031 Eppingen, Allemagne

abgegeben durch / *represented by / faite par:*

Marcus Fischer (Geschäftsführer / *Managing Director / Gérant*)

Eppingen, den 26.07.2013

Gez. Marcus Fischer



NIVUS GmbH
 Im Tafele 2
 75031 Eppingen

Telefon: 07282 9191-0
 Telefax: 07282 9191-999
 E-Mail: info@nivus.com
 Internet: www.nivus.de

EG-Konformitätserklärung

EC Declaration of Conformity

Déclaration de conformité CE

Für das folgend bezeichnete Erzeugnis:
We hereby declare that the design of the:
Le produit désigné ci-dessous:

Bezeichnung:	Durchflussmessumformer stationär OCM F / OCM FR / NFP
<i>Description / Désignation:</i>	<i>permanent flow measurement transmitter /</i> <i>convertisseur de mesure de débit fixe</i>
Typ / Type / Type:	OCF-00... / OCF-R0... / NFP-

wird bestätigt, dass es mit den folgenden Richtlinien übereinstimmt:
as delivered complies with the following EC directives:
Est certifié, conforme aux directives CE suivantes:

- 2006/95/EG
- 2004/108/EG

Die Geräte stehen im Einklang mit den folgenden harmonisierten Normen oder Dokumenten:
The devices furthermore comply with the following harmonised standards or documents:
En outre, ces appareils satisfont aux normes et documents harmonisés désignés ci-après:

- EN 61326-1:2006
- EN 61010-1:2001

Diese Erklärung wird verantwortlich für den Hersteller / Importeur:
This declaration is submitted on behalf of the manufacturer / importer:
Le fabricant / importateur assume la responsabilité de cette déclaration:

NIVUS GmbH
Im Tafele 2
75031 Eppingen, Germany

abgegeben durch / *represented by / faite par:*
Marcus Fischer (Geschäftsführer / *Managing Director / Gérant*)

Eppingen, den 26.07.2013

Gez. *Marcus Fischer*