

BRA!N BOXES



PCMCIA 1 Port RS232

2.1 EDITION OCTOBER 1999

Guarantee.

FULL 36 MONTHS GUARANTEE.

We guarantee your interface card for a full 36 months from purchase, parts and labour, provided it has been used in the specified manner. In the unlikely event of failure return your interface to your Dealer, with proof of purchase, who will determine whether to repair or replace this product with an equivalent unit.

COPYRIGHT.

COPYRIGHT © 1985-1999.

All rights reserved. No part of this hardware, circuitry or manual may be duplicated, copied, transmitted or reproduced in any way without the prior written consent of the Manufacturer.

Due to the Manufacturers commitment to quality, software is subject to continuous improvements: information regarding upgrades can be obtained from your supplier.

supplied to you by:



ACKNOWLEDGEMENTS.

IBM, COMPAQ, Hewlett Packard, H.P. and EPSON are trademarks of the relevant companies. Windows is a trademark of Microsoft.

The Layout Of This Manual

THE LAYOUT OF THIS MANUAL

Chapter 1 - Hardware Configuration, Summarises the features of the **PCMCIA 1 Port RS232 Card**.

Chapter 2 – Installing the card into the PC, Explains how to insert a new PCMCIA card

Chapter 3 –Software Installation

This chapter details how to install and configure the **PCMCIA 1 Port RS232 Card in Windows 95, Windows 98, Windows Millenium and Windows 2000**.

Chapter 4 – RS232 Port Cabling

Table Of Contents.

CHAPTER 1 HARDWARE GUIDE4

 Introduction.....4

 PCMCIA 1 Port RS232 Card Features.4

 Configuring PCMCIA Cards.4

CHAPTER 2 INSTALLING IN YOUR COMPUTER.....5

CHAPTER 3 SOFTWARE INSTALLATION6

 Introduction.....6

 Windows 95 Installation6

 Windows 95 CD ROM Installation Procedure7

 Windows 95 Floppy Disk Installation Procedure9

 Windows 98/Millennium Installation10

 Windows 98/Millennium CD Installation Procedure11

 Windows 98/Millennium Floppy Installation Procedure.....13

 PCMCIA Card Setup in Windows 95/ 98/Millennium.....15

 PCMCIA Port Setup in Windows 95/98/Millennium.....16

 Windows 2000 Installation19

 Windows 2000 CD ROM Installation Procedure20

 Windows 2000 Floppy Installation Procedure.....23

 PCMCIA Port Setup in Windows 2000.....25

 Windows NT4 Installation.....27

 Windows CE Installation30

CHAPTER 4 RS232 PINOUTS AND PORT CABLING.33

 Introduction.....33

 The RS232 Standard.33

 Serial Port Pin Outs.....34

 9 Pin D Serial Port RS232 Cables.....34

 9 Pin D Serial Port Connection To Another PC.35

 9 Pin D Serial Port To A Modem.....37

 9 Pin D Serial Port Loop Back Connector.37

INDEX.....40

CHAPTER 1

HARDWARE GUIDE

Introduction.

This chapter details the specifications of the PCMCIA 1 Port RS232 Serial card.

PCMCIA 1 Port RS232 Card Features.

- * One RS232 Serial port.
- * Reliable communications up to 50 feet, 15m, and beyond!
- * 100% 16C550 PC Compatible serial port, up to 115200 Baud.
16950 Compatible FIFO provides 16-byte input and 16-byte output buffer on each port.
- * Full modem control TXD, RXD, DSR, DCD, DTR, RTS, CTS and RI signals.
- * Fully double buffered for reliable asynchronous operation.
High speed integrated circuitry ensures operation with fast PC's e.g. 600 MHz Pentium III.
- * Fully Plug and Play.
- * Hot Pluggable

Dimensions: 2 x 3.3 in, 85x55 mm

I/O Connection:

Serial Port: 9 pin Male D type.

Weight: 16g

Configuring PCMCIA Cards.

PCMCIA cards, by definition, require no hardware configuration and can be installed "directly from the box".

CHAPTER 2 INSTALLING IN YOUR COMPUTER



This card is 'hot plug' compatible it may be inserted into your pcmcia type 2 slot when the machine is either off or powered on. Please refer to your machine user guide for detailed instructions on inserting a PC card.

CHAPTER 3

SOFTWARE INSTALLATION

Introduction.

This section describes the software installation procedure allowing the PCMCIA 1 port RS232 to be configured within the Windows 95, Windows 98, Windows Millenium and Windows 2000 operating systems.

Windows 95 Installation

- Insert the card into an available type2 socket. This can be done even if the machine is powered ON.



- If installing from a "power off" condition Windows 95 should then load normally. During the booting process, Windows 95 will detect the card and briefly display a message box indicating the detection process.
- Windows will then display the "Update Device Driver Wizard", requesting "insert any disk which came with the card". Insert the Serial Solutions CDROM installation disk or the Serial Solutions floppy disk into an appropriate drive and click 'Next'.

Windows 95 CD ROM Installation Procedure



Click Other Locations

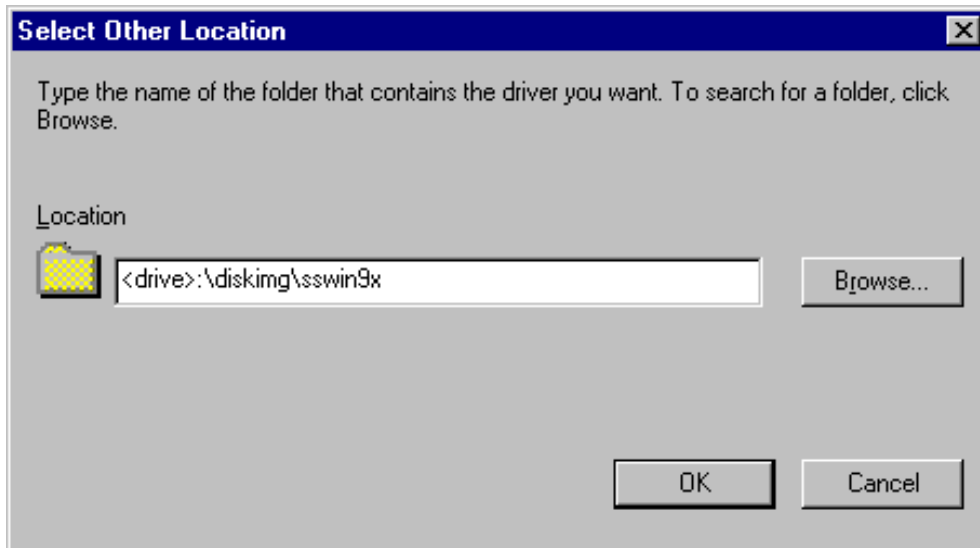

Type <drive>:\disking\sswin9x substituting the letter of your CD ROM drive for <drive>

Click OK



Click Finish



Click OK

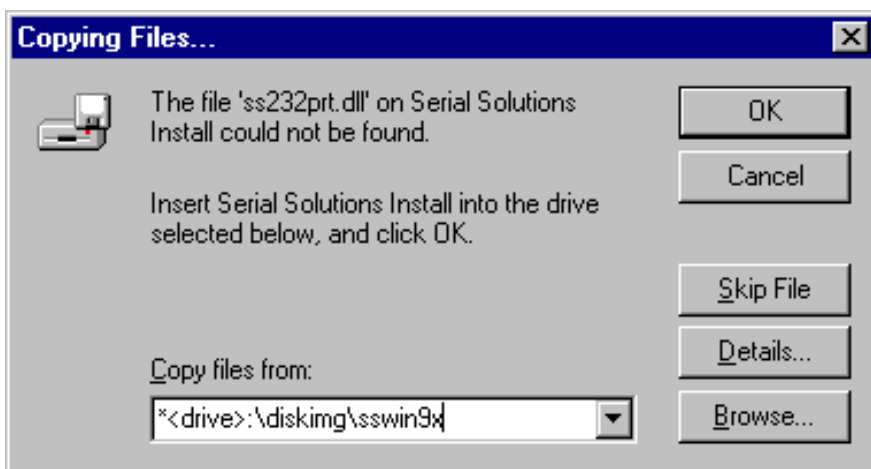

*Type<drive>:\diskimg\sswin9x substituting the letter of your CD ROM drive for <drive>

Click OK

Windows 95 Floppy Disk Installation Procedure



Click Finish



Click OK

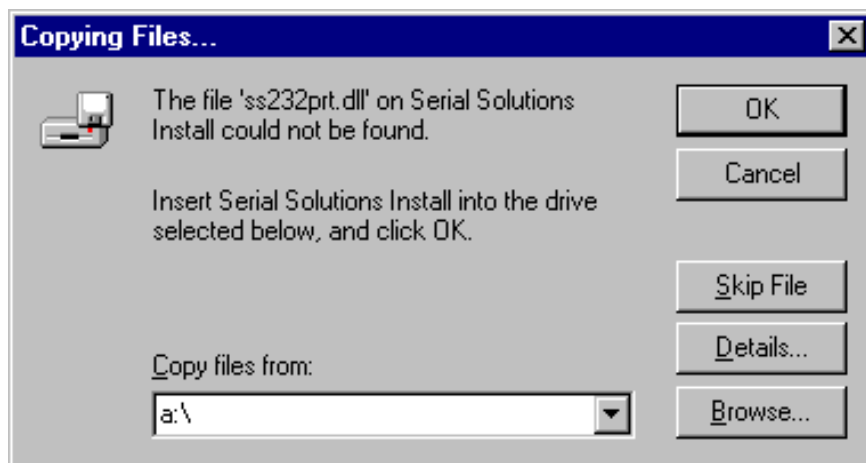

Type a:\

Click OK

Windows 98/Millennium Installation

- The installation for Windows 98 and Windows Millennium are the same.
- Insert the card into an available type2 socket. This can be done even if the machine is powered ON.
- If installing from a "power off" condition Windows 98 should then load normally. During the booting process, Windows 98 will detect the card and briefly display a message box indicating the detection process.



- Windows will then display the "Update Device Driver Wizard", requesting "insert any disk which came with the card". Insert the Serial Solutions CDROM installation disk or the Serial Solutions floppy disk into an appropriate drive and click 'Next'.

Windows 98/Millennium CD Installation Procedure

Choose the “Search for the best driver for your device”



Click Next

Select Specify a location



Type <Drive>:\diskimg\sswin9x\

Where <Drive> is the letter of your CDROM Drive

Click Next



Click **Next**



Click **Finish**

Windows 98/Millennium Floppy Installation Procedure

Choose the “Search for the best driver for your device”



Click Next



Select Floppy disk drives

Click next

PCMCIA 1 Port RS422/485

Software Installation



Click next



Click Finish

PCMCIA Card Setup in Windows 95/ 98/Millennium

Right Click My Computer -> Properties on the desktop

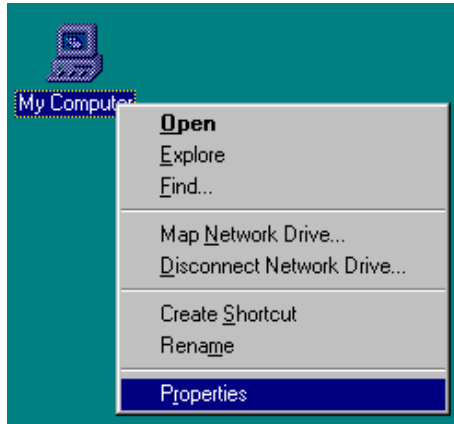

Click on the Device Manager tab

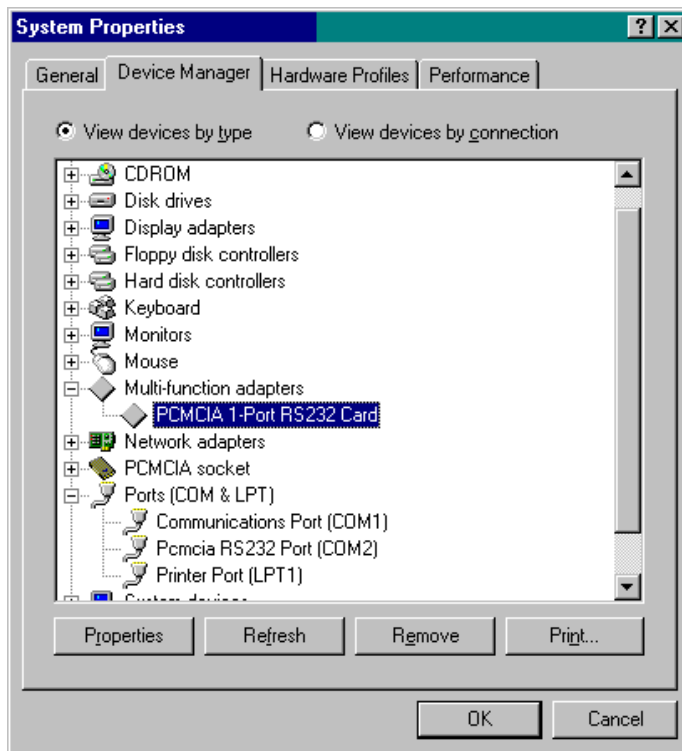

Under Multi-function adapters double-click on PCMCIA 1 Port 422 Card

PCMCIA 1 Port RS422/485

Software Installation

Click on the Serial Solutions tab

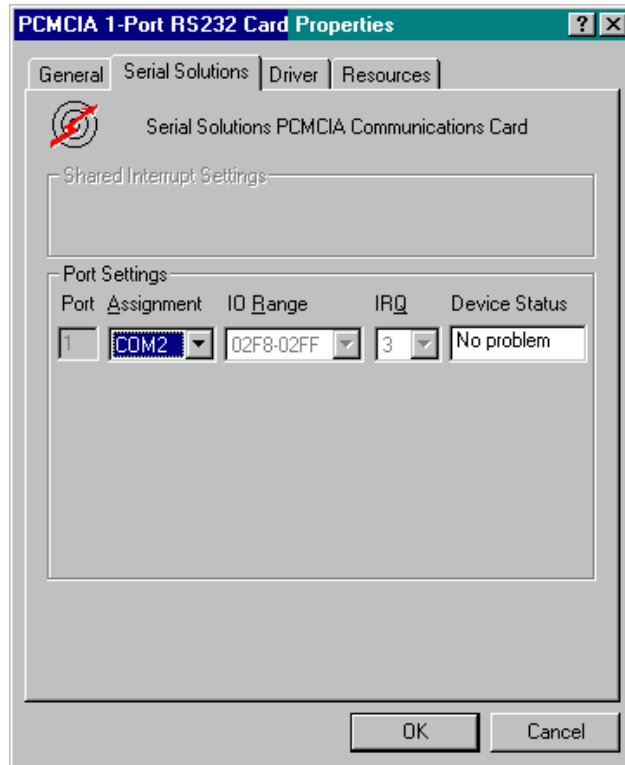

The Serial Solutions tab allows modification of any user controlled features for the card

PCMCIA Port Setup in Windows 95/98/Millennium

Right Click **My Computer** -> **Properties** on the desktop

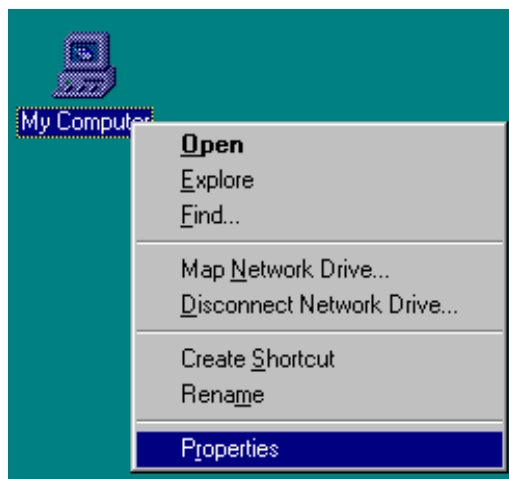

PCMCIA 1 Port RS422/485

Software Installation

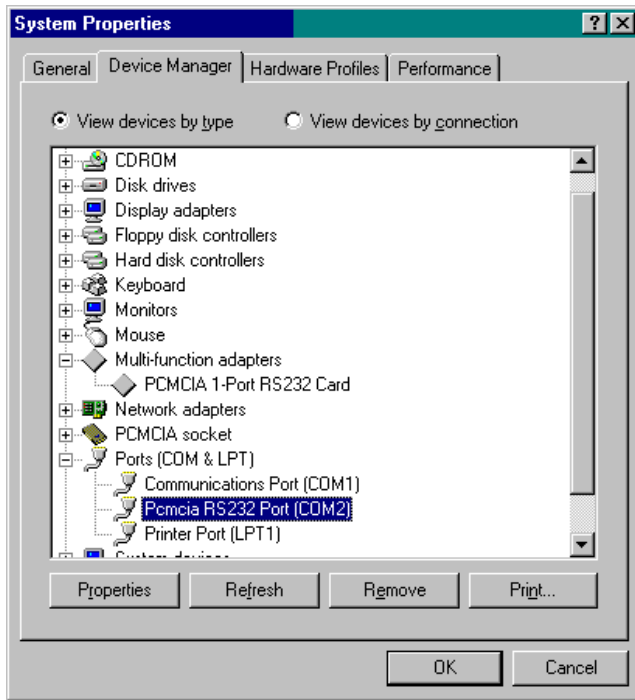

Under Ports (COM &LPT) double-click on
PCMCIA RS422 PORT (COM*)
*is the number allocated to the port.

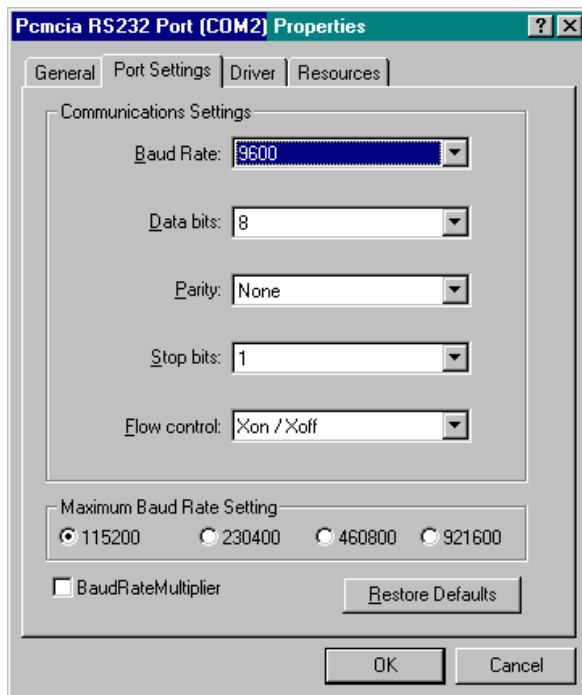

Click on the Port Settings tab

Settings available in this window are:

Baud Rate.
Data Bits.
Parity.
Stop Bits.
Flow Control.



Change to suit remote device.

Restore Defaults - When clicked, this will reset the selected port to the default values of:

Baud Rate:	9600
Data Bits:	8
Parity:	None
Stop Bits:	1
Flow Control:	Xon / Xoff

Maximum Baud Rate Setting

These settings allow access to the faster data rates available on this card. The faster rates are not enabled by default for compatibility purposes. The faster data rates are only available directly from your application if it uses the standard Windows dialogue for serial port settings.

Baud Rate Multiplier

This enables applications that do not use the standard Windows serial port configuration dialogue to access the faster data rates. e.g. with this option enabled, an application which selects 115,200 baud will actually set the hardware to the fastest possible rate of 921,600 baud. In other words the baud rate is multiplied by a factor of 8.

Windows 2000 Installation

- Insert the card into an available type2 socket. This can be done even if the machine is powered ON.
- If installing from a "power off" condition Windows 2000 should then load normally. During the booting process, Windows 2000 will detect the card and briefly display a message box indicating the detection process.



- Windows will then display the "Found New Hardware Wizard", requesting "insert any disk which came with the card". Insert the Serial Solutions CDROM installation disk **or** the Serial Solutions floppy disk into an appropriate drive and click 'Next' .

PCMCIA 1 Port RS422/485

Software Installation

Select "Search for a suitable driver for my device"



Click Next

Windows 2000 CD ROM Installation Procedure

Select Specify a location

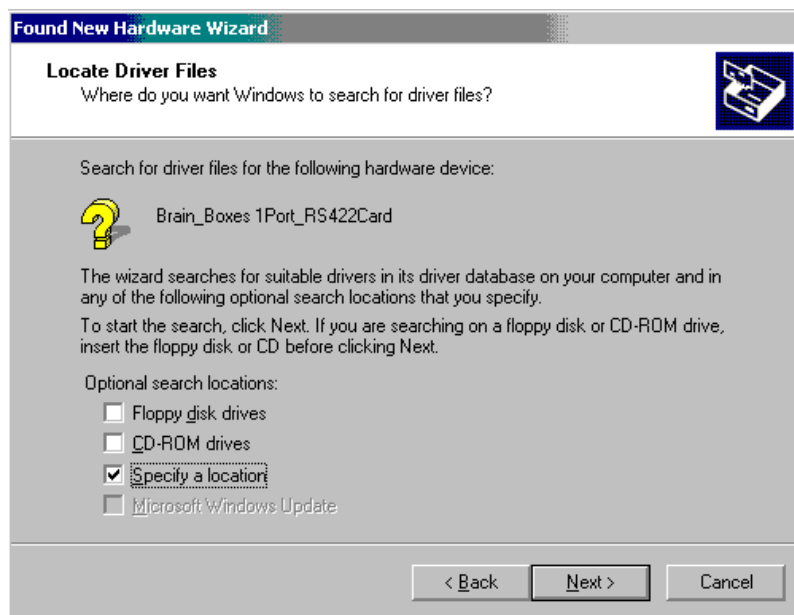

Click Next

PCMCIA 1 Port RS422/485

Software Installation

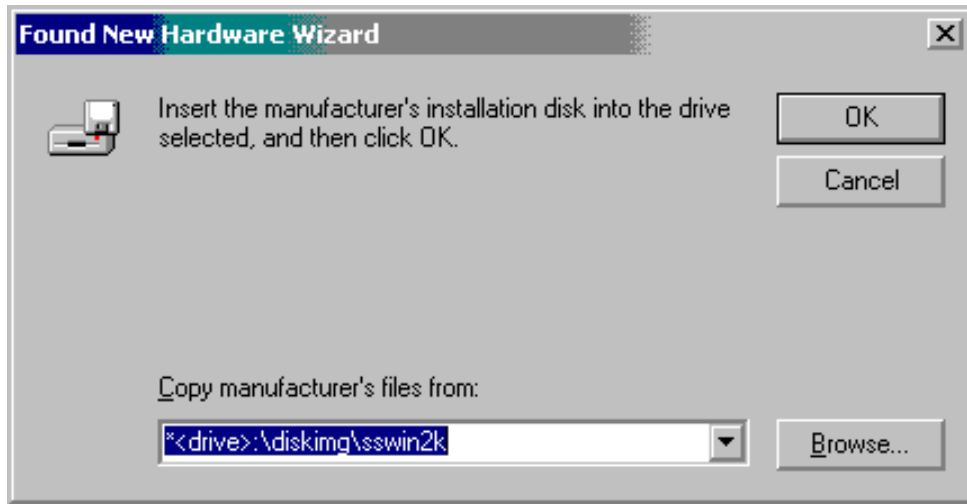

Type **<Drive>:\diskimg\sswin2k**

Where **<Drive>** is the letter of your CDROM Drive

Click OK

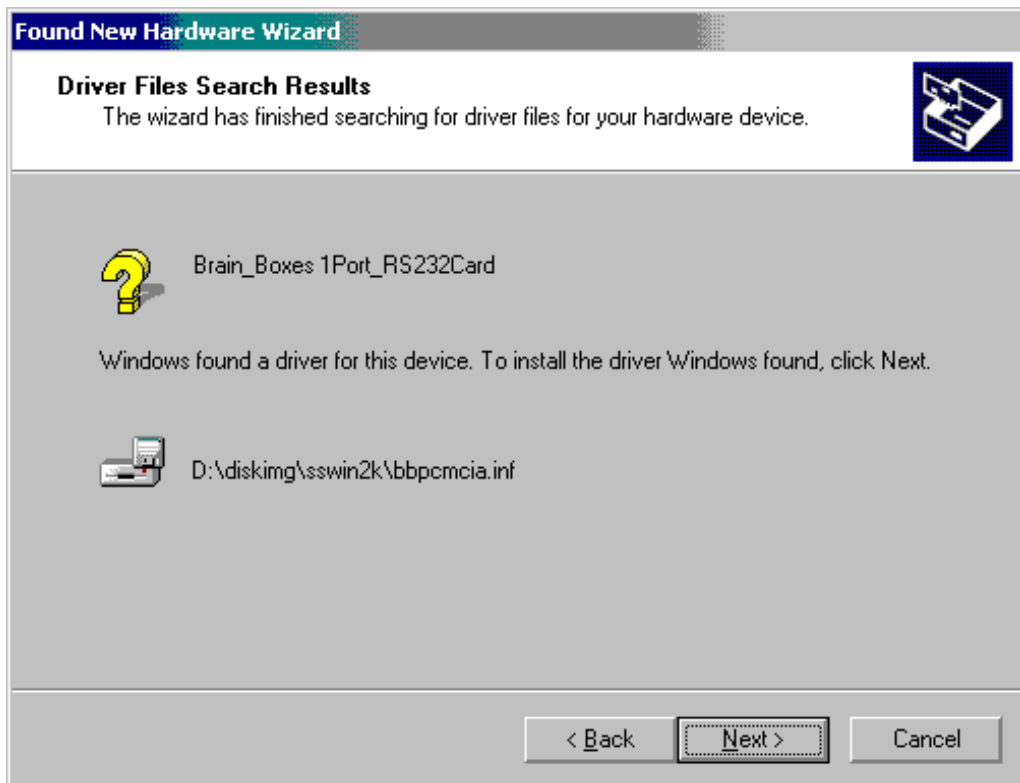

Click Next

PCMCIA 1 Port RS422/485

Software Installation

Please note, at the time of creation of this document, Windows2000 is still in BETA, and it is not possible to get drivers signed by Microsoft.
Brain Boxes fully intend to have obtained a driver signature for this product shortly after the operating system is available on general release.

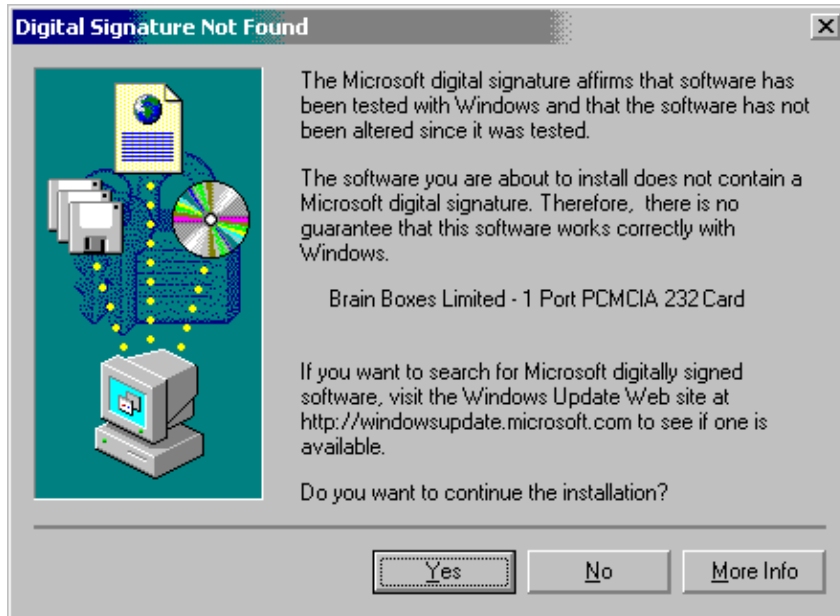

Click Yes

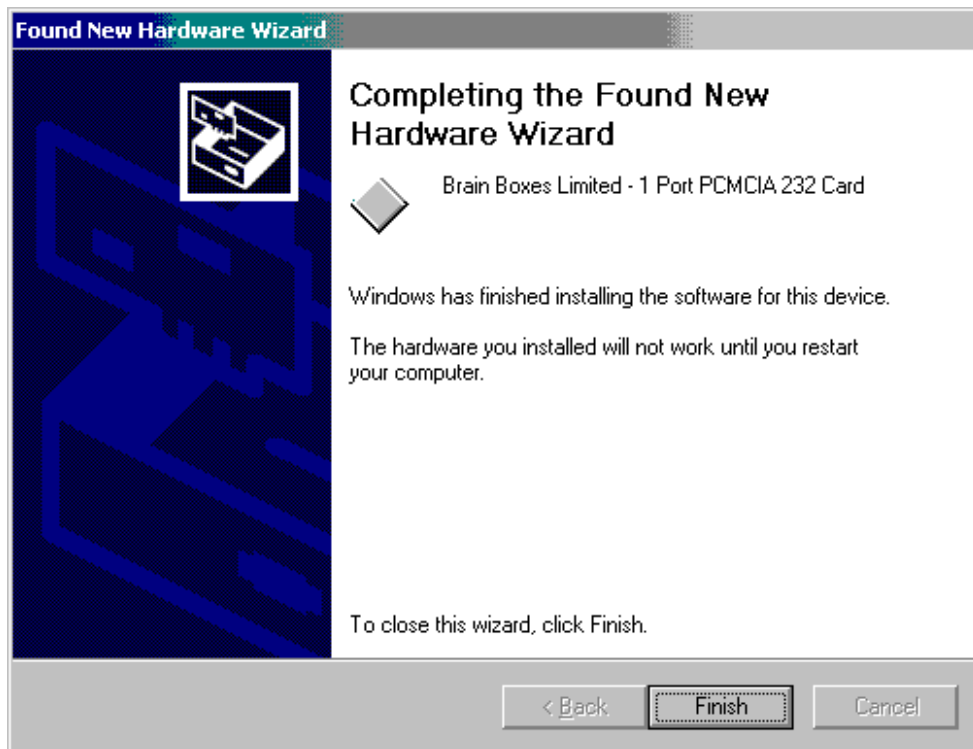

Click Finish

Windows 2000 Floppy Installation Procedure

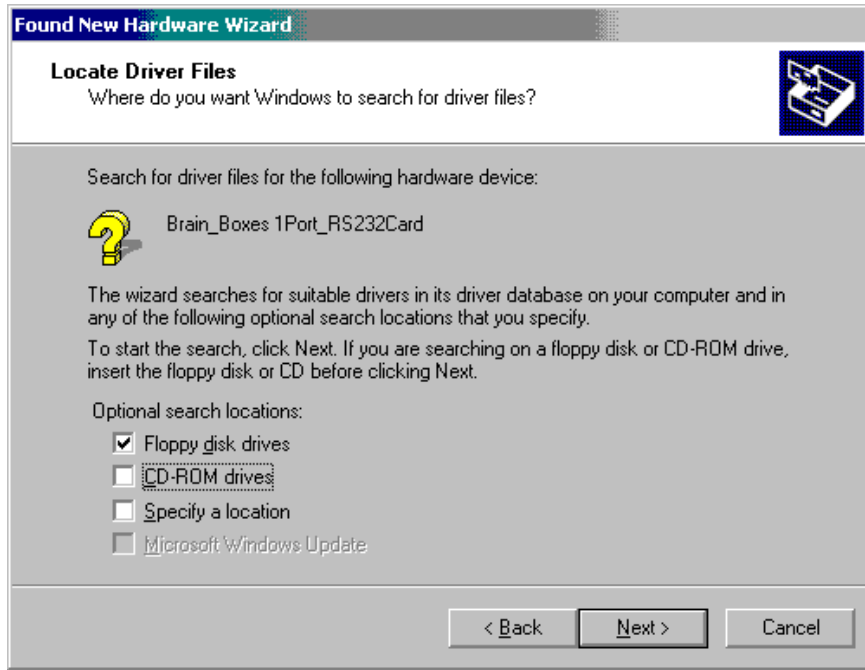

Select Floppy disk drives

Click next

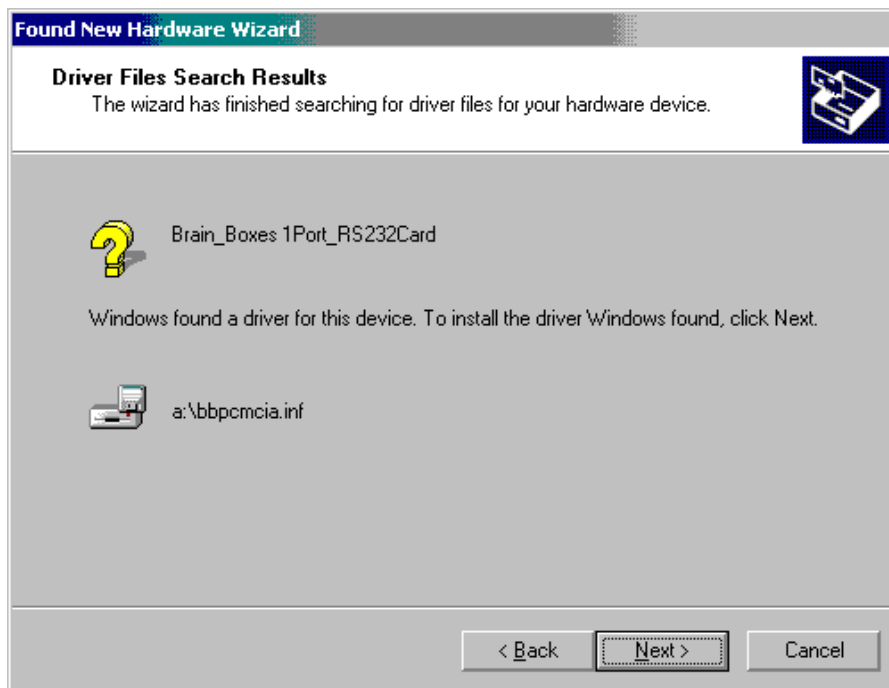

Click Next

PCMCIA 1 Port RS422/485

Software Installation

Please note, at the time of creation of this document, Windows2000 is still in BETA, and it is not possible to get drivers signed by Microsoft.
Brain Boxes fully intend to have obtained a driver signature for this product shortly after the operating system is available on general release.

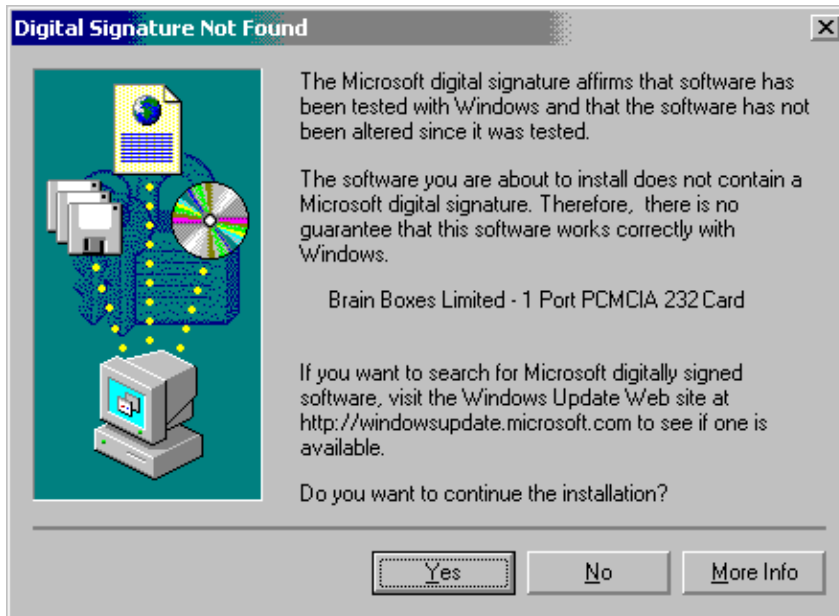

Click Yes



Click Finish

PCMCIA Port Setup in Windows 2000

Right Click My Computer -> Properties on the desktop

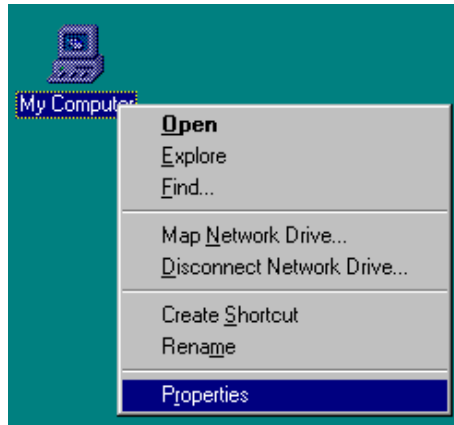

Select the Hardware Tab



Click Device Manager

PCMCIA 1 Port RS422/485

Software Installation

Click on Ports (COM & LPT)

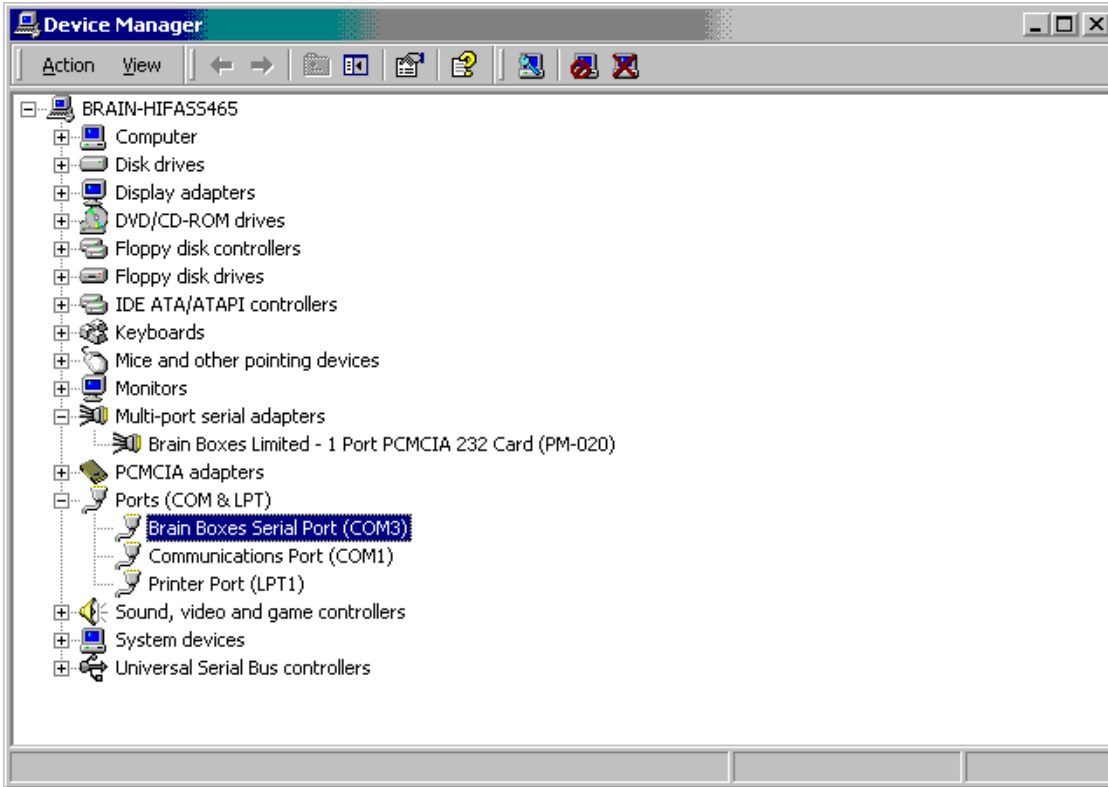

Double Click on Brain Boxes Serial Port

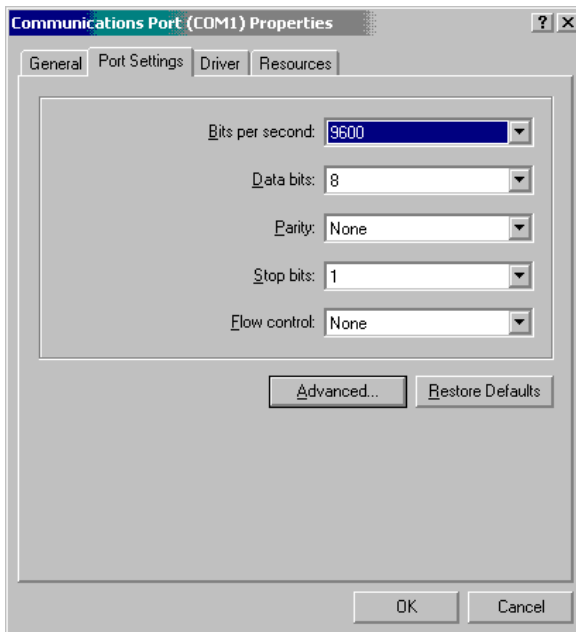

Select the Port Settings Tab
Click on Advanced

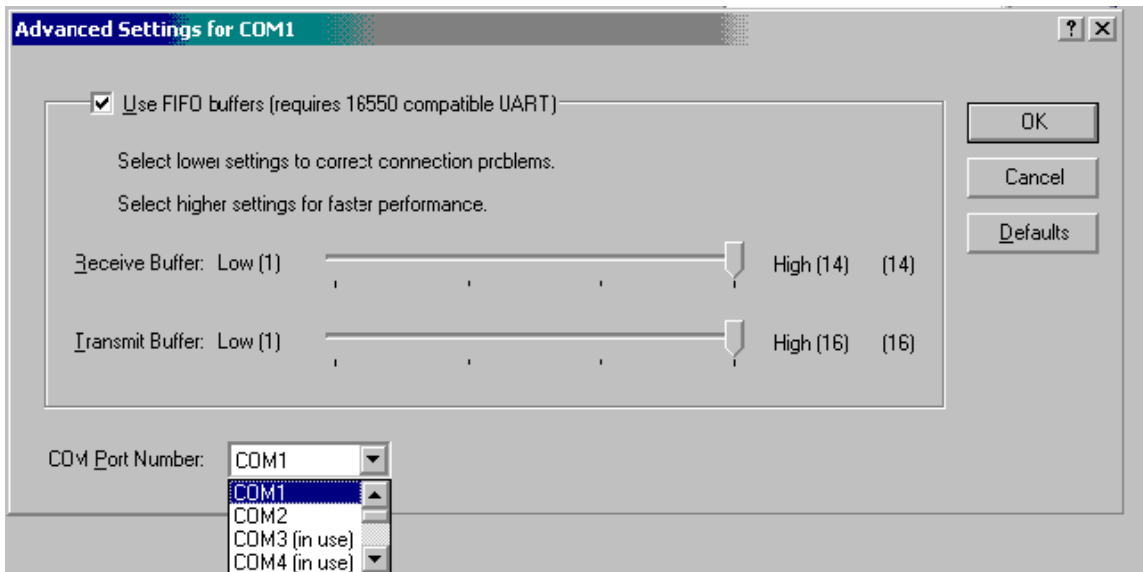

From this Screen COM port allocations can be changed.

Windows NT4 Installation

Though the PCMCIA 1 Port RS232 card can be used in Windows NT4 it is not yet available as a hot-pluggable card .

Before inserting the card

Click on Start => Settings => Control Panel

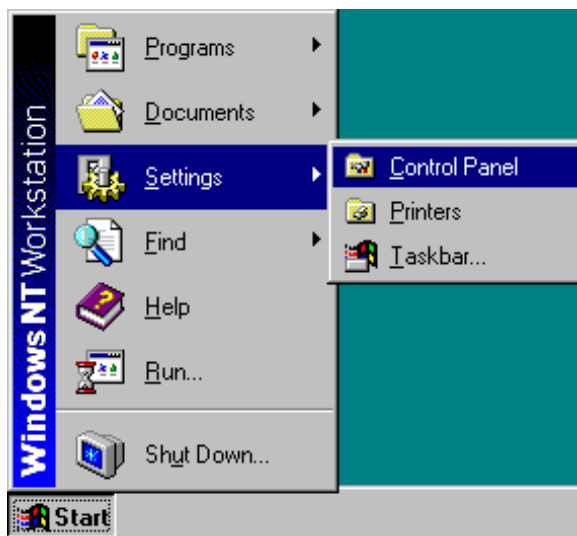

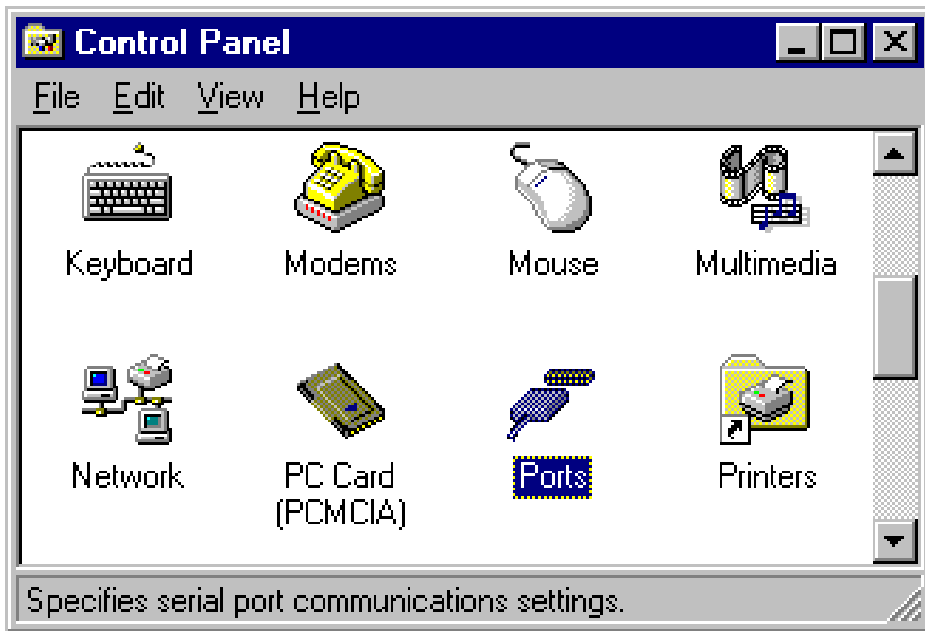

Double Click on the Ports Icon.

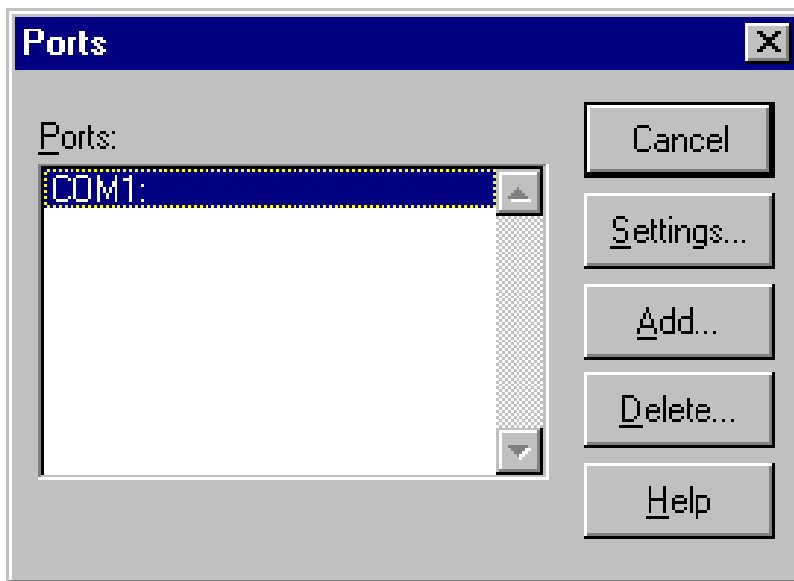

Note the COM Ports Listed
Click Cancel.

Power down your computer
Insert the PCMCIA Card.
Power up your computer.

PCMCIA 1 Port RS422/485

Software Installation

Click on Start => Settings => Control Panel

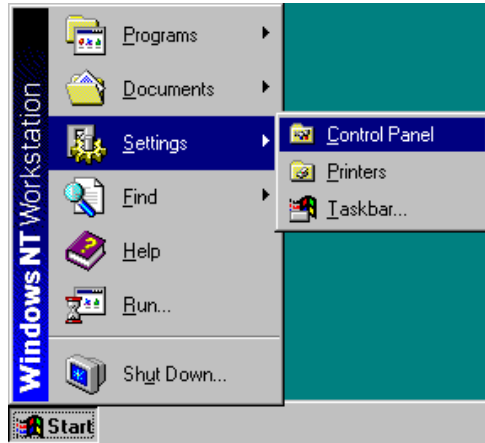

Double Click on the Ports Icon.

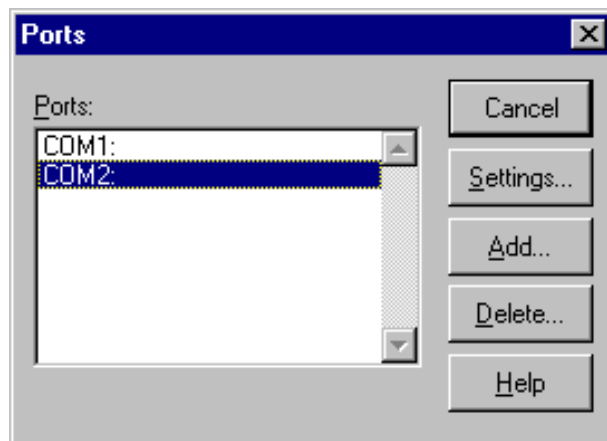
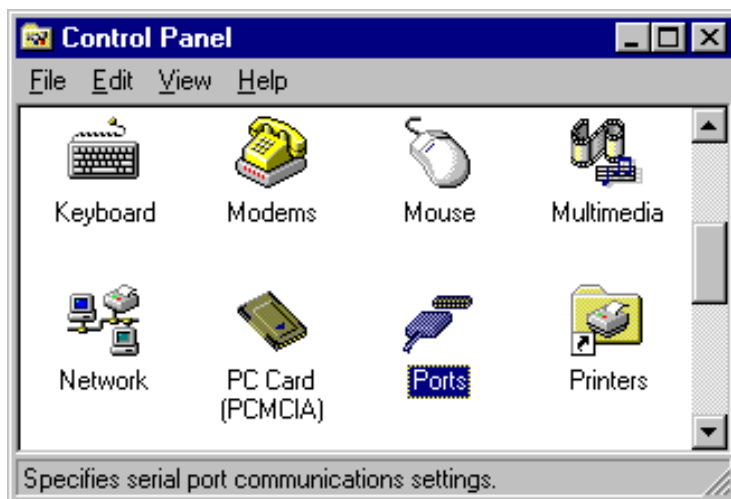

The New port listed (in this case COM2 will be the PCMCIA card port).

Windows CE Installation

Place card in socket

Select Start

Programs

Communications

Remote Networking

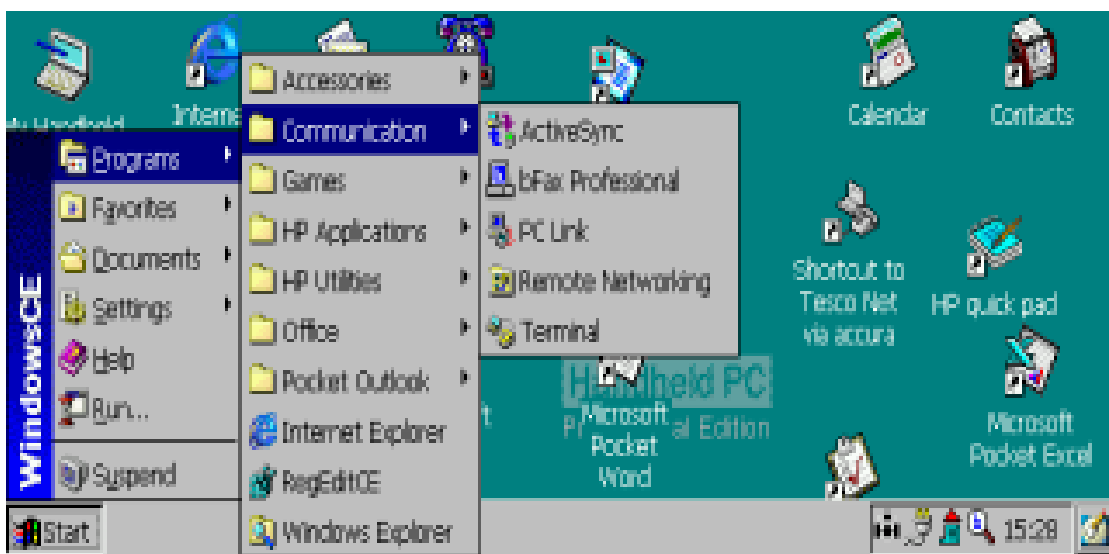

Select: " Make New Connection ", with your pen

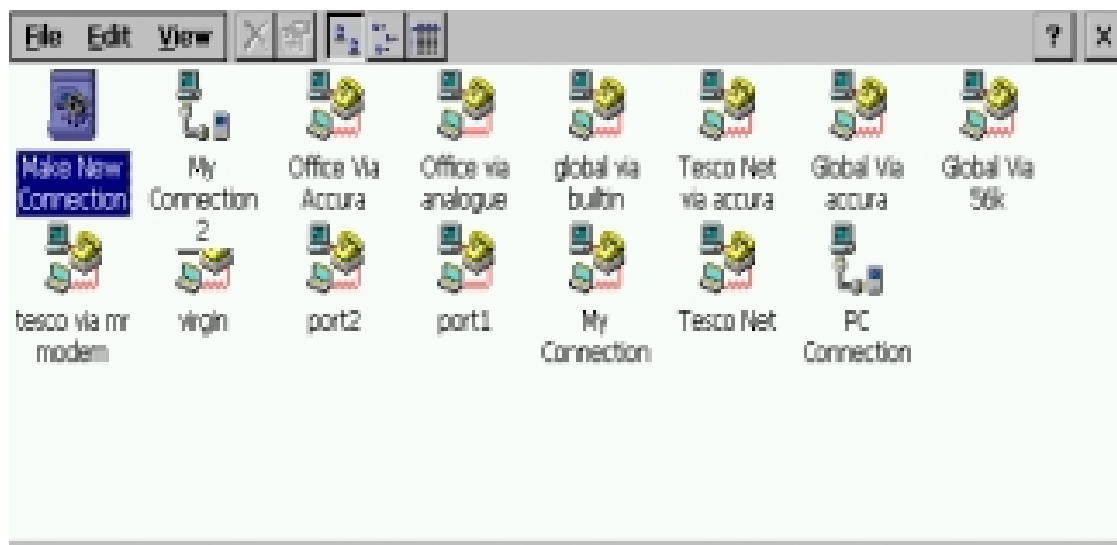

PCMCIA 1 Port RS232 RS232 Pinouts & Port Cabling

Type a name for the connection in the field under "Type a name for the connection"

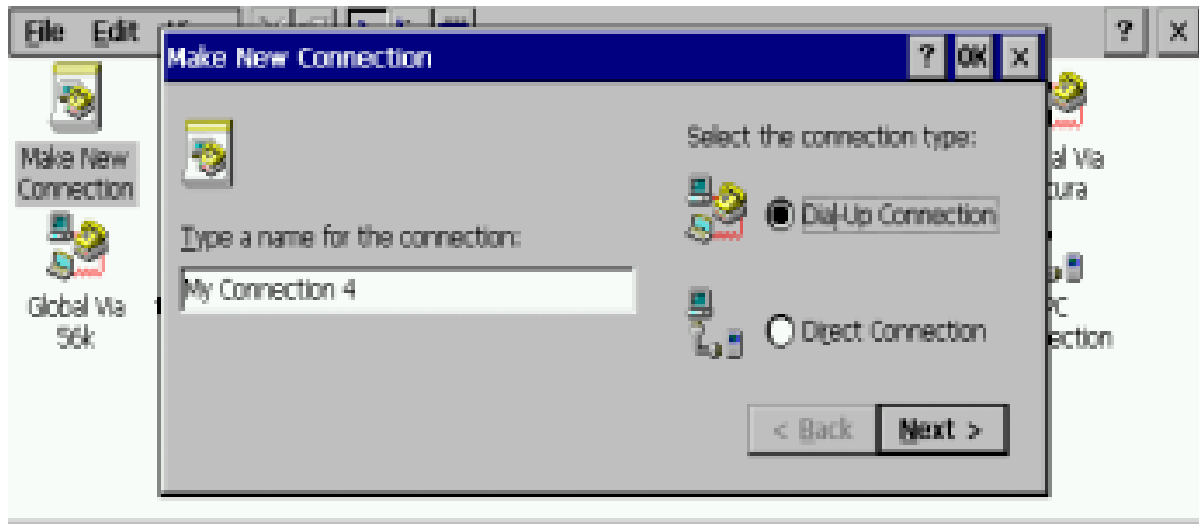

Select "Dial up Connection" Radio button
Select Next>"

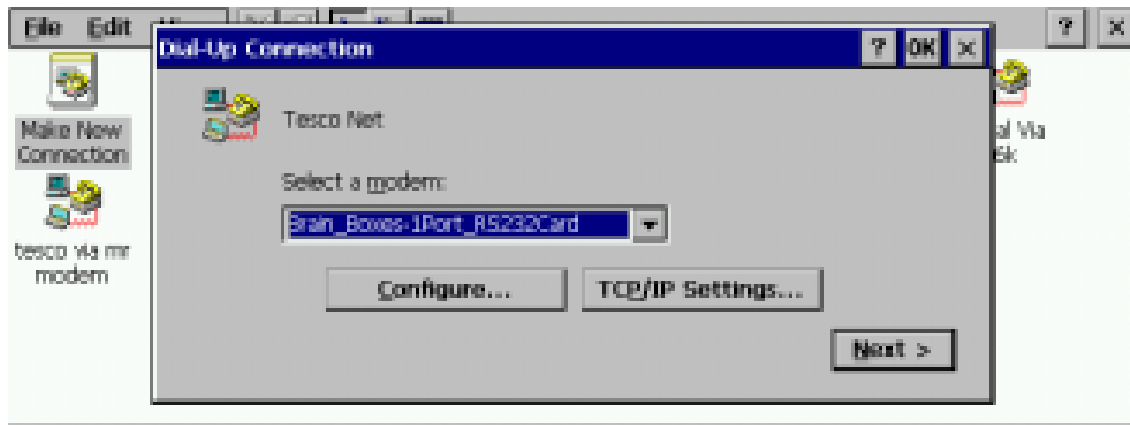

The Dialog shows a modem Icon with the name from the previous screen

There is a drop down dialog underneath "Select a Modem"

Select

Brain_Boxes-1port_RS232 Card

PCMCIA 1 Port RS232

Select configure Button

RS232 Pinouts & Port Cabling

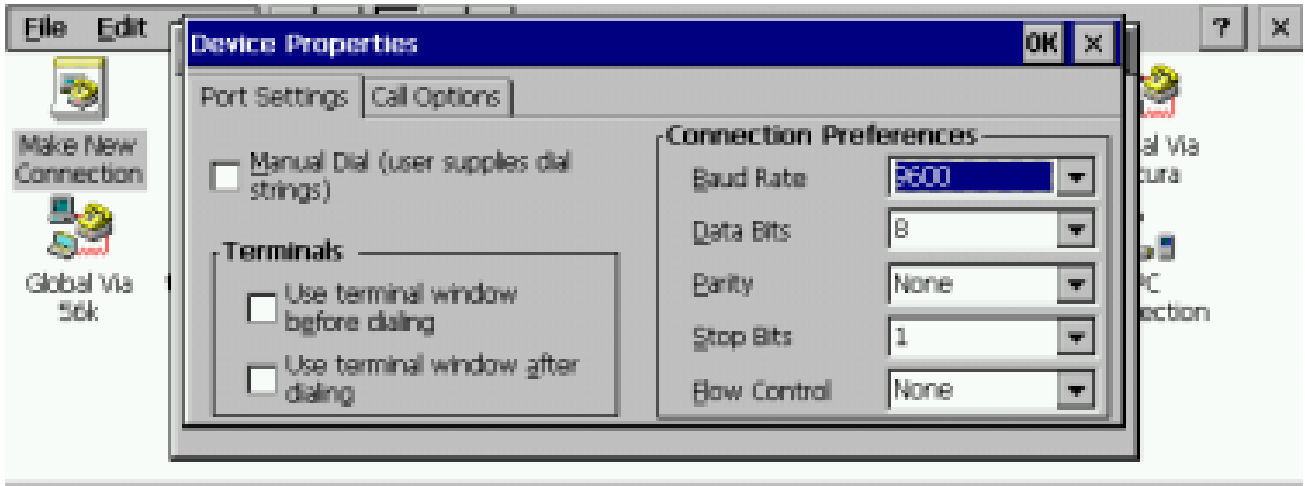

Device properties
set the following

Baud Rate	9600
Data Bits	8
Parity	None
Stop Bits	1
Flow Control	None

CHAPTER 4 RS232 PINOUTS AND PORT CABLING.

Introduction.

This chapter gives details of the 9 and 25 pin RS232 pin outs, cabling and connections, with information on how to connect the serial ports of two PCs and how to make a selftest loop back connector.

The RS232 Standard.

The RS232 standard is ancient in computer industry terms. Introduced in 1962, it is now widely established. RS232 is a slow, short distance, single ended transmission system (i.e. only one wire per signal). Typical RS232 maximum cable length is 50 feet with a maximum data rate of 20K bits per second.

Figure 4-1. RS232 Point To Point Connection.



RS232C Standard	
1 Driver 1 Receiver	
Line Length	Max Data Rate
50 Feet = 15m	20 Kbits/sec

PCMCIA 1 Port RS232 Serial Port Pin Outs.

RS232 Pinouts & Port Cabling

The pinouts of the 9 and 25 pin Male D connectors are given below.

Figure 4-2. Serial Port RS232 Pin Outs.

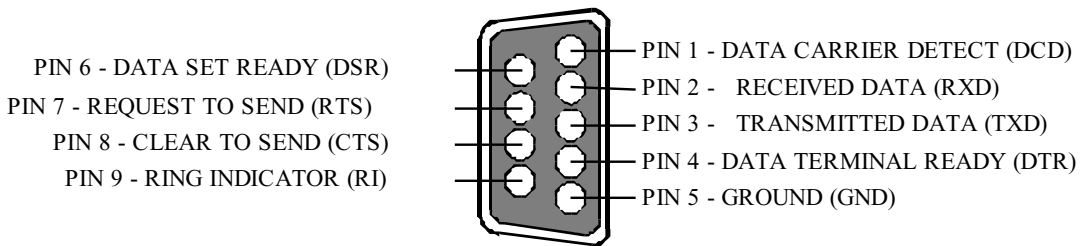

9 Pin connector:

25 Pin connector:

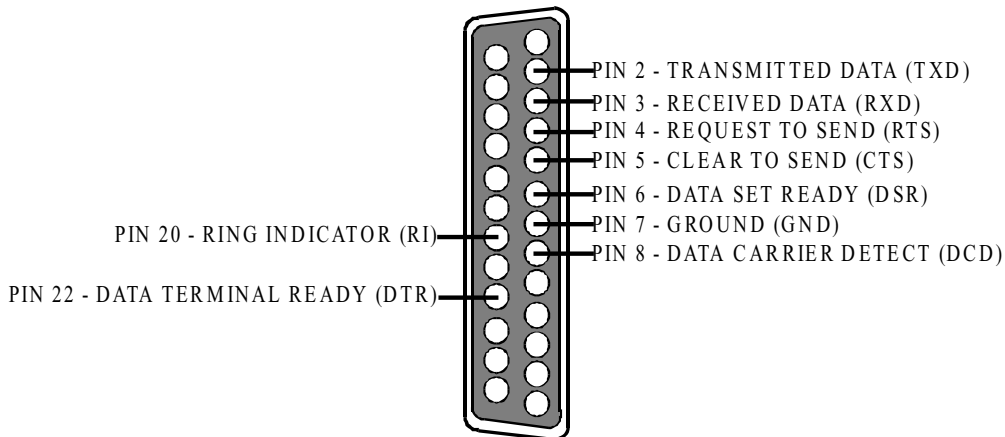

9 Pin D Serial Port RS232 Cables.

To connect to the AT style RS232 Serial Port like those found on the PCMCIA 1 Port card you will need a cable terminating in a 9 way female D connector. It is sound practice to use cables with screws fitted that will allow you to fasten the cable securely to the PC card.

In general, you will need to make up a "cross over" cable to correctly interface the PC to the RS232 port of another computer or device. Traditionally, making up the cross over cable has been

PCMCIA 1 Port RS232 RS232 Pinouts & Port Cabling

considered a black art. However, provided you have the pin outs and handshake requirements of both sides of your RS232 connection, the cross over cable becomes a matter of common sense. The cross over cable is simply to ensure that the right signals going out of one RS232 port go into the appropriate lines of the other RS232 port.

9 Pin D Serial Port Connection To Another PC.

Suppose we want to connect the AT style 9 pin D Serial Port to the serial port of another IBM PC. See Figure 4-3.

- 1) Connect the earth lines.
 Line 5 of Serial Port 2 to lines 1 & 7 of the other PC.
 This gives the two devices a common earth level.

- 2) Connect the Transmit and Receive lines together.
 Line 3, TXD, Port 2 goes to line 3, RXD, of the other PC.
 Line 2, RXD, Port 2 goes to line 2, TXD, of the other PC.
 This allows each to receive data transmitted by the other.

- 3) Connect the Port 2 DTR line, pin 4 to the other PC DCD, pin 8 and CTS, pin 5, lines.
 Also, connect up the other PC DTR line, pin 20 to the Port 2 DCD, pin 1 and CTS, pin 8, lines.
 This allows the receiving device to signal when it can no longer accept data. The receiving device sets DTR false when it is unable to receive any more data. The sending device reads DTR on its CTS and DCD pins. It should stop sending when CTS goes false.

- 4) Connect the Port 2 RTS line, pin 7, to the other PC DSR line, pin 6. Also, connect the other PC RTS line, pin 4, to the Port 2 DSR line, pin 6.
 This RTS line is used to let the other device know that it is ready for data exchange.

Figure 4-3. 9 Pin D Serial Port To Other PC Cable.

PCMCIA 1 Port RS232
AT SERIAL PORT Side
9 PIN D CONNECTOR

SCHEMATIC REPRESENTATION:

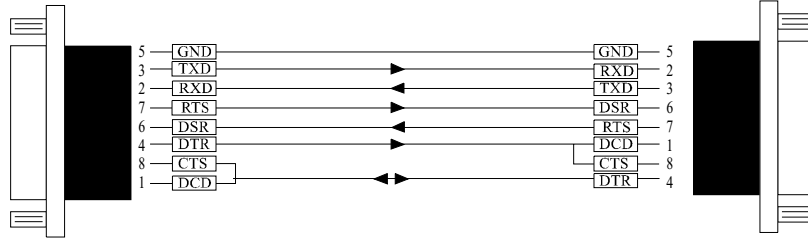

ACTUAL REPRESENTATION:

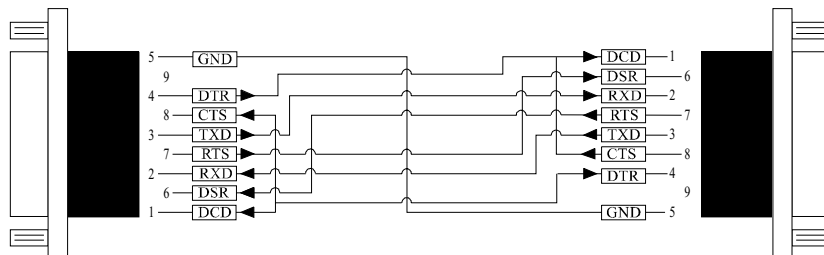

RS232 Pinouts & Port Cabling
Other PC SERIAL PORT Side.
9 PIN D CONNECTOR

9 PIN D CONNECTOR

SCHEMATIC REPRESENTATION

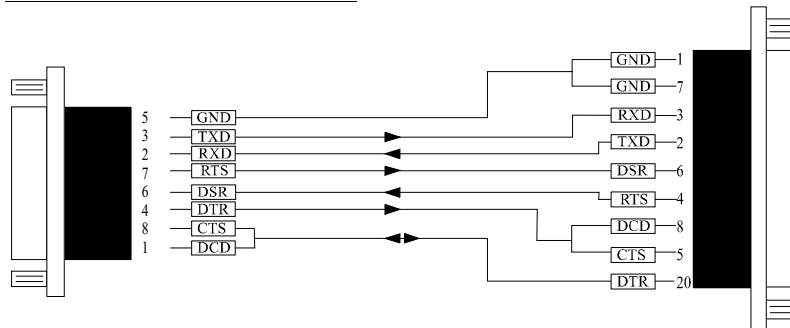

ACTUAL REPRESENTATION

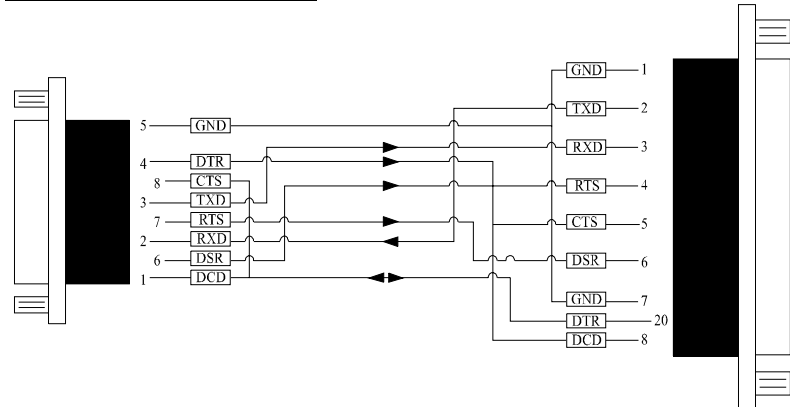

25 PIN D CONNECTOR

PCMCIA 1 Port RS232 RS232 Pinouts & Port Cabling
9 Pin D Serial Port To A Modem.

If you are connecting a MODEM to a 9 pin D Serial Port then you will NOT need a cross over cable and a straight through cable connected as the 9 to 25 pin adapter given in Figure 4-5.

9 Pin D Serial Port Loop Back Connector.

A loop back connector can be used to echo RS232 data transmitted by a serial port back into its own RS232 receiver. In this way, the function of the serial port can be tested.

For an AT style Serial Port use the a female 9 way connector wired as in Figure 4-4.

Figure 4-4. 9 Pin D Serial Loop Back Connector.

9 PIN D CONNECTOR

25 PIN D CONNECTOR

SCHEMATIC REPRESENTATION:

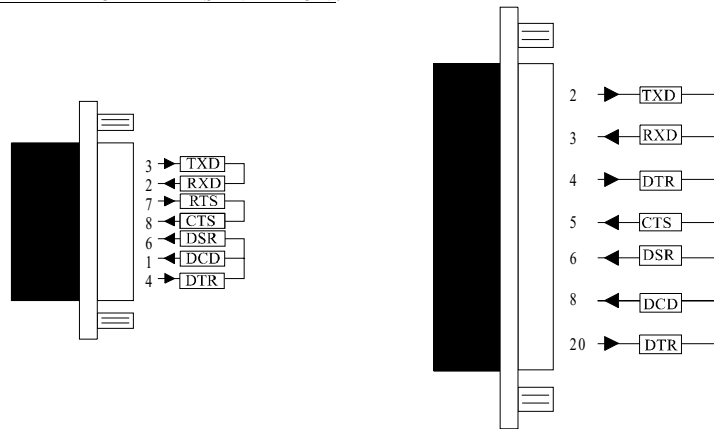

ACTUAL REPRESENTATION:

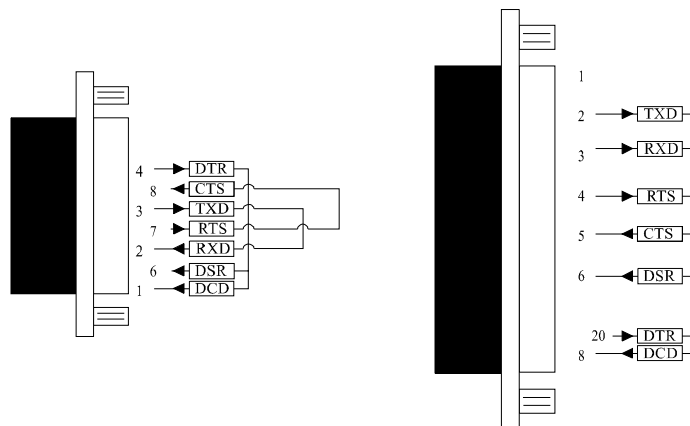

Figure 4-5. 9 To 25 Way Adapter.

PCMCIA 1 Port RS232 RS232 Pinouts & Port Cabling

This adapter cable makes the AT style 9-pin serial port, look like the standard PC 25 pin serial port. It is NOT a cross over cable!

9 Pin AT SERIAL PORT
9 Pin Female D Connector

25 Pin PC SERIAL PORT
25 Pin Male D Connector

SCHEMATIC REPRESENTATION:

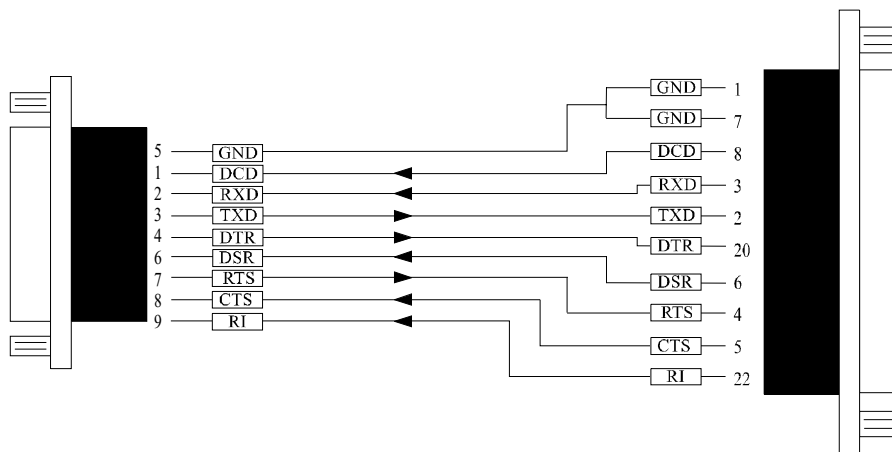

ACTUAL REPRESENTATION:

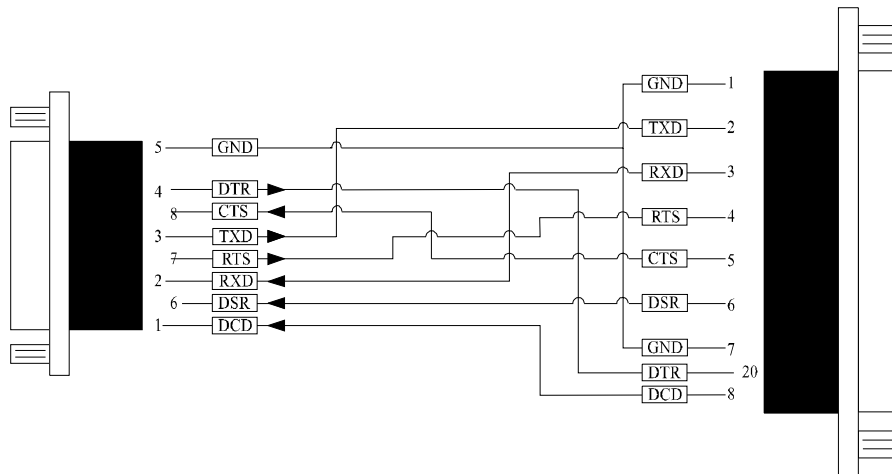

INDEX

16450 / 16550	4
adapter	37, 38
asynchronous	4
baud / baud rate.....	4
bits	33
buffer	4
buffered.....	4
cable.....	33, 34, 37, 38
connectors	34
cross over.....	34, 37, 38
CTS	4, 35
DCD.....	4, 35
DSR	4, 35
DTR	4, 35
FIFO.....	4
handshake	35
loop back.....	33, 37
modem	4
pin outs	33, 35
port / ports.....	4, 33, 34, 35, 37, 38
receive.....	35
RI	4
RS232	4, 6, 33, 34, 37
RTS	4, 35
RXD.....	4, 35
serial port	4, 33, 35, 37, 38
speed	4
TXD	4, 35
Windows.....	2