

Combined cryogenic insulation and thermal protection systems for reusable stages

Jascha Wilken^{1*}, Steffen Callsen¹, Dennis Daub³, Alexander Fischer¹, Martin Liebisch⁴, Carolin Rauh², Thomas Reimer², Henning Scheufler¹, Martin Sippel¹

¹ German Aerospace Center (DLR), Institute of Space Systems,
Robert-Hooke-Straße 7, 28359 Bremen, Germany

² German Aerospace Center (DLR), Institute of Structures and Design,
Pfaffenwaldring 38-40, 70569 Stuttgart, Germany

³ German Aerospace Center (DLR), Institute of Aerodynamics and Flow Technology,
Linder Hoehe, 51147 Cologne, Germany

⁴ German Aerospace Center (DLR), Institute of Composite Structures and Adaptive Systems,
Lilienthalplatz 7, 38108 Brunswick, Germany

* Corresponding Author

Abstract

Returning and reusing a launch vehicle stage after it has fulfilled its primary ascent mission significantly extends the range of thermal boundary conditions in which the stage has to safely operate, reaching from the cryogenic temperatures within the propellant tanks to the high external heat flux encountered during reentry to the vacuum of space. For a hydrogen-fueled stage, not only is cryogenic insulation needed but also an external thermal protection system in order to assure that the stage survives the heat loads during reentry. While usually treated as separate domains, for winged reusable launch vehicles cryogenic insulation and the thermal protection system have to be designed together since they are both integrated onto the propellant tanks external surface. This imposes new requirements on both designs. Additional complexity arises from the fact that multiple cycles of thermal and mechanical loads have to be survived without substantial refurbishment in order to assure a cost-effective design.

Within the DLR this topic was first explored in the AKIRA project, which investigated selected technologies that were deemed critical for operational reusable booster stages but which are not being covered within the flight demonstrator projects of the DLR. An overview over the AKIRA experimental campaign with representative test objects, which verified the thermal functionality of the derived design, is given. Within a currently ongoing follow-on project (TRANSIENT) the design is further refined and applied to both metallic and composite tank materials. For both cases segments meant to represent a slice of an RLV propellant tank are being manufactured and equipped with the cryogenic insulation and thermal protection systems and will be tested under representative loads for up to 50 cycles. In addition to the thermal loads investigated previously, mechanical loads will also be applied to the test objects.

Keywords: RLV, TPS, Cryogenic insulation, cryogenic propellant, Test

Acronyms/Abbreviations

AOA	Angle of Attack	LOX	Liquid Oxygen
CAD	Computer Aided Design	MECO	Main Engine Cut Off
CMC	Ceramic Matrix Composite	RLV	Reusable Launch Vehicle
DIC	Digital Image Correlation	RP-1	Rocket Propellant (Kerosene)
DLR	German Aerospace Center	RTD	Resistance Temperature Detectors
ELV	Expendable Launch Vehicle	SLB	SpaceLiner Booster
GLOW	Gross Lift-Off Mass	Ti	Titanium
ITO	Integrated Test Object	TPS	Thermal Protection System
LFBB	Liquid Fly-Back Booster	TRL	Technology Readiness Level
LH2	Liquid Hydrogen	TSTO	Two-Stage-To-Orbit
LN2	Liquid Nitrogen		

1. Introduction

At sufficiently high launch rates, Reusable Launch Vehicles (RLV), promise to be more cost-effective than their expendable counterparts. However, the safe return to and deceleration within Earth's atmosphere places additional requirements on the vehicle design. Specifically, RLV experience a large range of thermal boundary conditions during their mission, ranging from the temperatures of the propellant over the heat loads encountered during reentry to the vacuum of space during ballistic phases. This range of temperatures is extended substantially when using cryogenic propellants, especially hydrogen. While within Europe the use of hydrogen as a rocket fuel has been mastered for expendable launch vehicles, the use within RLV's comes with new challenges. As one critical technology for future hydrogen-fueled RLV reusable cryogenic insulation is being investigated by the DLR.

The number of operational RLV in the history of spaceflight is limited. None of them have made use of a cryogenic tank insulation on their reusable stages. The Space Shuttle and the Soviet Buran were orbital stages without any large cryogenic tanks. The Falcon 9 is a booster stage with integral tanks but without cryogenic insulation. Therefore, no practical experience with an operational RLV with reusable cryogenic tank insulation exists. For future RLV's however, the use of hydrogen as fuel has large benefits with regard to vehicle mass, size and environmental impact [5]. For a winged system the cryogenic insulation has to be integrated with the thermal protection system on the propellant tank, imposing new design requirements on both. Additional complexity arises from the fact that multiple cycles of thermal and mechanical loads have to be survived without substantial refurbishment in order to assure a cost-effective design.

Within this paper the current status of two projects of the German Aerospace Center (DLR) are presented in which this issue has been investigated. First the AKIRA project is discussed, which has been presented at the EUCASS previously[2]. However, the experiments had not been completed at that point, so no final conclusions were included. The experiments and their conclusions are shown in the first half of this paper. The second half concerns the TRANSIENT project in which the work from AKIRA is continued and expanded. This paper is an update of the status shown in [1] and discusses the current design of the Integrated Test Objects (ITO).

1.1. Technical challenge

The understanding of the behavior of reusable tank insulation is of crucial importance for an RLV with cryogenic propellants. The insulation not only reduces the losses through vaporization on the launch pad but also prevents ice from forming on the outer hull of the vehicle. If icing occurs at the outside of a winged stages it can cause serious damage to the vehicle structure or the thermal protection system (TPS) when it is shaken off during ascent of the vehicle.

As a winged RLV is subject to elevated temperatures during re-entry, the tank insulation becomes a complex system considering the high temperature gradients between TPS and cold propellant tank wall. Typical cryogenic insulations are usually limited to around 100°C to less than 200°C maximum temperature. On the other hand, high-temperature insulations of the TPS should be kept above the dew point of air during ground operations to prevent internal moisture condensation or even icing.

This thermal coupling as well as the joint integration onto a vehicle propellant tank surface means that these two previously separate subsystems have to be designed and tested together. Further complexity is introduced by the fact that these systems are expected to have a major impact on the refurbishment cost of the vehicle and thus a robust and low maintenance design is highly desirable.

2. DLR project AKIRA

Within the DLR project AKIRA[1] technologies deemed critical for reusable booster stages but not covered by current flight demonstrator projects were investigated. One of the technologies was reusable cryogenic insulation and its integration with the TPS. The focus was to develop a design and test its thermal performance with differently sized Integrated Test Objects (ITO) in the test facilities available within the DLR.

During the design evaluation phase, it was quickly found that the lowest allowable temperature for the TPS on the launch pad would be a significant design boundary. Initially, the goal was to achieve a temperature above 0°C in the TPS in order to avoid ice formation in the polycrystalline wool chosen as high-temperature thermal insulation. While it is not expected that the ice will directly cause damage, it is unknown how it will affect the performance of the TPS during re-entry, where it will quickly melt and evaporate and fill the segment with hot steam. Additionally, when considered for the entire surface of the vehicle it could lead to a noticeable increase in mass.

Ice on the outer surface of the TPS is also undesirable, as, depending on its location, it can break off during ascent and potentially damage the thermal protection systems of lower protruding elements, such as wings.

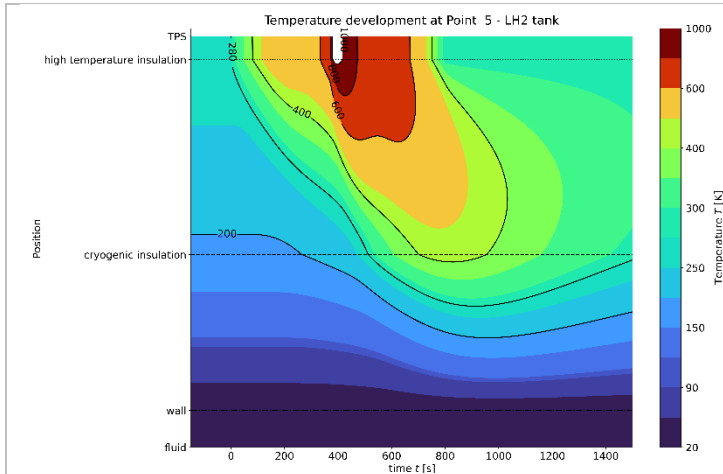

Figure 1: Exemplary evolution of temperature over time for an architecture without purge gap consisting of an external cryogenic insulation (PU-foam, 20mm) and a high temperature insulation (altramat, 25mm) and an external panel (CMC, 3mm)

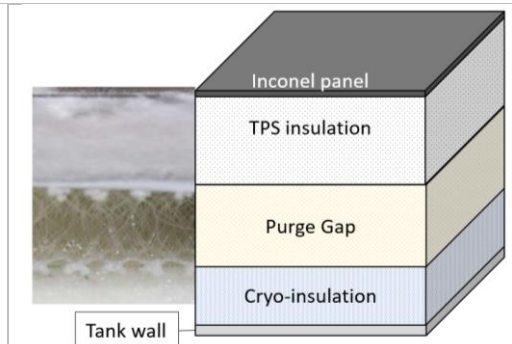

Figure 2: Layer architecture chosen for ITO within AKIRA

Avoiding sub-zero temperatures at the outer surface of the cryogenic insulation requires thicker insulation than for expendable systems, because the thermal protection layers effectively insulate the interface from “warm” external conditions that would usually heat up the external side of the cryogenic insulation.

First, 1-D heat conduction tools were used to efficiently assess different layer architectures. An exemplary result is shown in Figure 1. It was quickly found that for low external temperatures expected at European launch sites unfeasibly thick cryogenic insulation would be needed to keep the external thermal protection above the freezing point. In order to avoid thick and heavy insulation layers and still assure an ice-free system, different options of heating the TPS were evaluated. Finally, it was decided to include a purge gap into the design.

Through the purge gap, an inert gas (e.g. nitrogen or dry air) could be used to either heat the interface sufficiently to prevent any ice formation or simply displace any moist air from the system and thus prevent ice formation.

The main elements of the whole system were the cryogenic insulation directly attached to the tank wall (aluminium plate), a flexible spacer-mesh fabric on top of the cryogenic insulation, which provides for the purge gap, and the high-temperature insulation on top of the mesh fabric. The surface of the test articles consisted of a metallic Inconel panel. The surface panel was connected to the tank wall via a structural standoff connection which also served as the fixation for the purge gas supply tube. A more detailed description of the design and its derivation process can be found in [4].

In order to validate the thermal performance of this design, representative segments were prepared as ITO’s and tested under the thermal conditions expected for the different phases of the launch trajectory. In total, three ITOs were prepared for three different experimental facilities: A climate chamber to simulate various launch pad conditions, an arc-heated wind tunnel as well as the thermo-mechanical test facility INDUTHERM to apply reentry heat loads. Multiple mission’s thermal loads were applied to each test object in order to verify their thermal functionality and identify potential changes over the number of cycles. In all experiments liquid nitrogen was used to provide a cryogenic temperature boundary condition as a surrogate for the difficult to handle liquid oxygen or hydrogen.

2.1. Tests under launch pad conditions

The tests representing various launch pad conditions were performed with a climate chamber at the cryogenic laboratory at DLR Bremen. The core goal was validating the performance of the purge gap system and thus showing the ability to control the system at the interface and keep the high-temperature insulation ice free.

The ITO used in these tests was the largest, representing an 800x800mm slice of the tank structure with the different layers shown in Figure 2: Cryogenic insulation, purge gap, high-temperature insulation and finally a surface panel. On one side a container filled with liquid nitrogen provided the cryogenic temperature boundary condition while a climate chamber was used to achieve the desired “ambient” conditions. The experimental apparatus and its integration have been described in more detail in [1]. In order to account for multiple possible launch sites, different environmental profiles were applied to the test chamber that represented lab conditions, typical conditions at Kourou and Kiruna as well as an “ice condition” that was used to provoke ice formation.

Different purge gas mass flows and temperatures were applied in order to assess their effect on the thermal state. During the experimental campaign it became apparent that the nitrogen introduced via the purge gap quickly lowered the humidity in the entire chamber. This could not be entirely compensated by the climate control system. Thus, the humidity actually achieved was not always the target value. However, since the external temperature was not affected by this, the experiments can still show that the purge gap can control the interface temperature sufficiently to preclude any ice formation even at higher humidity values.

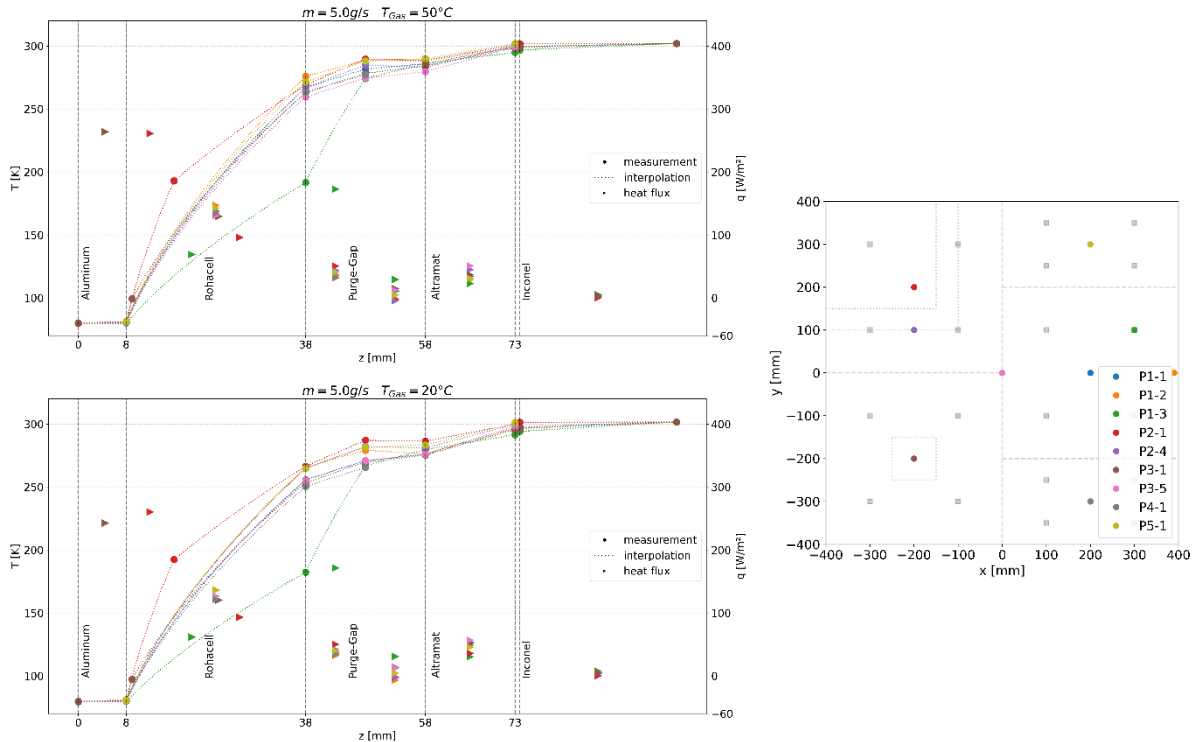

Figure 3: Selected temperature measurements and their positions within the ITO for launch pad condition test for two different purge gas temperatures

Figure 3 shows the temperature profiles of selected measurement points for different purge gas temperatures. It can be clearly seen that the standoff (P1-3) has much lower temperatures than the surrounding insulation and thus functions as a heat bridge. However, the effect of the purge gas streaming through the standoff is also visible: above the purge gap the temperature of the standoff is similar to the surrounding thermal protection layers.

With the gas temperatures and mass flows shown above, the temperature within the thermal insulation can still be slightly below 0°C but the dry gas displaces any humidity and thus no ice formation was found. For reference, the mass flow of 5 g/s is sufficient to cycle the gas within the system every ~6 s. It seems likely that lower mass flow rates would also be sufficient to prevent icing even if the temperatures in certain areas (especially around the standoffs) drop below the freezing point.

At the locations of the purposefully introduced damages of the cryogenic insulation, deviations in the temperature profile could be measured. However, this necessitates a sensor fairly close to the damage site. This is an unrealistic scenario for a full-sized vehicle with large surface areas, where the large number of sensors and cables would add substantial complexity and mass.

In conclusion, it was shown, that the ITO design performed as expected with regard to its thermal characteristics at launch pad conditions and that the purge gas system was successfully able to prevent conditions favorable to ice formation.

2.2. Test under re-entry thermal loads in INDUTHERM

During the re-entry leg of the flight, the vehicle’s outer surface is exposed to high thermal loads caused by aerodynamic heating. Obviously, this leads to high thermal gradients between the cryogenic propellant tank and the hot surface panel which must be tolerated for multiple missions. Hence, it was intended to test the entire insulation system also under the highly-transient thermal re-entry conditions in the thermo-mechanical test facility INDUTHERM of DLR.

For this purpose, an additional ITO was built to prove both the functionality and the reusability of the chosen insulation design concept including the purge gap system. Every test included both the steady-state cold soak condition representative of the pre-launch phase including the purging, as well as the subsequent transient high-temperature re-entry conditions. The experimental apparatus and the results are published in [24].

2.3. Tests in arc-heated wind tunnel

The third ITO was tested in the arc-heated wind tunnel L2K at DLR Cologne and because of the constraints imposed by the experimental facility was the smallest, with a surface area of 400x200mm, thus representing half a panel. The design of this ITO is also shown in more detail in [1].

While initial test runs were successful, two issues were encountered during the final tests: First, the adhesion of the cryogenic insulation to the tank wall failed which was caused by a manufacturing default of the tank. A new tank was fabricated and successfully integrated. Then, in the following experimental runs under reentry heat loads another issue appeared: Under certain conditions, the liquid nitrogen interfered with the water cooling of the support structure. Without effective cooling, the support structure was subsequently damaged by the heat loads experienced within the wind tunnel. The lessons learned were incorporated in a follow-on test campaign in the TRANSIENT project, depicted in section 3.3.2.

2.4. Conclusions from AKIRA

Overall it was found that the combined cryogenic insulation and external thermal protection system behaved as expected and predicted with the numerical simulation for both launch pad and re-entry thermal environments. The next step, evaluating the design under combined thermal and mechanical loads is being assessed in the currently active DLR project TRANSIENT.

3. DLR project TRANSIENT

The DLR project TRANSIENT (**T**hermalkontrollsystem für wiederverwendbare **T**räger) was initiated in the beginning of 2020 and will proceed until the end of 2022. The main goal is the further advancement of the technologies necessary to integrate a reusable cryogenic insulation with external thermal protection systems through thermo-mechanical experiments with representative test objects. Building on the work done in AKIRA, the designs are further refined and applied to both metallic and composite base structures. Within the experimental campaigns both versions will be put through up to 50 cycles of thermal and mechanical loads representative of a first stage RLV mission.

3.1. System aspects

In support of the experimental campaigns at the core of the project, system aspects are also being evaluated in order to assure a better understanding of the full-sized vehicle and provide representative boundary conditions for the sizing of the relevant subsystems.

3.1.1. Reference configurations

In order to assure that the boundary conditions of the following development efforts are applicable for future reusable first stages, reference configurations are needed. For this purpose, two consolidated DLR-studies were chosen, the SpaceLiner 7 Booster [7] and the ENTRAIN 2 HL [6] stage. The main requirement was the existence of an aerothermal database for the descent phase in order to accurately assess the heat loads. Both stages are also deemed sufficiently representative for future winged reusable stages. Their separation Mach numbers are 9 and 12 and thus cover the expected range for future stages. Both stages use hydrogen as fuel. While DLR system studies [5] indicate that hydrogen is the most attractive option for a European reusable first stage, the lessons learned remain valid for other fuels such as methane, since its storing temperature is similar to oxygen and thus the design for the oxygen tank can be applied to potential methane-fueled vehicles.

In addition to the thermal loads, mechanical loads for the reference points had to be generated. These points are situated at the front and back of each tank, with an additional reference point being placed at the middle of the large hydrogen tank (5 points in total) where bending moments are expected to be highest. In contrast to standard structural launcher design, the loads are not only analyzed at the critical trajectory points but instead over the whole flight. The structural analysis is performed with an in-house tool which simplifies the rocket to a bending beam which is why the results are separated into ‘tension side’ and ‘compression side’. While this methodology does not deliver the degree of detail of, for example, a FEM-tool, it enables the efficient generation of hundreds of computations along a trajectory and delivers useful upper and lower boundaries for the expected global mechanical loads.

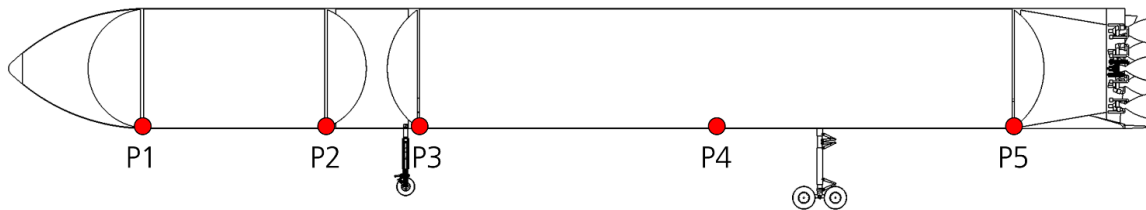

Figure 4: Reference points for analysis of thermal and mechanical loads of SpaceLiner 7 Booster

Figure 4 shows the aforementioned reference points along the underside of the vehicle. The diagram in Figure 5 shows the Von-Mises stress on both sides of the simulated bending beam along the ascent and descent trajectory of the SpaceLiner 7 Booster.

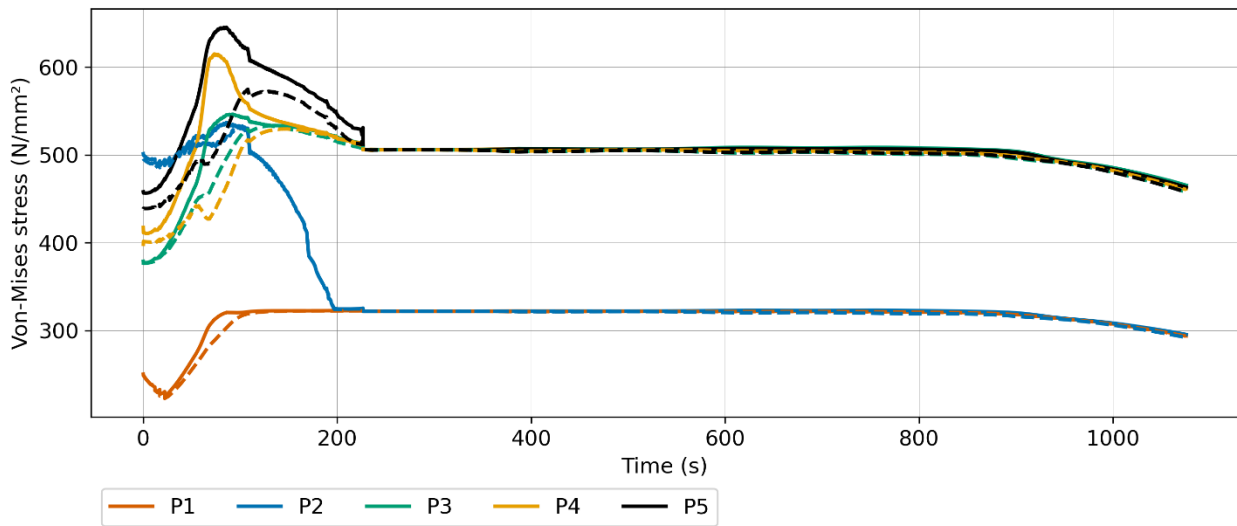

Figure 5: Von-Mises stress of the SpaceLiner booster on tension (dashed) and compression side (solid) at points P1 (front of oxygen tank) to P5 (back of hydrogen tank)

In general, the largest stress is the circumferential stress created by the internal tank pressure which is present throughout the whole flight. While this is the largest stress, it is not necessarily critical in sizing, as the internal pressure actually stabilizes the hull with regard to potential buckling causes by compressive loads.

During the flight the structure experiences additional loads. First of all, the propulsion system creates a significant force in axial direction. Secondly, profound bending moments are apparent during the phases with high dynamic pressures, even if the nominal angle of attack is zero. These are caused by wind and gust loads creating high effective angle of attacks which in combination with high dynamic pressures result in significant bending moments. These bending moments are considered critical for the overall sizing and thus mass of the structure.

Because of a low re-entry flight-path-angle of the SpaceLiner booster, the aerodynamic loads in the descent phase do not have a large impact on the overall stress experienced by the vehicle. The maximum dynamic pressure is also significantly lower than during ascent (40 kPa vs 5 kPa).

The compressed side of the stage experiences higher stress levels because the thrust from the propulsion system leads to a universal compression of the rocket structure which thus increases the compressive loads caused by the bending moment on one side while on the “tension” side the total stress is reduced.

Overall, the derived loads are deemed to be sufficiently representative for the experimental campaigns. For this early development stage, without a specific vehicle development driving the design, it is more critical to understand the general order of magnitude and distribution of the loads than to get exact values. For instance, the maximum stress shown in Figure 5 results from the high strength assumed for the aluminium alloy at cryogenic temperatures [8]. If a different alloy is used, the structure will be sized differently and exhibit different stresses.

3.1.2. Improvement of numerical tools to analyse entire vehicles

While sophisticated tools and methods exist to analyse segments of future reusable stages, applying them to entire vehicles quickly leads to unfeasible computational requirements, especially if different design variations shall be evaluated or optimized. In addition to the complexity of the involved physical phenomena, this is caused by the sheer size of the vehicle as well as the long simulation time to be covered in order to account for an entire mission.

In order to gain a better understanding of the full system and the interaction of its subsystems with each other, numerical tools are being developed or improved with the aim of assessing the thermal behaviour of the full vehicle throughout the entire trajectory while still keeping the computation effort in a magnitude that allows parametric studies and optimization at an early design stage.

3.1.2.1. CFD

Reusability introduces new challenges in the propellant management. For ELV the mission ends with the last engine cut-off, for RLV-stages the propellant and the tank pressures have to be controlled until the stage is successfully landed and all propellants can be safely vented without compromising the structural integrity. In the case of the Vertical Take-off Vertical Landing (VTVL), the spacecraft needs to perform a 180-degree rotation with a subsequent burn to reduce the loads for the ascent phase. For both RLV types it is essential to accurately predict the pressurant gas mass requirements with CFD solvers.

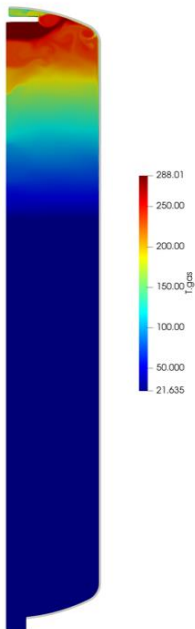

Figure 6: Thermal stratification during propellant pressurization

The inclusion of CFD solvers in early design stages requires fast, cost-effective and easy-to-use tools. Meshless methods such as the Smooth Particle Methods and scaled 2D-CFD sloshing simulations are investigated in order to evaluate if they fulfil the above requirements to deliver sufficient accuracy for the first trade-offs. Furthermore, heat and mass transfer models of CFD solvers are improved for stability, accuracy and for the use of unstructured grids. This approach significantly reduces the time-spent by costly engineers as the geometry can be meshed automatically with minimal input by the engineers.

3.1.2.2. FEM

In order to correctly assess the thermal state of a reusable launch vehicle, a variety of physical phenomena have to be considered:

- The external thermal loads, ranging from ambient conditions on the launch pad to the aerothermodynamic loads encountered during ascent, reentry and recovery
- The heat transfer within the vehicle subsystems, mostly by heat conduction
- The heat transfer into the cryogenic propellants.

While these phenomena are usually treated as separate problems with their own engineering tools, they have to be considered together in order to analyze and ultimately size a combination of cryogenic insulation and thermal protection system. In order to achieve this for a full vehicle surface, a tool suite is being created that allows the coupling of aerothermodynamic databases and propellant management software with an FEM Solver in order to size the various layers of cryogenic insulation and the TPS. A critical goal is the ability to quickly size the system (ideally in less than 30 minutes wall time) in order to be able to incorporate these advanced methods in pre-design studies

and parametric variations.

3.2. Integration of reusable cryogenic insulation with external TPS

The core of the TRANSIENT project is the further development of a reusable cryogenic insulation which is jointly integrated with an external thermal protection system (TPS) onto the propellant tank structure. Due to the actual development in rocket fuel tanks made of CFRP structures, TRANSIENT will investigate composite base structures in addition to the aluminium base structures, which have already been considered in the previous AKIRA project. For both material selections a combined thermal system is designed and will be investigated in experimental campaigns under thermal and mechanical loads. Flat plate samples are manufactured for the experimental investigation in a geometrical size, that allows a transition of the expected thermo-mechanical loads from the reference configuration (see section 3.1) to the experiment setup in the available test facilities.

3.2.1. Aluminium tank structure

Based on the findings of the AKIRA study a refined design is derived for a metallic tank structure. A main target of the current study is to investigate the behaviour of the cryogenic insulation at similar strain conditions as expected in a reference configuration. Main focus is the combination of mechanical stress in addition the thermal loads. In contrast to the AKIRA study a dedicated purge gap is omitted in the experimental apparatus. If needed, a purge system can be added to the design by milling channels into the cryogenic insulation.

For the experiment campaign aluminium AW 6061 will be used as base structure material. For the cryogenic insulation a spray on polyurethane foam is chosen. Such foams have been considered in recent European launcher developments. For the hot thermal protection, a combination of aluminium silicate wool and CMC plates is used, which is in similar configuration used on other DLR re-entry projects. A cross sectional sketch of the test article is shown in Figure 7. The liquid nitrogen bath provides the cold temperature to the aluminium wall plate, while the heat load is applied from underneath. The plate has integrated stiffeners to avoid bending when axial forces are applied. These stiffeners are also used for mounting the stand- offs. Temperature sensors will be integrated between the insulation layers to measure the temperature distribution throughout the layer structure. Several temperature profiles will be measured at distributed points in the area to get a temperature field of the whole ITO. Resistance Temperature Detectors (RTD) sensors will be used mainly for cold and warm temperatures, thermocouples will be used where high temperature are expected. Strain gauge measurement is planned at the surfaces of the aluminium plate and the cryogenic foam insulation. Fibre optical strain measurement is considered as well regarding cryogenic foam. The high temperature insulation is a loose wool material, which will not be load carrying. The TPS consists of individual plates with spacing to compensate for thermal expansion of the various components.

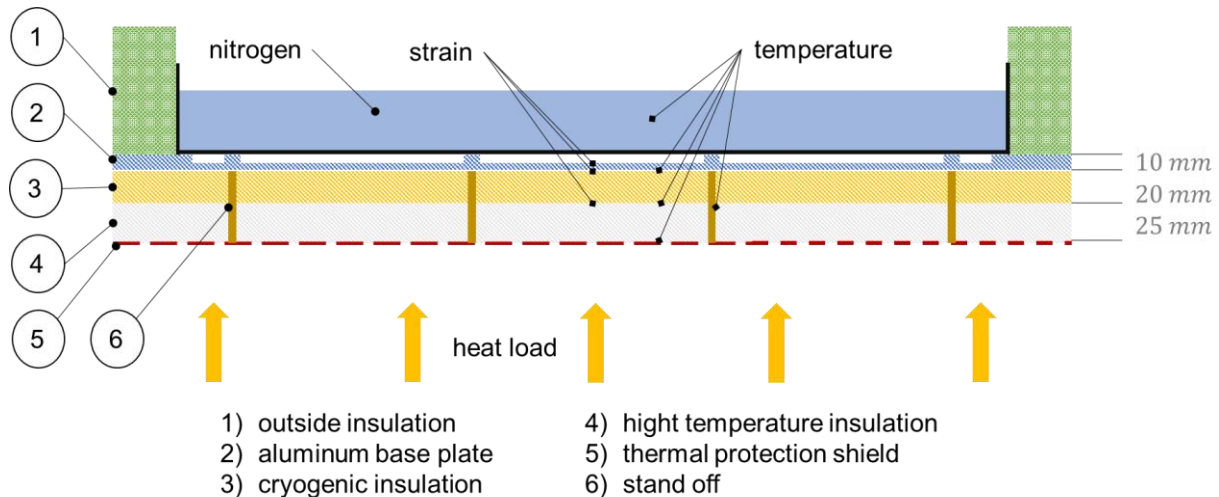

Figure 7: Sketch of cross section of the ITO representing metallic tank structures

3.2.2. Carbon fibre tank structure

A large fraction of a launcher's dry mass is composed by the propellant tank structure. Due to their low specific weight combined with high strength and stiffness, the use of carbon fibre composite materials as tank structure material promises a mass reduction by up to 30%, compared to conventional tank designs made of aluminium-lithium alloy [9]. However, demanding requirements need to be satisfied for the application of reusable cryogenic fuel tanks, which so far have precluded commercial use. On the one hand, the manufacturing of large composite components is still a challenge, and on the other hand, the anisotropic material properties call for sophisticated component designs. As one of the key issues, transverse microcracks occur in the resin as a consequence of the large temperature differences, which is due to the difference between the axial and the transverse coefficients of thermal expansion. These microcracks eventually lead to permeation leak paths and reduced mechanical strength.

Aiming to increase the TRL of composite cryogenic tanks, NASA and Boeing started the Composite Cryotank Technologies and Demonstration project (CCTD, 2011-2013), building on the experience of over 20 years of composite cryogenic tank development. This project involved the development of suitable material systems, corresponding structural concepts and associated manufacturing techniques. A tank with a diameter of 2.4m was built and cyclically tested successfully with LH2, reaching pressures of up to 9.3bar. [10]

To further advance the application of carbon composite materials for RLV, the integration of a thermal protection system onto a composite cryogenic tank structure was selected to be assessed in detail within TRANSIENT. Starting from the identification of a suitable carbon composite system for large cryogenic structures, the work includes the simulation-aided design of an ITO comprising of the composite structure, a cryogenic insulation, a thermal protection system and a fastening system. The same reference configuration and design-defining thermal requirements were applied as in AKIRA. Finally, the composite ITO will be subjected to thermo-mechanical tests in order to verify the insulation system.

Based on the achievements of the CCTD-project, a combination of conventional carbon-epoxy prepreg plies and carbon thin plies were chosen as material system for the tank structure. The selected prepreg system CYCOM®5320-1 is designed for out of autoclave manufacturing and thus is particularly suitable for large structures [11]. Micro-crack resistant thin plies of IM7-fibre tapes (TeXtreme®) were inserted in the centre of the laminate to minimise permeation. Test plates of different numbers of plies were produced for material characterisation. The laminate quality was verified via scanning electron microscopy, which proved a homogeneous quality with very low porosity.

The different laminates are furthermore tested for their gas permeation and leakage rate uncycled and thermally cycled with LN2. To do so, a sample plate of 125x125mm in size is placed into a sample holder. As schematically shown in Figure 10, one side of the plate is pressurised with a constant predefined helium test pressure. On the other side, the sample holder is connected to a helium leak detector which creates a vacuum in the system. If helium passes through the composite sample, it diffuses into the mass spectrometer and the leak detector outputs the leakage rate. First comparative tests proved a superior permeation performance of cycled laminates containing a small number of thin plies compared to cycled laminates without thin plies. These tests are still ongoing and the final evaluation will be presented after the test campaign is completed.

A design concept was developed based on the CCTD structural concept of the fluted core. The tank wall consists of a double-shell wall, separated and connected to each other via slanted stiffeners in longitudinal direction. Thereby the design incorporates the stiffness benefits of classic sandwiches without having to deal with the issues of bonding a foam core into a cryogenic structure, which can create problems of delamination. In addition, the design inherently creates channels in the tank structure wall that can be conveniently used for purging the structure.

The general concept of the Integrated Test Object (ITO) is presented in Figure 8. On top of the structure, there are two insulation layers, a cryogenic type insulation directly on the tank wall and a fibrous high-temperature insulation on top of the cryogenic insulation. The outer surface of the tank wall/insulation stack is covered with CMC panels, representing the vehicle surface.

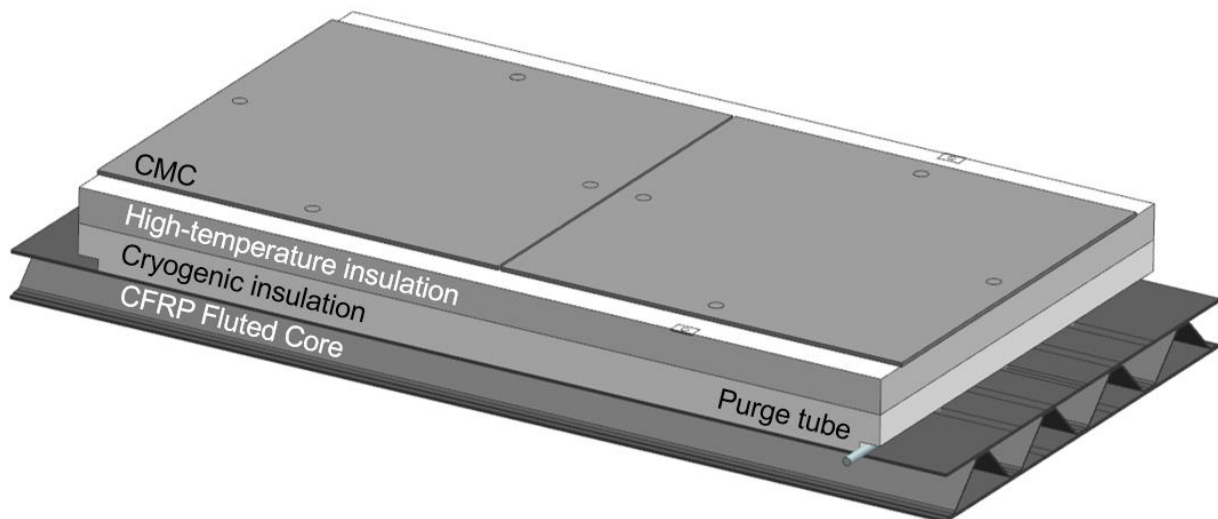

Figure 8: Concept of the ITO.

A detailed thermal simulation was carried out to investigate the effect of applying a purge gas flow in the fluted core structure and how this would influence the required insulation thicknesses. The conclusion in short from these numerical simulations was, that purging within the fluted core channels is quite effective. Different variants of the purge flow were investigated with respect to the gas velocity and temperature, resulting in different heat transfer values. Also, it was investigated if it is beneficial to purge only every second channel which opens towards the external face

of the tank wall structure. This proved in fact to be more efficient than to purge all channels, mainly because the heat flow into the cryogenic fuel in the tank is reduced in this way. In Figure 9 it is displayed that as a result of the purge flow in the fluted core structure, a temperature level in the high-temperature insulation above zero degree Celsius can be maintained in steady-state pre-launch conditions which is one design objective.

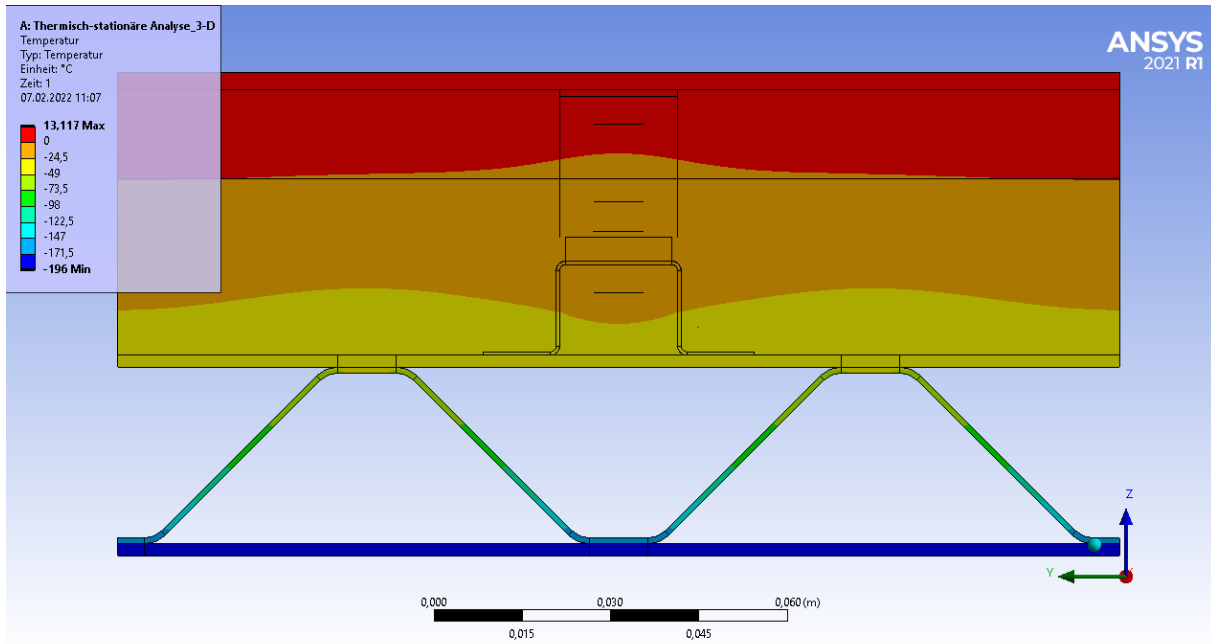

Figure 9: Temperature contours within the ITO under thermal steady-state conditions with liquid nitrogen as cryogenic propellant substitute.

The detailed structural design will be supported by thermal simulations. Following the example of the CCTD structural concept, a double-shell construction with internal longitudinal stiffening is envisaged as tank structure. Based on the AKIRA results [24], the potential benefits and the feasibility of a purged fluted core will be assessed in detail.

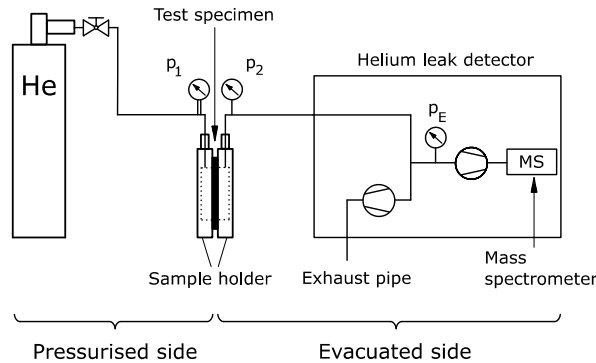

Figure 10: Scheme of the permeation test rig.

3.3. Outlook on thermo-mechanical experiments

The updated designs for both possible base structures will be integrated into ITOs meant to represent slices of an RLV propellant tank. In total, three test campaigns with three different ITO's are planned for the second half of 2022.

3.3.1. Thermo-mechanical test facility THERMEX

The THERMEX facility at DLR Brunswick is capable to investigate the behaviour of structures or assemblies under simultaneously coupled thermal and mechanical load conditions. The test objects can reach a maximum dimension of 1000x800mm and are thermally loaded by one-sided radiant heating up to 190 kW and 400 kN of axial force. It has been used in the past for similar investigations[20] of TPS systems. The investigation of stiffened CFRP panels has been part of past studies [21] and has recently become of interest again [22][23]. Here, the research focus is to elevated

service temperatures by novel material solutions and to investigate the mechanical loading capacity up to glass transition temperature. The facility is shown in Figure 11.

Common test programs investigate the structural behaviour of a load carrying base structure under various thermomechanical load conditions. Within the TRANSIENT project, the focus is on the cryogenic insulation and thermal protection system mounted onto a base structure that represents a cryogenic tank wall. The design of the base structure is adapted for the testing in order to apply representative mechanical strains and to investigate the structural mechanical interactions between base structure and TPS layers under the demanding thermomechanical load conditions that are expected during the mission of a reusable first stage.

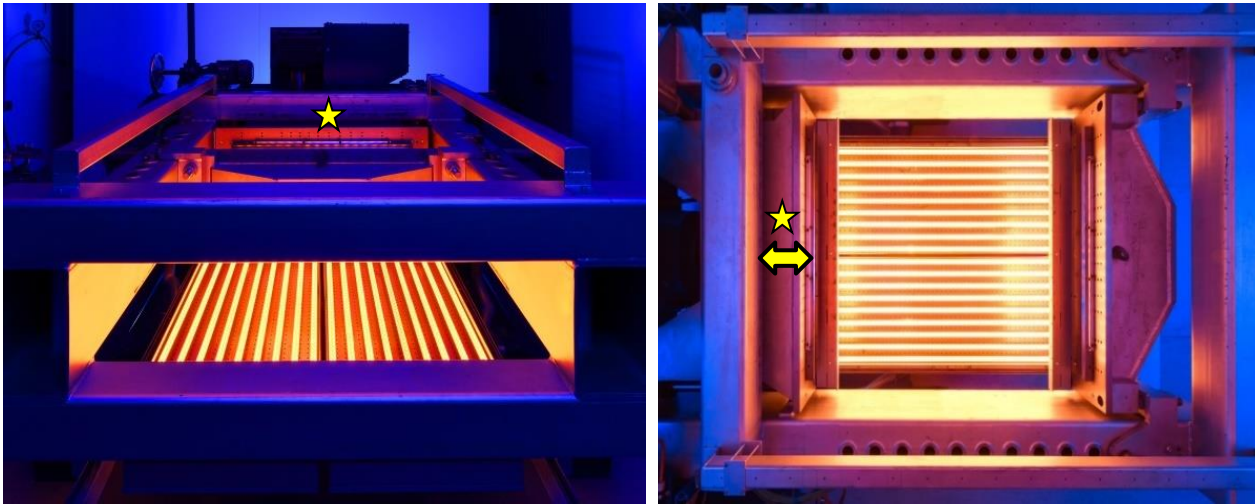

Figure 11: Front view (left) and top view (right) of the THERMEX facility. The structure is placed above the infrared heating unit. The star denotes the clamped side of the structure that applies axial forces.

3.3.1.1. *Planned tests*

The two ITOs, one with metallic base structure and one with carbon fibre composite material base structure will be integrated into the THERMEX facility and subjected to representative thermal and mechanical loads. The ITO's will be installed upside down, whereas the heat loads are imposed from underneath to the TPS protected ITO side and an open LN₂ bath will be used to impose cryogenic temperatures to the base structure, that represents the inner tank wall (see Figure 7). The mechanical loads are applied in axial direction of the ITO. Mechanical and thermal (heat) loads are adjusted and allow the investigation of several load conditions. Thermal response and mechanical strain behaviour of the ITO is carefully monitored, especially for the cryogenic insulation.

While damage in the outer layers can be assessed by inspection, cracks within the cryogenic insulation might not be immediately visible. However, monitoring the thermal response over numerous load cycles allows the observation of changing thermal behaviour implying local damages. Although the use of spray-on foam is common for cryogenic applications, the combination of strong thermal gradients with external mechanical loads is not well reported but yet important for the development of a reusable launch vehicle with cryogenic propellants.

The goal of the test campaign is to apply up to 50 representative load cycles to investigate functionality and structural integrity of the system. Possible degradations in performance are monitored and investigated in order to allow for designs that retain their functionality throughout a large number of missions without needing extensive refurbishment.

3.3.2. *Arc-Heated Wind Tunnel L3K*

A smaller ITO with a metallic tank structure will be tested in the arc-heated wind tunnel L3K at DLR Cologne (Figure 12, see also [12] for a full description of the facility). In this facility, air is heated to total temperatures between 4000 and 7000 K by an arc-heater, and then expanded and accelerated in a conical nozzle. A free jet forms in the test chamber that is evacuated before the wind tunnel run. The model is moved into the free jet after steady flow conditions are established. During the wind tunnel run, optical measurements of the surface temperature by infrared camera and pyrometers as well as surface deformation by a digital image correlation (DIC) system will be conducted in addition to temperature measurements inside the wind tunnel model (see [13] for an example of the DIC system at the L3K facility).

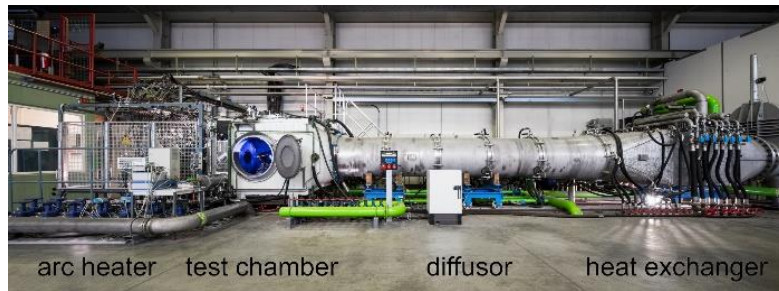

Figure 12: Arc-Heated Wind Tunnel L3K [13]

3.3.2.1. *Planned tests*

In the planned tests, an ITO with the same TPS and insulation design as in the THERMEX facility will be used including an internal tank filled with liquid nitrogen. However, the wind tunnel model will be adapted in size to the requirements of the L3K facility. Figure 13 shows a wind tunnel run in the arc-heated wind tunnel L2K conducted in preparation of the final model design and an example of the obtained temperatures of the TPS surface.

The main objectives of the wind tunnel experiments are:

- Investigation of the performance of TPS and insulation under repeated aerothermal load cycles
- Investigation of the effect of icing (as it may occur on the launch vehicle prior to launch) on the behaviour of the thermal control system
- Observation of potential deformations of the TPS surface

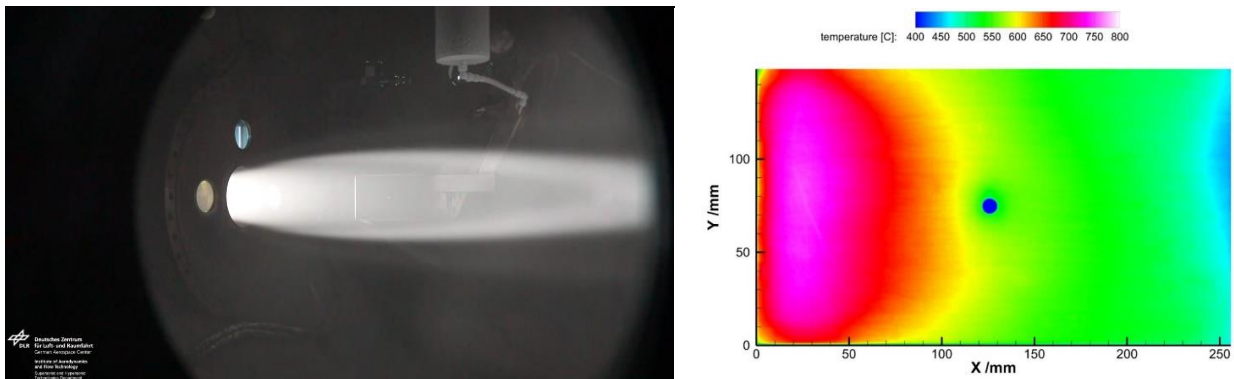

Figure 13: Wind tunnel model during preparatory test run in the arc-heated wind tunnel L2K and example of obtained TPS surface temperatures

The latter point is relevant as it has been shown in various studies on generic configurations that structural deformations can lead to significant increases in local heat flux and temperature [13][14][15][16][17]. Regarding actual vehicle structures, such behaviour was for example considered regarding X-33 TPS panels [18] or observed on the SR-71 [19]. In the present case, it would thus both be useful to show the absence of such effects or to observe to what extent they occur.

3.3.2.2. Wind Tunnel Model

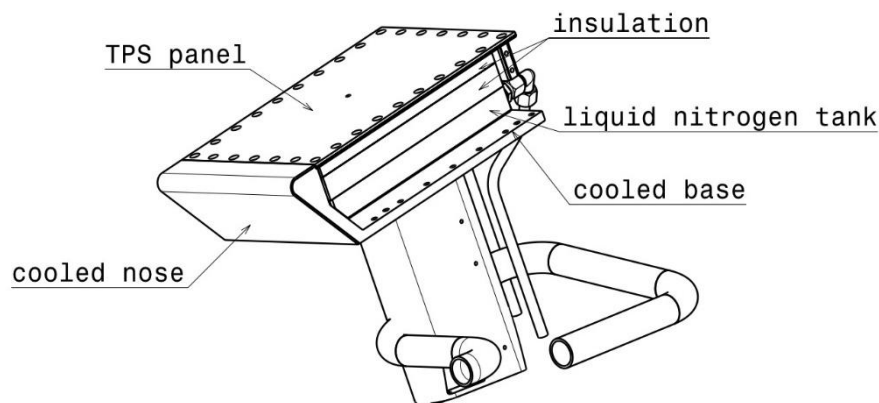

Figure 14: Sketch of L3K wind tunnel model (without side wall)

Figure 14 shows a sketch of the wind tunnel model for the planned tests in the wind tunnel L3K. Nose, base, and side walls of the model holder are water-cooled. On top, Inconel and ceramic TPS panels can be inserted. The setup enables to either allow or prevent thermal expansion of the TPS panels to investigate the influence of panel mounting on deformation of the structure. The configuration of the insulation layers will be the same as in the ITOs used in the THERMEX facility.

4. Conclusion

The DLR continues to investigate the combined integration of reusable cryogenic insulation with external insulation onto a cryogenic propellant tank for future reusable first stages. The thermal functionality of the derived designs has been verified in a first set of experiments within the AKIRA project. Within the subsequent TRANSIENT project experimental campaigns are currently being prepared where thermal and mechanical loads will be applied for up to 50 representative load cycles. The experiments will take place in the second half of 2022. This is a critical step for preparing this technology for future reusable launch systems as well as the next generation of in-flight demonstrators of reusable winged first stages.

References

- [1] Wilken, J. et al.: *Testing combined cryogenic insulation and thermal protection systems for reusable stages*. In: Proceedings of the International Astronautical Congress, IAC. 72nd International Astronautical Congress (IAC), 25. Okt. - 29. Okt 2021, Dubai, VAE. ISSN 0074-1795.
- [2] Sippel, Martin et al.: Focused research on RLV-technologies: the DLR project AKIRA. 8TH EUROPEAN CONFERENCE FOR AERONAUTICS AND SPACE SCIENCES (EUCASS) 2019, 01.-04.07.2019, Madrid, Spanien.
- [3] Sippel, M. et al: Enhancing Critical RLV-technologies: Testing Reusable Cryo-Tank Insulations, 70th International Astronautical Congress, Washington 2019
- [4] Rauh, C., Reimer, T., Sippel, M.: Investigation of an RLV Cryogenic Tank Insulation Including a Purge Gap System, International Conference on Flight Vehicles Aerothermodynamics and Re-entry Missions & Engineering (FAR 2019), Monopoli 2019
- [5] Stappert, S. und Wilken, J. und Bussler, L. and Sippel, M.: A Systematic Comparison of Reusable First Stage Return Options. 8th European Conference For Aeronautics and Space Sciences, Madrid, 2019
- [6] Stappert, S. et al.: European Next Reusable Ariane (ENTRAIN): A Multidisciplinary Study on a VTVL and a VTHL Booster Stage. In: Proceedings of the International Astronautical Congress, IAC. 70th International Astronautical Congress, 21.10-25.10.2019, Washington DC.
- [7] Sippel, M. und Trivailo, O. und Bussler, L. und Lipp, S. und Valluchi, C.: Evolution of the SpaceLiner towards a Reusable TSTO-Launcher. International Astronautical Congress 2016, Guadalajara, Mexico.
- [8] Hafley, R.A, Domack, M.S., Hales S.J., Shenoy, R.N.: Evaluation of Aluminum Alloy 2050-T84 Microstructure and Mechanical Properties at Ambient and Cryogenic Temperatures, NASA/TM-2011-217163, 2011

-
- [9] Vickers, J.: Composite Cryotank Project Structures for Launch Vehicles. Composites Australia Conference, March 2013
- [10] McCarville, D.A., Guzman, J.C., Dillon, A. K. et al.: Design, Manufacture and Test of Cryotank Components. Comprehensive Composite Materials II Vol. 3, 2017
- [11] Technical Data Sheet CYCOM®5320-1 Prepreg. SOLVAY Group
- [12] Gülhan, A. und Esser, B.: Arc-Heated Facilities as a Tool to Study Aerothermodynamic Problems of Reentry Vehicles, Advanced Hypersonic Test Facilities, Progress in Astronautics and Aeronautics, Vol. 198, AIAA, 2002
- [13] Daub, D. et al.: Experiments on High-Temperature Hypersonic Fluid-Structure Interaction with Plastic Deformation, AIAA Journal, Vol. 58, No. 4, 2020
- [14] Glass, C. and Hunt, L.: NASA TP-2632 -Aerothermal Test of Spherical Dome Protuberances on a Flat Plate at a Mach Number of 6.5, NASA, 1986
- [15] Martin, K. et al.: Numerical Modelling of Fluid-Structure Interaction for Thermal Buckling in Hypersonic Flow, Notes on Numerical Fluid Mechanics and Multidisciplinary Design: Future Space-Transport-System Components under High Thermal and Mechanical Loads, Springer, 2021
- [16] Martin, K. et al.: Coupled Simulation of Hypersonic Fluid-Structure Interaction with Plastic Deformation, AIAA Journal, Vol. 60, No. 6, 2022
- [17] Daub, D. et al.: Experiments on Aerothermal Supersonic Fluid-Structure Interaction, Notes on Numerical Fluid Mechanics and Multidisciplinary Design: Future Space-Transport-System Components under High Thermal and Mechanical Loads, Springer, 2021
- [18] Palmer, G. et al.: Surface heating effects of X-33 vehicle TPS panel bowing, steps, and gaps, 36th AIAA Aerospace Sciences Meeting and Exhibit, AIAA, 1998
- [19] Spottwood, S. et al.: Exploring the response of a thin, flexible panel to shock-turbulent boundary-layer interactions, Journal of Sound and Vibration, Vol. 443, 2018
- [20] Petersen, D. und Klein, H. und Schmidt, K. (1998) DLR THERMEX-B Test Facility for Cryogenic Tank Wall Structures. AIAA 8th International Space Planes and Hypersonic Systems and Technologies Conference, Norfolk, VA, USA, April 27-30, 1998,
- [21] Rolfes, R.; Tacke, S.; Zimmermann, R. (1998): Development and experimental verification of FE-model for stringer-stiffened fibre composite panels under combined thermal and mechanical loading conditions. ESA SP-428, February 1999. In: *European Conference on Spacecraft Structures, Materials and Mechanical Testing, Braunschweig*, S. 109–115.
- [22] Liebisch, M.; Hildebrandt, B.; Wille, T.; Brauner, C.; Gerrits, W.; Ortiz de Zarate, I.: THERMOMECHANICAL TESTING OF CFRP STRUCTURES UNDER VARYING THERMAL CONDITIONS. SAMPE EUROPE Conference and Exhibition 2021. Baden, Switzerland, 28-30 September 2021. In: Proceedings SE Conference 21 Baden / Zürich. Available online: <https://downloads.sampe-europe.org/se-conference-21-baden-zurich/>.
- [23] Liebisch, M. (2022): Enhanced thermomechanical Analysis to exploit Structural Reserves. In: *SuCoHS - Final Public Workshop*. Available online: <https://www.sucohs-project.eu/final-public-workshop>.
- [24] Reimer, T., Rauh, C., Di Martino, G.D., Sippel, M.: [Thermal Investigation of a Purged Insulation System for a Reusable Cryogenic Tank](#) . AIAA Journal of Spacecraft and Rockets (Article in Advance) pp. 1-9